

A11102 626292

NAT'L INST OF STANDARDS & TECH R.I.C.



A1102626292

Snyder, Wilbert F/Achievement in radio :  
QC100 .U57 NO.555 1986 V1986 C.2 NBS-PUB

# Achievement in Radio

Seventy  
Years of  
Radio Science,  
Technology,  
Standards, and  
Measurement at the  
National Bureau of Standards



U.S. Department of Commerce



**DATE DUE**

4-2-97	29442	13	



# Achievement in **Radio**

Seventy  
Years of  
Radio Science,  
Technology,  
Standards, and  
Measurement at the  
National Bureau of Standards

Wilbert F. Snyder  
Charles L. Bragaw

National Bureau of Standards  
Boulder, CO 80303  
October, 1986



U.S. Department of Commerce  
Malcolm Baldrige, Secretary  
National Bureau of Standards  
Ernest Ambler, Director

Library of Congress  
Catalog Card Number: 85-600619  
National Bureau of Standards  
Special Publication 555  
Natl. Bur. Stand. (U.S.),  
Spec. Publ. 555,  
863 pages (Oct. 1986)  
CODEN: XNBSAV

U.S. Government Printing Office  
Washington: 1986

For sale by  
The Superintendent of Documents  
U.S. Government Printing Office,  
Washington, DC 20402

## EPIGRAPH

*No subject can possibly be as interesting as its own history.*

—Opera News, August 1981

## DEDICATION

*To the fellow workers associated with our many years at NBS, we dedicate this historical account of the Bureau's work in radio.*





## FOREWORD

Radio has proved to be one of man's greatest boons—for communication, for newscasting, and for entertainment. In 1911 the National Bureau of Standards made its first measurement at radio frequencies—the calibration of a wavemeter. After World War I the Radio Section began a study of radio propagation, learning that it is a very complex phenomenon. In the mid-1950's, the NBS radio laboratories were moved from Washington, D.C., to a new laboratory center in Boulder, Colorado. With the passing years the Bureau engaged in many areas of research and engineering during the rapid development of radio technology. Indeed, we of NBS can be justifiably proud of our achievements as we met the challenges brought to us by Government and by industry in the use of radio as a medium of communication that is earthborne and that spans space. We, too, were pioneers.

This historical account of our achievement in radio is a semipopular presentation, yet gives extensive treatment of the technical features of 70 years of radio science, technology, standards, and measurement at NBS, both in Washington and in Boulder.

A handwritten signature in cursive script, reading "E. Ambler.", written in dark ink.

Ernest Ambler, *Director*



## PREFACE

### The Heritage Of The Past Is The Seed That Brings Forth The Harvest Of The Future

Inscription at south entrance,  
National Archives, Washington, D.C.

This aphorism applies significantly to the unparalleled development of radio and electronics during the 20th century. Yet its import is not always heeded, as was astutely stated by the editor (F. Hamburger, Jr.) in the February 1961 issue of the *Proceedings of the Institute of Radio Engineers (Proc. IRE)* when he said:

. . . The older an art becomes the more difficult it is for those who are entering the field to become familiar with the past and the lessons that it teaches. This has already happened in radio and in electronics despite their comparative youthfulness. There is significance associated with history and danger associated with its neglect.

The import of the history of a science or a technology was well expressed by Lynn White in his essay on "Engineers and the Making of a New Humanism," published in 1968, when he wrote: "One mark of a mature profession is consciousness of its own history."

The roots associated with the desire to prepare this history of the radio work of the National Bureau of Standards go back more than a half century to the earliest years of broadcasting, at a time when the author (WFS) took an early interest in the history of radio. Even then he developed a bit of writing on the subject and later desired to extend that writing.

It was upon perusing the pages of Cochrane's *Measures for Progress—A History of the National Bureau of Standards* (1966) given over to the Bureau's radio work that there came the urge to write a more comprehensive and detailed account of this facet of the Bureau's operations that was so laden with scientific and technical achievements. Here, indeed, was an extensive story worthy of telling in printed form!

A direct approach to the director, Dr. Lewis M. Branscomb, in the spring of 1971, resulted in the authorization of a project for a written history of the Bureau's work in radio.

Although not intentionally adhered to, the author's (WFS) viewpoint of this historical account is similar to that expressed by Robert Oppenheimer in his address at the dedication (September 26, 1962) of the Niels Bohr Library of the American Institute of Physics:

. . . I do not believe that any preconceptions about the practical value of the history of science should blur the basic and central value that it is nice to know what men thought, how they were led to think it, how men acted, how they conceived of their actions, and to know those things as near the truth as possible. The canons of truth in history are not identical with those in science, but there is a historiographical tradition almost as helpful in the study of history as is ours in the study of physics.

Radio work by the National Bureau of Standards can be dated as beginning in 1911 when the first measurement of a wavemeter was made by J. Howard Dellinger. About 1915, use of thermionic (vacuum) tubes began to free the Radio Section of equipment limitations, including those associated with measurements at radio frequencies. In 1920, broadcasting fever struck the Radio Section, leaving behind the spark-and-crystal days. Thereafter, the radio engineer's life at NBS would never be the same.

Andrew Gray, in his biography of Lord Kelvin, his mentor and in whose footsteps he followed as a professor of natural philosophy, wrote:

The discoveries of the experimentalist who finds a new element of hitherto undreamed-of properties attract world-wide attention, and the glory of the achievement is deservedly great. But the patient, plodding work which gives a universal system of units and related standards, and which enables a great physical subject like electricity and magnetism to rise from a mere enumeration of qualitative results to a science of the most delicate and exact measurement, and to find its practical applications in all the affairs of daily life and commerce, is equally deserving of the admiration and gratitude of mankind. Yet it receives little or no recognition.

Yet it has been in this profession of the measurement art that NBS has gained wide recognition—for its development of standards and precision measurement techniques at radio frequencies. As an example, the course of frequency measurements extends from the calibration of a wavemeter in 1911 to the latest developments in atomic frequency standards, with an increase in measurement accuracy of more than 100-billionfold!

Two events less than a year apart, and both external to the NBS, had a marked influence upon future programs of the Radio Section.

The first was the initial experiment on July 28, 1925, by Breit (formerly of the Radio Section) and Tuve of the Carnegie Institution of Washington, whereby the ionosphere was “sounded” by a new and more direct method, later further developed in the Radio Section by Theodore Gilliland. The result was the ionosonde. In the Radio Section and the Central Radio Propagation Laboratory the ionosonde proved to be an observational technique for very extensive studies of the ionosphere. Forecasting of radio transmission via the ionosphere resulted from these studies.

The second event was the signing of the Air Commerce Act by President Coolidge on May 20, 1926. At the time, it was called the “legislative cornerstone for the development of commercial aviation in America.” The Act led to the creation of the Aeronautics Branch of the Department of Commerce and, in turn, to the revitalization of the NBS air beacon system developed by Francis Dunmore, and then to the blind landing system mainly developed by Harry Diamond. A complete air navigation system by use of radio was demonstrated by the Radio Section, first on September 5, 1931, and then, over a long distance under adverse weather conditions, on March 20, 1933.

The phenomenal growths of radio and its handmaiden, electronics, left their stamp upon the growth of NBS. The Radio Section largely spawned the ordnance development program (radio proximity fuze) at NBS during the World War II period which, in turn, spawned the electronic computer program and the electronics programs at NBS. In 1946 the Radio Section was reorganized to form the Central Radio Propagation Laboratory (Radio Division) which eventually developed into seven technical divisions of NBS.

In other documents it has been noted that four Bureau programs have been associated with Nobel Prize work on the outside. However, little attention has been called to three persons, one a former member of the Radio Section and two who were long-term consultants to the Microwave Standards Section, who later became Nobel Prize winners in physics. It is noteworthy that all three were associated with frequency standards projects. Walter H. Brattain, a member of the Radio Section, aided in the development of a portable quartz frequency standard in 1930. Charles H. Townes and Polykarp Kusch provided expertise to the atomic frequency standards projects during the early years of development at NBS. (One other NBS worker, Robert Hofstadter, became a Nobel Prize winner after his association with NBS during World War II.)

In viewing the 70 years of radio science, technology, standards, and measurement at NBS, the achievements, and especially the achievements that have added to the total sum of scientific knowledge, can be ascertained from a viewpoint expressed by Ernest F. W. Alexanderson, a well-known radio engineer of former years. Writing on “Central Stations for Radio Communication” in the April 1921 issue of the *Proc. IRE*, he stated:

Radio achievements are often referred to as belonging in the realm of mystery, and it is indeed wonderful that we are now able to speak with a

voice that carries thru empty space across the oceans. Whenever knowledge conquers a new force of nature for the use of humanity, it ceases to be a mystery, but the pursuit of this knowledge makes an even greater appeal to the imagination.

Thus, we believe that the title of this historical account, *ACHIEVEMENT IN RADIO*, is a good choice, although it did not stem directly from the statement of Alexanderson, and the subtitle, *Seventy Years of Radio Science, Technology, Standards, and Measurement at the National Bureau of Standards*, could be just the shortest summary of our story. Interesting, however, is the fact that the word "radio" has all but disappeared in usage by NBS and by the groups that separated from NBS in 1965. Although the term "radio science" remains, today's language is much that of electromagnetics, electronics, telecommunications, wave propagation, and related terminology. Such is the trend of a science and technology and, indeed, of a language itself.

Lastly, one might quote Alistair Cooke's view of the historian: "A wise historian stops 20 or 30 years before his own time because, like the rest of us, he can't see the wood for the trees." The authors did not heed this admonition, rightly, we think, for thus the present generation of fellow workers will be able to read of their own achievements in radio.

## THE AUTHORS' INTRODUCTION

As noted in the PREFACE, the incentive for writing this historical account of the radio work of the National Bureau of Standards stems much from Cochrane's definitive history of NBS, *Measures for Progress*. Little if any material has been lifted from Cochrane's history. However, references are made occasionally to his book because of his more general treatment and, again, to specific treatments that need not be repeated in this account.

There is a "uniqueness" in the situation of the authors who have written this historical account. Although we entered NBS in the same year (1927), one (WFS) entered the Sound Section as a physicist, the other (CLB) entered the Detergent, Cement, and Corrosion Section as a chemist.

During World War II Snyder transferred to the Radio Section and Bragaw to the Information Section. Later, both of us became staff members of the Central Radio Propagation Laboratory (CRPL), Snyder at the time of organization in 1946, Bragaw in 1955 at Boulder, Colo.

Except for Kolster, Snyder was personally acquainted with the early workers of the former Radio Section and, of course, with many of those of the CRPL. Bragaw, in his Information Section activities, had a wide acquaintance with the CRPL staff. It can be said that "we were on the scene" and "experienced" the past. Although the project was initiated and largely written by Snyder (see PREFACE), Bragaw was, from the beginning, much occupied in researches and editorial reading. Later he took on the writing of chapters XII, XV, XX, and Appendix E, areas where he was well acquainted with the subject matter.

In a sense, the writing of *Achievement in Radio* was a matter of "putting it all together," yet the material had to be searched for, sifted out, organized, and then written down. Our sources of information are listed in appendix F; the individual items totaling in the thousands (30,000 photographs, for example). The published writings of the radio work of NBS comprise approximately 3680 papers plus hundreds of papers that are not listed in the open literature.

We have taken the stance in our subject treatments to stress "firsts" or "beginnings" in the matter of looking back, back, back to the origin of a theory, the original concept of an instrument or a technique, or an event that "triggered" a series of events or a project. Whole books have been written on "firsts" (e.g., Kane: *Famous First Facts*). We could class a sizeable portion of our writings to be in the area of incunabula.

As much as possible, the occurrences of events and actions are given to the date of the month as well as the year. However, not all records were dated in this detail; also, some events extend over a period of time and cannot be pin-pointed to a specific day. Duration of projects is usually given by calendar years, but sometimes by fiscal years because of annual reports having been prepared to cover periods extending from July 1 through June 30.

Completion times for various chapters have spanned a period of several years. Thus, programs that have extended to recent times (and to the present) have had different cutoff times of their writing. For example, chapter VIII was terminated at the close of 1976, whereas chapter XV was terminated in 1978.

The detailed information given in Monthly Reports of the Radio Section (until the formation of the CRPL in 1946) allowed for the inclusion of personnel information (entrance, transfer, and departure dates; also institutional affiliations prior or subsequent to association with NBS) to be stated, usually in footnotes. This was our practice until the writings encountered the period beginning with World War II, after which there was a great influx of entrants that continued into the early 1960's. The biographical accounts of several staff members have been treated extensively, particularly that of Dellinger in appendix D and of Austin in chapter II. Austin's "sojourn" of 28 years at NBS was so unusual (and misunderstood) that it bore treatment of considerable length.

As much as possible our writing has been in a narrative style, except in the introductory chapter (ch. I), in the WWV portion of chapter VIII, and in most of the appendices. Possibly to the consternation of some readers, our account is loaded with hundreds of footnotes, plus lists of literature references. But these lend themselves for documentation of the history. (Cochrane's *Measures for Progress* contains 1252 footnotes!) The footnotes serve as explanatory material or material of somewhat less importance than the text. However, we do invite the reader to peruse all of the footnotes—they contain many items of interesting or clarifying material.

Use of "NBS" and "Bureau" are resorted to many times for sake of brevity. The full name, "National Bureau of Standards," may be correctly used for the period 1901-1903 and, again, for the period 1934 to the present. The shorter name, "Bureau of Standards," is properly confined to the period of 1903-1934 (see Cochrane, *Measures for Progress*, pp. 47, 541).

In the early years of radio communication the reciprocal relation of wavelength and frequency was usually expressed in wavelength only and by the metric unit "meter." It was not until the early days of broadcasting that, in 1923, after recommendation by the Second National Radio Conference (Washington, D.C.), the Department of Commerce introduced the term "kilocycles per second" for frequency and dissuaded the use of wavelength. This deteriorated to "kilocycles," and even the Radio Section was not immune to this improper usage. In the spring of 1964 NBS adopted the policy of using the International System of Units (SI) in all publications. Some individuals and small groups were reluctant to adopt some of the new terminology, particularly that of replacing "cycles per second" with "hertz." For a time a consoling message on one of the Boulder Laboratories' bulletin boards read, "It only hertz for a little while."

During the planning stages of this history, a "miscellany" chapter was included in the outline. Had we developed it, subjects covered would have included NBS and Boulder Laboratories anniversaries, open houses, Science Fairs, employee associations, and the shops and plant operations. For several reasons, their coverage was dropped. Most of the subjects were associated with activities and operations after the move to Boulder in 1954 and were well covered in issues of *The Bureau Drawer*, and later, in the *NBS Standard*.

For complete listings of publications by NBS personnel relating to radio subjects one must refer to the many listings that have appeared in various formats since 1922. All papers that have appeared in NBS publications are listed in the many volumes of *Publications of NBS*. The number of items in these listings is so extensive (3680 publications, see app. F, footnote 4) that the cost of inclusion herein would have been prohibitive.

The authors were given complete freedom in the format for literature citations. Hopefully, we have selected well. Our choice was to use italics for citations of referenceable materials (open literature), including periodicals, the NBS non-periodical series, and books. However, specific titles in the NBS non-periodical series are given in roman type and enclosed in quotes. Roman type is also used for citations of non-referenceable materials (including internal documents and items of restricted circulation).

We have included complete coverage of Department of Commerce awards for scientific achievements. Coverage of many other awards and honors that have come to NBS personnel for achievements in radio science and measurements was not attempted, and, except for the biography of Dellinger, in appendix D, no biographical sketches, per se, appear in this account. Such can be read in the *American Men and Women of Science* and in the various publications of the Institute of Electrical and Electronics Engineers (formerly the IRE and the AIEE). Portraits are included in the latter sources.

Many persons have made valuable contributions to this project and we take this opportunity of acknowledging the sharing of their knowledge and experience and their assistance in locating and obtaining information. The diversity of their contributions is matched by the project itself. During the first 3 years of research and writing, Violet F. Immel of the Library staff (Department of Commerce, Boulder) gave inestimable assistance to the project after retiring and living in Alexandria, Va. She diligently searched records in the National Archives and the Library of Congress and at NBS Gaithersburg, Md. All was done without remuneration of any kind—she loved the task. "Vi" died on New Year's Eve 1974. We then depended upon Walter W. Weinstein (deceased), historical information special-

ist at NBS Gaithersburg. He too, diligently searched for materials in the Washington area at our beck and call, and often turned up the unexpected.

For information contained in the records of the Boulder Laboratories, including those on organization and administration actions, we depended upon the services of Yvonne C. Stahnke and, later, of John W. Camenga, both of the Records Management Office. Their services were very helpful.

We heartily commend the staff of the Department of Commerce Library (Boulder) for the searching of fragmented information, books and other publications on a nationwide scale in order to furnish us with a cross section of the "grist" and documentation that we required for our project. And especially do we thank Shirley A. Alldredge (deceased) of the library staff for the efforts of many hours that she gave to the project, and, also, Jane L. Watterson for the aids that she furnished for methods of indexing.

In the preparation of chapter XIX, the "scrapbooks" on the Boulder Laboratories assembled by Francis ("Franny") W. Reich, longtime secretary of the Boulder Chamber of Commerce, were most valuable. We are indebted to the local Chamber for the loan of these items that overflow with information.

Editorial review, a required process in the publication of a paper or book by NBS staff members, was a twofold process in preparing this history for publication. The first step was approval for publication by BERB (Boulder Editorial Review Board), the second step, approval by the Institute for Basic Standards (previous to March 1978). Our gratitude goes to Dr. Stephen Jarvis, Jr., chairman of BERB, who read and steered our writings through BERB processing. Our gratitude extends to each of the BERB editorial reviewers who carefully read a certain portion of our writings with regard to acceptability for publication. Each reviewer was selected on the basis of a superior knowledge of the subject matter and, or, having "lived" the events and contributed to the achievements of the period covered. Dr. Chester H. Page was selected as the editorial reviewer at the Institute level. Page was formerly chief of the Electricity Division, and, later, coordinator of International Standardization Activities of the Institute.

The BERB reviewers are listed below, with notations of the portion of the account that each reviewed: chapter I, L. Yardley Beers; chapters II and III, Percival D. Lowell; chapter IV, Elizabeth M. Zandonini; chapter V, C. McKay Allred; chapter VI, Wilbur S. Hinman, Jr.; chapter VII, Newbern Smith; chapter VIII, Byron E. Blair (deceased); chapter IX, Charles L. Bragaw (previous to being coauthor); chapter X, Roy E. Larson; chapter XI, Thomas N. Gautier; chapter XII, Jack W. Herbstreit; chapter XIII, Robert S. Kirby; chapter XIV, C. Gordon Little; chapter XV, L. Yardley Beers; chapter XVI and appendix A, John L. Dalke; chapter XVII and appendix B, Ernest K. Smith; chapter XVIII, Eldred C. Wolzien; chapter XIX, Paul S. Ballif; chapter XX, Jack A. Kemper; appendix C, Arthur R. Hauler; appendix D, Alan H. Shapley; appendix E, E. J. Pawlikowski; appendix F, Joan M. Maier; appendix G, Richard Silberstein; Preface and Authors' Introduction, L. Kenneth Armstrong.

The authors wish to acknowledge the suggestions made by Francis P. Phelps (deceased) upon careful reading of the first 10 chapters.

To Wilbur J. Anson, chief of the former Electromagnetic Metrology Information Center, goes the credit for steering a course through the project-handling procedures during the first 5 years; then to Ralph F. Desch (deceased), Program Information Office and to Charles K. S. Miller, Chief of the Electromagnetic Fields Division, during the later years.

During the final years of writing, Shirley G. Deeg of the Program Information Office gave valuable assistance in preparation of the manuscript for publication. For this service the authors are especially grateful.

In addition to the many thousands of photographs (and hundreds of negatives) obtained from Government repositories (see app. F), credits for the use of photographs from other collections are extended to Mary Ellen Johnson and to Russell B. Stoner of the Institute for Telecommunication Sciences, and to the Boulder *Daily Camera*; also the services performed by personnel of the Boulder Laboratories Photographic Laboratory, especially by Mary E. Henneke for searching out negatives, and by Raymond C. Lawson for being helpful in processing the many requests for photographic searches and services. Credit is extended to the International Telecommunication Union for furnishing copies of the portraits used in chapter I; also to Frank Reggia (formerly of NBS) of the Harry Diamond Laboratories for furnishing a photograph (see p. 320) of the bronze plaque in memory of Harry Diamond.



Credit is also extended to Edward R. Schiffmacher of NOAA who supplied us with a collection of photographs on the series of NBS Model C ionosondes.

The "mechanics" of preparation for the printing of so large a volume and so many photographs become quite involved. The typing of the voluminous draft was no small task, and all the more so when extended over a period of 7 years. The authors acknowledge with gratitude the typing services of Shir Lee Brubaker (called back to NBS years later after having served as secretary to the chief of the former Microwave Circuit Standards Section) for the laborious task of "deciphering" the material on thousands of none too legible handwritten sheets that made up the original manuscript. We are very grateful to W. Reeves Tilley, former chief of the Technical Information and Publications Division (Gaithersburg), to Patricia W. Berger, chief of the Information Resources and Services Division (Gaithersburg), and especially to her Electronic Typesetting staff, directed by Rebecca J. Morehouse, for their generous assistance in editing, layout and design, retyping and coding the manuscript for typesetting via photo-composition, and finally merging all the pieces into a complete package for printing.

No historical account worth its salt should be without an adequate index. Hopefully, we have provided such, and coming to our assistance in making up the indexing trio was Doris Schaffner. By means of a word processing technique, she was able to assemble the "indexing cards" in alphabetical sequence at an exceptionally fast pace.

To obtain the drawing that adorns the cover of our book we enticed Rudolph Townsend of the Boulder Laboratories toward applying his skilled artistry. For the pleasing result we thank "Rudy."

There existed among recent staff members at the Boulder Laboratories and among a few retirees a large fund of knowledge that was tapped for general or specific information relating to various subjects of our historical account. Although our amalgamated listing (found below) of those who contributed may lack completeness, our gratitude goes to those who made solid contributions as well as those who supplied only fragmentary information and are not listed. Contributors: David W. Allan, Vaughn L. Agy, Dana K. Bailey, Paul S. Ballif, Ross Bateman, Robert W. Beatty, L. Yardley Beers, Byron E. Blair (deceased), Edwin F. Florman, Roy Garstang (JILA, University of Colorado), William Hakkarinen, Donald Halford, Jack W. Herbstreit, James L. Jespersen, Robert S. Kirby, J. Virginia Lincoln, Percival D. Lowell, John B. Milton, Staff Office of the NBS Patent Advisor, Francis P. Phelps (deceased), Edward R. Schiffmacher, Harry G. Sellery, John H. Shoaf, Ernest K. Smith, Newbern Smith, Stephen J. Smith, Arthur D. Spaulding, George R. Sugar, John J. Tary, Lowell H. Tveten, Peter P. Viezbicke, Clark C. Watterson, and Elizabeth Zandonini.

During the course of preparing this historical account we now and then encountered incorrectness of statements, inconsistencies in records, and the like. Such will be the experience of a researcher when he encounters the records of human endeavor. If errors were suspected, they were subjected to careful analysis and multichecked for correction. In this we hope that we have generally succeeded—for "writing maketh an exact man." Although the history has been the subject of considerable editorial review and other "exposures," its correctness for factual information must finally be the responsibility of the authors.



# CONTENTS

	Page
FOREWORD .....	v
PREFACE.....	vii
THE AUTHORS' INTRODUCTION.....	x
 <b>Chapter I</b>	
<b>MAN'S QUEST TO COMMUNICATE THROUGH SPACE.....</b>	<b>1</b>
Radio—Its sphere of influence.....	1
Communications—And beyond.....	1
A chronology of events and landmarks in the development of radio, 1819-1976.....	2
In retrospect.....	25
References .....	26
 <b>Chapter II</b>	
<b>THE EARLY YEARS OF RADIO AT NBS.....</b>	<b>29</b>
Introduction .....	29
Events that became prologue.....	29
1. Louis W. Austin comes to the Bureau, 1904.....	29
2. Louis Cohen enters the Bureau, 1905—And stays awhile .....	32
3. The Navy ensconced at NBS—Some pioneering efforts in radio.....	33
Radio—A new science and technology enters the Bureau of Standards.....	38
1. Dellinger comes to the Bureau, 1907—Then Kolster, 1911 .....	38
2. Early instruments and measurements.....	41
3. Accepting “Radio” into the vocabulary, 1911 .....	42
4. Encountering the radio-frequency ammeter .....	43
5. Organizing and planning to serve the Government—With progress on many fronts .....	43
6. The problems of laboratory space .....	45
7. A slow growth—But growing .....	48
References .....	48
 <b>Chapter III</b>	
<b>FIGHTING A WAR WITH HERTZIAN WAVES.....</b>	<b>49</b>
The World War I period—1917-1918.....	49
1. The Radio Laboratory enters a war phase .....	49
2. France sends a delegation to the U.S.A.—And to the Radio Laboratory.....	52
3. Relation of the Radio Laboratory to the military services.....	52
4. Technical information for instruction—The Radio Laboratory embarks on a writing program.....	52
a) <i>Circular 74</i> .....	52
b) <i>The Principles Underlying Radio Communication</i> .....	53
c) <i>Vacuum Tubes, Theory and Use</i> .....	56
5. Radio systems applied to military uses.....	57
a) Coil aerials (antennas).....	57
b) Direction finders.....	57
c) Antennas for underwater reception and transmission of radio signals .....	58
d) Pioneering in air navigation by radio .....	59

	Page
6. Special projects for the military .....	60
a) The electron tube becomes essential to radio communication.....	60
b) To make more permanent crystal detectors.....	62
c) Insulating materials at radio frequencies.....	63
d) Experimenting with cathode-ray oscillographs .....	63
e) Shielding against unwanted signals .....	64
7. A burgeoning section reorganizes .....	65
8. From whence came the <i>Technical News Bulletin (TNB)</i> ?.....	65
9. “. . . And they shall beat their swords into plowshares. . . .” .....	66
References .....	67

## Chapter IV

<b>THE BUREAU OF STANDARDS LENDS A HAND</b> .....	69
The Postwar and Early Broadcast Period.....	69
Introduction .....	69
Continuation of World War I projects.....	71
Organizing for the postwar period .....	71
1. Toward a stabilized organization and unified name.....	71
2. World War I brings “Women’s Lib” to the Radio Laboratory .....	72
3. The radio boom versus low Government pay .....	73
4. The Dellinger “Credo” of administering the Radio Section .....	75
5. Cooperative research with universities.....	75
The broadcasting fever strikes the Radio Section.....	76
1. WWV broadcasts music .....	76
2. WWV broadcasts market reports.....	78
3. Aiding the broadcast listening public.....	80
a) The Letter Circulars on radio receiving sets.....	80
b) Spreading the information via <i>NBS Circulars</i> .....	81
c) A miscellany of tasks in the broadcasting boom .....	81
Remote control by radio.....	84
AC operation of electron tubes .....	85
1. Early use of ac operation of electron tubes .....	85
2. The “Better Mousetrap” .....	85
3. AC operation an accomplished fact .....	86
4. The meshes of “The Mousetrap” .....	87
Radio telephony becomes established.....	88
Promulgation of the written and spoken word.....	88
1. Radio information in multitudinous channels.....	88
a) The “Radio Information Clearing House” .....	88
b) The Dewey Decimal Classification of documents and files.....	89
c) The <i>Radio Service Bulletin</i> .....	89
d) Information on information .....	89
e) A bibliography on Aircraft Radio.....	89
2. Letting the public know .....	90
3. Books for the radio set fan .....	91
Services by conferees and committeemen to Government, industry, and to technical organizations .....	91
Bureau programs with roots in the 1920’s.....	92
1. The propagation and ionosphere programs.....	92
2. Standards of frequency and WWV.....	93
3. Radio navigation and landing of airplanes.....	93
Radio brings its problems .....	94
1. Problems imposed by radio broadcasting.....	94
2. Problems of the limited frequency spectrum and of interference.....	95
3. The problems of radio patents .....	96

The first Radio Advisory Committee .....	96
References .....	97

## Chapter V

<b>APPLYING THE MEASURING STICK .....</b>	<b>99</b>
Radio Standards and Measurements, Pre-CRPL Period .....	99
An Inheritance from the Electrical Division .....	99
1. Early measurements.....	99
2. Capacitance .....	100
3. Inductance .....	101
4. Resistance.....	102
5. RF current.....	103
The many-faceted period.....	104
1. The Kolster decremeter .....	104
2. Measurement of the properties of insulating materials .....	106
3. The Radio Section measures the properties of electron tubes .....	107
4. Measurement by the headphone receiver.....	109
5. Modulation measurement.....	110
6. An improvement on RF measurements .....	110
7. Antenna measurements.....	110
The doldrums period.....	110
1. Field intensity measurements .....	111
2. Measurements up to 200 MHz .....	112
References .....	112

## Chapter VI

<b>ANTENNAS, INSTRUMENTS, AND SYSTEMS IN DEVELOPMENT.....</b>	<b>115</b>
Antennas .....	115
1. Radio antennas become a part of the Bureau scene .....	115
2. The coil antenna adapted to many uses.....	115
3. The small condenser antenna.....	117
4. Experimenting with a directive antenna at 10-meter wavelength.....	118
a) Toward shorter wavelengths.....	118
b) The transmitter and a parabolic reflector antenna.....	118
c) The receiver .....	120
5. Dunmore designs an antenna for 100 meters .....	120
6. The submarine antenna of World War I.....	122
7. A theoretical study of antennas .....	122
Radiosondes.....	122
1. Early work in radio meteorographs (radiosondes) .....	122
2. An early NBS radiosonde .....	122
3. The Radio Section takes up radiosonde development.....	122
4. A technical breakthrough.....	126
5. A method of determining upper-air wind conditions.....	126
6. Further progress on the radiosonde.....	126
7. Flight testing and a serviceable product.....	128
8. The radiosonde attains technical stature .....	131
9. Further developments.....	131
Radio determination of upper-air wind velocity by phase-variation method .....	132
Automatic weather stations .....	136
1. Instrumentation and control.....	136
2. "Grasshopper" .....	137
3. Buoy weather station .....	138
4. Low-level sounding system—A wired sonde.....	138

	Page
Radio navigation systems .....	139
1. Safety at sea .....	139
a) The coil antenna adapted to shipboard use .....	139
b) The radio compass evolves .....	140
c) The radio compass becomes a manufactured product .....	144
d) Spinoffs from the radio compass program .....	145
Locating airplanes by radio .....	145
1. Kolster suggests a triangulation method (April 1917) .....	145
2. The U.S. Coast Artillery becomes interested in locating airplanes .....	146
3. Dunmore's "universal" direction finder .....	146
4. Dunmore adds to the ideas on locating airplanes .....	146
Radio—The aviator's guiding hand .....	147
1. The Bureau's early systems for airplane landing .....	148
a) Induction signaling .....	148
b) Landing on a "radiation cone" .....	149
c) A try at an electrical altimeter for aircraft .....	149
2. A directive radio beacon is developed for the U.S. Army Air Service .....	150
3. Developing an air navigation system .....	151
a) The early stage .....	151
b) Out of the laboratory and into field operations .....	153
1) The field site at College Park, Md. ....	153
2) The "night effect" on the radio beacon system .....	155
3) Radio receivers for the airways .....	155
4) Wrestling with ignition noise .....	156
5) The marker beacons .....	156
c) Improving the air navigation system .....	157
4. The Bureau's instrument landing system .....	159
a) A mission to Europe .....	159
b) Assisting in a fog landing system .....	159
c) The Bureau's radio system of blind landing .....	159
1) The runway localizing beacon .....	160
2) Boundary marker beacon .....	161
3) The landing beam .....	161
4) Proving the radio system of landing aids .....	161
5) Postlude to the radio system of landing aids .....	166
d) The aftermath of patents in abundance .....	166
1) Collision prevention .....	166
2) Automatic control for landing of aircraft .....	167
3) The many patents on radio beacons and blind landing system .....	167
References .....	168

## Chapter VII

<b>PROBING THE IONOSPHERE</b> .....	171
Pioneer probes of the ionosphere .....	171
1. Early conceptions .....	171
2. Early evidence .....	171
3. Experiments of 1925 that revealed the ionosphere .....	173
4. From the simple to the complex .....	174
The Bureau's early interest in radio propagation .....	175
1. How it began .....	175
2. Fading tests as a cooperative program .....	180
a) The initial fading tests .....	180
b) Fading tests on a quarterly schedule .....	181
c) Writing about the ionosphere .....	181
d) A study of conditions affecting distance range .....	182

e) Playing a role in an Arctic expedition—1923-1924 .....	183
f) The cooperative fading program of 1925.....	183
1) Radio waves and a solar eclipse.....	186
2) A potpourri of fading tests during 1925, 1926 .....	186
Studying the transmission of radio waves.....	187
1. Equipping for transmission measurements.....	188
a) Field stations—One, two, three, four, five, six.....	188
b) Receiving equipment .....	191
2. Enter S. S. Kirby .....	192
3. The Radio Section initiates its own measurement program .....	193
4. A point of view in 1927.....	193
5. Learning of fading at broadcast frequencies—Separating directional components, planes of polarization.....	194
6. Shuffling combinations of observations .....	195
7. The Bureau's first worker to the Antarctic.....	196
8. The Bureau informs the radio public on distance ranges.....	197
9. Data in abundance from transmission recordings .....	200
10. Searching out a geographic anomaly.....	200
11. Scads of data for a variety of purposes.....	201
Studying the ionosphere .....	202
1. Sounding the ionosphere.....	202
a) Gilliland pioneers the Bureau's ionosphere measurements.....	202
b) Gilliland gets a scheduled ionosphere measurement program under way ..	204
c) An early cooperative program on the ionosphere .....	206
d) The Bureau acquires its own system for ionosphere measurements.....	207
e) Improving the ionosphere recorder—The continuous recorder.....	208
f) The multifrequency automatic ionosphere recorder .....	209
g) The portable ionosphere recorder that became the CRPL Model A ionosonde .....	212
2. The ionosphere begins to yield its secrets.....	215
a) Widening the frequency range of observation .....	215
b) Progress in the making .....	215
c) Solar eclipses and the ionosphere .....	216
d) Taking part in the Second International Polar Year .....	220
e) A new cosmic phenomenon .....	221
1) The early months of observation by Dellinger and others .....	221
2) Relating the radio fadeout to Sun activity .....	223
3) A further study of radio fadeouts.....	223
f) Probing the ionosphere from the Arctic .....	225
g) Ionosphere storms .....	227
h) An early observation of the D layer .....	229
i) Observations of the "G layer" .....	229
3. Predicting ionospheric behavior—The ionosphere a useful medium of communication.....	230
a) The problem with a global solution .....	230
b) Investigating the ionosphere for the FBI.....	232
c) Enter Newbern Smith .....	233
d) A service to the radio amateur .....	233
e) Ionosphere information to the Nation.....	234
1) URSIgrams.....	234
2) Letter Circulars .....	235
3) Broadcasts by WWV .....	235
4) The IRE posts the Bureau's ionospheric information—Initiation of a service.....	236

	Page
f) Predicting the maximum usable frequency .....	237
1) A team reports on correlation between ionosphere and radio transmission.....	237
2) Relating the useful frequencies of transmission to vertical-incidence measurements.....	237
3) Toward a more exact relationship .....	238
4) Smith writes for readers of "Proc. IRE" .....	239
5) Smith and the "Lorentz polarization term".....	239
6) "Application of graphs of maximum usable frequency to communication problems".....	240
References .....	241

## Chapter VIII

<b>IN THE DOMAINS OF TIME AND FREQUENCY.....</b>	<b>243</b>
From LC Wavemeters to Atomic Frequency Standards .....	243
Introduction .....	243
The early frequency standards.....	243
1. Dellinger calibrates the first wavemeter at NBS.....	243
2. The Radio Laboratory develops its first standard wavemeters .....	244
3. The Bureau's RF standards of frequency in the 1920's.....	245
a) An improved LC circuit wavemeter.....	245
b) A frequency standard by use of the cathode-ray oscillograph .....	246
c) A frequency standard by use of a harmonic amplifier.....	246
d) Frequency measurement by standing waves on parallel wires .....	247
4. The Bureau's standard of radio frequencies until 1929.....	248
The quartz crystal program—Quartz, radio's useful servant.....	248
1. The Radio Section is introduced to quartz crystals.....	248
2. Learning and applying quartz crystal technology .....	249
3. Attainment of a national standard of frequency.....	253
a) The National Primary Standard of Radio Frequency .....	254
b) Early improvements to the primary standard.....	256
4. Refining the national standard of frequency .....	257
5. The NBS microwave frequency standard .....	258
6. Toward perfecting the adaptation of quartz crystals to frequency standards .....	260
The story of WWV and its scion stations.....	260
Sequel to the WWV story .....	289
1. The synchronization of time and frequency signals .....	289
a) Synchronization via satellites.....	289
b) Synchronization via TV transmission .....	290
2. On duty with WWV .....	292
Atomic frequency and time standards .....	292
1. The world's first atomic clock.....	293
2. Atomic oscillators and microwave frequency dividers .....	298
3. Studies in microwave spectroscopy.....	298
4. Developing a cesium beam atomic frequency standard .....	298
5. An atomic frequency standard program gets underway in Boulder.....	300
6. In quest of an ultimate in atomic frequency and time standards—Cesium atomic beam frequency standard .....	301
7. Thallium atomic beam frequency standard .....	305
8. The hydrogen maser at NBS.....	306
9. Lasers as frequency standards.....	306
10. Engaging in the technology of precision timing.....	306
a) Development of a portable rubidium clock.....	306
b) A support project for atomic frequency standards in satellites.....	306



11. The atomic second.....	307
12. NBS atomic time scale .....	308
13. Contributors to recent programs .....	308
14. NBS celebrates 25th anniversary of first atomic clock .....	309
References .....	310

## Chapter IX

<b>NBS FACES A SECOND WORLD WAR.....</b>	<b>315</b>
Radio work in World War II .....	315
The Radio Section in relation to NDRC of OSRD .....	316
The Interservice Radio Propagation Laboratory.....	317
High-frequency direction-finder research.....	317
Correlation of direction-finding errors with ionosphere measurements .....	318
The radio proximity fuze .....	319
Air-launched automatic weather station .....	321
Wind velocity measurement by radar method.....	323
1. Pulse repeaters .....	323
2. Reflectors of radar signals.....	326
Radar countermeasures .....	327
1. Project CXFD—"Moonshine," radar deception equipment.....	328
2. Project OBV—Test equipment and monitor for CXFD.....	330
3. Project CXJX—A "False Fleet" of ships consisting of radar reflectors and jammers, and simulated microwave search radar.....	331
4. Other radar countermeasures projects.....	333
Early development of microwave standards .....	334
Project Flapper—Vortex generator .....	335
Project Phantom—Vapors and aerosols as radar reflectors.....	336
Quartz crystal research during World War II .....	339
A miscellany of events .....	339
1. Mica—A strategic material .....	339
2. Space, and a new field site .....	340
3. Visitors on war missions .....	340
References .....	340

## Chapter X

<b>A NEW WORLD OF STANDARDS AND MEASUREMENTS.....</b>	<b>342</b>
The introduction to microwaves.....	342
1. "Romance of Measurement" .....	342
2. The doldrums period.....	342
3. A flush of activity.....	343
4. The microwave frequency standard.....	346
5. A microwave standards program is set into motion .....	347
Meeting a Nation's measurement need .....	347
1. Funding that set the wheels into motion.....	347
2. Progress on a broad measurement front.....	347
3. A measurement conference sets a trend.....	348
4. A measurement need.....	348
a) The Air Force takes the lead .....	348
b) NBS faces new problems.....	348
5. The move to Boulder .....	349
6. NBS and the Radio Standards Division face a new challenge.....	349
7. The Electronic Calibration Center.....	351
a) A new facility and a new organization in the making .....	351
b) The Electronic Calibration Center is dedicated.....	352

	Page
c) Growth and meeting a need .....	353
d) Metamorphose .....	355
8. A viewpoint, and then change .....	355
9. Computerization and the trend toward automated measurement systems.....	356
10. The media of learning .....	358
a) U.S.A.-U.S.S.R. exchange program .....	358
b) From workshops to measurement seminars.....	358
c) Multiplying the effectiveness of NBS through the printed word .....	358
11. Information as a valuable resource .....	359
a) Technical documents by the thousands .....	360
b) The Electromagnetic Metrology Current Awareness Service .....	360
c) The role of literature searches.....	360
d) A Bureau innovation—Metrology Guides.....	360
National RF standards in development .....	360
1. The development program begins .....	361
2. Attenuation—A starting point for standards .....	361
a) Getting started with waveguide below-cutoff attenuators.....	362
b) The waveguide below-cutoff attenuator becomes a reference standard .....	363
c) A study of attenuators pays off .....	366
d) In pursuit of other methods of measuring attenuation.....	366
3. Impedance—Its measurement the essential ingredient to radio metrology.....	367
a) The reflectometer in development .....	368
b) Impedance standards of lumped parameters (below 300 MHz).....	369
c) The in-between frequency region of impedance standards.....	371
4. Power—Its precision measurement became a long and difficult study.....	371
a) Early planning and getting started .....	372
b) Two roads to success with power standards at microwave frequencies .....	373
1) The impedance measurement approach .....	373
2) Development of the microwave microcalorimeter .....	374
c) Many facets enter into the measurement of microwave power at NBS.....	375
d) Measurement of power at the lower radio frequencies .....	377
1) The early developments in power standards.....	377
2) Calorimeters in development .....	377
5. Voltage—The useful measurement at the lower radio frequencies.....	378
a) A beginning on voltage standards.....	378
b) Micropotentiometers—A new approach to known RF voltages at microvolt levels.....	378
c) The AT voltmeter.....	379
d) Adapting a measurement technique to line production calibration .....	380
e) The Bolovac .....	380
6. Other RF standards and measurements advance on a broad front .....	380
a) The measurement of current .....	380
b) Noise—An attribution of nature—And its measurement.....	381
1) Developments at NBS Washington.....	381
2) Developments at NBS Boulder .....	381
c) Getting to know electromagnetic fields .....	384
1) From 1946—Refinement and adaptation of the two methods of calibrating field-strength meters.....	384
2) Further developments in field-strength measurements below 1 GHz .....	385
3) Antenna measurements above 1 GHz .....	386
d) The pulse domain .....	388
e) The measurement of phase shift .....	388

f) Studying the interaction of electromagnetic waves on matter—EM characteristics of materials.....	389
1) Probing the dielectric properties at microwave frequencies of many substances—In the gaseous, liquid, and solid states .....	389
2) Measurement of dielectric properties of materials—From 30 kHz up into the microwave frequencies.....	391
3) Sallying forth into the magnetic domain at radio frequencies .....	391
g) A sashay into low-frequency instrumentation and measurements.....	395
h) Theoretical work as background to standards and measurements.....	398
i) The coaxial connector—Problems and solutions.....	399
References .....	400

## Chapter XI

<b>THE WORLD AS A LABORATORY</b> .....	403
Introduction .....	403
The Interservice Radio Propagation Laboratory (IRPL).....	404
1. An “air disaster” in the European theatre of war.....	404
2. The predecessor to the IRPL.....	405
3. Instituting the Interservice Radio Propagation Laboratory .....	405
4. The IRPL in operation .....	407
a) Ionospheric data on a worldwide basis.....	407
b) Improving the prediction method of maximum usable frequency .....	409
c) Success in the calculation of field intensity .....	409
d) Solving the problem of minimum field intensity .....	409
e) Forecasting ionosphere storms .....	410
f) “Publications” in limited circulation .....	410
g) An “international” radio propagation conference .....	411
h) Research during a war period.....	411
i) Laboratories associated with the IRPL operation .....	412
j) Those who directed, and who were important to operation of the IRPL .....	412
k) “Conversion of IRPL Projects from War to Peace” .....	412
The Central Radio Propagation Laboratory.....	413
1. Extending the need for a centralizing laboratory .....	413
a) The need is foreseen .....	413
b) Implementing to fulfill a need.....	413
2. The CRPL established .....	415
3. The CRPL through 20 years of growth.....	416
Studies of the ionospheric regions.....	420
1. The anomalous characteristics of sporadic E.....	421
a) The early observations by NBS .....	421
b) Progress in sporadic-E studies during World War II.....	422
c) Can “sporadic-E” reflections come from meteor trails?.....	424
d) Ernest K. Smith conducts a lengthy study of sporadic E.....	424
2. Observing scatter F.....	425
3. The D layer—The reflection domain of long radio waves.....	426
4. The E and F layers.....	428
5. The case of the “G layer” .....	428
Improving upon the prediction services.....	428
Observations with the ionosonde.....	432
1. A sequence of ionosondes, and observation by vertical-incidence signals .....	432
2. The case of oblique-incidence observations of the ionosphere.....	436

	Page
Remote sensing beyond the ionosphere layers.....	436
1. A pioneering project at the Long Branch field station.....	436
2. A specialized radar facility on a grand scale .....	438
3. A look at Venus.....	439
4. A continuing program at the Jicamarca Observatory.....	439
Geographical nonuniformities of the ionosphere .....	439
1. Mapping the ionosphere on a worldwide scale .....	439
a) The January 1, 1942, world maps.....	439
b) The 1943 world maps.....	440
c) The 1948 world maps.....	440
d) "World Maps," and the 1962 world maps.....	441
2. Auroral blackouts and polar cap absorption .....	441
a) In the Arctic.....	441
b) In the Antarctic.....	443
3. Ionospheric observations near the geomagnetic equator .....	446
a) VHF signals across the geomagnetic equator .....	446
b) African studies.....	448
4. "Far East Anomaly".....	448
The Sun—The all-powerful control of the ionosphere.....	449
1. A long-time study of solar activity.....	449
a) Taking account of the Sun.....	449
b) Predicting sunspot numbers.....	450
c) The Sun in relation to the world.....	450
2. The Radio Disturbance Warning Service.....	451
a) Reporting on radio reception—A prewar service .....	451
b) The IRPL gives aid to World War II communications .....	452
c) A radio disturbance warning service.....	453
1) A service to radio communications .....	453
2) A service to the International Geophysical Year.....	455
3) A long, long warning service.....	455
The ionosphere in motion .....	456
1. Tidal motion.....	456
a) An early CRPL study of lunar tides .....	456
b) A theoretical treatment of ionospheric motion .....	457
c) A lunar effect at low frequencies .....	457
2. Ionospheric winds.....	457
a) Observations at the Sterling field station.....	458
b) Evidence of ionospheric winds from an analysis of backscatter observations .....	458
c) Observing ionospheric winds by a Doppler technique.....	458
d) Observations with artificial clouds .....	458
Around-the-world and above-the-earth experiments .....	459
1. Around the world on an 18-kHz wave .....	459
2. Observations of artificially ionized clouds in the ionosphere— Project Firefly.....	459
3. Observation of a nuclear explosion at the Jicamarca Radar Observatory.....	460
4. HANDS, across land and sea .....	461
Meteors—Fleeting visitors to the ionosphere .....	461
1. Viewing the Draconids by radar—October 9, 1946 .....	462
2. Early CRPL experiments with meteor-burst communication.....	464
3. A meteor-burst communication system in successful operation.....	464
4. Further study of meteor-burst communication .....	465
Theoretical studies of the ionosphere.....	465

Observing the night sky.....	466
1. An airglow program moves to Boulder.....	466
2. Roach and an international photometric unit for airglow.....	468
3. Taking a major role in the IGY airglow program.....	468
4. Observations from Fritz Peak.....	469
5. Refining the measurement techniques.....	469
From 300 kHz down, down, down.....	470
1. Low-frequency electromagnetic waves—A recurring interest.....	470
2. The CRPL initiates an observational study of LF propagation—At the Sterling field station.....	471
3. Ionospheric observations at the Sunset field station.....	473
4. Theoretical approaches toward the understanding of radio propagation at low frequencies.....	474
5. The Boulder Laboratories hosts VLF, ELF, and ULF symposiums.....	475
6. A proliferation of low-frequency papers.....	476
7. Field strength vs. distance—Contributions by the CRPL.....	476
8. An experimental study at LF.....	477
9. Experimental studies at VLF and ELF.....	477
a) Attenuation rates.....	477
b) Phase characteristics.....	478
c) A study in VLF fading.....	478
10. Theoretical studies in the 1960's.....	478
11. Writing for the sake of “general interest”.....	478
The “sounds” of radio waves at very low frequencies.....	479
1. Early observations of the “sounds” of radio waves.....	479
2. The CRPL studies sferics.....	480
3. Observing VLF emissions.....	480
4. The CRPL reports to the 1957 NBS Symposium on Propagation of VLF Radio Waves.....	480
5. Taking part in the IGY whistler program.....	481
6. Further investigations.....	482
CRPL participation in the IGY Program.....	482
1. Probing the ionosphere by vertical sounding.....	482
2. Radio noise data on a worldwide scale.....	483
3. Geophysical correlation of sporadic-E and F-scatter studies.....	483
4. VHF forward scatter experiments near the geomagnetic equator—And in the Antarctic.....	483
5. Observing airglow.....	484
6. Observing Sputnik I.....	484
7. The IGY World Warning Agency.....	484
8. International Geophysical Calendars.....	484
9. The CRPL contributes to IGY publications.....	484
NBS pioneers in radio communication by ionospheric forward scatter.....	485
1. Some evidence of ionospheric scatter.....	485
2. The initial experiment by NBS.....	486
3. Learning about ionospheric forward scatter as a means of radio communication.....	488
a) Observations at the Sterling field station.....	488
b) Some distance experiments.....	489
c) Another try at long distance.....	489
d) Variation of experimental conditions.....	489
e) Studies of ionospheric forward scatter at high latitudes.....	489
4. NBS leads the way toward a successful ionospheric forward scatter communication system.....	491
5. The unexpected occurs—On February 23, 1956.....	493
6. A new discovery, but problems of publication.....	494

	Page
7. Forward-scatter observations along the geomagnetic equator and in the Antarctic.....	498
8. Denouement? .....	498
Probing the ionosphere from above .....	498
1. Early probing of the upper ionosphere .....	498
2. CRPL observes Sputniks .....	499
a) Observing the Earth's first artificial satellite—Sputnik I.....	499
b) Observing Sputnik III and NASA satellites.....	500
3. Electron-density data for the Space Age.....	501
4. CRPL joins a NASA satellite program.....	502
a) Testing the Topside sounding system with rockets.....	503
b) CRPL observes the upper ionosphere with the Canadian Alouette I Topside Sounder satellite.....	503
c) CRPL directs the program for Explorer XX.....	504
d) The OGO's .....	507
References .....	507

## Chapter XII

<b>RADIO WAVES IN THE LOWER ATMOSPHERE.....</b>	<b>511</b>
Introduction .....	511
Research on tropospheric propagation gets underway.....	512
1. Early projects.....	512
2. Valuable meteorological and climatological data come from the U.S. Weather Bureau and other agencies .....	513
3. Suppression of microwaves by zonal screens .....	514
4. Survey of research in tropospheric propagation, 1948-1956 .....	514
Transmission loss.....	515
1. Definitions.....	515
a) Transmission loss .....	515
b) Basic transmission loss.....	515
c) System loss .....	515
d) Hourly median transmission loss.....	515
2. Formulas and graphs.....	515
3. Extensive transmission loss data summarized and published .....	515
4. Transmission loss predictions .....	516
Angular distance .....	517
Radio meteorology.....	517
1. Introduction .....	517
2. The radio refractive index .....	517
a) Its importance.....	517
b) Devices for simplifying solution of the equation for radio refractive index .....	518
c) The microwave refractometer.....	518
d) Refractive index inhomogeneities .....	519
3. Atmospheric bending of radio waves.....	520
a) Atmospheric ducts .....	520
b) Radio Refractive Index Data Center.....	521
c) CRPL exponential reference atmosphere .....	521
d) Refraction of radio waves at low angles within various air masses.....	522
e) Refraction in an exponential atmosphere .....	522
f) Graphical determination of radio ray bending .....	522
g) Correlation of monthly median transmission loss and refractive index profiles .....	523

4. Climatology .....	523
a) Climatic variation of absolute humidity .....	523
b) Studies of a continental polar air mass.....	523
c) Worldwide climatology.....	523
The Cheyenne Mountain Experiments .....	525
1. Background and preliminary preparations.....	525
2. Transmitter locations.....	528
3. Receiving locations .....	530
4. Facilities and equipment .....	532
a) General .....	532
b) Transmission.....	532
1) UHF transmitter—1046 MHz .....	532
2) VHF transmitters .....	533
c) Reception .....	533
1) UHF receivers.....	533
2) VHF receivers.....	533
3) Special receiving equipment .....	533
d) Recording devices.....	533
Terrain effects .....	533
1. Reflection coefficient at grazing angles .....	534
2. VHF measurements in the Rocky Mountain area .....	534
3. Pikes Peak in obstacle-gain experiments.....	535
a) The obstacle .....	535
b) From the north.....	535
c) From the south: Beulah-Pikes Peak-Table Mountain path .....	536
4. Over-water paths in the California coast region .....	537
a) San Nicolas Island—California coast .....	537
5. Fading phenomena .....	538
a) Prolonged space wave fadeouts.....	538
b) Measurements at 418 MHz well beyond the radio horizon .....	538
c) Within-the-hour fading.....	539
Problems of phase stability in tropospheric propagation .....	539
1. Introduction .....	539
2. Phase measurements over paths of varying length.....	540
3. Phase stability over low-level tropospheric paths.....	542
4. Path-length stability of ground-to-ground links .....	542
5. Hawaii experiment .....	543
6. Tracking missiles through the wild blue yonder.....	545
a) Theoretical considerations.....	545
b) Meteorological effects.....	545
c) Simulated tracking system.....	545
d) Over-water measurements of phase and amplitude.....	546
e) Simulated earth-to-space links.....	546
Space communications .....	547
1. Interference between surface and space communication systems .....	547
Tropospheric forward scatter.....	549
1. Introduction .....	549
2. Special issue of <i>IRE Proceedings</i> .....	549
3. CRPL research on tropospheric forward scatter .....	550
a) It gets started.....	550
b) Mathematical studies .....	551
4. Scatter measurements near the radio horizon .....	552
References .....	552

## Chapter XIII

<b>ENGINEERING FOR RADIO PROPAGATION</b> .....	555
Introduction .....	555
Noise—The limiting factor to radio reception .....	555
1. The IRPL studies the effect of atmospheric noise .....	555
2. The CRPL initiates a noise measurement program.....	557
3. NBS supervises the IGY noise program.....	559
4. Improving the techniques of noise measurement.....	562
5. Cooperating with the CCIR and with URSI .....	562
6. Some noteworthy observations .....	562
Antenna research.....	563
1. Antennas for vertical-incidence ionosondes .....	563
2. Corner-reflector antenna measurements.....	563
a) Studies at the Sterling field station .....	563
b) Studies at Boulder.....	565
3. Similitude with scaled-down antennas.....	566
4. Yagis on parade—Electronically-scanned antenna arrays.....	567
5. A miscellany of antenna projects .....	570
6. Theoretical approaches to antenna designs .....	571
Modulation research.....	571
1. The CRPL initiates modulation research .....	571
2. Progress in modulation research.....	571
3. Studies in advanced modulation techniques .....	572
Radio navigation .....	572
1. Involvement in Loran.....	573
a) Early Loran studies .....	573
b) Involvement in Cytac .....	573
c) Development of the Loran-C clock .....	574
2. Investigations of air navigation systems—Tacan.....	576
A measurement of the speed of EM waves.....	576
1. Discovering a source of error in phase measurements.....	576
2. Preparations for measurement of the speed of EM waves .....	577
3. A radio interferometer measurement of the speed of EM waves .....	577
Spectrum engineering .....	578
1. Introduction .....	578
2. The indispensable field-strength meter.....	579
3. Gauging transmission utilization—Service area .....	579
a) Early work by NBS.....	579
b) The rising tide of FM and TV broadcasting—CRPL efforts to keep pace.....	579
c) A new approach to service areas.....	581
d) The service area of a flying TV transmitter .....	582
4. Exploring frequency bands for communications services—Air-to-ground, air-to-air .....	583
5. The matter of frequency allocation—Contributions by the CRPL.....	584
a) The CRPL aids in matters of frequency allocation .....	584
b) A contribution to TASO.....	585
c) Writings on space communication .....	585
d) A writing on efficient use of the radio spectrum.....	585
e) Application of computer techniques.....	586
f) An epilogue to the many writings.....	586
Data processing .....	586
1. Introduction .....	586
2. Automatic data analysis.....	587
3. Expansion of computer program .....	587



4. Data reduction for tropospheric propagation research .....	587
a) Computation of refractive index of the atmosphere .....	588
b) Instrumenting for data reduction .....	588
5. Selection of optimum frequencies by electronic computer .....	588
A diversity of projects .....	589
1. Consideration of conductivity in groundwave propagation .....	589
2. A bout with color television .....	590
3. A radio system for investigating sferics—Ephi .....	592
References .....	593

## Chapter XIV

<b>BEYOND THE IONOSPHERE</b> .....	595
Cosmic radio noise .....	595
1. From earthborn static to the stars .....	595
2. Grote Reber joins the CRPL .....	595
3. The CRPL studies cosmic radio noise .....	596
4. An engineering viewpoint .....	598
Solar radio noise .....	598
1. Preparations for a study program .....	598
2. Observing the 1950 total eclipse of the Sun .....	600
3. A theory of solar noise bursts .....	600
4. A long series of solar observations .....	601
5. Matters of publication .....	602
“Twinkling” stars .....	603
1. Early observations of star scintillations .....	603
2. A method of observation .....	603
3. Interruptions by Sputniks .....	604
4. An observational program by the CRPL .....	605
“Signals” from Jupiter .....	605
1. Early observations .....	605
2. Observations of emissions at 8.9 and 10 MHz .....	606
Ionospheric absorption in conjugate regions .....	607
1. Early stages of the program .....	607
2. A fortuitous start in the conjugate point program .....	608
3. The conjugate point program in the making .....	609
4. The conjugate point program on a grander scale .....	610
The exosphere .....	611
1. An introduction .....	611
2. An experimental project at the Sterling station .....	612
3. Reporting on the exosphere to URSI .....	612
4. Phenomena associated with the exosphere .....	612
Space communication .....	613
1. The matter of frequency selection .....	613
2. Toward a decision of historical significance .....	614
3. Radio communication on the Moon .....	614
4. An international symposium .....	615
5. A tutorial paper appears .....	615
Safety in space travel .....	615
1. Evaluating the hazard of solar cosmic rays .....	615
2. Safeguarding the orbital flights of Mercury spaceships .....	616
References .....	617

## Chapter XV

<b>EXIT RADIO STANDARDS PHYSICS—ENTER QUANTUM AND PLASMA PHYSICS</b> .....	619
Introduction .....	619
1. Microwave spectroscopy for measurement standards .....	619
a) The ammonia atomic clock .....	619
b) Spectral lines of deuterated ammonias .....	619
c) Stark-cell microwave spectroscopy .....	619
2. Microwave spectral tables .....	620
a) <i>Circular 518</i> (1952) .....	620
b) <i>Monograph 70</i> (1964-1969) .....	620
3. Experiments with oxygen line .....	620
4. Cesium beam atomic clock .....	620
Millimeter-wave research .....	621
1. Purpose .....	621
2. Microwave Michelson interferometer .....	622
a) Pilot model .....	622
b) Construction .....	622
3. Microwave Fabry-Perot interferometer .....	622
4. Diffraction computations .....	622
Theoretical astrophysics .....	622
1. Solar atmosphere studies .....	622
2. A change of project title—Theoretical Astrophysics .....	623
a) Expanded objectives .....	623
b) Research projects .....	623
3. <i>Technical Note 30: Aerodynamic Phenomena in Stellar Atmospheres</i> .....	624
4. <i>Physics of the Solar Chromosphere—a book</i> .....	624
Plasma physics .....	624
1. Introduction .....	624
2. A team from Boulder goes to England to use the British thermonuclear machine ZETA .....	625
3. Upper atmosphere plasma physics .....	625
a) Cylindrical shock waves from exploding wires .....	626
b) Radiation produced from a plasma .....	626
c) High-speed camera for plasma physics research .....	626
4. Radio plasma .....	627
a) Brush-cathode plasma .....	627
Joint Institute for Laboratory Astrophysics .....	627
1. Organization .....	627
2. Research activities .....	629
3. Atomic Collision Data Center .....	630
4. Measurements of excitation of multiply charged ions .....	630
5. E. U. Condon closes career at JILA .....	630
Laser research .....	631
1. Development of laser program at Boulder Laboratories .....	631
2. Laser intensity stabilizer .....	631
3. Sensitive seismometer housed in abandoned gold mine .....	632
4. Laser electron paramagnetic resonance .....	633
5. Laser power and energy measurements .....	633
Speed of light by laser .....	634
1. Speed of light .....	634
a) Frequency measurements .....	634
b) Wavelength measurement .....	636
c) New standards envisioned .....	637
d) International recognition .....	637

Lunar ranging experiment (LURE) .....	638
1. Procedure.....	638
2. The lunar telescope.....	639
3. The Hawaiian Observatory .....	640
References .....	641

## Chapter XVI

<b>IN A CONSULTANT CAPACITY</b> .....	643
In the service of the Government.....	643
1. Service to the Department of Commerce.....	643
a) In the early years of the Radio Section.....	643
b) Broadcasting throttles the Department of Commerce.....	644
c) Continuing to serve the Department of Commerce .....	644
2. Service to the Federal Radio Commission .....	645
3. Interdepartmental relations in radio .....	646
a) In the early years of wireless telegraphy.....	646
b) A vignette of IRAC (Interdepartment Radio Advisory Committee).....	647
4. Service to the Armed Forces .....	648
a) Trials, with some successes .....	648
b) The World War II period .....	648
c) The postwar period .....	648
5. Service to Government agencies when radio was newly fledged.....	649
a) The Post Office Department's interest in flying the mail .....	649
b) Market news by radio interests the Department of Agriculture.....	649
c) Expertise for a Federal board .....	649
d) Service to the State Department.....	650
A Government industry relation—Dellinger's role with the Radio Technical Commission for Aeronautics .....	650
Relations with industry .....	651
1. Filling an urgent need.....	651
2. Radio "standardization" .....	651
3. Standards for electron tubes.....	652
The Radio Section contributes to technical societies.....	652
1. To the Institute of Radio Engineers.....	652
2. To the American Institute of Electrical Engineers.....	652
A medley of committees.....	653
Increased consultant capacity by proliferation of committees within the CRPL.....	653
1. Increased service to professional societies.....	654
a) An ambitious program to keep abreast of the state-of-the-art .....	654
b) The scope of committee participation.....	654
c) Service to science .....	655
2. Service to the country's defense .....	655
References .....	655

## Chapter XVII

<b>ON THE INTERNATIONAL SCENE</b> .....	657
The international telecommunication conferences.....	657
1. Early conferences.....	657
2. The Washington Conference of 1927.....	657
3. The later conferences—After Washington .....	659
The International Radio Consultative Committee (CCIR).....	660
1. The CCIR becomes a functioning organization: The first meeting—At The Hague, 1929.....	660

	Page
2. Meetings after The Hague—Before World War II .....	661
3. Meetings after World War II .....	662
The expert's role at international and Inter-American conferences .....	662
1. Taking part in an assortment of international conferences.....	662
a) To the time of formation of the CRPL.....	662
b) After formation of the CRPL .....	664
2. International conferences called for the Americas.....	665
URSI—Fulfillment in international scientific cooperation.....	666
1. What is URSI? .....	666
2. The U.S. joins URSI.....	667
3. The American Section grows—And matures .....	668
4. The American Section stages two General Assemblies.....	668
5. Reaching the international level.....	671
6. International intercomparison of laboratory standards .....	673
7. NBS contributes to the International Geophysical Year .....	674
8. Reflections of URSI.....	675
9. The proliferation of international committees within the CRPL—Then divergence.....	676
References .....	677

## Chapter XVIII

<b>THE PRECURSOR ROLES</b> .....	679
Taking a professional stance.....	679
1. The Bureau's early publications on radio.....	679
2. The Radio Section addresses professional societies and other groups—And publishes .....	680
The early roles with the Institute of Radio Engineers (IRE).....	681
1. In the wake of the beginning .....	681
2. Taking leading roles in the IRE .....	682
3. The Washington Section of the IRE .....	683
Precursor roles in the evolvement of national conferences.....	684
1. Conference on Precision Electromagnetic Measurements (CPEM).....	684
a) The 1949 Conference on High Frequency Measurements.....	684
b) The 1951 Conference on High Frequency Measurements.....	685
c) The Third and Fourth Conferences .....	686
d) The Conference moves from Washington to Boulder .....	686
e) A conference spawns another conference.....	687
f) The 1962 Conference becomes international.....	687
g) The Conference becomes firmly established .....	689
h) The Conference goes abroad.....	689
i) Success breeds success.....	690
2. A new conference meets a need—The National Conference of Standards Laboratories (NCSL) .....	690
a) A need—And a new conference is organized .....	690
b) What is NCSL? .....	691
c) The NCSL becomes a successful organization .....	691
Exercising the learning process—By schooling, by sharing technical knowledge with others .....	694
1. A book approach to learning in time of war .....	694
2. A handbook series bogs down .....	695
3. In-house education at NBS.....	695
a) The early period of the NBS Graduate School.....	695
b) In-hours courses in the early CRPL period .....	696
c) The Graduate School at Boulder Laboratories .....	696

	Page
4. Colloquia, symposia, seminars, conferences—Or by any other name.....	698
a) An early CRPL colloquium.....	698
b) Conferences, symposia, seminars at Boulder Laboratories .....	698
5. Professional groups of the region that had their origin within the Boulder Laboratories .....	699
a) The Boulder Branch of RESA .....	699
b) Boulder-related Professional Groups of the IEEE.....	700
References .....	701

## Chapter XIX

<b>“GO WEST YOUNG MAN” .....</b>	<b>703</b>
A new site for radio research.....	703
1. The Central Radio Propagation Laboratory encounters space problems.....	703
2. Slowly turn the wheels for funding a new facility.....	704
3. Relocating the Central Radio Propagation Laboratory.....	706
a) Could the location be Boulder, Colo.? .....	706
b) Boulder selected for relocating the CRPL .....	709
c) Boulder meets a challenge.....	711
4. NBS extends its facilities.....	712
a) NBS owns the Boulder site.....	712
b) Planning for a building—And interim quarters.....	713
c) Construction proceeds on the Radio Building.....	715
d) Campus features and peripheral facilities.....	718
5. The migration to Boulder .....	723
a) The vanguard.....	723
b) Preparations for the migration.....	724
c) The “moving day” of many weeks .....	725
d) The big “migration” .....	725
6. Dedication of the Boulder Laboratories .....	726
a) Preparations for a big event.....	726
b) Scientific conferences come to the Boulder Laboratories .....	726
c) President Eisenhower dedicates the Boulder Laboratories.....	727

## Chapter XX

<b>L’ENVOI .....</b>	<b>733</b>
Introduction .....	733
The Mission of ESSA .....	735
1. Functions of constituent organizations .....	735
a) Central Radio Propagation Laboratory.....	735
b) Weather Bureau.....	735
c) Coast and Geodetic Survey.....	735
NBS and ESSA share buildings and support functions .....	735
1. Buildings.....	735
2. Administrative and support functions .....	736
Epilogue .....	736
1. Subsequent changes in ESSA.....	736
a) ESSA Research Laboratories (ERL).....	736
b) ITS separated from ESSA.....	736
2. NOAA supersedes ESSA .....	736
Reference.....	737

**APPENDIX A—To Chapter XVI**

Committee Memberships relating to the general subject of radio, in Technical Groups, Professional Societies, and Government Sponsored Committees from the time of formation of the Central Radio Propagation Laboratory, May 1, 1946, to 1975 .....	739
---	-----

**APPENDIX B—To Chapter XVII**

Committee Memberships relating to the general subject of radio, associated with International Organizations and Conferences from the time of formation of the Central Radio Propagation Laboratory, May 1, 1946, to 1975 .....	749
--	-----

**APPENDIX C**

<b>ORGANIZATION AND ADMINISTRATION OF RADIO SCIENCE, TECHNOLOGY, STANDARDS, AND MEASUREMENT PROGRAMS AT THE NATIONAL BUREAU OF STANDARDS</b> .....	757
--	-----

**APPENDIX D**

<b>JOHN HOWARD DELLINGER—LONG-TIME PUBLIC SERVANT OF RADIO IN GOVERNMENT</b> .....	781
Proem .....	781
Growing up in Cleveland .....	782
Washington and the Bureau of Standards .....	782
Further schooling and the beginning of a career in radio.....	783
World War I .....	785
Chief of the Radio Section .....	786
Encompassed by broadcasting.....	786
The first, then many trips abroad.....	787
Radio propagation and the ionosphere.....	788
Radio and aeronautics.....	788
IRPL—Then CRPL, and retirement .....	789
URSI .....	791
CCIR .....	792
The IRE.....	792
In recollection—Bits out of the past .....	792

**APPENDIX E**

<b>NBS RADIO PERSONNEL PATENT THEIR INVENTIONS</b> .....	797
--	-----

**APPENDIX F**

<b>SOURCES OF INFORMATION USED IN PREPARATION OF ACHIEVEMENT IN RADIO</b> .....	803
---	-----

**APPENDIX G**

<b>COMMENTARY ON A RADIO TRANSMISSION PUBLICATION</b> .....	807
---	-----

<b>INDEX</b> .....	809
--------------------	-----

## Chapter I

### MAN'S QUEST TO COMMUNICATE THROUGH SPACE

#### RADIO—ITS SPHERE OF INFLUENCE

To most people the word "radio" means the broadcasting of speech and music, and to a lesser extent, communication with or between moving vehicles such as automobiles, ships, and planes. Yet from the rapid development of radio during the period from the late 1800's to the present time has come a host of devices and techniques that have had their impact on the scientific world and upon society. Hertz's interest was primarily that of demonstrating experimentally in the laboratory the actions of electromagnetic waves predicted mathematically by Maxwell nearly 20 years earlier. Little did the early investigators dream that radio would be used some day to probe the heavens into outer space and, again, to probe the interior of the atom. The driving force in the efforts of Marconi and his contemporaries was to develop a means of communicating over long distances without benefit of wires. They called it "wireless."

#### COMMUNICATIONS—AND BEYOND

Probably man's earliest form of communication was by sounds, and most likely they were animal-like utterances. These sounds gradually developed into the speech of modern man that uses language as a code. However, man also learned to communicate through the means of visual signals. At close range he used his hands and arms. For greater distances he learned to use semaphores, flags, the heliograph, and at night, lights. Smoke signals were very limited in the message content they could carry.

Over long distances sound and visual signals could be relayed from station to station. If speed of transmitting the signal was not too important, men could send an oral or written message over long distances by runners or riders on horseback operating in relays. Postal systems carried messages over land, sea, and finally through the air.

With the development of electrical technology came the telegraph and then the telephone, first over land wire then by submarine cable. Although transmission of messages had not reached the speed of light, the increase in speed was enormous over that of previous modes of transmission. Not satisfied with the transmission of speech only, the telephone engineers learned to transmit pictures over their systems, and still later learned to transmit computer signals at a very high rate.

Near the close of the 19th century men were able to transmit signals over short distances without the use of wires; then in 1901, Marconi spanned the Atlantic Ocean. Speed of transmission now reached the speed of light. Messages were first sent by telegraphic code; then came voice transmission. Facsimile transmission soon followed. Then came the broadcasting of music for entertainment and of speech to keep us abreast of the world. Television was not far away. Improved techniques of handling the "flying spot" of light quickly gave way to television as we experience it today.

But radio was destined to be a powerful tool in the hands of man to probe the secrets of Nature and to serve a multitude of uses in new technologies. He was to develop a frequency range of generating and detecting oscillations for communication that would cover approximately 25 octaves ( $10^4$  to  $3 \times 10^{11}$  Hz).

We have learned to transmit and receive messages in space at distances that now range in the hundreds of millions of miles. Yet using the techniques of microwave spectroscopy we can probe the inner realm of the atom. Using a related technique we have developed clocks that have an accuracy in timekeeping of the order of  $1 \times 10^{-13}$ . Radio techniques permit us to probe the Earth's upper atmosphere in order to learn of its locked-up secrets. In return, we have learned how to use the ionosphere to the maximum advantage in transmitting our messages from point to point over the entire world. The techniques of radio astronomy permit us to search the regions of interstellar space for "signal" information that reveals the character of energy that radiated millions of years ago.

Radio telemetry has given us the means of placing our observation instruments a short or great distance from the location at which we want to record the observations. By means of radio we can control mechanical movements and the operation of electrical devices at distances that are in terms of the Sun's planetary system.

Without radio navigation our air traffic would be limited to almost "hedge-hopping." Only through the means of radio can we move in three dimensions with safety and with accurate knowledge of where we are in reference to fixed points on the Earth and to moving objects above the Earth's surface. Moreover, radio lends a hand in giving us accurate information on the weather, operational information to the pilot of a plane, or information for tomorrow's outing.

In this realm of radio, it is rather interesting how we came to use the word that is so common around the world. The word "radio" appears to have come into existence by a shortening of the term "radioconductor," used first in 1897 by Branly in naming the device he had developed, which is better known as a coherer [1]. This device was first developed by Branly in 1891 as a means of controlling the conduction in an electrical circuit. Marconi was quick to apply it as a fairly sensitive detector in his early radio experiments. The British magazine *Tid-Bits*, in its May 1898 issue, made reference to the word "radioconductor" in describing some of Marconi's early work [2]. But the British were reluctant in giving up the word "wireless" in lieu of "radio" which soon came into popular usage in the United States. In 1912 the U.S. Navy directed the use of the term "radio" in lieu of "wireless."

## A CHRONOLOGY OF EVENTS AND LANDMARKS IN THE DEVELOPMENT OF RADIO<sup>1,4</sup> 1819-1976

There are observations of electricity and magnetism that go back into antiquity (e.g., the curious properties of amber and lodestone, and the phenomena associated with lightning); however, these are not directly associated with manmade electromagnetic radiation. The same is true of electric and magnetic observations made previous to 1800. But beginning with Oersted's observation in 1819 of the magnetic properties of an electric current, we can trace the development of radio principles more or less directly.

1819 Hans Christian Oersted (Denmark) observed magnetic properties of electric current.

---

<sup>1</sup> Guidance to material for this chronology came from a number of sources of a general chronological nature, plus literature references that are specifically indicated [3-8].

<sup>2</sup> It is the author's (WFS) intent in presenting a chronology of radio in connection with the contents of this book that emphasis be given to the scientific discoveries and technical achievements associated with the development of radio. However, events associated with the "first" uses of radio in man's affairs are noted because of significant historical importance.

<sup>3</sup> Dates of discovery or recognition of an invention, novel use of a device or system, or of a principle, can vary among historians, reports, et al. Different criteria can be used, such as: (a) date of filing for patent; (b) date of granting a patent; (c) publication date; (d) public announcement or demonstration; and (e) concept of idea as indicated in a notebook or other record. Other sources of confusion are misinterpretation of dates by historians and other writers and errors in ascribing dates. It will be found in making comparisons of dates of events given in the references noted in footnote 1 that these dates are not always in agreement among writers of the chronologies, for reasons stated above. When dates are in disagreement among the various chronologies, the author has traced down the original material or has cited the specific circumstances of the event involved, or he has given an explanatory note.

<sup>4</sup> When a name is first introduced in this chronology, the person's native land is indicated unless he had been Americanized the greater part of his life. All are Americans where no native land is indicated.



- 1821 André M. Ampère (France) established the relationship between electricity and magnetism.
- 1825 Georg Simon Ohm (Germany) propounded the relation  $R=E/I$  which came to be known as Ohm's Law.
- 1831 Michael Faraday (England) and Joseph Henry engaged simultaneously in the study of electromagnetic induction. Faraday's publication in November 1831 preceded Henry's by a few months.
- 1833 Michael Faraday observed the "extraordinary" increase in current through silver sulphide with temperature, indicating that the substance had a negative temperature coefficient of resistance. Faraday was observing a property associated with semiconductors.<sup>5</sup>
- 1838 Samuel F. B. Morse applied for a U.S. patent on the telegraph.
- 1842 Alexander Bain's (England) electrochemical recording telegraph established the basic principles of facsimile recording.
- Joseph Henry discovered that condenser discharges from Leyden jars are oscillatory [9-11].<sup>6</sup> (Note: The effect noted by Henry was probably by induction, with little or none of the action of electromagnetic radiation.)
- 1844 Morse transmitted his famous message "What hath God wrought" by telegraph between Washington, D.C. and Baltimore, Md. on May 24.<sup>7</sup>
- 1846 Faraday speculated on the electromagnetic theory of light [12].
- 1849 John Walker Wilkins (England), a pioneer in telegraphy, predicted the possibility of "wireless" telegraphy.

<sup>5</sup> M. G. Scroggie, in his *Principles of Semiconductors*, revised 1961 ed., Ilife Books, Ltd., London, states on p. 2 that "The rectifying properties of certain solid substances were discovered as long ago as 1835, by Munk Af. Rosenshold." Contact by the author with Scroggie (England) failed to locate the source of this information because of inaccessibility of the files containing the reference to Rosenshold.

<sup>6</sup> Henry also reported the effect of magnetizing needles at considerable distances by the discharge of Leyden jars.

<sup>7</sup> Although Morse has received public acclaim for development of or inventing the telegraph, there were others who pioneered in the development of the telegraph, either before or contemporary with the development work of Morse. A listing would include Wheatstone of England, Stienheil of the European Continent, Baron Schilling of Russia, Marshall of Scotland, and Joseph Henry of the United States.

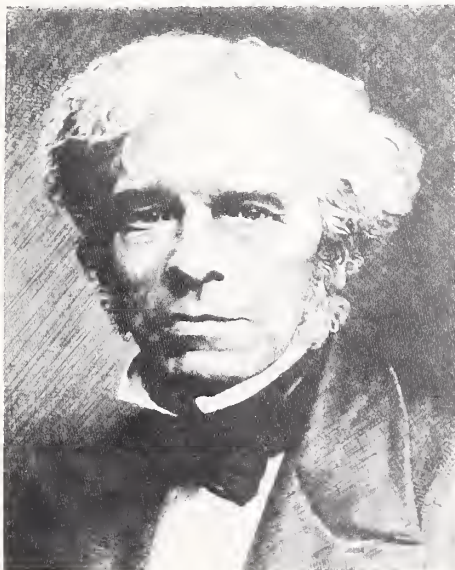

Michael Faraday  
1791-1867



William Thomson (Lord Kelvin)  
1824-1907

- 1853 Lord Kelvin (William Thomson, Scotland) published a paper on a mathematical analysis of transient electric current that explained the oscillatory nature of discharges from Leyden jars (phials) [13].<sup>8</sup>
- 1857 Heinrich Geissler (Germany) demonstrated the effect of high voltage on gases in a partial vacuum.<sup>9</sup>
- 1858 First transatlantic cable in operation. This cable failed after several weeks; the first successful cable was laid in 1866.
- 1864 James Clerk Maxwell (Scotland) was the first to establish a fundamental concept of electromagnetic waves by mathematical reasoning, his work resulting in "Maxwell's equations" which indicated the existence of electromagnetic waves that were later demonstrated by Hertz [14].<sup>10</sup>
- 1872 Mahlon Loomis was issued the first U.S. patent for a wireless system.<sup>11</sup>
- 1874 Karl Ferdinand Braun (Germany) observed the directional properties of current flow in galena, copper pyrites, and other crystalline substances that eventually came to be used for fairly sensitive crystal detectors.

---

<sup>8</sup> From Lord Kelvin's mathematical analysis of the oscillatory nature of a condenser discharge, expressed as the interval of time between peak currents of the oscillations, can be deduced the now familiar relation of  $f = (1/2\pi\sqrt{LC})$ , or when resistance of the circuit is considered,  $f = (1/2\pi)[(1/LC) - (R^2/4L^2)]^{1/2}$  for damped oscillations. It is interesting to note that Kelvin used the term "electrodynamic capacity" for what came to be called "inductance."

<sup>9</sup> In 1838 Faraday had reported observations on luminous discharges created by high voltage in rarefied gases contained in a glass vessel. He gave some thought to what the conduction might be if he had a perfect vacuum.

<sup>10</sup> Maxwell's treatment of electrical units on the basis of the absolute (base) units of mass, length, and time in relationships of dimensional analysis ("dimensional equations"—Maxwell) led him to the equation  $v = (1/\sqrt{k\mu})$ , the velocity of light. This velocity of approximately  $3 \times 10^{10}$  cm/s gave the relationship between the electrostatic and electromagnetic systems of units. In addition, it led Maxwell to the belief that light was a form of electromagnetic radiation.

Maxwell's lengthy paper on "The Dynamical Theory of the Electromagnetic Field" was read by him to the Royal Society of London on December 8, 1864. The paper was published in the *Philosophical Transactions of the Royal Society of London* [14], Vol. CLV, 1865, pp. 459-472. In this paper Maxwell's famous equations appeared in differential form whereas, today, they usually appear in the more familiar vector algebra form. These equations are the foundation upon which much of the modern treatment of the propagation of electromagnetic waves is based, whether in waveguide, open lines, or in free space. Maxwell arrived at the results contained in his 1864 paper on the basis of work that he read at the Cambridge Philosophical Society as early as 1855. The early work was an outgrowth of his study of Faraday's experimental research on electromagnetic induction. Maxwell gave a complete account of these papers in his now famous two-volume *Treatise on Electricity and Magnetism*, first published in 1873, and in two later editions.

<sup>11</sup> Beginning in 1864, Dr. Mahlon Loomis, a Washington, D.C. dentist, planned a system of transmitting and receiving signals by a combination of the Earth as a ground and an antenna elevated at a considerable height above the Earth.

Loomis was successful in sending and receiving signals between two locations on mountaintops 18 miles apart in the Blue Ridge Mountains west of Washington, D.C. in October 1866. For an antenna Loomis used a 600-foot length of copper wire that was elevated by a kite, the wire serving as the kite string. On the kite was a small square of fine copper wire gauze connected to the copper wire. No doubt it served as a slight additional capacitance leading to the antenna. Although a spark was obtained without a battery (upon keying the circuit), its strength, or even its existence, was very dependent upon the conditions of atmospheric electricity and, therefore, was dependent upon the weather. For a receiver Loomis used a magnetic-needle galvanometer. Had a coherer or crystal detector been available at the time, his receiver would have been far more sensitive. By using the same length of wire at each of the two stations, Loomis obtained a degree of tuning (for resonance) between the two systems, either knowingly or unknowingly. There were no other provisions for tuning the antenna circuits.

Although Loomis had some of the rudiments of a wireless system, it was far from a practical system. It is possible that he was using a system that combined both the induction principle as well as a system that radiated true but highly damped electromagnetic waves from spark discharges. The world had to wait until nearly the end of the 19th century for Marconi to develop a practical system of wireless telegraphy.

Lack of funds, including rejection of pleas to Congress for support, dogged Loomis in his experiments the remainder of his life.

1876 Alexander Graham Bell was issued a U.S. patent on the telephone. It was demonstrated publicly at the Centennial Exhibition in Philadelphia, Pa.

A plethora of reports appeared in 1876 describing the transmission and reception of oscillatory spark discharges over short distances.<sup>12</sup>

1878 William Crookes (England) demonstrated the properties of cathode rays.<sup>13</sup>

David E. Hughes, an American experimenting in London, demonstrated the transmission of signals over short distances in much the same manner as Edison, E. Thomson, and S. P. Thomson. His detection system, consisting of a steel needle and carbon block, was a precursor of the coherer.

1880 The Curie brothers, Jacques and Pierre (France), discovered the piezoelectric property of quartz crystals.

1882 Amos E. Dolbear was granted several U.S. patents for a "wireless" telephone system.<sup>14</sup>

1883 Thomas A. Edison observed the thermionic effect of an electric current passing across the evacuated space in an incandescent lamp from the hot filament to a cold metallic plate. The "Edison effect" was destined to give birth to many types of thermionic vacuum tubes in the 20th century.

1884 Paul Nipkow (Germany) was granted a German patent for inventing the mechanical scanning disk which was adapted to many types of television systems to be developed in the 1920's.

John Henry Poynting (England) published his well-known theorem on the flow of energy in an electromagnetic wave or in a current passing through a conductor as being proportional to the vector product of the electric and magnetic fields [15].

1886 Heinrich Hertz (Germany) began his studies of verifying experimentally the existence of electromagnetic waves, thus confirming the theory set forth by Maxwell in 1864 [16].<sup>15,16</sup>

1890 Edouard Branly (France) developed the coherer, which was to be used extensively as a detector of radio waves during the first few years of practical radio telegraphy [17].<sup>17</sup>

---

<sup>12</sup>Thomas A. Edison, Elihu Thomson, and Silvanus P. Thomson (England) reported on experiments conducted with spark discharges, with some reports dating back to 1871. These investigations were probably closer to "wireless" with radiated electromagnetic waves than anyone realized until many years after their experiments were completed in the early 1870's. See reference [7], Vol. 5, Aug. 1968.

<sup>13</sup>The pinkish rays of light produced by Crookes in an evacuated glass tube, fitted with metal electrodes at each end, was an indication of invisible particles causing the illumination. It was a step beyond what Geissler had first attained in 1857.

<sup>14</sup>This "wireless" system incorporated a condenser-type microphone that served as a telephone transmitter. Dolbear demonstrated his system in a paper read before the Society of Telegraph Engineers and of Electricians, London, in 1882. This and other demonstrations gave some indication that Dolbear was transmitting telephone messages by electromagnetic waves; probably there was a combination of both induction and radiation in the transmission.

<sup>15</sup>Hertz's papers on electromagnetic waves were published over a period of several years, beginning in 1887. By means of discharges from Leyden jars on a Holtz machine (type of static machine with one rotating disc), Hertz observed the reflection and refraction of electromagnetic waves. His "detector" was a wire loop with a small gap, across which could be observed faint sparks caused by radiation from the nearby source. Such a detector was too insensitive for practical telegraphy. Hertz died in 1894, and did not see the practical fruition of his experimental research, but he had confirmed Maxwell's theory.

An interesting account of Hertz's research, including a list of references is found in reference [7], Vol. 5, Dec. 1968.

<sup>16</sup>In later years Heinrich Hertz was honored as the pioneer in experimental radio by use of the term "hertz," with contraction to "Hz," as a means of simplifying the term "cycles per second."

<sup>17</sup>Sir Oliver Lodge (England) used the coherer as a detector in demonstrating Hertz's experiments in place of the spark gap in a loop of wire. It remained for Marconi to use the coherer (with some improvements in sensitivity over that of Branly's instrument) as a detector which spelled his success in a practical system of radio telegraphy.



*James Clerk Maxwell*  
1831-1879



*Heinrich Rudolf Hertz*  
1857-1894

1895 Guglielmo Marconi (Italy) had success in the spring of 1895 in transmitting signals up to distances of 2.4 km at his father's estate near Bologna, Italy, using a spark coil as the transmitter and a coherer as a detector.

Alexandr S. Popov (Russia) demonstrated a wireless system to the Russian Physico-Chemical Society on May 7, 1895, at St. Petersburg, using a source similar to that used by Hertz, and a coherer modeled after Branly's device.<sup>18,19</sup>

Wilhelm Conrad Roentgen (Germany) discovered X rays on November 8, 1895.

1896 Marconi filed for a British patent on June 2 for a system of wireless telegraphy. In September, Marconi transmitted and received signals over a distance of 2 miles on the Salisbury Plain in England.

1897 Marconi was granted a U.S. patent on July 13 for his system of wireless telegraphy.

Karl Ferdinand Braun (Germany) constructed the first cathode-ray tube for use as an oscilloscope—a forerunner to the modern TV viewing tube.

During the same year, Braun devised a wireless telegraph system using inductive antenna coupling in a spark transmitter and resonant-circuit tuning in the receiver. Braun also replaced the coherer with the more efficient crystal type of detector. In 1909 he was to share the Nobel Prize in Physics with Marconi for the development of wireless telegraphy.

Adolph K. H. Slaby (Germany) brought out a book describing a wireless telegraph system that he developed that was capable of carrying signals over a

---

<sup>18</sup> A very interesting and detailed critique of the beginning of radio telegraphy in the roles played by Lodge, Marconi, and Popov is given in reference [18].

<sup>19</sup> Credits and countercredits on priority of invention or discovery are not uncommon in the realm of science and technology. Such had been the situation of Marconi and Popov with radio telegraphy. So it was in the patents for the telephone; Gray and Bell applied for patents on the same day (February 14, 1876).

The discovery of electric induction by Henry and by Faraday more or less simultaneously grew out of studies by these two men over a period of time.

Adams of England first calculated the position of the planet Neptune, but observation of its position was delayed by the Greenwich Observatory. Although the Frenchman Leverrier calculated the position of Neptune at a later date than that of Adams, its observed position through the cooperation of the German astronomer Galle came earlier than the Greenwich observation.

distance of more than 10 miles. Slaby set up a firm to manufacture wireless equipment.

Joseph John Thomson (England), director of Cavendish Laboratory, Cambridge University, identified cathode rays as extremely small charged particles, electrons. Sir Thomson received the 1906 Nobel Prize in Physics "for his theoretical and experimental investigations into the transmission of electricity through gases."

1898 Michael I. Pupin was granted a U.S. patent for an electrolytic detector.

Oliver Lodge was granted a U.S. patent for a method of tuning radio circuits. Others who developed tuning circuits at this period were Marconi and Muirhead in England, Slaby and Braun in Germany, and John S. Stone in the United States.



*Edouard Branly*  
1844-1940

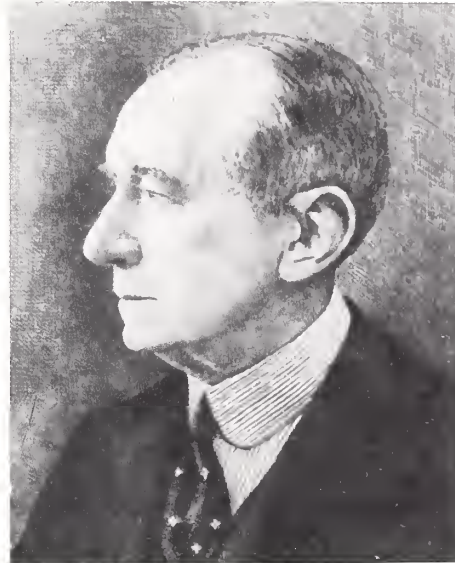

*Guglielmo Marconi*  
1874-1937



*Aleksandr-Stephanovich Popov*  
1859-1905

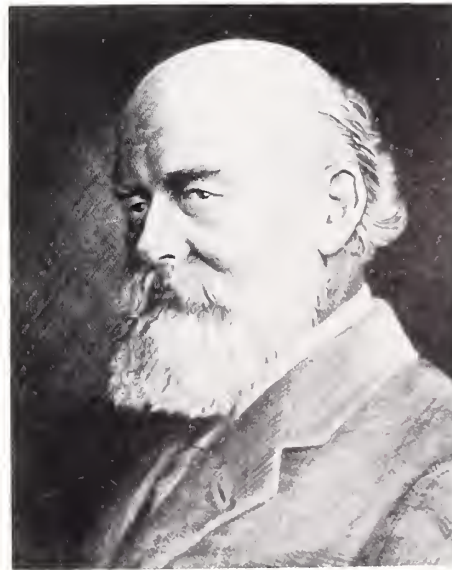

*Oliver Joseph Lodge*  
1851-1940

1899 Marconi communicated by wireless telegraphy across the English Channel on March 27, a first time for the mode of communication.

The first distress signal by wireless was sent by the *East Goodwin Sands* lightship off the English coast after being struck by the steamship *R. F. Mathews*.

The first American radio company was incorporated, the American Wireless Telephone and Telegraph Co.

The Marconi Wireless Telegraph Co. of America was organized on November 22.

1900 John S. Stone applied for a U.S. patent on a radio tuning device, February 8.

Marconi was granted a British patent for tuned circuits incorporating inductively coupled resonant circuits with capacitative tuning. The famous patent, bearing No. 7777, was granted on April 26. The tuned circuitry was the forebear of most tuning circuits to follow.

William D. Duddell (England) discovered that the electric arc could be made to generate high-frequency oscillations.

Nikola Tesla was granted a U.S. patent on control at a distance by radio.

Reginald A. Fessenden was first to be successful in the transmission and reception of speech, using a spark transmitter. The experiments were conducted in December at Cobb Island, Md. [19].

1901 On September 27 Fessenden filed for a U.S. patent on a system of wireless telephony.<sup>20</sup> On the following day, September 28, Fessenden filed for a U.S. patent on a method of receiving undamped waves (CW) which became known as the heterodyne method. This method was destined to become almost universally used for the reception of radio signals.<sup>21</sup>

Marconi succeeded in receiving the letter "S" in Morse code across the Atlantic Ocean on December 12. The signal was transmitted from Poldhu, in southwest England and was received at St. Johns, Newfoundland.

1902 On February 10 Cornelius D. Ehret of Philadelphia, Pa. filed for two U.S. patents on a method of modulation by varying the resistance or reactance of an oscillator, probably the first to state that it was a frequency-modulation method of controlling a carrier frequency.

---

<sup>20</sup> Up to the time of Fessenden's experiments on Cobb Island, Md., and his later filing of patents relating to wireless telephony, the development of radio was in the direction of using the "whiplash" effect of highly damped oscillations, whereas Fessenden saw the future was in the use of continuous oscillations (CW), especially for communication by voice and other sounds.

In his patent, filed on September 17, 1901, for "Wireless Telephony," Fessenden made the claim, "In a system for transmission of speech by electromagnetic waves, the combination at the sending station of means for the practically continuous generation of electromagnetic waves, a telephone transmitter for modifying the character of the waves or impulses ("modulation"—author), and a telephone receiver at the receiving station responsive to currents generated by the electromagnetic waves" [20].

Fessenden developed spark transmitters (operating at high spark frequencies) and, later, high-frequency alternators (rotating generators) that permitted him to use voice modulation on the carrier wave. For these attainments he was awarded the Medal of Honor in 1921 by the Institute of Radio Engineers for his developments in continuous wave telegraphy and telephony.

<sup>21</sup> Fessenden's U.S. patent for the heterodyne method of receiving radio signals was titled "Localization by generation and receiving two sets of waves of different periodicities." One of the several claims was, "In a system of signalling by electromagnetic waves, the combination of a source of waves of different periodicities and two or more receivers responsive respectively to the differing waves or impulses, and a wave-responsive device operative when the waves or impulses attain a certain predetermined phase relation" [21].

This patent was applied for on September 28, 1901, and granted on August 13, 1902, as No. 706,740. For years afterward the patent was subject to legal investigation.

It is interesting to note that Fessenden began calling it the "heterodyne" method of reception, taking the term "hetero" from the Greek for the "difference" frequency produced by beats between two frequencies, one the transmitted frequency, the other being generated locally at the receiving station by a small arc transmitter (oscillator). In later years the local oscillation was generated by a vacuum tube. It was the ease by which the difference frequency or beat note (intermediate frequency) could be amplified (accompanied by high selectivity and high signal-to-noise ratio in the circuitry) that gave rise to the great popularity of the superheterodyne receiver in later years.

Marconi was granted four U.S. patents on the magnetic detector.

Kaiser Wilhelm of Germany proposed holding an international radio conference.

Marconi discovered that radio signals can be received over much longer distances at night than during the day. Observations were made while voyaging on the SS *Philadelphia*.

Arthur E. Kennelly and Oliver Heaviside (England) independently suggested that Marconi's success with long distance wireless reception could be explained by reflection from an electrically conducting layer in the Earth's upper atmosphere [22,23]. These suggestions were to open up a vast field in radio science in future years.

Captain Henry B. Jackson of the British Navy (later Admiral Sir and First Sea Lord of the Admiralty) published the first extensive quantitative propagation measurements over land and sea (*Proceedings of the Royal Society*, London, Vol. 70, 1902). His observations formed a pioneer study of the effect on transmission of radio waves (approximately 1400 kHz) by atmospheric conditions, by obstacles of different land formations, and by lightning discharges.

1903 Valdemar Poulsen (Denmark) was successful in applying the electric arc as the oscillator in high-power radio transmitters.

On April 9 Fessenden applied for a U.S. patent on the electrolytic detector, calling the device a "liquid barretter."

The General Electric Co. at Schenectady, N.Y. constructed the first large-scale, high-frequency alternator for Fessenden, operating at a frequency of 10,000 Hz.<sup>22</sup>

(Preliminary) International Conference on Wireless Telegraphy convened in Berlin, Germany.

Lee de Forest was granted a U.S. patent on a magnetic detector.

<sup>22</sup>The conception of the high-frequency alternator (ac generator) is due to Fessenden, with some of the later developments contributed by Ernst F. W. Alexanderson of the General Electric Co., also by Rudolph Goldschmidt. Fessenden built the earliest models as generators for his wireless telephone equipment. Alternators were built to operate as high as 100,000 Hz, and at power ratings up to several hundred kilowatts, but fell into disuse with the advent of vacuum tubes that could serve in high-power transmitters. However, the abandonment of high-frequency alternators was a slow process, some of the machines being used as late as the World War II period.

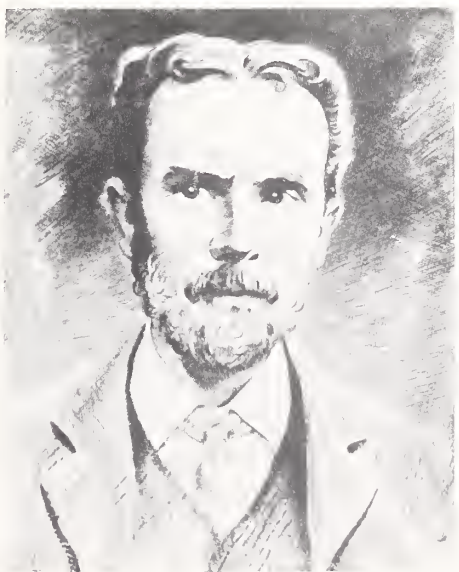

Oliver Heaviside  
1850-1925



Lee De Forest  
1873-1961

O. W. Richardson (England) showed that thermionic emission at saturation current in highly evacuated vacuum tubes was from free electrons emitted by the hot filament and was dependent upon the absolute temperature and work function of the filament.

1904 John Ambrose Fleming (England) applied for a British patent on the two-element vacuum tube for use as a detector [24,25].

1905 A U.S. patent was granted to Fleming on the two-element thermionic vacuum tube, known popularly as the "Fleming valve."<sup>23</sup>

1906 In January the first two-way transmission of messages by wireless telegraphy across the Atlantic Ocean was carried on by Fessenden. The stations were located at Brant Rock, Mass. and at Machrihanish in southwestern Scotland.

Ettore Bellini and Alessandro Tosi (Italy) pioneered in the development of radio direction finders [26].

First radio conference, known as the (First) International Radiotelegraph Conference, was held in Berlin. (A preceding conference, held in 1903, is known as the (Preliminary) International Conference on Wireless Telegraphy.)

H. C. Dunwoody discovered rectifying properties of carborundum crystals; Greenleaf W. Pickard discovered the rectifying properties of silicon.<sup>24</sup>

Lee de Forest invented the three-electrode thermionic vacuum tube, one of radio's greatest contributions [27,28].<sup>25</sup>

Fessenden transmitted music and speech with an 80-kHz alternator from Brant Rock, Mass.; the transmission was received by ships off the Virginia coast. This event is usually referred to as the first broadcast for entertainment.

1908 A. A. Campbell-Swinton (England) published a paper in *Nature* (London) that was remarkable in its prediction of television technology as we know it today [30,31].<sup>26</sup>

1909 On January 23 the SS *Republic* collided with the SS *Florida* off Nantucket Island near New York. Distress calls sent out by the radio operator of the *Republic* resulted in the saving of all but six lives in the disaster. The world acclaimed the use of radio at sea.

Marconi (Italy) and Braun (Germany) were awarded jointly the Nobel Prize in Physics "for their development of wireless telegraphy."

1910 On January 10 Lee de Forest used a transmitter incorporating an arc oscillator to broadcast the voices of Enrico Caruso and Emmy Destin from backstage of the Metropolitan Opera House. De Forest had used this system of radio telephony several years earlier but not until 1910 had he engaged the services of such illustrious performers in his broadcasts.

Distance observations of radiotelegraphic signals from Brant Rock, Mass., to two U.S. Navy ships in the Atlantic Ocean resulted in the well-known Austin-Cohen transmission formula. See chapter II, pp. 34-35.

<sup>23</sup>The "Fleming valve" became a popular detector until the more sensitive three-element tube, developed by de Forest, came into existence a few years later.

<sup>24</sup>These crystals, used as detectors, usually were operated in solid contact with a metal electrode, unlike the "cat whisker" used on galena crystals. These crystal detectors were the forerunner of some of the semiconductor devices to come in later years.

<sup>25</sup>Several years of experimenting with the Fleming-type vacuum tube resulted in de Forest introducing a third electrode (grid) between the filament and plate. With the adding of a "B battery" to obtain a high potential on the plate, de Forest had a radio detector of much greater sensitivity than that of other detectors in use at the time.

De Forest applied for a patent on his three-electrode thermionic vacuum tube as a detector of wireless telegraphy on October 25, 1906. The patent was granted January 15, 1907, as No. 841,387. He applied for a second patent on January 29, 1907, for use of the vacuum tube as a telephone repeater and relay. This patent was granted on February 18, 1908, as No. 879,532. The name "audion" became very popular for the three-electrode vacuum tube, whether used as a detector or as an amplifier. The name is attributed to one of de Forest's assistants, and was adopted by his engineers because "it had a pleasant, swinging sound" [29].

<sup>26</sup>Campbell-Swinton clearly indicated the fundamental limitations of mechanical systems of transmitting pictures at a distance, and proposed an all-electric system incorporating a scanning cathode-ray tube and photocells at the transmitting end, and a scanned cathode-ray tube at the receiving end, with synchronization of the signals.



The Radio Ship Act of 1910 was enacted (U.S. Public Law 262, Frye Bill).<sup>27</sup>

Oscillations in galena-crystal detectors were first observed by W. H. Eccles (England). Demonstrated before Physical Society of London in May 1910 [32].<sup>28</sup>

1912 Frederick A. Kolster of the Bureau of Standards developed the direct reading decimeter and wavemeter [33].

On the night of April 14 radio aided in saving approximately 750 lives in the SS *Titanic* disaster.

On May 13 the Institute of Radio Engineers was formed by combining the Wireless Institute and the Society of Wireless Telegraph Engineers [34].

The (Second) International Radiotelegraph Conference (first revisional conference) was held in London, England during June and July. The role played by wireless in the *Titanic* disaster just a few weeks before had a profound effect upon actions taken by the Conference.

On August 13 the Congress passed a bill that became Public Law 264. It gave the Government (Secretary of Commerce and Labor) power of the licensing and considerable control of commercial and amateur radio stations, and the licensing of operators. The act became effective on December 13.

Irving Langmuir developed the first highly evacuated thermionic vacuum tubes.<sup>29</sup>

Harold D. Arnold initiated development of oxide-coated filaments for thermionic vacuum tubes for greater tube life and more stable performance.<sup>30</sup>

In October, de Forest demonstrated the first cascaded amplifiers by using two or more three-element tubes.

1913 On February 13 the powerful radio station NAA at Arlington, Va. was commissioned for use by the U.S. Navy. Along with Navy communications and the time-signal service furnished by the U.S. Naval Observatory, it also had limited use by other Government departments.

In April, de Forest found that his three-element vacuum tube (audion) could operate as an oscillator and could be used as a heterodyne detector [36].

Edwin H. Armstrong filed application on October 29 for a patent on a regenerative or "feedback" circuit. Patent granted October 6, 1914.

1914 De Forest filed application on March 20 for a patent on a regenerative or "feedback" circuit. Patent granted September 2, 1924, after years of litigation [37].

On May 18 the American Radio Relay League (ARRL) of radio amateurs was organized through the efforts of Hiram Percy Maxim.

Radio had an important role in communications early in World War I.

---

<sup>27</sup> This law, effective July 1, 1911, made it unlawful for any ship carrying more than 50 passengers and crew, plying between ports more than 200 miles apart, to leave port in the United States unless equipped with proper wireless apparatus and having a skilled operator aboard.

The act was extended in 1912 to include cargo vessels, and to require that two or more skilled wireless operators were to be in charge of the wireless apparatus on certain passenger ships.

<sup>28</sup> Fourteen years after Eccles demonstrated the existence of oscillations in crystal detectors, several papers that included a variety of circuit designs appeared in 1924 in the English periodical *Wireless World and Radio Review*. It is interesting to note that these observed oscillations and amplifying properties of crystals preceded later developments of semiconductor diodes and transistors by several decades.

<sup>29</sup> Heretofore all vacuum tubes contained considerable amounts of residual gases because of inadequate evacuation techniques. These "soft" tubes were soon to be replaced by "hard" tubes that had only extremely small traces of residual gases and were far more stable in operation. A few types of tubes were purposely made "soft," especially those used for detection where gaseous ionization made the tube more sensitive to weak signals, e.g., the early "audions" or later soft tubes such as the type 200 tubes.

<sup>30</sup> Although Wehnelt (Germany) observed the copious thermionic emission from oxide-coated filaments in 1904, it was not until 1912 that Arnold of the Western Electric Co. suggested their use for large-scale production of vacuum tubes. By 1920 the Western Electric Co. had produced many types of vacuum tubes, including amplifier tubes for telephone relays, that used the oxide-coated filament for long life and greater stability of operation [35].

- 1915 Voice communications by the American Telephone and Telegraph Co. operating from NAA, Arlington, Va. were received in Paris, Canal Zone, and Honolulu.

In August, David Sarnoff, then of the Marconi Wireless Telegraph Co. of America, wrote his famous memo to his superiors proposing a "radio music box" that could be used to bring music into the home by "wireless." Radio broadcasting in the 1920's brought his proposal to fulfillment.

- 1916 Radio stations in Highbridge, N.J. and in New Rochelle, N.Y. began voice and music transmissions received by amateurs at distances up to several hundred miles.

Kolster of the Bureau of Standards applies for patent on Radio Compass, March 31.

- 1917 All amateur and commercial radio stations in the United States were either closed down or taken over by the Navy on April 7, after the United States entered World War I on April 6. The ban on amateur stations was removed in mid-1919.

Walter Schottky published his investigations on the random fluctuations in emission of electrons from emitters such as the cathode of vacuum tubes. Usually referred to as the "shot effect" [38].

- 1918 Radio telegraphy and telephony proved to be of great importance in warfare as World War I came to a conclusion at the signing of the armistice on November 11.

- 1919 The first scheduled broadcasts by a noncommercial organization were made by station 9XM (later WHA) operated by the University of Wisconsin at Madison, beginning in January.

On February 8 Major E. H. Armstrong applied for a patent on the superheterodyne circuit.<sup>31</sup> The patent, bearing No. 1,342,885, was granted June 8, 1920 [39].

Radio Corp. of America (RCA) was incorporated on October 17.

- 1920 On February 29 all commercial stations taken over by the U.S. Navy during World War I were returned to their owners by Executive order.

The broadcasting of the Harding-Cox election returns by KDKA, Pittsburgh, Pa., on the night of November 2 is usually regarded as the world's first scheduled broadcast by a commercial organization.<sup>32</sup>

- 1921 By 1921 the Radio Corp. of America possessed rights to over 2000 patents relating to radio.

Initial theory of the magnetron was developed by Albert W. Hull [42].

The Bureau of Standards initiated the development of an aural radiobeacon system for the Army Air Service for use on fixed airways. This work led to many developments in air navigation, including a visual-type radiobeacon and a blind landing system [43].

On November 5 President Harding formally opened the powerful facility "Radio Central" by sending a radiogram to all nations. The radio communications center, located at Rocky Point, near River Head, Long Island, was built and operated by the Radio Corp. of America. In October 1922 it began operation with 20-kW transmitting tubes.

---

<sup>31</sup> The superheterodyne circuit was a World War I development by Armstrong that grew out of the exigencies of the war for a very sensitive receiver, with sharp tuning, that would operate below 600 meters (above 500 kHz). The superheterodyne circuit has proved to be the most useful of all receiver circuits and is the basis of most receiver designs since the time that regenerative receivers proved to be impractical.

The technical story is traced in two references cited below, plus contained reference to Schottky that gives some little-known information on the background and development of the superheterodyne circuit [40,41].

<sup>32</sup> Dr. Frank Conrad, an engineer for the Westinghouse Electric and Manufacturing Co. of Pittsburgh, had been operating experimental station 8XK in nearby Wilkesburg for several years prior to 1920. Enough interest had been created in the Westinghouse Co. that an application had been authorized to set up a station for scheduled broadcasting. The letters KDKA (transmitter at East Pittsburgh) were assigned to the world's first commercial broadcasting station, with an operating wavelength of 360 meters (833.3 kHz).

Not to be overlooked, and with claims by other stations of priority in scheduled broadcasting before that of KDKA, were broadcasts from stations 9XM operated by the University of Wisconsin (see entry under 1919) and WWJ operated by the Detroit Free Press at Detroit, Mich.

On December 11 the first complete message on “short waves” (230 meters) across the Atlantic was transmitted by radio amateurs from Greenwich, Conn. and was received by an amateur at Ardrossan, Scotland.

1922 The First National Radio Conference, relating to broadcasting, convened on February 27 in Washington, D.C.

Edwin H. Armstrong presented a paper on the superregenerative circuit before the Institute of Radio Engineers in New York on June 7 [44].

On June 14 Warren G. Harding became the first President to make a radio broadcast by a commercial station. Station WEAR (later WFBR) in Baltimore, Md. broadcast Harding’s speech at the dedication of the Francis Scott Key Memorial at Ft. McHenry, Baltimore. Fifteen days earlier, on May 30, President Harding’s speech at the dedication of the Lincoln Memorial in Washington, D.C., had been broadcast by the U.S. Navy’s station NSF operated by the Naval Aircraft Radio Laboratory.

On June 20, 1922, Marconi pointed out in his address in New York, on the occasion of receiving the Medal of Honor from the Institute of Radio Engineers, the importance of short-wave radio (1 to 20 meters) in the future [45]. He particularly pointed out the recent work in this field by C. S. Franklin of the British Marconi Co.<sup>33</sup>

A. H. Taylor and L. C. Young of the Naval Aircraft Radio Laboratory observed sharp changes in signal strength as boats would pass between the transmitter and receiver located on opposite banks of the Potomac River below Washington. Changes in signal strength were accounted for by changes of amplitude in the interference wave pattern caused by boats moving across the transmission path. These observations are often referred to as the first radar “discovery.”

Near the end of 1922 a total of 569 radio broadcasting stations had been licensed.

The British Broadcasting Co. was formed on December 15 (became the British Broadcasting Corp. January 1, 1927).

Louis A. Hazeltine developed the neutrodyne circuit for radio receivers which became very popular for broadcast receivers for a period of about 5 years [46].<sup>34</sup>

---

<sup>33</sup> At the June 20, 1922, meeting referred to above, Marconi said, in part:

Before I conclude I should like to refer to another possible application of those waves which, if successful, would be of great value to navigation.

As was first shown by Hertz, electric waves can be completely reflected by conducting bodies. In some of my tests I have noticed the effects of reflection and deflection of these waves by metallic objects miles away.

It seems to me that it should be possible to design apparatus by means of which a ship could radiate or project a divergent beam of these rays in any desired direction, which rays, if coming across a metallic object, such as another steamer or ship, would be reflected back to a receiver screened from the local transmitter on the sending ship and thereby immediately reveal the presence and bearing of the other ship in fog or thick weather.

One further great advantage of such an arrangement would be that it would be able to give warning of the presence and bearing of ships, even should these ships be unprovided with any kind of radio.\* \*\*

\*It was not until 1930 that this prophetic statement of Marconi came true in the sense of radio signals being reflected from a metallic object—in this case reflections from a plane being observed by L. C. Young (and L. A. Hyland) of the U.S. Naval Research Laboratory.

\*\*Occasionally reference is made to Nikola Tesla as having first described the principle of radar, taking the cue from an article written by Tesla in the June 1900 issue of the *Century* magazine. In one instance Tesla states for electrical waves that:

For instance, by their use we may produce at will, from sending-station, an electrical effect in any particular region of the globe; we may determine the relative position or course of a moving object, such as a vessel at sea, the distance traversed by the same, or its speed;...

Whether Tesla envisioned “radar” in the same concept as Marconi in 1922 is a moot question.

<sup>34</sup> The neutralization of capacitive coupling in vacuum tubes had its origin with Hazeltine in 1918 when he reported on work with oscillating vacuum-tube circuits [47].

1923 First public demonstration of single-sideband radio telephony on January 5.<sup>35</sup>

C. Francis Jenkins transmitted photographs via radio from Washington to Philadelphia on March 23.

E. F. Nichols and J. D. Tear reduced the measured fundamental wavelengths of the electromagnetic spectrum from 7 mm (43,000 MHz) to 1.8 mm (167,000 MHz), an interval of 2 octaves [48].<sup>36</sup>

On November 27 the first two-way messages across the Atlantic at 100 meters were transmitted and received by radio amateurs at Hartford, Conn. and Nice, France.

Vladimir K. Zworykin filed a patent application on December 29 for an iconoscope. Patent finally issued December 20, 1938.

1924 First transatlantic transmission of photograph via radio, from New York to London.

U.S. Naval Research Laboratory designed and constructed the first crystal-controlled radio transmitter.

1925 Professor Edward V. Appleton (England) and several of his students determined the height of the Kennelly-Heaviside layer(s) by (1) a vertical triangulation technique, and (2) a frequency-change method of observing the height by an interference pattern of direct wave and skywave [49].

U.S. Naval Research Laboratory developed radio transmitting equipment using pulsed CW. Pulsed transmitters were to prove very useful in ionospheric observations and later for radar.

---

<sup>35</sup> This first demonstration by the American Telephone and Telegraph Co. and the Radio Corp. of America was used in transatlantic radio telephony between Rocky Point, Long Island, and New Southgate, England. Although single-sideband transmission had been used first some years previously for wire telephony, this was the first application to a commercial radio telephony system.

<sup>36</sup> At the time of this work in 1922, two more octaves in frequency remained to close the gap between the electrical wave spectrum and the far infrared. Although fairly accurate measurements were made at the fundamental frequencies of the electrical waves by Nichols and Tear, they were generating trains of highly damped oscillatory spark discharges and not CW radiation. Some years later the gap was closed by measured wavelengths in the far infrared. However, the gap was not closed with coherent radiation until many years later with the development of lasers.



*Edwin H. Armstrong*  
1890-1954



*Edward Appleton*  
1892-1965

Gregory Breit and Merle A. Tuve of the Carnegie Institution, Washington, D.C., with the cooperation of the Naval Research Laboratory, made the first observations of the ionosphere by reflection of pulsed radio waves [50].

C. Francis Jenkins demonstrated television on June 13, using a mechanically rotating scanning disk, by radio transmission between Anacostia Naval Air Station and his laboratory near Washington, D.C. [51].

- 1926 RCA established point-to-point radio facsimile service between New York and London, and transmitted the first commercial picture across the Atlantic on May 1.

Radio broadcast receivers operating from 60-Hz alternating current were introduced by RCA.

The National Broadcasting Co. was organized on September 9 with 24 stations comprising the NBC network, and began operations on November 15.

Yagi-Uda high-gain, directional VHF-UHF antenna was invented by Hidetsugu Yagi and Shintaro Uda (Japan) [52].

Albert W. Hull and N. H. Williams published development work on screen-grid tubes of improved design and operating characteristics [53,54].<sup>37</sup>

- 1927 Commercial radiotelephone service between New York and London was instituted on January 7.

Philo Farnsworth filed for a U.S. patent on an electronic television system on January 7.

John L. Baird (Scotland) described his television system, incorporating a mechanical disc with 30 lenses, at Glasgow, Scotland, on February 3.

On February 23 President Coolidge approved the Radio Act of 1927, enacted by Congress, that established the Federal Radio Commission for a period of 1 year. On March 2 Rear Admiral W. H. G. Bullard, USN (retired), became the first chairman.

Bell Telephone Laboratories demonstrated wire television between Washington, D.C. and New York on April 7 and radio television between Whippany, N.J. and New York on April 16.

The (Third) International Radiotelegraph Conference (2d revisional conference) was opened by President Coolidge in Washington, D.C. on October 4; it was presided over by Secretary of Commerce Hoover.<sup>38</sup>

- 1928 U.S. Government began installations of radio range stations as navigational aids to mail-carrying planes.

First practical construction and use of cyclotron type of magnetron by H. Yagi (Japan) [55].

J. B. Johnson of the Bell Telephone Laboratories determined experimentally the noise power of the thermal fluctuations in resistors, an effect usually referred to as "Johnson noise." Concurrently, H. Nyquist succeeded with a theoretical approach to the noise problem.<sup>39</sup>

---

<sup>37</sup> Although the first development on screen-grid tubes was carried out by W. Schottky (Germany) as early as 1919, it was Albert W. Hull's contributions published in 1926, of more complete shielding of the grid, that led to a manufactured tube (of the 222 type for radio receivers) in 1927. A screen-grid tube suitable for ac heating of the cathode appeared in 1929 and became quite popular. Tetrodes suitable for transmitters also became available.

<sup>38</sup> It was at this conference that the International Radio Consultative Committee (CCIR) was set up to "study technical and operating questions relating specifically to radio communications and issue recommendations on them," and that the committee "shall pay due attention to the study of questions directly connected with the establishment, development, and improvement of telecommunications in new and developing countries, in both the regional and international fields." This committee would play, and continues to play, a prominent role in the technical aspects of radio on an international basis.

<sup>39</sup> The noise power equation  $E^2 = 4kRT(f_2 - f_1)$  is a very important relation in electronic circuitry, where  $E^2$  is the mean square voltage,  $k$  is Boltzman's constant,  $R$  the resistance component of impedance producing the thermal voltage,  $T$  the temperature in kelvins, and  $f_2$  and  $f_1$  the upper and lower limits of the frequency band considered. F. B. Llewellyn of Bell Telephone Laboratories made extensive use of the noise power equation in the study of noise in the circuits associated with vacuum tubes.

Color television was demonstrated by John L. Baird (Scotland) on June 3 in England, using a three-spiral mechanical scanning disc at transmitter and at receiver.

- 1929 Application was filed on May 23 for a patent on the Espenshied-Affel coaxial cable for use as a wide-band, long-distance transmission cable including transmission of television signals.

Vladimir K. Zworykin demonstrated the kinescope (cathode-ray TV picture tube) to the Institute of Radio Engineers on November 18.

- 1930 Two-way wire television demonstrated by Bell Telephone Laboratories on April 9.

First round-the-world broadcast from Schenectady, N.Y. and back to point of origin (accomplished with several relay stations).

Pentode tubes became available for the power output stage of broadcast receivers, although such tubes had been in use in Europe for several years before 1930.

U.S. Naval Research Laboratory made some "accidental" observations on a short-wave direction-finding system that was an important step toward the development of radar.<sup>40</sup>

- 1931 Microwave transmission of voice-modulated carrier of 18 cm (1700 MHz) across the English Channel between Dover, England and Calais, France on March 31.

Experimental television transmitter opened on July 21 by Columbia Broadcasting System at the top of the Chrysler Building, New York City.

On September 5 two pilots, in the employ of the Department of Commerce, made the first blind landing at the airport at College Park, Md., using radio equipment developed by the Bureau of Standards [56].<sup>41</sup>

Experimental television transmitter opened on October 30 by the Radio Corp. of America on top of the Empire State Building, then the world's tallest building.

During the period 1931-1932 Marconi found that propagation at a wavelength of 60 cm was at least five times the optical distance, in contradiction to theory [57].

- 1932 The (Fourth) International Radiotelegraph Conference (3d revisional conference) was held in Madrid, Spain at which time the Telegraph Union and the Radiotelegraph Union were merged into one organization, named the International Telecommunication Union (ITU).<sup>42</sup>

Karl G. Jansky of Bell Telephone Laboratories published his first paper in December of work started in August 1931 on directional studies of atmospheric in

---

<sup>40</sup> In using a short-wave direction-finding system, Naval Research Laboratory personnel observed unusual operating conditions occurred when planes passed between a transmitter and a receiver located at several miles distance. These "accidental" observations gave impetus to the development of radio methods of detecting distant objects. Previously, in 1922, personnel of the Naval Research Laboratory had observed unusual reception of signals when ships passed between a radio transmitter and a receiver located on opposite shores of the Potomac River. The observed phenomenon of "beat" signals showed promise of a means of detecting ships in a fog or entering a harbor.

<sup>41</sup> Many blind landings were made at College Park subsequent to this event by using a hooded cockpit. A similar radio installation was made at the airport at Newark, N.J. On March 20, 1933, the plane taking off from College Park for Newark encountered "no-visibility" conditions and continued its flight and landed at the Newark Airport by means of the instrument-flying radio equipment.

<sup>42</sup> From the volume published by the ITU on the occasion of the centenary of the International Telecommunication Union, entitled *From Semaphore to Satellite* (Geneva, Switzerland, 1965), we learn that the word "telecommunication" was first used at the beginning of the 20th century by Edouard Estaunie, at that time Director of the Ecole Supérieure des Postes et Télégraphes de France.

The new term "telecommunication" was defined at the Madrid Conference as "any telegraph or telephone communication of signs, signals, writings, images, and sound of any nature, by wire, radio, or other system or processes of electric or visual (semaphore) signalling." Today the ITU defines telecommunication as "any transmission, emission, or reception of signs, signals, writings, images, and sounds, or intelligence of any nature by wire, radio, visual, or other electromagnetic systems."

the short-wave region (14.6 meters, 20.5 MHz) that soon led him and others to open up the whole new field of radio astronomy [58,59].<sup>43</sup>

- 1933 On March 4 the inauguration ceremonies of President Franklin D. Roosevelt were broadcast internationally.
- 1934 C. E. Cleeton and N. H. Williams of the University of Michigan observed the ammonia inversion transition using a magnetron oscillator. Their investigation was the first experimental work in microwave spectroscopy and opened a whole new field in physics [60].

Station WLW, Cincinnati, Ohio, began broadcasting on 500,000 watts on May 1 as an experimental operation. Authorization for this high output was later withdrawn, with no licensing of broadcasting transmitters with output above 50,000 watts thereafter.

On June 9 the Communications Act of 1934 was signed by President Roosevelt, establishing the Federal Communications Commission as the successor to the Federal Radio Commission.

Successful experiments were performed by Ross Hull in New England during the summer of 1934 in transmission, at 5 meters, up to several times the calculated distance based upon the then existing theories. An outstanding achievement by a radio amateur who was able to explain the type of propagation.

On October 9 the Supreme Court of the United States upheld Dr. Lee de Forest as the inventor of the regenerative or "feedback" circuit.

During 1934 the Naval Research Laboratory designed and constructed the world's first pulse-type radar. It was successfully operated in December at 60 MHz, receiving saturated signals reflected from an airplane at 1 mile distance.

- 1935 In June a team of British scientists under direction of Robert A. Watson-Watt demonstrated (secret project) the first use of radar by the English of detecting echoes from an airplane. By March of 1936 they were able to detect planes at a distance of more than 80 miles.<sup>44</sup>
- 1936 George C. Southworth of Bell Telephone Laboratories and W. L. Barrow of Massachusetts Institute of Technology published accounts of developments in waveguide theory and experimental equipment.<sup>45</sup> During the next several years Southworth presented a number of experimental lectures on the properties of waveguide before various technical groups.

In May, Edwin H. Armstrong published his very important paper on a complete frequency-modulation system (transmitter and receiver) for minimizing static [63]. The design, construction, and testing of the equipment covered several years prior to publication of investigations.

On June 11 the Radio Corp. of America demonstrated the operation of a two-way radio relay system between New York and Philadelphia, operating above 30 MHz.

The Naval Research Laboratory succeeded in operating a radar with a single antenna by using a duplexer to control switching of the transmitter and receiver.

In December the coaxial cable installed between New York and Philadelphia by the American Telephone and Telegraph Co. was placed under test.

---

<sup>43</sup> Jansky's large rotating antenna was located at Holmdel, N.J., where he performed the early work on radio astronomy. The antenna was dismantled in 1944 but an operating replica is set up at the National Radio Astronomy Laboratory at Green Bank, W. Va.

<sup>44</sup> Robert A. Watson-Watt was knighted in 1942 as Sir Robert, as "a pioneer in radio location, who harnessed radar as a practical operational science."

<sup>45</sup> Propagation of electromagnetic waves in hollow metal pipes was suggested by J. J. Thomson as early as 1893, and later by Lord Rayleigh in 1897. Southworth gives a short but excellent account of the history of waveguide development in his treatise on the subject [61]. An interesting account of microwave antennas and waveguide techniques developed by Hertz, Lodge, Marconi, and others before 1900 is given in a paper by Ramsey [62].

1938 In January RCA engineers demonstrated the use of radar techniques for an altimeter and as a warning device to indicate the presence of mountains or other aircraft.

The International Telecommunication Union met for the International Telecommunication Conference (4th revisional conference) in 1938 in Cairo, Egypt. A far-reaching result of this conference was the allocation of radio channels for intercontinental air routes.

First atomic and molecular beam resonance experiments by I. I. Rabi and students at Columbia University [64]. The method developed is now used as the basic principle in all cesium (and other) beam frequency standards.

The first operational radar installation on a U.S. Navy vessel was installed on the U.S.S. *New York*.

On October 10 the Bell Telephone Laboratories demonstrated a radio altimeter that gave a dial reading in feet of the distance above the earth's surface.

1939 On January 17 Edwin H. Armstrong demonstrated a frequency-modulation system operating at 7.5 meters (40 MHz) with a 40-kW transmitter (W2XMN) set up at Alpine, N.J. across the Hudson River from New York City. It was the forerunner of many FM broadcasting stations to come.

On February 17 the National Bureau of Standards inaugurated a new science, the forecasting of radio transmission data, an "ionosphere" reporting service similar to that of weather forecasting [65,66].<sup>46</sup>

The first practical klystron was developed by the Varian brothers, Russell and Sigurd [68].

Television was introduced, with great success, to the public at the New York World's Fair, by the National Broadcasting Co. At the opening ceremony on April 30, Franklin D. Roosevelt was the first U.S. president to be televised.

The National Broadcasting Co. applied for a license on July 13 to operate the first FM transmitter for regularly scheduled radio broadcasting service.

High-power, pulsed, cavity-type magnetrons were developed by H. A. H. Boot and J. T. Randall (England) at the University of Birmingham, England [69].

On September 1 the world heard broadcast announcements of the German invasion and bombing of Poland, initiating World War II.

1940 Color television, using electronic equipment only (no mechanical or rotating devices), was demonstrated by RCA to the Federal Communications Commission on February 6.

Color television, using a mechanical rotating disc in a sequential three-color system, was demonstrated by the Columbia Broadcasting System on August 28.

Work on the proximity fuze started in the United States in August 1940 under the auspices of the Office of Scientific Research and Development (OSRD).

Radiation Laboratory established under the administration of the Massachusetts Institute of Technology.

In November, Alfred L. Loomis suggested an electronic air navigation system which led to the development of the Loran system by Radiation Laboratory at MIT. The first Loran system was placed in operation on October 1, 1942, between Delaware and Nova Scotia.

---

<sup>46</sup>The prediction service inaugurated in 1939 became much more sophisticated in later years as the science of the ionosphere developed. See [67]. In the early service, prediction could be made for a period 1 month after publication of a chart(s). The charts indicated the maximum usable frequencies (muf) for skywave transmission (reflection from ionosphere layers) for the days of an undisturbed ionosphere, in terms of local time at location of reflection (halfway between transmitter and receiver for one "hop" or single reflection from ionosphere). (See ch. VII, p. 238, footnote 96, for the term "muf.")



1941 On January 1, 20 years after the pioneer broadcasting by KDKA, Pittsburgh, there was a total of 802 broadcasting stations in the United States, and over 51 million radio receivers.

First broadcasting of color television on February 20 by the National Broadcasting Co. from transmitter on the Empire State Building in New York City.

In the spring of 1941 the U.S. Navy took responsibility for developing proximity fuzes for rotating projectiles such as anti-aircraft and artillery projectiles,<sup>47</sup> while the U.S. Army took responsibility for nonrotating projectiles such as bombs, rockets, and mortars [70,71].<sup>48</sup>

On December 7 the news was flashed by radio at 2:19 p.m., Eastern Standard Time, that the Japanese had attacked Pearl Harbor. War was declared on Japan on December 8, and on Germany on December 11.

All U.S. amateur radio stations were closed by order of the Federal Communications Commission on December 7.

1942 In August the U.S. Navy conducted successful trials with radio proximity fuzes by firing at radio-controlled target planes.

Development of printed circuits was initiated in 1942 by the National Bureau of Standards for the Army Ordnance Department for use in radio proximity fuzes. Large-scale production of the printed circuits came early in 1945 [72].<sup>49</sup>

1943 On January 5 first shells equipped with radio proximity fuzes were fired by the U.S.S. *Helena* in Pacific combat actions.

On April 27 the U.S. Army and Navy announced the lifting of restriction on the use of the word "radar."<sup>50</sup> Within a month the Navy released the first information on radar.

1944 In April an electromechanical computing machine, named the IBM Automatic Sequence Controlled Calculator, and more familiarly as "Mark I," was placed in operation at Harvard University. Construction of ENIAC, a completely electronic computer, was started in 1943 and completed in 1946 by the University of Pennsylvania.

R. Kompfner (England) initiated work in 1942 at the University of Birmingham, England, on the development of the travelling-wave tube, with completion of an operating tube in 1944 [73].

On August 5 Alfred N. Goldsmith applied for a U.S. patent on a three-gun tube, all-electronic color television system. The patent was issued to the Radio Corp. of America with whom Goldsmith was associated as a consultant.

---

<sup>47</sup> Development of proximity fuzes for rotating projectiles was placed under administration of Johns Hopkins University Applied Physics Laboratory, Silver Spring, Md.

<sup>48</sup> Development of proximity fuzes for nonrotating projectiles was placed under administration of the National Bureau of Standards, the group later to be known as the Diamond Ordnance Fuze Laboratories, and still later as the Harry Diamond Laboratories, agencies in the Department of the Army. The world's first successful radio proximity fuze was tested by NBS on February 12, 1941, at the Navy Dahlgren Proving Ground, Va.

<sup>49</sup> Subsequent to large-scale production in 1945 of printed circuits on an insulator base (usually a ceramic for small dimensional units), during the next 25 years there was a remarkable growth in the development of miniaturized electronic circuitry with accompanying industrial processes of manufacture. It is beyond the scope of this chronology to trace out the development in detail. Briefly, it took the course of printed wiring, the high density packaging of components, the development of thin film techniques (virtually a two-dimensional process), and, more recently, integrated circuits that combine solid-state elements. The field can now come under the general term of microelectronics. Advances in this technology have, and should continue to be, amazing.

<sup>50</sup> The name "radar" was coined by two U.S. Naval officers, F. R. Furth and S. M. Tucker, from the words Radio Detection And Ranging.

- 1945 A new weapon known as the "Bat" was the first fully automatic guided missile to be used in combat. It was used against Japanese ships and land targets in the Pacific area during the last year of the war.<sup>51</sup>

World War II ended on August 14 with the announcement by President Truman that the Japanese had surrendered.

After nearly 4 years of silence, the Federal Communications Commission lifted the wartime ban on one amateur band on August 21, and on other bands on November 15.

On October 22 Western Union opened service on a radio relay system between New York and Philadelphia—a forerunner of radio relay links that was to bring on a new method for communications.

On November 21 the Federal Communications Commission announced new rules and engineering standards for television, based upon technological advances made during World War II.

- 1946 On January 10 the Evans Signal Laboratories of the U.S. Signal Corps at Belmar, N.J. reflected a radar signal of 111.6 MHz from the Moon's surface. The elapsed time was 2.4 seconds for the round trip distance of 477,600 miles.

First transmissions of television over coaxial cable from Washington to New York were made on February 12.

On April 19 the first color television pictures were sent over the coaxial cable between Washington and New York.

Color television with an all-electronic system was first demonstrated publicly by the Radio Corp. of America at Princeton, N.J. on October 30.

- 1947 On January 3 the U.S. Congress was televised for the first time, the occasion being the opening of the 80th Congress.

The Nobel Prize in Physics was awarded to Sir Edward V. Appleton (England) "for his investigations of the physics of the upper atmosphere, especially for the discovery of the so-called Appleton layer."<sup>52</sup>

The International Telecommunication Conference (Atlantic City Conference) met in Atlantic City, N.J., for a 4 1/2 months session, beginning May 15. Of chief concern was the matter of frequency allocations on an international basis, because of the burgeoning of radio traffic due to World War II.

- 1948 At the beginning of 1948 there was a total of 1691 AM broadcasting stations and 374 FM broadcasting stations in the United States.

J. Bardeen and W. H. Brattain of the Bell Telephone Laboratories published their discovery of the transistor, a solid-state electronic device that could be used as an amplifier, oscillator, and for other purposes for which a vacuum tube could be used [74]. The date of December 23, 1947, is usually referred to as the time of the actual discovery of the point-contact transistor.

- 1949 On January 6 the world's first atomic clock (ammonia cell), developed by Harold Lyons of the National Bureau of Standards, was announced and demonstrated to newspaper reporters. It was the forerunner of many types of atomic clocks to be developed in the following years by research groups in various parts of the world.

President Truman's inauguration was televised on January 20, the first time for a Presidential inauguration.

---

<sup>51</sup>The "Bat," which incorporated a complete radar system that set the missile controls to home on an enemy target, was preceded by two other guided missiles, the "Robin" and the "Pelican." All were designed to be launched from a "mother" plane and glide to their target. The project was a cooperative effort between nine Government agencies and industrial laboratories, coordinated by the National Bureau of Standards.

<sup>52</sup>In 1924 Appleton and Barnett used a frequency variation method of observing the Kennelly-Heaviside layer. In 1926 they discovered the upper or F<sub>1</sub> layer, sometimes called the Appleton layer. It was found to be approximately 200 km or more above the Earth's surface.

W. Shockley, G. L. Pearson, and J. R. Haynes of the Bell Telephone Laboratories published their developments of the theory, physical explanation, and measurements of the mobility of electrons and movement of holes ("hole injection") by emitters in germanium in the operation of transistors [75].

1950 The FCC on October 11 adopted the standards for the field-sequential system of color television developed by the Columbia Broadcasting System, to be followed later by the CBS providing a broadcasting service.

1951 On March 25 H. I. Ewen and E. M. Purcell of Harvard University first detected the radiation of galactic hydrogen at 1420 MHz [76].<sup>53</sup>

1952 The first cesium atomic beam frequency standard to be constructed was placed in operation by the National Bureau of Standards, using a magnetic-resonance technique. This atomic frequency standard was the forerunner of several types of cesium beam "clocks" developed by the National Bureau of Standards and by other laboratories [77].<sup>54</sup>

1953 Invention of the Mills cross antenna [78].<sup>55</sup>

On December 17 the Federal Communications Commission gave approval for standards for color television compatible with black-and-white. The decision came as a result of much viewing and analyzing of several television systems that were submitted for consideration as far back as 1949.

1954 Charles H. Townes, along with J. P. Gordon and H. J. Zeiger, developed the first maser,<sup>56</sup> using ammonia gas, whereby energy at microwave frequencies could be greatly amplified for signal purposes [79].

1955 Construction was begun on the "White Alice" project of the Alaska Air Defense System, a communication system developed for the U.S. Air Force in Alaska, but also used as a public phone service. The system operates in the general range of the UHF-TV band and depends upon tropospheric scatter for extended distance in transmission beyond the line of sight.

An unexpected discovery was made at the Owens Valley (Calif.) radio observatory of the Carnegie Institution of Washington that the planet Jupiter emits intense bursts of radio noise. The observers found that the periods of strong emission occurred at intervals equaling Jupiter's rotation period, indicating that certain localities are responsible. Such areas probably include the Great Red Spot.

1956 H. E. D. Scovil, G. Feher, and S. Seidel of Bell Telephone Laboratories developed the first solid-state maser using a synthetic ruby crystal.

William Shockley, John Bardeen, and Walter Houser Brattain were awarded the Nobel Prize in Physics "for their researches on semiconductors and their discovery of the transistor effect."

1957 The first parametric amplifier and oscillator was developed by Max T. Weiss of the Bell Telephone Laboratories, based on a proposal made a few months earlier by H. Suhl, also of the Bell Telephone Laboratories [80].<sup>57</sup>

---

<sup>53</sup> The existence of the radiation of this spectrum line in space, the ground state of hydrogen, was suggested in 1945, but eluded observation by radio astronomers until 1951. The frequency of this hyperfine doublet of hydrogen was measured in the laboratory by Kusch and Prodell in 1950.

<sup>54</sup> The use of atomic and molecular beams goes back to 1911 but it was Professor I. I. Rabi of Columbia University who suggested in 1945 their use as frequency standards. Professor Polykarp Kusch of the Physics Department of Columbia University served as a consultant on the NBS project and supplied fundamental information for the design of the frequency standard. In 1955 he shared in the award of the Nobel Prize in Physics "for his determination of the magnetic moment of the electron."

<sup>55</sup> This was the first large-scale antenna to use electronic signal processing for narrow beam-width focusing. The antenna was designed for operation at 80 MHz, with a beam-width of less than 1 degree and capable of scanning approximately one-half of the celestial sphere.

<sup>56</sup> The maser takes its name from the acronym of Microwave Amplification by Stimulated Emission of Radiation.

<sup>57</sup> Weiss used a ferrite as an inductor for the nonlinear reactance. Later, the more successful amplifiers, that required less pumping power, used a semiconductor p-n junction as a nonlinear capacitor. Parametric amplifiers are noted for their very low noise contribution to the amplified signal.

Dew Line (Distant Early Warning radar), built and operated jointly by the United States and Canada, was begun in 1954 and became operational on July 31, 1957. It extended originally from northwestern Alaska to northeastern Canada, and later was extended from the Aleutian Islands to across Greenland.

The world's largest steerable radio telescope, of 250-foot-diameter antenna, became operative on August 2 as a facility of the University of Manchester. It is located at the Jodrell Bank Experimental Station near Manchester, England.<sup>58</sup>

The Year of Sputnik! On October 4 the Soviet Union launched the first manmade satellite to orbit the Earth. This event inaugurated the Space Age.

In October a young Japanese physicist, Leo Esaki, revealed the results of his research on the tunneling effect in thin semiconductor junctions. This effect was utilized in the development of tunnel diodes that have taken their place alongside transistors for many uses in electronic devices [81].

Participation by 67 countries in the International Geophysical Year (IGY) during 1957-1958, in the study of the many physical properties of the Earth and its atmosphere, including radio propagation physics of the ionosphere.

- 1958 On January 31 Explorer I, developed by the Army Signal Research and Development Laboratory, was launched and became the first United States satellite. On board were instruments that indicated to James A. Van Allen of Iowa State University the existence of two radiation belts far beyond the Earth's atmosphere. They are now called the Van Allen Belts.

On March 17 the U.S. Navy's satellite Vanguard I was orbited, the first satellite equipped with solar cells for conversion of sunlight into electricity.

A. L. Schawlow and Charles H. Townes outlined a theory and proposed a device for a maser that would operate at light frequencies. This optical maser soon became known as the laser [82].

- 1960 On January 1 the transition frequency of 9192.631700 MHz in cesium beam equipment was adopted as the U.S. Frequency Standard, replacing a group of quartz crystals.

Theodore H. Maiman of Hughes Research Laboratories demonstrated laser action using a synthetic ruby crystal operating in the visible red region. This was a pulse-type laser and did not operate with continuous action [83].

On January 28 the U.S. Navy publicly demonstrated use of the Moon as a reliable reflector of radio signals for stations at a considerable distance apart on the Earth's circumference, in this case between stations in Maryland and Hawaii, 5000 miles apart.

The first of the Tiros satellites (Television Infra-Red Observation Satellite) was orbited on April 1. This weather-information satellite was the first to carry both radio and television transmitters.

- 1961 A. Javan, W. R. Bennett, Jr., and D. R. Herriott of Bell Telephone Laboratories constructed the first laser to produce coherent light continuously, using helium-neon gas in the infrared region.

In March the Goldstone Tracking Station, operated by NASA in the Mojave Desert, successfully reflected radar signals from the planet Venus. Much new information on the planet has been gained by this process.

---

<sup>58</sup> The full descriptive name of this radio telescope is a Steerable Paraboloid Altazimuth Radio Reflector. With synchronized measurements it is possible to steer the axis of the antenna to nearly the entire expanse of the sky. Within several months after it became operative, the telescope was used to locate Sputnik I, and has been used to locate many orbiting manmade devices since that historic event of the orbiting of the Earth's first artificial satellite.

After the United States launched its first men into space on May 6 (the Soviet Union made its first launch on April 12), President Kennedy delivered a special message to Congress for greatly increasing the funds for space research and exploration.

The Federal Communications Commission approved, effective June 1, the multiplex operation of FM broadcast transmitters for stereophonic programs.

On June 24 the first topside sounding was made of the ionosphere from above, this by means of rocket-borne instrumentation. On September 29, 1962, similar observations were first made from a satellite, Alouette 1 (Canada); and later by Explorer XX (United States) on August 25, 1964.

BMEWS (Ballistic Missile Early Warning System) became operational in June. Complementary to the DEW Line, this system detects approaching ballistic missiles to more than 2000 miles. A chain of three radar installations was set up, the stations located at Clear, Alaska; Thule, Greenland; and in northern England.

On July 24 President Kennedy announced the administration's policy on private ownership and operation of satellite systems designed for communications.

- 1962 The solid-state laser of a junction diode of gallium arsenide was developed by various investigators almost simultaneously, and has developed into the new field of light-emitting semiconductors.

On May 9 a small area of the Moon's surface was illuminated with a very narrow beam from a powerful ruby crystal laser. A team of scientists of the Massachusetts Institute of Technology and the Raytheon Co. performed this feat for the first time.

B. D. Josephson (England), a research student in physics at Cambridge University, announced his theoretical prediction of superconducting tunneling which later became known as the Josephson effect [84].<sup>59</sup>

The world's largest movable radio telescope was installed at the National Radio Astronomy Observatory, Green Bank, W. Va. The transit-type telescope was constructed with a 300-foot-diameter antenna.

- 1963 The first Syncom was launched in February to serve as a fixed-position communication-system satellite, relative to the rotation of the Earth. Several of these in space at selected locations above the Earth serve for a worldwide communications system.

J. B. Gunn of the IBM Research Center found that very small crystals of gallium arsenide serve as oscillators for very short microwaves, opening up many uses for a simple type of microwave generator.

Radar reflections from the planet Jupiter were observed by radio astronomers of the Soviet Union. The round-trip time required to receive the echo signal was 66 minutes.

The world's largest fixed-type transit radio telescope became operational at the Arecibo Ionosphere Observatory, Puerto Rico in November. The 1000-foot-diameter antenna is in a fixed position within a huge bowl of the surrounding terrain.

- 1964 The Nobel Prize in Physics was shared jointly with two Russian scientists by Charles H. Townes. He was cited "for fundamental work in the field of quantum electronics which has led to the construction of oscillators and amplifiers based on the maser-laser principle."

---

<sup>59</sup>The ac Josephson effect has many characteristics and applications. Interesting applications are: A very accurate method of measuring the ratio of  $2e/h$ , an invariant fundamental constant; and a source of precise dc voltages characterized by irradiation of a Josephson junction with microwaves of specific frequencies.

The year 1964 can be considered the period in which the frequency gap was closed by breaking through the barrier in the submillimeter range.<sup>60</sup>

- 1965 In February the Army Electronics Command laboratories at Ft. Monmouth, N.J. demonstrated the use of a laser beam to transmit seven TV channels simultaneously.

Arno A. Penzias and Robert W. Wilson of Bell Telephone Laboratories observed, by means of radio astronomy, the temperature of the fossil heat that remains from the "Big Bang" that created the universe (now a widely accepted theory).

The world's largest equatorially mounted (polar axis parallel to Earth's axis) radio telescope was installed at Green Bank, W. Va. The 140-foot-diameter antenna can be sighted to very nearly every direction above the Earth's surface.

On May 2 the Intelsat 1 satellite, "Early Bird," was used to demonstrate an international TV program. It became available for commercial telephone service on June 28.

- 1966 On March 1 the Soviet Union's instrumented space vehicle, Venera 3, crash-landed on the planet Venus after a 100-day flight.<sup>61</sup>

On a 3-day space flight in July two spacecraft (Gemini 10 and Agena) were first used to control the functions of one spacecraft by another by means of radio signals.

- 1967 The 13th (International) General Conference on Weights and Measures defined the "second" as: "the duration of 9192 631 770 periods of the radiation corresponding to the transition between the two hyperfine levels of the ground state of the cesium-133 atom."

No. 35 of the Explorer series of satellites indicated that the Moon is nonmagnetic, has no radiation belts, and no evidence of a lunar ionosphere.

- 1969 On a flight to the Moon, beginning May 18, the Apollo 10 made the first live color TV pictures of the Earth. During orbital circuits around the Moon, color TV pictures were taken of the Moon's surface.

On July 20 the first lunar landing was made by the U.S. astronauts, Armstrong and Aldrin, with Collins in the commandship. All the world observed this epoch-making event via television and radio. Communications technology had reached a zenith of attainment.

- 1970 The Effelsberg 100-meter-diameter radio telescope neared completion. Located near Bonn, West Germany, this telescope of the Max Planck Institute for Radio Astronomy can continuously track a celestial object in any part of the sky.

- 1971 On November 11 the National Bureau of Standards measured the frequency of a helium-neon laser—a frequency of 88,376.245 GHz, the highest ever made by direct measurement.

---

<sup>60</sup>Closing the frequency gap between radio waves and the infrared region had been a long sought quest by a number of investigators, especially from the time of the work of Nichols and Tear in 1923. In May 1964 Gebbie (Scotland) and his coworkers at the National Physical Laboratory, England, reported on the generation and measurement of energy in the infrared region to 0.34 mm [85]. This was accomplished with a stimulated emission source using hydrogen cyanide. Measurements were made using the Michelson and Fabry-Perot interferometer techniques.

In July 1964 Jones and Gordy of Duke University reported on the generation and measurement of radio waves down to 0.43 mm [86]. Later they reduced the measured wavelength to 0.37 mm. This was accomplished with a klystron generator and taking the 12th harmonic from a silicon crystal. The frequency measurement was referenced to WWV.

The process of breaking through the frequency barrier in the submillimeter range is still a matter of operating at more or less discrete frequencies with pulsed energy. To obtain continuous frequency coverage with coherent radiation that can be modulated with lower frequencies is a goal still to be achieved.

<sup>61</sup>On a subsequent flight, the instrumented Venera 4 obtained much information on the characteristics of Venus, indicating a dense atmosphere almost entirely of carbon dioxide and a temperature much above that of the Earth. No magnetic field or radiation belts were indicated.

1972 On May 28 President Nixon addressed the people of the Soviet Union via television from Moscow, the first U.S. president to use this communication medium in Russia.

On November 17 the National Bureau of Standards announced a new determination of the speed of light with a hundredfold increase in accuracy over previous measurements—299,792.4562 km/s.<sup>62</sup>

1973 Spacecraft Pioneer 10 approached to within 81,000 miles of Jupiter on December 3.

1974 Spacecraft Pioneer 11 approached to within 26,600 miles of Jupiter on December 2 without damage to its equipment by Jupiter's intense radiation. Thereafter its flight would take the spacecraft to the vicinity of Saturn in 1979.

1976 On July 20 America's unmanned Viking I spacecraft landed successfully on Mars to begin a series of observations, including the detection of possible life forms on the red planet. Within a matter of moments NASA facilities received pictures of the Martian landscape via highly sophisticated radio transmitting and receiving systems.

On September 3 the second spaceship, Viking II, landed successfully at a location far removed on the planet Mars from the landing spot of Viking I.

### Commentary Notes

1. If the reader is familiar with the development of remote control by radio signals (sometimes called radio guidance) of electrical apparatus, mechanical movements, moving vehicles, etc., he will observe that this subject is missing from the chronology. Much of the development in this area has been shrouded in secrecy because of military applications. Also, the area has had its share of claims and counterclaims for priority of development and success. Refer, for example, to [87-89]. In the post-World War II period with guided missiles, and still later in the Space Age, with spacecraft, remote control by radio has reached fantastic levels of sophistication.

2. This chronology does not cover the developments of antenna types, which have taken many different forms over nearly a century of use. The radiators or antennas used by Hertz were reconstructed later by those who developed short-wave techniques. Low-frequency equipment required long-length antennas and some of the arrays took on gargantuan proportions. More recently microwave and millimeter wave antennas have taken on the semblance of optical devices. It is interesting to note that antennas or radiators were sometimes called "wave-gates" around 1900.

3. The complex radio systems that have been developed for aids to air navigation are not covered in this chronology except the very earliest and relatively simple systems. Later systems incorporate operational functions that add much to their complexity.

### IN RETROSPECT

How aptly was it stated, as far back as 1910, by George W. Pierce, professor of physics at Harvard University, when he wrote of the practical result of scientific research:

The history of this development (radio) is a striking example of the manner in which the labors of scientists in fields of pure research apparently unrelated to commercial applications may result in discoveries of the utmost material importance. Maxwell in his search for a rational grasp of the undulatory theory of light and Hertz in his experimental effort to establish a relation between electromagnetic force and the dielectric

---

<sup>62</sup>The new determination of speed of light was accomplished by two separate experiments: (1) with a frequency stabilized laser measured in terms of the cesium frequency standard; (2) the wavelength of a similar laser measured in terms of the krypton length standard. The product of frequency and wavelength gives the speed of light.

polarization of insulators were unwittingly laying the foundation for radiotelegraphy, which is, in fact, after all only a single development from among a host of other consequences of perhaps even greater significance that have grown out of the remarkable discoveries of Maxwell and Hertz.

From: *Principles of Wireless Telegraphy*, George W. Pierce, McGraw-Hill Book Co., New York, 1910, p. 328.

Even earlier, in 1906, Arthur E. Kennelly, professor of electrical engineering at Harvard University, as he "dipped into the future, far as human eye could see," stated in the introduction to the Preface of his book, *Wireless Telegraphy*:

Wireless Telegraphy is a wonderful fascinating subject. It has come to abide. It is ubiquitous in range, and there is no corner of the world, above the level of conductors, which is exempt from the play and passage of its ethereal waves. The laws obeyed by these waves, when stated without embellishment, vie with fiction in wonderment and interest. The possibilities which these waves hold in store for the benefit of man can at present only be guessed at, but they are probably great, judging from the importance of the work already done.

From: *Wireless Telegraphy*, Arthur E. Kennelly; Moffat, Yard and Co., New York, 1906.

## REFERENCES

- [1] Charles Süsskind, "On the first use of the term 'radio,'" *Proc. IRE*, Vol. 50, No. 3, Pt. 1, Mar. 1962, pp. 326-327.
- [2] F. Hamburger, Jr., "Poles and zero—Radio," *Proc. IRE*, Vol. 49, No. 9, Sept. 1961, p. 1373.
- [3] Orrin E. Dunlap, *Radio and Television Almanac*, Harper and Bros., New York, 1951.
- [4] Orrin E. Dunlap, *Communications in Space*, Harper and Bros., New York, 1962.
- [5] L. S. Howeth, *History of Communications—Electronics in the United States Navy*, U.S. Government Printing Office, Washington, D.C., 1963. Note: App. A contains an extensive chronology of developments in communications and electronics through 1945, with emphasis on developments by the U.S. Navy.
- [6] *From Semaphore to Satellite*, International Telecommunication Union, Geneva, Switzerland, 1965.
- [7] Charles Süsskind, "The early history of electronics," *IEEE Spectrum*, Vol. 5, No. 8, Aug. 1968, pp. 90-98; Vol. 5, No. 12, Dec. 1968, pp. 57-60; Vol. 6, No. 4, Apr. 1969, pp. 69-74; Vol. 6, No. 8, Aug. 1969, pp. 66-70; Vol. 7, No. 4, Apr. 1970, pp. 78-83; Vol. 7, No. 9, Sept. 1970, pp. 76-79.
- [8] Fiftieth Anniversary issue of *Proc. IRE*, Vol. 50, No. 5, May 1962. Note: This special issue contains many articles relating to the development of radio, particularly in the United States.
- [9] Joseph Henry, no recorded title, *Proc. Am. Phil. Soc.*, Vol. 2, No. 22, May-June-July 1842, pp. 193-196. Note: A record of Henry's verbal account of his third of five lectures on Contributions to Electricity and Magnetism before the American Philosophical Society, June 17, 1842. He spoke of magnetizing needles at a distance of 30 feet through room construction by discharging Leyden jars. Also see: *Joseph Henry's Scientific Writings*, Vol. 1, Smithsonian Institution, Washington, D.C., 1886, pp. 200-203.
- [10] W. F. Magie, "Joseph Henry, pioneer in space communication," *Proc. IRE*, Vol. 30, No. 6, June 1942, pp. 261-266.
- [11] Thomas Coulson, *Joseph Henry, His Life and Work*, Princeton University Press, Princeton, N.J., 1950.
- [12] Michael Faraday, "Thoughts on ray vibrations," *Phil. Mag.*, Series 3, Vol. XXVIII, May 1846; also see: Faraday, *Experimental Researches in Electricity*, Vol. III, Taylor and Francis, London, 1885, pp. 447-452.
- [13] William Thomson (Lord Kelvin), "On transient electric currents," *Phil. Mag.*, Series 4, Vol. 5, June 1853, pp. 393-405; also see: *Sir William Thomson, Mathematical and Physical Papers*, Vol. 1, Cambridge University Press, 1882, pp. 540-553.
- [14] James Clerk Maxwell, "The dynamical theory of the electromagnetic field," *Phil. Trans. Royal Soc. London*, Vol. 155, 1865, pp. 459-512; also see: Maxwell, *A Treatise on Electricity and Magnetism*, Ch. XX, "Electromagnetic Theory of Light," pp. 431-450, Vol. 2, 3d Ed., Oxford University Press, London, 1892.
- [15] John Henry Poynting, "Transfer of energy in the electromagnetic field," *Phil. Trans. Royal Soc. London*, Vol. 175, 1884, pp. 343-361.
- [16] Heinrich Hertz, *Electric Waves, being researches on the propagation of electrical action with finite velocity through space*. English translation by D. E. Jones, Macmillan and Co., London, 1893.
- [17] Edouard Branly, "Variation of conductivity by varying electric power," *Compt. Rend.*, Vol. 111, 1890, pp. 785-787; Vol. 112, 1891, pp. 90-93.
- [18] Charles Süsskind, "Popov and the beginnings of radiotelephony," *Proc. IRE*, Vol. 50, No. 10, Oct. 1962, pp. 2036-2047.
- [19] Helen M. Fessenden, *Fessenden, Builder of Tomorrows*. Coward-McCann, Inc., New York, 1940, p. 81.
- [20] Charles Henry Sewall, *Wireless Telegraphy*, D. Van Nostrand Co., New York, 1903, p. 118.
- [21] Charles Henry Sewall, *Wireless Telegraphy*, D. Van Nostrand Co., New York, 1903, pp. 117-118.
- [22] Arthur E. Kennelly, "On the elevation of electrically conducting strata of the earth's atmosphere," *Electrical World and Engineering*, Vol. 39, No. 11, Mar. 15, 1902, p. 473.
- [23] Oliver Heaviside, "Telegraphy," *Encyclopedia Britannica*, 10th Ed., Vol. 33, 1902, pp. 213-218.



- [24] British Patent Specification No. 24,850, Nov. 16, 1904.
- [25] J. A. Fleming, "On the conversion of electric oscillations into continuous currents by means of a vacuum valve," *Proc. Roy. Soc. London*, Vol. 74, No. 505, Mar. 16, 1905, pp. 476-487.
- [26] Ettore Bellini and Alessandro Tosi, "A directive system of wireless telegraphy," *Electrical Eng. (England)*, Vol. 2, 1907, pp. 771-775; also: *Electrical World (USA)*, Vol. 50, No. 25, Dec. 21, 1907, pp. 1203-1206.
- [27] Lee De Forest, "An Audion, a new receiver for wireless telegraphy," *AIEE Proc.*, Vol. 25, Oct. 1906, pp. 719-747.
- [28] Lee De Forest, "The Audion—detector and amplifier," *Proc. IRE*, Vol. 2, No. 1, Mar. 1914, pp. 15-36 including discussion.
- [29] Georgette Carneal, *A Conqueror of Space—The Life of Lee de Forest*, Horace Liveright, New York, 1930, p. 191.
- [30] A. A. Campbell-Swinton, "Distant electric vision," *Nature (London)*, Vol. 78, June 18, 1908, p. 151.
- [31] A. A. Campbell-Swinton, "Presidential Address," *J. Roentgen Soc.*, Vol. 8, Jan. 1912, p. 7.
- [32] W. H. Eccles, "On an oscillation detector actuated solely by resistance temperature variations," *Proc. of Phys. Soc. (London)*, Vol. 22, Pt. III, Sept. 1910, pp. 360-368.
- [33] Frederick A. Kolster, "A direct-reading instrument for measuring the logarithmic decrement and wave length of electromagnetic waves," *Bull. Bur. of Stds.*, Vol. 11, No. 3, May 1915, pp. 421-455, *Scientific Paper 235*.
- [34] Fiftieth Anniversary issue of the Proceedings of the Institute of Radio Engineers, *Proc. IRE*, Vol. 50, No. 5, May 1962.
- [35] Gerald F. J. Tyne, "The saga of the vacuum tube," Pts. 9, 10, and 11, *Radio News*, Vol. 30, Dec. 1943, p. 30; Vol. 31, Jan. 1944, p. 38; Vol. 31, Mar. 1944, p. 50; and Vol. 31, Apr. 1944, p. 54.
- [36] Georgette Carneal, *A Conqueror of Space—The Life of Lee de Forest*, Horace Liveright, New York, 1930, p. 250.
- [37] Lee De Forest, "The Audion—amplifier and detector," *Proc. IRE*, Vol. 2, No. 1, Mar. 1914, pp. 15-36 including discussion.
- [38] Walter Schottky, "Spontaneous current fluctuations in various conductors," *Ann. d. Phys.*, Vol. 57, No. 23, 1918, pp. 541-567.
- [39] Edwin H. Armstrong, "A new system of short wave amplification," *Proc. IRE*, Vol. 9, No. 1, Feb. 1921, pp. 3-27 including discussion.
- [40] Edwin H. Armstrong, "The super-heterodyne—its origin, development, and some recent improvements," *Proc. IRE*, Vol. 12, No. 5, Oct. 1924, pp. 539-552.
- [41] Walter Schottky, "On the origin of the super-heterodyne method," *Proc. IRE*, Vol. 14, No. 5, Oct. 1926, pp. 695-698.
- [42] Albert W. Hull, "The effect of a uniform magnetic field on the motion of electrons between coaxial cylinders," *Phys. Rev.*, Vol. 18, No. 1, July 1921, pp. 31-57.
- [43] J. H. Dellinger, H. Diamond, F. W. Dunmore, "Development of the visual-type airway radiobeacon system," *Proc. IRE*, Vol. 18, No. 5, May 1930, pp. 796-839.
- [44] Edwin H. Armstrong, "Some recent developments of regenerative circuits (super-regeneration)," *Proc. IRE*, Vol. 10, No. 4, Aug. 1922, pp. 244-260. Presented before Institute of Radio Engineers, June 7, 1922.
- [45] G. Marconi, "Radio telegraphy," *Proc. IRE*, Vol. 10, Aug. 1922, pp. 215-238, quoting from p. 237.
- [46] Louis Hazeltine, "Tuned radio frequency amplification, with neutralization of capacity coupling," *Proc. Radio Club of America*, Vol. 2, Mar. 1923.
- [47] Louis Hazeltine, "Oscillating audion circuits," *Proc. IRE*, Vol. 6, No. 2, Apr. 1918, pp. 63-98.
- [48] E. F. Nichols and J. D. Tear, "Short electric waves," *Phys. Rev.*, Vol. 21, No. 6, June 1923, pp. 587-610.
- [49] E. V. Appleton and M. A. F. Barnett, "Local reflection of wireless waves from the upper atmosphere," *Nature*, Vol. 115, Mar. 7, 1925, p. 333.
- [50] G. Breit and M. A. Tuve, "A radio method of estimating the height of the conducting layer," *Nature*, Vol. 116, Sept. 5, 1925, p. 357.
- [51] C. Francis Jenkins, "Radio vision," *Proc. IRE*, Vol. 15, No. 11, Nov. 1927, pp. 958-964.
- [52] Hidetsugu Yagi, "Beam transmission of ultra short waves," *Proc. IRE*, Vol. 16, No. 6, June 1928, pp. 715-741; Pt. I, "Beam radiation for 4-meter waves," pp. 715-729.
- [53] Albert W. Hull and N. H. Williams, "Characteristics of shielded-grid pliotrons," *Phys. Rev.*, Vol. 27, No. 4, Apr. 1926, pp. 432-438.
- [54] Albert W. Hull, "Measurements of high frequency amplification with shielded-grid pliotrons," *Phys. Rev.*, Vol. 27, No. 4, Apr. 1926, pp. 439-454.
- [55] Hidetsugu Yagi, "Beam transmission of ultra short waves," *Proc. IRE*, Vol. 16, No. 6, June 1928, pp. 715-741; Pt. II, "Magnetron oscillators," pp. 729-741.
- [56] Frank G. Kear, "Instrument landing at the National Bureau of Standards," *IRE Trans. Aeronautical and Navigational Electronics*, Vol. ANE-6, No. 2, June 1959, pp. 61-66.
- [57] Guglielmo Marconi, "Radio communications by means of very short waves," original 1933 paper reprinted in *IRE Trans. on Antennas and Propagation*, Vol. AP-5, No. 1, Jan. 1957, pp. 90-99.
- [58] Karl G. Jansky, "Directional studies of atmospherics at high frequencies," *Proc. IRE*, Vol. 20, No. 12, Dec. 1932, pp. 1920-1932.
- [59] Karl G. Jansky, "Electrical disturbances apparently of extraterrestrial origin," *Proc. IRE*, Vol. 21, No. 10, Oct. 1933, pp. 1387-1398.
- [60] C. E. Cleeton and N. H. Williams, "Electromagnetic waves of 1.1 cm wave-length and the absorption spectrum of ammonia," *Phys. Rev.*, Vol. 45, No. 4, Feb. 15, 1934, pp. 234-237.
- [61] George C. Southworth, *Principles and Applications of Waveguide Transmission*, Ch. I, "Introduction," pp. 8-12, D. Van Nostrand Co., New York, 1950.
- [62] John F. Ramsey, "Microwave antennas and waveguide techniques before 1900," *Proc. IRE*, Vol. 46, No. 2, Feb. 1958, pp. 405-415.
- [63] Edwin H. Armstrong, "A method of reducing disturbances in radio signalling by a system of frequency modulation," *Proc. IRE*, Vol. 24, No. 5, May 1936, pp. 689-740.

- [64] I. I. Rabi, J. R. Zacharias, S. Millman, and P. Kusch, "A new method of measuring nuclear magnetic moment," *Phys. Rev. (Letter to the Editor)*, Vol. 53, No. 4, Feb. 15, 1938, p. 318.
- [65] Quality of wireless reception can now be forecast, National Bureau of Standards, Department of Commerce, announces—News release by Department of Commerce, Feb. 17, 1939.
- [66] T. R. Gilliland, S. S. Kirby, and N. Smith, "Characteristics of the ionosphere at Washington, D.C., January 1939," *Proc. IRE*, Vol. 27, No. 3, Mar. 1939, pp. 226-227.
- [67] Ionospheric Radio Propagation, *Nat. Bur. Stand. (U.S.), Circ. 462*, June 25, 1948.
- [68] Russell H. Varian and Sigurd F. Varian, "A high frequency oscillator and amplifier," *J. Applied Phys.*, Vol. 10, No. 5, May 1939, pp. 321-327.
- [69] H. A. H. Boot and J. T. Randall, "The cavity magnetron," *Proc. IEE (London)*, Vol. 39, Pt. 3A, No. 5, 1946, pp. 928-938.
- [70] *Nat. Bur. Stand. (U.S.), Tech. News Bull.*, Vol. 31, No. 1, Jan. 1947, pp. 3-8.
- [71] Chester H. Page and Allen V. Astin, "Survey of proximity fuze development," *Am. J. Phys.*, Vol. 15, No. 2, Mar.-Apr. 1947, pp. 95-110.
- [72] Cleo Brunetti and Roger W. Curtis, "Printed-circuit techniques," *Proc. IRE*, Vol. 30, No. 1, Jan. 1948, pp. 121-161.
- [73] R. Kompfner, "The travelling wave valve," *Wireless World*, Vol. 52, No. 11, Nov. 1946, pp. 369-372.
- [74] J. Bardeen and W. H. Brattain, "The transistor, a semi-conductor triode," *Phys. Rev.*, Vol. 47, No. 2, July 15, 1948, pp. 230-231.
- [75] W. Shockley, G. L. Pearson, and J. R. Haynes, "Hole injection in germanium—quantitative studies and filamentary transistors," *Bell System Tech. J.*, Vol. 28, July 1, 1949, pp. 344-366.
- [76] H. I. Ewen and E. M. Purcell, "Observation of a line in the galactic radio spectrum," *Nature*, Vol. 168, Sept. 1, 1951, p. 356.
- [77] J. E. Sherwood, Harold Lyons, R. H. McCracken, and P. Kusch, "High frequency lines in the hfs spectrum of cesium," (Abstract), *Phys. Rev.*, Vol. 86, May 15, 1952, p. 618.
- [78] B. Y. Mills and A. G. Little, "A high-resolution aerial system of a new type," *Australian J. Phys.*, Vol. 6, No. 3, Sept. 1953, pp. 272-278.
- [79] J. P. Gordon, H. J. Zeiger, and C. H. Townes, "Molecular microwave oscillator and new hyperfine structure in the microwave spectrum of  $\text{NH}_3$ ," *Phys. Rev.*, Vol. 95, No. 1, July 1, 1954, pp. 282-284.
- [80] Max T. Weiss, "A solid-state microwave amplifier and oscillator using ferrite," *Phys. Rev.*, Vol. 107, No. 1, July 1, 1957, p. 317.
- [81] Leo Esaki, "New phenomenon in narrow germanium p-n junctions," *Phys. Rev.*, Vol. 109, No. 2, Jan. 15, 1958, pp. 603-604.
- [82] A. L. Schawlow and C. H. Townes, "Infrared and optical masers," *Phys. Rev.*, Vol. 112, No. 6, Dec. 15, 1958, pp. 1940-1949.
- [83] T. H. Maiman, "Stimulated optical radiation in ruby," *Nature*, Vol. 187, Aug. 6, 1960, pp. 493-494.
- [84] B. D. Josephson, "Possible new effects in superconductive tunneling," *Physics Letters*, Vol. 1, No. 7, July 1, 1962, pp. 251-253.
- [85] H. A. Gebbie, N. W. B. Stone, and F. D. Findlay, "A stimulated emission source at 0.34 millimetre wavelength," *Nature*, Vol. 202, May 16, 1964, p. 685.
- [86] Gordon Jones and Walter Gordy, "Extension of submillimeter wave spectroscopy below a half-millimeter wavelength," *Phys. Rev.*, Vol. 135, No. 2A, July 20, 1964, pp. A295-296.
- [87] J. H. Hammond, Jr. and E. S. Purlington, "A history of some foundations of modern radio-electronic technology," *Proc. IRE*, Vol. 45, No. 9, Sept. 1957, pp. 1191-1208.
- [88] Discussion of "A history of some foundations of modern radio-electronic technology," *Proc. IRE*, Vol. 47, No. 7, July 1959, pp. 1253-1268.
- [89] Benjamin Franklin Miessner, *On the Early History of Radio Guidance*, San Francisco Press, San Francisco, Calif., 1964.

## Chapter II

### THE EARLY YEARS OF RADIO AT NBS<sup>1</sup>

#### INTRODUCTION

Three developments occurred in the scientific and technical world during the latter part of the 19th century that were to have a profound effect upon man's entire world in the 20th century. These were:

1864—Clerk Maxwell established a fundamental concept of electromagnetic waves, resulting in "Maxwell's equations."

1886—Heinrich Hertz verified experimentally the existence of electromagnetic waves, thus confirming Maxwell's theoretical studies.

1895—Guglielmo Marconi transmitted his first wireless signals near Bologna, Italy.

Marconi's successes led to the first transmission of wireless signals across the Atlantic on December 12, 1901.

#### EVENTS THAT BECAME PROLOGUE

It was but 9 months before Marconi transmitted the letter "S" across the Atlantic by wireless that the Enabling Act to establish the National Bureau of Standards was enacted on March 3, 1901. During the next several years the Bureau was busying itself to make the move from its downtown location to a new and remote location far out on Connecticut Avenue in northwest Washington. There it would be relatively free from the disturbing effects of noise and vibration of urban activity, and of the effects of electrical and magnetic disturbances upon sensitive laboratory equipment. Fifty years later, the radio projects of the Bureau had to "flee" from the metropolitan area of Washington in order to escape the disturbing effects of radio interference and noise; the flight was to Boulder, Colo.

In another 15 years the remainder of the Bureau was fleeing the city to suburban Gaithersburg, Md.

#### 1. Louis W. Austin comes to the Bureau, 1904<sup>2</sup>

The movement from downtown Washington to the less urban location in northwest Washington was at a somewhat leisurely pace during 1904. And it was in the late fall of 1904 that a guest worker arrived at the Bureau to begin a new career in the very young

<sup>1</sup> Because of the greatly expanded and diversified program of radio projects initiated within NBS after World War II, and specifically with the organization of the Central Radio Propagation Laboratory (CRPL) as Division 14 on May 1, 1946, chapters II through VII relate to events and developments from the earliest beginnings of radio within NBS until the formation of the CRPL.

<sup>2</sup> Biographical and other accounts of Louis W. Austin have been lacking in certain areas of authenticated information, particularly in his relation to NBS. Considerable effort has been made by the author (WFS) to search for, and to record herein, some of the "missing gaps" in order to gain a better understanding of Dr. Austin's work and possibly to correct some of the misinformation that has crept into accounts of his work. Sources of information included: (a) The file on Louis W. Austin, National Personnel Records Center, GSA (Civilian Personnel Records), St. Louis, Mo. Referred to hereafter as "Austin Personnel Record."; (b) Records of John Howard Dellinger, National Archives, GSA, Washington, D.C.; and (c) Radio File.

science of wireless telegraphy (the name "radio" would come later). Dr. Louis W. Austin came freshly inspired after spending 2 years as an employee of the Physikalisch-Technische Reichsanstalt (the national standards laboratory of Germany) at Charlottenburg (near Berlin), Germany.<sup>3,4</sup> In the period of 1901-1902 he had engaged in research work at the University of Berlin. One must believe that an interest in wireless was kindled by Dr. Austin during his second sojourn in Germany.

<sup>3</sup> Louis Winslow Austin was born October 30, 1867, at Orwell, Vt. He received the A.B. degree from Middlebury College (Vermont) in 1889, and the Doctor of Science degree from the same institution in 1920. After attendance at the University of Strassburg (Germany), Austin continued graduate studies on a fellowship for 2 years at Clark University. He received the Ph. D. degree from the University of Strassburg in 1893.

<sup>4</sup> Austin's employment with the Physikalisch-Technische Reichsanstalt was most unusual. In a letter by John J. Esch, U.S. Representative of Wisconsin, to George B. Cortelyou, Secretary of Department of Commerce and Labor, dated May 17, 1904 (Austin Personnel Record), Esch stated in part:

. . . His present duties with the German Government concern the German Bureau of Standards. Dr. Austin's standing in science and mathematics was of so high a character, that he received appointment from the German Government and there is but one other instance where an American has been tendered a civil office in any official capacity in Germany. Dr. Austin is at present under Prof. Kohlrausch, one of the leading authorities of Germany, and for some time was associated with Prof. Roentgen, of Munich....



*Louis Winslow Austin*

*The name and work of Louis Winslow Austin were associated closely with the Bureau of Standards for 28 years, yet he was never a member of the Radio Section nor was his salary paid directly from Bureau funds.*

*Austin was born at Orwell, Vt., October 30, 1867, and received the A.B. degree from nearby Middlebury College in 1889. He received the Ph. D. degree from the University of Strassburg (Germany) in 1893. After teaching physics for 9 years at the University of Wisconsin he returned to Germany and was employed for 2 years at the Physikalisch-Technische Reichsanstalt. While in Germany Austin became interested in wireless telegraphy. In 1904 he entered the Bureau of Standards as a guest worker and made a study of detectors of electrical oscillations.*

*From 1908 to 1923 Austin was employed by the Navy Department and headed the United States Naval Wireless Telegraphic Laboratory, located at the Bureau of Standards. During this period he conducted pioneering studies in radio wave propagation. These studies led to a 1911 publication of the semi-empirical formula now well known as the Austin-Cohen equation. Then, in 1923, Austin headed the Laboratory for Special Radio Transmission Research, located at the Bureau of Standards but financed by outside funds. During this period Austin's research continued in radio propagation, but with greater attention to the properties of the ionosphere and to the nature of atmospheric static.*

*Early in the 1920's Austin became closely identified with the International Scientific Radio Union (URSI), serving in several capacities, both in the American Section and internationally. He was honored with the presidency of URSI several months before his death. Austin was the third president of the Institute of Radio Engineers, and in 1927 was awarded its Medal of Honor. Of his 100 research papers, approximately two-thirds related to radio transmission and from these he gained world recognition. Many of his earlier papers appeared as Bureau publications. (For a more detailed account see pp. 29-38.) The accompanying photo was published in the January 1923 issue of Radio News.*

During his 2-year employment in Charlottenburg, Austin was in frequent correspondence with Dr. Stratton, director of NBS (the records are not clear how Austin first made his acquaintance with Stratton). Among the various subjects discussed in their correspondence (Austin Personnel Record) was that of enticing an expert glassblower in the Berlin area to come to the Bureau in Washington. After much negotiation, no success was reached in getting either of two candidates to move to America.

Most significant of the subjects of their correspondence was that of Austin's request to become a member of the Bureau staff at a fairly high level.<sup>5</sup> In a letter to Austin, dated September 23, 1904 (Austin Personnel Record), Stratton stated, in part:

In regard to the appropriations for the year, I would state that while we were allowed several new places none of them were over \$1600 per year. Since the total amount of our appropriation was somewhat limited, owing to the economy of Congress at the session preceding the Presidential election, we were compelled to add several minor positions which were very much needed in connection with work which has already been established. However, we shall be pleased to see you in America, and I hope that some day we may have you at the Bureau.

Within a short time (1904) Austin would arrive at the Bureau, but for the next 4 years he would be supporting himself as a guest worker in order to pursue his desire of working in the growing field of wireless telegraphy. (There is some evidence that he may have received some remuneration from a wireless telegraph firm.)

It is in an early paper of Dr. Austin, published as *Scientific Paper 22* in the *Bulletin of the Bureau of Standards*, that we find the first evidence of radio work at the Bureau. The paper, entitled "Detector for very small alternating currents and electrical waves," was published November 1905 [1]. This paper describes Austin's investigation of electrolytic detectors (an effective and popular detector in the early 1900's; much superior to the coherer) consisting of copper electrodes in a solution of copper sulphate. Austin stated that he had noticed the rectification property a number of years earlier. At the Bureau he tested the rectification properties of the device with radio waves.

Austin's interest in radio detectors continued for several years. His investigations covered a variety of detectors: electrolytic, silicon, tellurium, each with various kinds of metals to make contact with the material having the rectification properties. This research was in the field of semiconductors that was to come into such great prominence many years later in the development of transistors and similar devices. Although his explanations, as well as those of other investigators, of the rectification properties were slanted largely in the direction of thermoelectric action, nevertheless Austin was learning the properties of semiconductors at the early stage of a new field of physics.

In a Bureau paper published in 1908, Austin gives credit (as do the historians) to Greenleaf W. Pickard for the development of the silicon detector in 1906 [2]. Nevertheless there is some reason to believe that Austin's investigations of the silicon detector may have predated those of Pickard.<sup>6</sup>

In 1910 Austin published an account of his studies of the sensitiveness of a variety of radio detectors, including the Fleming vacuum valve and the de Forest audion [3]. By now Austin's interests were in the direction of the transmission properties of radio waves and he wrote less thereafter on instruments.

---

<sup>5</sup> In the early editions of the American Men of Science ratings were taken by fellow scientists for the order of distinction of workers in the several sciences. The 1903 rating included 150 in the field of physics.\* Although Austin had not yet engaged in research in radio propagation (for which he became world famous), he already was recognized in physics and received a rating of 102 in the order of distinction. For information on ratings of NBS scientists, see Cochrane, *Measures for Progress*, p. 99, footnote 89.

\*Published in 1906 and reprinted in the *Fifth Edition of American Men of Science* (1933), pp. 1269-1271.

<sup>6</sup> To pursue further information on this subject, the reader is referred to Fessenden's Letter to the Editor, entitled "Austin thermo-electric wave detector," in the November 10, 1906, issue of *Electrical World*, and Pickard's reply, entitled "Thermo-electric wave detectors," published in the November 24 issue of the same periodical.

## 2. Louis Cohen enters the Bureau, 1905—And stays awhile

Within a short time after Dr. Austin came to the Bureau, Louis Cohen, with a Ph. D. degree recently received from Columbia University (1905), entered the Bureau as a Civil Service employee. He entered as 1 of about 15 laboratory assistants assigned to about an equal number of employees of scientific professional status.<sup>7</sup> His work assignments were with Dr. Edward B. Rosa who headed the electricity projects and specialized in the inductance and capacitance investigations. Dr. Cohen's first Bureau paper was coauthored

<sup>7</sup> A folder in the Boutell Collection, dated November 3, 1905, lists Louis Cohen as a laboratory assistant. The folder lists all scientific and technical personnel.

### Board of Visitors

Dr. IRA REMSEN, President of Johns Hopkins University.  
Dr. HENRY S. PRITCHETT, President of Massachusetts Institute of Technology.  
Dr. EDWARD L. NICHOLS, Professor of Physics, Cornell University.  
Dr. ELIHU THOMSON, Electrical Engineer, Lynn, Massachusetts.  
Mr. ALBERT LADD COLBY, Metallurgical Engineer, New York.

### Scientific Staff

SAMUEL W. STRATTON, Director.  
EDWARD B. ROSA, Physicist.  
WILLIAM A. NOYES, Chemist.  
LOUIS A. FISCHER, Associate Physicist.  
FRANK A. WOLFF, Associate Physicist.  
CHARLES W. WAIDNER, Associate Physicist.  
GEORGE K. BURGESS, Associate Physicist.  
HENRY N. STOKES, Associate Chemist.  
NOAH E. DORSEY, Assistant Physicist.  
ALBERT S. MERRILL, Assistant Physicist.  
MORTON G. LLOYD, Assistant Physicist.  
PERLEY G. NUTTING, Assistant Physicist.  
FREDERICK W. GROVER, Assistant Physicist.  
EDWARD P. HYDE, Assistant Physicist.  
HERBERT B. BROOKS, Assistant Physicist.  
FRANKLIN S. DURSTON, Assistant Physicist.  
CAMPBELL E. WATERS, Assistant Chemist.  
JOHN R. CAIN, Assistant Chemist.  
JOHN C. BLAKE, Laboratory Assistant.  
ROBERT C. DICKINSON, Laboratory Assistant.  
ROY Y. FERNER, Laboratory Assistant.  
NATHAN S. OSBORNE, Laboratory Assistant.  
GEORGE W. MIDDLEKAUFF, Laboratory Assistant.  
FRANCIS E. CADY, Laboratory Assistant.  
WILLIAM W. COBLENTZ, Laboratory Assistant.  
HENRY C. P. WEBER, Laboratory Assistant.  
CLAUDE C. COFFIN, Laboratory Assistant.  
EUGENE F. MUELLER, Laboratory Assistant.  
ARTHUR T. PIENKOWSKY, Laboratory Assistant.  
LOUIS COHEN, Laboratory Assistant.  
J. V. S. FISHER, Laboratory Assistant.

HENRY D. HUBBARD, Secretary.  
CHARLES F. SPONSLER, Engineer.  
DANIEL E. DOUTY, Librarian.

*The name of Louis Cohen appears on this very early listing of the Bureau's scientific staff. Cohen engaged in earliest mathematical work at the Bureau on electrical circuits at radio frequencies. Frederick W. Grover, a college professor, worked at intermittent periods in later years on radio projects. The listing is a copy taken from an original two-page folder, dated November 3, 1905—a part of the Boutell Collection (see p. 804). The folder probably served as a directory; the other page listed operational functions in various rooms of the two existing buildings.*

with Dr. Rosa on the subject of the mutual inductance of two circular coaxial coils of rectangular section, published September 1, 1906. They continued to coauthor papers as well as individually write papers relating to inductance problems. However, Cohen's interest soon turned toward the properties of coils at frequencies extending toward the radio region [4].<sup>8,9</sup> His treatment of the problems was both theoretical and experimental.

Cohen left the Bureau in 1908 to pursue the career of a radio engineer. He did have close associations over many years with the Army Signal Corps Radio Laboratory established at the Bureau in 1908.<sup>10</sup> Cohen also participated in lecture courses at the Bureau in connection with the educational programs.

During his 4 years on electricity projects, Cohen published a number of the Bureau's early *Scientific Papers* in the *Bulletin of the Bureau of Standards*. These papers were largely mathematical discussions of inductance and of circuits involving inductors.

### 3. The Navy ensconced at NBS—Some pioneering efforts in radio

Louis W. Austin came to NBS in 1904 and remained until his death in 1932, first as a guest worker, then as an employee of the Navy Department, and third as a Civil Service employee but with salary paid from an outside source. Probably no other person in the Bureau's 75 years, who was not compensated by Bureau funds, has enjoyed the privileges of its laboratories and given so much prestige to the institution as did Dr. Austin during his 28 years of relations with NBS. He had a marked influence on the propagation studies of the Radio Section and the later Central Radio Propagation Laboratory.

With the vast possibilities of wireless telegraphy for communications, yet encountering perverse problems, the Navy set up a research facility at the Bureau in 1908 to study this growing field of science and technology. It was the result of the director, Dr. Stratton, offering the Navy Department the facilities of NBS as an aid in solving their problems with communications equipment [5]. Dr. Austin came into employment of the Navy and was selected to head the new facility that was named the United States Naval Wireless Telegraphic Laboratory.<sup>11</sup> From 1908 until it became a part of the newly established Naval

<sup>8</sup> It is a matter of interest that the first reference to work relating to radio listed in the Bureau's annual reports was given in the *1906 Annual Report to the Secretary of Commerce and Labor*. It stated that: "Condensers and inductance (sic) have been tested for educational institutions and the Government, including standards of capacitance and inductance and instruments employed in wireless telegraphic work."

Author's (WFS) note: The rather indiscriminate use of the electrical terms for objects and for properties is quite evident in early NBS publications. There is interchange of the terms capacitor ("condenser" was the more widely used term) and capacitance, also inductor and inductance. Today NBS is more careful in the usage of these terms.

<sup>9</sup> In the biography by Helen M. Fessenden, entitled *Fessenden, Builder of Tomorrows* (Coward-McCann, New York, 1940), it states in chapter 15, p. 148, in relation to the development of several types of continuous-wave oscillators by Fessenden that:

Some of these gave very good results. Bureau of Standards tests on the compressed nitrogen gap showed one-half kilowatt of pure sine waves at frequencies measuring as high as 2,000,000.

From other information in the chapter these tests would have been performed in the period of 1903-1904. However, the National Bureau of Standards had no facilities to perform such tests until about 1920 or later. In answer to an inquiry of the National Archives and Records Service, their letter of July 19, 1972, stated:

A search of NBS Test Folders for the years 1901-1904, now in the custody of our Washington National Records Center (GSA), failed to disclose any tests performed for Reginald A. Fessenden, or for other Government agencies or private firms with which he might have been associated, relating to his research in wireless telegraphy.

<sup>10</sup> For a number of years the Army Signal Corps Radio Laboratory at the Bureau was under the guiding hand of Ernest R. Cram. The Laboratory was gradually phased out during the 1920's.

<sup>11</sup> In a letter from the director to the Bureau of Equipment, Navy Department, dated September 28, 1907 (Austin Personnel Record), Dr. Stratton stated:

During the past two years Dr. L. W. Austin has been working at the Bureau of Standards on wireless telegraph problems. The Bureau has never had any appropriation for this work, hence Dr. Austin has been merely a guest. In the meantime he has had some connection with one of the commercial wireless telegraph companies.

It has occurred to me that Dr. Austin would be an excellent man for the Navy Department in case it wishes to take up any experimental work along that line, hence I have asked him to call upon you and state what his work has been.

In case the Navy Department desires to make any arrangement with Dr. Austin the Bureau of Standards would be pleased to extend him the same facilities as in the past.

Research Laboratory in Bellevue, Anacostia (southeast Washington) in 1923, this facility at NBS was known by several names, the last being the U.S. Naval Radio Research Laboratory.<sup>12</sup>

During the 15 years of operation on the Bureau grounds, the Navy facility was staffed with both civilians and Navy personnel. From 1908 to 1920 Austin had the valuable assistance of George H. Clark, particularly for his wave propagation studies.<sup>13</sup>

Beginning with the Navy's wireless communications problems in the late summer of 1908, Austin's investigations for the next 15 years covered a variety of subjects such as: detectors, antenna characteristics, properties of circuits, and energy losses in condensers. But it was his propagation studies that were most fruitful and brought lasting fame.

The Navy became interested in determining the range of radio-telegraphic communication between ships and between ships and shore stations. In his first quantitative tests, Austin selected the powerful station at Brant Rock (south of Boston, Mass.), operated by the National Electric Signaling Co. (Fessenden), as the land-based station, leasing the station for Navy use. Late in 1909 and during 1910, two Navy ships, fitted with transmitters and receivers, sailed the Atlantic out to distances of more than 1000 miles from Brant Rock.<sup>14</sup> Observations at 1000 and 3750 meters were taken of the RF current in the receiving antennas under conditions of night and day and at various distances from the several transmitters (Brant Rock and the two ships). The result led to the well-known Austin-Cohen equation or transmission formula for expressing the magnitude of the received signal in terms of the transmitted signal [6].<sup>15-17</sup> In 1913 measurements were made of NAA, the Navy's Arlington (Virginia) station (3800 meters) from a ship out to more than 2000 miles distance.

---

<sup>12</sup> During the length of Austin's career at NBS his 100 published papers showed a variety of organizational sources, yet all were related to NBS. In addition to using the name Bureau of Standards, Austin used the designations of: U.S. Naval Wireless Laboratory, U.S. Naval Radio-Telegraphic Laboratory, U.S. Naval Radio Research Laboratory; plus his position of physicist-in-charge, Director, or Head. After resigning from the Navy Department in 1923 and becoming associated with the Bureau, he used the designations of: Radio Physical Laboratory, Chief; and Laboratory for Special Radio Transmission Research, often with the addition of "Bureau of Standards," but then again without.

<sup>13</sup> George H. Clark was a graduate of MIT. In 1920 he joined the Radio Corp. of America and later became an historian. His voluminous collection of "Radioana" was deposited in the Engineering Library of MIT. The Clark Collection is now located in the Division of Electricity and Nuclear Energy, Smithsonian Institution, Washington, D.C., and is a treasure trove for the history of radio and electronics.

<sup>14</sup> Dr. Dellinger in an address to the Boulder Laboratories in 1961, stated, in speaking of Austin:

A precursor of the Bureau's own radio work was that of Dr. Louis W. Austin who conducted the U.S. Naval Radio Research Laboratory located at the Bureau from 1905 on.\* He was the "American pioneer" in radio research. He worked on means of generating and detecting radio waves. He published studies of detectors of that day, various kinds of crystals, electrolytic detectors, Fleming valves, and audions. He was famous principally for his semiempirical formula for long-distance-received field strength at low frequencies, VLF and LF. He started that work in 1909 and it is the mistaken idea that that was part of the Bureau of Standards work which led to mention of the date (1909) in the printed program of this meeting.

In the "Program for National Bureau of Standards 60th Anniversary, 1901-1961, Boulder Laboratories" it was stated under the caption of "Central Radio Propagation Laboratory" that, "NBS research in radio propagation dates back to 1909 with radio work established as a section of the Electricity Division in 1913." It was this statement in the program that Dellinger wished to correct. In reality, the radio propagation work of NBS did not begin until the early part of the 1920's. See chapter VII.

\*Correctly, 1908.

<sup>15</sup> During the 1910 experiments with the Brant Rock station, Louis Cohen assisted Austin in the measurements. Although Cohen's name did not appear as a coauthor with Austin on the original transmission paper, his name has become associated with the transmission formula. Because of his mathematical ability, one is inclined to believe that Cohen had a definite part in developing the semiempirical formula. In fact, Austin stated in his paper, entitled "Some Quantitative Experiments in Long-Distance Radiotelegraphy" (cited in [6]), that Cohen had observed certain characteristics of the formula during the course of its development.

<sup>16</sup> In its initial form the Austin-Cohen equation indicated the current in the receiving antenna. In the early 1900's the only reliable radio frequency measurement instrument was the ammeter (weak signals in a receiving antenna were measured with a variable shunt across a telephone receiver, calibrated in terms of RF current). In later versions the equation indicated the received signal in microvolts per meter.

The received signal is dependent, of course, upon the radiated power of the transmitter and its distance. Of particular interest to Austin and other investigators (theoretical approach first by Sommerfeld in 1909) was the exponential term (or scattering term) in the equation which is dependent upon the attenuation factor, distance, and



In a report to the International Scientific Radio Union (URSI), October 1927, as Chairman of the Commission on Radio Propagation, Austin was somewhat pessimistic of his formula as indicating the true values of field intensity of the lower frequency radio waves propagated over long distances. To quote:

Since the discovery of the great variability of the signal intensity at different times, the general interest in transmission formulas has been much diminished, as it is evident that any formula laying claim to general accuracy would be so complicated that it could hardly be of practical value even if our knowledge of the subject were sufficient to derive it. The most that can be claimed for any of the formulas thus far suggested is a very rough approximation to the actual results averaged over very long periods. Thus far there has been no attempt to produce a formula applicable to the ultra short waves [7].

Time proved that Austin was overly pessimistic of his formula. He had come to realize, however, that:

The somewhat confused picture, which we have gained is rather that masses of ionized gas forming an extremely irregular and shifting lower surface if we are dealing with reflection and possibly with openings through which the rays may pass at times to higher levels before being turned back toward the earth.

Today, we know that the ionosphere is a complex structure and subject to much variation.

Although Marconi had observed the increased strength of low frequency signals at night over long distances as early as 1902, Austin's studies of the vagaries of long-distance transmission, beginning in 1909, were exploratory and were to be his chief interest during the remainder of his life. Both Kennelly and Heaviside had independently suggested in 1902 the existence of an electrically conducting layer above the Earth to explain Marconi's observations. However, it remained for Austin to explain, by his own observations, that the vagaries of transmission are caused by changes in the ionized layer.

From 1911 until his death in 1932, Austin wrote nearly 70 papers relating to the propagation of radio waves (a few of these papers were published concurrently as similar papers in several publications).<sup>18</sup> His first study was propagation over salt water. This was followed later by observations over land, as well as combinations of land and sea. His early observations of the vagaries of transmission, due to diurnal and seasonal effects, led him into many avenues of research. His second propagation paper in 1913 was on the subject of day and night effects. Then came a paper in 1915 on seasonal effects.

After a decade of observing radio signals at low frequencies, Austin could hardly escape the deleterious effects of atmospheric disturbances of "static" upon the weaker signals. He brought out his first paper on this subject in 1921, describing the characteristics of static and advancing explanations on the sources. During the next 2 years he published a series of bimonthly reports in the *Proceedings of the Institute of Radio Engineers (Proc. IRE)* on

---

wavelength. It was this attenuation factor, that expresses the loss of energy in the ground wave and in the skywave, that intrigued Austin in later years. He found that the skywave was subject to diurnal and seasonal variation, also to sunspot cycles.

The Austin-Cohen transmission formula is generally applicable in the frequency range from 20 kHz to the broadcast range beginning at 550 kHz.

<sup>17</sup> In later years other investigators became interested in the quantitative measurements of radio waves over long distances, and especially in transatlantic transmissions. These investigations led to various values of the constants in the exponential term of the Austin-Cohen formula.

<sup>18</sup> A listing of Dr. Austin's 100 papers is given in Letter Circular 194, revised July 1, 1964 by Charles L. Bragaw for internal use at the Boulder Laboratories, Department of Commerce, entitled "List of scientific publications of the Laboratory for Special Radio Transmission Research, formerly the U.S. Naval Radio Research Laboratory, by L. W. Austin." Seventy-five of Austin's publications are gathered into a binder, entitled "Collected Papers of Dr. Louis Winslow Austin, 1900-1932." The binder has been catalogued in the Department of Commerce Library, Boulder, Colo.

Austin's bound volumes of the *Proc. IRE*, Vol. 1 (1913) through Vol. 15 (1927) were given to NBS October 13, 1932, and designated "From the Library of Dr. L. W. Austin." They now form part of the set of the *Proceedings* in the Boulder Laboratories, Department of Commerce Library.

observations of atmospheric disturbances, as well as signal-strength observations of powerful radio transmitters.

Austin's observations of radio transmission over long distances, plus his studies of the relations of atmospheric disturbances to solar activity, eventually led him to an awareness of the dependence of certain characteristics of long-distance transmission upon changes in solar activity. His first presentation of such observations was to the American Section of URSI on April 21, 1927 [8].<sup>19,20</sup>

Shortly before the formation of the Naval Research Laboratory at Anacostia on July 1, 1923, Dr. Austin resigned from the Navy Department because of ill health. Although in poor health, he continued his radio-wave studies for the next 9 years as an employee of the Bureau of Standards.<sup>21,22</sup> He died on June 27, 1932, after a serious operation.

<sup>19</sup> The conclusion to his presentation is of much interest today as we view it in retrospect.

In conclusion, the observations show with considerable certainty that there is a general increase of signal strength with increasing sunspot numbers. There also appears to be a possible periodic relationship between the sunspot numbers and daylight signals, in which, in the case of most stations observed, the signals are nearly in opposite phase to the periodic changes of the sunspots. This is in agreement with the results of Pickard in the broadcasting range. While the work thus far must be considered to be in the preliminary stage, it seems probable that the relations of solar activity and radio phenomena will be found to be as worthy of study as those of solar activity and terrestrial magnetism.

<sup>20</sup> Later, in 1928, in his address at the time of being inducted as president of the Institute of Radio Engineers,\* Dr. Alfred N. Goldsmith in handing accolades to the former presidents, said of Dr. Austin:

. . . who has literally been a right hand of the Government in radio matters and has shown the way in orderly measurement of complicated radio transmission phenomena.

\**Proc. IRE*, Vol. 16, No. 3, Mar. 1928, p. 252.

<sup>21</sup> On July 1, 1923, Austin joined the Bureau of Standards, transferring as a Civil Service employee from the Navy Department where he had been classed as a Radio Aid at a salary of \$4000. In a new position set up at the Bureau, he was classed as a Scientist (Physicist) in charge of a unit in the Electrical Division (rather than a unit of the Radio Section) to be known as the Laboratory of Radio Physics, the salary to be \$4000 (Austin Personnel Record). The transfer papers indicate that, initially, Austin's salary was paid from an appropriation titled, "Radio Research, Bureau of Standards." However, this support was of short duration, as indicated in footnote 22.

The transfer papers stated that:

Dr. Austin is an expert in radio and has been employed by the Navy Department for many years. He is familiar with the Bureau's work, having been detailed to the Naval Radio Laboratory located at the Bureau of Standards. The Navy Department is unable to continue Dr. Austin on their rolls on account of shortage of funds and the proposed transfer has been informally approved.

Austin's Classification Sheet, dated July 23, 1923, showed that:

The object of the laboratory of which this employee is the head is the investigation of the purely scientific aspect of radio telegraphy. It involves especially the study of the propagation of radio waves over the surface of the earth and connected phenomena, including the natural radio waves called atmospheric disturbances. This work has been going on for the past fifteen years under the Navy Department and will to a considerable extent still be carried on at the stations of the U.S. Navy and of the commercial companies.

On supervision, the Classification Sheet stated:

On his own responsibility as to the technical and scientific details, under the supervision of the Chief of the Division and the Director of the Bureau.

Noteworthy, on this last point, is the fact that although Austin was located in the Radio Building with the Radio Section, he was not a staff member of the Radio Section under Dellinger, but was of a unit of the Division Office under E. C. Crittenden. Many documents in the Austin Personnel Record indicate this relationship.

<sup>22</sup> Two documents among the Dellinger papers at the National Archives (NN365-90, Box 11) appear to clear up the matter of Dr. Austin's relation to NBS during the period of 1923 to 1932, and the financial arrangement set up to support the "Radio Research" project. One of these documents, probably prepared jointly by Austin and Dellinger (but not so indicated), could have served various purposes; it stated:

Work Of The Radio Transmission Research Laboratory

(Conducted jointly by the American Section of the International Union for Scientific Radiotelegraphy and the Bureau of Standards.)

This laboratory was established in 1908 at the Bureau of Standards by the Navy Department and since that time has been in charge of Dr. L. W. Austin, being known until 1923 as the U.S. Naval Radio Research Laboratory. Its work has always been devoted largely to the investigation of the physics of radio transmission, that is, the passage of the radio waves over the surface of the

Dr. Briggs, then acting director (Dr. Burgess, the director, had died but 5 days after Austin), stated in an obituary [9]:

His devotion to his work speaks for itself in a last treasured note: "I am going to the hospital tomorrow, and if things should go wrong, I most earnestly beg of you to see to it that the Bureau continues my signal measurement work, at least until such a time as all workers are agreed

---

earth, including the effects of possible reflecting layers and absorbing media in the earth's atmosphere, and to the study of the origin and nature of atmospheric disturbances (static).

In 1923 when the Naval research work was concentrated at Bellevue, D.C., the purely scientific part of the radio work was transferred to the Bureau of Standards. The economy demanded by Congress made it impossible for the Bureau of Standards to develop the laboratory according to the original plan and therefore in 1924 it was resolved to seek outside financial assistance for the work. With the approval of the Director of the Bureau of Standards, the laboratory was then placed under the joint control of the Bureau of Standards and the International Union for Scientific Radiotelegraphy which is a part of the National Research Council.

The plans for the future work of the laboratory are in close accord with the program which has been outlined by the International Union. They include the continuation of the twice daily observations on a number of long-wave distant stations with the corresponding measurements on static intensity which are necessary for the eventual comparison of radio phenomena with meteorological, solar and other natural processes. It is also desired, if a sufficient number of assistants is obtained, to carry on continuous twenty-four hour observations so as to obtain more accurate knowledge of the diurnal variations of signal intensity and static. Other subjects of investigation which have begun in a fragmentary way are the sunrise and sunset effects on intensity, and the peculiar apparent direction variations both at night and after sunrise and before sunset. These will probably eventually throw light on the conditions in the upper atmosphere, far above the regions explorable by meteorological means, which control the variations and fading in radio transmission that are at present so little understood, especially at the ultra short wave lengths. Another important subject is the more exact study of static. If we are ever to learn how to eliminate or avoid this chief difficulty of radio transmission, it will obviously first be necessary to get a better understanding of its sources and nature.

Radio transmission is in very much the same condition as the electrical engineering of forty years ago. There has been, of course, large development along practical lines, but it is almost entirely lacking in a foundation of exact scientific knowledge which must form the basis of a satisfactory future development.

The present force of the laboratory consists of Dr. Austin and two assistants, one of these being furnished by the Signal Corps through the new arrangement with the Union. Nearly all of the apparatus has been loaned by the Navy Department. This force is sufficient only for the carrying out of routine observations and the necessary computations. The minimum requirements for the extension of the work as indicated above would be one additional assistant with thorough scientific training at a salary of approximately three thousand dollars, and an observer who must be an operator with some training in making scientific observations, at eighteen hundred or two thousand dollars. The requirements for additional apparatus will amount to from two to three thousand dollars per year, and if it should become necessary to replace the apparatus loaned by the Navy Department, about six thousand dollars would be needed.

Of course, it must be understood that more support would enable the problems to be solved with proportionally greater rapidity. Funds for the laboratory will be placed in charge of the National Research Council and will be disbursed through them.

The second was a memo by E. C. Crittenden, chief of the Electrical Division (who served as Austin's supervisor) to Dr. Fay C. Brown, technical assistant to the director. The memo of January 20, 1925, stated:

Confirming our conversation of today I wish to submit to the Publication Committee the following statement regarding the form of Dr. Austin's paper which I handed to you. It is recognized that the form used does not follow regular Bureau practice in the case of technical papers in which it is customary to give the author's title on the Bureau rolls. I am quite sure, however, that Dr. Austin would prefer not to follow the usual form because he wishes to emphasize the outside connections of his laboratory rather than its dependence on the Bureau. Furthermore, as was pointed out to you, there is some justification for maintaining his laboratory as a separate entity since the work of the laboratory has been carried on for many years and was for a long time quite independent of the Bureau.

In view of this situation we would suggest that the general form used by Dr. Austin be followed but that in order to avoid any possible misunderstanding, the title be used exactly as transmitted to the National Research Council last summer. The title then given to the laboratory was "Laboratory for Special Radio Transmission Research (conducted jointly by the Bureau of Standards and the American Section of the International Union of Scientific Radio Telegraphy)."

that other observations, such as those on Kennelly-Heaviside heights, can take the place of signal intensity measurements for correlation purposes.”

His work is going on.<sup>23</sup>

And most certainly the Radio Section and the Central Radio Propagation Laboratory carried on in the spirit of Austin’s “devotion to his work” in the study of radio propagation.

Shortly after the Institute of Radio Engineers was formed, Austin became a member (January 22, 1913), and served as president in 1914 (third president). He was awarded the Medal of Honor in 1927 “for his pioneer work in the quantitative measurement of radio transmission.”

Austin became widely known in international radio affairs. He took part in the (Second) International Radiotelegraph Conference in London, during July and August of 1912, as 1 of 12 delegates representing the United States (Austin was listed as Director of the Radiotelegraphic Laboratory, Navy Department). Austin was very active in the affairs of the International Scientific Radio Union (URSI). He was appointed the first chairman of the Wave Propagation Commission in 1922 and served until the time of his death in 1932. For many years he was chairman of the American National Committee of URSI.<sup>24</sup> He served as vice president from 1921 until 1932 (each General Assembly elects an additional vice president), and was honored with the presidency a few months before his death.

## RADIO—A NEW SCIENCE AND TECHNOLOGY ENTERS THE BUREAU OF STANDARDS<sup>25</sup>

### 1. Dellinger comes to the Bureau, 1907—Then Kolster, 1911

There is no better source from which to gain a knowledge of the very earliest investigations by the Bureau in the area of radio science and technology than from the earliest worker, J. Howard Dellinger. Later he became chief of the Radio Section, and then chief of the Central Radio Propagation Laboratory until his retirement in 1948. Let us learn directly from Dr. Dellinger of the earliest event in radio measurements by the Bureau as he related the story in his address at a meeting of the Boulder Laboratories staff on March 3, 1961, in celebration of the 60th anniversary of the National Bureau of Standards (and the 50th of the Bureau’s work in radio).<sup>26</sup>

The first radio job of the National Bureau of Standards was the standardization in 1911 of a wavemeter submitted by a professional radio

<sup>23</sup> A very interesting note on an insight into the personality of Dr. Austin is contained in a letter by Miss Sara Ann Jones, librarian at NBS Washington to Charles L. Bragaw, NBS Boulder Laboratories, dated July 8, 1964. The letter was written as an aid to Bragaw in preparing a biographical sketch on Austin for the Center for History of Philosophy of Physics, American Institute of Physics. In part, the letter states:

I read your sketch to EMZ (Miss Zandonini)\* and she said you had done a beautiful job. I asked if she could add any personal reminiscences about him and she said that he was a real gentleman whom everyone liked. She recalled a trip abroad by boat. Dr. Austin went first class and she third. EMZ spent a lot of time in the radio room of the ship and invited Dr. Austin to meet the men there. He said he had a lot more fun with the people he met among the third-class passengers than with those in the first class. She said both Dr. Austin and his wife were very well educated, wealthy, etc., but that they accepted people on their own worth regardless of their position.

\*Elizabeth M. Zandonini was associated with the former Radio Section for 33 years, serving in many capacities.

<sup>24</sup> At its meeting on April 27, 1933, the American Section of URSI adopted the following resolution:

The American Section of the International Union has lost its beloved leader in the death of Dr. Louis W. Austin, June 27, 1932. His devotion to science, and to our mutual interests in this organization, his outstanding contributions to radio research, and his benevolent personality were assets which we grieve to have taken away. Dr. Austin was not only Chairman of the American Section but had just been elevated to the presidency of the International Union; the termination of his distinguished career of service is an irreparable loss.

<sup>25</sup> Although established in 1901 as the National Bureau of Standards, the word “National” was dropped in 1903 (with no good reason). The original name was restored in 1934.

<sup>26</sup> Referred to as “Dellinger Address, 1961” (Radio File).

engineer.\* I was then working in the Inductance and Capacity Section, in part of a room in the South Building.<sup>27</sup>

\*The late J. V. L. Hogan, one of the triumvirate that founded the IRE.

I was taking a course in Maxwell and had been intensively studying high-frequency phenomena. So this job was handed to me. It had to be in the Inductance and Capacity Section, for how else could you make a frequency standard at radio frequencies than by setting up a resonating LC circuit? I had to improvise such a circuit and to devise ways to connect to it the buzzer circuit which generated the current and the crystal rectifier to detect resonance, all without vitiating the value of frequency calculated from the L and the C.

Dellinger had entered the Bureau in 1907 as a student and completed his college work with a Bachelor of Arts degree at George Washington University in 1908. His first major assignment in the Electricity Division was the meticulous determination of the temperature coefficient of resistance of copper, and with F. A. Wolff, the electrical conductivity of commercial copper wire. The result was the publication of two important papers in the subject field.

<sup>27</sup> Dr. Harvey L. Curtis was chief of the Inductance and Capacity Section from 1907-1946. The section was one of a number in the Electricity Division in 1911; the division being headed by Dr. Edward B. Rosa who wrote a number of papers relating to inductance and capacitance. Dr. Rosa is best known for his determination in 1907 (with Dr. N. E. Dorsey) of the ratio of the electromagnetic to the electrostatic units of electricity, which is the numerical value of the speed of light, and was an important confirmation of Maxwell's theory of light.

## Program

1. Reception in the Library, 3rd floor,  
8.30 to 9.30 o'clock
2. Exhibit and Experiments in the Lecture  
Room, 3rd floor; room 204, 2nd floor;  
and rooms 101, 102, 104 and 112 1st  
floor. Other laboratory rooms are also  
open to those wishing to see the instruments  
and equipment, 9.30 to 10.30 o'clock.
3. Refreshments will be served in the Library  
10.30 o'clock

Nov. 21, 1907

## Scientific Staff

SAMUEL W. STRATTON	✓ ARTHUR T. PIENKOWSKY
EDWARD B. ROSA	CHARLES W. BURROWS
LOUIS A. FISCHER	HENRY C. P. WEBER
FRANK A. WOLFF	• HARVEY L. CURTIS
CHARLES W. W AidNER	✓ EUGENE F. MUELLER
HENRY N. STOKES	✓ FREDERICK J. BATES
GEORGE K. BURGESS	HARRY C. GIBSON
HENRY D. HUBBARD	PAUL C. AGNEW
H. ERNEST DORSEY	HAROLD D. BARCOCK
EDWARD P. HYDE	✓ FRANK WENNER
CHARLES F. SPONSLER	BENJAMIN T. BROOKS
MORTON G. LLOYD	WALTER S. LEWIS
PERLEY G. NUTTING	JOHN M. MILLER
✓ CAMPBELL E. WATERS	THEODORE T. FITCH
DANIEL E. DOUTY	JAMES V. S. FISHER
✓ HERBERT B. BROOKS	IRWIN G. PRIEST
✓ HOBART C. DICKINSON	ERNEST C. McKELVY
FRANKLIN S. DURSTON	GEORGE E. POST
• JOHN R. CAIN	✓ RICHARD F. JACKSON
ROY Y. FERNER	THOMAS B. FORD
EDGAR BUCKINGHAM	AUGUST H. SCHAAF
✓ NATHAN S. OSBORNE	BAYARD H. VEAZEY
✓ WILLIAM W. COBLENTZ	WALTER HEALD
LOUIS COHEN	ERNEST F. WENDEROTH
GEORGE W. MIDDLEKAUFF	✓ GRACE C. U. McDERMUT
FRANCIS E. CADY	✓ JOHN H. DELLINGER

List of names of the 52 members of Bureau's scientific staff as they appeared on a two-page folder, dated November 21, 1907, that served for an "open house." Both Louis Cohen and John H. Dellinger (later his preference was J. Howard Dellinger) were on the staff. Louis W. Austin was a guest worker during period of 1904-1908 and his name does not appear on 1905 and 1907 listings. This folder exists as a photostat copy in the Boutell Collection. Many of the persons listed became well-known scientists in later years, including John M. Miller who was a member of the Radio Laboratory (Section) until 1919.

During the year (1911) that Dellinger performed the first calibration of a radio instrument at NBS, as a service to the public, Dr. Rosa brought in a man to cope with some of the problems the Bureau was facing in the rapidly expanding technology of wireless telegraphy. In contrast with the relatively little practical experience Dellinger had with wireless, Frederick A. Kolster came to the Bureau as a physicist, with several years experience in assisting in the development of wireless equipment.<sup>28,29</sup> After graduating from Harvard in 1908, Kolster joined up with the firms of John Stone and of Lee de Forest, and

---

<sup>28</sup> Frederick A. Kolster entered the Bureau on December 18, 1911, as a temporary appointee, with the grade of assistant physicist, "qualified in radio-telegraphy at \$1800 per annum," pending a special examination. After an examination and certification from the register, Kolster took the oath of office on March 1, 1912, to enter duty as an assistant physicist. A few months later, on July 3, 1912, he was promoted to the grade of associate physicist at \$2000 per annum.

Two advances in salary (\$2200 and \$2700) within the grade of associate physicist came as a result of letters to the Secretary of Commerce by Dr. E. B. Rosa, chief of the Electricity Division, but serving as the acting director at the times of writing to the Secretary. In his letter of August 7, 1914 (increase to \$2700), Dr. Rosa stated:

. . . I would state that Mr. Kolster is in charge of the work in radio-communication. He is a very competent and trained expert in wireless and has designed a fundamental instrument for measurement of wireless waves.

Author's (WFS) note: The instrument was the Kolster decremeter.

After Kolster's promotion to the grade of physicist in 1915, Dr. Stratton, the director, wrote to the Secretary of Commerce on September 23, 1916, recommending a further increase in salary, which Kolster received within 4 days. Sixty years later, Dr. Stratton's letter reveals the importance of the early work in radio at the Bureau and that of Kolster's contributions. Stratton's letter follows, in full:

I respectfully recommend the promotion and appointment of F. A. Kolster from the position of physicist, Bureau of Standards, at \$3000 per annum, to the position of physicist, at \$3600 per annum, vice new position, the compensation being payable from the appropriation, "Radio Research, Bureau of Standards, 1917."

This employee has rendered satisfactory service in this grade, but he has been receiving a lower rate of pay than others doing the same class of work. The proposed increased salary is not in excess of that paid for same or similar services elsewhere in the Bureau during the previous fiscal year.

This recommendation is made in view of the splendid achievements of Mr. Kolster in the field of radiotelegraphy. He has shown himself to be a specialist of the highest attainments in this very technical field. Not only has he been the leader of the Bureau's work on this subject and handled it with unqualified success, but he has invented apparatus and equipment which shows the gift of originality and ability of unusual order. His invention of the decremeter for measuring the rate of decay of wireless impulses would alone entitle him to this distinction, but his system of fog signaling and his apparatus for direction finding by means of which the sending station can be accurately located is literally an epoch-making discovery. It is therefore with special satisfaction that I make this recommendation, which is a moderate recognition of the important service which he has rendered to the Bureau and the public.

On July 31, 1921, Kolster resigned from the Bureau after having taken 6 months of a year's leave of absence. For the next three decades he was engaged as a consulting engineer, and was employed by several radio equipment firms. In the mid-1920's a commercially produced broadcast receiver was named after Kolster. It was a six-tube, tuned radio-frequency circuit, equipped with ganged capacitors for tuning. He died July 24, 1950.

Author's (WFS) note: Much of the above information was obtained from Kolster's personnel record at the National Personnel Records Center, GSA, St. Louis, Mo.

<sup>29</sup> In October 1975, James R. Wait of the Environmental Research Laboratory, National Oceanic and Atmospheric Administration, furnished the author (WFS) with some interesting information relating to steps taken by the Bureau of Standards to establish a wireless and high-frequency group in 1908, 3 years before Kolster was employed as a staff member.

Dr. Wait was informed in a letter, dated October 3, 1975, from Professor Robert Kouyoumjian of the Department of Electrical Engineering, Ohio State University, that his father (Harold K. Kouyoumjian) had received a post card from a George W. Nasniyth, dated September 25, 1908, mailed from Baltimore, Md., relating to a position at the Bureau. (A reproduced copy of the card was enclosed with the letter of October 3, 1975. Nasniyth was a classmate of Harold Kouyoumjian at Cornell University, in the class of 1906.) The card stated:

9-25-08

Dear Harold,

. . . The Bureau of Standards wants a man to take charge of its new division of wireless and high frequency work; they offered \$1200 a year to start. Shall I recommend you? Answer quick.

G.W.N.

later with Fritz Lowenstein. All three of these men had made, and were to continue to make, contributions to the radio art.

One of Kolster's first assignments was to attend the (Second) International Radiotelegraph Conference that met in London during June and July of 1912. He served as a technical advisor to Professor Arthur G. Webster (Clark University) who served as a consultant to the Bureau of Standards and represented the Bureau as a delegate to the Conference.

The Radio Ship Act that became effective on July 1, 1911, made it a requirement that ocean sailing vessels leaving U.S. ports, carrying more than 50 passengers and crew, more than 200 miles between ports, be fitted with wireless apparatus and have a skilled operator aboard. In 1912 the act was amended to require two operators instead of one, plus the inclusion of cargo vessels.<sup>30</sup> Inspection of equipment and enforcement of the act came within the operations of the Bureau of Navigation (Department of Commerce and Labor). This act, plus Army and Navy requirements, plus the wireless industry's need for aid on Government controls, brought a new responsibility to the Bureau of Standards. We find this well expressed in the Bureau's *Annual Report* for the fiscal year ending June 30, 1913. Referring to the work of the Electricity Division the report stated:

In wireless telegraphy the Bureau ought to maintain a first class laboratory, devoted to the determination of the fundamental facts needed by the various departments of the Government making use of wireless telegraphy. With the present limited equipment and personnel engaged in this work the Bureau has been assisting the Bureau of Navigation and, to some extent, other Bureaus of the Government, making use of wireless telegraphy.

Such was the climate within the Bureau and within the Electricity Division beginning in 1911. Kolster was to spearhead many of the radio projects during the next 10 years to meet the needs of various Government departments.

## 2. Early instruments and measurements

Kolster's first major assignment was the development of an easy-to-use decremeter, plus the incorporation of a wavemeter into a common assembly. In the early days of wireless telegraphy, with transmitters emitting highly damped oscillations, it was usually desirable to minimize the rate of decay of individual bursts of energy in order to reduce interference.<sup>31</sup> Such an instrument was useful to the wireless station, and a needed tool to the Bureau of Navigation radio inspectors enforcing the U.S. law on maximum permissible decrement of wireless signals. Note: Refer to chapter V for a more detailed account on the Kolster decremeter.

---

This information that has come to the attention of the author, reveals an interesting aspect to the beginnings of the wireless (radio) program at the Bureau of Standards which probably has been lost in the records these many years. This fragment of information indicates that recruiting was underway by the Electricity Division 3 years in advance of the selection of Kolster for the wireless program established at the Bureau in 1911.

<sup>30</sup>The *Titanic* disaster on the night of April 14, 1912 (collision with an iceberg in the Atlantic south of the Grand Banks of Newfoundland with loss of 1513 lives), brought worldwide attention to the use of wireless on the seas, yet indicated that its full potential had not been made use of in the disaster. More rigid requirements were in the offing. Actions taken by the Second International Radiotelegraph Conference in London, plus actions taken by Congress in August of 1912 brought about amendments to the Radio Ship Act of 1910. One of these new requirements was that of reducing interference by limiting the (logarithmic) decrement of spark transmitters to a value not to exceed 0.2.

<sup>31</sup>There were occasions in the early days that an operator would adjust his equipment to obtain a very rapid decay of the oscillatory discharges in order to "blanket" a considerable width of the frequency spectrum, giving him greater assurance that his message was getting through.

The importance of the Kolster decrometer in the remaining years of the spark transmitters can be summed up by quoting from the *1914 Annual Report to the Secretary of Commerce*:<sup>32</sup>

The decrement or rate of decay of the train of waves emitted by a radiotelegraphic antenna is limited by law. The inspectors of this Department have the duty of enforcing the law and there was heretofore no instrument by which the measurement of decrement could be made with speed and accuracy. A decrometer was therefore designed which has proved itself to be very satisfactory in practice, and which has been adopted by the War and Navy Departments, and by the Bureau of Navigation of the Department of Commerce for the use of its inspectors.

### 3. Accepting "Radio" into the vocabulary, 1911

During the early development of radio the English-speaking participants became accustomed to using the term "wireless," although the word "radio" is traced back to 1897. However, in the Radio Ship Act that was approved by the President on June 24, 1910, and became effective on July 1, 1911, the term "radio-communication" was used. During 1911 preparations were made by the United States to take part in the (Second) International Radiotelegraph Conference, to be held at London in 1912. Regulations for radio communications came within the jurisdiction of the Bureau of Navigation, Department of Commerce and Labor. The Secretary of the Department had requested of Dr. Stratton that the Bureau of Standards assist the Department in revising its regulations which, in turn, would influence proposals made at the London Conference. It was on this occasion that the director, Dr. Stratton, called upon Dellinger for suggestions. The letter to the Secretary, of October 24, 1911, prepared by Dellinger, stated, in part (NARG 167, Box 10, General Correspondence 1901-1922, IET-IG):

In the title of the circular and elsewhere, we believe that "radiotelegraph" would be a better word than "wireless." It is to be noted that the act of June 24, 1910, speaks only of "radiocommunication" and does not use the word "wireless." The latter is not a satisfactory descriptive term, applied either to the apparatus or to the operators and inspectors. The word "wireless" will probably continue to be used colloquially but the word "radiotelegraph" is coming to be more and more the accepted accurately descriptive term for the apparatus, etc., involved in communication by electromagnetic waves.

The suggestion made by Dellinger was carried out by the American delegation to the London Conference for the word "wireless" did not appear in any of the proposals made by the delegation (as recorded in the Documents of the International Radiotelegraph Conference). In fact, the term wireless seems to have fallen into disuse at the Conference.

In his address to the Boulder Laboratories, "Fifty years of radio at the National Bureau of Standards," on March 3, 1961 (Dellinger Address, 1961), Dr. Dellinger modestly referred

---

<sup>32</sup>In March of 1913 the Department of Commerce and Labor was separated to become two new departments, those of Commerce and of Labor.



to his suggested use of the term “radiocommunication,” which easily resolved itself into the shorter “radio.”<sup>33,34</sup>

#### 4. Encountering the radio-frequency ammeter

Hard on the heels of Dellinger’s performing the first calibration of a wavemeter by NBS, came the need to calibrate radio-frequency (RF) ammeters. The RF ammeter was the most needed and useful of any electrical indicating instrument associated with a radio transmitter—small stations often had but this one instrument. With it the operator had the assurance of knowing approximately how much “power” he was radiating into space even though he was reading the “energy” as antenna current in amperes. An accurate knowledge of radiated power and field strength was to come many years later. With time, the usefulness of the RF ammeter diminished as a means of observing the radiated output from a transmitter. After a long period of dormancy there has been some renewed interest in the use of RF current meters as a precision measurement instrument.

Dellinger made the Bureau’s first calibrations of RF ammeters and the project proved to be an intriguing assignment. His interest grew to the extent that a study of RF ammeters developed into a doctoral dissertation at Princeton University (degree conferred in 1913). The thesis was published as a Bureau *Scientific Paper* [10].<sup>35</sup>

#### 5. Organizing and planning to serve the Government—With progress on many fronts

The Radio Laboratory Section was formed in 1913 under the leadership of Frederick A. Kolster.<sup>36</sup> It was designated as Section 6 in the Electricity Division (the familiar symbol, I-6, was to remain with the section until May 1, 1946). For some years to come the titles of Radio Laboratory, Radio Section, and Section 6 (within Division I) were used interchangeably. There seemed to have been no fixed pattern of usage until October 1918 when the large section was organized on a more formal basis. The designation “Radio Section” was now

---

<sup>33</sup> In his address, Dellinger said:

. . . I had been asked to criticize a draft of the International Wireless Convention of Regulations which had been prepared by the U.S. Delegation for the 1912 Conference in London. Among my proposals was one to change the word “wireless” to “radio”. Radio was not in use, but I had read in a book the idea that radio, connoting radiation would be more realistic than wireless. Fortunately my proposal was accepted and London came out with a radio instead of a wireless agreement. The 1912 Radio Communications Law of the United States followed suit and in a few years the word “radio” was used more than “wireless”.

Author’s (WFS) note: This statement by Dellinger in his 1961 Address has been a puzzlement to the author. Apparently he accepted credit for recommending the use of the word “radio” in place of “wireless” for the International Wireless Convention of Regulations of 1912 (known as the London Radiotelegraph Regulations of 1912), yet in 1906 the words “radio” and “radiotelegraph” had been used extensively in documents of the First International Radiotelegraph Conference held in Berlin.

<sup>34</sup> Refer to chapter I, p. 2 for early use of the word “radio.”

<sup>35</sup> The RF ammeters of the early radio transmitters were of three general types, all of them thermal ammeters. For small currents (10 amperes or less) a thermoelement was used. In larger currents the hot-wire type was used, which incorporated a single strand of wire. For very large currents up to 300 amperes or more, multiple-wire or strip construction was used for the hot-wire element. All early types were subject to considerable error with increase in frequency, and particularly the multi-wire type. Dellinger made a critical study, both theoretical and experimental, of the causes and magnitude of errors in a variety of RF ammeters. He suggested improvements in design to minimize frequency effects and to improve accuracy.

<sup>36</sup> The author (WFS) has found considerable variation and discrepancies in the dates, even in terms of years, on the initiation of radio projects within the Bureau and the initial steps taken to set up an organizational structure within the Electricity Division to encompass the radio projects. These discrepancies exist in published articles, both within and outside NBS, also within the Radio Section’s own records. Some of these dates are, without doubt, in error. A publicity note found with the Monthly Report for October 1922, states:

The Radio Laboratory of the Bureau of Standards of the Department of Commerce was established in 1910, and during the past few months, parts of its work have come to the attention of most of the radio experimenters and radio broadcast listeners throughout the country.

The notation hardly fits the facts. The most acceptable date is to select 1913 as the year when a section was formed within the Electricity Division to give direction to several radio projects.

used, titles were assigned to those responsible for section operations, and a listing was made of personnel assignments to the various projects. (See app. C.)

After the development of the decremeter by Kolster and the first calibration of a wavemeter and high-frequency ammeter by Dellinger, there came additional requests for calibrations. In the *1914 Annual Report to the Secretary of Commerce* the electrical testing included: "4 wavemeters, 35 decremeters (for the Army and Navy and Bureau of Navigation), and 2 high-frequency ammeters."

After the initial development of a new type of decremeter, Kolster brought out a series of designs to meet various needs of the Bureau of Navigation and for the Army and Navy. Construction of these decremeters was given to several different firms on a bid award basis.

By 1915, with the help of the Inductance and Capacity Section, an assortment of inductors had been designed and constructed with the distributed capacity and resistance kept as low as possible. Special types of variable condensers (capacitors) were also designed and constructed. This laboratory equipment would serve two purposes: (1) standards of capacitance and inductance at radio frequencies, (2) standards for frequency or wavelength by the LC technique. The standards provided for wavelength measurements to 20,000 meters (15 kHz). The technology of the time was given over to long wavelengths.

But it was in the technical areas of field equipment that the section could offer the greatest service to the Government. The thinking and attitude of Bureau personnel was well expressed in the *1915 Annual Report* relating to proposed work in radiotelegraphy.

This Bureau hopes to be of greater assistance to other civil branches of the government in the future than it has been able to be heretofore, particularly to such as are engaged in the protection of life and property at sea. Such assistance may take the form of information upon the technical possibilities of radio instruments and equipment, the standardization of apparatus, and the adaptation of radio equipment to the particular needs of a given service.

During the period from 1914 to the spring of 1917 when the Bureau entered on war-related projects, the Radio Laboratory was providing assistance to:

1. Bureau of Navigation, D. of C.:
  - Design and calibration of decremeters
  - Calibration of wavemeters
  - Consulting service
2. Bureau of Lighthouses, D. of C.:
  - Design of communication equipment, especially for lighthouse tenders
  - Development of "fog signalling" equipment (systems to locate ships or lighthouses under fog conditions, primarily direction finders)
  - Consulting service
3. Coast and Geodetic Survey, D. of C.:
  - Design of communication equipment

Services for the Post Office Department and the Department of Agriculture would have to wait until and after World War I. The Navy Department became much interested in the development of direction finders because of their potential usefulness in naval operations.

Antenna research became a matter of concern, with some study given to this subject. Coil antennas for direction finders received considerable study and development.

For a period of time, around 1916, Dr. Dellinger was assigned to a project that crossed all areas and subjects of the Electricity Division. It was a critical study to determine any advantages in suggested changes to the International System of Electric and Magnetic Units as set up by the London Electrical Conference of 1908. Dellinger's conclusion was that no advantages would be gained and only confusion would result from such changes. His lengthy analysis was published as a Bureau *Scientific Paper* [11].

He followed this paper with *NBS Circular 60*, entitled "Electric Units and Standards," issued March 12, 1920. Consolidated into this circular was information on the electric and magnetic units that was scattered through many Bureau publications. It was a useful guide

until January 1, 1948, when the "concrete" standards and the units of the former International System gave way to the "absolute" units of the MKSA system.

Because of his experience and expertise in the radio art, Kolster was called upon several times to give testimony on patent cases. Radio patents were subjected to much litigation from the very beginning of wireless telegraphy. Kolster stated in his section's Semiannual Report of January 1 to July 1, 1916, that, "The need for unbiased reports and the presentation to the court of true scientific principles and facts are matters which apparently should receive attention for future consideration."

## 6. The problems of laboratory space

The requirements by Austin, in 1908, for space to set up the new Navy facility at NBS were modest indeed. This could also be said of the Army Signal Corps Radio Laboratory set up at about the same time. Room could be found in the South Building, which served largely as a laboratory area. With completion of the West Building in 1910, space was provided for these two outside groups.<sup>37</sup> With the entrance of Kolster in 1911, space was provided for him in the West Building to set up his laboratory. The Electricity Division had a new home for their laboratories with the construction of the East Building. Beginning in 1914 the radio projects would be housed on the fourth floor of this building until late in 1918.

<sup>37</sup> The Signal Corps Radio Laboratory at the Bureau served as the location of a unique event on September 18, 1910. It was the occasion of the first demonstration of "wire-wireless" or "line radio," an invention of Major George O. Squier, who later became Chief Signal Officer of the U.S. Army. By use of carrier frequencies in the range of 20 to 100 kHz several telephone messages were carried simultaneously over a telephone circuit between the Bureau and the downtown Signal Corps Laboratory at 1710 Pennsylvania Ave. The method came to be known as multiplex telephony and is widely used today on a carrier-frequency system. In 1922 the Signal Corps demonstrated the system for broadcasting but it never came into popular usage. Today's cable TV can be considered an offspring from this earlier system of more than 50 years ago.

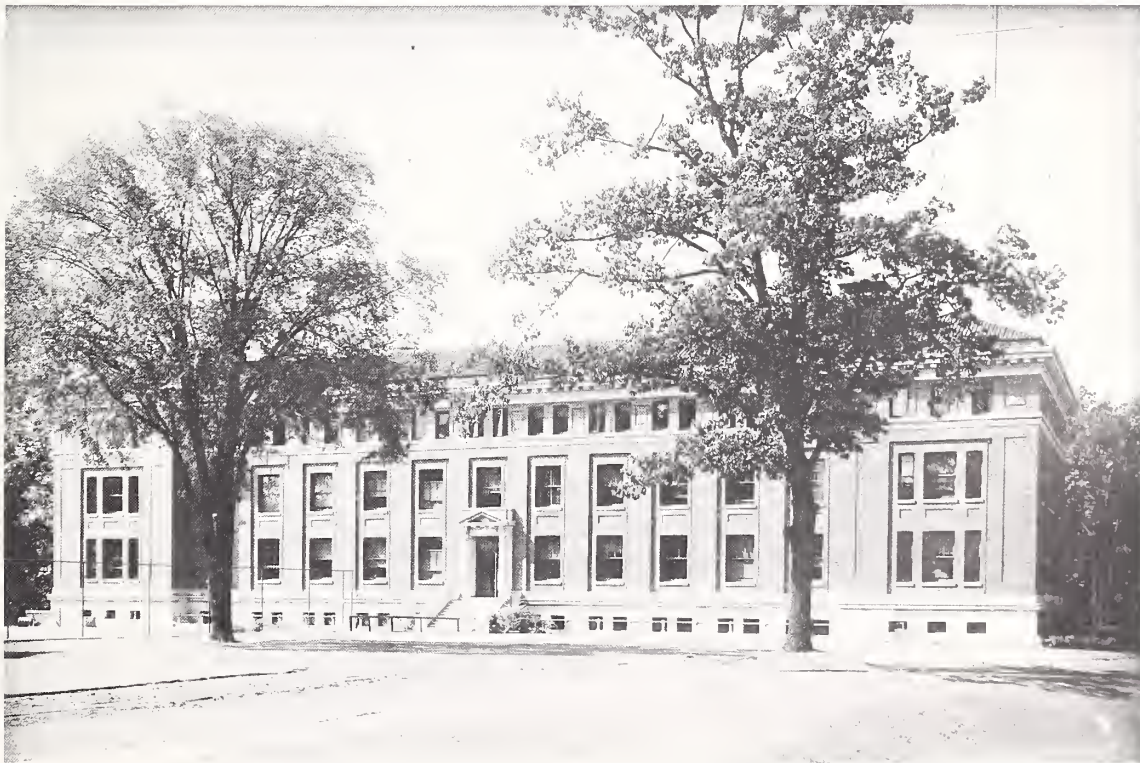

*Radio antenna at northwest corner (right) of Engineering, or West Laboratory (West Building) in 1913. The Army Signal Corps occupied third-floor rooms in this building for operating spark and arc transmitters and conducting research on dielectric properties of materials at radic frequencies.*



*Wireless Laboratory, December 1915, located at north end of fourth floor, East Building. Many measurement instruments appear on the tables, including a standard capacitor and inductor, and Kolster receiver in center foreground. A two-coil direction finder is on the right.*



*Antenna mast, buckled by a snowstorm of March 1914, was located to the east of the recently constructed East Building that housed the Bureau's radio laboratory. (Original print shows the arrays of guy wires "supporting" this mast.) It is the only known picture of a radio antenna associated with this laboratory.*

In the meantime Kolster and Dr. Rosa were planning for the future.<sup>38</sup> In the FY 1913 they had asked for a new building to house the radio laboratories. We find an interesting and revealing item in the *1914 Annual Report to the Secretary of Commerce* which indicates the expected growth in radio by those charged with the responsibility of this new operation by the Bureau. In part, we find the following statement:

Radio communication has recently become of extreme importance both in Government work and to the public. This method of communication is still largely in the experimental stages. Future progress and improvement in radio communication will be in direct proportion to the progress that is made in the knowledge of the underlying scientific principles involved. Several departments of the Government are deeply interested in maintaining this method of communication on the best possible basis. To do this they will each be compelled not only to keep in close touch with the progress of other countries in this respect, but to undertake such scientific and technical investigations as may be necessary. It would not only be more economical, but productive of much more efficient work to concentrate the laboratory work of the Government at one place in a small laboratory especially designed for it. It has been agreed by all of the Departments concerned, namely, War, Navy, Treasury, Post Office, Agriculture, and Commerce, that the location of the laboratory at the Bureau of Standards would prove of great benefit both as to the economical performance of the work and by its close proximity to the scientific work of the Bureau, especially that of the electrical division. An item of \$50,000 for the construction of a suitable radio laboratory, and another of \$10,000 to enable the Bureau of Standards to carry on that part of radio work which naturally falls to the Bureau in connection with the radio supervision work of the Department of Commerce, were included in the estimate for the current year, but were not appropriated for. It is recommended that they be again submitted in the estimate for the next fiscal year.

This feeling had already been expressed in an informal report by the Radio Laboratory, covering the period of July 1913 to January 1914, which stated:

The field for research in high frequency work is very large and inviting but up to the present the Laboratory has not had the facilities at hand for the work. It is hoped that sufficient funds will be at our disposal for necessary equipment and for the addition of at least two assistants.

As happens frequently in requests for scientific facilities by Government agencies, the Bureau had to wait for nearly 5 years before it would occupy a building that was suitable for radio investigations. The efforts by those early workers in radio during World War I had to be carried on under extremely crowded conditions. In early October of 1918, 1 month before the war ended, they moved into their new quarters in what became known as the Radio Building.

It would appear that the Radio Laboratory (along with the Electrical Division) was uneasy in occupying the new building. For within a few weeks after moving, a preliminary survey was made for a site on the Bureau grounds to construct another building that would house all of the branches of the work in electrical communications, those within the Electrical Division and those of the military that had been set up within the Bureau. By the end of November 1918 the survey had been made. But this proposed new building died aborning. Not until 1946, after the Central Radio Propagation Laboratory had come into being, were there serious proposals for a new building—to materialize with the new radio laboratory at Boulder, Colo., in 1954.

Antennas could be a problem, particularly the large-scale outside antennas used for receiving, research, and later for transmission. A mast was erected on the West Building to accommodate an antenna, and a tall mast was erected on the lawn to the east of the East

---

<sup>38</sup> A memo prepared by Kolster, dated February 28, 1912, on the subject of a wireless ground for a new radio building indicates that planning for such a building began no later than early 1912.

Building that would serve as a support to an antenna for the fourth-floor radio laboratory. The new Radio Building was fitted with two 150-foot steel towers during January 1920, to suspend various forms of antennas. The towers were placed beyond the two ends of the long building and anchored into the ground.

## 7. A slow growth—But growing

From Kolster's entrance in 1911 to early 1917 the personnel of the Radio Laboratory had grown to seven. With Kolster, just preceding the country's entrance into World War I, were: R. D. Duncan,<sup>39</sup> M. E. Finn,<sup>40</sup> and Percival D. Lowell; and for part time on radio work were: Dr. Dellinger, J. A. Willoughby, and Dr. John M. Miller. This small group was destined to grow to 40 people by the end of the war.<sup>41</sup>

Then came war's alarms. . . .

---

<sup>39</sup> During the war Duncan became a 1st Lieutenant in the Army and was assigned to the Signal Corps Radio Laboratory at the Bureau.

<sup>40</sup> Finn became a 1st Lieutenant in the Army Air Service.

<sup>41</sup> See Cochrane, *Measures for Progress*, pp. 167-171 on personnel problems of the Bureau during the war period.

## REFERENCES

- [1] L. W. Austin, "Detector for very small alternating currents and electrical waves," *Bull. Bur. Stand.*, Vol. 1, No. 3, Nov. 1905, pp. 435-438, *Scientific Paper 22*.
- [2] L. W. Austin, "Some contact rectifiers of electric currents," *Bull. Bur. Stand.*, Vol. 5, No. 1, Aug. 1908, pp. 133-147, *Scientific Paper 94*.
- [3] Louis W. Austin, "The comparative sensitiveness of some common detectors of electrical oscillations," *Bull. Bur. Stand.*, Vol. 6, No. 4, Nov. 1910, pp. 527-542, *Scientific Paper 140*.
- [4] Louis Cohen, "The influence of frequency on the resistance and inductance of solenoid coils," *Bull. Bur. Stand.*, Vol. 4, No. 1, Dec. 1907, pp. 161-178, *Scientific Paper 76*.
- [5] L. W. Austin, "The work of the U.S. Naval Radio-Telegraphic Laboratory," *J. Am. Soc. Naval Engineers*, Vol. 24, No. 1, Feb. 1912, pp. 122-141.
- [6] L. W. Austin, "Some quantitative experiments in long distance radiotelegraphy," *Bull. Bur. Stand.*, Vol. 7, No. 3, Oct. 1911, pp. 315-363, *Scientific Paper 159*.
- [7] L. W. Austin, "Report of the chairman of the Commission on Radio Wave Propagation, International Union of Scientific Radiotelegraphy," reprinted in *Proc. IRE*, Vol. 16, No. 3, Mar. 1928, pp. 348-358.
- [8] L. W. Austin, "Long-wave radio measurements at the Bureau of Standards in 1926, with some comparisons of solar activity and radio phenomena," *Proc. IRE*, Vol. 15, No. 10, Oct. 1927, pp. 825-836.
- [9] Lyman J. Briggs, "Obituary, Louis Winslow Austin," *Science*, Vol. 76, Aug. 12, 1932, p. 137.
- [10] J. H. Dellinger, "High frequency ammeters," *Bull. Bur. Stand.*, Vol. 10, No. 1, Jan. 1914, pp. 91-159, *Scientific Paper 206*.
- [11] J. H. Dellinger, "International system of electric and magnetic units," *Bull. Bur. Stand.*, Vol. 13, No. 4, Mar. 6, 1917, pp. 599-631, *Scientific Paper 292*.

## Chapter III

### FIGHTING A WAR WITH HERTZIAN WAVES<sup>1</sup>

#### THE WORLD WAR I PERIOD—1917-1918<sup>2</sup>

##### 1. The Radio Laboratory enters a war phase

The declaration of a state of war on April 6, 1917, between the United States and Germany did not find the Radio Laboratory without some capability of applying its experience and know-how to wartime problems in radio communication. Yet the laboratory had very much to learn in the months ahead. The roster of personnel would swell from 7 to 40 by the end of 1918. The swelling numbers would work in crowded quarters until they could move into the new Radio Building during October 1918, a few weeks before the war's end with the armistice.

The seven men laid out an ambitious program to meet the exigencies of war, although the planning must have been largely that of Kolster.<sup>3</sup> It was an ambitious program. As the war work progressed there must have been some feelings of frustration at times. This is indicated in the Annual Report of the Radio Laboratory to the Electricity Division for the year ending June 30, 1918. The report stated:

The policy of the military branches to maintain strict secrecy has, in many instances, made it difficult for the Section to effectively assist in war work. Better progress would result if the radio work of the Section were more intimately connected with that of the military branches of Government, not temporarily but continually.

Nevertheless, by midyear of 1917 the impact of the war had its effect on the Radio Laboratory and imbued its personnel with the importance of their war effort. This feeling is

---

<sup>1</sup>The total program of the Bureau's work in World War I was well documented by *NBS Miscellaneous Publication 46*, "War Work of the Bureau of Standards" (299 pages). The material was compiled and edited by Hugh G. Boutell, who for many years was chief of the Information Section. The material for the portion on Radio Communication (23 pages) was largely compiled and written initially as a Confidential report by Dellinger and Laurens E. Whittemore (secretary, as well as a physicist in the Radio Section at the time of writing). Much of the information contained in this chapter is based upon the *War Work* document and any direct reference to it will be designated *War Work*.

<sup>2</sup>The climate of a war of world scope and the Bureau's total contribution to the war effort are well portrayed by Cochrane in chapter IV, "The War Years," *Measures for Progress*.

<sup>3</sup>To quote from *War Work*, p. 223:

When this country entered the war, the Bureau of Standards was ready with methods, apparatus, and trained personnel for the solution of many of the fundamental problems which confronted military men. Among the problems which had to be solved, and solved quickly, were: (1) The establishment of high-power transoceanic radio systems for use in case all the cables should be cut; (2) the development of low-power radio equipments which should send out just enough but not too much power for communication in the congested area of any given sector at the front; (3) a means for the location of enemy radio stations and airplanes, submarines, and ships; (4) apparatus for communication with and from submarines, particularly when totally submerged; (5) simple and reliable apparatus for radio telephoning; (6) the production of radio apparatus which could be easily carried and yet comprise everything necessary to make the most effective use of radio waves; (7) the training of great numbers of men in a complex and rapidly changing subject.

ARRANGEMENT OF ROOMS

NEW RADIO LABORATORY.

- 101 Storage batteries
- 102 Naval Radio
- 103 Naval Radio
- 104 Naval Radio
- 105 Office, Dr. Austin
- 106-7 Shop
- 109 Carpenter shop and shipping room
- 110 Office, Capt. Pernot
- 111 Signal Corps
- 112 Signal Corps
- 113 Signal Corps
- 114 Dynamos and storage shelves
- 201 Reading and writing room
- 202 Braun tube, drafting
- 203 Transmission and reception laboratory
- 204 Laboratory and stock shelves
- 205 Laboratory, F.A.Kolster
- 206 Office, F.A.Kolster and L.E.Whittemore
- 207 Business office and files
- 210 Office, J.H.Dellinger
- 211 Laboratory, J.H.Dellinger
- 212 Laboratory, J.H.Dellinger and miscellaneous testing.
- 213 Laboratory, J.M.Miller
- 214 Office and laboratory, J.M.Miller

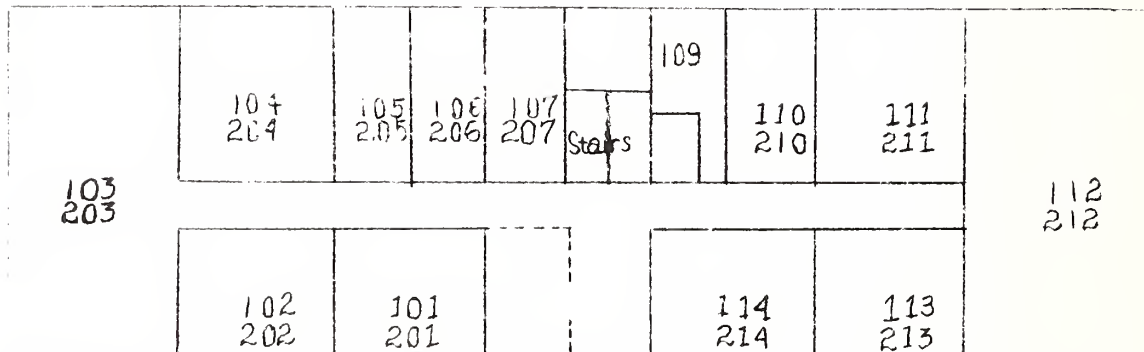

*Page from the Weekly Report of Radio Section, July 1-6, 1918, shows arrangement of rooms for the new radio laboratory to be occupied in October 1918. A third story was added during World War II. These rooms were familiar surroundings to those who occupied the building until move of the Central Radio Propagation Laboratory to Boulder, Colo. in 1954.*



WEEKLY REPORTS ON RADIO WORK

1918

List of Researches.

- a. Portable radio equipments for field service.....Kolster.
- b. Design of airplane radio equipment.....{Kolster  
Whittemore
- c. Location of airplanes by radio.....Kolster
- d. Radio direction finder .....Kolster
- e. Fog signalling apparatus.....Kolster
- g. Closed-circuit transmission.....{Kolster  
Dellinger  
Miller
- h. Utilization of electron tubes.....{Miller  
Kolster  
Dellinger
- i. Precision radio instruments and measurements.....{Kolster  
Dellinger  
Miller
- j. Radio instruments and measurements(Circular No.74)....{Dellinger  
Miller  
Grover
- k. Capacity, inductance, and resistance of antennas..... Miller
- l. Measurement of high-frequency current.....Dellinger
- m. Preparation of instruction material for Signal Corps  
radio courses.....Dellinger
- n. Properties of insulating materials at radio frequencies {Dellinger  
Southworth  
Preston
- o. Characteristics of inductance coils used in radio  
circuits .....{Kolster  
Whittemore
- p. Improvement of crystal rectifiers as radio detectors...{Dellinger  
Vinal  
Ould

*List of projects and project leaders in Radio Section during summer of 1918, taken from a page of the Weekly Report of July 1-6, 1918. Many of the projects were associated with the war effort.*

indicated in the 1917 Annual Report to the Secretary of Commerce on the subject of Radio Science to the Government that stated, in part:

. . . Additional men and funds will enable the laboratory to expedite the work in military problems and to make the laboratory more efficient in its cooperation with the military departments of the Government. Radio signaling is playing an extremely important part in the War, and the radio laboratory staff is taking an active part in the development and improvement of radio apparatus for military purposes and is endeavoring to make the work of the laboratory as useful as possible.

## 2. France sends a delegation to the U.S.A.—And to the Radio Laboratory

Shortly after the Declaration of War the French government sent a delegation to this country known as the French Scientific Commission (or Mission). The purpose was to bring technical information and equipment to this country, and particularly to the Bureau, that would demonstrate the advances made during the war in scientific military equipment. The team visiting the Radio Laboratory was headed by Professor Henri Abraham of the University of Paris who was a leader in applying electrical science to radio apparatus for war purposes. To quote from Dr. Dellinger's "Address, 1961":<sup>4</sup>

We remember especially Professor Henri Abraham, a rosy-cheeked, roly poly "Santa Claus." He had collaborated in Paris with E. H. Armstrong in adapting the superheterodyne principle to practical use in military equipment. We passed on the information to the Signal Corps, giving them further help away from older types of equipment.

Indeed, Professor Abraham proved to be a real Santa Claus. From out of his sack he pulled some surprises in the form of electron tubes, electron-tube amplifiers, and the superheterodyne circuit, most of which were new to men of the Radio Laboratory and to others in this country. These surprises, that were left for study and use, proved to be a boon to later developments by the Radio Laboratory during and after the war.

## 3. Relation of the Radio Laboratory to the military services

Previous to World War I two military radio laboratories had been established at the Bureau: the U.S. Naval Radio Research Laboratory (1908) and the Army Signal Corps Radio Laboratory (1908). To these were added, during the war: a Naval Aircraft radio experimental laboratory and a radio laboratory for the Intelligence Division of the Army Signal Corps. Much mutual assistance was given between these four military laboratories and the Bureau.

During the war the Radio Laboratory was able to furnish considerable information and assistance to the National Research Council. However, it was to the Signal Corps of the Army that the greatest assistance was given and from whom the Bureau received considerable amounts of supporting funds. For these services the Signal Corps was appreciative, as indicated by the report made by the Chief Signal Officer to the Secretary of War in 1919:

The outcome of this research work has been of vital importance to the Signal Corps, and it is felt that every additional facility should be afforded to the Bureau of Standards so that it may continue to collaborate with the Signal Corps on these special problems.

## 4. Technical information for instruction—The Radio Laboratory embarks on a writing program

### a) *CIRCULAR 74*

The war with its overtones of technical advances in military equipment and the supporting equipment brought on a desperate need for technical know-how, instruction, and specialized training. To meet this need the Radio Laboratory was requested by the Signal Corps to disseminate its specialized knowledge as widely as possible, and especially in radio schools conducted in universities. On December 29, 1917 (nearly 8 months after the Declaration of War), a group of college and university representatives met with personnel of the Signal Corps and the Radio Laboratory to plan and steer a course for the production of books and manuals to be used for radio instruction. The outcome was a marked achievement with the written word.

Almost providentially, the Electricity Division was prepared for one of the tasks. Among the earliest unpublished writings and the publications of the division were those relating to mathematical concepts of the electrical quantities of capacitance, inductance,

---

<sup>4</sup> See chapter II, p. 34.

and resistance, and their embodiment in physical devices to be used as standards. This program was largely the concepts of Dr. Edward B. Rosa, but his aides joined in on the program that would extend over a period of many years. The growing field of wireless telegraphy caused them to move up in frequency from direct current and power frequencies. This forced them to alter their concepts and formulas in order to be applicable to radio frequencies as well. By 1914 or so there was a considerable effort toward consolidating all of this material into one publication that could have wide use, both within and outside the Bureau. Such was the circumstance when the conference was held on December 29, 1917. Although the written material had a somewhat Topsy-like growth, the effort was not too great to have it "jell" into a usable book within several months. On March 23, 1918, this manual was published as *NBS Circular 74*, entitled "Radio Instruments and Measurements." The book approached some proportions, with 330 pages. It became an all-time "classic" in Bureau publications.<sup>5</sup>

The Signal Corps was furnished with 2000 copies of *NBS Circular 74* and in years to come it became a "best seller." Sometime later the circular became available in a clothbound edition, printed by the Wireless Press. Although not noted in the original edition, the book was prepared under the guiding hand of Dellinger, plus his own contributions, and by J. M. Miller, F. W. Grover and G. C. Southworth, along with lesser contributions.<sup>6</sup>

A second and revised edition of *NBS Circular 74* was published on March 10, 1924, 6 years after the first edition. It was essentially much like the first edition. Again Dellinger took the leading role in the revision, assisted by L. E. Whittmore and R. S. Ould of the Radio Section.

The circular was reprinted January 1, 1937, with type corrections and a list of errata.

#### b) *THE PRINCIPLES UNDERLYING RADIO COMMUNICATION*

*NBS Circular 74* was prepared primarily for training of officers at the college level and in advanced radio courses. But with the very rapid application of radio communication to the war effort there was dire need for a more practical manual for the operators of radio equipment. To meet this need the Training Section of the Signal Corps requested the Bureau in April 1918 to prepare a more elementary text. It was now a year after war had been declared. To be realistic in getting out a book of this nature in a reasonable time required a "crash program" approach. It was underway in June. Three months were set for its preparation—no one writer could undertake such an assignment and it was turned into a syndicated operation. Again, Dr. Dellinger was the guiding hand, but most of the writing was turned over to a team of college professors.<sup>7,9</sup>

---

<sup>5</sup> Although *NBS Circular 74* was rapidly put together as a war effort for instructional purposes, its total concept was that of stating the basic principles of radio communication. Part I, entitled "Theoretical Basis of Radio Measurements," delved into the principles of alternating currents, with primary attention to their behavior in circuits at radio frequencies (up to 2 MHz). Part II was given over to instruments and methods of radio measurements, mostly based on the Bureau's work. Fortunately, there had been enough experience on the part of the section's personnel that material could be included on electron tubes and their use in radio circuits. Part III contained formulas and information on the design of standards of capacitance, inductance, and resistance. Appendices included a description of radio work at the Bureau and an extensive bibliography.

<sup>6</sup> By 1917 Dr. John M. Miller had made contributions on radio circuits and had been pioneering in electron tubes for the Radio Laboratory. Miller entered the Bureau in 1907 and resigned from the Radio Section on July 31, 1919, to join the Atwater Kent Manufacturing Co., Philadelphia. He was selected to be the assistant superintendent of the Naval Research Laboratory upon its formation in 1923.

Dr. Frederick W. Grover had a number of Bureau publications to his credit on the fundamentals of electrical circuits and was serving part-time in the Radio Section (from the Electricity Division) in applying these fundamentals to radio frequencies. Grover served as a consulting physicist to the Bureau, being a professor of electrical engineering at Union University, Schenectady, N.Y.

George C. Southworth entered the Radio Laboratory on June 30, 1917, and resigned September 13, 1918. Southworth was to reap fame many years later as the author of the well-known treatise, *Principles and Applications of Waveguide Transmission*, while being employed by the Bell Telephone Laboratories (1934-1955).

<sup>7</sup> The six-man team of writers included: Dr. F. W. Grover, Assistant Professor of E. E., Union University (at various times employed by the Bureau as a consulting physicist); Professor C. M. Smith, Associate Professor of Physics, Purdue University; Professor G. F. Wittig, Assistant Professor of E. E., Yale University; Dr. D. A. Cole, Professor of Physics, Ohio State University; Dr. L. P. Wheeler, Assistant Professor of Physics, Yale University; and Professor H. M. Royal, Professor of Math., Clarkson College of Technology.

Because of the syndicated writing, this book was not published as a Bureau document but as *Radio Pamphlet 40* by the Signal Corps, U.S. Army, with the title *The Principles Underlying Radio Communication*. Although in preparation but 3 months, and ready by September 1918, the Signal Corps encountered problems and it was not ready for publication until December 10, 1918 (date of publication). It was finally issued in March 1919—World War I had ceased 4 months earlier, with an armistice on November 11, 1918. Although 50,000 copies were contemplated, only 6000 were printed.

The textbook and training manual used only a scattering of mathematics. Briefly, 355 pages covered the areas of: elementary electricity, dynamo-electric machinery, radio circuits, electromagnetic waves, radio apparatus, and vacuum tubes. It was profusely illustrated with line drawings and photographs.

The book became a popular item in schools and elsewhere. Shortly after the war, in a letter of April 25, 1919, to the director (Stratton), Thomas A. Edison commented on the book, stating:

. . . This is the greatest book on this subject that I have ever read, and I want to congratulate you and your Bureau on its production.

Usually, books on radio communication are fairly bristling with mathematics, and I am at a loss in trying to read them. This book, which your Bureau has sent me, is simple, and I have enjoyed reading it. I know a great deal more about the subject than I ever did before.<sup>10</sup>

A much larger and revised edition (619 pages) was published by the Signal Corps in 1922. This edition was prepared under the direction of Dellinger, with much of the work by R. S. Ould, plus the assistance of E. S. Purington and L. M. Hull, all of the Radio Section. The material was carefully examined by Dr. H. S. Uhler of Yale University. It became available in buckram binding to the public at a price of \$1, a bargain even in those days.

---

<sup>8</sup> One should not overlook the comment made on this book by Dr. Dellinger in his "Address, 1961," in which he said:

. . . We set them to writing the "Principles Underlying Radio Communication," commonly called the "PURC." This was wanted by the Signal Corps for the training of enlisted men. The professors produced the book and also several poems. Here is one:

(Tune—"Keep the Home Fires Burning")

They were summoned from O-hi-o,  
They were called in from Pur-due;  
And the Bu-reau found them rea-dy  
To rush this war book through.

They were guests of the Field Bat-tal-lion,  
They were out at Col-lege Park,  
And al-though their heads are bursting  
Still they treat it as a lark.

There's no sil-ver lining  
Through the dark clouds shin-ing  
For the lad who reads that book  
In the Sig-nal Corps.

We were told to write for college  
We were told to write for camp  
'Twas to be a mass of knowledge  
And for every man a lamp.

But alas for good intentions—  
When we thought 'twas nearly through  
We were told it was too high-brow (but more delicately)  
And we had to start anew.

<sup>9</sup> In addition to the rather voluminous training manual, the Radio Laboratory prepared a number of brief instruction pamphlets on radio subjects for the Signal Corps. In turn, training pamphlets prepared by the Signal Corps were submitted to the Radio Laboratory for editing or revision. This project was largely carried on by Dellinger.

<sup>10</sup> Letter to Stratton by Edison, April 25, 1919 (NN365-25, Box 4).

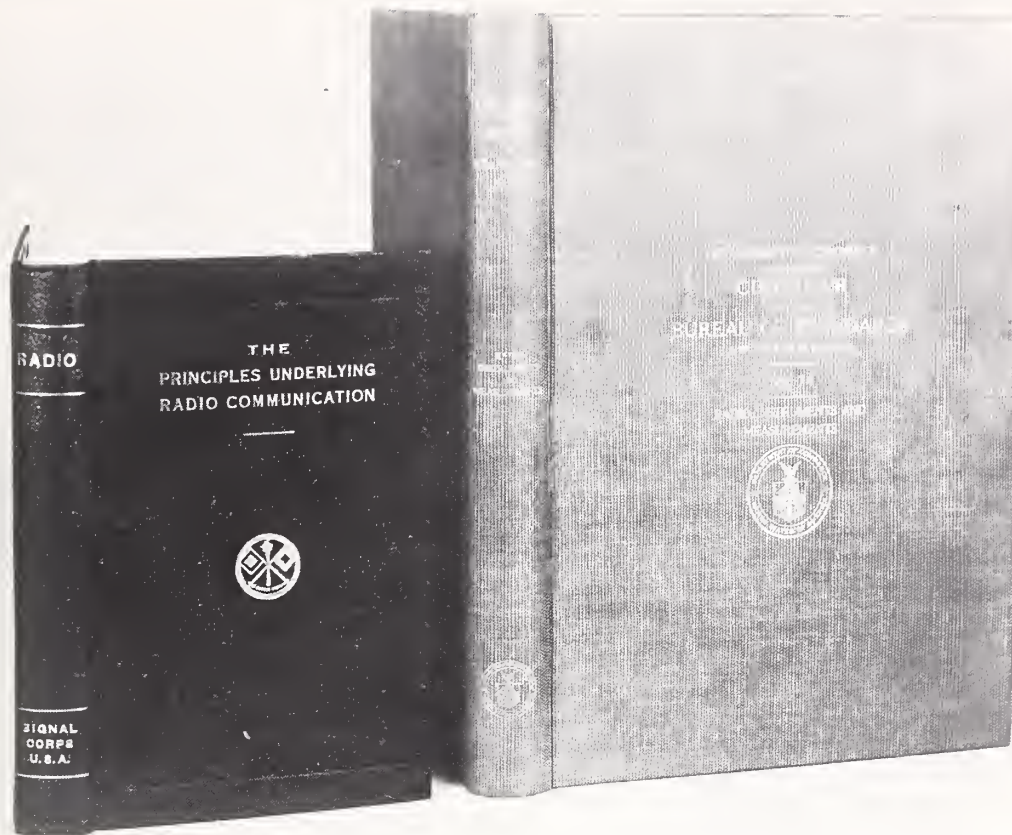

*The two books written during World War I period of 1917-1918 that became "classics" of their kind. NBS Circular 74, "Radio Instruments and Measurements" was written by staff members and brought into print much information that had been gathering in the Radio Section. The Principles Underlying Radio Communication published as a textbook at request of Army Signal Corps. Much of it was written by a sextet of electrical engineering professors under guidance of Dellinger.*

of Standards have assisted in the work of revision by suggestions, and by preparing new material. The section on batteries has been rewritten by Mr. G. W. Vinal. Much of the revision of the chapter on electron tubes has been done by Mr. E. S. Purington and Mr. L. M. Hull. The authors who prepared the first edition have offered valuable suggestions for desirable changes. Mention is made of the work of Professor C. M. Smith on the index.

Acknowledgment is made to the General Electric Co. for photographs of the Alexanderson alternator, to the Federal Telegraph Co. for photographs of the arc converter, to the Western Electric Co. for detailed drawings of a telephone transmitter and receiver, and to the Electric Storage Battery Co. for a photograph of a lead storage cell.

Authors 211

<u>Introduction</u>	<u>Chap. 4, A to D</u>
Wheeler	Wheeler
Smith	Dellinger
Grover	<u>Chap. 4, E to H</u>
Dellinger	Grover
<u>Chap. 1, A to H</u>	<u>Chap. 5</u>
Smith	Royal
Dellinger	Dellinger
<u>Chap. 1 I</u>	<u>Chap. 6</u>
Grover	Cole
<u>Chap. 1, J</u>	Grover
Wittig	Dellinger
<u>Chap. 2</u>	<u>Appendixes</u>
Wittig	Cole
<u>Chap. 3</u>	Grover
Grover	Dellinger

Page from preface to second edition of *The Principles Underlying Radio Communication* found in Dellinger's copy deposited in the archival collection of Boulder Laboratories library. Dellinger wrote down names of authors of the various chapters of the first edition (see p. 53 for a listing of the authors and their professional associations).

### c) VACUUM TUBES, THEORY AND USE

The third book prepared by the Bureau on radio subjects during the war period was published by the Army Signal Corps during March 1918, with the title *Vacuum Tubes, Theory and Use*. Although a clothbound book of 201 pages, it appears to have been a very

limited edition as only 200 copies were issued by the Signal Corps. The title page stated that it was:

For use of officers and authorized civilians engaged in radio development work.

The purpose and contents of the book can be described best by quoting the short introduction by the compiler, S. J. Crooker.

In consequence of the universal application of discharge tubes which depend upon thermionic currents for their operation, it becomes imperative to study more in detail the underlying physical principles, the theory of the circuits, and the various ways in which these tubes can be used. To make possible such a study in a brief time this information has been compiled with the aid of Dr. F. A. Wolff and Mr. H. H. Beltz, from a number of scientific and technical papers giving a comprehensive treatment of the subject.<sup>11</sup>

Tube types described in the book included the Fleming valve, the kenotron, audion, pliotron, dynatron, and pliodynatron. The compilers made use of material from 38 scientific and technical papers, including papers by Armstrong on audion receivers and heterodyne receivers using vacuum tubes. (Armstrong had not yet published on the superheterodyne circuit.)

## 5. Radio systems applied to military uses

Several projects that were developed after the United States entered the war had their roots in earlier developments, dating back to 1915. The concepts, as well as the successful application, of these projects were dependent upon both the theoretical aspects and the constructional design of antenna systems. Moreover, the increased use of vacuum tubes in radio apparatus enhanced the success achieved in application of the new antenna systems.

### a) COIL AERIALS (ANTENNAS)

Although the concept of a coil aerial was not new, Kolster believed that it had various applications in radio where its usefulness as an antenna could serve very specific purposes. Kolster began experimenting with the coil aerial in 1915 and later was joined by Dellinger and J. M. Miller for study of the properties of such antennas.

Both the Army and the Navy were interested in the use of coil aerials (or loop antennas) for communication purposes. Coil antennas, which are closed conductive circuit antenna systems in contrast with the open circuit of the condenser or elevated type of antennas, have the advantages of compact size, directional characteristics, and a degree of interference reduction. For communication purposes the coil aerial was found to be good for reception (particularly with vacuum-tube receiver circuits), but there was disappointment with coils as transmitting antennas because of low radiation output. As a complete communication system, the use of coil aerials for both transmission and receiving did not prove as successful as hoped.<sup>12</sup>

### b) DIRECTION FINDERS

Radio direction finders were of much interest to the Navy for use on naval vessels. During 1916 Kolster had applied some of his ideas on radio direction finders to use by the Bureau of Lighthouses (Department of Commerce). Either a ship equipped with a direction finder could locate a lighthouse in a fog or a lighthouse could locate a ship that was radiating signals. He used the term "fog signalling" for these operations. From this development came the Kolster radio compass. In 1917 the Navy adopted the radio compass for its vessels and by the early 1920's approximately 130 ships of commercial lines,

<sup>11</sup> Dr. F. A. Wolff was chief of the Telephone Service Standards Section in the Electricity Division, and H. H. Beltz was a member of that section. However, during the war Beltz was assigned to the Radio Laboratory for a period of time.

<sup>12</sup> A communication system involving the use of coil aerials was called a closed-circuit transmission system by the Radio Laboratory.

Government agencies, and the military had been fitted with the Kolster radio compass (see ch. VI). To a limited extent the radio compass was adapted to submarines.

The Army also had use for direction finders on or near the battlefields. With portable field equipment, enemy radio transmitters could be located and subjected to artillery fire or aerial bombardment.

### c) ANTENNAS FOR UNDERWATER RECEPTION AND TRANSMISSION OF RADIO SIGNALS

Although a submarine could communicate by wireless with ships and shore stations when its antenna was above the water's surface, the crew found itself cut off from the world when submerged (communicating underwater with supersonic frequencies had not yet arrived in World War I). It was with considerable boldness that John A. Willoughby and Percival D. Lowell of the Radio Laboratory suggested the possibility of receiving and even transmitting wireless signals while a submarine was submerged.<sup>13</sup>

Submarine radio signaling was not among the seven objectives to be pursued by the Radio Laboratory after war was declared, nor was it among the research projects reported by Section 6 at the close of 1917. However, beginning early in November of 1917, Willoughby and Lowell conducted a series of experiments with a waterproofed coil antenna in fresh water and found some degree of transmission of radio signals from underwater. The original purpose was to develop apparatus for the detection of enemy submarines. Although their success with the coil antennas was somewhat limited, they were undaunted in their efforts. To quote from Dellinger's "Address, 1961" we find:

. . . Among the glamorous successes (of World War I) was the creation of a single-loop antenna that worked underwater on a submarine, by Percival D. Lowell after the rest of us told him it couldn't be done.\*

\*In his editorial review of this chapter Lowell stated that Willoughby was the prime mover on the submarine antenna and that his name should have appeared also in Dellinger's statement.

Such was the situation in which Willoughby and Lowell found themselves in trying to solve a problem that seemingly had no solution. But success was not too far away. With some new ideas the two men found themselves located at the Navy submarine base at New London, Conn. during the late spring and summer of 1918. For several days J. M. Miller also took part in the program at New London. The team had marked success with the loop antenna that finally evolved in this cooperative project with the Navy. Willoughby and Lowell reported on their success in the following year at the Washington meeting of the American Physical Society on April 26, 1919 [1].<sup>14</sup> It was at this meeting that several members of the Radio Section reported on work done for the military during World War I.

The Navy was satisfied with the results of the underwater signaling to the extent that they began equipping their submarines with this loop antenna beginning in the summer of

---

<sup>13</sup> John A. Willoughby entered the Bureau in 1916 and resigned on March 15, 1922, later to join the Naval Research Laboratory.

Percival D. Lowell joined the Bureau on February 4, 1913, and resigned from the Radio Section on July 15, 1922, to join the Radio Instrument Co., Washington, D.C. He rejoined the Radio Section on March 17, 1941, and retired from NBS on September 6, 1962.

<sup>14</sup> The final design of the antenna was a loop formed of two insulated wires grounded at the extreme ends of the submarine hull, carried over supports to the bridge, then down into the hull to the receiving and transmitting equipment (a spark transmitter was used in these early experiments). Thus the two ends of the loop fed into the apparatus, with the metallic hull completing the circuit of the single-turn loop. They found that the loop had directional properties, both when above and below the water's surface, and could be used as a direction finder. Even when totally submerged they were able to receive European stations. However, they soon found (as would be expected) that the ability to receive signals at the threshold of audibility at various maximum depths was a function of the wavelength. At a wavelength of 10,000 meters (30 kHz) signals could be heard with the top of the loop submerged to a 21-foot depth in salt water.

With a 1-kW spark transmitter operating at 952 meters (315 kHz) they could transmit signals to a distance of 10 or 12 miles with the loop submerged, and to a lesser distance of 2 or 3 miles with the top of the loop 9 feet below the surface.



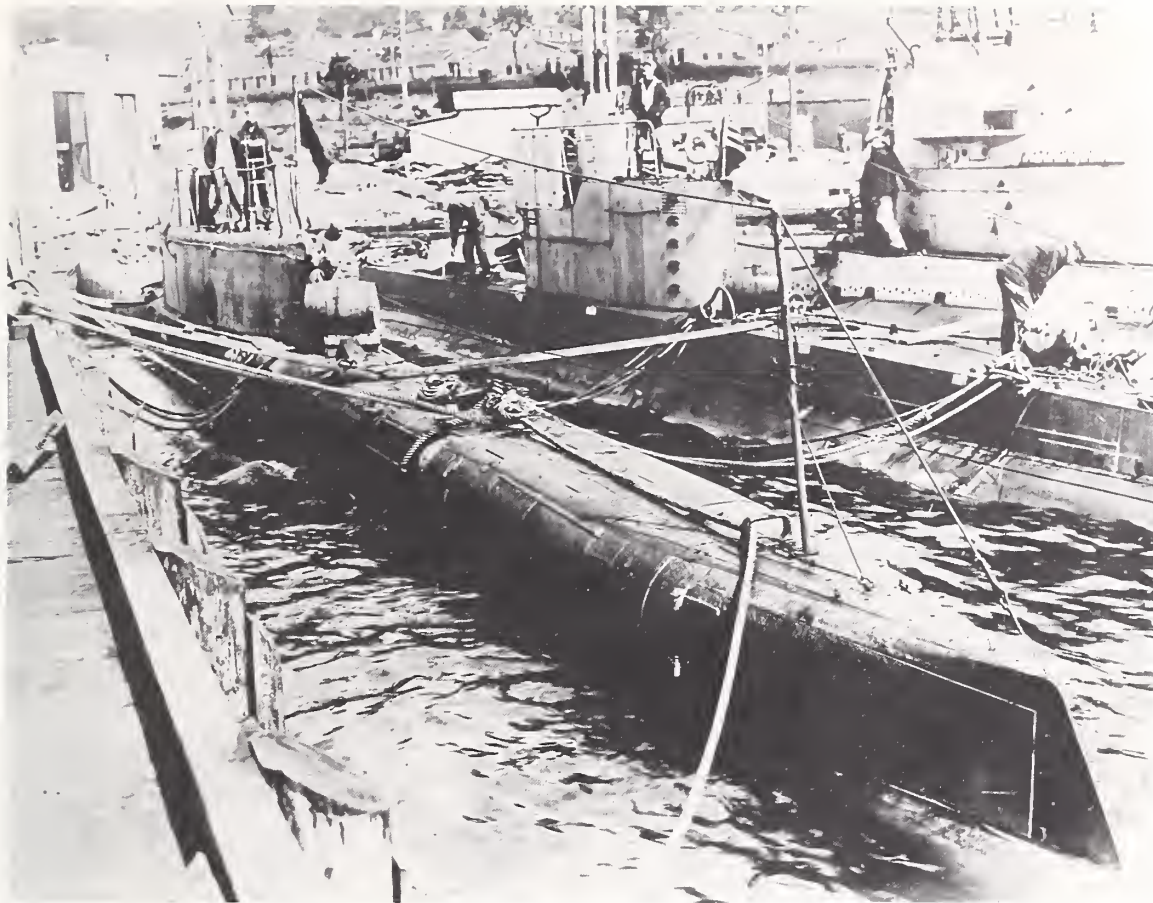

*Submarine (G-3) at Navy base, New London, Conn. fitted with loop antenna designed in 1918 by Willoughby and Lowell. A pair of insulated wires from the bridge, each grounded to an end of the hull, formed loop circuit that had directional properties. Signals were received from European stations with loop completely submerged. Signals from spark set on board could be transmitted up to 10 miles with loop submerged.*

1918. The Navy's interest in underwater antennas (or any subsurface antenna) extended to other investigations both before and after World War I.<sup>15</sup>

After the war Willoughby and Lowell applied for a patent on the submarine antenna. This was contested later by J. Harris Rogers. On June 9, 1922, the Examiner of Interference of the Patent Office handed down a decision on the case, holding that Rogers was entitled to prior conception of the use of the loop antenna on submarines, but that Willoughby and Lowell had independently conceived the device and reduced it to practice and were entitled to the patent. In July, Rogers appealed to the Examiner-in-Chief on the decision made in June. Defense of the case by the Department of Justice brought a final decision in favor of Willoughby and Lowell. (Patent No. 1,708,071 was finally issued April 9, 1929, nearly 10 years after the original application, October 31, 1919.)

#### **d) PIONEERING IN AIR NAVIGATION BY RADIO**

It was natural that personnel of the Radio Laboratory, and especially Kolster, would be considering various applications of direction finding to air navigation as a war effort. As a result of his development work for the Bureau of Lighthouses in "fog signalling," Kolster suggested a method of detecting and locating aircraft with direction finders in April 1917 by

<sup>15</sup> The Navy's interest in "ground" antennas began in 1909. During World War I the Navy had the services of J. Harris Rogers of Hyattsville, Md., a man of independent means, who had been experimenting with ground antennas. An account of his work with the Navy and of other Navy work on ground antennas is given in an historical account by A. Hoyt Taylor in 1919 (Taylor later became the first superintendent of the Naval Research Laboratory) [2].

A short account of "ground" antennas is given in the second edition of *The Principles Underlying Radio Communication*, pp. 327-330, and the submarine antenna on pp. 338-339.

means of a triangulation technique using two or more transmitters.<sup>16</sup> Viewed from the other side of the coin, an aviator flying a plane fitted with a radio compass could determine a course to a landing field serviced by a transmitter if he were closed in by weather or darkness.

These measures were becoming a reality, but another radio navigation device was a necessity for landing in a fog or in darkness. In the summer of 1918 the Post Office Department asked the Bureau to assist in developing a method of determining the exact location of an airfield for its air mail service. After some small-scale experiments, Kolster came up with an induction field method employing a low-frequency alternating current (500 Hz). To test the method from a plane the director, Dr. Stratton, suggested using the Radio Building as a "simulated" flying field. It is most interesting, that on November 11, 1918, the day when the armistice was declared to end World War I and a day when excitement and celebration ran high in Washington, as well as in the rest of the country, that Kolster and the Post Office Department conducted their full-scale "landing" of a plane on the Radio Building by electronic techniques (see ch. VI, p. 148).

## 6. Special projects for the military

Although projects associated with antenna systems formed a large segment of war work by the Radio Laboratory, a number of other projects were set up or extended from previous investigations. Some of these projects were strictly wartime measures, others would be extended into the postwar period.

### a) THE ELECTRON TUBE BECOMES ESSENTIAL TO RADIO COMMUNICATION

After de Forest introduced the third electrode (grid) into the two-electrode vacuum tube (Fleming valve) in 1906, there was great potential for many radio developments to come. However, judging by today's short time-lapse between a scientific discovery or invention and its practical application, the more than a decade that it required to make wide use of the three-electrode vacuum tube was slow indeed.

It was the French Scientific Commission (Mission) to this country in the late spring of 1917 that introduced the Signal Corps and the Bureau's Radio Laboratory to the many new developments in electron tubes and communication equipment that were brought on by the war in Europe.

Within the Radio Laboratory Dr. John Miller was probably the best informed on electron tubes, his interest preceding the war period. Thus most of the research, measurements, testing, and standardization work by the laboratory during the war period came under his direction and with his participation. The Signal Corps requested the Bureau to carry out a number of projects that would aid in an intensive effort to adapt the electron tube to wartime equipment. One of these projects, of a research nature, brought wide recognition to Miller's study of a puzzling characteristic of the electron tube. The Signal Corps requested that the explanation be found.

It had been observed by many designers of vacuum-tube amplifiers that the grid-input circuit to a tube would absorb energy in differing degrees depending upon the nature of the reactance in the plate circuit, and that the effect was quite dependent upon frequency and especially at high radio frequencies. Miller tackled the problem, first, from a theoretical approach, and second, experimentally confirmed his findings [3]. The result was that of an understanding of the characteristics of what is often called the "Miller effect."<sup>17</sup> In brief, Miller found that the input impedance of a three-element electron tube is capacitative if the plate circuit is purely resistive. Otherwise, the input impedance will have a resistive component, and thus absorb energy, if the plate circuit has a reactive component. Miller found that, for design purposes, the input impedance could be represented as a series resistance and a capacitance, the values depending upon the components of the plate circuit and the capacities between the tube elements, particularly between the grid and plate. Actually, in some circuitry the Miller effect is taken advantage of, but in most amplifier

<sup>16</sup> An unpublished document in the Radio File entitled "A method of determining the location of an airplane by radio," dated April 1917.

<sup>17</sup> The "Miller effect" is the subject of an entire chapter in the treatise, *The Radiotron Designer's Handbook*, edited by F. Langford Smith, published by The Wireless Press, Sydney, Australia, 1941.

circuits it has a deleterious effect at high radio frequencies. In later tube designs, incorporating multigrad structures, the Miller effect could be minimized.

Miller's study of the input impedance of three-electrode vacuum tubes was at least a partial solution to the problem of understanding electron tubes as noted in *War Work*, to quote:

. . . When one considers the extensive applications of these devices (electron tubes and associated circuitry) which have already been made, it seems strange that so little is known regarding the principles of their operation.

Miller also studied other characteristics of electron tubes, especially as determined by the structure and spacing of the tube elements [4,5]. He also established standardized tests by which tubes could be tested and accepted for procurement by the military. This was especially of benefit to the Signal Corps. During the latter part of the war electron tubes were being manufactured in the United States at the rate of 25,000 per week for the military.

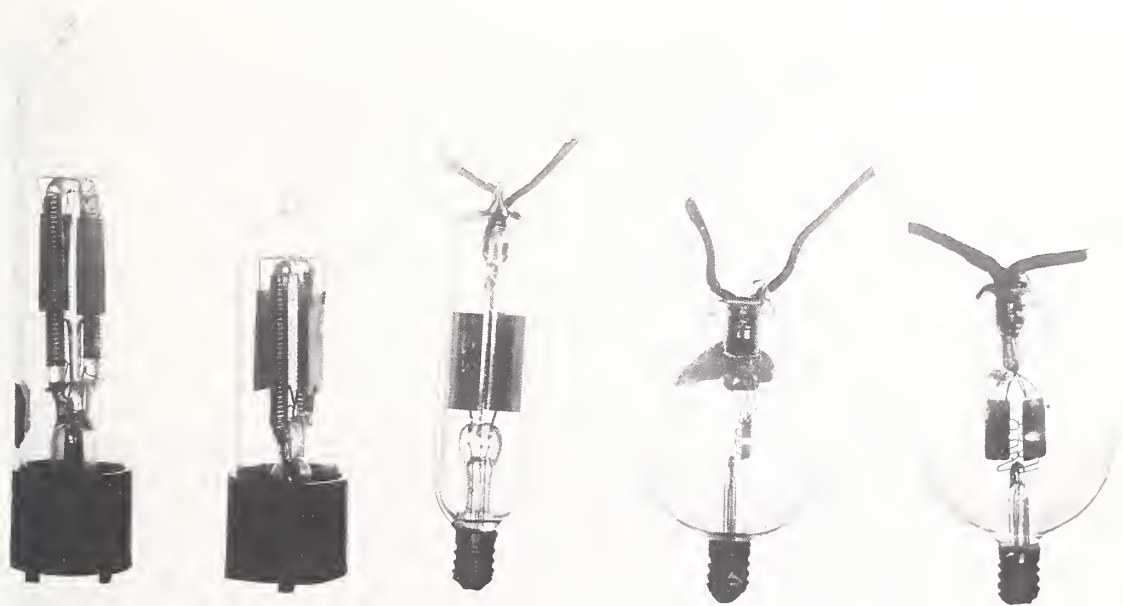

*Electron tubes of the de Forest type that were available to the Radio Section during the period of World War I.*

The rapid adoption of electron tubes to communication systems during the war brought about many problems to designers of equipment. Among these problems was the efficient use of the large-size power tubes in transmitters. Loss of power output at the fundamental frequency in the form of power loss in the harmonics was a sticky problem. One of Miller's associates, Lewis M. Hull, worked on this problem with considerable success.<sup>18</sup> The power tubes were also incorporated into high-voltage plate supplies, with novel circuitry, in place of the usual two-electrode rectifier tubes (kenotrons). Hull also made studies of vacuum tubes for generators and transmitters.

The intensive investigations on electron tubes by Miller and his associates, including Kolster and Dellinger, during the war period and for a short period thereafter, led to approximately 40 unpublished papers in the Radio Section Reports (some quite voluminous) to the Signal Corps, and to no less than 7 published papers. Rapid progress was also made in radio measurements by adopting electron-tube equipment such as amplifiers, generators, and detectors to the measurement systems. This resulted in measurement systems of much greater sensitivity and in use of generators with fairly pure sine-wave content. It was during this period that the research efforts within the Bureau on electron tubes reached the apogee of activity. Within recent years there has been considerable research on semiconductors and solid-state devices by the Electronic Technology Division, NBS.

<sup>18</sup> Hull entered the Radio Laboratory on August 23, 1918, and resigned on July 19, 1922.

## b) TO MAKE MORE PERMANENT CRYSTAL DETECTORS

Although the three-electrode vacuum tube was rapidly displacing the crystal detector in radio receivers, nevertheless there was an abundance of communication equipment in the military that would continue to use crystals for some time to come. In March 1918, the Signal Corps requested the Radio Laboratory to investigate the possibility of more permanent forms of crystal detectors, that is, to eliminate the "cat's whisker" in favor of a fixed point of contact. The accomplishment would mean a more reliable device, particularly when subject to vibration, either in actual use or in transport. Heretofore, only carborundum and molybdenite showed good characteristics of serving as detectors with a fixed point of contact. Many types of crystals, including the sensitive galena crystal, were processed and fitted with fixed contact points, but to no avail. Their sensitivity was dependent upon the "cat's whisker" and a more permanent contact inhibited this sensitivity. No success came from the project—success would have to wait for many years, with the advent of other types of semiconductor diodes.

Working on the project with R. S. Ould was Dr. Louise S. McDowell of Wellesley College.<sup>19</sup>

---

<sup>19</sup> Miss Louise S. McDowell, a physics professor of Wellesley College, Mass., entered the Radio Laboratory during the week of August 12-17, 1918. She returned to Wellesley College in January 1919. Dr. McDowell was a guest worker in the Radio Section on several occasions for short periods of time as late as 1931.

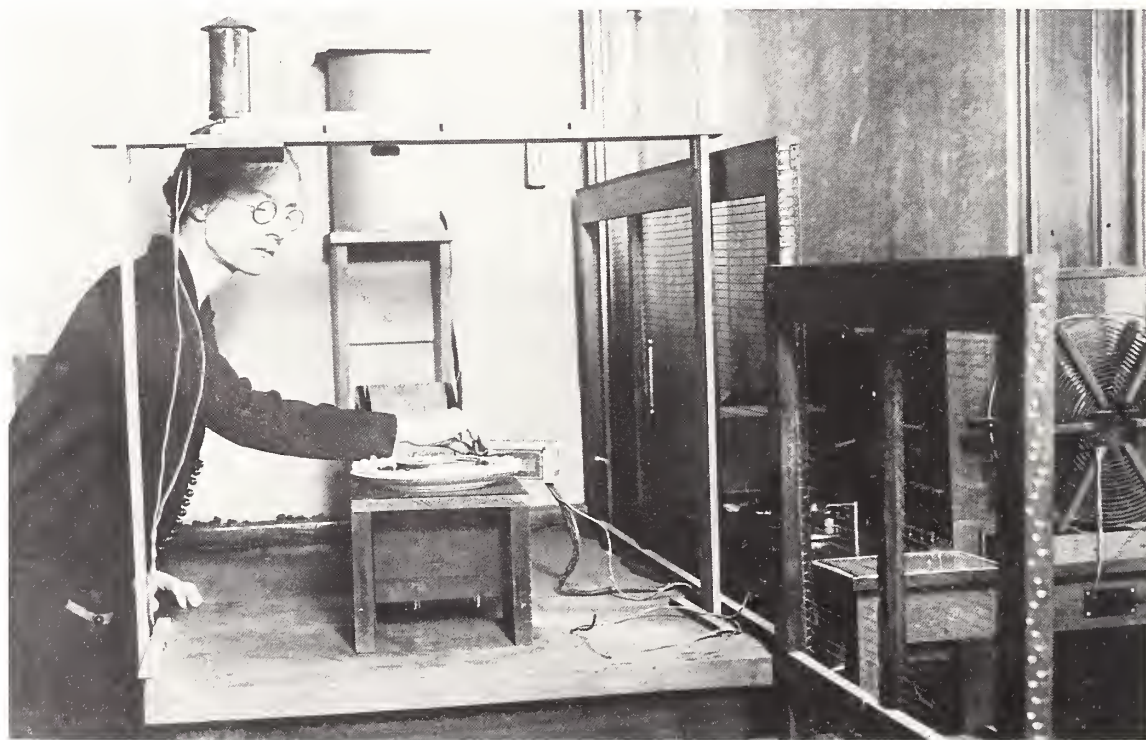

*Dr. Louise S. McDowell, Professor of Physics, Wellesley College, one of several college professors who worked in the Radio Laboratory during World War I (period of August 1918 to January 1919). She returned to work for short periods in the Radio Section as late as 1931. This 1925 photograph was taken when she was studying the properties of insulating materials at radio frequencies. Cochrane states, in Measures for Progress (p. 170), that Professor McDowell was the first woman with a doctor's degree to work at the Bureau.*

#### e) INSULATING MATERIALS AT RADIO FREQUENCIES

Because of some of the mechanical and thermal shortcomings of hard rubber as an insulating material in wireless equipment, the relatively new phenol products, such as bakelite, became popular as electrical insulators by the time of World War I. Yet the properties of these materials were not well understood, especially the electrical properties at radio frequencies. These properties were studied by several groups within the Bureau on various phenol-methylene resins, ranging from the molded pure resins through many types containing various amounts of fillers or laminations of fibrous substances. Within the Radio Laboratory studies were made of dielectric or power factor loss, phase-angle change, and high-voltage breakdown. For a more detailed account of this research program see chapter V, pp. 106-107.

The insulation program was directed by Dr. Dellinger. Later Dellinger and J. L. Preston published two Bureau papers on the wartime and postwar program.

#### d) EXPERIMENTING WITH CATHODE-RAY OSCILLOGRAPHS

The first cathode-ray oscilloscope was constructed by Braun (Germany) in 1897 but its adoption as a laboratory instrument to observe radio frequencies came slowly. Cathode-ray oscillographs that were available by 1918 were largely of an experimental nature so the Radio Laboratory set out to build its own. In July 1918, parts consisting of anodes, cathodes, and screens were obtained from the General Electric Co., from which Braun tubes (cold cathode) could be constructed. With the aid of a glassblower, several Braun tubes were assembled and pumped down to a suitable vacuum with a Langmuir condensation pump, with the tube housed in an oven heated to about 400 °C to aid in evacuation of occluded gases. Tubes were also borrowed from several universities.

For excitation of the tube, a power supply incorporating a high-voltage transformer, two kenotron rectifiers, and a low-pass filter gave as high as 20,000 volts between the anode and cathode. Deflection coils, external to the tube, as well as electrostatic deflection plates mounted within the tube, were used to deflect the beam for signal observation.

But hot-cathode tubes were far superior for the low voltages and small currents encountered in studying vacuum-tube characteristics. To this end the laboratory used oxide-coated platinum for hot cathodes. Voltage sensitivities of about 0.25 cm deflection per volt were achieved.

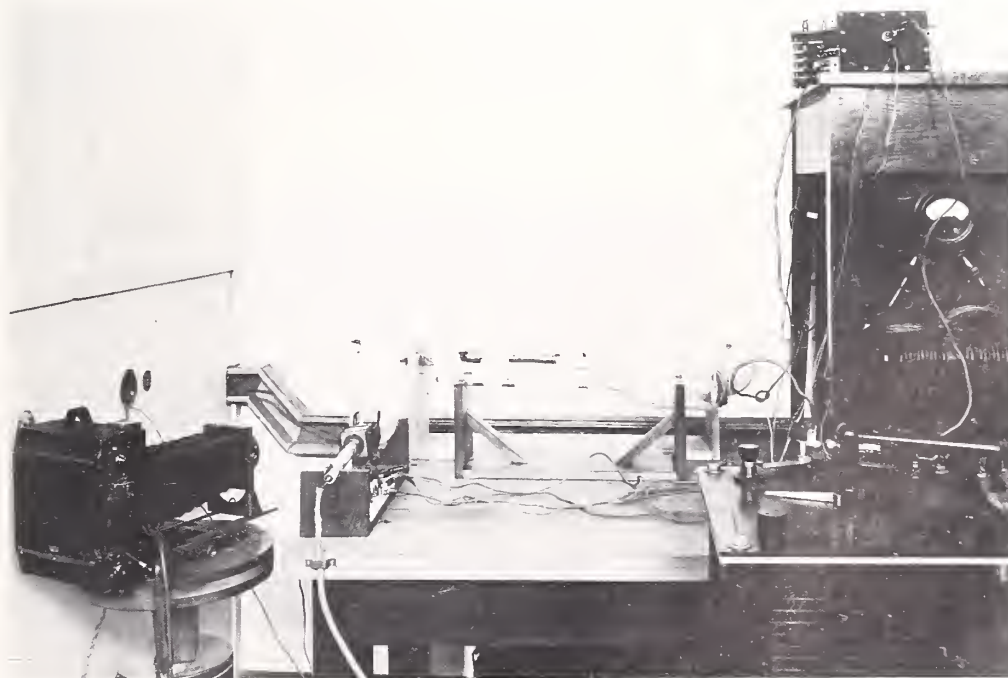

*Early form of cathode-ray oscillograph used in Radio Section. Their construction began in July 1918 from parts secured from a variety of sources. The photograph shows two Braun tubes, with a camera at lower left.*

Although Lissajous figures could be obtained to observe frequency relations between two sources of alternating current, it was necessary to provide for a time axis for many of the observations. By today's standards, the time-axis control was rather crude and synchronization of the scanning was quite difficult. The time-axis sweeps were obtained from high-frequency generators, 500-Hz alternators, and by oscillating discharges from a capacitor that was periodically charged from an alternating current source.

During the war period, and for a short time thereafter, the oscillographs were used for study of: radio frequency current and voltage wave forms; the behavior of spark transmitters; the modulation of electron-tube transmitters; the plate-current, grid-voltage characteristics of vacuum tubes acting as generators; and to synchronize radio frequency circuits. In the one publication that came from this wartime project, Lewis M. Hull stated:

The usefulness of the cathode-ray oscillograph in radio measurements is chiefly qualitative. Except when it is employed as an aid to frequency comparison between two circuits, precision measurements cannot be made, as the deflections cannot be accurately measured when photographed. It is as an aid to research, permitting visual observations of phenomena hitherto unseen and furnishing qualitative data for new ideas and new theories, that the cathode-ray oscillograph performs a service that can be achieved by no other device [6].

Several years after World War I the oscillograph was put to considerable use for a period of time as a laboratory tool for the frequency standards program. Today, the cathode-ray oscillograph serves a multitude of uses within NBS and hundreds of the instruments in various degrees of sophistication are found in the many laboratories. But these developments came from outside the Bureau. In 1918 the personnel of the Radio Laboratory had to design and construct their own oscillographs.

#### e) SHIELDING AGAINST UNWANTED SIGNALS

In the fall of 1917 the Radio Laboratory encountered its first problems associated with reduction of unwanted radio signals by use of metallic enclosures or cages (ideally, the Faraday cage for the electrical component of electromagnetic radiation). The first attempt was shielding against a transmitter located within the East Building operating at 1000 meters (300 kHz). The wavelength being long, a beginning was made by using chicken wire, with some degree of success. Grounding of the cage made no difference in its attenuation of radio waves. Considerable success was attained in shielding receivers against the very strong signals of NAA at Arlington across the Potomac River. Later, galvanized hardware cloth was used and still later copper or bronze window screen was used as interest increased toward working at high frequencies.



*An early shielded room or "cage" developed by the Radio Section. The first attempt at shielding was in 1917 with considerable success in minimizing the strong signals of NAA, the powerful Navy station across the Potomac in Arlington, Va.*

Not until 1946 was copper sheeting used for shielding, when the enclosure could be ventilated with air conditioning equipment. The Radio Building of the Boulder Laboratories was constructed with a total of 18 shielded rooms of large size (some, 24×48 feet) using paper-backed, electrolytically-formed copper sheeting as the shielding material. Another room, a specially constructed shielded enclosure of outside manufacture, attenuates radio signals by as much as 140 dB, a necessary requirement for an environment for noise measurements.

## 7. A burgeoning section reorganizes

The Radio Laboratory had grown from 7 members in April 1917 to 40 at the time of the armistice. In addition, many people, both civilians and military personnel, were detailed by the Army and Navy to the section for training and aiding in the development programs. From the welter of administrative problems that was coming out of this explosive growth, a definite step was taken about mid-1918 to reorganize the section on a businesslike basis. By October, at the time of moving into the new building, the reorganizational plan went into effect.

The Radio Laboratory was now definitely known as the Radio Section, a title it apparently had never attained fully before, although it had been designated as Section I-6 as far back as 1914. Briefly, the section took on the following structure.<sup>20</sup> It was clearly indicated that Kolster was the section chief, with responsibility for the cooperative programs with the military and other organizations. He was also in charge of a number of technical projects of an engineering nature such as navigational systems. Dr. Dellinger was designated as the research assistant, in charge of research programs and the publishing programs. L. E. Whittemore was designated as the business assistant in charge of the section office, plus his interests in certain technical projects.

## 8. From whence came the *Technical News Bulletin (TNB)*?

Because the Radio Section made many contributions to the Bureau's publication, the *Technical News Bulletin*, in its early years, it is a matter of some interest how this publication had its beginning. For the first 1 1/2 years the publication was known as the Confidential Bulletin, accompanied by the issue number and the date of publication, and was printed on letter stationery with a Bureau letterhead. It was circulated as mimeographed copies. The Confidential Bulletin came about to meet a wartime need of other Government bureaus, and particularly the military. The No. 1 issue was published December 15, 1917, approximately 8 months after the Declaration of War. The first issue stated its purpose and gave an outline of the Bureau's work.<sup>21</sup>

---

<sup>20</sup> A chart indicating the entire section structure, personnel, technical projects, and operational functions is shown in appendix C.

<sup>21</sup> The first three paragraphs stated the purpose of publishing the Confidential Bulletin, as quoted below:

In accordance with the requests of several military bureaus to be kept informed as to the scientific and technical activities of the Bureau of Standards, as far as they relate to the military services, the Bureau has decided to issue periodic confidential statements to those bureaus regarding the progress of such work.

The Bureau believes that copies of these statements might well be placed in the hands of those officers and civilian employees having in charge technical and engineering problems of a type comprised in the appended outline or the applications of the same. To this end, the Bureau will be glad to receive from each department a list of the names to which it is desired that this information be sent, or if considered preferable, a statement of the number of copies which each office will arrange to circulate.

Suggestions regarding the form and scope of these bulletins will be gladly received, as the Bureau wishes to make them as useful as possible. Inquiries on any of the subjects treated or mentioned in them will at all times be given full and careful consideration.

There then followed more than three pages outlining the Bureau's work, with a closing statement as follows:

The above are illustrative of the Bureau's fields of activity and the problems which arise in them. In some of these cases the Bureau undertakes an exhaustive research of the problem as a

It was not until Confidential Bulletin 5 of March 3, 1918, that the Radio Laboratory appeared with an item, but the item was relating to a project that was of "great importance" to the military. To quote:

5. Vacuum Tube Data: A large number of important technical papers relating to vacuum tube amplifiers have been studied. These instruments have assumed great importance in the reception of radio signals; accordingly a digest of the information has been prepared and mimeographed for distribution to officers and engineers of the (military) services concerned.

For many years thereafter there was a steady stream of news items from the Radio Section being fed into the Confidential Bulletin and its successor.

The Confidential Bulletin continued until the June 20, 1919, issue. Beginning with the same issue (June 20, 1919) it became known as the *Technical News Bulletin* and retained the letter stationery format, with mimeographed copies, through May 1925. Thereafter it took on several different printed formats, starting with illustrations in 1946, until it reached the full-fledged format as we have known it in recent years. Yet another change came over the "TNB." Beginning with the August 1973 issue it was renamed *DIMENSIONS/NBS*.<sup>22</sup>

## 9. " . . . And they shall beat their swords into plowshares. . . ."

In appraising the value and progress made in the development of radio during World War I, both by the Bureau and by other laboratories, and by industry, some significant statements were made in the postwar publication *War Work*. To quote:

The radio work carried out during the war presents a conspicuous example of scientific advancement of permanent value. It has been estimated that in two years of war the progress in radio was equal to that in 10 ordinary years. The work of the Bureau contributed to the progress made upon the electron tube, the direction finder, control of radio waves, radio measurements and design, submarine signalling, airplane communication, and radio instruction.

The progress in these various areas of development are then related in detail. For years to come the Radio Section would be engaged in further development in these areas. One in particular would stand out, that of air navigation. Presaging things to come, to quote further from *War Work*:

One of the incontestable benefits which has been salvaged from the war is the application of radio to airplane communication. In the future of aerial navigation, as in policing the air, radio will play an important part. The electron tube has made possible conversation between airplanes and the ground, the direction finder is the compass of the aviator, and radio methods supply the signals by which a landing may be made in fog or darkness. . . . Radio supplements the older systems of communication, and no spot on earth or in the air is too remote for it to reach.

---

(Continued)

whole; in others, essential features of the problems are worked out; while in others, the Bureau furnishes advice along scientific lines needed by the military services in the development of their own distinctive problems.

Respectfully,  
S. W. STRATTON  
Director

<sup>22</sup> Director Roberts stated in the first issue under the new name:

. . . So many, and such varied activities are proceeding at the Bureau that it is truly a many faceted organization. We think the new title, *DIMENSIONS/NBS*, reflects the multidiscipline activity. . . .

. . . We will attempt to report more broadly on the Bureau's activities, especially those of current interest to the scientific and general public. . . .



## REFERENCES

- [1] J. A. Willoughby and P. D. Lowell, "Development of loop aerial for submarine radio communication," *Phys. Rev.*, Vol. 14, No. 2, Aug. 1919, pp. 193-194 (abstract only).
- [2] A. Hoyt Taylor, "Short wave reception and transmission on ground wires (subterranean and submarine)," *Proc. IRE*, Vol. 7, No. 4, Aug. 1919, pp. 337-361.
- [3] J. M. Miller, "Dependence of the input impedance of a three-electrode vacuum tube upon the load in the plate circuit," *Bur. Stand. Sci. Paper*, Vol. 15, 1919-1920, pp. 367-385. Note: The term *Scientific Paper* was first used as a series designation with Vol. 15 to designate a continuation of the *Bulletin of the B. of S.*
- [4] J. M. Miller, "A dynamic method of determining the characteristics of three-electrode vacuum tubes," *Proc. IRE*, Vol. 6, No. 3, Mar. 1918, pp. 141-148.
- [5] J. M. Miller, "The dependence of the amplification constant and internal plate circuit resistance of a three-electrode vacuum tube upon the structural dimensions," *Proc. IRE*, Vol. 8, No. 1, Feb. 1920, pp. 64-73.
- [6] Lewis M. Hull, "The cathode-ray oscillograph and its application in radio circuits," *Proc. IRE*, Vol. 9, No. 2, Apr. 1921, pp. 130-149.



## Chapter IV

### THE BUREAU OF STANDARDS LENDS A HAND<sup>1</sup>

#### THE POSTWAR AND EARLY BROADCAST PERIOD

##### INTRODUCTION

Preceding World War I the interests in radio were directed toward its unique application to safety at sea and to general communication purposes served by commercial concerns. There was also a very small segment of the population, that became known as the radio amateur, that discovered a new outlet for technical curiosity and the thrill of communicating instantly on the "ether waves" over long distances.

During World War I and for a short period thereafter the imagination and efforts of the radio engineer were turned to radio as a service medium in war and battle operations. The French Army in particular made many technical advances in radio equipment and in the application of the vacuum tube. Near the end of the war the Radio Laboratory was caught up in the advancing art.

In the postwar period that extended through the 1920's, many changes came over the Bureau. In 1921 Herbert Hoover became Secretary of Commerce (and later the 31st President of the United States) and brought about many changes to increase the scope and usefulness of the Bureau of Standards during the 1920's. Dr. Stratton, director, left the Bureau at the close of 1922 and was followed by Dr. George K. Burgess. Eugene C. Crittenden became chief of the Electricity Division in 1921 after the sudden death of Dr. Rosa. For the next 25 years Crittenden would be the division chief for the Radio Section, until the formation of the Central Radio Propagation Laboratory on May 1, 1946.

The Radio Section was just beginning to emerge from some of the investigations that continued after World War I, when broadcasting burst upon the Nation and upon much of Europe. The Radio Section was caught up in its wake and was faced with many problems and took on a variety of new projects. Cochrane in his history, *Measures for Progress*, chose to entitle his account of the Radio Section during the 1920's as "Policing the Ether." The

---

<sup>1</sup>This chapter heading is the title of a paper by J. H. Dellinger published in the November 1922 issue (Vol. 1) of *Radio Broadcast*. Dr. Dellinger stated in the introduction to his paper that:

The recent remarkable popularity of radio in the United States has caused the widespread impression that radio is something very new. While it is true that its use for popular entertainment is new, the principles have been undergoing development for many years. The seed of the present extraordinary growth was, in fact, planted sixty years ago by the scientific research of the English physicist, Maxwell. This article will endeavor to give a glimpse of what Uncle Sam's radio laboratory is doing to increase the knowledge and extend the usefulness of this science.

##### The Changing Appeal of Radio

Radio is now being exploited through its appeal to the play instinct of mankind, but it contains also the means of satisfying the service instinct; it is one of those extensions of man's powers which science is ever revealing. It seems certain that the present radio boom will last several years, and that its present popularity based on its entertainment features will be succeeded by an era of more substantial progress based on actual service. It is this which justifies whole-hearted effort and serious scientific radio work by Government and commercial interests alike. One of the interesting things about radio is that it furnishes perhaps the greatest stimulus to the popular study of science known. Radio puts life into the study of science—something which, possibly through his own fault, the average man has not always observed there.

reader is referred to chapter V of Cochrane's history for the Bureau's story during the 1920's.

During this emergence period, with close ties still remaining with the military, Dellinger prepared a document, dated June 5, 1920, that reveals his viewpoint (and probably that of the Radio Laboratory as a whole) at the time of the relation of the Bureau's radio work to the Government. In the opening statement he wrote:

The work of the Bureau of Standards radio laboratory includes research on fundamental principles, various kinds of measurements and standardization of instruments, radio engineering for Government agencies, and the collection and dissemination of information.

The nature of cooperation with Government agencies was related in some detail by Dellinger. In part, Dellinger stated:

One of the directions in which this Bureau can be useful is in the coordination of the radio work of the Government. Certain of the departments make use of radio apparatus or methods and have found it convenient to call upon the Navy, Signal Corps, or Bureau of Standards, for assistance. While the Navy or Signal Corps provides apparatus, installations, etc., the Bureau of Standards advises on principles and methods, undertakes the testing of apparatus, and assists in coordinating the activities of the several radio organizations by making the results and proposals of each available to the others. The branches of the Government which have been assisted in the use of radio are the Signal Corps, Navy, Post Office, Air Service, Board of Vocational Education (instruction material), the Patent Office, Shipping Board, Committees of Congress (technical assistance on radio legislation), and the following bureaus of the Department of Commerce: Coast and Geodetic Survey, Bureau of Lighthouses, Bureau of Fisheries, and Bureau of Navigation (technical supervision of radio inspection service). Coordination of the Government's radio work should be furthered more than in the past by conferences and technical committees.

The scope of the Bureau's activities relating to the fast growing interest in radio brought on by broadcasting during the early 1920's was shown by the chart used by Dellinger in the *Radio Broadcast* article of November 1922. Relations with the public and Government agencies were manifold.

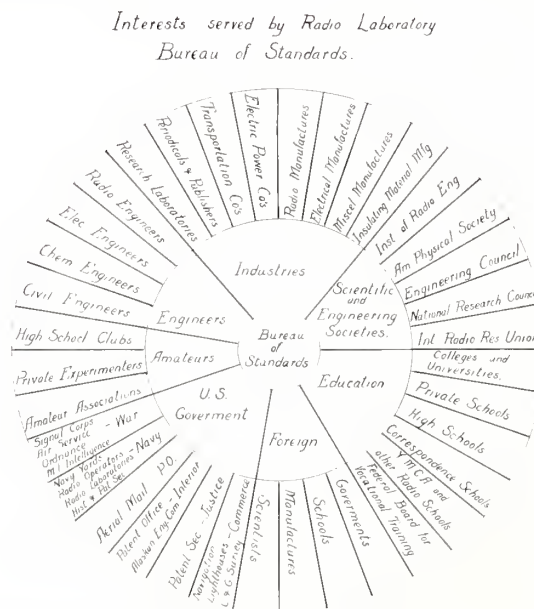

Wheel chart prepared by Radio Section showing the varied and extensive interests served by its broadened activities after World War I.

## CONTINUATION OF WORLD WAR I PROJECTS

Like "old soldiers never die," some of the projects that were born out of the exigencies of World War I took a number of years to "fade away." This was particularly true of the project or projects related to vacuum tubes. Much needed to be learned about the vacuum (or electron) tube itself and about its application in radio circuitry as a detector, amplifier, oscillator (or generator), and modulator. The Army Signal Corps and, later, the Navy, were interested in the standardization of methods of testing vacuum tubes for procurement. This program of development of test methods continued for several years and the Radio Building became well fitted with test instrumentation. A Letter Circular was published on methods of measuring the properties of electron tubes. During FY 1924 the section engaged in life tests of vacuum tubes, finding, in general, that filament emission in most tubes began to deteriorate after 1000 hours.

A very comprehensive *NBS Circular* on vacuum tubes was in preparation over a period of several years but was never completed because of a rapidly changing staff and the growing availability of books on the subject from other sources.

Of the other projects that were spawned during the war effort, some were soon to be phased out, others continued for a number of years, and some grew in scope. Among the projects were: insulation research at radio frequencies, antenna developments, improvements on the cathode-ray oscilloscope, air navigation by radio techniques, and direction finders.<sup>2</sup> Extensive use of the vacuum tube as an amplifier made many of the new developments possible. It was the use of vacuum tubes in a radio-controlled relay very early in the 1920's that helped spark the idea to Lowell and Dunmore in energizing such devices and amplifiers with 60-Hz alternating current. (See pp. 85-88.)

## ORGANIZING FOR THE POSTWAR PERIOD

### 1. Toward a stabilized organization and unified name

When the Radio Laboratory moved into its own building during October 1918 the Radio Section was reorganized for more efficient operation of the wartime activities and with a much enlarged staff. Kolster was designated as chief, with Dellinger as research assistant (see ch. III, p. 65). But changes came rapidly following the war period and in less than a year, by August 1919, the section was again reorganized, this time into two subsections. Dr. Dellinger headed the subsection known as Section 6a—Radio Research and Testing, with L. E. Whittemore as alternate chief; Kolster headed the subsection known as Section 6b—Radio Development, with F. W. Dunmore as alternate chief.<sup>3</sup> An Office and Equipment Testing group, headed by Whittemore, served both sections.

If there was dissatisfaction with the organizational structure during this period it never came to the surface in any Monthly Reports of the section(s). Yet, again, this time on February 1, 1921, the Radio Laboratory was reorganized, this time returning to the one-section structure and now known as the Radio Communication Section (Division I—Section 6).<sup>4</sup> Dellinger became chief of the section and Whittemore alternate chief. By 1925 the title of Radio Communication Section was set aside and the name became the Radio Section until May 1, 1946, when the Central Radio Propagation Laboratory was organized. The familiar and long-used name "Radio Laboratory" began to fade away during the 1920's.

<sup>2</sup> Refer to chapters III, V, and VI for detailed accounts of projects that had their beginning during World War I and that, in many instances, continued for a number of years after the war.

<sup>3</sup> Laurens E. Whittemore joined the Bureau in September in 1917 and transferred to the Department of Commerce on September 14, 1923, to become full-time secretary to the Interdepartmental Radio Advisory Committee (IRAC). Less than a year later he transferred to the Bureau of Navigation within the Department. Later he joined the American Telephone and Telegraph Co.

Francis W. Dunmore entered the Radio Section on January 14, 1918. He was leader or took important roles in a variety of projects during the 31 years he was associated with the radio work of NBS. He retired January 31, 1949. In February 1950 Dunmore was awarded the Department of Commerce Silver Medal for Meritorious Service.

<sup>4</sup> On January 31, 1921, the day before the reorganization, Kolster took a year's leave of absence and did not return to the Bureau thereafter. Records that have been preserved (other than Monthly Reports) indicate there was growing dissatisfaction with Kolster's supervision in 1919 and 1920 among staff members of the Radio Section. No doubt Kolster sensed the situation and chose not to return to the Bureau after having taken a leave of absence.



*Early photograph of new Radio Building occupied October 1918 (view to SW). This picture appeared as the frontpiece to March 19, 1924 edition of NBS Circular 74, "Radio Instruments and Measurements."*

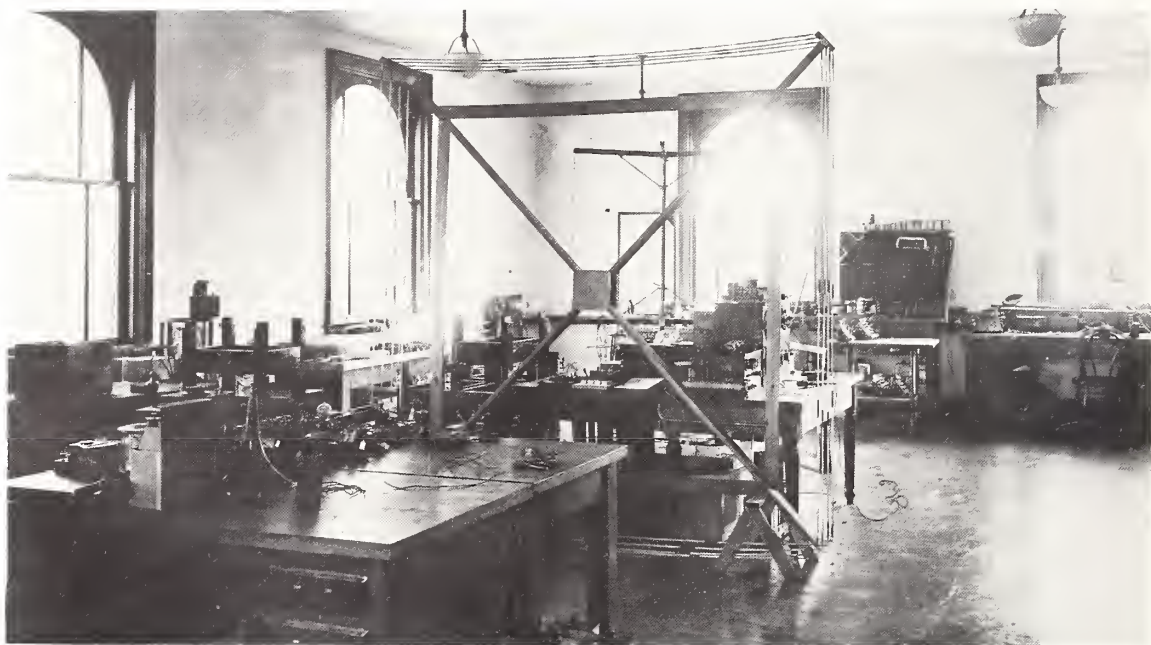

*Transmitting and receiving laboratory, Room 203, Radio Building, about 1920. The large loop (or coil) antenna was used to receive signals from European stations.*

## 2. World War I brings "Women's Lib" to the Radio Laboratory

Cochrane, in his *Measures for Progress* (pp. 169-170), speaks of Dr. Stratton's reluctance to hire women to work at the Bureau, but a change of heart came with World War I and the manpower shortage. It was then that the Radio Laboratory began taking on women, first as laboratory assistants, then as scientists, to carry on the workload.<sup>5</sup> And ever since women have been associated with the Bureau's radio projects.

<sup>5</sup> See chapter III, p. 62 on the employment, by the Radio Laboratory, of Professor Louise S. McDowell of Wellesley College during World War I.

After World War I two women entered on the staff of the Radio Laboratory whose affectionately known cognomens or sobriquets "ANKie" and "EMZie" were to be heard and seen until CRPL moved to Boulder in 1954. Miss Adeline Noel entered on the staff on February 11, 1919, as a clerk in the section office. Upon marriage in 1926, Miss Noel's name became Adeline N. Kincheloe, and thus grew the sobriquet ANKie. Mrs. Kincheloe's duties were primarily secretarial work over the 35 years she was associated with the Radio Section and CRPL. Dr. Dellinger's voluminous secretarial load was taken care of very ably by Mrs. Kincheloe over the years until his retirement in 1948. During this same period, ANKie directed the operations of the clerical staff of the section. During the CRPL years in Washington she was the administrative assistant to the Administrative Officer, first with S. W. J. Welch and later with R. C. Peavy.

Miss Elizabeth M. Zandonini entered the Radio Laboratory on July 28, 1921, as a radio aide. Her career with the section, and later with CRPL, was to be a long and colorful one. In the same year that she joined the Bureau, Miss Zandonini became owner and operator of amateur radio station W3CDQ, a Washington-based station, and one that she continues to operate. Because of her many activities in the Radio Section, a deserving appellation would be that of a "factotum excellentia." Among her many duties and special abilities in association with the Radio Section were: librarian, office clerk, typist, compiler of bibliographies, searcher of the technical literature, translator (French, German, Italian, and Spanish), laboratory assistant, radio operator, lecturer, writer, guide, and hostess. EMZie elected not to follow the Central Radio Propagation Laboratory to Boulder and transferred to the Bureau's Radioactivity Section (Radiation Physics Division). She retired from the Bureau on June 30, 1965.

### 3. The radio boom versus low Government pay

The aftermath of World War I and the rapid rise of the broadcasting industry left a trail of personnel problems with the Radio Section. In numbers the section peaked out with 40 on the staff at the time of the armistice in November 1918. Because of wartime problems and of the employing of persons of the teaching profession, there had been many turnovers of employees during the war period.

By the end of FY 1920 personnel losses began to be serious, particularly at the higher professional level.<sup>6</sup> In his Annual Report Dellinger stated:

On account of the ease of securing higher salaries in other institutions, it is very difficult to maintain a laboratory staff. Salaries paid elsewhere average about 50 percent higher than those paid here, as judged both by the positions secured by those who leave here and by the replies which we obtain from persons to whom we offer positions...

However, Dellinger was very appreciative of those who remained. He stated in a later paragraph:

This opportunity is taken of expressing appreciation of the very marked loyalty and active spirit of the members of the Section; without such a spirit it would have been impossible to carry on the work with such success as has been attained, in spite of the numerous difficulties, particularly those incident to rapid changes of personnel.

Two months later Dellinger wrote in a Monthly Report on "the disintegration of the Laboratory work caused by the serious losses of personnel." In his Semiannual Report of July-December 1920 Dellinger stated:

. . . It has been necessary to abandon more and more of the research projects which it was hoped to cover during this period, because of the continuous diminution of the staff. The branch of the work which has thus

---

<sup>6</sup> Dr. John M. Miller became associated with the Atwater Kent Co. as a radio engineer. In 1923 he joined the newly formed Naval Research Laboratory at Washington, D.C.

Ellison S. Purington became associated with the Hammond Research Corp. of Gloucester, Mass., as a radio engineer.

suffered the most is the important field of electron tubes. Not a single person remains in the Section of those who were working upon electron tubes or the related field of radio telephony.<sup>7</sup>

It was during this period that seven research projects were dropped due to losses in personnel.

Although 17 persons were added to the section during FY 1921, there were 23 separations leaving a total of 25 on June 30, 1921. The seriousness of the situation was that experienced people were leaving to join the broadcasting boom with its higher salaries; only the tyros could be enticed to join the Bureau. In the annual report it was stated:

While there are a number of applicants for positions of the lower grades such as radio aid, it is still almost impossible to secure persons properly qualified to carry on independent research work and having the ability required for directing the work of one of the groups in the radio laboratory. . . .

There was one exception. A year later (July 15, 1922) Dr. Charles B. Jolliffe joined the section as the assistant chief, and remained until 1930.<sup>8</sup>

In writing his article, "The Bureau of Standards lends a hand," for the November 1922 issue of *Radio Broadcast*, Dellinger stated in his concluding paragraph:

The greatest difficulty is that the technical work in this field which requires the most highly specialized knowledge, has to be carried on with constantly changing staff. The salaries which the Government pays scientific assistants are such as, in general, to retain only inexperienced men just out of college. These men must be trained by the Bureau in this special field of work and they remain on the average but a short time. To maintain a staff of twenty scientific workers there has been a total of seventy different persons on the radio staff in the past three years. This type of difficulty is especially serious at the present time when there is great demand for the services of any one who has a specialized knowledge of radio. Indeed, it may be stated that one of the Bureau's valuable functions in the radio field is the training of men for the industry.

Again, in FY 1923 separations outnumbered new employees and the section total dropped to 20. By July 1924 the number bottomed out at 18 but, again, with serious losses of experienced personnel. Thereafter the number of personnel gradually increased—the radio boom on the outside was waning.

<sup>7</sup> Previously eight persons in the section had been engaged in this field that was growing so rapidly outside the Bureau.

<sup>8</sup> Jolliffe transferred to the Federal Radio Commission on March 1, 1930, to become the chief engineer until 1935. In later years he became vice president and technical director of the Radio Corp. of America. He retired from RCA in 1964 and became an electronic consultant. While in the Radio Section he was active on many technical committees associated with radio.



*Scientific staff of Radio Section, November 1, 1924, at entrance to Radio Building. (Front row, left to right) Dr. J. Howard Dellinger, Francis W. Dunmore, Elizabeth M. Zandonini, Taintor Parkinson, Grace Hazen, Elmer L. Hall, Morris S. Strock. (Rear row, left to right) Hoy J. Walls, Dr. Charles B. Jolliffe, John P. Buckley, August Hund, Richard P. Battle, Herbert B. DeGroot, Thomas F. O'Keefe.*



#### 4. The Dellinger "Credo" of administering the Radio Section

In July of 1920 Dr. Dellinger issued the first of at least 10 editions of his "Information for members of the Radio Section," the last one being dated August 1, 1943. This information was of such a nature as to be a "credo" for administering the section. The format and the subject matter changed but little through the years.

In retrospect, and particularly to those who experienced any or all of those years in the Radio Section, this "Information" can bring back a poignant response. For it describes the atmosphere in which the personnel worked and conducted themselves. The table of contents of, say, the 1928 edition, must suffice as to the general nature of the "Information." We read thus, as found in the Radio Reports file:

1. Laboratory organization
2. Laboratory hours and personnel matters
3. Periodic reports
4. Equipment
5. Preparation of official letters and technical reports
6. Meetings
7. Technical information and education
8. Outside work, patents, etc.

There were several items of special note that could have been and probably were a bane to some and a boon to others. Until the late 1930's the use of tobacco in the Radio Building was "not approved," and later only in a few designated areas. Again, "It should be a matter of pride with members of the Laboratory to be actually at work at all times within the official hours. This applies particularly to the minutes just after 9:00 a.m." (9:00 to 4:30 were the work hours in those years, with Saturday as a workday).

From the technical view there was good counsel: "All members of the Section are urged to continue their technical training," and "The difference between accuracy and precision of measurement should be understood." There was admonishment on transmissions (or emissions), thus: "The Radio Building is a place primarily for measurement work. No emissions may take place in or near the building except upon specific approval of Section Chief and after notice to all persons in the building. The Beltsville station is the normal place for emissions. Emissions limited to kinds approved in advance. No emissions at broadcast frequencies except upon specific approval by Section Chief (1939)."

Other procedures for administration and working aids prepared by Dellinger included:

- Notes on procedure in Radio Laboratory
- Notes of stock of Radio Section and purchase of equipment
- Notes on composition of letters and scientific papers
- Preparation of papers
- Radio terminology

Dellinger was especially strong on communication among the Radio Section staff on technical matters. This was particularly the case in the postwar period. There were biweekly radio staff conferences, usually on specific topics prepared in advance.<sup>9</sup> There were also group meetings of a more informal nature. The Radio Section members were also urged to attend the weekly meetings of the Electricity Division and the Bureau staff meetings, both held during the winter months.

#### 5. Cooperative research with universities

Under the designation of "University Research" the Radio Laboratory carried on a cooperative program with a number of universities for several years beginning in 1919. It was "lending a hand" to the schools by reviewing their radio research programs, suggesting programs, supplying technical information, and advising on equipment. In one project radiation studies were made over the transmission path between the Bureau and the university transmitter. As a designated program this cooperative research was short-lived and lost its significance in the years of the radio boom.

---

<sup>9</sup>The first staff meeting of the Radio Section (Laboratory) was held during the week of February 18-23, 1918, with 14 in attendance, including Dr. Rosa, chief of the Electricity Division. It was the precursor of such meetings that could be counted almost without number from that time to the present.

## THE BROADCASTING FEVER STRIKES THE RADIO SECTION

### 1. WWV broadcasts music

Although the extensive use and the inventive spirit in radio communication that developed during World War I carried over into the immediate postwar period, there existed the stifling effect of the deadlock on vacuum tube and radio circuit patents.<sup>10</sup> Yet in spite of the legal problems besetting the radio industry, the urge to use radio telephony to broadcast voice and music could not be suppressed. The Radio Laboratory, a few private groups, and several engineering schools were swept up in the fever to be "on the air." Fulfillment of the Bureau's request to operate an experimental radio transmitter was the announcement made in the October 1, 1919, issue (No. 30) of the *Radio Service Bulletin* (issued monthly by the Bureau of Navigation, Department of Commerce).<sup>11</sup> During the spring of 1920 the Radio Laboratory experimented with some U.S. Army Signal Corps equipment for the transmission of voice and music. Also, a radio telephone transmitter was constructed that used four type U tubes (General Electric Type VT-18, 50 watts output) as a modulator and the transmitter output oscillator. This was preceded by a speech amplifier, plus several types of sound pickup devices (transducers) including a carbon telephone transmitter.

<sup>10</sup>The deadlock on vacuum tubes ended on July 1, 1920; that on radio circuits on June 30, 1921. Many hundreds of patents, some of them of a very basic nature, were involved in agreements between large firms such as: General Electric, Westinghouse, American Telephone and Telegraph, and the Radio Corp. of America.

<sup>11</sup>Listing in the *Radio Service Bulletin* indicated that the new Government land station was of an experimental type, located at Washington, D.C., and using the "call letters" of WWV. The station would be used for "Government business exclusively" by the Bureau of Standards at no assigned wavelength and with no regular hours of operation.

Note: Oddly, in the detailed and meticulously prepared Monthly and Annual Reports of Dellinger and Kolster nothing was ever noted on the request for an experimental station or the assignment of the call letters of WWV—call letters that have become so well known in the field of broadcasting.

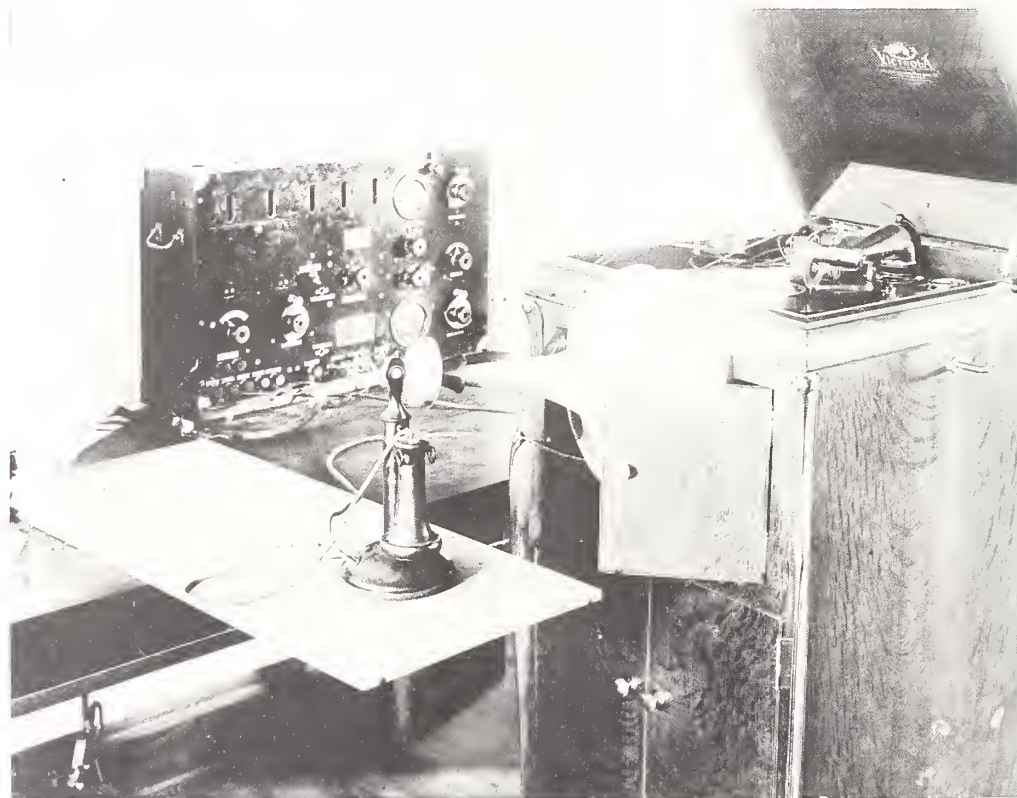

*During the spring of 1920 the Radio Section broadcasted music over station WWV in advance of the scheduled commercial broadcasts later in the year. A Victrola phonograph was the source of music, with pickup by a "microphone" using a telephone transmitter fitted with a "morning glory" horn. U.S. Army Signal Corps radio equipment served as the transmitter.*

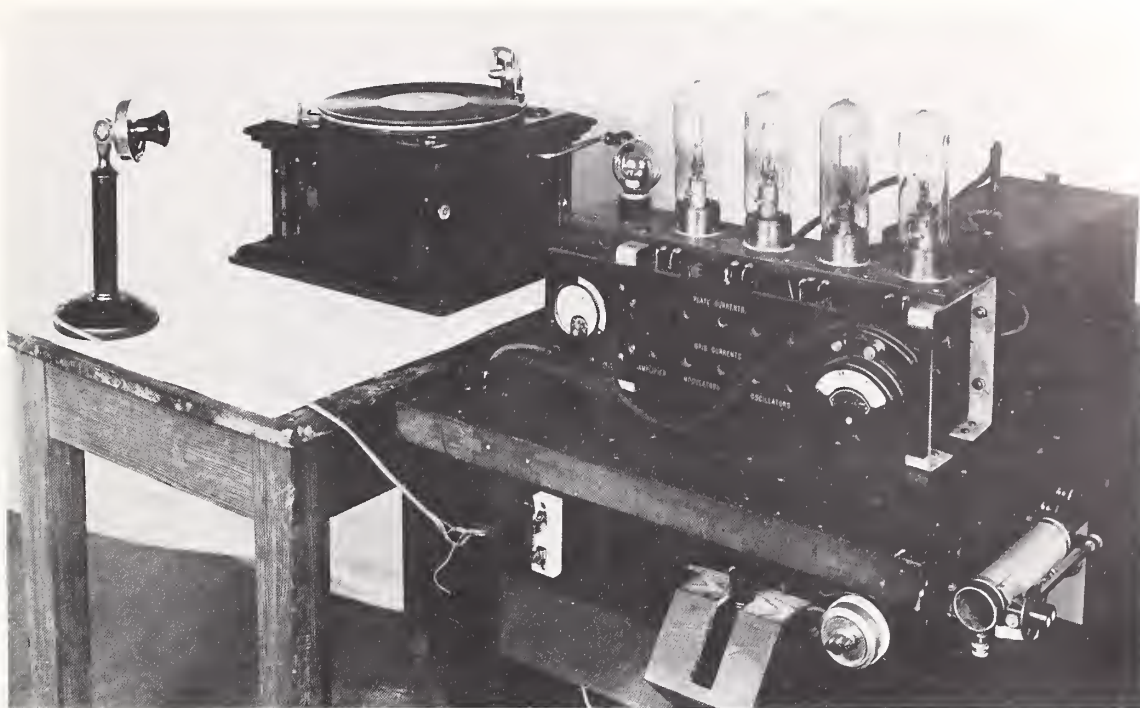

*The Radio Section was successful in the spring of 1920 with its own design of a broadcast transmitter, using 50-watt tubes in the modulation and oscillator circuits. A Columbia Graphophone served as the source of music, with pickup by a telephone transmitter.*

By May 1920 the transmitter was in operation from the Radio Building. Its introduction to the Washington community was described well in the *Technical News Bulletin* of June 4, 1920.

Music can be transmitted by wireless in the same manner as speech or code signals. As an incidental result of research work on radio telephony at the Bureau of Standards, it has been shown that music can be transmitted by radio without loss of quality. The possibilities in this direction are great and very interesting. By this means a concert given in one place may be available to those living at a distance. Experimental concerts are at present being sent out on Friday evening from 8:30 to 11, by the Radio Laboratory of the Bureau of Standards, using a wave length of 500 meters. One way of transmitting music has been to place a phonograph so that the sound from it will pass into the radio transmitter. The Bureau of Standards has made an interesting improvement upon this method, which consists of substituting the carbon microphone, which is the mouthpiece of an ordinary telephone, for the vibrating diaphragm ordinarily used on the phonograph. As a result, the phonograph sound record produces direct variations of electric current in the telephone apparatus instead of producing sound, thus while no sound is heard where the phonograph record is being played, the music is easily heard by those at the distant receiving stations.

The consistent receiving range was out to 25 miles. Dellinger in a news release of May 28, 1920, entitled "Radio Music," stated, in part:

. . . This means that music can be performed at any place, radiated into the air by means of an ordinary radio set, and received at any other place even though hundreds of miles away. The music received can be made as loud as desired by suitable operation of the receiving apparatus. The entire feasibility of centralized concerts has been demonstrated, and, in fact, such concerts are now being sent out by a number of persons and institutions.

Such concerts are sometimes sent out by the radio laboratory of the Bureau of Standards in connection with trials of experimental apparatus. This music can be heard by anyone in the states near the District of Columbia having a simple amateur receiving outfit. The pleasant evenings which have been experienced by persons at a number of such receiving stations suggest interesting possibilities of the future.

The broadcasting experiment of WWV progressed for several months. The Radio Laboratory had proved the feasibility of this new communication medium. Yet how little did the Radio Laboratory personnel realize in the spring of 1920 the tremendous effect that radio broadcasting and, later, television, would have on the social, educational, and political life of the world in years to come.

In keeping abreast of the times and on the occasion of experimental broadcasts of WWV, Dr. Dellinger addressed the Bureau staff with a demonstration lecture entitled "Explanation of Principles of Radio Telegraphy and Telephony." A short account of the lecture appeared in the June 4, 1920, issue of the *Technical News Bulletin*:

Communication by means of electricity without wires has progressed very rapidly during the last few years, and has probably been given more consideration by the general public than almost any other scientific subject. It is, nevertheless, a fact that due to the somewhat inaccurate and misleading newspaper accounts which have appeared from time to time dealing with the principles of radio communication and which have been apt to surround the whole matter with an air of mystery, most people believe that the principles underlying wireless transmission are not very well known. On the contrary, radio communication is a natural effect following well-known causes. With the object of giving a concise and easily understood explanation of the principles underlying radio communication, a lecture was given at the Bureau of Standards during May of this year, in which the whole subject was thoroughly discussed in a way easily understood by all. The similarity between various forms of wave motion, of which radio communication is one, were described and illustrated. Copies of this lecture will be available for distribution to those interested.

Previously, Dellinger had presented the lecture to the Secretary of Commerce and his staff. For some years hence the Secretary, the Department of Commerce, and the Radio Section were to play important roles in the development of broadcasting in the United States.

The pioneer commercial broadcasting station KDKA (Westinghouse Electric Co., Pittsburgh, Pa.) did not make its formal bow to the world until the evening of November 2, 1920, when it broadcast the election returns of the Harding-Cox Presidential campaign.

## **2. WWV broadcasts market reports**

Late in the fall of 1920 the Bureau of Markets of the Department of Agriculture requested assistance in the inauguration of an experimental radio service for the dissemination of market news. The service would be to farm bureaus and other agricultural organizations, and not a broadcasting service to the public. Again, WWV was the station call, but a 2-kW spark transmitter was operated in code for this more specialized use by the Radio Laboratory. Service began on December 15, 1920, and continued for 4 months, transmitting the daily market reports at 5:00 p.m., except on Sundays and holidays. The reports were furnished by the Bureau of Markets, the 500-word reports being called the Daily Radio Marketgram. The operating radius was 200 miles out of Washington, with transmission on a wavelength of 400 meters (750 kHz).

Beginning on April 15, 1921, the radio market service was taken over by the Air Mail Radio Service of the Post Office Department, with radio transmitting outlets from Washington, D.C., Bellefonte, Pa., St. Louis, and Omaha.



*Receiving market reports to monitor the Bureau's station, WWV, during the winter of 1920-1921. The experimental program was initiated at the request of the Bureau of Markets, Department of Agriculture, using a 2-kW spark transmitter and code. Reception in this photograph was on a commercially produced crystal set.*



*Receiving market reports in code with a very early commercially produced three-tube regenerative receiver designed for broadcast reception. The loudspeaker was an early design that had considerable popularity during the first years of broadcasting.*

### 3. Aiding the broadcast listening public

#### a) THE LETTER CIRCULARS ON RADIO RECEIVING SETS

The radio boom in the United States was a most extraordinary phenomenon in the development of communication and the effect upon society [1].<sup>12</sup> The period of the radio boom, from around 1921 to about 1928, was a period of a budding and then a full-bloom technology and the advent of a new social force. The "Golden Age" of radio is usually linked with the 1930's when radio became a dominating force in the entertainment and educational world and a widely used news medium.

In the early stages of the boom the Radio Section received many requests for information on the construction of radio receiving equipment, for both the simple crystal sets and the electron-tube receivers. At the request of the Bureau of Markets, the section tested a number of different types of receiving sets during the fall of 1921. Although designed for code reception, these sets were suitable for reception of the programs from the many broadcasting stations getting "on the air." The experience gained from this study and testing project made a large contribution toward meeting the public's requests for information on broadcast receivers. But answering the many requests by individual letters

<sup>12</sup> Paul Schubert has given a good account of this phenomenon in the chapter entitled "The Radio Boom" in his book *The Electric Word*, Macmillan, New York, 1928. To quote from the introductory paragraphs:

In the seven years between the dawn of 1921 and the dawn of 1928 the popular use of radio spread as nothing before has ever spread, not only into every nook and cranny of the United States, but in growing waves all over the earth. On the former date there were not over six or seven thousand privately owned sets of radio receiving instruments in this country; at the end of those seven years the number was on the order of 10 million, three quarters of which were "tube" sets of a high standard of scientific perfection, and the radio audience of a few thousand had grown to number, on occasion, more than half the adult population of the land. . . .

It is perhaps difficult for those who have lived through this change to comprehend what it signifies in terms of world history. No nation ever had greater communication barriers than those of the wilderness infancy of the United States; no nation has ever broken those barriers down or achieved such astonishing unanimity and rapidity of thought conveyance as has this one in its young maturity. It took aeons of time for the use of fire to spread among men, aeons of time to develop a substantial man-made structure to shelter him from the elements, aeons of time for him to learn to speak, other aeons to write—his progress along the pathway up from bruteness has been painfully slow . . . and now, in this new era of science and intercommunication, of which these United States are such a vital expression, an entire nation has come to the point of absorbing some new thing into its life, a thing that will henceforward play a profounder part in its environment than it can guess, in the short span of a little more than two thousand days.

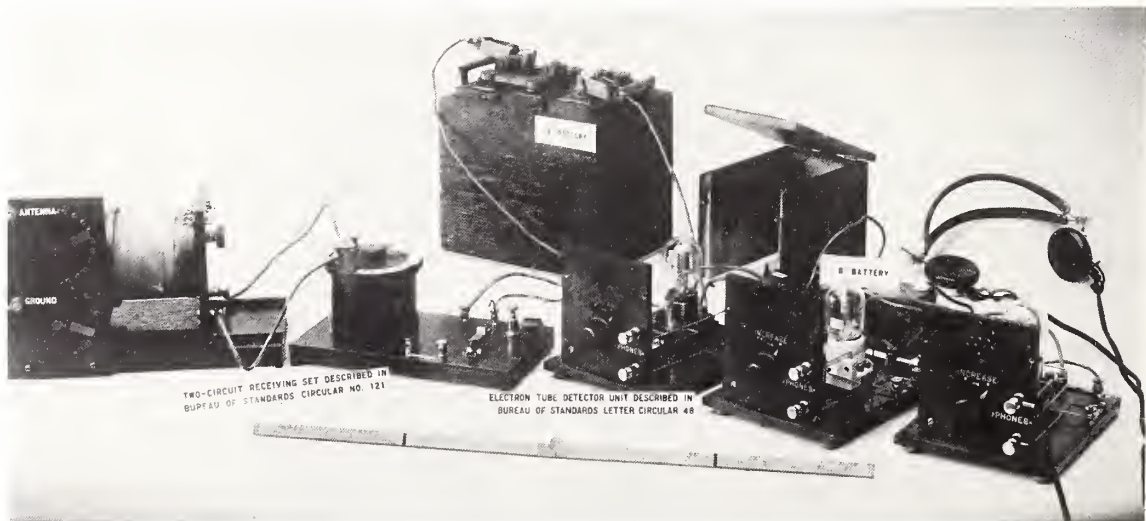

*Radio broadcast receiver with two-circuit tuning unit, electron-tube detector, and two-stage amplifier, constructed from directions given in three NBS Circulars published in 1922. Complete with batteries and headphone, this assembly of heavy equipment occupied considerable space, judging by the 2-ft ruler. Today, the equivalent in a transistor radio with enclosed loudspeaker could be held on palm of the hand.*

grew out of hand and the Bureau's typewritten information vehicle—the Letter Circular—was put to an urgent use. Letter Circular 43, under the title "Construction and operation of a very simple radio receiving equipment" (crystal detector), was issued February 15, 1922, and the supply was quickly exhausted. Newspapers reprinted the Circular in whole, and the public clamored for more information on receiving sets. In quick succession during 1922, six more Letter Circulares were issued on the construction of receivers, including one with an electron-tube detector, and another on an audio amplifier unit.

From 1922 through 1956 the Radio Section brought out nearly 100 Letter Circulares on various radio subjects. However, a number were revisions that updated previous material. Nevertheless, in total, this source brought a prodigious amount of information on radio to the public.

#### b) SPREADING THE INFORMATION VIA *NBS CIRCULARS*

The Letter Circulares served as a stopgap measure but were quickly followed by *NBS Circulars* set up in printer's type.<sup>13</sup> These sold for 5¢ and 10¢ each—a real bargain for those who wanted to build their own receivers or could not afford the inflated cost of a manufactured receiver. *NBS Circulars* on five different subject areas on the construction of homemade receiving sets were published during the period of April 1922 to March 1923.<sup>14</sup> Cost of parts ranged from approximately \$10 for the crystal set with headphones to around \$75 for a tuning circuit equipped with an electron-tube detector and one-stage amplifier units, including the batteries.<sup>15</sup> In 1922 a "hard" or amplifier-type electron tube cost \$6.50. Years later this same type of tube could be purchased for less than \$1, particularly the "bootleg" tubes.<sup>16</sup>

#### c) A MISCELLANY OF TASKS IN THE BROADCASTING BOOM

The Radio Section went all out, within the limitations of the number of personnel, to "lend a hand" in the growing broadcasting field—to the listener, to industry, and to the Government. The listener-to-be was furnished detailed instructions in Letter Circulares and *NBS Circulars* on how to construct reliable receivers.

The development of methods of testing radio receiving sets became an important project of the Radio Section in 1921 and 1922. First requested by the Department of Agriculture (receivers for market reports), the requests soon came from manufacturers of receivers, from testing laboratories, and trade associations. The information gained from this project was

---

<sup>13</sup> The Bureau's *Circulars* were discontinued in June 1959, to be replaced largely by *Special Publications* and *Technical Notes*.

<sup>14</sup> *Circular 120*—Construction and operation of a simple homemade radio receiving set

*Circular 121*—Construction and operation of a two-circuit radio receiving equipment with crystal detector

*Circular 133*—Description and operation of an electron-tube detector unit for simple radio receiving outfits

*Circular 137*—Auxiliary condensers and loading coil used with simple homemade radio receiving outfits

*Circular 141*—Description and operation of an audio-frequency amplifier unit for simple radio receiving outfits

These five *Bureau Circulars* were written by J. L. Preston and M. S. Strock, although, in keeping with the editorial policy at the time, their names did not appear on the publications.

<sup>15</sup> The *Circular* on the electron-tube detector unit did not mention the possibility of using the tube in combination with a modified tuning circuit to obtain regeneration and thus increase the sensitivity by many fold (equivalent to adding one or two stages of amplification). In the late summer of 1922 when the Letter Circulares and *Bureau Circulars* were being prepared on using electron tubes in radio-receiving circuits, a study was being made on regenerative circuits, including Armstrong's superregenerative circuit. (During a following period Dr. Jolliffe made a detailed study of regeneration in circuits.) It was recorded in the Monthly Report of October 1922 that the decision had been made not to publish a paper (*Bureau Circular*) on a simple regenerative receiving set. This was after consultation with one of the large manufacturers of radio receivers. Probably the reason for omitting this feature was to avoid any possible association with patent infringement so rampant at the time. Later, in *Circular 133* it was stated that: "This publication describes simple apparatus of satisfactory performance without reference to the possible existence of any patents which might cover parts of the apparatus." The Radio Section was already involved in patent problems and more were to come.

<sup>16</sup> Vacuum tubes that were illegally manufactured without payment of royalties for patented designs or construction features and sold at prices that undercut fair market values were called "bootleg" tubes.

circulated via Letter Circulars, a total of seven being written. In 1924 the project was summarized in a Bureau *Technological Paper* [2].<sup>17</sup>

The burgeoning radio industry was not without its growing pains in the early 1920's. Lack of standardization within the entire broadcasting field was brought to the attention of the Bureau by producer, distributor, and consumer alike. By the latter part of 1922 no less than seven national technical and business organizations brought pressure on the Bureau to initiate action for standardization. Yet "standardization" meant many things to many people.<sup>18</sup>

At the call of the Bureau, a conference was held in New York City on January 12, 1923, over which Dr. F. C. Brown, acting director of the Bureau presided.<sup>19</sup> One hundred and six were in attendance, representing nearly that number of different associations, manufacturers, dealers, and broadcast operating companies.

A Sectional Committee sponsored by the Institute of Radio Engineers and the American Institute of Electrical Engineers was set into motion. Many subcommittees operated within its framework, the total effort going toward recommending standards to the American Engineering Standards Committee.<sup>20,21</sup> Dellinger, Whittimore, and Jolliffe took active roles in the standardization programs for a number of years.

To popularize radio broadcasting, early in the summer of 1921 a portable receiver was built in the laboratory and dubbed a "Portaphone." The three-tube circuit, with batteries and loop antenna enclosed within a wood carrying case, provided enough sound from a "morning glory" horn to entertain a passerby with music from local broadcasting stations. Such was the appeal of radio in the early stages of broadcasting. Today's transistorized receiver held in the hand is many stages in advance of the Bureau's "Portaphone," but the magic spell has largely disappeared.<sup>22</sup>

---

<sup>17</sup> Laboratory tests developed by the section included determination of frequency range, sensitivity to weak signals, and selectivity of the tuning circuit to wanted signal with suppression of signal from stations of adjacent frequencies (before the common use of superheterodyne receivers, tuning with high selectivity was a serious problem). Ruggedness of construction was evaluated with a motor-driven shaking table.

<sup>18</sup> The clamor for standardization included the subjects of nomenclature, terminology, definitions, proper labeling of radio products, power rating of transmitting tubes, standardization of tube bases and sockets, dimensional standards for connectors, safety standards, acceptable testing procedures, performance ratings, quantitative information rather than adjective descriptions, and restraints on expression of receiver performance in terms of the occasional freak reception expressed in miles from a broadcasting station.

<sup>19</sup> Dr. Stratton had resigned from the director's office effective at the end of 1922; Dr. Burgess was not appointed until April 21, 1923. During the interim, Dr. Fay C. Brown, technical assistant to Stratton, served as the acting director.

<sup>20</sup> Later to become the American Standards Association and more recently the American National Standards Institute (ANSI).

<sup>21</sup> One field of activity in standards of continuing prominence and value has been that of the Standards Committee and the many subcommittees set up within the Institute of Radio Engineers shortly after its founding in 1912. Over the years it has continued to be a functioning group (now within the Institute of Electrical and Electronics Engineers), bringing out reports of a broad scope every few years. Important in the early years was standardization of terminology.

<sup>22</sup> An interesting project is noted in the Monthly Report of May 21, 1921 which stated:

Efforts were made to construct a pocket receiving set for the use of the Director around the Bureau grounds so that the Director's office could communicate with him at any time. The construction of such a small set was found to involve a number of difficulties, including special problems in amplifier design, and a satisfactory set has not yet been constructed.

There is no evidence that the project was continued in later years when such a receiving set would have been more feasible with the advancing technology. The Bureau had to wait nearly 50 years before adopting a "walkie-talkie" two-way communication system for use on Bureau grounds by the Plant Division at the Boulder Laboratories. Similar communication systems have been in operation for a number of years at NBS Gaithersburg. Transistor operation made these communication systems vastly superior to the bulk and energy requirements of 1921 vacuum tubes.



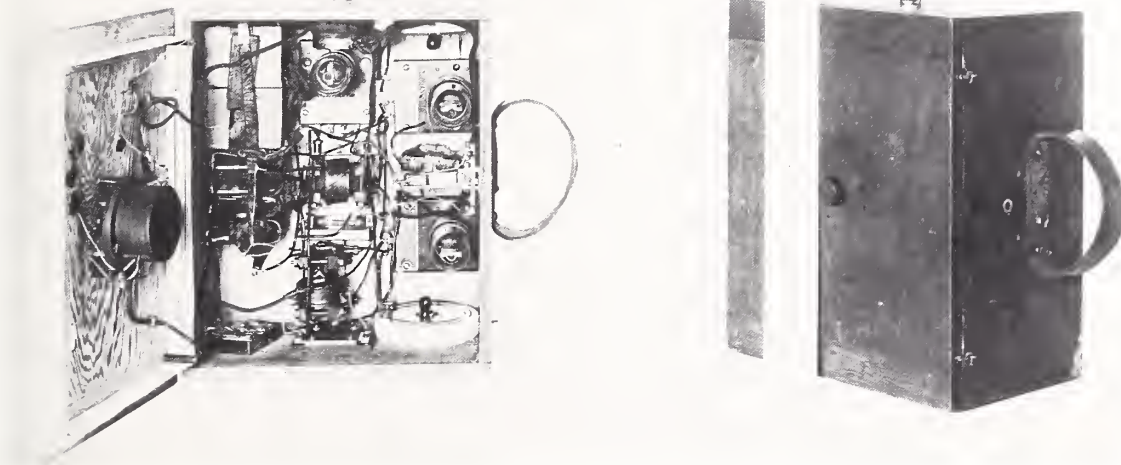

*The "Portaphone," a portable radio receiver constructed by the Radio Section in 1921. Included within the wood case (12×12×6 in) was a loop antenna with tuning capacitor, electron-tube detector, two-stage amplifier, and dry batteries. A loudspeaker driver unit fitted with a small "morning glory" horn provided sufficient volume to entertain the passerby with music from local broadcasting stations. A later model completely enclosed a wood horn.*

In addition to the many novel uses to which radio broadcasting was applied, there was its therapeutic value to hospital patients as a means of entertainment and news source. Thus it was in 1924 that the *New York Sun* and S. L. Rothafel (of Roxy Theatre fame) raised funds for radio reception facilities in all Government hospitals. Dr. Jolliffe took a very active part as a committeeman in engineering of these installations. The project was begun with three hospitals in Washington, D.C., and then carried to all sections of the country. When completed, facilities were provided that enabled 120,000 patients to "listen in."

As the radio boom was fading away the Radio Section engaged in two events that were above the "stunt" status. In each event a Ford trimotor plane was used, furnished by the Ford Motor Co. With much haste a plane was fitted with equipment that permitted an announcer to view the cruiser *Memphis* move up the Potomac River to Washington and then follow the cavalcade of cars to the Washington Monument grounds where Colonel Charles Lindbergh was received by President Coolidge. This was on June 11, 1927, after Lindbergh's historic crossing of the Atlantic by air from New York to Paris. The plane's transmitter relayed the announcer's descriptive account to the Bureau's radio facility at College Park where it was rebroadcast and also picked up by the telephone lines of the United Press for rebroadcasting. On April 14, 1928, in cooperation with the All America Aircraft Show at Detroit, Mich., Radio Section equipment was used as a flying studio and airborne transmitter to stage a radio program from the air. The program was heard across the country by rebroadcasting from a high-power Detroit station. The event was an outstanding feature of the aircraft show.

## REMOTE CONTROL BY RADIO

Even before wireless telegraphy became an engineering reality at the close of the 19th century there had been the contemplation of remote control of electrical devices by "wireless." At the request of the U.S. Army Air Service, the Radio Section initiated such a project in the summer of 1921.<sup>23</sup> This project was a natural for Francis Dunmore who by now had developed an aptitude for electron-tube circuits. It was his application of the electron tube to the control unit at a distant point that spelled early success. Nearly a decade before, several entrepreneurs with an inventive bent had some success with remote control by wireless without the use of electron tubes.

In the spring of 1922 Dunmore published a paper on his accomplishment [3].<sup>24</sup> The term "relay recorder" used in the title of his paper is somewhat misleading for the device controlled a relay and, in turn, the relay could serve various purposes ranging from a telegraph "sounder" and operation of a signal recorder to the control of mechanical movement.

<sup>23</sup> More than a year earlier experiments were made by the Radio Laboratory on the use of an electron tube as a relay in a block signal device for safety of railroad trains. Request for this development came from the Bureau of Safety of the Interstate Commerce Commission.

<sup>24</sup> The object of the development was to operate a moderately sensitive telegraph-type relay from a radio signal under conditions of vibration such as on board an airplane. This was accomplished by using an electron-tube receiving set with sufficient output signal of an audiofrequency tone (from a modulated transmitter or a heterodyne note) to operate an electron tube (two UV201 tubes in parallel) in a plate-rectification mode (using approximately 30 volts negative bias). This method of operation gave Dunmore the advantage of differentiating the control signal from moderate levels of static. By tuning the secondary of the audio transformer (feeding the relay circuit) with a variable capacitor, Dunmore was able to gain additional frequency selectivity against extraneous noise or unwanted signals. At 10-mA plate current he was able to obtain a speed as high as 48 contacts per second from the relay.

As an additional feature to obtain reliance against operation from unwanted signals, Dunmore suggested the simultaneous reception of audio tones from two separate radio frequency signals in order for the relay to function. There is no evidence that this scheme was used by Dunmore. However, he operated two relays in series from two different audio tones in order to obtain reliance against unwanted signals.

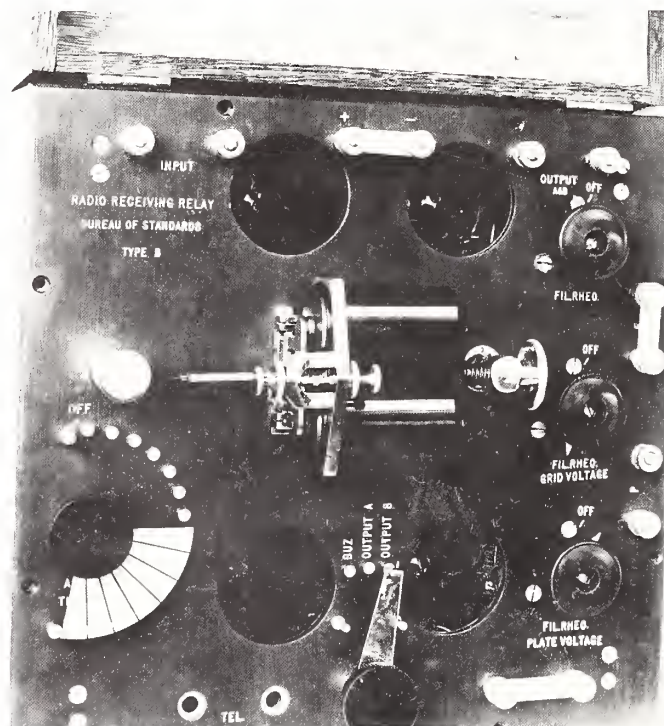

*Remote control by a radio signal was achieved in 1922 by Dunmore with his design of this "radio receiving relay." One model was energized by batteries, another operated from 60-Hz alternating current—a new achievement. Remote control by radio signals became a common mode of operation in later years—eventually to distances of interplanetary space.*

Dunmore's remote-control relay was among the forerunners of the many devices that were to be developed in later years for telemetering and remote control by radio signals, ranging from short distances out to interplanetary space. Such was the unforeseen potential of this development in the Radio Section. However, his device had another feature that was to have great potential within a few years. Dunmore came out with two designs of his remote-control relay, one for use on batteries, the other for use on "60-cycle, 110-volt, A-C supply."<sup>25</sup> Concurrently with the development of this alternating-current feature, Lowell and Dunmore were developing methods of energizing a radio receiving set with 60-Hz alternating current.

## AC OPERATION OF ELECTRON TUBES

### 1. Early use of ac operation of electron tubes

The millstone around the neck of early radio receiving sets and amplifiers was the weight, size, cost, and nuisance of batteries—the storage-type "A" battery (filament heating) and the dry-cell type "B" batteries (plate supply). If dry-cell type "C" batteries were necessary for grid bias there was but little problem, for they were relatively cheap and had a lifetime equivalent to their shelf life. The broadcast listener of the early 1920's learned to live with the battery problem—there was no choice unless he was satisfied with a crystal set. The first tubes that came out with filament operation from dry cells were a partial answer to the battery problem. Then came the "A" battery eliminator of several types. But not until vacuum tubes became available in the mid-1920's for ac operation from the house lighting circuit was there a satisfactory solution to energizing the receiving set. The much greater energy requirements to operate transmitter tubes brought on the early use of direct-current power sources such as motor generators and the rectification of alternating current to power both the filaments and plates of these tubes. Before 1920 the Radio Laboratory was designing and building power supplies for the plates of the larger electron tubes. These consisted of a transformer (multiwinding), two-element tubes (kenotrons) and sometimes three-element tubes (grid and plate shorted) for rectifiers, and choke coils and large capacitors for "smoothing" or filter circuits to minimize the hum of pulse components of the rectified current.

### 2. The "Better Mousetrap"

The early developments in the Radio Laboratory of audio-frequency and radio-frequency multistage amplifiers around 1920 brought on the need of energizing the many electron tubes by means other than the cumbersome batteries. Thus it was that Percival Lowell and Francis Dunmore put themselves to the task of developing the "better mousetrap." Their project in the winter of 1921-1922 was the development of a five-stage amplifier (three RF stages and two AF stages), plus tuning circuits, with the electron tubes energized from 60-Hz alternating current. By February 1922 they had an improved model of their equipment in operation. The Monthly Report for February 1922 stated that: "The use of AC supply makes this amplifier much more convenient for use by the general public than the usual amplifier having DC supply, since the inconvenient storage battery is not necessary."

In the spring of 1922, as Lowell was writing a paper on the project for a technical journal, a premature announcement of the development came out as a press release by the Department of Commerce. It caused the "world" to beat a path to the doorstep of the Bureau to see and learn more of this "better mousetrap." What took place was well

---

<sup>25</sup> With a special six-winding transformer (110-volt primary), the tube filaments were supplied with raw ac. Grid and plate voltages came from separate windings, with receiving tubes used as half-wave rectifiers (grid and plate tied together) and large capacitors used to smooth the ac ripple. Residual ac hum was not a serious problem with the one-stage circuit.

described in the May 1922 Monthly Report of the Radio Section.<sup>26</sup> The manufacturers and dealers in storage batteries were, indeed, alarmed about this new method of operating receiving sets—broadcasting had brought a bonanza to the storage battery industry.

### 3. AC operation an accomplished fact

On May 10, 1922, the Bureau published Letter Circular 65 entitled "Electron tube amplifier using 60-cycle alternating current to supply power for the filaments and plates." Although a circuit diagram of the complete amplifier and tuning circuit was included, many of the technical details were missing. Significantly it stated that:

The storage battery ordinarily required to light up the filament of electron tubes is a drawback to the general use of radio sets. The battery must be charged from time to time, it is bulky and heavy, and the acid in it is a source of danger and damage in a household. In this amplifier both the filament storage battery and the dry battery used in the plate circuit are replaced by a special transformer, and an electron tube rectifier and accessories, the aggregate bulk and weight of which is less than that of the batteries.

Lowell wrote a technical paper on the development for two publications, including a Bureau *Scientific Paper* [4,5].<sup>27</sup> He gave credit to Dunmore as a coworker. Radio engineers and broadcast listeners were now aware that the problems associated with battery operation could be overcome. But new receivers operating from "60-cycle alternating current" did not appear overnight.

Lowell resigned from the Bureau on July 15, 1922, at about the time that his two papers on the development of the ac operation of electron tubes were published. He was not to return until March 17, 1941, when the Radio Section was beginning to take an active part in development of wartime projects. Dunmore continued work in the Radio Section, and later in CRPL. He retired in 1949.

---

<sup>26</sup> "Electron tubes.—Through an error, an incorrect statement was released to the press through the Department of Commerce Press Room regarding the amplifier developed by Mr. Lowell which uses 60-cycle alternating-current supply for both filaments and plates. The publicity release stated that about May 1st the Bureau of Standards would have on sale for 5 cents a publication describing this amplifier. This error was due to a confusion of *Circular 120*, describing a simple crystal detector receiving set, with Mr. Lowell's paper describing this amplifier, which is to be published in the 'Journal of the American Institute of Electrical Engineers.' As a result of this error, both the Bureau and the Superintendent of Documents have received a great many orders for the amplifier paper. A number of storage battery companies have viewed with alarm the amplifier, using alternating-current supply, as a probable source of a marked decrease in the storage battery business. Some storage battery companies have sent representatives to the Bureau to get the details concerning this amplifier, and they have been supplied with information as to the possibilities and the limitations of the device."

<sup>27</sup> The development of the ac-operated amplifier was a series of several progressive steps. The first step was that of supplying 60-Hz alternating current to the filaments only of a receiving set fitted with one stage of RF amplification, an electron-tube detector, and one stage of AF amplification. Success was attained in minimizing hum by using a balancing resistor (voltage divider) for each grid return, keeping the grid voltage to the average voltage of the electrical midpoint of the filament. However, Lowell and Dunmore experienced considerable hum from the detector circuit. The electron-tube detector was replaced with a crystal detector, with a marked reduction in hum.

The next step was to power the plate circuits with rectified ac by using a three-element tube as a rectifier (grid and plate connected together). A large capacitor gave a smoothing action to minimize hum. (In later years receiving sets and amplifiers were designed with inductive-capacitive filters that held ac hum to very low levels.) In their final design Lowell and Dunmore constructed a receiving set by using three stages of RF amplification, two stages of AF amplification, and a crystal detector. Thus they obtained fairly high sensitivity and a degree of hum that was quite acceptable. Not until the arrival of indirectly heated cathode tubes a few years later was it practical to use alternating current to heat the detector-stage tube.

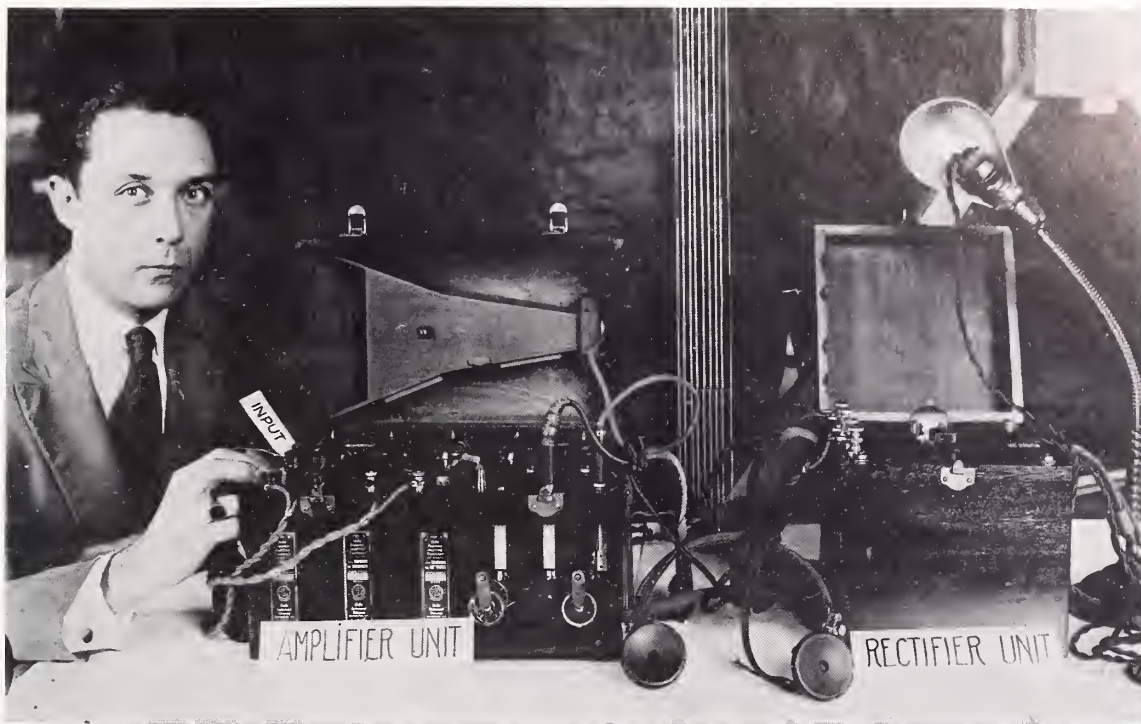

*Percival D. Lowell joined the Bureau in 1913 to become its first laboratory technician to work in radio. Among his many contributions was the development, along with Dunmore, of a method of energizing the filaments and plates of an electron-tube receiver with rectified and partially filtered 60-Hz alternating current. Two patents led to much litigation in later years. (Photo taken June 16, 1922.)*

#### 4. The meshes of “The Mousetrap”

On March 21, 1922, Dunmore and Lowell filed for a patent on energizing the electron tubes of a power amplifier from an alternating current power source (normally 60 Hz). Patent 1,606,212, entitled “Power amplifier,” was issued on November 9, 1926. Various circuit configurations were used to reduce hum.<sup>28</sup> Novel to the circuitry was minimization of audible hum from a moving coil or armature type of loudspeaker by phase neutralization of the hum component(s) in the coil with hum component(s) in the winding of the electromagnetic field (energized by rectified current) of the loudspeaker. After 12 years of litigation, a disclaimer for this novel method of reducing hum was filed August 16, 1938, by Dunmore and Lowell and the exclusive licensee, the Dubilier Condenser Corp. Use of the field winding as a reactance for a filter circuit was retained in the patent.

A second patent on ac operation of electron tubes was filed 6 days later, on March 27, 1922. This patent, entitled “Radio receiving apparatus,” was filed by Lowell and Dunmore, the order of the names being reversed from the first patent. The order of names was in deference to the priority and importance of the contributions each made to the two patents. The second patent was issued May 15, 1923, as Patent 1,455,141.

Again, after the passage of 10 years and of litigation, a disclaimer for certain features of the original design was filed July 8, 1933, by Lowell and Dunmore, and the exclusive licensee, the Dubilier Condenser Corp. Many of the circuit features of the patent for ac operation of power amplifiers (first patent) were incorporated in the receiver circuit. Only certain of these remained in the patent after the disclaimer.

The potential of these two patents for large financial returns to the patentees or any licensee was high. The potential was the manufacture of millions of radio receiving sets and

<sup>28</sup> A specially constructed six-winding transformer was used to energize the amplifier. Choke-coil reactances, capacitors, and resistors were used to form different types of circuits to filter or block the 60-Hz alternating current. A two-element “tungar” rectifier was used to energize the loudspeaker field winding, and a three-element (with grid and plate shortcircuited) tube was used as a rectifier for the plate circuits. Voltage dividers across the filament circuit for grid return stabilized the grid voltage with a minimum of hum.

various types of amplifiers, incorporating ac operation, during the life of the patents. However, because of the lack of a definite and uniform policy on patents issued to Government employees, Dunmore and Lowell were caught up in the meshes of patent litigation during the 15 years following their filing for the two patents in 1922. A detailed account of the litigation that ensued is beyond the scope of this account. A summary account was written by Cochrane in *Measures for Progress* as an extensive footnote (footnote 148, pp. 348-349) to his treatment of the patents.

In retrospect we can view the inventive genius of these two members of the Radio Section as having thought out novel and important features of radio circuitry for a burgeoning technology at a time when the radio listening public had need of a more convenient means of operating its sets. It is true there were more ac operation features to come, by others, such as the heater-type tubes; nevertheless, Dunmore and Lowell must be given much credit for developing some of the essential features for ac operation of radio sets.

## RADIO TELEPHONY BECOMES ESTABLISHED

By the close of World War I the Radio Section was caught up in the meteoric rise in the use of vacuum tubes. By 1920 most of the section's transmitting and receiving equipment was converted to or being built for electron-tube operation. Radio telephone equipment was developed for the Navy Department and the section borrowed some of the design features for its experimental broadcast transmitter. In turn, this engendered the development of laboratory equipment and new types of receiver circuitry that incorporated electron tubes.

Vacuum-tube amplifiers became the order of the day and the section was busy at developing audio- and radio-frequency amplifiers for laboratory use, resulting in several publications. Out of these developments came the alternating-current operation of amplifiers by Lowell and Dunmore.

With the aid of the electron tube the Radio Section made rapid progress in two areas during the 1920's: the development of short-wave techniques and of piezoelectric oscillators and resonators for frequency standards (see chs. VI and VIII).

## PROMULGATION OF THE WRITTEN AND SPOKEN WORD

### 1. Radio information in multitudinous channels

Early in 1922, at the beginning of the radio boom, there were plans to prepare a Bureau publication on "Radio for Everybody," but the plans came to naught. Yet during the next few years there was a profusion of information in many forms that came out of the Radio Section.

It was probably a combination of Dellinger's methodical procedures of documenting information and the burgeoning of information from the radio boom that brought about an abundance of reports, publications, file records, lectures, and radio talks during the first half of the 1920's. The result became a treasure trove of information that today serves as a most helpful means of probing the past.

Shortly after World War I Dellinger insisted that all the war projects be documented and filed for a permanent record. It was from this material that the radio subjects were taken for *NBS Miscellaneous Publication 46*, "War Work of the Bureau of Standards" (see ch. III).

#### a) THE "RADIO INFORMATION CLEARING HOUSE"

A reference file on sources of radio information that had a modest beginning with Richard Ould in January 1920 skyrocketed in the number of entries, and by 1921 had over 10,000 entries and took on the name "radio information clearing house." By 1938 the reference file had grown to 35,000 cards. When the radio boom began to sweep the country the Radio Section was swamped by inquiries for information at the rate of several hundred per day. This "clearing house" file became a very valuable asset to the section in answering inquiries. The issuance of Letter Circulars and the use of form letters eased the correspondence load considerably, but the overall problem of answering mail remained for

several years. The listing of literature references on radio subjects, in both the U.S. and foreign literature, largely became the product of Miss Elizabeth Zandonini. In later years it became known as "References to the Current Radio Periodical Literature."<sup>29</sup>

Without a doubt, this list of literature references on radio subjects, collected and classified over a period of 9 years, was one of the most extensive for the period covered (1920-28). In choice of selection it was slanted essentially toward the interests of the professional engineer. However, today, the location of this card file on radio information is unknown. Many inquiries have failed to disclose its location or even its existence. If irretrievable, the technical libraries have lost a valuable resource for searching radio literature of a period when radio broadcasting and listening reached the height of popularity.

#### **b) THE DEWEY DECIMAL CLASSIFICATION OF DOCUMENTS AND FILES**

The growth of the "radio information clearing house" brought on the need for classification of this information and the section's files on radio science and engineering subjects in general. After some study of the problem, the Dewey Decimal Classification was selected and used.<sup>30</sup> The whole subject of radio in the Dewey Classification came under the number 621.384 which, for simplicity, was replaced by the letter "R." As many as six digits followed the "R" for the Bureau's purpose. Out of the efforts of the Radio Section to classify its own files, records, documents, and books came *NBS Circular 138*, entitled "A Decimal Classification of Radio Subjects—An Extension of the Dewey System," released March 21, 1923. This became a useful document in the fast growing field of radio literature. Revisions continued until 1947. The second edition (1930) was reprinted in the August 1930 issue of the *Proc. IRE*.<sup>31</sup> By then approximately 1800 radio subjects and subclasses of subjects had been classified.

#### **c) THE RADIO SERVICE BULLETIN**

By 1922 the monthly lists prepared for the "radio information clearing house" began to appear in printed form in the *Radio Service Bulletin*, a monthly publication of the Department of Commerce that began in January 1915. It was first issued by the Bureau of Navigation as a successor to the quarterly supplement to the *List of Radio Stations in the United States*. During 1927 the publication was taken over by the Radio Division of the Department. The bulletin served as a guide to Radio Inspectors of the Department and to operators of Government and commercial radio stations. Among other informative items were the listings of new stations and changes in the radio laws and regulations. The Radio Section of NBS furnished items of technical interest for a number of years. Publication ceased in 1933.

#### **d) INFORMATION ON INFORMATION**

In September 1923 the section published *NBS Circular 122*, entitled "Sources of Elementary Radio Information."<sup>32</sup> Covered in this publication were the current periodicals, Government publications, books, radio call books, sources of information on radio laws and regulation, and miscellaneous information. In later years supplements in the form of Letter Circulars filled in for reference to the growing number of publications being written by the Radio Section.

#### **e) A BIBLIOGRAPHY ON AIRCRAFT RADIO**

A bibliography of over 250 entries on aircraft radio, prepared by Dr. Jolliffe and Miss Zandonini, appeared in the July 1928 issue of the *Proc. IRE*. It was the result of the section's

<sup>29</sup> Files of these literature references were made available to the Library of Congress, the Engineering Societies Library in New York City, and the John Crerar Library in Chicago.

<sup>30</sup> This classification of subject matter, popular at the time for libraries, was the product of the librarian, Melvil Dewey, who introduced the system in 1876. It has been supplanted in some libraries by the Library of Congress Classification.

<sup>31</sup> The 1st edition was edited by L. E. Whittemore and R. S. Ould, the 2d edition by J. H. Dellinger and C. B. Jolliffe.

<sup>32</sup> The *Circular* first appeared as a Letter Circular in January 1922. The term "elementary" was a bit misleading, for a considerable portion of the material referenced was at a substantial technical level of radio engineering.

program on radio navigation for airplanes and came at a time when there was a greatly increased interest in aviation (shortly after Lindbergh's historic flight of 1927).

## 2. Letting the public know

During the 1920's the work of the Radio Section was a favorite means of popularizing the radio boom through the news media. Possibly at no other time or in any other scientific or engineering field has the Bureau been so popularized.<sup>33</sup> A prelude to what was to come was a motion picture news story of the Radio Laboratory made by the Pathe Co. in 1919.

Almost from the beginning of its extensive life (from 1917) the *Technical News Bulletin* had the Radio Section (and later the Central Radio Propagation Laboratory) as a major source of news contributions. This was especially so during the 1920's when the Bureau was being popularized by its role in the radio boom.

But it was through the newspapers and popular radio magazines that the Radio Section received its widest publicity. Throughout the radio boom period many reporters and feature writers used material gathered from the developments and operations of the Radio Section. Also, many of these accounts were direct contributions by Dellinger and others of the section staff, their names being listed as authors. The extent and variety of these news stories made for interesting reading during the years of the radio boom.<sup>34,35</sup>

During the 1920's the Radio Section was much visited by those whose interests ranged from that of the research worker to those simply entranced with radio broadcasting. In some years more than a thousand visitors were listed, among which were the "greats" and "near greats" of radio science and engineering. Publicity brought visitors to the Radio Section, and they left as bearers of publicity. The Monthly Report of April 1922 bewailed the situation that furnishing information was stifling research programs.<sup>36</sup>

<sup>33</sup> There could be one exception to this circumstance, that of the publicity brought about by the AD-X2 (battery additive) case of the early 1950's; but then the situation was less favorable to the Bureau than that of the years of the radio boom (see Cochrane, *Measures for Progress*, pp. 483-487).

<sup>34</sup> A sampling of subject matter that appeared as news accounts included:

The radio work of the Department of Commerce, J. H. Dellinger, *QST*, June 1921.  
Blindfold navigation by radio, F. A. Kolster, *Shipping*, Feb. 25, 1921.  
Fading of signals, S. R. Winters (non-NBS), *Radio News*, Feb. 1921.  
New York first with radio lighthouses, F. A. Collins (non-NBS), *New York Tribune*, May 8, 1921.  
Objects that distort radio waves, L. E. Whittemore, *Radio Broadcast*, June 1922.  
Reducing the guesswork in tuning, J. H. Dellinger, *Radio Broadcast*, July 1923.  
Radiant future for radio forecast, J. H. Dellinger, *Manufacturers News*, Apr. 12, 1924.  
Radio and time keeping, L. E. Whittemore, *The National Jeweler*, Nov. 1923.  
U.S. Bureau of Standards sets pace for radio, J. H. Dellinger, *Chicago Tribune*, Nov. 16, 1924.  
How broadcasting has changed since it started in 1921, J. H. Dellinger, *N.Y. Herald-Tribune*, Aug. 9, 1925.  
Static a puzzler to radio research, J. H. Dellinger, *New York Times*, Sept. 13, 1925.  
Fewer stations or more interference, J. H. Dellinger, *New York Sun*, Oct. 31, 1925.  
Radio paradise, J. H. Dellinger, *N.Y. Herald-Tribune*, Nov. 2, 1925.

<sup>35</sup> A sampling of subject matter that was given as talks to groups or via radio broadcasts:

Performance tests of radio receiving sets, L. E. Whittemore, Washington Section of AIEE, Oct. 10, 1922.  
What's coming in radio, J. H. Dellinger, station WRC (Washington), Dec. 28, 1923.  
Reradiating receivers, C. B. Jolliffe, station WRC (Washington), Jan. 25, 1924.  
What you want to know about antennas, J. H. Dellinger, station WRC (Washington), Apr. 9, 1924.  
Facts and fancies about the crystal set, M. S. Strock, station WRC (Washington), Dec. 20, 1924.  
Radio as a vocation, J. H. Dellinger, station WRC (Washington), Jan. 31, 1925.  
The fading and other vagaries of radio waves, J. H. Dellinger, station WRC (Washington), May 30, 1925.  
Radio as seen from the Bureau of Standards, J. H. Dellinger, Patent Office Society (Washington), Feb. 12, 1926.  
The electron tube, C. B. Jolliffe, station WRC (Washington), Sept. 26, 1925.  
How the Bureau of Standards assists the amateur, E. M. Zandonini, station WMAL (Washington), June 14, 1926.  
Applications of radio in air navigation, J. H. Dellinger, American Society of Mechanical Engineers, Philadelphia, Sept. 7, 1926.

The possibilities of directional radio transmission, J. H. Dellinger, Franklin Institute, Philadelphia, Mar. 3, 1927.

<sup>36</sup> "The time of the most of the members of the Section continues, as has been the case for several months, to be devoted primarily to desk work, so that the Section is much more of a clearinghouse than a research laboratory. Only a comparatively small amount of experimental work is being done. The desk work includes a large volume of miscellaneous correspondence, activities in connection with the broadcasting conference, including much correspondence, the preparation of very elementary instruction material for the novice, the compilation of lists of publications, publication routine, the preparation of reports of experimental work heretofore completed, and preparation of publicity material. At the present time there are employed in the Section, six clerks, besides one aid who does considerable clerical work."



### 3. Books for the radio set fan

A Lefax book (looseleaf book of a bygone period) came out as the *Lefax Radio Handbook* in 1922, and a bound edition in 1924. Published by Lefax, Inc. of Philadelphia, this 130-page handbook was written by Dellinger and Whittemore. Its several sections took up the subjects of: the uses of radio, principles of reception, antenna construction, fundamentals of transmission, and construction of receiving sets. It was a practical guide to those taken with the broadcast fever.<sup>37</sup>

Richard S. Ould of the section brought out a book near the close of 1924 that was entitled *How Radio Is Received*. It was one of a radio series known as *The Experimenter's Library* published by the Consrad Co. of New York City. Previously, Ould had taken a major part in the revision of the Bureau's *Radio Pamphlet 40*, entitled *The Principles Underlying Radio Communication* (see ch. III, p. 53).

#### SERVICES BY CONFEREES AND COMMITTEEMEN TO GOVERNMENT, INDUSTRY, AND TO TECHNICAL ORGANIZATIONS

Along with the rapid growth of radio communication during the 1920's, the Radio Section was developing an expertise that gave a guiding hand to many conferences and committees. It was a period when the section was becoming involved with various Government agencies, national technical and industrial groups, and in the affairs relating to international communications. These relationships gave stature to the radio work of the Bureau and to the Bureau itself. The breadth and scope of the section's services during the 1920's can be elicited from a listing of these conferences and committees. A more detailed account is given in chapters XVI, XVII, and XVIII.

The Radio Section became an active participant in Government circles during World War I and continued with increased participation thereafter. Among these relationships were:

- Interdepartmental Radio Conferences (to 1919)
- Interdepartment Radio Advisory Committee (IRAC) (continuing to the present)
- Subcommittee on Policy and Legislation of IRAC
- Technical Staff of American Delegation, Washington Conference on Limitation of Armaments (1921-1922)
- Committee on Radio Apparatus, Federal Specifications Board
- First, Second, Third, and Fourth National Radio Conferences (called by Secretary of Commerce Herbert Hoover), with participation in Committee on Frequency Allocation and Committee on Interference
- Federal Radio Commission, as advisors (Dellinger, chief engineer, 4 months) (Jolliffe, chief engineer, 5 years)
- Executive Committee on Aeronautical Radio
- Liaison Committee on Aeronautical Radio Research
- Special Committee on Air Transport Radio, all of the Department of Commerce
- Subcommittee on Communications, National Advisory Committee for Aeronautics

Kolster had become an active member of the Institute of Radio Engineers (IRE) in its early years, joining the organization within a month after its formation in 1912. The Washington Section was among the early sections of the IRE. Members of the Radio Section

---

<sup>37</sup> In their preface, the authors stated:

Radio has taken its place in modern life alongside the telephone, the phonograph, and the automobile. Civilization is communication, and radio is the unique supplement of all other means of communication. With its novelty and mystery, radio has an appeal to everyone, but it has also rapidly increasing real utility.

. . . It is the hope of the authors that this book will really assist in making radio less of a mystery and more of a familiar friend, and that the information given will contribute to the satisfaction and service which the reader gets from radio.

took an active part in IRE affairs, first locally, and later at the national level. Among the many activities of the Radio Section in the IRE during the 1920's were:

Institute of Radio Engineers (Dellinger, vice president 1924, president 1925)

Washington Section of IRE

Standards Committee (Dellinger, one-time chairman) including: Subcommittee on Radio Telephone Transmitter and Receiver Terminology, Subcommittee on Receiving Sets, Subcommittee on Vacuum Tubes, Subcommittee on Bibliography

The Fourth Annual Convention of the IRE convened in Washington in 1929, with C. B. Jolliffe as general chairman of the convention.

The Radio Section engaged in many standardizing activities in addition to those associated with the Institute of Radio Engineers. Most of the standards work of the 1920's came about from the demands of manufacturers, retailers, and owners of receiving sets as a result of the radio boom.

After the Radio Standardization Conference of January 12, 1923, in New York City (see p. 82), as a result of Bureau efforts, other groups followed in the train, with Radio Section personnel taking part, principally on:

American Engineering Standards Committee (preceding the American Standards Association) with: Subcommittee on Radio, Subcommittee on Electron Tubes, Sectional Committee on Radio.

Other groups with which the section took part in committee functions included:

Insulating Material Committee, American Society for Testing Materials

Advisory Technical Committees, American Radio Relay League

Interference Committee, American Radio Association

Radio Committees, National Electric Code, National Board of Fire Underwriters

Subcommittee on Telephony, Telegraphy, and Radio, Standards Committee,

American Institute of Electrical Engineers

Committee on Earth Currents and Polar Lights, American Geophysical Union

Committee on Radio Broadcasting, American Engineering Council

Beginning in October 1920 the Bureau took part in its long association with the affairs of the International Scientific Radio Union (URSI). It was then that Kolster attended, by invitation, the first meeting of the American Section of Radiotelegraphy of URSI. In later years Dellinger and others became much involved in the affairs of URSI, particularly with the American Section and with the international meeting in Washington (1927). Included among the committee activities was that of the Committee on Methods of Measurement and Standards.

Late in the 1920 decade the Radio Section took part in the first meeting of the International Radio Consultative Committee (CCIR), convening at The Hague in 1929. As participants, Dellinger was chairman of the American Committee on Frequency Maintenance, and Jolliffe the chairman of the Committee on Transmitter Interference. Each served as a technical assistant to the American Delegation at The Hague meeting.

Four members of the section served as technical advisors at the (Third) International Radiotelegraph Conference that met in Washington, D.C. during October 1927. At this time Dr. Dellinger served on the Special Committee on Frequency Measurements.

## BUREAU PROGRAMS WITH ROOTS IN THE 1920'S

### 1. The propagation and ionosphere programs

Austin's investigations on radio wave propagation for the Naval Wireless Telegraphic Laboratory (in close association with, and located at the Bureau) dated back to 1909. In a Bureau publication of 1911 Austin accounts for anomalies in his observations as being due to absorption of radio signals in the ionized layer above the Earth.<sup>38</sup> In a 1913 paper Austin explains the increased strength of nighttime signals by reflection from an ionized layer that is less uniform during the day.

<sup>38</sup> Kennelly and Heaviside had independently suggested in 1902 the existence of an electrically conducting layer in the Earth's upper atmosphere—later to be called the Kennelly-Heaviside layer (see ch. I, p. 9; ch. VII, p. 172).

In 1919 Lt. Commander A. Hoyt Taylor observed and published an account of large variations in the strength of nighttime signals received on a loop antenna, accompanied by large variations of directional bearing of the transmitter. These effects were attributed to reflection and refraction in the ionosphere. Taylor was associated with the Naval Aircraft Radio Laboratory (located in the Radio Building) that had close associations with the Radio Section.

In the spring of 1919 L. E. Voorhees of the Radio Laboratory observed the same variational effects as Taylor, using a loop antenna as a direction finder. Voorhees recorded his own observations and his confirmation of Taylor's work in a report deposited in the Radio File.<sup>39</sup> Thus the Bureau was making its own and first observations of radio propagation as knowingly affected by the ionosphere.

The fading of radio signals was of much concern to the Radio Laboratory, and was a puzzle to operators and scientifically minded observers from the very beginning of radio. On June 1, 1920, a cooperative program was initiated by the Radio Laboratory with the American Radio Relay League (ARRL) in a broadside approach by enlisting a large number of radio amateurs to observe fading effects. The vagaries of transmission observed by the growing multitude of listeners in the broadcast frequencies gave added incentive to study fading phenomena. The cooperative program on fading studies with the ARRL and later with several universities and radio stations continued until 1927. Thereafter, fading observations were made by section personnel with automatic recording equipment.

The Bureau's first measurements of the height of ionosphere layer(s) were made in February 1929 by T. R. Gilliland, using a pulse technique. Transmissions came from the Naval Research Laboratory in southeast Washington, with reception at a Kensington, Md. field site 5 miles north of the Bureau grounds. By January 1930 an organized study of the ionosphere was underway. Thereafter came the many-faceted and extensive program of probing the secrets of the ionosphere and the vagaries of radio propagation under the able direction of Dr. Dellinger. The detailed account is given in chapters VII and XI.

## **2. Standards of frequency and WWV**

Although the Bureau's first encounter with frequency measurements related to radio waves dates back to 1911, no steps were taken to seriously improve upon the technique and accuracy of measurement until after World War I. Various measurement techniques and types of frequency standards were tried during the 1920's but it was not until the latter part of the decade that a breakthrough came by utilizing the potentials of the quartz crystal as a frequency standard. A group of quartz crystals would serve as the National Primary Standard of Radio Frequency (and the basis of all frequency standards) until 1960 when the transition frequency of 9192.6317700 MHz of the cesium atom was adopted as the U.S. Frequency Standard. Yet it was during the radio boom in the 1920's that the Bureau's standard frequency broadcasts of WWV and the calibration of wavemeters gave yeoman service to the new technology of broadcasting. The detailed account on frequency standards and WWV is given in chapter VIII.

## **3. Radio navigation and landing of airplanes**

Radio as an aid to the navigation and landing of airplanes had a modest state of development early in the 1920's. With the creation of the Aeronautics Branch of the Department of Commerce in 1926, the slowed-down development program within the Radio Section took on a sudden burst of activity. During the next few years a navigation system and a blind landing system for airplanes was developed at the College Park (Md.) Airfield, primarily from the ingenuity of Diamond and Dunmore. In September of 1931 the first blind landing of a plane was made at College Park with the aid of Bureau-designed radio equipment. The project carried over until the mid-1930's. The detailed account is given in chapter VI.

---

<sup>39</sup>The observations by Taylor and by Voorhees were reported briefly in April and May 1919 issues of the Bureau of Standards Confidential Bulletin (predecessor of the *Technical News Bulletin*).

## RADIO BRINGS ITS PROBLEMS

### 1. Problems imposed by radio broadcasting

The sudden thrust of radio broadcasting upon the American scene in the early 1920's was received with wonderment, but accompanied by apprehension and perplexity because of the problems that surfaced. It was the Department of Commerce that bore the brunt of the problems, particularly the Secretary, the Bureau of Navigation, and, to a lesser extent, the Bureau of Standards. Broadcasting was not much more than 1 year old (dated from the KDKA broadcast of November 2, 1920) when Secretary Herbert Hoover called the Department of Commerce Conference on Radio Telephony (later known as the First National Radio Conference) at Washington, D.C. for February 27 and 28, 1922. A large number attended this conference at which the Bureau's director, Dr. Stratton, served as chairman. In attendance were invited Government officials, representatives of the radio industries, and representatives of the broadcasting interests. Herbert Hoover's concern for the future of radio communications in general and for the broadcasting segment in particular was well voiced in his short address that opened the conference.<sup>40</sup> Hoover took a very active part throughout the 2-day conference.

The committee that handled the conference was headed by Dr. Stratton. In putting the conference deliberations into action three committees were set up, with Dr. Stratton as chairman of the Technical Committee, with well-known radio engineers, including Goldsmith and Armstrong, serving on the committee.

The road toward regulating radio broadcasting was a hard one to travel and the journey would be long. Three more National Radio Conferences were to follow, the fourth being held on November 9, 10, and 11, 1925, almost 4 years after the First Conference. By this time

---

<sup>40</sup> Among the many topics broached by Secretary Hoover, he said:

This Conference has been called at the request of the President (Harding) and its purpose is to inquire into the critical situation that has arisen through the astonishing development of the wireless telephone, to advise the Department of Commerce as to the application of its present powers of regulation and to develop the situation generally with a view to some recommendation to Congress, if it be necessary, to extend the present powers of regulation. This is one of the few instances that I know of in this country where the public—all of the people interested—are unanimously for an extension of regulatory powers on the part of the Government. . . .

We have witnessed in the past four or five months one of the most astounding things that has come under my observation of American life. This Department estimates that today over 600,000 (one estimate being 1,000,000) persons possess wireless telephone receiving sets, whereas there were less than fifty thousand such sets a year ago. We are indeed today upon the threshold of a new means of widespread communication of intelligence that has the most profound importance from the point of view of public education and welfare. . . .

Congress some few years ago authorized the Secretary of Commerce to license radio sending stations, and to impose certain conditions in the licenses designed to prevent interference between stations and to serve the public good. . . . Until the last four or five months there has been but little difficulty in handling these regulations, because sending purposes have been largely confined to radio telegraph, and to a very small extent to the radio telephone. The extraordinary development of the radio telephone, however, has brought us face to face with an entirely new condition upon which licenses should be issued. It raises questions as to what extension in the powers of the Department should be requested of Congress in order that the maximum public good shall be secured from the development of this great invention. . . .

The problem is one of most intensely technical character, but is not one without hope of fairly complete solution. . . .

There is involved, however, in all of this regulation the necessity to so establish public right over the ether roads that there may be no national regret that we have parted with a great national asset with uncontrolled hands. I believe this conference with the skill it represents will be able to determine upon a method which should give satisfaction in all directions, and should stimulate the creation of a new addition to our national life. . . .

Note: These excerpts taken from Minutes of Open Meetings of the Department of Commerce Conference on Radio Telephony, Washington, D.C., February 27 and 28, 1922. Available in Library, Boulder Laboratories, Department of Commerce.

considerable optimism existed that solutions to problems were not far away. Said Secretary Hoover to the 500 attendees, in opening the Fourth Conference:

We have great reason to be proud of the results of these Conferences. From them we have established principles upon which our country has led the world in the development of this science. We have accomplished this by a large measure of self-government in an art and industry of unheard of complexity, not only in its technical phases but in its relations both to the Government and the public. Four years ago we were dealing with a scientific toy; today we are dealing with a vital force in American life. . . .

In his address Secretary Hoover enumerated the accomplishments by the Department of Commerce in regulating radio communications but emphasized the many problems still confronting the Government and industry. Among the nine committees reporting and making recommendations to the Conference were Committee No. 1: General Allocations of Frequency (or wavelength bands), on which Dellinger served, and Committee No. 7: Interference, on which Jolliffe served. Technically, these two committees were the most important and were confronted with many knotty problems.

With Congress reluctant to pass needed legislation that would give some semblance of national regulation to the chaotic situation of licensing broadcasting stations, it was not until the Radio Act of 1927 (signed by President Coolidge on February 23) that the new Federal Radio Commission was given authority for licensing, frequency allocation, and transmitter power regulation. Beginning August 1, 1928, Dellinger served as chief engineer of the Federal Radio Commission for a period of 4 months, taking a leave of absence from the Bureau.<sup>41</sup> However, Dellinger's services to the Engineering Division of the Commission extended for several months after his return to the Radio Section. Jolliffe transferred to the Commission on March 1, 1930, to be the chief engineer until 1935. (The Federal Radio Commission was renamed to Federal Communications Commission in 1934.)

## 2. Problems of the limited frequency spectrum and of interference

It was in the technical areas of operating frequencies and interference that the Radio Section could exercise its talents during the chaotic period when broadcasting stations swarmed over the land. Dellinger and others of the Radio Section were caught up in the chaos with its technical complexities. The bulk of the earliest broadcast stations was assigned 360 meters (833.3 kHz) as the operating wavelength. Low transmitter power, geographical separation of stations over the spaciousness of the United States, and sharing of time were factors that permitted broadcasting at one frequency. But this lasted only for a short time. Then came the allocation of frequencies over a fairly wide band, the boosting of power, the proliferation of stations, and the concentration of stations around large cities. Because of the inability to be or not to remain "on" frequency, interference became a serious problem. The wide use of regenerative receivers, with their accompanying tendency to radiate "squealing" signals, lent to the interference problems in the early years.

It was to the Radio Section that the Department of Commerce had to turn for technical assistance. It took the form of better design of: (1) wavemeters for more accurate frequency measurements, (2) RF current meters, and (3) field intensity meters, all for use by the Department's radio inspectors. A Letter Circular was issued on how to cope with manmade electrical interference. Probably the technical advice that could be offered to the Department was the greatest contribution made by the Radio Section during the 1920's.

Dr. Dellinger, in particular, was much concerned over the technical limitations that radio communications were encountering and especially in the broadcast frequency band. His lectures and writings of the mid-1920's revealed apprehensions, yet indicated his understanding of the technical problems. One of his magazine articles, for the general reader, appeared in the January 1927 issue of *The Forum*, just a month before the Radio Act of 1927 was signed by President Coolidge. It was in this article that Dellinger pointed out the problem of compressing more than 600 broadcast stations (actually 732 stations when

---

<sup>41</sup> For this "leave of absence" it was necessary from legal considerations that Dellinger resign from the Bureau (and the Department of Commerce) in order to serve as chief engineer of the Federal Radio Commission. He was reinstated to the Bureau after 4 months duty with the Commission.

the Radio Act of 1927 became law) into 90 channels, plus the 5 channels for Canada, over the spectrum of 550 to 1500 kHz [6].<sup>42</sup>

Of course, the solution to the problem was limitation of the number of stations that could occupy the broadcast band. The Federal Radio Commission exercised its regulatory powers to bring about the limitation.

Interference by atmospheric static had to be tolerated. Very little in the early technology could reduce its nuisance to radio broadcasting. Reception during the winter season offered the greatest relief. Broadcasting networks, using interconnecting telephone lines, with national programs available from local stations, partly solved the static problem. But not until frequency-modulation equipment became available around 1940 was the problem of interference by static successfully solved. Frequency modulation brought on a whole new frequency band for utilization by the broadcasting interests, plus its advantage of high-fidelity communication.

### 3. The problems of radio patents

The abundance of patents that came out of the Radio Section during the 1920's and 1930's was the result of a flourishing technology and the inventive genius of some of the personnel. Yet the Bureau's patent policy was changeful and clouded with uncertainties. Stratton's view was that any development that could be considered novel and patentable was to be assigned to the Government and be free to the public.

A World War I project, an antenna for underwater reception and transmission of radio signals developed by Willoughby and Lowell (see ch. III, p. 58), was a matter of concern after the war when application was made for a patent.<sup>43</sup>

Caught up in the lack of a written patent policy, both within the Bureau and in the Government, the two patents granted to Lowell and Dunmore on the operation of electronic apparatus from 60-Hz alternating current passed through much litigation over a 15-year period (see Cochrane, *Measures for Progress*, pp. 348-349 for details). Not until Executive Order 10096 was issued on January 23, 1950, was there a uniform patent policy throughout the Federal Government.<sup>44</sup> Thus for 30 years Bureau employees (and the Bureau administration) were uncertain on patent rights of their inventions.

## THE FIRST RADIO ADVISORY COMMITTEE

The first advisory committee relating to radio programs within the Bureau met for its initial meeting on March 9, 1926. An account of the meeting, as written by Dellinger in the Monthly Report of March 1926, lists the attendees and notes the reactions of the committee

---

<sup>42</sup> Dellinger's title of this paper during preparation was "The limitations of radio." In published form the title became "The empery of the empyrean," probably at the suggestion of an editor. In more familiar words this published title was more like "The sovereignty of the ether."

Dellinger's concluding paragraph bears quoting, in retrospect:

To sum up, the principal difficulty in the present radio situation is the lack of comprehension of its physical limitations. The public simply will not believe that the number of broadcasting channels is sharply limited. Consequently the demand that additional stations be licensed continues, and the broadcasting chaos grows worse. The underlying cause of this situation will undoubtedly be more and more recognized, and the unsatisfactory condition of broadcasting will be mitigated when individual and public policy conforms to the natural limitations of radio.

<sup>43</sup> In the Monthly Report of June 1919, Dellinger stated:

The recent issuance of a patent to J. H. Rogers on a submarine radio aerial of the exact type developed in the experiments of Messrs. Willoughby and Lowell last summer, has made it evident that something should be done to secure protection to the Bureau and its members for devices which are developed here. This particular case was taken up with the Patent Office, Navy Department, Committees of Congress, and the Attorney-General. It is recommended that the Bureau urge prompt passage of legislation for the designating of a body to represent Government employees in the application for and administration of patents.

<sup>44</sup> An explanation of patent rights for employees and others of the Bureau, based upon the Executive Order of 1950, was printed in the May 1973 issue of *The NBS Standard*.

at this first meeting.<sup>45</sup> Through the years these advisory committees would be meeting on the Bureau grounds. As the radio program broadened it became necessary for several committees to advise on the several generalized areas of radio programs within the CRPL.

## REFERENCES

- [1] Paul Schubert, "The Radio Boom," Ch. 10, *The Electric Word*, Macmillan, New York, 1928.
- [2] J. L. Preston and L. C. F. Horle, "Some methods of testing radio receiving sets," *Tech. Papers Bur. of Stand.*, No. 256, Mar. 26, 1924.
- [3] F. W. Dunmore, "A relay recorder for remote control by radio," *J. Am. Inst. Elec. Engrs.*, Vol. 41, Apr. 1922, pp. 310-313.
- [4] P. D. Lowell, "An electron tube amplifier using 60-cycle alternating current to supply power for the filaments and plates," *Bur. Stand. Sci. Paper*, Vol. 18, 1922-1923, pp. 345-352.
- [5] P. D. Lowell, "Note on the development of an electron tube amplifier which uses 60-cycle alternating current to supply power for the filaments and plates," *J. Am. Inst. Elec. Engrs.*, Vol. 41, July 1922, pp. 488-490.
- [6] John Howard Dellinger, "The empery of the empyrean," *The Forum*, Vol. 77, No. 1, Jan. 1927, pp. 107-112.

---

<sup>45</sup> Nine organizations had been invited by the Bureau to appoint representatives on the Radio Advisory Committee. The report read:

Radio Advisory Committee.

The following members of the committee were present at the first meeting held March 9 (1926): Mr. O. B. Blackwell, American Tel. and Tel. Co.; Mr. F. Conrad, Westinghouse Electric and Mfg. Co.; Dr. A. N. Goldsmith, Radio Corporation of America; Prof. L. A. Hazeltine, Institute of Radio Engineers; Mr. E. M. Kinney, General Electric Co.; and Mr. George Lewis, National Association of Broadcasters. This group met with the members of the Bureau twice during the day, the time between meetings being taken up with a general inspection of the work of the laboratory. The general opinion expressed by members of the committee was that the present program is substantially satisfactory. There was general agreement that efforts should be made to limit the number of different projects upon which each individual works. Several other suggestions were made, and each of the members was asked to write suggestions after he had had time to consider the work.





## Chapter V

### APPLYING THE MEASURING STICK

#### RADIO STANDARDS AND MEASUREMENTS, PRE-CRPL PERIOD

##### An Inheritance from the Electrical Division

###### 1. Early measurements

By an Act of Congress approved March 3, 1901, the Office of Standard Weights and Measures of the Treasury Department was, on July 1, 1901, superseded by the National Bureau of Standards, the functions of which may be briefly stated as follows: the custody of standards used in scientific investigations, engineering, manufacturing, commerce, and educational institutions, with the standards adopted or recognized by the Government; the construction, when necessary, of standards, their multiples and subdivisions; the testing and calibration of standard measuring apparatus; the solution of problems which arise in connection with standards; the determination of physical constants and the properties of materials. The Bureau will also furnish such information concerning standards, methods of measurement, physical constants, and the properties of materials, as may be at its disposal, and is authorized to exercise its functions for the Government of the United States, for State or municipal governments within the United States, for scientific societies, educational institutions, firms, corporations, or individuals.

Thus was the opening paragraph in the first *Annual Report of the Director of the National Bureau of Standards* (for the fiscal year ended June 30, 1902) to the secretary of the Treasury Department by the director (S. W. Stratton) of NBS.

It was the electrical group, later to become the Electrical Division, under the leadership of Dr. Edward B. Rosa that first began to carry out in earnest the precepts of the purpose of the Bureau. One of the early projects in the group was conducted by Rosa and his colleague, Dr. Noah E. Dorsey (later, he used the name N. Ernest Dorsey), on a new determination of the ratio of the electromagnetic to the electrostatic unit of electricity, the ratio being the speed of light [1].<sup>1</sup> This relationship was first derived by Clerk Maxwell in 1864. The two physicists probably were not aware that they were measuring very accurately a physical constant of electromagnetic radiation in which the lower frequency region would be a major field of research and technical development within their group (division) not many years hence.

---

<sup>1</sup> By a somewhat "classical" method of using spherical, cylindrical, and plane capacitors, Rosa and Dorsey came up with a value of the speed of electromagnetic radiation of  $2.9979 \times 10^{10}$  cm/s, with an uncertainty of 1 part in  $10^4$ . It is interesting that in 1972 a group at the Boulder Laboratories which can trace its lineage back to the former Washington group (via Quantum Electronics Division, Radio Standards Laboratory, CRPL, Radio Section, and to the Electrical Division) came up with a value that was two orders of magnitude more accurate than other recent measurements. The value was  $2.997924562 \times 10^{10}$  cm/s, with a measurement uncertainty of 3 parts in  $10^9$  [2]. (Actually, this value of the speed of light was the combination of a frequency measured by the group on a methane-stabilized laser and the wavelength measured on a frequency-controlled interferometer by a group of the Joint Institute for Laboratory Astrophysics of NBS and the University of Colorado. The product of the two measurements gave the speed of light.) The uncertainty of measurement had been reduced by nearly 5 orders of magnitude since the time of the measurement by Rosa and Dorsey.

Beginning in 1904 and during the next 15 years or so a number of papers were written by members of the Electrical Division on standards and precision measurement techniques of the electrical quantities of capacitance, inductance, resistance, voltage, and current, both for direct current and for alternating current at power frequencies. These papers were written mainly by Rosa, F. W. Grover, and Louis Cohen (see ch. II). Cohen's writings brought the division into the lower radio frequencies. With Dellinger's exposure to a radio frequency problem in 1911 and Kolster's entry into the Electrical Division during the same year to study radio problems, there came the need to extend the range of the division's standards and measurement techniques into the radio frequencies. Requests were being made of the Bureau by the Government and commercial firms for information and services relating to new uses of radio technology. With Kolster's arrival, the division had a measurement program underway.

## 2. Capacitance

All radio circuits exhibit the effects of capacitance, whether in the tuning of circuits, in coupling, in the pickup of stray signals, or in measurement circuits. From the beginning of radio measurements, capacitors (condensers) were more adaptable than inductors to measurement precision. The precision movement of metal plates in contrast to the less precise movement or control of coils of wire in an inductor accounts for this fact. By mid-1916 the design for a variable condenser for precision laboratory use had been developed in sizes ranging from 0.0001 to 0.007 microfarad. The largest contained 59 fixed and 60 movable plates, of approximately 3-inch radius. Quartz rods and quartz spacers were used in the construction to minimize changes in capacity caused by temperature changes, and for low dielectric loss and high resistance. These condensers, known as the "Bureau of Standards Type" (and the standard inductors), became almost a trademark of the Radio Laboratory for many years. They performed yeoman service in nearly all of the precision measurements made in the laboratory and in the field. They were well described in *NBS Circular 74* (1918). This type of variable condenser was the heart of the LC circuit wavemeters, including the two wavemeters used as the frequency standard until 1930 (see ch. VIII, p. 245). Other uses included: capacitance comparisons, antenna measurements, and power-loss measurements of insulating materials.

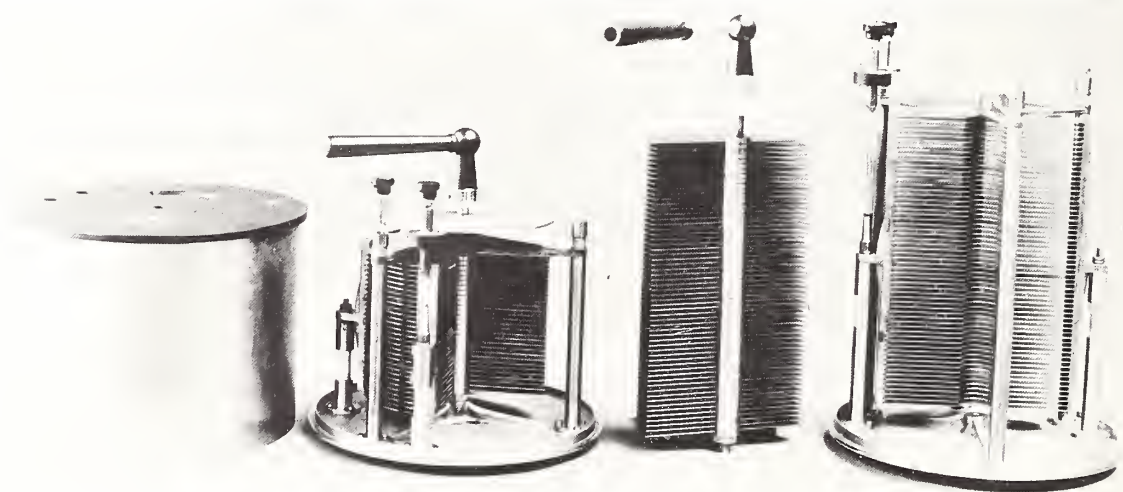

Variable condensers (capacitors) of "Bureau of Standards Type," with quartz insulation, designed in 1915 for laboratory standards. One at left includes the housing. One at right contains 59 fixed and 60 movable plates, with a capacity of 0.007 microfarad.

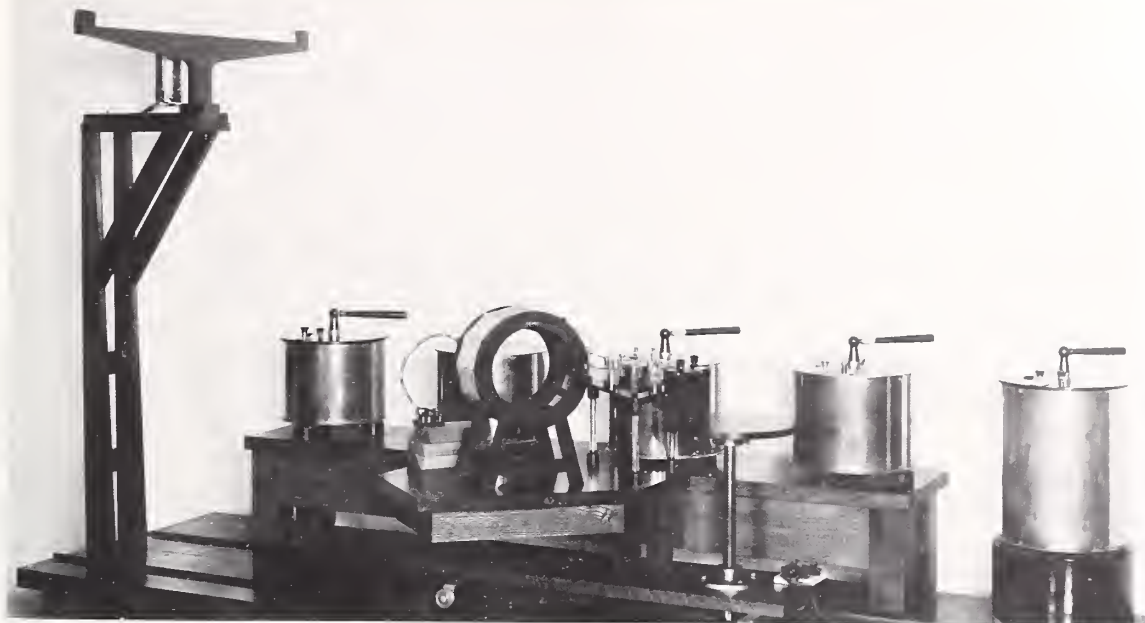

Equipment used for calibration of standard capacitors. The several variable capacitors are of Bureau of Standards design and construction and were very useful for various types of measurements during the early years of the Radio Section.

Another laboratory capacitor was the Bureau of Standards Type R, high-tension, variable capacitor, designed in 1915. This was a large-scale capacitor designed to operate to 35,000 volts when filled with oil. The usual capacity was about 0.005 microfarad.

For fixed capacitors, special types of mica condensers were used in the wavemeters and other measurement circuits. At high voltages a Leyden jar type of condenser was used.

### 3. Inductance

As an initial step toward the understanding and use of coils as standard inductors at radio frequencies Kolster published a paper in 1913 [3]. It was the sixth paper to be published by the newly organized Institute of Radio Engineers in its *Proceedings*, and the first to appear by a Bureau of Standards author. In summarizing his paper, Kolster stated:

It is shown experimentally that an inductance having distributed capacity may be practically replaced by an inductance (called its "true inductance") in parallel with a capacity (called its "effective capacity"). Methods of calculating each from observations are given and it is shown how strong response to one or more frequencies in wave meters and so-called untuned detector circuits is caused by distributed capacity inductances, particularly those with dead-ends.<sup>2</sup>

Over a period of years the Electrical Division and then the Radio Laboratory developed a number of formulas for the inductance of coils in a variety of forms. These formulas proved very useful in the design of inductors to be used as standards. The inductance could be determined independently, either by calculation or by measurement and then cross-checked. At radio frequencies it was necessary to take into account the RF resistance of the coils and the power loss in the dielectric supporting forms.

A study was initiated in 1914 on inductors specifically designed for wavemeters and later for use as inductance standards. Facilities were made available for the measurement of

---

<sup>2</sup> Following Kolster's presentation of his paper at the New York meeting in February (probably) 1913, there was a discussion by more than 10 persons, the discussion taking up 7 pages following the printed paper. This practice of printing the discussion was dropped by the IRE some years later. (Kolster joined the IRE on June 3, 1912, within a month after the founding of the Institute.)

inductance over the range of 50 to 1000 kHz. Development of standard inductors for use over a greater frequency range was not completed until the end of World War I and into the early 1920's. Ideally, an inductance standard should have the property of inductance only—without distributed capacitance, resistance, or power loss to the surrounding medium, nor should it be affected by stray coupling to its surroundings. By a development of careful design these deleterious effects were minimized. The result was a bakelite form of cage-like appearance on which was wound a coil of wire that had a dodecagon cross-section. This allowed the coil to be of nearly circular cross section but touching at almost a point on each of 12 strips of a thin dielectric. The inductors were constructed in several cross-sectional sizes to cover a range of a few microhenries to many millihenries of inductance. Multilayer windings had to be used for the larger inductances. Litzendraht (braided cable of very fine wire) was used on the larger inductors to minimize skin effect, thereby decreasing the RF resistance. By the mid-1920's inductors for short waves were made of self-supporting heavy conductors.

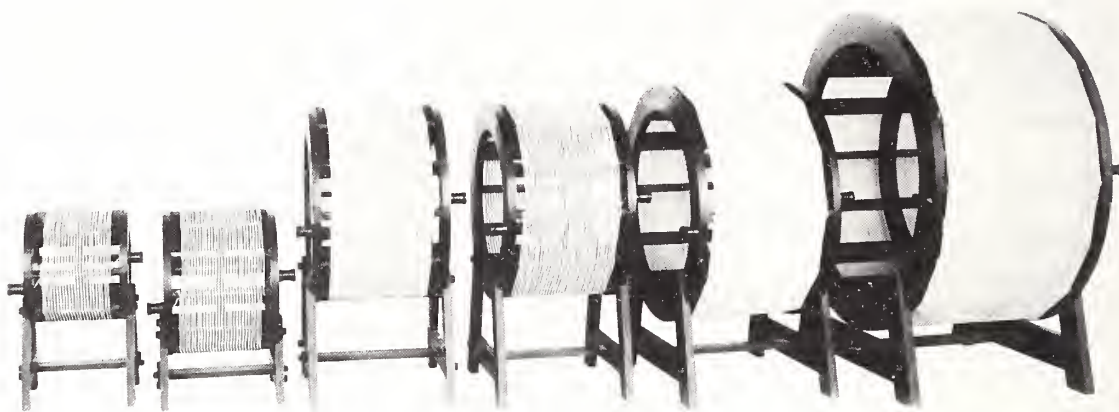

*Standard inductors, with the wire wound on polygonal forms of bakelite strips, were designed and constructed by the Radio Section during the period of 1919-1920. Later types, for short waves, were made of self-supporting heavy conductors.*

These standard inductors of Bureau of Standards design were much used by the Radio Laboratory in frequency meters, inductance measurements, and antenna measurements. More than a dozen values of fixed inductance became available. Apparently no type of a variable form was developed; adjustment of reactance was obtained by the precision capacitors. Today, these laboratory standards of the 1920's are but museum pieces. Over the years a number of the Radio Section personnel took part in the standard inductor developments. In 1923 Grover published a paper on formulas for calculating the inductance of coils of polygonal form [4].

#### 4. Resistance

Of the three derived electrical quantities of capacitance, inductance, and resistance, that of resistance had the most extensive treatment in *NBS Circular 74*. Possibly it was understood the best at the time of preparing the *Circular* in 1917. Four methods of measuring resistance at radio frequencies were listed: (1) calorimeter method, (2) substitution method, (3) resistance-variation method, and (4) reactance-variation method.

For resistance standards at radio frequencies a radical change had to be made in the design in contrast to resistors used at dc and power frequencies. The resistance standards were straight lengths of wire for minimum inductance and consisted of wire in different diameters, lengths, and resistivity. Manganin wire was usually used because of its low temperature coefficient. The short length of resistance wire of very small diameter was supported at each end with a much thicker copper wire sealed in a glass tube for protection. Contact to the measurement circuit was with mercury cups. The standard resistances

ranged from a short circuit to approximately 40 ohms, with a maximum inductance of about 0.15 microhenry.

*NBS Circular 74* gave rise to a number of progenies in the form of Letter Circulars and published papers. Four Letter Circulars in 1922 formed a supplement of *NBS Circular 74*. A sizeable cross-section of the section's personnel had a hand in these writings over several decades. Several papers treated the coupling characteristics of circuits at radio frequencies.

## 5. RF current

In the early years of measurements at radio frequencies the role played by current measurement was an important one. *NBS Circular 74* stated:

The measurement of current is a cardinal operation in high-frequency work, to a much greater degree than at low frequencies, since upon it depends also the measurement of resistance, and it is involved in most measurements of other quantities.

Today the role of current is much reversed. Rarely are current measurements made at radio frequencies—much more can be learned from voltage, power, and impedance measurements. The ease of connection facilitates voltage measurement.

In general, the design of ammeters and methods of current measurement at radio frequencies was done by adapting low frequency techniques to higher frequencies by minimizing the effects of inductance and capacitance upon the elements of the circuitry. However, such adaptation could tax the ingenuity of the physicist and engineer. Considerable material written in *NBS Circular 74* on RF ammeters was based upon Dellinger's doctoral dissertation (see ch. II, p. 43).

The basic principle of measuring RF current in the early years was conversion of RF energy into heat, with some method of indicating the process. The indication was usually by three methods: the linear expansion of a metal wire or strip, the thermoelectric effect (by thermoelement and dc milliammeter), and by calorimetry. Ammeters could be designed to handle several hundred amperes, while thermoelements could be used to indicate accurately in the order of several milliamperes. But in all designs the matter of reactance in the circuitry was of paramount consideration in order to gain high accuracy.

The use of current transformers, widely used at power frequencies, had some adaptability to radio frequencies. An RF meter developed by R. D. Duncan used this method of operation. The Duncan Volt-Ammeter, Bureau of Standards Type A, was used by the radio inspectors of the Bureau of Navigation, Department of Commerce. It would measure to 150 volts and 25 amperes.

Other forms of current measurement devices existed at the time *NBS Circular 74* was written. These included bolometers and semiconductor devices (the crystal detector). The latter was unreliable because of instability but was a very sensitive device. In later years the electron tube was used to a limited extent in current measurements. NBS had to wait until the 1950's and again in the 1960's to adapt the electrodynamicometer principle to accurate measurement of current at radio frequencies (see ch. X, p. 380).

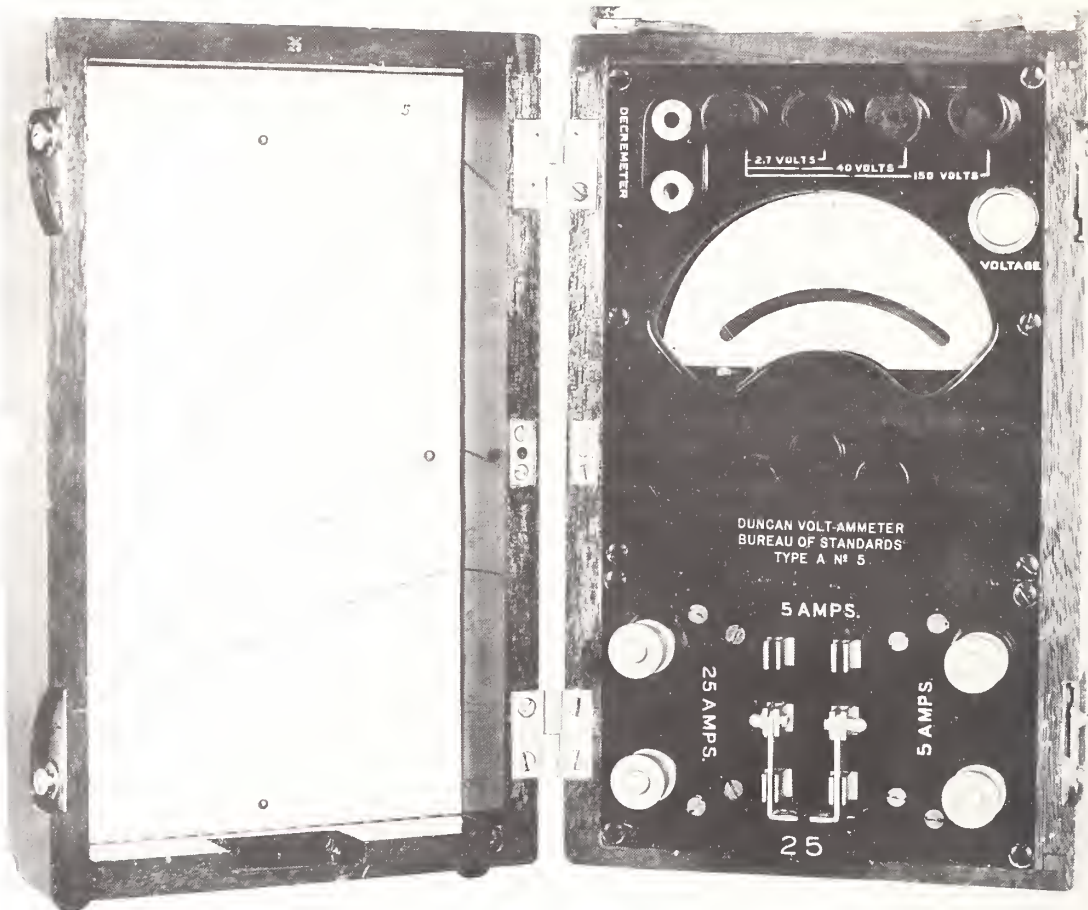

*An RF meter designed by R. D. Duncan of the Radio Section, and known as the Duncan Volt-Ammeter, measured up to 150 volts and 25 amperes. It was used by radio inspectors of the Bureau of Navigation, Department of Commerce.*

## THE MANY-FACETED PERIOD

World War I brought on new demands for measurements of considerable accuracy at radio frequencies, and the War and the Navy Departments turned to the Bureau for aid. *NBS Circular 74* brought much of the Radio Laboratory's "know how" into a consolidated handbook on instruments and measurements that was useful to the radio engineer. But developments in radio technology brought on new requests of the Bureau to measure performance at radio frequencies and the need for such work carried on for a number of years after the Armistice of 1918. The Radio Laboratory was now pioneering beyond the measurement techniques associated with dc and power frequencies of the Electrical Division. Kolster had been the first to enter this new frequency region with the development of his decremeter in 1912. Wide-scale introduction of the electron tube into the laboratory's operations during World War I opened up many new avenues of research, instrumentation, and measurement techniques.

### 1. The Kolster decremeter

Kolster's direct-reading decremeter was the first measurement instrument for use at radio frequencies to be developed by the Bureau. Kolster entered the Bureau at a period when the spark transmitter was the common means of generating radio waves (NBS was still using a spark transmitter in 1923). But the spark transmitter was notorious for its interference properties caused by the wide-band transmission of energy due to the highly damped waves. Devices such as the quenched spark gap were developed to reduce this interference effect.

At the time Kolster began the development of his decremeter, Government regulations called for operation of a spark transmitter with a logarithmic decrement no greater than 0.2.<sup>3</sup> A decremeter was a part of a kit of instruments used by the radio inspectors of the Bureau of Navigation, Department of Commerce, to enforce the radio regulations. Previous to Kolster's development of the direct-reading decremeter it had been necessary to calculate the logarithmic decrement from a series of readings taken on a decremeter. The radio inspector needed a direct-reading instrument and one that was compact and easily carried. Much of the inspector's work was on board ships.

Kolster designed the direct-reading decremeter in 1912 for the Bureau of Navigation. His Type B decremeter incorporated a wavemeter which allowed the portable instrument to serve a dual purpose. It was quickly adopted by the War and Navy Departments for their growing use of wireless equipment. Kolster's lengthy paper on the decremeter was published in 1915 [5].<sup>4</sup> Several models of various designs were developed over a period of years. The decremeters were manufactured to Kolster's design and specifications and met with wide popularity. The need for a decremeter as an inspection instrument passed out of existence with the spark transmitter and today it is but a museum piece.

<sup>3</sup>The logarithmic decrement of damped radio waves is the Napierian logarithm of the ratio of successive amplitudes of the damped oscillations. It is commonly expressed by the Greek letter  $\delta$  (delta).

<sup>4</sup>The direct-reading decremeter designed by Kolster worked on the method of variation of reactance in a wavemeter circuit to produce resistance changes as indicated by definite ratios of current read on an RF ammeter. Kolster's decremeters featured a variable capacitor with specially shaped plates such that the readings of logarithmic decrement were spread reasonably uniformly over the dial. The decremeters were designed to read logarithmic decrements in 0.001 increments over a range of 0 to 0.3, the value 0.2 being the maximum permitted by Government regulation.



*An early form (1912) of a series of direct-reading decremeters designed by Kolster. Among the users of these instruments were the radio inspectors of the Bureau of Navigation, Department of Commerce. The instrument provided a test that determined the degree of interference caused by damped oscillations of spark transmitters.*

## 2. Measurement of the properties of insulating materials

Because of some of the mechanical and thermal shortcomings of hard rubber as an insulating material in wireless equipment, the relatively new phenol products, such as bakelite, became popular as electrical insulation by the time of World War I.<sup>5,6</sup> Yet the properties of these materials were not well understood, especially the electrical properties at radio frequencies. After the United States entry into the War in April 1917, the War and the Navy Departments became concerned about the use of these new phenol products in their radio equipment and in the shortages of products that were occurring. Manufacturers wanted more technical information on their products. In October of 1917 the first requests came to the Bureau for measurements on the properties of insulation of the phenol type. Thus was started an extensive investigation by several sections in the Bureau that resulted in *Technological Paper 216*, entitled "Properties of Electrical Insulating Materials of the Laminated Phenol-Methylene Type," prepared by J. H. Dellinger and J. L. Preston. The 127-page paper was issued July 21, 1922. Concurrent with this publication was a Bureau *Scientific Paper* by the same authors that described the measurement methods and particularly the electrical measurements [6].

Measurements were made over a frequency range of approximately 100 to 1000 kHz. To determine the dielectric constant of a specific insulating material, a sheet of the material was placed between two pools of mercury (acting as two plates of a capacitor) and the capacity measured by comparison with a Bureau of Standards variable standard condenser. The dielectric constant was computed from the measured capacitance and dimensions of the sheet of material. Measurement of dielectric loss, in terms of phase difference or power factor, was by means of a resonant circuit and known values of a standard capacitor and standard resistors. Some of the earliest work of Elmer L. Hall contributed much to these dielectric measurements.

<sup>5</sup>The phenolic resin known as "bakelite" was named after Leo H. Baekeland, who discovered the resin plastic in 1909 after many attempts of combining phenols and formaldehyde.

<sup>6</sup>During the 1920's when construction of homemade radio receivers was at the height of popularity, the phenolic type of resin such as bakelite, formica, and micarta, were in great demand for panels and subpanels to mount the receiver components. Dry wood or dense fiberboard could have served as well, but instructions called for "bakelite" which was much more difficult to process with tools. But these phenol resins gave "stature" to the receiver. It was a different matter with transmitters where high voltages and high dielectric losses were encountered.

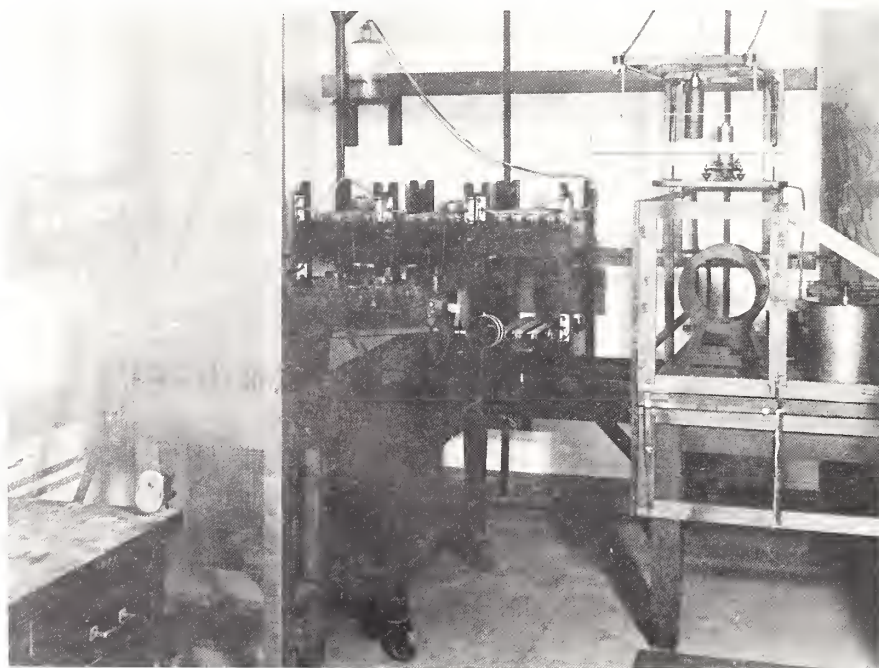

*Apparatus used in 1921 to measure the phase difference (or power factor) and dielectric constant of insulating materials from 7.5 to 3000 kHz. Measurements were performed in a shielded room of window screening. Dellinger was the principal investigator on the project for several years.*



A novel method of measuring the flash-over voltage and breakdown voltage at radio frequencies of the insulating materials was designed by G. C. Southworth for voltages ranging from 5000 to 50,000 volts. A bank of six power-type electron tubes in an oscillator circuit was energized by two dc generators at 1200 volts on the plates. Across the resonant circuit was a large-sized cylindrical condenser of but 30-picofarad capacitance. A small sample of the insulating material, fitted with metallic lugs of a specific spacing, was placed in parallel with the special condenser. RF voltage across this arrangement could be built up to 50,000 volts in terms of the equation  $E = (I/2\pi fC)$ , where the known current,  $I$ , could be quite large and the known capacitance,  $C$ , was very small. The voltage,  $E$ , was determined by calculation and not by direct measurement. Much interesting and useful information on the high voltage properties of insulating materials at radio frequencies was gained from this ingenious scheme.

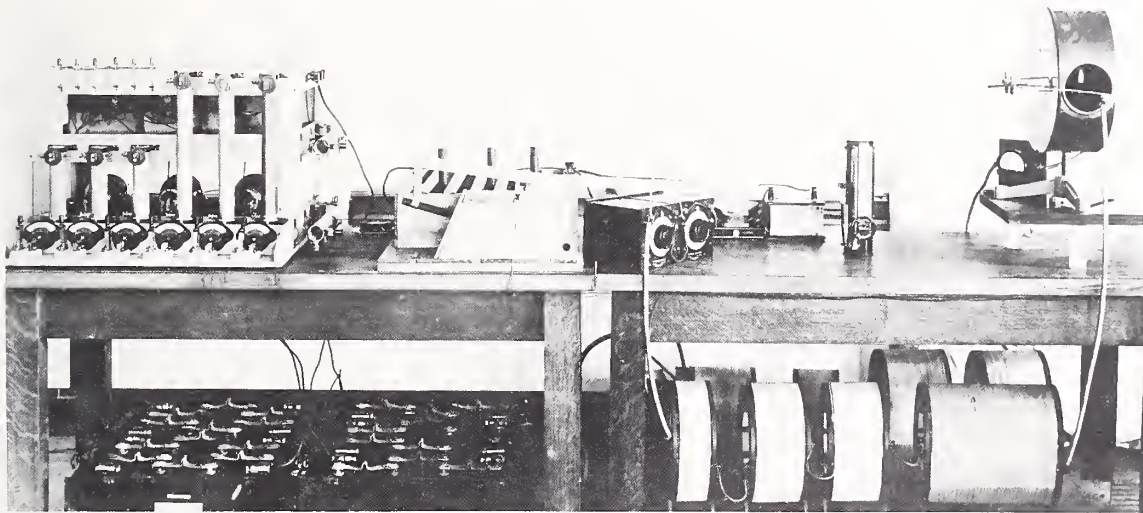

*To test for flash-over voltage and breakdown voltage of insulating materials, this assembly of apparatus incorporated some novel circuitry. An oscillator consisting of six high-power electron tubes (high for 1918) fed a resonant circuit across which 50,000 volts could be obtained at radio frequencies.*

The surface resistivity and volume resistivity of the materials were measured under several conditions of relative humidity. Other sections of the Bureau measured mechanical properties, including density, moisture absorption, tensile strength, hardness, impact strength, and machining qualities. Measurements were made on the thermal coefficient of expansion and observations on resistance to various chemicals.

In all, the Bureau, and especially the Radio Laboratory, made a valuable contribution to industry in carrying out this extensive program on insulating materials. It had or developed the "know how" of aiding a new industry in learning about a product that was very useful to radio technology. Two papers were written to disseminate the information gathered during this extensive program.<sup>7</sup>

### **3. The Radio Section measures the properties of electron tubes**

The Radio Laboratory was introduced dramatically to many new types of electron tubes by the French mission late in the spring of 1917 (see ch. III, p. 52). During World War I the Signal Corps enlisted the aid of the laboratory to study the measurement of tube

---

<sup>7</sup>Letter Circular 50, Nov. 4, 1922, "Bibliography of books and periodicals on properties and uses of electrical insulating materials." Letter Circular 51, Nov. 4, 1922, "List of the more important U.S. Patents covering the materials and methods of manufacture of insulating materials."

characteristics and methods of tube testing. The measurement programs continued until 1924.<sup>8</sup> During the early 1920's these measurement programs were under the guidance of C. B. Jolliffe.

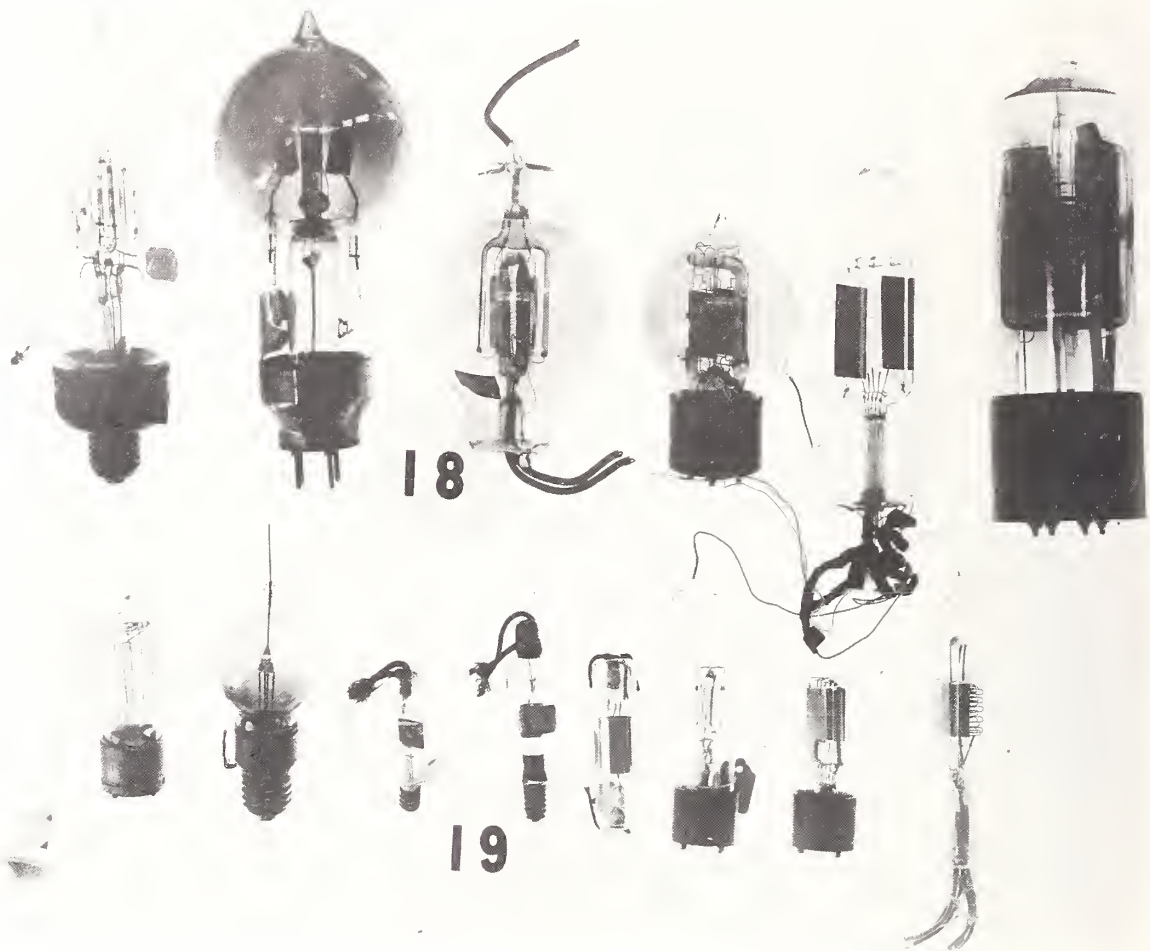

*Electron tubes of receiving type of American manufacture that became available after World War I. The Radio Section quickly adapted these tubes to various radio circuits and became much interested in their characteristics.*

The several treatises on electron tubes in preparation by the section never materialized. From the measurement program two Letter Circulars were completed. One of these, Letter Circular 87, issued January 27, 1923, entitled "Methods of measuring properties of electron tubes," covered a fairly wide range of electron tube properties, with measurement methods described in detail. By means of an alternating-current bridge the input resistance, output resistance, and amplification coefficient of a tube could be determined under a variety of impressed voltages. With a large assortment of indicating instruments a system was described by which the dc characteristics of tubes could be measured under a multitude of operating conditions. The system would also measure the power output capabilities of power-type tubes used as RF generators. Measurement of detection factor was less satisfactory, primarily because of the lack of a uniform definition of the term.

<sup>8</sup>The Radio Section's pioneering period with electron tubes was over by 1924. The section began to depend upon the tube manufacturers and engineering laboratories for operating characteristics of tubes and application to electronic circuits. This new period coincided with the advent of the multigrad tubes. Many special types of tubes were to come later, particularly the tubes designed for short waves and microwaves, and the high power tubes.



*Laboratory equipment for measuring the characteristics of electron tubes for use as detectors, amplifiers, and oscillators. Due to lack of performance information by manufacturers of tubes, the Radio Section, at the request of the Army Signal Corps, initiated a measurement program during World War I that was continued until 1924 when such information became readily available.*

Letter Circular 86, issued on January 26, 1923, entitled "Methods of measuring voltage amplification of amplifiers," was applicable to both RF and AF amplifiers, although two different measurement systems were necessary. The audio system was capable of measuring amplification to 20,000. Radio-frequency amplifiers could be measured over the range of 75 to 500 kHz. Usually, the voltage amplification would be less than 100. These Circulars were prepared with the point of view that a well equipped laboratory could duplicate the measurement systems and techniques.

#### **4. Measurement by the headphone receiver**

Early workers in the measurement of intensity of radio signals were not blessed with the sophisticated apparatus that has evolved over the years for signal-strength measurements. Except for the very strong signals, reliance was almost entirely upon auditory observation. This often left much to be desired. A common procedure was to use a variable shunt resistor across the telephone receiver and compare signal strength with the condition of the signal being just audible. The "audibility meter" (a form of resistive attenuator) was often used for this purpose.

The Radio Section made some attempts in the early 1920's to improve upon the auditory method of measuring signal strength by using instruments as an aid in the measurement process. Use was made of the condenser microphone of the Wente type, an "artificial ear," and the thermophone.<sup>9</sup> In this area of sound measurement the Radio Section was more than

<sup>9</sup>The thermophone was developed by the Research Laboratories of the A.T. & T. (later, Bell Telephone Laboratories) in 1917, as an accurate method of calibrating microphones and similar equipment on an absolute basis.

a decade in advance of the work carried out by the Sound Section in the 1930's. Only one paper was published on this measurement development [7]. Many of the technical details were omitted, but were preserved in laboratory reports deposited in the Radio File. Impedance studies of headphone receivers were conducted by C. T. Zahn during the same period as a corollary program.<sup>10</sup>

With the development of high-gain amplifiers, synchronous detector systems, correlation techniques, and the many types of recording systems, the need for auditory methods of measuring signal strength has practically vanished. Yet much was accomplished with the ear as a measuring device in those earlier years.

## 5. Modulation measurement

The study and measurement of modulation of continuous wave (CW) transmission was not carried on extensively by the Radio Section. Little was published in this area. However, use was made at times of the oscilloscope to observe the effects of modulation on the output of RF generators and transmitters.

During 1924 C. B. Jolliffe studied the operating characteristics of detector tubes as a means of arriving at a logical and useful definition of "detection factor" and its measurement. In this study he made extensive use of the vacuum-tube voltmeter which was coming into popularity. As an outgrowth of this study Jolliffe applied the vacuum-tube voltmeter as a peak reading device to the measurement of modulation of transmitters. Thus a relatively simple device had evolved to measure an important function in the operation of an RF transmitter. A paper was published in December 1924 [8].

## 6. An improvement on RF measurements

In 1924 August Hund published a paper that described the development of a balanced-transformer circuit that incorporated a differential method of measuring the effective resistance and effective inductance of coils and straight sections of conductors [9]. Measurements were in terms of a variable condenser of the "Bureau of Standards Type" used as a standard. The method was superior to those used previously in the Radio Section which had not been improved upon since described in *NBS Circular 74* of 1918.

## 7. Antenna measurements

It is somewhat paradoxical that, with the extensive development of a variety of antennas and complete radio systems by the Radio Section from before World War I and extending into the early 1930's, little was reported in the literature on measurement methods. Little was written on the subject in *NBS Circular 74* in 1918 or in the revised edition of 1924. Yet over many years to follow, measurements were made on the various antenna systems that were developed. This is evidenced by the photographs left in the section's records of apparatus being used in the vicinity of the antennas to measure their characteristics and performance. Thus we are left to ponder over an enigma.

## THE DOLDRUMS PERIOD

Beginning in the late 1920's the efforts of the Radio Section toward advancement of the science of measurement and standards in radio appears to have slackened. Apparently there was little need to increase the accuracy of measurements except in the area of frequency. By 1930 a whole new field was opening up in frequency standards with use of the quartz crystal, to be followed later with atomic frequency standards. By 1930 Diamond and Dunmore were much engaged in radio navigation and a blind landing system for airplanes. In the late 1930's Diamond, Hinman, and Dunmore were wrapped up with the radiosonde. And during the whole period of sparse activity on radio standards and measurements Dellinger and others were giving their efforts to an intensive study of the ionosphere.

---

<sup>10</sup> Charles T. Zahn entered the Radio Section on October 7, 1920, as an assistant physicist, and remained about 1 year. He returned many years later (1946) to join the CRPL. Dr. Zahn chose not to go to Boulder in 1954 and remained with the Electricity Division until retiring in 1964.



*A balanced-transformer method for the rapid measurement of capacitance, inductance, and resistance at radio frequencies, described in a 1924 Bureau publication by August Hund. Later, Hund authored several well-known technical books on radio subjects.*

## 1. Field intensity measurements

During the summer of 1926 a field intensity measuring set (later known as a field strength meter) was developed in the section under the guidance of Jolliffe. The section was in need of an instrument, calibrated in terms of field intensity, for measuring the radiated output of radio stations and for observations of fading phenomena. Even more important was the need by Supervisors of Radio of the Department of Commerce for measuring the field intensities of broadcast stations. The Supervisors were required to make measurements within the reliable service zone of a station to determine conditions of interference and regulation of radiated power. The measuring set was designed for installation within the Supervisor's test car, with a direction-finder loop antenna mounted on the car. Operation was within the broadcast range of 550 to 1500 kHz and field intensities in the range of 5 to 50 millivolts per meter.

A service for calibrating field strength meters at broadcast frequencies was initiated in 1932. Preceding this service during a period of years beginning in 1926, steps were taken in a measurement program to develop a calibration method. The program was characterized by much frustration in arriving at a satisfactory relation between measured values and calculated values of field intensity at a distance from a transmitting antenna. Initially, a coil antenna was the radiator, set up at the Kensington field station, about 5 miles north of the Bureau. Then a single-turn antenna was tried, then a small condenser antenna. Later, a standard field, as a calibration method, was obtained by means of the mutual inductance between two loop antennas. All methods were less than satisfactory toward obtaining a calibration technique of desirable accuracy.

During the latter part of 1927 a measurement facility was set up on the shores of the Potomac River in Washington. The transmitter was located at the Naval Air Station on the Anacostia shore, with the receiver site at Hains Point. Several condenser antennas were tried, finally using a large one with a radius of 750 cm and 114 cm in height. The

transmission path across the river was 3200 meters. In terms of the height of the condenser antenna and the antenna current, the field intensity could be calculated in volts per centimeter. Confronting the project personnel, S. S. Kirby and K. A. Norton, was the unexpected observation that the ratio of the measured field intensity to the calculated field intensity decreased as the frequency was increased [10]. The effect was accounted for by an increased absorption at the higher frequencies, even over relatively short transmission paths. When checked with a vertical antenna at the transmitter the effect was the same.

As a further step in the study, the field intensity meter was operated at various distances from the transmitter (fitted with a loop antenna) by using a boat. These observations were then compared with measurements made over land. The frequencies ranged from 590 to 5400 kHz. The conclusion reached after several years of study was that absorption of the radio waves must be taken into account and that it varies with ground properties (primarily electrical conductivity) and that it is a function of frequency. To have minimal effects of the absorption, it was concluded that measurements should be made within five wavelengths of the transmitter.

As a further study of field intensity, the investigation included measurements under daylight conditions made on 12 broadcasting stations as far away as Chicago, plus some airway beacon stations. The frequency range was from 290 to 1460 kHz. Observations were made by traveling in a laboratory truck, making measurements at distances ranging from one to several hundred kilometers from the transmitting station. Comparison of these measurements with calculations by the long established Austin-Cohen transmission formula showed lack of agreement in most cases. This was attributed to attenuation of the ground wave, a factor that varies considerably with ground conductivity.

In 1935, when he was a staff member of the Federal Communications Commission, Norton pointed out an error in the frequently used Sommerfeld formula on the attenuation of radio waves over a plane Earth. In a letter to *Nature* published June 8, 1935 (Vol. 135), Norton stated, "The purpose of this letter is to point out an error in sign in Professor A. Sommerfeld's original paper (1909) on the attenuation of radio waves." The error was that of a reversed sign at the bottom of the integral in an equation used to compute the field intensity from a distant radio transmitter. Norton was led to his discovery of the error from anomalies of measurement values compared with computed values in the observations of field intensity made by him and Kirby at an earlier time.

During the World War II period H. E. Sorrows, R. C. Ellenwood, and W. E. Ryan developed methods of calibrating field intensity measurement equipment in the VHF band from 40 to 160 MHz (frequency range of FM, TV, and navigational aid equipment used by the Civil Aeronautics Administration). Several techniques were developed to calibrate the internal circuits. Calibration of the antenna system was by the standard-field method.

## 2. Measurements up to 200 MHz

In 1944, E. L. Hall published a paper on the use of the Q-meter to study the behavior of radio components in the region of 25 to 200 MHz [11]. During that same year the new technology of microwaves rather suddenly came upon the section, resulting in an upsurge of interest in radio standards and measurements within the section that was to continue throughout the CRPL period and beyond. World War II had hastened the need for an advancing front in the measurement art.

## REFERENCES

- [1] E. B. Rosa and N. E. Dorsey, "A new determination of the ratio of the electromagnetic to the electrostatic unit of electricity," *Bull. Bur. Stand.*, Vol. 3, No. 3, 1907, pp. 433-604, *Scientific Paper 65*.
- [2] K. M. Evenson, et al., "The speed of light from direct frequency and wavelength measurements in the methane-stabilized laser," *Phys. Rev. Letters*, Vol. 29, No. 19, Nov. 6, 1972, pp. 1346-49.
- [2] Frederick A. Kolster, "The effects of distributed capacity of coils in radio-telegraphic circuits," *Proc. IRE*, Vol. I, Part 2, Apr. 1913, pp. 19-26, plus 7 pages of discussion.
- [4] Frederick W. Grover, "Formulas and tables for the calculation of the inductance of coils of polygonal form," *Bur. Stand. Sci. Paper*, Vol. 18, 1922-1923, pp. 737-762.
- [5] Frederick A. Kolster, "A direct-reading instrument for measuring the logarithmic decrement and wave length of electromagnetic waves," *Bull. Bur. Stand.*, Vol. 11, No. 3, 1915, pp. 421-455, *Scientific Paper 235*.

- [6] J. H. Dellinger and J. L. Preston, "Methods of measurement of properties of electrical insulating materials," *Bur. Stand. Sci. Paper*, Vol. 19, pp. 39-72.
- [7] Helen H. Smith, "Some measurements of telephone sensitivity," *The Wireless Age*, Vol. 9, No. 11, Aug. 1922, pp. 65-66, 96.
- [8] C. B. Jolliffe, "The use of the electron tube peak voltmeter for the measurement of modulation," *J. Opt. Soc. Am.*, Vol. 9, No. 6, Dec. 1924, pp. 701-704.
- [9] August Hund, "Measurements at radio frequency," *Electrical World*, Vol. 84, No. 19, Nov. 8, 1924, pp. 998-1000.
- [10] S. S. Kirby and K. A. Norton, "Field intensity measurements at frequencies from 285 to 5400 kilocycles per second," *Proc. IRE*, Vol. 20, No. 5, May 1932, pp. 841-862. (Also published in *J. Res. Bur. Stand. (U.S.)*, Vol. 8, No. 4, Apr. 1932, pp. 463-479.)
- [11] E. L. Hall, "VHF behavior of radio components," *Electronics*, Vol. 17, Mar. 1944, pp. 114-118.





## Chapter VI

### ANTENNAS, INSTRUMENTS, AND SYSTEMS IN DEVELOPMENT

#### ANTENNAS

##### 1. Radio antennas become a part of the Bureau scene

An antenna is an all-important component of a radio system, whether serving as the radiator for a transmitter or as the absorber or collector of radio waves for a receiver. Radio antennas became a part of the Bureau's facilities beginning with Dr. Louis Austin, probably in 1905. As head of the U.S. Naval Radio Research Laboratory on the Bureau grounds, he made use of antennas until the time of his death in 1932. Antennas appeared on the South, West, and East Buildings and in that order around the "quadrangle" which included the North Building. Finally, in 1918, antennas became associated with the new Radio Building at the southeast corner of the quadrangle. Until 1954, a variety of antennas appeared on the Radio Building, on the lawn, and in the nearby woods. Many antennas were located at the several field stations in the Washington area over a period of three decades.

These antennas were of many types. Over the years there were fan types, cage antennas, and the familiar T-type and inverted L-type. There were large and small size coil (loop) antennas, condenser antennas, and at least one parabolic antenna. As the frequency range was extended toward the shorter waves dipoles began to appear. A few microwave horn antennas were around the laboratories before the move to Boulder, Colo. A variety of antennas appeared at the Sterling field station. Several of the types of antennas came in for considerable study and for adaptation to radio systems developed by the Radio Section for special purposes. Among these were the coil antenna, condenser antenna, a parabolic antenna, a submarine antenna, and the dipole.

##### 2. The coil antenna adapted to many uses

The coil antenna was not new with NBS. It originated with Heinrich Hertz in 1888 when he used a circle of wire as a receiver, even noticing its directional properties. In 1908 G. W. Pickard used a coil antenna as a direction finder. Kolster began experimenting with the coil antenna shortly after he came to the Bureau in 1911. (See p. 139 on the coil antenna for fog signaling.) In 1919 Dellinger published a paper on the principles of transmission and reception with antennas that included the coil antenna [1]. Dellinger's study revealed many properties of coil antennas, both in transmission and reception, that were previously unknown. Formulas for performance, based upon theory, were confirmed by experimental observations. He suggested various subjects for future research. Among these was obtaining a better understanding of the effects of surrounding objects on the current developed in coil antennas. This became the objective of a study, in the spring of 1919, supported by the U.S. Army Signal Corps.

The coil antenna showed great promise as an accurate direction finder (within 1 or 2 degrees of true direction). To study the effect of surrounding objects a small collapsible coil antenna was designed for field studies in the frequency range of 300 to 1500 meters (1000 to 200 kHz). With a transmitter on the Bureau grounds, observations were made from different locations in Washington. At the Washington Monument grounds it was found that larger metallic bodies (in this case the elevator shaft) could distort the field greatly and cause directional errors by as much as 90 degrees, particularly at or near the resonance frequencies of metallic objects. Trolley lines and electric lines were also a source of large directional errors [2]. It was during this same period that methods were developed by

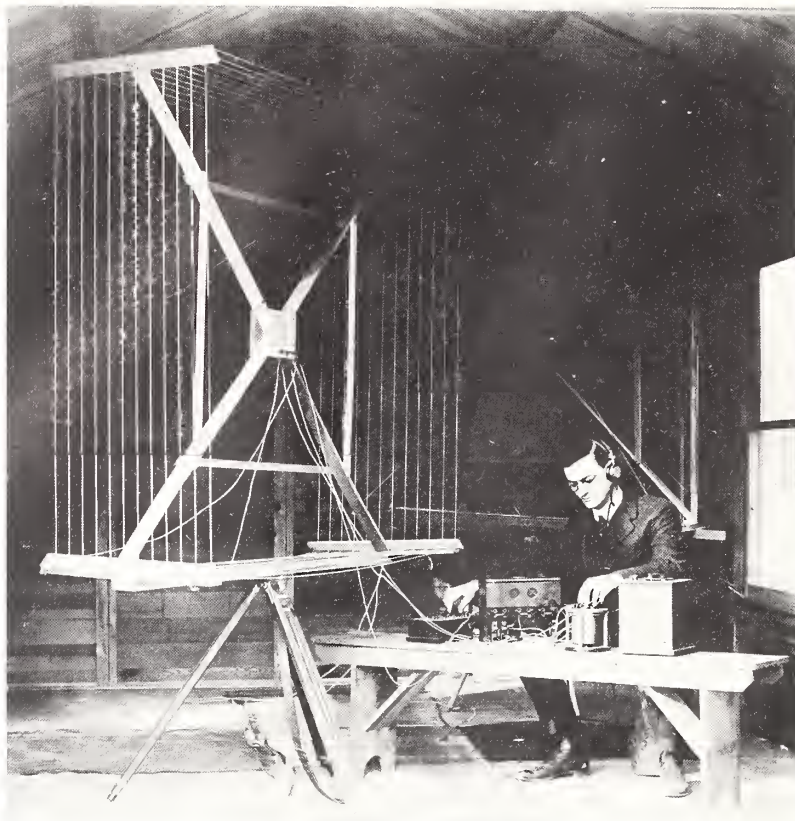

*W. G. Wade receiving signals from a coil (or loop) antenna at Kensington, Md. field station in 1919. The Radio Section made extensive studies of coil antennas for several decades, beginning in 1911, mainly for use in direction finding.\**

*\*This photograph has been miscaptioned in several Bureau publications. The year is 1919 and not 1914. The operator is W. G. Wade and not Kolster. It is a coil antenna for receiving radio signals and not designed specifically for direction finding as the antenna assembly lacks the mechanism for determining azimuth angle.*

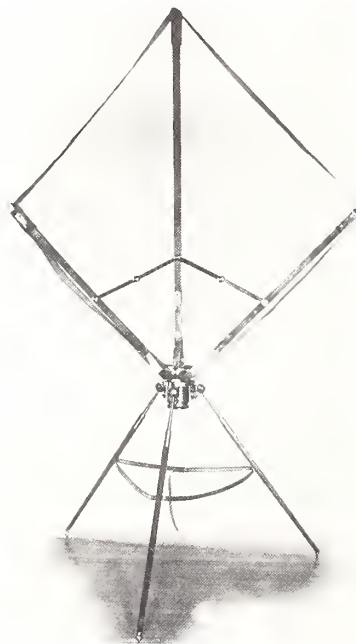

*Field-type direction-finder antenna developed by Radio Section at an early period. The collapsible feature allowed for easy carrying. A circular scale, graduated in degrees and attached to the vertical shaft, permitted the operator to determine azimuth angle of direction of transmitted signal being received.*

Kolster and Dunmore to use the coil antenna as a unidirectional antenna, thereby serving as a reliable direction finder without the ambiguity of the figure-of-eight pattern. This was accomplished by a tuned network circuit from the coil to ground. This study and improved instrumentation led to the success that Kolster and Dunmore had in a new radio navigation system for the Bureau of Lighthouses (see p. 144).

### 3. The small condenser antenna

Although Dellinger was a strong advocate of the use of coil antennas for many applications, he believed there were possibilities in the use of an antenna that was wholly capacitive (in actuality, it would be only nearly so because of residual inductance). The salient features of such an antenna would be the reduction of conductor resistance and the reduction of dielectric losses in the field of the antenna as compared with the ordinary elevated antenna. In the summer of 1920, John C. Warner of the Radio Laboratory, under Dellinger's direction, carried out a series of experiments with the condenser antenna on the lawn in front of the Radio Building.

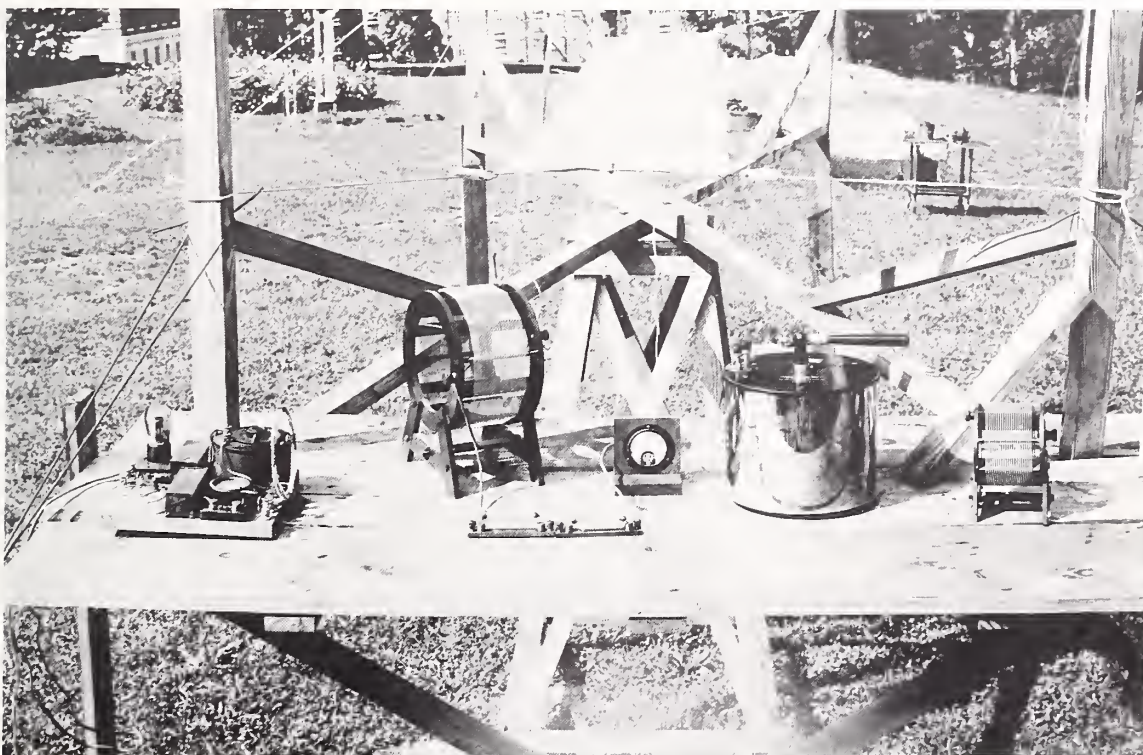

*Apparatus, including standard inductor and standard capacitor, used to measure constants of a condenser antenna. Lower plate of antenna is seen beyond measurement equipment. Location is on lawn of Radio Building in the summer of 1920. (East Building at left, recently constructed Industrial Building in far background to the north.)*

The two plates of a condenser were suspended in a horizontal position placed at various heights ranging up to about 10 feet above the ground. The plates were separated at distances ranging from 50 to 225 cm. Iron and copper screen wire netting in several areas of sizes up to  $90 \times 310$  cm (for the smaller of the two plates) was used as plates of the condenser. Most measurements of the condenser as a receiving antenna were made over a range of 200 to 450 meters (1500 to 670 kHz). The antenna showed very little directional characteristic. Warner found that the voltage induced in the antenna by a radio wave was approximately proportional to the distance between the two plates.<sup>1</sup> Experiments indicated that the condenser antenna furnished a greater signal strength than a coil antenna of comparable

<sup>1</sup>The induced voltage followed approximately the well-known transmission formula where the current in the receiving antenna is proportional to the height of the transmitting antenna and to the height of the receiving antenna (simple flat-top antenna).

height at wavelengths less than 250 meters (for the sizes of antennas used) but that the coil antenna was superior above about 300 meters. From these experiments, Warner's conclusion was:

The Bureau of Standards tests show that the low resistance of the two-plate antenna gives it a decided advantage over other forms of antennae. However, the impression should not be given that this feature alone makes a two-plate antenna as effective as a large overhead antenna when loud signals are desired. Amplification is almost as necessary with the two-plate antenna as with the coil antenna. The two-plate antenna does, however, lend itself to indoor use even though the dielectrics so introduced into the field raise the resistance somewhat. . . . [3].<sup>2,3</sup>

Dellinger's concept of the condenser antenna as being fairly efficient was proven correct by experiment, but the antenna never proved to be a popular type.<sup>4</sup> However, the Radio Section made considerable use of the condenser antenna in the late 1920's as a source of known radiation for the measurement of field intensity as a means of calibrating field intensity meters (see ch. V, p. 111).

#### 4. Experimenting with a directive antenna at 10-meter wavelength

##### a) TOWARD SHORTER WAVELENGTHS

Within a month after Marconi disclosed his and C. S. Franklin's experiments with short waves in an address to the Institute of Radio Engineers at New York City (June 20, 1922; see ch. I, p. 13), Dunmore and Francis H. Engel began to construct equipment to experiment with directional antennas at a wavelength of 10 meters (30,000 kHz). In less than 6 months they submitted a paper for publication on this first effort by the Radio Section to study the properties of waves in the 10-meter region [4].

For NBS, Dunmore and Engel were pioneering in a new frequency region. Their purpose was twofold: (1) as an aid in reducing interference, directional antennas appeared to be one solution, if not for broadcasting, at least for point-to-point communication; and (2) the higher frequency region appeared to be more promising for lower static levels.

##### b) THE TRANSMITTER AND A PARABOLIC REFLECTOR ANTENNA

For the first time the Radio Section was limited in extending the frequency range of its transmitters by the interelectrode capacities of electron tubes. To reach down to 10 meters in a tenfold jump the two men dispensed with the tuning condenser, using one turn of wire for each of the two inductors (grid and plate coils) of a Hartley circuit (plus the interelectrode capacitances) as the oscillating circuit of a 50-watt tube. Both CW and phone signals were available from the transmitter. Another turn of wire fed a dipole antenna. The dipole radiator was at the focal position of a reflector of parabolic-cylinder shape consisting of 40 vertically hanging wires. The wires could be tuned to the transmitter frequency by adjustment to proper length; they could be detuned and removed at selected interval

---

<sup>2</sup> Warner's published paper appeared in March 1923, long after the initial announcement of the condenser antenna experiments appeared in the November 5, 1920, issue of the *Technical News Bulletin*. The reason for the long delay is not evident in the section's records.

<sup>3</sup> In the Radio Section Reports is found an interesting paper, dated August 9, 1922, that apparently was prepared for publication by H. F. Harmon, one of the section personnel. An attached note indicated that it needed revision before submitting for publication. By a series of experiments Harmon developed an antenna on the condenser concept by using a "plate" of crisscrossed wire in the top of a Ford touring car. The car chassis served as the other plate of the condenser antenna. His experiment met with considerable success as having produced a complete automobile radio receiver at an early date. This form of antenna came into considerable use in the early years of automobile radios until the metal "turret" top spelled its demise. It again appeared in the form of a metallic screen or plate under the running board until that feature on automobiles disappeared. Finally the "whip" antenna overtook the condenser antenna.

<sup>4</sup> Another form of condenser antenna in the early years of radio was the use of the metal bedspring—a convenient form of antenna for the bedside radio. (The bedspring antenna for radar, in more recent years, is not a condenser but a planar array of dipoles.)

spacings. Variations in the wire combinations gave different patterns to the directional characteristics of radiation from the antenna. The hanging antenna was turned on a vertical axis to determine its directional characteristics.

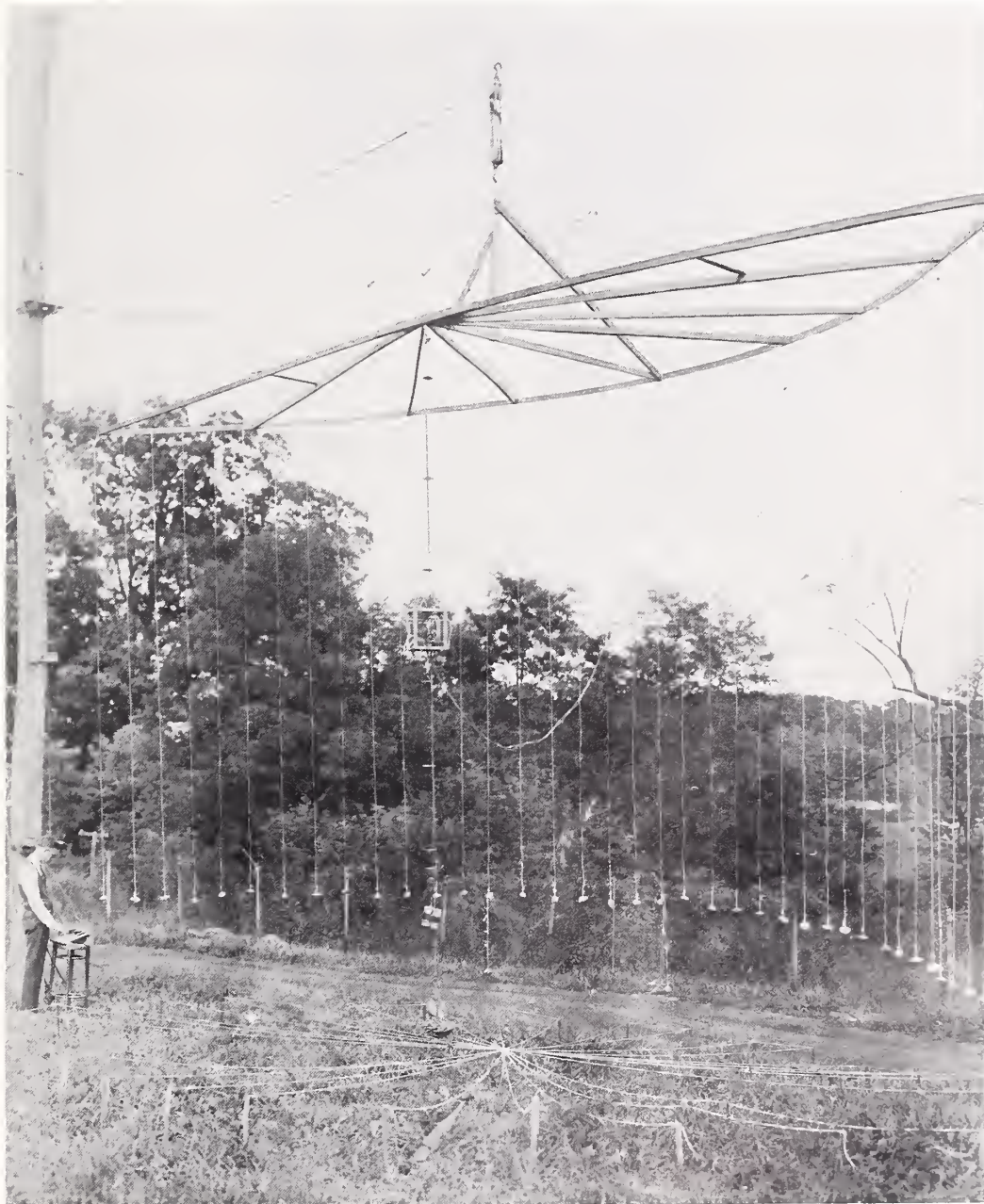

*In the summer of 1922 Dunmore and Engel experimented with a transmitter and a receiver that operated at 10 meters (30,000 kHz), the upper frequency being limited by interelectrode capacitance of the transmitting tubes then available. A single-turn loop coupled to the oscillator fed two cage antennas that served as a dipole radiator at the focal point of a parabolic-cylinder-shaped reflector consisting of 40 vertically hanging wires. Various directional characteristics were obtained by changes in the reflecting system and tuning relations of dipole and reflecting wires.*

### c) THE RECEIVER

A single loop of wire with a very small variable capacitor served as a combination directive antenna and tuned circuit for the detector. An auxiliary oscillator served for heterodyning the CW signals.

Dunmore and Engel found a directive effect to their parabolic antenna to the extent that at least 75 percent of the radiated power was confined to an azimuth angle of 40 degrees. The parabolic reflector-type antenna did not come into common use by the Radio Section. Some years later when Dunmore became one of the team working on a radio guidance system for landing aircraft, a Yagi-type dipole antenna was used. By 1930 NBS was operating this new directive antenna at 100 MHz, a threefold increase in frequency from that used on the parabolic antenna in 1922. And the newer tubes permitted tuning of the transmitter.

## 5. Dunmore designs an antenna for 100 meters

With the availability of electron tubes designed for the shorter waves, after World War I, the Radio Laboratory began experimenting at wavelengths much below the early broadcast region that centered on the 360-meter wavelength. Noticeable features of the shorter wavelengths were greater freedom from static and fading characteristics that differed considerably from the longer wavelengths. At the request of the U.S. Army Air Service, Dunmore, assisted by Engel, designed equipment for operation at 100 meters (3 MHz) and explored the properties of radio waves at this wavelength. The Army Air Service was interested in the practicability of utilizing the higher frequencies for its radio communication services.

Of particular interest was the antenna—one of rather unorthodox design. Both in appearance and in operating characteristics the antenna was a “hybrid” of condenser and coil antennas.<sup>5</sup> Directional characteristics observed at an installation at McCook Field, Dayton, Ohio from an airplane flying at various heights and directions showed that, indeed, the antenna had characteristics of each type (coil and condenser) and a combination of each type, depending upon the configurations used.

Probably more important than the uniqueness of this antenna were the two-way tests conducted with it by Dunmore along with Frank Conrad of the Westinghouse Electric and Manufacturing Co. of Pittsburgh. (Conrad is usually credited with the first scheduled broadcasts by a commercial station, which was the pioneer broadcast station KDKA.) In May and June of 1922 the two men made many observations of the transmission between Washington and Pittsburgh, Pa. This 200-mile transmission path had already reached notoriety because of the excessive fading at night observed by the 1921-1922 broadcast listeners in the two areas. Dunmore and Conrad found but little fading of the 100-meter signals and that the daylight transmission was nearly as strong as that of the night.<sup>6</sup> Dunmore published two papers on this project, one in *QST*, and a longer one in the *Proc. IRE* [5].

---

<sup>5</sup>The antenna was rectangular in vertical cross section, 18 feet high and 40 feet long, and consisted of 23 wires in parallel and held apart at 3-inch intervals by wood spreaders to form a plane of wires. The wires were joined together in a fan fashion at the bottom of the rectangle and inductively coupled to the output of a transmitter. An 18-inch gap was formed in the loop of 23 wires which gave the effect of the two plates of a condenser antenna (the 23 wires were bridged by metallic foil on each side of the gap). The small capacitance of the gap gave somewhat the effect of a single-turn loop tuned to 105 MHz (operating frequency) with some directional properties to the whole antenna. To observe the directional effects, Dunmore provided for gaps at three locations, one on the top plane, and one on each of the two vertical planes; however, only one gap was used at each observation. Although the antenna acted somewhat in the fashion of a single-turn loop, the 23 wires in parallel reduced the resistance considerably.

<sup>6</sup>In later years the Radio Section could explain Dunmore and Conrad's observations. For the distance of 200 miles between Washington and Pittsburgh at a wavelength of 100 meters, there would be one reflection from the ionosphere and at the frequency of 3 MHz there is no great difference between day and night signals at a 200-mile separation.



FIGURE 6—Special Type of Antenna for Transmission on 105 Meters, Consisting of 23 Turns in Parallel



*Unique antenna for operation at 100 MHz, designed by Dunmore, combined properties of condenser and coil antennas. Original photo shows the general nature of the antenna; the recopied picture with wire structure enhanced by drawn-in lines gives a better concept of the antenna structure (small loop antenna on roof of building is not a part of the larger antenna). This antenna was used in 1922 for study of transmissions to Pittsburgh, Pa.*

## 6. The submarine antenna of World War I

In 1918 John A. Willoughby and Percival D. Lowell developed an antenna for submarines that was capable of transmitting and receiving radio signals with the entire antenna submerged in seawater. Because of its development as a wartime measure, the account is covered in chapter III.

## 7. A theoretical study of antennas

In 1925 Frederick W. Grover of Union College (and University), who at various periods served as a consultant to the Radio Section, completed an extensive theoretical paper on the capacity of antennas.<sup>7</sup> He developed formulas by which the electrostatic values of the capacity of single and multiple wire antennas could be calculated for engineering purposes. Grover developed capacity formulas for 18 different types of antennas [6].

# RADIOSONDES

## 1. Early work in radio meteorographs (radiosondes)

Radiosonde or radio meteorograph<sup>8</sup> projects within NBS were established with substantial support by other government agencies. The field of development was not entirely new, dating back to 1929, about 6 years before NBS entered the field.<sup>9</sup>

## 2. An early NBS radiosonde

At the request of the U.S. Weather Bureau, L. F. Curtiss and A. V. Astin of the Electricity Division completed a radio meteorograph in 1935 to be attached to a free balloon. Observation of the sensing elements was by means of an Olland telemeteorograph.<sup>10</sup> They later replaced the spring-driven clockwork with a very small electric motor. The transmitter operated at 5 meters (60 MHz) and used a dipole antenna. Signals could be heard out to 80 miles.<sup>11</sup> Several years later Curtiss and Astin adapted their radio meteorograph for observation of cosmic rays in the stratosphere.

## 3. The Radio Section takes up radiosonde development

The second project in the development of radiosondes at NBS had its genesis in a cooperative program with the National Geographic Society and Army Air Corps

---

<sup>7</sup> Professor Frederick W. Grover was a member of the Electricity Division from 1902 to 1911. During the period of being professor of electrical engineering at Union University (Schenectady, N.Y.) from 1920 to 1946, he was also a consulting physicist with the Bureau until 1946, for much of this period with the Radio Section. Professor Grover died in the spring of 1973 at the age of 96.

<sup>8</sup> The term "radio meteorograph" crept into the literature about 1930. Beginning in November 1938, the Radio Section replaced the term "radio meteorograph" with "radio sonde," in harmony with the agreement among Government departments through the Interdepartmental Radio Advisory Committee. By 1946 the term "radio sonde" had contracted to one word "radiosonde," a typical transition in the English language. "Sonde" is the French word meaning "sounding."

<sup>9</sup> A detailed account of the earliest developments in radiosondes is given by Middleton in his book on invention of meteorological instruments [7]. Middleton gives credit for the first documented radiosonde ascent to a Frenchman named Bureau, who made the first observations on June 10, 1929, with a time-cycle device transmitting indications of temperature and pressure. Others in Germany, Russia, and Finland followed with various types of time-cycle mechanisms controlling the sequence of observing the sensing devices. Several laboratories in the United States had developed radiosondes shortly before NBS entered the field.

<sup>10</sup> The "Olland principle" is a century-old method of observing data by interpreting angular deflections of sensing devices in terms of time intervals. It was named after H. Olland of Utrecht, Holland.

<sup>11</sup> A summary report of the development and operation of this radio meteorograph was published by Curtiss and Astin in 1939 [8].



stratosphere balloon flights.<sup>12</sup> In preparing for a second flight, this time with "Explorer II," the Army Air Corps requested the Radio Section to use some of its newly developed UHF techniques<sup>14</sup> to observe radio signals at long and short distances from a balloon-borne transmitter at altitudes not reached before. Transmitter frequencies were selected at 55 and 108 MHz. Harry Diamond and G. H. Lester took part in this program.<sup>15</sup> In advance of the scheduled flight of "Explorer II," Diamond and Lester made some tests at the Stratosphere Bowl with a 108-MHz transmitter suspended from three weather balloons and followed the signals up to the 41,000-foot altitude reached by the balloons. They stated in the Monthly Report for July 1935: "The tests demonstrated the possibility of obtaining radio data from the stratosphere by means of weather balloons; a number of meteorological applications are also indicated." The first attempt with "Explorer II" on July 13, 1935, was postponed due to a tear in the balloon. Although the UHF radio transmission program was cancelled for the

<sup>12</sup> On the first flight made by the stratosphere balloon "Explorer I" on July 28, 1934, near Rapid City, S.D., a receiver at the Meadows field station near Washington, D.C., was used to pick up signals from the transmitter W10XCX mounted on the balloon gondola. It was a test for observing variations in field intensity as the transmitter increased in height above ground. Any variations of the 13.05-MHz signal were obscured by the diurnal changes occurring in the ionosphere.

<sup>13</sup> "Explorer I" did not ascend to the expected height due to a tear in the balloon fabric. The recorded altitude was 60,613 feet.

<sup>14</sup> UHF techniques had been under development by the Radio Section for use as radio aids to air navigation, including radio landing systems.

<sup>15</sup> Harry Diamond entered the Radio Section on July 18, 1927, having been an instructor in electrical engineering at Lehigh University for several years previous. In December 1942 he transferred to the group that was to become the Ordnance Development Division.

Author's (WFS) note: Although there is agreement in various accounts of biographical information that Harry Diamond was born on February 12, 1900, his place of birth is given as either Russia or as Quincy, Mass. Most reliable would be the place of birth given in Diamond's Official Personnel Folder in the Civilian Personnel Records at the National Personnel Record Center, GSA, St. Louis, Mo. Diamond's folder indicates that he was born in Minsk, Russia, and that he became a naturalized citizen of the United States on June 4, 1923.

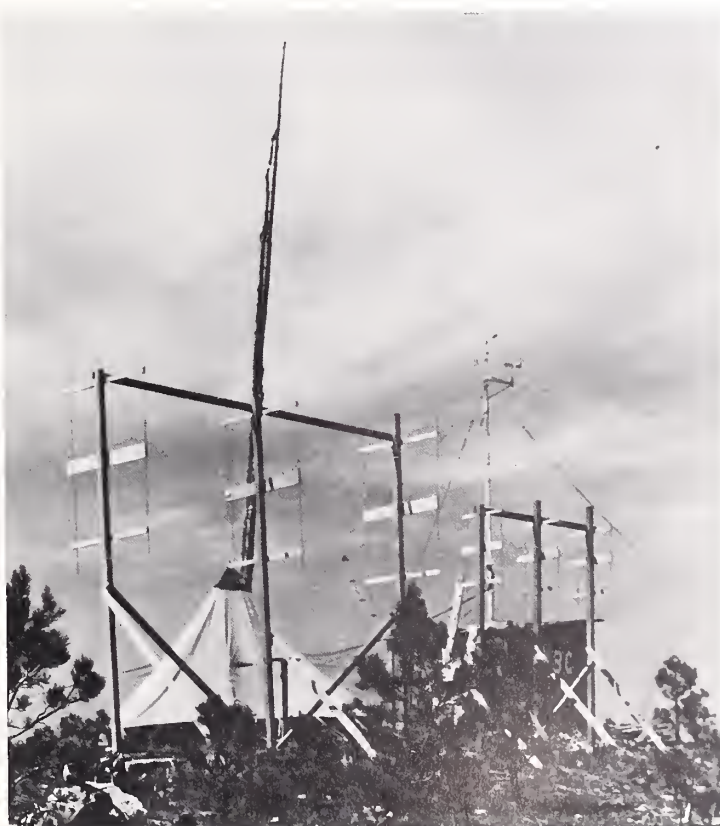

*UHF antennas at rim of Stratosphere Bowl, near Rapid City, S.D., used to receive signals from the 1935 National Geographic Society—Army Air Corps stratosphere balloon flight. Diamond and Lester used the occasion to pick up signals from miniature transmitters carried aloft by weather balloons. This experiment initiated the Radio Section's extensive radiosonde program.*

second attempt (this successful flight of 72,395-foot altitude was made on November 11, 1935), the preparations for this venture initiated the extensive radiosonde program taken up by the Radio Section.

Within a month or so after the weather-balloon experiment at the Stratosphere Bowl, Diamond and his team began construction on a balloon-borne, lightweight, 200-MHz transmitter. They passed up the "Olland principle" that had been the foundation for most or all previous radio meteorographs; other approaches had greater appeal to them. Change in barometric pressure was observed by the change in a modulation frequency of approximately 1000 kHz. It was their intent to observe wind speed and direction with two direction finders on a base line. They also made arrangements with Coblenz and Stair of the Radiometry Section for equipping the transmitter with a phototube to measure ultraviolet light at high altitudes.<sup>16</sup>

<sup>16</sup> Six flights with a modified radiosonde were made by Coblenz and Stair in 1937 to observe the ultraviolet solar intensities in the stratosphere. A radiosonde was fitted with a photoelectric cell and ultraviolet filter for these observations. Below 14 km the ultraviolet light was found to be fairly constant with altitude in spectral quality and intensity, but they found the amount of ozone increased rapidly above 14 km, and to 19 km, the maximum height attained for good quantitative measurements.

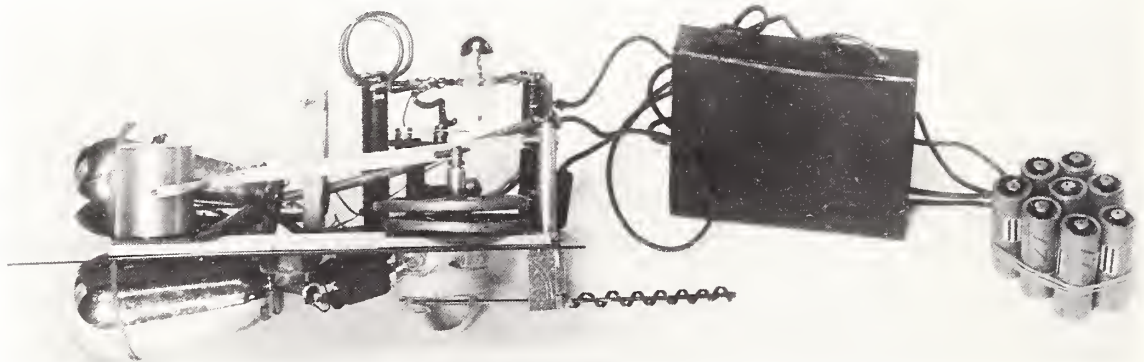

*Earliest form of the radio meteorograph (later called radiosonde) developed by the Radio Section in 1935. An aneroid barometer indicated air pressure (hence altitude); the rotation of a spiralled bimetallic strip indicated temperature; each movement modulated the transmitter oscillator. Observation of humidity was to come later.*

From the beginning came a series of rapid and progressive steps toward the development of a highly successful radiosonde brought into fruition several years later. By January 1936 the Navy Department requested development of radio meteorographs for the aerological services. In the laboratory, the team of workers now consisting of Diamond, Dunmore, and W. S. Hinman (later E. G. Lapham joined the team) developed circuitry that would lead to the final design.<sup>17</sup> They had come to the decision of using a relaxation oscillator (with selection of a voltage-controlled, negative transconductance relaxation oscillator) to provide audio-frequency modulation to the transmitter output, with the modulation frequency controlled by changes of resistance in the resistor elements in each weather-sensing device. The first step was to use an electrolytic resistor for the temperature sensor. This sensor was developed largely by D. Norman Craig of the Electrochemistry Section.<sup>18</sup> The pointer arm of a pressure element (a slyphon bellows as used in an aneroid barometer) moving across a resistor gave resistance changes to indicate pressure changes. At first a hair hygrometer was used and its pointer movement across a resistor provided the resistance changes to indicate relative humidity. This was to be replaced later by an electric hygrometer, developed by Dunmore, which proved to be much more satisfactory. A fixed resistor provided for a frequency in the audio modulation circuitry that served as a

<sup>17</sup> Wilbur S. Hinman, Jr. entered the Radio Section on August 6, 1928. In October 1941 he was assigned to a war-related Confidential project that later developed into the Ordnance Development Division. Later Hinman became technical director of the Diamond Ordnance Fuze Laboratories.

<sup>18</sup> Although early development of an electrolytic resistor as a temperature sensor was by Craig, at a later time Francis W. Dunmore of the Radio Section filed for a patent on the device on December 22, 1938. Patent 2,210,903 was issued on August 13, 1940, entitled "Method of measuring temperature."

reference for the three audio frequencies controlled by the three sensing devices. To "decipher" the information carried by the several audio frequencies detected in the receiver, it was necessary to use an electronic frequency meter at the ground station.

In April 1936 a development project with the title "Radio Meteorograph" was authorized and was funded by the Navy Department's Bureau of Aeronautics. Previously, the development was a part of the Ultra High Frequency project; but with the new authorization it was separated and given a Confidential security classification. The services of the Julien P. Friez Co. of Baltimore, Md. were engaged to assist in some of the instrument features of the radio meteorograph, and later for ground-station equipment.



*The earliest model (1936) of radiosonde constructed for Radio Section by a commercial firm on a Navy Project. At upper right is one type of electrolytic resistor (in glass tubing) used as the temperature sensor. The two sections of hair hygrometer for measuring relative humidity are clearly shown, as well as a side view of the aneroid barometer. Electron-tube circuitry forms another portion of the chassis.*

#### 4. A technical breakthrough

On May 20, 1936, a trial balloon flight was made with a 185-MHz transmitter. Enough was learned on this flight to indicate that the design features were sound but many refinements were needed. The biggest problem was that of sequencing the readings of pressure, temperature, and humidity. In fact, three methods had been considered which the team called A, B, and C, and also a modification called the D method. Method A was tried on May 20 but left something to be desired. July found the team coming up with method E which eventually proved to spell success. It was a method of switching the three sensors, each in turn, for transmission of sensor information. Switching operation came from the pointer of the pressure element. The novel feature was that temperature and humidity were indicated at the receiver in terms of pressure or altitude instead of by time-sequential intervals as would be indicated by the "Olland principle" or by any other time-sequential device.

#### 5. A method of determining upper-air wind conditions

The team had not lost sight of combining weather observations so that wind speed and direction could be obtained along with pressure, temperature, and relative humidity observations. This was one reason they were clinging to the design of a transmitter that would be providing audio-frequency modulation on a continuously radiated carrier. It was in August 1936 that they observed an interesting phenomenon of very marked interference of the wave reaching the receiving antenna directly from the transmitter with that reaching it after reflection from the ground. This observation led to an accurate means of determining the angle subtended by the balloon with the ground; knowing the height of the balloon above ground, the distance along the ground to the balloon was known by a simple trigonometric calculation. With an azimuth-angle direction finder the position of the transmitter could be determined from a single ground station. Time-related observations would give wind speed. A disadvantage of the measurement system was the necessity of moving the receiver or a receiving antenna along a vertical axis above the ground plane and observing null points in order to determine the subtended angle. This measurement system led to the filing of a patent in December 1938.<sup>19</sup>

#### 6. Further progress on the radiosonde

By midsummer of 1936 a number of steps were still required to bring on a device that would meet the Navy's requirements for a device to sound the upper air. The hair hygrometer was sluggish in responding and lost much accuracy at high altitudes where low temperatures and low absolute humidity were encountered. Dunmore embarked on an investigation of salt hygrometers (electric hygrometers) that would serve as a resistive element in the radiosonde circuitry. Eventually this program covered a period of nearly 10 years. Dunmore's quest for an electric hygrometer for the radiosonde reads much like Thomas Edison's search for producing a filament for the incandescent electric lamp. The technical achievements can be found in two NBS publications [9,10].<sup>20</sup> Details of the long story and of the numerous experiments can be gained only from the Monthly Reports of the Radio Section.

---

<sup>19</sup> Harry Diamond, Francis W. Dunmore, and Wilbur S. Hinman, Jr. filed for a patent on December 22, 1938. Patent 2,434,263 was issued January 13, 1948, entitled "Determining upper air wind conditions by radio direction finding."

<sup>20</sup> An electric hygrometer senses the moisture content of the air by changes in resistance of a hygroscopic material and thereby indicates the relative humidity. Dunmore's improved electric hygrometers for radiosondes consisted of a thin-walled aluminum tube that would quickly take on the temperature of the air. The tube was coated with a polystyrene resin for an electrically insulated surface, over which was a bifilar winding of palladium wire. The surface was then coated with partially hydrolyzed polyvinyl acetate with the addition of a small amount of lithium chloride. Changes in resistance of this hygroscopic salt between the bifilar winding sensed the moisture content of the air. This "resistor" was one of the several sensing elements in the radiosonde.



*Early form of the electrical hygrometer developed by Dunmore for use on radiosondes to determine relative humidity. Dunmore experimented with this device for more than a decade, bringing about many changes and improvements. In principle, the electric resistance of a film of lithium chloride indicates relative humidity over a wide range. Several patents came from this device and it is used quite extensively today.*

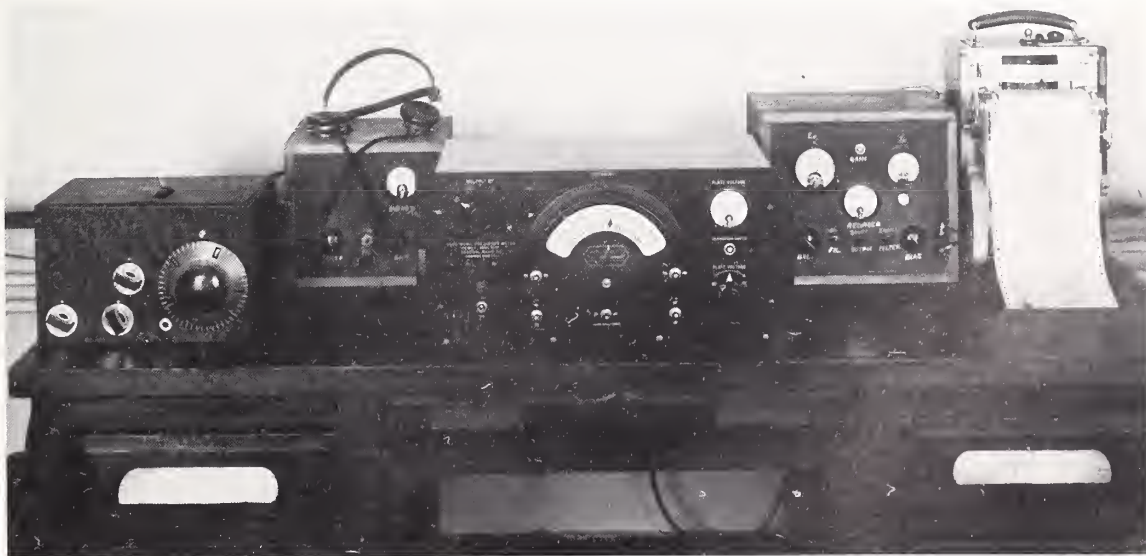

*Complete receiving and recording equipment for the radiosonde as it appeared in December 1936. The electronic frequency meter at center indicated the audio frequencies controlled by the effective values of air pressure, temperature, and humidity, thus revealing upper air conditions.*

A satisfactory flight incorporating the method E of sequencing and recording readings was made on November 9, 1936. Considering all factors involved, the method appeared to be able to yield accuracies of 1 percent for readings of temperature and humidity. Facilities were set up in the laboratory whereby flights to high altitudes could be simulated and calibration of the radiosondes conducted in the laboratory. Thus, there was assurance of a well-calibrated device before it was launched by a balloon. On one experimental flight observations were made of cloud height and cloud thickness by incorporating a phototube in the radiosonde circuitry. This adaptation and these measurements did not become a regular feature of radiosondes in the future.

Diamond, Hinman, and Dunmore came out with their first publication on the radiosonde in the *Bulletin of the American Meteorological Society* of March 1937 [11]. The paper had been read initially at the Atlantic City meeting of this Society on December 29, 1936. The published paper appeared in company with several other papers in the same issue on contemporary developments in radio meteorographs.

In April 1937 the team prepared performance specifications for the Navy for the purchase of 50 radiosondes. On April 28 and 29 an exhibit on the radiosonde was shown at the annual meeting of the American Meteorological Society at Washington, D.C. The Radio Section radiosonde was beginning to arrive.

## 7. Flight testing and a serviceable product

June of 1937 brought on some solid accomplishments. A standard procedure for calibrating the radiosondes was worked out that incorporated simplifications, yet increased the overall accuracy of measurement. A receiving station was set up at the Naval Air Station at Anacostia, D.C. This station was to serve for many flight observations over the next several years. It was also to serve as a training area for Navy personnel in the early stages of introducing the radiosonde into upper-air soundings. The first flight was made with an electric hygrometer as an improvement over the hair hygrometer. Future use of the radiosonde appeared bright but more refinements were indicated.

In rapid succession came many flights of the radiosondes. Comparison flights with the regularly scheduled airplane flights for weather soundings were often made. This was largely a matter of comparison with an established weather service in order to determine the superiority and economy of using radiosondes. Many multiflights of radiosondes were made to compare the performance and reliability of readings between a number of the instruments that were exposed to the same flight and atmospheric conditions. The results were gratifying both to NBS and to the Navy.

Many flights were made in the spring of 1939, both with balloons and Navy planes, during the transition period of conversion from the hair hygrometer to the electric hygrometer developed by Dunmore. It was an uneasy period of experimentation, both for NBS and the Navy, to accept a potentially superior device for measuring relative humidity. It meant acceptance of the device on a daily routine basis under the severe conditions of low temperature and low moisture content found in the upper air and extending its use into the stratosphere. The time-honored hair hygrometer was finally cast aside during the transitional period in 1939 and 1940. During the same period the balloon-borne radiosonde was fast taking over the meteorograph carried by planes.

Service use of the radiosonde began in the Navy Department on June 1, 1938, at the Naval Air Station, Anacostia, D.C. During the next year the U.S. Weather Bureau, the Coast Guard, and later, the War Department, set up facilities for upper-air soundings by means of radiosondes. Some of the installations were aboard ships, where a relatively small boat could become a useful and effective as well as a mobile weather station.

The Radio Section's team became quite occupied in the planning and assistance in setting up radiosonde facilities among the various Government agencies that provided aerological services. Assistance was also given in the training of station personnel. Technical assistance was given to, as well as received from, the manufacturer of radiosondes. By 1940 the radiosondes were being produced at the rate of 15,000 units per year.



*This radiosonde was manufactured in large quantities by 1940, and incorporated improvements developed by the Radio Section. The batteries, transmitter, and pressure unit were housed in an insulated box to minimize temperature changes. Temperature tube and electric hygrometer (at rear) were shielded against solar radiation by double-walled metal tube. Total weight less than 1 kg; cost was \$25 in 1940. The finder, after balloon flight, received a monetary award upon return of radiosonde to Bureau.*

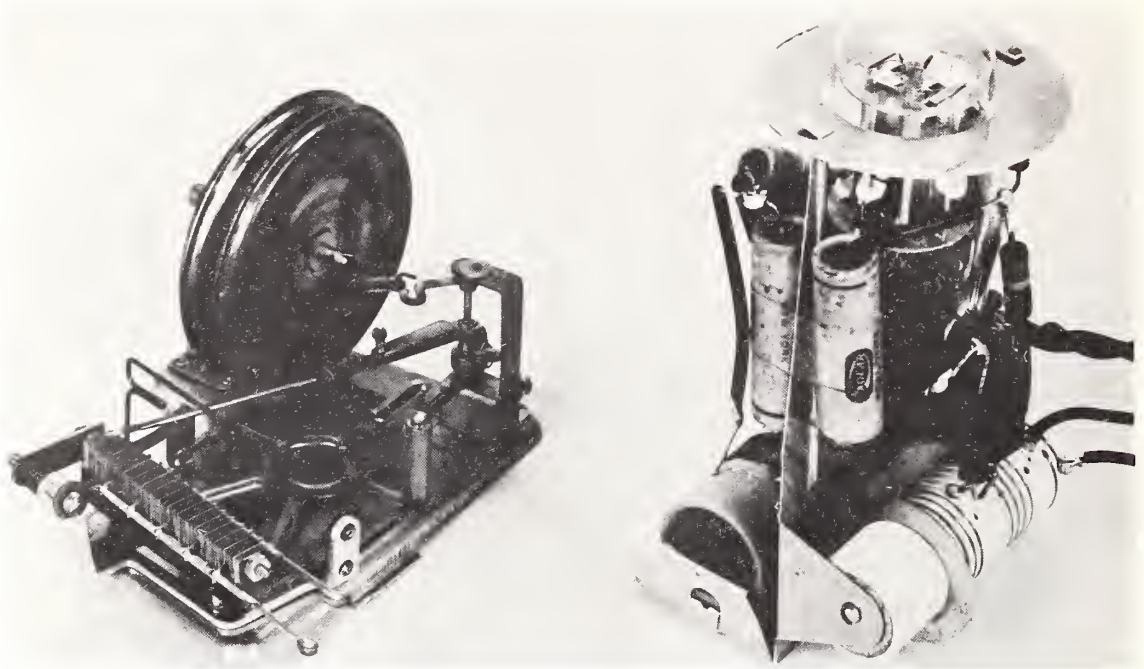

*Pressure unit (left) operated a switching contactor to provide sequencing of pressure, temperature, and humidity information at indicated altitudes (pressures). Transmitter operated at 65 MHz with two triodes in a single glass envelope (type 19 tube), one triode as the carrier oscillator, the other as the modulating oscillator.*

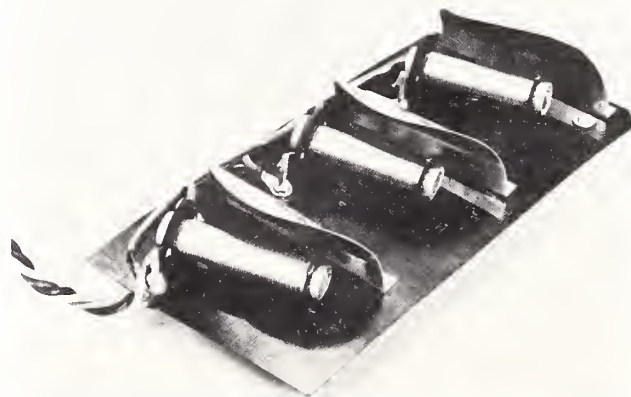

*Glass tube (upper component) encloses electrolyte used as a resistance thermometer. On opposite side of panel a group of electric hygrometers in three sensing ranges indicated a wide range of relative humidity.*



## 8. The radiosonde attains technical stature

During the course of its development the Radio Section's radiosonde received good documentation in the technical literature by the development team. It was also a popular subject for other writers. By 1940, Diamond, Dunmore, Hinman, and Lapham had published, in several combinations or individually, 11 papers on the development of the radiosonde plus numerous reports for the Navy Department and the section files. Moreover, they had presented many papers before technical groups and had given a number of lectures that popularized the subject. A lengthy and detailed account of the matured radiosonde was published in the *NBS Journal of Research* in 1940 [12].

A description of the operating principles of the radiosonde in the stage of development as it became widely used by 1940 is beyond the scope of this historical account. For such information, as well as the details of the components and performance characteristics, the reader is referred to the publication noted above [12].

The three vacuum tubes used in the earlier models were reduced to one tube that housed two triodes. One triode served as the 65-MHz transmitter feeding a dipole antenna. The other triode served as a relaxation oscillator for modulating the transmitter. Although oscillating at about 1 MHz, it would be periodically blocked (and restarted) at an audio frequency rate by a resistance-capacitance network that supplied information on temperature, humidity, and atmospheric pressure. At the ground station the received signal was fed to an electronic frequency meter. The resulting direct current, proportional to the modulation frequency from the radiosonde, was fed to a tape recorder. By means of a special slide rule, the frequency signals were converted to readings of temperature and relative humidity in terms of atmospheric pressure readings and altitude.

As a balloon-borne measurement instrument to probe the upper atmosphere, the radiosonde had reached a very acceptable degree of accuracy in performance. Barometric pressure readings were accurate to  $\pm 5$  millibars, temperature readings to  $\pm 0.75$  °C, and relative humidity to  $\pm 5$  percent. Below a temperature of  $-60$  °C the electric hygrometer became unreliable.

Dunmore continued his investigations on electric hygrometers until 1948. In a later form the tubular hygrometer was built on a small strip of polystyrene. With this construction the entire humidity range for radiosondes could be covered with a single unit. From his hygrometer researches Dunmore received two patents.<sup>21</sup> In addition to its contribution to the marked success of the Radio Section's radiosonde, this electric hygrometer has had wide application in industry. In all cases it utilized lithium chloride in an organic binder as the sensing material of a resistor in an electrical measurement circuit. A novel hygrometer using this principle was reported in 1953 where the sensing element was small enough to fit into the end of a hypodermic needle. In this extremely small form it was used by cereal food processors to probe for moisture content in wheat grains.

## 9. Further developments

In 1946 the Federal Communications Commission reassigned the frequency bands for radio meteorological devices such as radiosondes.<sup>22</sup> The lowest of these bands was 400-406 MHz. Now working in CRPL, Lowell and William Hakkarinen converted the existing design of radiosondes to this new band in the UHF region for the Navy Department. The conversion was aided by some adaptations of a UHF meteorological telemetering system developed by the Army Signal Corps during World War II. The conversion incorporated pulse modulation instead of the amplitude modulation of older radiosondes. The conversion resulted in a much reduced power drain from the batteries, thereby reducing the battery weight. The pulse system also increased the distance range.

---

<sup>21</sup> The two patents issued to Francis W. Dunmore were:

- 1) Patent 2,285,421, entitled "Humidity variable resistance," filed June 8, 1940, issued June 9, 1942; and
- 2) Patent 2,295,570, entitled "Humidity measuring," filed December 22, 1938, issued September 15, 1942.

<sup>22</sup> During the war period most radiosondes being manufactured had been converted to operate in the frequency band of 70-73 MHz.

In 1960 Lowell replaced the active elements of the radiosonde with transistors (except for the transmitting vacuum tube). Using transistors in a pulse-power amplifier circuit, Lowell was able to pulse-modulate the transmitter to gain certain advantages over grid modulation. Another advantage gained was elimination of the 120-volt plate supply battery and replacing with a low-voltage battery used for transistors. The radiosonde had gone a long way from its beginnings in 1935 and was kept up to date with the newer technological developments.

The development of the radiosonde was an outstanding contribution to the fields of aerology and weather forecasting. In his book, commemorating the 100 years of the U.S. Weather Bureau, the author, Patrick Hughes, stated:

The development of the radiosonde was an epoch landmark in meteorological history, leading to many revisions of man's concept of the structure of the atmosphere under, and in which, he lives . . . [13].

### RADIO DETERMINATION OF UPPER-AIR WIND VELOCITY BY PHASE-VARIATION METHOD<sup>23</sup>

With the expertise gained by the Radio Section in the early developments of radiosondes (beginning in 1935), the Navy Department again turned to the Bureau (summer of 1937) for development of radio methods of determining upper-wind velocity. Measurement of wind velocity was considered to be an important part of the overall observation of the upper air as a means of reliable weather forecasting. Information gained from accurate weather forecasting always influences and sometimes determines the planning of military air and surface actions.

Air navigation, whether by military aircraft or by commercial aircraft, requires accurate knowledge of wind velocity (the vector of speed and direction) in the upper air. In order to minimize headwinds, the pilot or flight controller selects altitudes that will reduce the time of flight and economize on the operation. Accuracy in long-range gunnery also requires knowledge of moving air strata at the higher altitudes.

The conventional method of measuring wind velocity above the ground was by means of observing small free balloons with a theodolite. Such observations were limited by visibility of the balloon, accurate readings of the azimuth and zenith angles, and by assumption of a given rate of ascent of the balloon. Some form of radio determination of wind velocity would be superior in most or all respects to that of the theodolite method.<sup>24</sup> Several radio methods were considered. In any of these methods a transmitter would be suspended from the free balloon.

Early in this new project several reports were sent to the Navy of analytical studies made preliminary to the actual development of a measurement system. It was soon determined that a triangulation method involving two stations would yield observations with rather gross errors of wind velocity. Determination of altitude of a balloon by measurement of zenith or elevation angle from a single ground station was subject to much error, particularly if made from aboard ship. From these early studies there evolved a phase-variation method of determining wind velocity with an acceptable accuracy of measurement.

On March 12, 1938, observations of wind velocity at upper-air levels were successfully made for the first time by a phase-variation method. The early experiments made by this method were developed and conducted by Dunmore and Evan G. Lapham under the direction of Harry Diamond.

---

<sup>23</sup> Because no paper was prepared for publication on this project, due to World War II, a rather detailed account is given here.

<sup>24</sup> Blair and Lewis reported on the radio tracking of meteorological balloons by the Signal Corps at Ft. Monmouth, N.J. in 1931 to determine wind speed and direction [14]. They developed a small balloon-borne transmitter that operated at a wavelength of 125 meters (2.4 MHz). Two direction-finder loop antennas on a long baseline and a known rate of rise gave position of the balloon, from which wind speed could be calculated. Observations were made to a distance of 10 miles.

In its simplest form for this successful test, the phase-variation method required a ground-based transmitter with amplitude modulation by a single audio signal, and a free balloon carrying a small re-emitter, a combination transmitter and receiver; with later usage, this was more commonly called a pulse-repeater or transponder. The balloon receiver received the radio signal from the ground-based transmitter, extracted the audio modulation signal which was then used to amplitude-modulate the balloon radio transmitter, and reradiated this signal at a different radio frequency to the ground-based receiver. The phase of the audio output from the ground receiver was then compared with that of the audio modulation of the ground transmitter. Any change in distance between the balloon and the ground station, due to travel of the balloon, results in a change in phase between the two audio signals at the ground station. This change could be observed on a cathode-ray oscilloscope. In its earliest operating form, no provisions were made for measurement of azimuth and zenith angles to determine wind direction and balloon altitude or to correct for velocity with respect to horizontal direction.

During the next several years improvements were made in the wind-velocity measurement system with support by the Bureau of Engineering, the Bureau of Ships, and the Bureau of Aeronautics, all of the Navy Department. The program was administered with a Confidential security classification.

It was realized that full usefulness of the measurement of wind velocity would not be reached until the wind direction could be determined accurately. Several means of determining the wind direction were possible, but observation of the azimuth angle of the balloon-borne equipment with a direction finder at the ground station was the most promising and became the accepted method. It was also found that altitude of the balloon could not be relied upon by assuming a constant rate of climb, making it necessary to use a pressure indicating method for determination of altitude.

In June 1941, the project was continued with Edwin F. Florman as project leader, with the assistance of Victor C. Pineo and Albert H. Boyer and under the direction of Harry Diamond.<sup>25</sup>

One of the most serious problems with the phase-difference method was spurious frequency modulation associated with the desired amplitude modulation, with decreased ability to render accurate readings. Improved operation was attained by extensive circuit modifications, in both the ground-based equipment and the balloon-borne re-emitter, which resulted in increasing the accuracy of the phase (or distance) measurements. A number of improvements were also made in the ground-based radio direction-finding equipment at Beltsville, Md., including an antenna "lobe switching," motor-driven, capacity-coupled switch, and the mounting of the rotating antenna array within an all-weather radome enclosure.

Evolving from these various improvements was the development of a field-operation system for the Navy that was adaptable to both shore-based stations and shipboard use. Concurrently, a system of measuring wind velocity by a radar technique was being developed in the Radio Section for the Navy Department. This latter system was quickly adopted for shipboard use with the Navy's Mark IV fire-control radars (see ch. IX).

The phase-variation project was completed in the early part of 1943. Approximately 50 test flights had been made at the WWV site at Beltsville, Md. In March 1943, the ground station equipment was moved to the U.S. Naval Air Station at Alameda, Calif. Here it was operated on a routine basis of one or two daily flights for more than a year. The balloon-borne equipment could be tracked to distances of 90 miles with altitudes ranging normally up to 60,000 feet. At the Alameda Station azimuth angles could be measured with an accuracy of  $\pm 1.5$  degrees, distances to the balloon with an accuracy of  $\pm 50$  meters, and altitude measurements to  $\pm 5$  percent. At Beltsville, at altitudes of 30,000 to 40,000 feet,

---

<sup>25</sup> Edwin F. Florman entered the Radio Section on June 5, 1941. He remained with the CRPL in Boulder until 1965 when he transferred to the Defense Communications Engineering Office (Washington, D.C.).



*Launching a balloon-borne re-emitter (receiver-transmitter) at the Beltsville, Md. field station to determine wind speed and direction by a phase-variation method. Re-emitter package held on pole to prepare for launching (package can be seen at treetop line). The parachute will safely lower the re-emitter after bursting of balloon at high altitude. Building houses the directional antenna and ground-based electronic equipment. A project of the early 1940's.*

wind velocities in excess of 100 miles per hour were measured, indicating the presence of what is now known as the "jet stream."<sup>26</sup>

In its final form this telemetering system used a ground-based transmitter of 250 watts operating at a frequency of 21.775 MHz, with a sine-wave modulation signal of 10 kHz. The

---

<sup>26</sup> In a private communication to the author (WFS), received on September 5, 1972, from Florman, leader of this project, was a copy taken from the project notebook for the date of December 17, 1942, for Flight Test No. 28, which states:

This was a perfect flight test. The signal was extremely stable and, even though the balloon disappeared into the clouds within a few minutes after being released, it was followed for a distance of 61 miles up to an altitude of 62,200 ft. Time of flight was 53 minutes. Wind velocities up to 120 miles p. hr. were recorded.\*

\*The underlining was by Florman on the original record.

It is quite evident that the balloon had been carried along in what we now call the jet stream. This flight may have been one of the first direct evidences of the existence of the jet stream. During World War II the navigators on U.S. bombing missions over Japan became acutely aware of the effects of the jet stream on high-altitude flying. After the war various groups began studies on the nature and location of the jet streams around the globe.



*Interior of ground station at Beltsville, Md. field station for phase-variation method of observing wind speed and direction. The 22-MHz transmitter is at far left. Receiver and recorder at center. Above is the rotatable directional dipole array to determine wind direction. Balloon transmitter operated at 75.5 MHz.*

receiving equipment included a sharply directive rotatable antenna array (employing off-axis lobe switching) with equipment for automatic tracking of the balloon. A receiver and paper-strip recorder designed for measuring and recording the phase changes, the direction to the balloon, and the barometric pressure, completed the ground-station equipment.

The balloon-borne re-emitter consisted of a receiver tuned to the ground station RF signal, and a 75.5-MHz transmitter. The 10-kHz output from the receiver modulated the transmitter. The transmitter was also modulated by a relaxation oscillator whose frequency was determined by the pressure-operated barometric switch, providing observation of atmospheric pressure.

The principle of operation was much the same as with the initial experiments made 5 years earlier in 1938. Distance to the balloon was determined by observing the phase changes of the 10-kHz modulation signal, transmitted to and received from the balloon, with respect to the 10-kHz modulation signal of the ground transmitter; each 360-degree change in phase of the received 10-kHz modulation signal represented a change in distance to the balloon of 9.3 miles. A sequence of tones from the re-emitter, listened to by the operator and manually recorded on the strip chart in code, indicated the atmospheric pressure. The recorder gave an indication of the distance, azimuth angle, and elevation of the balloon, converted into wind speed and direction or velocity of the balloon.

## AUTOMATIC WEATHER STATIONS

In the late spring of 1939 the Bureau of Aeronautics, Navy Department, requested the Radio Section to develop an automatic weather station for installation on islands and other remote localities. Weather information would be transmitted to distant receiving stations by radio. It was simply an expansion of services already in use by the Navy with radiosondes. There were differences, however, in the mode of operation. By using a modulation system somewhat different from that of the recently developed radiosonde, the receiving system could be simplified and the cost reduced substantially. Instead of using modulation frequencies ranging up to several hundred hertz to convey information on the weather sensing instruments, frequencies in the range of 0.15 to 3 Hz were used. The information (in the form of slow-rate pulses) could be observed with a very simple tape recorder or the pulses could be counted by using headphones and a stop watch.

### 1. Instrumentation and control

The automatic weather station was designed by Diamond and Hinman for observing barometric pressure, air temperature, relative humidity, wind speed, wind direction, and rainfall. By incorporating a phototube in the circuitry, observations of visibility could be made. The modulating system for pulsing the transmitter differed somewhat from that designed for the radiosondes. It retained the features of pulsing a 1-MHz oscillator at a rate dependent upon the time constant of a resistance-capacitance circuit. The variable resistance of this circuit was determined by the various sensing devices such as the pressure unit or the electrolytic thermometer. The pulses of no more than three per second operated a relay that keyed the transmitter with information from the sensing devices. Contacts on the cup anemometer gave direct keying to the transmitter to indicate wind speed.

Sequencing of the keyed information was accomplished with a rotary switch operated by a ratchet relay energized by a storage battery (a storage battery supplied all electrical power). During each transmission period (typically on an hourly schedule) the station call was given, a reference frequency transmitted that indicated proper functioning of the modulation system, then coded signals would designate each of the several sensing devices, after which the pulse rate of the signal from each sensing device would indicate its "reading."

The experimental station was set up in April 1940 at the Naval Air Station, Anacostia, D.C. A month of observations showed the design features to be quite acceptable to the Navy. Accuracy data indicated a satisfactory operating performance. Shortly thereafter Diamond and Hinman published their account of the work on the Navy project [15].



*Automatic weather station installed in 1940 at Naval Air Station, Anacostia, District of Columbia. Designed by Diamond and Hinman, the experimental station transmitted radio information on barometric pressure, air temperature, relative humidity, wind speed, wind direction, rainfall, and visibility of the atmosphere.*

As a result of the development of the automatic weather station, based upon their earlier work on the radiosonde, Diamond and Hinman were issued three patents.<sup>27</sup>

## 2. "Grasshopper"

Growing out of the radio-telemetered Automatic Weather Station, developed by Diamond and Hinman, was a meteorological observation system that had usefulness in military operations. Beginning in 1940 the Navy's Bureau of Ships and Bureau of Aeronautics became interested in developing a method of remote weather reporting from isolated shore stations. From this first concept came the development of a number of systems of increasing complexity that were to serve the Navy for remote weather reporting in inaccessible areas and in enemy territory.

During World War II the team of Lowell and Hakkarinen in the Radio Section developed the "Grasshopper," an air-launched automatic weather station for the Bureau of Ships and Bureau of Aeronautics [16]. The device could be launched from a plane as a bomb-shaped mechanism. An attached parachute lowered the station to the desired landing spot with minimal mechanical shock to the contained equipment. At launch an electric clock turned on the electronic equipment and controlled all sequences of operation thereafter. Upon impact an explosive charge disengaged the parachute; another charge set the station in an upright position by means of six "grasshopper" legs and a third charge extended the telescopic vertical antenna to a height of more than 15 feet.

<sup>27</sup> The three patents issued to H. Diamond and W. S. Hinman, Jr. were:

- 1) Patent 2,283,919, entitled "Art of radiometeorography," filed May 4, 1938, issued May 26, 1942;
- 2) Patent 2,287,786, entitled "Automatic weather station," filed August 30, 1941, issued June 30, 1942; and
- 3) Patent 2,322,229, entitled "Pressure switching," filed May 4, 1938, under the title of "Art of meteorography," but divided and separately filed November 22, 1941, and then issued June 22, 1943, under the title of "Pressure switching."

In operation, the electric clock turned on and off in sequence the circuits that sensed temperature, barometric pressure, and relative humidity. The pulse rate of signals produced from each of these circuits indicated at the distant receiver station the ground level readings of temperature, pressure, and humidity at the remote weather station.

Output from the pulse-modulated transmitter was about 5 watts at a frequency in the region of 5 MHz. Reliable range was about 100 miles. Dry batteries were used in the first model that gave an operating life beyond 15 days, transmitting information at 3-hour intervals.

A patent was granted Lowell and Hakkarinen for the "Grasshopper" type of remote station.<sup>28</sup>

### 3. Buoy weather station

Near the close of and after World War II it was but a step from the land station to a water-borne weather station. The first stage of development by Lowell and Hakkarinen for the Bureau of Ships was a free-floating automatic weather station mounted in a cylindrical buoy [17].<sup>29,30</sup> In addition to transmitting data on barometric pressure and air temperature, this station observed water temperature, wind speed, and wind direction. Observation of wind direction in a free-floating buoy presented a knotty problem but was solved by using a modified aircraft-type magnetic compass mounted in the buoy, plus a slave needle that rotated over 36 resistor-connected contacts to give 10-degree bearings for the wind direction.

With a transmitter output of 20 watts at a frequency in the region of 5 MHz, the reliable range was 400 miles over a water path. With transmission at 3-hour intervals the battery pack had a 30-day life.

### 4. Low-level sounding system—A wired sonde

Although early attempts in France and Germany with telemetry on kite and balloon wires date back to World War I for transmission (wired carrier-frequency technique) of meteorological observations, Lowell and Hakkarinen started development on a mobile low-level sounding system for the Navy Department during World War II [20]. The system was designed to operate in combination with an Army mobile meteorological station. The system was not completed during the war and the project was reinitiated by CRPL as a means of making low-level meteorological observations for tropospheric propagation studies.

Modifications were incorporated in the design to measure temperature, moisture, and atmospheric pressure distributions and gradients from near ground level and to elevations of 2000 feet above ground over different types of terrain [21]. Support for the sensing instruments was from a kite, balloon, or kytoon. An ingenious "gravity motor" provided circulation of air across the sensing elements, dispensing with a battery-driven motor. The three-conductor cable served for transmitting the impedance changes in the sensing elements to the electronic recorder located on the truck, as well as for a tethering cord. The third conductor was a precautionary measure for grounding the elevated equipment against build-up of static charges. Sixty-hertz ac energizing of the sensing circuits permitted greater stability of operation and recorded information that was previously obtained with a dc energizer.

<sup>28</sup> Percival D. Lowell and William Hakkarinen filed for a patent on an air-launched radio-operated remote weather station on June 20, 1945. Patent 2,555,352 was issued on June 5, 1951, entitled "Air launched radio station."

<sup>29</sup> Lowell and Hakkarinen, as a team, continued their development of meteorological sounding equipment with CRPL until 1949. The "team" and the projects were successively transferred to the Electronics and Ordnance Division, Electronics Division, Electricity and Electronics Division, and to the Electronic Technology Division. Lowell retired from NBS in 1961 and Hakkarinen transferred to the Naval Air Systems Command, Department of the Navy in 1966.

<sup>30</sup> Following the success of an automatic weather station housed in a free-floating buoy, the Navy's Bureau of Aeronautics supported a program for the development of NOMAD (Navy Oceanographic Meteorological Automatic Device). Lowell and Hakkarinen directed this development for the Navy after transferring from CRPL to the Electronics Instrument Section, within several divisions in succession. NOMAD was a boat-type automatic weather station, completed in 1955, that would transmit signals up to 1000 miles distance at a frequency of 5.34 MHz. In September of 1960 it gave the first indication of the formation of hurricane Ethel while anchored to a depth of 2000 fathoms in the Gulf of Mexico. In 1966 NOMAD was improved by adding a nuclear powered charger to the batteries, allowing for greater periods of time without servicing the station [18,19].



## 1. Safety at sea

From the earliest days of practical wireless, its application to promote safety at sea was paramount to inventors, communication firms, shipping interests, and national governments. For the first time man could communicate across trackless seas. However, adoption of this new means of communication came rather slowly and wireless as a means of navigation came even more slowly.

Kolster entered the Bureau at a period when some of the Government agencies were considering the greater use of wireless in their operations. In 1912 he attended the (Second) International Radiotelegraph Conference in London as a technical advisor. The *Titanic* had sunk several weeks before the conference opened. He must have been quite thoughtful on the subject of safety at sea from this exposure.

In May 1913, Kolster served as a representative of the Department of Commerce on the Interdepartmental Radio Committee on Safety at Sea. He

strongly advocated that serious consideration be given to the possibilities of radio signaling as an aid to navigation and that the matter be brought before the International Conference on Safety at Sea which was held in London during the year [22].

Beginning in 1913 Kolster and others would be much occupied for the next decade in the development of radio navigation aids for the Bureau of Lighthouses, Department of Commerce. Although supplemental to light beacons and fog horns, these radio aids would soon surpass the time-honored devices for dependability in fog and over long distances. This long-term project was often referred to as "radio fog signaling."

### a) THE COIL ANTENNA ADAPTED TO SHIPBOARD USE

The coil or loop antenna was not a new development with Kolster but he made abundant application of its directional properties.<sup>31</sup> Its application to the radio fog signaling system was the key to success. In 1916 he built a coil antenna for direction-finding development which was housed in one of the laboratory rooms in the East Building. With an electron-tube receiver his equipment was sensitive enough to receive signals from European stations. This antenna served as a prototype for adoption by the Navy as a form of direction finder and was much used during World War I. It also served as the prototype for a navigation system to be used later by Kolster on lighthouse tenders. Late in the winter of 1917 Kolster made an inspection of direction finders of his design on seven ships of the Atlantic Fleet located in Cuban waters.<sup>32</sup> He found the installations were far from satisfactory.

As another phase of the radio navigation system, Kolster developed an automatic radio beacon transmitter to be located in the vicinity of a lighthouse or on a lightship. The transmitter would be used to "home" with a directional coil antenna. In 1916 such a transmitter was installed at the Navesink light station at Atlantic Highlands, N.J. (near Sandy Hook, to the south of Brooklyn, N.Y.). A direction finder with a coil antenna was installed on the lighthouse tender *Tulip*. With a spark transmitter of this period, tests in the vicinity of the light station were successful and encouraging. But World War I interrupted the program with the Bureau of Lighthouses. However, direction-finder programs on a modest basis were carried on by the Radio Laboratory during the war.

---

<sup>31</sup>The coil antenna as a direction finder was described by Pickard in 1908. Kolster became interested in radio direction finders while employed with the Stone Radio and Telegraph Co. of New York City previous to his coming to the Bureau in 1911.

Earlier, in 1906, Bellini and Tosi of Italy had pioneered in the development of radio direction finders (see ch. I, p. 10).

<sup>32</sup>Kolster served as a part-time consultant to the Navy Department during World War I, aiding in the adoption of his direction finder for Navy use.

## b) THE RADIO COMPASS EVOLVES

Within a month after the cessation of hostilities a conference was held with the Navy Department to learn of the Navy's experience with direction finders during the war. In January 1919 several conferences were held with the Navy and with the Bureau of Lighthouses on the radio compass and on fog signaling. In reviewing its program of safety at sea, interrupted by World War I, the Bureau of Lighthouses found itself on the horns of a dilemma. The choice was that of a system of determining the location of a ship's position (and especially in a fog) by a system developed by the Navy or the system suggested by Kolster.<sup>33</sup> The decision was to develop the method advocated by Kolster (known as the Bureau of Standards system). The superiority of the system was proven with time.

In the fall of 1919 tests of the direction-finder system were made in the lower portion of Chesapeake Bay. A transmitter was operated as a radio beacon from each of three lighthouses located in the Bay.<sup>34</sup> Direction-finder equipment was installed on the lighthouse tender *Arbutus*. It was located amidships and corrected for metallic parts of the ship in order to give true bearings.<sup>35</sup> The tests were highly successful. They were carried out under Dunmore's direction with the assistance of others of the Radio Laboratory.

With the Bureau of Lighthouses the Radio Laboratory moved its fog signaling and radio compass project into the area of the approach to Lower New York Bay (south of Long Island and east of New Jersey) during the summer of 1920.<sup>36</sup> Again, three transmitters (rotating spark, operating at 1000 meters) were set up as radio beacons. Automatically produced signals of one, two, and three dots came from the stations, each combination of dots designating the station location. The lighthouse tender *Tulip* was again used as the navigating vessel. Four years after his first tests in the same vicinity, Kolster fitted the *Tulip* with a much improved direction finder, now designated as a radio compass, and one that was carefully calibrated for true readings of direction. The coil antenna was rotated directly above the ship's magnetic compass and its readings were correlated with the compass readings. A number of runs were made in the general area of the three radio beacons. Without previous experience, the captain of the *Tulip* was able to navigate his ship with the radio compass, with only small errors, by triangulation on the three radio beacons. Kolster and Dunmore were able to do the same. The Bureau of Lighthouses pronounced the results remarkable and extremely satisfactory.

---

<sup>33</sup> By 1919 the Navy Department had established an extensive system of direction-finder stations on the Atlantic Coast furnishing to ships, upon request, radio bearings of the ship taken by two or more of the land-based stations. The bearings obtained would be communicated to the ship by radio. Such a system had several disadvantages. Trained personnel were required at each land-based station to operate the equipment at all times. A station could take bearings on but one ship at a time. Any signals sent by a ship could divulge its position to an enemy using radio direction-finder equipment. Also, a considerable amount of time was necessary to complete a radio-bearing procedure.

With the Bureau of Standards system the beacon radio transmitter was automatic in operation at all times, requiring no additional operators, only operation and maintenance by the lighthouse keeper. A ship used only receiving equipment, therefore not divulging its position with transmitted signals. Within a few moments a ship could determine its position without the aid of land-based personnel.

<sup>34</sup> Transmitters of the rotary-spark type were installed at Wolf Trap and Smith Point lighthouses; a transmitter using electron tubes was installed at the Windmill Point lighthouse (the electron tube was beginning to replace the spark and arc as a source of RF oscillations).

<sup>35</sup> In operation, for maximum accuracy of determining the direction of a signal source (radio beacon), the coil antenna was oriented to produce minimum signal. This would be a position where the plane of the coil was 90 degrees to the direction of the signal source (the minimum or zero signal in the figure-of-eight directional pattern). Actually, two minimum signal positions of the coil existed, 180 degrees apart, and the position of the signal source would be indicated in either of the two opposite directions. The ambiguity of direction was resolved by adding a circuit from the antenna to ground that gave the coil a unidirectional characteristic. However, when the coil antenna was used in this mode it lost much sharpness in sense of direction.

<sup>36</sup> Two of the radio beacons were located on the lightships at Fire Island and Ambrose Channel. The third was land-based at Sea Girt, south of Asbury Park, N.J.

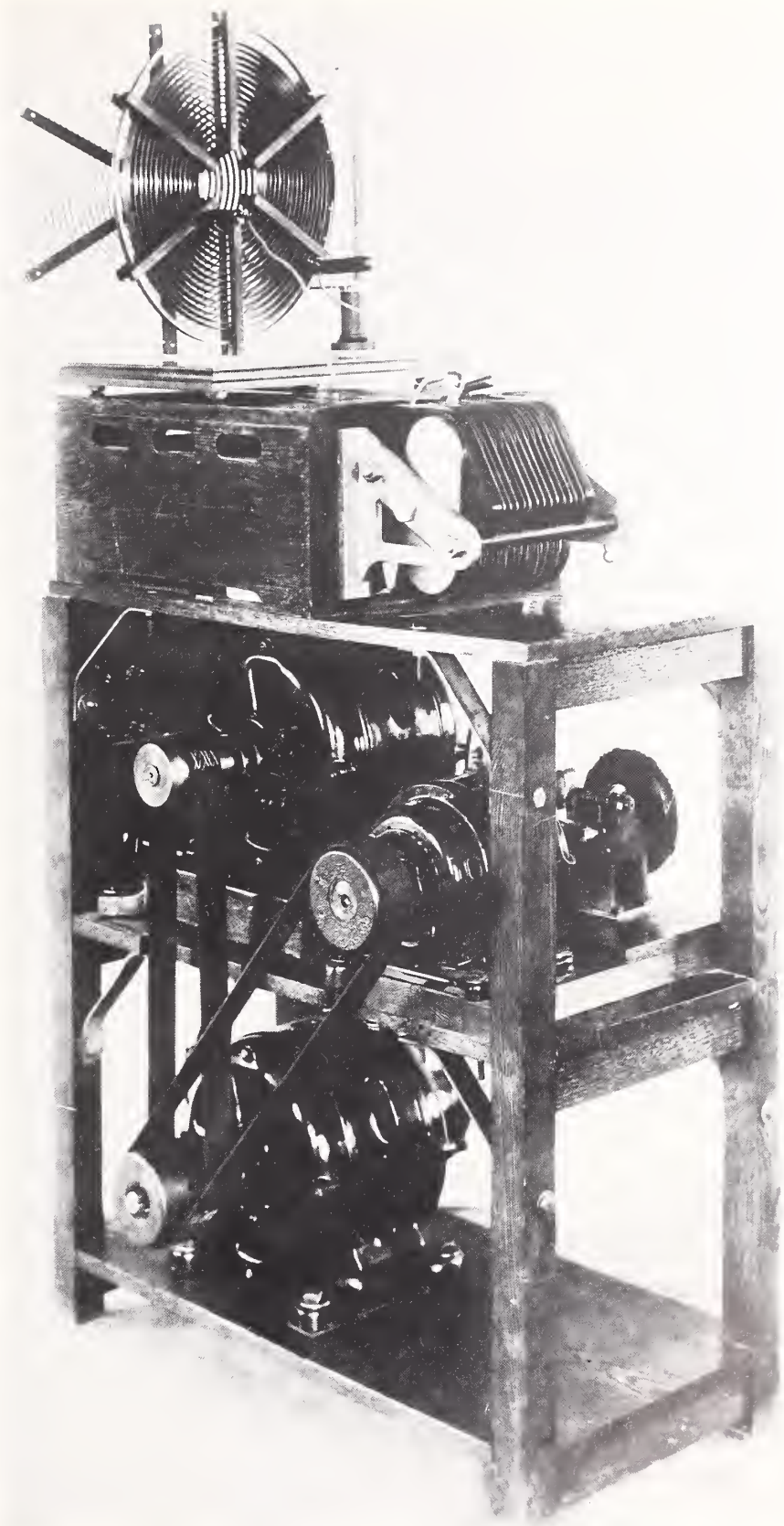

*One-half-kilowatt spark transmitter designed by Radio Section for automatic and continuous coding of signals. This and other types of transmitters were used at lighthouses in the Lower New York Bay area for radio "fog signaling" experiments by the Radio Section and Bureau of Lighthouses, beginning in 1917 and extending to the mid-1920's.*

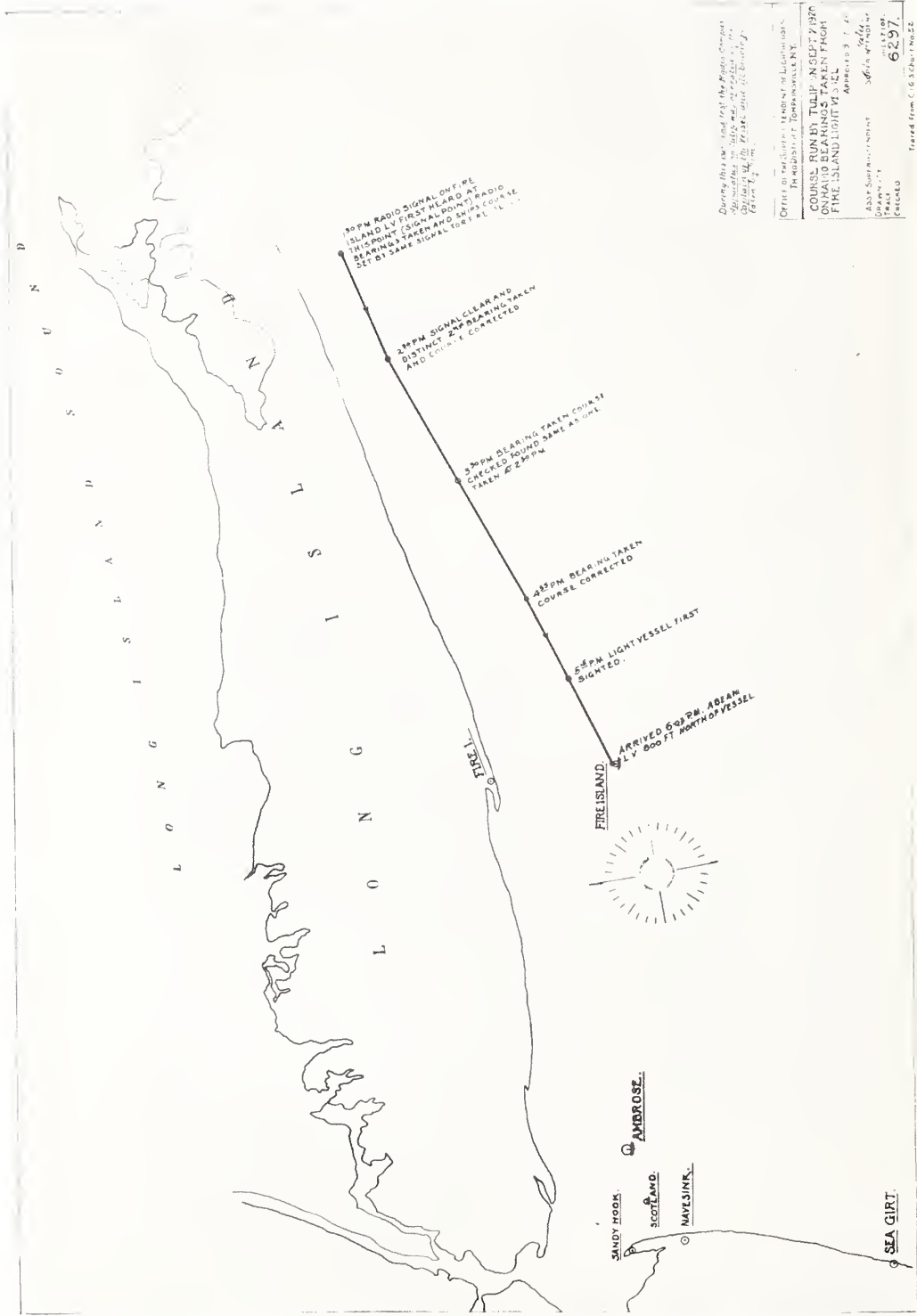

Course taken by the lighthouse tender Tulip on September 2, 1920, from radio bearings taken on signals transmitted by the Fire Island light vessel in Lower New York Bay. During a 4 1/2-hour period the captain of the tender, without aid by Radio Section personnel, navigated his ship entirely by radio, taking a straight course toward the transmitter.

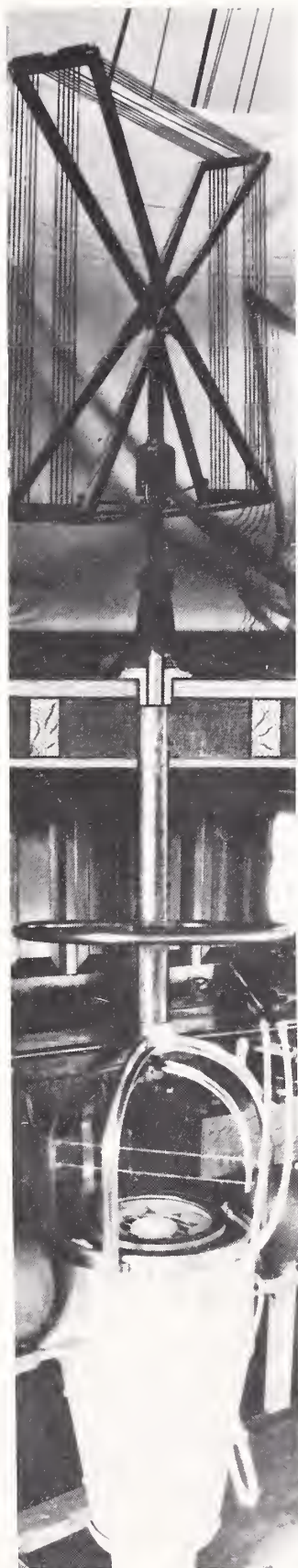

*Composite photograph of radio compass installation on board the Bureau of Lighthouses tender Tulip during the summer of 1920. The directional loop antenna was mounted above deck, with rotational control and directional bearing indication and the compass below deck.*



*Model prepared by Radio Section to demonstrate a radio "fog signaling" system—using a direction finder (or radio compass) to determine position of ship by triangulation method. Radio direction bearings are taken on two land-based transmitters.*

Various improvements were made to the new navigation system particularly on the antennas and the automatic keying device. Navigation runs on June 27 and 28, 1921, were demonstrated to Government officials, representatives of shipping interests, manufacturers of radio equipment, newspaper and magazine reporters, and Bureau personnel including director Stratton.<sup>37</sup> Navigation errors averaged 1.5 degrees, with a maximum of 3 degrees. The event was publicized in New York City papers.<sup>38</sup>

#### c) THE RADIO COMPASS BECOMES A MANUFACTURED PRODUCT

Following the marked success with the radio navigation system in the New York harbor area, a radio beacon was installed on the *San Francisco* lightship and at Diamond Shoal (off Cape Hatteras, N.C., a dangerous shoal area notorious for shipwrecks). On March 27, 1922, the Bureau issued Letter Circular 35 that stated the advantages and disadvantages of the two systems, that of having the direction finder on shore or that of having the direction finder on shipboard. Kolster and Dunmore had previously published *Bureau of Standards Scientific Paper 428* on their radio beacon program [22].

Interest in the new navigation system continued to grow. On May 12, 1922, nine companies interested in the manufacture of radio direction finders (becoming known as the Kolster radio compass) met at the Bureau to confer with the Assistant Secretary of Commerce, the Commissioner of the Bureau of Lighthouses, Director Stratton and others of the Bureau. On this occasion it was announced that the Department of Commerce would be installing radio beacons at a number of new locations. It was learned at this conference that foreign shipping companies were also interested in the new radio beacon system on the U.S. coasts, as some of their ships were outfitted with direction finders of European design.<sup>39</sup>

<sup>37</sup> Kolster did not take part in these demonstrations. On January 31, 1921, he had taken a year's leave of absence.

<sup>38</sup> To publicize this new radio navigation system, a working model had been demonstrated at the National Marine League Exposition at New York City in April 1920 and later in Philadelphia.

<sup>39</sup> A variety of direction finders had been developed in Europe, including the direction finder made by the Marconi Co. of England for shipboard use.

Kolster left the Bureau early in 1921 and Dunmore was placed in charge of the project and continued in this capacity until it was gradually phased out in the middle 1920's.<sup>40</sup> In April 1921 Dunmore, with the aid of the Bureau of Lighthouses, prepared specifications for the construction and installation of the Radio Direction Finder for Marine Use, U.S. Bureau of Standards, Type B. This specification, along with subsequent revisions, was used for a number of years by the Bureau of Lighthouses in its procurement of the Kolster direction finder. However, by 1923 the Federal Telegraph Co. brought legal pressure upon the Bureau and the Department of Commerce for infringement upon the patent structure associated with direction finders and the Kolster radio compass in particular.<sup>41</sup> The available records on the matter are incomplete and a detailed record is beyond the scope of this account. Kolster and Dunmore had each been issued a patent on the direction finder.<sup>42</sup>

By the mid-1920's at least 150 U.S. vessels, exclusive of Navy ships, were outfitted with the Kolster radio compass. By that time most of the beacon spark transmitters had been replaced with electron-tube equipment.

During 1924 and 1925 the Radio Section gave technical assistance to the Navy Department in evaluating and improving upon its radio navigation system. A study in depth was made of both the Department of Commerce radio beacon system and the Navy Department radio compass system. The Navy was gradually solving the problems associated with the system it had adopted during World War I. Over the years the Bureau of Lighthouses had encountered relatively few technical problems with the system suggested and set up by Kolster and Dunmore.

#### **d) SPINOFFS FROM THE RADIO COMPASS PROGRAM**

The success that came to Kolster's radio compass stimulated the development of other devices for use to promote safety at sea. Early in the program the Radio Section assisted the Bureau of Lighthouses in the development of radio telephone equipment for communication between boats and with land-based facilities. Assistance was also given to the U.S. Coast Guard for similar equipment. In 1925 a small type of direction finder was developed for the Coast Guard to be used on small boats. This equipment operated at 2100 kHz. With radio beacons, small boats could locate each other as well as navigate by aid of land-based stations.

### **LOCATING AIRPLANES BY RADIO**

#### **1. Kolster suggests a triangulation method (April 1917)**

Being intrigued by various uses for his direction finder, in April of 1917 Kolster came up with a method of using it for locating or "spotting" airplanes. He had just returned from an extensive journey during March on board several battleships plying Cuban waters. The U.S. Navy had retained him as a consultant to make a study of the direction finders recently installed on some of the ships. On April 6 the United States declared war on Germany.

In April the Chief Signal Officer of the Army had suggested an experimental investigation of using directional antennas to locate airplanes in fog, clouds, or beyond the horizon. Kolster proposed a method by triangulation, using two or more stations fitted with directional finders, with a means of communication between them. By simultaneous observations the airplane could be located and its course followed. The method required, of

<sup>40</sup> On January 31, 1921, Kolster took a year's leave of absence and did not return to the Bureau. In 1921 he joined the Federal Telegraph Co. at Palo Alto, Calif. as a research engineer to pursue further development and the manufacture of his radio compass. He remained with the company until 1931.

<sup>41</sup> Infringement was on the basis of the Bureau specifying certain features in the design and operational functions of the direction finder for manufacture of the device and procurement by the Department of Commerce for use by the Bureau of Lighthouses.

<sup>42</sup> Frederick A. Kolster filed for a patent on March 31, 1916. Patent 1,311,654 was issued July 29, 1919, entitled "Radio method and apparatus." The patent was later controlled by the Federal Telegraph Co. While with the Federal Telegraph Co., Kolster was issued another patent on the radio compass. Francis W. Dunmore filed for a patent on February 4, 1921. Patent 1,405,905 was issued February 7, 1922, entitled "Radio receiving apparatus." This patent was licensed to the U.S. Government.

course, that the plane be fitted with a radio transmitter (radar was about two decades away, by which location could be made from a single station and by signal reflection from the plane's surfaces). There is no evidence that the system was further developed by the Radio Laboratory during World War I.<sup>43</sup>

## 2. The U.S. Coast Artillery becomes interested in locating airplanes

In 1920 the U.S. Coast Artillery, a branch of the Army, became interested in a new use of radio direction finding particularly adaptable to coastal defense. It was direction of artillery fire on enemy ships from coastal positions by radio observation of an airplane passing over the target. This could be done in any type of weather or in darkness. At the zero position a signal from the plane would indicate the exact time for shore-based direction finders to take a bearing on the enemy's position. This signal would be different from the signal continuously emitted while the plane was coursing in the general area of the target. By triangulation, using two direction-finder stations and simultaneous observations, the zero position of the plane could be determined, thus giving the target position.

Late in 1920 the U.S. Signal Corps, acting for the Coast Artillery Corps, requested the Bureau to develop a direction finder for this special purpose. Such a device would have to follow closely the movement of a plane and have a bearing accuracy of better than 1/2 degree. Moreover, at times it would have to be adaptable for mobility on a truck body or railroad car. It was on this project that Lowell, along with C. E. Bohner of the Signal Corps Research Laboratory (located at the Bureau of Standards), came up with the novel design of a direction finder that incorporated two coil antennas. The crossed-coil antenna formed a narrow equisignal path (actually two paths in opposite directions in the simple form) for the received signal rather than the broader path of the null signal from a figure-of-eight pattern of the conventional direction finder. It was adaptation of this design of a double-coil or crossed-coil antenna that was to eventually lead to the directive or localizer beacon for instrument landing systems for airplanes (see p. 150 and p. 152).

Experiments carried out in the vicinity of Washington during 1921 indicated the feasibility of the method but the inaccuracy of the bearing in spotting a plane was three to five times greater than could be tolerated for accurate gunfire. After a series of tests that appeared discouraging, the project of Confidential status was phased out. The military had to wait for the more accurate radar method of spotting the enemy and determining the range for accurate gunfire.

## 3. Dunmore's "universal" direction finder

During the mid-1920's Dunmore was engaged in the development of a portable type of direction finder for the Signal Corps and for the Navy. It was a multipurpose device for locating the source of radio signals throughout the range of 90 to 7700 kHz. A set of seven small interchangeable coil antennas and a short vertical rod served as the antenna system. A set of seven interchangeable coils was used with the superheterodyne receiver to cover the frequency range. Automatic features reduced controls to one tuning dial, plus a balancing control to obtain minimum signal when the antenna was properly oriented on a signal source. The instrument became known as a "universal" direction finder.

## 4. Dunmore adds to the ideas on locating airplanes

In 1935 Dunmore proposed two methods of locating airplanes in flight by observing radio reflections from the plane.<sup>44</sup> One method was by observing the interference between reflected waves from a plane and waves received directly from a transmitter. Two or more observing points were required in this method in order to observe the azimuth motion of the plane.

---

<sup>43</sup> After the war Kolster prepared a report on the triangulation method of locating airplanes but it was not noted in *NBS Miscellaneous Publication 46*, "War Work of the Bureau of Standards."

<sup>44</sup> Information on these methods is taken from the Radio File.



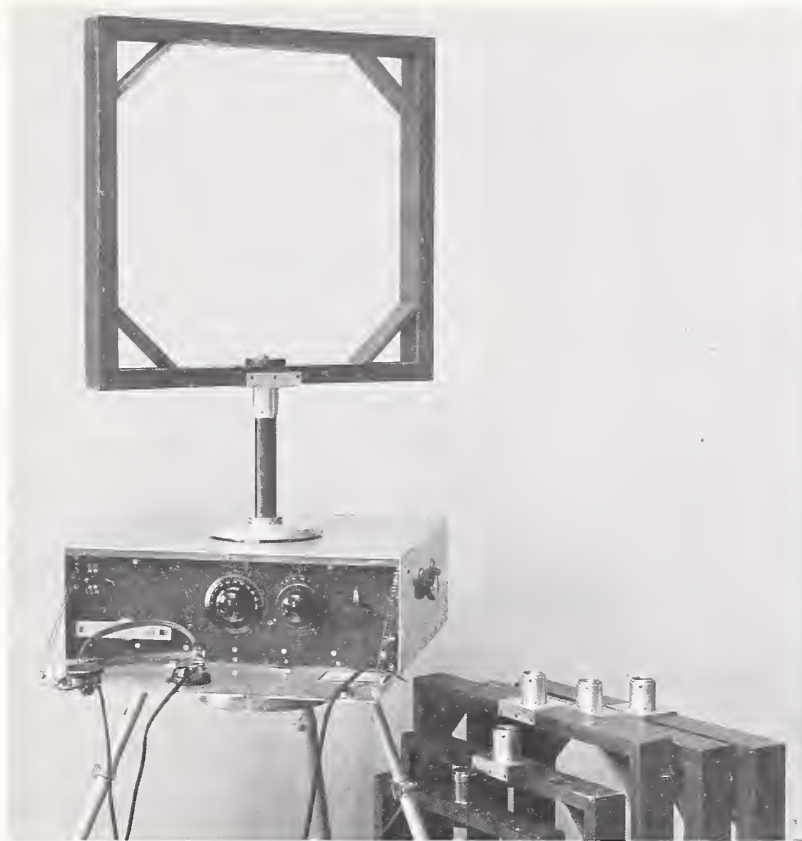

*A portable-type direction finder developed by Dunmore in 1925 for the Navy and the Army Signal Corps. It was known as a "universal" type because of the wide frequency range—90 to 7700 kHz, using seven sizes of loop antennas. A single tuning control was one of the many features.*

The second method required but one location for transmitting and receiving (similar to radar) to observe the azimuth position and motion of a plane. A UHF transmitter with a directive antenna could be used to determine the azimuth angle. The distance in miles would be determined by observing the time delay of a reflected wave in terms of the peak value of successive oscillations of a variable modulation frequency. This method of detecting and observing the position of airplanes by reflected waves was following closely upon the heels of the radar method being developed by England and by the United States. (See introductory chapter, p. 17.)

Another method proposed by Dunmore, in 1938, was similar to that of radar, yet it is doubtful that he had knowledge of the radar systems which by that time were in various stages of development in the United States and in England.

## **RADIO—THE AVIATOR'S GUIDING HAND**

The airplane pilot (and navigator) must orient himself in a 3-dimensional medium in order to move from a take-off spot to a landing field that may be several thousand miles distant. Anywhere along the route terrestrial and celestial guide points may be obliterated by clouds, fog, or darkness.<sup>45</sup> Radio navigation aids, developed over the years, permit the aviator to fly through the 3-dimensional medium, allowing him to know at any moment where he is and how to reach his destination safely.

<sup>45</sup> In a fog, heavy clouds, or in total darkness the aviator of a bygone era was not completely without some sense of orientation. The altitude of the plane (with Earth as frame of reference) could be observed from panel instruments. A general sense of direction could be obtained from a compass and a fairly reliable indication of height from an altimeter (but not a safe aid in mountainous terrain). Although the aviator could observe his air speed before the existence of radio aids, he had no way of observing wind drift or velocity with reference to the Earth when his vision of landmarks was obliterated. Without means of orientation and navigation, the aviator was helpless when caught in a three-dimensional opaqueness. It was radio that came to his rescue.

The airmen of World War I did not have radio's guiding hand, nor did those pilots who first flew the airmail service route between Washington, D.C. and New York City beginning on May 15, 1918. Thus was the situation in August 1918 when the Aerial Mail Service of the Post Office Department proposed to the Bureau of Standards the development of a directional transmitter for guiding airplanes. Kolster already had assisted the Bureau of Lighthouses in the early developments of a radio guidance system (fog signaling) for use in fog (see p. 139). But the Post Office had a greater need, that of aiding the pilot to locate the exact position of the landing field in case of fog or darkness. The Post Office Department made the proposal at the time the American Expeditionary Force was preparing for its fall offensive in France—the armistice was still 3 months away.

## 1. The Bureau's early systems for airplane landing

### a) INDUCTION SIGNALING

In spite of wartime activity in the Bureau and in the Radio Section, Kolster appears to have been anxious to aid the Post Office in this new problem. On September 3 he sent a memorandum to the Bureau's director, Dr. Stratton, suggesting a localized signaling system for airplane landing. In fact, for several weeks he had been working on the scheme before writing the memo. Kolster proposed using an induction signaling system which would become effective only when an airplane was in close proximity to the landing field. After his initial experiment of using two coils about 200 feet apart, he was ready to carry on a full-scale experiment. Dr. Stratton suggested that the experiment be carried out over the Bureau grounds.

On November 11, 1918, the day of the signing of the armistice (see ch. III, p. 60), Kolster tried out the induction method with an airplane. Six turns of insulated No. 12 copper wire had been coiled around the edge of the roof of the new Radio Building. The coil was energized at 24 amperes from a 500-Hz generator. Forty turns of magnetic wire in a large loop on each side of the lower wing of a type JN-4 ("Jenny") plane, furnished by the Post Office, served as the "searching" coil on the "landing" plane. Both the ground loop and plane loop were tuned to resonance for strong 500-Hz signals by very large capacitors. A three-stage amplifier strengthened the signal in the observer's headphones. Signals would be observed 3000 feet above the Radio Building. The experiment was a success!

After a January 1919 conference on a cooperative program by the Post Office Department, the Navy Department, and the Bureau of Standards (the Army Air Service was also interested in the project), the aviation field at College Park, Md. (to the northeast of the District of Columbia) was selected for landing field experiments. After some initial experiments, a single turn of wire encircling an area of 1500 by 2500 feet was used as the ground coil. But after some rather pessimistic results at frequencies of 500 to 1000 Hz, the group turned to radio frequencies.

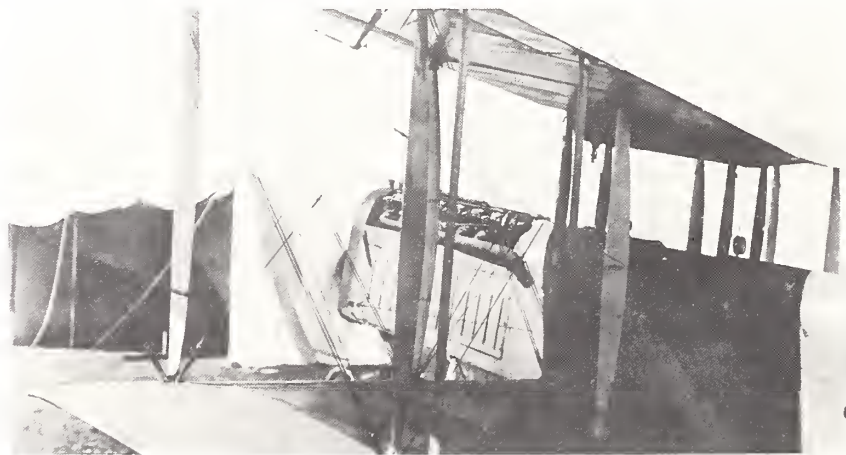

*Post Office Department biplane used by Radio Section at College Park, Md. Airfield in early 1919 for landing experiments. Two coils, one under each lower wing, could pick up the low frequency (500 Hz) induction field from a large coil encircling the field, with the plane at several thousand feet altitude. A tent in the background served as a temporary hanger.*

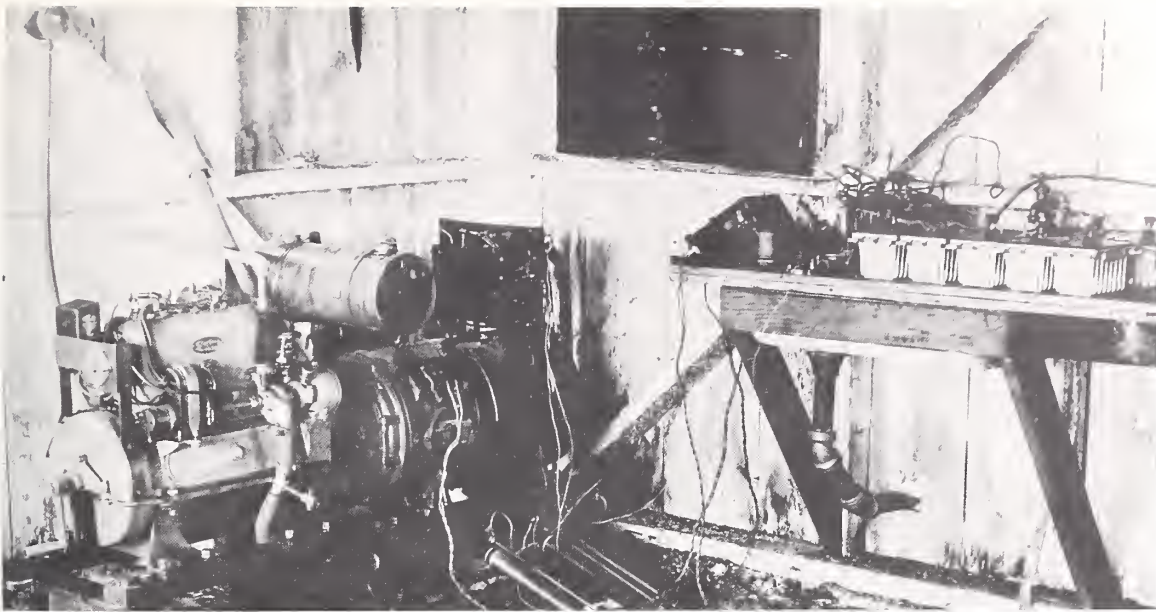

*Motor generator used at the College Park Airfield to energize a 1500×2500 ft coil for landing experiments. For field operation the equipment was driven by a gasoline engine. The large capacitors (upper right) were used to tune the large coil for resonance at the 500-Hz generator output. A 1000-Hz generator was also used, but the experiments were abandoned in favor of radio frequency methods of locating airfields in fog or darkness.*

#### **b) LANDING ON A "RADIATION CONE"**

After trying RF at 1500 meters (200 kHz) in a large single-turn loop (7000 feet of wire) with very little success as a landing marker, another of the Radio Laboratory personnel, J. A. Willoughby, came up with a novel antenna system. He found that by using two horizontal coils spaced a short distance apart and feeding RF current to the coils in opposite directions, a cone of radiation formed in the vertical direction with a maximum signal at about 30 degrees to the vertical. Such a signal pattern could serve as a landing marker. Initial tests in the summer of 1919 indicated that this system was more promising than the induction system. For an unexplained reason, further testing and the project itself went into early oblivion, but not before Gregory Breit published a theoretical treatment of this type of antenna [23]. The radiation pattern proved to be of no practical use for the guidance systems to be developed by the section a decade later.

#### **c) A TRY AT AN ELECTRICAL ALTIMETER FOR AIRCRAFT**

At the request of the U.S. Army Air Service the Radio Section tried its hand in 1922 to develop an electrical altimeter that would supplement the induction signaling method as an aid in landing an airplane. Although it was desirable that the device indicate height above ground during the last 50 feet of approach, success eluded Francis H. Engel in a reliable indication beyond 20 feet in height above the landing strip.

The system made use of the variation in capacitance between metal screens on the underside of each wing. In approaching the ground the capacitance between the two large screens increased. Change in capacitance was indicated on a thermogalvanometer, calibrated in feet, by the "induced current" method that incorporated a vacuum-tube oscillator. First tests were on laboratory models. Flight tests were made at McCook Field, Dayton, Ohio. The altimeter was not incorporated into any of the radio landing systems developed by the Bureau or by the Army in later years. The capacitance-variation electrical altimeter would have been impractical to use on the metallic planes of a later period.

Interestingly, three devices for this altimeter project were processed through the initial steps in preparation for application for patents.<sup>46</sup>

## 2. A directive radio beacon is developed for the U.S. Army Air Service

Navigation by homing on a nondirectional radio beacon is subject to wind drift with an airplane or water-current drift with a boat and a straight course is rarely followed. Homing on a directional radio beacon of the simple figure-of-eight pattern can be over a fairly wide path on the maximum signal and with no signal available in a direction at 90 degrees to the maximum signal. An improved system that would provide a narrow approach path was desirable.

At the request of the U.S. Army Air Service a program was initiated in December 1920 of using radio as an aid to air navigation. (To a limited extent, the Signal Corps was also interested in this program.) Several approaches were considered. Based upon a suggestion by Lowell of the Radio Section,<sup>47</sup> Engel and Dunmore began experimenting with the crossed-field pattern of two coil (loop) antennas placed at an angle of approximately 135 degrees to each other to form an equisignal radiation path.<sup>48,49</sup>

An initial experiment on the Bureau grounds with two 20-foot square coil antennas (two turns to each antenna) indicated that Lowell's suggestion was a sound one. The next step was to carry out a full-scale experiment. Two single-turn coil antennas, each 40 by 150 feet in a vertical plane, were crossed at an approximately 135-degree angle. These two antennas were energized with a 2-kW spark transmitter operating at 300 kHz. The dot and dash of the letter "A" was used on one antenna and the dash of the letter "T" on the other, alternating from one antenna to the other. With a receiver on a Bureau of Lighthouses tender plying the waters of the Potomac River 31 miles south of the Bureau grounds, it was found that on the equisignal line there was a path approximately 1 1/4 miles wide and that the signal from each antenna was approximately equal. The hoped-for narrow path of the radiated directional beam was achieved.

In the fall of 1921 the aerial navigation project was set up at McCook Field near Dayton, Ohio, to test the equisignal double-coil radio beacon with an airplane. Again, a large antenna system was set up with two coil antennas crossed at 135 degrees. This time a 5-kW quenched spark transmitter was used, operating at 300 kHz. Ground reception was from a truck cruising along a road that coincided roughly with an equisignal line of radiation from the antenna system. Reception on crossroads perpendicular to the equisignal line ranged from distances of 13 to 51 miles from the transmitter. Again, a narrow beam was observed. Tests from an airplane, using a trailing antenna, showed equally good results. However, to minimize observed effects of distortion of the field pattern caused by the airplane and the long trailing antenna, it was necessary to use a relatively short and heavily weighted antenna to obtain as nearly a vertical orientation as possible. With the short trailing

---

<sup>46</sup> In a list of patents issued to, pending, and applied for, by Bureau of Standards employees, and furnished to the Chief Clerk of the Department of Commerce by memo on October 31, 1922 (for the newly established Interdepartmental Patents Board ordered by Executive Order), the following information was given that applications for patents were being prepared by the Department of Justice for:

Capacity altimeter, by the applicant J. H. Dellinger; Electrical altimeter, by the applicant Francis H. Engel; Method of indication of aircraft altimeter, by the applicant L. E. Whittemore.

At the request of the authors, a search was made of the files of the Patent Office by the Patent Agent of the NBS Office of the Legal Adviser, with the result that no patents on altimeters as aids to the landing of aircraft were found that had been issued to any of these three individuals.

<sup>47</sup> The suggestion of a double-coil or crossed-coil antenna was by Lowell of the Radio Section and C. H. Bohner of the Signal Corps Research Laboratory (see p. 146). No patent was issued to Lowell on this type of coil antenna that came into use for air navigation.

<sup>48</sup> R. Keen, in his book *Wireless Direction Finding* (Iliffe and Sons, London, 1947, 4th ed.), states that Scheller of the Lorenz Co. (Germany) was granted a patent in 1907 for an antenna system with an equisignal path that was formed from crossing two long horizontal antennas at the transmitter. Keen gives credit to Engel and Dunmore for being first to use the crossed-coil antenna system to produce an equisignal path for radio guidance.

<sup>49</sup> The equisignal path in the 135-degree angle of two figure-of-eight patterns of two coil antennas was considered a more desirable path (actually two paths in opposite direction) than that of a 90-degree angle. Thus the planes of the coil antennas were set at 135 degrees rather than at 90 degrees. Selection of this angle of crossed coils gives the strongest signal strength on a narrow beam of radiation.

antenna it was found that a pilot could guide his airplane into McCook Field by means of the radio beacon from distances out to 100 miles. He could home on a straight course and be free of any changing of direction of his flight path due to wind drift. See reference [24].

This success with the crossed-coil antenna directive radio beacon in 1921 would begin to reap rewards for NBS in 1926. Beginning in the summer of 1926 the Radio Section adopted the system developed by Engel and Dunmore (with modifications for greater flexibility of operation) for the radio beacon of the navigation system being developed by the Aeronautics Branch of the Department of Commerce. It was the system that became known as the radio range beacon system and later was incorporated into the instrument landing system (ILS).



*Antenna system of two 10-ft square coils that could be oriented on vertical axes to form a directive crossed-coil radio beacon; located at the "compass house" northeast of Radio Building. This was the original system used by Dunmore in the spring of 1926 to develop an airfield runway localizer for pilot visual indication of course deviation. The transmitter consisted of two RF oscillators, one modulated at 500 Hz, the other at 1000 Hz, each feeding its own coil antenna, but operating at the same radio frequency. Course deviation could be noted by the pilot on a visual indicator controlled by the two modulation frequencies. A receiver located in an open field about 2 miles distance served as the plane's indicator and position in relation to a simulated approach to a radio beacon.*

### 3. Developing an air navigation system

After the successful field trials with Engel and Dunmore's crossed-coil antenna at Dayton, Ohio, in the fall of 1921, the Army Air Service pursued further development of this new radio system as a navigation aid for airplanes. During the next few years the Army Air Service improved upon the technique of signal observation and introduced a goniometer into the antenna feed circuit to permit orienting the beam directions without moving the antennas. The schemes were based on 1907 German patents.

Although the Post Office Department took an early lead (before the end of World War I) in searching for and supporting new developments in radio aids for its planes in the airmail service, it was slow in adapting these aids to its flying services.

#### a) THE EARLY STAGE

Following the burst of activity in 1921 for the Army Air Service, there came a period of several years preceding 1926 when the activities of the Radio Section were but little

involved in aiding the aviation industry or the flying services. But the need for its technical abilities was growing. Thus, in the Monthly Report of February 1926 it was stated: "Because of the interest in commercial air navigation, a study has been started on various aids to airplanes." At the time, Lindbergh's epoch-making flight from New York to Paris was more than a year in the future. With the mid-1920's, commercial aviation was beginning to take the interest of the American public.

Dunmore was completing several projects in the winter of 1925-1926. It was an opportune time to return to the radio beacon project that was set aside late in 1921. His ingenuity was soon at work with an innovation to the radio beacon system developed by Engel and him for the Army Air Service in 1921. The new device was a panel-mounted visual beacon course indicator by which the pilot could observe his course navigation with only occasional glances at the instrument [25].<sup>50,51</sup>

<sup>50</sup> The Radio Section's development of the airway beacon system and the instrument landing system brought on a large number of papers published in the *NBS Journal of Research* and in outside publications. A number of the papers were very nearly duplications in the *NBS Journal of Research* and in the *Proc. IRE*. Where duplications exist, preference has been given in the citations to the *Proc. IRE* because of its greater circulation and greater availability. Only a limited number of citations are listed in this account. Complete listings on the subjects treated are found in citation listings in various NBS publications.

<sup>51</sup> Up until the development of the visual indicator, the pilot followed the radio beam course by listening to signals via headphones. Now he was able to be in continuous aural contact to receive verbal messages on weather, flight instructions, and other information. Moreover, the aural system had technical disadvantages that made it desirable to go to a visual indicator.

Emerging from Dunmore's experimentation was a small panel instrument on which the pilot observed two vertical and broad white lines. When the lines were of the same vertical length the pilot was on course. When one line was longer he would steer the plane in the direction of the shorter line to bring the lines to equal length and the plane back on course.

The indicator was made of two vibrating metal reeds with whitened tabs on the tips. One reed was tuned to 65 and the other to 86.7 Hz. They were energized into vibration by modulation signals from each of the two antennas of the crossed-coil antenna of the radio beacon. In order to adapt the course indicator to the direction of approaching to or receding from a radio beacon, the indicator was simply rotated 180 degrees when required. This system was found to offset the disadvantages of two other visual systems being developed concurrently by Dellinger and Haraden Pratt. The disturbing effect of extraneous noise in the aural system was practically eliminated by the tuned-reed system. It proved to be very successful until replaced by another type of indicator in the instrument landing system of a few years later.

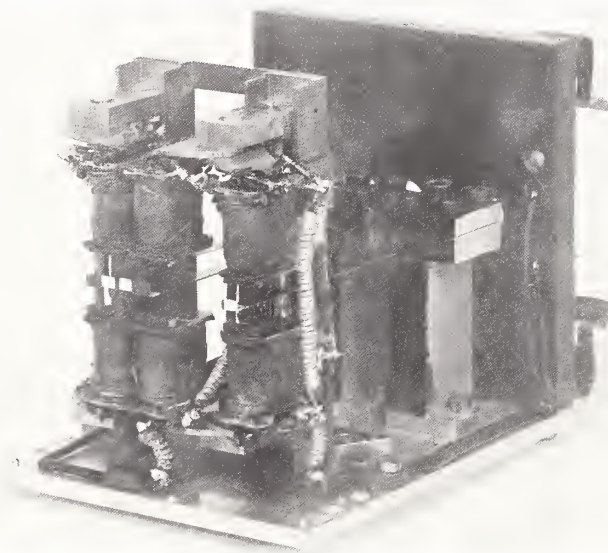

*Earliest vibrating-reed-type visual indicator (type A) designed by Dunmore in 1926 for the radio beacon installed at the College Park, Md. Airfield. The two white-tipped ends of permanently magnetized steel reeds can be seen at middle left. Electromagnets from headphone receivers drove the reeds. One reed vibrated at a 60-Hz modulation frequency in response to deviation of plane to one side of course, the other at 85 Hz for opposite side of course. The third reed (right) was used to indicate marker beacons spaced at different distances from airfield. Dunmore brought out a series of reed indicators, each successive stage an improvement in design and performance, and with minor changes in the reed frequencies.*

During the spring of 1926 action was pending in Congress to improve upon the country's commercial aviation service.<sup>52</sup> This led to the approval by President Coolidge of the Air Commerce Act on May 20, 1926, which, among other measures, authorized the creation of a Federal Airways system that would be marked with light and radio beacons. This act was "the legislative cornerstone for the development of civil aeronautics in America."

A month later, on June 22, 1926, a conference was called by the Department of Commerce to advise the Department on the technical aspects of radio aids to air navigation. Dr. Dellinger presided over the conference that was attended by representatives of other Government departments, commercial air transport companies, and several technical groups.<sup>53</sup> Out of this conference came 15 conclusions on steps to take in meeting the technical requirements of the Air Commerce Act. The Radio Section would play a prominent role in these programs for the following 7 years.

The Air Commerce Act led to the creation of the Aeronautics Branch in the Department of Commerce in July, 1926, under the guidance of William P. McCracken, Jr., Assistant Secretary of Commerce for Aeronautics. Very soon thereafter its research division was organized within the Bureau's Radio Section. Thus was born within the Radio Section in the summer of 1926 the organizational elements and the means of developing radio aids for air navigation that within a few years would lead to the very successful development of the ILS (instrument landing system) for aviation—one of the major all-time contributions by NBS to technology and to the Nation.

## **b) OUT OF THE LABORATORY AND INTO FIELD OPERATIONS**

The early stages of development of a radio air navigation system called for radio direction beacons, radio marker beacons to serve as "mileposts," and a radio telephone system by which the pilot could receive weather information along his route and instructions for selection of a landing field [26,27].

### **1) The field site at College Park, Md.**

With these objectives for development clearly in perspective, and with financial support by the Aeronautics Branch, during the summer of 1926 the Radio Section set about to develop field facilities at the airport at College Park, Md. (a few miles to the northeast of the District of Columbia).<sup>54</sup> The installation would serve as an experimental station for air navigation by radio and as a prototype for future stations around the United States. A 70-foot wood tower served as the apex support for two triangular single-turn antennas modeled after the design of Engel and Dunmore and installed at Dayton, Ohio in 1921. By making use of the goniometer adapted by the Army Air Service, the radiated beams could be set in various directions without turning the antennas. The antennas were fed by a 500-watt transmitter, operating at 290 kHz (aircraft beacons were assigned the frequency band of 285 to 315 kHz by the 1927 International Radio Convention). To complete the complement of ground-installed equipment at this first experimental station required a 500-watt radio telephone transmitter operating in the band of 500 to 550 kHz (later in the 315- to 350-kHz band), and a 5-watt marker beacon operating at 290 kHz.

---

<sup>52</sup> The action was initiated at the insistence of Herbert Hoover, then Secretary of Commerce, who urged the Morrow Board to take all steps necessary to place commercial aviation services on a firm footing. Hoover believed that "the foundation for military aviation was a strong commercial service." The Morrow Board had been instrumental in bringing other aviation legislation out of Congress.

<sup>53</sup> The Monthly Report of June 1926 stated under the topic of Government Radio:

By a recent Act of Congress the maintenance of landing fields and air routes for civil aviation has been put under the jurisdiction of the Department of Commerce. This Section has been requested to develop as rapidly as possible the various radio aids to aviation. Several conferences have been held with members of the Department of Commerce, other Government representatives, and representatives of commercial aviation companies. Mr. Dunmore and the Section Chief were in Dayton, Ohio, June 6 to 8 inspecting the work which has been done by the Army on aviation beacons. Work on radio aids to navigation is being expanded as rapidly as men and materials can be obtained. A report (R520Q) "Use of radio in air navigation", was prepared by the Section chief.

<sup>54</sup> This airport was privately owned (Newman Estate) and was operated by the Brinkerhoff Flying Service. Previous to its being leased for use by the Bureau, the facility had been used as an airmail field by the Post Office Department.



*Seventy-foot wood tower radio beacon erected at College Park, Md. Airfield in 1926. Single-wire triangular antennas in two vertical planes replaced the earlier coil antennas used by Dunmore. A goniometer housed at base of tower provided for an equisignal beacon that could be rotated in azimuth for the desired directions. The 4-course beacon was expanded later into a 12-course beacon.*

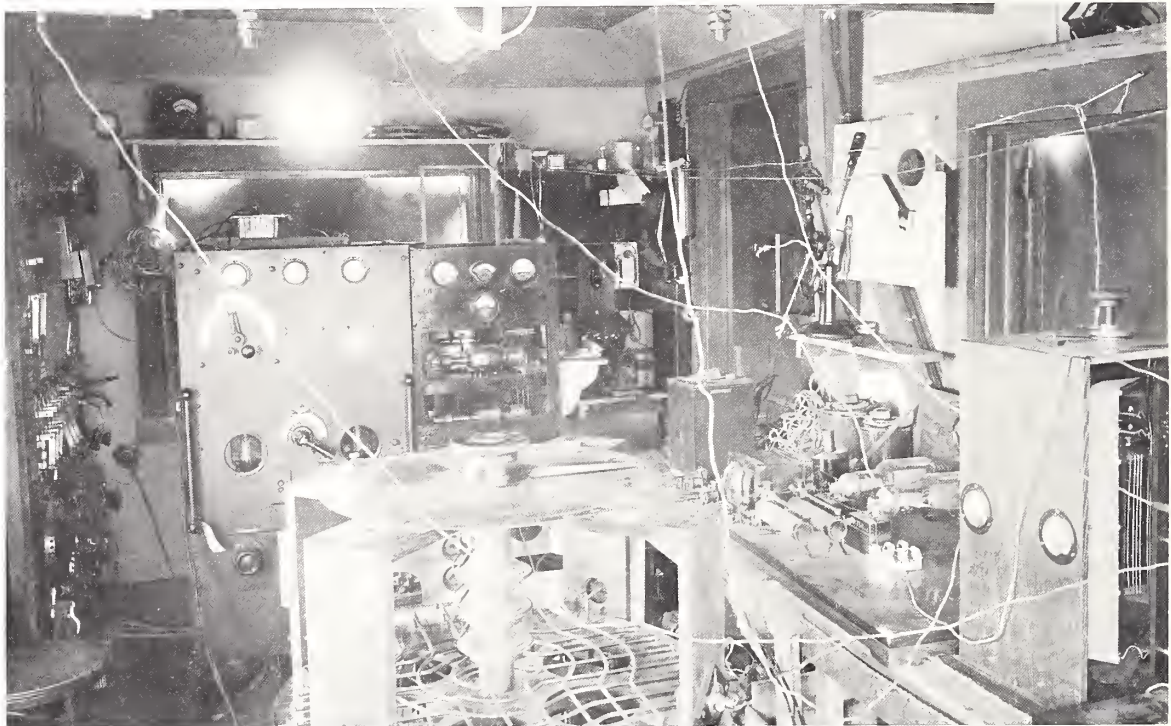

*Experimental transmitting equipment at base of radio beacon tower, College Park, Md. Goniometer (mutual inductor in antenna feed to control direction of transmitted signals) in foreground. Another type of goniometer at right.*

Concurrent with the installation of field-site equipment, a laboratory model of a beacon system was developed and constructed. It could be used for experimental purposes without resorting to full-scale equipment. Also, flight tests were made of a beacon system installed by the Ford Motor Co. at Dearborn, Mich. for use by Stout Air Services. This system was a commercial venture on the part of the Ford Motor Co. and was useful to the Radio Section as a means of gaining information on radio beacons.

By January 1927, experimental flights were made at College Park testing the radio beacon and the tuned-reed equipment mounted in a plane. Many improvements were made during the following months.





*Radio Section personnel associated with early development of the radio beacon for civil airways, with plane used in the earliest experiments—photo, May 31, 1927. Left to right: Dellinger, Dunmore, P. T. Howard, J. Wells, F. G. Gardner, and C. B. Hempel. In plane: H. Pratt and E. Z. Stowell. Diamond would join the group within 2 months.*

With the aid of the Post Office Department, a radio beacon was installed at the Air Mail Field, Bellefonte, Pa., located on the airmail route between New York and Cleveland. This site, near the center of Pennsylvania, was selected because of its location on an airway route and its location in a rugged section of the Allegheny Mountains. The site was in sharp contrast to the flat terrain at College Park. The area was the scene of several fatal airplane accidents in the early days of the airmail service. This radio beacon was in operation by July 1927 for experimental purposes.

## 2) The “night effect” on the radio beacon system

It was in August of 1927 that Haraden Pratt was looking for the possible effects of the “night effect” upon direction finders caused by signal reflection from the ionosphere (the horizontal component of reflected signals introduced bearing errors in conventional direction finders).<sup>55</sup> It was not unexpected to find the night effect present when he first took bearings at about 90 miles distance from the Bellefonte beacon. Later observations indicated no serious shifting in indicated direction out to 20 miles distance. The beacon was fairly dependable at 50 miles, but was useless at 125 miles at night. Azimuth errors, beyond 100 miles distance, could be as much as 100 degrees in the reading from the true bearings, but usually no greater than 25 degrees. The solution to the problem was substitution of a vertical rod antenna on the aircraft for the weighted trailing wire antenna that was being used. The vertical antenna (6 to 8 feet above the fuselage) minimized the effect of the horizontal component of the wave reflected or refracted from the ionosphere. Tests began to prove that reliability of direction with the rod antenna was within 2 to 5 degrees. Daylight reception provided an operating range of 100 miles. A few years later Diamond would come up with an even better solution.

## 3) Radio receivers for the airways

High-quality radio receivers were vital components of the equipment being designed by the Radio Section for use on the Civil Airways. The 1927 International Radio Conference allocated the 285- to 315-kHz band for radio beacon service and the adjacent 315- to 350-kHz band for aircraft communication service, both bands for international use. Pratt and Diamond were assigned this phase of the rapidly expanding program.

<sup>55</sup> Haraden Pratt entered the Radio Section March 17, 1927, with the grade of radio engineer. He resigned July 31, 1928, to become vice president and chief engineer of the Mackay Radio Telegraph Co. In 1938 he was president of the IRE and was a director for 27 years. He also held the offices of secretary and of treasurer. On July 31, 1951, President Truman appointed Pratt to the newly-created post of Telecommunications Advisor to the President, at the time, the highest appointed position in the communications field.

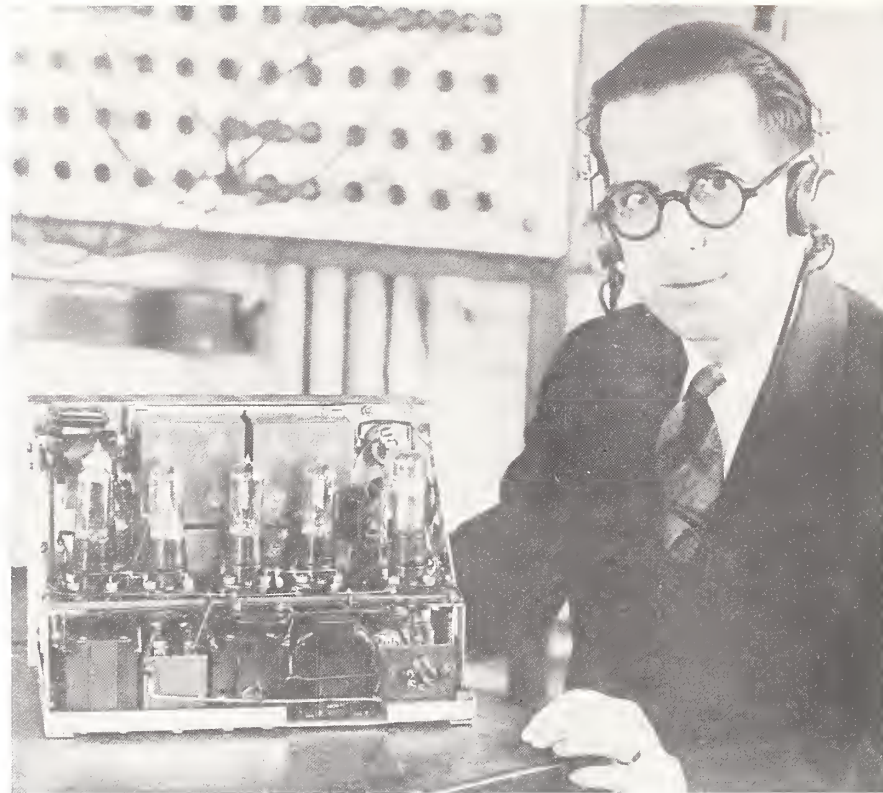

*Harry Diamond with small seven-tube airplane receiver that he aided in designing for radio beacon visual indicators—photographed April 6, 1928. Diamond entered the Radio Section July 1927.*

Because the receivers operated from the rather short antenna, they had to be especially sensitive, and consequently they incorporated three stages of RF amplification plus regeneration. Other design features were rugged construction to withstand vibration, high selectivity over the band of 285 to 350 kHz, and operation on automatic volume control (a later feature). After completion of the prototypes, production of the receivers was turned over to several manufacturers.

#### **4) Wrestling with ignition noise**

Ignition noise was not a new problem to the Radio Section in the development of the Department of Commerce navigation system. It had been encountered back in 1921. At that time, during the development of several projects for the Army Air Service, Charles T. Zahn had experimented with the shielding of aircraft engines to minimize the noise at radio frequencies that was produced by the ignition system. Tests were conducted on an engine operating in the high-altitude chamber of the Bureau's Dynamometer Laboratory.

With the use of very sensitive receivers on board the aircraft, it was essential that all portions of the engine associated with the ignition system be very well shielded. Metal tubing and braided metal cable, joined with interlocking fittings, provided for a complete metal housing of the spark plugs, magnetos, distributors, and the ignition switch. Diamond and F. G. Gardner guided the program in cooperation with manufacturers of items that made up the various components of the ignition system [28]. Results of their efforts were aircraft engines that were completely shielded to the extent that no ignition noise was evidenced in the aircraft receivers. It was another facet of development that spelled success for the total program.

#### **5) The marker beacons**

Not only did the pilot need to know that he was on a beacon course, in following a designated airway, but he needed to know his location along the course. Radio marker beacons were developed for this purpose, particularly for use in the vicinity of landing fields or at the intersection of two beacon courses. Transmitters of but a few watts output were

used as the beacon signal needed to be radiated only a few miles. The marker beacons operated at the same frequency as the direction beacon. Several types of antennas were used depending upon local requirements of radiation patterns. At first, aural signals were used; later Dunmore developed a 40-Hz vibrating-reed visual indicator for the marker beacon signal.

### c) IMPROVING THE AIR NAVIGATION SYSTEM

During 1927 and 1928 a directive radio beacon system of the aural type was in operation on the airway between Hadley Field (New Brunswick, N.J.), Bellefonte, Pa., and Cleveland, Ohio. This had been installed by the Airways Division (Bureau of Lighthouses), Department of Commerce. Problems were encountered in orienting the beam courses to the airway directions and with coding of the beacons that resulted in interference. F. G. Kear<sup>56</sup> and W. E. Jackson took a hand in solving the problems and brought the beacon system into satisfactory operation.

With the rapid growth of the airmail service and passenger service, most of the larger airfields required a multiple-beacon course system for the airways converging into one field. The first step taken by the Radio Section was to modify the design of the directive beacon at College Park in order to accommodate four courses. Several methods were used including the use of an auxiliary vertical antenna. From the 4-course beacon a bold step was taken to develop a 12-course beacon, for the need came all too soon. By May 1929 an experimental 12-course beacon was in operation at the College Park site.<sup>57</sup>

<sup>56</sup> Frank G. Kear entered the Radio Section on September 20, 1928, and resigned September 22, 1931. He earned a doctoral degree at MIT in 1933 with a dissertation on the elimination of night effect in radio range beacons. Since 1944 he has been a consulting radio engineer in Washington, D.C.

<sup>57</sup> The 12-course directive beacon went through several stages of development before a completely satisfactory system was attained. The resultant system was that of retaining the double-coil loop antenna, but fed by three RF power amplifiers through a goniometer of three stator and three rotor coils. Each of the power amplifiers was switched at its grid input by a three-phase voltage source that energized each amplifier in turn by a displacement of 120 degrees in time phase. The three phases of a 290-kHz carrier were each modulated at a different low frequency, viz: 65, 86.7, and 108.3 Hz. The result was 12 beacon courses of equisignal zones ranging from 1 to about 3 degrees in width, with the angles between the 12 courses controllable over a considerable range. This multicourse system was the development of Diamond and Kear.

For a complete system, the 12-course beacon required an indicator aboard the plane that would be applicable to all 12 courses, yet reasonably simple to the pilot in its operation. Again, Dunmore made a novel contribution. By utilizing 3 tuned reeds (65, 86.7, and 108.3 Hz) and a 6-color coding scheme that tied the indicator operation to a color coding on an airways map, he was able to give the pilot a simple means of accommodating guidance indications to any 1 of 12 beacon courses of an airways junction, both in approaching and departing from the junction.

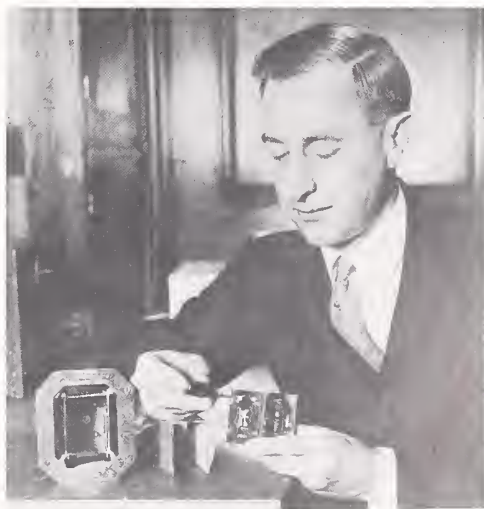

*Francis W. Dunmore with one form of the vibrating-reed radio beacon course indicator that he developed for radio navigation.*

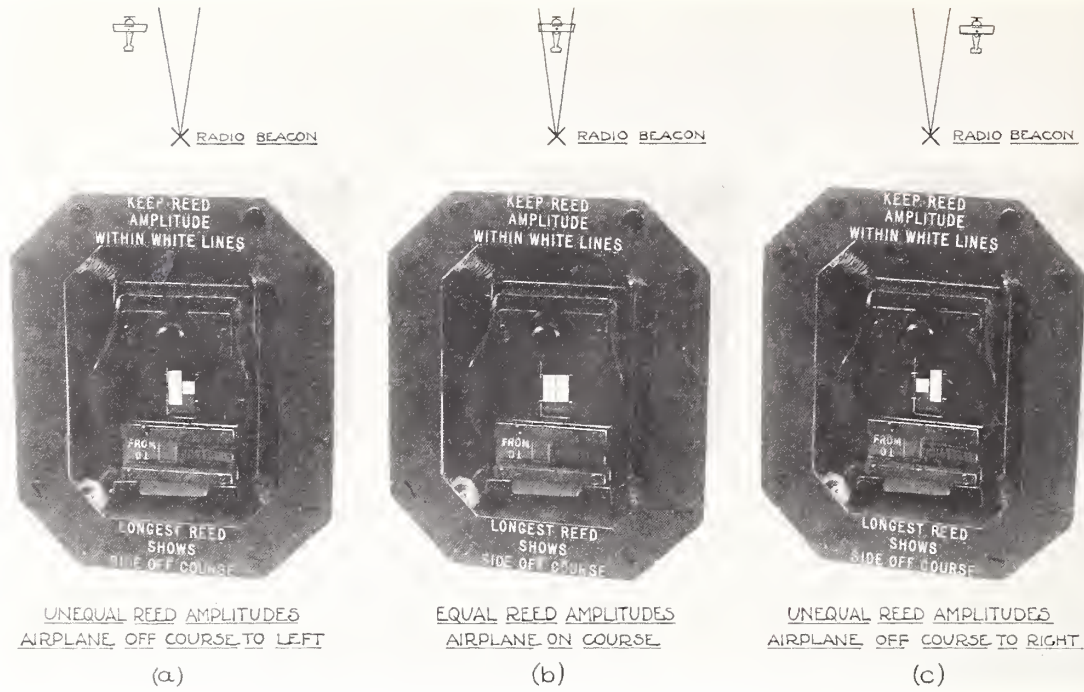

*Much improved design of vibrating-reed course indicator—showing the three conditions of travel along beacon course.*



*Dellinger points out features of vibrating-reed type runway course indicator to William P. McCracken, Jr., the first Assistant Secretary of Commerce for Aeronautics (in flying suit)—photographed March 20, 1928.*

#### 4. The Bureau's instrument landing system

Kolster's first effort in 1918 of developing an induction signaling system as an aid in landing an airplane began at a frequency of 500 Hz. Later, other methods brought the operating frequency into the RF region. Within a decade after Kolster's initial work, the Radio Section was embarking on a radio landing aid that would be operating near 100 MHz. The fast growing radio industry brought on developments in vacuum tubes and associated circuitry that made it possible to develop landing aids that were designed at the very frontier of the radio art.

##### a) A MISSION TO EUROPE

In the summer of 1927 Dellinger visited five European countries that were developing navigational aids and landing systems for aircraft. He found at one airfield in England and one in France that "leader cables" were being used in the development of landing aids. The English system, in essence, was much the same as the type Kolster experimented with in 1918 and 1919, that of an induction field in the vicinity of the airfield. It was formed by an underground cable looped around the airfield and energized at 34 Hz. One French system used a cable as a guidance system between two airfields. This cable, energized at 1200 Hz, served the same purpose as the Bureau's radio direction beacon, but at a much greater cost for the cable system.

##### b) ASSISTING IN A FOG LANDING SYSTEM

Early in 1929 the Radio Section entered into a cooperative program in fog landing experiments with the Guggenheim Fund for the Promotion of Aeronautics and with the Sperry Development Co. A runway localizing beacon and marker beacon were installed at Mitchel Field, Long Island, for visual indication in the cockpit of a plane. An aural type of beacon was already in place to serve as the directive or range beacon. The service of Lt. James H. Doolittle (later General) of the Army Air Service was enlisted by the Guggenheim Fund to perform a series of landing experiments. By means of newly developed attitude instruments, including an artificial horizon indicator and a directional gyroscope, plus a sensitive altimeter that could be corrected for barometric pressure from radio information, there was available a method of landing a plane under fog conditions. In September of 1929 Lt. Doolittle performed a series of successful hooded landings at the airfield, including several under heavy fog conditions, the first such landings of their kind. Although progress was being made at blind landing an aircraft, this combination of the radio beacon, marker beacon, and cockpit instruments left much to be desired. A radio landing beam to indicate a more exact glide path would be the answer.

##### c) THE BUREAU'S RADIO SYSTEM OF BLIND LANDING

Simultaneously with the development work on a fog landing system at Mitchel Field, experiments were being carried on at the College Park airfield on a radio method of providing a glide path for airplanes to make precision contact with the airfield surface. Initial tests in June 1929 with the loop antenna of a marker beacon were unsuccessful. The lack of success quickly initiated a study and early development of a landing beacon and a complete instrument landing system [29,30].

Progress in development did not follow at a uniform rate. There was much trial and error in the experiments performed during the next several years. Until the test pilots were satisfied and felt confident with the system being developed, the team of workers could not let up on their labors. By 1933 success with the instrument landing system was assured. Working on this project were Diamond and Dunmore, assisted by Kear, Hinman, and others.

To make a safe and precision landing by means of a radio guidance system required three subsystems to coordinate the movement and positioning of the plane to the landing point after the plane had approached the airfield. These were the runway localizing beacon, the boundary marker beacon, and the landing beam. Each of these subsystems went through various stages of development from 1929 to 1933. In the vicinity of the airfield would also be the directive or range beacon by which the pilot or navigator followed an airway to the landing field.

## 1) The runway localizing beacon

Required for the runway localizing beacon was a version of the airway directive beacon scaled down in size, plus refinements to provide for a precision landing path on the airfield. Except for the necessary refinements and some changes of the indicating system, this subsystem was fairly well developed in the directive beacon that had been in use for some time on the fixed airways.<sup>58</sup>

<sup>58</sup>The localizing beam at College Park was designed to operate at one end of the beacon frequency band (285 to 315 kHz) for the directive beacon, thereby both beacons could come in on the same receiver. As the pilot approached the airfield he would switch from the directive beacon frequency to the runway localizing beacon frequency. Since the beacon was housed at the airfield boundary, the double-coil loop antenna was made small to minimize its obstructiveness to aircraft. Effective radiation needed to be out to approximately 15 miles.

The design directional characteristics of the antenna were such that the horizontal plane had a pattern of a very elongated lobe of the form  $\cos n\theta$  ("n" is number of wavelengths and " $\theta$ " the polar angle, with "n" very large for a narrow beam). The aircraft would follow along the axis of the lobe or the line of maximum field intensity.

A reed-type indicator was used in the early experiments. Later, a pointer-type indicator was used to show the on-course location of the aircraft in respect to the beacon. Incorporation of a needed automatic volume control in the receiving circuit yielded the extra bonus of an indicating instrument that showed the approximate distance, in miles, of the plane from the airfield.

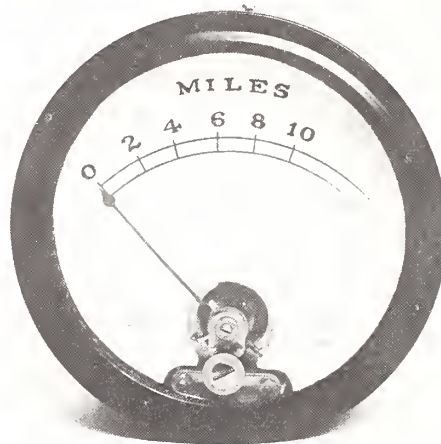

*Distance indicator to show approximate distance of plane from runway (actually, distance from the airfield marker beacon transmitter).*



*Early pointer-type runway localizer beacon course indicator. A later development of the vibrating-reed indicator, differing only in visual display to pilot.*

## 2) Boundary marker beacon

In the early design for the College Park airfield the low-power boundary marker beacon was fed to a double-coil antenna and the received signal observed visually on a 40-Hz vibrating reed. In passing over the marker beacon the pilot observed a "zero" signal. In a later design quite an opposite indication was used with a very long horizontal antenna located 90 degrees to the localizing beam. Observation was made aurally (reducing the number of visual indicating instruments to be observed), a "maximum" signal indicating the crossing of the marker beacon antenna.

## 3) The landing beam

The early success attained by the team on the landing beam project can be attributed to two factors, the use of short radio waves and the recent mention of a new type of antenna. Required was a type of directive antenna that would provide a proper glide path for the landing aircraft. Such an antenna system had been invented a short time before (1926) by Yagi and Uda of Japan [31].<sup>59,60</sup> To keep the directive antenna within reasonable size it was necessary to use a short wavelength transmitter. The frequency selected was 93.7 MHz (3.2 meters). By 1929, high-power (500 watts) transmitting tubes were available at this frequency. The transmitter circuit was mounted on a horizontal wood beam along with the directive antenna array. The entire assembly was located at the far end of the landing strip at the College Park airfield. The broadly tuned receiver was a relatively simple two-tube device that served, essentially, as a vacuum-tube voltmeter with a pointer indicator (a microammeter). A small dipole mounted above the wing of the aircraft served as the antenna for the horizontally polarized waves radiated by the Yagi antenna.<sup>61</sup>

## 4) Proving the radio system of landing aids

Many flight tests for each of the subsystems (runway beacon, marker beacon, and landing beam) had to be made over the period of development. During the summer of 1931 preparations were made for shakedown tests of the complete radio system. For these tests a "Fledging" plane, a product of the Curtiss Aeroplane Co., had been procured. It was a two-place open cockpit biplane, fitted with a radial, air-cooled engine. The pilot's cockpit was provided with a hood for blind flying. A copilot could take over in emergencies during blind operations. After a number of test flights, using the complete system, Marshall S. Boggs, a Department of Commerce pilot, with James L. Kinney as check pilot, made the first completely blind landing on September 5, 1931.<sup>62</sup> This historic flight at the College Park airfield ushered in a new era in aviation, that of a successful radio guidance system for

---

<sup>59</sup> This high-gain, directional VHF and UHF antenna is now commonly called the Yagi antenna or simply a "Yagi." It is much used for TV and FM reception and by amateurs.

<sup>60</sup> In the discussion of Yagi's IRE paper (see reference [31]) Dellinger stated:

Professor Yagi's remarkable work stimulates thought of a radical order. I venture to suggest that before many years radio operations will generally be considered divided into two classes, broadcasting and directive radio. . . . Not only in this ingenious suggestion but throughout a wide field of basic possibilities in directive radio, Professor Yagi has done exceptional fundamental work and has set forth a series of principles which will unquestionably guide much of the further development. . . . In conclusion, I would like to say that I have never listened to a paper that I felt so sure was destined to be a classic.

<sup>61</sup> The design directional characteristics of the transmitting antenna were such that the vertical plane had a pattern of a very elongated lobe of the form  $\cos n\theta$ . The antenna was directed so that the axis of the lobe was at a small angle above the horizontal. Upon entering the radiation field of the antenna the pilot would select a curved, equal-field-intensity path below the lobe's axis by means of the pointer indicator located in the cockpit. By keeping the pointer at a constant position (pointer horizontal at center of scale) the pilot would be following an equal-intensity path that was an acceptable glide path for landing the aircraft. A rise of the pointer above the horizontal position indicated that the aircraft was above the proper glide path, and below the horizontal position indicated that the aircraft was below the path. It was to Dunmore that credit was given for this novel idea.

After early experiments it was found to be advantageous to the pilot to have the two pointer indicators incorporated into one instrument. By keeping the two pointers intersected at a central spot on the indicator face, the pilot was on course on the runway localizing beam and on the proper path on the landing beam.

<sup>62</sup> Pilot Marshall S. Boggs, who had pioneered in the early test flights at College Park, was killed in an air crash on January 26, 1933, in the southwestern part of the United States while on other duties.



Earliest form of directive antenna array at College Park Airfield for glide-angle or landing beam for blind landing of aircraft. A 93.7-MHz transmitting oscillator fed the radiating dipole antennas. Other horizontal antennas served to direct the narrow landing beam.

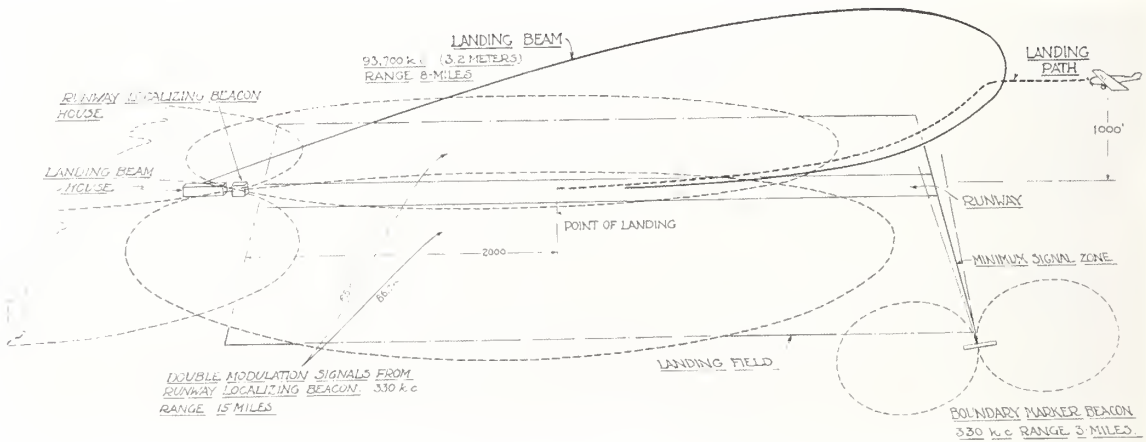

Three-dimensional diagram of radio system developed by Radio Section for blind landing of aircraft. Plane approaches from right.





*Early form of landing beam indicator. Used by pilot to follow proper glide angle in a blind landing.*

BUREAU OF STANDARDS RADIO SYSTEM FOR BLIND LANDING OF AIRCRAFT.  
COMBINED LANDING INSTRUMENT INDICATIONS.

AIRCRAFT TO LEFT OF  
 RUNWAY AND ABOVE THE  
 PROPER LANDING PATH.

AIRCRAFT OVER THE  
 RUNWAY AND ON THE  
 PROPER LANDING PATH.

AIRCRAFT TO RIGHT OF  
 RUNWAY AND BELOW THE  
 PROPER LANDING PATH.

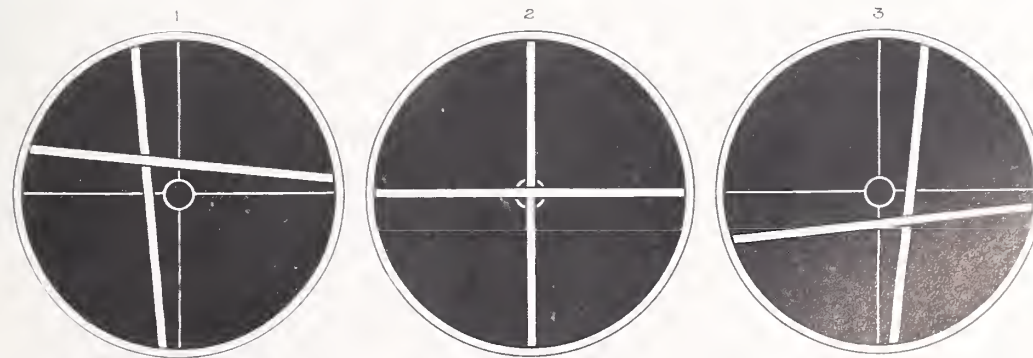

A = LANDING BEAM AND RUNWAY LOCALIZER BEACON.

*The two pointer-type instruments were successfully combined, allowing the pilot to easily observe on one instrument the position of his plane in relation to the runway localizer beacon course and the landing beam. When the two pointers intersected at the central circle, the pilot was "on the beam."*

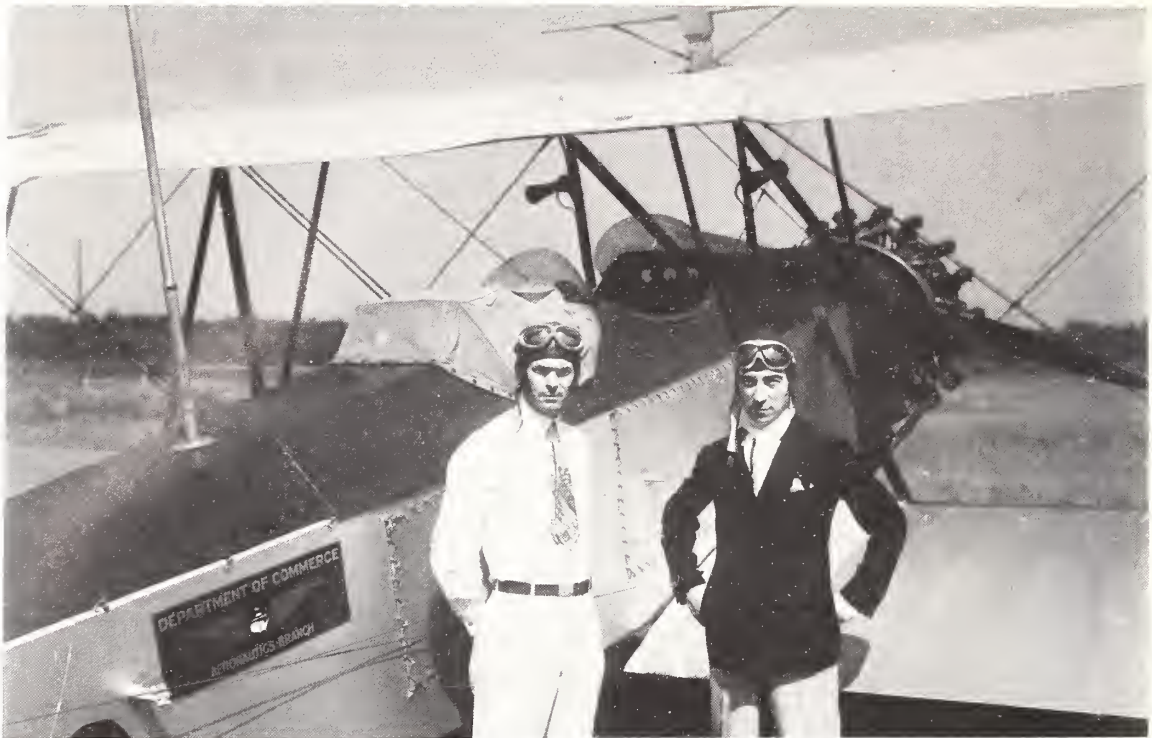

*Department of Commerce pilot Marshall S. Boggs (left) and Colonel Clarence Young, Assistant Secretary of Commerce for Aeronautics, with Curtiss "Fledging" biplane used to make the historic first blind landing by radio navigation on September 5, 1931, at the College Park, Md. Airfield. Vertical antenna, located behind hooded cockpit, received signals from the runway localizing beam. Double horizontal antenna above upper wing received the glide-path signals.*

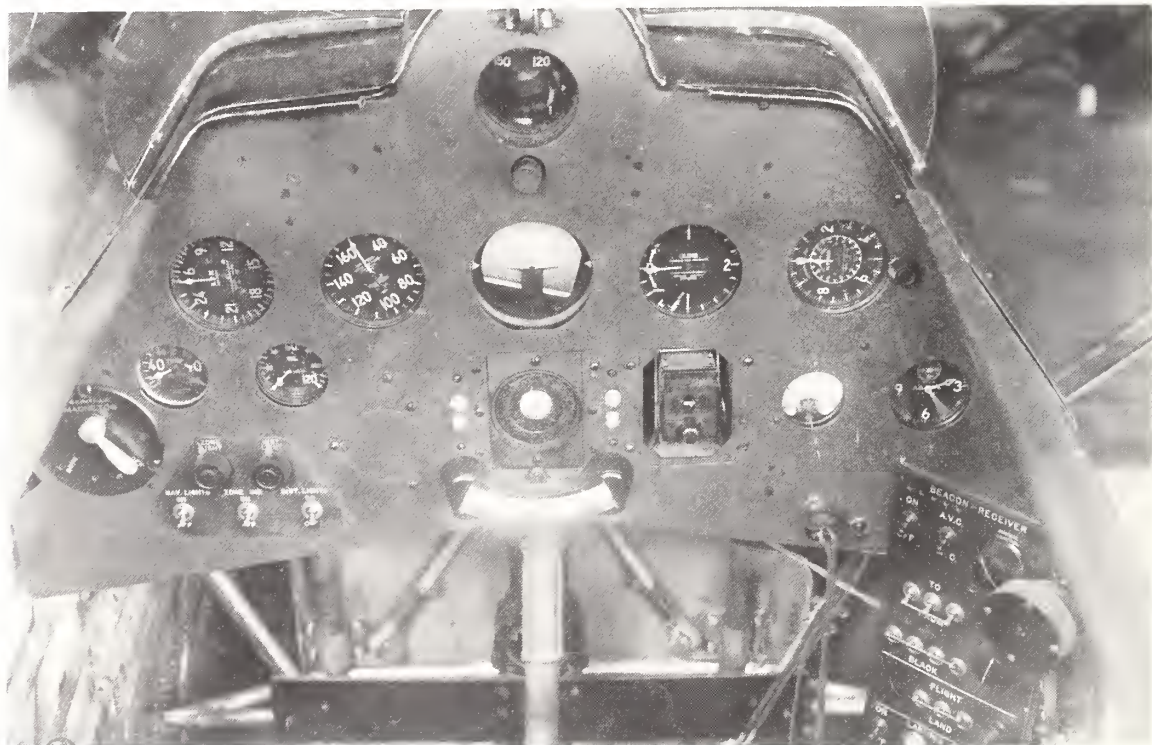

*Instrument panel of Curtiss "Fledging" as it appeared for the historic blind landings of September 5, 1931. The cross-pointer indicator to show both runway localizing beacon path and glide path can be seen above the ball-type bank indicator (just above handle grip of "joy" or control stick). To right of cross-pointer indicator is a reed indicator that could be used as an alternate indicator of beacon path. Further right is the distance indicator (round, white-faced dial), graduated to 7 miles, to show approximate distance from airfield.*

aircraft. It was later to be known as the Instrument Landing System (ILS). In May 1932, the Aeronautics Branch of the Department of Commerce licensed the first pilot with a Scheduled Air Transport Rating (SATR) for instrument and radio-flight proficiency.

In August 1931, just preceding the very successful blind landing test, the city of Newark, N.J. requested the installation of a complete radio guidance system at the Newark Airport. For many months thereafter the Radio Section found itself involved in the development of this new facility including participation in the many tests to check out the system. It was during the checkouts that another flight of historic significance was made. In a demonstration of the entire radio system of navigation and landing, a flight was made from College Park to Newark on March 20, 1933, under adverse conditions of visibility over the entire route. With James L. Kinney of the Aeronautics Branch as pilot, and Harry Diamond and a mechanic as passengers, the plane left College Park in a very low ceiling of clouds. The pilot followed the beacon course to New Brunswick, N.J. and on to Newark, flying at an altitude of 3000 feet. The airport at Newark was closed to all air traffic, yet pilot Kinney landed the plane without difficulty by means of the radio landing facilities, seeing the runway only during the last 100 feet of descent.

Beginning with the successful flight tests at College Park in the fall of 1931, and continuing for the next 2 years, the radio landing system was demonstrated to many Government officials, newspaper reporters, aircraft and airline representatives, and foreign visitors.<sup>63</sup> A number of planes in service by the Aeronautics Branch were fitted with complete equipment for navigation and blind landing by radio. However, problems remained. Not all of the directive beacon courses were satisfactory, particularly in mountainous areas at distances greater than 30 miles from the range-beacon station. A solution to this problem was achieved by Diamond in 1932 with much success—the development of a transmission line antenna system for radio range-beacon transmitters to minimize or eliminate the night effect caused by radiation of horizontally polarized components from loop antennas (or crossed-loop antennas of range beacons).<sup>64</sup> In case of strong winds from various directions one runway and one landing beam would not suffice. Although further developments were needed, the Radio Section program came to a series of halting actions, beginning in June 1933 and continuing to October as the result of a drastic economy move that struck the entire Bureau.<sup>65</sup> From a total of 44 persons in the Radio Section in June the number was reduced to 17 a few months later.<sup>66</sup> Much of the curtailment was in the air navigation program. By October the only remaining projects of the program were the landing beam and a study of the lack of dependability associated with several of the western airway beacon systems. In contrast to the work curtailment, the blind

---

<sup>63</sup> In the following years visual-type radio beacons and the blind landing system of the type developed by the Bureau were installed in a number of European countries.

<sup>64</sup> Previously, Pratt had considerable success in minimizing radio-beacon errors by use of a vertical antenna for the plane-mounted receiver (see p. 155). However, elimination of errors was not complete. Also, a vertical rod antenna is subject to ice formation with deleterious effects, although this hazard could be reduced by use of a symmetrical T antenna (either transverse or longitudinal with the fuselage) fitted with a short vertical lead-in—a development by Diamond and Gomer L. Davies.

Diamond achieved success in eliminating the night effect by improvements to several types of directional transmitting antennas developed in England during the early 1920's. These antenna systems were developed independently by Alcock, by Eckersley, and by others, to minimize the night effect caused by reflections from the ionosphere. This was accomplished by minimizing or eliminating the horizontally polarized component of the transmitted wave. Diamond ingeniously accomplished this by using transmission lines and transformer arrangements to feed each of four vertical antennas in order to eliminate horizontal radiation from the crossed-loop antenna system of the range beacon, at College Park, Md., with consequent elimination of the night effect [32]. A small coil antenna on the plane obviated the need of a vertical antenna or of a symmetrical T antenna.

<sup>65</sup> The reader is referred to Cochrane's *Measures for Progress*, pp. 344-357, "Curtaiment by Limitation of Funds," for an account of the economy actions.

<sup>66</sup> Among those of the Radio Section enmeshed in the reduction-in-force action were Frank G. Kear, Gomer L. Davies, W. H. Orton, and D. O. Lybrand, who almost immediately established the Washington Institute of Technology. Kear served as chief engineer from 1933 to 1941. The Institute was primarily an organization of 10 or 12 professional engineers engaging in development work. In the early years it was located at the airport at College Park, Md., where the Bureau's radio beacon and blind landing system had been developed.

It is interesting to note that among the others separated from the Radio Section and the Bureau on June 30, 1933, was Lloyd V. Berkner who later became a world-famed scientist (see ch. VII, footnote 37).

landing program was receiving a great amount of publicity in newspapers and magazines. By July 1934 the 8-year development program with the Aeronautics Branch was completely phased out. After 8 years the aeronautical radio research facilities at College Park, Md. were discontinued. All experimental equipment at College Park was moved to the Radio Building or to the Beltsville site.

#### 5) Postlude to the radio system of landing aids

During the phasing-out period of FY 1933 the team of workers was assisting in the installation and testing of navigation aids at airports in various parts of the country and two in particular, at Newark, N.J., and Oakland, Calif. In the same period the studies on the lack of dependability of several airway beacon systems (known in reports as "bent and multiple courses") did not yield definite conclusions on the causes. Various corrective measures were taken with some degree of success.

Aircraft not regularly using the airway radio beacons were not fitted with the special receiving equipment, yet had need for some device whereby the pilots could home on radio transmitters. Even a broadcast station would serve to orient a pilot if he lost his bearings in a sudden change to adverse weather. A reliable direction-finding antenna fitted to a relatively low-cost multiband receiver would suffice. Toward this objective Hinman developed such a homing device [33].<sup>67</sup> A loop antenna was used, with periodic grounding of each end at a rapid rate by electronic control, that gave the desired two-way, yet unidirectional, pattern. A pointer-type course indicator on the instrument panel provided visual observation of the pilot's homing maneuvers.

Early in 1931, during the development of the radio landing beam, Diamond and Dunmore planned for the eventual location of the antenna to be underground near the center of the airfield. A study and experiments showed that a steeper and more desirable glide path could be achieved with a dipole antenna at the surface or just below the surface in a pit. In time, at the desire of the pilots, the curved glide path was brought to a straight line. Approach lights were also added to the airfields, which made for more accurate touchdown of the aircraft to the runway surface.

Emerging from all of the later developments came the overall system that was designated as the Instrument Landing System, or simply ILS. But with the use of radar in the early 1940's by the military, another equally important system was developed, known as Ground-Controlled Approach, or simply GCA. For informative accounts of these and other systems and their development, the reader is referred to a special issue of the *IRE Transactions of Aeronautical and Navigational Electronics* of June 1959 [34].

#### d) THE AFTERMATH OF PATENTS IN ABUNDANCE

During the 8-year period of the development of radio aids to air navigation a surprisingly large number of patents were filed by personnel of the Radio Section, but mainly by Diamond and by Dunmore. No doubt the number was the largest associated with any one program in the Bureau's 75 years. Several of the patents were somewhat beyond the immediate requirements of the Bureau's program with the Department of Commerce, e.g., patents on collision prevention.

#### 1) Collision prevention

In the summer of 1933, after the Aeronautics Branch began to curtail its program at College Park, Diamond and Dunmore started some laboratory experiments on collision

---

<sup>67</sup> Hinman filed for a patent on September 6, 1933. Patent 2,145,876 was issued February 7, 1937, entitled "Radio direction finder."

prevention for aircraft.<sup>68</sup> There appears to be no evidence of the patented methods being utilized but the subject is as much alive today as it has been for several decades.

## 2) Automatic control for landing of aircraft

With Dunmore's turn of mind for ingenious devices it was quite natural that he would devise some equipment to add to the blind landing system for greater ease of operation. Thus he invented some automatic controls for landing of aircraft during a blind landing maneuver. One of his patents was on automatic control of elevation, another on steering during descent and landing.<sup>69</sup>

## 3) The many patents on radio beacons and blind landing system

No less than 19 patents were issued to personnel of the Radio Section as a result of the radio navigation program with the Aeronautics Branch of the Department of Commerce. In addition were the several patents, cited above, that were closely related to the Department's program. This creditable list of patents is cited below.<sup>70</sup>

<sup>68</sup> Beginning in July 1930 and extending for about 1 year, some initial experiments were undertaken by the Radio Section on collision prevention of planes within a proximity of 3 miles. Progress was slow because of difficulties encountered with the ultra high frequency equipment used on board the planes. Renewing the project in 1933, the first of several schemes of collision prevention used a combination transmitter and receiver, fitted with two antennas, whereby the device would transmit and receive at half-cycle intervals of an alternating current source. Signals from a nearby aircraft, fitted with the same equipment, would indicate its presence on a panel meter.\*

\*It is interesting that about 10 years later Diamond would be a member of a project at NBS that developed the radio proximity fuze that used a combination of transmitter and receiver to evidence the proximity of a target, but used a reflected signal rather than one developed by a nearby combination of receiver and transmitter.

Diamond and Dunmore filed for a patent on July 18, 1933. Patent 1,989,086 was issued January 29, 1935, entitled "Radio warning signal."

Dunmore's other method involved a short-range transmitter, radiating vertical-polarized waves, and a receiver with a loop antenna operating as a direction finder, the combination mounted in each aircraft. In general, these would be tuned to the same frequency on all aircraft, particularly on those flying the same airway.

Dunmore filed for a patent on May 11, 1933. Patent 2,146,724 was issued February 14, 1939, entitled "Radio system for collision prevention."

Several years later (in 1936 at the request of the Bureau of Air Commerce) Dunmore invented a much more sophisticated method of indicating the proximity of aircraft. Again each aircraft would carry a transmitter and receiver. For several years Diamond and Dunmore had been experimenting with the higher radio frequencies, and Dunmore suggested a wavelength of 3.5 meters (86 MHz) for the proximity indicator. There were several arrangements to Dunmore's method. The more simple one used but one transmitter and one receiver on each of the planes using the system. A warning light would indicate the proximity of a plane (within 20 miles) and its altitude. The pilot receiving this information would then signal the other pilot (by a coded signal) his intention of increasing or decreasing his altitude, thereby taking a new yet known course to avoid possible collision.

Dunmore filed for a patent on May 10, 1937. Patent 2,157,122 was issued May 9, 1939, entitled "Warning system for indicating the proximity of aircraft."

<sup>69</sup> The purpose of automatic control during a blind landing operation was stated by Dunmore in one of the patents:

Heretofore it has been necessary for a pilot to perform many operations during a blind landing, taxing his skill to the utmost. With the herein disclosed systems (elevation control) for automatically controlling the aircraft during the glide, the pilot may merely set into operation an automatic air speed control and start the aircraft off on a runway localizer course some 6 or 7 miles out from the field, preferably at a predetermined altitude.

Dunmore filed for the patent on March 3, 1936. Patent 2,133,285 was issued October 18, 1938, entitled "Radio system for automatic control of aircraft, as during landing."

A second corollary patent for control of steering was filed on the same date as that on elevation control, March 3, 1936. Patent 2,137,241 was issued November 22, 1938, entitled "Automatic steering system."

<sup>70</sup> H. Diamond. Method of adjusting radio beacon courses. Filed November 24, 1931. Patent 1,910,427 issued May 23, 1933.

H. Diamond and F. G. Kear. Triple-modulation directive radio beacon system. Filed March 9, 1932. Patent 1,913,918 issued June 13, 1933.

H. Diamond and F. W. Dunmore. Course shift-indicator for the double-modulation type radio beacons. Filed July 6, 1931. Patent 1,923,920 issued August 22, 1933.

F. G. Kear. Radio beacon course shifting method. Filed November 24, 1931. Patent 1,923,934 issued August 22, 1933.

H. Diamond. Twelve-course aural type, triple modulation directive radio beacon. Filed October 29, 1932. Patent 1,961,206 issued June 5, 1934.

## REFERENCES

- [1] J. H. Dellinger, "Principles of radio transmission and reception with antenna and coil aerials," *Bur. Stand. Sci. Paper*, Vol. 15, 1919-1920, pp. 435-495.\*
- \*At one time Dellinger used the term "aerial" in a limited sense, meaning the elevated conductor portion of a condenser antenna. He also applied the term to a coil. In later years the term "aerial" was dropped completely by the Radio Section in favor of antenna.
- [2] Frederick A. Kolster and Francis W. Dunmore, "The radio direction finder and its application to navigation," *Bur. Stand. Sci. Paper*, Vol. 17, 1922, pp. 529-566.
- [3] John C. Warner, "Experiments with the two-plate condenser antenna," *Radio News*, Vol. 4, No. 9, Mar. 1923, pp. 1618-1620.
- [4] Francis W. Dunmore and Francis H. Engel, "Directive radio transmission on a wave length of 10 meters," *Bur. Stand. Sci. Paper*, Vol. 19, 1923-1924, pp. 1-16.
- [5] Francis W. Dunmore, "Continuous-wave radio transmission on a wave length of 100 meters, using a special type of antenna," *Proc. IRE*, Vol. 11, No. 3, June 1923, pp. 243-255.
- [6] Frederick W. Grover, "Methods, formulas, and tables for the calculation of antenna capacity," *Bur. Stand. Sci. Paper*, Vol. 22, 1927-1928, pp. 569-629.
- [7] W. E. Knowles Middleton, *Invention of the Meteorological Instruments*, The Johns Hopkins Press, Baltimore, 1969, pp. 328-346.
- [8] L. F. Curtiss, A. V. Astin, L. L. Stockmann, and B. W. Brown, "An improved radio meteorograph on the Olland principle," *J. Res. Nat. Bur. Stand. (U.S.)*, Vol. 22, No. 1, Jan. 1939, pp. 97-103.
- [9] F. W. Dunmore, "An electric hygrometer and its application to radio meteorography," *J. Res. Nat. Bur. Stand. (U.S.)*, Vol. 20, No. 6, June 1938, pp. 723-744.
- [10] F. W. Dunmore, "An improved electric hygrometer," *J. Res. Nat. Bur. Stand. (U.S.)*, Vol. 23, No. 6, Dec. 1939, pp. 701-714.
- [11] H. Diamond, W. S. Hinman, Jr., and F. W. Dunmore, "The development of a radio-meteorograph system for the Navy Department," *Bull. Am. Meteorological Soc.*, Vol. 18, No. 3, Mar. 1937, pp. 73-99.
- [12] Harry Diamond, Wilbur S. Hinman, Jr., Francis W. Dunmore, and Evan G. Lapham, "An improved radio sonde and its performance," *J. Res. Nat. Bur. Stand. (U.S.)*, Vol. 25, No. 3, Sept. 1940, pp. 327-367.
- [13] Patrick Hughes, *A Century of Weather Service*, Gordon and Breach Science Publishers, Inc., New York, 1970, pp. 60-61.
- [14] W. R. Blair and H. M. Lewis, "Radio tracking of meteorological balloons," *Proc. IRE*, Vol. 19, No. 9, Sept. 1931, pp. 1531-1560.

---

(Continued)

F. W. Dunmore. Pointer type course indicator. Filed October 25, 1932. Patent 1,981,589 issued November 20, 1934.

F. W. Dunmore. Deviometer. Filed April 12, 1932. Patent 1,981,857 issued November 27, 1934.

H. Diamond. Method and apparatus for a multiple course radiobeacon. Filed March 9, 1932. Patent 1,992,197 issued February 26, 1935.

F. W. Dunmore. Method and apparatus for radio beacon course and quadrant identification. Filed February 4, 1933. Patent 1,992,927 issued February 26, 1935.

F. W. Dunmore. Aircraft blind landing beam system. Filed March 3, 1936. Patent 2,104,028 issued January 4, 1938.

H. Diamond and F. W. Dunmore. Automatic volume control for radio receiving apparatus. Filed December 27, 1935. Patent 2,110,761 issued March 8, 1938.

F. W. Dunmore. Course indicator for blind flying and landing. Filed November 10, 1932. Patent 2,119,530 issued June 7, 1938.

H. Diamond and F. W. Dunmore. Radio guidance of aircraft. Filed August 26, 1935. Patent 2,120,241 issued June 14, 1938.

F. W. Dunmore. Course indicator for the double and triple modulation directive radio beacons. Filed March 9, 1932. Patent 2,120,245 issued June 14, 1938.

H. Diamond. Radio transmitting and receiving system. Filed April 25, 1933. Patent 2,121,024 issued June 21, 1938.

F. W. Dunmore. Radio beam and receiving device for blind landing of aircraft. Filed August 5, 1932. Patent 2,127,954 issued August 23, 1938.

F. W. Dunmore. Radio system for azimuth indication. Filed May 16, 1933. Patent 2,128,923 issued September 6, 1938.

H. Diamond. Directive antenna system. Filed May 5, 1933. Patent 2,172,365 issued September 12, 1939.

H. Diamond. Method of blind landing of aircraft. Filed August 5, 1932. Patent 2,179,499 issued November 14, 1939.

- [15] Harry Diamond and Wilbur S. Hinman, Jr., "An automatic weather station," *J. Res. Nat. Bur. Stand. (U.S.)*, Vol. 25, No. 5, Aug. 1940, pp. 133-148.
- [16] "An air-launched automatic weather station," *Nat. Bur. Stand. (U.S.), Tech. News Bull.*, Vol. 35, No. 5, May 1951, pp. 61-63.
- [17] "A free-floating automatic weather station," *Nat. Bur. Stand. (U.S.), Tech. News Bull.*, Vol. 36, No. 3, Mar. 1952, pp. 36-37.
- [18] E. F. Corwin, J. C. Appleby, and L. J. Allison, "The floating automatic weather stations of the United States Navy," *Weatherwise*, Vol. 12, No. 5, Oct. 1959, pp. 192-199.
- [19] R. E. Mottern, E. F. Corwin, and A. F. Pyle, "The meteorological buoy program of the U.S. Navy," *The Marine Observer*, Vol. 37, 1967, pp. 178-185.
- [20] W. E. Knowles Middleton, *Invention of the Meteorological Instruments*, The Johns Hopkins Press, Baltimore, 1969, pp. 326-328.
- [21] P. D. Lowell, W. Hakkarinen, and D. L. Randall, "National Bureau of Standards mobile low-level sounding system," *J. Res. Nat. Bur. Stand. (U.S.)*, Vol. 50, No. 1, Jan. 1953, pp. 7-17.
- [22] Frederick A. Kolster and Francis W. Dunmore, "The radio direction finder and its application to navigation," *Bur. Stand. Sci. Paper*, Vol. 17, 1922, pp. 529-566.
- [23] Gregory Breit, "The field radiated from two horizontal coils," *Bur. Stand. Sci. Paper*, Vol. 17, 1922, pp. 587-606.
- [24] F. H. Engel and F. W. Dunmore, "A directive type of radio beacon and its application to navigation," *Bur. Stand. Sci. Paper*, Vol. 19, 1923-1924, pp. 281-295.
- [25] F. W. Dunmore, "Design of tuned reed course indicators for aircraft radio beacon," *J. Res. Bur. Stand.*, Vol. 1, No. 5, Nov. 1928, pp. 751-769.
- [26] J. H. Dellinger and Haraden Pratt, "Development of radio aids to air navigation," *Proc. IRE*, Vol. 16, No. 7, July 1928, pp. 890-920.
- [27] J. H. Dellinger, H. Diamond, and F. W. Dunmore, "Developments of the visual type airway radiobeacon system," *Proc. IRE*, Vol. 18, No. 5, May 1930, pp. 796-839.
- [28] H. Diamond and F. G. Gardner, "Engine ignition shielding for radio reception in aircraft," *Proc. IRE*, Vol. 18, No. 5, May 1930, pp. 840-861.
- Note: This paper includes reference to a Conference on Airplane Engine Ignition Shielding held at the Bureau of Standards on June 11, 1929, at which 56 representatives of Government agencies, manufacturers, and laboratories attended (see pp. 858-859). The four-fold purpose of the Conference was stated by the authors.
- [29] H. Diamond and F. W. Dunmore, "A radio beacon and receiving system for blind landing of aircraft," *Proc. IRE*, Vol. 19, No. 4, Apr. 1931, pp. 585-626.
- [30] H. Diamond, "Performance tests of radio system of landing aids," *J. Res. Bur. Stand.*, Vol. 11, No. 4, Oct. 1933, pp. 463-490.
- [31] Hidetsugu Yagi, "Beam transmission of ultra short waves," *Proc. IRE*, Vol. 16, No. 6, June 1928, pp. 715-741.
- [32] H. Diamond, "On the solution of the problem of the night effect with the radio range beacon system." *Proc. IRE*, Vol. 21, No. 6, June 1933, pp. 808-832.
- [33] Wilbur S. Hinman, Jr., "A radio direction finder for use on aircraft," *J. Res. Bur. Stand.*, Vol. 11, No. 6, Dec. 1933, pp. 733-741.
- [34] *IRE Trans. Aeronautical and Navigational Electronics*, Vol. ANE-6, No. 2, June 1959. A special issue on Instrument Approach and Landing—early development, current progress, and future plans.





## Chapter VII

### PROBING THE IONOSPHERE

#### PIONEER PROBES OF THE IONOSPHERE

##### 1. Early conceptions

The unfolding of bits of Nature's secrets, leading to a pursuit of knowledge of the ionosphere, has resulted in one of the most fascinating and productive fields in physics or, more specifically, in radio science. Through the years the ionospheric and radio propagation projects grew into one of the Bureau's most extensive research programs, to be transferred in 1965 to the Environmental Science Services Administration of the Department of Commerce. Not only was the Bureau's program broad in subject matter and involving hundreds of scientists, engineers, and technicians, but the whole world served as the laboratory. In his address to the Boulder Laboratories staff on March 3, 1961, on the occasion of the 60th Anniversary of NBS, Dr. Dellinger said in retrospect of the propagation program:

The greatest of the radio kingdoms we began to occupy around 1920 was radio wave propagation. While we had done some work in 1912-17 on transmission formulas and directional transmission and reception, our work from 1920 on began with a study of fading. The early broadcast listeners were pleased to receive over great distances at night but didn't like the great variations of received intensity. With the aid of a number of volunteer observers we investigated the fading phenomenon and were able to work out an explanation in terms of the Kennelly-Heaviside layer.

In order to gain an understanding of the Bureau's participation in and contributions to ionospheric research and radio propagation, one should view the backdrop of historical development upon which NBS projected its program.<sup>1</sup> The source of the Earth's magnetism long remained a puzzle to the scientists. It was Gauss who in 1839 suggested that galvanic currents flowing external to the Earth's surface could be a source of magnetism as well as the cause of the aurora borealis. In 1860 Lord Kelvin (William Thomson) postulated that the rarefied gases of the atmosphere at great heights could serve as a conductor of electric current. His estimate of 100 miles as the beginning of such a region was later found to be surprisingly close to actuality. Later, in 1878, the Scottish physicist and meteorologist Balfour Stewart suggested that a conducting layer existed only 5 to 10 miles above the Earth's surface.

##### 2. Early evidence

Marconi's successful transmission of wireless signals across the Atlantic Ocean in 1901 stimulated much thought on how this was possible over such a long arc of the Earth's

---

<sup>1</sup> For further information than covered here, the reader is referred to other summaries, including:

A. L. Green, "Early history of the ionosphere," *A. W. A. Technical Review*, Vol. 7, No. 2, Dec. 1946, pp. 177-228.

Kenneth Davies, *Ionospheric Radio Waves*, Blaisdell Publishing Co., Waltham, Mass., 1969.

S. S. Kirby, L. V. Berkner, and D. M. Stuart, "Studies of the ionosphere and their application to radio transmission," *J. Res. NBS*, Vol. 12, No. 1, Jan. 1934, pp. 15-51.

With several exceptions, the "backdrop" presented here contains no citations to publications.

curvature. His discovery, while voyaging on the SS *Philadelphia* in 1902, that wireless signals could be received over much longer distances at night than during the day led to more postulations (and bewilderment) of the mode of transmission. But it was within this same year that Arthur E. Kennelly (United States) and Oliver Heaviside (England) each independently suggested that Marconi's success with long distance wireless reception could be explained by reflection from an electrically conducting layer in the Earth's atmosphere. Their names were long associated with the ionized layer now more commonly referred to as the ionosphere.<sup>2,3</sup>

Austin's observations from U.S. Navy vessels, beginning in 1909, of radio signals over long distance led to the development of the Austin-Cohen transmission formula in 1911 (see ch. II). The exponential term of the equation contains an attenuation factor that expresses loss of energy in the ground wave and in the sky wave. Austin attributed loss of energy in the sky wave to absorption in an ionized region of the upper layers of the atmosphere. Later, Austin became much interested in the effect of diurnal and seasonal variations in the Kennelly-Heaviside layer upon transmission of radio signals by the sky wave.

Marconi's long-distance transmissions of 1901 and 1902 were explained by some as being due to refraction by the atmosphere. Based upon an earlier ionization theory of Lorentz (Netherlands), Eccles (England) in 1912 suggested transmission by refraction through an ionized layer as well as by reflection from a higher layer. The same explanation was supported later by Larmor (England) in 1924.

It appears that the first experimentally observed evidence of the ionosphere was by Lee de Forest in 1912. With a Poulsen arc (continuous waves) transmitter, de Forest observed an interference phenomenon over the San Francisco-Honolulu transmission circuit operated by the Federal Telegraph Co. This he attributed to interference between the direct wave and a wave reflected from an ionized layer which he estimated to be 62 miles above the ocean surface. In 1915 Leonard F. Fuller, another engineer working for the same company, reported on a nighttime interference phenomenon (caused by an ionized layer) while determining the optimum wavelength for transmission between San Francisco and Honolulu.

Over a short period of about 3 years, beginning in 1920, three widely different types of observations were made that gave experimental evidence of the ionized layer(s) in the upper atmosphere. Beginning in June 1920, the Bureau of Standards, with the cooperation of the American Radio Relay League, initiated a series of programs extending over a period of several years to study the characteristics of the fading of radio signals. From the beginning of the program it was believed that fading was due to interference between the direct (or ground) wave and waves reflected from the Kennelly-Heaviside layer. However, reflections from fog or masses of industrial fumes were not ruled out. Pickard in 1924, and others, also made fading observations. Some observations were conclusive in indicating the Kennelly-Heaviside layer; others were less conclusive.

In 1921 T. L. Eckersley of England reported on his observations of nighttime errors of radio direction-finding apparatus during the latter part of World War I. With the use of a double-coil antenna (a horizontal loop and a rotating vertical loop), Eckersley concluded that the nighttime errors were due to interference from abnormally polarized waves reflected by

---

<sup>2</sup>The term "ionosphere" first appeared in the literature in 1931 as a more simple expression of "Kennelly-Heaviside layer." It was used by Johannes N. Plendl (then of Germany) as the German term "ionosphäre" in his first two similar papers on "Concerning the influence of the eleven-year solar activity period upon the propagation of waves in wireless telegraphy." It first appeared in the February 1931 issue of the *DVL Jahrbuch 1931*. An English translation of the second paper appeared in the March 1932 issue (Vol. 20) of the *Proc. IRE*, with the term "ionosphäre" translated as "ionization sphere," whereas the then unfamiliar "ionosphere" would have been a more simple term to have been used in the translation.

Note: Correspondence in 1961 between Dellinger and Thomas J. Carroll (formerly of the Central Radio Propagation Laboratory, and in 1961 of the Bendix Corp., Baltimore, Md.) on the first use of the term "ionosphere," and 1961 correspondence between Dellinger and Plendl confirming first usage of the term, is found in the Radio File under the title "Ionosphere."

The term "ionosphere" was first used by the Radio Section in 1933, replacing "Kennelly-Heaviside layer" which had been used for a few years previously.

<sup>3</sup>Just preceding the printing of this historical account, an author (WFS) surprisingly learned that R. A. Watson-Watt had used the term "ionosphere" in an English journal in 1929. See Watson-Watt, "Weather and Wireless," *Quarterly J. Royal Meteorological Society*, Vol. 55, 1929, p. 278 and p. 301.

the Kennelly-Heaviside layer. This would be verified in later years by observers within the NBS Radio Section.

Evidence of a conducting layer in the upper atmosphere from Marconi's long-wave transmissions in 1901 and 1902 was more strongly evidenced by his "short-wave" transmission at 100 meters reported in 1924. This was over a path length equal to half the circumference of the Earth between England and Australia. There was evidence later that the radio signals were transmitted over one path part of the day and over a path on the opposite side of the Earth another part of the day, depending upon daylight and nighttime conditions of the ionosphere over the transmission paths.

### 3. Experiments of 1925 that revealed the ionosphere

It was not until 1925 that proof by designed experiments indicated the presence and approximate location of the Kennelly-Heaviside layer. Moreover, there were indications that the layer structure was not confined to a single layer. E. V. Appleton<sup>4</sup> and M. A. F. Barnett of England devised two methods of probing the ionosphere using frequencies of about 770 kHz. In one method they used (in winter of 1924-1925) a carrier frequency of 770 kHz, frequency modulated very slowly at rates extending to a period of 30 seconds, to obtain interference between the direct wave (ground wave) and the reflected wave (sky wave) [1]. This method yielded a height of about 85 km, but some observations indicated a layer height of more than 200 km. Within a short period of time Appleton definitely observed the existence of three layers in the Kennelly-Heaviside region.<sup>5</sup> In the second method, called the angle-of-incidence or angle-of-arrival method, a vertical antenna and a loop antenna were used to observe both the ground wave and the downcoming wave reflected from the conducting layer [2]. The height was determined to be between 85 and 115 km.

Concurrently with the investigations of Appleton and Barnett was the development and use of a new technique of probing the ionosphere by Breit<sup>6</sup> and Tuve of the Carnegie Institution of Washington [3,4]. Their pulse method of observing reflected signals had the rudiments of early radars and was destined to be the basic technique of most of the equipment that would be developed during the next few decades for ionospheric observations. Some experiments by Breit and Tuve early in 1925 with "chopped" signals from several broadcast stations gave no conclusive evidence of reflections from the conducting layer. During the same period the U.S. Naval Research Laboratory was

---

<sup>4</sup> Later, in 1941, Appleton was knighted as Sir Edward Appleton. He was awarded the Nobel Prize in Physics in 1947 "for his investigations of the physics of the upper atmosphere, especially for the discovery of the so-called Appleton layer" (E layer). He was president of URSI from 1934 to 1952, and attended the American meetings in 1927 (Washington) and 1957 (Boulder). As founder of the *Journal of Atmospheric and Terrestrial Physics* in 1951, he served as Editor-in-Chief until his death in 1965. Appleton was the recipient of many honors and awards.

<sup>5</sup> In answer to a query from Dellinger of NBS in a letter to Sir Edward Appleton, dated February 13, 1943, on naming the layers of the ionosphere, Appleton stated in his letter of March 20, 1943:

I was very interested to have your question on the early history of the nomenclature for the ionosphere layers. The story of how I came to give them the names D, E and F is really a very simple one. In the early work with our broadcasting wavelengths, I obtained reflections from the Kennelly-Heaviside layer, and on my diagrams I used the letter E for the electric vector of the down-coming wave. When therefore in the winter of 1925 I found that I could get reflections from a higher and completely different layer, I used the term F for the electric vector of the waves reflected from it. Then about the same time I got occasional reflections from a very low height and so naturally used the letter D for the electric vector of the return waves. Then I suddenly realized that I must name these discrete strata and being rather fearful of assuming any finality about my measurements I felt I ought not to call them layers A, B and C since there might be undiscovered layers both below and above them. I therefore felt that the original designation for the electric vector D, E and F might be used for the layers themselves since there was considerable latitude for the naming of any layers that might come to light as a result of further work. I am afraid that that is all there is in the story.

The above information is contained in a Letter to the Editor by Richard Silberstein of the Central Radio Propagation Laboratory, published in the Nos. 3/4 issue, Vol. 13, (1959) of the *Journal of Atmospheric and Terrestrial Physics*, p. 382.

<sup>6</sup> Dr. Gregory Breit was a member of the Radio Section from 1918 to 1921, then joined the Department of Terrestrial Magnetism, Carnegie Institution of Washington.

successful in pulsing a short-wave radio transmitter. The combination of a crystal-controlled master oscillator and a 500-Hz modulation of the transmitter amplifier tubes gave a pulsed train of signals that had reasonably good frequency stability. At a distance of 8 miles from the transmitter (NKF, Naval Research Laboratory at Bellevue in southeast Washington, D.C.) Breit and Tuve recorded the train of pulsed signals of the direct or ground wave and of the reflected wave on photographic film in a drum-type oscillograph. The first transmission was on July 28, 1925, at a wavelength of 71.3 meters (4210 kHz). The conducting layer was

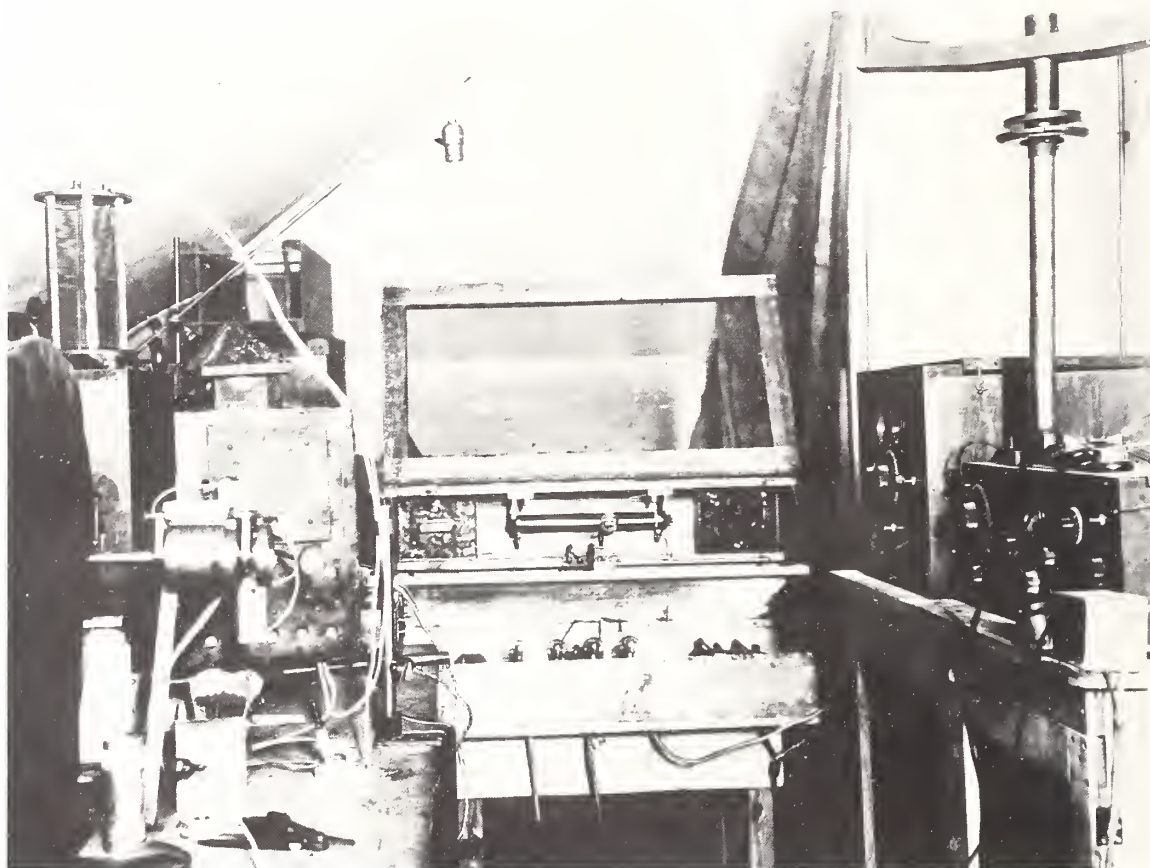

*Equipment used by Breit and Tuve in early experiments of observing reflection of radio waves from the ionosphere. Their earliest successful observation was on July 28, 1925, of pulsed signals at 71.3 meters (4210 kHz) transmitted from the Naval Research Laboratory, Bellevue, Washington, D.C., with ground wave and reflection wave recorded 8 miles distance at laboratory of the Department of Terrestrial Magnetism, Carnegie Institution of Washington.*

estimated to be at a height ranging from 80 to 160 km. Later, with more sharply formed pulses, and more extensive observations, they found several ionized layers ranging in height from 80 to 225 km, and changes in heights as observations were made at different times during the day and night. They, as well as others taking up the study, were finding that the Kennelly-Heaviside layer was not a simple structure, nor did it remain stable from day to night and from year to year. This complexity was to be the source of intensive study by hundreds of scientists the world over—and NBS would play a major role in searching out the secrets of the ionosphere. NBS would distill the wrested secrets into engineering information that would make maximum use of the ionosphere as a communication medium.

#### **4. From the simple to the complex**

The experiments of 1925 indicated the existence of several layers of ionized gases in the upper atmosphere, each having its own mode of reflecting radio waves. Concurrent with these experiments, the theoretical investigations of Appleton, and of H. W. Nichols and J. C. Schelleng of the Bell Telephone Laboratories (published early in 1925), indicated that the Earth's magnetic field must be taken into account in the propagation of radio waves through the ionosphere. Nichols and Shelleng showed that the plane of polarization is

rotated by an amount that depends on the density of free electrons, on the magnetic field, and on the frequency (the effect reverses at about 1400 kHz, at the gyro frequency). Double refraction of the wave is caused by the magnetic field at right angles to the direction of transmission and produces two components or waves of different polarization and absorption (the ordinary and the extraordinary wave).

In 1927 Breit, followed later by Appleton, suggested that radio fading at the higher frequencies could be due to small variations of the Earth's magnetic field. In 1928 Appleton and Ratcliffe observed the circular polarization of waves reflected from the ionosphere. For their experiment they used three loop antennas.

## THE BUREAU'S EARLY INTEREST IN RADIO PROPAGATION

### 1. How it began

Austin's close association with the Bureau by his leadership of the U.S. Naval Wireless Telegraphic Laboratory (1908-1923)<sup>7</sup> located on the Bureau grounds, brought his researches into identification with those of the Bureau. Some of his research programs were published

<sup>7</sup> Known by at least five different names during its existence on the Bureau grounds from 1908 to 1923. After resigning from the Navy in 1923, Austin continued work at the Bureau as a member of the Electricity Division, until his death in 1932, as head of the Laboratory for Special Radio Transmission Research (see ch. II, pp. 36-37).

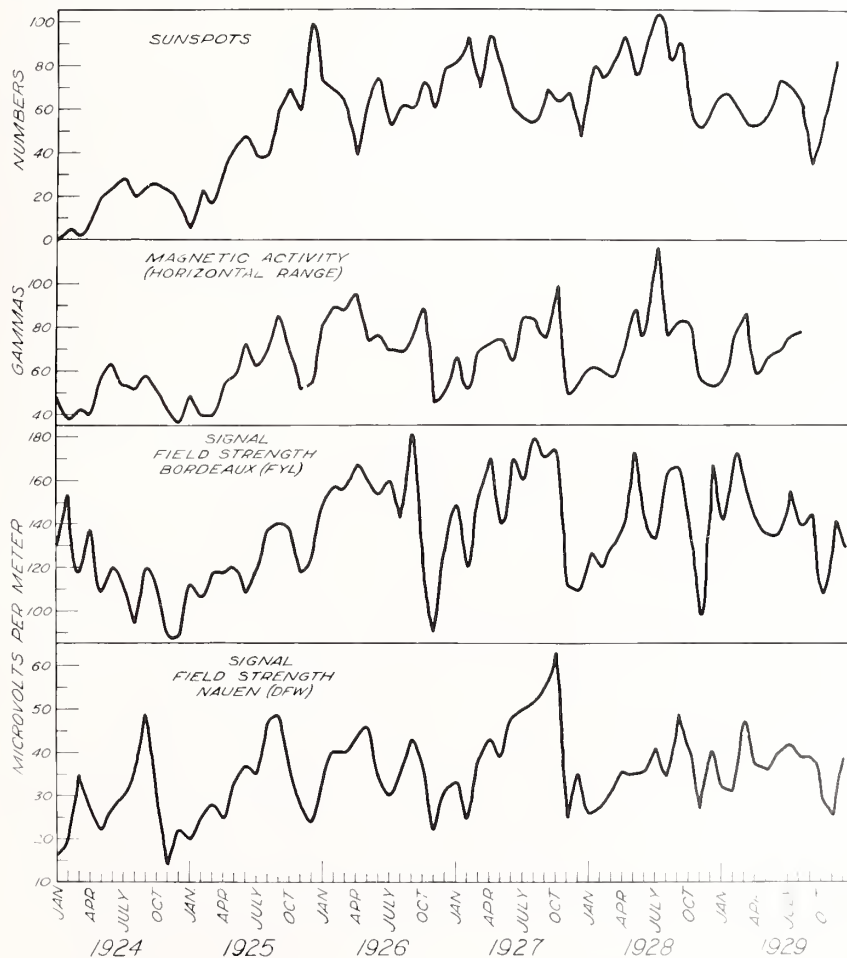

The relation of solar and magnetic activity to long distance radio transmission is indicated by these 1924-1930 observations of Austin and colleagues (of the Laboratory for Special Radio Transmission Research, associated with the Radio Section (see ch. II, pp. 36-37). Monthly averages of signal levels from two low-frequency transmitters (Bordeaux, France, 15.9 kHz; Nauen, Germany, 23.4 kHz) show fairly close correlation with magnetic activity and less correlation with solar activity. Austin stated in a publication that, "The deep drop of both magnetic and signal curves in November (more rarely in December) is especially striking." The effect of early winter North Atlantic transmissions had often been noticed by others.

as Bureau literature. It was thus that much of his early radio propagation studies is listed and referred to as Bureau programs. In actuality, they can be considered as closely associated with the radio work of the Bureau and, without the least doubt, his researches had a marked influence on the Bureau's radio projects. This is certainly true of his early propagation studies, beginning in 1911, that led to the Austin-Cohen formula of radio transmission (see ch. II, pp. 34-35). As early as 1912 Austin observed that radio signals in the winter were usually several times stronger than in summer, and that night signals were stronger than those received during the day. During the 1920's Austin became much interested in the causes and effects associated with the vagaries of radio propagation and atmospheric disturbances, resulting in many publications on these subjects.<sup>8</sup>

Austin readily accepted the concept of an ionized layer in the upper atmosphere as the cause of much of the observed phenomena associated with radio propagation. On the day before his death in 1932, he said to Dr. Briggs

I must earnestly beg of you to see to it that the Bureau continues my signal measurement work, at least until such a time as all workers are agreed that other observations, such as those on Kennelly-Heaviside heights, can take the place of signal intensity measurements for correlation purposes.

Added to the very unusual relation of Austin to the Bureau was another, and again a Navy relationship, that set the stage for the Bureau to embark on its long and extensive program in the field of radio propagation. Late in 1918 Lt. Commander A. Hoyt Taylor was selected to head the Naval Aircraft Radio Laboratory to be located on the Bureau grounds.<sup>9</sup>

Early in 1919 Taylor was studying the reliability of direction finders with long wavelength radio signals as a guidance system for Navy planes on transatlantic flights. His signal source was the Naval Radio Station at New Brunswick, N.J., operating at 13,600 meters (22 kHz). Although he found very small bearing errors in the daytime, the radio compass showed variations in bearings as great as 90° at sunset and sunrise, and with great variation in signal strength under nighttime operation. In a Bureau paper Taylor explained the variation in compass bearings as being caused by the reflection and refraction of waves from an ionized layer at high altitudes [5].

Under the direction of Kolster, who was much occupied with the development of the radio compass, a program was initiated in the Radio Laboratory to check the observations of Taylor with another direction finder. The U.S. Army Signal Corps was also interested in the project because of its own program on direction finders. At the same time, Dellinger was completing an extensive paper that related to coil antennas.<sup>10</sup> A direction finder was installed at a field site located in Kensington, Md. Thus the Bureau's receiver was located a distance of 5 1/2 miles to the north of the Navy's receiver placed on the fourth floor of the East Building on the Bureau grounds. A 24-hour observation of the New Brunswick transmitter (approximately 200 miles distance) taken on March 21-22, 1919, at each receiving station, showed a very marked similarity of the two records for variations in the compass bearings with time of day. Previously, there had been assurance that local disturbances and any effects of the surroundings were no cause for error in direction bearings at either of the two stations. Thus, the errors, which reached a maximum of nearly 50 degrees in each direction from the true bearing, were attributed only to reflection from the ionosphere.

<sup>8</sup> During the period from 1923 to 1932 Dr. Austin and two of his assistants published about 25 papers on subjects relating to radio wave transmission and the effects of solar activity on transmission. Most of these papers were published in the *Proc. IRE*. This was during the period when Austin was head of the Laboratory for Special Radio Transmission Research, located on the Bureau grounds.

Typical of the subjects on which Austin was writing are the following:

- Some transpacific radio field intensity measurements (1925)
- Long distance receiving measurements in 1924 (1925)
- Long wave radio receiving measurements at the Bureau of Standards in 1930 (1931)
- Solar activity and radiotelegraphy (1932)

<sup>9</sup> Upon the formation of the Naval Research Laboratory in 1923 at Bellevue, Anacostia, in southeast Washington, Taylor was selected as superintendent of the Radio Division.

<sup>10</sup> Dellinger had been preparing a paper on "Principles of radio transmission and reception with antennas and coil aeriels," which was submitted as a Bureau publication on June 18, 1919 (see p. 115, ch. VI). In treating the Austin-Cohen transmission formula in his paper, Dellinger considered the absorption of power in the wave in transmission over water or land as absorption in the ground wave only and did not mention absorption in a sky wave.

It fell to the lot of L. E. Voorhees, associated with Kolster, to make the observations at the Kensington site.<sup>11</sup> An unpublished report, dated August 8, 1919, entitled "The variation of direction of long electromagnetic waves with time" provides the information on what can probably be considered the Bureau's first recorded and reported (but not published) observations of radio propagation that showed distinct evidence of reflection from the ionosphere.<sup>12</sup>

<sup>11</sup>L. E. Voorhees transferred to the Radio Laboratory on October 16, 1918, from the Heat Division. A year later, on September 30, 1919, Voorhees left the Radio Laboratory.

<sup>12</sup>The unpublished paper by Voorhees in the Radio File states that a 100-turn coil antenna on a 5-foot square frame was used at the Kensington station.\* A compensating circuit maintained symmetry of the coil capacity to the ground. In contrast to reception from the New Brunswick station, signals from the Navy Station (17,000 meters, 17.6 kHz) at Annapolis, Md., 30 miles away, showed but little variation in bearing direction, either night or day.

Voorhees attributed the variation in bearing direction

. . . to reflection of part of the wave between stations, thus diminishing the amount of wave affecting the receiving antenna. Such reflections and refractions make it necessary to suddenly change the position of the direction finder coil aerial in order to obtain a zero signal. . . . we get the largest variations in direction at the Bureau of Standards, Washington, D.C. (and Kensington, Md. field station) at sunset, when the stations pass from earth's penumbra into umbra at about 9:30 p.m., when the stations pass from earth's umbra to penumbra at about 3 a.m., and at sunrise.

(Note: This would be in March, when the observations were made.)

Since the nature of the disturbing element is so complex and varying it seems next to impracticable to attempt to use long wave transmission for direction finding purposes . . .

It would remain for some years to come before the Bureau would give fuller explanation to the disturbing effects of ionosphere reflections upon radio direction finders and radio navigation systems. In sequence, the observations and explanations were by:

- (1) Haraden Pratt in 1927 on the night effect on radio beacons for air navigation (see ch. VI, p. 155).
- (2) World War II research by Diamond, Lifshutz, and Poast, also by K. A. Norton, on errors in high-frequency direction finders caused by waves reflected from the ionosphere (see ch. IX, p. 317).
- (3) World War II cooperative research program by the Radio Section and others on correlation of direction-finding errors with ionosphere measurements (see ch. IX, pp. 318-319).

\*A very brief and generalized account of the work by Taylor and Voorhees was given in the April 15 and 19, 1919, issues of the Bureau of Standards Confidential Bulletin.

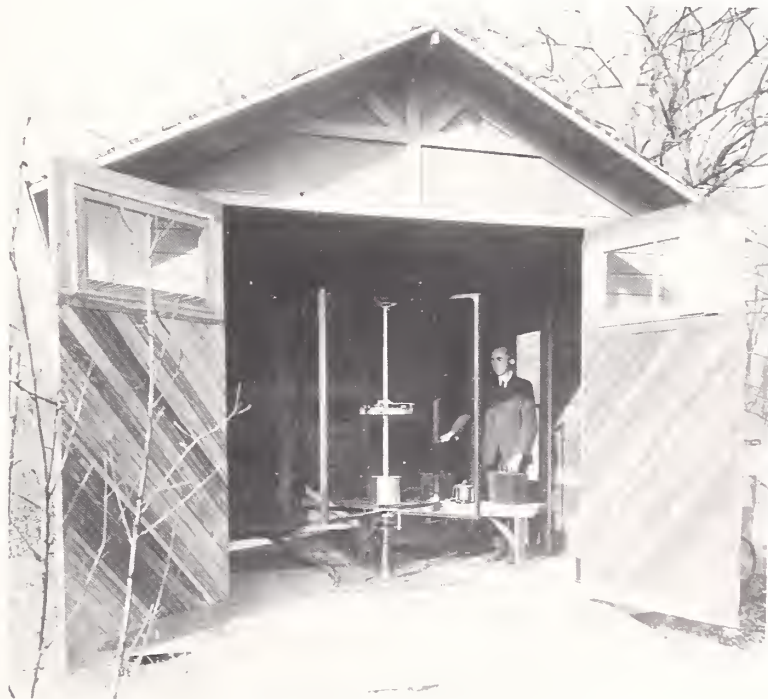

*Direction finder at Kensington, Md. field station in 1919, being operated by L. E. Whittemore. A cooperative program (engaged in by L. E. Voorhees) with the Navy revealed large errors in directional bearings caused by the ionosphere. The received signals were from transmissions of long wavelengths (e.g., 13,600 meters, or 22 kHz).*

1. Naval Aircraft Laboratory.

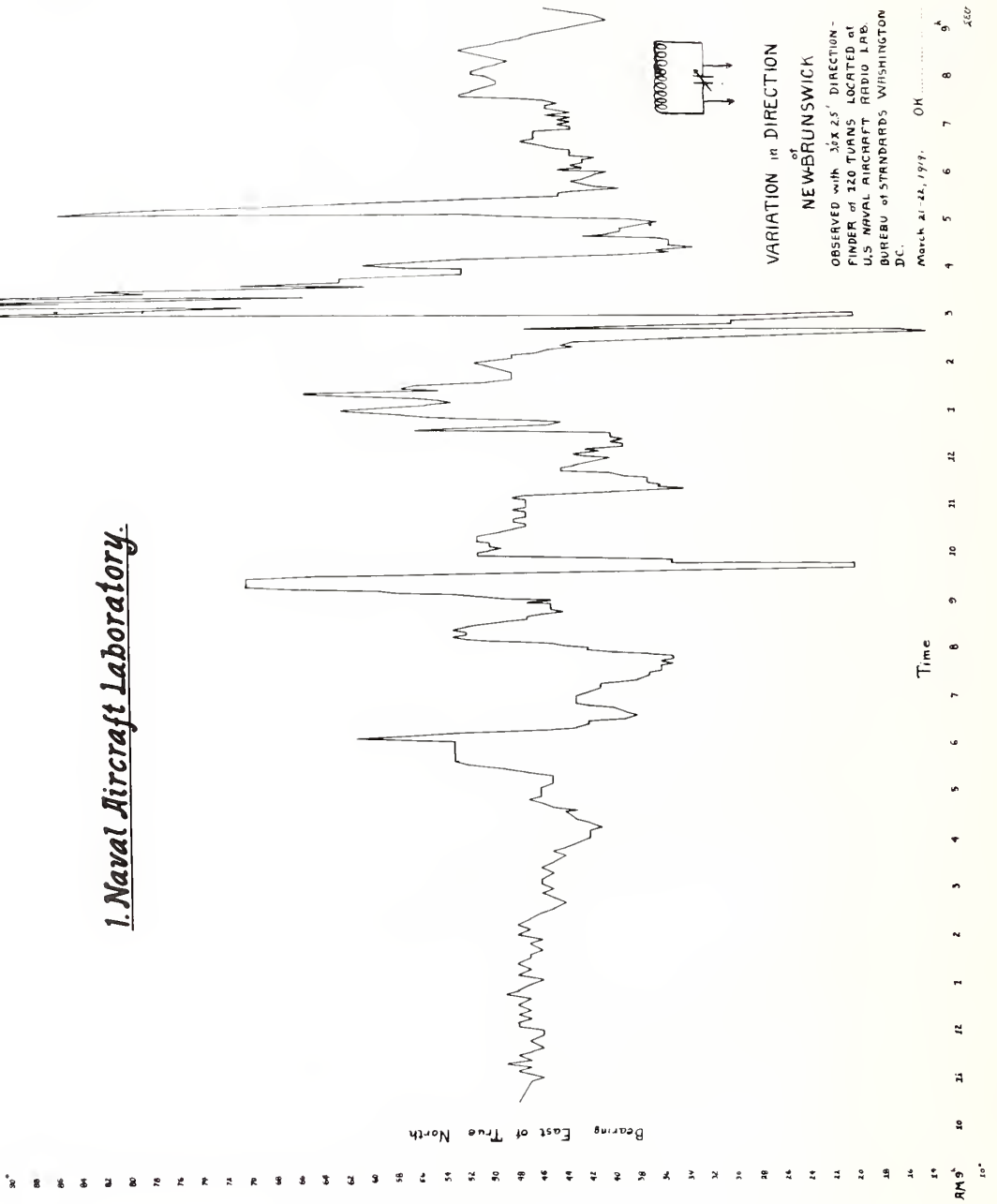



## 2. B.S. Field Station.

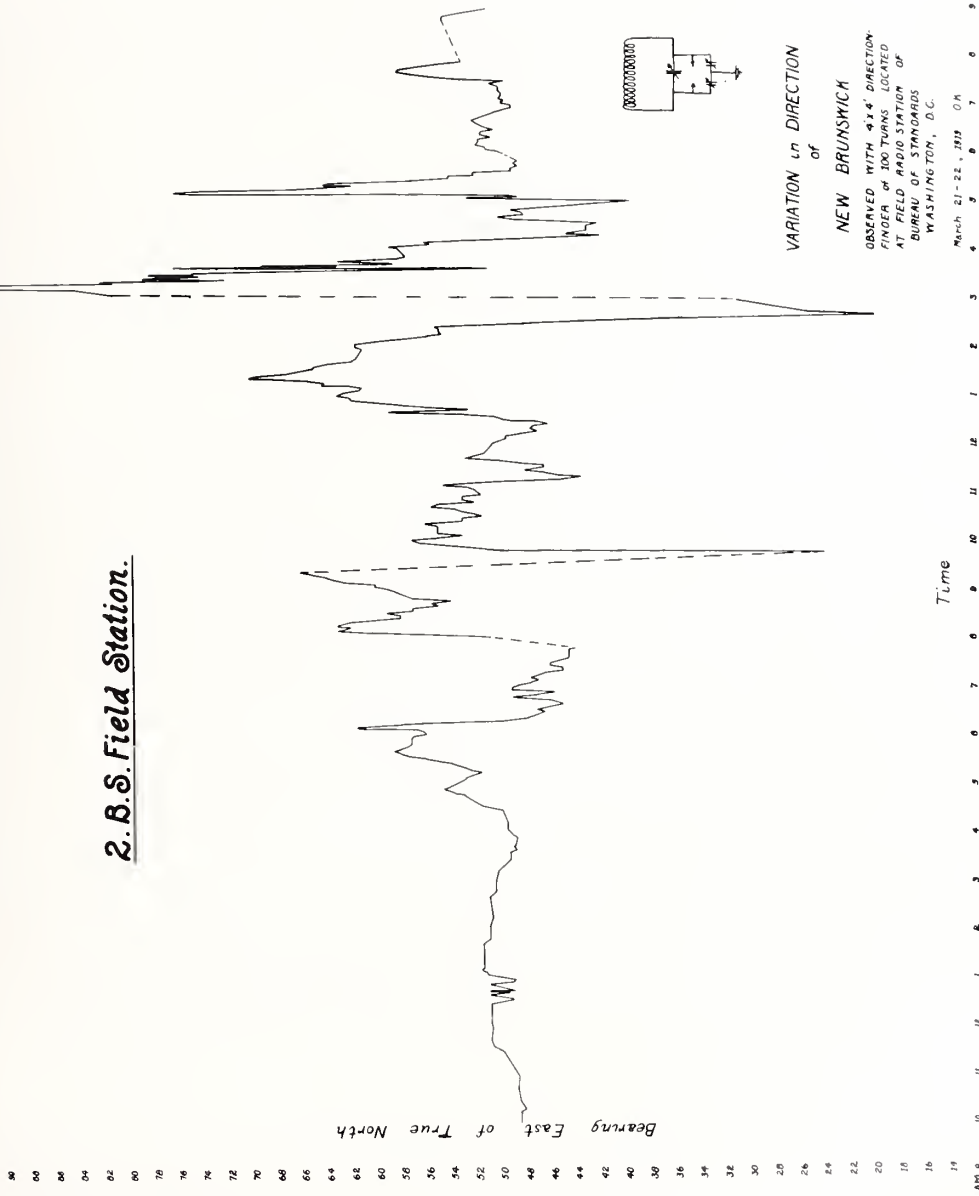

This pair of graphs of the variation of direction-finder bearings was made from observations on the night of March 21-22, 1919; one set at the Naval Aircraft Radio Laboratory on the Bureau grounds, the other at 5 miles distance at the Bureau's field station, Kensington, Md. Comparison reveals close agreement in bearings, yet the bearings are much in error (up to 50 degrees) on occasion. The postulated cause of bearing errors was an effect of the ionosphere.

## 2. Fading tests as a cooperative program

The fading or variation of intensity (sometimes called the "swinging" of radio signals) associated with night reception was a commonly experienced characteristic of radio signals from the time of Marconi's observation in 1902. The cause of fading was the source of error in the direction finder bearings observed by Taylor and by Voorhees in March 1919. It is apparent from the writings and early propagation work of Dellinger that this subject had a fascination for him as well as creating a deep-seated desire to better understand the physics of the phenomena involved.

During the fall of 1919 and extending into the winter, some transmission tests were made, as a cooperative project with the Johns Hopkins University, between Baltimore and Washington, a distance of about 40 miles. Unmodulated and modulated waves at 820 meters (375 kHz) were used. Although the tests were made to check transmission formulas, apparently nothing unexpected resulted from the tests.

### a) THE INITIAL FADING TESTS

In March 1920 correspondence began with the American Radio Relay League (A.R.R.L.) on a cooperative project to observe radio transmission phenomena, and particularly that of fading. On April 7 a conference was held with officers of the A.R.R.L. to plan the project. Previously, the Bureau and A.R.R.L. had independently been contemplating a cooperative and large-scale approach to observe the effects and to study the possible causes of fading. For the Bureau the program was under the guidance of Dellinger, L. E. Whittemore,<sup>13</sup> and S. Kruse.<sup>14</sup>

Fading was a common occurrence at the longer distances at the amateur wavelengths below what became the broadcast band. The first round of tests took place in June and July 1920. Among the amateurs these were known as the QSS tests.<sup>15</sup> The test region was confined to the northern part of the United States east of the Mississippi Valley. The first tests were hampered by summertime static. Seven transmitters (five spark and two electron tube), operating at 250 meters (1200 kHz), at widely separated locations were used, with 51 recording stations spread over the entire region. The typical receiving station was a regenerative receiver with two stages of audio amplification. A standardized form was used by each recording station to indicate the degree of fading by drawing a curve on a scale of 10.<sup>16</sup> Weather data were also noted. All transmissions started at 10 p.m. E.S.T. by listening to the time signals from the Navy Arlington station—NAA.

It fell to the lot of Kruse to analyze the recorded data. The average distance of received signals was 400 miles. There was no definite correlation of fading characteristics on a time scale in terms of the observations of a single transmitter by a number of receiving stations. However, three definite patterns of fading were observed: (1) a very abrupt type, appearing mainly in New England, (2) a less rapid and less abrupt type that was general over the entire region, and (3) a very slow type that was general. There was no definite relation of transmission characteristics to the weather. Kruse reported the initial tests of the program in the September, November, and December 1920 issues of *QST* (the official organ of the A.R.R.L.).

---

<sup>13</sup> Laurens E. Whittemore, an instructor of Physics at the University of Kansas, joined the Bureau in July 1917. After taking a very active part for 6 years in the affairs of the Radio Section, he transferred to the Department of Commerce on September 14, 1923, to become the full-time secretary to the Interdepartmental Radio Advisory Committee (IRAC). Less than a year later he transferred to the Bureau of Navigation within the Department. Later, he joined the American Telephone and Telegraph Co., becoming staff engineer. Whittemore was vice president of the IRE in 1928.

<sup>14</sup> (Robert) S. Kruse entered the Radio Laboratory on February 24, 1919, and resigned February 17, 1922, to become technical editor of *QST*, the official organ of the American Radio Relay League. Later he became a consultant and technical writer.

<sup>15</sup> As a question, the abbreviation QSS is "Are my signals fading?"; as an answer it is "Your signals are fading."

<sup>16</sup> The recording signal intensity ranged from no signal to very strong. The signal format was, after sending the alert signal of *QST* (have you received the general call?), the words "Bureau of Standards ARRL fading test," then the letters of the alphabet, each repeated five times, the entire alphabet repeated five times, first forward and then backwards.

## b) FADING TESTS ON A QUARTERLY SCHEDULE

With some degree of progress and with further improvements in the testing procedure fading tests were conducted in October, then in January and April of 1921. It was on November 2, 1920, that KDKA initiated commercial broadcasting on a scheduled basis. Interestingly, its chief engineer, Frank Conrad, was operating station 8XK at Pittsburgh on 250 meters, using electron tubes, as a participating transmitter in the Bureau of Standards and A.R.R.L. fading tests.

Transmissions at 200, 300, and 325 meters were added to the tests, also transmissions at sunset and at noon on special tests. Several methods of synchronizing the signals of pairs of stations were tried in order to compare the fading of signals from two nearby sources.

Dellinger, Whittemore, and Kruse reported the fading tests in 1923 in a *Bureau of Standards Scientific Paper* [6]. The general conclusion reached was

that fading is caused by variations in the absorption of radio waves as they travel along the Heaviside surface. Fading and very great transmission distances with short waves occur only at night, because in the daytime the waves do not reach the Heaviside surface. The variations are apparently so local in their character that the transmitting or receiving area over which the fading is uniform is very small indeed.<sup>17</sup>

## c) WRITING ABOUT THE IONOSPHERE

Two years before the paper by Dellinger, Whittemore, and Kruse was published as a *Bureau of Standards Scientific Paper*, Dellinger and Whittemore had a paper on fading published in June 1921 in the *Journal of the Washington Academy of Sciences* [7]. This paper had been presented before the Philosophical Society of Washington on January 29, 1921. The topic covered in this paper makes for interesting reading after a time interval of more than 50 years. One is taken back to a time when little was known of the ionosphere—not even direct evidence of its existence. Yet the Bureau-A.R.R.L. fading tests indicated the effects of a “Heaviside surface” that had much to do with long distance transmission of the shorter waves and with the fading of signals. Dellinger and Whittemore stated:

The theory here given may only be a rough approximation but it has the advantage of giving a clearer picture than has been available. The interrelation of radio phenomena and the atmosphere’s electrical condition is very close. Subordinate in importance to the atmospheric conductivity are the other electrical properties, the solar constant, and the terrestrial magnetic and meteorological conditions.

After stating the “complexity of the problem,” they said:

. . . A complete study of the problem would require about 500 separate researches, each of them on a large scale. The completion of some of these researches would cost millions of dollars . . . .

This statement, made in 1921, viewed in retrospect was, indeed, an understatement in terms of the magnitude of the researches that were to come both from the Bureau and outside.

---

<sup>17</sup>In the early 1920’s the term “Heaviside surface” was used by the Radio Section. Later, at about 1930, the more universally used term “Kennelly-Heaviside layer” came into the Bureau’s publications. Dellinger in writing on radio transmission commented in the February 1926 issue of *Radio News* on “Facts and fancies of radio wave transmission,” that:

Heaviside did not know much about the phenomena of radio wave propagation and did not postulate a layer. What he did do was very valuable and still stands, namely, the suggestion that at a certain height in the atmosphere a conducting surface can exist which can effect and assist the propagation of radio waves. Beyond this he did not go, and it seems to me that the expression “Heaviside surface” is in accordance with Heaviside’s ideas, but that the expression “Heaviside-layer” is not. Since, furthermore, the recent theories of Larmor and of Nichols lead to the existence of numerous levels rather than a single level in the atmosphere which facilitate the propagation of waves at particular frequencies, even the expression “Heaviside surface” is no longer very useful.

After a discussion on "Intensity and fading of signals at night," the authors said:

This theory of night wave transmission is strikingly like the explanation of the flight of the projectile from the German long-range gun. In both cases it is now realized that there exists a region of the upper atmosphere of surprising low opposition or resistance.

This analogy led to a most interesting newspaper article by Dellinger, published in 1925.<sup>18</sup>

#### d) A STUDY OF CONDITIONS AFFECTING DISTANCE RANGE

A broadcast listener of the early 1920's soon became aware of the vagaries of radio transmission such as: fading, interference, and atmospheric disturbances. In pursuance of further studies on fading the Radio Section took a new approach, that of a statistical observation of a single broadcast station. The pioneer station, KDKA, operated by the Westinghouse Electric and Manufacturing Co. at East Pittsburgh, Pa., was selected as the transmitter. C. M. Jansky, Jr., consulting radio engineer, and a member of the Radio Section

---

<sup>18</sup> During the early years of broadcasting many popular and semi-popular feature articles appeared in the newspapers, and especially on the "radio page" or in supplements. The larger papers had their radio editors. Over Dellinger's name in a lengthy article in the *New York Times* of Sunday, September 13, 1925, appeared the headline:

"Hope to Cure Fading By Corkscrew Waves" with the subtitle: "Concerts Shot High Into the Sky, Like Long-Range Gun That Bombarded Paris, May Overcome Wavering Signal Intensity—Radio 'Roof' Discussed."

Dellinger possibly wrote the headline but it is doubtful that he composed the subtitle—newspaper editors have their stratagems of catching the eye of the reader.

The most interesting portion of this newspaper article is that section in which Dellinger said:

In 1920 the Bureau of Standards introduced the idea that waves may be transmitted either along the earth's surface or along the upper atmospheric conducting surface, and used this idea to explain the superiority of long waves in the day and shorter waves at night, and also worked out from this an explanation of the prevalence of fading and great transmission distances at night. This explanation, published in 1921, cleared up many of the peculiarities of radio transmission that had previously been a mystery. It was the basis of the numerous discussions of the double transmission path (ground waves and upper air waves) which have appeared since.

The simile of a radio roof or ceiling of the sky, with waves reflected as from the dome of a whispering gallery, was not used in the bureau's explanation and does not give a true picture of what happens. Probably a better picture is that set forth in the original publication, radio wave transmission being compared with the German long-range gun which bombarded Paris at a distance of seventy miles.\*

\*This long-range gun of 8.26-inch caliber, built by the Krupp works, was used by the Germans to fire on Paris during the spring of 1918 from a distance of 76 miles. It was often referred to as "Big Bertha," a name used previously by the Germans for a large howitzer-type gun.

The rarefied higher portions of the atmosphere which permitted the projectile to fly toward Paris with little resistance played the same role that the upper electric strata of the air play in radio transmission as by their particular conditions of ionization they permit radio waves of particular frequencies to travel enormous distances around the earth. And just as the Germans aimed the gun at a very high elevation so as to put the projectile quickly up into the little resisting portions of the atmosphere so we are nowadays using new forms of antennae to shoot high frequency radio waves upward instead of starting them out horizontally.

Reading Dellinger's article a half-century later leaves one in a quandary. There is no evidence that the Radio Section had been experimenting with antennas in the early 1920's that would radiate radio waves in a manner to simulate the launching of a projectile from a long-range gun. Such an antenna would be of the helical type, first developed in 1947 by Kraus.\*\* With such an antenna it is possible to radiate a circularly polarized radio wave whose plane of polarization will rotate in a corkscrew fashion and with a narrow-beam directional characteristic or "trajectory." Secondly, the passage of time has indicated that use of a circularly polarized wave, propagating in a corkscrew fashion, has no particular merit in overcoming the effects of fading of radio signals. It was learned some years later, by several investigators, that the Earth's magnetic field reacts with radio waves and rotates the plane of polarization during propagation in the ionosphere.

In retrospect, we should probably view Dellinger's hope of curing fading by radiating corkscrew waves as "hopeful" thinking.

\*\*The end-fire long helical antenna was invented by Kraus in 1947. See: John D. Kraus, "Helical beam antenna," *Electronics*, Vol. 20, Apr. 1947, pp. 109-111.

staff at intermittent periods during the early 1920's, conducted the study.<sup>19</sup> Cooperating in the project was the Westinghouse Co., the A.R.R.L., and the University of Minnesota.

Approximately 100 observers, at various directions from the station, made more than 8000 observations of transmissions from KDKA over the period from August 1, 1922, to August 1, 1923. Data were logged on two special forms with more than 20 categories of information requested. First transmissions were at 833 kHz (360 meters) and later transmissions on the reallocated frequency of 950 kHz (316 meters), at a power of 1000 watts to the antenna. Most observations were analyzed and evaluated on a monthly basis. It was not unexpected to find that atmospheric disturbances were strongest during the summer months. Magnitude of fading was fairly uniform throughout the year, but with some indication of an increase during the fall months. Of most significance was the clear indication that at distances from 100 to 200 miles the signals were less reliable than at lesser distances and at greater distances (from 200 to 450 miles). This verified the opinion "that signals from distant stations are often of greater intensity than signals from stations of similar power but located comparatively near the observer, has often been expressed" [8].

#### e) PLAYING A ROLE IN AN ARCTIC EXPEDITION—1923-1924

The MacMillan Arctic Expedition of 1923-1924 was fitted with the first short-wave radio equipment (200 meters) for use in the arctic region. The 80-foot schooner *Bowdoin* plied arctic waters for more than a year and wintered in northern Greenland. With the increasing interest in radio wave propagation and, particularly, the fading and distance tests, this expedition gave opportunity for observation in a polar region.

Dellinger represented the Bureau on the Committee on Earth Currents and Polar Lights, American Geophysical Union, for study of fading and the effect of the aurora on radio signals. In cooperation with the American Radio Relay League and the Department of Terrestrial Magnetism, Carnegie Institution, the Radio Section gave data handling assistance to the Expedition for observation of radio propagation.

Observations in the Greenland region, mainly at 200 meters, indicated that fading was bad at all times and that reception of signals was less in distance when the Sun's path was above the horizon. There appeared to be no effect on radio signals by the aurora.

#### f) THE COOPERATIVE FADING PROGRAM OF 1925

At a period when manpower in the Radio Section was near a low point and interest in radio wave phenomena was running high, the personnel roster was bolstered by the addition of a worker, T. Parkinson, as a research associate.<sup>20,21</sup> During 1924 a cooperative project was set up that included 23 laboratories selected as observation points to record special transmissions from the broadcasting stations WGY (General Electric) at Schenectady, N.Y. and KDKA (Westinghouse) at East Pittsburgh, Pa. This was a large-scale program from which it was expected to obtain much new information on the puzzling aspects of fading phenomena. The recording stations ranged from the island of Bermuda to Lincoln, Nebraska, and from Washington, D.C. to Ottawa, Canada, but were concentrated in the northeastern section of the United States.

The recording method used was that developed by G. W. Pickard several years earlier. The majority of the observers used a superheterodyne receiver with rectifier output, and a galvanometer recorder with paper tape on a revolving drum. (The recorder was a development of H. S. Shaw, who financed the research associate program in the Radio Section.)

---

<sup>19</sup> C. M. Jansky, a professor of radio engineering at the University of Minnesota, was a member of the Radio Section as a consultant at irregular periods during the early 1920's. He was president of the Institute of Radio Engineers in 1934. With S. L. Bailey, he formed the radio consulting firm of Jansky and Bailey in 1930 at Washington, D.C. He has engaged as a radio consultant in many Government operations and conferences.

<sup>20</sup> The term "Radio wave phenomena" was used extensively by the Radio Section during the 1920's as the subject or title to cover the projects on fading, distant reception, atmospheric, etc.

<sup>21</sup> Taintor Parkinson entered the Radio Section as a research associate on February 6, 1924, and remained until February 15, 1930. His salary, until July 1928, was paid by the American Section of the International Union of Scientific Radio Telegraphy (URSI) with the financial support from a radio engineering enthusiast, H. S. Shaw, Jr., of Newton Center, Mass. and later of Exeter, N.H.

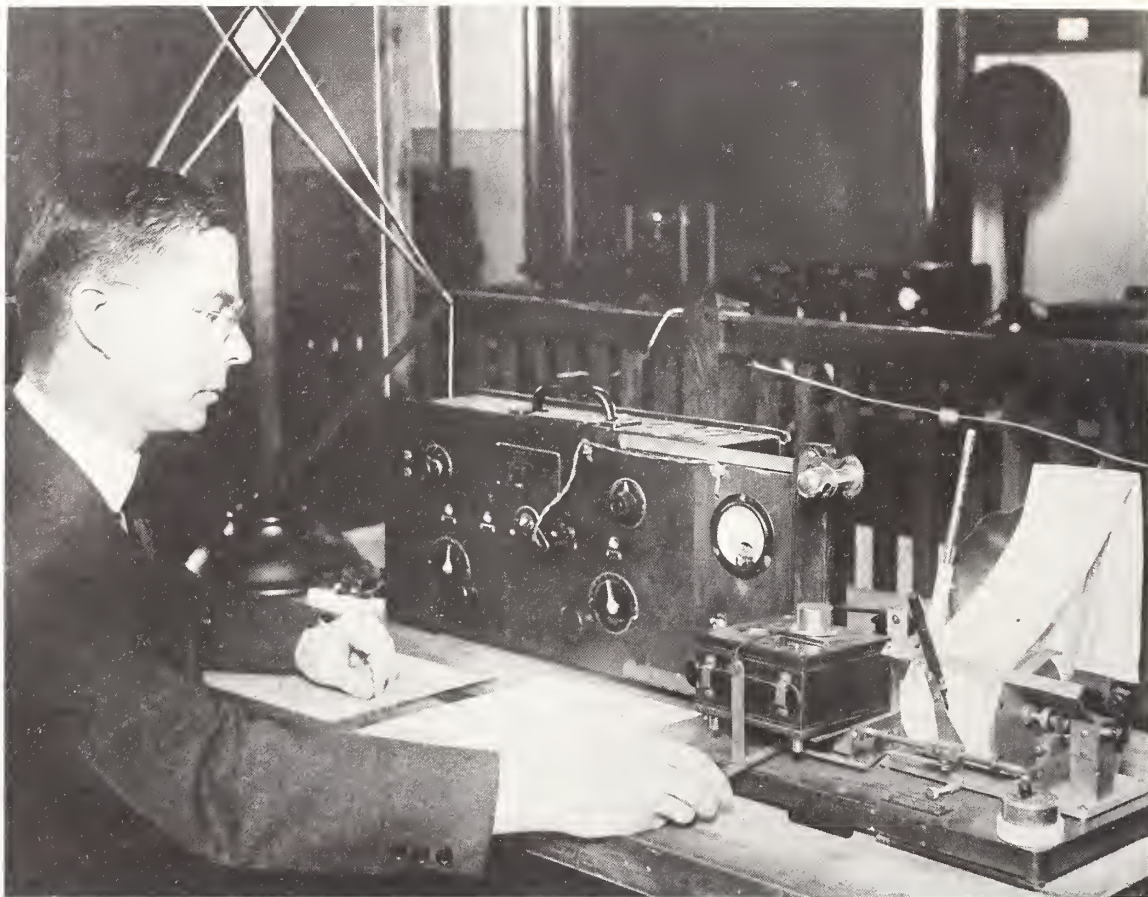

*Taintor Parkinson recording the fading of radio signals in 1926 with portable-type equipment. He was employed in the Radio Section for 6 years beginning in 1924, first as a research associate, then as a Bureau employee. Salary for more than 4 years was paid by a benefactor, the funding administered by URSI (see footnote 21, p. 183). Parkinson engaged in transmission studies, particularly fading phenomena.*

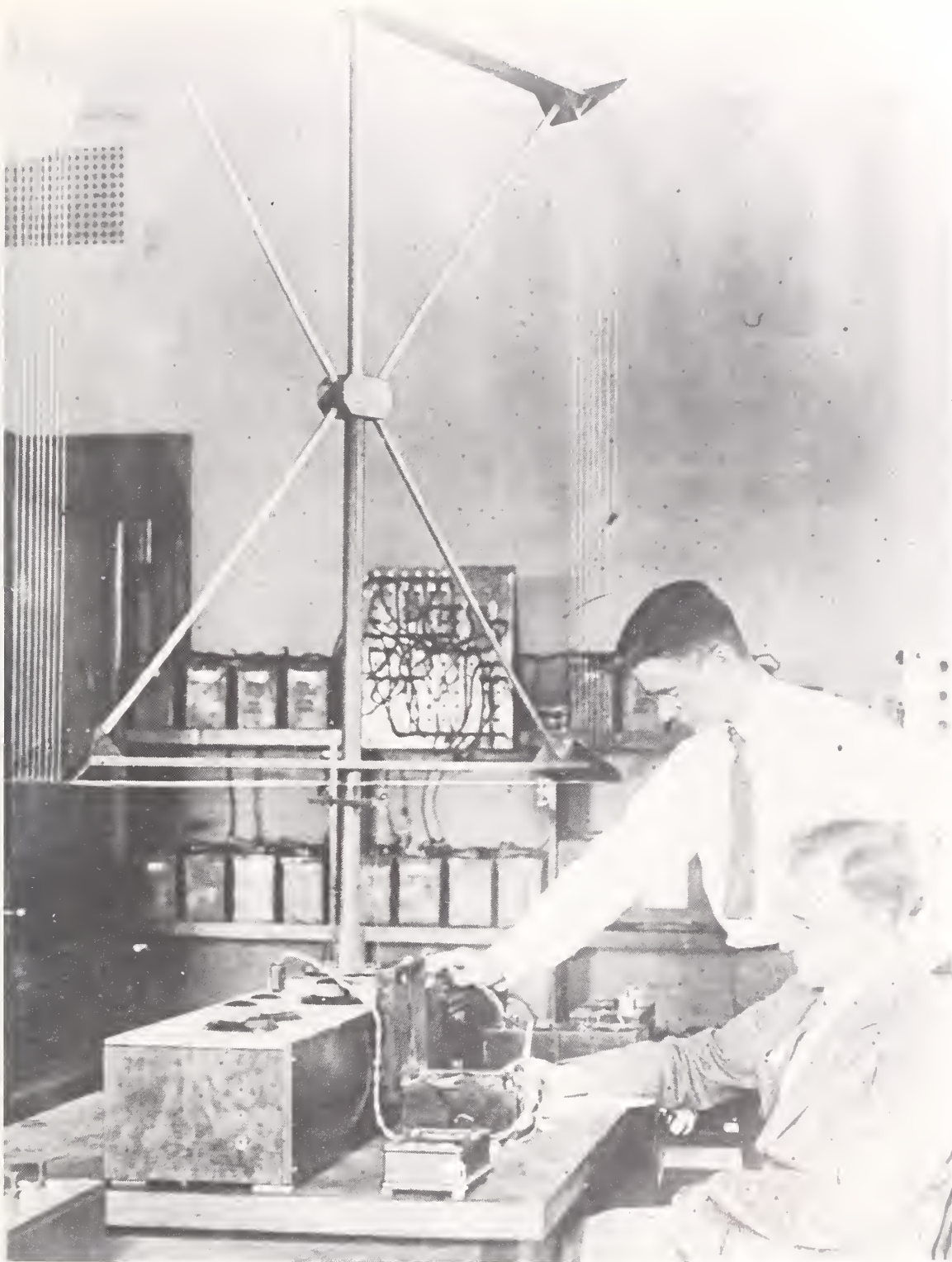

*Dellinger (seated) and Taintor Parkinson measure the field strength of a distant high-power radio station with early-type equipment. Use of a loop antenna was considered "standard" procedure for making such measurements. Photo taken September 4, 1925. A year later the Radio Section developed its first field-intensity (strength) meter (see ch. V, p. 111).*

## 1) Radio waves and a solar eclipse

On the morning of January 24, 1925, there was a total eclipse of the Sun across southern Canada and northeastern United States, with 95 percent totality in Washington, D.C. With the public interest in radio broadcasting and the special interest of engineers in radio wave propagation, it was relatively easy to stir up enthusiasm and cooperation for the first large-scale observation of the effects that a solar eclipse can have on propagation. Certain effects had been predicted more than a decade before. Under the general direction of G. W. Pickard, a consulting engineer of the Wireless Specialty Apparatus Co. of Boston, Mass., a number of radio stations, many laboratories, and many broadcast listeners (associated with a project sponsored by the periodical *Scientific American*) took their parts in the cooperative program [9,10]. Staff members of the Radio Section played their roles in preparing observation forms, enlisting the cooperation of laboratories, and in taking assignments for the Bureau's observations of the radio phenomena associated with the eclipse.<sup>22</sup>

The result of the many observations confirmed the expected effects; that a total eclipse brings on a condition of the ionosphere that is intermediate between daylight and nighttime transmission and is akin to the conditions of sunset and sunrise.

## 2) A potpourri of fading tests during 1925, 1926

Following the eclipse tests, fading observations during sunset periods were made in the Bureau's program during four 10-day periods spread at intervals over the calendar year. In December 1925, a 24-hour run was made of WGY (Schenectady, N.Y.) operating on 790 kHz. Also, in August, station WGY was used to determine if fading fluctuations were affected by transmitting power. With a power ratio of 50 to 2.5 kW there was no evidence of any effect of high power on fading.

Observations were made on a number of radio stations at different distances, some from the Kensington field station, some by a mobile receiver-recorder installed in a new automobile truck. Other laboratories in the cooperative program were making similar observations, to be analyzed and correlated with the Bureau's observations.

For several months recordings of transmissions of four Philadelphia broadcast stations were made at noon and night at the Kensington site. The four stations were operating as two pairs in synchronized operation at frequencies of 590 and 760 kHz. No definite conclusions were reached on the fading characteristics of four transmissions over a common land path (the night transmission paths could have differed to some extent).

By 1927 Dellinger, Jolliffe, and Parkinson had the data of the 23 cooperating laboratories organized and analyzed, and had reached some definite conclusions on the nature of the transmitting medium that had so recently come to the notice of the many millions of broadcast listeners. Without a doubt these conclusions had a definite impact upon the thinking of the Radio Section and on the programming of the propagation projects for years to come. An insight into the viewpoint of a half century ago can be gleaned from a reiteration of these conclusions [11].<sup>23</sup>

---

<sup>22</sup> In the spring of 1918 (during World War I) the Department of Terrestrial Magnetism, Carnegie Institution of Washington, proposed a cooperative program with the Radio Laboratory to make radio observations of the total eclipse of the Sun of June 8, 1918 (crossed the United States from State of Washington to Florida). Dellinger noted in the weekly report of May 20-25, 1918: "that we could not undertake observations during this eclipse, but that similar work would be very desirable to take up in the future and should be done upon a cooperative scale with other institutions." The Radio Section would have to wait 7 years until it took part in the observation of a total eclipse.

<sup>23</sup> 1. There is a degree of regularity in the average intensity during conditions of fading which has not hitherto been suspected. The ratio of average night to day intensity has a logarithmic relation to distance. This relation gives quantitative indication that the earth absorption effective in the daytime disappears at times at night and permits calculation of the absorption coefficient.

2. There is a series of maxima and minima of fluctuation with respect to distance from the transmitting station. The first maximum occurs at about 100 km.

3. The preceding conclusions, taken together with the dying away of the ground-transmitted wave, indicate that the fading of several minutes period is due to variable absorption in the upper atmosphere, and that the fading of several seconds period observed at distances less than about 200 km is largely due to interference between the ground-transmitted wave and the wave



By 1927 the multi-laboratory program on the fading tests of 1925 was analyzed and published. Although a number of conclusions had been reached (see footnote 23) from the cooperative program, Dellinger and his associates must have realized that they were but

which has traveled to the Kennelly-Heaviside layer and undergone variable changes of intensity, phase, and polarization.

4. There is some evidence of correlation between direction shifts and fast fading. This corroborates the conclusion just stated as to the role of interference in producing the fading of several seconds period, since some of the same interference effects would also be manifested as direction shifts.

5. The average of a number of records made on several days at any receiving locality during the sunset period shows a rise in average intensity, starting about an hour before sunset, then (with the exception for north-south transmission noted below) a decrease slightly before or during sunset at the receiving point, and then a rise to a night value, reached usually an hour or two after sunset. This value may not be the night maximum, which may occur many hours later. In case of north-south transmission the limited evidence is that there is no lessening of the rate of increase during the sunset period. All of this is in accordance with a theory advanced by Kennelly and by Nagaoka.

6. There is similarly an increase in the fluctuation, beginning about one hour before sunset, usually with a decrease at or near sunset at the receiving point, and then an increase to a night value, which also fluctuates.

7. Except for the general diurnal correlation just stated, there is no correlation between intensity and fluctuation changes.

8. The maximum diurnal intensity appears at about the same time (during the three hours just preceding sunrise, in December) at all receiving points within 500 km of the transmitting station. (This conclusion is based on a single 24-hour observation period).

9. There is no consistent correlation between fading and weather conditions, as shown on weather maps covering the test periods.\*

10. There is sometimes a special periodic type of fading, beginning about 15 to 20 minutes after sunset, of great regularity, the periodicity of which shows a correlation with the distance between the transmitting and receiving points, and which is evidently due to an interference phenomenon.

11. The effect of a solar eclipse is to produce fading conditions intermediate between those of night and day, similar to sunset conditions.

12. Changes of transmitting power do not affect the characteristics of fading.

\*Author's (WFS) note: There was fairly widespread belief during the 1920's that radio transmission at broadcast frequencies was affected by weather conditions. One tenet held by some observers was that the strength of signals and fading characteristics were related to the patterns of barometric pressures over the transmission path. But known to every broadcast listener was the fact that reception was clear and distant reception was good in the absence of atmospheric disturbances or "static." Many years later we were to learn that atmospheric conditions do affect the transmission of radio waves of very short wavelength.

<sup>24</sup> During the period from 1927 to 1944 the Radio Section used for the various titles of its major project on the transmission of radio waves the following:

Radio wave phenomena (used earlier for some of the fading tests)  
 Study of radio fading, atmospheric and related phenomena  
 Character and cause of variations of radio wave intensity and direction  
 Character and cause of variations of radio wave intensity  
 Variations of radio wave intensity  
 Radio wave intensity

<sup>25</sup> Beginning in 1930, a major project on the ionosphere was set up in the Radio Section (see p. 206). Thereafter, because of the closely related nature of the two major projects of the "ionosphere" and the "transmission of radio waves," the subjects of: laboratory operations, personnel assignments, and reporting of progress, often interlinked the two major projects. This close relationship and interlinkage of the two major projects continued through the years until the programs changes after 1944. It was aptly expressed in the Annual Report of 1940:

The processes of radio wave transmission continued to be investigated by continuous recording of radio wave intensities from distance stations and by vertical-incidence ionosphere measurements. These two types of investigation complemented one another in supplying information on the physical structure of the ionosphere and on applications to practical radio transmission problems.

scratching the surface of a great body of knowledge of the transmission medium that surrounded the Earth. So it was that in the winter of 1927-1928 they took stock of what they had been learning and made plans for future programs. As a result, the Radio Section brought out a special series of reports entitled, "Monthly Report on Status of Work on Radio Wave Phenomena." Beginning with the January 1928 report, these were distributed for the next 3 years to the laboratories that cooperated in the 1925 program. The reports had no status as a Bureau publication.<sup>26</sup>

The first and rather lengthy report was prepared by Dellinger. Thereafter, the monthly reports were written by T. Parkinson, the section's research associate and later a Bureau employee.<sup>27</sup> Included within the broad program of this major project was the development of field intensity instrumentation and measurement techniques (see ch. V, pp. 111-112). In the main stream of activity by 1928 were those projects relating to fading that came as an outgrowth of the cooperative measurements conducted in 1925 and published in 1927 (see pp. 183-187).<sup>28</sup> These projects covered a variety of investigations. Dellinger stated that this program

has for its aim the increase of knowledge of radio wave transmission phenomena, the development of methods and apparatus for their measurement, and the promotion of cooperative study of the problems involved.

Before the year 1928 closed out a related but new and vigorous program was underway—that of studying the ionosphere itself as a medium of transmission.

## 1. Equipping for transmission measurements

### a) FIELD STATIONS—ONE, TWO, THREE, FOUR, FIVE, SIX

By the mid-1920's only a limited amount of instrumentation was at hand in the Radio Section to make observations of radio transmissions. There were further limitations when used for observation of weak signals when operated on the Bureau grounds because of local interference. By 1926 the Section's Chevy Chase Experimental Station on the Brookville Road in Chevy Chase, Md. proved inadequate for the newer programs and a site was selected on a farm near the (then) small community of Kensington, Md., 5 miles to the north of the Bureau grounds.<sup>29,30</sup> The new site offered much in the reduction of manmade interference although it was no escape from atmospheric noise.<sup>31</sup> The new site was occupied in May 1926 and was developed for a variety of projects, with several small buildings constructed to house equipment, plus a selection of antenna structures.<sup>32</sup> By September equipment was installed for making fading records.

<sup>26</sup> A complete set of the reports, extending over a period of 3 years, is contained in the Radio File.

<sup>27</sup> See p. 183 and footnote 21.

<sup>28</sup> In the first of these monthly reports, dated January 31, 1928, Dellinger had stated that by the end of 1926 it appeared that further problems in fading could be attacked most fruitfully by laboratories working more independently than in 1925. On November 1, 1926, the Bureau sent to each of the cooperating laboratories a suggested program of semi-cooperative research entitled "Some Problems of Radio Wave Phenomena Requiring Observations." Six problems were enumerated—all six were investigated by the Radio Section. The cooperation was largely that of broadcasting stations supplying special broadcast transmissions in addition to their scheduled programs.

<sup>29</sup> Almost nothing appears to have been recorded on the use of a field site in or near Kensington, Md. 5 1/2 miles to the north of the Bureau grounds. However, there is evidence that the site was in the Capitol View subdivision and near the present junction of Stoneybrook Drive and Capitol View Avenue to the southeast of Kensington. The site was used during 1919 for study of coil antennas, primarily as radio direction finders. This was the first of many field sites to be used or established by the Bureau in many parts of the world for the next 50 years for radio investigations.

<sup>30</sup> A field site with antenna masts and a small wooden building was erected early in the summer of 1921 on the Brookville Road near Shepard Street (to the northeast of Chevy Chase Circle, approximately 3 miles airline distance from the Bureau site), Chevy Chase, Md.

<sup>31</sup> On September 19, 1925, the Bureau issued Letter Circular 182 entitled, "Electrical interference with radio reception." Years later, after the formation of the Central Radio Propagation Laboratory, the Bureau made extensive studies of radio noise and interference.

<sup>32</sup> The Kensington field station was on Saul Road to the west of Connecticut Ave., the location being in the southwestern part of the suburban town of Kensington, Md.

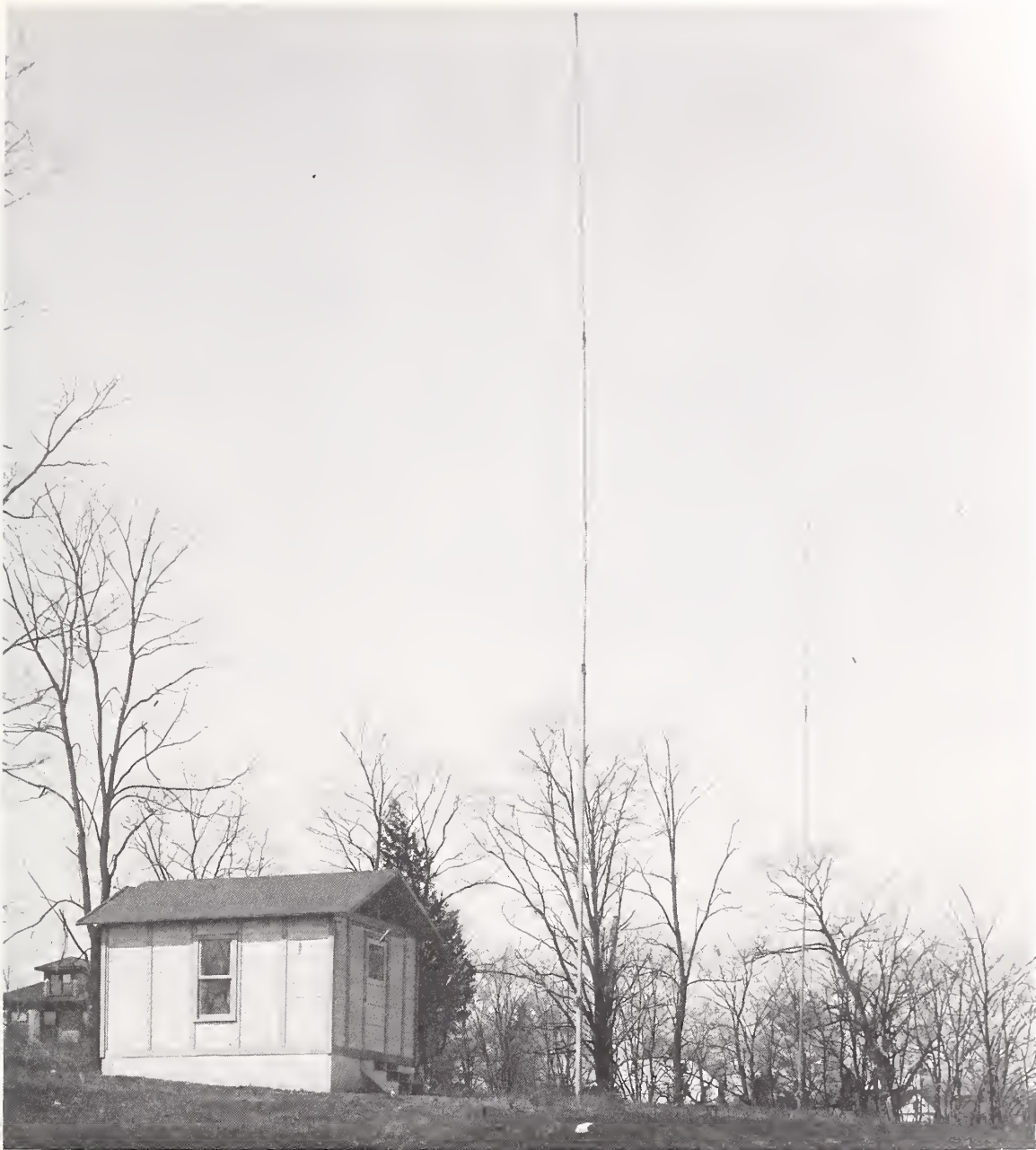

*Field station located on Brookville Road near Shepard St. (northeast of Chevy Chase Circle), Chevy Chase, Md., approximately 3 miles from Bureau grounds. The site was used for several years beginning in 1921.*



*On July 23, 1926, Dellinger (left) and Crittenden (chief of Electricity Division) inspect the newly purchased radio truck at west entrance to East Building. The truck was to serve as a mobile laboratory for many years.*

An automobile truck (Stearns) was procured in the summer of 1926 and outfitted with receiving and recording equipment, accompanied by suitable antennas to serve as a "mobile" field station. The mobile laboratory not only allowed selection of distance from a transmitter but permitted a choice of "quiet" spots of low radio noise. This truck was the forerunner of the many that would be used by the CRPL for field operations many years later.

The rapidly expanding program in the study of radio transmission, augmented by the ionosphere program, brought on a need for more field stations. In 1931 two new field sites were selected, one near Beltsville, Md., primarily for transmitters, the other at Meadows, Md., primarily as a receiving station.<sup>33</sup> They were both occupied by the Radio Section in 1932. Gradually the facilities at Kensington were moved to these new sites until the station was abandoned in 1933.

---

<sup>33</sup> The Beltsville facility was located on the Experimental Farm of the Department of Agriculture, northeast of Washington and 13 miles northeast of the Bureau grounds. In December 1932 it became the site for Station WWV. Until abandoned in 1966, the site served many uses for the Radio Section.

The Meadows field station, located southeast of Washington and 14 miles southeast of the Bureau grounds, was used by the Radio Section until February 1943 when the facilities were moved to Sterling, Va., to the northwest of Washington. The 450-acre Sterling site was taken over by NBS in June 1943. The site later became part of Dulles International Airport. The Meadows station became a part of the site of Andrews Air Force Base.



*Air view of March 8, 1933, to a northerly direction, of the Meadows field station, near Meadows, Md., southeast of Washington, D.C. and 14 miles southeast of the Bureau grounds. The 200-acre site was owned and used by the Bureau from 1932 to 1943. Along the straight white strip (formed from burying the power cable) from center toward upper right can be distinguished faintly three small white frame buildings that housed equipment for transmission and ionosphere studies. Nearby are many wood poles that supported antennas. Entrance to site was from the upper right corner of photo. The former Bureau property is now centered on the runways of Andrews Air Force Base. At this airfield come and go high government officials of many countries.*

#### **b) RECEIVING EQUIPMENT**

As sources of radio transmissions the Bureau simply depended upon the many broadcasting stations and other transmitters that were available over the years. A number of these stations took part in the cooperative programs.

By the mid-1920's the Radio Section was fairly well equipped with receiving apparatus, including the Shaw-type fading recorders, for observing radio transmissions (primarily fading observations) on a relative scale, but lacked the capability of measurement of field intensity in terms of known electrical quantities (especially, today, as field strength in volts/meter). In 1926, at the request of the Department of Commerce, the section developed a field intensity meter for use by the Supervisors of Radio as a means of determining interference and measuring radiated power. From that time to the present the development of instrumentation for field strength has continued within the Bureau.

The radio wave transmission project benefited from the early developments of field intensity instrumentation. In the late 1920's commercial-type receivers, accompanied by recorders, served as instrumentation for fading measurements. By 1932 more sophisticated equipment was designed and assembled by Kenneth A. Norton and Stephen E. Reymer as a continuous recorder of field intensity. The equipment proved to be very useful in transporting in the special truck over long distances as a mobile laboratory for measurement of field intensity. The equipment had a frequency range of 540 to 20,000 kHz and a signal voltage range of 1 to 300,000 microvolts. Novel features were immunity to changes in power-supply voltage and a logarithmic scaling of the recorder. The latter

feature permitted the compression of enormous changes in field intensity to a single sweep of the recording pen. The complete system could be calibrated in terms of known values of field intensity. Four of the new recorder systems were installed at the Meadows field station.

## 2. Enter S. S. Kirby

The Section's Monthly Report of June 1926 stated, under the subject of Personnel:

Mr. S. S. Kirby joined the staff on June 12 as assistant scientist and will work on radio wave phenomena.

And thus began Kirby's extensive career with the Radio Section until his death in 1941, at which time the Monthly Report stated:

The Section suffered a severe loss in the death of Mr. S. S. Kirby January 16.

For a number of years Samuel S. Kirby pioneered in, and had immediate direction of, the two projects, "Transmission of radio waves" and "Ionosphere phenomena." He also was involved in related projects such as, "Radio field intensity." He was the author and coauthor of a number of published papers, as well as many of the section's unpublished papers. He was also a member of a variety of technical committees.

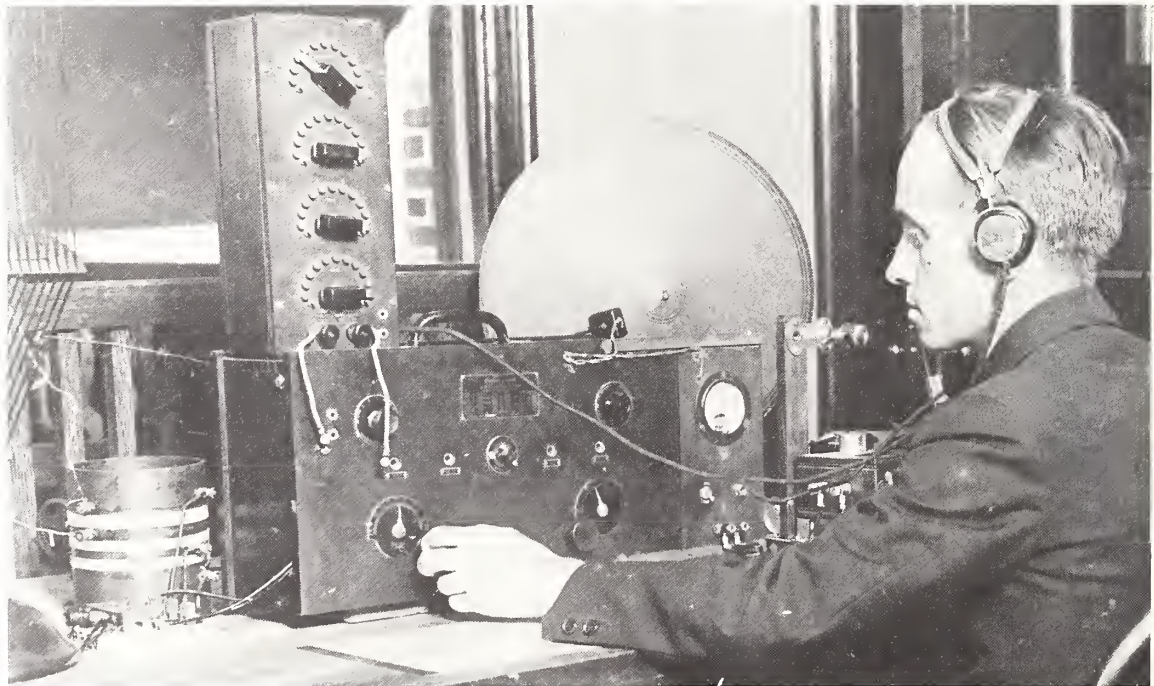

*Samuel S. Kirby observing the fading of radio signals. Photograph taken within a month after he joined the Radio Section in June 1926. In the next 15 years, until his death in 1941, Kirby took a major role in the study of radio transmission and the ionosphere. He was the father of Robert S. Kirby of the Central Radio Propagation Laboratory.*

### 3. The Radio Section initiates its own measurement program

During the 6-month period of January to June 1927 night observations were taken at the Kensington field station of signal reception from stations WJAX (890 kHz), Jacksonville Fla., and WBBM (1300 kHz), Chicago, Ill. The purpose was to determine possible correlation of field intensity with sunspot activity. Analysis of the data indicated definite correlation on the basis of 7-day-period averages of the field intensity with 20-degree central zone figures of sunspot numbers. It was satisfying to find the results in good agreement with the data of G. W. Pickard taken of the Chicago station at Newton Center, Mass. There appeared to be ample proof of a definite correlation of the intensity of night signals from distant stations and sunspot numbers.

### 4. A point of view in 1927

In the Annual Reports for the period of 1927 to 1929 the Radio Section expressed its programs and accomplishments with a rather predominating theme of the correlation of radio transmission with natural phenomena such as sun-spot cycles and the vagaries of the Earth's magnetism. Yet for quite a period the section published but little on its observations. However, an interesting point of view was written down by Dellinger that came into print in the spring of 1927 in the *Proc. IRE*. It was a discussion on a paper by G. W. Pickard published in the *Proceedings* with the title "The correlation of radio reception with solar activity and terrestrial magnetism."<sup>34</sup>

In writing on Pickard's paper Dellinger commented [12]:

Mr. Pickard's paper marks a definite step in advance in our knowledge of the mechanism of radio transmission. It is not generally appreciated to what an extent this question of radio wave vagaries is the outstanding problem of radio engineering today. It is not too much to say that this subject is the major and typical subject of the present era of radio development.

. . . We have no cure for fading, atmospheric disturbances, wave direction shifts, and other forms of interference and disturbances of reception. At the beginning of the decade (1921-1930) we did not even know what caused them. There was very little information as to the laws of their behavior, much less of the laws of their production. For those scientists and engineers who are concerned with fundamental progress, this subject of wave vagaries was clearly a problem which had to be met and so it has remained.

. . . Numerous investigators have been doing pioneer work and assembling much valuable data giving the characteristics of fading, wave intensities, atmospheric disturbances, wave polarization, etc., as a function of various conditions such as time of day and year, frequency, weather, distance, topography, terrestrial magnetism, etc. Among the numerous things that stand out as a result of this work, one conclusion of interest, is that there is no important correlation between radio conditions and weather. Among the principal elements of the new knowledge are the role of the ionized upper portions of the atmosphere and the phenomena of very high frequencies. . . .

It is not my purpose in a discussion of this paper to give a summary of the knowledge of radio wave phenomena as it stands today. . . . How fruitful it will be to have this demonstration that the variations of electrical condition on the sun give rise to some of the characteristic radio wave variations, only time can tell. It can certainly be concluded that it will give

---

<sup>34</sup>Pickard (a consulting engineer for the Wireless Specialty Apparatus Co. of Boston, Mass.) was very active in the study of radio transmission phenomena. During the 1920's the Radio Section carried on several cooperative programs with Pickard.

impetus to further studies and analysis not only of radio wave phenomena but also the phenomenon of related sciences such as terrestrial magnetism and astrophysics.

This was the point of view of Dellinger and his associates in the spring of 1927. Their contributions and of others to follow in the Radio Section and in the Central Radio Propagation Laboratory to the study of radio wave phenomena would unfold with the years.

### **5. Learning of fading at broadcast frequencies—Separating directional components, planes of polarization**

During 1928 the section's research associate, T. Parkinson, conducted a series of experiments at the Kensington Md. field station to learn more of the fading characteristics of waves at broadcast frequencies [13].<sup>35</sup> He selected WJZ at Boundbrook, N.J. (660 kHz) at 300 km distance, and WBAL at Baltimore, Md. (1050 kHz) at 50 km distance as the two principal transmitters to be observed. Others at greater and lesser distances and at various frequencies over the broadcast band were occasionally observed. He found evidence of fading at distances as short as 13 km.

<sup>35</sup>See p. 183 and footnote 21.



*Building No. 2 and west antenna tower at Kensington, Md. field station. This building was used as a general laboratory and workshop area. Building No. 3 (not shown) housed the field-intensity recording equipment.*



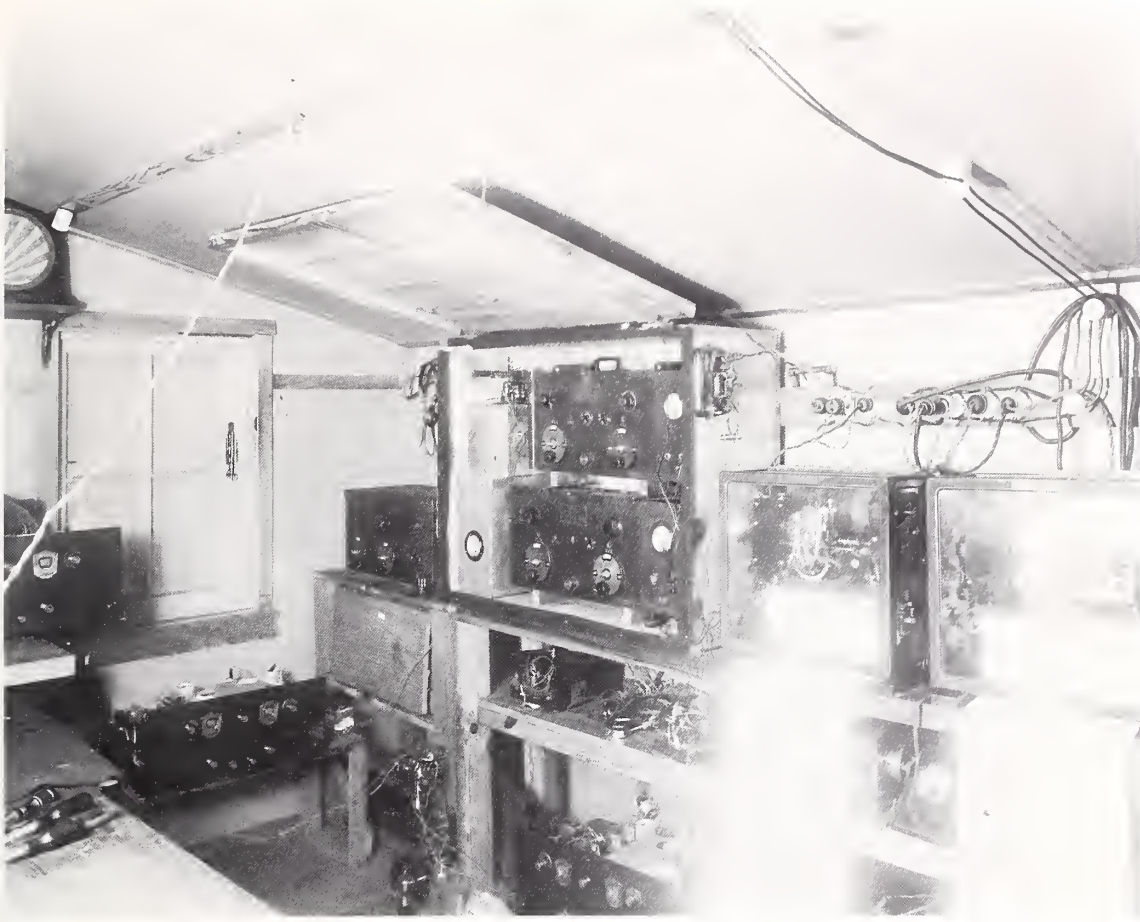

*Field-intensity recording equipment in Building No. 3, Kensington, Md. field station. Recorders at right, temperature-controlled receivers at center (note heavy wood housing to stabilize temperature). This equipment was much used in early transmission studies.*

Parkinson worked with four types of antennas, oftentimes operating them simultaneously in pairs with two receivers, in order to separate directional components and planes of polarization of the radio waves. His study was being made at a time when many experimentalists were using various methods to probe the ionized region of the upper atmosphere, and many theories were being advanced on transmission and on fading. His experimental techniques were not unique but he made good use of the available tools to carry on the Radio Section's desire to learn more of the puzzling features of fading in the broadcast band. Parkinson was particularly interested in the intensity changes that have periods ranging from a few seconds to several minutes.

We can sum up Parkinson's study in his own words:

It was concluded that, in addition to the more commonly accepted causes, there may be a number of indirect rays with varying paths and with rotating planes of polarization which give rise to the variations in intensity of the received signal. Some of the conclusions are consistent with those of other workers in the field, but new explanations are necessary for some of the data.

Some of the explanations would be forthcoming within a short time, within the Radio Section itself, others would require the passage of years.

## **6. Shuffling combinations of observations**

For a period of several years various combinations of observations were tried as possibilities of obtaining a better understanding of fading in particular and wave transmission in general. The earlier work was at broadcast frequencies, later work at higher

frequencies extending up to 25,000 kHz. In any one combination, observations were made simultaneously in order to observe fading effects of two or more conditions at the same instants of time. Parkinson's observations follow:

- a) Simultaneous fading records for same transmission path but different frequencies. Two or more distant stations located in the same vicinity but operating at different frequencies would be selected for observation, with the several receivers in close proximity (within 15 feet or so). Usually, variations of field intensity, caused by fading, were not simultaneous.
- b) Simultaneous fading records of same transmission, with two receivers separated by short distances (40 to 165 ft). No evidence of variation in field intensity, caused by fading on simultaneous recordings. Broadcast stations ranged from 200 to 960 km in distance.
- c) Simultaneous fading records of same transmission, with two receivers separated by considerable distances (out to several miles).<sup>36</sup> Under this condition the two recordings could be quite different, indicating different transmission paths, especially from sky waves.
- d) Fading records from two transmission paths, each from two widely separated transmitters in synchronized operation (same modulation and transmitter frequency). The synchronization of broadcasting stations in the early 1930's gave opportunity to the Radio Section to record the fading characteristics of signals with identical modulation on the same frequency but the signals radiated from widely separated transmitters, such as New York and Baltimore. Fading due to wave pattern interference of the two signals was usually observed, both at night and day. Distortion of the resultant signal could often be observed, especially in areas where the two signal levels would be equivalent or approximately so.

## 7. The Bureau's first worker to the Antarctic

Lloyd V. Berkner of the Radio Section was selected to serve as a radio officer with the 1928-1930 Byrd Antarctic Expedition to Little America.<sup>37</sup> For a period of time (June to October 1929), during a winter layover, Berkner had the opportunity of studying long-distance transmission and fading of radio signals from a receiving site near Dunedin, New Zealand. Most of the transmitters were located in the United States; all were operating in the frequency range of 9000 to 15,000 kHz [15].<sup>38</sup>

---

<sup>36</sup>The fixed position was the Kensington field station, the mobile station was a receiver-recorder mounted in the automobile truck. An ingenious system for synchronizing the two recorders utilized a 60-Hz modulated transmitter (1700 kHz) at the Kensington site. A receiver-amplifier on the truck demodulated and amplified the 60-Hz signal which, in turn, supplied the same (synchronized) ac power to a clock motor driving the recorder as was driving the motor on the recorder at the fixed site [14].

<sup>37</sup>Lloyd V. Berkner entered the Radio Section on May 9, 1928, transferring from the Bureau of Lighthouses to join the Byrd Antarctic Expedition which sailed from New York City on August 25, 1928. He left the section on June 30, 1933, going to the Department of Terrestrial Magnetism of the Carnegie Institution where he continued ionospheric studies. In 1950 Berkner proposed that in 1957-1958 there should be a third International Polar Year—25 years after the second. The proposal resulted in the International Geophysical Year of 1957-1959. He was president of the International Scientific Radio Union (URSI) during the years 1957-1960. Berkner was president of IRE in 1961, and president of the International Council of Scientific Unions during the period of 1957-1960. He received many awards and honorary degrees before his death on June 4, 1967.

<sup>38</sup>Berkner observed that usually there was a decrease in signal intensity as the long transmission paths became wholly lighted by the Sun. There was a rise in signal intensity as the path became partially dark, with the highest frequencies showing the first evidence of increased strength. (Berkner would understand the nature of this dependency upon frequency several years later when studying data taken from ionosphere recorders.) A steady fall in intensity would occur after a maximum was reached, with the highest frequencies preceding the lower frequencies. There was evidence of changes in transmission paths under certain conditions, a circumstance noted by others some years earlier. While sailing to Little America he found evidence of correlation between magnetic disturbances and loss of signal strength along certain transmission paths, but with lack of correlation along other paths at the same time.

During four sailings between New Zealand and Little America, Berkner observed the transmissions of many broadcasting stations spread over the world. A number of U.S. stations at a distance of more than 12,000 km were heard fairly consistently after sunset at the ship when the transmission path was in total darkness. This reception was characterized by slow fading with periods of 3 to 5 minutes, in contrast to the rapid flutter of the high frequency transmissions.

It was Berkner who was in the vanguard long in advance of those from the Central Radio Propagation Laboratory that later carried on research in the Antarctic.

## 8. The Bureau informs the radio public on distance ranges

On January 25, 1932, the Bureau released Letter Circular 317, "Distance ranges of radio waves," that informed the radio public on the distance ranges of practical radio communication. Two graphs indicated distance ranges (in kilometers) in relation to the

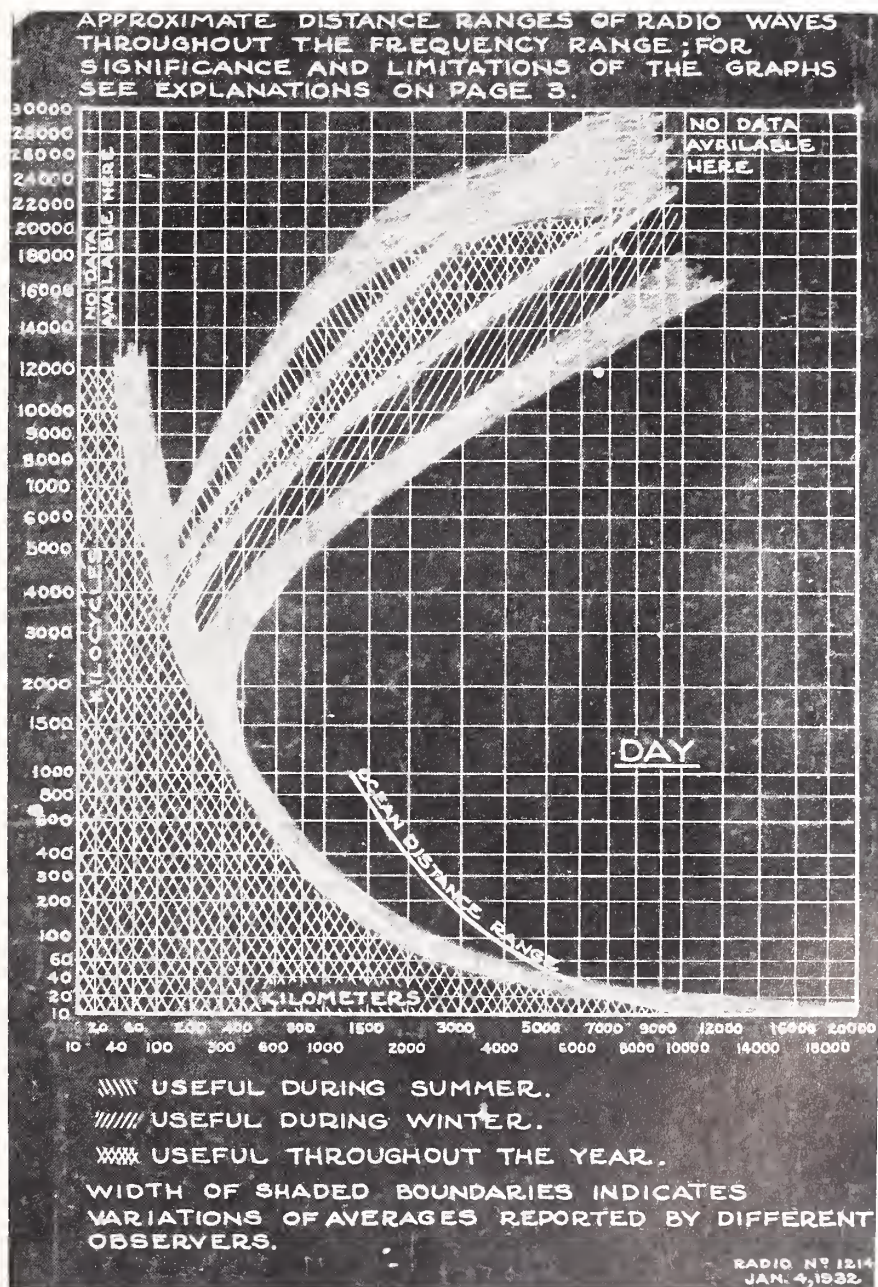

Approximate distance ranges in latitude of Washington, D.C. for practical radio communication with average background interference, during day. Published in Letter Circular 317, January 25, 1932, along with graph for night condition.

frequency of transmission, one for day conditions, the other for night. The relatively small difference between summer and winter conditions was taken into account.

In reviewing the graphs, with their estimates of distance ranges, more than 40 years later, one must keep in mind that they were based upon information available through 1931. Not until more data became available with ionosphere recorders did it become possible a number of years later to predict radio wave propagation on a more reliable, and on a world, basis. To view the situation at the time the Letter Circular was published (1932) we can read:

With present knowledge of propagation conditions, it is impossible to postulate any generally applicable formulas or any tables or any charts which could be used to determine distance range over any given path accurately. The attached graphs give average distance ranges as observed by a number of experimenters to occur most frequently over a number of transmission paths.\* Through certain frequency ranges, available data were so inconsistent as to require extrapolation which may be considerably in error. Wide variations of distance range and skip distance must be accepted as normal.

\*Fourteen references were cited, of which two were publications by the Bureau.

The graphs were based on the lowest field intensity which permitted "practical" or "useful" reception in the presence of actual background noise. The limiting field intensity (strength) was taken to be 10 microvolts per meter in the broadcast frequency range.<sup>39</sup>

Eight years later (1940), and with much more information available, the data were recalculated, and published as a second Letter Circular (LC615) on the distance ranges for radio waves. A third circular (LC658) was published August 5, 1941, with the more specific title of "Radio distance ranges, summer 1941 and winter 1941-42."<sup>40</sup> There turned out to be a large demand for these pamphlets. Shortly thereafter, with the country's entrance in World War II, the circular was classified as CONFIDENTIAL.

As a prediction service to radio amateurs the Radio Section prepared graphs on minimum and maximum useful distances for publication in the periodical *QST* on a quarterly schedule. Predictions were for the different hours of the day and for each month. The frequencies ranged from 2 to 28 MHz. The first graphs were published in the September 1940 issue. With the country's entry into World War II the service was discontinued after the January 1942 issue. (See p. 234 for additional information.)

<sup>39</sup> While adequate for radio communication, a field strength of 10 microvolts per meter would be much too low for high quality reproduction of musical programs in the presence of static such as on a summer night.

<sup>40</sup> By 1941 the Radio Section had amassed a great amount of data on radio wave propagation and had learned how to predict usable communication services under different conditions of time of day and night and the time of year, also taking into account the effect of the sunspot cycles. In the preparation of Letter Circular 658, published August 5, 1941 (cited above), 26 published papers were referenced, 10 of which were authored by members of the Radio Section. An interesting table of field intensities required for reception was a part of the paper and is reproduced here.

The attached graphs show the limits of distance over which practical radio communication is possible, both radio-telegraph (CW) and radio telephone (phone). They are based on the lowest field intensity which permits practical reception in the presence of average background interference or noise. For the broadcast frequencies this does not mean satisfactory program reception. Field intensities required for CW reception were taken to be about one-tenth of those required for phone reception. The limiting field intensity is different at different frequencies and times. The following table gives limiting field intensity values typical of those used in determining the distance ranges, based on data in a number of papers listed in References at end hereof. This assumes the use of a good receiving set.

TABLE 1. *Average Field Intensities Required for Good Radio-Telephone Reception*

	0.1 Mc	1.0 Mc	5.0 Mc	10.0 Mc
Summer day	60 $\mu\text{v/m}$	10 $\mu\text{v/m}$	10 $\mu\text{v/m}$	3 $\mu\text{v/m}$
Summer night	170	90	15	1
Winter day	25	1	2	1
Winter night	100	15	4	1

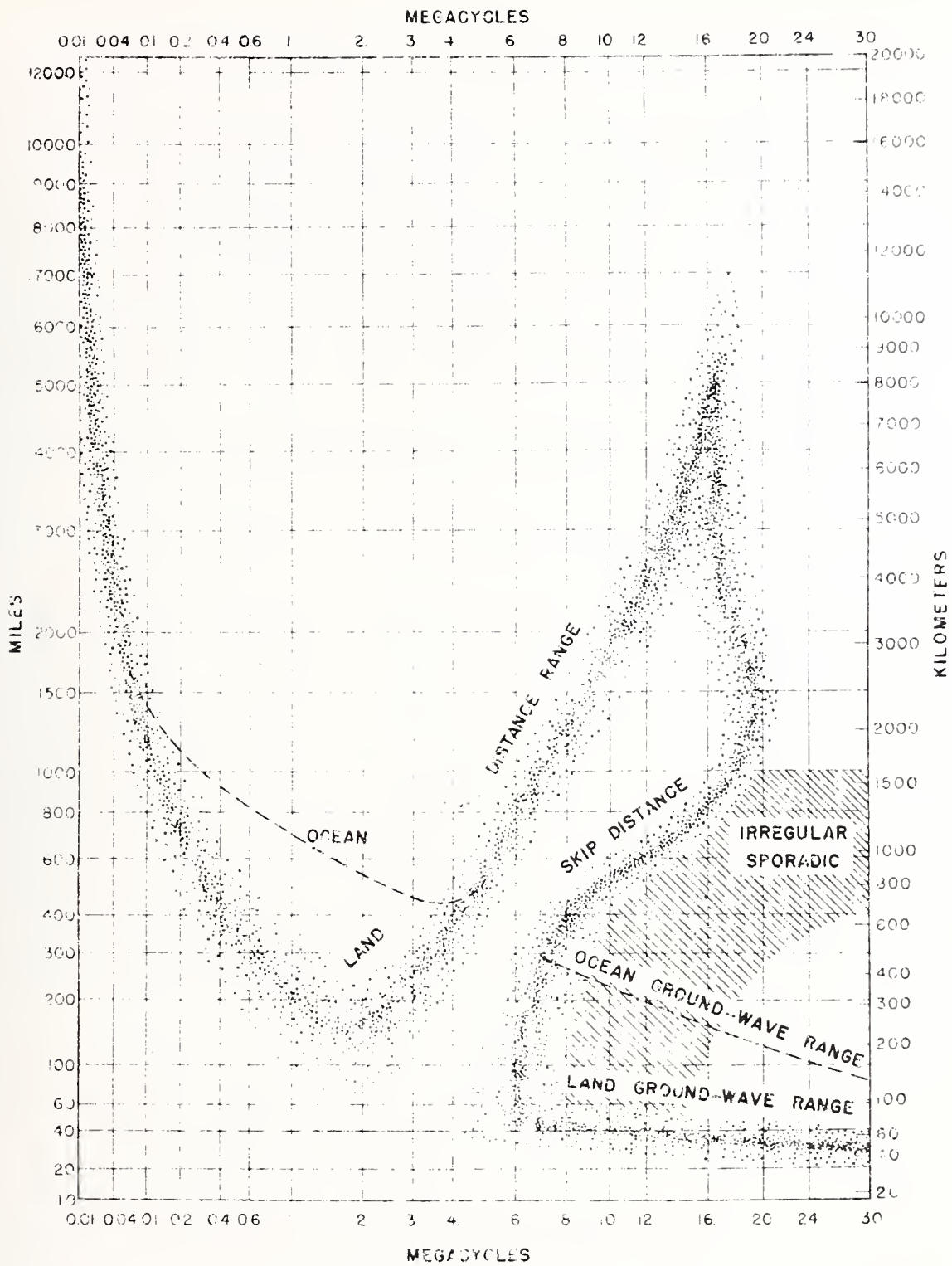

SUMMER 1941

DAY

*Predicted approximate distance ranges in latitude of Washington, D.C., for practical radio communication with average background interference, during day of summer 1941. Published in Letter Circular 615, October 25, 1940, along with graphs for day transmission in winter, and for night in summer and winter 1941.*

## 9. Data in abundance from transmission recordings

With the use of four field intensity recorders operating over a period of several years at the Meadows field station, it was possible for Norton, Kirby, and Gordon H. Lester to acquire an enormous amount of data on radio transmissions in the 550- to 1500-kHz broadcast band [16].<sup>41</sup> This "steam-shovel process" acquired transmission data on 300 broadcasting stations in the United States, plus recordings of Hawaiian stations. Many of the measurements were taken after 2 a.m. during Federal Radio Commission frequency monitoring schedules. By applying some rather arbitrary treatment, it was possible to compress the data into a manageable form for plotting and to arrive at several meaningful equations of expressing field intensity in terms of radiated power and of distance.

The three found no large changes of received field intensity with season or frequency (within the broadcast band), although signals were slightly weaker in the summer. Signals received during the day at distances greater than about 600 km were due to sky waves and could be predicted by a formula. Variation of field intensity at night with distance appeared to be determined primarily by directive characteristics in the vertical plane of the transmitting and receiving antennas.<sup>42</sup>

These observations were made during a period when WLW (700 kHz) Cincinnati, Ohio, was experimenting with 500 kW of radiated power (not permitted to continue because of the blanketing effect on adjacent channels).

## 10. Searching out a geographic anomaly

Observations of low frequency (16 to 24 kHz) radio transmissions across the North Atlantic by Elbert B. Judson in 1931 and 1932 indicated the anomaly of considerable attenuation of signals across the path compared with transmission paths in other parts of the world.<sup>43</sup> This was interesting enough to Dellinger that he initiated a program to make extensive observations at broadcast frequencies. After some preliminary arrangements with several European broadcast authorities, observations were started in January 1935 to record the field intensities of several European broadcast stations at the Meadows field station between the hours of 1 and 4 a.m. Because of the very weak signals it was difficult to make recordings or even to make aural observations. In contrast, signals from several Argentine stations at a much greater distance were received at considerably higher levels. The observations were continued for several months after which the European signals were lost because of an overlap of the time of darkness across the Atlantic and the late evening programs of American stations which caused interference. Thus began a series of observations that would continue for several years of transmissions at broadcast frequencies from two continents in different directions (one to the east, one to the south). Yet in the first year of observation some interesting information had been gathered, as stated in the Monthly Report of March 1935.

The observations on received intensities of European broadcast stations made in January and February by RCA Communications Inc. and Bell Telephone Laboratories, as well as by Messrs. Kirby, Judson and Lester here, were analyzed by the Section Chief. A report was sent to Mr.

---

<sup>41</sup> Kenneth A. Norton entered the Radio Section on July 15, 1929, and took a 9-months leave of absence during the school year of 1930-1931 to attend Columbia University. He resigned on December 16, 1934, to enter the Engineering Department of the Federal Communications Commission. He rejoined NBS in 1946 to take an active role in various projects of the CRPL.

Gordon H. Lester joined the Radio Section on September 8, 1930, and was first associated with propagation projects. In 1935 he became engineer-in-charge of WWV, until 1950.

<sup>42</sup> In 1934 Kirby published a report on the field intensity and distance characteristics of a high vertical antenna used for broadcasting at 1080 kHz, located at Charlotte, N.C. He found that the vertical antenna produced a ground wave twice the field intensity of an L-antenna. With capacity loading at the top of the mast, fading was reduced somewhat within a 150-km radius. With the vertical antenna the amplitude of night fading was reduced considerably within a 150-km radius, but was more rapid than at greater distances.

<sup>43</sup> Elbert B. Judson was an assistant to Dr. Louis Austin from 1919 to the time of Austin's death in 1932. He joined the Radio Section on July 1, 1932, and resigned February 16, 1936, being associated with the ionosphere measurement studies.

Brillard of the International Broadcasting Union (Brussels, Belgium), who arranged the emissions. The results substantiate the existence of a remarkably excessive attenuation in transmission across the North Atlantic.

The tests were continued in the months from November through February for the next four years, observations at the Meadows field station being made by Kirby and Newbern Smith during the small hours of the morning. The use of more sensitive continuous recording equipment increased greatly the amount of data obtained. Five years of observations gave ample evidence of an anomaly in radio transmission over two different paths. A number of European laboratories participated by making measurements upon received field intensities of North and South American stations. The Argentine government joined in a cooperative program with the Bureau for the extended study which resulted in a published paper by Dellinger and A. T. Cosentino, of the Ministry of the Interior, Argentina [17]. In their words:

This work has definitely established the fact that radio transmission between South America and either North America or Europe is relatively free from influences that seriously impair transmission between North America and Europe. This difference in transmission conditions is enormous. For the time of year at which the measurements were made (northern winter or southern summer), this study has shown that the received intensities for transmission between North America and South America average approximately 25 times the intensities (28 decibels) between North America and Europe, that the received waves are only about 1/15 as variable, and that ionospheric storms depress the intensities of radio waves transmitted between North America and Europe but have little effect on the other transmission paths.

The authors explained the anomaly as being due to ionospheric storms in the general vicinity of the north magnetic pole and auroral zone and thus on the North Atlantic transmission path. Moreover, as they stated:

The effect of ionospheric storms upon radio transmission between North America and Europe is magnified by the fact demonstrated in this work, that the radio effects of ionospheric storms at broadcast frequencies persist for several days after the magnetic effects. Thus the North America-Europe transmission path is almost never free from the effects of recurring ionospheric storms, while the transmission path between South America and either North America or Europe is little affected thereby.

See appendix G for a commentary on this anomaly.

## 11. Scads of data for a variety of purposes

Beginning in 1935, Kirby and N. Smith extended the field intensity recording program at the Meadows field station, including around-the-clock operation at various frequencies. This program yielded extremely valuable data, continuing until the 1950's at Sterling. Over this period the field intensities (in microvolts per meter) of several dozens of transmitters were recorded, some continuously, others at certain times of the day, and others at certain periods of the year. Frequencies ranged from the lower portion of the broadcast band (600 kHz) to above 25,000 kHz. Distances ranged from 25 km for WWV at Beltsville, Md. to 6700 km for Berlin stations in Europe and 8400 km for Buenos Aires in South America.

S. S. Kirby, Newbern Smith, F. R. Gracely, T. R. Gilliland, A. S. Taylor, and others were using these recordings to seek solutions to the many problems that were confronting the Radio Section on the vagaries of radio transmission. Only a brief listing of the problems that were being studied during this period must suffice in this account. The number and complexity of the problems were formidable, indeed, for the few workers involved.

By 1940 this group had listed no less than nine problems or projects of diverse nature that were "supported" by data taken from automatically recorded information and listening

observations of field intensity at the Meadows site.<sup>44</sup> Treatment of the data over a period of years led to many publications and to papers presented at scientific meetings. But some of the problems would take many years to solve.

Much of what was learned from these projects supported by the field intensity data found its way in abbreviated form into reports on radio propagation to the Institute of Radio Engineers and the International Scientific Radio Union (URSI). Dellinger served on radio propagation groups of URSI and other international organizations and conferences. He served as Chairman of the IRE Committee on Radio Wave Propagation for several years beginning in 1938. K. A. Norton also served on this committee.

## STUDYING THE IONOSPHERE<sup>45</sup>

### 1. Sounding the ionosphere

#### a) GILLILAND PIONEERS THE BUREAU'S IONOSPHERE MEASUREMENTS

Cooperative work in 1925 on investigation of the Kennelly-Heaviside layer with Dr. Gregory Breit (formerly of the Radio Section) of the Department of Terrestrial Magnetism, Carnegie Institution of Washington, led to a long association of the Radio Section with this laboratory on radio propagation studies.<sup>46</sup> With Breit and Tuve's historic achievement in 1925 of the development and use of the first ionosphere (oscillograph) recorder to test the existence and measure the height of the conducting layer (ionosphere) (see pp. 173-174), the Radio Section was easily motivated to develop its own equipment to sound the ionosphere, following the method of Breit and Tuve.<sup>47</sup>

In the summer of 1928, several months after he entered the Radio Section, Theodore R. Gilliland began to assemble and modify some equipment that was similar to the apparatus

---

<sup>44</sup>The Annual Report of 1940 listed the following problems awaiting solution or completion of those partially solved:

- (1) General study of the diurnal, seasonal, and year-to-year variations of ionosphere characteristics and maximum usable frequencies.
- (2) Variation of radio field intensities with frequency, distance, time of day, time of year, and over paths in different parts of the globe.
- (3) Correlation of transmission conditions over medium and long paths with vertical-incidence ionosphere data observed at Washington.
- (4) Ionosphere irregularities and their effects on radio transmission (such ionosphere irregularities as sudden ionosphere disturbances, ionosphere storms, sporadic E-layer, scattered reflections, and prolonged periods of low-layer absorption).
- (5) Determination of ionosphere conditions over extended regions from the data of long distance radio transmission.
- (6) Investigation of the validity of including the Lorentz polarization term in equations for ionization density.
- (7) Variation of intensity of ground-wave at broadcast frequencies.
- (8) Relation of true to virtual heights of the ionosphere layers.
- (9) Eclipse effects and recombination coefficients in the ionosphere.

<sup>45</sup>Over the period from 1930 to 1944 the Radio Section used for the various titles of its major project on the ionosphere the following:

Measurement of height of Heaviside layer  
Study of heights of ionosphere layers  
Phenomena of the ionosphere  
Ionosphere phenomena

<sup>46</sup>The laboratory facilities of the Department of Terrestrial Magnetism were located slightly over 1 mile from the Bureau grounds.

<sup>47</sup>This method was referred to as the group retardation or pulse method. It has similarities to radar of later years. The investigations by the Radio Section, using this method, were referred to in the early developments as "radio echo signal research."



used by Breit and Tuve.<sup>48,49</sup> The project was an outgrowth of some of the radio fading measurements. By November 1928, Gilliland had sufficient equipment put together that he could make photographic observations with an oscillograph of "retardation of signals arriving by indirect paths" from the conducting layer. Initially, distortion of pulse signals in the equipment proved to be a problem (as was the case with Breit and Tuve) but a direct-current amplifier feeding the oscillograph element cleared up the trouble.

As with Breit and Tuve, Gilliland had the cooperation of the Naval Research Laboratory, located in southeastern Washington (Bellevue, in Anacostia), to furnish pulsed signals that could be recorded as reasonably sharp and distinct reflections from the conducting layer.<sup>50</sup> The transmitting station NKF operated at 4435 kHz.

Gilliland visually observed and photographically recorded (with a system similar to Breit and Tuve, using a Duddell galvanometer-type oscillograph) reflection signals from NKF at various times from February to June 1929 at the Radio Building, a distance of 13.5 km from the transmitter. Some of the observations were for a 24-hour period. Daytime recordings indicated an ionized layer that varies in height between 200 and 330 km. His main problem was that of local interference and in June he moved the equipment to the Kensington, Md. site, a distance of 20 km from the Navy transmitter. By now the Navy was transmitting signals at 8100 kHz, in addition to the 4435-kHz signals. In October the Navy had to discontinue operations of NKF.

<sup>48</sup> Theodore R. Gilliland entered the Section on May 16, 1928. During the school year of 1930-1931, he received an M.S. degree in communication engineering at Harvard. He remained in the Radio Section until 1944. Later, in 1949, Gilliland established the CRPL-NBS ionosphere field station at Ramey Air Force Base, Puerto Rico, being the Engineer-in-Charge until 1963. He retired from NBS in 1963.

<sup>49</sup> A detailed historical account of the development of vertical-incidence ionosphere sounding by the Radio Section, and later by the Central Radio Propagation Laboratory, will be found in *NBS Technical Note 28* by Sanford C. Gladden [18]. Included is information on the many field stations operated by CRPL and its predecessor, the IRPL.

<sup>50</sup> In the laboratory language at the time, these signals were called interchangeably, "pulses," or "peaks," or "jabs." Gilliland often used the latter term.

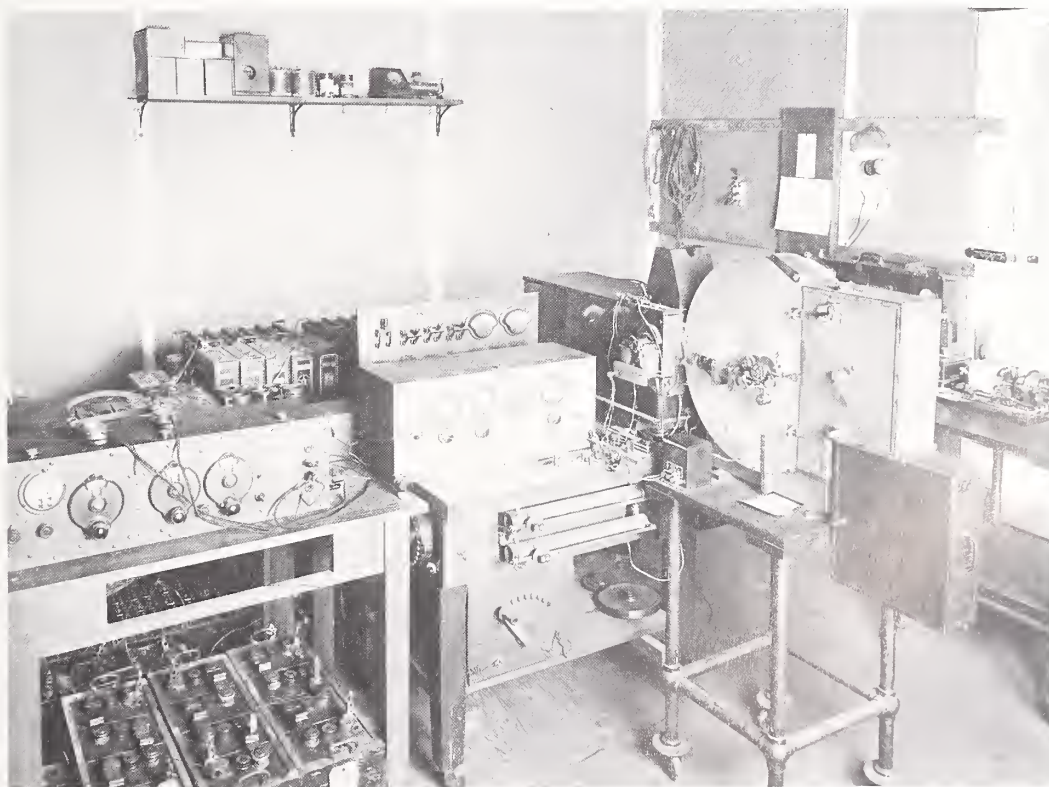

*Equipment designed and assembled by Gilliland and used by him in early 1929 at Radio Building, Washington, to observe pulsed signals reflected by ionosphere with transmitter operated by Naval Research Laboratory at Bellevue, southeast Washington. Photo shows equipment at the Kensington, Md. field station where it was moved in June 1930. Receiver (left), amplifier (middle), and oscillograph (right). Continuous recording on oscillograph was at single frequencies, 4435 and 8100 kHz.*

b) GILLILAND GETS A SCHEDULED IONOSPHERE MEASUREMENT PROGRAM UNDER WAY

On January 13, 1930, the Navy transmitter, NKF, was back "on the air" to give assistance to the Bureau on a cooperative ionosphere measurement program. The new transmissions were at 4045 and 8650 kHz, with a much improved and sharpened pulse signal developed by a multivibrator circuit pulsing a 20-kW output stage. The pulse width was approximately one-half millisecond at a rate of about 30 per second. Gilliland had made improvements with his receiving and recording equipment housed in a new building at the Kensington field station. During the 5-month period from January 16 to June 19, 1930, the Navy and the Radio Section operated on a scheduled program [19].<sup>51</sup>

---

<sup>51</sup> Gilliland's first paper on ionosphere measurements was published in the November 1930 issue of the *NBS Journal of Research*, and later in the January 1931 issue of the *Proc. IRE*. During the 1930's many papers of the Radio Section were published as nearly identical papers in both of these periodicals, a practice frowned upon today. Where duplication occurred, preference is given in the literature citations associated with this chapter to the *Proc. IRE* because of its greater availability.

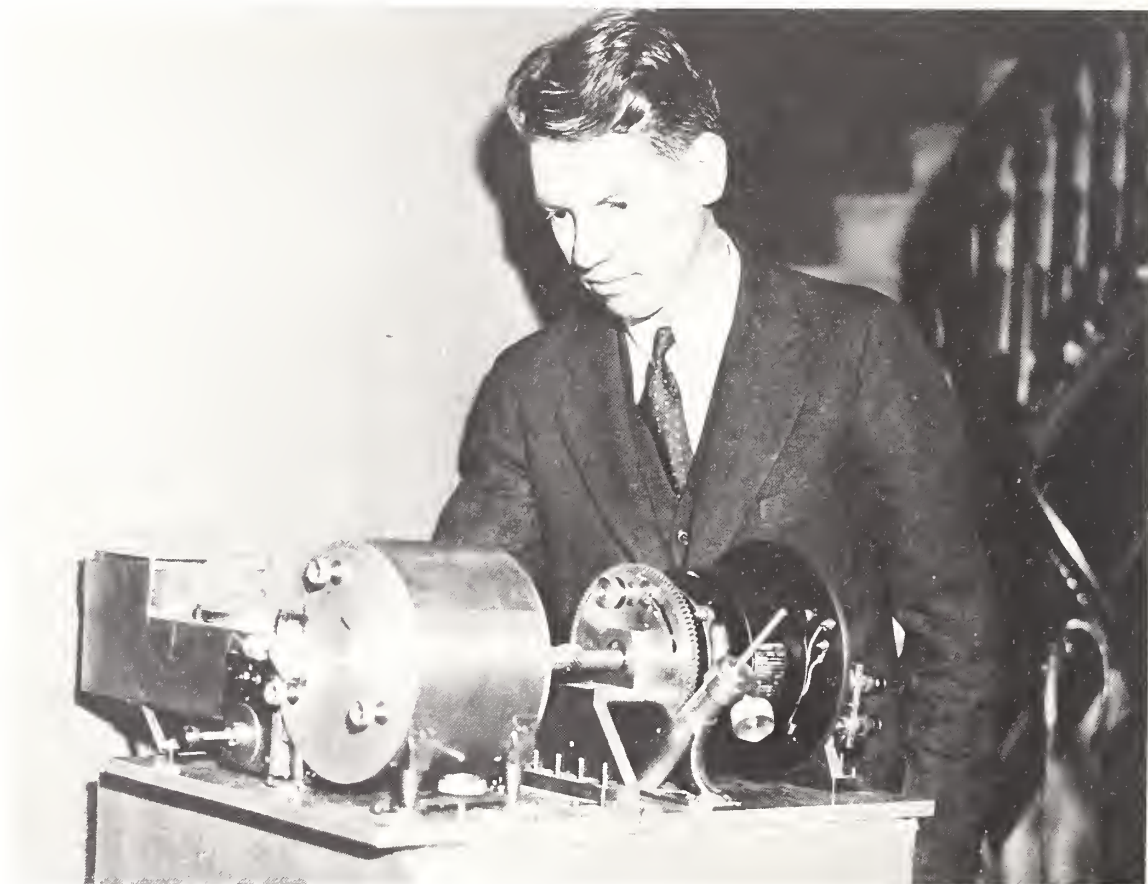

In 1928 Gilliland began assembling and modifying equipment similar to that used by Breit and Tuve several years earlier. On December 11, 1931, Gilliland appeared for this news photograph with his continuous ionosphere recorder for observations at single frequencies. His multifrequency recorder was developed in 1932.

Gilliland reported in the March 1930 Monthly Report that his 11:30 a.m. recordings at 4045 kHz showed a height of the conducting layer at 225 km.<sup>52,53</sup> At 8650 kHz the heights were 287 km for the morning, and 290 km in the afternoon. After sunset he found the height to increase. At sunrise it abruptly returned to normal daytime height. There was evidence occasionally of a lower layer at about 120 km for the 4045 kHz transmissions. In a magnetic storm during March 11-17 the virtual height rose to 250 km at 4045 kHz and 440 km at 8650 kHz. On April 28, the day of a partial solar eclipse at Washington, D.C., the layer height was lower (202 km) than usual in the morning and higher than usual in the afternoon. Gilliland concluded his March 1930 Monthly Report by stating:

It is planned to extend the study to other frequencies in order to understand more completely the distribution of ionization, and to continue the observations over a considerable period of time so that seasonal variations may be studied.

Little did Gilliland realize at the time how involved he and his colleagues would become during the ensuing years with the various projects in probing the ionosphere.

<sup>52</sup> Gilliland stated:

By measuring on the oscillogram the interval of time between the reception of the ground wave and the sky wave, it is possible by simple calculation to determine the apparent height in the atmosphere which the wave reached. In this method of calculation it is assumed that reflection takes place from an ionized layer in the upper atmosphere. Actual reflection as from a mirror does not take place, but a gradual bending or refraction occurs, due to increase of ionization with heights so that the actual height reached by the wave is somewhat less than that given by the calculation.

<sup>53</sup> Over the 5-month period Gilliland observed a low height of 219 km at 4045 kHz (except 202 km during solar eclipse) and a high of 450 km. He found no particular correlation with changes in sunspot activity or Earth's magnetism (except during magnetic storm), but believed this was due to observations not being taken over a long enough period.



*Building No. 1 and east antenna tower at Kensington, Md. field station, located 5 miles north of Bureau grounds. Site occupied from mid 1920's until facilities were moved at various times to the Beltsville, Meadows, and Sterling stations. The early ionosphere reflection observations were made in this building for several years, beginning in 1930.*

c) AN EARLY COOPERATIVE PROGRAM ON THE IONOSPHERE

Concurrently with his first program on sounding the ionosphere, Gilliland carried on a cooperative program with Tufts College of Medford, Mass., with the collaboration of the Naval Research Laboratory and the Department of Terrestrial Magnetism, Carnegie Institution of Washington. Working on the project with Gilliland were P. A. de Mars, professor of electrical engineering at Tufts College, and G. W. Kenrick of the Radio Section [20].<sup>54</sup> This trio reported its early ionosphere observations at the April 1930 meeting of the American Section of URSI in Washington, D.C.<sup>55</sup>

Transmissions on 4045 and 8650 kHz from the Navy NKF station were observed by the three laboratories. In addition, a 1410-kHz transmission was provided by Tufts College at its Lexington, Mass. station, WLEX. This frequency was specially chosen for observation.<sup>56</sup> Because of the oblique transmission path, giving a complex pattern of multiple reflections to the recordings, the Bureau had great difficulty in determining ionosphere heights from the 1410-kHz transmissions from Lexington. However, at Tufts College, over a transmission path of but 15 km for the ground wave, it was definitely observed that several strata of ionized layers existed, as postulated by Appleton and Eckersley of England.

<sup>54</sup> Dr. G. W. Kenrick was appointed a consulting engineer to the Radio Section on April 17, 1930, being an associate professor of electrical engineering at Tufts College. Previously he had pioneered in some ionosphere observations at the University of Pennsylvania. He left the Radio Section on June 30, 1931. In 1929 at the University of Pennsylvania Kenrick met Newbern Smith and interested him in Kennelly-Heaviside layer studies—later, Smith presented a paper on the ionosphere at an AIEE meeting at Lehigh University.

<sup>55</sup> This report appears to be the earliest account to the public made by the Radio Section in its then budding program of the ionosphere by direct observation.

<sup>56</sup> In 1925 Nichols and Schelleng of the Bell Telephone Laboratories had pointed out that the frequency of  $1.4 \times 10^6$  Hz (1400 kHz, 214 meters) is a "critical" frequency at which there is maximum absorption of the radio wave energy by the free electrons of the ionosphere. Later this became known as the "gyro frequency."



Typical 1410 kc pattern as received at Kensington, Md., during night period, (3:33 A.M., April 13, 1930). Note small peak, large peak, and then series of small peaks.

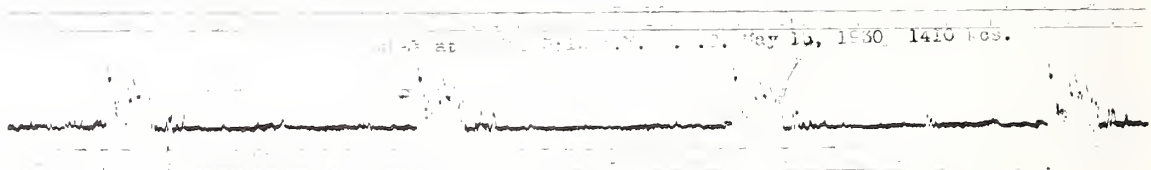

1410 kc as received at Tufts College at 3:15 A.M. E.S.T., May 13, 1930. Note extremely complex dawn patterns.

*These early observations of the ionosphere are two of a group of recordings made of pulse transmissions at 1410 kHz, from WLEX (operated by Tufts College), Lexington, Mass. on a cooperative program of the Bureau, Tufts College, Carnegie Institution of Washington, and Naval Research Laboratory in 1930. A frequency of 1410 kHz was selected as the critical frequency postulated by Nichols and Schelleng in 1925 (see footnote 56). At 600 km distance from Lexington the signal pattern observed at Kensington, Md. field station showed evidence of several transmission paths caused by the ionosphere. At 15 km from Lexington the signal pattern at Tufts College usually showed fairly sharp pulses reflected from the ionosphere but, at times, particularly at dawn, an extremely complex pattern existed, indicating reflections from several layers of the ionosphere for short periods of time.*

Although in their published report the Bureau and Tufts College indicated a continuation of the cooperative program beyond the preliminary stage, no work was reported further.

**d) THE BUREAU ACQUIRES ITS OWN SYSTEM FOR IONOSPHERE MEASUREMENTS**

Early in the summer of 1930 the Navy found it necessary to dismantle the pulse transmitter at station NKF, leaving the Bureau without a source of pulse transmissions suitable for measurements of height of the Kennelly-Heaviside layer. Thus it was that by July 1930 the Radio Section had developed and constructed its first pulse transmitter for operation at its field facility at Potomac Yards (railroad) on the north side of Alexandria, Va. Being in the same general locality as the former Navy transmitter, allowed for direct comparison with the earlier measurements. Although the Bureau transmitter was less in power (500 watts), more and different frequencies were available, ranging from 590 to 10,000 kHz. With further development, pulses were sharpened to about two-tenths millisecond pulse width, which increased the accuracy of height measurement.



*The Radio Section set up its first pulse transmitter (right) for ionosphere measurements in these unpretentious surroundings at its field facility at Potomac Yards (railroad) on the north side of Alexandria, Va., operation beginning July 1930. Previously, dependence was upon a pulse transmitter operated by the Naval Research Laboratory across the Potomac River from Alexandria. At right, can be seen reels for handling the variable length antenna. Reception of signals was at the Kensington, Md. field station, about 20 km distant. By 1932 a pulse transmitter was in operation at Beltsville, Md. and the Potomac Yards station abandoned.*

Associated with Gilliland in the measurements made throughout most of 1930 were Kenrick and Kenneth Norton. Gilliland's coworkers were able to add much to the interpretation of the observations [21]. Most important in their findings was the definite existence of two ionized layers in the daytime in the frequency range of 3 to 5 MHz.

Beginning on June 1, 1931, the Radio Section began issuing weekly "URSIgrams" of "cosmic data" collected by Science Service, including Kennelly-Heaviside data on noon ionosphere heights at selected frequencies. This information was published quarterly in *Terrestrial Magnetism and Atmospheric Electricity*. (See p. 234 for detailed information.)

#### e) IMPROVING THE IONOSPHERE RECORDER—THE CONTINUOUS RECORDER

In the spring of 1931 Gilliland took steps to improve the ionosphere instrumentation. First, was to minimize frequency change while pulsing the transmitter by placing the "chopper" in a low-power amplifier circuit to produce the "jabs" or pulses. But far more important was the development of an automatic recorder to give a continuous height record of the Kennelly-Heaviside layer. Heretofore, the oscillograph recorded the layer height for a fraction of a second only for each observation. Desired was a continuous recording of the height with time, say for a 24-hour period. Then only would it be possible to get a better understanding of the diurnal characteristics of the layer. Without an automatic method for continuous recording, Gilliland estimated that six workers would be required over a 24-hour period to obtain the desired information. With the aid of Kenrick (then of Tufts College) the two developed and installed a prototype recorder at Tufts College.<sup>57</sup> Recordings were first made at Tufts College in the summer of 1931 at a frequency of 4045 kHz over a ground distance of 5 km.

Gilliland and Kenrick concluded in a short account of their development that:

. . . to insure the continuity of records, it appears probable that problems arising in the interpretation of these records are likely to be of paramount importance. Thus, the complex records obtained in the presence of "split peaks," multiple reflections, and other intricate phenomena, greatly complicate the work of interpretation of the records. Re-enforced and interpreted by supplementary records taken by the oscillographic methods previously employed, however, continuous records of this kind represent a distinct addition to the methods heretofore available for study of Kennelly-Heaviside layer phenomena.

Indeed, this and later instrumentation revealed many of the secrets of the ionosphere.

After some preliminary experiments with the automatic continuous recorder in the summer of 1932, Gilliland set up a combination transmitter and receiver-recorder at the Bureau's Beltsville, Md. field station. With the equipment consolidated into one assembly, it was possible to drive the "chopper" (pulse rate of 15 per second) in the transmitter and the revolving mirror in the recorder from a common shaft of a synchronous motor, thus eliminating phasing problems between the two motors when the transmitter and recorder were separated, as in previous installations. During the winter months from November 1932 to March 1933 Gilliland obtained a large number of recordings of virtual heights of the ionosphere at a frequency of 4100 kHz [22]. At this frequency he found that in the morning and afternoon the virtual heights of the F layer to be about 240 km. Around midday the reflection often split into two components, the one at 240 km usually disappearing, the other

---

<sup>57</sup>To obtain a continuous recording the "chopper" in the transmitter was driven by a synchronous motor. With another motor the rotating mirror in the recorder rotated in synchronization with the chopper. Thus the ground-wave pulse would appear at a fixed point, while pulses reflected from the Kennelly-Heaviside layer would change in position if the layer height changed. A continuous record was obtained by recording on a moving strip of photographic paper.\* Layer height(s) would appear as a line parallel to the ground-wave line unless the height(s) changed with time.

Stationary lines, caused by power frequency disturbances, were a disturbing factor in interpreting the early records, but were converted to drifting lines by using a gear ratio of 127 to 64 on the synchronous motors.

\*All the early oscillograph recorders developed and used by the Radio Section operated with recording material of sensitized photographic paper of 4-inch width. The record could be read easily without enlargement. Not until 1940 was 35 mm motion picture film used. Choice of using film in 1940 was not altogether wise. The nitrate film deteriorated and turned out to be a hazard. Many months of data in the 1940's had to be destroyed without copying.

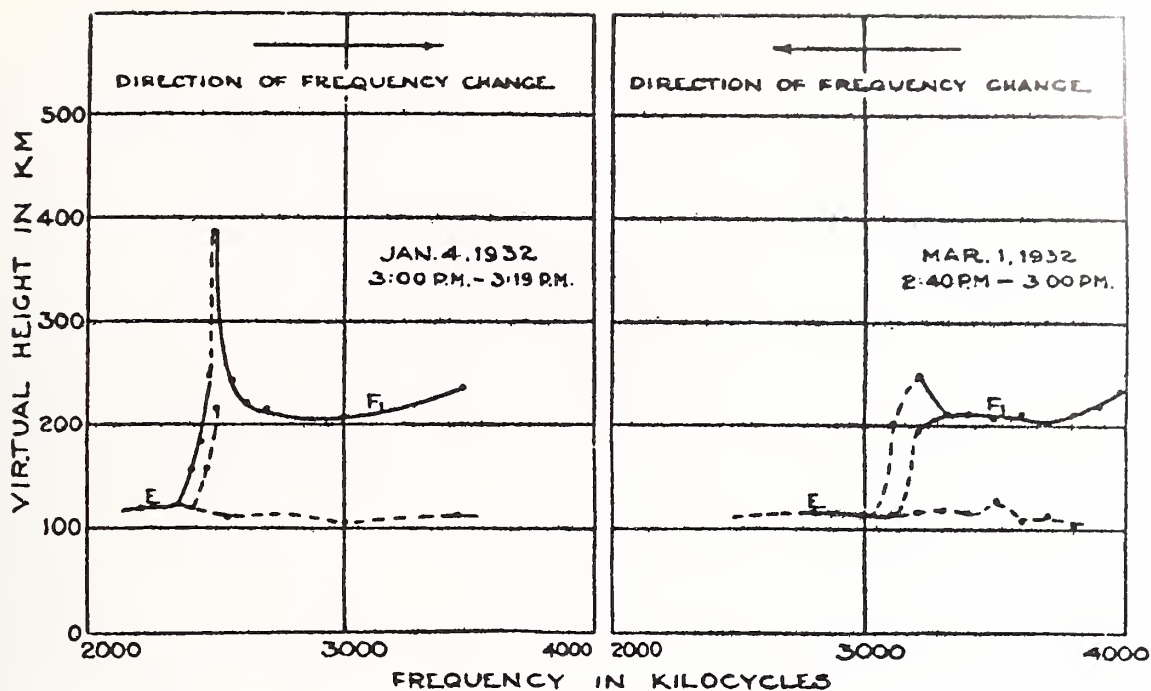

The first ionogram in the form of a continuous curve (fitted to observed readings as points on graph) published by the Radio Section, showing the relation of virtual height of the ionosphere to frequency in vicinity of Washington, D.C. on afternoon of January 4, 1932. Observations were made by manual operation of transmitter frequency changes (mostly at 100-kHz increments) and visual readings of receiver output. Automatic operation would come a short time later (see figures on p. 211).

rising to 300 km or more, but lowering to 240 km at sunset. At night the E layer would usually appear, but both the E layer and the F layer could disappear and then reappear irregularly. Gilliland indicated that much more needed to be learned to understand the ionization processes of the upper atmosphere.

#### f) THE MULTIFREQUENCY AUTOMATIC IONOSPHERE RECORDER

The continuous recorder was an important step toward an even more desirable instrument, that of a method of recording virtual height over an extended frequency range. Such a method would yield information on the characteristics of the ionosphere as a function of frequency and would give a quick and direct indication of critical frequencies, the importance of which was to grow during the next few years.<sup>58</sup> In March 1932 Gilliland planned the development of a continuous automatic recorder that would give the virtual height as a function of frequency. A year later equipment for a frequency range of 2500 to 4400 kHz was installed at the Beltsville field station and the first recordings made on April 20, 1933.<sup>59</sup> Gilliland reported on the development in a paper presented at a meeting of the American Section of URSI at Washington, D.C. on April 27, 1933. Later he published an account of the development and of measurements made in May 1933 [23].

<sup>58</sup>The critical frequency is that frequency at which a radio wave just passes through the ionized layer at vertical incidence. It is commonly used as a measure of the maximum electron density in the layer.

<sup>59</sup>The equipment developed by Gilliland to record the reflected wave as a function of frequency was an adaptation of the earlier equipment designed for continuous recording at a fixed frequency. Tuning capacitors in the transmitter and receiver were revolved by cams (of experimentally determined curvatures) from a common shaft. Rate of rotation gave a change of tuning rate of 200 kHz per minute, or a sweep of the tuning range of 2500 to 4400 kHz in 9.5 minutes, or about 6 sweeps per hour. At least three of these recorders were constructed.



*Radio transmitter (front) and receiver with recorder (rear) for automatic recording of virtual heights of ionosphere. This first automatic multifrequency recorder (or ionosonde), with a frequency range of 2500 to 4400 kHz, was developed by Gilliland in 1932 and installed in Building No. 3 at the Beltsville, Md. field station, and later moved to the Meadows, Md. field station.*



*Beginning in 1932, this modest structure (Building No. 3) at the Beltsville, Md. field station provided the field laboratory for the Bureau's first automatic multifrequency ionosphere recorder that became the progenitor of all Bureau ionosondes that were to follow. The accompanying transmitter was also housed in this building. Later, the recorder was moved to the Meadows station.*



The Radio Section now had within its grasp a basic tool for the study of the ionosphere, although the full potentialities were not realized at the time. Forty years later, the sweep frequency automatic ionosphere recorder, usually referred to as the ionosonde, remains as a powerful and basic tool for sounding the ionosphere, whether for new investigations or for obtaining information on routine predictions. Truly, Gilliland pioneered a most useful measurement instrument. The principle upon which this ionosphere recorder operated soon would be adopted by the Carnegie Institution of Washington, the British Radio Research Board, Australian Radio Research Board, and Harvard University.

In using the multifrequency recorder at the Beltsville field station in May 1933, Gilliland was able to observe more clearly, than by previous methods, the structure of the ionosphere. In these observations over the frequency range of 2500 to 4400 kHz he usually found three ionized layers or strata in the daytime, the E layer at a virtual height of about 120 km, the  $F_1$  layer at about 200 km and the  $F_2$  layer at 280 km and higher.<sup>60</sup> In sweeping through the frequency range various changes in virtual height were observed and the critical frequencies were in obvious evidence. Diurnal changes of the virtual heights and transitions of reflections from one layer to another could easily be read from the recorder.

<sup>60</sup>In noting his recordings Gilliland had adopted the system used by Kirby, Berkner, and Stuart (after Appleton) in a Radio Section paper that was being prepared concurrently. Expressions of the extraordinary ray and ordinary ray (caused by splitting of the radio wave into two components by the Earth's magnetic field) with single and double prime letters was the notation of Appleton and Builder of England. Other notations have been used, including the subscripts "o" and "x" for the ordinary and extraordinary wave, respectively.

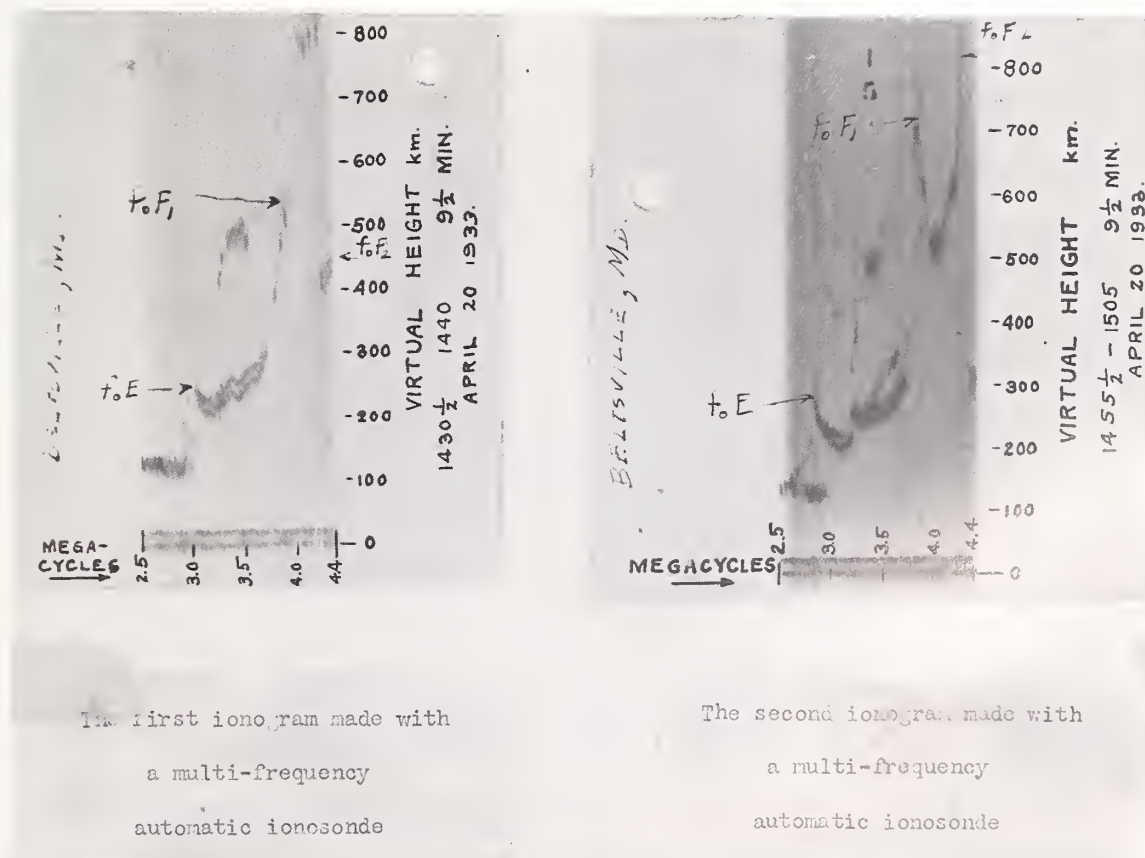

First and second recordings (ionograms) made by Gilliland on his newly-developed automatic multifrequency ionosphere recorder (ionosonde). Recordings made at the Beltsville, Md. field station on April 20, 1933. The original recording, made on sensitized photographic paper of 4-in width, is in the Radio File.

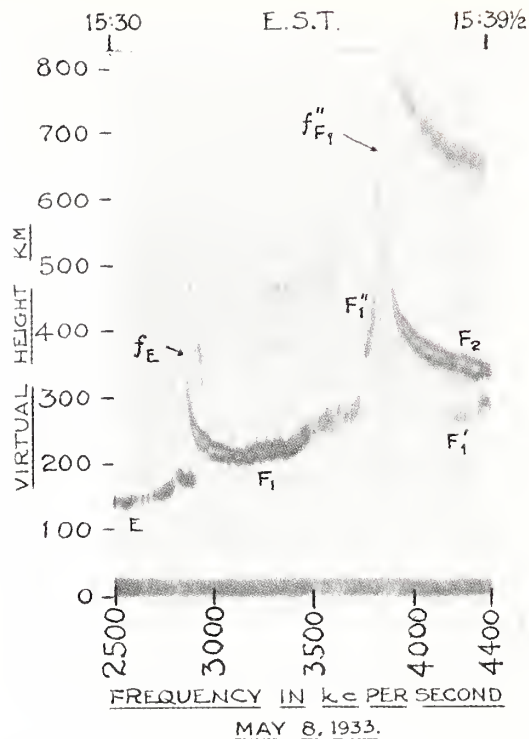

Early recording taken by Gilliland on multifrequency automatic recorder, showing daytime observation of ionosphere, with notation of the several reflections and the critical frequencies. Reflections at the several layers are indicated by E, F, and F<sub>2</sub>. F<sub>1</sub>'' is reflection of ordinary ray from F<sub>1</sub> layer. F<sub>1</sub>' is probably reflection of extra-ordinary ray from F<sub>1</sub> layer. f<sub>E</sub> denotes critical frequency of E layer, f<sub>F1</sub>'' denotes critical frequency for ordinary ray in F<sub>1</sub> layer. Upper right reflection is multiple of the F<sub>2</sub> trace.

Gilliland continued to make extensive observations with the equipment at this location for a year, until April 1934, and further observations at a later period [24]. From hourly observations much detailed information was gathered. He found that late in the afternoon the F<sub>1</sub> and F<sub>2</sub> layers tended to merge with a virtual height of an F layer at 240 km and higher. At night the E layer would disappear with the decreased ionization. In the winter Gilliland found the critical frequency of the F layer decreasing to a minimum by midnight, then increasing to a maximum at about 4 a.m., but dropping to a second minimum before sunrise. There was also evidence of a sporadic type of E layer which might appear at any time, but was usually associated with summer.

#### g) THE PORTABLE IONOSPHERE RECORDER THAT BECAME THE CRPL MODEL A IONOSONDE

From the time of its initial use in 1933 the multifrequency automatic ionosphere recorder, designed by Gilliland, performed years of yeoman service to the Radio Section. Yet it was bulky and refinements were in order. In May 1939 Gilliland (and joined later by A. S. Taylor) began detailed planning for a portable-type (for vehicular transportation) ionosphere recorder that could be transported for expeditions as well as for general purpose use.<sup>61</sup> It was rushed to completion late in the winter of 1940 for observation of an annular eclipse on April 7, at Fort Clark in southern Texas (see p. 217). Later, in October, the equipment was used to observe a total eclipse in Brazil (see p. 217).

<sup>61</sup> Archer S. Taylor entered the Radio Section on July 12, 1938, and was assigned to the project on "phenomena of the ionosphere." He was associated with the ionosphere projects until his leaving the section on May 12, 1943.

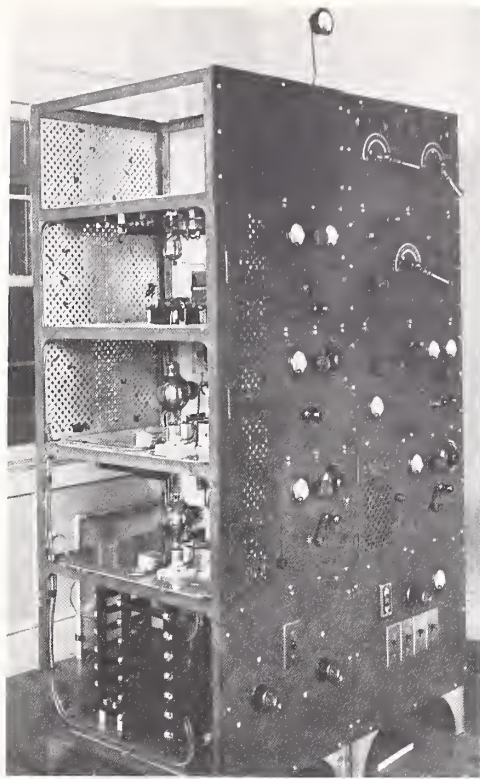

*The 1-kW pulse transmitter for ionosphere research in the frequency range 1750–25,000 kHz, installed in 1933 in Building No. 2, Beltsville, Md. field station. Signals were received at the Meadows, Md. field station, 25 km distant.*

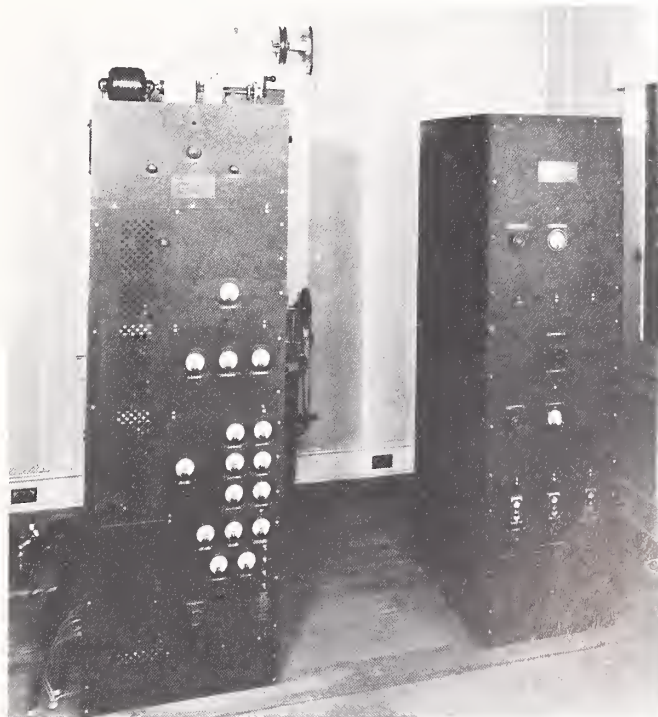

*Model B ionosonde or automatic multifrequency ionosphere transmitter and recorder (left) set up in 1934 at the Meadows, Md. field station. At right is the power supply and control unit. Initially, the frequency range was 500 to 2500 kHz (somewhat wider than the broadcast band), but was later extended to 16 MHz in a number of bands that were automatically switched. Output peak power was approximately 5 kW.*

*In 1943 the Model B ionosonde (so designated in 1946) was moved to Beltsville, Md., and a few months later to the new Sterling, Va. field station. On January 30, 1947, the equipment met an "ignoble" end by "self-inflicted" fire caused by a malfunctioning component.*

The new design incorporated many desirable features based upon the growing experience with the 1933 multifrequency recorder and the later expansion of frequency ranges [25]. The new equipment had a frequency range of 700 to 14,000 kHz which could be swept in 1 minute. The recorder now operated with 35-mm positive film.<sup>62</sup>

The new ionosphere recorder, designed primarily for field measurements, became known as the CRPL Model A ionosphere recorder in 1946. At that period of time the recorders were renamed ionosondes, hence the Model A became known as the CRPL Model A ionosonde.

---

<sup>62</sup> The transmitter consisted of two units, each with two frequency ranges, with a total range of 700 to 14,000 kHz. Peak power output was approximately 2 kW. Four antennas were required. Switching of frequency ranges of the antennas was automatic through relays and switches for a continuous frequency sweep within 1 minute. Pulses of about one-tenth millisecond at a rate of 20 per second were initiated by a thyratron rather than the former "chopper." Cam-operated tuning capacitors in the transmitter and receiver kept the general tuning in step with frequency change. However, a variable oscillator, common to both, kept the receiver automatically and precisely in tune with the transmitter by a beat-frequency technique.

The recorder utilized a Duddell galvanometer-type oscillograph and a rotating mirror of the same kind as used on the former recorder. The photographic paper for recording was replaced by 35 mm positive film at a great reduction in size of handling components and in cost of operation.

For field operation the ionosphere recorder operated from a 32-volt storage battery power source, with a gasoline-engine driving a generator for charging. A rotary converter energized the equipment with 60-Hz alternating current. A tuning fork controlled the frequency of a 60-Hz power supply for timing lines and timing operations.

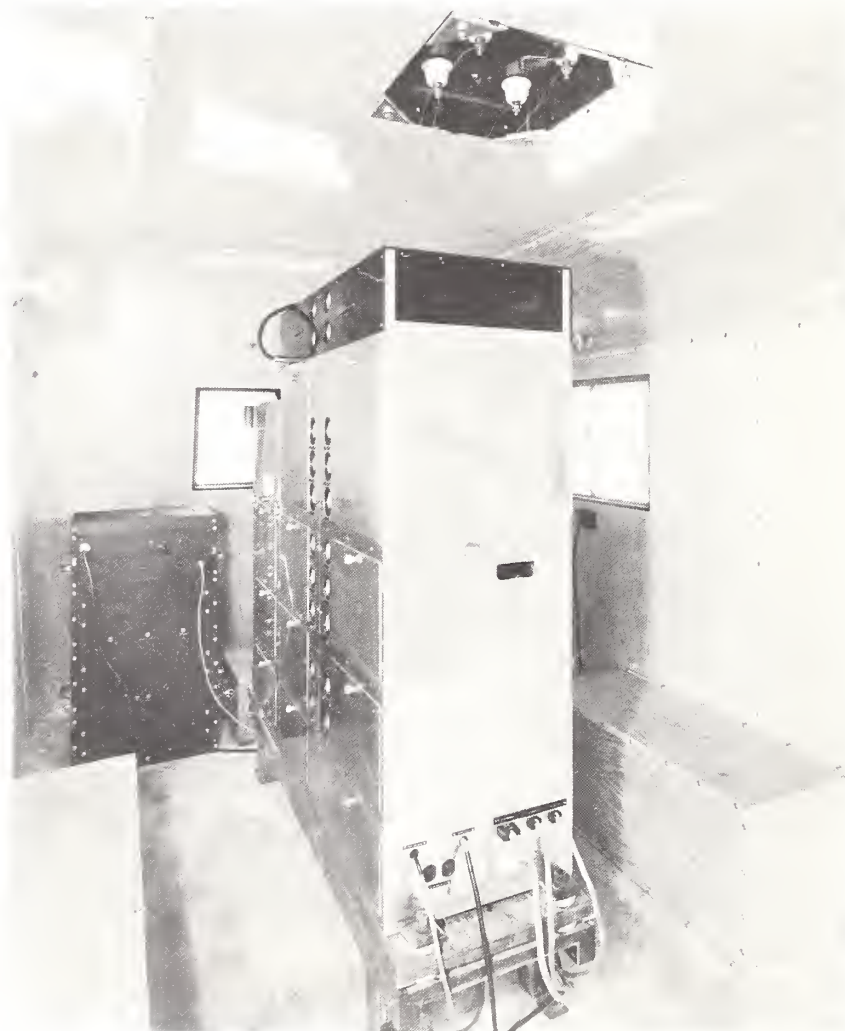

*Portable or mobile transmitter and ionosphere recorder mounted in trailer, developed by Gilliland and used by him for total eclipse of sun, October 1, 1940, at Patos, Brazil. In 1946 this equipment became known as the CRPL Model A ionosonde (or ionosphere recorder).*

## 2. The ionosphere begins to yield its secrets

### a) WIDENING THE FREQUENCY RANGE OF OBSERVATION

Following Gilliland's development of the Radio Section's first ionosphere recorders, a team under the direction of S. S. Kirby began probing the ionosphere with equipment designed for wider frequency coverage than Gilliland's original apparatus. During the period from September 1930 to April 1933, Kirby, L. V. Berkner, and D. M. Stuart made observations of the virtual height of the ionosphere and a study of the variation of height. Over the period observations were made as low as 590 kHz and as high as 12,000 kHz. The first observations were made at the Kensington field station with the transmitter at Potomac Yards, north of Alexandria, Va., at a distance of 20 km. Some transmissions were also received from the Navy station, NKF, in southeast Washington. With the development of field stations near Beltsville, Md., and at Meadows, Md. in 1932, a transmission path of 25 km was established between the two sites, the transmitter at Beltsville, the receiver at the Meadows station.<sup>63</sup>

Although the team was primarily interested in the critical frequencies of the several layers of the ionosphere under day and night conditions and with the seasons, the multifrequency automatic recorder was not available until their project was being phased out. Observations usually were made at frequency increments of 100 kHz, a complete run taking 30 to 60 minutes, consequently effects caused by sudden changes in the ionosphere could be missed. There was abundant evidence of several layers and they were able to determine the relative electron densities at the critical frequencies. The team found the critical frequencies of the E and  $F_1$  layer to be highest at noon in the summer and lowering both diurnally and seasonally as the angle of the Sun's rays with the vertical increased. The  $F_2$  critical frequency was greatest on a summer evening and greater on a winter noon than on a summer noon. The published observations covered the frequency range of about 2000 kHz to an upper limit of 12,000 kHz [26]. However, the equipment was capable of going considerably beyond this range, both at low and high frequencies.

### b) PROGRESS IN THE MAKING

Moving into 1934, progress by the Radio Section in gathering information on the ionosphere was proceeding on an ever-widening front. The Annual Report for 1934 stated that:

the collection of over a year's automatic records at the frequencies 2500 to 4400 kc probably represents the most complete and significant set of data on the ionosphere in existence.

By 1935 the Radio Section stated in the *Director's Annual Report to the Secretary of Commerce* that:

Measurements made throughout the year of the heights and critical frequencies of the ionized layers of the upper atmosphere which are responsible for long-distance radio transmission, constitute the most complete body of data in existence on this subject. . . .

Among the observations made and conclusions reached during FY 1934 were:

Daytime E-layer ionization densities followed in phase with the ionizing force of the sun, thus establishing with high probability that the ionization of the E layer in the daytime is due to ultraviolet light.

Diurnal variations of the E critical frequency during the daytime were found to vary as the fourth root of the cosine of the zenith angle of the sun.

$F_2$  layer ionization densities may increase or decrease at any hour of the night.

---

<sup>63</sup>The field station on the Experimental Farm of the Department of Agriculture at Beltsville, Md., northeast of Washington, D.C., became the site of station WWV for many years. The multipurpose field station at Meadows, Md., southeast of Washington, became the site of the Andrews Air Force Base in 1943.

The complex reflections received at frequencies above  $F_2$  critical frequencies were believed to be returned by another poorly defined higher layer which may be called the G layer.

During the early morning periods of November 16 and 17 (1933) special ionosphere observations were made to see if any effect of the Leonid meteorite showers could be noted. No phenomena were observed which were believed to be caused by the Leonid showers.

In later years various investigators observed the reflection of radio waves from meteor trails in the ionosphere, and attributed the sporadic E layer due at least partially to the presence of meteor particles.

#### c) SOLAR ECLIPSES AND THE IONOSPHERE

1918, 1919, 1923 Over the years the Bureau has observed the effects of one of Nature's most dramatic events—the total solar eclipse.<sup>64</sup> In the spring of 1918 the Department of Terrestrial Magnetism, Carnegie Institution of Washington, proposed a cooperative program with the Bureau to make radio observations of a total eclipse, but the project did not materialize (see footnote 22). Again, in April 1919, the National Research Council requested that attention be given to radio observations at the time of the solar eclipse (partial in the United States) of May 29. Nothing appears to have been recorded on any observations, if they were made.

In 1923 Dr. Louis Austin, of the Laboratory for Special Radio Transmission Research located on the Bureau grounds, observed radio transmissions during the eclipse of the Sun on September 10 that had a totality path across a portion of southern United States.

1925 The Radio Section took part in the cooperative project, directed by G. W. Pickard (a well-known consulting radio engineer), of observing radio transmissions during the eclipse of the Sun that was total in northeastern United States on January 24 (see p. 186).

1930 Observations made at the Kensington, Md. field station on April 28 of the annular eclipse that crossed the United States and Canada showed no indication on field intensity records of changes or disturbances in radio transmissions during the time of the eclipse.

1932 The section had to wait until 1932 before it carried out its own program of observing the effects of a solar eclipse on radio transmission. By then the section had developed the kind of equipment that was necessary to make quantitative measurements on the ionosphere. Observations were made by Kirby and Berkner at Washington, D.C. (with three transmitters at the Beltsville field station and two receivers at the Kensington field station), where the eclipse was 90 percent total. Gilliland and Norton took equipment to Sydney, Nova Scotia where 90 percent totality would take place on the opposite side of the path of totality from Washington. The primary purpose of selecting this observation point was to check the suggestion by Professor Sidney Chapman (England) that the E layer was ionized by corpuscles emitted by the Sun (Sydney, Nova Scotia would be in an area where the effect could be studied to substantiate Chapman's suggestion).

Observations were made on the afternoon of August 31 of the eclipse at Washington and at Sydney, with a continuous recorder (at single frequencies) and visually with a specially designed cathode-ray oscillograph [27]. Each of the two teams found that ionization of the E layer decreased to about 30 percent of normal value at the eclipse maximum, and ionization of the  $F_1$  layer to about 40 percent.

---

<sup>64</sup> Photographs of the total eclipse of the Sun were taken by Dr. Irvine C. Gardner, Chief of the Bureau's Optical Instruments Section, on several expeditions. On June 19, 1936, he took the first color photographs of a total eclipse with a special 14-foot camera of his design, that was constructed by the Bureau. The 1936 expedition was to the Kazak region in Asiatic Russia. The camera was used by Gardner in 1937 on Canton Island in the South Pacific. Later, he accompanied two expeditions to Brazil, the first in 1940, the second in 1947.

These values were in agreement with observations made by other groups. No significant changes occurred in the  $F_2$  layer. Also, there was no evidence at either Washington or Sydney that ionization of the E layer is caused by corpuscles emitted by the Sun. Yet, in the coming years much of the phenomena associated with the ionosphere would be explained as the effect of corpuscles from the Sun entering the outer regions of the Earth's atmosphere.

- 1935 The eclipse of the Sun at Washington, D.C. on February 3, although only 35 percent of totality, was of special interest because of the possibility of a clearer indication of the effect of an eclipse on ionization of the  $F_2$  layer in the winter than in summer. This eclipse was studied by Kirby, Gilliland, and Elbert B. Judson, using the newly available multifrequency automatic recorder for the frequency range of 2500 to 4400 kHz. Above and below this range they had to use recorder equipment at single frequencies with manual control.

The team observed that ionization in the E layer was reduced to 0.85 of normal at the maximum of the area of the Sun's disk being covered. Ionization of the  $F_1$  layer was reduced to 0.88 of normal with a time lag of about 20 minutes, but poorly defined because of poor definition of the  $F_1$  layer in the winter. A time lag of 9.5 minutes was observed for the  $F_2$  layer. The team came up with several viewpoints on the nature of recombination of charged particles in the total ionization process.

- 1936 The solar eclipse of June 19 that crossed Siberia in totality was observed at Washington by Kirby, Gilliland, Smith, and Reymer. Observations were made of the critical frequencies of the E,  $F_1$ , and  $F_2$  layers, and the virtual height of the  $F_2$  layer over a 4-day period from June 17 to 19. A severe magnetic storm at the time of the eclipse obliterated any changes of the ionosphere that may have otherwise been observed. Magnetograms from the nearby Cheltenham, Md. Magnetic Observatory of the U.S. Coast and Geodetic Survey indicated the severe storm disturbances. Correlation of conditions of the ionosphere with the magnetic storm corroborated earlier observations made by the Radio Section.

- 1940 Late winter of 1939-1940 found Gilliland and Taylor rushing a portable-type multifrequency ionosphere recorder to completion for use on an eclipse expedition to southern Texas and later to Brazil (see p. 212). An annular solar eclipse occurred on April 7 in southern Texas, and Gilliland and Taylor took the equipment to Fort Clark for a 10-day period spanning the eclipse event. Observations also were made at the Meadows, Md. field station. The observations largely confirmed those made of the 1935 eclipse at Washington.

Gilliland accompanied the joint National Geographic Society-NBS expedition to Patos, Brazil (Paraíba State, in northeastern Brazil) to record the total eclipse of the Sun on October 1. Observations were made over a 14-day period spanning the eclipse. The Radio Section was particularly interested in the ion density before, during, and after the eclipse in the E,  $F_1$ , and  $F_2$  layers, and also the rates of ion recombination. Analysis of the recordings and calculations indicated anomalies in the expected and the observed results. The observation of a definite decrease in ion density occurring at the same time the Moon obscured a large sunspot was considered significant as a possible means of identifying the source of certain ionizing radiation within given areas of the Sun.

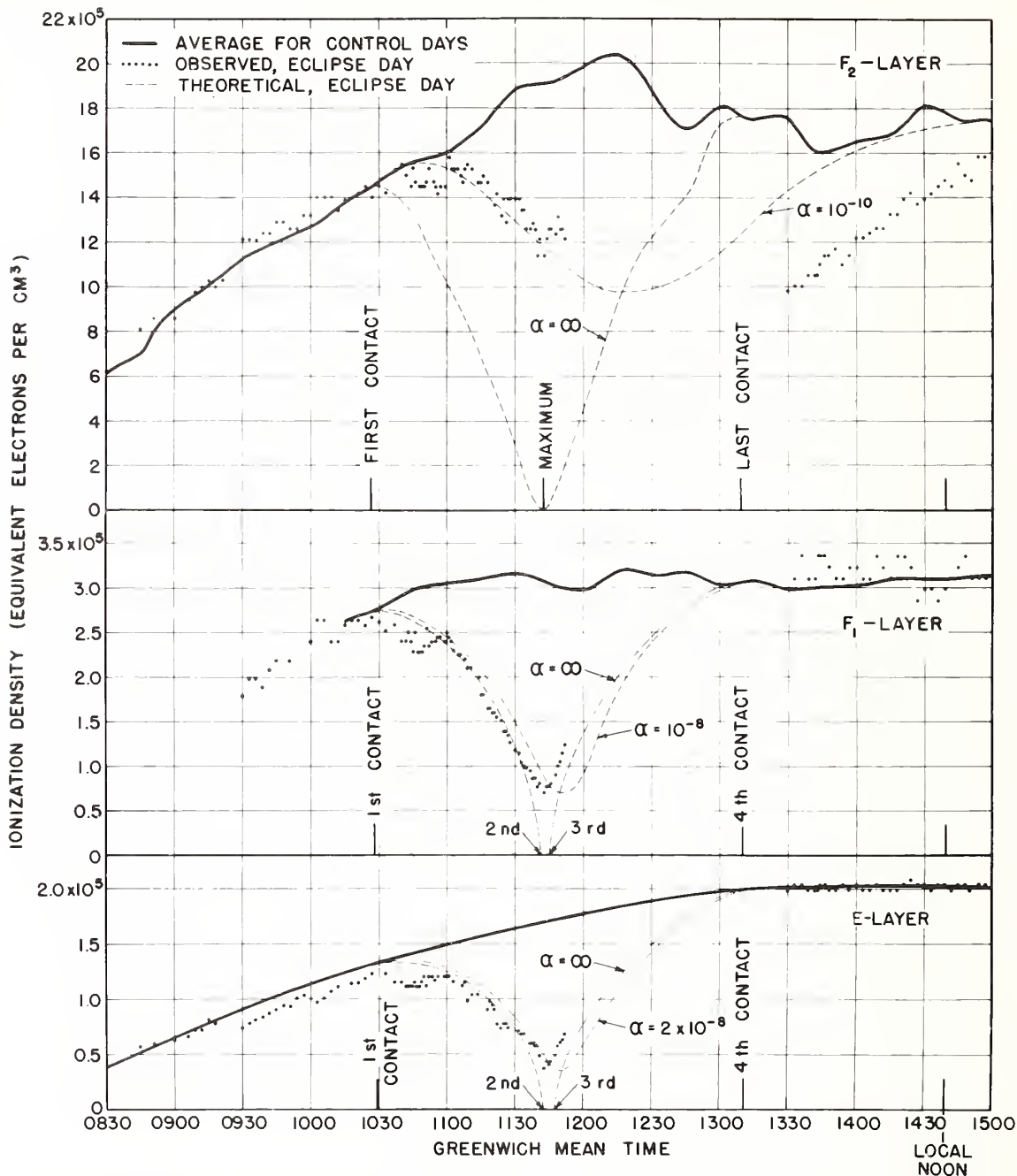

Gilliland's observations of ion densities in ionosphere layers before, during, and after, total eclipse of October 1, 1940, observed from station at Patos in northeastern Brazil. Ion density reached a fairly sharp minimum in the E and  $F_1$  layers at time of total eclipse which lasted 282 seconds (between 2nd and 3rd contacts noted on graphs). Dashed curves show calculated values by N. Smith of ion density for assumed values of recombination coefficient  $\alpha$ .

Newbern Smith provided an assist to the two expeditions by furnishing critical frequency predictions in advance that could be adapted to the paths of the two eclipses.

1947 In the late spring of 1947, Dr. Lyman J. Briggs, then recently retired as director of NBS, led the joint National Geographic Society-Army Air Force Eclipse Expedition to Brazil. Accompanying the expedition were James M. Watts and Franklin Kral of the Field Operations Section (CRPL). They were equipped with the prototype model of the newly developed Model C ionosonde. With the new equipment it was possible to make time-lapse records on movie film for later projection to speed up a viewing of ionosphere reflections.



The eclipse occurred on May 20 and was observed by the expedition near the Brazilian village of Bucaiuva, located on a semiarid plain about 400 miles north of Rio de Janeiro. The path of the total eclipse ranged from Santiago, Chile to the Kenya Colony in East Africa.

Several years later (1950) in writing on the variation of electron density in the F layer during the eclipse, Jacob Savitt, of the Upper Atmosphere Research Section, found that the recombination and attachment coefficients of free electrons varied systematically with height and were in general agreement with other investigations. Best agreement of observation and theory was obtained at a height of 260 km, assuming the attachment process (with neutral particles).

1950 Grote Reber (Upper Atmosphere Research Section) and E. A. Beck (Tropospheric Propagation Research Section) participated in the Naval Research Laboratory Expedition to observe the total eclipse of September 11. This eclipse traveled a path in a southeasterly direction across eastern Siberia, across the Bering Sea, and over the Pacific Ocean toward Hawaii. The expedition installed its equipment on Attu Island, the most westerly in the chain of the Aleutian Islands. As could be expected, "observations" were made during a severe rainstorm of the inhospitable climate.

Observations were made with a radar antenna of 10-foot diameter, measurements of solar radio intensity being taken at 3-, 10-, and 65-cm wavelengths. Observations of change in intensity were taken over a period of 2 hours before to 2 hours after the totality of 73 seconds. There was an unexplained rise of about 10 percent in the intensity at the time of first contact and the last contact of the Moon's disk with the Sun. The intensity decreased to about 30 percent of normal during totality, the change being very gradual before and after totality.

1955 On June 20 Vernon H. Goerke (Upper Atmosphere Research Section) conducted radio observations of a total eclipse of the Sun in the vicinity of Baguio on the island of Luzon, Philippines. His findings confirmed with greater accuracy the scanty results of previous observations on eclipses that in the recombination of ions in the D layer of the ionosphere there is a very short relaxation time.

1958 On October 12 a total solar eclipse passed over the Danger Islands (northeast of Samoa Islands) in the Central Pacific and its effect upon the ionosphere was observed with a C-2 ionosonde by Garth H. Stonehocker (Sun-Earth Relationship Section) and Leo W. Honea (stationed at Maui, Hawaii). A paper published in 1960 by CRPL personnel revealed interesting and new information on photochemical rates in the equatorial F<sub>2</sub> region from the eclipse by a new method of analyzing the electron-density data [28].

1963 The effect on VLF signals propagating over short paths by the total eclipse of the Sun on July 20 across Alaska and Canada was observed by the CRPL at Hanover, N.H. The project was conducted by James H. Crary and Dennis E. Schneible. Observations showed that the response in the D region to ionizing radiation does not necessarily reach a minimum at time of maximum optical eclipse but may show variations associated with locations of active x-ray producing regions.

The CRPL also analyzed vertical incidence radio soundings taken at time of eclipse at 22 locations across North America. The analysis showed a well-marked and consistent geographical pattern of variation of the ordinary-wave critical frequency of the F<sub>2</sub> layer with eclipse time.



*“ . . . my tumbled down shack by a” South Sea shore—one of the Danger Islands, northeast of the Samoa Islands in the Central Pacific. Garth H. Stonehocker and Leo W. Honea of the CRPL, occupied this “shack” during 11 days of observation of the effects on the ionosphere of the total solar eclipse of October 12, 1958. Housed with them was a C-2 ionosonde and its associated equipment, plus a complete amateur radio station. Radio antennas occupied the immediate “premises.”*

#### **d) TAKING PART IN THE SECOND INTERNATIONAL POLAR YEAR**

Fifty years after the First Polar Year of 1882-1883, the Second International Polar Year was staged for the period 1932-1934. The ionosphere measurement capability of the Radio Section had matured to the extent that a definite contribution could be made to the international program. The project was directed by S. S. Kirby.

Observations were made at the Beltsville and Meadows field stations for Washington-based data. Measurements of virtual heights of the ionosphere layers were made at 2050, 4100, and 8000 kHz at noon and midnight (local time) on the scheduled “international day” of each month. Also observed were the critical frequencies of the E and F<sub>2</sub> layers. Although not on the planned program, during the latter part of the Polar Year nearly continuous observations were made in the frequency range of 2500 to 4400 kHz on the newly developed multifrequency recorder. A severe magnetic storm was observed for a period of several days, with an abrupt disappearance of echoes at 4100 kHz for several minutes on February 24, 1933.

The “Polar Year Report of the National Bureau of Standards,” of August 7, 1934, was presented at the General Assembly of the International Scientific Radio Union (URSI) in London on September 14, 1934, by the American delegation.

Although much information was gathered by the Radio Section during the Second Polar Year, a number of years would have to pass before there would be a more detailed understanding of the ionosphere.

1) The early months of observation by Dellinger and others

Scattered among the observations, recordings, and measurements on radio transmission that had been compiled in 1935 (and that bore the label, "constitute the most complete body of data in existence on this subject . . ." see p. 215), was some evidence of a type of ionosphere disturbance that had eluded the Radio Section heretofore. The subject was first noted in the Monthly Report for July 1935 that a "peculiar effect" had been observed. It was stated that:

Through correspondence with French and American engineers, it was established that a peculiar effect occurred on May 12 (1935), when at noon GMT all high-frequency signals decreased to zero and remained out for 15 minutes, both in France and the U.S.A.<sup>66</sup>

The Monthly Report of August 1935 stated:

Further correspondence brought to light additional information on the sudden fadeouts mentioned in last month's report as having occurred May 12. The same phenomenon has been occurring at approximately 54-day intervals, twice the period of the sun's rotation. It affects all high-frequency transmission in the sun-lighted half of the globe. This warrants further study.

Observations at several radio communications stations and by radio amateurs showed that fadeouts of approximately 15-minute duration had occurred on March 20, May 12, and July 6 (1935).<sup>67</sup> Dellinger predicted the next fadeout for August 28 to 30. At 6:20 on the evening of August 30 (EST) the sudden drop in field strength of signals received by the Radio Section at the Meadows field station was noted.

Letters were sent by Dellinger to the periodicals, *Science* and *Physical Review* (letter dated September 21, 1935), mentioning the next probable date of occurrence of a sudden fading out of long-distance, high-frequency signals [29,30]. In his letter to *Physical Review* he stated that the 15-minute fadeouts generally occur during periods lasting from several hours to several days when there are considerable fading periods accompanied by terrestrial magnetism disturbances and fluctuating Earth currents. He made the suggestion that the sudden fadeouts were probably due to some solar emanation that lasts for only a few minutes.

In his letter, Dellinger suggested that those concerned with such observations make continuous recordings during the predicted fadeouts and communicate with the Bureau on their observations. (Subsequently, reports were received from radio operators, communication companies, radio amateurs, and others, cooperating heartily in the study.)

---

<sup>65</sup> This title was borrowed from that of a communication by Dellinger to the periodical, *Science*. It appeared in the October 11, 1935, issue as the first public announcement of Dellinger's calling attention to a newly observed radio transmission phenomenon. The announcement preceded a somewhat more detailed account that appeared in the periodical, *Physical Review*, just 4 days later (see references [29] and [30]).

<sup>66</sup> Dellinger related in a letter to the editor of *Physical Review* (see reference [30]) that a correspondent in France brought to his attention that high-frequency signals received at a station near Paris had suddenly disappeared at 1157 G.m.t. on May 12 (1935), and that after several minutes of complete silence the signals slowly regained the normal intensity by 1215 G.m.t. Dellinger also learned, upon inquiry, that at the time of disappearance of signals at Paris the same occurred with signals received at the stations of RCA Communications, Inc. at Riverhead, N.Y. and the Bell Telephone Laboratories at Necong, N.Y.

In a later account Dellinger relates in more detail the circumstances of how he became aware of this newly observed phenomenon [31]. In June 1935 he received a letter from Dr. R. Jouaust, who was Secretary of the French National Committee of URSI. Dr. Jouaust referred to a statement made by a Mr. Garnier of the Compagnie Radio-France located at Villecresnes, to the southeast of Paris, that general fading occurred on all short-wave receptions from 1157 to 1215 G.m.t. on May 12, 1935. Dr. Jouaust inquired if a similar fading was observed at the same time in the United States.

<sup>67</sup> A radio operator at Atlanta, Ga., reported that on November 28, 1934, beginning at 11:10 a.m., CST, a sharp fadeout occurred for a 30-minute period on a number of high-frequency transmissions, but not in the broadcast band. This report was the earliest on record in the files of the American Radio Relay League of a sudden and complete fadeout at high frequencies during the daytime.

Based upon the averaged 54-day interval that he had observed between fadeouts, Dellinger predicted the next fadeout to be during the period of October 21 to 25 (1935). One can well imagine the anticipation on the part of the Radio Section and of many radio operators in preparing for the predicted event. But on this occasion the phenomenon was not of the same kind at all; it was on a far greater scale than the 15-minute fadeouts observed previously. It was of the kind that was later to be called an "ionosphere storm." Beginning on October 10 there was an increased sunspot activity with a gradual increase of the critical frequency in the  $F_2$  layer. By October 23 the critical frequency had reached 12,600 kHz, the highest that had ever been recorded by the Radio Section at Washington. Radio operators found that daytime transmissions were unusually good during this period of increasing critical frequency. Then on October 24 a complete reversal took place. The critical frequency of the  $F_2$  layer dropped to about one-half (6400 kHz) of the day before, and the virtual height increased to 460 km from the previous 250 km. Transmissions at the higher frequencies dropped out completely. By the next day, October 25, conditions returned to those of October 23, and then gradually to normal conditions. Accompanying the ionosphere disturbance was a magnetic disturbance of considerable intensity on October 23 and 24, reported by the Coast and Geodetic Survey. The magnetic disturbance was on a worldwide scope on October 24. The solar, ionosphere, and magnetic events of October 1935 left many unanswered questions. Among these was the observed 54-day period of the sharp fadeouts, which was twice that of the 27-day period of the rotation of the Sun; simply a "fortuitous" event as described by Dellinger.

An interesting circumstance in terminology came about at an early date in the naming of this "peculiar effect" as it was called by Dellinger in the Monthly Report of July 1935. It was sometimes referred to as a sudden "fading out" of signals (and of short duration), and sometimes as a "wiping out" of the signals. The appellation of the "Dellinger effect" appeared very early, first in the December 1935 issue of the radio amateur periodical, *QST* [32]. In a staff-written article, entitled "A new radio transmission phenomenon," it was stated: "This 'Dellinger effect' is an intriguing thing, and we amateurs can help in its ultimate identification." Thereafter, *QST* used the term a number of times especially in editorial introductory notes.

The term "Dellinger Wipe Out" appeared as a title to a paper in the November 1936 issue of the *T and R Bulletin* of the Radio Society of Great Britain. The paper relates to two theories of ionization in the F layer in explanation of the phenomenon of sudden fadeouts. The term "Dellinger effect" was used in the text. Other terms that appeared in the literature were: radio fadeout, sudden fadeout, sudden ionospheric disturbance, solar flare disturbance, and similar expressions. Although fadeout appeared to be the most commonly used in the earlier years, the term "Dellinger effect" was used, on occasion, over the many years.<sup>68</sup> Gradually, however, the term "sudden ionosphere disturbance" or "SID" has come to be the accepted term, and certainly is descriptive of the causation of sudden radio fadeouts. Yet biographical sketches of Dr. Dellinger will usually ascribe his study of the "Dellinger effect" as his greatest scientific achievement.

---

<sup>68</sup> Of rare usage has been the term "Mögel-Dellinger effect" for the sudden fadeout of radio signals. In his paper published in the July 1939 issue of the *Journal of the Franklin Institute*, Dellinger commented that he had learned that T. L. Eckersley (England) and H. Mögel (Germany) had observed the simultaneous occurrence of radio fadeouts in 1928 without attributing them to any specific cause.

In his paper entitled "Sudden disturbances of the ionosphere," published in the November 1937 issue of the *Journal of Applied Physics*, Dellinger acknowledges the observations made, and explanations advanced, on sudden radio fadeouts given by Eckersley. This was published in a lengthy paper in the 1929 *Journal of The Institution of Electrical Engineers (London)*, entitled "An investigation of short waves." Under the subject of magnetic storms Eckersley refers to short-period fadeouts or "fades" and, in particular, one on October 28, 1928, of remarkable suddenness and relative rapidity of recovery, lasting, in total, about 1 hour. It was not accompanied by a magnetic disturbance. The fadeout was also reported in Germany. Eckersley attributed the phenomenon to a very penetrating radiation, perhaps ultraviolet, that ionized lower layers of the ionosphere and that had its source in sudden bursts of energy from the Sun. Eckersley also noted that the fadeout appeared on the illuminated side of the Earth with some evidence of its not occurring on the dark side. However, unlike Dellinger, he did not trace these fadeouts to specific and correlated events of solar flares as the source of the ultraviolet radiation.

The first recognition by NBS of an SWF (short wave fadeout) was on April 8, 1936, at the Meadows field station. Examination of prior records at Meadows showed an SWF on February 14 and April 6, 1936.

## 2) Relating the radio fadeout to Sun activity

Dellinger lost no time in contacting the Mt. Wilson Observatory for evidence of unusual solar activity at the time of observed radio fadeouts. By November 1935, R. S. Richardson of the Observatory reported that he had examined the spectrohelioscope records and found sudden and marked changes in the form and intensity of hydrogen flocculus (solar flare) on the Sun within a few minutes of the time of fadeouts on July 6 and August 30, 1935. There had been unusual activity on October 24, the disturbance being over a much longer period than at other times. No observations had been made at the time of the earlier fadeouts on March 20 and May 12. By the end of 1935 observations and records indicated that there was a direct correlation of radio fadeouts at high frequencies with sudden or sometimes with extensive disturbances on the Sun, and that the fadeouts always occurred on the illuminated half of the Earth. By January of 1936 Dellinger had published five articles in the scientific literature on the solar radio disturbances observed in 1935.

## 3) A further study of radio fadeouts

After his important discovery in the latter part of 1935 of the relation of radio fadeouts to sudden solar disturbances, Dellinger continued his study over the next several years. By the close of 1937 he had published no less than 12 papers on the subject.<sup>69</sup> With further observations, the individuality of single and very sudden fadeouts with a 54-day period lost their original uniqueness. In the August 1937 issue of the *NBS Journal of Research*,

<sup>69</sup>The first of four papers published in *QST*, in which the term "Dellinger effect" was first used, was a *QST* staff-written paper. It is often listed as Dellinger being the author.

# NOV. 24, 1936

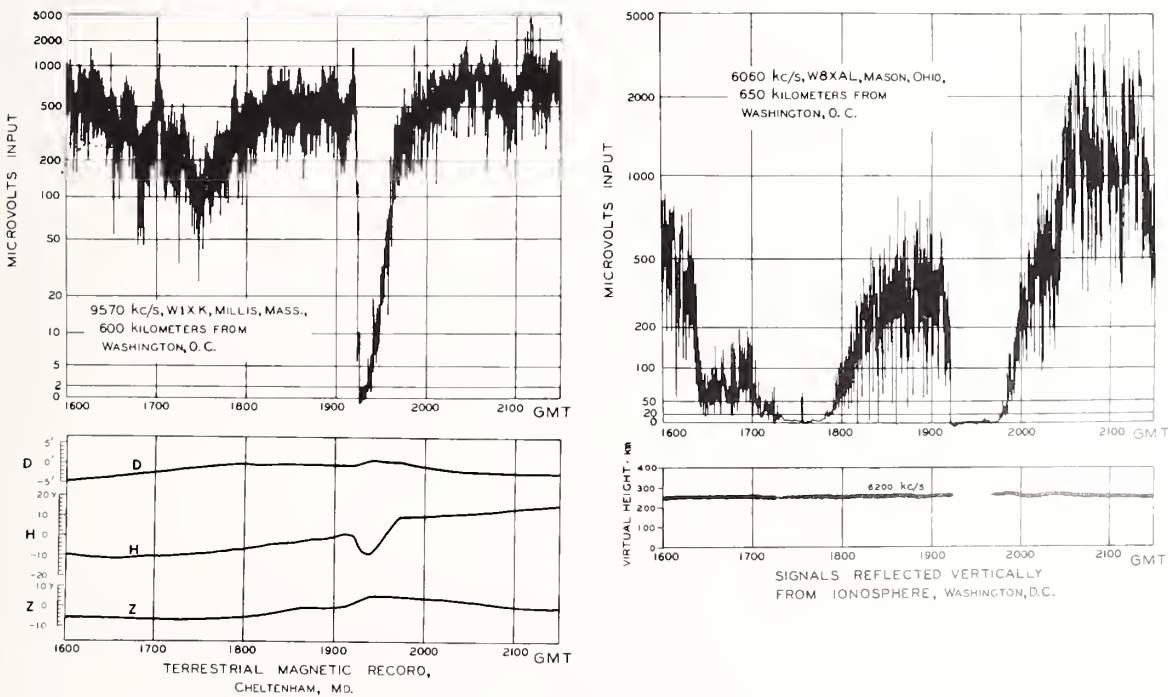

A graphic example of Dellinger's studies of the mid-1930's of sudden disturbances or fadeouts of the ionosphere is shown in these recordings of the phenomenon of November 24, 1936. The characteristic sudden drop of signal intensity to zero or near zero occurred shortly after 1900 G.m.t. at the two frequencies being observed, each from stations of very different geographic locations in relation to the Meadows, Md. field station near Washington, D.C. Recovery of signal after the disturbance was typically slow. A fadeout of more gradual nature had occurred in signals from the Mason, Ohio station preceding the sudden fadeout.

Ionosphere sounding at Meadows showed complete disappearance of reflected signals during the severe fadeout. Magnetic record taken at nearby observatory at Cheltenham, Md. showed a broad pulse in shifting of magnitude of horizontal component during the severe fadeout.

Dellinger summarized much of his study of the previous 2 years (this lengthy paper also appeared in the October 1937 issue of the *Proc. IRE*) [33]. By the end of 1936 Dellinger had amassed large quantities of records taken by the Radio Section and by many radio operators that indicated a total of 118 occurrences of radio fadeouts since November 1934.<sup>70</sup> He found there was a total of five separate fadeouts on May 28, 1936, the maximum recorded for a single day. On some fadeouts he received observations from more than a dozen sources of wide geographical distribution. With few exceptions, all fadeouts related to transmissions were above 1500 kHz. It was from this mass of data that Dellinger was able to draw a number of conclusions with a good degree, yet some with a lesser degree, of certainty.

Dellinger summarized the transmission characteristics of radio fadeouts in his lengthy paper published in October 1937 (*Proc. IRE*) as given below.<sup>71</sup> He concluded that the sudden disturbances in the ionosphere, causing the fadeouts, were due to a sudden increase of ionization in a layer (or layers) below the E layer. It was but 5 months earlier that Newbern Smith and S. S. Kirby had identified this layer, which is usually referred to as the D layer (see p. 229). Dellinger attributed the strong ionization of this layer as probably due to ultraviolet radiation from sudden disturbances (solar flares) in the vicinity of sunspots. The radiation would have to penetrate the layers (E, F<sub>1</sub>, and F<sub>2</sub>) above the intensely disturbed layer, these layers being ionized by radiation from the Sun of a different character. Upon strong ionization, the lowest layer absorbs all of the energy of radio waves that is normally reflected from the upper layers and thus long distance transmission is reduced to only ground wave transmission. With a rapid ebbing of the ultraviolet radiation, the strongly ionized layer below the E layer rapidly returns to normal and transmission of signals by the upper layers is restored. The mode of recombination of ions in the layer is such that transmission at the higher frequencies is restored before that of the lower frequencies.

Because of the strong ionization in the Earth's atmosphere caused by sudden solar disturbances, perturbations often occur, but not always, in the Earth's magnetism and in Earth currents. Perturbations associated with radio fadeouts were found to be quite different than those associated with magnetic storms.

Dellinger expressed himself quite freely in his 1937 paper, that:

Ionosphere phenomena, as detected by radio, terrestrial-magnetic, and earth current effects thus become the unique means by which we can study various classes of radiation from the sun.

On another occasion he stated:

The sudden ionosphere disturbance is the only known instance in which a specific happening on the earth follows directly from a specific random happening on the sun or other heavenly body.

Dellinger's early study of sudden solar disturbances led to many avenues of approach in revealing Nature's secrets of the ionosphere and of the Sun.

---

<sup>70</sup>Data on the radio fadeouts were based on:

- (1) experiences of operators receiving radio signals
- (2) graphical records from field intensity records
- (3) observations of echo-signal pulses from the ionosphere

Beginning August 1935, an extensive recording program on fadeouts was set up at the Meadows field station using the automatic field intensity records. Several transmitters were recorded on a continuous time schedule.

<sup>71</sup>The . . . facts clearly outline a phenomenon which is some type of sudden change, somewhere in the ionosphere. Whenever the phenomenon occurs, it is most intense in that region of the earth where the sun's radiation is perpendicular and diminishes to zero at the outer edge of the illuminated hemisphere. Its onset usually occurs within a minute, and is simultaneous throughout the hemisphere affected. Its various effects begin simultaneously, and last from ten minutes to several hours, the occurrences of greater intensity in general producing effects of longer duration. The effects include the sudden blotting out of high-frequency radio sky-wave transmission, sudden changes in low-frequency atmospherics, sudden changes in terrestrial magnetic intensities, and sudden changes in earth currents. The effects are markedly different from other types of changes in these quantities. They are more intense where it is noon than where it is other times of the day, and are more intense in equatorial regions than in high latitudes. The radio effects are very large, indicating that the ionosphere changes producing them are intense ones.

#### f) PROBING THE IONOSPHERE FROM THE ARCTIC

A chance meeting of Dellinger with Miss Louise A. Boyd, a well-known Arctic explorer, on board ship on one of his transatlantic journeys led to a Radio Section field trip to the Arctic.<sup>72</sup> Later, on March 15, 1938, Miss Boyd visited the Radio Section to discuss the possibilities of the Bureau doing some ionosphere work on one of her expeditions in the vicinity of Greenland. To accommodate the section's desire to do some ionosphere work in the vicinity of the north magnetic pole and in a region resplendent with auroral displays, she expressed a willingness to make her 1940 expedition up the west coast of Greenland (the expedition was made in 1941). But let Dr. Dellinger speak of it in his own words as he related the tale in his address to the staff at the Boulder Laboratories on March 3, 1961, on the occasion of the 60th Anniversary of the Bureau.

. . . Once, on returning from an international conference, I met an interesting lady on board ship. She asked me what I was doing and I asked her what she was doing and we got together very fast when I told her about the radio work and she told me that she was an explorer specializing in Greenland. She said, you know the radio is a part of what ought to be my field that I have never been able to do anything with. She was Louise Boyd, the leading world authority on East Greenland. She had taken several expeditions up there; she is a wealthy woman and paid for these expeditions herself. She is also a great expert in photography and the pictures which she took in Greenland and in some other countries were of great use to our military during the war. Well, the proposal very rapidly developed that she would take an expedition up along West Greenland for the Bureau. I had explained to her that one of our greatest troubles was trying to do something about the auroral zone, because we hadn't been able to get any data from there, radio conditions there were very special, and radio transmission across there was difficult and of unique commercial and military importance. She said, I'll go up there and get you some data: you detail some of your men to go with me. I will hire a ship and a crew and take them up for as long as you like. So all one summer our Mr. A. S. Taylor and Mr. F. R. Gracely, with some of the equipment the laboratory developed, were on the ship that she took up; they got a lot of data and it was a great success. This was in 1941, just before we got into the war. The ship she hired was that of Captain Bob Bartlett who had taken many voyages in the Greenland region, and had a lot of publicity, and was a very, very colorful character. He was quite an expert in profanity, even among seafaring men, so I thought. Miss Boyd said, however, no he wasn't; it was true that not four words came out of his mouth without at least two being profane, nevertheless they were always the same words. His vocabulary of profanity was very limited. Bob Bartlett said at the beginning of one of his books that women are good luck on land, but bad luck at sea. At the beginning of this voyage he drew a line on the deck and pointed out: Miss Boyd, you're that side of the line, and I'm this side of the line. Soon after this voyage he died.

Miss Boyd was appointed as a consulting expert of the Bureau on a dollar a year basis. Miss Boyd was the self-appointed leader of the expedition, with Capt. Robert A. Bartlett, the master of the ship *Effie M. Morrissey*. The Radio Section had two of its members on board, A. S. Taylor and F. R. Gracely.<sup>73</sup> Both had taken part in the section's large-scale project on the study of transmission of radio waves. Others on board included a radio operator detailed by the Coast Guard, a physician, and 11 crew members.

---

<sup>72</sup> The Radio Section had given assistance to the Mac Millan Arctic Expedition of 1923-1924 for data handling of the observations of radio transmissions (see p. 183).

<sup>73</sup> Frederick R. Gracely entered the Section on March 19, 1938. He left on July 31, 1944, to join the Ordnance Development Division, after being associated with wave propagation projects for 6 years.



*On deck of the Effie M. Morrissey in Long Island Sound on October 29, 1941. This 5-month Greenland expedition was the 7th into Arctic regions sponsored by Louise A. Boyd (of San Francisco, Calif.) during the period of 1926 to 1941. At the request of NBS, Miss Boyd, for the first time, set a course along the west coast of Greenland and into the Baffin Bay region. It was the first opportunity by NBS for an extensive study of the ionosphere at Arctic latitudes*

*Shown from left to right: Frederick R. Gracely, NBS; Louise A. Boyd; Archer S. Taylor, NBS; and T. A. Carrol, U.S. Coast Guard radio operator.*

The Louise A. Boyd Arctic Expedition sailed from Washington, D.C. on June 11, 1941. The ship cruised up the west coast of Greenland into the Baffin Bay region, then down the east coast of Baffin Island and along the coast of Labrador. The expedition returned to Washington on November 3. On November 14 Miss Boyd addressed the Bureau's scientific staff on "Arctic Expedition 1941." Three weeks later the United States entered World War II and Miss Boyd's knowledge and photographs of Greenland and the surrounding regions would be much valued by the military during the war.

Among the instruments used on the expedition by Taylor and Gracely was the portable ionosphere recorder developed by Gilliland for the earlier expedition to Brazil to observe the total eclipse of October 1, 1940. In addition to the recordings of ionosphere heights, observations were made of radio transmissions from distant stations, of aurora, the Earth's magnetism in the arctic region, and the intensity of ultraviolet light in the region.<sup>74,75</sup>

<sup>74</sup> Measurement equipment for the Earth's magnetism was furnished by the Department of Terrestrial Magnetism, Carnegie Institution of Washington; Cornell University supplied a photometer and spectroscope for aurora observations; the Bureau's Radiometry Section furnished equipment for recording the intensity of ultraviolet light.

<sup>75</sup> No published account appeared on the results of the scientific observations of the expedition, probably due to the exigencies of World War II. Two short accounts appeared in the *Technical News Bulletin*, the first in the July 1941 issue, the second in the December 1941 issue after the return of the expedition.



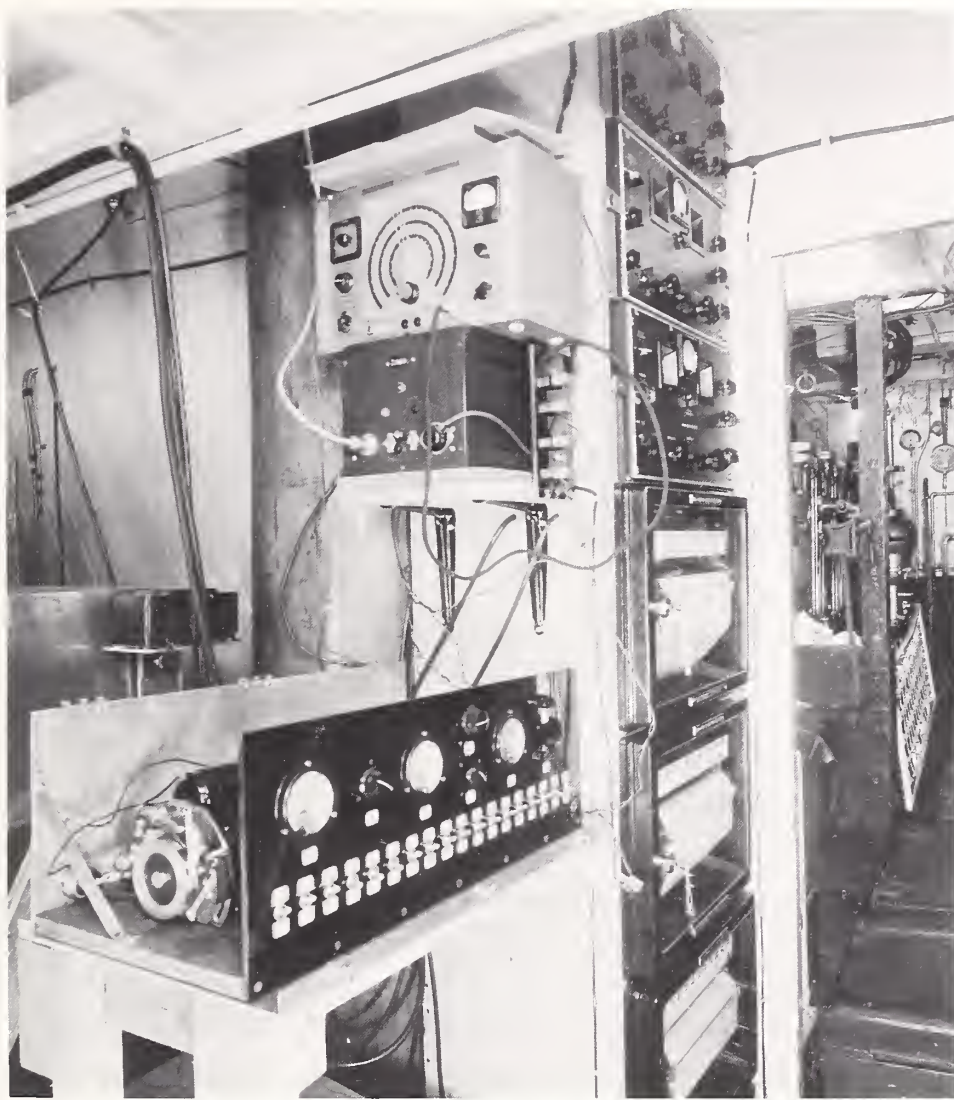

*Measurement equipment aboard the Effie M. Morrissey, used by Radio Section personnel to study the ionosphere on 1941 Greenland expedition sponsored and headed by Miss Louise A. Boyd. In foreground is field-intensity receiver and recorder. At center, the control panel for measurement of Earth's magnetism. Top center, ultraviolet recorder. A portable ionosphere recorder was included with the equipment.*

#### **g) IONOSPHERE STORMS**

September 18, 1941—An evening to remember.

Ionosphere storms were first reported by Appleton and his coworkers (England) in 1933 as a result of observations taken during the International Polar Year of 1932-1933. They found magnetic disturbances at evening and during the night quite the normal condition rather than the exception at the Observatory of Tromso in northern Norway, as compared with conditions in England. During their onset, the magnetic disturbances in England were accompanied by violent fading of radio signals and absence of "echoes" from the ionosphere.

Over a period of 3 years the team of Kirby, Gilliland, Judson, N. Smith, and Reymer found many evidences of magnetic and ionosphere storms in the recordings taken at the Meadows field station. Over this period (1935-1938) they reported their observations in four Letters to the Editor of *Physical Review*. No concerted study of ionosphere storms was made by them as a subject per se, but they did study the relationships of magnetic and ionospheric storms to the general conditions of the ionosphere. No full-fledged paper on ionosphere storms as a printed publication was prepared by the Radio Section.

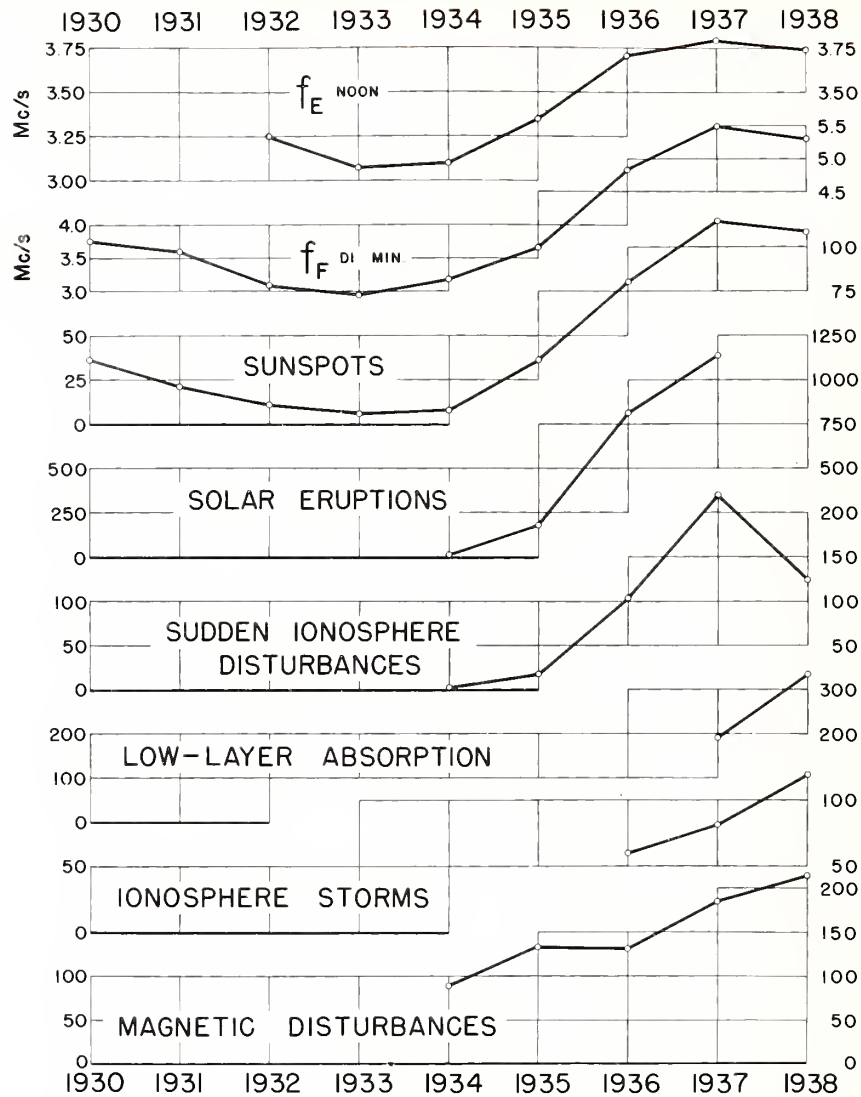

Observations of the ionosphere over a period of 9 years by the Radio Section in relation to solar activity and the accompanying earthbound effects. Correlation of the observed effects was quite evident to researchers of the 1930's.

In their four Letters to the Editor (*Physical Review*), the team reported they had found that:

- (1) Ionosphere storms, like magnetic storms, consist of two phases, the first a turbulent phase, the second a moderate and longer phase, with a gradual return to normal conditions.
- (2) During the disturbed ionosphere conditions the critical frequency of the daytime  $F_2$  layer is lowered (by as much as one-half, and indicating a decrease in ionization density) as the virtual height is greatly increased, thus making for poor signal transmission over a considerable frequency range.
- (3) The storms have their origin in the auroral zone and the effects extend south to Washington, and in storms of great intensity will extend to much lower latitudes toward the equator.

Such was the ionosphere storm and the accompanying auroral display experienced in Washington, D.C. on the evening of September 18, 1941—the greatest display ever observed in the locality [34]. On September 10 a large group of sunspots appeared on the edge of the Sun's disk. (Solar activity, in terms of sunspot numbers, was on the decline from a maximum number in 1937 and would reach a minimum in 1944.) By September 17 the group

had moved to about the center of the disk (in distance approximately one-quarter of the Sun's rotation of 27 days), and radio communications began to be disrupted in northeastern United States and across the Atlantic. Shortly after midnight, and beginning early on September 18 in the eastern United States, the ionosphere was violently disrupted by a tremendous burst of electric particles from the Sun. With the coming of evening a brilliant auroral display was forming in the northern sky at Washington. By 8 p.m. shimmering shafts of green light came out of the north, east and west across the zenith, and on to the southern sky. Actually, the streamers were coursing the "lines" of the Earth's magnetic field which, in Washington, take a somewhat northwest-southeast direction. Shortly after 8 p.m. the intensity of the auroral light began to diminish and by midnight had faded away in the Washington area. Indeed, it was an evening to remember.

During the 24-hour period that encompassed September 18 the ionosonde recordings taken at the Meadows field station showed no normal-incidence reflections, indicating a very abnormal condition of the ionosphere. Radio transmissions were extremely erratic and much static accompanied the signals. It was a matter of several days, during the period of the moderate disturbance phase, before transmissions began to approach normal conditions. As would be expected, the ionospheric disturbance was accompanied by, or associated with, disturbances of the Earth's magnetism.

#### h) AN EARLY OBSERVATION OF THE D LAYER

In 1935 and 1936 several observers, including S. S. Kirby and E. B. Judson of the Radio Section, reported on evidence of ionosphere layers below 100 km. This would be a region of low ion density compared to the densities of the upper layers in which, because of high absorption or penetration or very weak reflection, radio waves would not be observed by the pulse method at normal incidence. Nevertheless, N. Smith and Kirby did obtain evidence of such a layer by the method of continuous automatic field intensity recording and reported their observations in May 1937 in a Letter to the Editor of the *Physical Review*, stating that: "The evidence we present is therefore the first proof of the existence of a truly reflecting layer below the E layer" [35].<sup>76</sup> They found evidence of an ionization layer (called the "D layer") with a critical frequency of 1040 kHz (in the broadcast band) when observed over a distance of 480 km. This corresponds to a normal incidence critical frequency of less than 450 kHz and an equivalent electron density of the layer of less than  $2.5 \times 10^3$  per  $\text{cm}^3$ .

#### i) OBSERVATIONS OF THE "G LAYER"

In a paper on studies of the ionosphere first read at the April 27, 1933, meeting of the International Scientific Radio Union (URSI) at Washington, D.C., Kirby, Berkner, and Stuart noted their observations of "scattered reflections" at virtual heights generally above 600 km and extending to 1500 km. They published their paper first in the January 1934 issue of the *NBS Journal of Research*, and later in the *Proc. IRE* [36].<sup>77</sup>

<sup>76</sup>On October 13, 1927, E. V. Appleton presented a short paper before the URSI General Assembly at Washington, entitled "The existence of more than one ionized layer in the upper atmosphere" (*Scientific Papers of the General Assembly of URSI, Washington, D.C., October 1927*; Vol. 1, Part 1, July 1928, Brussels). Appleton's experimental observations in England, taken during the period of October 1926 to May 1927, indicated the existence of two ionized layers, which he termed the E and F layers—see footnote 5. During a part of the daylight period he also observed a third layer, below the E layer, which he called the D layer. On this third layer he stated:

As the day further proceeds the experimental results show that another region of ionization (D layer) is formed below the Kennelly-Heaviside layer, which, while causing attenuation of the waves, does not materially affect the height at which they are deviated. Occasionally "reflected" waves are detected from this layer. Its main function is, however, to absorb the waves which are only slightly bent in passing through it, and which are finally deviated by Layer E.

Interestingly, in a review paper of his experimental studies of the ionosphere, published in 1932, Appleton does not mention the D layer.

<sup>77</sup>Observations were made in frequency steps over a range of 400 to 12,000 kHz. The reflections at these great heights were of small and variable amplitude, and of rapid variation through small ranges of the several virtual heights. The authors described the observed effect as "rapidly popping in and out at various heights."

The authors indicated that what they observed was possibly the same phenomenon as that described by A. H. Taylor and L. C. Young (Naval Research Laboratory) in the May 1928 issue of the *Proc. IRE*. However, Taylor and Young essentially dismissed the possibility of an ionized layer at about 1400 km as an explanation for echo effects in long distance transmission.

On the occasion of another meeting, a year later, this time the Ninth Annual Convention of the I.R.E. (May 28-30, 1934), Kirby and E. B. Judson presented a paper entitled, "Recent Studies of the Ionosphere." In the presentation they characterized the different layers of the ionosphere, based upon information gathered from their observations beginning June 1933. In the abstract for their presentation (published in advance for the May 28-30 Convention in the May 1934 issue of the *Proc. IRE*) they stated, in describing reflecting layers, that:

. . . The E and  $F_2$  layers, and another, which we tentatively call the G layer, with a virtual height between 700 and 800 kilometers, are believed to return the radio waves by reflection.<sup>78</sup>

A year later Kirby and Judson published their paper in the April 1935 issue of the *NBS Journal of Research*, and later in the July 1935 issue of the *Proc. IRE* [37].<sup>79</sup>

### 3. Predicting ionospheric behavior—The ionosphere a useful medium of communication

In his address to the staff at the Boulder Laboratories on March 3, 1961, on the occasion of the 60th Anniversary of the Bureau, Dr. Dellinger stated:

If I were suddenly forced to answer the invidious question, "What was the most outstanding of all the Bureau's radio achievements in these fifty years?"—it is indeed hard to choose but I might very well say it was the propagation prediction and warning service. . . .<sup>80,81</sup>

If there remains some doubt that the propagation prediction and warning service was the outstanding achievement in radio by the Bureau, certainly it would rank equal with any other achievement.

#### a) THE PROBLEM WITH A GLOBAL SOLUTION

The Annual Report of the Radio Section for FY 1935 stated that:

A beginning was made in the application of the ionosphere data in the determination of optimum frequencies to be used in practical radio communication at specific times and distances.

This statement referred to a rather singular, and certainly a significant, set of events that took place in the preceding fall (1934). Early in October 1934, the Radio Section received a

---

<sup>78</sup> Within a period of about 2 months after the abstract by Kirby and Judson was published in the May 1934 issue of the *Proc. IRE*, Harry Rowe Mimno of Harvard University published a short paper in the July 14, 1934, issue of *Nature* in which he described his observations of G and H reflections. He placed the G reflections at an effective height of approximately 600 km, and the H reflections between 1100 and 1800 km. Mimno's paper, entitled "Wireless Echoes from Regions above the F Layers," was dated May 14, 1934.

Author's (WFS) comment: It is an unusual coincidence that the paper of several years work, published by Mimno in the July 14, 1934, issue of *Nature*, was dated May 14, 1934, at approximately the same time the abstract of Kirby and Judson appeared in print in the May 1934 issue of the *Proc. IRE*.

<sup>79</sup> Kirby and Judson stated in their paper, referring to the newly observed layer above the  $F_2$  layer, that:

We have tentatively called this the G layer. . . .

G-layer reflections were observed at frequencies above the  $F_2$  critical frequencies, especially during the summer evenings but also during the fall evenings.

<sup>80</sup> "Dellinger Address, 1961"—Radio File.

<sup>81</sup> Dellinger concluded his statement by saying:

I will suggest another possible answer before I finish. (To which he added later), I think I could even go on to conclude that the most outstanding achievement of the Bureau's fifty years in radio has been the basic establishment of radio science, along with electronics and its other powerful offshoots, in our civilization. . . .

The term "radio science" could have been construed to mean the entire scope of propagation, or an even greater scope, that of the entire field of radio from the scientific and technological approach. Just what Dellinger may have had in mind at the time of his address is now a moot question.

letter from the Superintendent of Communications of American Airlines, Inc. of Chicago, Ill. requesting a possible explanation:

which might account for the apparent difference in communicating with aircraft on essentially the same frequencies in the southwestern and northeastern parts of the United States, and assuming that there is some logical reason for this when may we expect an improvement in the present condition?<sup>82</sup>

The letter, addressed to Dr. Dellinger as Secretary of the Liaison Committee on Aeronautical Radio Research (Department of Commerce), was received by the Radio Section while he was on an extensive European trip.

It was under these circumstances that Gilliland took immediate steps in search of an explanation for the serious situation that American Airlines was encountering with ground-to-ground station and ground-to-plane communications on the Chicago-Newark route. Within 10 days, on October 16 (1934), a report was prepared by Gilliland to be sent to American Airlines explaining the cause of the failure of communications. The report was entitled "Application of ionospheric measurements to a practical radio communication problem."<sup>83</sup> The information contained in this report appeared, almost in its entirety, as a portion of a Bureau publication by Gilliland 5 months later, and later as an IRE publication [38]. The 6 years of observations and recordings of the ionosphere by the Radio Section had suddenly and unexpectedly borne fruit in explaining a serious communication problem

---

<sup>82</sup> Letter, American Airlines, Inc. to Dellinger, Oct. 4, 1934, and associated correspondence (NARG 167, 1934 IDS-IG, Box F 373, General Correspondence). The letter received from American Airlines, Inc. had been preceded by an earlier letter, dated September 26, 1934, sent by American Airlines, Inc. to the firm of Aeronautical Radio, Inc. (though not indicated, this company probably supplied the radio equipment). In the first letter it was related that signals at the communication frequency of 3257.5 kHz were skipping very badly in the previous 3 weeks as received in Newark, N.J. from stations along the Chicago-Newark route. Reception was exceptionally bad between midnight and 4:30 a.m. Also, at certain periods it was impossible for these ground stations to communicate with the airplanes. In contrast, signals on nearly the same frequency of 3232.5 kHz had remained relatively good throughout the night on the route between Fort Worth and Los Angeles, in southwestern United States. To alleviate the situation of communication with planes on the Chicago-Newark route, ground stations on the Nashville-Fort Worth route were being used to communicate with planes on the Chicago-Newark route. There was substantial evidence that the assigned frequency of 3257.5 kHz was gradually becoming ineffective with time in northeastern United States.

<sup>83</sup> In his report (Radio File) Gilliland prepared two tables of data and five figures, plus a discussion, to explain the cause of communication failure and to suggest a remedy. From tabulated data a graph was prepared that showed the decrease of the F-layer extraordinary ray critical frequencies at Washington, D.C. during the night from 11 p.m. to 5 a.m. for the period of September 11-30 in 1933 and in 1934. However, there was evidence that the critical frequency was increasing in 1934 and was following the trend of the sunspot curve, but at that time the Radio Section was hesitant to predict the trend in advance for lack of extensive observations in point of time. During the several previous years the critical frequencies had been decreasing with time as a result of decreasing solar activity. With the aid of another graph it was possible to determine the distance from the transmitter within which signals would not be received from the propagated sky wave, and within which only the ground wave would be received and at relatively short distances from the transmitter. Another set of curves showed that the critical frequencies decrease rapidly near midnight until dawn during the summer months in contrast to the winter months.

Gilliland corralled enough information from the section's ionosphere recordings that he was able to state and thereby suggest to American Airlines:

The results of this study show that at times night transmission over short distances at a frequency of 3257.5 kc/s pass through the ionosphere and are lost from the earth. The results also indicate that a lower frequency such as 2750 kc/s passes through the ionosphere at a given angle a much smaller percentage of the time. It would be necessary to go below 2500 kc/s to obtain practically complete freedom from skipping.

Gilliland was not able to refer the airlines company to publications on the subject. He said: "There are no publications in the literature which bear directly on this problem." This was a new field and pioneering steps needed to be taken. He did refer the company to some publications by the American Telephone and Telegraph Co. that had a bearing on the general subject of radio telephone communications.

For lack of ionosphere observations beyond the Washington area in 1933 and 1934, Gilliland was not able to explain the reasonable success in communications that American Airlines was having on its route in southwestern United States and not in the northeast (where the observations at Washington were reasonably applicable). Yet there appeared to be ample evidence from operation of the communication systems that ionosphere conditions differed over the two areas.

where life and property were at stake in the flights of planes. Thus was the very beginning of what was eventually to develop into a propagation prediction service of global proportions.

In his published paper Gilliland made several significant statements relating to future use of ionosphere data that the Radio Section had been, and would be, gathering and studying. He stated:

Although the results obtained give a considerable part of the whole cross section it is desirable to extend the present system so that all of the critical frequencies will be obtained for the 24 hours. When more complete information of this type is available for different parts of the world and when the results are compared with actual transmission data a more complete understanding of sky-wave transmission should follow.

. . . World-wide information will be necessary for an intelligent allocation of frequencies to be used in different types of service.

And so the trend of events took such a course in the years to follow.

#### b) INVESTIGATING THE IONOSPHERE FOR THE FBI

Beginning in the summer of 1935, at the request of the Federal Bureau of Investigation (FBI), the Radio Section conducted a series of tests over a period of 1 year to determine the feasibility of voice transmission from a transmitter at Washington, D.C. to cover the entire United States (exclusive of territorial areas). The purposes for which a single transmission would be used appear to have been veiled at the time and today remain in limbo.<sup>84</sup> By 1935 enough had been learned of the ionosphere by the Radio Section that coverage of the country with a single transmitter was possible by judicious selection of frequencies for different periods of the day and year.

Station WWV at Beltsville, Md. was used as the test transmitter with voice transmission at 1-kW radiated output (on occasion 15 kW of power were used). Daytime transmissions were made at 5000, 10,000 and 15,000 kHz; nighttime transmissions at 4200 and 6800 kHz. At four periods during the year of testing, intelligibility tests were conducted by transmissions from WWV and by observation of transmissions from other stations at various frequencies.<sup>85</sup>

As a result of the testing program, the Radio Section stated in its Report to the FBI of August 28, 1936, that:

. . . A radio broadcasting service from Washington, receivable at all times throughout the United States, can be provided by the use of a radio

---

<sup>84</sup> In reporting on the project the Bureau's *Annual Report of 1936 to the Secretary of Commerce* stated:

. . . Special experiments were made for the Federal Bureau of Investigation on voice broadcasting to cover the entire United States from a single station. Preliminary results indicated that the proposed system would be a success.

<sup>85</sup> Voice intelligibility tests were of two kinds: one conducted by the Bureau, using observers at locations spread over the country listening to WWV; the other, listening to distant stations at night by observers of the Radio Section and the FBI. The WWV transmission tests were made at four periods, on 4 days in September, December 1935, and March, June 1936. Fifty unrelated polysyllable words were used, to be observed on special report forms prepared and furnished by the Bureau to observers around the country. As many as 435 observers in 193 localities during one of the testing periods turned in reports from which was determined the intelligibility of each report. The information was condensed to graphs that showed the percent intelligibility at distances out to 2400 miles at the four seasons on the five frequencies.

Listening tests of distant stations conducted by observers of the Radio Section (at the Meadows field station) and by the FBI (at downtown Washington headquarters) brought up a number of problems of grouping, scaling, weighting, and averaging the data. All tests were made between the hours of 10 p.m. and 2 a.m. on stations above 1500 kHz. During the 4-hour period the observer would log in as many stations as he could identify and was able to judge the intelligibility on a 5-point scale. The final format was in the form of graphs that summarized the observations. One set delineated the weighted intelligibility in four frequency bands centered around 1700, 2500, 6000, and 9500 kHz for each month of the year's period, for stations out to 4000 miles (European stations at the greatest distances). Best listening was found to be in the band around 6000 kHz, although the band around 9500 kHz was superior at long distances. Continuous field intensity records taken in these bands indicated their relative usefulness for the purpose involved in the investigation.

transmitter having a range from about 2500 to 20,000 kilocycles and capable of broadcasting on two radio frequencies simultaneously (one to cover areas near Washington by a ground wave, the other to cover the most distant parts of the country by a sky wave—Author). The transmitter could be in either one or two units; its power should be 50 to 100 kilowatts. Authority should be obtained to use about eight different frequencies. The station management would have to be guided by accumulated experience and knowledge of radio transmission in selecting the two frequencies to be used at different times of the day, different seasons, etc. . . .

The report pointed out the desirability or necessity of locating the receivers at quiet locations, preferably outside of cities, in order to minimize interference from man-made static.

As a suggestion to the FBI the report stated:

It therefore appears that transmission frequencies near the maximum useful frequency for a given path are advantageous. In determining the best frequency to use one can be guided by radio transmission data and ionosphere data. . . .

Thus the Radio Section at an early time was giving valuable information to others on the efficient utilization of the ionosphere as a communication medium.

The FBI project was a team effort by the Radio Section. Progress reports referred to the project as "High-frequency radio telephone broadcasting." Those participating in the section's study were: J. H. Dellinger, E. L. Hall, S. S. Kirby, W. D. George, N. Smith, G. H. Lester, E. M. Zandonini, and V. E. Heaton. Hundreds of radio listeners in the United States participated in the intelligibility tests.

The information that was acquired, although quite interesting and certainly of value during the early years in utilizing the ionosphere, was never published. It was, however, a significant input to the work leading to an understanding of distance ranges, noise, and ionospheric absorption. Nor was the FBI project developed into an operating system.

#### c) ENTER NEWBERN SMITH

On August 1, 1935, Newbern Smith entered the Radio Section, coming from a physicist's position in Philadelphia.

He was assigned to the projects on transmission of radio waves (at the time designated as "Character and cause of variations of radio wave intensity") and the ionosphere (at the time designated as "Study of height of ionosphere layers"), both projects being directed by S. S. Kirby. For the next 7 years Dr. Smith became much involved in studies of the ionosphere. During the war years of 1942-1945 Smith took a prominent role in organizing and administering the Interservice Radio Propagation Laboratory (IRPL) to develop and operate a worldwide propagation prediction service (see ch. XI). Upon organization of the Central Radio Propagation Laboratory (CRPL) on May 1, 1946, Smith was selected as assistant chief of the new division. On the retirement of Dellinger in 1948 Smith became chief of CRPL. He resigned from the position early in 1954 to take a teaching position at the University of Michigan and to engage in extensive research programs. Smith was the author and coauthor of many publications relating to the ionosphere and became a recognized authority in the field.

#### d) A SERVICE TO THE RADIO AMATEUR

In the May 1937 issue of *QST*, the well-known periodical of the American Radio Relay League, appeared a short article by which Newbern Smith introduced the radio amateur to a method of calculating the distance to which radio signals could be transmitted by the sky wave [39]. With the title of "Skip-distance calculation," the paper bore the subtitle "Rapid graphical determination of secant of angle of incidence." Smith introduced a chart that could be used to determine the frequency to select, for a desired distance of transmission, that had a certain relation to the frequency of a wave at normal incidence to an ionosphere layer of a known vertical height (this information being obtained from the Bureau through weekly publication or radio broadcast).

With the graph, based upon the "secant law," and a straight edge, the secant of the angle of incidence of the sky wave to the normal to the ionosphere layer(s) could be determined.<sup>86</sup> The frequency at normal incidence multiplied by the secant value gave the frequency to be used for the desired distance of transmission. The graph also indicated the maximum distance for a single hop of the sky wave for zero angle of elevation from the surface of the Earth. The chart and method of calculation had been used for some time by the Radio Section. Later charts showed the single-hop distance at a number of elevation angles. Many improvements and more accurate methods of calculating transmission distance, skip distances, and the selection of effective frequencies were to be advanced by the section during the next several years.

Three years later, beginning with the September 1940 issue of *QST*, Newbern Smith and S. S. Kirby initiated a series on "Predictions of useful distances for amateur communication" at 3-month intervals. The series continued until concluding with the January 1942 issue, a month after the Pearl Harbor incident. The names N. Smith and S. S. Kirby appeared as authors in the first issue. Thereafter the source of the predictions was designated as the "National Bureau of Standards, Washington, D.C.."

The amateur was now furnished with far more information than could be obtained from the chart of 1937.<sup>87</sup> The later charts were very easy to read for minimum and maximum distances of readable signals at a selected frequency and at a selected time of day and month.

#### e) IONOSPHERIC INFORMATION TO THE NATION

The Bureau was not slow in disseminating information the Radio Section had been gathering on the ionosphere beginning early in 1929. Fortunately, concurrent with Gilliland's increasing observations of the ionosphere, a cosmic data disseminating service for the United States was being initiated by the International Scientific Radio Union (URSI). This service, by radio broadcasting and a weekly publication, began August 1, 1930, following by 2 years a similar service by URSI in France.

#### 1) URSIgrams

Beginning on June 1, 1931, the Bureau entered into a cooperative program with URSI to supply information on the ionosphere for broadcasting and weekly publication—the first publication of regular observations. This was at a time when the Radio Section had its pulse transmitter at the Potomac Yards field facility near Alexandria, Va., and the receiver and recording equipment at the Kensington, Md. field facility. The continuous recorder was still in the stage of development, and the field facilities at Beltsville and Meadows, Md. were 2 years away. Broadcasting of the information was from the Navy station at Arlington, Va., and publication of URSIgrams by Science Service, Washington, as well as in the quarterly issues of *Terrestrial Magnetism and Atmospheric Electricity*.<sup>88</sup>

<sup>86</sup> The elements of the "secant law" and of skip distance and angle of incidence of a propagated wave with the normal to the ionosphere layers go back to the paper by Breit and Tuve of 1926 [4].

<sup>87</sup> The useful distances of communication in the amateur bands could easily be read from curves on three groups of charts, a group for each of 3 months in advance of the publication date. Four or five charts made up each group, each chart for a frequency in the amateur bands of 2, 4, 7, 14, and 28 MHz. From a chart selected for the month of interest and a selected frequency, one could easily read the range of minimum and maximum distances of predicted transmission in terms of local time at place of reflection from the ionosphere. The curves formed boundaries to the chart areas that indicated skip distances, useful distances, and distances where signals were not readable due to absorption in the ionosphere. Time of sunrise and sunset were indicated. The charts were very simple to read for prediction of useful distances. Beginning with the April 1941 issue, information was added that indicated the difference in useful distances between readable signals from CW and phone transmitters.

<sup>88</sup> URSIgrams or URSI cosmic data broadcasts had their origin in France in 1928 as an operation of URSI. In 1929 a program was set up by a special joint committee of the American Section of URSI and the American Geophysical Union to arrange for the daily broadcast of cosmic data by a Government radio station. Serving on this committee were Dellinger and L. W. Austin (of the Laboratory for Special Radio Transmission Research, located at the Bureau). On June 1, 1931, information on the ionosphere was added to the cosmic data for solar constant, terrestrial magnetism, and auroras. The information supplied under the code name KHL (Kennelly-Heaviside Layer) included: the place of observation as Washington, D.C. (U.S. Bureau of Standards) or Medford, Mass. (Tufts College), the frequency, day of the week, nearest hour of observation in Greenwich time, and height of the Kennelly-Heaviside layer in kilometers. All this information was coded for the URSIgrams and transmitted daily by the Navy station, NAA, Arlington, at 5 p.m. standard time on frequencies of 12,040 and 4015 kHz [40].



## 2) Letter Circulars

The Letter Circular (from 1921) performed yeoman service in the disseminating of technical information by the Bureau, and was much used as a publication vehicle by the Radio Section. On May 5, 1937, the Radio Section brought out its first of a series of three Letter Circulars relating directly to the ionosphere, the first, LC499, with the title "The weekly radio broadcast of the National Bureau of Standards on the ionosphere and radio transmission conditions." This first issue announced the beginning of broadcasting information on the ionosphere by station WWV.<sup>89,90</sup>

The second Letter Circular (LC575), issued several years later (Dec. 9, 1939), was titled, "The ionosphere and radio transmission conditions, with special reference to the observing and reporting service of the National Bureau of Standards." A third Letter Circular (LC614) came out in October 1940, and was titled, "Radio transmission and the ionosphere."<sup>91</sup>

## 3) Broadcasts by WWV

The Bureau initiated a broadcasting service on ionosphere information on June 1, 1937, over station WWV at Beltsville, Md. The first broadcasts were on a weekly schedule (Wednesday) in the early afternoon on three frequencies in succession. These early broadcasts gave the normal-incidence critical frequencies and virtual heights of the E layer and F<sub>2</sub> layer at Washington at noon on the day of the broadcast, and the estimated skip distances for a number of frequencies. Unusual conditions during the preceding week, such as magnetic storms, were described briefly. The weekly broadcasts were discontinued at the end of April 1940 (see footnote 89).

On January 9, 1946, broadcasting was resumed from WWV on warnings of expected disturbances in radio propagation across the North Atlantic. Prediction services were now available in monthly publications and in greater detail than could be handled by broadcasting. On July 1, 1952, broadcasts of 12-hour conditions in the auroral zone over the North Atlantic were initiated. The quality of transmission was given in terms of nine conditions ranging from "impossible" to "excellent." Early in 1952 forecasts of conditions in the North Pacific and Alaska were initiated at the NBS Radio Propagation Field Station, Anchorage, Alaska. This was followed in January 1954 by the broadcast service provided by station WWVH on the Island of Maui, Territory of Hawaii.

Stations WWV (now at Ft. Collins, Colo.) and WWVH (now on Island of Kauai, Hawaii) continue to be used for information on radio propagation. Short-term propagation forecasts for the North Atlantic area are given on an hourly schedule by voice and are prepared by

---

(Continued)

The American URSIgrams for publication were compiled by Science Service (The Institution for the Popularization of Science, organized in 1921—a non-profit corporation) of Washington, D.C. The URSIgrams were prepared weekly in mimeograph form for distribution. Science Service also informed newspapers on the occurrence of unusual cosmic phenomena. The information was also noted in *Terrestrial Magnetism and Atmospheric Electricity*, beginning with the September 1931 issue.

Today, the older American URSIgram has taken on an international flavor and has become embodied with International URSIgram and World Days Service (IUWDS).<sup>\*</sup> The "telegrams" are broadcast by stations WWV and WWVH.

<sup>\*</sup>The IUWDS is a service of URSI in association with the International Astronomical Union and the International Union for Geodesy and Geophysics.

<sup>89</sup>Broadcasts by the Bureau of information on the ionosphere were announced in the letter circular as beginning on June 1, 1937, using three frequencies (5, 10, and 20 MHz) of WWV. The weekly broadcasts were made each Wednesday, beginning at 1:30 p.m., broadcasting at each frequency for 10 minutes.

The letter circular gave a description of the ionosphere and the application of this information to radio transmission. An accompanying chart could be used to determine the ratio of maximum usable frequency to normal-incidence critical frequency.

<sup>90</sup>Before the broadcasts by WWV, information on ionosphere conditions had been mailed periodically in mimeograph form to other laboratories and radio stations requesting such information.

<sup>91</sup>The two later publications contained much material added to the first circular. During the 3 years the Wave Phenomena Group of the Radio Section had learned how to use the ionosphere effectively for radio transmission and how to predict its characteristics several months in advance. The effects of ionosphere irregularities, such as sporadic E-layer transmission and the sudden ionosphere disturbances, were described. By now a fairly extensive literature on characteristics of the ionosphere could be included as a useful bibliography.

the Institute for Telecommunication Sciences, National Telecommunications and Information Administration, Boulder, Colo. Geoalerts of solar and geophysical information are also on an hourly schedule by voice and are prepared by the Space Environment Services Center, National Oceanic and Atmospheric Administration (NOAA), Boulder, Colo.

Storm warnings for mariners plying the Pacific Ocean are broadcast three times each hour, with the information updated every 6 hours.

#### 4) The IRE posts the Bureau's ionospheric information—Initiation of a service

The *Proc. IRE* provided another vehicle of extensive circulation for the publication of ionospheric information. The initial number in a series of monthly publications that extended over a period of 4 years appeared in the issue of September 1937. It bore the title, "Characteristics of the ionosphere at Washington, D.C., January to May 1937," and was the contribution of T. R. Gilliland, S. S. Kirby, N. Smith, and S. E. Reymer.<sup>92</sup> This number followed by 4 months the first publication in *QST* of ionospheric information, started primarily for use by the radio amateur (see p. 233). Information in these early issues was presented by a graph that summarized the monthly averages, for each of the 24 hours of the day, of the critical frequencies and virtual heights for the E, F<sub>1</sub>, and F<sub>2</sub> layers. Time of sunrise and sunset was indicated. This information was supplemented by transmission data from field-intensity recordings. By studying the two types of observations in combination, the Radio Section was able to identify the layer that was effective at a given time, and thus compute the best usable frequency for transmission. Data on fadeouts were given in tabular form that gave date, time of beginning of fadeout, beginning of recovery and time of complete recovery, location of transmitter, and minimum signal intensity in fractions of normal.

A press notice was released on February 17, 1939, by the Department of Commerce, entitled "Quality of Wireless Reception Can Now be Forecast, National Bureau of Standards, Department of Commerce, Announces."<sup>93</sup> Although not stated in the announcement, the notice was referring to a portion of an article that was to appear in the March 1939 issue of the *Proc. IRE*, entitled "Characteristics of the ionosphere at Washington, D.C., January 1939," prepared by Gilliland, Kirby, and Smith.<sup>94,95</sup> For 2 years

---

<sup>92</sup>The September 1937 issue actually contained three separate articles under the same title, except for the designated months covered by the "characteristics;" the first article was for the period January through May, the second for June, and the third for July. Beginning with the October issue, each article covered the characteristics for the month of 2 months past. Thus the October issue covered the month of August.

<sup>93</sup>A portion of the news release read:

New methods of securing data which can be directly applied by the radio engineer in his choice of frequencies for any communication job have been announced by the National Bureau of Standards, Department of Commerce.

An "ionosphere" reporting service, somewhat similar to weather reporting services, though quite independent of it, is being successfully conducted by the Bureau of Standards, according to Dr. J. H. Dellinger, Chief of the Bureau's radio section.

The Bureau of Standards has, as a result of its successful experiments, established an ionosphere reporting service. It gives data, weekly and monthly, obtained from its charting of the ionosphere, which assists in the predetermination of radio transmission conditions. Such service is in some respects like the weather reporting service. The reliability of ionosphere prediction will probably surpass that of weather because the controlling factors are somewhat better known and more uniform, according to Dr. Dellinger.

<sup>94</sup>The concluding paragraph stated:

This report inaugurates a new service, forecasting of radio transmission data for the month following the one in which this report is published. Fig. 4 gives the expected monthly average values of the maximum usable frequencies for radio communication by way of the regular layers, for April 1939. These estimates had to be made three months in advance. They are based on the observed trends of the critical frequencies in the eleven-year solar cycle and information on diurnal and seasonal variations accumulated over a period of several years. It is believed that the estimates will be accurate within fifteen per cent, for undisturbed days.

Note: Fig. 4 was captioned "Predicted maximum usable frequencies for sky-wave radio transmission; average for April 1939 for undisturbed days, for dependable transmission by the regular F and F<sub>2</sub> layers." Plotted, was a series of curves with dependable transmission distance via sky waves as a parameter, with maximum usable frequency

this team had been reporting on the characteristics of the ionosphere at Washington, D.C. in the *Proc. IRE*, the report appearing several months after the ionospheric events of a (previous) month's duration. Beginning in the March 1939 issue, there would be the added material of forecasting of radio transmission data for the following month (April 1939). Although the press release was probably initially prepared by Dellinger, it is odd that the word "Wireless" appeared in the title of the release. Dellinger had suggested the term's disuse in 1911, 28 years before (see ch. II, p. 42). Announced to the public on this occasion was a technical service on forecasting the characteristics of a transmission medium (the ionosphere) that continues to the present time, first by NBS, then by the Environmental Science Services Administration (1965-1970), and now by the National Oceanic and Atmospheric Administration.

Beginning with the December 1939 issue, prediction of the maximum usable frequency for various skip distances for the following month was given in graphical form. Also reviewed was the same information plus a graph of critical frequencies and virtual heights of the several layers, for the month of 2 months past. By now data on ionosphere storms were added, including an estimate of severity on a numerical scale. With the country's entrance into World War II, publication was discontinued after the December 1941 predictions for January and February 1942.

#### f) PREDICTING THE MAXIMUM USABLE FREQUENCY

Intensive study of the ionosphere by several British groups and by the Bureau, beginning in the late 1920's and on into the 1930's, was slowly revealing an understanding of the complexity of the ionosphere. The twofold acquisition of recordings at the Meadows field station—field intensity recordings of distant stations and vertical-incidence readings of the ionosphere—was studied for sought-out relations between transmission and characteristics of the ionosphere. Thus we find the Radio Section ready to report on its most recent study of the relations in the spring of 1936.

##### 1) A team reports on correlation between ionosphere and radio transmission

At one of the many joint meetings in Washington, D.C. of the American Section of URSI and the IRE, this on May 1, 1936, the team of N. Smith, S. S. Kirby, and T. R. Gilliland presented a paper entitled, "Recent correlations between the ionosphere and high-frequency radio transmission." Unknown to those of the team at the time, this oft-referred-to presentation became the nucleus of a series of publications by the Radio Section during the next several years (see pp. 201-202). The field intensity recordings of several years taken of two radio stations, one at 6060 kHz and 650 km distance, the other at 9570 kHz and 600 km distance from Washington, had been examined by N. Smith for careful study of these transmissions in relation to that of virtual heights and critical frequencies taken from vertical-incidence measurements. The result was the finding of correlations that indicated definite transmission of sky-waves from the E region, from the F region, or simultaneously from both regions.

##### 2) Relating the useful frequencies of transmission to vertical-incidence measurements

It was Newbern Smith of the team who embarked on a method of extending the vertical-incidence (normal incidence to the ionosphere) measurements to the "geometry" of oblique-incidence transmission. In the July 1937 issue of the *NBS Journal of Research*, a

---

plotted in local time at place of reflection. The information was applicable, in general, to the latitude of Washington, D.C., although not specifically stated as such.

<sup>95</sup> More than a year after the press release, the *NBS Technical News Bulletin (TNB)* reported in the June 1940 issue somewhat indirectly the Bureau's provision of a service on the forecasting of radio transmissions via the ionosphere. At a meeting of the American Section of the International Scientific Radio Union at Washington, D.C., April 26, 1940, Newbern Smith presented a paper on the prediction of ionospheric characteristics. *TNB* reported:

The forecasting of monthly average values for ionospheric and radio conditions was undertaken at the Bureau last year. Beginning in the March 1939 issue of the *Proceedings of the Institute of Radio Engineers*, the Bureau has published each month, in addition to past observed values, predicted values for the month following that of publication. Because of the necessary lag in publication procedure, the predictions had to be made 3 months in advance.

type of "transmission curve" (specific condition of frequency and distance) was shown as developed by Smith which, when superimposed upon a frequency-virtual height curve, would give directly information on limiting frequency and skip distance as well as height of reflection from the ionosphere [41]. The method was based on consideration of a flat Earth and flat ionosphere. This method was used during the 1936-1937 period in preparing data for the WWV broadcasts of information relating to radio transmission and the ionosphere. It was a method of deriving maximum usable frequencies from vertical-incidence measurements.<sup>96</sup>

<sup>96</sup>The term "maximum usable frequency (muf)" was introduced by Smith into the Bureau publications at this period.\* It first appeared in a paper by Gilliland, Kirby, Smith, and Reymer that was published 1 month earlier (June 1937) than Smith's paper noted above [42]. The term "maximum usable frequency" was to become a household expression thereafter in the writings of the Radio Section and its successor the Central Radio Propagation Laboratory; later, more often written as "MUF."

The June 1937 paper, entitled "Characteristics of the ionosphere and their application to radio transmission," summed up the observations and interpretations of data from early 1934 on. In addition to observing the recurrence from year to year of the diurnal and seasonal variations of the critical frequencies and virtual heights of the ionosphere layer, the team also noted a continuous long-time increase of critical frequencies associated with the 11-year sunspot cycle (maximum in 1937). By now the Radio Section had a fairly good grasp on an understanding of the effects that absorption, virtual height, and critical frequency, have on sky-wave transmission. The team expressed its interpretation of these effects to considerable length in the June 1937 paper.

\*The maximum usable frequency for any distance is defined as the highest frequency which can be used for sky-wave transmission over the given distance. Waves of higher frequencies penetrate through the ionosphere and are not returned to the Earth; waves of lower frequencies are reflected and are usable for transmission over the selected distance.

A comparable term, that of "maximum transmission frequency," had been used on one occasion in the paper by Gilliland, Kirby, Smith, and Reymer.

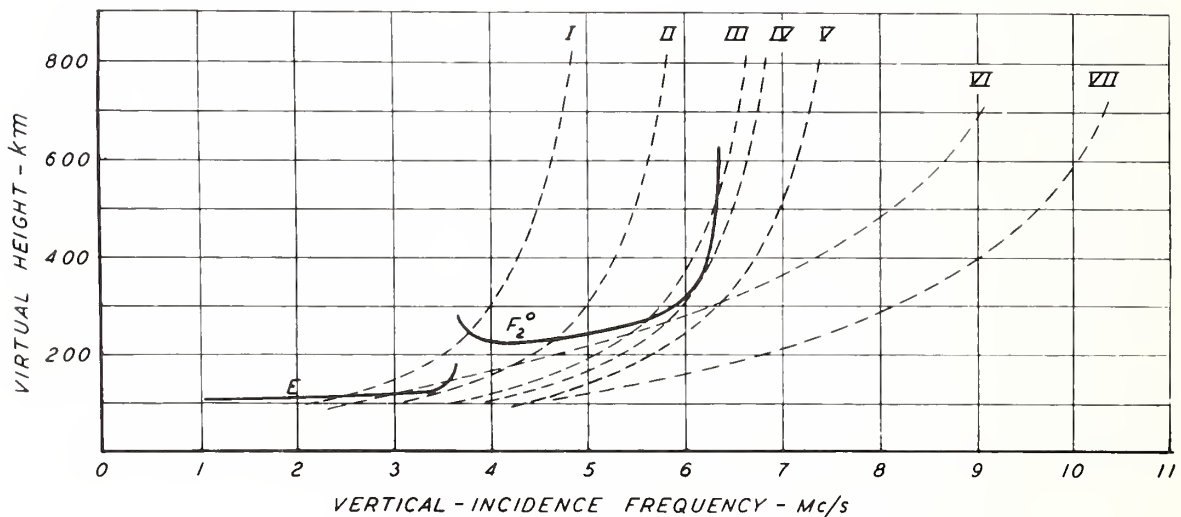

Earliest published (July 1937) transmission curves by NBS for determination of frequency for selected distances of transmission (assuming flat Earth and flat ionosphere). In a generalized form, this whole procedure by Newbern Smith shows the various relationships. The solid curve is a typical normal-incidence observation of virtual height vs. frequency, showing the E and  $F_2$  layers of the ionosphere. The dotted curves depict conditions of transmission for various frequencies and several distances. For example, curve IV depicts maximum possible frequency for a given distance. Adoption of this method became valuable for predicting median values of maximum usable frequency for propagation over any path at any time of day for several months ahead, and provided for world charts during World War II for predictions.

### 3) Toward a more exact relationship

In his paper of July 1937 Smith was quite aware of the effect of the Earth's curvature (including that of the ionosphere) on distant transmission, also the effect of the Earth's magnetic field on ionosphere transmission (as based on the ray theory), however small or considerable the effects might be. His extensive treatment of the effects of the Earth's curvature was published about a year later (May 1938) [43]. Analysis showed that the

Earth's curvature causes the maximum usable frequency to be higher than that calculated by the flat-earth approach. To take into account the curvature of the Earth and ionosphere, Smith modified his previous method, which resulted in considerably greater but more correct readings of the limiting frequency of transmission, or maximum usable frequency, for the greater distances of transmission.

It had been known for more than 10 years that the Earth's magnetic field could affect the transmission of waves in the ionosphere. Experimentally, this was found to occur in the F layer, producing what came to be called the ordinary and extraordinary wave components. Smith took this into account by plotting with two transmission curves, one for the ordinary wave, the other for the extraordinary wave.

Further refinement of the transmission-curve method of determining the maximum usable frequency took into account the absorption effect in a layer below the one in which reflection occurs. In addition, Smith added sophistication to his earlier "secant-law" chart published in *QST* (see pp. 233-234) by adding curves for a number of angles of departure and arrival of the radiated wave. All of these refinements added to the closer agreement of observations in the study of correlation of radio transmission with ionosphere measurements.<sup>97</sup>

#### 4) Smith writes for readers of "Proc. IRE"

Newbern Smith's paper of May 1939, published in the *Proc. IRE*, entitled "The relation of radio sky-wave transmission to ionosphere measurements," is a much quoted one in various areas relating to the ionosphere, and particularly that of "maximum usable frequencies" [45]. In this paper Smith combined and condensed the material that appeared in his two previous papers on the same subject matter that were published in the *NBS Journal of Research*.<sup>98</sup>

#### 5) Smith and the "Lorentz polarization term"

A paper, somewhat of a sequel to his other papers on maximum usable frequency, was written by Smith and published in the February 1941 issue of the *NBS Journal of Research*, with the title, "Oblique-incidence radio transmission and the Lorentz polarization term." He was able to show from experimental evidence, obtained from maximum usable frequency measurements, that the constant in the equation of the Lorentz force on an electron by an electromagnetic wave in the ionosphere is zero, as postulated by the Sellmeyer theory, rather than a value of one-third as postulated by the Lorentz theory. This difference between the two theories had been discussed in ionosphere circles for 10 years.

---

<sup>97</sup> A paper of a somewhat corollary nature was published in the same issue of the *NBS Journal of Research* (May 1938) as Smith's paper. Again, it was a publication by the team of Gilliland, Kirby, Smith, and Reymer [44]. Vertical-incidence ionosphere measurements for the months of March, June, and December (equinoctial, summer, and winter conditions) during the period of 1933-1937 were transformed to graphs by the method devised by Smith to indicate the maximum usable frequencies for specific ionosphere conditions and transmission distance.

Information to be gained from these graphs was applicable at latitudes differing not too widely from Washington, D.C. The authors briefly treated the transmission characteristics of reflections from the sporadic E layer, absorption of wave energy in the E layer, and scattered reflections from the highest levels of the ionosphere.

The importance and influence of the project can be ascertained by quoting directly from the authors' paper:

For practical applications the principal value of these graphs is to estimate transmission conditions in the future either diurnally, seasonally, or over longer periods. . . . the diurnal and seasonal characteristics are regular and may in general be predicted. In addition, there is a large variation of ionization densities with the 11-year sunspot cycle, as indicated by the increase of maximum usable frequencies from 1933 to 1937. At the end of the year 1937 the sunspot cycle was near a maximum and is expected to return to a maximum about 1944. In a rough way these graphs may be used for corresponding times on the descending part of the sunspot cycle.

<sup>98</sup> This paper appeared 3 years after portions of it were presented at a joint meeting of URSI and IRE in Washington, D.C., May 1, 1936. (See p. 237). Following a custom, beginning around 1930, the published papers of this presentation would have appeared in both the *NBS Journal of Research* and the *Proc. IRE*. Although this rather unusual procedure of publication in more than one periodical continued for some years, it was dropped at the time Smith was preparing his paper(s) as a printed record for the presentation on May 1, 1936. Thereafter appeared his two papers in the *NBS Journal of Research*, and the subsequent paper in the *Proc. IRE* that combined and condensed the two NBS publications. Probably because of its condensation into one paper, and also its greater reading audience, it is the paper that was published in the *Proc. IRE* that is usually quoted.

Smith concluded that:

For the cases considered in this paper, the data indicate that the Lorentz polarization term should not be included in the theory of oblique-incidence radio transmission by way of the ionosphere.

With the passage of time the "Lorentz polarization term" is no longer used in ionosphere propagation theory, thus indicating the correctness of Smith's experimental deduction.

### 6) "Application of graphs of maximum usable frequency to communication problems"

Thus was the title of the published paper by Smith, Kirby, and Gilliland that gave valuable information to all those who were using, or would be using, the ionosphere as a medium for radio transmission. The paper was published in January 1939 [46].<sup>99</sup> It was in

<sup>99</sup>This paper brought together many of the elements of interpreting the characteristics and applying the knowledge of the ionosphere that had been acquired by the Radio Section over a period of 5 years or more. The team of Smith, Kirby, and Gilliland had developed three methods of plotting graphs of maximum-usable-frequency curves from the variables of: distance, frequency, and time of day. Of these three methods of plotting, the one to show the maximum-usable-frequency curves against time of day and with distance as a parameter proved to be most useful for fixed radio stations, and was the most commonly seen in the published prediction service. The method that showed the skip distance in terms of local time was the most suitable for mobile radio units.

In selecting the optimum frequency for communication the authors stated: "choose the highest available frequency that will not skip, allowing for variations in critical frequency." They found that, for "quiet" days, variations in critical frequency and maximum usable frequency were (for lower values) usually less than 15 percent below the monthly average. Thus they recommended choosing a frequency at least 15 percent below the average maximum usable frequency to avoid the possibility of skipping.

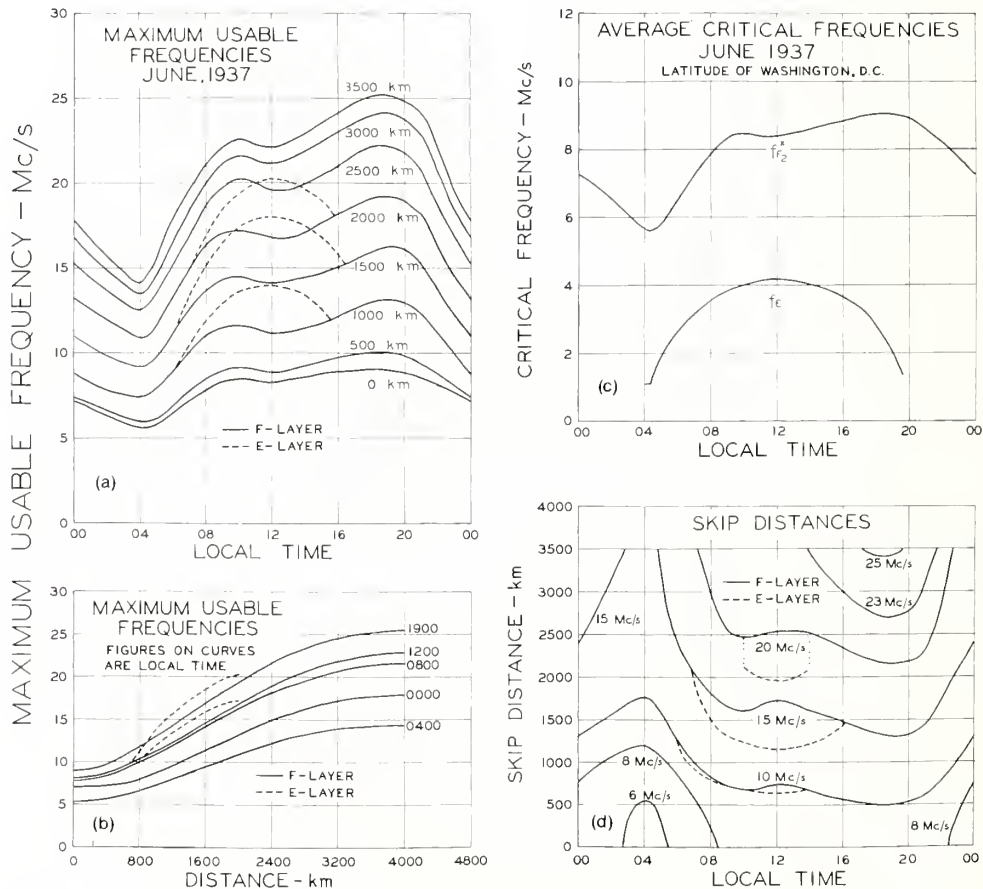

Use of maximum-usable-frequency data for transmission information—in this example, data taken from average critical frequencies at vertical incidence (curves c) for June 1937, at latitude of Washington, D.C. Curves (a) show maximum-usable-frequencies at local time of day (at midpoint) at various distances of receiver from transmitter. In this form the information is the most useful. Curves (b) show maximum-usable-frequencies as a property of distance at various times of day. Curves (d) give skip distances in terms of time of day for various frequencies.

February 1929 that Gilliland began his early observations of the ionosphere with "breadboard" equipment (see p. 203). Upon publication of the paper in January 1939, almost exactly a decade later, the team of Smith, Kirby, and Gilliland "had arrived," indeed. A firm foundation had been laid by these three men of the Radio Section that would lead to what Dellinger said in 1961 if he were asked "What was the most outstanding of all the Bureau's radio achievements in these fifty years?" he might answer ". . . it was the propagation prediction and warning service. . . ." (see ch. II, p. 38). Smith, Kirby, and Gilliland said, in conclusion, in their 1939 paper:

And finally, to use the maximum-usable-frequency factors, in conjunction with our present knowledge of ionosphere conditions, suggests the possibility of estimating usable frequencies months and perhaps even years in advance, in accordance with the variations of season and of the sunspot cycle.

The Radio Section soon would be ready to enter the years of the Interservice Radio Propagation Laboratory during World War II when its capabilities would be called upon to develop a worldwide prediction and warning service.

## REFERENCES

- [1] E. V. Appleton and M. A. F. Barnett, "Local reflection of wireless waves from the upper atmosphere," *Nature*, Vol. 115, Mar. 7, 1925, pp. 333-334.
- [2] E. V. Appleton and M. A. F. Barnett, "On some direct evidence for downward atmospheric reflection of electric rays," *Proc. Roy. Soc.*, Vol. A109, Dec. 1, 1925, pp. 621-641.
- [3] G. Breit and M. A. Tuve, "A radio method of estimating the height of the conducting layer," *Nature*, Vol. 116, Sept. 5, 1925, p. 357.
- [4] G. Breit and M. A. Tuve, "A test of the existence of the conducting layer," *Phys. Rev.*, Vol. 28, Sept. 1926, pp. 554-575.
- [5] A. Hoyt Taylor, "Variation in direction of propagation of long electromagnetic waves," *Bur. Stand. Sci. Paper*, Vol. 15, 1919-1920, pp. 419-433.
- [6] J. H. Dellinger, L. E. Whittemore, and S. Kruse, "A study of radio signal fading," *Bur. Stand. Sci. Paper*, Vol. 19, 1923-1924, pp. 193-230.
- [7] J. H. Dellinger and L. E. Whittemore, "Radio signal fading phenomena," *J. Washington Academy of Sciences*, Vol. 11, No. 11, June 4, 1921, pp. 245-259.
- [8] C. M. Jansky, Jr., "A statistical study of conditions affecting the distance range of a radio telephone broadcasting station," *Tech. Papers Bur. Stand.*, No. 297 (Vol. 19), Oct. 8, 1925.
- [9] *Bur. Stand. Tech. News Bull.*, No. 94, Feb. 10, 1925, p. 6.
- [10] Greenleaf W. Pickard, "The effect of the solar eclipse of January 24, 1925, on radio reception," *Proc. IRE*, Vol. 13, No. 5, Oct. 1925, pp. 539-569.
- [11] J. H. Dellinger, C. B. Jolliffe, and T. Parkinson, "Cooperative measurements of radio fading in 1925," *Bur. Stand. Sci. Paper*, Vol. 22, 1927-1928, pp. 419-450.
- [12] J. H. Dellinger, "Discussion on the correlation of radio reception with solar activity and terrestrial magnetism (G. W. Pickard)," *Proc. IRE*, Vol. 15, No. 4, Apr. 1927, pp. 326-329.
- [13] T. Parkinson, "Some observations of short-period radio fading," *Proc. IRE*, Vol. 17, No. 6, June 1929, pp. 1042-1061.
- [14] T. Parkinson and T. R. Gilliland, "A radio method of synchronizing recording apparatus," *Proc. IRE*, Vol. 17, No. 3, Mar. 1931, pp. 335-340.
- [15] L. V. Berkner, "Some studies of radio transmission over long paths made on Byrd Antarctic Expedition," *J. Res. Bur. Stand. (U.S.)*, Vol. 8, No. 2, Feb. 1932, pp. 265-278.
- [16] Kenneth A. Norton, Samuel S. Kirby, and Gordon H. Lester, "An analysis of continuous records of field intensity at broadcast frequencies," *Proc. IRE*, Vol. 23, No. 10, Oct. 1935, pp. 1183-1200.
- [17] J. H. Dellinger and A. T. Cosentino, "A radio transmission anomaly, co-operative observations between the United States and Argentina," *Proc. IRE*, Vol. 28, No. 10, Oct. 1940, pp. 431-437.
- [18] Sanford C. Gladden, A History of Vertical-Incidence Ionosphere Sounding at the National Bureau of Standards, *Nat. Bur. Stand. (U.S.), Tech. Note 28*, Sept. 1959.
- [19] T. R. Gilliland, "Kennelly-Heaviside layer height observations for 4045 and 8650 kc/s," *Proc. IRE*, Vol. 19, No. 1, Jan. 1931, pp. 114-119.
- [20] P. A. de Mars, T. R. Gilliland, and G. W. Kenrick, "Kennelly-Heaviside layer studies," *Proc. IRE*, Vol. 19, No. 1, Jan. 1931, pp. 106-113.
- [21] T. R. Gilliland, G. W. Kenrick, and K. A. Norton, "Investigations of Kennelly-Heaviside layer heights for frequencies between 1,600 and 8,650 kilocycles per second," *Proc. IRE*, Vol. 20, No. 2, Feb. 1932, pp. 286-309.
- [22] T. R. Gilliland, "Continuous measurements of the virtual heights of the ionosphere," *Proc. IRE*, Vol. 21, No. 10, Oct. 1933, pp. 1463-1475.

- [23] T. R. Gilliland, "Note on multifrequency automatic recorder of ionosphere heights," *Proc. IRE*, Vol. 22, No. 2, Feb. 1934, pp. 236-246.
- [24] Theodore R. Gilliland, "Multifrequency ionosphere recording and its significance," *Proc. IRE*, Vol. 23, No. 9, Sept. 1935, pp. 1076-1101.
- [25] T. R. Gilliland and A. S. Taylor, "Field equipment for ionosphere measurements," *J. Res. Nat. Bur. Stand. (U.S.)*, Vol. 26, No. 5, May 1941, pp. 377-384.
- [26] S. S. Kirby, L. V. Berkner, and D. M. Stuart, "Studies of the ionosphere and their application to radio transmission," *Proc. IRE*, Vol. 22, No. 4, Apr. 1934, pp. 481-521.
- [27] S. S. Kirby, L. V. Berkner, T. R. Gilliland, and K. A. Norton, "Radio observations of the Bureau of Standards during the solar eclipse of August 31, 1932," *Proc. IRE*, Vol. 22, No. 2, Feb. 1934, pp. 247-264.
- [28] T. E. Van Zandt, R. B. Norton, and G. H. Stonehocker, "Photochemical rates in the equatorial  $F_2$  region from the 1958 eclipse," *J. Geophys. Res.*, Vol. 65, No. 7, July 1960, pp. 2003-2009.
- [29] J. H. Dellinger, "A new cosmic phenomenon," *Science (Discussion)*, Vol. 82, Oct. 11, 1935, p. 351.
- [30] J. H. Dellinger, "A new radio transmission phenomenon," *Phys. Rev. (Letter to the Editor)*, Vol. 48, Oct. 15, 1935, p. 705.
- [31] J. H. Dellinger, "A new solar radio disturbance," *Electronics*, Vol. 9, No. 1, Jan. 1936, pp. 25, 34.
- [32] "A new radio transmission phenomenon," *QST*, Vol. 19, No. 2, Dec. 1935, pp. 21, 29.
- [33] J. H. Dellinger, "Sudden disturbances of the ionosphere," *Proc. IRE*, Vol. 25, No. 10, Oct. 1937, pp. 1253-1290.
- [34] "The aurora of September 18, 1941," *Nat. Bur. Stand. (U.S.), Tech. News Bull.*, Oct. 1941, pp. 85-86.
- [35] N. Smith and S. S. Kirby, "Critical frequencies of low ionosphere layers," *Phys. Rev. (Letter to the Editor)*, Vol. 51, No. 10, May 15, 1937, pp. 890-891.
- [36] S. S. Kirby, L. V. Berkner, and D. M. Stuart, "Studies of the ionosphere and their application to radio transmission," *Proc. IRE*, Vol. 22, No. 4, April 1934, pp. 481-521.
- [37] Samuel S. Kirby and Elbert B. Judson, "Recent studies of the ionosphere," *Proc. IRE*, Vol. 23, No. 7, July 1935, pp. 733-751.
- [38] T. R. Gilliland, "Multifrequency ionosphere recording and its significance," *Proc. IRE*, Vol. 23, No. 9, Sept. 1935, pp. 1076-1101.
- [39] Newbern Smith, "Skip-distance calculation," *QST*, Vol. 21, No. 5, May 1937, pp. 47-48.
- [40] "Changes in cosmic data broadcasts," *Proc. IRE*, Vol. 19, No. 10, Oct. 1931, pp. 1706-1711.
- [41] Newbern Smith, "Extension of normal-incidence ionosphere measurements to oblique-incidence radio transmission," *J. Res. Nat. Bur. Stand. (U.S.)*, Vol. 19, No. 1, July 1937, pp. 89-94.
- [42] T. R. Gilliland, S. S. Kirby, N. Smith, and S. E. Reymer, "Characteristics of the ionosphere and their application to radio transmission," *Proc. IRE*, Vol. 25, No. 7, July 1937, pp. 823-840.
- [43] Newbern Smith, "Application of vertical-incidence ionosphere measurements to oblique-incidence radio transmission," *J. Res. Nat. Bur. Stand. (U.S.)*, Vol. 20, No. 5, May 1938, pp. 683-705.
- [44] T. R. Gilliland, S. S. Kirby, N. Smith, and S. E. Reymer, "Maximum usable frequencies for radio sky-wave transmission, 1933 to 1937," *Proc. IRE*, Vol. 26, No. 11, Nov. 1938, pp. 1347-1359.
- [45] Newbern Smith, "The relation of radio sky-wave transmission to ionosphere measurements," *Proc. IRE*, Vol. 27, No. 5, May 1939, pp. 332-347.
- [46] Newbern Smith, Samuel S. Kirby, and Theodore R. Gilliland, "Application of graphs of maximum usable frequency to communication problems," *J. Res. Nat. Bur. Stand. (U.S.)*, Vol. 22, No. 1, Jan. 1939, pp. 81-92.



## Chapter VIII

### IN THE DOMAINS OF TIME AND FREQUENCY

#### FROM LC WAVEMETERS TO ATOMIC FREQUENCY STANDARDS

##### INTRODUCTION

From its earliest concepts and experimental trials as a means of carrying intelligence from a transmitter to a distant point, radio has been associated with the frequency domain. The perception of oscillations in the generation and reception of radio waves is expressed quantitatively in terms of frequency, i.e., number of cycles per unit of time—a cycle per second (c/s) is called a hertz (Hz). Frequency, expressed as the inverse of a period of an oscillation, provides us with time, which along with length, mass, and four other units are the base quantities of the now universally adopted International System of Units (SI). (See Hellwig and Halford [1].) In radio science and technology, frequency looms as the quantity that is encountered most. Thus we assign to it the mark of great importance.

Frequency has the unique characteristic of being a quantity that can be easily “transported” from one location to another by means of electromagnetic waves. In reality, the very standard that we wish to transport is a characteristic of the means of transportation, that is, the oscillations of the radio wave itself.

Frequency is also a quantity that has yielded to very great accuracy of measurement with the development of atomic frequency standards. By a counting process of the oscillations we can obtain an “atomic clock,” giving us a standard for the base quantity of time. It is almost axiomatic that the conceptual realization of time precedes that of frequency while the realization of frequency as a useful standard precedes that of time. Such was the case in the development of the atomic standards of frequency and of time as we know them today.

This chapter traces the beginnings of NBS involvements in standard frequency and time devices and dissemination techniques from 1911 through 1975. Many orders of magnitude of improvements have evolved through the efforts of concerned NBS scientists and technicians.

##### THE EARLY FREQUENCY STANDARDS

###### 1. Dellinger calibrates the first wavemeter at NBS

In his experimental introduction to radio in 1911, necessitated by the Bureau's need to calibrate a wavemeter, Dellinger relied upon a frequency comparison with an LC circuit.<sup>1</sup> He deduced the frequency of resonance of the LC circuit from low frequency measurements of the inductance and the capacitance and used the familiar equation of the resonant frequency,

$$f = \frac{1}{2\pi \sqrt{LC}}. \quad ^2$$

With the development of mathematical expressions for inductance and capacitance at radio frequencies by the Electricity Division during the next few years, based upon the constants

<sup>1</sup> See chapter II, p. 38.

<sup>2</sup> An equation developed by Lord Kelvin in 1853. See chapter I, p. 4.

and dimensions of the inductor and capacitor components, it became possible to calculate the resonant frequency with considerable accuracy. The two methods provided a means of crosschecking the resonant frequency data.

It is singular that Lord Kelvin was associated with the method used by the Bureau in calibrating its first wavemeter by means of an equation developed by Kelvin in 1853. And it is most singular that Lord Kelvin should later be associated with the concept of atomic frequency standards, a concept to be developed with reality as a working model by NBS in 1948, for it was Kelvin who presaged in the late 1870's the possible use of atoms as frequency standards.<sup>3</sup>

## 2. The Radio Laboratory develops its first standard wavemeters

It appears that the development of a frequency standard (wavemeter) as a laboratory standard was not too urgent a matter until the early 1920's with the advent of broadcasting stations.<sup>4</sup> Consequently, the development came slowly during the early years of the Radio Laboratory. Kolster's interest in the development of decimeters and Dellinger's study of RF ammeters probably were contributing factors in slowing the development of frequency standards. Also, the nature of calibration requests could have been a factor. This is evidenced by the report on the calibration (testing) of radio instruments first made in the *Annual Report to the Secretary of Commerce* for the year ending June 30, 1914. During the 1914 fiscal year, 35 calibrations were made on decimeters and only 4 on wavemeters.

An early proposal for a frequency standard was listed in the laboratory's Semiannual Report of July 1 to December 31, 1915, which stated:

It is believed that a high frequency alternator of the latest Alexanderson type would be a valuable addition to the laboratory. Such a machine would give absolute values of frequency.

Again, in *Circular 74* (Radio Instruments and Measurements) issued March 23, 1918, it was stated:

The most direct method for the wave length calibration of a standard or commercial wavemeter is a comparison with a high frequency alternator. From the speed of the machine and the number of poles or other structural data the frequency of alternation can be computed directly. The range of such alternators is, however, limited; the usual construction does not furnish a wave length shorter than 3000 meters.

Whether or not an alternator was ever used by the Radio Laboratory for this purpose is not evidenced in the records. There was access to such an alternator, operating up to 100 kHz, in the Signal Corps Radio Laboratory in the West Building.

As a predecessor to a wavemeter standard, Kolster had designed a wavemeter into his first decimeter development as early as 1912. It covered a range of 300 to 2500 meters (1000 to 120 kHz). This Type B Kolster Decimeter (with wavemeter) was developed for the Bureau of Navigation, Department of Commerce. By 1918 a standard wavemeter, developed by the Radio Laboratory, was illustrated in *Circular 74*. It was an LC circuit consisting of a variable condenser (capacitor) and standard coils developed for inductance standards. Calibration of the wavemeter was by computation from low frequency measurement of the inductance and capacitance.

Near the close of World War I a portable type of wavemeter for laboratory use had been designed by H. M. Freeman and designated as the Type L Wavemeter. With four coils connected in various combinations by a rotary switch, the wavemeter had a range of 1000 to 16,000 meters (300 to 18.7 kHz).

<sup>3</sup> See this chapter, p. 292.

<sup>4</sup> Several of the earliest types of wavemeters that were manufactured around 1903 are noted by J. A. Fleming in his treatise *The Principles of Electric Wave Telegraphy and Telephony* (3d ed., 1916): (1) the Dönitz wavemeter, a German product consisting of a combination inductor and variable capacitor; and (2) Fleming's own cymometer (Greek "kyma" or "cymo" for wave), a combination variable inductor and variable capacitor, each component being of unusual design. R. H. Marriot notes in his paper "United States radio development," *Proc. IRE*, Vol. 5, June 1917, that the U.S. Navy first used wavemeters of German manufacture early in 1903.

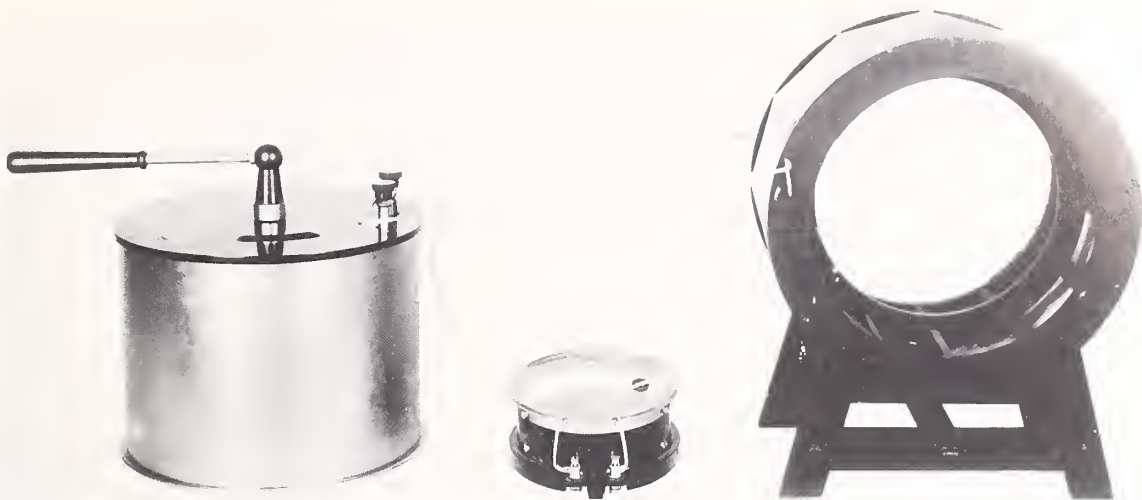

*Very early wavemeter developed by Radio Section. This photograph was published in NBS Circular 74, "Radio Instruments and Measurements" (issued March 23, 1918), with the title "Standard wave meter circuit." Wavelengths over the range of 100 to 13,000 meters were calculated from low frequency calibrations of several capacitors and inductors, taking into account the high frequency effects of leads, distributed capacity of inductors, and losses in capacitors. Resonance was indicated by current flow in loosely-coupled, single-turn loop and thermal ammeter.*

### 3. The Bureau's RF standards of frequency in the 1920's

By 1920 there was a fairly steady demand for calibration of wavemeters and a growing need for greater accuracy of measurement. Four approaches toward improvement of wavelength or frequency measurement were taken:<sup>5</sup>

1. Improvements in the LC circuit technique.
2. Measurement of frequency ratios by Lissajous figures on a cathode-ray oscillograph from a known frequency generated by an electrically-driven tuning fork.
3. Measurement by frequency multiplication with an electron tube generator from an electrically-driven tuning fork of known frequency.
4. Direct measurement of wavelength of standing waves of very short wavelength on parallel wires, related by known ratios to lower radio frequencies.

Actually, a fifth method of utilizing the quartz crystal was just beginning to emerge as a possibility for a frequency standard in 1920. By 1929 it would supplant the other methods and by 1960 the quartz crystal would, in turn, be replaced by atomic frequency standards as the national standard of frequency.

Recommendations of the Second National Radio Conference of March 20-24, 1923, called for broadcasting stations to keep within 2 kHz of their assigned frequency. The Bureau was calibrating wavemeters to no better than 1 part in 100 (10 kHz near center of the broadcast band). As a first step toward a better service the goal was set to improve the accuracy to 1 part in 1000. Thus came the improvement program on four fronts in the early 1920's.

#### a) AN IMPROVED LC CIRCUIT WAVEMETER

As an improved LC circuit wavemeter came the Type R70B standard wavemeter developed by R. T. Cox<sup>6</sup> and J. L. Preston [3]. By now this type of wavemeter had reached a high state of development. It incorporated the quartz-pillar variable condenser of an earlier period. To cover the range of 65 meters to 85,000 meters (4620 to 3.5 kHz) seven inductors and four fixed capacitors were used.

<sup>5</sup>These four methods were well described by Dellinger in a semipopular paper prepared for the periodical *Radio Broadcast* [2].

<sup>6</sup>Richard T. Cox entered the Radio Section on July 1, 1920, and resigned on September 15, 1922.



*Richard T. Cox, who shared in improving the Bureau's standard wavemeter that became known as type R70B is shown making adjustments. Rods in fixed positions, used to connect the several components, minimized variation of calibrated values. This design, developed in 1920, served during the 1920's as the basic reference for other types of wavemeter standards. With four fixed mica capacitors and seven inductors, the wavelength range was 65 meters to 85,000 meters (4620 to 3.5 kHz).*

#### **b) A FREQUENCY STANDARD BY USE OF THE CATHODE-RAY OSCILLOGRAPH**

The basis of this frequency standard had its beginning with L. M. Hull of the Radio Laboratory in 1919 who applied the cathode-ray oscillograph to radio measurements. By means of Lissajous figures on the screen, fixed ratios between two frequencies could be very exactly set and by a step-up (or step-down) process frequencies at fixed points over a considerable range could be determined on the basis of a reference frequency. Others in the laboratory took up the development of this method and it was completed by Miss Grace Hazen and Miss Frieda Kenyon [4].<sup>7</sup>

The reference standard was an electrically-driven tuning fork (1024.2 Hz) calibrated by the Sound Section. With the aid of 2 tunable RF generators it was possible to cover a range of known frequencies up to 500 kHz by a two-stage process, each stage permitting a frequency multiplication up to 22 times as determined accurately on the oscillograph. By some "bootstrapping" techniques the total frequency range was from 3.5 to 5000 kHz.

#### **c) A FREQUENCY STANDARD BY USE OF A HARMONIC AMPLIFIER**

Another method that was less cumbersome, yet somewhat similar to the Lissajous-figure method of setting frequency ratios, was to use harmonic amplifiers (operation by nonlinear characteristic of electron tube) and tuned circuits to establish frequency ratios [5]. A two-stage process gave a frequency range up to 4000 kHz. A 100- and a 1004-Hz tuning fork, calibrated by the Sound Section, served as the reference frequencies.

For calibration of a fixed frequency standard, such as a quartz crystal oscillator, a sonometer was used to determine accurately the beat-note frequency between the oscillators

<sup>7</sup> Miss Grace Hazen entered the Radio Section on October 16, 1922, transferring from the Weights and Measures Division. She resigned from the section on March 7, 1927. Miss Frieda Kenyon entered the Radio Section on June 1, 1922, transferring from another section in the Electrical Division. She left the section on June 30, 1923.

and a high harmonic from the tuning fork.<sup>8</sup> The accuracy of measuring or setting the frequency of a wavemeter was limited only by the accuracy of the fundamental frequency source (tuning fork) and the precision of reading or setting the indicator on the wavemeter.

<sup>8</sup>The sonometer is a device used to determine the frequency of an audio-frequency tone (in this case the beat note). The frequency is determined from the length, tension, and mass per unit length of a steel piano wire that is vibrated by an electromagnetically impressed signal.



*In the mid-1920's quartz plates, used as frequency standards, were calibrated by beat-note comparison with a high harmonic (from a harmonic amplifier) of a calibrated tuning fork. Miss Grace Hazen is using a sonometer (stretched steel wire calibrated at audio frequencies) to determine frequency of beat note.*

#### **d) FREQUENCY MEASUREMENT BY STANDING WAVES ON PARALLEL WIRES**

A method of producing standing waves at radio frequencies on a parallel wire system was first devised by Lecher (called Lecher wires) in 1888, although somewhat similar systems were used earlier by Hertz and by Lodge. The wire system can be used to measure the wavelength of radio waves quite accurately. Such a system was used by F. W. Dunmore and F. H. Engel of the Radio Laboratory early in the 1920's to measure the wavelength of short waves in the range of 9 to 16 meters (33,300 to 19,000 kHz) [6].

This system was used to calibrate wavemeters over a range of 30,000 to 352 kHz (10 to 850 meters). At the lower frequencies a harmonic generator was used to produce frequencies of short enough wavelength to be measured on the Lecher-wire system. The wavelength setting on the wavemeter was simply the linear measurement of this wavelength multiplied by the harmonic number.

#### 4. The Bureau's standard of radio frequencies until 1929

The standards of radio frequency of the Bureau of Standards are wavemeters consisting of standard variable air condensers with a number of interchangeable inductors.

Thus wrote Elmer L. Hall for a periodical in 1924 [7].<sup>9</sup> And thus they remained the frequency standards until replaced in 1929 by quartz crystal oscillators.

Basic to the several wavemeters that were developed during the period from about 1917 and into the 1920's was the quartz-pillar variable condenser (approximately 0.001 microfarad maximum capacity for wavemeters) described in *Circular 74*, published March 23, 1918 (see ch. V, p. 100). Associated with this special condenser for use in wavemeters was the development of a series of air-core inductors (on polygonal forms) to serve as tunable LC circuits (see ch. V, p. 102).

In 1920 this first wavemeter to serve as the frequency standard was replaced by another of the same general design but with the components connected permanently by heavy conductors to gain stability of calibration. This was the development of Cox and Preston cited previously. A coil of two turns of wire connected to a thermogalvanometer or a crystal rectifier (with a dc milliammeter) served as the resonance indicator. In practice there were actually two wavemeters that served as the frequency standard, each differing by the selection of inductors used. The useful range was approximately 18 to 4600 kHz (16,600 to 65 meters). Precision of setting the capacitor was 0.1 percent and better. Accuracy of frequency measurement approached this same value. These two frequency standards were used during the 1920's as the basic reference for other types of frequency standards and measurement equipment being developed.

### THE QUARTZ CRYSTAL PROGRAM—QUARTZ, RADIO'S USEFUL SERVANT

#### 1. The Radio Section is introduced to quartz crystals

The quartz crystal has been a most useful servant to radio technology. Its piezoelectric properties were discovered by Pierre and Jacques Curie in 1880.<sup>10</sup> Before 1920 Professor W. G. Cady of Wesleyan University and later Professor G. W. Pierce of Harvard University became interested in the use of piezoelectric crystals in radio circuits. It was early in 1920 that Cady sent four crystal resonators to the Radio Section for calibration as fixed frequency standards.<sup>11</sup> It was the section's introduction to piezoelectric devices for radio application. Herbert M. Freeman was assigned to the calibration project.<sup>12</sup> He wrote a detailed report of

---

<sup>9</sup> Elmer L. Hall entered the Radio Laboratory on April 9, 1919, and took a very active part in the frequency standards and measurement program during the first two decades of his 35 years with the Bureau's radio programs. Later he engaged in various development and measurement programs. Hall transferred to the Diamond Ordnance Fuze Laboratories when CRPL moved to Boulder in 1954.

<sup>10</sup> The piezoelectric effect is a twofold property of certain natural and synthetic asymmetrical crystals (quartz, etc.) that: (1) produces a mechanical stress in the crystal by application of an electric field (voltage) and (2) produces a voltage when subjected to mechanical stress. The effect is very useful in frequency-stabilized oscillators, generators (transmitters), and certain types of high-frequency filters.

<sup>11</sup> Cady's submission of the four crystal resonators for calibration preceded his first authorship on piezoelectric resonators by a year. He presented a published abstract of a paper to the December 30, 1920, meeting of the American Physical Society. In 1922 he published a full paper on this topic [8]. It was in this paper that Cady stated that two applications of piezoelectric crystals were promising: (1) as a resonator for wavelength (frequency) standards and (2) as a frequency stabilizer or a means of generating electric oscillations of very constant frequency. Professor Cady later became an outstanding authority in the field of piezoelectricity.

<sup>12</sup> Freeman joined the Radio Laboratory shortly after July 1, 1917 (coming from the University of West Virginia), and left on September 14, 1920, to join the Westinghouse Electric and Mfg. Co. at Pittsburgh, Pa. He left shortly before the 5-month calibration period of the four resonators was completed.

the calibration which extended over a period of 5 months.<sup>13,14</sup> It was in this report that Freeman made a statement that had a prophetic ring. He wrote:

Very little work has been done on either type of these crystal combinations (quartz crystal, and Rochelle salt crystal with steel rod) because of lack of opportunity. The subject is one which is well worth a complete investigation with the object of establishing convenient standards of frequency. . . .

Within a few years and to continue for more than 50 years to the present time the quartz crystal was to play an important role in the technology of radio communication at NBS, primarily with standards of frequency and standard frequency dissemination.

In his Annual Report of FY 1920 Dellinger referred to this calibration as: "Measurements have been made on a remarkable new type of wavemeter consisting of a quartz crystal."

During 1922 Professor Cady submitted four more piezoelectric resonators for calibration: two were of quartz crystals and two were of quartz crystals with steel bars. The resonators ranged between 14.5 and 236 kHz. During October 1923 seven more resonators submitted by Cady were calibrated by Miss Grace Hazen. These ranged in frequency from 14.5 to 763 kHz. This series was of particular interest as Professor Cady had previously carried the resonators to Europe for calibration in two laboratories in England, two in Italy, and one in France. Also a check had been made at Harvard University. All comparison measurements were made with an accuracy of approximately 0.1 percent, with agreement in frequency between the different laboratories within this accuracy in most cases.

## 2. Learning and applying quartz crystal technology

A year after the Radio Section had calibrated Cady's seven crystal resonators that had toured five European laboratories, an announcement was made in the *Technical News Bulletin* that the Bureau was engaging in the study of quartz crystals and their application to radio communication. In the October 10, 1924, issue it was stated:

Piezoelectricity is an old phenomenon which is having some remarkable new applications. . . . American investigators have found that the frequency of vibration of the piece of quartz is extraordinarily constant, and that it is a very useful radio standard.

Studies being made at the bureau indicate that such a quartz oscillator has many valuable applications in radio work. Means of producing audio as well as radio frequencies are being worked out. The crystals can be used to control or determine the frequency of a transmitting station and to hold it strictly constant. This will mean a great advance in radio transmission technique. The crystals are also useful in accurate setting of receiving apparatus and in controlling the frequency of radio-frequency generators used in laboratory measurement work. The value of these various applications will be particularly great at the frequencies above 2000 kilocycles which are now rapidly coming into use.

The application of this new technology arrived in the nick of time. By the end of 1922 approximately 570 American broadcasting stations were occupying a frequency band of 1000 kHz. The Department of Commerce was wrestling with acute problems, such as compressing the many stations into a relatively narrow band of the spectrum, and inspecting the radiated signals for adherence to assigned frequencies. Each of the stations had its problems

---

<sup>13</sup>The report, found in the Radio File, is entitled "The use of the piezo-electric effect for establishing fixed frequency standards" and is dated September 11, 1920.

<sup>14</sup>The crystal resonators submitted by Cady were of two types: one utilized a quartz crystal suspended by a thread between two brass plates that formed the capacity of an electron tube oscillator circuit; the other was a steel bar cemented to and driven by a Rochelle salt crystal, also made a part of an oscillating circuit. Calibration was by means of an LC wavemeter. Four resonators were calibrated three times over a 5-month period at wavelengths ranging from 3410 to 3930 meters (approximately 88 to 77 kHz). It was during these calibrations that R. T. Cox of the section made some written suggestions on a method of utilizing piezoelectric crystals for stable frequency generators.

of keeping the transmitter to the assigned frequency. Interference among the broadcasting stations was becoming a serious and pressing problem. The use of quartz crystals, both for control and for monitoring of frequency, appeared to be, and truly was, the answer to a vexing situation. The Bureau, as the radio laboratory for the Department of Commerce, was to play a prominent role in squarely meeting the situation.

In December 1923, a year after he had entered the section, August Hund was assigned the project of applying quartz crystal technology to alleviate the pressing problem related to interference among the broadcasting stations.<sup>15</sup> He had already gained considerable experience in radio engineering at frequencies much above the broadcast range. During the next several years he would be giving considerable time toward the quartz crystal work. From Hund's efforts, along with others, came a series of seven Letter Circulars related to the use of quartz crystals in radio equipment, primarily in frequency meters and in piezo oscillators, including their use in controlling the frequency of transmitters. No doubt this publication vehicle was chosen for this series of printed papers in order that the information would be quickly and readily available to radio engineers.

---

<sup>15</sup> August Hund entered the section December 19, 1922, and transferred to the Sound Section on June 16, 1925. He returned to the Radio Section on July 1, 1928, and resigned May 2, 1929, to join the Thomas A. Edison Laboratory, Orange, N.J. Over a period of many years he wrote four extensive treatises relating to radio engineering, including one on *High Frequency Measurements* (1951) and another on *Frequency Modulation* (1942).



*August Hund examining quartz crystals (December 15, 1925). Hund contributed extensively to the technology of quartz crystals as frequency standards during the 1920's. He was the author of several well-known treatises on radio engineering.*



Letter Circular 186, issued on November 20, 1925, entitled "Specification for Portable Piezo Oscillator, Bureau of Standards Type N," was of special interest. This oscillator, which served as a frequency meter, was originally designed for the radio inspectors of the Department of Commerce;<sup>16</sup> its use, however, extended much beyond the original need. It was estimated that the device could be built for about \$150 including the crystal. Very detailed instructions, plus drawings, were given for its construction. One type UV-201A tube, operating from batteries, energized the quartz crystal as a highly stabilized frequency oscillator. Quoting from the February 1926 *TNB*, it was stated:

While the application of piezo oscillators is new and has not yet had the advantage of prolonged trial under varied conditions, it seems likely that it will be very useful. If all radio transmitting stations were equipped with the device and used it properly, frequency variations and whistling interference due to beat frequencies would probably disappear.

---

<sup>16</sup> Previously, a Letter Circular (LC180, Sept. 16, 1925) had been issued for a Type B radio frequency indicator which would serve as an interim measure before the quartz crystal frequency meter became a practical instrument. It was a refinement of the earlier wavemeter in that it was set at a fixed frequency for monitoring purposes.

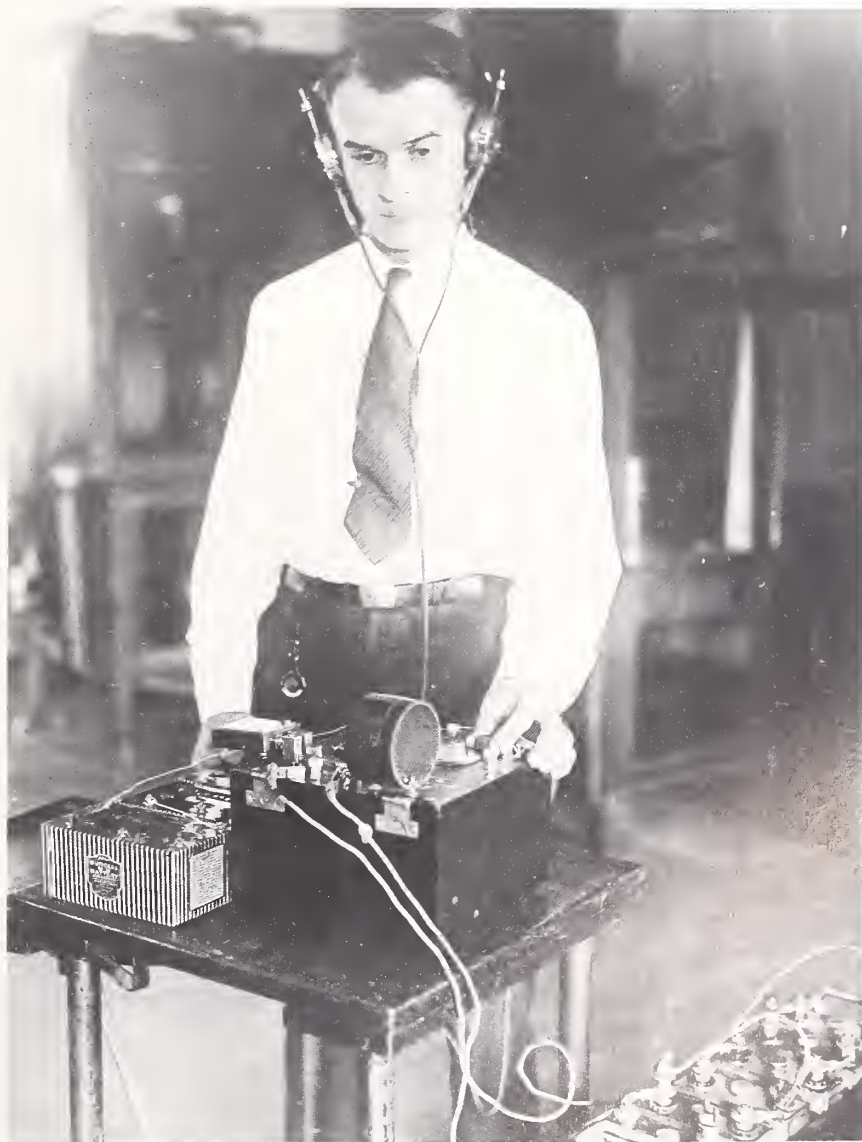

*Elmer L. Hall observing performance of a portable piezo oscillator in 1926. Hall was associated with the Bureau's frequency standards programs for two decades, beginning in 1919. He transferred to the Diamond Ordnance Fuze Laboratories in 1954.*

Eventually the ether waves in the broadcast band were cleared of whistles but it was due to various factors including suppression of the heterodyne whistles originating in the receivers.

Out of this period in the middle 1920's came but one publication on the quartz crystal program, a tutorial paper by Hund on the uses and possibilities of piezoelectric oscillators [9]. The paper served well to bring to light the new technology and to show some potential uses.

One of the actions taken by the Federal Radio Commission (created by Congress on February 23, 1927) toward minimizing interference among the broadcasting stations was to require maintenance of frequency to 500 Hz (0.5 kHz) of the assigned frequency. The February 1928 issue of *TNB* reported "an exceptional demand for radio tests of this kind (piezo oscillator) which is greatly in excess of the capacity of the bureau for immediate service." Scheduling of tests was necessary by priority on a waiting list. In the March 1928 issue the hope was expressed that commercial laboratories at some future time could take over much of this testing load suddenly thrust upon NBS. In the same issue a fee schedule was published.<sup>17</sup>

An action taken by the section early in 1927 was toward developing methods of holding the quartz crystal at a constant temperature, thereby increasing the frequency stability and its accuracy as a frequency standard. Assigned to this development program was Vincent E. Heaton.<sup>18</sup> From this development came a portable type of temperature-controlled piezo

<sup>17</sup> Examples of these calibrations were: (1) determination of one fundamental frequency of a piezo oscillator or resonator or quartz plate, at room temperature, \$15 fee; and (2) determination of one fundamental frequency of a piezo oscillator or resonator or quartz plate, provided with a suitable thermostat at specified temperature above that of the laboratory, \$25 fee.

<sup>18</sup> Heaton entered the section on April 1, 1927, and immediately took part in the quartz crystal program. Heaton was closely associated with the time and frequency programs throughout his long career in the section. He retired from the Boulder Laboratories on December 30, 1965.

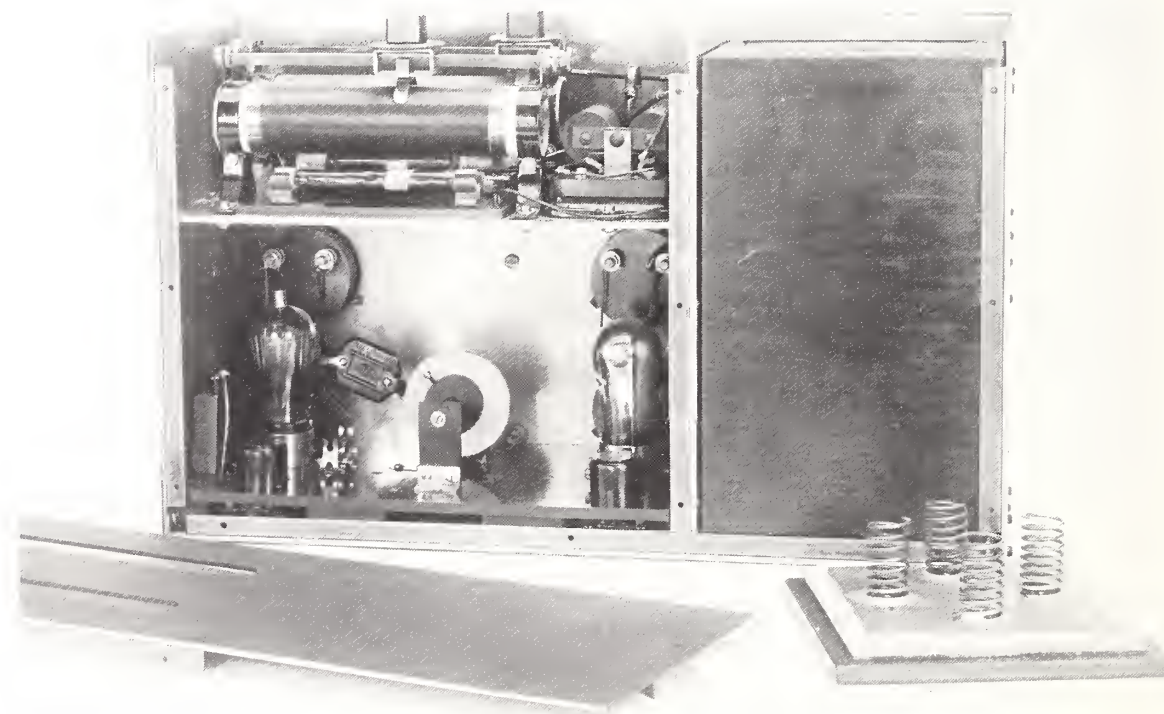

*Portable, temperature-controlled, piezo-oscillator, frequency standard designed by Vincent E. Heaton and Walter H. Brattain in 1929. Spring mounting (right) provided vibration isolation to temperature-controlled chamber housing the quartz crystal. Brattain joined Bell Telephone Laboratories in 1929; in 1956 he shared the Nobel Prize in Physics with Shockley and Bardeen for discovery of the transistor effect.*

oscillator with superior features [10].<sup>19</sup> Assisting Heaton in this development was Walter Brattain, who later won the Nobel Prize in Physics in 1956.<sup>20</sup>

Advanced technology in the frequency control of broadcasting transmitters and increased need for tighter control of operation on assigned frequencies brought about Rule 144 in June 1932 by the Federal Radio Commission of maintenance to within 50 Hz of the assigned values. In turn, this move required a more advanced type of frequency monitor than was available in 1932 and the commission required that such monitors meet with approval after tests by NBS. The testing program was carried out under the direction of William D. George.<sup>21</sup>

No specifications for design features were prepared by the Federal Radio Commission but the frequency monitors were required to meet a series of tests performed by the Radio Section. Ten of the 15 quartz crystal monitors submitted for the test program were approved by the commission and found to have an accuracy of 1 part in 100,000, 5 times better than the required accuracy (rather an uncommon superiority). George published a report of the tests in April 1934 [11].

Many years later, in the 1950's, two more advanced types of portable quartz crystal frequency standards were developed within CRPL. One of these, developed by P. G. Sulzer, was a 1-megacycle standard stable to a few parts in  $10^8$  per day. The other, developed by A. H. Morgan, was a small and compact standard that could operate for several hours without an external power source.

### 3. Attainment of a national standard of frequency

By the mid-1920's the Radio Section was encouraged by the possibilities of piezoelectric crystals, and particularly quartz, as frequency standards of considerable stability and accuracy. During the summer of 1926 a quartz crystal oscillator was exhibited by the Radio Section in the Bureau's exhibit at the Sesquicentennial Exposition at Philadelphia, Pa. Thus "exposure" to the public was made by the Bureau of a new and promising servant to radio technology.

Feeling the need of a cooperative effort among U.S. laboratories developing quartz crystal frequency standards, the Radio Section organized a conference on February 7, 1927. The purpose was:

. . . for establishing a basis of frequency measurement against which comparative tests could be made with an accuracy greatly in excess of the certainty of absolute measurement of frequency. A standard thus established will be analogous to the international electrical standards of current, resistance, etc.

No doubt this conference was a significant step forward in the establishment of frequency standards as we know them today. It was agreed that three of the laboratories would

---

<sup>19</sup>This piezo oscillator was a portable frequency standard that was constant to better than 1 part in 100,000. The "Curie cut" quartz crystal was mounted in a holder that provided air gaps to the electrodes; the assembly was closed in a heavy copper cylinder to minimize temperature fluctuations. Spring mounting of the heavy cylinder made the standard relatively immune to mechanical shock. The quartz plate was placed between the grid and filament circuit of a Type 201A tube that served as the oscillator. A screen-grid tube served as an amplifier and a means of decoupling the crystal from the output circuit of the standard.

<sup>20</sup>Walter H. Brattain was awarded the Nobel Prize in Physics in 1956 along with William Shockley and John Bardeen (all of the Bell Telephone Laboratories) "for the investigation on semiconductors and the discovery of the transistor effect." Brattain was the first of three men associated with radio work at NBS to win the Nobel Prize in Physics. The others were Kusch in 1955 and Townes in 1964 (see p. 299 and p. 298). Interestingly, all three of the prize winners were associated with the frequency standards programs.

An interesting account of Brattain's contributions and experiences in the development of the transistor by the Bell Laboratories team can be found in the January 1973 issue of *Spectrum*, written by Charles Weiner and entitled "How the transistor emerged."

Brattain entered the section on August 1, 1928. He resigned at the end of the fiscal year, on June 30, 1929, to join the Bell Telephone Laboratories where he remained until 1967.

<sup>21</sup>George entered the section on August 5, 1929, and took a very active part in the frequency standards and dissemination program for many years, until his death on February 12, 1963. He was in charge of WWV for many years. From 1946 to 1956 he was chief of the High Frequency Standards Section (and Branch) and was acting chief of the Radio Standards Division from 1956 to 1960.

conduct a program of intercomparing seven quartz crystal frequency standards. The Naval Research Laboratory, the Bell Telephone Laboratories, and the NBS would make frequency measurements against time standards to be compared with NBS Standards.<sup>22</sup> NBS made its frequency determinations in terms of the mean solar second as obtained from the U.S. Naval Observatory at Washington, D.C.

The Bureau's program took on an international scope in even its earliest stages. In 1924 some frequency comparisons were organized by the Radio Section by direct radio transmissions between national laboratories of England, France, Italy, Germany, and the United States. The results were less than satisfactory and agreement between the standard frequencies was but 2 parts in 1000. Taking up a procedure used by Professor W. G. Cady at an earlier time, the Bureau sent a quartz crystal oscillator to several European laboratories beginning in late 1925 and repeated with a second oscillator in 1926. This was followed later with another oscillator sent to Canada and to Japan. The result was an agreement of frequency measurement between all laboratories of several parts in 10,000—a gratifying result at the time [12].

In the summer of 1927 Dellinger personally carried a newly developed temperature-controlled quartz crystal oscillator to Europe and made frequency measurements at four European laboratories. The result was a tenfold increase in accuracy of agreement among the five laboratories. Departures from the mean were within 3 parts in 100,000. Progress was being made rapidly in a new technology.

By 1929 the measurement program being carried on by NBS with the Naval Research Laboratory and the Bell Telephone Laboratories indicated an agreement in the accuracy of frequency determination of 1 part in 100,000. Within 4 or 5 years the Radio Section had increased the accuracy of its frequency standards by a thousandfold!

Planned equipment to serve as a national frequency standard was becoming a reality. After a year of development and construction by the Bell Telephone Laboratories, four complete temperature-controlled quartz crystal oscillators were delivered to NBS during August 1929. Although performance specifications had been prepared by the Radio Section, many of the design features were products of experience gained by Bell Telephone Laboratories personnel.

#### a) THE NATIONAL PRIMARY STANDARD OF RADIO FREQUENCY

Within a short time after receiving the equipment from New York, the section had set up the four quartz oscillators plus an array of ancillary equipment that provided for a self-contained observational facility of determining performance on a continuous basis. The Bureau was now the focal point and the fountainhead for the dissemination of standard frequencies of a high order of accuracy and could rightfully call this new installation the National Primary Standard of Radio Frequency [13,14].<sup>23</sup>

---

<sup>22</sup> In addition to these three laboratories, others represented at the conference were the War Department, American Telephone and Telegraph Co., Radio Corp. of America, General Electric Co., and the Westinghouse Electric and Mfg. Co. It was among the latter four that cross-licensing of patents in the manufacture of electron tubes and radio equipment was negotiated in the early 1920's.

<sup>23</sup> In its earliest period the primary standard consisted of four temperature-controlled quartz crystal oscillators, each operating at a design frequency of 100 kHz. This group of oscillators became known as section I of the frequency standard. The crystal plates were cut in the form of a toroid to obtain a small temperature coefficient. The rings were each mounted on a horizontal fiber rod with an aluminum disk on each side to serve as the electrodes. Each quartz toroid was mounted in a heavy aluminum cylinder fitted with electric heaters. Each crystal assembly was sealed in a glass bell jar that was slightly evacuated, thus keeping the crystal under uniform condition of humidity and air pressure. The total assembly was suspended on damped springs to minimize vibration and housed in a temperature-controlled chamber. Variation of temperature of the quartz toroid was less than 0.001 °C. A power supply of many lead-acid storage batteries, divided into many different supply units with accompanying charging facilities, energized the standard at constant voltage.

In the standard's early use one quartz oscillator was used as a reference and beat frequencies were observed between the reference and each of the three other oscillators. Variations in frequency could be observed to 1 part in 10<sup>8</sup>. By means of a submultiple type of vacuum-tube generator the 100-kHz frequencies could be reduced to 1000 Hz.

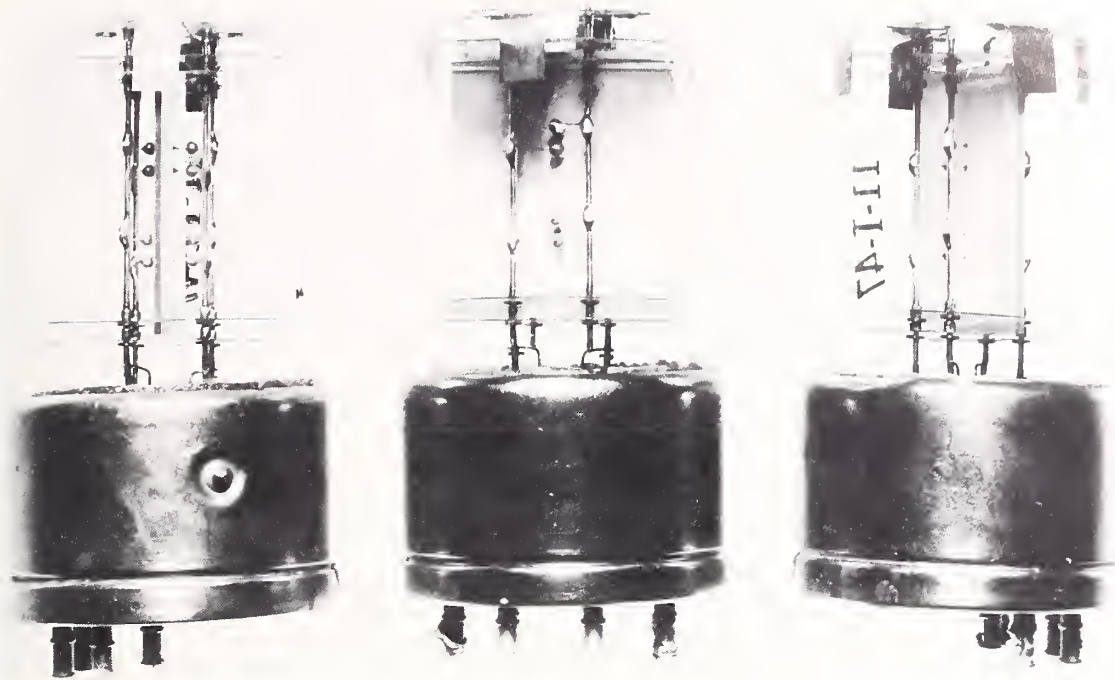

*The 100-kHz quartz crystal units pictured were those used in the National Primary Standard of Radio Frequency, beginning in 1929.*

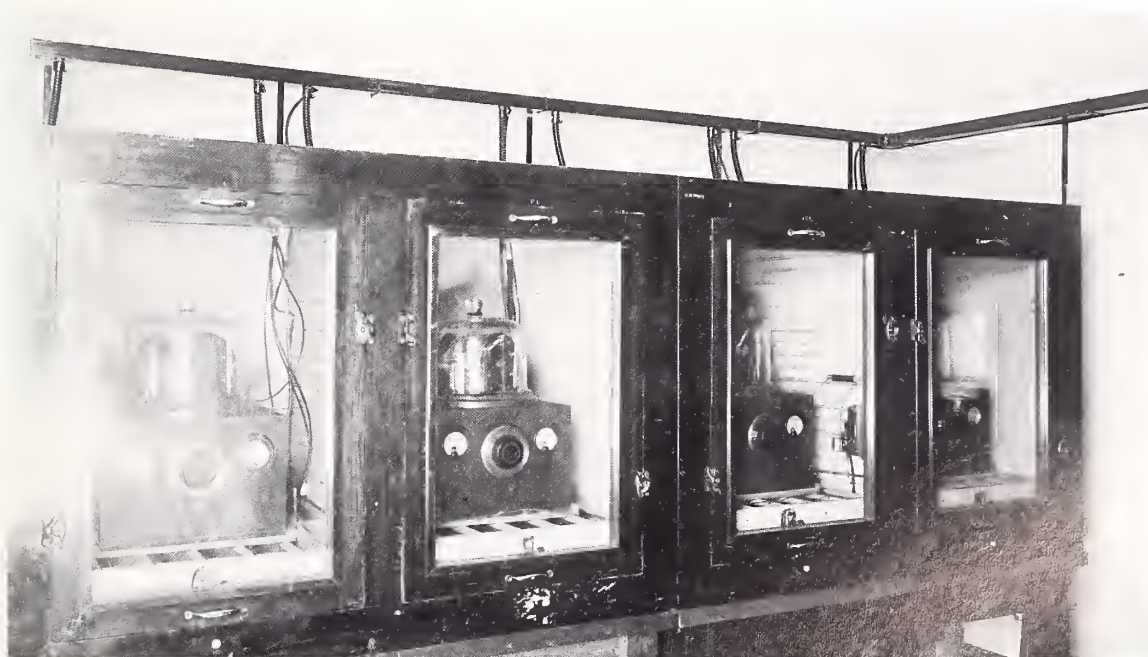

*In 1929 these four 100-kHz quartz oscillators, with auxiliary circuitry and temperature-control equipment, were installed in the Radio Building, to become the National Primary Standard of Radio Frequency.*

A 100-Hz synchronous-motor clock operating from the submultiple frequency drove a clock that was geared to read mean solar time when the motor was driven at exactly 1000 Hz. The clock rate could be compared with time signals from the U.S. Naval Observatory via radio signals from its Arlington, Va. transmitter. It was now possible for the Bureau to maintain a frequency standard with an accuracy of about 1 part in  $10^7$ , based upon mean solar time. However, it was found that the quartz crystals were subject to drift with an increase in frequency of about 1 part in  $10^7$  per month. Thus the hopeful "standard" lacked long-term stability.

## b) EARLY IMPROVEMENTS TO THE PRIMARY STANDARD

The knowledge and experience gained by the team of workers with the new frequency standard, as well as from research within the section on the piezoelectric properties of quartz crystals, placed the team in good stead for further development of the primary standard. During the next several years, after setting up the original four oscillators, NBS added two more oscillators to the frequency standard; both new units were constructed within the Bureau. This latter group of oscillators became known as section II of the frequency standard [15].<sup>24</sup>

---

<sup>24</sup>The added oscillators (forming section II) differed in design from each other and from the four composing section I. One had a 100-kHz circular quartz plate, the other a 200-kHz plate with a cut much like the shape of a spoked wheel. Although weak in its response, this latter crystal was quite insensitive to external circuit parameters and had a very small temperature coefficient. The crystals were cut in the Bureau's optical shop. Considerable improvements in power supplies were incorporated in these new oscillators.

One oscillator from each section was checked daily with time signals from the Naval Observatory in order to arrive at an absolute determination of frequency. Many comparisons were made in different combinations to determine the relative changes among the six oscillators. It was soon learned that each oscillator showed individual characteristics. These observations were made on an electric chronograph (driven by a 100-Hz synchronous motor using a circular wax-coated sheet as the recording medium). Signals from the primary standard and from the Naval Observatory were recorded with time differences that could be accurately determined within a few thousandths of a second. The method was an improvement over the one used several years earlier.

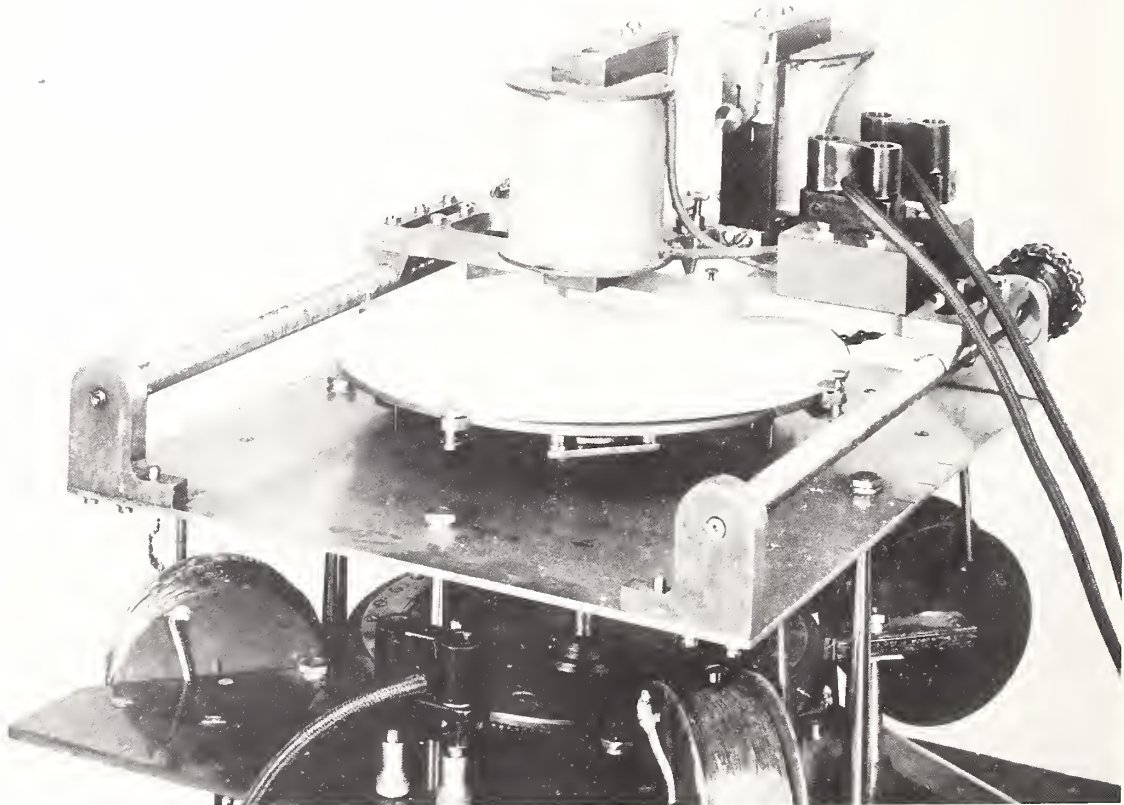

*The 100-Hz synchronous-motor clock driven by a 1000-Hz submultiple of quartz-crystal primary frequency standard. Used for comparison of seconds from clock with 1-second time signals from the U.S. Naval Observatory (via radio from the Navy's Arlington, Va. transmitter, NAA); recordings were made on wax-coated paper rotated on a disk geared to the clock. The comparison provided for absolute measurement of the frequency standard.*

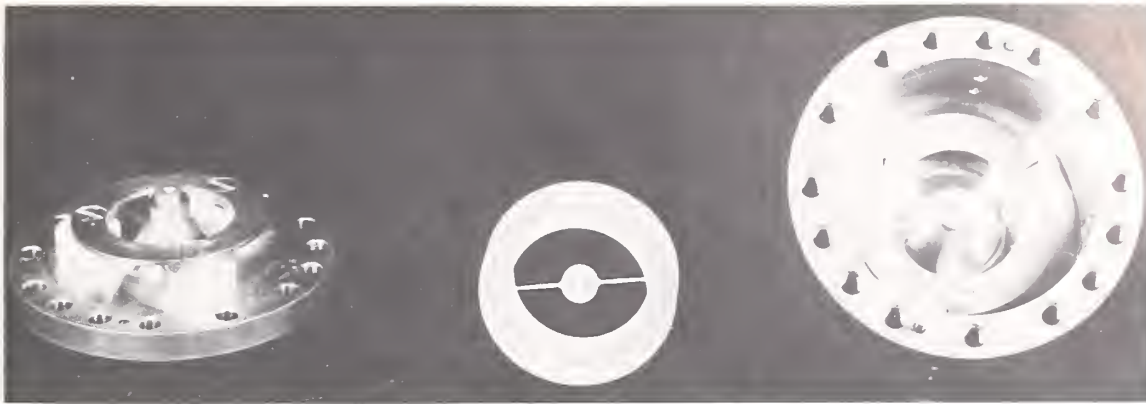

Quartz ring or toroid crystal unit used in Section II of the National Primary Standard of Radio Frequency as a further development in quartz crystal technology. The 200-kHz quartz crystal ring (center) is supported by two arms which are part of the mother crystal. Sections of crystal housing are shown at left and right.

Engaged in the development of the primary frequency standard in its early years were E. L. Hall, V. E. Heaton, and E. G. Lapham,<sup>25</sup> all of whom added various features to the equipment and took an active part in its operation. Also contributing to its early development were the section personnel engaged in quartz-crystal research, including A. Hund, C. G. McIlwraith, and R. B. Wright.

#### 4. Refining the national standard of frequency

As years went by quartz oscillators incorporating newer developments were added to the national primary frequency standard. By 1952 the standard included six oscillators plus eight quartz crystal resonators [16,17].<sup>26</sup> In addition, three quartz oscillators were used at WWV with daily comparisons made via radio signals with the standard at NBS laboratories in Washington, D.C.

Daily checks with mean solar time of the U.S. Naval Observatory provided an absolute determination of frequency and time of the primary frequency standard.<sup>27</sup> By 1952 the accuracy was about 2 parts in  $10^8$ , an accuracy that was better than could be obtained from observations of the daily rotation of the Earth.

A new method of temperature control of the quartz crystal oscillators was initiated at the WWV station by placing the oscillators in a small underground chamber about 25 feet below the ground surface. Some experiments were initiated by placing a quartz crystal unit in a well casing 60 feet below ground surface. But later experiments at Boulder in 50-foot wells were abandoned when the quartz crystals gave way to atomic standards.

<sup>25</sup> Evan G. Lapham entered the Radio Section on July 17, 1929. After engaging in a variety of activities, he resigned on March 25, 1941.

<sup>26</sup> The quartz crystal oscillators had been improved over a period of 20 years by using 100-kHz GT-cut crystals that were uniform in frequency over a fairly wide range of driving amplitude. The crystals were now driven at an RF current amplitude of about one-third that previously used in order to obtain greater frequency stability.

In contrast to the oscillators, which were operated continuously, eight 100-kHz crystal resonators were added to the frequency standard and were used but a short time each day in a balanced bridge network for comparison with the oscillators. The resonators used an improved form of GT-cut quartz crystal (with a Q of about 4 million) developed and fabricated by the Bell Telephone Laboratories. Although the resonators served as auxiliary standards to the oscillators, they were more free of aging conditions due to their simplicity and lack of external circuitry of a vacuum tube and other components.

Frequency comparisons were made daily between all of the units (oscillators and resonators) with a precision of about 1 part in  $10^{10}$ . Improvements in temperature control increased the frequency performance.

<sup>27</sup> On occasion the primary frequency standard was referred to as a crystal clock. The frequency standard, with its dissemination of time signals via WWV, was closely checked with the U.S. Naval Observatory. Thus the legal basis of time for the U.S. (Naval Observatory) was disseminated via "crystal clock" at NBS. See Vincent E. Heaton, "The crystal clock," *H.I.A. Journal* (The Horological Institute of America), Vol. 2, No. 4, July 1946, pp. 21-23.

Associated with the primary frequency standard in the heyday of its use as the most accurate frequency standard available were John M. Shaull, Vincent E. Heaton, and John H. Shoaf.<sup>28,29</sup>

After the national primary frequency standard was housed in the Radio Building for 25 years, it became necessary in 1954 to move the standard across country to Boulder, Colo. (for details see p. 275). But the rapidly growing art of developing a superior system for a frequency standard was catching up and would soon surpass the performance of the long-time servant of radio technology—the quartz crystal—at least as the national frequency standard. In the fall of 1957 an atomic frequency standard was used to observe the constancy of frequency transmissions of WWV and WWVH. During the next several years a complete changeover was made to atomic frequency standards. During January 1961, NBS commenced using the Boulder-based low-frequency broadcasts, WWVB and WWVL, as received at Greenbelt, Md., to control the frequency of the WWV broadcasts through manual adjustment of the WWV oscillators. Besides the improvement in frequency control, such use of WWVL and WWVB permitted calibration of the WWV frequency in terms of the NBS primary frequency standard (based on atomic frequency standards) [18]. Such low-frequency control of WWVH, referenced to NBS atomic frequency standards at Boulder, Colo., commenced in March 1963. Later, the time signals of WWV from Greenbelt, Md. were synchronized to approximately  $\pm 10$  microseconds in terms of the NBS primary time scale through portable crystal-clock synchronization and the low-frequency broadcasts, WWVL and WWVB [19].

Quartz crystals still play a very useful role in radio technology, even serving as oscillators in the present frequency standards at Boulder. The use of quartz crystals had a phenomenal growth during World War II in their adaptation to myriads of communications systems and this use continues through the present day. Within the Frequency-Time Standards Section a very marked improvement in the performance and measurement of the short-term stability of quartz crystal resonators has been achieved during the past several years.

## 5. The NBS microwave frequency standard

To meet the growing need of frequency standards (as well as other standards) at microwave frequencies during World War II, the Bureau was requested to establish and maintain a frequency standard as a defense measure.<sup>30</sup> With the aid of the Radiation Laboratory at the Massachusetts Institute of Technology, a frequency standard operating over the range of 300 to 40,000 MHz was completed in 1945; added improvements were made over the next several years. The standard provided frequency multiplication of several hundred thousand times from one of the 100-Hz quartz crystal oscillators of the national primary frequency standard. The standard had an accuracy of 1 part in  $10^8$  for spot frequencies beginning at 300 MHz, but the accuracy decreased rapidly at higher frequencies due to the deleterious effects of frequency and phase modulation and of noise in the calibration signal [20].<sup>31</sup>

The early development was mostly by Benjamin Husten under the direction of Harold Lyons. Nearly all of the calibration work on various types of cavity wavemeters performed during the first few years was for the armed services for their radar and navigation systems. However, the rapid increase of microwaves for civilian uses, such as relay links, brought on additional needs for the frequency standard.

---

<sup>28</sup> Shaull entered NBS on March 21, 1939. He transferred to the Diamond Ordnance Fuze Laboratories when the Central Radio Propagation Laboratory (CRPL) moved to Boulder in 1954.

<sup>29</sup> In 1959 Heaton was awarded the Department of Commerce Silver Medal for Meritorious Service "for long, faithful, and exceptionally competent service in maintaining the USA primary standard of frequency and time interval."

<sup>30</sup> Refer to chapter X, p. 346 for further information on this new NBS program.

<sup>31</sup> Frequency coverage in both spot frequencies and continuous coverage from 300 to 40,000 MHz was obtained by frequency multiplication with a series of frequency multipliers, a decade frequency generator, and a precision oscillator and frequency converters. At the highest frequencies a silicon crystal was used as a harmonic generator. The latest developments in vacuum tubes and klystron oscillators were incorporated in the standard.



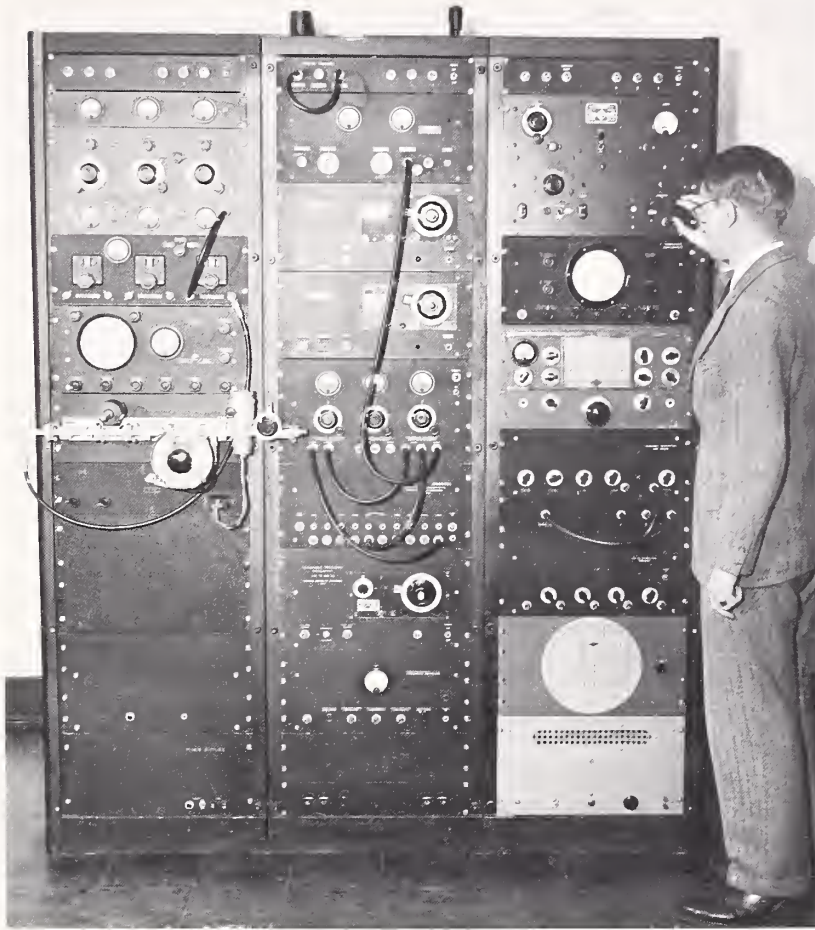

*Early form of the microwave frequency standard developed by Microwave Standards Section for calibration of frequency meters in ranges of 300 to 40,000 MHz. Benjamin F. Husten at controls. Frequency multiplication from one of Bureau's 100-kHz quartz crystals of the primary standard provided microwave frequencies constant to one part in  $10^8$ . This standard was used from 1945 to 1952 when it was replaced by more advanced equipment and the range extended to 75,000 MHz.*

Before the microwave frequency standard was moved to the Boulder Laboratories in 1954, improvements in the equipment and accuracy of the standard were made by Lauren J. Rueger and Albert E. Wilson. Increased signal strength at the higher frequencies enhanced the accuracy of measurement by reduction of frequency and phase modulation and random noise signals. Stabilizing of the klystrons with temperature-controlled oil baths also improved the performance [21].

After the move to Boulder many new features were added to the microwave frequency standard under the direction of Roy E. Larson. Assisting in these developments were Lawrence W. Miller and Mohammed H. Zamboorie. The standard became a part of the operating features of the Electronic Calibration Center but the need to provide a calibration service for outside laboratories became less in later years.

Associated with the microwave frequency standard program was the development of two related calibration services. One was that of the measurement of frequency stability of signal sources developed by John H. Shoaf. The other was the development of a method of power spectrum analysis of signal sources by Shoaf and Esther Gilman, based upon earlier research by James A. Barnes and others of the Radio Standards Laboratory.

## 6. Toward perfecting the adaptation of quartz crystals to frequency standards

Before the atomic frequency program within CRPL was to prove the superiority of this approach to a national frequency standard, a project was initiated within the High Frequency Standards Section in 1952 to investigate possible improvements in the frequency stability of quartz crystals. Quartz crystal technology for frequency standards had come a long way from the work of Professor Cady in the early 1920's and later by the Bell Telephone Laboratories. But no measures taken appeared to prevent quartz crystals from drifting in frequency (usually toward a higher frequency) as an aging effect. However, a possible correction method appeared by operating the crystal at a very low temperature (down to 4 K with liquefied helium).

During the last 3 years of this project, from 1956 to 1959, support was received from the U.S. Army Signal Research and Development Laboratories because of their wide interest in quartz crystal technology. It was found that the aging process of quartz crystals could be reduced by more than one order of magnitude by operating down to 4 K. Moreover, the Q of a crystal would increase to as much as 50 million (with the property of extremely sharp resonance) accompanied by exceptional performance in short-term stability. Various kinds of laboratory-type cryogenic apparatus were developed for precision control of the low temperature. The design of a quartz oscillator unit for operation at cryogenic temperatures resulted in a patent issued to the investigating group.<sup>32</sup>

The onrush in development of atomic frequency standards swept aside the need for such refinements to the quartz crystal standards and the project was terminated in midsummer of 1959. Those associated with the project included Francis P. Phelps, Philip A. Simpson, and Catherine Barclay.<sup>33</sup>

### THE STORY OF WWV AND ITS SCION STATIONS

#### The broadcasting service for dissemination of frequency and time signals<sup>34,35</sup>

October 1, 1919            The first public announcement of the station call letters WWV, assigned to the Bureau of Standards, was made in the October 1, 1919, issue of the *Radio Service Bulletin* of the Bureau of Navigation, Department of Commerce.<sup>36</sup> (See ch. IV, p. 76.)

<sup>32</sup> Philip A. Simpson, Catherine Barclay, and Francis P. Phelps filed for the patent on June 25, 1958. Patent 2,931,924 was issued on April 5, 1960, entitled "Quartz oscillator unit for operating at low temperatures."

<sup>33</sup> During World War II, Francis P. Phelps, a member of the Polarimetry Section, was placed in charge of a research group to develop methods of testing quartz crystals including testing for the serious defect of optical twinning. Methods developed by the group were used to test 6 million pounds of quartz during the war period. In 1950 Phelps was awarded the Department of Commerce Silver Medal for Meritorious Service "for outstanding scientific achievement in polarimetry, with particular reference to the optical properties of quartz and the development of improved standards for the world-wide grading of sugar."

Phelps joined NBS in February 1912, starting in the Polarimetry Section. In 1943 he headed up a quartz research laboratory within the quartz inspection complex set up at NBS as a wartime measure. After 47 years of service with NBS Phelps retired on January 30, 1959, having been in charge of the Quartz Crystal Laboratory at Boulder for many years.

Shortly after World War II the small group of Phelps, Simpson, and Barclay was transferred to the Mineral Products Division and later to the High Frequency Standards Section in the CRPL. In 1954 the group moved with the CRPL to Boulder, Colo.

<sup>34</sup> A considerable portion of the material gathered in this account is taken from material prepared by W. D. George and V. E. Heaton in 1961 for Rexmond C. Cochrane in preparation of his history of NBS, *Measures for Progress*.

<sup>35</sup> Because of the many dates that are included and the extensive listing of technical accomplishments and services offered, this account of the progressive development of WWV is presented in a chronological outline format for ease of reading.

<sup>36</sup> The July 1, 1915, edition of *Radio Stations of the United States*, published by the Bureau of Navigation, Department of Commerce listed the U.S. Army station at the Bureau of Standards with the call letters WUQ. The station was listed for Government service exclusively with no assigned "wave lengths" and no specified hours of operation.

- December 1922 "A conference of members of the staff was held regarding the proposed transmission of standard wave length signals. It was decided to transmit such signals as soon as possible, and it is expected that preliminary tests will be started early in January."<sup>37</sup>
- January 29-30, 1923 Preliminary transmission of standard frequencies was made to and received by about 30 observers located within 1000 miles of Washington, D.C. Previous arrangements had been made with these observers and reports were received from most of them.  
The fan antenna above the Radio Building was replaced with a T-antenna for transmission of the standard frequencies.
- February 1, 1923 Announcement was made in the February 1, 1923, issue of the *Radio Service Bulletin* that the first broadcast of standard frequencies by station WWV was scheduled for March 6, 1923.
- February 23, 1923 A news release of February 23 described the early project of transmitting standard frequency signals.<sup>38</sup>  
These early transmissions were intended to enable the radio inspectors of the Bureau of Navigation, Department of Commerce to keep their

<sup>37</sup> Quoted from the Monthly Report of Section 6, Division I, December 15, 1922. There appears to be no earlier record of any discussions or suggestions within the Radio Section on the transmission of standard frequencies.

<sup>38</sup> Dept. of Commerce News Release

RSO:MWB  
1-6

Radio Laboratory  
Bureau of Standards,  
February 23, 1923

#### BUREAU OF STANDARDS TRANSMITS STANDARD RADIO WAVE LENGTH SIGNALS

The Bureau of Standards at Washington, D.C., on January 29 and 30 conducted a preliminary series of tests which were preliminary to regular transmissions of signals of constant and known wave frequency or wavelength. The first such transmission will be on March 6. The transmission of such signals will make it possible for any person having suitable receiving equipment to calibrate his own wavemeter and transmitting and receiving equipment. The preliminary tests included the measurement of the frequency (wave length) of the signals transmitted from the radio laboratory of the Bureau of Standards on January 29 and 30 by thirty observers located within 1000 miles of Washington, and demonstrated the practicability of transmitting such waves.

These tests were conducted primarily for the purpose of ascertaining what would be feasible and desirable in the way of standard wave signals, that is, the range of wavelengths and the schedule for transmission. Another purpose was to obtain information as to the accuracy of wavemeters used by the various observers. From the information obtained, it appears that it is desirable to transmit standard wave signals after 11:00 o'clock p.m. (Eastern Standard Time) when broadcasting stations are through with their programs. The wavemeters of the observers were in general in fair agreement but some differences were as much as 7 per cent. It is desirable that wavemeters be in closer accord than this, and it is hoped that the system of standard wave transmission will have as a result the more accurate measurement and adjustment.

Standard waves will be transmitted from the Bureau of Standards on March 6 from 11:00 p.m. to 1:15 a.m., and will include wave lengths from 550 to 1500 meters. The detailed schedule of the March 6 transmission has appeared in the daily press, and in the February 1 issue of the *Radio Service Bulletin*.

The general call will be "QST de WWV Standard Wave Signals" repeated, and will be on the same frequency as the test signals. The standard wave signal will be the letters WWV repeated. In the announcements the wave length of the test signal will be stated. The general call and announcements will be made by both radio telephony and radio telegraphy. For the standard wave signal and for announcement by radio telegraphy, unmodulated continuous waves will be used.

Announcement of later transmissions on other wave lengths will be made in the press, and in the *Radio Service Bulletin*, a monthly periodical published by the Bureau of Navigation of the Department of Commerce. The transmissions planned for the immediate future will be on shorter wave lengths than those of March 6.

Department of Commerce Washington, D.C.

Note: The letters "QST" were and still are used as the abbreviation for a general call preceding a message addressed to amateurs and ARRL members. The French word *de* is used for the English word *from*.

wavemeters calibrated and to assist other users of radio transmitting and receiving apparatus such as radio communication companies, radio manufacturers, schools, laboratories, and radio amateurs.

The Radio Section was embarking on a means of disseminating the physical quantity frequency (the inverse of the base quantity of time) over a large geographic area and by a relatively simple means of observation. No other measurement quantity has been disseminated so widely and with such high accuracy. Truly, the Radio Section in 1923 was pioneering in what has proven to be a technological achievement of high merit.

March 6,  
1923

Standard "wave" signals were transmitted on several wavelengths between 550 and 1500 meters (545 and 200 kHz).

A 1-kW electron tube transmitter had been constructed for these standard frequency transmissions. Both code and voice were used to announce signals.

April 25,  
1923

Letter Circular 92 was published, entitled "Radio signals of standard frequency and their utilization."<sup>39</sup>

May-June  
1923

Standard frequency signals were transmitted on an approximately weekly schedule with announcements of transmission through the press and in the *Radio Service Bulletin* (published monthly by Bureau of Navigation, Department of Commerce). Accuracy of the transmitted frequency was quoted as being "better than three-tenths of one per cent." By now the term "wave-length signals" had given way to "standard frequency signals." The frequencies were extended in a range from 75 to 2000 kHz (4000 to 150 meters).

<sup>39</sup> This was the first of a long series of Letter Circulars to be prepared by the Radio Section on the utilization of the frequency and time signals transmitted by WWV. In more recent years this information has appeared in several forms of NBS publications, the latest being *NBS Special Publication 236* (yearly updated) entitled "NBS Frequency and Time Broadcast Services." It was preceded by *NBS Miscellaneous Publication 236* entitled "Standard frequencies and time signals from NBS stations WWV and WWVH," first published in December 1960.

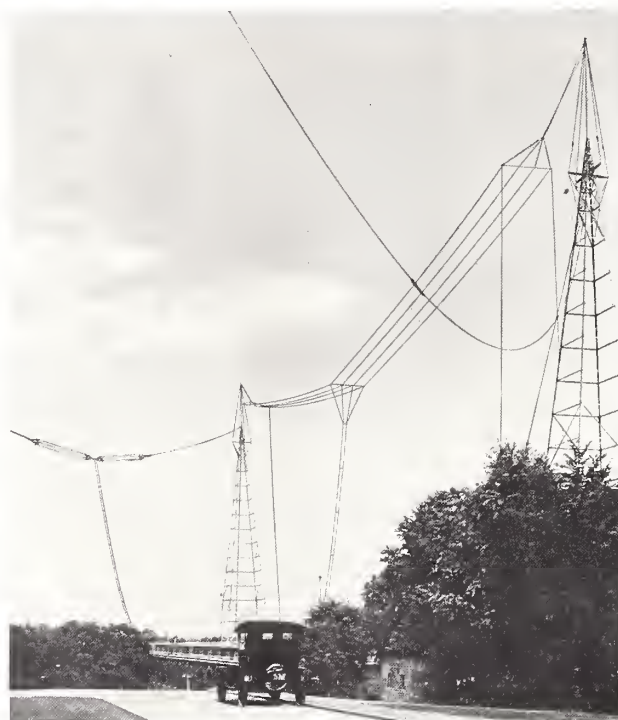

Antennas at Radio Building in 1923, used for initial operation of WWV. Flattop T-antenna, 200 ft long, with natural frequency of 750 kHz, served as radiator below 300 kHz. Small T-cage antenna, 80 ft long, operated with a counterpoise 10 ft above ground, with natural frequency of 1350 kHz, served as radiator above 300 kHz.

The frequency transmissions were produced by equipment largely developed by Hoy J. Walls.<sup>40</sup> After about a year's operation of the dissemination of standard frequencies from WWV, Walls published a detailed account of the equipment being used [22].<sup>41</sup>

- 1923 In the latter part of the year the Radio Section began an interesting project that was carried on for some time. A number of stations (broadcasting, commercial, military) were monitored frequently to observe the constancy of operation on their assigned frequency. The purpose of the monitoring was to determine the adequacy of various stations for utilization as standard frequency transmissions in addition to WWV. In the first published list of these stations (*Technical News Bulletin*, Nov. 10, 1923), seven stations met the qualification for adequacy. The average deviation from the assigned frequency was no greater than 0.3 percent.<sup>42</sup>
- 1924 Transmissions were scheduled at approximately 2-week intervals. Station WWV signals could be utilized throughout the eastern half of the United States. By now the frequency range was 75 to 6000 kHz (4000 to 50 meters).<sup>43</sup>  
On September 5 a standard frequency signal service was inaugurated at Stanford University, Palo Alto, Calif. over Station 6XBM to cover the western half of the United States. A crosscheck by three methods kept stations WWV and 6XBM operating on the same standard frequency within close tolerances. The transmission continued until June 1926, the entire effort being that of a voluntary service.
- 1926 Cooperative effort was made with the American Radio Relay League for standard frequency dissemination of the higher radio frequencies to 9000 kHz from Station IXM at the Massachusetts Institute of Technology.

---

<sup>40</sup> Hoy J. Walls entered the Radio Section on July 5, 1922 and transferred to the Bureau of Lighthouses on February 15, 1925.

<sup>41</sup> As an editorial note to this paper, it was stated by *QST* that:

Probably no radio station has ever rendered the American radio world so great a service as that of WWV in transmitting the standard wave signals. Before these signals began both broadcasting and amateur waves were uncertain and often wavemeters disagreed violently. Since the signals began those in the East have been able to make precision calibration on their own wavemeters and to pass the information on into the West.

The WWV transmitter, completed in February-March 1923, operated over a range of 75 to 2000 kHz at many preset frequencies, with calibration by comparison against a standard wavemeter of the LC type. The transmitter was the master-oscillator power-amplifier type, using a 50-watt vacuum tube in a Hartley circuit as the oscillator. The RF amplifier used four 250-watt tubes to give a power output of 1 kW. A modulator tube and speech amplifier provided for voice announcements.

A flat top T-antenna 200 feet long, with a natural frequency of 750 kHz served as the radiator below 300 kHz. The ground was 1000 feet of heavy copper wire (two turns) buried 6 inches in the soil in the form of a rectangle. A small T-cage antenna 80 feet long, operating with a counterpoise 10 feet above the ground, with a natural frequency of 1350 kHz, served as the radiator above 400 kHz.

The standard frequencies were heard as far away as England and Italy.

<sup>42</sup> In an article published in the July 1923 issue of *Radio Broadcast*, Dr. Dellinger commented on this method of disseminating standard frequencies by stating: "It seems quite certain that before long the ether itself will be a standard wavemeter with the frequencies of a number of the transmitting stations as its fixed points." This was a novel concept but the method was short-lived.

<sup>43</sup> The format of transmitted signals, using CW telegraphy and telephony, was an 8-minute period for each frequency. First came a "general call," including a statement of the frequency, for a period of 2 minutes. Then came a series of very long dashes, which was the standard frequency signal, with the call letters (WWV) intervening. This was followed by an announcement of the next frequency after which a 4-minute interval of silence ensued until the transmitter could be adjusted for the next frequency. Occasionally only code was used for the announcements to shorten the time of transmission. Eight frequencies were transmitted on any one evening which was a sufficient number to check the calibration of the wavemeter being covered on a particular evening. Transmissions began at 10:00 p.m. and continued for several hours.

Later, a similar arrangement was made with Station 9W1 operated by the Gold Medal Flour Co. in Minneapolis, Minn.

During the year the Bureau suggested discontinuing operation of WWV for dissemination of standard frequencies. Service by a number of stations monitored by the Bureau was available, piezo oscillators were being used, and other laboratories had come into existence for calibrating wave meters. But a flood of replies to the announcement indicated the desire of many institutions and individuals that the service by WWV be continued. The continued service from that time indicates its usefulness to the Nation.

January  
1927

A piezo (quartz) oscillator was used for the first time to control an operating frequency of WWV.

1927

A second receiving station was set up in Kensington, Md. (a suburban area to the north of WWV) to monitor transmitters serving as standard frequency stations. For more accurate measurement of these stations a piezo oscillator was used for the first time in the receiver. All frequencies were determined in reference to harmonics from the piezo oscillator.

It was in the spring of 1927 that the term "kilohertz" was introduced to the radio public by order of the Federal Radio Commission. The Bureau had been using the term for several years in its announcements over WWV.

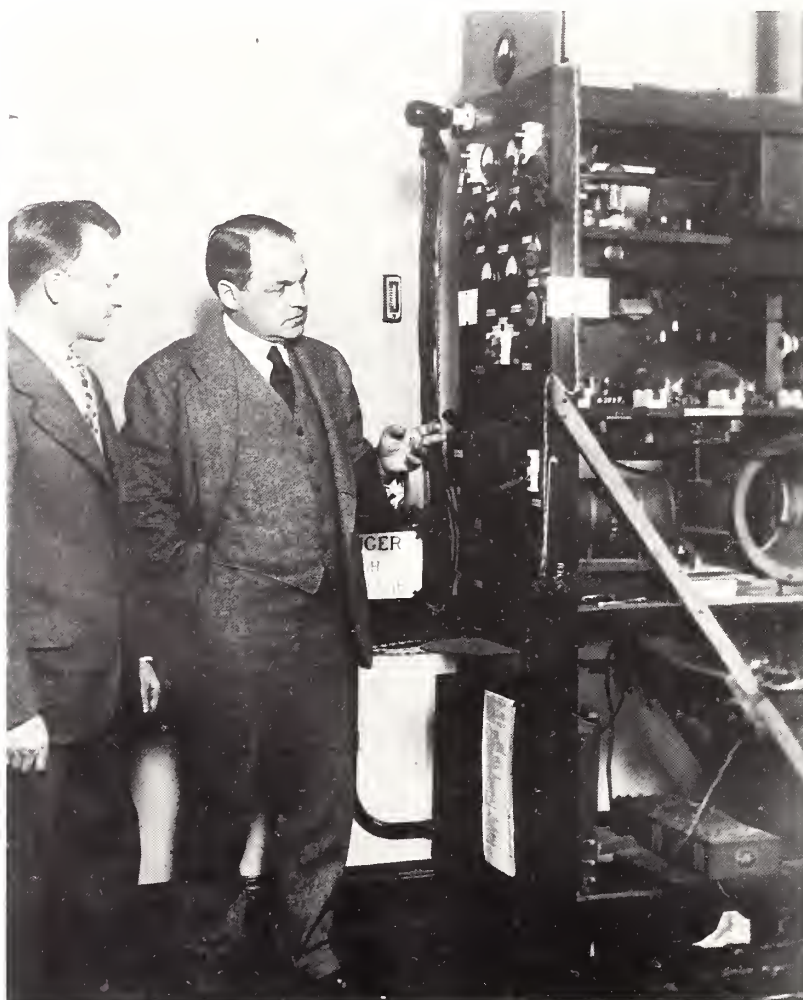

*Dellinger (left) explains operation of the WWV transmitter to Orestes H. Caldwell of New York City, a member of the newly organized Federal Radio Commission, on his first visit to the Bureau on March 17, 1927. The 1-kW transmitter was used during the early years of standard frequency broadcasts, beginning in March 1923.*

- January 1928      The monitoring of stations and the publishing of data of stations suitable for standard frequency signals were discontinued because of the extra load on the staff.
- March 1928      Frequencies of WWV were measured with harmonics of a temperature-controlled piezo oscillator but still checked with a working standard frequency meter (Type B Radio Frequency indicator, a one-point wavemeter).
- 1930            At the close of 1930 an 8-year period had ended with WWV located on the Bureau grounds in Washington. Those taking a major role in the design and operation of the station were M. S. Strock and H. J. Walls. F. W. Dunmore and E. L. Hall took part in some of the activity; Dellinger gave general direction to the project.
- January 1931      Standard frequency transmissions were begun from a new location at College Park, Md. (northeast of Washington, D.C.). The College Park site was being used for the aeronautical navigation projects of the section. Initially, a 150-watt transmitter operating at 5000 kHz was used. The frequency was controlled with a quartz crystal to an accuracy of a few parts in  $10^6$  of the designated frequency. Although several frequencies were transmitted, the multifrequency operation was later discontinued. By 1932 the power was increased to 1 kW and the accuracy of frequency control was better than 2 parts in  $10^7$ . The station was monitored from the Bureau site in Washington to check agreement with the primary frequency standard.



*Transmitting building of station WWV used for the broadcasting of standard frequencies from January 1931 to December 1932; located at College Park, Md., northeast of Washington, D.C.*

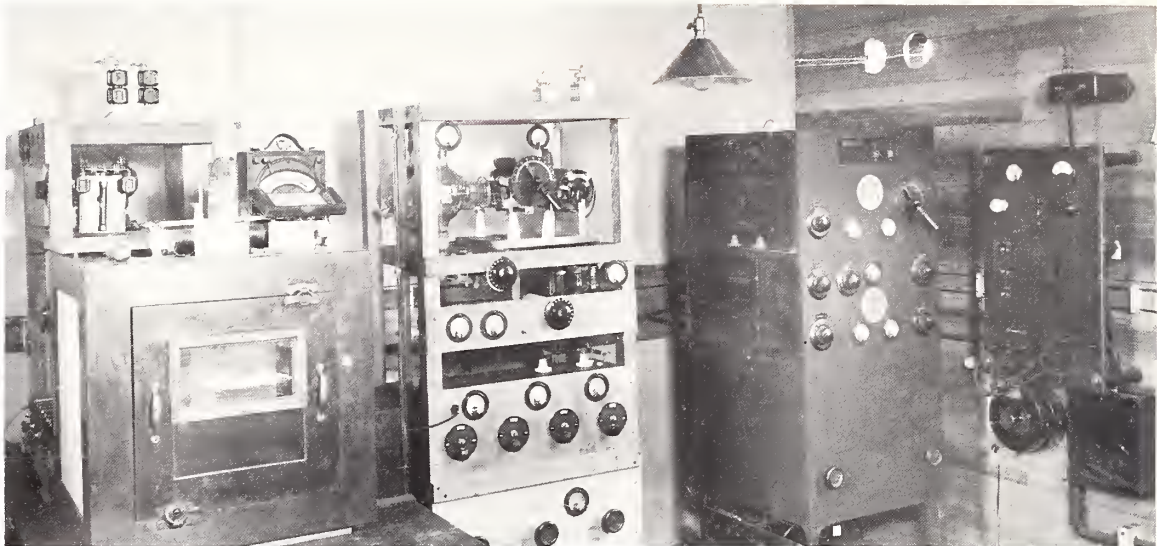

*Transmitting equipment of station WWV, College Park, Md.  
 Left front, temperature-controlled cabinet housing 200-kHz control piezo oscillator.  
 Left rear, 150-watt, 5000-kHz transmitter  
 Center, 1-kW 5000-kHz transmitter  
 Right, 1/2-kW multifrequency transmitter  
 Far right, switchboard*

- December 1932 The College Park transmitter was moved to a 25-acre site at the Experimental Farm of the Department of Agriculture at Beltsville, Md. northeast of Washington, D.C.
- April 1933 A new 30-kW transmitter was installed at the Beltsville location operating at 5000 kHz.<sup>44</sup> Regular service began on April 18. The former 1-kW transmitter was used as an emergency standby.
- February 1935 Regular transmission service at 10 and 15 MHz, with power output of 20 kW, was initiated on February 1 after a trial period. No night emissions were required on 5, 10, and 15 MHz as reception on one or more of these three frequencies was possible anywhere in the United States during the day.
- The accuracy of all three frequency transmissions was better than 2 parts in  $10^7$  at all times. Constancy of frequency during a transmission was within 4 parts in  $10^9$ .

<sup>44</sup>The new transmitter, designed by L. Mickey and A. D. Martin, was described in their paper on standard-frequency transmitters [23]. It is interesting to note from their paper the selection process by which the 5000 kHz operating frequency was chosen:

The advantages of a low or medium frequency were more than offset by the cost of the required installation, while broadcast frequencies were undesirable for obvious reasons. The choice, therefore, lay in the region above 1,500 kc/s. A study of transmission phenomena for day and night, winter and summer conditions showed that no single frequency would actually give universally satisfactory service. A frequency of 5,000 kc/s was chosen as the best compromise value, because of its usual lack of skip distance and yet its comparatively wide coverage, its relative freedom from interference with previously assigned stations, and its convenient integral relation with most frequency standards. The harmonic frequencies of 10,000, 15,000, and 20,000 kc/s were also chosen for future experimental purposes.

(Today WWV continues to operate at each of these four frequencies plus the harmonic, 25,000 kHz, and the subharmonic, 2,500 kHz.)

A 200-kHz temperature-regulated quartz oscillator frequency standard controlled the transmitter through a multistage harmonic amplifier and the 30-kW amplifier (frequency range of 4000 to 20,000 kHz).





Official inspection by Bureau personnel of transmitting building of station WWV, Beltsville, Md., August 8, 1932.  
Left to right:

<i>C. F. Keleher</i>	
<i>O. T. Meyer</i>	
<i>Clarence W. Elliot</i>	<i>Plant Division</i>
<i>B. F. Brandon</i>	
<i>Dr. Hobart C. Dickinson</i>	<i>chief, Heat and Power Division</i>
<i>Oscar L. Britt</i>	<i>chief, Plant Division</i>
<i>Dr. Lyman J. Briggs</i>	<i>director, Bureau</i>
<i>Dr. J. Franklin Meyer</i>	<i>asst. chief, Electrical Division</i>
<i>Dr. J. Howard Dellinger</i>	<i>chief, Radio Section</i>
<i>R. R. Chamberlin</i>	
<i>George H. Vaneman</i>	<i>chief, Purchase and Stores Section</i>
<i>Eugene C. Crittenden</i>	<i>chief, Electrical Division</i>
<i>Henry D. Hubbard</i>	<i>asst. to director</i>
<i>Elmer L. Hall</i>	<i>Radio Section</i>
<i>Samuel S. Kirby</i>	<i>Radio Section</i>
<i>M. Cox</i>	
<i>J. H. Courtney</i>	<i>Building and Housing Division</i>



*Transmitting building of station WWV used for the broadcasting of standard frequencies from December 1932 until destroyed by fire on November 6, 1940. This and other Radio Section buildings were located on the Experimental Farm of the Department of Agriculture, Beltsville, Md., northeast of Washington, D.C. Antennas and transmission-line feeders can be seen in the photograph.*

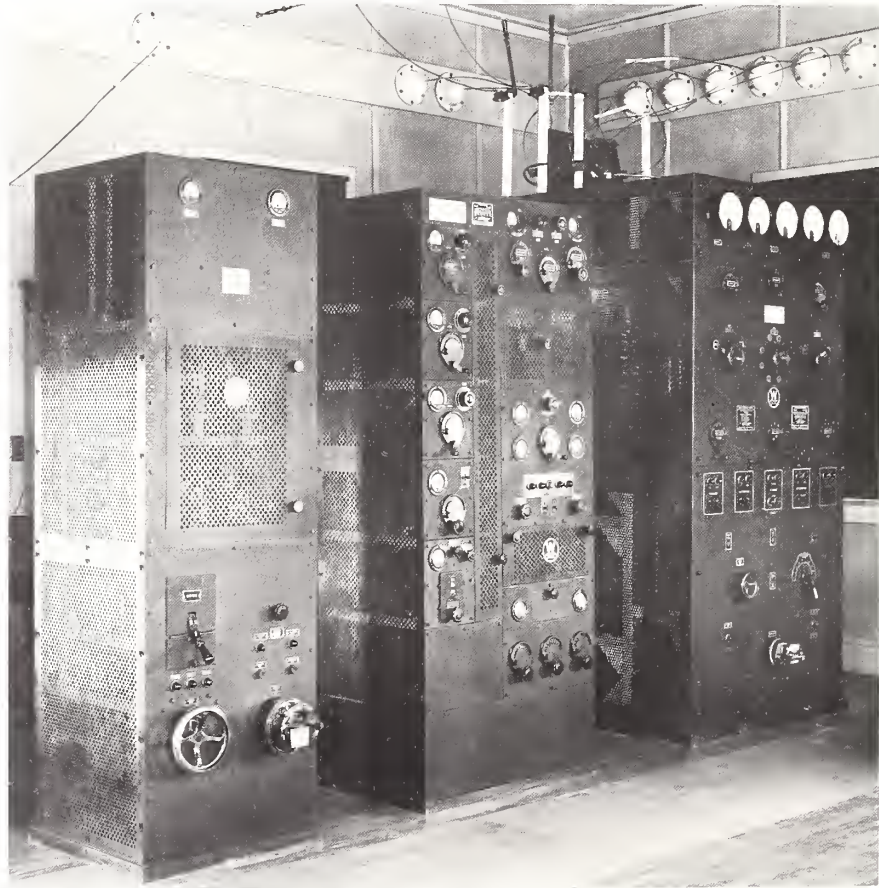

*Thirty-kW transmitter of station WWV, Beltsville, Md., 1932-1940.*

*Left to right: exciter rectifier, 1-kW exciter unit, 30-kW power amplifier. Control equipment was nearby; large power supplies were located underneath, in the basement.*

- October 1,  
1935      The first scheduled broadcast of the 1000-Hz modulation occurred on transmitted frequencies of 5000, 10,000, and 15,000 kHz. Some experimental broadcasts of 1000 Hz had been made as early as April 1935. The first broadcast of 1000 Hz was limited to 1 kW of sideband power but was increased in later years.
- 1936      Improvements in equipment and operating conditions provided an accuracy in the standard frequency transmissions of better than 2 parts in  $10^7$  at all times with an average of 4 parts in  $10^8$ .  
             In FY 1936 the Federal Bureau of Investigation requested NBS to conduct some radio telephony tests over WWV. Their purpose was to determine the feasibility of using one transmitter to cover the entire country for FBI purposes. Approximately 80 observation points in the country were used to monitor these tests. In addition, the section's receiving facilities at Meadows, Md. were used to monitor other transmitters around the country. Although there was some initial enthusiasm on the part of the FBI for the one-station coverage of the country, a final decision ruled out the system as it was unreliable for complete coverage of the country under all operating conditions. (See ch. VII, pp. 232-233.)  
             For a period before and during 1936, personnel associated with the Standard Frequency Dissemination project included W. D. George, E. L. Hall, V. E. Heaton, E. G. Lapham, and G. H. Lester. They were later joined by J. H. Shaul (1939).
- August 29  
1936      At the request of a number of musical organizations, the musical note A of 440 Hz (A above middle C) was broadcast for the first time on this date as a scheduled transmission. Some earlier experimentation paved the way for a regular schedule.<sup>45</sup>
- June 1  
1937      Beginning on this date, an expanded service was initiated that included 1-second pulses of high accuracy and the broadcasting of ionosphere information, plus the 440- and 1000-Hz frequencies that had been on regular schedule. For a period of time the 15,000-kHz frequency was dropped, being replaced with a 20,000-kHz transmission until May 1940.
- March 25-26,  
1939      W. D. George attempted to reflect 20,000-kHz signals from the Moon using a WWV transmitter at Beltsville, Md. He was unsuccessful but it was a pioneering effort to perform this feat.(a)(b)(c)(d) It was first successfully performed by the U.S. Signal Corps on January 10, 1946 (see ch. I, p. 20).(e)(f)

(a) A report (R113.410) for the Radio File on the Moon experiment was written by George on March 27, 1939. The report was accidentally found by the author (WFS) 4 years after the Radio File had been "sifted" through for useful material in preparation for writing this historical account. The accidental discovery of the report has revealed a pioneering effort associated with NBS that otherwise probably would never have come to light. There was no mention of this Moon experiment in the monthly reports or in the 1939 Annual Report of the Radio Section. W. D. George and Gordon Lester, the two staff members most closely associated with the development and operation of the WWV transmitters during the 1930's, have been deceased for a number of years. It is probable that George was moved to perform the Moon experiment because of Dellinger's suggestion of such an experiment in his paper published in the February 1939 issue of the *Journal of the Franklin Institute* entitled, "Some contributions of radio to other sciences."

<sup>45</sup> Under the subject of Standard Frequency Dissemination, the Monthly Report of August 1936 stated, in part:

Considerable testing, adjusting, and inspecting was done on the 50-watt three-frequency transmitter in preparation for the continuous broadcast of 440 cycles per second from Aug. 29 to Sept. 12.

The 440-cycle standard musical pitch was included as a five-minute broadcast over the National Broadcasting Co. stations in the Music Guild Program August 26. The broadcast took place from the Bureau's Radio Building. The standard frequency of 440 cycles per second was derived from a multi-vibrator from one of the standard 200-kc oscillators and was transferred by wire line to the N.B.C. network. During the broadcast, an explanation of its purpose and method, and also an announcement of the Bureau's broadcast from WWV Aug. 29-Sept. 12, were given by the Section Chief.

- (b) In order that the reader grasp the nature of this experiment as W. D. George experienced it, the full text of his report is given:

WDG:ANK

I-6

R113.6b

(later recoded to R113.410)

Radio Section,

National Bureau of Standards,

March 27, 1939

20,000 kc Radio Reflections from the Moon

At Beltsville on March 25 and 26 attempts were made to receive reflections of 20,000-kc radio waves from the moon. The experiments were made when the moon was in the first quarter and was passing through its highest overhead arc. The round-trip distance at that time was about 450,000 miles. From 3:30 P.M. to 5:30 P.M. on March 25 at approximately 15-minute intervals, short pulses were transmitted in groups of four to six. A sensitive radio receiver was used for listening on 20,000 kc. No reflections were heard; however, rain clouds were forming at the time, the local temperature was above normal, and radio noise high.

From 4:00 P.M. to 5:30 P.M. on March 26 the experiments were repeated using a more sensitive and selective receiving equipment, but no reflections were heard. There was considerable noise and a large amount of it, no doubt, was man-made. During the tests a strong carrier modulated at 60 cycles was on 20,000 kc a number of times.

The same antenna was used for transmitting and receiving; it was switched from one position to another in about 0.2 second. Adjustments were first made on a horizontal antenna about 1/2 wave length above ground with a reflector 1/4 wave length below the antenna. This antenna, in a north-south plane, was tipped about 15° to the south; measurements then indicated that the impedance match between transmission line and antenna was only slightly changed, about 3 percent.

A National receiver type HRO with a single-tube tuned pre-selector was used. Because of noise the full amplification was not used. The radio receiver was quiet without an antenna. On March 25 the radio receiver was used with its built-in CW oscillator adjusted for an audio-frequency output of about 1000 cycles. For about 5 minutes listening was done over a small band of frequencies about  $\pm 10$  kc. On March 26 an external heterodyne oscillator was used. This consisted of the 10-watt 10,000-kc transmitter in No. 2 building, its antenna removed. It was supplied with a frequency whose second harmonic was 2,001 kc. A 1000-cycle filter was used in the radio receiver's output. A very weak field of 20,000 kc in this way could be detected and greater stability resulted. The set-up was checked before and after each listening test by setting up a 20,000-kc field at No. 1 building which was just audible in the radio receiver.

Plate power input to the transmitter was 38 kilowatts; its output was approximately 20 kilowatts. The antenna gain of 4 to 1 would give a radiated power of 80 kilowatts in the direction of the moon. Direction of the beam was adjusted by sighting on the moon.

It is expected to repeat the experiment in the early morning hours a few weeks hence. A low noise level is then expected. An antenna having greater directivity could be tried.

Department of Commerce,  
Washington, D.C.

- (c) A rather puzzling aspect of this experiment relating to the equipment used is what was the method used by George in pulsing the high powered transmitter? This is not clear in George's report and pulse techniques were still in their development stages in 1939. In a telephone interview with Vincent E. Heaton (April 1, 1976), a member of the 1939 group responsible for standard frequency dissemination, Heaton recalled the event but stated that he did not take part in the Moon experiment. He had no knowledge of the pulse technique used. Heaton also stated that George was always eager to experiment with new ideas in equipment or in novel uses of equipment.
- (d) The written account of George's Moon experiment in 1939 was brought to the attention of Dr. Yardley Beers of the Time and Frequency Division of NBS, Boulder Laboratories. With much interest he calculated the signal power that George should have received from the Moon's surface based upon the information available from the written report. Considering a reasonable value for the noise power present in the receiver used, Beers concludes that George should have had a fairly good chance of detecting the reflected signal, especially so if George had persisted in repeating the experiment many times distributed over several days or a few weeks. Beers believes that with some encouragement by George's superiors, this experiment would have been successful and radio astronomy advanced by a number of years.
- (e) The team of John H. DeWitt, Jr. and E. K. Stodola of the U.S. Army Signal Corps at Evans Signal Laboratory, Belmar, N.J. reported on their successful Moon experiment at a frequency of 111.5 MHz in the March 1949 issue of the *Proc. IRE*.

Less than 1 year before the Signal Corps' success in detecting radio signals reflected from the Moon, Sir Edward Appleton had indicated that with a powerful transmitter and with transmitting and receiving antennas of high gain it would be possible to detect radio signals reflected from the Moon. This was asserted by Appleton in the "Thirty-Sixth Kelvin Lecture" delivered before the Institution of Electrical Engineers (London) on April 25, 1945. (See "The Thirty-Sixth Kelvin Lecture, 'The Scientific Principles of Radiolocation,'" by Sir Edward Appleton, *J. Inst. Electrical Engineers* (London), Vol. 92, Pt. I, No. 57, Sept. 1945, pp. 340-353.)

Author's note: W. D. George tried the Moon experiment 6 years before Appleton indicated the possibility of its success.

A complete account of the Moon experiment (known as Project Diana) performed by DeWitt and Stodola in 1946 was published 34 years later in the May 1980 issue of *Spectrum*. It is an interesting story in perseverance to reach a specific goal by hooking up a varied assortment of World War II equipment.

- (f) Twelve years after George's unsuccessful Moon-reflection experiment, on October 28, 1951, Sulzer and Montgomery of NBS, in cooperation with the Collins Radio Co., successfully relayed a continuous-wave 418-MHz radio signal from Cedar Rapids, Iowa to the NBS field station at Sterling, Va. using the Moon as a reflector. On November 8 they relayed successfully a modulated-wave signal with the message selected by Morse in 1844, "What hath God wrought," a message associated with a landmark in telecommunications history. The experimenters believed that this was the first successful Moon-relay at UHF and the first complete message to be received by Moon reflection. (See Peter G. Sulzer, G. Franklin Montgomery, and Irvin H. Gerks. "An U-H-F moon relay," *Proc. IRE Correspondence*, Vol. 40, No. 3, Mar. 1952, p. 361. Also, see "Lunar reflections of UHF communications," *Nat. Bur. Stand. (U.S.) Tech. News Bull.*, Vol. 36, No. 3, Mar. 1952, p. 35.)

November 6,  
1940 Station WWV was almost entirely destroyed by fire of an undetermined origin. Salvaged from the frame building was the standard frequency equipment located in the basement. With this equipment and a 1-kW transmitter, all housed in an adjacent building, WWV was back on the air at Beltsville on November 11 at 5 MHz without loss in accuracy of the standard frequency. However, announcements could only be made in telegraphic code. Second pulses and the 440-Hz frequency came later as well as a 15-MHz transmission.<sup>46</sup>

July  
1941 An act of Congress provided \$230,000 for a new standard frequency radio transmitting station.

August  
1941 A new site for WWV was selected 3 miles south of the former site at the Beltsville Research Station (formerly the Experimental Farm) of the U.S. Department of Agriculture. An unsuccessful attempt had been made to secure a site near Langley, Va., northwest of Washington, D.C.

January  
1943 While waiting for high-power transmitters, sufficient equipment had been moved into the new brick building such that transmissions could be made from the new quarters using new antenna systems. The exigencies of the war called for operating with blackout curtains.

<sup>46</sup> During the period of service of WWV at Beltsville there were several other interruptions in transmission ranging up to several hours duration, due to a variety of causes.



Entrance to grounds of station WWV, Beltsville, Md.; showing transmitting building and antennas.



*Entrance to station WWV, Beltsville, Md., April 1943, showing operating personnel.*

*Left to right: G. H. Lester (engineer-in-charge), E. C. Wolzien, W. D. George (head, standard frequency project), J. F. Kagle, T. E. Diedrich, J. M. Shaull, H. W. Bond.*

August 1,  
1943

Using the new 10-kW transmitters, broadcast services at a higher power were initiated at 5, 10, and 15 MHz, with provision for the 440- and 4000-Hz modulations, and the 1-second pulses.

Three 100-kHz quartz crystals were sealed in insulated boxes and kept in a concrete vault about 25 feet below the ground level. In this environment of nearly constant temperature and humidity, the crystal oscillators served as the source of standard frequencies for operation of WWV. Each could be used as the controlling frequency by remote switching.<sup>47</sup>

---

<sup>47</sup> Technical description of the WWV facilities that replaced those destroyed by fire appears not to have been published. However, in 1947 W. D. George published a rather detailed account of the broadcast services available by WWV [24].

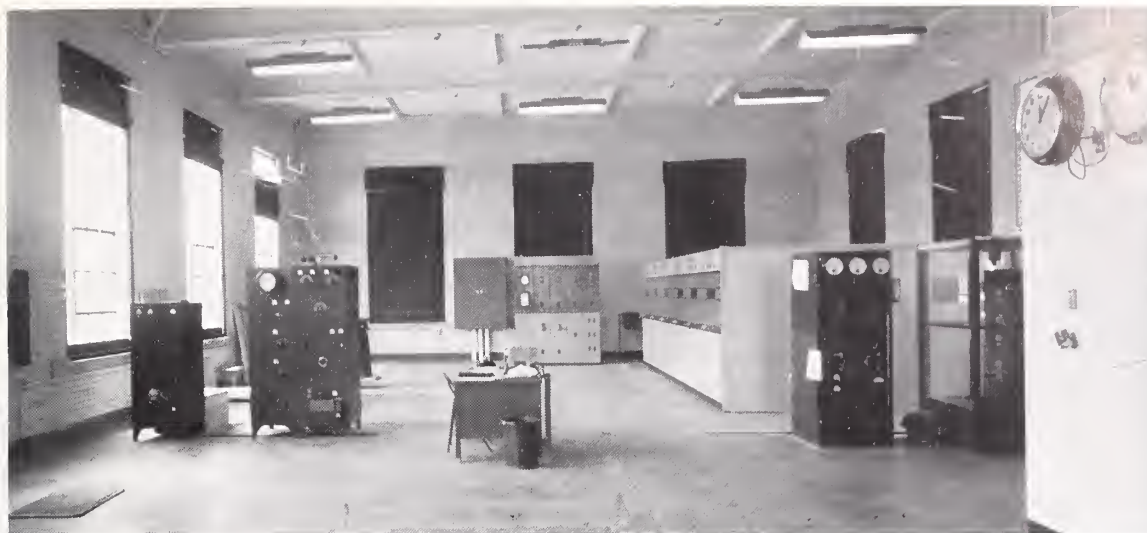

*Interior view of station WWV, Beltsville, Md., showing transmitter equipment. This building was used from January 1943 until broadcasting ceased on November 30, 1966, when the new WWV facility near Ft. Collins, Colo. began operating. Photographed April 1943.*

- February 1,  
1944      Transmission at 2.5 MHz began as a regular service using a 1-kW transmitter. This was primarily a service for evening coverage within 1000 miles of Washington, D.C.
- For the first time the 1-second pulse at the 59th second of each minute was omitted. Response from observers indicated the desirability in this change of format.
- June  
1944      The Superintendent of the U.S. Naval Observatory authorized the synchronization of the WWV time signals with those of the Observatory.
- October 2,  
1945      At 1530 hours on this date the automatic announcing equipment was placed in operation and the broadcast of standard time announcements was given at 5-minute intervals in telegraphic code.
- January 9,  
1946      Radio propagation disturbance warnings were initiated using equipment for automatically transmitting International Morse Code announcements at half-hour intervals.<sup>48</sup>
- January 11,  
1946      A conference between members of the staffs of the Naval Observatory and NBS resulted in the smoothing out of irregularities between the time announcements broadcast by the Navy Department. The Navy's time base was pendulum clocks, while the standard time signals broadcast by WWV were referenced to the group of quartz crystal oscillators.
- December  
1946      Transmitters operating at 20, 25, 30, and 35 MHz were put into operation. Assignments of modulation frequencies varied considerably among the transmitters. NBS now had seven transmitters in operation with 24-hours-a-day coverage of the entire United States plus many other parts of the world. Accuracy of the transmitted radio frequencies was now 2 parts in 10<sup>8</sup>.

<sup>48</sup> A warning service became available during World War II within the Radio Section (see ch. XI, p. 452) but transmission by WWV would have aided the enemy in determining the probability of reliable high frequency radio communications and radio direction finding for paths over the North Atlantic and continental U.S.

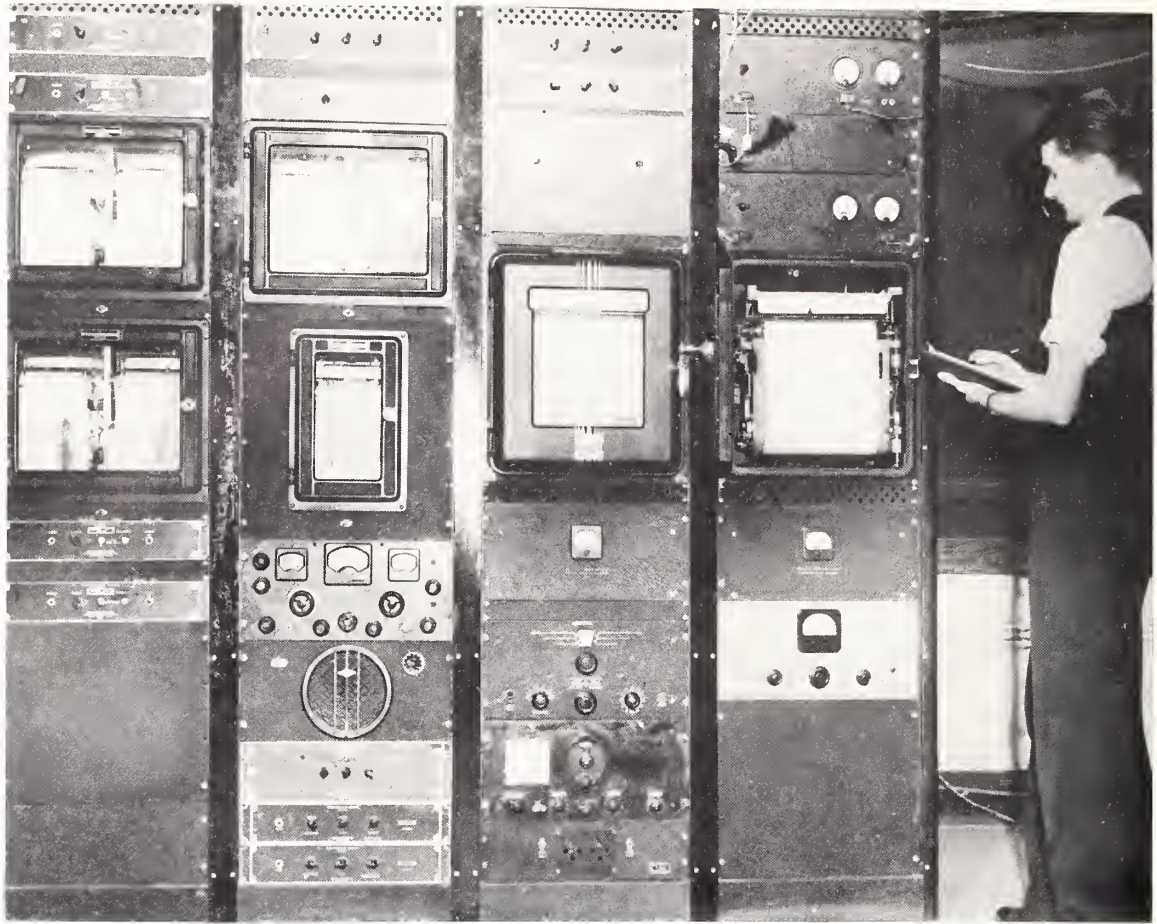

*Equipment in Radio Building on NBS grounds used for monitoring transmissions of WWV located at Beltsville, Md., 12.5 miles distant. Two instrument racks at right record the transmitted standard frequencies in terms of Primary Standard. Two racks at left record variations of field intensity at the Bureau site. Cecil M. Kortman taking data.*

November 22,  
1948

An experimental low-powered standard frequency station, WWVH, began as a continuous operation at Kihei on the Island of Maui, Territory of Hawaii. Transmissions at 5, 10, and 15 MHz with modulation of 440 Hz and 1-second pulses were initiated. Agreement in frequencies with transmissions by WWV was better than 2 parts in  $10^8$ . Synchronization of signals from WWVH and WWV was obtained by allowing for a 27-millisecond delay between Washington and Maui. This new station provided much better standard frequency coverage of the Pacific area [25].<sup>49</sup>

---

<sup>49</sup> Leo W. Honea was the first chief operator of WWVH and served in this capacity for a number of years.



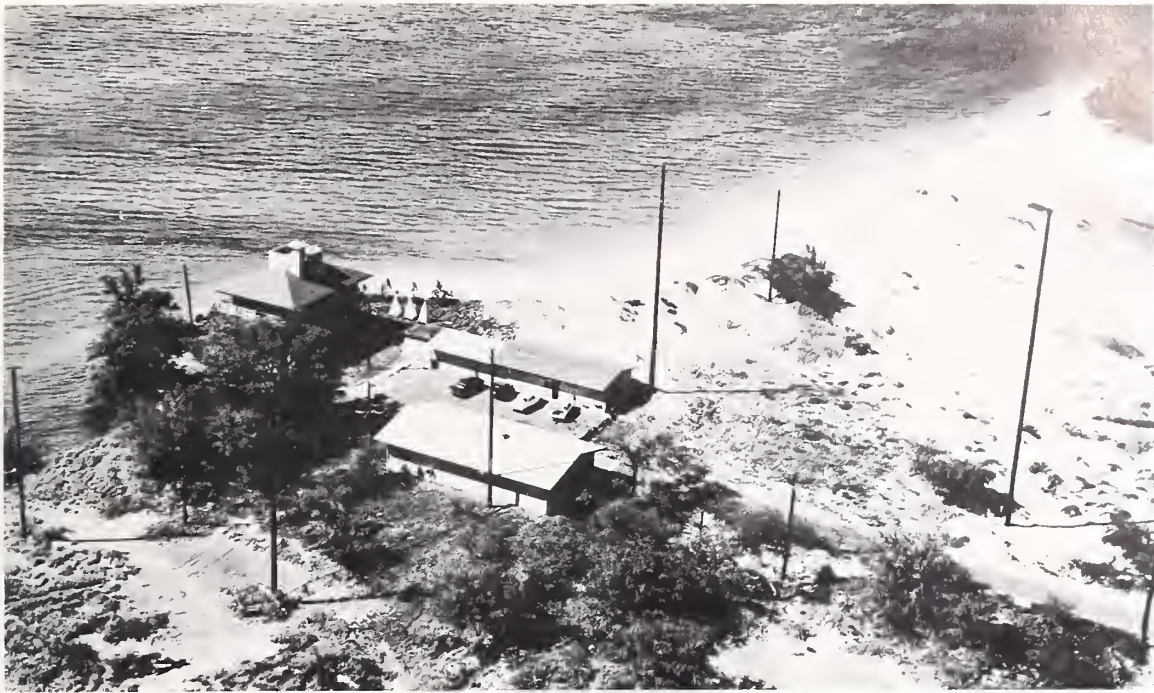

*A sea gull's view of station WWVH, located on the south shore of Island of Maui, Hawaii. This station, a counterpart of WWV to serve the Pacific region, operated from November 22, 1948 to July 1, 1971, when similar transmission operations were transferred to the Island of Kauai, Hawaii.*

- January 1,  
1950                    Voice announcements of standard time were initiated at WWV after 4 years of announcement by telegraphic code, with continuation of announcements at 5-minute intervals. The 4000-Hz modulation was discontinued in favor of a 600-Hz tone for several technical reasons.
- July 1,  
1952                    New short-wave disturbance forecasts of ionosphere conditions over the North Atlantic transmission paths were initiated on the WWV transmission. The quality of transmission, in terms of nine conditions of transmission ranging from "impossible" to "excellent," was stated in the 12-hour forecasts.
- January  
1953                    Transmissions at 30 and 35 MHz were discontinued.
- January 5,  
1954                    WWVH initiated a 12-hour forecast of radio propagation conditions over the North Pacific area.<sup>50</sup>
- June  
1954                    Two quartz crystals from the National Primary Frequency and Time Standard at Washington were transported by plane to Denver and then by automobile to the Boulder Laboratories. The remaining two quartz crystals were moved in October 1954.<sup>51</sup>

<sup>50</sup> Beginning early in 1952, the NBS Radio Propagation Field Station at Anchorage, Alaska initiated a program of forecasts of radio propagation conditions in the North Pacific and Alaskan areas.

<sup>51</sup> This was the first time that NBS had moved a National Standard (base or prototype) from the Washington location. (Twelve years later, on March 3, 1966, the platinum-iridium meter bar and the kilogram mass standard were moved from Washington to Gaithersburg, Md.)

In moving the frequency standard to Boulder, two of the four quartz crystals were hand-carried to the Washington Airport by A. H. Morgan and placed on the plane. J. M. Shoaf received them at Denver and hand-carried them to Boulder where he placed them in operation. During the next several months the two halves of the frequency standard were intercompared by means of radio transmission from WWV (controlled by the two crystals remaining in Washington). V. E. Heaton carried on the operation in Washington and Shoaf in Boulder. The transfer by plane of the two remaining crystals took place on October 11, 1954. Auxiliary equipment associated with the four crystals was shipped by truck. At no time was the Nation without a reliable National Standard of Frequency even though the two halves of the standard were separated physically by 1500 miles for several months.

The frequency standard in its entirety was of considerable complexity and is described briefly on pp. 257-258. It was replaced in 1957 by atomic frequency standards.

- July 7,  
1954
- Assessment by means of WWV transmission received at Boulder Laboratories began on the planned transfer of the National Standards of Frequency and Time Interval from Washington, D.C. to Boulder, Colo.
- 1954
- Single sideband transmitters were installed at WWV for the standard frequencies of 2.5, 5, 10, 15, and 20 MHz with transmission on the upper sideband.<sup>52</sup>
- Monitoring of WWV and WWVH at 5, 10, and 15 MHz from a receiving station at Gunbarrel Hill, Boulder, indicated that Doppler frequency errors existed to the extent of 3 or 4 parts in  $10^8$  at certain times. The effect is caused by the up and down movement of ionosphere layers. There was indication of need to provide transmission at much lower frequency in order to minimize frequency error due to Doppler effect.
- January 17,  
1956
- Improvements in equipment and mode of operation increased the accuracy of transmission on this date to 1 part in  $10^8$  for both WWV and WWVH. WWV was kept within 1 part in  $10^9$  and WWVH to 5 parts in  $10^9$  of the National Frequency Standard.
- The initiation of silent periods of approximately 4 minutes beginning 45 minutes and 15 seconds after each hour was accomplished by removal of carriers from antennas. Later this format of transmissions was changed.
- Time signals on both stations were kept in close agreement with the new uniform time, known as UT2, determined by the U.S. Naval Observatory at Washington and in Florida.<sup>53</sup>
- 1956
- A questionnaire survey conducted during FY 1956 on the value to the many WWV and WWVH users indicated the greatest use to be the standard radio frequency signals and the time signal portions of the broadcasts. A similar survey had been made during FY 1952. The value of the broadcasts was well stated in the *NBS Annual Report of 1958*.<sup>54</sup>
- July 1,  
1956
- Experimental station KK2XEI (later WWVB) began standard frequency broadcasts at 60 kHz from the Boulder Laboratories with a 2-kW transmitter (radiated power 2 watts). Observations at Harvard University and elsewhere indicated the usefulness of 60 kHz (a low frequency transmission) to minimize frequency error due to Doppler effect of the ionosphere. These standard frequency experiments were described in a *TNB* article [26].
- July 1,  
1957
- Broadcasting of Geolerts (solar and geophysical data) was begun as a service related to the International Geophysical Year. The Geolert service has continued to the present time.

---

<sup>52</sup> Considerable experimentation had indicated that single-sideband operation of standard frequency transmissions was feasible, with certain advantages to be gained, including spectrum conservation.

<sup>53</sup> UT2 (Universal Time) is determined from star transits and includes correction for both polar motion of the Earth's axis and seasonal variations of the Earth's rotation.

<sup>54</sup> To quote from the *NBS Annual Report of 1958*, p. 97:

The radio-broadcast technical services are widely used by scientific, industrial, and government agencies and laboratories as well as by many airlines, steamship companies, the armed services, missile research laboratories and contractors, IGY personnel, satellite tracking stations, schools and universities, numerous individuals, and many foreign countries. They are of importance to all types of radio broadcasting activities such as communications, television, radar, air and ground navigation systems, guided missiles, antimissile missiles, and ballistic missiles.

October 9, 1957	An atomic frequency standard (commercial type, checked with an NBS laboratory cesium beam standard) was used for the first time to observe the constancy of frequency transmissions from WWV and WWVH. <sup>55</sup>
1957 1958	Coded signals were transmitted twice each hour by WWV and WWVH to convey information to IGY (International Geophysical Year of 1957-1958) stations throughout the world.
June 1958	New quartz crystal oscillators for control of WWV and WWVH provided an operating frequency stability of 2 parts in $10^{10}$ for periods up to 1 day.
October 1958	Studies were initiated for establishing a VLF (Very Low Frequency) broadcast station of high power to disseminate frequency and time standards for worldwide coverage. <sup>56</sup>
January 1, 1960	Beginning on this date the NBS cesium beam frequency standard(s) was given a tentative value of 9 192 631 770 hertz. <sup>57</sup> On the same date the broadcast frequencies of WWV and WWVH were offset by $-150$ parts in $10^{10}$ from the Atomic Time to give a time scale in substantial agreement with the value of UT2 at that date. <sup>58</sup>
April 5, 1960	Scheduled operation began on the 20-kHz standard frequency station WWVL at an interim site at Sunset in Four-mile Canyon, northwest of Boulder. <sup>59</sup>
January 1961	The WWV broadcasts from Greenbelt, Md. were referenced in frequency to the NBS primary frequency standard through reception of the WWVL and WWVB transmissions and manual adjustment of the WWV oscillator on the basis of phase recordings. Improvements in precision of the WWV transmission became apparent soon thereafter.
1961	Early in the year the location name of WWV was changed from Beltsville to Greenbelt, Md. and the post office address was changed from Lanham to Greenbelt, Md. <sup>60</sup>

---

<sup>55</sup> Notice of using an atomic frequency standard as the reference for WWV and WWVH transmissions was given in the May 1958 issue of the *Proc. IRE*. Included with the notice was a table of deviations of the broadcast frequencies with respect to the U.S. Atomic Frequency Standard during several preceding months.

These deviation tables were published in the *Proceedings* for the next decade but were discontinued after the October 1968 issue. However, the format and kind of deviations changed through the years with the technical advances in equipment and measurement techniques. The information continues to be available in monthly *NBS Time and Frequency Bulletins*.

<sup>56</sup> The station would be located near Boulder, Colo. in an area of high ground conductivity to contribute to high efficiency of antennas. Such an area of 379 acres was located approximately 7 miles north of Ft. Collins to the east of the foothills, about 50 air miles distance from the Boulder Laboratories. The ground conductivity is exceptionally high due to the high alkalinity of the soil.

<sup>57</sup> In terms of one unit (second) of Ephemeris Time. See reference [74].

<sup>58</sup> For more detailed information on the generation and dissemination of time scales by NBS, the reader is referred to references [27-29].

<sup>59</sup> This pioneering effort in the transmission of a standard frequency at the very low frequency (VLF) of 20 kHz is described in considerable detail in a *TNB* article [30]. Although this installation radiated less than 15 watts of radio power, observations were made as far away as New Zealand. Accuracy of frequency measurement at several thousand miles was increased by more than a thousandfold above that of the transmissions from WWV. The frequency transmissions were monitored from Boulder by three different methods in terms of the NBS frequency standard.

Because of an entry of a new technical service into a frequency band of long-term usage and worldwide coverage, NBS had to negotiate with no less than three national and international groups to be permitted to operate at 20 kHz for standard frequency transmissions.

<sup>60</sup> In the late 1950's the expanding community of Greenbelt, Md. (of Great Depression fame) began to edge close to the site of WWV on the grounds of the Beltsville Research Station of the U.S. Department of Agriculture. NASA's Goddard Space Center was literally next door to WWV and finally became legal owner of the WWV site. For various reasons, but primarily because of a more central location and closer proximity to the Boulder Laboratories, it was better to move WWV to the new Ft. Collins site than to remain in the Washington, D.C. area.

October 28,  
1961

A new technique of controlling the accuracy of standard frequency broadcasts from a distant frequency standard was put into operation. By an automatic pulse-locking technique, the 20-kHz transmission from WWVL at Sunset was compared with the U.S. Frequency Standard at the Boulder Laboratories, approximately 11 miles air distance. A radio transmission link connected the two facilities. Being successful with this operational control, it was with confidence that the planned frequency transmission facilities near Ft. Collins could be frequency-controlled from the Boulder Laboratories with a very high degree of frequency stability (at least 2 parts in  $10^{11}$ ).



*View to west at Sunset in Four-mile Canyon, northwest of Boulder, with Continental Divide in distance. Across canyon was stretched a cable that served as the antenna for experimental transmission of standard frequency at 20 kHz. Scheduled operation of station WWVL began on April 5, 1960. Accuracy of frequency measurement at several thousand miles distance was increased by one-thousand-fold over broadcasts from WWV. In 1963 operation of WWVL began at the Ft. Collins, Colo. site.*

- 1962 NBS began construction of new LF and VLF antennas and transmitting facilities near Ft. Collins, Colo.
- April 24,  
1963 The time scale transmitted by WWV was brought into synchronization, within 5 microseconds, with the time scale at the Boulder Laboratories. This was accomplished by transporting a high-precision quartz clock between Boulder and the WWV transmitter at Greenbelt, Md.
- July 5,  
1963 Station WWVB began transmitting at the new Ft. Collins site after several years of operation at the Boulder Laboratories on a low-powered radiated signal. The 60-kHz transmission was phase-locked by a VHF radio servo-loop to the U.S. Working Frequency Standard (consisting of several commercial-type atomic frequency standards) located at the Boulder Laboratories, approximately 50 miles air distance. Stability of control of the transmitted frequency was about 2 parts in  $10^{11}$ . The transmitter was later replaced with one of 7-kW radiated power and later with one of 13-kW with an improved ground system.

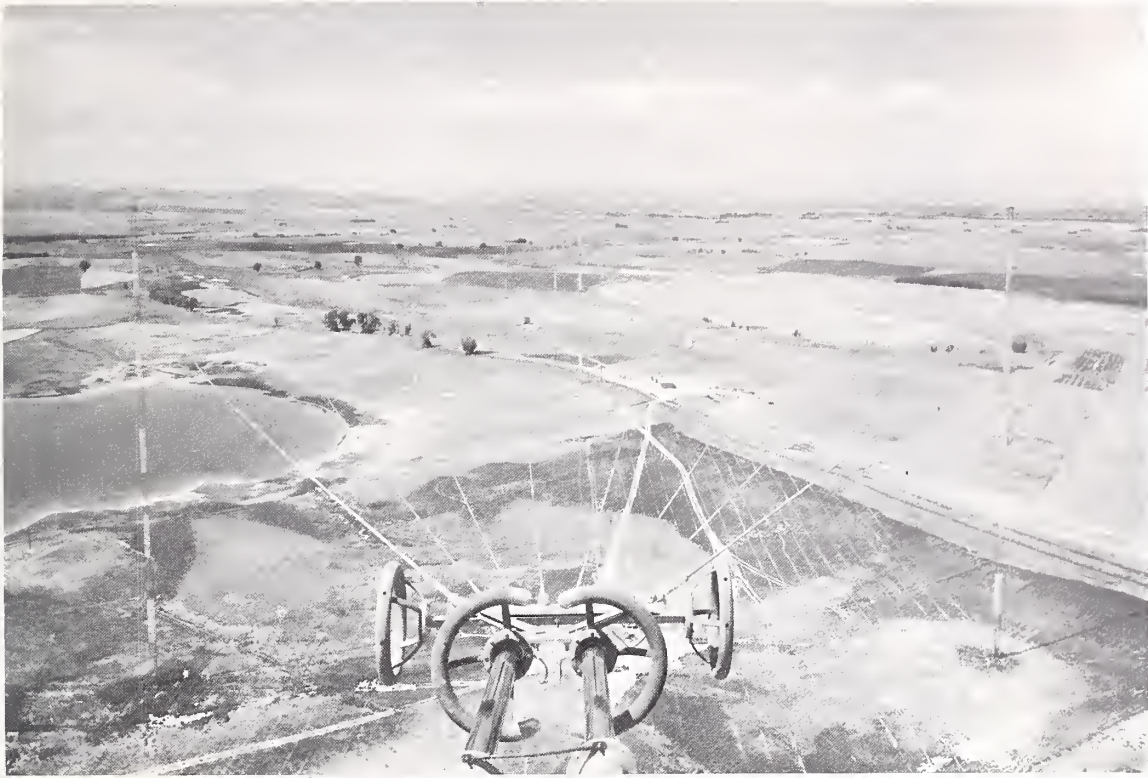

*View to northwest from 400-ft height at top of one of the masts supporting antenna array for station WWVB, near Ft. Collins, Colo. The 60-kHz transmitter is housed in building seen near center of picture.*



*Administration wing and building that houses the 60-kHz transmitter and associated equipment of station WWVB, located near Ft. Collins, Colo. Antenna masts of the WWVL station (operated at 20 kHz) are in background.*

August  
1963

NBS radio station WWVL commenced transmitting a 20-kHz standard frequency at the new site near Ft. Collins after several years of operating at Sunset, Four-mile Canyon, near Boulder.<sup>61</sup>

<sup>61</sup> The expanded facilities of WWVB and WWVL were dedicated on August 13, 1963, by Dr. Astin, director of NBS, at a technical session held at the Boulder Laboratories. The session was addressed by Dr. R. D. Huntoon, deputy director of NBS, who spoke on the subject of "The present status of national standards for the basic physical quantities." The address was followed by the presentation of five papers relating to technical features of the two stations and the use of low frequencies for frequency and time transmissions. The dedication ceremony was a special program of the Symposium on Ionospheric Propagation of Very Low Frequency Waves being held at the Boulder Laboratories.

Each of the two stations was fitted with a 50-kW transmitter with radiated output from the large antennas of 1 kW at 20 kHz for WWVL, and 7 kW at 60 kHz for WWVB. The antennas were designed by William W. Brown, an antenna expert and a retiree of the General Electric Co. For his contributions to the designs, Brown was awarded (in 1962) the Department of Commerce Silver Medal for Meritorious Service "for outstanding service in electronic engineering as required in the establishment of long-wave standard frequency broadcast stations." The two stations were controlled by the U.S. Atomic Frequency Standard at the Boulder Laboratories by a 100-mile round-trip servo-loop designed primarily by R. L. Fey of the Frequency-Time Broadcast Services Section.

As a portion of the dedication ceremonies, a bronze plaque and a large framed photograph were placed at the Ft. Collins site in memory of William D. George. George was killed in an automobile accident in Switzerland on February 12, 1963, while attending the Xth Plenary Assembly of the International Radio Consultative Committee (CCIR) at Geneva as a U.S. Delegate.\* For 33 years George had taken part in the radio work of NBS. In 1946 he was appointed chief of the High Frequency Standards Section and later served as acting chief of the Radio Standards Division for approximately 5 years. At the time of his death he was a consultant to the chief of the Radio Standards Physics Division.

George was posthumously awarded the Department of Commerce Gold Medal for Exceptional Service in 1964 "for long and distinguished service both internationally and nationally in the field of radio propagation and radio standards."

\*The W. D. George Memorial Award was established in 1963 to honor William D. George. The award is for the best undergraduate student project on instrumentation, in a specific year, related to the activities of the Institute of Electrical and Electronic Engineers. The award consists of a Certificate of Recognition and a monetary award.



*In August 1963, in preparation for the dedication of stations WWVB and WWVL, Dr. John M. Richardson (center), chief of the Radio Standards Laboratory, discusses potential coverages of the stations with Dr. L. Yardley Beers (left), chief of the Radio Standards Physics Division, and Alvin Morgan (right), chief of the Frequency and Time Dissemination Section*



*Portrait photograph and plaque in tribute to William D. George for placement at Ft. Collins, Colo. site of WWVB and WWVL. George was killed in automobile accident while attending an international meeting in Switzerland early in 1963. For 33 years he was associated with the frequency standards programs of NBS. This scene in auditorium of Boulder Laboratories at dedication of the two frequency standard stations, August 13, 1963. Left to right, Dr. John M. Richardson, chief of Radio Standards Laboratory; Dr. Robert D. Huntoon, NBS deputy director; Dr. Allen V. Astin, NBS director; Russell B. Scott, manager of Boulder Laboratories; Dr. L. Yardley Beers, chief of Radio Standards Physics Division.*

- July 1  
1964                      Voice announcements added to WWVH, Maui, Hawaii, for station identification and time (Hawaiian standard) every 5 minutes. Previously, time announcements were in code.
- January 1,  
1965                      The broadcasting of the international unit of time (atomic second) over WWVB as determined by the NBS cesium beam frequency standards was begun. For the first time NBS was broadcasting the national standards of frequency and time interval, as well as time signals, based on an atomic time scale, all controlled by the U.S. Frequency Standard [31].<sup>62</sup>
- July 1,  
1965                      NBS radio station WWVB began broadcasting a continuous time code through level shift of the carrier.

<sup>62</sup> On February 13, 1965, David H. Andrews, chief of the Frequency-Time Broadcast Services Section, was awarded the Department of Commerce Silver Medal for Meritorious Service "for significant improvement of frequency and time broadcasts." Andrews retired from NBS in January 1968. He was followed by Peter P. Viezbicke as chief of the section.

December 1,  
1966

The midnight hour of 0000 Greenwich mean time beginning the day of December 1, 1966, at 0 longitude was selected as the time to shut down WWV at Greenbelt, Md. and transfer the frequency and time transmissions to a site near Ft. Collins, Colo.<sup>63</sup>

At 7:00 p.m. Eastern Standard Time, November 30, 1966, WWV shut down its RF transmission at Greenbelt, Md. At this "zero hour" of 5:00 p.m. Mountain Standard Time, November 30, 1966, (0000 hours December 1, 1966 G.m.t.), a switch was thrown by Dr. H. M. Altschuler to initiate transmissions from the new WWV facility.<sup>64</sup> At the time, Altschuler was acting chief of the Radio Standards Laboratory. Approximately 80 guests had been invited to view the ceremony at the Ft. Collins site. Among the guests were two former engineers-in-charge of WWV, Gordon Lester and Frederick Sera, and also Leo Honea who was engineer-in-charge for the last 18 months of operation of WWV at Greenbelt. Richard F. Carle was the first engineer-in-charge of the new Ft. Collins WWV facility.

---

<sup>63</sup> To acknowledge the reception of "first day" signals from WWV at its new location, the Frequency-Time Broadcast Services Section mailed QSL cards to approximately 10,000 amateurs of the radio audience. To qualify for the First Day QSL card it was necessary to quote correctly the new WWV voice announcement and to have the report postmarked before December 2, 1966, local time. (Note: QSL is the abbreviation for "I acknowledge receipt of your message." As a question it means "Can you give me acknowledgement of receipt?")

A contest was sponsored for the design of a new QSL card to be used after the First Day acknowledgement. The first place award was given to Donald W. Valentine, an illustrator in the Institutes of Environmental Research, for his design motif "Indians giving way to settlers in the Ft. Collins area." The colonial setting of the earlier WWV had given way to a setting associated with the opening of the West.

<sup>64</sup> Of the six transmitters (plus two standbys) at the new facility, three were designed to radiate at 10 kW on 5, 10, and 15 MHz, and the other three at 2.5 kW on 2.5, 20, and 25 MHz. Frequency control of the transmitters came from three independent frequency generators, each including a commercial-type cesium beam atomic frequency standard. By HF radio link these generators were phase-referenced to the NBS Frequency Standard at the Boulder Laboratories; such comparisons were checked periodically by portable clock visits. The accuracy of the frequency transmissions in 1966 was 1 part in  $10^{11}$ . For more technical details see *NBS Technical Note 611* [32].



*Station WWV located at the NBS site near Ft. Collins, Colo., approximately 50 miles from the Boulder Laboratories. The new WWV station was placed in operation at 5 p.m. mountain standard time, November 30, 1966.*





*At the "zero hour" of midnight Greenwich mean time and 5 p.m. m.s.t., November 30, 1966 (0000 hours December 1, 1966, G.m.t.) Dr. Helmut M. Altschuler (acting chief, Radio Standards Laboratory) throws switch to signal initiating operation of WWV at NBS site, near Ft. Collins, Colo. Flash by nearby free-lance photographer momentarily blinded view by 80 spectators of the switching ceremony. TV cameraman at right. The final broadcast announcement of time and frequency signals from WWV, Greenbelt, Md. was received by a local receiver.*

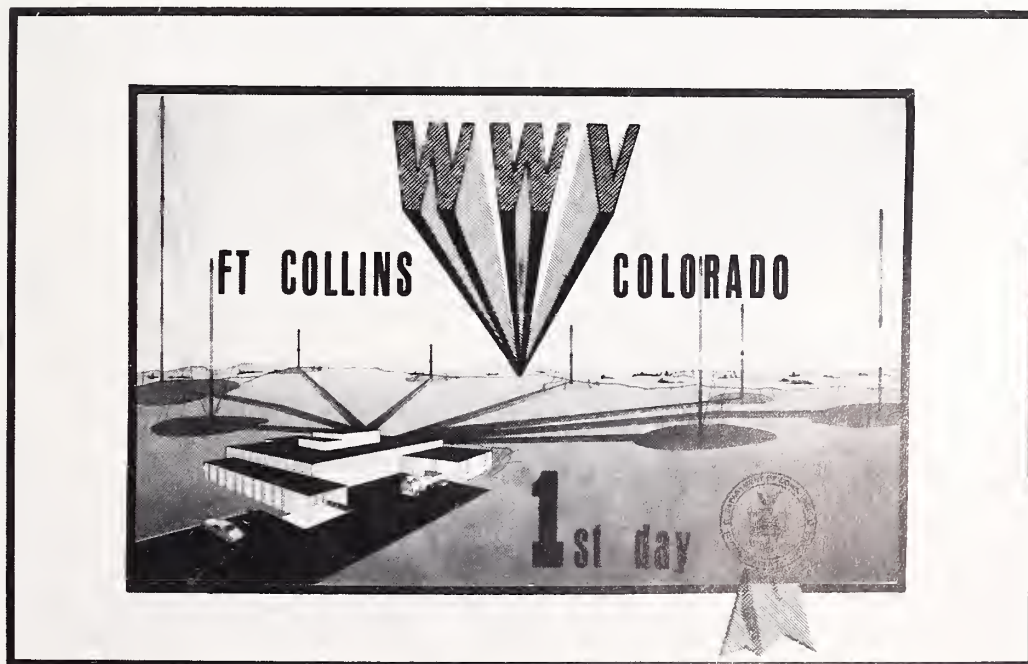

*First Day QSL card sent to listeners of initial broadcast of signals from station WWV located at NBS site near Ft. Collins, Colo. To qualify for card, the listener had to correctly identify the new voice announcements and have his mailed reply postmarked by midnight of the "first day."*



*New Signals from the Edge of the Rockies*

*Arapahoe Chief Niwot watched settlers take over his land a century ago. He marked time by the moon and signaled with smoke. Today, WWV's atomic-based frequency and time radio signals reach all points of the world.*

*QSL (I acknowledge receipt) card designed for use by WWV after relocation of station to new NBS site near Ft. Collins, Colo. Card was sent to listener acknowledging his reception of signals from WWV. The design motif is "Indians giving way to settlers in the Ft. Collins area."*



*Goodrid Hicks of the Frequency and Time Dissemination Section sorts the "mountains" of mail received after station WWV went on the air at the NBS Ft. Collins site on November 30, 1966. Approximately 10,000 amateurs of the radio audience reported correctly on the new WWV voice announcements and mailed their reports in time to qualify for First Day QSL cards.*

Beginning in 1928 and continuing to 1935 W. D. George was the engineer-in-charge of WWV.<sup>65</sup> From 1935 to 1950 Gordon H. Lester was the engineer-in-charge. Later Lester joined the Harry Diamond Laboratories in Washington, D.C. Frederick Sera was the engineer-in-charge from 1950 to 1964. Sera is now with the Office of Communications, Department of Commerce, Washington.<sup>66</sup> Leo W. Honea, formerly at WWVH, Maui, was engineer-in-charge of WWV from 1964 to the closing date on December 1, 1966. He is now retired.

An interesting and informative account of the installation at Ft. Collins and the NBS Time and Frequency program was published by Dr. Yardley Beers for the amateur radio periodical *QST* shortly after WWV was moved to Colorado [33]. At the time of writing Dr. Beers was chief of the Radio Standards Physics Division at the Boulder Laboratories.

- April 28,  
1967      The voice announcements on WWV and WWVH began using the time reference of the Greenwich meridian in England rather than the local time at each site.
- July 29,  
1967      WWV Day—July 29, 1967, was the day selected to recognize the achievements made by NBS in the dissemination of time and frequency standards via radio broadcasting. The day was featured at the Ft. Collins site with an address by the Honorable Gordon Allot, U.S. Senator from Colorado.
- August 1,  
1967      The International Amateur Radio Union awarded its "Worked all Continents" (WAC) certificate to WWV. Concurrently, the American Radio Relay League awarded its "Worked all States" (WAS) certificate. Normally, these certificates are awarded on the basis of two-way communication; these awards to WWV are unusual in that the communication is a one-way operation.
- 1968      Propagation characteristic studies of WWVB (60 kHz) and WWVL (20 kHz) transmissions indicated that significant improvement of the precision of timing signals could be achieved at distant receiving locations. Taken into account were phase fluctuations of the signals and correlation between signals from the two stations.
- May  
1968      The VHF radio continuous phase loop, used between Ft. Collins and Boulder, Colo. for comparing the broadcast master clock with the NBS clock, was replaced with a new television (TV) technique.<sup>67</sup>
- December  
1968      NBS began broadcasting HF time signals on the coordinated Universal Time (UTC) system as coordinated by the Bureau International de l'Heure (BIH), Paris, France (International Time Bureau).

---

<sup>65</sup> See footnote 61.

<sup>66</sup> In February 1962 Sera was awarded the Department of Commerce Silver Medal for Meritorious Service, the citation reading "for outstanding achievement and improvement of the continuous broadcast of technical radio services from Station WWV."

<sup>67</sup> This method was originally by Tolman, et al. in Czechoslovakia. Initially, horizontal sync pulses from Denver TV stations were used but were replaced in November 1969 by the line-10 horizontal sync pulse in the odd field of the vertical blanking interval. The Boulder and Ft. Collins master clocks can be synchronized to at least 30 nanoseconds [34].

July 1,  
1971

WWVH initiated transmissions from its new location near Kekaha on the Island of Kauai, Hawaii.<sup>68</sup>

<sup>68</sup>The older site of WWVH on the Island of Maui was being eroded by sea water and had to be abandoned. Also, the transmitting equipment of the late 1940's had reached a state of obsolescence.

The 10-kW transmitters operate at frequencies of 2.5, 5, 10, 15, and 20 kHz. Frequency control comes from locally based commercial-type cesium beam atomic frequency standards. These standards, in turn, are compared with the NBS Frequency Standard by phase-locked signals from WWVB, portable clock checks, and through U.S. Navy clocks via Loran-C measurements.

Charles L. Trembath, formerly of the Electromagnetics Division, was placed as engineer-in-charge of the new WWVH facility. Previously, Sadami Katahara had been engineer-in-charge of the transmitter at Maui. In 1966 Katahara received the Department of Commerce Bronze Medal for Superior Service "for continued, faithful, and competent performance as chief of the NBS field station at Maui, Hawaii."

The Silver Medal for Meritorious Service was awarded to Katahara in 1971 and was presented to him on August 24, 1971, by Assistant Secretary of Commerce James H. Wakelin at the dedication of the new WWVH station on the Island of Kauai, Hawaii. The citation read in part, referring to the former station on the Island of Maui: "The outstanding reputation of this field site is primarily due to the outstanding leadership of its Engineer-in-charge, Sadami Katahara. The excellence in engineering, planning, and organization provided by Mr. Katahara has resulted in optimum efficiency in providing the vital service of time and frequency. . . . He has coordinated the efforts of his own staff and other agencies in bringing about solutions to difficult problems. Mr. Katahara's constant willingness to assume additional duties for the U.S. Department of Commerce reaches far beyond normal requirements and expectations."



*The Bureau's standard frequency broadcasting station that serves the Pacific region is WWVH, located on the Island of Kauai, Hawaii. Operation began on July 1, 1971.*

- July 1,  
1971 At stations WWV and WWVH voice announcements of Greenwich mean time were made each minute instead of at 5-minute intervals. Also, audio tone of 500 Hz added to those of 440 Hz and 600 Hz, and Geoalerts and Propagation Forecasts were in voice instead of code. WWVH time announcements were given by a feminine voice, with a masculine voice at WWV.
- July 1,  
1971 Time-of-day live broadcasts via telephone were initiated by direct dialing of a Boulder, Colo. number (303-499-7111). By 1975 the calling rate was about 1 million calls per year.
- January 1,  
1972 A time-scale adjustment was made on transmission from WWV, WWVH, and WWVB such that the Coordinated Universal Time (UTC) system would be an integral number of seconds difference in respect to International Atomic Time (IAT), a base for the UTC system, as maintained by the Bureau International de l'Heure (International Bureau of the Hour), Paris, France. This action was taken at the recommendation of the International Radio Consultative Committee (CCIR).
- June 30,  
1972 The first "leap second" in history was made by WWV and WWVB at 6:00 p.m. Mountain Daylight Time, corresponding to 0000 hours Greenwich mean time on July 1, 1972. WWVH made a corresponding addition of 1 second to its time scale. The addition of 1 second to the UTC system was in accordance with the agreement with the International Radio Consultative Committee (CCIR) and was the first action taken after the initial adjustment for the new scale on January 1, 1972.<sup>69</sup>
- July 1,  
1972 NBS VLF station WWVL (20 kHz) transmissions were curtailed. This transmission was generally considered experimental and is available to broadcast VLF programs on an intermittent basis, depending upon needs and funds.<sup>70</sup>
- 1973 NBS observed the golden anniversary of WWV with 50 years of broadcasting of standard frequencies dating from March 6, 1923 [35]. Standard time announcements were to come more than 20 years later.
- Thanksgiving Day, November 22, marked the silver anniversary of WWVH, Hawaii, first on the Island of Maui, then in 1971 on the Island of Kauai.
- April 1,  
1973 Time-of-day telephone announcements were initiated from WWVH. This service accommodates the Hawaiian Islands. The calling rate in 1975 was about 200,000 calls per year.
- July 4,  
1973 Beginning of round-the-clock broadcasting by WWVB on its 60-kHz standard frequency plus standard time signals and time intervals.
- January 1,  
1974 Upon recommendation of the CCIR the long-used announcement of WWV and WWVH in Greenwich mean time (G.m.t. was changed to Coordinated Universal Time (UTC) on January 1, 1974). UTC designates, more precisely, the reference time scale maintained and disseminated by NBS for a number of years.

<sup>69</sup> An interesting and fairly extensive popular account of the first "leap second" can be found in the August 27, 1973 issue of *The New Yorker*.

<sup>70</sup> From its beginning in 1960, station WWVL located at Sunset in Four-mile Canyon near Boulder was operated on an experimental basis to determine its feasibility as a standard time and frequency broadcasting facility. Although showing relatively good success for frequency comparisons, time comparisons were more difficult and would require additional new VLF equipment at the Ft. Collins site. Even in its new Ft. Collins location, the radiated power of about 2 kW was quite limited in comparison with similar installations such as operated by the U.S. Navy. Advancing technology has brought on low frequency communication and navigation systems (Omega and Loran-C) which could serve well for the dissemination of standard frequency and time information.

- January 1,  
1975                   The fourth leap second in history (since the first at the end of the day of June 30, 1972) was added to Coordinated Universal Time (UTC), or the international time scale, to change the standard time signals of WWV, WWVH, and WWVB. The change occurred at Boulder Laboratories at 5:00 p.m. Mountain Standard Time, December 31, 1974, corresponding to 0000 hours January 1, 1975, at the Royal Greenwich Observatory, England (on zero meridian for time zones).<sup>71</sup>
- January 8,  
1975                   An extensive 4-month user survey was initiated to determine which services of WWV and WWVH could be modified with least inconvenience to the general public. Alternatives for operating these HF broadcasts would be based upon a government-wide effort to reduce costs and to conserve energy. The survey indicated that the voice time-of-day announcements are the most used services of the HF broadcasts [37].

<sup>71</sup>The fourth leap second differed from the previous three in that a change in the procedure was recommended by the CCIR in July 1974. The change consisted of a 0.9-second tolerance between UTC and UTI (astronomical time) time scales in place of the former tolerance of 0.7 second [36].

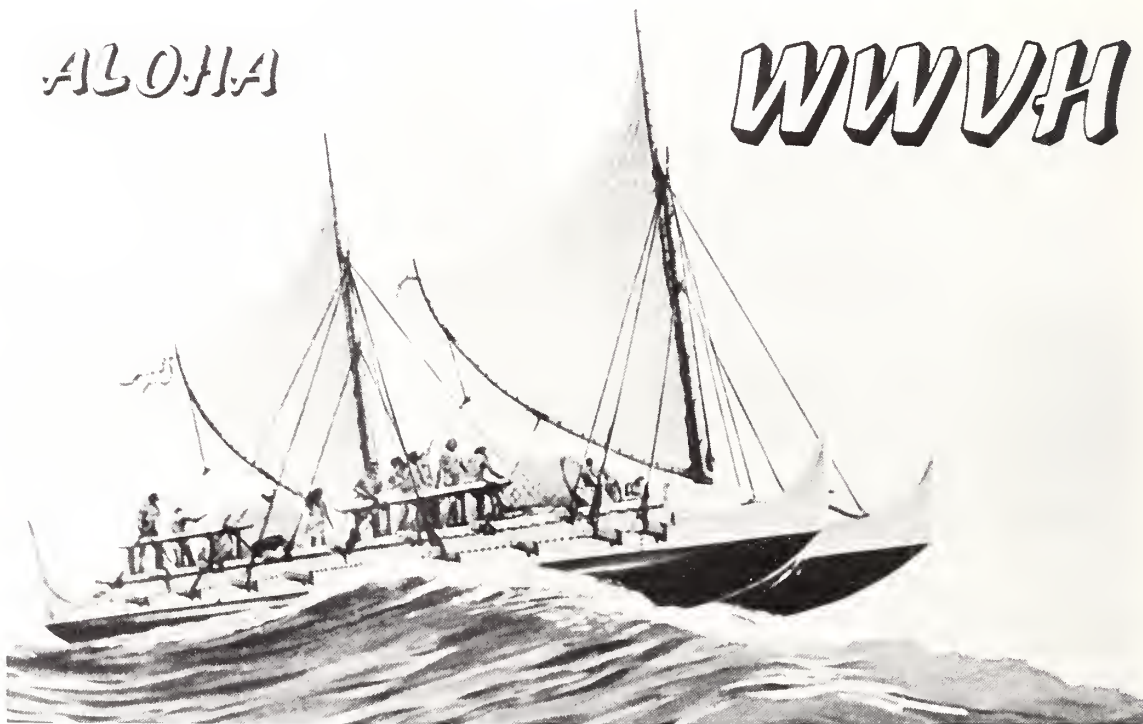

*QSL (I acknowledge receipt) card designed for use by WWVH, Kauai, Hawaii, in recognition of Hawaii's celebration of U.S. Bicentennial. The card honors Bicentennial voyage of a Polynesian voyaging canoe that sailed from Hawaii to Tahiti in 1976 without modern navigational aids. The voyage was sponsored by the National Geographic Society and private individuals. Illustration was furnished by Polynesian Voyaging Society. Card (in color) was sent to listener acknowledging his reception of signals from WWVH. (David Lewis, "Hokulēa' follows the stars to Tahiti," National Geographic Mag., Vol. 150, No. 4, Oct. 1976, pp. 512-537.)*

## Sequel to the WWV Story

Advanced technology has revealed that it is possible to disseminate time signals with very high accuracy by methods other than by direct transmission to the user from a specialized broadcasting station. Also, systems exist (or can be modified) other than the WWVL transmitter (now discontinued as a regular VLF transmitter) by which standard references can be disseminated at VLF or higher frequencies.<sup>72</sup>

### 1. The synchronization of time and frequency signals

The synchronization of time scales and of time signals has been carried on successfully by NBS since 1963 by physically transporting a crystal clock or atomic frequency standard from one location to a distant location. For synchronization by comparison on a continuous basis, a phase-lock system was used via radio transmission between two locations. Each of these systems supplements the other for check on the accuracy of synchronization. Nevertheless, they are independent methods and the "traveling clock" can suffice without radio transmission in a synchronizing process [38]. Although moving a portable atomic clock from one location to another as a comparison method yields high precision, it is an expensive and time-consuming operation.

Within recent years there has been a growing need for the synchronization of timing systems controlled with the precision of atomic clocks. These systems range from two-station coordination to scattered worldwide systems. Vagaries of transmission, due primarily to irregular skywave reflections, place limitations on the radio method of synchronization. This was true even for the relatively short-distance use of the closed-loop phase-locked servo-system formerly used via VHF signals between Boulder and Ft. Collins, Colo.

#### a) SYNCHRONIZATION VIA SATELLITES

During a 10-day period in June and July 1967, NBS was successful in synchronizing precision clocks (portable-type crystal and cesium beam to 5 microseconds) at several widely separated locations (Barstow, Calif. and Maui, Hawaii; Barstow and Boulder, Colo. This was accomplished by using a VHF satellite transponder (reception at 149 MHz, transmission at 135 MHz) operating on the NASA Applications Technology Satellite (ATS-1)[39].

More recently, beginning in August 1971, the Frequency-Time Dissemination Research Section engaged in a 2-year program of determining the advantages that might be gained in broadcasting time and frequency signals from a satellite stationed at a fixed position above the Earth's equator (geostationary). After various considerations of antennas and receivers and programming of information, successful experiments were carried out with the transmitter at Boulder Laboratories and receiving stations located at Boulder and Massachusetts in the United States and at observatories in Peru and Brazil. A transponder on the NASA ATS-3 satellite received the 149-MHz signal from NBS Boulder and retransmitted the information at 135 MHz. Coverage of the signals retransmitted from a location about 35,000 km above the equator included the North and South American Continents, much of the Atlantic and Pacific Oceans, and portions of Europe and Africa totaling about 40 percent of the Earth's surface with line-of-sight propagation. This contrasts with the WWV and WWVH high frequency signals which, besides being limited by noise and propagation vagaries, cover only 10 to 15 percent of the Earth with equal reliability.

Programmed information relayed over the system contained voice announcements of time-of-day and position of satellite, second ticks, 1-kHz frequency-modulated signals, and a time code based on the NBS time scale. The 15-minute program was relayed twice a day, 5 days a week. Time delay, from the NBS master clock (UTC) to the receiver or user's clock, was approximately one-fourth second with a time accuracy of several milliseconds [40,41].

---

<sup>72</sup> Omega is a VLF navigation system presently designed for the basic frequency of 10.2 kHz using the hyperbolic mode of navigation. Eight transmitters located at fixed points will enable global navigation. Completion of the system is expected by late 1976 with the exception of one transmitter. The system is quite adaptable to the dissemination of precise time and of a standard frequency as atomic oscillators are used for frequency sources.

Loran-C is a navigation system operating with pulsed modulation on a carrier frequency of 100 kHz, using the hyperbolic mode of navigation. Unlike Omega, it is more susceptible to terrain effects and sky-wave transmission because of the higher frequency. The system is quite adaptable to the dissemination of precise time and a standard frequency.

There was ample evidence that some features of the system were superior to WWV and WWVH transmissions and certainly it could supplement the services of these two stations. There also was optimism that accuracy of measurement could be substantially increased.

Engaged in the 2-year satellite program were D. Wayne Hanson, Wallace F. Hamilton, and Alvin J. D. Clements.

#### b) SYNCHRONIZATION VIA TV TRANSMISSION

Among the several methods of accurately disseminating time information today is a relatively simple and quick method developed and tried in Europe in 1964, that of utilizing the synchronizing pulses of an existing television system (incorporating microwave relay links) to compare precision clocks.

The Frequency-Time Dissemination Research Section commenced extensive study of synchronization via TV signals for adaptation to NBS systems [42]. From May 1968 until December 1969 the master clock (operated from a local cesium beam standard) for WWV was compared daily with the UTC (NBS) clock at the Boulder Laboratories by using the horizontal synchronization pulses from a nearby TV station as the transfer standard. Since December 1969 the daily clock comparisons have employed a refined procedure using the line-10 horizontal sync pulse in the odd field of the vertical blanking interval from Denver TV stations. Synchronization of WWV time signals to at least 30 nanoseconds is obtained by this procedure, a marked advance over the earlier methods used.

For additional information on the synchronization and dissemination of time signals by television see NBS publications [43-45].<sup>73</sup>

A service of interest to users of frequency standards became available in 1974, that of several methods of calibrating frequency standards and oscillators via live color TV programs. The service comes from a rubidium frequency standard at the originating studio of each of three major television networks that is measured at NBS Boulder with respect to the rate of the NBS Atomic Time Scale, AT(NBS). One method yields an accuracy of frequency measurement of 1 part in  $10^{11}$  over a 15-minute observation period [46].<sup>74</sup>

Today, no special receiver is necessary to tune in on WWV. The time signals can be received on the nearest telephone anywhere in the continental United States ("Lower 48" or contiguous states). This service out of Boulder, Colo. from a direct line to the station at Ft. Collins became available on September 10, 1970, although publicly announced later (July 1, 1971). The signals include a voice announcement of Greenwich mean time (now UTC) every minute, 1-second time intervals, standard audio-frequency tones, and special announcements of interest to radio operators, geophysicists, and navigators. A time-of-day service also became available from WWVH in April 1973.

---

<sup>73</sup> For a recent and extensive coverage of the generation, dissemination, and applications in the domain of time and frequency, the reader is referred to a special issue on the subjects in *Proceedings of the IEEE* [47]. J. L. Jespersen, B. E. Blair, and L. E. Gatterer of the Frequency-Time Dissemination Research Section served as guest editors.

A selection of NBS papers of considerable interest relating to the radio dissemination of standard frequencies and time signals will be found in *NBS Special Publication 300 (Precision Measurement and Calibration)*, Volume 5, entitled "Frequency and Time."

More recently, an NBS Monograph of a tutorial nature under the editorship of Byron E. Blair was published in 1974 that gives extensive coverage to time and frequency subjects [48]. In addition to NBS authorship, several outside authors were invited to participate in the writing of this informative volume.

<sup>74</sup> Dicky D. Davis of the Time and Frequency Service Section has been the principal investigator in the TV timing project. On November 6, 1975, Davis received the NBS Applied Research Award "for the development of novel time and frequency dissemination methods, equipment, and services using existing nationwide television signals." The award was established in 1975 to recognize superior achievement in the practical application of the results of scientific or engineering research. Davis was the first recipient.



# NATIONAL BUREAU OF STANDARDS FREQUENCY AND TIME FACILITIES

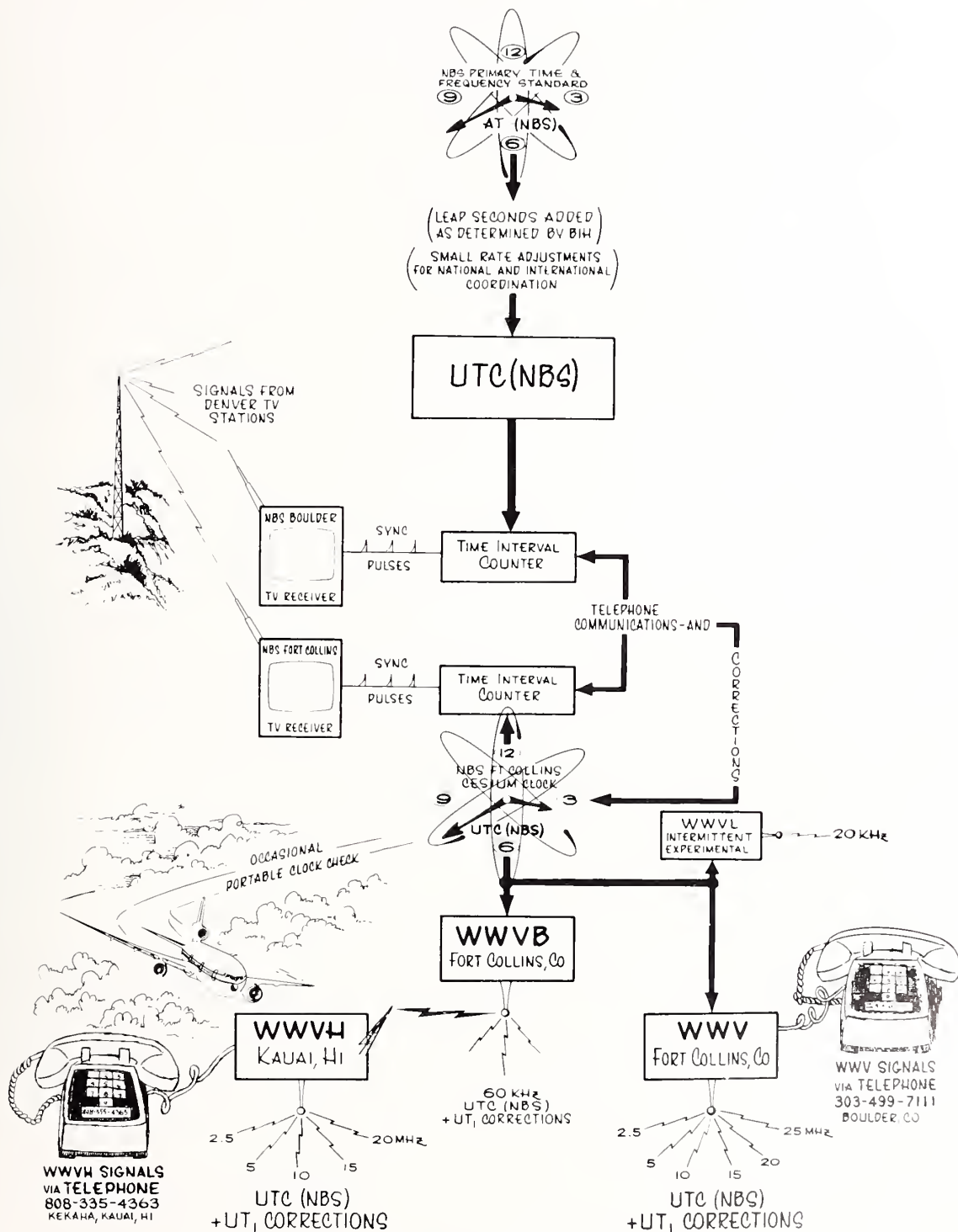

*Relationship (December 31, 1975) between the NBS Frequency Standards and the NBS broadcasting and dissemination of standard time and frequency, initiated May 1968 and later improved. Time of day from WWV signals via telephone were initiated July 1, 1971; from WWVH signals were initiated April 1973.*

## 2. On duty with WWV

Beginning with the formation of the Central Radio Propagation Laboratory in 1946, WWV was operated by the High Frequency Standards Section under the general supervision of W. D. George, chief of the section. With the formation of the Radio Standards Division after the move to Boulder, Colo. in 1954, the Radio Broadcast Service Section was organized within the division with Alvin H. Morgan as chief. Although located near Washington, D.C., WWV was supervised by this section from the Boulder Laboratories. The same was true of the Hawaiian station WWVH. Early in 1962 the section became a part of the newly formed Radio Physics Division (later to be known as the Radio Standards Physics Division) with Morgan continuing as section chief.

In 1963 operations of the Radio Broadcast Service Section were divided among two newly formed sections, the Frequency-Time Dissemination Research Section, with Morgan as chief, and the Frequency-Time Broadcast Services Section, with David H. Andrews as chief. The latter section had responsibility for operating stations WWV and WWVH and later the added stations WWVL and WWVB. The time and frequency programs became a part of the new Time and Frequency Division in September 1967 and included the two sections mentioned above. James A. Barnes was appointed division chief, and Morgan became a consultant to the chief of the Division.<sup>75</sup> After the retirement of Andrews on January 15, 1968, Peter P. Viezbicke became chief of the Frequency-Time Broadcast Services Section with general supervision of the Ft. Collins and Hawaii facilities. James L. Jespersen became chief of the Frequency-Time Dissemination Research Section.

As facilities at the Ft. Collins site became operative in 1963, Richard F. Carle was designated as engineer-in-charge and served in this capacity until October 1969.<sup>76</sup> John T. Stanley became engineer-in-charge, after entering the Bureau on June 19, 1969, until October 1974 when he was assigned as project leader for automation of NBS broadcast stations controlled by the Time and Frequency Division. The duties of engineer-in-charge then were taken over by John B. Milton. On January 1, 1975, the Frequency-Time Dissemination research Section and the Frequency-Time Broadcast Services Section were combined as one section in the Time and Frequency Division with the title Time and Frequency Services Section. Roger E. Beehler was appointed chief of this new section with combined responsibilities of the previous two sections; James Jespersen became a consultant to the division. In August 1975, Peter Viezbicke was transferred to station WWVH, Kauai, Hawaii to aid in antenna modification and the automation of this HF broadcast station.

Others associated with the Frequency-Time dissemination Research Section in recent years are: Byron E. Blair, Dicky D. Davis, R. Lowell Fey, Lawrence E. Gatterer, Wallace F. Hamilton, and George Kamas.

## ATOMIC FREQUENCY AND TIME STANDARDS<sup>77</sup>

The concepts of utilizing the resonances of atoms and molecules as frequency and length standards in terms of recent electronic technology have existed only within the past several decades. However, it is interesting to note that Lord Kelvin proposed the use of atoms as fundamental natural standards nearly a century ago [49]. It was at Clerk Maxwell's suggestion that Lord Kelvin proposed the use of the vibrational states of hydrogen and sodium atoms as natural standards of frequency and length (wavelength).<sup>78</sup>

---

<sup>75</sup> Alvin H. Morgan retired from NBS on December 28, 1968.

<sup>76</sup> Richard F. Carle entered August 18, 1963, and resigned from NBS on January 17, 1970.

<sup>77</sup> This account of the development of frequency and time standards covers the period through 1974, although the program continued to be very active thereafter.

<sup>78</sup> It is most interesting that the cesium atom (a member, along with sodium, of the alkali metal family) was the first element to be used in an atomic beam frequency standard in 1952 and the hydrogen atom in a hydrogen maser as a frequency standard in 1960. The world had to wait approximately 75 years before Lord Kelvin's proposal came into being as an atomic frequency standard.

## 1. The world's first atomic clock<sup>79</sup>

The first atomic clock—based upon a frequency standard using the strong ammonia absorption line—had its origin in the field of microwave absorption spectroscopy.<sup>80</sup> The 3.3 inversion frequency of ammonia was reported by Cleeton and Williams of the University of Michigan in 1934 as the first experimentally observed microwave spectrum line. Their apparatus was crude by present-day standards and it was not until after World War II that a large variety of microwave equipment became available that would provide the means of making microwave spectra useful for many purposes. During the period of 1947-1948 several groups of investigators reported on the experimental frequency stabilization of klystrons with a spectral line (ammonia). It would now be a significant step forward to achieve the inverse (time rather than frequency), that of stabilizing a clock to a sufficient degree that the device would surpass all former clocks in accuracy of timekeeping. Such a device could truly be called an "atomic" clock. Early in 1948 Dr. Harold Lyons, chief of the Microwave Standards Section, and several of his coworkers initiated an experimental study of the 3.3 absorption line of ammonia for use as a frequency standard. This would be accomplished by the application of microwave techniques. On April 30, 1948, at the Washington meeting of the American Physical Society, Dr. Lyons presented an invited paper entitled "Microwave Frequency Standards," which outlined the advantages to be gained in the use of atomic (or molecular) vibrations for frequency standards [52].

The (CRPL) Quarterly Report for April, May, June 1948 stated:

Dr. Lyons presented a discussion of atomic clocks and frequency standards using spectroscopic methods in his paper. This was the first proposal of a clock using the method of stabilizing a complete quartz-crystal oscillator-frequency multiplier chain.

On August 12, 1948, the world's first atomic clock was given its initial run. This clock, operating from the 23,870.1-MHz absorption line of ammonia, was given a public announcement to the press on January 6, 1949 [53]. At this press conference, held at the Bureau, Secretary of Commerce Sawyer spoke on the potential uses of such a clock and Dr. Condon explained in simple terms the property of the ammonia molecule as it applied to the clock. Dr. Lyons presented a simple explanation of the clock and spoke on some of the applications it would have in science and engineering.

---

<sup>79</sup>The terms "atomic clock" and "atomic frequency standard" are used interchangeably to a considerable extent in this discourse. Occasionally the Bureau has used the term "spectrometer" in place of clock or frequency standard. Within NBS the term atomic clock was used almost exclusively in the early stage of development of the atomic frequency standards program. And the first development was truly a clock that indicated real time. (In actuality, an atomic clock incorporates electronic circuitry that integrates the cycles of pulsations of an atomic frequency standard over a considerable length of time.) Later developments were more in the direction of frequency standards per se. For an interesting discussion on such terminology the reader is referred to Richardson's paper "Time and Its Inverse" [50].

The term "atomic clock" first appeared in the NBS literature during the 1920's. On the first page of the Bureau's *Standards Yearbook, 1928, Miscellaneous Publication 83* (the second of a series of seven yearbooks from 1927 to 1933) was the following paragraph:

Time measurements today are taking account of the latest findings of astronomy (sic), which is so precise that a change of 40 seconds in 80 years has been measured. For small time intervals, the oscillation of a quartz crystal at constant temperature is used to standardize radio-frequency (waves per second) and inversely to measure time, giving a time scale subdivisible into hundred-millionths of a second or less. Any radiation frequency emitted by an atom is the ticking of an atomic clock, the oscillation mechanism of which causes hundreds of trillions of waves per second. The accurate standardization of these frequencies—some of which, like those of the iron atom, have thousands of distinctive rates—is the basis of spectroscopy, which has created a new astronomy, a new chemistry, and a new physics.

Two decades would have to pass before a better knowledge of the vibrational states of atoms and the techniques of microwave spectroscopy borrowed from radar would be employed by NBS to develop the first atomic clock.

<sup>80</sup>An excellent survey of the development of atomic frequency standards appeared in an historical review in 1967 by R. E. Beehler of the National Bureau of Standards [51].

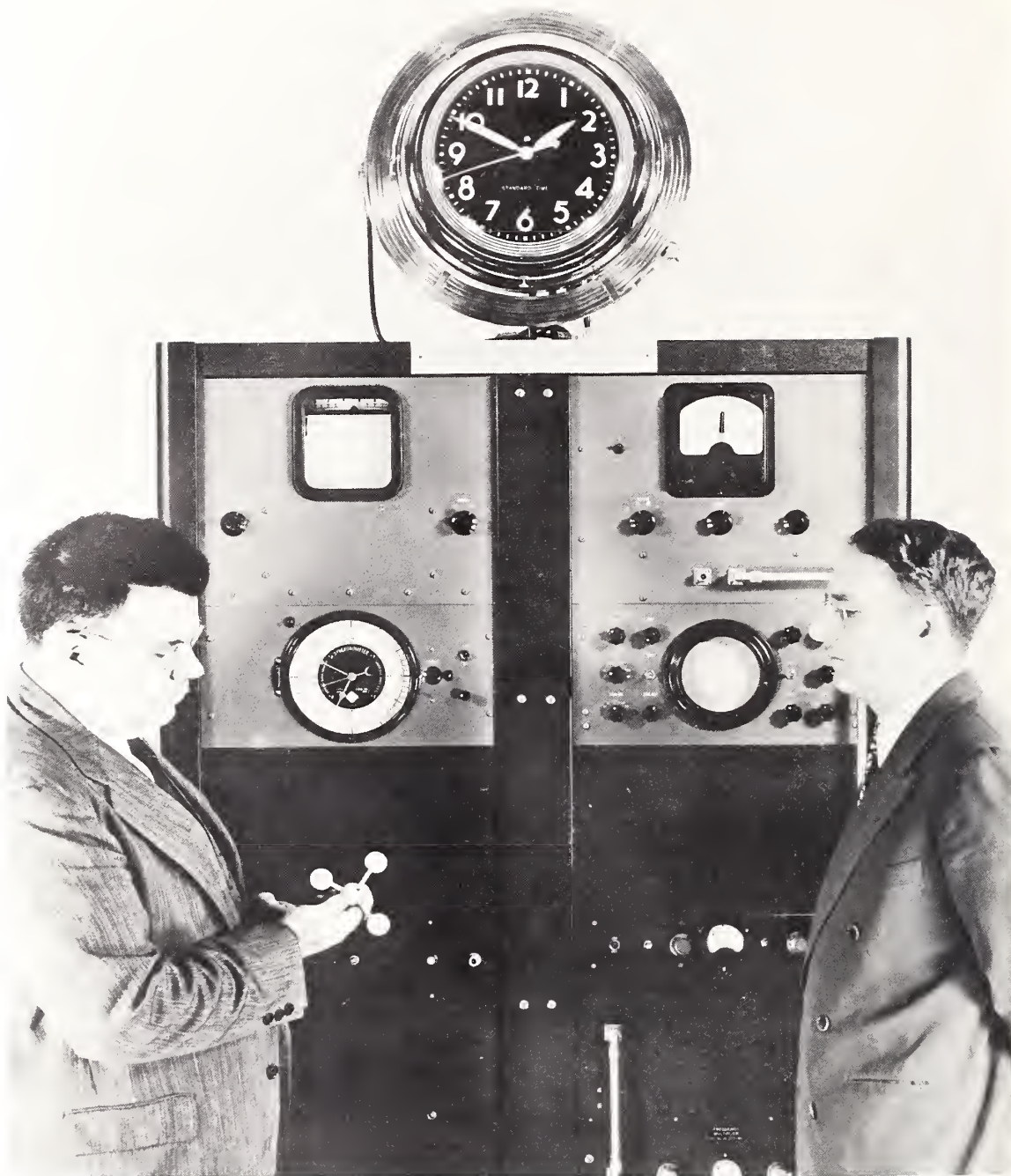

*Dr. Harold Lyons (right), inventor of the ammonia absorption cell atomic clock, observes, while Dr. Edward U. Condon, director of NBS, examines model of ammonia molecule. Frequency control, and thus time-rate control of clock, came from the inversion or absorption frequency of ammonia at 23,870.1 MHz.*

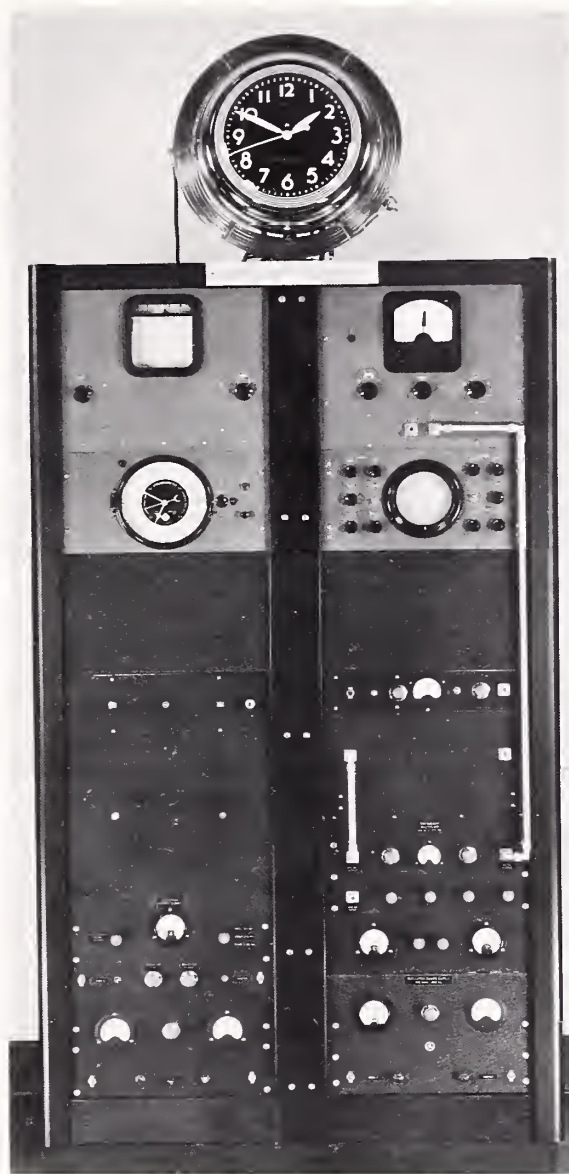

*World's first atomic clock as it appeared January 6, 1949 on occasion of public announcement. Ammonia absorption cell of 25 ft of K-band waveguide is coiled around the 50-Hz electric clock. Frequency deviation recorder at upper left.*

Additional publicity in the form of two radio broadcasts on the development of the atomic clock followed the announcement of January 6. On January 12 Condon and Lyons appeared on the *Voice of America* broadcast of the Department of State, followed on January 14 by a 5-minute interview with Lyons by Edward R. Murrow over the CBS Network.

On January 10, 1949, Dr. Lyons presented a paper entitled "Microwave Spectroscopic Frequency and Time Standards and Measurements," at the First Conference on High-Frequency Measurements.<sup>81</sup> The paper presented technical details of the clock and its potential uses. The clock received publicity in the press and in both technical and popular magazines. It was the basis for an Exceptional Service Award (Gold Medal) at the Department's first Honor Award Program and for the first Arthur Fleming Award by the Junior Chamber of Commerce of Washington, D.C. These two awards were given to Dr.

<sup>81</sup>This conference was the first of a series, held in Washington, that was cosponsored by the Bureau with the AIEE and the IRE. The conferences have been continued in Boulder beginning in 1958. In recent years these biennial conferences have taken on an international flavor and are now called the Conference on Precision Electromagnetic Measurements (see ch. XVIII). A number of technical groups have sponsored the more recent conferences.

Lyons early in 1949. In 1958 the Franklin Institute awarded its Certificate of Merit to Dr. Lyons for his pioneering developments of atomic clocks. In the same year he was elected as a fellow in the Institute of Radio Engineers "for his contributions to the development of atomic frequency standards."

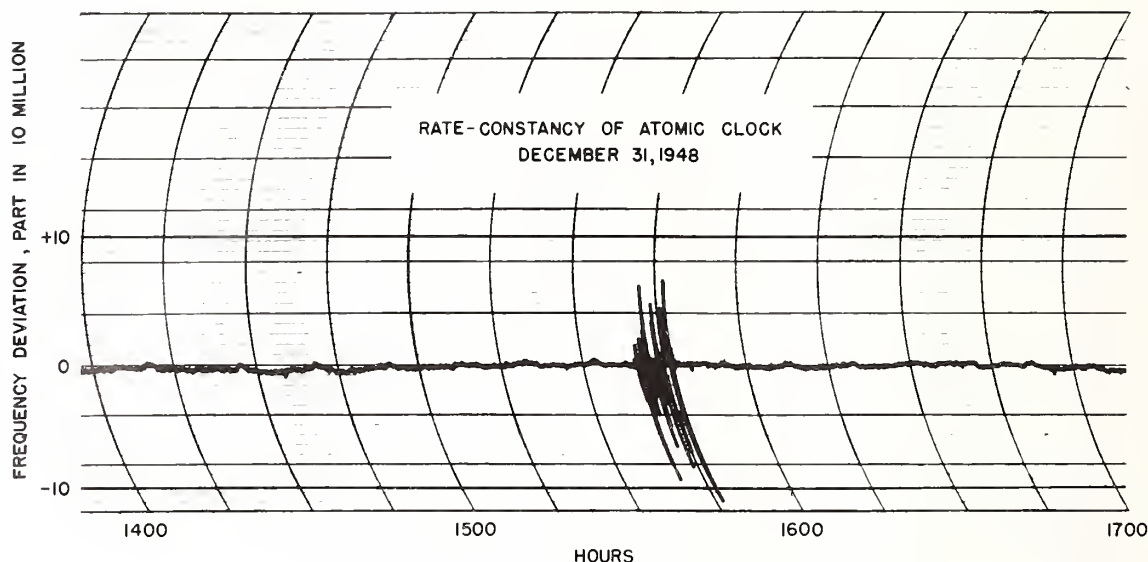

*Historic rate-constancy recording of first atomic clock showing frequency control of quartz crystal by ammonia (1 part in 10 million), and deviations (as much as 10 parts in 10 million) when servo control was removed.*

In its original form the first atomic clock had an accuracy of 1 part in 10 million, but unlike other frequency standards in existence such as quartz crystals, the frequency was invariant [53-58].<sup>82</sup> Its frequency was not dependent upon environment, age of components, or upon perturbing forces.<sup>83</sup> Basically, the clock (or frequency standard) consisted of a 100-kHz quartz crystal oscillator, a frequency multiplier chain (multiplication factor of 237,600) and frequency discriminator or servo-circuit locked to the ammonia line, a frequency divider driving a 50-Hz clock from the 100-kHz oscillator, and a waveguide absorption cell. The rectangular, K-band, copper waveguide (1/2×1/4 inch outside dimensions) was approximately 30 feet long and spiraled around the synchronous-motor clock. It was gold-plated both inside and out to minimize corrosion and filled with ammonia gas at a pressure of about 10 microns mercury.

It was evident that many kinds of atomic and molecular vibrational states of substances were useful for frequency standards and that many circuit arrangements were useful in obtaining automatic frequency control. In the first atomic clock the short-term stability was provided by the quartz crystal oscillator and the long-term stability by the ammonia line [52]. An improved design of the servo-system led to the development of the NBS Model 2 Ammonia Clock in which the servo-system corrected for drifts in the crystal oscillator without affecting the normal short-term stability of the oscillator [59-62]. This clock had a frequency stability of about  $\pm 2$  parts in  $10^8$  (originally stated as: approached 1 part in 50 million). Development of a Model 3 Ammonia Clock was to incorporate klystron tubes that were better suited for the circuit requirements and an improved discriminator circuit that would allow operation more precisely on the center frequency of the ammonia line [62]. It was expected that this clock would have a stability of about 1 part in 100 million which

<sup>82</sup> To maintain a time relation with the terminology, understanding, and writings of the period the term "invariant" is retained in this historical account of the earliest atomic clock. Understanding, at a later date, of the processes involved has shown that the term "invariant" is not correct except, possibly, as a descriptive term that was suitable only in the early 1950's.

<sup>83</sup> Although the inversion frequency of the ammonia molecule is invariant, the actual operating microwave frequency of the clock was subject to the perturbations of collision broadening and Doppler broadening. Although these perturbations could be reduced by some degree, progress of the order of a number of magnitudes in increased accuracy of operation lay in the direction of atomic beam techniques.

appeared to be about the upper limit for the ammonia absorption line operation. However, the potentials for much greater accuracy with atomic beam techniques overshadowed the ammonia-cell method and the third model of the ammonia clock was never completed.

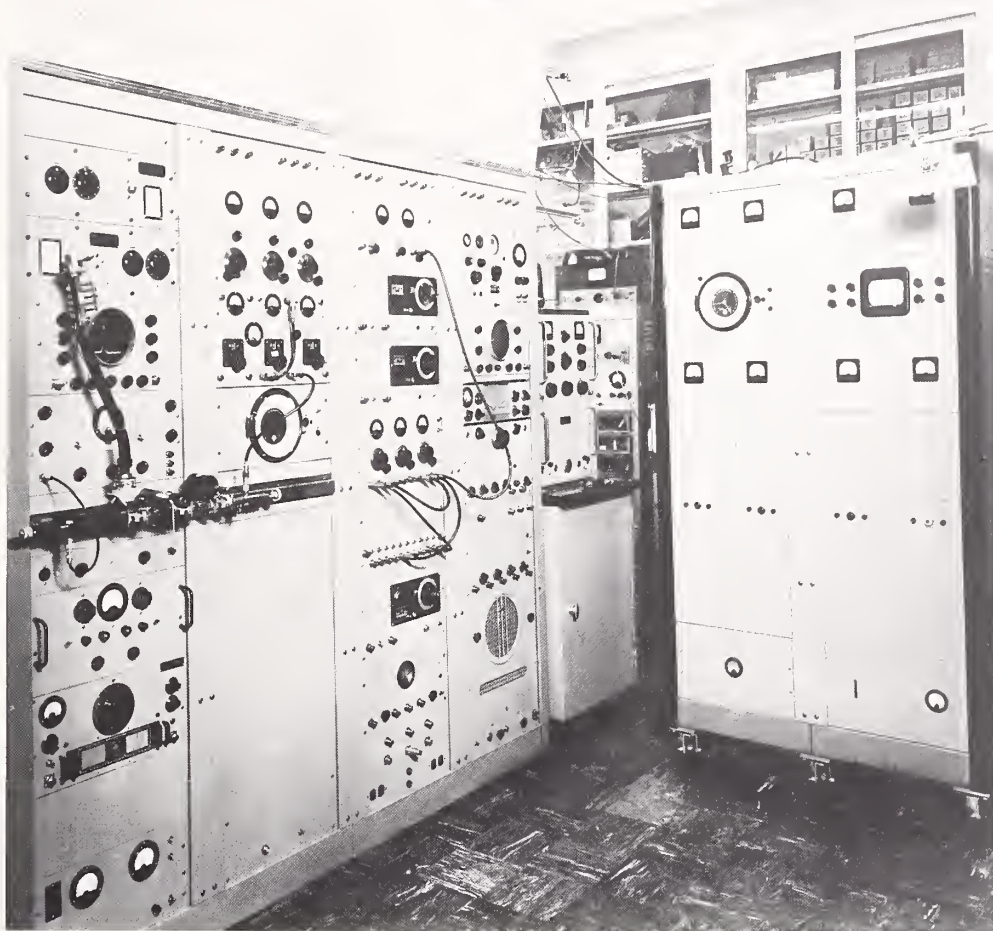

*Model 2 ammonia-cell atomic clock (right) which attained an accuracy of five times better than the original atomic clock. At left is improved model of microwave frequency standard, equipped for the calibration of frequency meters.*

Other gases for frequency control by spectral lines also looked promising. Oxygen lines in the neighborhood of 60,000 MHz offered advantages that were much greater than by using ammonia. These lines have a higher  $Q$  (approximately 10 times that of ammonia), much less collision broadening, and lower saturation. However, the oxygen lines are of lower intensities and are affected by the Earth's magnetic field. Nevertheless, a study was made of the possibilities of oxygen for an atomic frequency standard. The frequency of the 60,435-MHz line was accurately determined by John M. Richardson to 1 part in  $10^7$  [63].<sup>84</sup> Although the line was not used experimentally to control a frequency standard because of advances with the cesium clock, it was believed that a stability of 1 part in 1 billion could be attained.

The move to Boulder meant the disassembly of the Model 2 ammonia-cell clock. It was never reassembled. Only portions of the Model 3 clock had been constructed. In view of new approaches to the atomic frequency standards program, the limitations of accuracy did not

---

<sup>84</sup> Although the early study of using an oxygen spectrum line in place of the ammonia inversion line for an atomic clock was initiated in Washington, the experimental equipment was set up in Boulder, Colo. beginning in the summer of 1952. Dr. John M. Richardson, formerly with the Denver Research Institute, University of Denver, was assigned to the project. He was assisted by George E. Schafer, then a graduate student at the University of Colorado. The equipment was first set up at the National Guard Armory Building and in 1954 was moved to the new Boulder Laboratories building. Richardson received the 1959 Boulder Scientist Award from the Boulder Branch of the Scientific Research Society of America (RESA) for his publication "Experimental evaluation of the oxygen microwave absorption as a possible atomic frequency standard."

warrant further study of this type of clock. The first ammonia-cell clock has been retained as a museum item.

Closely associated with Lyons in the development of the ammonia-cell clock were Benjamin F. Husten and Emory D. Heberling.<sup>85</sup> Lauren J. Rueger took over in further developments of the ammonia-cell clock, both on Models 2 and 3. Lyons and Husten were issued a basic patent in 1955 of considerable scope on atomic clocks.<sup>86</sup>

## 2. Atomic oscillators and microwave frequency dividers

Concurrent with the development of the several models of the ammonia-cell clock, investigations were being made of atomic oscillators and microwave frequency dividers operating from spectral lines of gases and solids [56,62,64].<sup>87</sup> The atomic oscillators incorporated regenerative feedback rather than a servo-system as used in the ammonia-cell clock. In one type a special klystron amplifier operating at the 23,870-MHz ammonia line frequency was used in the feedback circuit. The ammonia cell could be coupled into the system through a microwave magic-tee or a waveguide six-arm junction. With a combination of frequency-multiplier and amplifier klystrons, it proved feasible to operate a frequency standard as well as a frequency divider in the range of 3000 to 9000 MHz. Deuterated ammonia, which has spectral lines in this frequency range, was used in the gas cell or absorption-line filter in such a system.

A study was made of the possibility of utilizing nuclear electric quadrupole absorption spectra as a means of precision frequency control [62]. Crystalline halogen substances appeared to be rather promising as a medium for frequency control at frequencies below microwaves. Experimental investigations proved that the signal-to-noise ratio was too low for practical types of circuitry. Also, advantages of simplicity and compactness that may have been gained in such a device were outweighed by inherent weaknesses of the system.

## 3. Studies in microwave spectroscopy

In association with the atomic clock and the atomic oscillator and microwave frequency divider programs came a series of projects in support of or allied to these programs. Lauren J. Rueger and Richard G. Nuckols developed and constructed a Stark-cell microwave spectrograph for operation over a frequency range of less than 900 to above 17,000 MHz. Although some features had been developed by others, Rueger and Nuckols adapted the spectrograph for the lower frequencies by incorporating coaxial equipment. With this versatile equipment the microwave spectroscopy group measured well over 100 microwave spectral lines of the 3 deuterated ammonias.

As a project in the microwave spectroscopy program, Professor Charles H. Townes of Columbia University initiated the compilation of a set of molecular microwave spectral tables that was published in 1952 as an *NBS Circular*. This was followed many years later (1964-1968) by a five-volume *NBS Monograph* on microwave spectral tables prepared by Paul F. Wacker and others.

## 4. Developing a cesium beam atomic frequency standard

Almost from the beginning of the Bureau's atomic clock program it was believed that the atomic beam technique offered the best approach to an atomic frequency standard of the highest precision and accuracy (25 years later this earlier belief proved to be quite correct).

---

<sup>85</sup> Husten and Heberling transferred to the Corona Laboratories in 1951. The Bureau's missile research and development and related work had been transferred to Corona, Calif. In 1954 the Corona Laboratories were transferred to the Navy and became known as the U.S. Naval Ordnance Laboratory, Corona.

<sup>86</sup> Harold Lyons and Benjamin F. Husten filed for a patent on an atomic clock on April 30, 1949. Patent 2,699,503 was issued on January 11, 1955, entitled "Atomic Clock."

<sup>87</sup> Beginning in August 1948 and extending for a period until after the move to Boulder, Colo. in 1954, Professor Charles H. Townes of Columbia University was retained as a consultant in the Microwave Standards Section for the programs of gas and quadrupole absorption techniques. In 1964 the Nobel Prize in Physics was shared jointly by Professor Townes with two Russian scientists. He was cited for "fundamental work in the field of quantum electronics which has led to the construction of oscillators and amplifiers based on the maser-laser principle."



Borrowing from a method of measuring nuclear magnetic moments by the molecular beam resonance technique of Rabi and others,<sup>88</sup> an experimental program was started in the summer of 1949 to develop an atomic beam clock incorporating a quartz crystal oscillator [56,57,62]. Professor Polykarp Kusch of Columbia University, a coworker with Rabi, was retained as a consultant to take part in the development of a cesium beam atomic clock (or frequency standard).<sup>89,90</sup> It was well understood that the molecular beam technique had the advantage of greatly increasing the  $Q$  over that of the ammonia cell by the nearly complete elimination of line broadening due to collisions and Doppler effect. By using cesium or thallium atoms in the beam, it was believed that an accuracy of 1 part in 10 billion could be achieved. This predicted and hoped-for accuracy was to be exceeded a decade later with improved techniques.

Briefly, the first atomic beam device, including a quartz oscillator, was constructed at NBS and consisted of a large cylinder evacuated to a very low pressure ( $1 \times 10^{-6}$  mm Hg) and housing the cesium oven, beam-collimating slits, beam-deflecting magnets, means of excitation of the cesium atoms at a microwave frequency, and a detector. Surrounding the large vacuum chamber was a large Helmholtz coil to minimize effects caused by changes in the Earth's or nearby magnetic fields. The quartz crystal oscillator, error-signal and control circuitry, frequency multiplier, and divider circuits were external to the beam chamber.<sup>91</sup>

Jesse E. Sherwood, with the assistance of Robert N. McCracken, was largely responsible for the design and construction of the beam portion of the cesium beam clock. Early in 1952 the team of Sherwood, Lyons, McCracken, and Kusch reported on the first direct measurement of the field-insensitive cesium line (approximately 9192 MHz) [67].<sup>92</sup>

In the summer of 1954 the cesium beam clock was disassembled for shipment to Boulder. Several years later it became known as NBS-I Atomic Frequency Standard as it entered into the larger atomic frequency standards program. In 1966, the NBS-I standard was disassembled after serving a useful life of 15 years—a long record for experimental

---

<sup>88</sup> The use of atomic and molecular beams goes back to 1911 but it was Professor I. I. Rabi of Columbia University who suggested in 1945 their use as frequency standards. This suggestion is ascribed to Rabi in the Richtmyer Lecture given before a joint meeting of the American Physical Society and the American Association of Physics Teachers on January 20, 1945, in New York City.

<sup>89</sup> Professor Kusch began his services in the Microwave Standards Section in September 1948 and continued there until after the move to Boulder in 1954. In 1955 Professor Kusch shared the award of the Nobel Prize in Physics "for his determination of the magnetic moment of the electron."

<sup>90</sup> Kusch presented a paper entitled "Some design considerations of an atomic clock using atomic beam techniques," at a symposium organized by Lyons. This symposium, as a session (April 30, 1949) of the spring meeting of the American Physical Society in Washington, consisted of six invited papers on atomic frequency and time standards. Two other papers were presented by the CRPL staff (Kusch and Townes as consultants), one by Lyons entitled "The Atomic Clocks of the National Bureau of Standards," and one by Townes entitled "Ultimate accuracy of an atomic clock using absorption lines."

<sup>91</sup> Technical explanations of frequency standards (including quartz crystal oscillators) and atomic clocks are beyond the scope of this historical account. A tutorial discussion on the basic concepts, with a nonmathematical treatment, is found in an *NBS Technical Note* [65].

In another *NBS Technical Note* is found a technical discussion of the physical basis of atomic frequency standards [66]. The reader is referred to this informative paper in order to gain a greater knowledge of the operating principles of atomic frequency standards as involved in the energy levels of atoms and their interaction with electromagnetic radiation. The essential features of cesium beams, hydrogen masers, and rubidium gas cells are covered.

<sup>92</sup> Reported was a frequency of  $9192.632 \pm 0.002$  MHz for the  $\nu_0$  transition frequency at zero field (ground state splitting) measured with excitation over a transition region of a 1 cm path length. At a later time with a transition region of 50 cm path length (Ramsey method), the frequency measurement was  $9192.63187 \pm 0.0001$  MHz. This measurement was not published but was noted in the Annual Report of CRPL (July 1, 1952, to June 30, 1953), NBS Report 2793, September 14, 1953. This measurement, in terms of WWV and Naval Observatory time, made with equipment that had a resonance sharpness with a " $Q$ " of about 30 million, was probably the most accurate physical measurement that had ever been made. See [62].

It is interesting to note that Essen and Parry of the National Physical Laboratory (England) reported a value in 1955, and later in 1958, for the cesium transition frequency of  $9192.631770 \pm 0.000020$  MHz, the value in terms of the second of ephemeris time. Based upon this value by Essen and Parry and later confirmation in 1967, the 13th General Conference of the International Bureau of Weights and Measures (BIPM) defined the second as "the duration of 9 192 631 770 periods of the radiation corresponding to the transition between the two hyperfine levels of the ground state of the cesium-133 atom."

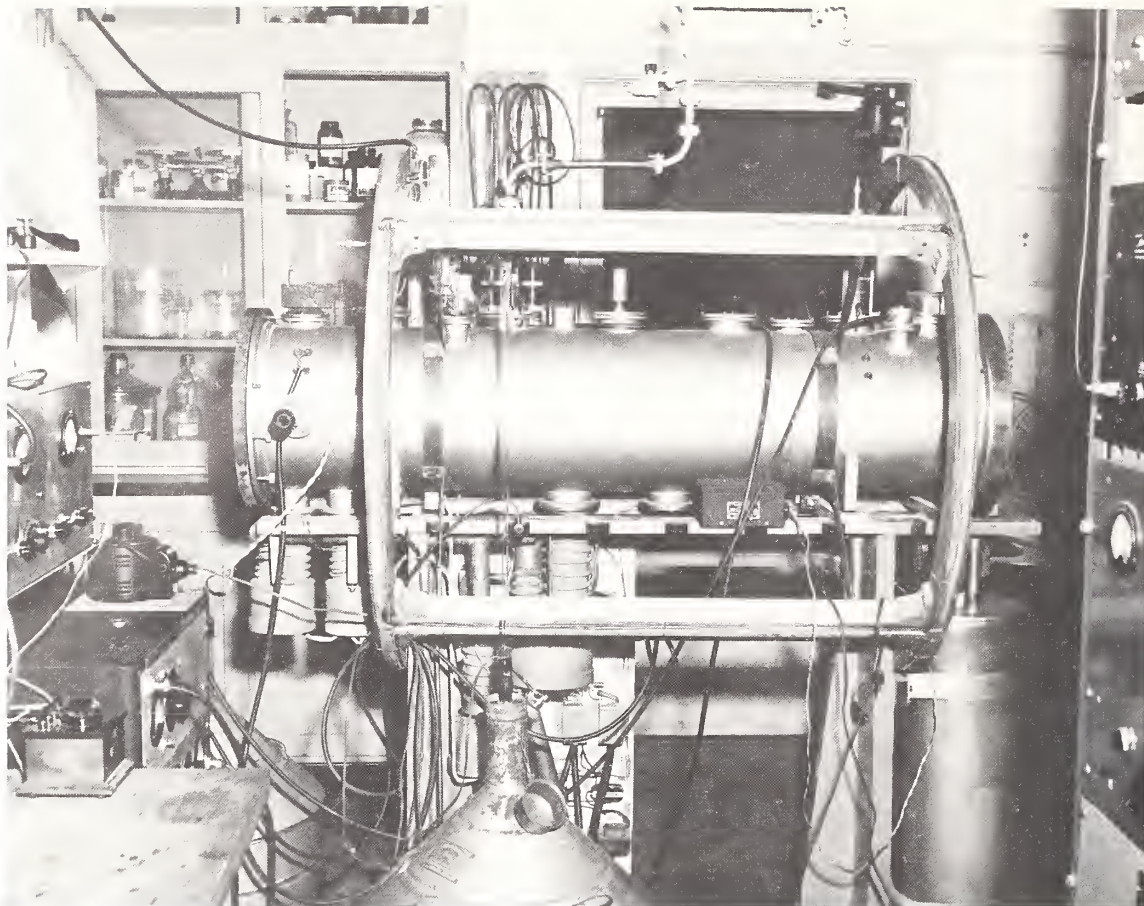

*Cesium beam frequency standard constructed and set into operation in 1951. This was the first of a series using a beam of cesium atoms, and after reassembly at the Boulder Laboratories it became known as the NBS-1 Atomic Frequency Standard.*

laboratory equipment. Portions of the beam equipment now form parts of the Time and Frequency items of the NBS Museum at Gaithersburg, Md. The cesium source or oven is on permanent display with the standards for the base units of mass, length, and time.

## **5. An atomic frequency standard program gets underway in Boulder**

It was clear by 1954 that the Bureau should engage in a long-range program to exploit the possibilities of frequency and time standards incorporating control by invariant spectrum lines. The possibility of frequency standards with accuracies of four, five, or more orders of magnitude greater than had been available with the ammonia clock was reason for much optimism and enthusiasm. Not only would such frequency-controlled devices be useful as a new standard of frequency, but they would have application for astronomical and geophysical observations, navigational aids, in military equipment, and for study of physical phenomena such as relativity. As a frequency or time standard such a device could serve as a reference along with a whole new order of physical units on an atomic basis [68].

Although the maser principle is credited to Professor Townes, its realization as an operational device in the form of the ammonia maser was a team effort on the part of Townes and his colleagues, Gordon and Zeiger, at Columbia University in 1954 (also Basov and Prokhorov in the USSR in the same year).<sup>93</sup> The maser provided another method of frequency control by spectral lines within the microwave region. Work was initiated during the first year at Boulder, under the direction of Lyons, on the construction of an ammonia molecular beam clock using the maser principle.<sup>94</sup> A second ammonia maser was constructed

<sup>93</sup> The acronym "maser" comes from microwave amplification by stimulated emission of radiation.

<sup>94</sup> Dr. Harold Lyons resigned from the Bureau in May 1955 as assistant chief for research in the Radio Standards Division to become a senior member of the technical staff of the Research Laboratories, Hughes Aircraft Co., Culver City, Calif.

in 1957 for a critical study of the stability of these devices [69]. It incorporated a double beam for minimizing Doppler effect in order to give greater reproducibility of a particular transition frequency (the Bohr frequency of the transition). Lack of reproducibility of the generated frequency offset some of the advantages otherwise gained in the ammonia maser. It was now possible to determine the relative stability of two masers of somewhat different construction. Under carefully controlled conditions this was found to be about 1 part in  $10^{12}$  for short periods of time (minutes)—a very high order of stability for laboratory apparatus.

An intensive effort was now in order to improve upon and refine the many component parts of two rather complex systems, the cesium atomic beam apparatus and the ammonia maser, that incorporated many features in the field of physics and electronic engineering. It was quite evident that one or both of these systems had great potential as a frequency standard of unprecedented stability and accuracy. A program comparing beam techniques with maser techniques has been in progress since about 1957 with notable success. Among the studies made was the stabilization of the multiplier chain itself, with a maser, in order to increase the reliability of a cesium beam operating in conjunction with a quartz crystal oscillator. The ammonia maser had also proved to be a useful tool in the analysis of noise, sideband modulations, and other extraneous frequencies found in a frequency standard, particularly in the crystal oscillator [70].

Beginning in May 1955, the atomic frequency and time standards program came under the immediate direction of Richard C. Mockler and continued so until July 1965.<sup>95,96</sup> Associated with the program over a portion or the whole of this period were David W. Allan, James A. Barnes, Roger E. Beehler, R. Lowell Fey, David J. Glaze, Donald W. Halford, F. Russell Petersen, Jack B. Snider, and Richard L. Strombotne with the laboratory assistance of Henry F. Salazar, Charles S. Snider, and Arthur E. Wainright.

A second (NBS-II) and much more refined cesium beam standard was constructed in 1958-1959, incorporating a transition region for excitation of the cesium atoms that was three times longer (164 cm) than in the previously built apparatus [71,72]. At a later time the apparatus was designed to accommodate thallium, an element with a higher transition frequency (21,310.8 MHz) than cesium and having other advantages over cesium.

## 6. In quest of an ultimate in atomic frequency and time standards—Cesium atomic beam frequency standard

The first cesium beam apparatus (constructed in Washington) was completely rebuilt in 1958 in order to gain greater precision of measurement. By the spring of 1959 it was in regular operation. With this frequency standard, now known as NBS-I, it was possible to compare the stability of two highly-developed cesium beam devices which differed, essentially, in their transition regions (55 cm for NBS-I, 164 cm for NBS-II) and thus in the resonance linewidths achieved and in their beam cross-sections. A comparison between the two was made over a period of many months, the frequencies agreeing to an accuracy of about 1.5 parts in  $10^{11}$  with a measurement precision over a period of several hours of 2 parts in  $10^{12}$  [73]. The transition frequency was given as 9 192 631 770.0 MHz.<sup>97</sup>

---

<sup>95</sup> In 1961 Mockler was awarded the Department of Commerce Gold Medal for Exceptional Service "for scientific leadership and personal technical contribution of the highest order in the achievement of a frequency and time interval standard of previously unknown accuracy, one which has brought the U.S. frequency standard to a level of accuracy and precision believed to exceed any other similar standard in the world." Later, Mockler received the Bureau's 1963 Wesley Stratton Award for outstanding achievements in leading the NBS atomic frequency and time standards program.

<sup>96</sup> In July 1965, Dr. Mockler transferred from chief of the Atomic Frequency and Time Interval Standards Section to chief of the Quantum Electronics Section. He resigned from the Bureau in September 1966 to teach in the Physics Department of the University of Colorado.

<sup>97</sup> The same value to an equal number of significant figures had been reported by Essen and Parry in 1955 and later in 1958. See footnote (92).

On January 1, 1960, the cesium beam equipment with the longer transition region (NBS-II) was adopted as the U.S. Frequency Standard (USFS) [74].<sup>98</sup> In turn, this standard was regularly compared with several commercial atomic frequency standards and the data used to correct the standard frequencies transmitted by Stations WWV, WWVH, and WWVB. Occasionally, for the next 3 years, NBS-II was compared with NBS-I as a means of checking the performance of one with the other and as an assurance factor of their relative stability and accuracy.

As another step in the direction of increased accuracy, construction was started in 1959 on a third cesium beam standard to be known as NBS-III. It was designed for a transition or oscillatory field region of 366 cm, over twice the length of NBS-II. This standard became operational in September 1963. With a spectral line width of about 48 Hz, the instrument had a phenomenal Q-value of approximately  $2 \times 10^8$ . The radio art had come a long way from early tuning circuits with Q's of 10 to 100. However, operation of an atomic frequency standard with high accuracy is more than the attainment of an extraordinarily high Q. There are many perturbations and types of fluctuations that contribute toward the instability of operation and inaccuracy of measurement that restrict attainment of the ultimate accuracy.<sup>99</sup>

During the succeeding years from the time of construction and initial evaluation of the NBS-III standard, much effort has gone into the analysis and minimization of the more than a dozen sources of errors. There have been changes in the design of various components to bring about better performance or to minimize the effects of systematic errors or bias. Much of the former electronic circuitry that used vacuum tubes has been converted to solid-state operation, with improved performance. Much of this overall effort has been directed toward reduction of frequency modulation caused by flicker noise (the noise that has its power spectrum in the lowest frequencies—the power content being inversely proportional to frequency).

In order to reach the maximum possible frequency stability with the cesium beam standard it would be necessary to reduce all sources of noise to such states that the irreducible minimums are governed only by an operable condition of the equipment. It is then that one must cope with the random processes of particulate matter and "Nature" takes over in the limiting conditions. This assumes, of course, that all other perturbing forces and biases have been minimized beyond the effects of noise-induced errors. It is in the direction of minimizing the very small errors at their respective sources that the NBS-III standard has been undergoing modifications since 1965 culminating in a largely new standard, designated NBS-5 (peripheral parts of NBS-III were used to construct NBS-5).

After several years the NBS-III cesium frequency standard was found to be operating with a precision of  $\pm 1$  part in  $10^{13}$  and with an accuracy, in terms of the uncertainty, of  $\pm 5$  parts in  $10^{12}$  ( $3\sigma$ ) [76].<sup>100</sup>

---

<sup>98</sup> Beginning in 1929, groups of quartz crystal oscillators had served as frequency standards in the Radio Section and as the standard for monitoring WWV. Although these groups of quartz crystal oscillators were retained for this purpose in the 1950's, they were gradually being supplanted by atomic frequency standards. First came the use of several commercial-type atomic frequency standards to initiate conversion from quartz crystals. For a period of a few months in the fall of 1959 and up to January 1, 1960, the rebuilt and reevaluated cesium beam NBS-I served as the United States Frequency Standard. Beginning January 1, 1960, it began to serve as an alternate to NBS-II [74]. Although originally designed as the USFS, comparable commercial atomic frequency standards provided an impetus to designate these laboratory atomic standards as the NBS Frequency Standards.

<sup>99</sup> A definitive account by NBS authors of the error sources in cesium beam frequency standards is found in the international metrology journal *Metrologia* [75].

<sup>100</sup> Expressing the performance of atomic frequency standards in terms of the above indicated precision and accuracy is an oversimplification. First, the standard deviation expressed in  $\sigma$ 's (sigma) of the mean of the random errors must be taken into account. Second, calculation of the standard deviation takes into account the sampling time and the total period of sampling of the observations. Third, estimates of the systematic errors or biases can be subject to considerable complexities.

The definition of the precision of measurement in this account refers to the uncertainty within which a frequency standard gives reproducible measurements under specified sampling. Usually it is expressed in terms of  $1\sigma$ .

Definition of the accuracy of measurement in this account refers to the uncertainty in determining the true value of an atomic state separation of the free atom associated with the particular frequency standard. It is expressed in terms of  $3\sigma$  for random errors and by the estimated extreme limits of the systematic errors.

With the improvements attained with the NBS-III standard by August 1969, the precision (expressed as the relative frequency stability) had improved to 1 part in  $10^{13}$  while the accuracy had improved to the extent that the uncertainty was no greater than  $1.5 \times 10^{-12}$  ( $3\sigma$ ) [77].<sup>101</sup> On the basis of a measurement of the transition frequency of cesium, the accuracy of this last measurement was more than a millionfold improvement over that of the first measurement by the NBS team back in 1952. The Bureau had come a long way in its achievement of conducting some of the world's most accurate physical measurements. At each period the degree of accuracy was almost without precedent.

After evaluation in 1969, the NBS-III cesium standard was dismantled and some of its components were used in a newly designed system to be known as NBS-5. Assembly of the standard (NBS-5) was completed in August 1972. By the summer of 1974 a series of comparisons had been completed between the NBS-4 and NBS-5 devices (with each considered to be a primary frequency standard) that indicated a stability of 9 parts in  $10^{15}$  ( $9 \times 10^{-15}$ , where expressed as fractional frequency stability) for an averaging period of 20,000 seconds.<sup>102</sup> An evaluated accuracy ranging from 1 to 2 parts in  $10^{13}$  was indicated [78]. This accuracy, translated to the time scale of an atomic clock, represents an uncertainty in time measurement approaching 1 second in 300,000 years. This recent work has been under the guidance of Helmut Hellwig and David Glaze of the Time and Frequency Division.

<sup>101</sup> During the fall of 1965 a series of comparisons was made with the NBS-III cesium beam standard, a commercial-type cesium beam standard, and two commercial-type atomic hydrogen masers. The result of these comparisons indicated that the accuracy capability of the NBS-III standard, in terms of the uncertainty, was 1.1 parts in  $10^{12}$ .

<sup>102</sup> A cesium standard first known as NBS-X4, later named NBS-4 after new techniques demonstrated its usefulness as a primary standard, was completed in 1973. The NBS-II cesium standard was first converted for operation with thallium and later dismantled. Some of its parts have been used in investigations of methane stabilized helium-neon lasers. NBS-X4, constructed in a joint effort between NBS and the Hewlett Packard Co., was not originally envisioned to be used as a primary cesium-beam frequency standard. Novel techniques, coupled with its design quality and high stability, enable its use as a primary frequency standard.

SCHEMATIC ILLUSTRATION OF MAJOR COMPONENTS AND BEAM PATHS OF NBS-5

\*VERTICAL SCALE EXAGGERATED

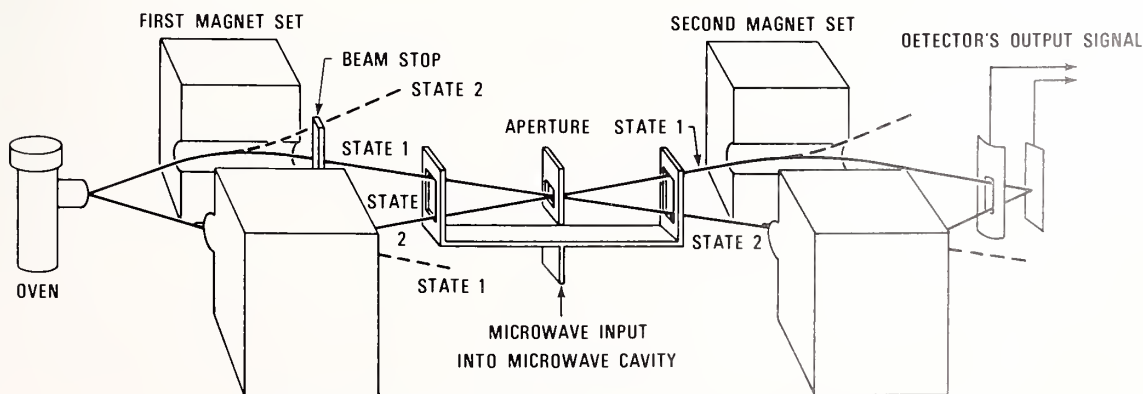

SOLID LINES SHOW OPTIMAL APPLICATION OF THE MICROWAVE FREQUENCY AND POWER TO THE CAVITY TO EFFECT A COMPLETE CHANGE OF ENERGY STATE.

*Simplified schematic of atomic beam frequency standard, showing path taken by ionized atoms in traversing the several beam-control and other components from oven source to detector.*

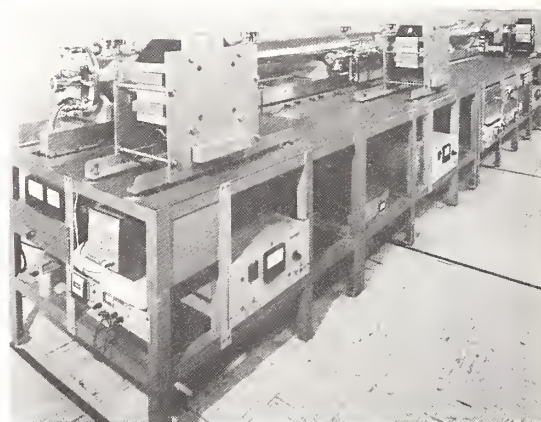
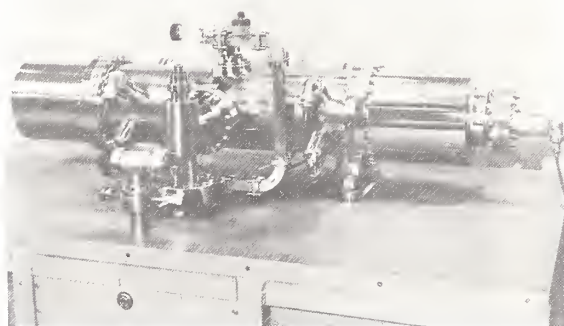
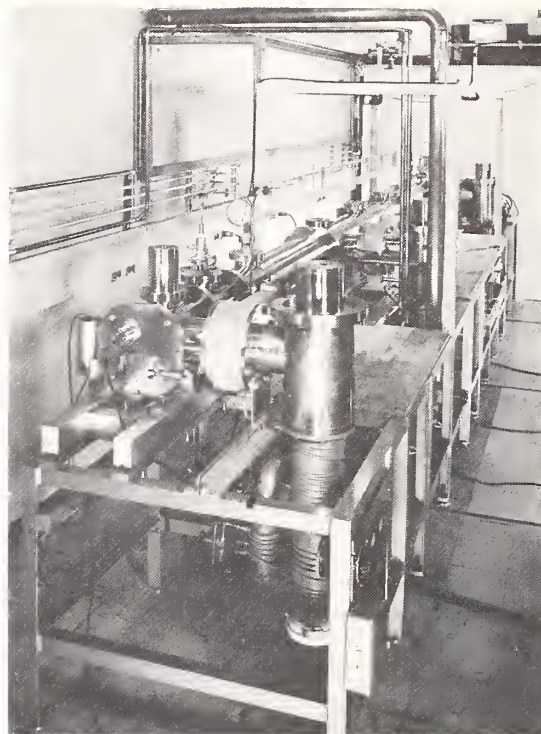
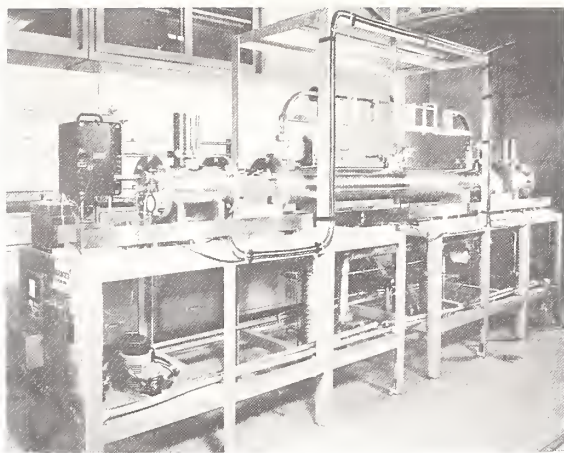

*Progressive stages in development of the cesium beam frequency standard at NBS. Upper left, frequency standard NBS-II that became the U.S. Frequency Standard on January 1, 1960. Its transition region was three times (164 cm) that of NBS-I (first developed at NBS Washington 1950-1952 and later reassembled and developed further at Boulder Laboratories after 1954, and called standard NBS-I). Upper right, standard NBS-III that became operational in September 1962, with transition region twice (366 cm) that of NBS-II. Together, until October 1965, NBS-II and NBS-III served as the National Bureau of Standards Frequency Standard. NBS-III operated with accuracy, in terms of uncertainty, of  $\pm 5$  parts in  $10^{12}$ .*

*At lower left is the beam section of NBS-X4 that has served both for experimental purposes and as mutual support to NBS-5 as the primary NBS frequency standard. Lower right is NBS-5, operational since January 1973, that emerged from NBS-III after disassembly and reconstruction, and serves as one of two components of the NBS Frequency Standard. Accuracy, in terms of uncertainty, is 1 to 2 parts in  $10^{13}$ .*

# THE ACCURACY OF TIMING THROUGH HISTORY

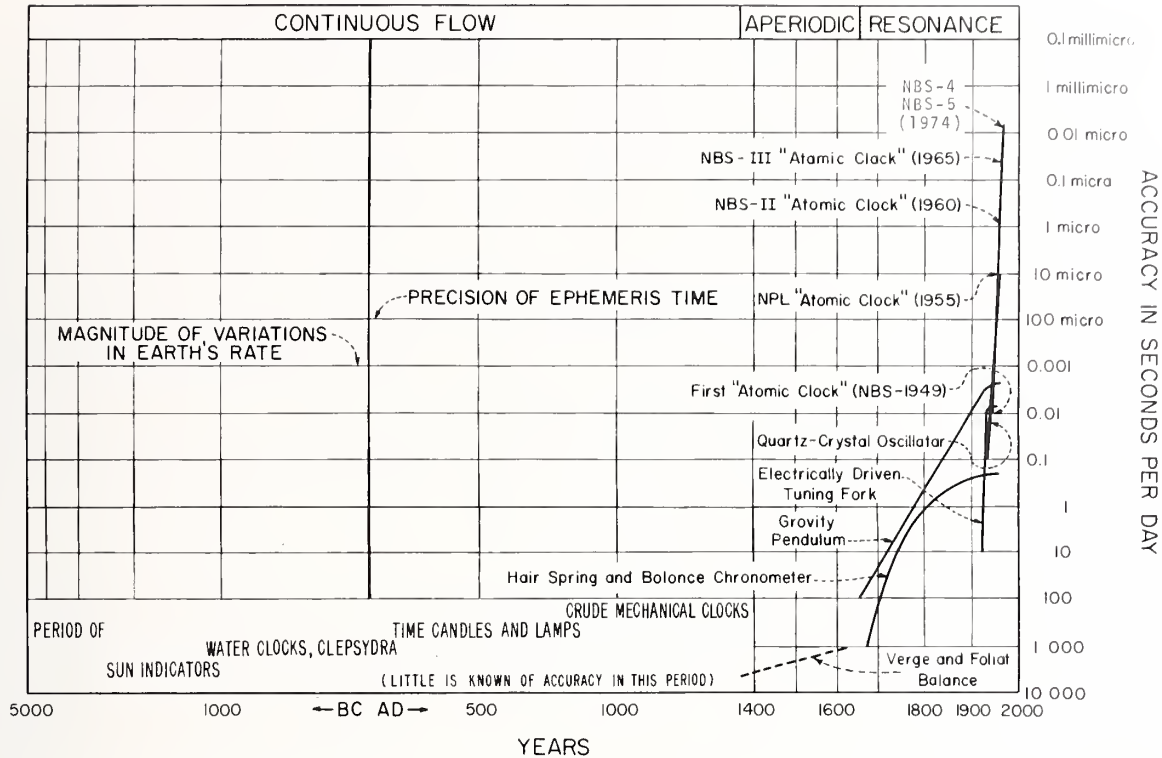

After W.A. Marrison, BTSJ (1948); also, Richardson and Brockman, Am. Phys. Teacher, Sept. 1966

*Accuracy of timing in relation to evolution of clock mechanisms, from BC era to NBS-5 atomic clock in 1974. Progressively, through the years, the period of clocks became smaller and smaller, from observations of a day in length to oscillations of  $10^{-10}$  second.*

## 7. Thallium atomic beam frequency standard

Kusch of Columbia University had suggested, in 1957, the possible advantages of using the element thallium in place of cesium in an atomic beam frequency standard. Upon this suggestion, Beehler and Glaze converted the original cesium beam equipment used in Washington (later known as the NBS-I frequency standard) to operation with thallium.<sup>103</sup> Several changes had to be made in the beam equipment, including the detection system, in order to accommodate the use of thallium.

After conversion in the fall of 1962, the thallium beam was operated over a period of about 1 1/2 years to evaluate its performance. Typical performance indicated a precision of 2 parts in  $10^{12}$  and an accuracy with an uncertainty of 1 part in  $10^{11}$ . On the basis of comparing the performance of this thallium beam, and that of a later version using NBS-II, with the NBS-III cesium beam standard (having a transition or interaction length seven times that of the thallium beam), the thallium beam was comparable to the cesium beam. However, certain advantages favored the cesium beam and the thallium beam project was discontinued.

Beehler and Glaze had the opportunity of measuring the specific energy state transition frequency of thallium in terms of the measured frequency of cesium. This could be done with a high degree of accuracy. The measured frequency was  $21\,310\,833\,945.9 \pm 0.2$  Hz [79].

<sup>103</sup>In 1964 Beehler was awarded the Department of Commerce Silver Medal for Meritorious Service "for contributions to the invention of atomic beam and frequency devices, specific evaluation of the cesium beam atomic frequency standards, and the thallium prototype standard, and to research which makes the United States Frequency Standard the most accurate in the world."

## 8. The hydrogen maser at NBS

After becoming familiar with maser techniques in the form of ammonia masers, F. Russell Petersen constructed two hydrogen masers in the mid-1960's. After some modifications these masers were used in a cooperative effort of NBS with Harvard University and the Smithsonian Astrophysical Observatory to evaluate the accuracy potential of hydrogen devices. This effort was led by Helmut Hellwig and gave a new number for the hydrogen frequency as  $1\,420\,405\,751.768$  Hz with an accuracy of  $1 \times 10^{-12}$  [80]. This is the presently accepted accuracy of the hydrogen maser which is limited principally by the wall-collision effect; thus it might be ranked below cesium beams as primary frequency standards.

Hydrogen still looked promising. However, other new device techniques also looked promising. As a result, two new hydrogen devices were developed by Hellwig and their feasibility was successfully tested during 1971-1972. The hydrogen dispersion device and the hydrogen storage beam tube in combination showed a frequency stability of 4 parts in  $10^{13}$  (or  $4 \times 10^{-13}$ ). By coupling the two devices, their good features could be maximized and their poorer features minimized [81].

An excellent survey paper on recent advances in atomic frequency standards, including hydrogen masers and related devices, was published by Hellwig in early 1975 [82].

## 9. Lasers as frequency standards

Lasers should not be ruled out as frequency standards. Recently they have served as a part of a frequency measurement system at NBS in arriving at a new value for the speed of light in combination with a new determination of a wavelength of light. It is true, of course, that the frequency measurement was based on the NBS-III cesium frequency standard but this does not rule out other methods of approach.<sup>104</sup> For a more detailed account see chapter XV on the subject of lasers.

## 10. Engaging in the technology of precision timing

### a) DEVELOPMENT OF A PORTABLE RUBIDIUM CLOCK

Of the two alkali metals, cesium and rubidium, that have proved to be the chemical elements most suitable for use in atomic frequency standards, rubidium has gained the favor for use in the commercial development of portable-type atomic clocks. A recent and corollary project in the program of the Frequency and Time Standards Section has been the modification of a commercial rubidium portable clock such that the temperature and environment characteristics give stabilities in the  $10^{-12}$  range under typical clock-carrying conditions. A tenfold reduction in weight was obtained from a 100-kg cesium "portable" clock to a 11-kg rubidium clock. From the portability viewpoint, this was a modification from two-man handling and stowage as extra baggage to that of the atomic clock being carried aboard an aircraft as hand luggage by the traveler.

### b) A SUPPORT PROJECT FOR ATOMIC FREQUENCY STANDARDS IN SATELLITES

Another recent project within the Frequency and Time Standards Section is that of evaluating prototypes of rubidium atomic frequency standards for use in the Global Positioning System (GPS) satellites. Rubidium, cesium, and hydrogen frequency standards are in various stages of development for the system. The GPS is planned to be a major navigational and time dissemination system in the 1980's, employing 24 clock-carrying satellites and permitting global time synchronization to nanoseconds and navigational positioning to within a distance of 10 meters or less [83].

---

<sup>104</sup> Development of a saturated absorption stabilized laser using methane for a frequency standard, is being conducted by the Time and Frequency Division. The methane frequency of 88.3762 THz had been measured by the Quantum Electronics Section by comparison with the NBS-III frequency standard via a harmonic generator chain.



## 11. The atomic second

The second, as the unit of time, has been labeled with several definitions in recent years. Prior to 1956 the second was defined in terms of the rotation of the Earth on its axis. In 1956 the second was redefined in terms of the revolution of the Earth around the Sun and became known as the "ephemeris second." The ephemeris second is defined as the fraction  $1/31,556,925.9747$  of the tropical year for 1900, January 0 at 12:00 ephemeris time.<sup>105</sup> Exacting determination of both of these "seconds" is by painstaking astronomical observations over periods of many months. But Nature has endowed atoms and molecules with vibrational states that, seemingly, are invariant in frequency. With the rapid strides made with atomic frequency standards in several laboratories during the 1950's, it appeared to be quite feasible to again redefine the second, this time on the basis of a frequency associated with a particular atomic vibrational state.<sup>106</sup>

As a procedural step in the operation of the International Bureau of Weights and Measures (BIPM) to establish an atomic definition of the second, the Consultative Committee on the Definition of the Second met in Paris in December 1963.<sup>107</sup> J. M. Richardson, then chief of the Radio Standards Laboratory, and R. C. Mockler, chief of the Atomic Frequency and Time Standards Section, were among the members of the committee representing various laboratories. Representing one of the various astronomical institutions was W. Markowitz of the U.S. Naval Observatory who, along with Essen of NPL (England) and others, determined the resonance frequency of cesium in terms of the second of Ephemeris Time. The committee met to evaluate several types of atomic frequency standards and to recommend the method of defining an atomic second to the next General Conference. Among the actions taken by the 12th General Conference on Weights and Measures meeting in Paris during October 1964, was a temporary definition of the atomic second. The definition was in as close agreement with the 1956 definition based on the Ephemeris Second (based on observation of the Earth's orbit of the Sun) as was experimentally possible. The definition was:

The standard to be employed is the transition between the two hyperfine levels  $F=4, m_F=0$ , and  $F=3, m_F=0$  of the fundamental state  $^2S_{1/2}$  of the atom cesium-133 undisturbed by external fields and the value  $9\ 192\ 631\ 770$  hertz is assigned.

A. V. Astin, director of NBS, was the U.S. voting delegate to the General Conference.

The Consultative Committee on the Definition of the Second met again in July 1967 with Richardson attending. By now there was wide acceptance of the atomic second. By an overwhelming vote, the 13th General Conference, meeting in October 1967, adopted an atomic definition to replace the definition based on the Earth's orbital motion around the Sun. The atomic second was now more simply defined:

The second is the duration of  $9\ 192\ 631\ 770$  periods of the radiation corresponding to the transition between the two hyperfine levels of the fundamental state of the atom of cesium-133.<sup>108</sup>

Again, Astin was the voting U.S. delegate.

In brief, the recent story of defining the second is that of accurate knowledge of movement in the microcosmic world supplanting that in the macrocosmic world. But further research and development is not to cease in order that a higher accuracy in the definition of the atomic second may be attained. NBS continues to lend a hand in this direction [87].

<sup>105</sup> Ephemeris refers to ephemeris time, the measurement of time based on the revolution of the Earth around the Sun. The tropical year, or solar year, is the time interval between two successive passages of the Sun through the same equinox.

<sup>106</sup> As a result of the work by Essen and Parry (see [84]) on transition frequency of the fundamental state of cesium-133, Sir E. C. Bullard, director of the National Physical Laboratory (England), suggested in 1955 "to define a 'physical second' in terms of the natural period of the cesium atom, choosing the numerical value so that it agrees as well as may with the current estimates of the second of Ephemeris Time" [85].

<sup>107</sup> For an understanding of the operations of the International Bureau of Weights and Measures and how it functions through an echelon of organizational structure see [86].

<sup>108</sup> The selected frequency was that obtained with a cesium beam frequency standard by Essen and Parry at the National Physical Laboratory, England, and Markowitz at the U.S. Naval Observatory, Washington, D.C. [84,88].

## 12. NBS atomic time scale

On January 1, 1960, the NBS-II cesium beam equipment was adopted as the NBS Frequency Standard. NBS now had the means of setting up an atomic time scale by counting the cycles or oscillations of this frequency standard using some reference base as a starting point in the counting process. However, in itself, an atomic time scale is useful primarily for scientific purposes only. On the other hand, the world's time scales which serve the needs of navigation and astronomical observations, or to determine the civil day or year, are based on the Earth's rotation on its axis or its rotation around the Sun. The two time scales differ and thus diverge; however, procedures were established for periodically relating the two within stated limits [89].

From the welter of possible time scales, NBS presently maintains two to serve its own needs and to be most useful to the Nation. These are the AT (NBS) or Atomic Time Scale, and the UTC (NBS) or Coordinated Universal Time and are based on an ensemble of continuously running cesium clocks [90].<sup>109</sup> NBS atomic clocks directly contribute to the world's uniform time scale, the International Atomic Time Scale (TAI) maintained by the Bureau International de l'Heure (BIH) in Paris, France. By international agreement, beginning on January 1, 1972, the UTC scale has differed from the International Atomic Time Scale (TAI) by an integral number of seconds. The first adjustment of the UTC scale came on June 30, 1972, with the addition of a "leap second" [91]. It was followed on December 31, 1972, with a second one. The AT (NBS) atomic time scale serves as the base or reference scale for NBS and is not normally adjusted.

The cesium beam equipment used as the NBS Frequency Standard does not lend itself for direct use as a time measurement system (clock). In consequence, an ensemble of clocks has served as the timekeeping devices (working standards) which, compared with the cesium beam Frequency Standard, provided for the AT (NBS) and UTC (NBS) time scales. Initially, this ensemble started with three quartz crystal oscillators. Later, two rubidium gas cells were added. The ensemble then consisted of nine commercial-type cesium beam standards. During 1975 the NBS-4 primary standard was modified for clock operation and showed a performance for stability and accuracy superior to that of the ensemble of nine commercial atomic clocks. Since joining the "elite" NBS clock ensemble it receives heavy weighting because of its superior performance and, as a result, the NBS time scale generation shows improvement.

The method of statistically combining all of the comparison processes and stabilities of an atomic time scale becomes quite involved. The computed atomic clock scale has been referred to as a "paper" time scale. But the complexity of the measurement system and the number of individual clocks available are such that elegant statistical methods must be resorted to for optimum performance of the time scale. For technical details of the procedures that have been developed at NBS for timekeeping by atomic frequencies, the reader is referred to fairly recent publications with an accompanying list of references [93,94].

## 13. Contributors to recent programs

In 1965 James A. Barnes became the acting chief of the Atomic Frequency and Time Interval Section until he became chief of the Time and Frequency Division in 1967.<sup>110</sup> It was then that Donald Halford became chief of the section and directed the research until November 1972 when the section was dissolved and team projects established. In 1974 the familiar section structure was reestablished with two sections relating to the frequency and time program: the Frequency-Time Standards Section with Helmut W. Hellwig as chief and the Time and Frequency Services Section with Roger E. Beehler as chief. Engaged in the various research programs with Halford and Hellwig were David W. Allan, James E. Gray,

<sup>109</sup> To obtain a unified time system for the United States based upon the "timekeeping" systems of NBS and the U.S. Naval Observatory, on October 1, 1968 the two systems were synchronized within almost 1 microsecond to attain a new accuracy for the Nation's Coordinated Universal Time (UTC) [92].

<sup>110</sup> Barnes received the Department of Commerce Silver Medal for Meritorious Service in 1965 "for the establishment of an atomic time scale of unsurpassed accuracy and for contributions in the area of atomic frequency standards and spectral analysis of signal generators of high stability."

David J. Glaze, Stephen Jarvis, Jr., Howard Machlan, Allan S. Risley, Fred L. Walls, David A. Howe, and John Shoaf. Laboratory assistance has been given by Howard E. Bell, Henry F. Salazar, Jorge L. Valega, and Arthur E. Wainright. Guest workers on a yearly program basis have been Andrea DeMarchi of Italy, Alain Geutrot of France, Peter Kartaschoff of Switzerland, and Kazuyuki Yoshimura of Japan.

#### 14. NBS celebrates 25th anniversary of first atomic clock

With passage of the years there came an appropriate time that NBS could justly set an anniversary occasion for recognizing the accomplishment of the Bureau's development of the first atomic clock. Although August 12, 1948, was the date of the first operation of the ammonia-cell atomic clock and January 6, 1949, the date of its public announcement, for reasons of a convenient date, February 22, 1974, was selected for the 25th anniversary recognition of the initial development of the atomic clock. Fittingly, the Boulder Laboratories was host to the anniversary program, for in 1954 the atomic frequency standards program was moved to Boulder [95].

Five short talks were presented at the morning program.<sup>111</sup> Two speakers, Dr. Condon, former director of NBS, and Dr. Lyons, who developed the first atomic clock, had been speakers at the public announcement ceremonies of a quarter century before (see pp. 293-295). Charles Sawyer, former Secretary of the Department of Commerce, who also spoke at the 1949 announcement ceremonies, was expected to attend the 25th anniversary but was prevented from coming to Boulder at the last moment. A significant statement was made by Lyons in closing his presentation, in referring to the work on atomic frequency standards by the present group at Boulder Laboratories:

. . . These people have done an outstanding job in a field that is already very sophisticated and where it is difficult to push out further. But they have been doing that, and they have been creatively looking at all possible directions to push the frontiers out further. So that the time may come when we won't be so very far from a fundamental and rather exciting limitation of nature itself, which is the famous quantum-mechanical uncertainty principle. And really, they're not so far, I believe, from actually reaching that limit.

On display in the lobby of the Radio Building was the original ammonia-cell atomic clock, very nearly in its original form of 25 years before. Also on display were exhibits on timekeeping through the centuries, literally "A Walk Through Time," the title of a brochure that was made available for distribution. The entire event, as well as the scientific world, was saddened by the death of Dr. Condon a month later.

---

<sup>111</sup> Speakers at the morning program, February 22, 1974, of the "25th Anniversary Celebration of Atomic Clocks" were:

B. W. Birmingham, Deputy Director, Institute for Basic Standards, National Bureau of Standards and Head of the Boulder, Colorado Laboratories—"Welcome and Introduction"

Dr. Richard W. Roberts, Director, National Bureau of Standards—"Atomic Clocks in Perspective"

Dr. Betsy Ancker-Johnson, Assistant Secretary of Commerce for Science and Technology—"Promises and Fulfillment of Atomic Timekeeping"

Dr. E. U. Condon, Director, National Bureau of Standards in 1949—"Why the Atomic Clock Was Developed"

Dr. Harold Lyons, Chief, Microwave Standards Section in 1949—"How the First Atomic Clock Was Developed"

Dr. James A. Barnes, Chief, National Bureau of Standards Time and Frequency Division—"Cesium Atomic Clocks, Today and Tomorrow"



At celebration of 25th Anniversary (1974) of the world's first atomic clock, at Boulder Laboratories in Colorado, Dr. Lyons and Dr. Condon stand in front of original clock and again examine the selfsame model of ammonia molecule that was pictured in photograph of January 6, 1949. Condon died 1 month later.

## REFERENCES

- [1] Helmut Hellwig and Donald Halford, "Accurate frequency measurements: Relevance to some other areas of metrology," *Nat. Bur. Stand. (U.S.), Monogr. 140*, Ch. 7, May 1974, pp. 137-149.
- [2] J. H. Dellinger, "Reducing the guesswork in tuning," *Radio Broadcast*, Vol. 3, July 1923, pp. 241-245.
- [3] R. T. Cox, "Standard radio wavemeter, Bureau of Standards Type R70B," *J. Optical Society of America*, Vol. 6, No. 2, Mar. 1922, pp. 162-168.
- [4] Grace Hazen and Frieda Kenyon, "Primary radio frequency standardization by use of cathode-ray oscillograph," *Bur. Stand. Sci. Paper*, Vol. 19, 1923-1924, pp. 445-461.
- [5] C. B. Jolliffe and Grace Hazen, "Establishment of radio standards of frequency by the use of a harmonic amplifier," *Bur. Stand. Sci. Paper*, Vol. 21, 1926-1927, pp. 179-189.
- [6] Francis W. Dunmore and Francis H. Engel, "A method of measuring very short radio wave lengths and their use in frequency standardization," *Proc. IRE*, Vol. 11, No. 5, Oct. 1923, pp. 467-478.
- [7] E. L. Hall, "The standard wavemeter of the Bureau of Standards," *The Sibley J. of Engineering*, Vol. 38, No. 5, May 1924, pp. 123-126, 134.
- [8] W. G. Cady, "The piezo-electric resonator," *Proc. IRE*, Vol. 10, No. 2, Apr. 1922, pp. 83-114.
- [9] August Hund, "Uses and possibilities of piezoelectric oscillators," *Proc. IRE*, Vol. 14, No. 4, Aug. 1926, pp. 447-469.
- [10] V. E. Heaton and W. H. Brattain, "Design of a portable temperature-controlled piezo oscillator," *Proc. IRE*, Vol. 18, No. 7, July 1930, pp. 1239-1246. (Also published in the Mar. 1930 issue of the *J. Res. Bur. Stand. (U.S.)*)
- [11] W. D. George, "The testing of frequency monitors for the Federal Radio Commission," *Proc. IRE*, Vol. 22, No. 4, Apr. 1934, pp. 449-456.

- [12] J. H. Dellinger, "The status of frequency standardization," *Proc. IRE*, Vol. 16, No. 5, May 1928, pp. 577-590 plus discussion.
- [13] "New fundamental frequency standard," *Bur. Stand. (U.S.), Tech. News Bull.*, May 1930, p. 43.
- [14] Elmer L. Hall, Vincent E. Heaton, and Evan G. Lapham, "The national primary standard of radio frequency," *J. Res. Nat. Bur. Stand. (U.S.)*, Vol. 14, No. 2, Feb. 1935, pp. 85-98.
- [15] *Ibid.*
- [16] "Improvements in the NBS primary standard of frequency," *Nat. Bur. Stand. (U.S.), Tech. News Bull.*, Vol. 37, No. 1, Jan. 1953, pp. 8-12.
- [17] J. M. Shaull and J. H. Shoaf, "Precision quartz resonator frequency standards," *Proc. IRE*, Vol. 42, No. 8, Aug. 1954, pp. 1300-1306.
- [18] B. E. Blair and A. H. Morgan, "Control of WWV and WWVH standard frequency broadcasts by VLF and LF signals," *Radio Science, J. Res. NBS/USNC-URSI*, Vol. 69D, No. 7, July 1965, pp. 915-928.
- [19] David H. Andrews, "LF-VLF frequency and time services of the National Bureau of Standards," *IEEE Trans. Instr. and Meas.*, Vol. IM-14, No. 4, Dec. 1965, pp. 233-237.
- [20] Benjamin F. Husten and Harold Lyons, "Microwave frequency measurements and standards," *Trans. Am. Inst. Elec. Engrs.*, Vol. 67, Pt. 1, May 1948, pp. 321-328.
- [21] L. J. Rueger and A. E. Wilson, "The microwave frequency standard," *Electronics World*, Vol. 49, No. 3, Mar. 1953, pp. 5-7, 40-41.
- [22] Hoy J. Walls, "The standard-frequency set at WWV," *QST*, Vol. 8, No. 3, Oct. 1924, pp. 9-12.
- [23] L. Mickey and A. D. Martin, "Development of standard frequency transmitting sets," *J. Res. Bur. Stand.*, Vol. 12, No. 1, Jan. 1934, pp. 1-12.
- [24] W. D. George, "WWV standard frequency broadcasts," *FM and Television*, Vol. 7, No. 6, June 1947, pp. 25-27, 44.
- [25] G. H. Lester, "Experimental standard-frequency transmitting station, WWVH," *Communications*, Vol. 29, No. 9, Sept. 1949, pp. 20-23, 32-33.
- [26] "Experimental standard frequency broadcast at 60 kilocycles," *Nat. Bur. Stand. (U.S.), Tech. News Bull.*, Vol. 41, No. 7, July 1957, pp. 99-100.
- [27] J. A. Barnes, D. H. Andrews, and W. D. Allan, "The NBS-A time scale—its generation and dissemination," *IEEE Trans. Instr. and Meas.*, Vol. IM-14, No. 4, Dec. 1965, pp. 228-232.
- [28] John B. Milton, Standard Time and Frequency: Its Generation, Control, and Dissemination from the National Bureau of Standards Time and Frequency Division, *Nat. Bur. Stand. (U.S.), Tech. Note 379*, Aug. 1969, 27 pages.
- [29] D. W. Allan, J. E. Gray, and H. E. Machlan, "The National Bureau of Standards atomic time scales, generation, dissemination, stability, and accuracy," *IEEE Trans. Instr. and Meas.*, Vol. IM-21, No. 4, Nov. 1972, pp. 388-391.
- [30] "New standard frequency broadcasts," *Nat. Bur. Stand. (U.S.), Tech. News Bull.*, Vol. 44, No. 7, July 1960, pp. 120-122.
- [31] "NBS low-frequency station WWVB to broadcast international unit of time," *Nat. Bur. Stand. (U.S.), Tech. News Bull.*, Vol. 49, No. 2, Feb. 1965, p. 27.
- [32] Peter P. Vierzicke, NBS Frequency-Time Broadcast Station WWV, Ft. Collins, Colorado, *Nat. Bur. Stand. (U.S.), Tech. Note 611*, Oct. 1971, 29 pages.
- [33] Yardley Beers, "WWV moves to Colorado," *QST*, Vol. 51, Jan. 1967, pp. 11-14; Pt. II, Feb. 1967, pp. 30-36.
- [34] D. D. Davis, Byron E. Blair, and James F. Barnaba, "Long-term continental U.S. timing system via television networks," *IEEE Spectrum*, Vol. 8, No. 8, Aug. 1971, pp. 41-52.
- [35] "Golden anniversary of WWV," *Nat. Bur. Stand. (U.S.), Tech. News Bull.*, Vol. 57, No. 6, June 1973, pp. 140-142.
- [36] "New time rules," *Nat. Bur. Stand. (U.S.), Dimensions*, Vol. 59, No. 2, Feb. 1975, pp. 40-41.
- [37] J. A. Barnes and R. E. Beehler, Report on the 1975 Survey of Users of the Services of Radio Stations WWV and WWVH, *Nat. Bur. Stand. (U.S.), Tech. Note 674*, Oct. 1975, 91 pages.
- [38] "Atomic clocks, international travelers," *Nat. Bur. Stand. (U.S.), Tech. News Bull.*, Vol. 56, No. 10, Oct. 1972, p. 233.
- [39] J. L. Jespersen, George Kamas, Lawrence E. Gatterer, and Peter F. MacDoran, "Satellite VHF transponder time synchronization," *Proc. IEEE*, Vol. 56, No. 7, July 1968, pp. 1202-1208.
- [40] D. W. Hanson and W. F. Hamilton, Time and Frequency Broadcast Experiments from the ATS-3 Satellite, *Nat. Bur. Stand. (U.S.), Tech. Note 645*, Nov. 1973, 115 pages.
- [41] NBS, "At the signal...via satellite time," *Nat. Bur. Stand. (U.S.), Dimensions*, Vol. 58, No. 4, Apr. 1974, p. 94.
- [42] "Time dissemination and clock synchronization via television," *Nat. Bur. Stand. (U.S.), Tech. News Bull.*, Vol. 54, No. 6, June 1970, pp. 125-126.
- [43] *ibid.*
- [44] John B. Milton, Standard Time and Frequency: Its Generation, Control, and Dissemination from the National Bureau of Standards Time and Frequency Division, *Nat. Bur. Stand. (U.S.), Tech. Note 379*, Aug. 1969, 27 pages.
- [45] D. D. Davis, Byron E. Blair, and James F. Barnaba, "Long-term continental U.S. timing system via television networks," *IEEE Spectrum*, Vol. 8, No. 8, Aug. 1971, pp. 41-52.
- [46] "Color TV used to calibrate oscillators," *Nat. Bur. Stand. (U.S.), Tech. News Bull.*, Vol. 58, No. 8, Aug. 1974, pp. 188-189.
- [47] Special issue on Time and Frequency, *Proc. IEEE*, Vol. 60, No. 5, May 1972.
- [48] Byron E. Blair, ed., Time and Frequency: Theory and Fundamentals, *Nat. Bur. Stand. (U.S.), Monogr. 140*, May 1974, 459 pages.

- [49] Wilbert F. Snyder, "Lord Kelvin on atoms as fundamental natural standards (for base units)," *IEEE Trans. Instr. and Meas. (Correspondence)*, Vol. IM-22, No. 1, Mar. 1973, p. 99.
- [50] John M. Richardson, "Time and its inverse," *Science and Technology*, Vol. 1, No. 6, June 1962, pp. 54-61.
- [51] R. E. Beehler, "A historical review of atomic frequency standards," *Proc. IEEE*, Vol. 55, No. 6, June 1967, pp. 792-805.
- [52] Harold Lyons, "Microwave frequency standards," *Phys. Rev.*, Vol. 74, No. 9, Nov. 1, 1948, p. 1203. An invited paper of the Washington Meeting, American Physical Society, May 1, 1948. Noted by title only.
- [53] Atomic Clock Developed by the National Bureau of Standards, *NBS Technical Report General*, TRG-6057, Jan. 6, 1949.
- [54] The Atomic Clock, an Atomic Standard of Frequency and Time, *NBS Technical Report 1320*, Jan. 1949.
- [55] Harold Lyons, "The atomic clock," *Instruments*, Vol. 22, No. 2, Feb. 1949, pp. 133-135, 174.
- [56] "The atomic clock, an atomic standard of frequency and time," *Nat. Bur. Stand. (U.S.), Tech. News Bull.*, Vol. 33, No. 2, Feb. 1949, pp. 17-24.
- [57] Harold Lyons, "Microwave spectroscopic frequency and time standards," *Electrical Engineering*, Vol. 68, Mar. 1949, p. 251 (abstract only).
- [58] Harold Lyons, "Atomic clocks," *Scientific American*, Vol. 196, No. 2, Feb. 1957, pp. 71-82.
- [59] Harold Lyons, "The atomic clock—A universal standard of frequency and time," *The American Scholar*, Vol. 19, No. 2, Spring 1950, pp. 159-168.
- [60] Harold Lyons, "Microwave spectroscopic frequency and time standards," *URSI Proc. IXth General Assembly* (Zurich, Switzerland, Sept. 11-12, 1950—Commission I), Vol. VIII, Pt. II, Paper No. 91, 1950 (Sec. Gen. of URSI, Brussels, Belgium), pp. 47-57.
- [61] B. F. Husten, "Improved NBS ammonia clock," *Proc. IRE*, Vol. 39, No. 2, Feb. 1951, p. 208 (abstract only).
- [62] Harold Lyons, "Spectral lines as frequency standards," *Annals of the New York Academy of Sciences*, Vol. 55, Art. 5, Nov. 1952, pp. 831-871.
- [63] John M. Richardson, "Experimental evaluation of the oxygen microwave absorption as a possible atomic frequency standard," *J. Appl. Phys.*, Vol. 29, No. 2, Feb. 1958, pp. 137-145.
- [64] Harold Lyons, "Microwave frequency dividers," *J. Appl. Phys.*, Vol. 21, No. 1, Jan. 1950, pp. 59-60.
- [65] Helmut Hellwig, Frequency Standards and Clocks: A Tutorial Introduction, *Nat. Bur. Stand. (U.S.), Tech. Note 616*, Apr. 1972, 65 pages.
- [66] A. S. Risley, The Physical Basis of Atomic Frequency Standards, *Nat. Bur. Stand. (U.S.), Tech. Note 399*, Apr. 1971, 54 pages.
- [67] J. E. Sherwood, Harold Lyons, R. H. McCracken, and P. Kusch, "High frequency lines in the hfs spectrum of cesium," *Phys. Rev.*, Vol. 86, No. 4, May 15, 1952, p. 618 (abstract only). Presentation at Annual Meeting of American Physical Society, New York City, Feb. 2, 1952.
- [68] R. D. Huntoon and U. Fano, "Atomic definition of primary standards," *Nature*, Vol. 166, July 29, 1950, pp. 167-168.
- [69] R. C. Mockler, J. Barnes, R. Beehler, H. Salazar, and L. Fey, "The ammonia maser as an atomic frequency and time standard," *IRE Trans. Instr.*, Vol. I-7, No. 3-4, Dec. 1958, pp. 201-202.
- [70] J. A. Barnes and R. C. Mockler, "Power spectrum and its importance in precise frequency measurements," *IRE Trans. Instr.*, Vol. I-9, No. 2, Sept. 1960, pp. 149-155.
- [71] R. C. Mockler, R. E. Beehler, and C. S. Snider, "Atomic beam frequency standards," *IRE Trans. Instr.*, Vol. I-9, No. 2, Sept. 1960, pp. 120-132.
- [72] "Atomic frequency standards," *Nat. Bur. Stand. (U.S.), Tech. News Bull.*, Vol. 45, No. 1, Jan. 1961, pp. 8-10.
- [73] R. E. Beehler, R. C. Mockler, and C. S. Snider, "A comparison of atomic beam frequency standards," *Nature*, Vol. 187, Aug. 20, 1960, pp. 681-682.
- [74] NBS, "National standards of time and frequency in the United States," *Proc. IRE (Correspondence)*, Vol. 48, No. 1, Jan. 1960, pp. 105-106.
- [75] R. E. Beehler, R. C. Mockler, and J. M. Richardson, "Cesium beam atomic time and frequency standards," *Metrologia*, Vol. 1, No. 3, July 1965, pp. 114-131.
- [76] R. E. Beehler and D. J. Glaze, "The performance and capability of cesium beam frequency standards at the National Bureau of Standards," *IEEE Trans. Instr. and Meas.*, Vol. IM-15, No. 1-2, Mar.-June 1966, pp. 48-55.
- [77] D. J. Glaze, "Improvements in atomic cesium beam frequency standards at the National Bureau of Standards," *IEEE Trans. Instr. and Meas.*, Vol. IM-19, No. 3, Aug. 1970, pp. 156-160.
- [78] David J. Glaze, et al., "Accuracy evaluation and stability of the NBS primary frequency standards," *IEEE Trans. Instr. and Meas.*, Vol. IM-23, No. 4, Dec. 1974, pp. 489-501.
- [79] R. E. Beehler and D. J. Glaze, "Evaluation of a thallium atomic beam frequency standard at the National Bureau of Standards," *IEEE Trans. Instr. and Meas.*, Vol. IM-15, No. 1-2, Mar.-June 1966, pp. 55-58.
- [80] Helmut Hellwig, et al., "Measurement of the unperturbed hydrogen hyperfine transition frequency," *IEEE Trans. Instr. and Meas.*, Vol. IM-19, No. 4, Nov. 1970, pp. 200-209.
- [81] Helmut Hellwig and Howard E. Bell, "Some experimental results with an atomic hydrogen beam frequency standard," *Metrologia*, Vol. 8, No. 2, Apr. 1972, pp. 96-98.
- [82] Helmut W. Hellwig, "Atomic frequency standards: A survey," *Proc. IEEE*, Vol. 63, No. 2, Feb. 1975, pp. 212-229.
- [83] B. W. Parkinson, "Global Positioning System an evolutionary research and development program," *Proc. Sixth Annual Precise Time and Time Interval (PTTI) Planning Meeting* (held at U.S. Naval Research Laboratory, Washington, D.C.), Dec. 3-5, 1974, pp. 465-495.
- [84] L. Essen and J. V. L. Parry, "An atomic standard of frequency and time interval," *Nature*, Vol. 176, Aug. 13, 1955, pp. 280-282.
- [85] E. C. Bullard, "Definition of the second of time," *Nature*, Vol. 176, Aug. 13, 1955, p. 282.

- [86] J. Terrien, "The manner in which progress is made in the standards for physical measurement," *Metrologia*, Vol. 4, No. 4, Oct. 1968, pp. 190-195.
- [87] H. Hellwig, "Areas of promise for the development of future primary frequency standards," *Metrologia*, Vol. 6, No. 4, Oct. 1970, pp. 118-126.
- [88] W. Markowitz, R. Glen Hall, L. Essen, and J. V. L. Parry, "Frequency of cesium in terms of ephemeris time," *Phys. Rev. Letters*, Vol. 1, No. 1, Aug. 1, 1958, pp. 105-107.
- [89] "New time rules," *Nat. Bur. Stand. (U.S.), Dimensions*, Vol. 59, No. 2, Feb. 1975, pp. 40-41.
- [90] John B. Milton, Standard Time and Frequency: Its Generation, Control, and Dissemination by the National Bureau of Standards, *Nat. Bur. Stand. (U.S.), Tech. Note 656*, June 1974, 21 pages.
- [91] E. J. Kahn, Jr., "The leap second," *The New Yorker*, Vol. 49, No. 27, Aug. 27, 1973, pp. 50, 52, 54-58.
- [92] "Nation Gets Unified Time System," *Nat. Bur. Stand. (U.S.), Tech. News Bull.*, Vol. 53, No. 2, Feb. 1969, p. 34.
- [93] James Barnes, "The development of an international atomic time scale," *Proc. IEEE*, Vol. 55, No. 6, June 1967, pp. 822-826.
- [94] David W. Allan, James E. Gray, and H. E. Machlan, "The National Bureau of Standards atomic time scales: Generation, dissemination, stability, and accuracy," *IEEE Trans. Instr. and Meas.*, Vol. IM-21, No. 4, Nov. 1972, pp. 388-391.
- [95] "Atomic timekeeping 25 years later," *Nat. Bur. Stand. (U.S.), Dimensions*, Vol. 58, No. 3, Mar. 1974, pp. 68-69.





## Chapter IX

### NBS FACES A SECOND WORLD WAR

#### RADIO WORK IN WORLD WAR II

The suddenness of attack upon the United States by Japan at Pearl Harbor on December 7, 1941, did not find the National Bureau of Standards completely disassociated from the technical developments that had already emerged from World War I. Hostilities had opened more than 2 years before, on September 1, 1939, and there had been rumblings of war several years in advance of actual hostilities. The newly organized National Defense Research Committee (NDRC) had made early overtures to NBS for development and investigations into areas related to war on a global scale and modes of warfare that involved the latest technological advances.

This was no new experience to some of the NBS employees. However, in World War I they had experienced the conditions of wartime operation for a much shorter time than during World War II—the war period for the United States was much less and NBS was but little engaged in any war activity in advance of hostilities. As a reflective thought on the experience by NBS in World War I one reads in the Introduction to the historical account, *War Work of the Bureau of Standards* [1]:

It is hoped that those who read the following pages will find some material of assistance to them in their work, as it is the belief of this Bureau that many of the problems—the solution of which was undertaken as a war measure—are of equal or even greater importance in the arts of peace. Their solution was one of the real benefits resulting from the war.

Possibly those who experienced the World War II period at NBS had a somewhat different viewpoint—if so, it was not expressed in an account of the latter.

The historical account of the work of NBS in World War II was prepared by Dr. Lyman J. Briggs shortly after cessation of hostilities and after he became Director Emeritus. On October 11, 1945, Henry A. Wallace, Secretary of Commerce, wrote to Dr. Briggs stating:

. . . I very much wish that you could prepare at your leisure, but complete in the not too distant future, an account of the part played by the Bureau of Standards in winning the war. You owe it to yourself, to the Bureau, to the Department, and to the country to shake off some of your customary modesty and let the world know something of what was done.

With the help of many contributors, Dr. Briggs wrote *NBS War Research—The National Bureau of Standards in World War II* [2]. Although completed by, and dated August 15, 1946, a year after hostilities ceased, it was not issued until September 1949. Even at that late date and for a period thereafter, certain radio projects of the war period remained in a security classification and could not be revealed in their full scope. This was particularly true of work performed by the Radio Section for the Navy Department. In this present account, written nearly 30 years later, the nature of these projects can be fully revealed—see section on Radar Countermeasures.<sup>1</sup>

---

<sup>1</sup> Because much of the material in this chapter has been written for the first time for publication due to the lifting of secrecy, there is considerable detail involved in describing the various projects and in listing the personnel who participated.

The historical account by Dr. Briggs gives considerable coverage in the area of "radio weather"—the work of the Interservice Radio Propagation Laboratory (IRPL). In his opening paragraphs Dr. Briggs stated:

Perhaps the four most significant as well as striking projects in which the Bureau was engaged during the war were the atomic bomb project, the proximity fuze, guided missiles, and "radio weather." Each represented a major scientific effort, and in each the Bureau took an active part in collaboration with other agencies.

Immediately after the Pearl Harbor attack and declarations of war, arrangements were made for the rapid shutting down of any of the Radio Section's transmitters as might be required, including the standard frequency and the ionosphere transmitters. However, such action was not required for the duration of the war.

For a broader perspective of the Bureau's work in World War II in relation to the period leading up to the war period and the period that followed, the reader is referred to Cochrane's history, *Measures for Progress* [3]. In chapter VII—World War II Research (1941-45)—Cochrane presents a fairly extensive and an interesting account of the role played by NBS. Chapter VI sets the stage for chapter VII, and chapter VIII relates the tapering-off cycle after the high pitch of activity during the war.

## THE RADIO SECTION IN RELATION TO NDRC OF OSRD<sup>2</sup>

Unlike wars of old, modern military operations require close association with the prevailing technology and there must be planning by the military for future developments in technology. So it was that the Council of National Defense was created in 1916 during the World War I period. This Council of six Departmental secretaries (War, Navy, Interior, Agriculture, Commerce, Labor) created the National Defense Research Committee (NDRC) on June 27, 1940, with the approval of President Roosevelt. Dr. Vannevar Bush, president of the Carnegie Institution of Washington, was appointed chairman. The committee was directed to correlate and support scientific research on the mechanisms and devices of warfare, except those relating to problems of flight included in the field activities of the National Advisory Committee for Aeronautics (NACA). All operations would be carried on by contract.

Five divisions were created within NDRC, of which Division C (Communications and Transportation) would have its influence on the Radio Section through Section C-1 (Communications) under the chairmanship of Dr. C. B. Jolliffe.<sup>3</sup> Dr. Dellinger was designated a member of Section C-1 in October 1940. This position carried over into the period when NDRC became a part of OSRD.

The Office of Scientific Research and Development (OSRD) was created by Executive order on June 28, 1941, as an organization of larger scope than NDRC to:

1. include engineering development;
2. correlate research with other groups such as NACA;
3. expand military medicine.

OSRD was headed up by Vannevar Bush as director, with the chairmanships of divisions and sections of NDRC carrying over into OSRD. NDRC became an advisory group to OSRD, but the total organization was usually referred to as NDRC of OSRD. With the new organization came Division 13, entitled Electrical Communication, with Jolliffe as chief. Within this division was organized a section designated as Section 13.2, Radio Propagation Problems, with Dellinger as chief. Dellinger also served as a member of the Direction-Finder Committee.

---

<sup>2</sup> NDRC (National Defense Research Committee) of OSRD (Office of Scientific Research and Development). For a detailed account of these organizations in World War II see [4]. Also, see [5] for the story of developments in weapons and other technical advances in World War II by the OSRD.

<sup>3</sup> Dr. Charles B. Jolliffe was formerly of the Radio Section during the period of 1922 to 1930. He was a radio engineer of the RCA Laboratories at the time of his appointment to the NDRC as vice-chairman of Division C. Later he was to become executive vice-president and technical director of RCA and the RCA Laboratories.

Later in the war period a new group, Division 15—Radio Coordination, was organized with Jolliffe as a member. Within this division was organized a Committee on Propagation on which Dellinger and T. J. Carroll served as members.<sup>4</sup>

During the war period of 1941 through 1945 the OSRD assigned and supported many war-related development projects at NBS in areas of Bureau specialization.

## THE INTERSERVICE RADIO PROPAGATION LABORATORY<sup>5</sup>

By 1939 a sufficient amount of knowledge of the ionosphere had been gained by the Radio Section that the step was taken as a published statement to predict the effect of the ionosphere upon radio propagation for a period of 1 month.<sup>6</sup> This first step was for rather simple and limited situations of radio transmission, but progress had been made and it was opening the door to a new application of scientific knowledge.

During the period 1941-1942 the NDRC requested the Radio Section to prepare a "radio transmission handbook." The first book, entitled Radio Transmission Handbook, Frequencies 1000 to 30,000 KC, was issued January 1, 1942, and followed by others.

During the summer of 1942 the Interservice Radio Propagation Laboratory (IRPL) was established as a part of the operations of the Radio Section by order of the U.S. Joint Chiefs of Staff acting through the Wave Propagation Committee of the U.S. Joint Communications Board. The IRPL was directed to centralize radio propagation data and furnish the resulting information to the armed services. Dr. Dellinger and Dr. Newbern Smith directed the operations of IRPL (see ch. XI).

## HIGH-FREQUENCY DIRECTION-FINDER RESEARCH

The development of radio frequency direction finders had its beginning in the early 1900's as an outgrowth of observing the directional characteristics of some of the early forms of antennas. Over the ensuing years it was found that direction-finding (d-f) antennas were subject to various errors and many designs were developed to increase the accuracy of directional bearings [6]. Further improvements came slowly during the 15 years preceding World War II. Within the Communications Division (Division 13, later known as Electrical Communication), NDRC of OSRD, a Direction-Finder Committee was formed of which Dellinger was one of five members. This committee awarded many contracts during the war period, several of which were given to the National Bureau of Standards. One of these contracts, Research Project C-18, High-Frequency Direction-Finder Apparatus Research, approved April 1941, received development by Harry Diamond, as project leader, Harold Lifschutz,<sup>7</sup> and La Verne M. Poast, all of the Radio Section. Kenneth A. Norton of the Federal Communications Commission gave a substantial contribution to this project with his comprehensive theoretical study of the polarization of downcoming ionospheric radio waves [7].<sup>8</sup> Six reports were submitted to the NDRC during the course of the investigation. These reports are listed in the bibliography associated with the summary and final report published by NDRC in 1946 [8].

Work on the project covered the period of April 1941 through June 1942. The frequency range was from 2 to 30 MHz so that emphasis was placed on the problems of direction finding associated with ionospheric radio waves. A direction finder can be responsive to both

---

<sup>4</sup> Upon organization of the CRPL in 1946 Dr. Thomas J. Carroll was appointed chief of the Basic Microwave Research Section.

<sup>5</sup> The IRPL came into existence from the exigencies of World War II. But it was inevitable that many of its functions, operations, and achievements would have come into existence within the not too distant future had there been no war. A detailed account of this technical growth appears in a more continuous pattern by incorporation into chapter XI. The story of the IRPL covers the transition period between the ionospheric propagation work of the 1930's and the organization of the CRPL in 1946.

<sup>6</sup> Refer to date of February 17, 1939, Chronology, chapter I. Also, see chapter VII, p. 236.

<sup>7</sup> Harold Lifschutz changed his surname to Lyons by court order in 1944.

<sup>8</sup> Kenneth A. Norton had been in the Radio Section during the period 1929-1934, and in 1946 rejoined NBS with the formation of CRPL.

vertical and horizontal polarization, and a combination of both polarizations in a downcoming ionospheric wave can result in more or less random combinations of polarizations. However, in general, the average of a series of swinging bearings will give a bearing that is close to the true bearing if the swinging is caused only by polarization error.

For the study of polarization errors a method was developed having advantages over previously used methods and was applicable to many d-f antenna systems. In this method a figure-of-merit designated as the "pickup ratio" was introduced. The pickup ratio was defined as the ratio of the pickup factor,  $h$ , of the d-f antenna system for desired radiation field components to its pickup factor,  $k$ , for the undesired field components. Knowing the pickup ratio and the directional pattern of the response of the d-f system, it was possible to determine polarization errors for downcoming skywaves. Advantages of this method were that measurements could be made near the ground and that it yielded the maximum polarization error. The figure-of-merit for the polarization error was independent of ground constants and of the height of the direction finder above the ground.

Upon development of a theoretical basis and experimental technique for the determination of errors of measurement in direction finders, a group of direction-finder systems of different designs was examined in different localities.<sup>9</sup>

It was found that d-f systems using loop-antenna elements showed much lower polarization errors and site errors than those using open-antenna elements. During the study a new method for rapidly measuring the ground constants of a site was developed.

In the seven-volume history prepared by the OSRD for its scientific accomplishments in World War II, the commendation was made in the volume on Applied Physics [9] that the two reports cited above, references [7] and [8], had become of great importance in direction-finder developments. The history states: "A great deal of the subsequent direction-finder development, not only within NDRC but within the Allied Services as well, is based upon the fundamental theories expounded in these two reports." Of Norton's report the history states that it was: "a thorough development of the physics of ionosphere reflections, (and) has become a classic on the subject."

## CORRELATION OF DIRECTION-FINDING ERRORS WITH IONOSPHERE MEASUREMENTS

Although observations with direction finders were suspect under varied conditions of reflection of signals from the ionosphere, there had been no coordinated study made of this disturbing factor previous to World War II. The prospect of a global war with its need of long-distance communication and navigation made it a necessity that d-f errors be better understood and be minimized by correction. A coordinated study of the problem on an extended geographical scale was in order.

After a series of conferences within Division C of the NDRC, beginning in January 1941, plans were formulated and a contract made with NBS (Research Project C-13) for systematic observations of ionosphere characteristics and of d-f errors in the range of 2 to 30 MHz. The work would be coordinated by the Radio Section. Observations of the ionosphere and field intensity measurements were made at five stations located at: Washington, D.C. (Meadows, Md); College, Alaska; Baton Rouge, La.; Palo Alto, Calif.; and Puerto Rico. NBS also had the cooperation of the Louise A. Boyd Arctic Expedition in the summer of 1941 to make observations in waters west of Greenland. It was the first time that comprehensive data on the ionosphere were obtained in the vicinity of the north magnetic pole (see ch. VII, p. 225). Signals from a large number of radio stations spread over the world were observed at these several stations for a period of 1 year (July 1, 1941, through June 30, 1942). Data were also obtained at six d-f stations of the Navy and eight d-f stations of the Federal Communications Commission.

Research Project C-13 with NDRC closed out on June 30, 1942. The final report, prepared by Theodore R. Gilliland, was issued to the NDRC of OSRD as a Confidential

---

<sup>9</sup> 1) A rotatable, balanced-H antenna of the Adcock type, at Laurel, Md.; 2) an SCR-551-T1 installed at Ft. Monmouth, N.J.; 3) a 10-frequency Adcock system using balanced-H antennas, located at La Guardia Airport, New York City; 4) an elevated, rotatable, spaced loop-antenna system, at Laurel, Md.; and 5) a Collins CXAL direction finder installed at Cedar Rapids, Iowa.

document April 26, 1943 [10]. Much of the work was of a pioneering effort toward correlating ionosphere information for predicting transmission characteristics several months in advance. Further knowledge was gained of those conditions in the ionosphere that cause the irregularities of transmission. There was better understanding of the causes of d-f errors by the ionosphere from great-circle bearings on distant stations. The study also indicated the importance of predicting ionosphere conditions for radio communication in military operations. Much of this earlier work led to the development of the prediction service given later by the IRPL (see ch. XI).

Another project was set up in the Radio Section by the Communications Division, NDRC of OSRD, for a Coordinated Study of Correlation of High-Frequency Direction-Finder Errors with Ionospheric Conditions (Project 13.2-92) during the period July 1, 1943, through June 30, 1944. It was a cooperative project of five laboratories using d-f sites at Washington, D.C. (Sterling, Va.); College, Alaska; Palo Alto, Calif.; Puerto Rico; and Cambridge, Mass.

Measurements were made of approximately 30 radio stations scattered in direction, distance, and frequencies within the range of 6 to 19 MHz. The study provided the relationships for bearing errors, field intensities, maximum usable frequencies, skip distances, geomagnetic disturbances, absorption in the ionosphere, transmitter antenna directivity, and also the effects of sporadic-E scattering and ionosphere disturbances.

The study indicated that, at the higher frequencies, deviations from true bearing of the d-f equipment was largely due to the maximum usable frequency dropping below the predicted value. Large errors accompanied weak field intensities. Bearing inaccuracies during geomagnetic disturbances were largely associated with transmission paths across the auroral zone. With strong absorption of signals in the ionosphere, deviations of more than 50 degrees were observed on some transmission paths at the lower frequencies. The final report on this investigation was issued August 31, 1944, to the NDRC of OSRD as a Restricted document and was prepared by La Verne M. Poast [11].

## THE RADIO PROXIMITY FUZE

Along with the atomic bomb and radar, the radio proximity fuze is rated with the outstanding technical achievements of World War II. Its conception, as an aid in weaponry, came later than the early forms of radar, but development came at a very rapid pace with war breaking out in Europe.

A proximity fuze project was brought to NBS by NDRC in 1940 with the objective of investigating several principles of fuze operation. The most promising of several methods appeared to be that of the Doppler effect of reflected radio waves. The experience gained by Harry Diamond and Wilbur S. Hinman, Jr. in the development of the radiosonde in the Radio Section made them especially prepared to take part in the earliest developmental stages of the radio proximity fuze of the nonrotating type<sup>10</sup> at NBS. Dr. Allen V. Astin,<sup>11</sup> who also had experience with a type of radiosonde and with a radio telemeter method for observing cosmic rays, soon became a member of the team engaged in developing the proximity fuze. Both Diamond and Hinman served as consultants to Section A-Ordnance of NDRC early in the development stage of the proximity fuze. Hinman transferred from the Radio Section in 1941, Diamond in 1942, to join the group that was later known as the Ordnance Development Division.<sup>12,13</sup> Accounts of the development of the radio proximity fuze can be found in Briggs's historical account, NBS War Research, and Cochrane's *Measures for Progress*. Technical information on the development of the radio proximity fuze of the nonrotating type will be found in papers by Hinman and Brunetti [12], and by Page and Astin [13]; also refer to the *Technical News Bulletin* [14].

<sup>10</sup> Proximity fuzes of the nonrotating type are used in bombs, mortar shells, and rockets.

<sup>11</sup> Harry Diamond became chief of the Ordnance Development Division and retained this position until his death, June 21, 1948. Astin became chief of the Electronics and Ordnance Division, and director of NBS in 1951 (first as acting director, and then director, May 30, 1952).

<sup>12</sup> The Ordnance Development Division became known as the Electronics and Ordnance Division until 1953, Wilbur S. Hinman, Jr. becoming chief when Astin became acting associate director of NBS in 1950. In 1950 the former Electronics and Ordnance Division was divided into three divisions: Electronics, Ordnance Development, and Missile Development. In 1951 the Missile Development Division was moved to Corona, Calif., and remained with

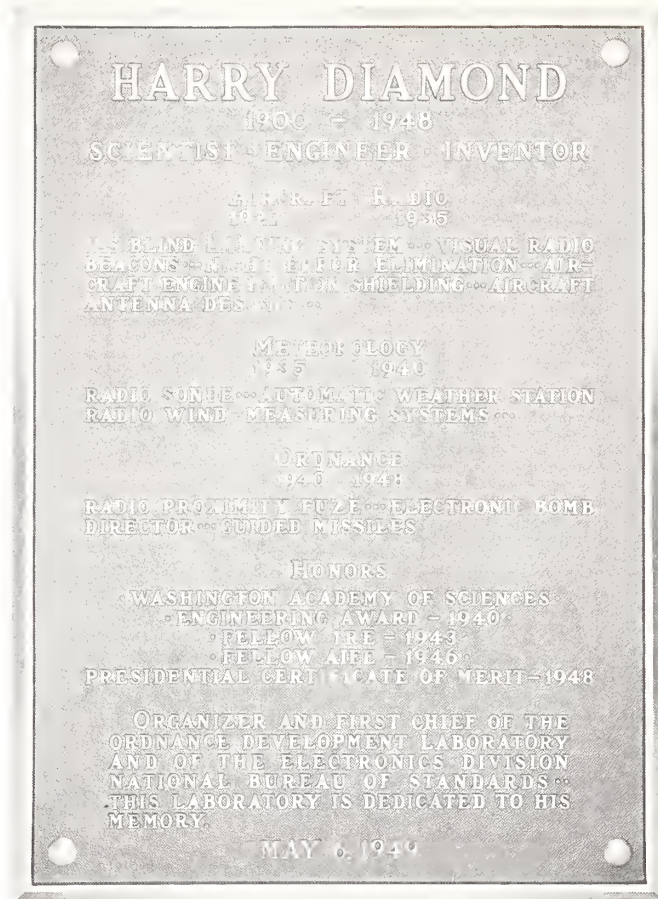

*This bronze plaque was unveiled on May 6, 1949, in a conference room at the National Bureau of Standards in memory of Harry Diamond, first chief of the Electronics and Ordnance Division.*

(Continued)

NBS until Sept. 27, 1953. In 1953 most of the NBS ordnance development activity was transferred to the Army Ordnance Corps and took on the name of the Diamond Ordnance Fuze Laboratories (DOFL), with Hinman as technical director. In 1962, after reorganization of technical services within the Army, DOFL was changed in name and became known, as it is today (1975), as the Harry Diamond Laboratories. This research and development laboratory is organized within the Army Materiel Command. Hinman retired from Government service in 1963.

At the First Honor Award Program held by the Department of Commerce on February 14, 1949, Harry Diamond was awarded, posthumously, the Gold Medal for Exceptional Service, the citation reading "for contributions to electronic ordnance, meteorological instrumentation, and radio aids to air navigation."

<sup>13</sup> Members of this research facility (now named the Harry Diamond Laboratories) and others of the friends of Harry Diamond initiated a move in 1949 to establish a suitable award program in his memory. Thus was established the Harry Diamond Memorial Award in the IRE (now the IEEE) which is one of nine IEEE Field Awards presented annually. The Award:

was established in 1949 by friends of the late Harry Diamond who felt that his professional life exemplified the highest type of scientific effort in government service. The award shall be made by the IRE (IEEE) Board of Directors on the recommendation of the appropriate Field Awards Committee and the Awards Board for outstanding technical contributions in the field of government service in any country, as evidence by publication in professional society journals. The award consists of a certificate and one thousand dollars.

Staff members of the National Bureau of Standards who have received the Harry Diamond Memorial Award for contributions in areas of radio engineering and science are the following:\* Newbern Smith (1952), W. S. Hinman, Jr. (1956), J. W. Herbstreit (1959), K. A. Norton (1960), William Culshaw (1961), James R. Wait (1964), Allen V. Astin (1970), and David M. Kerns (1978).

Note: In recognition of his early contributions to the field of radio and electronics, Diamond had been awarded fellowship in the Institute of Radio Engineers "for his contributions to the development and application of radio aids in air navigation and meteorology."

\*Three other staff members of the NBS have received the Harry Diamond Memorial Award for work not directly related to radio, namely: Chester H. Page (1974), Louis Costrell (1975), and Jacob Rabinow (1977).

## AIR-LAUNCHED AUTOMATIC WEATHER STATION

Development of the radiosonde by Diamond, Dunmore, and Hinman, beginning in 1935, led to the development of an automatic weather station, reported in 1940 [15]. During World War II, the Bureau of Ships, Navy Department, supported a program within the Radio Section for the development of an automatic weather station that could be launched from a plane and descend by parachute into enemy territory. In its first form it was designed to land on the ground and was called "Grasshopper;" in a later form the equipment was housed within a buoy for floating on water. After landing, the radio transmitter would send signals that revealed the local weather conditions at the landing site. The weather information received could be an aid in planning a military operation in the area (see pp. 137-138).



*Automatic weather station designed for descent by parachute from airplane to observe weather conditions in remote sectors of enemy territory. The sensing equipment and radio transmitter were patterned after the radiosonde that had its initial development about 7 years earlier in the Radio Section. The six "legs" of "Grasshopper" (the name selected after initial development) are shown in their folded position for carrying in bomb rack.*



*Upon contacting the ground, an explosive charge released the parachute and set "Grasshopper" in upright position stabilized by its six legs. Another charge elevated the whip antenna. An electric clock sequenced circuits for sensing temperature, barometric pressure, and relative humidity; the corresponding radio signals could be received up to 100 miles.*

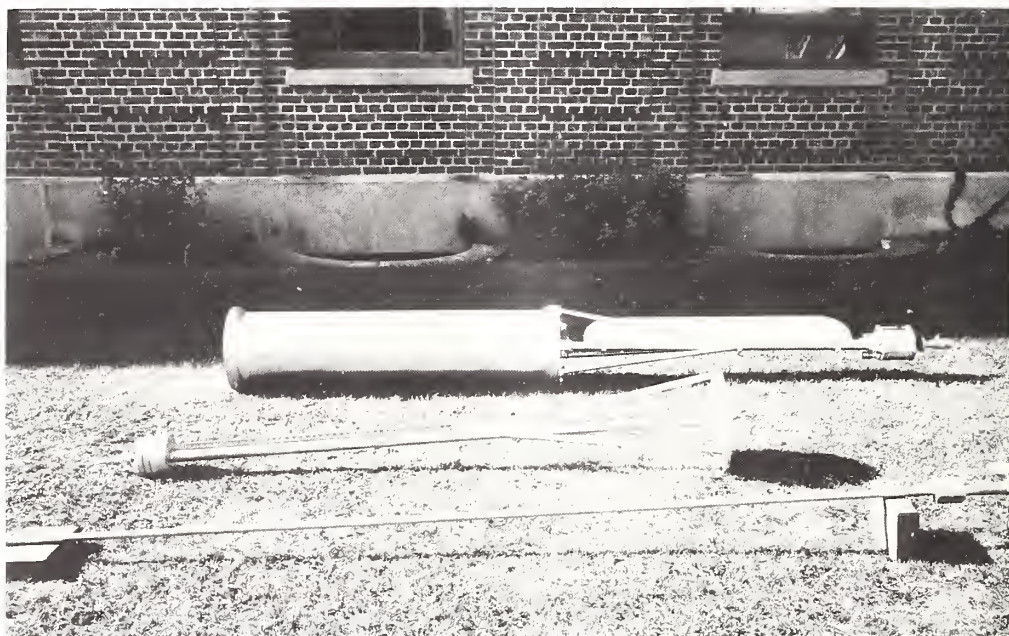

*Buoy-type automatic weather station developed for the Navy, shown here disassembled in three sections for transportation. Copied in principle after "Grasshopper," this remote weather station was the first of a series of the buoy-type developed by NBS for the Navy since World War II. Observation of wind speed and direction was an added feature. Today, these stations operate for many months at a time without servicing.*



This wartime project, carried on by Percival D. Lowell and William Hakkarinen of the Radio Section, is described in greater detail as a sequence of developments in radiometeorology in chapter VI. The May 1951 issue of the *Technical News Bulletin* gave a short account of "Grasshopper" [16].

## WIND VELOCITY MEASUREMENT BY RADAR METHOD

### 1. Pulse repeaters

In April of 1942 the Navy Department, through the Bureau of Ships and the Bureau of Aeronautics, requested NBS to further its activities in the development of radio-operated weather observation equipment. Although the Radio Section was requested to continue development of wind-velocity measurement by the phase-variation method, the Navy believed it more urgent to develop a method that could make use of radar equipment that was installed or was rapidly being installed on board Navy vessels. In particular, the Navy had in mind making use of the Mark 4 fire-control radars, although some search-type radars could also be used.

Although the Navy had requested development of a radar method of measuring wind velocity, it is interesting to note that the Radio Section had come up with essentially the same method several years earlier *sans bénéfice* military-type radars. During FY 1939 a balloon-borne, two-tube, re-emitter was designed and constructed for pulse operation at 65 MHz with a superregenerative detector. The ground-station transmitter operated at 200 MHz with pulses of about 4 microseconds in duration at a repetition rate of 1500 Hz. The receiving equipment incorporated a cathode-ray tube with a sweep circuit operating at 15 kHz. Vertical markings from the sweep circuit gave a time scale, hence a scale for determining distance to the re-emitter. With this equipment it was possible to observe the change in distance of the drifting balloon, and thus know the wind speed from the time rate-of-change of the balloon's position.<sup>14</sup>

The first pulse repeater (re-emitter) for use with the Mark 4 radar incorporated five vacuum tubes with a superregenerative detector that also served as the transmitter. A common tuned circuit (700 MHz) served for both the receiver and transmitter, thus minimizing change in carrier frequency of the radiated pulse in reference to the received signal. The bent dipole antenna made reception and transmission fairly omnidirectional.

Considerable effort went into the design and choice of a power supply. In order to minimize weight (final weight of total equipment 2 3/4 lb), yet to maintain good performance for 2 1/2 hours at temperatures ranging from +40°C to -40°C, the use of dry cells was out of the question. Perchloric acid cells (a reserve-type cell), with introduction of the electrolyte just before use, became the answer. Two batteries, one at 7.2 volts, the other at 175 volts, were required.

---

<sup>14</sup>Francis W. Dunmore, who had participated in this pulse-echo project of measuring wind velocity, filed for a patent on November 10, 1939. Patent 2,582,971 was issued on January 22, 1952, entitled "Pulse echo distance and direction finding." In addition to the pulse technique of measuring distance to the drifting balloon on a cathode-ray tube, Dunmore describes the use of a Yagi antenna to determine direction of the balloon by observing the azimuth reading on a cathode-ray tube.

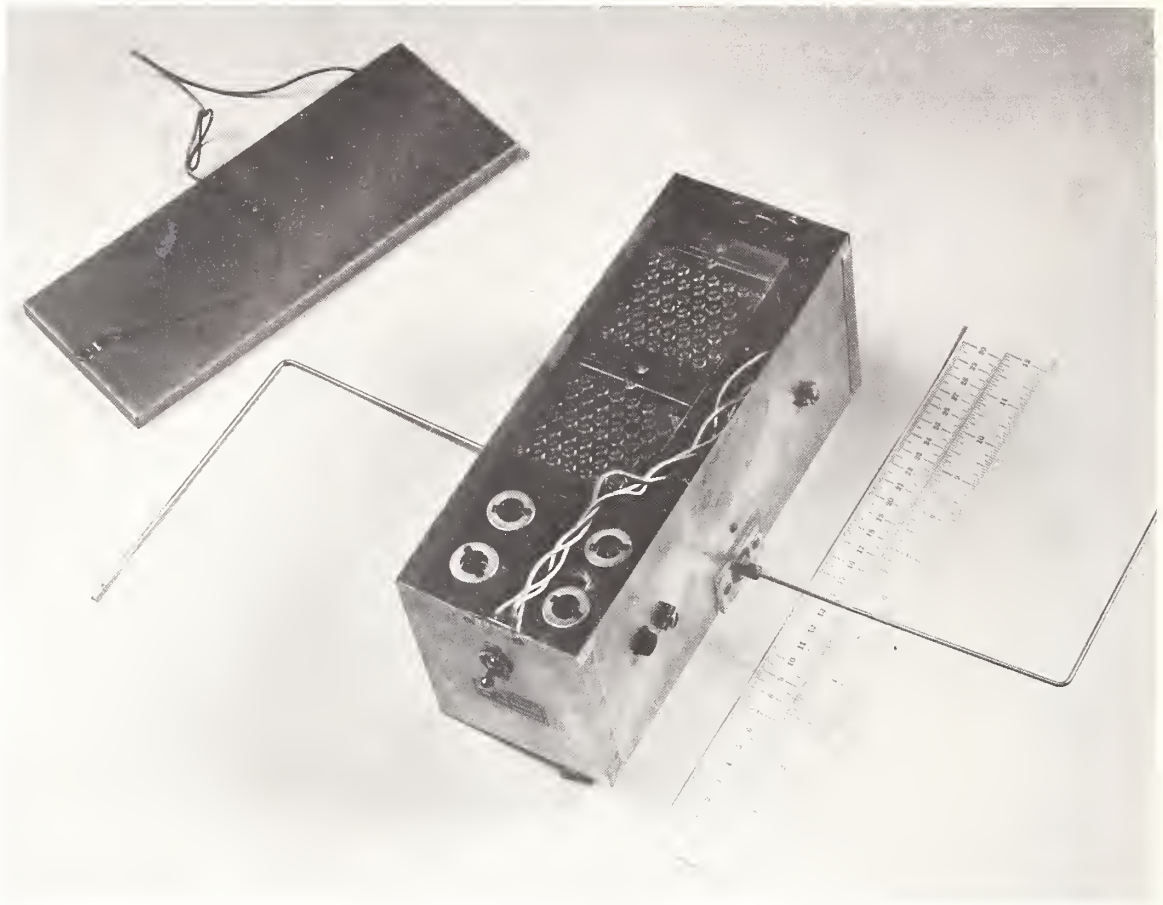

*Balloon-borne pulse repeater of 220-MHz radar signals for wind velocity measurement (wind speed and direction). The four-tube circuit served both as a receiver of the radar signal and as a transmitter, sending a repeated signal back to the radar receiver. Time rate-of-change of signal at radar receiver gave wind speed; azimuth reading gave wind direction. Perchloric-acid batteries for operation at low temperatures occupied about two-thirds of container. The bent dipole served as antenna with approximately omnidirectional characteristics.*

Some effort was given to the design of the high-voltage supply by powering a high-frequency synchronous vibrator from the low-voltage battery. However, the state-of-the-art had not progressed sufficiently at the time to give full development to this system. In the meantime several manufacturers were successful in developing a lightweight, high-voltage, perchloric acid battery that had a long shelf life.

After a series of successful field tests with a Mark 4 radar mounted at the Chesapeake Bay Annex of the Naval Research Laboratory, the pulse repeater was placed in production by a contractor and many thousands were built for the Navy. Another model was designed for use with a fire-control radar operating at 900 MHz, still another to operate with a search-type radar at 220 MHz.

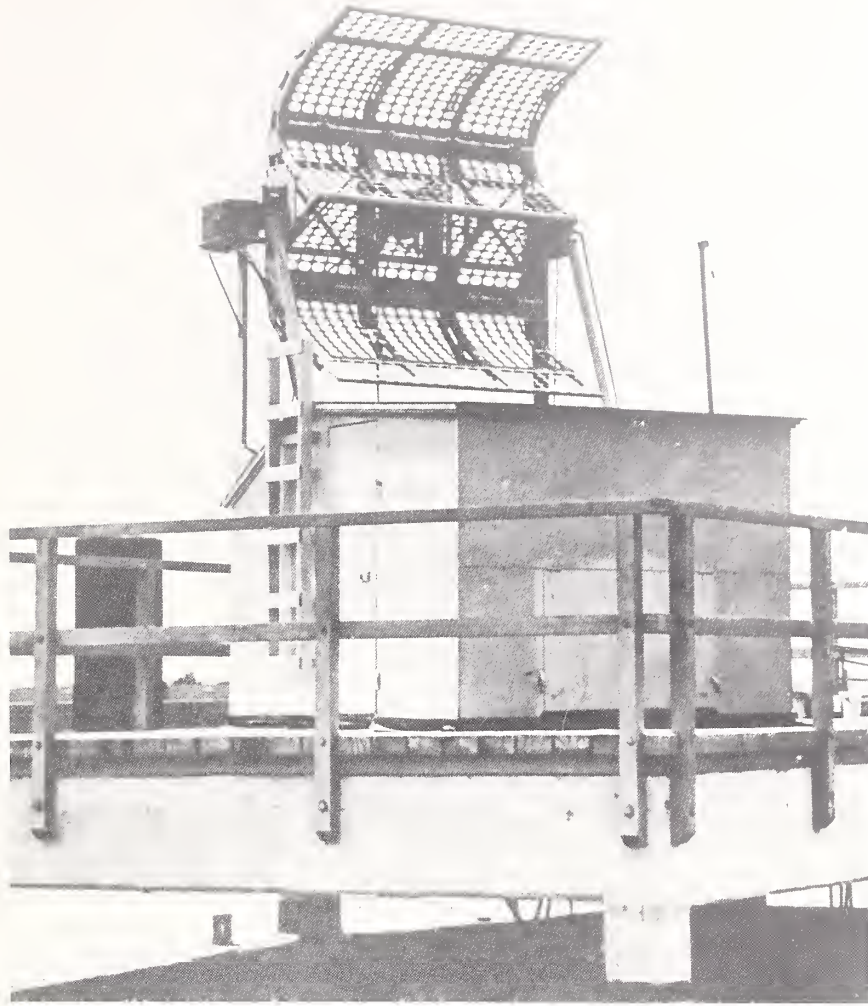

*Navy Mark 4 radar, converted for shore station operation, to measure wind velocity up to 60,000 ft by use of balloon-borne pulse repeater.*

Unlike the phase-variation scheme (see ch. VI, pp. 132-136), which required both a direction-finder and a pressure method of determining altitude, the radar technique had a built-in method of determining both azimuth angle and altitude. These features allowed the radar technique to be immediately adaptable to shipboard use.

By strapping the pulse repeater to a radiosonde and using a balloon of sufficient lifting capacity, it was possible by a single observational flight to obtain all of the essential readings for weather conditions at various altitudes in the local area. Such information was particularly valuable for ships in remote areas of the seas.

As a precaution against injuring people or damaging property, it was necessary to return the pulse repeater (and radiosonde) to earth by parachute. Upon bursting of the balloon at high altitudes, the parachute and its load dropped at a safe speed when nearing land or water.

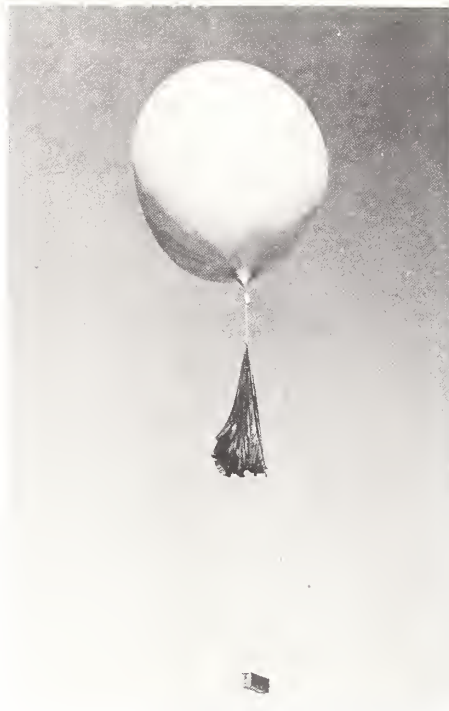

*Balloon-borne pulse repeater, attached to parachute, for determination of wind velocity to altitudes of 60,000 ft by radar method. Parachute provided for slow descent of 3-lb repeater after bursting of balloon at high altitude.*

Development on these pulse repeaters for the Navy Department continued for several years after the close of World War II. Capability of observing a flight extended out to distances of more than 100 miles, with altitudes up to 50,000 feet.

Personnel engaged in this project under the direction of Harold Lyons were Jacob J. Freeman, Wilbert F. Snyder, Emory D. Heberling, and others.

## **2. Reflectors of radar signals**

Pulse repeaters served their purpose well for wind-velocity measurement but they were quite expensive and required considerable manipulation before launching. These disadvantages were offset by the recording of strong re-emitted signals, by obtaining high-altitude observations, and by long tracking distances. In contrast, signal reflections from passive devices suspended from balloons were relatively weak, thus limiting the altitude of wind measurement (maximum tracking distances of 20 miles limited radar readings to the lower altitudes of balloon ascension due to the shorter elapsed time of flight). Difficulty in observing the weaker signals reduced the accuracy of wind-velocity determinations. Nevertheless, further study of reflectors deserved attention.

Over a period of several years a variety of passive devices were tried as reflectors, the studies being made concurrently with development of the pulse repeater. Antenna arrays of dipoles sized to the radar wavelength met with only partial success. Various geometric forms of metallic surfaces were tried, with the greatest success in the use of a multiple, cube-type, aluminum reflector.

Each cube-type cell of the assembly served as a "corner reflector" to provide a good return of the radar signal in the direction from its reception. The aluminum foil was backed with pliofilm for increased strength against tearing. A lightweight frame of balsa wood, together with cords, supported the foil. The packed assembly opened by means of a delayed-action timer after launching of the balloon. The reflector weight of 2 3/4 pounds was approximately that of a pulse repeater. These reflectors were manufactured in large quantities.<sup>15</sup>

<sup>15</sup> Francis W. Dunmore and Harold Lyons filed for a patent on a multicorner reflector on September 27, 1946. Patent 2,498,660 was issued on February 28, 1950, entitled "Collapsible multicorner reflector for ultra high frequency radiant energy." The patent states that the reflector can be carried from a free balloon and with a radar the wind velocity can be determined at all heights traversed by the balloon.

Reflectors of the 12-cube size designed for 700-MHz radars could be tracked fairly accurately out to about 20 miles. Smaller reflectors, consisting of fewer cube cells, were used for short-range observations. In order to gain altitude in a shorter time, small-size reflectors were inserted within the balloon at time of inflation to reduce drag on the balloon. Balloons were also covered with a lightweight metallic mesh. However, none of these experiments to reduce drag met with any marked success, primarily because of reduced signal return in comparison with that from the 12-cube reflectors.

Personnel of the Radio Section engaged in the radar reflection studies were Dunmore, Freeman, and Heberling, under the direction of Lyons.

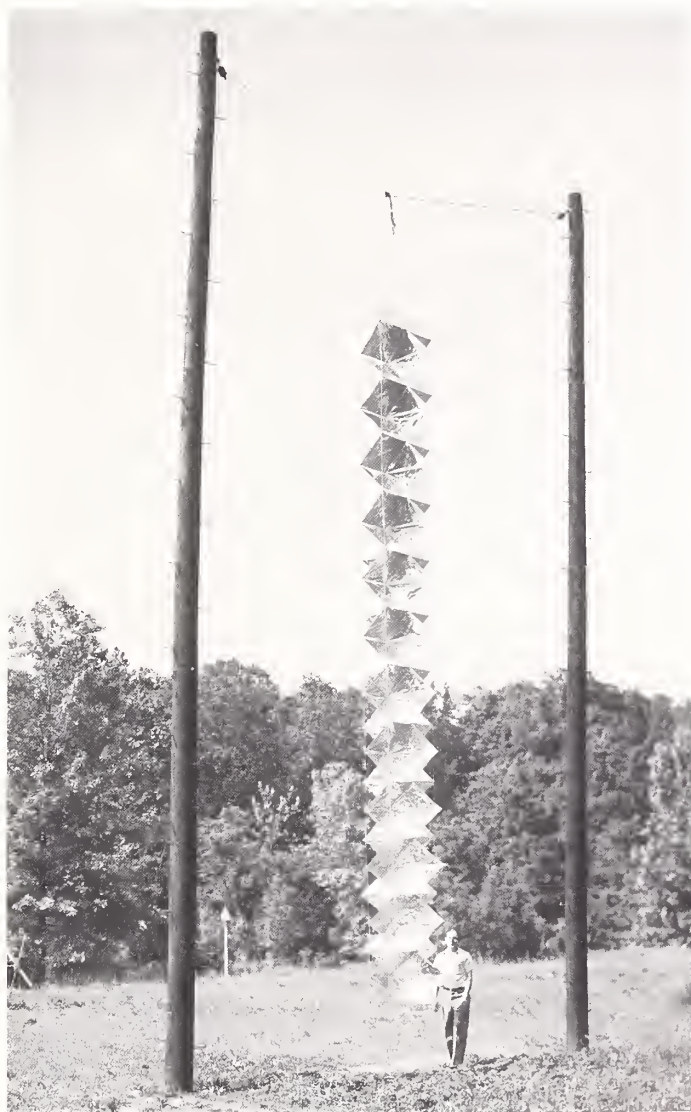

*Twelve-cube, accordion-type reflector with 48 reflecting surfaces of aluminum foil, backed with Pliofilm, used for determination of wind velocity by radar method. The balloon-borne reflector of radar signals was serviceable out to distance of 20 miles. It came folded in a small package for storage.*

## **RADAR COUNTERMEASURES**

In the science of warfare, as an offensive weapon is developed it is eventually countered or neutralized by a defensive weapon, although often not quickly enough, thus causing defeat of the defender. The same has been true in the tactics of warfare, and in the logistics that support the fighting forces. Such was the case in the use of radar during World War II. Although unknown to the world at large, search-type radar had been under development for

several years before hostilities broke out on September 1, 1939, in Europe. Countermeasures to combat usefulness of radar by the enemy naturally followed. Large groups of physicists, mathematicians, and electrical and electronic engineers were organized to combat the use of radar. Such an operation was that of Division 15 within the National Defense Research Committee [17]. The various groups were scattered among a number of laboratories in the United States, with some work performed in England. These groups operated within security measures of a very high order, even more than that placed upon radar itself [18]. Thus came jamming, deception, false targets of a passive nature ("window," "chaff," "rope"), false targets by pulse-repeater devices, and means of analyzing the enemy's signals. So it was that the Radar Countermeasures Section of the Bureau of Ships, Navy Department, approached the Radio Section for aid in the development of equipment and systems to combat the use of radar by the enemy—Japan, Germany, and Italy.

To meet the growing need and commitment to the Navy Department for development of radar equipment to pursue the war effort, a group (Navy X Group or Radar Countermeasures Group) was organized within the Radio Section under the leadership of Harold Lyons for the development of radar countermeasures.

## 1. Project CXFD—"Moonshine," radar deception equipment

Already, the Navy Department, through the Bureau of Aeronautics, had requested NBS to develop a method of sensing the direction and measuring the speed of wind by use of radar facilities on board ship. Early in 1942 the Bureau of Ships revealed to the Radio Section some radar countermeasure methods that had undergone development in England for use against long-range search radar. A pulse-repeater of low power, borne by a small balloon, could be triggered by an enemy radar and transmit signals to the radar's receiver that would indicate a target (ship) that actually did not exist. By delaying the returned signal, the receiver would indicate a nonexistent ship at a more distant location. This method of radar deception took on the name of "Moonshine."<sup>16</sup> The U.S. Navy contracted for some of these devices to be built by a manufacturer of communications equipment. By employing a group of these balloon-borne pulse-repeaters it would be possible to confuse the enemy's observer with false signals, but this type of deception had little tactical value.

Greater possibilities could be foreseen in a tactical use of pulse-repeaters and "Moonshine" developed into a sophisticated device to deceive the enemy on a grandiose scale. Project CXFD evolved into the development and manufacture of equipment to deceive Japanese long-range search radars by generating false signals simulating the approach of a large fleet of bombing planes. The objective was to confuse the enemy's air-warning and the fighter-plane command with the decoying of interceptors to areas at the choice of the U.S. forces. Tactical operation is shown on p. 329. A single plane carries the "Moonshine" equipment which simulates an approaching fleet of planes, flying at high altitude, on the enemy's radar screen. The enemy's interceptor planes find nothing; even the single plane has made a speedy and evasive return to its base after a near approach to the enemy's radar. Meanwhile, the real bombing fleet has taken a circuitous course at very low altitude to escape radar detection with the purpose of destroying the airfield without engaging the enemy's interceptor planes. Such tactical use of CXFD equipment was much more suitable among the islands of the Pacific than in the European theater of operations.

The CXFD equipment was specifically designed to operate against long-range search radars developed by the Japanese. Two of these radars were found in the South Pacific, one at Guadalcanal in the Solomon Islands, after being abandoned by the Japanese. They were reworked, installed, and operated by the Naval Research Laboratory at its Chesapeake Bay Annex facility at Randle Cliff, Md. With a degree of irony, these two radars were given names of the "Snake" and the "Viper." With the aid of Navy personnel, the two radars were used in the development stage of "Moonshine" in order to test the equipment under conditions of field operation.

---

<sup>16</sup>The radar deception method designated by the code name, "Moonshine," was described briefly by R. V. Jones in his recently published book entitled *The Wizard War—British Scientific Intelligence 1939-1945*, (Coward, McCann and Geoghegan, Inc., New York, 1978). In the Glossary, Jones defines the Moonshine radar deception method as: "Device used to amplify radio echoes to make one aircraft appear as a swarm."

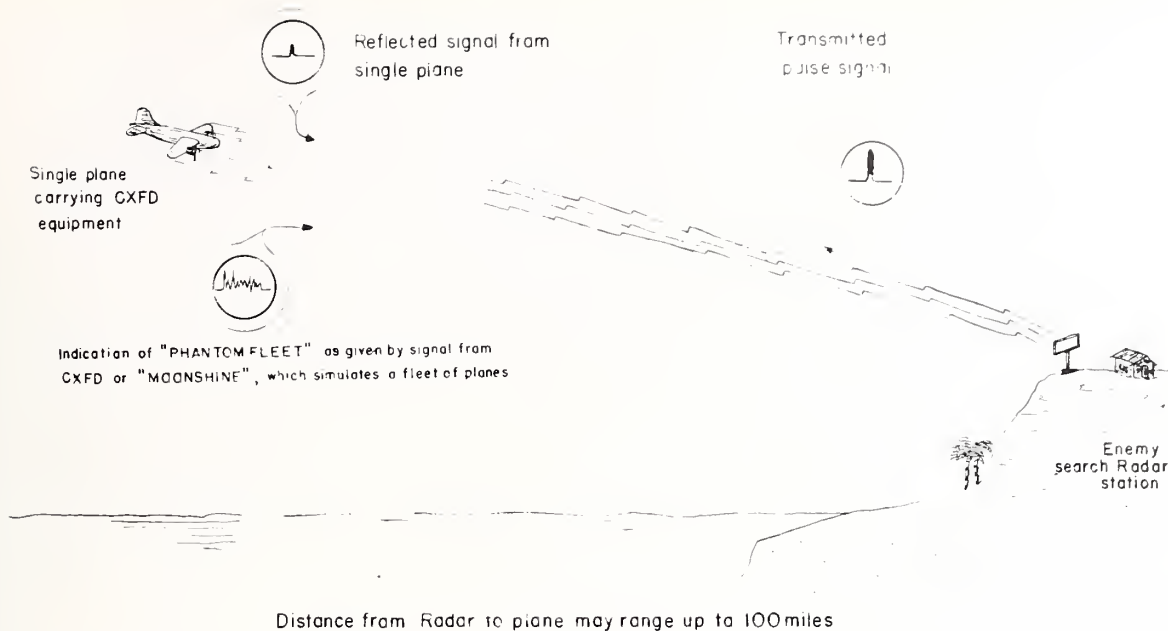

Circular diagrams show what Enemy sees on his Radar equipment, with and without CXFD equipment, also transmitted Radar signal

### CXFD or "MOONSHINE" in operation

*The Navy's Project CXFD or "Moonshine" was conceived in England for use in the European war theatre, but it was uniquely suited for use among the islands of the Pacific. While the "phantom fleet" of planes approach an island to be intercepted by enemy planes, the real fleet comes in undetected from a different direction to perform its mission.*

In brief, the important requirements for CXFD equipment to operate against the Japanese search radars were:

- 1) Pulse-repeater operation, with a superheterodyne receiver picking up enemy radar signal and translating to a transmitter that simulates a fleet of planes.
- 2) Operation in two frequency bands, 65-85 MHz and 85-115 MHz.
- 3) Operation of receiver and associated equipment at pulse repetition rates from 50 to 2000 Hz and pulse width of 2 to 25 microseconds.
- 4) Delay between reception of enemy signal and re-emitted signal less than 1 microsecond.
- 5) Re-emitted signal from transmitter of a nature to simulate on the enemy radar screen the approach of a fleet of planes, that is, a "phantom fleet." Adjustment for operation to simulate flights ranging from 0.5 mile to 5 miles in depth.
- 6) Automatic control of strength of re-emitted signal by strength of enemy radar and distance from enemy station.
- 7) Blanking of receiver to prevent feedback during transmission.
- 8) Aural monitoring and visual indication of enemy's signal strength.
- 9) A nondirectional antenna to receive and transmit a horizontally polarized wave.

Work on CXFD was started in December 1942 and a prototype was tested and sent to the manufacturer in the summer of 1943. Fifteen units were manufactured by July 1, 1944 by General Electronic Industries, Greenwich, Conn., with Radio Section personnel carrying out a major portion of the production engineering and testing.

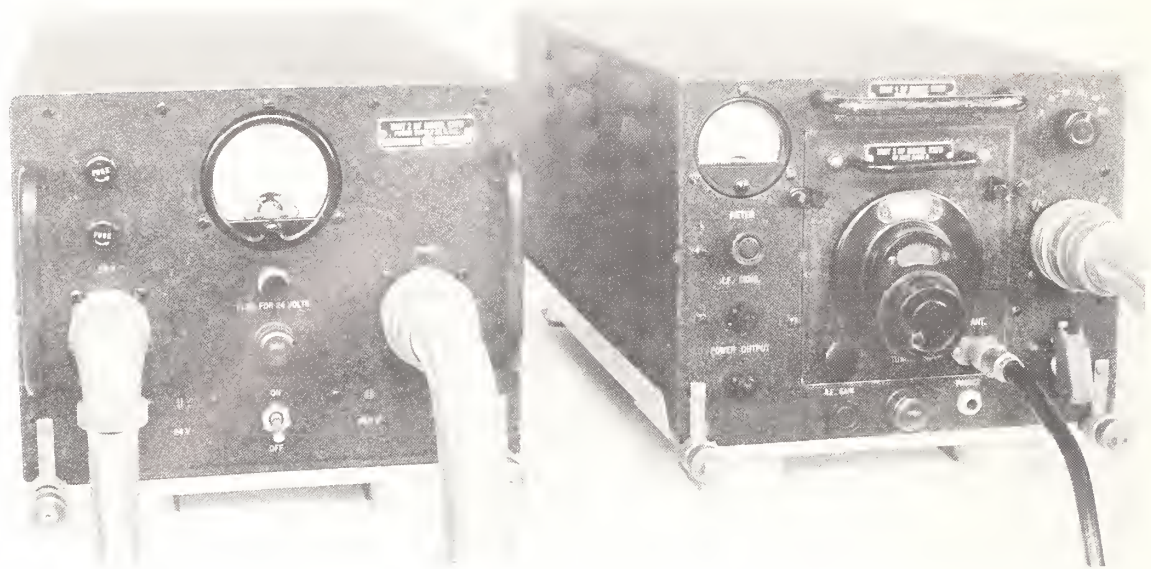

*CXFD or "Moonshine" equipment for operation on board a fighter plane, shown here on right, with power supply and auxiliary circuitry at left. The enemy's radar pulse signal was received and then triggered a return signal to the enemy's radar that appeared as a fleet of incoming planes rather than the single plane bearing the CXFD equipment.*

In addition to successful flight testing in the Chesapeake Bay area out to distances of over 100 miles, manufactured units of CXFD were tested and used in maneuvers by the Navy in the Pacific area. These tests were made against U.S. Navy radars having the same characteristics as the Japanese search radars. Although the Navy reported successful operation of the equipment in these tests, the nature of conflict with the Japanese in the closing months of World War II did not allow for actual combat use of "Moonshine."

In a letter to the director of NBS, dated 17 May 1944, the group within the Radio Section that engineered the development of CXFD was commended by the Bureau of Ships, Navy Department, for: "a) The high degree of interest demonstrated and willingness to set personal convenience aside to help get the job done promptly. b) The excellent level of technical skill demonstrated."

Radio Section personnel who took a major part in the development of the CXFD equipment were: Lyons, Snyder, Howard E. Sorrows, and Samuel J. Kryder.

Although this system of radar deception proved to be a reality in World War II, it would not be possible today. Even before World War II terminated, methods were developed to give a detailed analysis of the characteristics of radar pulses received either directly from a transmitter or by reflection from an object. Thus the enemy could "read" on his receiver the difference in signals from an actual fleet and a "phantom fleet" of planes.

## **2. Project OBV—Test equipment and monitor for CXFD**

In the development of CXFD (see previous section) it was soon realized that for its full and proper effectiveness as a radar deception device, it would be necessary to carefully and continuously monitor its operation while in flight during an actual mission against the enemy. This need led to the development of the OBV test equipment and monitor for CXFD equipment. The two units were weakly coupled to the CXFD antenna through a resistive network. A built-in and small cathode-ray oscilloscope provided visual indication of the signals emitted by the CXFD.



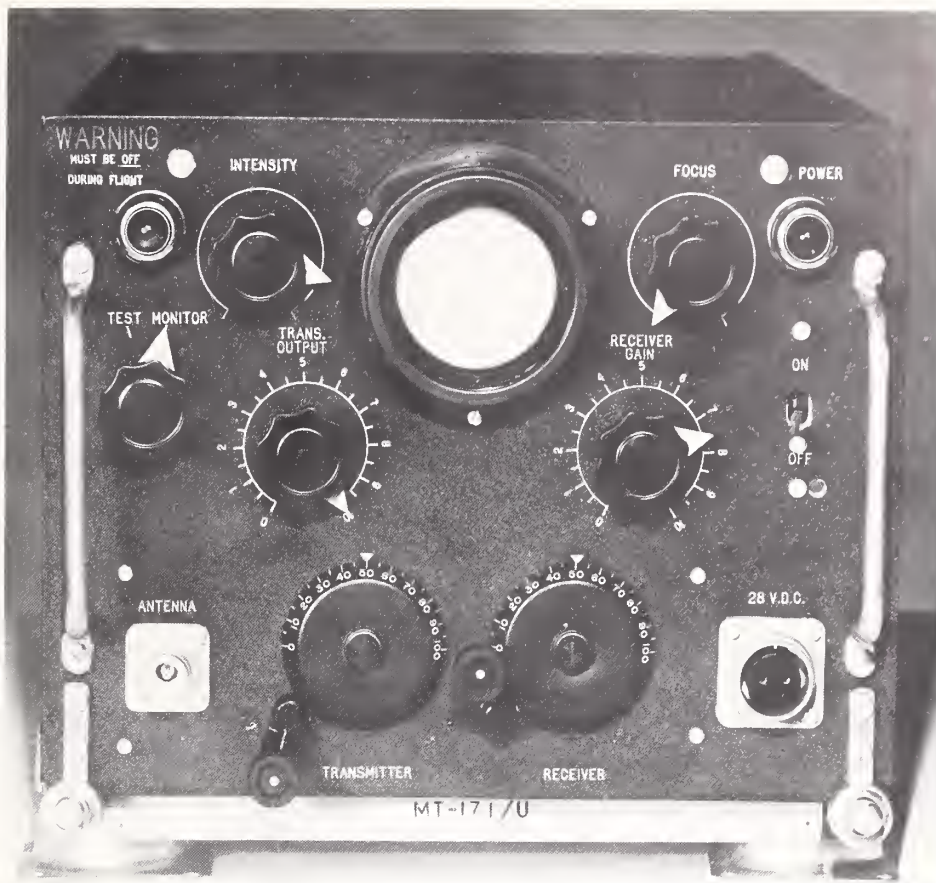

*For successful use of CXFD equipment it was very necessary to monitor the tactical operation. Project OBV equipment was designed to serve a dual purpose. When out of range of enemy's radar, OBV provided a signal that simulated the enemy's radar pulse and allowed monitoring of the "false fleet" signals transmitted by the CXFD equipment. Within range of the enemy's radar, OBV served only as a receiver to observe the enemy's signal.*

In operation, OBV served two purposes:

1) On the ground or during flight when out of range of the enemy radar, the transmitter served as a miniature radar and was used to activate or "trigger" the CXFD. The action was the same as would be caused by an enemy radar when CXFD was used on a tactical mission. The signal emitted by CXFD was picked up by the OBV receiver and viewed on the oscilloscope. The two pieces of equipment working in conjunction with each other gave an overall test.

2) During an actual tactical mission when CXFD was being activated or "triggered" by the enemy radar, the OBV was used as a receiver only, with the oscilloscope indicating the character of the "false fleet" signal being transmitted by the CXFD. Because of the complexity of operation of CXFD and the precise and delicate nature of the deception requirements, it was only through the use of this special equipment that the operator could be assured that CXFD was functioning properly. Lyons and Ralph Deutsch directed the design and construction of the OBV equipment.

### **3. Project CXJX—A "False Fleet" of ships consisting of radar reflectors and jammers, and simulated microwave search radar**

In planning for amphibious and other fleet operations in the Pacific theater of the war, the Navy did not overlook the many possibilities of using deceptive radar signals to confuse the enemy or of using jamming techniques to clutter up his radar screens. One hopeful fact remained, that the enemy's development of radar had not progressed to the stage where the more elementary methods of deception and jamming were no longer usable. Thus project CXJX was assigned to the Radar Countermeasures Group of the Radio Section led by Harold Lyons.

CXJX equipment was of several kinds, but all housed on buoys that could be dropped overboard from PT boats or other small craft. In a tactical mission the equipment would simulate a "false fleet" of boats or an "augmented" fleet of boats preparing for a landing operation or on a reconnaissance mission. By a combination of jamming signals, simulated radar signals, and reflected signals, plus simulated communication signals, the enemy's radar and radio communication equipment would reveal fleet operations which could not otherwise easily be observed and verified on a dark night or in foul weather. Thus the enemy could be confused or delayed in its counteroperations.

The jamming equipment consisted of two ultra-audion, self-blocking oscillators, one tunable in the frequency range of 95 to 145 MHz, the other in the range of 135 to 205 MHz. The blocking action of the oscillator resulted in a square-wave modulated carrier useful for jamming. The oscillator was mechanically frequency-modulated by a rotating capacitor, with a 5-MHz sweep. A folded-dipole turnstile antenna with a nondirectional pattern was specially designed for the purpose. The antenna could be assembled with ease and was mounted on a 12-foot collapsible mast. The whole assembly was mounted on a buoy (one buoy for each of the two frequency ranges) that would sink in approximately 4 hours (effective time of power supply and sufficient time for a tactical mission) by means of a water-soluble wax plug.

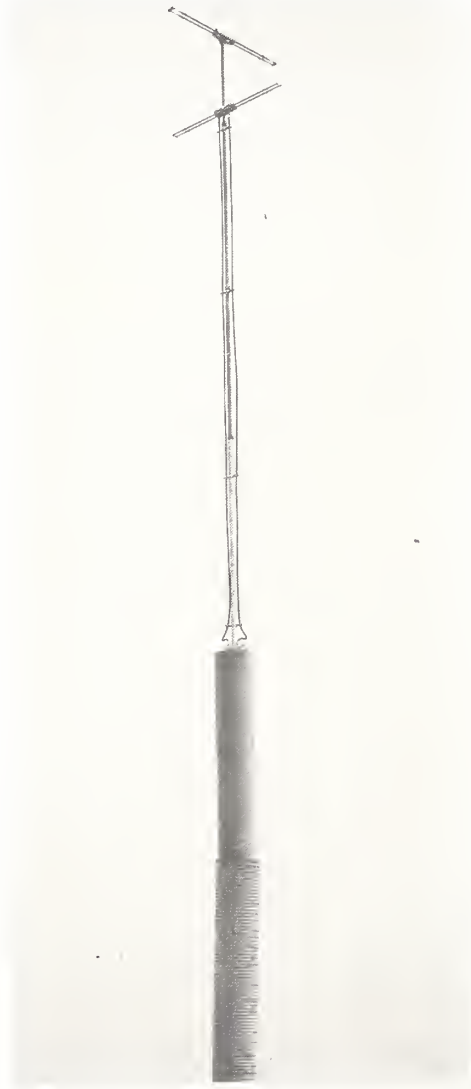

*As a component of the Navy's Project CXJX of simulating a false fleet of ships was this buoy-supported jammer of radio signals. The turnstile antenna gave an omnidirectional pattern to the radiated signals. Small boats could be used to launch these jammers along an enemy shoreline in preparation for an amphibious landing. A water-soluble plug allowed the device to sink after several hours of operation.*

Although the power output was designed to give only partial but a vexing amount of jamming to low-power Japanese search radars, it was found that the square-wave modulation was less effective in jamming than noise modulation.

Corner reflectors<sup>17</sup> were to be used to simulate the presence of small boats by returned radar signals from the reflectors. However, the tests conducted on Chesapeake Bay indicated that much larger reflectors and supporting buoys were required than were furnished by the Navy. Signals from reflectors placed a few feet above the water's surface did not simulate the presence of small naval boats to the extent of giving sufficiently defined deception signals on a Japanese radar.

The directive on CXJX also called for the design and development of an S-band radar transmitter in a buoy to simulate a Japanese shipborne search radar. Fitted with a rotating parabolic antenna system, the total assembly would simulate the presence of a radar-equipped boat in an offshore maneuver or reconnoitering mission. The development unit incorporated a package-type magnetron, a battery-operated vibrator power supply, and a dipole-fed parabolic antenna that would rotate on a shaft extending from the buoy.

Cessation of hostilities with Japan terminated further developments and production of CXJX equipment. Sophistication of radar techniques soon made these deceptive devices obsolete.

#### 4. Other radar countermeasures projects

Project "Chick" was the development of a deception jammer to be dropped from an airplane and descend slowly by parachute. A large number would be used in tactical operations within 10 miles of an enemy observation point to make it difficult for a radar operator to observe a flight of planes within this range. The same jamming-type circuitry was used as in the CXJX jammers. When tested in the Chesapeake Bay area "Chick" successfully jammed the Japanese "Snake"<sup>18</sup> radar operated by the Naval Research Laboratory at the Chesapeake Bay Annex facility. However, further development was cancelled in favor of the development of CXJX jammers for Navy fleet operations.

It was believed possible for a ship to remain out of range of an enemy radar, operating at search-radar frequencies, if its superstructure was beyond the line of sight. This would be true except for anomalous transmission caused by bending of the line of propagation by refraction through atmospheric ducts or, as was learned a few years later, by some degree of forward scatter effects. By means of a pulse repeater (transmitter activated by a coupled receiver) elevated some hundreds of feet above the ship and supported by a captive balloon, it would be possible for a ship to cruise out of range of the enemy's radar yet would be able to observe the enemy's searching activity. The pulse-repeater would intercept a radar signal from the enemy's long-range search radar and relay it to the ship below by means of a very low-powered transmitter to minimize detection by the enemy. Of course, the enemy's radar frequency would have to be known in order to tune a simple receiver of the pulse repeater. The transmitters, in relaying the pulse to the ship, would operate at quite a different frequency from the enemy radar to further escape detection. With this equipment it would be possible to determine if the enemy were searching with radar and if he possibly suspected the presence and position of the ship.

A prototype pulse-repeater was designed, built, and found successful in operation to meet the Navy's requirements. Anemometer cups caused the antennas to revolve in the wind, thus obtaining omnidirectional patterns to the dipole antennas.

Other radar-related projects were of a relatively minor nature and required but little time and effort in contrast with those described in this account.

---

<sup>17</sup> See section 2, Wind Velocity Measurement by Radar Method, for description and use of reflectors for radar signals.

<sup>18</sup> Refer to p. 328 of section on Project CXFD.

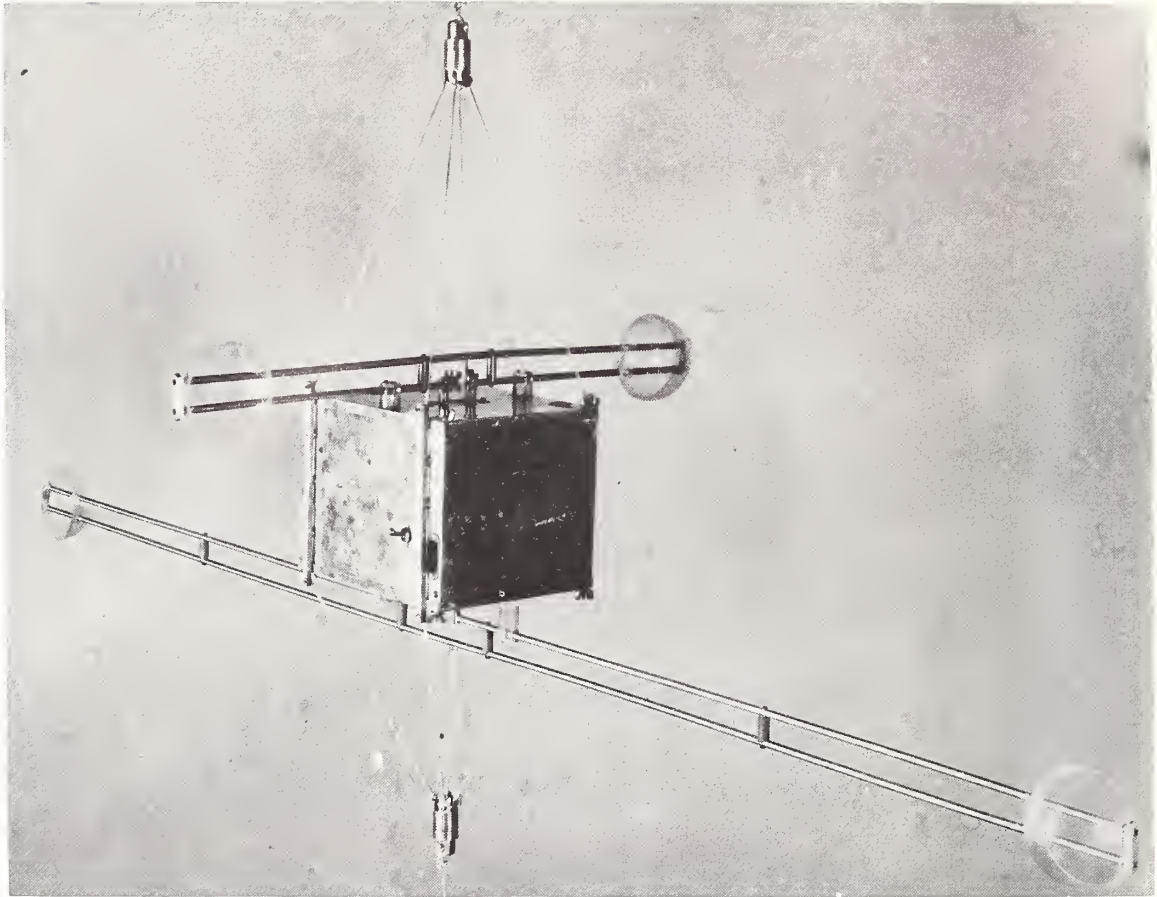

*Prototype of balloon-borne pulse-repeater for captive use on shipboard. Elevated several hundred feet above deck, enemy search-radar signals could be retransmitted at very low power and observed on shipboard while cruising at distances much beyond the horizon without detection by enemy radar. The anemometer cups rotated the equipment giving omnidirectional patterns to the antennas.*

## EARLY DEVELOPMENT OF MICROWAVE STANDARDS

The very rapid development of microwave technology during the late 1930's, in the laboratories of both England and the United States, gave impetus to the development of radar for military purposes. World War II spawned an enormous expansion of this technology. But slow in catching up with these developments was the means of accurately measuring the electrical quantities involved in microwave energy. It was out of this situation that the Joint Communications Board<sup>19</sup> made its request to the National Bureau of Standards to establish a national frequency standard for microwave frequencies in the range of 1550 to 11,000 MHz.

Assistance to this new project in the Radio Section in 1944 was given by the Armed Forces, OSRD, and the NDRC through the Massachusetts Institute of Technology (Radiation Laboratory), and by various industrial laboratories. Members of the Radio Section taking part in these early developments included: Freeman, Deutsch, John M. Shaull, and others, under the leadership of Lyons and William D. George.

Within a year after the request from the Joint Communications Board, frequency standards became available covering the microwave range continuously up to 30,000 MHz, with an accuracy of 1 part in 10 million. Fixed frequencies at approximately 1-percent intervals were made available from 300 to 30,000 MHz with an accuracy of 1 part in 100 million. These standard frequencies were derived by frequency multiplication and mixing

<sup>19</sup> See chapter X, p. 345.

from the group of quartz-crystal oscillators that constituted the national frequency standard at that time. Calibration services for frequency standards of the Armed Services and their contractors became available before the close of hostilities. Improvements in equipment, in accuracy, method of measurement, and increase in frequency range has continued to the present.

It soon became clear that to fulfill its mission to the rapidly expanding microwave industry and its application to national defense, the Radio Section would have to apply its talents to the development of standards and measurement techniques for the various electrical quantities at microwave frequencies. Before the war effort came to a close, studies were initiated for the development of waveguide below-cutoff attenuators and power measurement techniques. A supporting program was the assembling of an extensive reference library of classified American and British reports. These reports embraced the subjects of microwave theory, microwave components, and electron tubes for the generation of microwaves. Also collected were reports on measurements at both high and microwave frequencies covering the range from 30 kHz to 30,000 MHz. This library proved to be a source of valuable information for many years.

The reader is referred to chapter X for a more detailed account of these developments and facilities.

### PROJECT FLAPPER—VORTEX GENERATOR

In the fall of 1944 the Navy Department asked the Radar Countermeasures Group to investigate the possibilities of the use of vortices in air for several purposes, including the reflection of radar signals and the possible destruction or disabling effect upon aircraft. The possibility of vortex motion in air as an anti-aircraft weapon had been proposed by various persons, partly because of the effective area of a large (and powerful) vortex. The possibility of using a large-scale vortex gun against Japanese suicide pilots in small "Kamikaze (Divine Wind)" planes was also considered. It was learned that the Germans had been making a study of vortex motion produced by a special type of explosive projectile for use against aircraft [19]. Radar reflections from vortices could have application similar to "window," the reflecting foil scattered by planes.

The early laboratory experiments made by the group were with small-scale vortex generators or "guns," making studies of the efficiency of the gun mechanisms and the properties of the vortices, particularly their translational propagation characteristics. It was found that with a handgun using 22-caliber blank cartridges and several designs of an elongated funnel system (serving somewhat as a venturi system) good vortices could be generated having fairly high speeds and long ranges. The vortex gun had the ability to strike a target with surprising accuracy. Having developed an effective small-scale vortex gun, a large number of observations were made in an unused airplane hangar to study the translational motion of vortices. Muzzle velocities up to 300 feet per second and ranges up to 120 feet were obtained. Outer diameters of the vortex rings expanded to about 6 to 10 inches, depending upon gun configuration, and remained constant in diameter after travelling about 20 feet. Size of vortex could be observed by means of a flat target consisting of several hundred rotating vanes. Translational velocities at any point along the trajectory were measured by means of an electronic counter circuit and pressure-operated electronic switches. The distant target operated on the principle of a condenser microphone.

Concurrent with the development of the small-scale vortex gun was a search of the literature on aerodynamics for information on the properties of vortices. Very little was found on the translational motion of vortices. After diligent search of related literature, it was found that a number of studies of this nature had been made and published in several European countries at the turn of the century. A concerted effort had been made by meteorologists, engineers, physicists, ordnance engineers, and others in the attempt to minimize hail damage to vineyards by "shooting" vortices toward hail-forming clouds. The result of this extensive undertaking was the calling together in Graz, Austria, in 1900, of an International Conference of Experts on Wetterschiessen (Weather Shooting). A second conference was held in Padua, Italy in 1901. A 160-page report of this conference appeared in an Austrian periodical [20]. Reported was the use of large-scale vortex guns with a muzzle velocity of 500 feet per second and working distances up to 1600 feet.

Field experiments with medium-size vortex guns were planned to be staged at the Chesapeake Bay Annex of the Naval Research Laboratory, located at Randle Cliff, Md. For the initial experiments a gun had been designed by the Bureau of Ships and fabricated by a Massachusetts contractor. The design was such that many configurations of the gun assembly could be made in order to obtain optimum results for projection of vortices. The majority of the muzzle diameters was approximately 15 inches. An optimum powder charge was 30 grams of smokeless powder loaded into a 20-mm cartridge case. A special breech mechanism housed the loaded cartridge. Firings under optimum conditions of gun configurations yielded vortices of 5 to 6 feet in outer diameter and travel distances to beyond 500 feet. Total flight times were as long as 10 seconds.

Observation of the travel of a fairly powerful vortex can be a weird experience. The sound produced can be described best as a "screaming sound like a banshee wail." As the vortex progresses in its flight, the composite of frequencies trails off to a lower pitch due to reduction of energy in the swirling mass of air. In appearance the vortex has the shape of a large and thick doughnut or a large-size automobile tire. It is easily seen in the daytime due to the refraction of light caused by different densities in the swirling mass of air. An unusual optical effect is observed on humid days. On the face of the vortex, as observed from a position behind or to a side of the gun, can be seen a series of six to eight light and dark bands across the width of the vortex annular ring. In color, the bands are bluish but with very definite shades in the light and dark bands. Several explanations have been given for this banding phenomenon. In the course of these experiments many observations were made of the velocity of travel at different distances from the gun.

In the fall of 1946 another vortex gun of somewhat larger size than the previous gun was field tested. The muzzle diameter was approximately 21 inches for most configurations of the gun's assembly. The optimum charge for this gun was 90 grams of smokeless powder loaded into a "one-pounder" shell case. Vortex diameters averaged 6 feet. Ranges of travel were beyond 600 feet with flight times as high as 15 seconds. On several occasions colored motion pictures were made of the vortex flights.

Although a few field tests were made in the summer of 1947, the Navy's interest in Project Flapper was waning. The planned tests of the aerodynamical effects of vortices on drone planes were dropped, and so were the tests scheduled for radar reflections from vortices. In consequence, no large-scale vortex guns were developed.

Associated with this project were Lyons, Snyder, and Edwin A. Pellett.

## PROJECT PHANTOM—VAPORS AND AEROSOLS AS RADAR REFLECTORS

The developing art of using radar in World War II had a powerful influence on the development of ideas and concepts to counteract or neutralize the advantages gained by use of radar.

Although hostilities had ceased, the Bureau of Ships, Navy Department, requested NBS to explore the possibilities of using large clouds of vapors or aerosols as "phantom" targets. The clouds would be formed by dispensing chemicals from planes, artillery or mortar shells, or by rocket devices. Upon formation, the chemical cloud would serve as a false target to an enemy's radar signal, as radar camouflage or screening, or as a target to fire proximity-type detonators under chosen conditions. The firing could take place at quite a distant spot from the target selected by the enemy. The usefulness of phantom as a countermeasure was worthy of investigation. The project was assigned to the Radar Countermeasures Group in the latter part of 1945 and was later continued by the Microwave Standards Section after organization of CRPL.

In 1944 the Countermeasures Section of the Electronics Division, Bureau of Ships, in cooperation with Elco Division of the Electric Boat Co., conducted investigations in the Chesapeake Bay area on the reflection of radar signals by artificial fog or clouds. The basic material used in these experiments was iron pentacarbonyl,  $\text{Fe}(\text{CO})_5$ , a liquid that readily diffuses in the atmosphere. It has properties that made it unique as an aerosol for the Phantom project. In its pure state it is a viscous yellowish liquid with a specific gravity of about 1.5. Upon release from an air- and light-tight container it oxidizes very rapidly, and especially so in sunlight by photochemical decomposition. Oxidation can be so rapid that the

substance will ignite into a flaming cloud when a large amount of the liquid is thrown into the air on a sunny day.

Oxidation of iron pentacarbonyl is a complex reaction of photochemical decomposition when under the influence of sunlight. Rate of reaction is quite dependent upon various factors. Suffice it to say, the end products of oxidation are iron oxide in the  $\text{Fe}_2\text{O}_3$  form and carbon monoxide. The iron oxide appears as a fine brownish yellow dust that forms a dense cloud. The liquid, being a metal carbonyl, is highly toxic. Upon oxidation, with the formation of ferric oxide, the material loses its toxicity. For purposes of security and identification, iron pentacarbonyl was designated as X1 in all reports and communications.

Field experiments by the Bureau of Ships contractor had found the action of X1 in the atmosphere as a reflector of radar signals to be quite erratic. For this reason, NBS was requested to make a detailed study of its action as a reflector and/or absorber of electromagnetic energy at radio frequencies. The initial step in the study was a literature survey of the physical and chemical properties of iron pentacarbonyl and, to a limited extent, that of nickel carbonyl (a very toxic substance). The literature references amassed to over 200 in number. A survey was made of intelligence reports and microfilms of German documents on radar camouflage and related subjects to determine if the Germans had been working on a project similar to Phantom. Nothing was found to indicate their interest in the subject.

As a laboratory approach to the problem, a study of the dielectric properties of X1 during its reaction with air appeared to be the most promising. At the time, no equipment was available for such a study. Several methods of measurement showed possibilities of yielding information; the one selected being that of observing changes in the resonance frequency of a microwave cavity during flow of a gas through the cavity, or of an aerosol as in the case of X1. For the basic unit of a measurement system, a cavity Q-meter was obtained from the Radiation Laboratory at MIT. It was during this initial period of study that the Microwave Standards Section had taken on a new employee—George Birnbaum. Birnbaum's training and experiences in physics, chemistry, radio, and microwave work made him especially suited for the Phantom project.

During a period of more than a year after procuring the cavity Q-meter, a system was developed by Birnbaum whereby the dielectric constant and loss of gases and aerosols could be measured in a microwave cavity. Early observations were made with dry and moist air. Later, measurements were made on carbon dioxide, oxygen, nitrogen, helium, hydrogen, ammonia, and water vapor. All of these early measurements were made at 9000 MHz in the X-band region. Many radars had been designed during the war for operation at frequencies in the X-band (8200-12,400 MHz).

Measurement of the dielectric constant and loss of X1 as a continuous process under varying conditions of oxidation brought on many new problems with the measurement system. There were the problems of introducing pure iron pentacarbonyl (commercial grade of the X1 material was purified by the NBS Chemistry Division) into the measurement system, of controlling the rate of oxidation caused by air and sunlight, and measurement under conditions of flow of the aerosol through the cavity.

Two transmission-type cavities of identical dimensions were formed out of a common block of metal of sufficient mass that the two cavities are maintained at a uniform and constant temperature over short periods of time. Each cavity is swept through its resonance frequency from an oscillator in the cavity Q-meter. One cavity serves as a reference, the other contains the gas being measured, either by being filled with the gas or by a gas flowing through the cavity. In the measurement process the dielectric constant is determined from the difference of the resonance frequencies of the two cavities. Dielectric loss is determined by power absorbed in the gas being measured. With special circuitry and a recorder it was possible to determine the changes in the dielectric constant and loss with time due to changes brought on by oxidation of X1.<sup>20</sup>

---

<sup>20</sup> For a detailed account of a recording refractometer for the measurement of the dielectric constant of gases or changes in the dielectric constant of liquids and solids at microwave frequencies, see [21]. Measurement methods and measurements at microwave frequencies of the dielectric properties of various substances and of the atmosphere are described in considerable detail in chapter X.

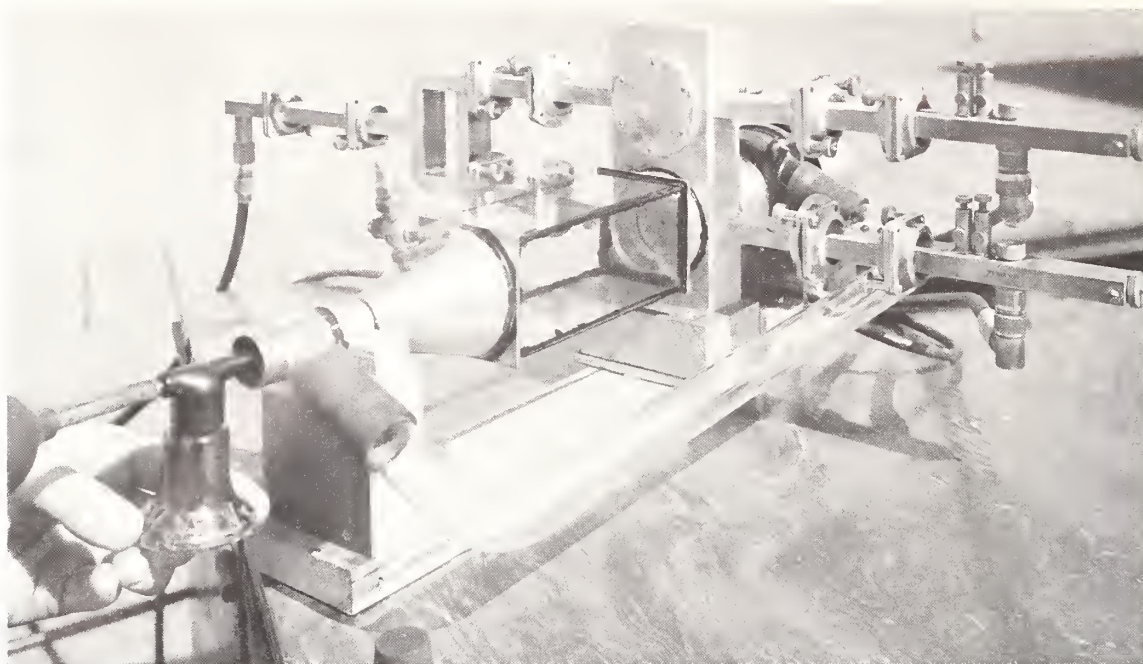

*Glass enclosed ionization chamber for observation of effect of sunlight upon iron pentacarbonyl (Project Phantom). The equipment (partially shown) was a form of double-cavity refractometer for measurement of dielectric properties of vapors at microwave frequencies.*

In addition to the dielectric properties of X1 as determined by laboratory observations, the Navy Department was furnished with calculations on the extent of reflection to be expected from a cloud of X1, based upon information available at that time (1948). The calculations indicated the not too promising possibility of using X1 as a reflector of radar signals. Nevertheless, field experiments were planned in order to test the concept of using X1 for such a purpose.

Seven radars of the Naval Research Laboratory's Chesapeake Bay Annex facility were made available in the fall of 1948 to conduct field tests on X1. These radars ranged in frequency from 200 to 9000 MHz. Observations were made on several different days to determine any presence of echoes under normal weather conditions without the artificial formation of aerosol clouds. Occasionally echoes were observed with no cause for their presence due to ships, planes, birds, or any other visible objects. These mysterious echoes could be troublesome when searching for any weak echoes from X1.

Early in November initial field tests were made by dispensing 50 to 60 gallons of water from a plane flying at about 500 feet above the Bay's surface. A long cloud of mist was formed at about 5000 yards from the radars. No echoes were observed at any of the radar frequencies. Test runs with the dispensing of an FS smoke mixture (a smoke screen that forms sulphuric and hydrochloric acid in reaction with moisture in air) gave definite echoes at some frequencies. In the calm of the day these echoes lasted more than an hour. The echoes were of a signal strength comparable to that from a plane.

Tests with the dispensing of X1 were dramatic experiences. A billowing and flaming yellowish cloud followed the plane—"a chariot of fire" through the air. An echo was observed on one radar. A test run was made with a combination of FS smoke and X1. On this run definite echoes were observed on all but one radar, the cloud forming at a distance of about 7000 yards.

The Navy Department was not encouraged by the results of the field tests. Considering the problems and danger in handling and dispensing X1, no further field tests were made. But the project had spawned several new measurement techniques and a number of research projects for the future.

Personnel of the Microwave Standards Section associated with this project included: Lyons, Birnbaum, Snyder, and Kryder.



## QUARTZ CRYSTAL RESEARCH DURING WORLD WAR II

The Radio Section gave support to the quartz crystal inspection and testing service provided by a large group under the supervision of the Polarimetry Section of the Optics Division. During the war period this group inspected over 10 million pounds of quartz from which were selected crystals of a grade that was suitable for use in radio equipment for military use.<sup>21</sup> With quartz crystals as oscillators, it was possible to operate transmitters within very narrow frequency intervals and frequency bands, thus providing for a greater number of operating channels. Also, the frequency band could be changed in a brief moment with the assurance of operating and remaining within a selected frequency band.

A valuable asset to the quartz inspection service was the operation of a small research laboratory and pilot plant for the fabrication of experimental quartz oscillator plates. This facility was headed by Francis P. Phelps of the Optics Division, who later became associated with CRPL.<sup>22</sup>

The Radio Section furnished equipment to the Optics Division and developed measurement techniques by which the quartz laboratory could measure the operational characteristics of the finished experimental quartz plates.

The demands made upon the large-scale production and quality testing of quartz crystals and plates during World War II for oscillators in radio transmitters brought on the need for measurements of parameters that would be the most useful to engineers. Heretofore, measurements of the characteristics of quartz plates were made on multielement circuits with the plate as one of the components. To the design engineer it is more useful if he knows the parameters associated with the quartz plate itself. Of greatest interest are the parameters of impedance, equivalent reactance, and equivalent resistance. From this information the engineer can predict the overall performance of an oscillator or filter circuit incorporating a quartz plate.

To meet this need that was accelerated by the war, several members of the Radio Section initiated a program in the spring of 1944 on the correlation of quartz-crystal oscillator performance with the electrical parameters of quartz plates. The team of William D. George, Myron C. Selby, and Reuben Scolnik reported their extensive investigation in two periodicals several years after the war [22,23]. They found that the several measurement parameters of interest could be determined with RF bridges, Q-meters, and a stable RF generator. Graphical representation of the parameters on a log graph simplified the use of these parameters for engineering design of quartz-crystal units. A method was developed for observation of spurious responses that are of a "nuisance value" in the design of quartz oscillators and filters. This investigation was particularly valuable in connection with the precision calibration of new types of crystal-unit test sets.

### A MISCELLANY OF EVENTS

#### 1. Mica—A strategic material

The restraints placed on the importation of strategic materials during the war made it necessary to seek domestic sources of mica. Formerly, the high-grade mica from India was used almost exclusively for the manufacture of radio capacitors. To meet the requirements of high performance at radio frequencies, mica is usually selected on the basis of a low power factor which is indicative of low power loss. Over a period of several years during the war the Radio Section conducted a program, under the guidance of Elmer L. Hall, on measuring the power factor of many samples of domestic micas. This program was carried on at the request of the Council of National Defense, Bureau of Mines, Geological Survey, War Production Board, and the Board of Economic Warfare. During the program Hall published a paper describing the measurement method and some observations on the electrical properties of various types of mica [24].

---

<sup>21</sup> See Cochrane, *Measures for Progress*, chapter VII.

<sup>22</sup> The quartz project in the Optics Division, and later in the Mineral Products Division, was transferred to the High Frequency Standards Section, CRPL, in 1952. Phelps retired from the Radio Broadcast Services Section at Boulder in 1960, after engaging in quartz crystal research for 20 years.

## 2. Space, and a new field site

The Radio Section encountered a sizeable share of the Bureau's problems relating to physical facilities during the war. With an enlarged working force it was necessary to seek larger quarters to house the added personnel and equipment. The staff had grown from 23 employees on July 1, 1940 (increased by 1 during FY 1940), to 160 at the time of organization of CRPL (May 1, 1946). Tentative plans for a third floor to the Radio Building (completed October 1918) were prepared in October 1941, with construction completed in May 1943. Previously, the Radio Section had overflowed from the Radio Building into 10 rooms constructed out of the Bureau's main lecture room in the East Building. There was no time during the war for the usual Friday morning lectures in this room that had become traditional at NBS. Later, the section took on additional quarters on the third floor of the Northwest Building.

On November 6, 1940 station WWV was nearly completely destroyed by fire. Although a vestige of frequency broadcasts was resumed by November 11, it was not until December 1942 that partial restoration of services began in the new building.

Early in September 1942 the Bureau was notified that the Meadows, Md. receiving station would have to be vacated to make way for a new airfield for the Army Air Force. The site became known as Andrews Field (Andrews Air Force Base) and was better known in later years as the airport used by the President and other Government officials in high office, as well as being used as the reception and departure airfield for foreign dignitaries.

Radio receiving facilities were temporarily set up in the vicinity of WWV at Beltsville while search was made for a new site in the Washington area. A 450-acre tract of very nearly level land at Sterling, Loudoun County, Va., to the northwest of Washington, was selected as the future site for various types of field work. The site was procured by the Office of the U.S. Army Engineers. The station, with its newly constructed brick buildings, was turned over to NBS in June 1943 for operation and maintenance. It was at this site that the Radio Section and CRPL conducted direction-finder and antenna research, ionosphere and troposphere observations, and field-strength measurements, until the move to Boulder. Once again, about a decade later, an NBS field site yielded to the demands of aviation, and the Sterling station was abandoned for development of the Dulles International Airport.

## 3. Visitors on war missions

The war brought a large number of visitors to the Radio Section, ranging from among the officialdom of Washington to visitors from allies abroad. Among those from England were the well-known men of radio, Sir Edward Appleton, then Secretary of the British Department of Scientific and Industrial Research, and Dr. R. L. Smith-Rose of the National Physical Laboratory.

Eighty-eight were in attendance at the International Radio Propagation Conference held at NBS from April 17 through May 5, 1944. The conference was held under the auspices of the Wave Propagation Committee of the Combined Communications Board, with the IRPL serving as host (see ch. XI, p. 411). The purpose of the conference was to determine ways and means of increasing the usefulness of radio propagation information for the Services. Dellinger took a leading role in the conference.

## REFERENCES

- [1] War Work of the Bureau of Standards, *Bur. Stand., Misc. Publ. 46*, Apr. 1, 1921.
- [2] Lyman J. Briggs, NBS War Research—The National Bureau of Standards in World War II, issued Sept. 1949 (no NBS publication classification).
- [3] Rexmond C. Cochrane, Measures for Progress—A History of the National Bureau of Standards, *Nat. Bur. Stand. (U.S.), Misc. Publ. 275*, July 1966.
- [4] Irvin Stewart, *Organizing Scientific Research for War (The Administrative History of the Office of Scientific Research and Development)*, Little, Brown and Co., Boston, 1948.
- [5] James Phinney Baxter, 3d, *Scientists Against Time*, Little, Brown and Co., Boston, 1946.
- [6] Ronald Keen, *Wireless Direction Finding*, 4th Ed., published for *Wireless World* by Iliffe and Sons, Ltd., London, 1947.
- [7] K. A. Norton, "The polarization of downcoming ionospheric radio waves," *FCC Report 60047*, National Bureau of Standards, May 1942.

- [8] Direction Finder and Antenna Research, *Summary Technical Report of Division 13, NDRC*, Vol. I, Ch. 2, "NBS high-frequency direction-finder research," pp. 22-54, OSRD, Washington, D.C. 1946.
- [9] *Applied Physics, Book One: Electronics*, edited by C. G. Suits (OSRD history, *Science in World War II*, Little, Brown and Co., Boston, 1948), p. 136.
- [10] T. R. Gilliland, Coordinated Study of Ionospheric Transmission and Direction Errors at High Frequencies, National Bureau of Standards, Washington, D.C., Apr. 26, 1943.
- [11] L. M. Poast, Coordinated Study of Correlation of High-Frequency Direction-Finder Errors with Ionospheric Conditions, National Bureau of Standards, Washington, D.C., Aug. 31, 1944.
- [12] Wilbur S. Hinman, Jr. and Cleo Brunetti, "Radio proximity fuze design," *J. Res. Nat. Bur. Stand. (U.S.)*, Vol. 37, No. 1, July 1946, pp. 1-13.
- [13] Chester H. Page and Allen V. Astin, "Survey of proximity fuze development," *Am. J. Phys.*, Vol. 15, No. 2, Mar.-Apr. 1947, pp. 95-110.
- [14] "Radio proximity fuze development," *Nat. Bur. Stand. (U.S.), Tech. News Bull.*, Vol. 31, No. 1, Jan. 1947, pp. 3-8.
- [15] H. Diamond and W. S. Hinman, Jr., "An automatic weather station," *J. Res. Nat. Bur. Stand. (U.S.)*, Vol. 25, No. 2, Aug. 1940, pp. 133-138.
- [16] "An air-launched automatic weather station," *Nat. Bur. Stand. (U.S.), Tech. News Bull.*, Vol. 35, No. 5, May 1951, pp. 61-63.
- [17] *Applied Physics, Book One: Electronics*, edited by C. G. Suits, (OSRD history, *Science in World War II*, Little, Brown and Co., Boston, 1948), Pt. 1: History of Division 15, NDRC, pp. 9-122.
- [18] *Ibid*, p. 11.
- [19] Leslie E. Simon, Report on German Scientific Establishments, A.S.F., Office of Chief of Ordnance, Washington, D.C., Sept. 1945.
- [20] J. M. Pernter, "International Conference of Experts on Weather Shooting," *Jahrbucher der K.D. Central-Anstalt fur Meteorologie und Erdmagnetismus*, Wien, Vols. 38-39, 1901-1902; Supplement—"Bericht uber die Internationale Experten-Conferenz fur Wetterschiessen in Graz."
- [21] George Birnbaum, "A recording refractometer," *Rev. Sci. Inst.*, Vol. 21, No. 2, Feb. 1950, pp. 169-176.
- [22] William D. George, Myron C. Selby, and Reuben Scolnik, "Electrical characteristics of quartz-crystal units and their measurement," *J. Res. Nat. Bur. Stand. (U.S.)*, Vol. 38, Mar. 1947, pp. 309-328.
- [23] W. D. George, M. C. Selby, and R. Scolnik, "Precision measurement of electrical characteristics of quartz-crystal units," *Proc. IRE*, Vol. 36, No. 9, Sept. 1948, pp. 1122-1131.
- [24] E. L. Hall, "Equipment and method of measurement of power factor of mica," *Proc. IRE*, Vol. 32, No. 7, July 1944, pp. 393-396.

## Chapter X

### A NEW WORLD OF STANDARDS AND MEASUREMENTS

#### THE INTRODUCTION TO MICROWAVES

##### 1. "Romance of Measurement"

Upon his retirement in 1938, Henry D. Hubbard,<sup>1</sup> assistant to the director of NBS, circulated to the staff a small brochure of his own writing, entitled, "Romance of Measurement." Hubbard's viewpoint and evaluation of the science of measurement as he observed it for nearly four decades within the Bureau was summarized so well in a legend which he related in the brochure.

In days of old a poor man in thoughtful mood asked a wise man, "Why am I poor?" The wise man cut a staff thigh high, cut notches in it a hand width apart, gave it to the poor man and said: "I give you the scepter of success, a measuring stick. Measures rule the world. They come in pairs—the measure of the sandal must match the measure of the foot. So all things are made to measure, always two matched measures. Let this stick measure what you make, measure well for use. Three loops of cord make it a balance to weigh what you buy or sell. Set it upright in the sun and the stick will measure the shadow hours of time—allot them thy tasks. Tune thy life to its circling shadows. When in spring the noon shadows grow short is time to plant. Measure your portion and your neighbors. Make wisely, measure truly, trade justly, and you will prosper."

Now let us take a more contemporary view of the science of measurement. On May 1, 1953, Dr. Astin, director of NBS, in giving an invited address, "The National Bureau of Standards," before the American Physical Society at its Washington meeting, stated:

We believe that there is romance in precision measurement, and that ability to extend the absolute accuracy of measurement by one decimal place frequently demands as much in ingenuity, perseverance, and analytical competence as does the discovery of a new principle or effect in science. We believe further that many of the important advances in science are possible only through the availability of instruments of high precision which enable the measurement of small differences or minute effects [1].

The point of view of the wise man expressed in the legend, and that related by Astin in 1953, has been a guiding force to a number of the personnel within NBS associated with the development of standards and precision methods of measurement at radio frequencies, especially since the mid 1940's. Their "romance" with measurement at radio frequencies brought on a whole new world within the Bureau, to be passed on to the outside.

##### 2. The doldrums period

During the two-decade period from 1925 into 1944, the Radio Section found itself in a doldrums cycle in the area of standards and measurement (see ch. V, p. 110). Interests

---

<sup>1</sup> Henry D. Hubbard came to the Bureau in 1901 from the University of Chicago with Dr. Stratton (first director) to serve as secretary for the Bureau and to Stratton, and later as assistant to the director. He retired on September 1, 1938. He was known best for his modernization of Mendeleev's periodic table of the elements, first printed as a large chart in 1924 and made available by the Welch Scientific Co.

within and outside the Radio Section were directed toward the use of radio for air navigation, the development of the radiosonde, the development of a national frequency standard and WWV, and investigation of the ionosphere.

The lack of activity toward development of standards and precision measurement during this doldrums period can be judged by the accounts found in the Bureau's *Technical News Bulletin*. During the two-decade period only two articles (in 1927 and in 1928) relating to standards and measurements, other than development of the frequency standard and WWV, appeared in the *TNB*. Beginning in 1946, no less than 52 articles on these subjects appeared by the end of 1973, each of these relating to the development of a new standard, a new method of measurement, or a new calibration service. Such has been the activity since World War II. In addition, many hundreds of papers in this area have been published by Bureau personnel since 1946.

There was one isolated area of activity in measurement and testing that extended from 1938 to 1952, that of the examination of diathermy generators used for therapeutic heat treatment of body tissue with high-frequency electromagnetic waves. This program was conducted largely by E. L. Hall who previously had been active in the development of the frequency standards. The earlier measurements were made for the amount of RF power generated by the device. Later observations were related to the performance of maintaining frequency within certain tolerances of the frequencies set aside for diathermy equipment on an international basis, and to the maximum levels of harmonic radiation [2].

### 3. A flush of activity

Around the last day of April 1944, a secret document arrived at NBS via the Secretary of Commerce from the Joint Communications Board of The Joint Chiefs of Staff. This document, dated April 26, 1944, requested:

. . . That as promptly as possible primary frequency standards for radio frequencies between 1550 and 11,000 megacycles per second be established and maintained by the National Bureau of Standards of the Department of Commerce.

For reasons of security, all standards and information relating thereto at frequencies above 2400 MHz were to be classified as Secret.

This document proved its importance as it provided the means by which funds came to NBS from the Department of Defense in support of a large and fast developing program of standards and measurements at the higher radio frequencies. It was a document that sparked an extensive standards and measurement program in the former Radio Section, continued on through CRPL and the Radio Standards Laboratory, and at the present time is a major effort within the Electromagnetics Division.

It was primarily the development before, and the continued development and use of radar during World War II, that brought on the request of The Joint Chiefs of Staff for NBS to extend the frequency range and, later, the scope of its standards and measurement program at radio frequencies. It is most interesting that much of this program evolved from the use of waveguide in radar which largely had its development in the pioneering work of George C. Southworth, who was a member of the Radio Section during World War I. Much of the development of waveguide and practical development of radar before World War II came from the American Telephone and Telegraph Co., including the Bell Telephone Laboratories, with whom Southworth was associated from 1923 to his retirement in 1955.<sup>2</sup>

<sup>2</sup>In his autobiography, *Forty Years of Radio Research*, Southworth gives a well-told account of his development of microwave techniques for radio wave transmission [3]. Unknowingly at the time, the rudiments of Southworth's pioneering of the development of waveguide as a means of transmitting microwaves had their beginnings in his measurement of the dielectric constant of water at high radio frequencies. This was in 1920 when he was experimenting with "resonant troughs" of water while a graduate student at Yale University. Years later, as he states in his autobiography:

Remembering well the resonant troughs used at Yale in 1920 . . . , I decided in the late summer of 1931 to go back and pick up the trail which I had left a decade earlier. This led to microwave technique as we know it today.

This early work was with the American Telephone and Telegraph Co. In 1934 it was transferred to the Bell Telephone Laboratories where waveguide techniques were well developed by Southworth by the time of World War II. The development culminated in Southworth's textbook, *Principles and Applications of Waveguide Transmission*, published in 1950, that became a classic in the technical literature [4]. Southworth died in 1972.

**SECRET**

THE JOINT CHIEFS OF STAFF  
WASHINGTON  
25 DC

JOINT COMMUNICATIONS BOARD

26 April 1944

My dear Mr. Jones: **UNCLASSIFIED**

The Joint Communications Board has decided that there is a need by our Armed Forces for primary radio frequency standards for frequencies between 1550 and 11,000 megacycles per second. These standards are necessary for the proper calibration of secondary standards by which the radio equipments of our Armed Forces can be calibrated in the field. No primary standards of frequency determination for use in the radio spectrum between 1550 and 11,000 megacycles per second are now known to be available.

The Joint Communications Board requests that as promptly as possible primary frequency standards for radio frequencies between 1550 and 11,000 megacycles per second be established and maintained by the National Bureau of Standards of the Department of Commerce.

The Joint Communications Board particularly requests that these standards and information relating thereto, in so far as frequencies above 2400 megacycles per second are concerned, be made available to the U.S. Army and Navy, and to NO OTHERS except by permission of the J.C.B., because the security of this information is necessary for the successful prosecution of the war.

The Joint Communications Board desires to cooperate fully with the National Bureau of Standards in any program which may be undertaken to establish standards in this frequency band, and its representatives will be glad to furnish further details of the types of standards that would be most useful to the Armed Forces when the program is undertaken.

The Honorable  
Jesse H. Jones  
Secretary of Commerce  
Washington, D. C.

*G. B. Myers*  
G. B. MYERS  
Captain, U.S. Navy  
Secretary



Unclassified in accordance with EO 11562

**SECRET**

76X 5280

*Letter of Joint Communications Board, The Joint Chiefs of Staff, to Secretary of Commerce, dated April 26, 1944, requesting development of frequency standards extending into microwaves. This request set into motion the development of standards at microwave frequencies by the Bureau that continues to the present time.*

By May 3, 1944, a letter was sent by the Secretary to the Joint Communications Board, The Joint Chiefs of Staff that:

The Department of Commerce will be glad to undertake the establishment at the National Bureau of Standards of standards for radio frequencies in the range of 1550 to 11,000 megacycles per second.

No one within the Radio Section at the time realized the magnitude of such a program, a program that has extended for more than three decades to the present time. However, there was concern expressed in the letter of May 3, 1944. It stated:

A difficulty which must be foreseen is the lack of men with experience in measurement at the super-high frequencies specified. It will therefore be most advantageous if the Armed Forces can cooperate in the project by assigning some qualified personnel to work with the Bureau of Standards staff.

Through action taken by the Navy Department by July 1944, cooperation was obtained from the NDRC (National Defense Research Committee) of OSRD (Office of Scientific Research and Development) to supply information, equipment, and technical assistance to the Radio Section for development of a microwave frequency standard (the consultative project became known as AN-19).<sup>3</sup> The Departments of Navy and the Army financed the early stage of this new program at NBS (project I-6/AN, initially at \$100,000 for the fiscal year 1945). With the organization of the Central Radio Propagation Laboratory (CRPL) the program was supported by direct congressional appropriation.

Although the project began as a crash program to furnish the Armed Forces and the country's development programs with microwave standards of frequency, it was soon evident that the project would have to be expanded into other areas of standards and measurements such as: attenuation, impedance, voltage, and power. Moreover, there was the need to upgrade and expand the Bureau's total standards and measurements program at radio frequencies from 30 kHz upwards into the microwave frequencies to 11,000 MHz, and later to 40,000 MHz. Thus the Radio Measurements and Standards Group (also known as the Radio Measurements and Standards Project) was organized within the Radio Section early in 1945. In this early period the group was supervised by W. D. George and H. Lyons. Others in the group, until the organization of the CRPL, included: R. Deutsch, R. E. Ellenwood, J. J. Freeman, F. M. Greene, V. E. Heaton, E. D. Heberling, B. F. Husten, R. H. McCracken, W. J. Otting, F. Reggia, W. E. Ryan, J. M. Shaull, M. C. Selby, and H. E. Sorrows.

With the organization of the CRPL on May 1, 1946, the Microwave Standards Section (above 300 MHz) was formed and the high frequency work expanded with the formation of the High Frequency Standards Section (below 300 MHz).<sup>4</sup> Further expansion took place with the new facilities in Boulder, Colo., leading to the organizing of the Radio Standards Laboratory. Eventually three divisions came from this growth so that by 1967 there existed the Radio Standards Physics Division, the Radio Standards Engineering Division, and the Time and Frequency Division. The roots for this dramatic growth in standards and precision measurements at radio frequencies largely trace themselves back to the document of April 26, 1944—it virtually became a directive to keep pace with a rapidly expanding technology.

During the formative period many conferences were held with liaison personnel of the Navy, Army, MIT Radiation Laboratory, and commercial firms operating on defense contracts. A series of lectures over a period of several months was given by Lyons and Freeman on microwave theory and practice, the first introduction that the Radio Section had to microwaves in the laboratory. During the introductory period the subject was classified Secret, then reduced to Confidential, and finally to Unclassified. The project having reached an Unclassified status, Dr. Lyons presented several illustrated lectures to Washington technical groups on the wartime developments of microwaves and waveguide components.

<sup>3</sup> Assisting in this project was the MIT Radiation Laboratory. Other organizations taking part were: Naval Research Laboratory, Bell Telephone Laboratories, Western Electric Co., General Electric Co., Radio Corporation of America, and the Sperry Gyroscope Co. Hundreds of American and British classified reports in the area of microwave developments were supplied by these organizations and soon became a sizeable collection that served as a small library of valuable information.

<sup>4</sup> For a short period these sections were known as the Microwave Measurement Standards Section and the Ionospheric Measurement Standards Section.

#### 4. The microwave frequency standard

By December 1944 work was in progress on the microwave frequency standard. Norman C. Colby was detailed by the MIT Radiation Laboratory to assist on the project. Colby was experienced in the development of frequency standards and microwave equipment at the Radiation Laboratory. Because of its association with other wartime projects in the Radio Section, the early development of the microwave frequency standard is treated in chapter VIII (pp. 258-259), also chapter IX (pp. 234-235). By September 1945 a Confidential report, entitled "Microwave frequency standards at the National Bureau of Standards," had been sent to the chiefs and presidents of 150 Government agencies, industrial firms, and universities, describing the new microwave frequency standard and the available calibration services.

Beginning in June 1945, calibrations of microwave frequency meters and cavities (fixed frequency) were made for various defense agencies. This calibration service would continue as a fairly large-scale operation for the next 20 years; the frequency range would be extended to around 100 GHz, with improvements in the measurement technique.



*Norman Abshire of the Electronic Calibration Center calibrating a cavity-type wavemeter at microwave frequencies in 1963. By this time, 18 years after the first microwave frequency standard had been developed by the Bureau, the upper frequency limit of the standard had reached 90 GHz. Limits of uncertainty of measurement were about 2 parts in  $10^6$ .*



## 5. A microwave standards program is set into motion

During the summer of 1945 and before the cessation of hostilities with Japan, a well-planned program for the development of standards and measurement techniques at microwave frequencies (with use of rigid waveguide) was underway, with concurrent development in coaxial equipment below 300 MHz.<sup>5</sup>

The early efforts of development were directed toward the most needed electrical quantities that required precision measurement at radio frequencies. Included were the quantities of power and voltage, and the quantities of impedance and attenuation (quantities associated with circuit elements or standards).

During this early development period on a fairly wide front, field-strength meters were developed to meet the need of measurement brought on by the increasing use of the FM and TV frequency bands.

## MEETING A NATION'S MEASUREMENT NEED<sup>6</sup>

### 1. Funding that set the wheels into motion

Initial funding to set a microwave standards program into motion was to the extent of \$100,000 for FY 1945, shared equally by the Navy and War Departments. This was increased to \$150,000 for FY 1946, again shared equally between the two departments. By now both the Army Signal Corps and the Army Air Force shared an interest in equally supporting the War Department's funding. After organization of the CRPL, funding of the standards work was largely supported by direct congressional appropriations. Beginning in FY 1957, the Department of Defense came back into the funding picture, this time in support of the new Electronic Calibration Center, and this large-scale support extended until 1968.

### 2. Progress on a broad measurement front

With the ample funding that became available, there was but little to deter a rapidly advancing front in the development of standards and precision measurement methods across the frequency spectrum from 30 kHz to 24,000 MHz, later to be extended to 40,000 MHz and beyond. The areas of early development were for the electrical quantities of attenuation, impedance, power, voltage, current, noise, and field strength, plus the dielectric and magnetic properties of materials.

In 1948 a program was initiated by Harold Lyons, chief of the Microwave Standards Section, to use microwave technology as a means of developing frequency and time standards based on the vibrational states of molecules and atoms. Within a few months the world's first atomic clock was in operation and there followed an atomic frequency standards program of many facets. In retrospect, one notes a significant statement in the Bureau's *Annual Report of 1950* (p. 91) which reads:

The aim of the Bureau's program in this field (atomic clocks) is a new atomic standard of time and frequency to replace the mean solar day. Such a standard may make it possible to change all of the present arbitrary units for physical quantities to atomic units. In fact, it should be possible to base both length and time standards on one spectrum line by multiplying the frequency of an atomic clock up into the millimeter bands and making use of an "atomic ruler," that is, an interferometer driven by the multiplied frequency from the clock. This would automatically give a precise value for the velocity of light. . . .

<sup>5</sup>In these early stages of development most of the work was done with X-band equipment (waveguide of 1/2" by 1" outside dimensions, rectangular cross section, frequency range of 8200 to 12,400 MHz) because of its convenient dimensions and the availability of many types of components in this waveguide size. There was also the early need to develop coaxial measurement equipment below 300 MHz. In time, standards were developed in both smaller and larger sizes of rigid waveguide, and the coaxial equipment was extended to much higher frequencies.

<sup>6</sup>It is the purpose in writing this portion of chapter X to give a more or less chronological yet topical account of activities, large-scale and special programs, and relations with other groups, in order to meet the Nation's needs for standards and measurements at radio frequencies. The account of the development of the standards and measurement techniques is largely contained in the last portion of this chapter.

This was a prophetic statement by the Bureau in 1950; with the passage of time much of it has come to realization with NBS itself (see chs. VIII and XV).

### **3. A measurement conference sets a trend**

Within 2 years after the organization of the two standards sections within CRPL (May 1, 1946), there came the desire and feeling of need within the AIEE Subcommittee on High-Frequency Measurements for a national conference in the field of high-frequency measurements and instrumentation. Harold Lyons, chief of the Microwave Standards Section, was a member of this committee and the result was the joint sponsorship of a conference by the American Institute of Electrical Engineers (AIEE) and the Institute of Radio Engineers (IRE) with the National Bureau of Standards. This first conference of its kind held on a national basis, convened in Washington, D.C. during the period of January 10-12, 1949, and was the forerunner of the many conferences of its type that have continued to the present day. Not only has the long-time repetition of these conferences given them an international flavor in recent years, but initiated another series of conferences with even wider sponsorship, and also was the source of a new organization—the National Conference of Standards Laboratories.

### **4. A measurement need**

#### **a) THE AIR FORCE TAKES THE LEAD**

The new and rapidly developed technologies that came out of World War II, such as radar, brought on a variety of problems related to procurement requirements, maintenance, adaptation to field use, and direction of research for further development. The Air Force, within the Department of Defense (three military services in one department, August 10, 1949), was especially cognizant of these various problems and took steps to understand and then set out to solve the problems. Such responsibilities were primarily those of the Air Materiel Command (headquarters at Wright-Patterson Air Force Base, near Dayton, Ohio) and on November 26, 1951, several of its representatives visited NBS to discuss informally the calibration needs of the Air Force.<sup>7</sup> The purpose of their visit was to learn if NBS would be interested in providing a greatly expanded calibration service to meet the needs of the Air Force. The service would be in the area of electrical and electronic standards, covering a very extensive frequency range in a number of electrical quantities. This was a new challenge to NBS.

At this period of time the Air Force requirements were periodic calibration of interlaboratory or transfer standards for 15 depots in the United States and foreign countries. In addition, the Air Force desired consultative and advisory services on special problems and the development of standards and instruments to meet new requirements.

#### **b) NBS FACES NEW PROBLEMS**

To NBS the request by the Air Force appeared to be within the scope of the Bureau's mission, yet of such a magnitude that the project would require special facilities. It appeared that such a project was a logical addition to the facilities at the Boulder Laboratories, then in the planning stage. NBS estimated that the program would require funding for an adequate facility at a cost ranging to at least \$5,000,000 and an annual operating cost of around \$750,000. During the next several years (after 1951) several conferences were held with the Air Force, and were mostly related to funding. During this period the Navy (primarily the Bureau of Aeronautics) and the Army (primarily Army Ordnance) became interested in the program. Many problems were encountered on how the venture should be financed, with each of the various parties involved, including the Bureau of the Budget, having its own point-of-view, which was not without change. The intricacies of these problems were to plague the planning, and then the operation, of the facility for more than a decade. A major problem was ownership of the equipment and, later, method of

---

<sup>7</sup>Over a period of several months at this time, the Microwave Standards Section gave a series of 3-day tours through its laboratories for the training of Air Force Electronic Inspectors. These training courses, that included lectures on microwaves, were conducted by NBS at the request of the Air Materiel Command.

capitalization of the equipment. Availability of funds would have to wait until after the move of CRPL to Boulder, Colo.

## 5. The move to Boulder

During the summer of 1954 the laboratory equipment of the High Frequency Standards Section and the Microwave Standards Section was moved to the new Boulder Laboratories. Personnel of the two sections who chose to move to the new location followed their equipment during the summer and into the fall of the year. The two sections became a new division, to be known as the Radio Standards Division, with Dr. Harold A. Thomas as the chief.<sup>8</sup> Thomas resigned in September 1956 and William D. George served as acting division chief until May 1960, when Dr. John M. Richardson became chief of the division (Radio Standards Laboratory).<sup>9</sup> (Additional information will be found in ch. XIX and app. C.)

## 6. NBS and the Radio Standards Division face a new challenge

The 1950's brought in the Space Age and the pace of development was accelerated after the launching of Sputnik on October 4, 1957. The new technology of fabricating, launching, and controlling spacecraft placed new and severe demands on the accuracy of measurements. These demands came to a focus on the national standards developed and maintained by NBS, and particularly on the standards at radio frequencies by the Radio Standards Division. The matter of accurate measurements came sharply to the attention of the general public by an article published in the September 10, 1960, issue of *The Saturday Evening Post* [5]. The article, "The measurement pinch," written by a layman, had a subtitle of: "Space-age technology has put fantastic new demands on the National Bureau of Standards." The phrase, "The measurement pinch," became an oft-used expression to incisively describe the prevailing situation at the time. The term "measurement gap" became an even more popular expression. And the Radio Standards Division found itself in the midst of the problem. Manifestation of the need to close the "gap" brought supplemental funding to the Radio Standards Division.

More than being just cognizant of the situation, the Aerospace Industries Association (AIA) through its Quality Control Committee, took an active stance by conducting an "Industry Calibration Survey" in 1958 and 1959 to obtain factual information on the state-of-the-art of various measurement categories. In an analysis the required accuracies were compared with the "best routine accuracy" provided by NBS, with an indication of problem areas. The categories of Electrical (AC, DC, Audio and Video), Radio Frequency (to 1000 MHz), and Microwave (above 1000 MHz), were treated in considerable detail and showed much lacking in calibration services, particularly in the microwave range.

Many actions took place as a result of the AIA Survey through which NBS took a prominent role. Among these was a series of 20 Measurement Research Conferences, held in Washington and in Boulder, attended by representatives of industry and by members of the NBS staff. These conferences were held over a period of 2 years, beginning in May 1960. All those relating to electrical quantities at radio frequencies were held in Boulder, nine in all. Much was gained from these conferences in defining ranges and accuracies that were most needed, and why they were needed, also what immediate and long-range actions might best be taken by NBS, industry, and by the military.<sup>10</sup>

---

<sup>8</sup> Harold A. Thomas came to the Boulder Laboratories from the Naval Ordnance Laboratory, Corona, Calif. Previously (from 1947) he had been with NBS Washington, working on the precision measurement of nuclear and atomic constants.

<sup>9</sup> Several years later, in 1964, Richardson received the Department of Commerce Gold Medal for Exceptional Service "in recognition of highly distinguished accomplishments in the development of radio standards and the organization and administration of essential research and standards programs for high radio frequencies."

In 1965 Richardson was elected a fellow of the IEEE "for contributions to atomic frequency and time interval standards."

<sup>10</sup> An interesting viewpoint crept into the total NBS picture during this period of "soul searching" as a result of a request by the director. Dr. Astin asked for suggestions on revision of the Bureau's mission. In a memo to the



*A survey made in 1958-1959 by the Aerospace Industries Association provided factual information on the state-of-the-art of various measurement categories. The result of this survey initiated a series of 20 Measurement Research Conferences during the next 2 years in cooperation with NBS. The first of these conferences was held in Boulder on May 24, 1960 on a subject of much importance—that of microwave power. A number of Boulder Laboratories personnel came into view of the photographer's camera on that occasion.*

---

(Continued)

director, dated January 14, 1957, Dr. Silsbee, chief of the Electricity and Electronics Division, stated, among many of his comments:

. . . I am sure that plenty of your advisors will be startled by my next sentence, but I will in what follows express our opinions as to desirable emphasis.

(1) Calibration service, and jointly with it the issuance of standard samples, is in our opinion the primary purpose for which NBS exists. . . .

(7) Uncommitted basic research can be justified on either of two counts: (a) The existence of a number of programs at NBS will be of definite assistance in recruiting personnel for the much more justified research relating to standards, and (b) to the extent that funds are not needed for higher priority work, uncommitted basic research is adequately justified on the basis that by the "Principle of Serendipity" unforeseen methods and materials valuable in the art of measurement may be brought to light.

Please do not misinterpret these remarks as indicating that I personally, like nearly all my colleagues, would not prefer to work on uncommitted research, I have often referred to it as the "frosting on the cake" of our services here at NBS. . . .

With publication of the "Statement of the NBS Mission" in the *Annual Report of 1960*, we find:

The National Bureau of Standards must provide national leadership in the development and use of accurate and uniform techniques of physical measurement. . . .

The Bureau, in its measurement leadership responsibility, must strive to stay ahead of the measurement requirements of science and technology. It must anticipate tomorrow's measurement problems and lead in their solution particularly in assuring that adequate standards and measurement techniques are available. It is the Bureau's responsibility to insure that measurement inadequacies do not retard scientific and technological progress.

## 7. The Electronic Calibration Center

### a) A NEW FACILITY AND A NEW ORGANIZATION IN THE MAKING

The 84th Congress authorized the construction of an additional wing (Wing 6) to the Radio Building of the Boulder Laboratories for housing the special facility designed for a large-scale calibration operation. It was a new venture on the part of NBS. At the request of the Air Force, during the design stage, the decision was made to incorporate facilities for the calibration of direct current and low frequency standards and instruments into the operation. The wing was completed in the late spring of 1957 and was occupied early in July by a small group that was being organized as the Electronic Calibration Center (ECC).

Recruiting for personnel went on at a rapid rate. The group was to become a very large section (approximately 90 persons) within the Radio Standards Laboratory (a single division at the time). The center was headed by Harvey W. Lance as the section chief, and Wilbert F. Snyder as the assistant section chief.<sup>11</sup> The center was organized functionally into three units across a broad range of the communication frequencies of the electromagnetic spectrum and extending down to zero (direct current). The Low Frequency Unit (0-30 kHz) was headed by Frank D. Weaver, formerly of the Electricity Division at NBS Washington. Lance was acting head of the High Frequency Unit (30 kHz-300 MHz). The Microwave Unit (300 MHz-40 GHz) was headed by Roy E. Larson.

<sup>11</sup> Lance had come from the Naval Ordnance Laboratory, Corona, Calif., where he had been head of the Microwave Systems Section. He had joined NBS in 1948, later transferring to the Naval Ordnance Laboratory, Corona, Calif., at first an NBS facility.



*A squad of young recruits to help man the Electronic Calibration Center, March 29, 1957, with the calibration wing (Wing 6) still under construction. All but one chose to remain at Boulder Laboratories. Through the years they have achieved technical success in their varied areas of specialty. Left to right, Francis "Frank" Ries, Wilbur Larson, David "Dave" Russell, Ira Berry, Raymond "Ray" Jones, Harold "Bud" Taggart, Lawrence "Larry" Miller, August "Mick" Spano.*

In order to meet the pressing need by the military and the space industry for an extensive calibration and measurement service, steps were taken to expedite the procurement, development, and construction of laboratory equipment. Many in the Radio Standards Division were engaged over a period of months in the design and construction of specialized equipment to be used in the measurement systems. The Electricity Division in Washington gave its support in planning for and selecting equipment to be used in the low frequency measurement systems. Meanwhile the new recruits of the center, both professional and subprofessional, were being trained to develop, construct, and operate the calibration systems. After 1 1/2 years as an operating organization, the ECC performed its first calibration, and on February 14, 1958, reported to the Navy on the measurement of a high frequency Q standard.

#### b) THE ELECTRONIC CALIBRATION CENTER IS DEDICATED

On August 13, 1958, the Electronic Calibration Center was formally dedicated as part of the program of a 3-day Conference on Electronic Standards and Measurements held at the Boulder Laboratories.<sup>12</sup> The outdoor ceremony was staged on a beautiful summer day at the shipping entrance to the calibration wing. NBS Director, Dr. Astin, welcomed the many conferees and invited guests. Undersecretary of Commerce, Walter Williams, delivered the dedicatory address. He was followed by Dr. Edward G. Witting, Deputy Director of Research and Development for the Department of the Army, who spoke in the interest of the Department of Defense. Speaking for the electronics industry, was Robert C. Sprague, Chairman of the Board of the Sprague Electric Co., and a member of one of the NBS advisory committees.

<sup>12</sup>These conferences began in 1949 in Washington, D.C. and were held biennially through 1955. The 1955 Conference was a disappointment in attendance but a renewed interest 3 years later and a change of location brought 870 registrants to the 1958 Conference in Boulder.



*Dedication of the Electronic Calibration Center, August 13, 1958. Addressing the outdoor audience, under a cloud-flecked Colorado blue sky, were: Dr. Allen V. Astin, director of NBS; Undersecretary Walter Williams, Department of Commerce, who gave the dedicatory address; Dr. E. G. Witting, deputy director of Research and Development, Department of Army; and R. C. Sprague, chairman of board, Sprague Electric Co.*

In its original layout the calibration wing contained 27 rooms, with 17 rooms in calibration areas (most of these were 24×48 feet in floor dimensions). Of the laboratory rooms, 11 were shielded to minimize electrical and radio interference. A high-capacity air conditioning system provided an abundance of filtered fresh air and maintained temperature and humidity within close operating tolerances. Many of the laboratory's features were used by others developing new standards laboratories.

As a segment of its very extensive calibration program, the Air Force maintained a facility at the Boulder Laboratories in conjunction with the ECC over a number of years, beginning in 1958. The facility was known as the USAF Electrical Standards, Dayton AF Detachment, and was headed by Howard L. Coile. Many of the calibration problems encountered by the Air Force were aided in solution by the very close association and cooperation of the ECC with the Air Force through its Boulder facility.

**c) GROWTH AND MEETING A NEED**

During the next several years after the dedication (1958), progress was directed toward development of many new measurement techniques. To meet the demands of military requirements and the rapidly expanding space programs, it was necessary to increase the accuracy, frequency range, and magnitude range of the existing measurement techniques, as well as to engage in the development of precision measurement methods heretofore not explored by the Bureau. Much of the progress was dependent upon the basic research work of other sections in the Radio Standards Division.

GEOGRAPHICAL UTILIZATION OF SERVICES OFFERED  
BY NBS ELECTRONIC CALIBRATION CENTER

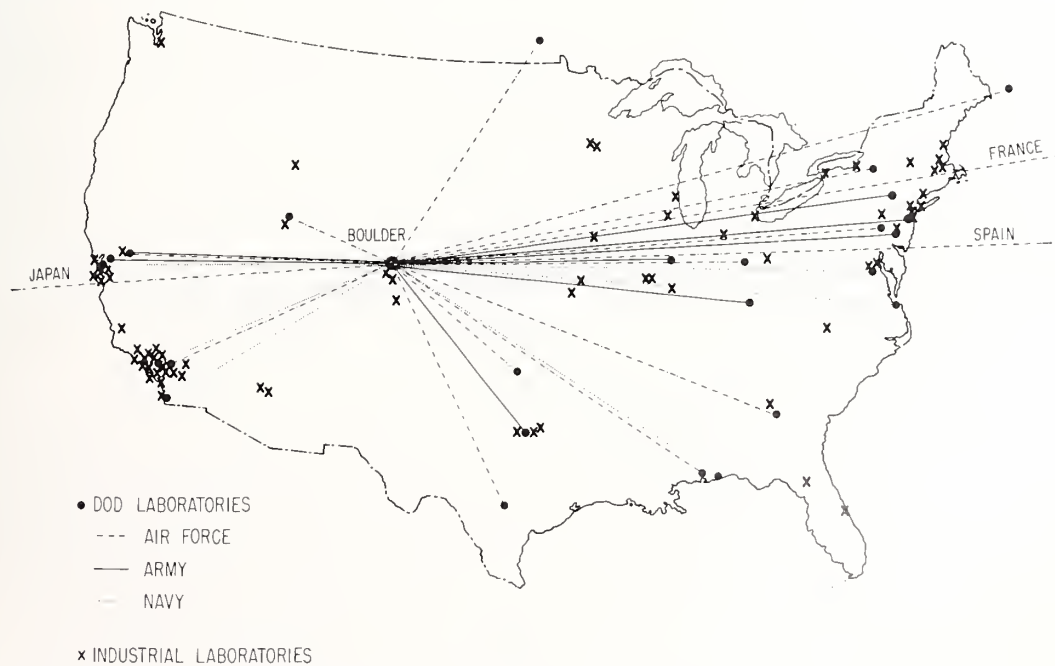

*After a year of operation, beginning in February 1958, the Electronic Calibration Center was servicing nearly 100 reference standard laboratories. In the echelon of electronic laboratories that was developing, the reference laboratories serviced other laboratories at lower levels (usually classified in terms of required accuracy of measurement). The chart indicates 15 laboratories for the Air Force, 8 for the Army, and 6 for the Navy, in 1959. Industrial or public laboratories totalled 66, but grew rapidly and by 1974 had totalled nearly 550 that had been serviced since 1958. Department of Defense reference standard laboratories increased for some years, then shrank to relatively few in recent years as changes were incorporated in the overall measurement systems.*

# CURRENT SERVICES FURNISHED BY NBS ELECTRONIC CALIBRATION CENTER

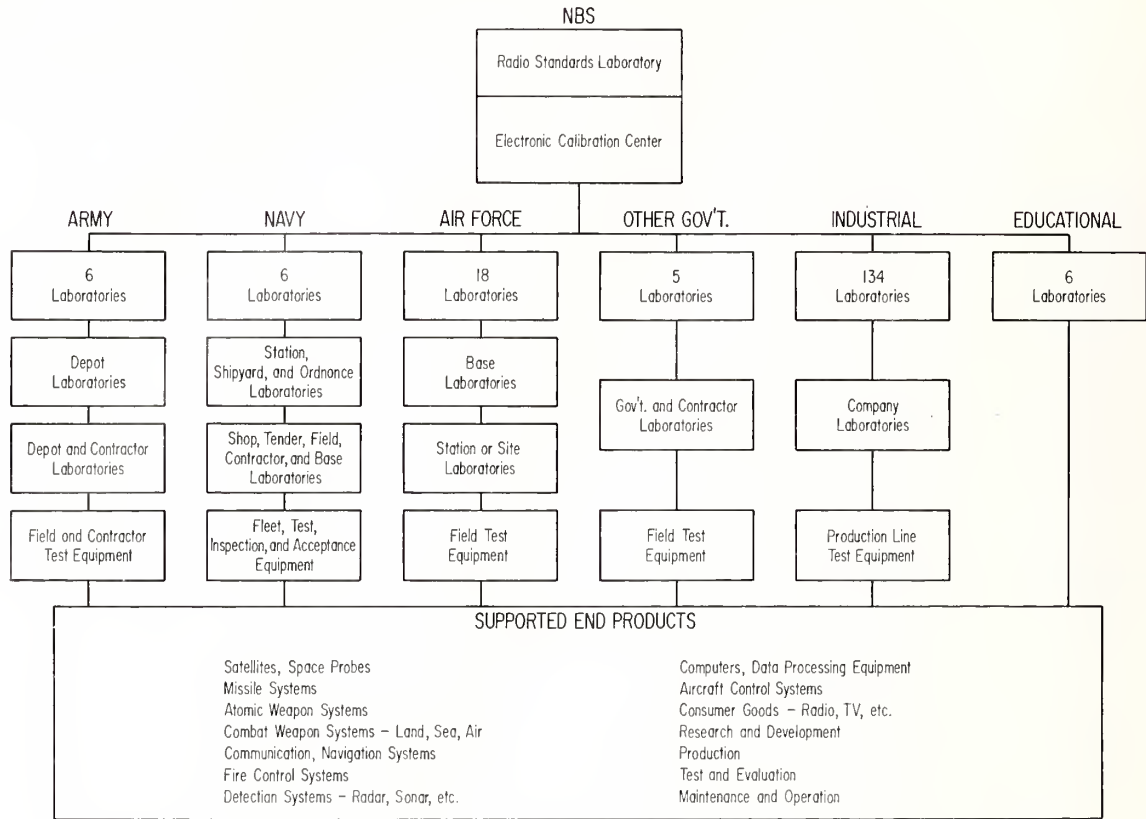

*Laboratories and programs serviced by the Electronic Calibration Center during the early years (1958-1962).*

In January 1962 the Division was reorganized to form two divisions (Radio Physics and Circuit Standards Divisions), and in April 1962 the three units of the ECC were given the status of technical sections within the Circuit Standards Division.<sup>13</sup>

The magnitude of the ECC operation can be appreciated from statistical information. Beginning in early 1958, by the end of FY 1964 the center had performed calibrations for 381 public customers (primarily industry) and 42 different laboratories in the Department of Defense. During this same period 20,000 standards and instruments had been calibrated, with 60 percent of the items being calibrated on a yearly schedule.<sup>14</sup> Beginning in 1960, and extending to 1966, the time required for the laboratory calibrations averaged more than 20,000 man-hours per year.

<sup>13</sup>In the reorganization Dr. George E. Schafer became chief of the Circuit Standards Division, with Lance as the assistant chief. With further reorganization and the formation of three calibration sections in April 1962, Frank D. Weaver was appointed chief of the Low Frequency Calibration Services Section, Robert C. Powell acting chief of the High Frequency Calibration Services Section (to be followed later by Karl R. Wendt as chief of the section), and Roy E. Larson as chief of the Microwave Calibration Services Section. Snyder was selected as Coordinator of Calibration Services, with Warren C. Stickler as technical assistant (followed after Stickler's death, in 1966, by Ira S. Berry). The three calibration services sections (reduced to two in 1966) and the Office of the Coordinator, retained the administrative operations of the Electronic Calibration Center for calibration services until 1969.

It was at this time of reorganization of the Division that Lance received the Department of Commerce Silver Medal for Meritorious Service, with the citation "for outstanding performance in improvement of electronic standards, measurements, and calibrations, particularly the organization and management of the nation's Electronic Calibration Center."

Later, in 1968, Snyder received the Department of Commerce Bronze Medal for Superior Service, the citation reading, "for exceptional devotion to duty in establishing electronic calibration services needed for our National Measurement Systems."

<sup>14</sup>Each time a standard or instrument was submitted the count was made as a new entry, whether the device had been submitted before or not.



In the spring of 1966 Bureau management found it advisable to have but one location for an electrical (up to 30 kHz) calibration facility, with the choice at Washington in the Electricity Division. Over a period of several months the Low Frequency Calibration Services Section was phased out and the measurement equipment incorporated into the new laboratory facilities at Gaithersburg, Md.<sup>15</sup> This action brought a sharp reduction in the number of standards calibrated within the ECC.

By the end of FY 1964 the total accrued cost of equipment in the center had reached \$5,000,000. Thereafter the rate of increase tapered off quite rapidly.

#### d) METAMORPHOSE

By the mid 1960's the Department of Defense, through its calibration and electronic instrument and systems maintenance programs, found it increasingly difficult to sustain the rate of financing in aiding in the support of the Electronic Calibration Center. By 1968, after a decade of provisional financial support by the DoD, an agreement was reached through a Memorandum of Understanding for a method of financing that has continued to the present time.<sup>16</sup> Much of the former problem had hinged on the wide difference between the fee or hourly rate charged the DoD for calibrations and that charged to the public. Hereafter the rate would be the same for each.

In the following year (March 22, 1969) a directive by the Department of Defense set up a coordinating body, called the DoD Calibration Coordination Group (CCG), that provided a single DoD point of contact with NBS on all matters relating to DoD requirements for calibration services and for development projects relating to instruments and measurement systems. This *modus operandi* has been highly successful during the ensuing years.<sup>17</sup> Although funding by DoD is not of the former magnitude when the ECC was in the stage of rapid growth to meet a "measurement gap," both the DoD and NBS have benefited by the engineering developments ("hardware" and measurement techniques) provided by NBS in recent years.

Although the name of Electronic Calibration Center as a functional operation slowly phased out in 1969, the calibration services at radio frequency have been continued by various sections of the Electromagnetics Division. From the time of the first calibration performed by the ECC early in 1958, to the end of FY 1974, a total of 547 public customers have been provided calibration services. During the same period nearly 39,000 standards and instruments have been calibrated (see footnote 14 for method of enumeration). Although the ECC as an organized Bureau facility has metamorphosed, and even the name gone into memory, it met a very pressing need to fulfill the Bureau's responsibility to the Nation in providing for a measurement service at radio frequencies during a critical period.

## 8. A viewpoint, and then change

With the burgeoning of projects within the Radio Standards Laboratory in the early 1960's, and facing the necessity of providing for more space, planning for the future was set into motion during FY 1963. The result was the planning of a 5-year program to prepare for the contemplated expansion in order to meet the country's need of electromagnetic

---

<sup>15</sup> Frank Weaver, chief of the Low Frequency Calibration Services Section, chose to retire at this time, after 25 years of service with NBS. Weaver was awarded the Department of Commerce Bronze Medal in the spring of 1966. The citation read: "For very valuable contributions in the field of electrical metrology, and highly successful leadership in the development of measurement systems and calibration services."

<sup>16</sup> The purpose of the agreement of 1968 read:

#### Purpose

The purpose of this agreement is to establish a uniform procedure for: (a) determining DoD requirements for calibration and calibration engineering services; (b) a joint DoD/NBS review of these requirements to identify those services NBS can provide and to estimate their cost; and (c) planning to budget and fund the estimated cost of the services that by mutual agreement are to be provided by NBS.

<sup>17</sup> The Calibration Coordination Group has three members, representing each of the three military services: Army, Navy, Air Force. There are a number of sub groups or Working Groups representing different areas of measurements and on each of these NBS has an observer.

measurement services. Information was prepared in the form of tables and charts to visualize the planned program. This information would then be updated from year to year. Probably with even more boldness and vision was the planning of an entirely new building to house the standards and measurement programs, along with related research. An ample congressional appropriation permitted the planning of this multi-million-dollar building (approximately \$15 million at the time).

Lack of an appropriation delayed the construction of the building during the next several years. Then began a period of leveling off of operating funds, and then curtailment. Other agency funds slipped away and Bureau funding became tight. Reduction in personnel was a partial solution, along with various economies of operation. Then it became a matter of "survival" operations to save all of the remaining staff. New management in the Radio Standards Engineering Division, beginning in May 1969, took a new look at the situation, both from within and recognizing the technological trends of the time. Funding from other agencies for types of projects, heretofore untapped, began to bolster the sagging financial situation.<sup>18</sup> The name of the division was changed to that of the Electromagnetics Division to indicate the broader scope of the overall program.

## 9. Computerization and the trend toward automated measurement systems

The almost unlimited capabilities of electronic computers can be applied in many ways to the processing of measurement data, whether from intricate mathematical equations or from a multitude of simple numerical observations. Probably one of the first uses of the electronic computer in the Radio Standards Laboratory (RSL) was in the Electronic Calibration Center. In 1962 Patrick H. Lowrie (Low Frequency Calibration Services Section) improved upon the method of calibrating volt boxes by introducing a small computer into the console measurement system, thus relieving the operator of the onerous task of many computations, plus the dividend of reduced personal errors. The use of this relatively new laboratory tool caught the fancy of others and soon many of the RSL personnel were adapting computers or computer access equipment to their measurement systems.

The development and use of automated measurement systems received a new impetus at the Boulder Laboratories with accents on new technologies in measurements as expressed by Dr. Raymond C. Sangster who became chief of the Radio Standards Engineering Division (later, the Electromagnetics Division) in 1969.<sup>19</sup> Later regrouping of personnel strengthened the program of automation development within the division.

A number of programs in automated measurements have been implemented since 1970. The largest of these projects has been the procurement, expansion, and improvement of a

---

<sup>18</sup> Beginning in 1970, a number of Government agencies have funded projects in the Electromagnetics Division for a variety of programs relating to research, development of measurement systems, evaluation studies, and consultation. The larger projects have been funded by:

Army—Army Security Agency, Army Communications Command.

Navy—Bureau of Ships, Naval Electronics Laboratory Center

Air Force—Wright Patterson Air Force Base, Brooks Air Force Base, Rome Air Force Development Center, Space and Missiles Systems Organization.\*

Department of Health, Education, and Welfare—Bureau of Radiological Health

Department of the Interior—Bureau of Mines

Department of Justice

Federal Aviation Administration

National Aeronautical and Space Administration

The change in funding received from Other Agencies, beginning in 1970, resulted in the establishment of a Technical Liaison function in the division managed by R. E. Larson. This change resulted in substantial increase in Other Agencies funding, as much as 10 times greater.

\*This was an extensive project in the development of standards and calibration services for WR-15 (50-75 GHz) rigid waveguide. The electromagnetic quantities involved were: power, noise temperature, attenuation, reflection coefficient magnitude, and antenna gain and pattern. The project was under the general supervision of Charles K. S. Miller.

<sup>19</sup> Sangster became chief of the Radio Standards Engineering Division on May 1, 1969. Formerly, he was director of research of the Bayside (Long Island, N.Y.) Laboratory of General Telephone and Electronics Laboratories, Inc.

Previous to Sangster, Dr. Helmut M. Altschuler had been chief of the Division for approximately 5 years, having come on duty September 15, 1964. Formerly, he had been engaged in microwave research at the Polytechnic Institute of Brooklyn. He remained in the Division as a Senior Research Scientist.

commercially produced automatic network analyzer with a frequency range of 0.1 to 18 GHz. In its more highly developed form the analyzer is capable of the programmed measurement of reflection in waveguide systems of several configurations. Measurement can be made of several parameters including reflection coefficient magnitude, phase, and attenuation. Microwave power measurement is also available. Other automated systems have been developed in the Division for more specific types of measurement, and in some instances, their development has been supported financially by the DoD for the Department's laboratory requirements. The various automated systems include:

- (1) The Y-factor system for noise measurement (see p. 383)
- (2) System for calibration of power measurement devices
- (3) Automated time domain reflectometer
- (4) System for calibration of micropotentiometers
- (5) Antenna measurement systems

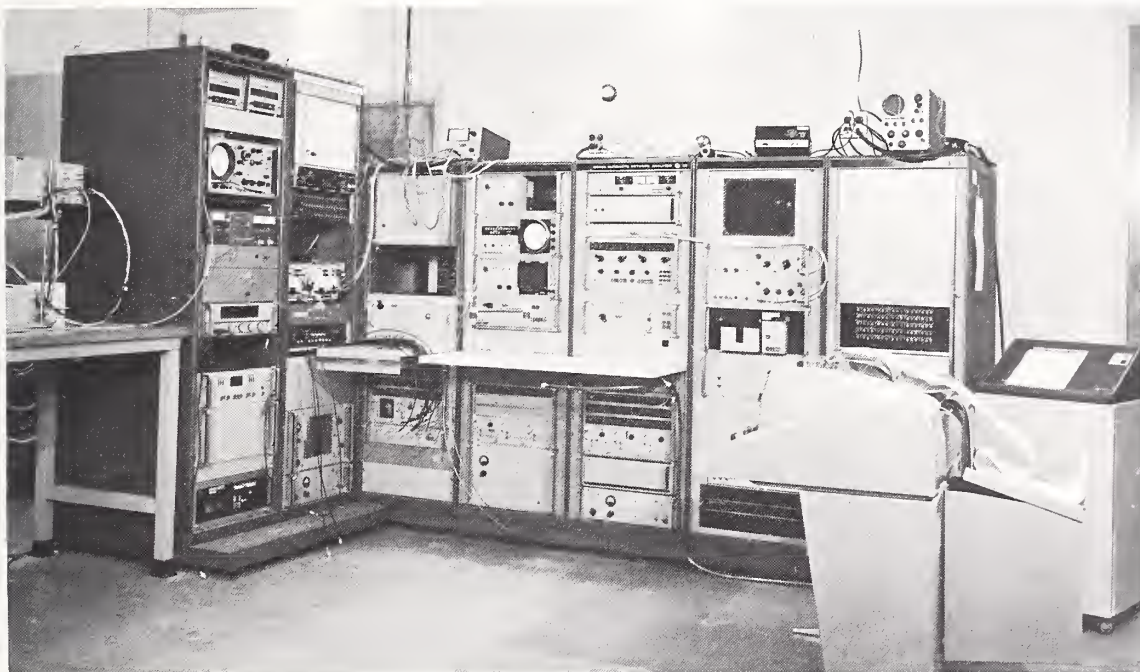

*Application of automation to measurement techniques brings about data in abundance from complex processing steps, reduces greatly the time of measurement, and minimizes chances of error (albeit that computers and other equipment can malfunction). A project in the automation of RF measurements, begun in 1970, has resulted in the array of equipment shown in this photograph. Known as the NBS automatic network analyzer, it covers the frequency range of 0.1 to 18 GHz with a system that includes signal generators, measurement circuitry, and signal processing equipment, all under computer control. The analyzer is designed for accurate measurement of impedance, attenuation, phase, voltage, and power.*

Principal contributors in the development of the automated systems have been: McKay Allred, James Andrews, Don Boyle, Glenn Engen, Ernest Komarek, William Little, Allen Newell, Francis Ries, David Wait, and John Wakefield.

Automated measurement systems serve their purpose not only to minimize the often encountered drudgery of making measurements, plus the minimization of personal errors, but more important, the observation and continuous plotting of circuit parameters over extended frequency ranges. Such data far exceed the value of fragmentary information taken by a laborious and time-consuming point-by-point method. However, the high capital investment in equipment has to be compensated with savings accrued in reduction of labor cost. Yet automation can be a boon to the measurement art.

## 10. The media of learning

### a) U.S.A.-U.S.S.R. EXCHANGE PROGRAM

The Radio Standards Laboratory took an active role in an exchange program of American and Russian scientists conducted within the control of the U.S. State Department. Harvey Lance, head of the Electronic Calibration Center, was selected as one of a seven-man team of measurement experts from the NBS to visit various measurement laboratories in Russia during June 1963.<sup>20</sup> His area of expertise on the team was that of observing and evaluating the quality of the Russian measurements at radio frequencies, which he found to be quite advanced.

In the following January (1964) a team of three Russian scientists visited the Boulder Laboratories and had the opportunity of viewing many of the measurement systems and other facilities, as well as interviewing a number of the personnel. One of the visiting team presented an invited lecture to Boulder staff members.

### b) FROM WORKSHOPS TO MEASUREMENT SEMINARS

At the suggestion of several defense agencies, the first of three workshops for technical supervisors of DoD standards laboratories was provided by the Electronic Calibration Center in March 1961. The 5-day meeting was limited to subjects at microwave frequencies, half the time given to classroom lectures on basic theory of the measurement of power, impedance, frequency, attenuation, and noise, the other half given to laboratory demonstrations of precision measurement. The success of this workshop with 40 in attendance, resulted in the staging of two more, one for high-frequency measurements, the other for low-frequency measurements.<sup>21</sup>

The workshop program gave impetus to a more educationally oriented program that would benefit not only measurement personnel in defense agencies but in industry. Thus was started, in 1963, the series of NBS Precision Measurement Seminars, both in Washington and at Boulder, that have been so successful and well received over these many years. No charge was made for attendance at these 5-day seminars (sometimes of shorter duration) in the early years, but later they became self-supporting by a charge commensurate with the service offered.

On a larger scale than the 5-day seminars were the 3-week courses in electromagnetic measurements and standards for credit at the graduate level (in association with the University of Colorado) given at the Boulder Laboratories in the summers of 1963 and 1965. At the suggestion of David M. Kerns (consultant with the Radio Standards Laboratory and an adjunct professor of the University), Robert W. Beatty (consultant with the Radio Standards Engineering Division) organized the content of this extensive and in-depth course that was made available in a printed format. The 1963 course had 153 enrolled, with participants from 5 foreign countries.

For the edification of its own personnel, the Radio Standards Laboratory conducted a series of seminars of 1- and 2-day duration in the area of the larger RF electronic systems associated with space and missile equipment. These seminars, held in 1963 and 1964, were addressed by scientific personnel of industrial firms concerned with the development of such equipment. The seminars were largely the product of the effort of Myron Selby. For additional information on educational programs see chapter XVIII.

### c) MULTIPLYING THE EFFECTIVENESS OF NBS THROUGH THE PRINTED WORD

Although hundreds of published papers have come out of the radio frequency standards and measurement programs these many decades, probably none had the wide impact as the group of invited papers from the two divisions of the Radio Standards Laboratory published

---

<sup>20</sup> In the fall of 1959 Lance had made a 14-week visit for the U.S. Air Force to a number of European national laboratories for the purpose of determining their suitability as sources of calibration services in support of Air Force contracts in Europe.

<sup>21</sup> Later, an extensive series of half-day workshops was conducted by the ECC for personnel being trained by the Air Force at the Lowry Air Force Base (Denver) for measurement work in laboratories and bases at locations spread over the globe. Officers and measurement personnel of the air services of several foreign countries also participated in this training program.

in the June 1967 issue of the *Proceedings of the IEEE*. This special issue was the first of the *Proceedings* to be given exclusively to radio frequency measurements. It is to the credit of Beatty and Bruno O. Weinschel (Weinschel Engineering Co.), who jointly conceived and edited the special issue, that this voluminous source of information was so favorably received. Twenty-seven papers, plus a poem, came from Laboratory personnel.<sup>22</sup> Most of these invited papers related to specific technical subjects and were largely of a tutorial nature. The others were of an editorial and general nature. The papers of this issue brought the reader up to date from developments out of the recent past in the whole gamut of measurements of electromagnetic quantities at radio frequencies (sometimes referred to as radio metrology). NBS made a most significant contribution to this "Special issue on radio measurement methods and standards."

The many NBS papers on radio frequency standards and measurements presented at the Conference on Precision Electromagnetic Measurements, held biennially since 1958, have received wide distribution through the special issues given to this subject area in the *IEEE Transactions on Instrumentation and Measurement*.<sup>23</sup> This periodical has proved to be a good publication vehicle for disseminating papers relating to electrical and electronic instrumentation and measurement.

Due to publication in the periodical *Metrologia (International Journal of Scientific Metrology)*, two companion papers from the Radio Standards Laboratory had an international flavor. In these two invited papers on the subject of the system of electromagnetic quantities, M. C. Selby wrote for the frequency range of 30 kHz to 1 GHz, and R. W. Beatty wrote for the frequency range above 1 GHz [6,7]. A blend of portions of the two abstracts characterizes the scope and nature of the two papers.<sup>24</sup>

Most of the significant papers on radio frequency standards and measurements published by NBS since 1950 have appeared in reprinted form in the Bureau's two compilations of its publications on *Precision Measurement and Calibration*.<sup>25</sup> In such form these collected papers, bound in several volumes, become a valuable and easily obtained asset for the libraries of standards and calibration laboratories, and even for the desks or book shelves of laboratory personnel.

## 11. Information as a valuable resource

To provide the Bureau technical staff and others outside of NBS with information on the use of radio frequency standards and on the use and evaluation of precision measurement systems, an information center was organized early in 1968 as a part of the Radio Standards Laboratory, with Wilbur J. Anson as manager. In 1970 the information center became a section of the Electromagnetics Division, under the name of Electromagnetic Metrology Information Center, with Anson as chief. Taking on a relatively new concept in information centers, the group was staffed with several scientists, each with metrology experience of long standing, plus several persons who became trained as information specialists. As backup, in the form of specialized technical experience, the

---

<sup>22</sup>The poem, "Ode to a special issue," written by Raymond N. Jones, is possibly one of the few poems that ever was published in the technical journals of the IEEE or the former IRE and AIEE. As a sample of the verses, Jones in speaking of his own (as co-author) technical article in the special issue, stated:

They wanted it tutorial and entirely complete  
Giving history, and theory, and the latest technique,  
The level of the reader covered all degrees,  
From high school sophomores to PhD's.

<sup>23</sup>Other issues of the *Transactions* covered papers presented at the several Electrical and Electronic Measurement and Test Instrument Conference(s) (Canada). Boulder Laboratory personnel have participated in these conferences.

<sup>24</sup>"Basic and derived physical quantities, and conceptual bases of standards and methods of measurement are described. . . . some of the problems involved in obtaining a higher order of accuracy are discussed. Comparison of standards of different nations are mentioned and the benefits to be derived from such comparisons are described. Areas needing further research as well as those which would benefit from international cooperation, are designated."

<sup>25</sup>Vol. 1 of *Precision Measurement and Calibration (NBS Handbook 77)* related to *Electricity and Electronics*, February 1961. Vol. 4 of *Precision Measurement and Calibrations (NBS Special Publication 300)* related to *Radio Frequency*, June 1970.

talents of many of a cross-section of the professional staff of the division have been used on various projects conducted by the center.

Several significant products have come out of the section since the early formative period.

a) **TECHNICAL DOCUMENTS BY THE THOUSANDS**

A depository file has grown to more than 15,000 documents, consisting of reprints and reproduced copies of publications relating to the art of measurement of electromagnetic quantities in the frequency range from 30 kHz into the millimeter range. Many times related matter will be included, such as fabrication techniques, in order to round out the information in a specialized field. Index systems are set up for easy retrieval of the documents.

b) **THE ELECTROMAGNETIC METROLOGY CURRENT AWARENESS SERVICE**

An Electromagnetic Metrology Current Awareness Service was provided to Navy laboratories in July 1969, and was expanded on a monthly report basis to other organizations in September 1970. The service is sponsored by eight technical organizations that aid in financial support. Each month several hundred annotated references to the current literature in the field of electromagnetic metrology (from dc to millimeter waves) appear in a report that is sold on a subscription basis. The material is summarized, or abstracts are rewritten, by measurement specialists within the division. The service saves very much time on the part of research workers in their scanning of contemporary literature in preparation for or continuation of research projects.

c) **THE ROLE OF LITERATURE SEARCHES**

Properly organized research projects use as background material the earlier work of others that is related to and even remotely related to the project being pursued for study. Thus, it is most important that a literature search be made as a preparatory step. The Information Center performs a most useful function in this area and has conducted searches ranging up to several thousand in total number of literature references that have been scanned. The "working" list or the published bibliography might be but a fraction (a fourth, for example) of the total number that were scanned. These literature searches have been particularly useful in aiding personnel of the Electromagnetics Division toward attaining their research objectives.

d) **A BUREAU INNOVATION—METROLOGY GUIDES**

More recently the Information Center has sponsored the preparation of three *Metrology Guides* as a pilot program to determine the usefulness of such publications. These *Guides* were prepared by measurement specialists within the division to disseminate measurement know-how by critical comparison of measurement methods. Two of the *Guides* are particularly slanted toward the accurate measurement of electromagnetic quantities, those of noise (as a measurement of noise performance factor) and of impedance (as a measurement of lumped parameter impedance). These *Guides* were published as *NBS Monographs*. A third *Guide* appeared as an NBS Internal Report on test procedures for a special type of radio receiver.

## **NATIONAL RF STANDARDS IN DEVELOPMENT**

To quote from the 1960 Statement of the Central Continuing Mission of the National Bureau of Standards,<sup>26</sup> the mission:

. . . includes the development and maintenance of the national standards for physical measurement, fundamental studies to improve or create new standards to meet existing or anticipated needs, research on the interaction of basic measuring processes on the properties of matter and physical and chemical processes, determination of the important physical constants,

---

<sup>26</sup> *Annual Report, Fiscal Year 1960, NBS Misc. Pub. 237*, p. 151.

which may serve as reference standards, analysis of the self-consistencies of measured values of the important physical constants, and international correlation of the national standards and definitions of the units of measurement.

Through three decades, since 1944, the Bureau has been intensely engaged in implementing this mission at radio frequencies.

## 1. The development program begins

By 1945 the initial planning for further development of RF standards and measurement techniques was well underway. Heading up the "Radio Measurements and Standards" project were W. D. George and H. Lyons in a cooperative effort, with George responsible for the frequency range up to 300 MHz and Lyons in the region above 300 MHz (essentially that of microwaves). Thus the lower frequency range related to lumped-constants (or parameters) circuitry involving coaxial equipment. In the early stages of development the higher frequency range (above 300 MHz) related to rigid waveguide components, and later included coaxial equipment. The early planning and development stages were limited to standards for the active quantities of power and voltage, and the passive quantities of impedance and attenuation.<sup>27</sup> Limitation to these four quantities was almost solely based upon that of first developing the most needed and most important standards and measurements methods—developments for other quantities would come later.<sup>28</sup>

## 2. Attenuation—A starting point for standards

With the microwave frequency standard developed to the stage of being useful in meeting the country's need for the calibration of frequency meters, effort could now be directed toward the development of other standards. The first electrical quantity so chosen for development of standards was that of attenuation.

Measurement of attenuation is required in the precision use of signal generators, receivers, field-strength meters, and in various types of laboratory measurements. In earlier years control of signal amplitude at the lower radio frequencies came from voltage-divider networks, with later developments of complex resistive networks that operated with constant input and output impedance. Capacitative networks have also been used in signal generators. Some of the early measurements of attenuation in coaxial equipment, beginning in 1945, were performed with purchased attenuators that incorporated resistive networks in coaxial configuration. These were specially constructed for precision up to 300 MHz. They were calibrated by direct-current measurement. With the advent of waveguide equipment, an entirely new approach to attenuation control had to be developed. A commonly used method was the insertion of an energy absorption resistor strip into the waveguide. But these attenuators had limitations in absorbing microwave power and were lacking in precision control of attenuation. Moreover, they lacked the fundamental requirements of a laboratory reference standard.

---

<sup>27</sup> "Active" has the sense of a source(s) of energy in circuit elements, thus the electrical quantity of power (or energy) is considered active.

"Passive" has the sense of no source of energy in circuit elements such as in a resistor, thus the electrical quantity of resistance is considered passive.

<sup>28</sup> The historical accounts of the development of standards and measurement techniques for the electrical quantities of power, voltage, impedance, and attenuation are treated more extensively and in greater detail than for the other quantities because of their greater importance and the many facets of the development stages at NBS. The sequential order of the quantities is mainly a chronological order and based upon the initiating of their development, rather than upon their importance to the measurement art or consideration of placing the more fundamental quantities before derived quantities.

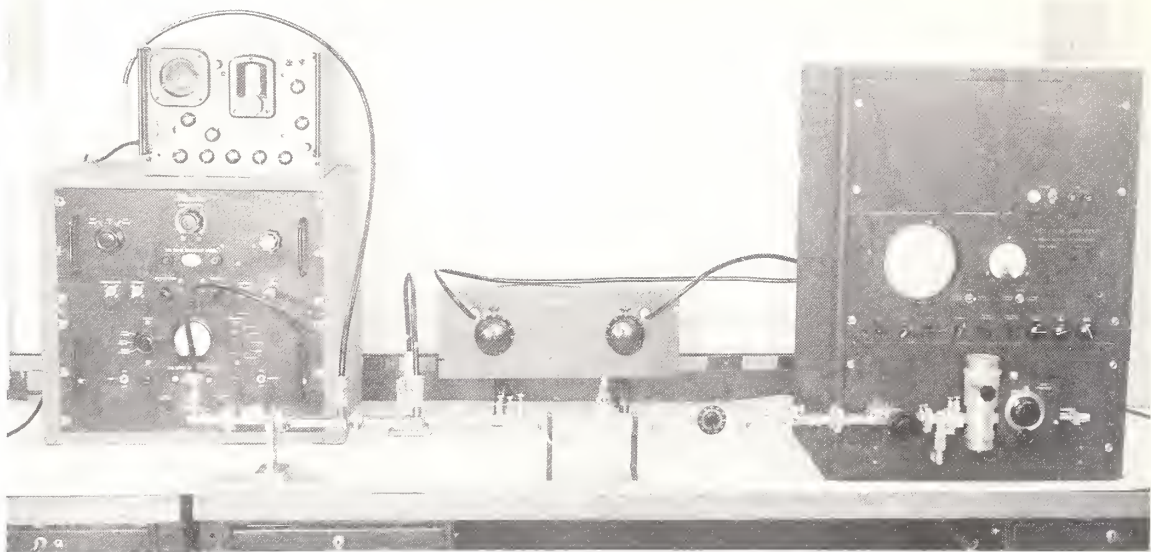

Measurement of X-band attenuator in 1946, using a heterodyne system operating at 20-MHz intermediate frequency. A carbon resistor coaxial-type attenuator covering a range of 40 dB was used as the standard attenuator. Microwave power came from the klystron oscillators.

Out of a development by the Hazeltine Corp., New Jersey, dating back to 1935, and a later development in England in 1947, came the concept and design of an extremely useful instrument for the precision measurement of attenuation at microwave frequencies.<sup>29</sup> This device became known as the waveguide below-cutoff attenuator and has become a most useful laboratory-type of reference standard of attenuation.<sup>30</sup>

#### a) GETTING STARTED WITH WAVEGUIDE BELOW-CUTOFF ATTENUATORS

During July 1945 J. J. Freeman<sup>31</sup> spent the month at the Radiation Laboratory, MIT, primarily to learn the theory and design of waveguide below-cutoff attenuators. Freeman's study led to the Bureau's first paper on piston attenuators, a CRPL Report, dated December 27, 1946. The paper was later published in the *NBS Journal of Research* with the title "Theory and design of a cavity attenuator"[8]. The conclusion reached was that attenuators of rectangular cross-section have two advantages over those of circular cross-section. Some of each type were designed and constructed, but in later years the circular cross-section showed superior features and became the sole type of the many that have been constructed within NBS.

Early studies by J. J. Freeman and R. E. Grantham<sup>32</sup> indicated that the heterodyne or i.f. substitution method, with the standard attenuator in the i.f. circuit, was much superior in accuracy of measurement and flexibility of operation over wide ranges of microwave frequencies than any other method (and has remained so to the present time). By the summer of 1946 an attenuation standard of the waveguide below-cutoff type of circular cross-section had been constructed in the shop, to be followed a short time later with one of rectangular cross-section. The heterodyne method was evaluated extensively with X-band

<sup>29</sup> The fact must not be overlooked that in 1897 Lord Rayleigh, published a paper in the *Philosophical Magazine* that postulated the propagation properties of electromagnetic waves in a metallic tube at frequencies much below the cutoff frequency.

<sup>30</sup> Sometimes called the piston (or cavity) attenuator. Essentially the waveguide below-cutoff attenuator consists of a length of waveguide with a uniform internal cross-section, through which a signal below the cut-off frequency decays exponentially with distance. Measurement of attenuation is dependent primarily upon the relative change in distance of a receiving probe that can be moved within the guide with a high degree of precision.

<sup>31</sup> Jacob J. Freeman entered the Radio Section on November 1, 1940. He initiated the first work in noise at microwave frequencies at NBS. Freeman chose not to move with the CRPL to Boulder and transferred to the Naval Research Laboratory in Washington, D.C. in 1954.

<sup>32</sup> Rodney E. Grantham entered the Radio Section on December 27, 1945, as a radio engineer. He transferred to the Naval Ordnance Laboratory at White Oak, Md. in 1951.



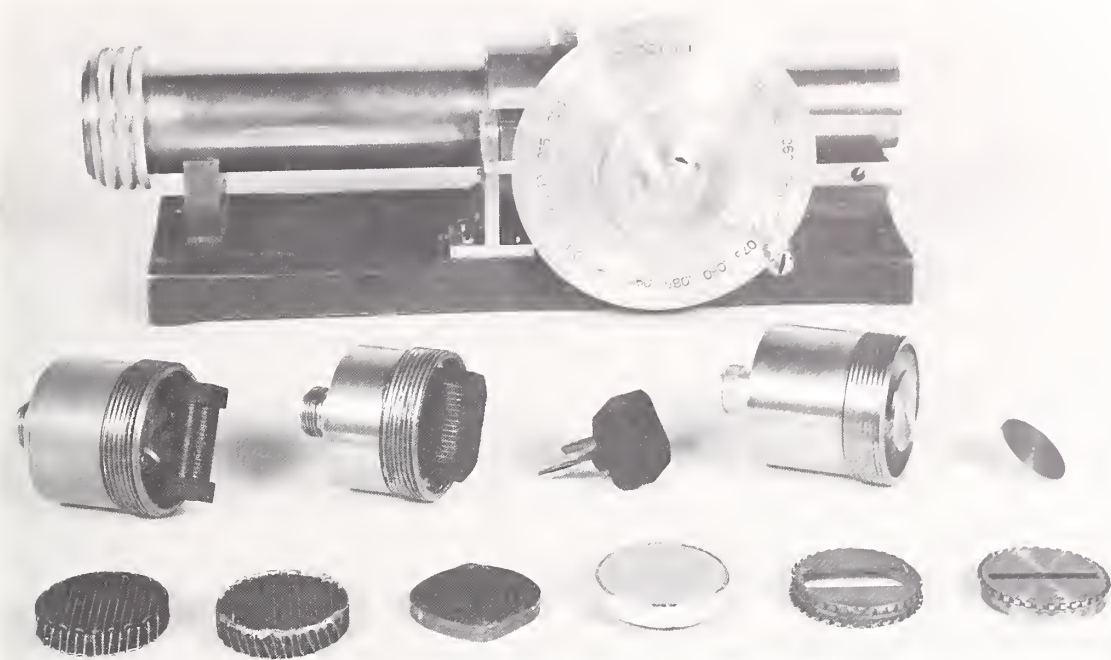

*First waveguide below-cutoff or piston-type attenuator designed by Microwave Standards Section and constructed in Bureau shops in 1946. It was used at an intermediate frequency of 20 MHz in the heterodyne method of calibrating attenuators at microwave frequencies. Shown here with experimental components used to determine best operation. In lower row are various types of filters used to suppress unwanted modes of the wave that progressively decays through the piston. In upper row are several means of "launching" the wave and the pickup or receiving coil. This instrument was the progenitor of a lineage of waveguide below-cutoff attenuators that now reach a high state of development at NBS, and is preserved as an historic item.*

waveguide components at a frequency of 9000 MHz and an intermediate frequency of 20 MHz. Considerable information was learned on suppression of higher modes in the operation of the piston attenuator. This early study resulted in a joint presentation at the AIEE winter meeting of January 1946 and in a June 1948 publication [9].

#### **b) THE WAVEGUIDE BELOW-CUTOFF ATTENUATOR BECOMES A REFERENCE STANDARD**

With an understanding of the potential of the waveguide below-cutoff (or piston) attenuator as a reference (or primary) standard of attenuation that could be used in a measurement system over a very wide frequency range, both of the standards sections (High Frequency and Microwave) proceeded with improving electrical and mechanical features that would occupy much effort for many years to come. Improvements in mechanical features were largely the work of A. A. Feldmann, a mechanical engineer.<sup>33</sup> Beginning in the summer of 1948, several piston attenuators were constructed with waveguide of rectangular cross-section that were precision-made by the electroforming process. These were designed for operation at 20 MHz. However, experience proved that the piston or

<sup>33</sup> Albert A. Feldmann entered the Radio Section on November 14, 1945. He resigned from the Radio Standards Division in 1958 to join the Hughes Aircraft Co. During his years with NBS Feldmann engaged in various activities related to the mechanical design and fabrication of precision laboratory apparatus. In cooperation with the Bureau's Electrodeposition Section, pioneering studies were made in the successful production of intricate and precision-type waveguide components by the electroforming process.\* Some of the components could be fabricated by no other process. Also developed by Feldmann were special methods of machining of powdered iron materials and ferrites which, because of their fragility and hardness (often with the characteristics of a ceramic), create difficult machining problems. Several publications resulted from these various engineering advances.

\*Electroforming is the electrodeposition of metals in considerable thickness over a mandrel that can be removed intact or dissolved by chemical solutions.

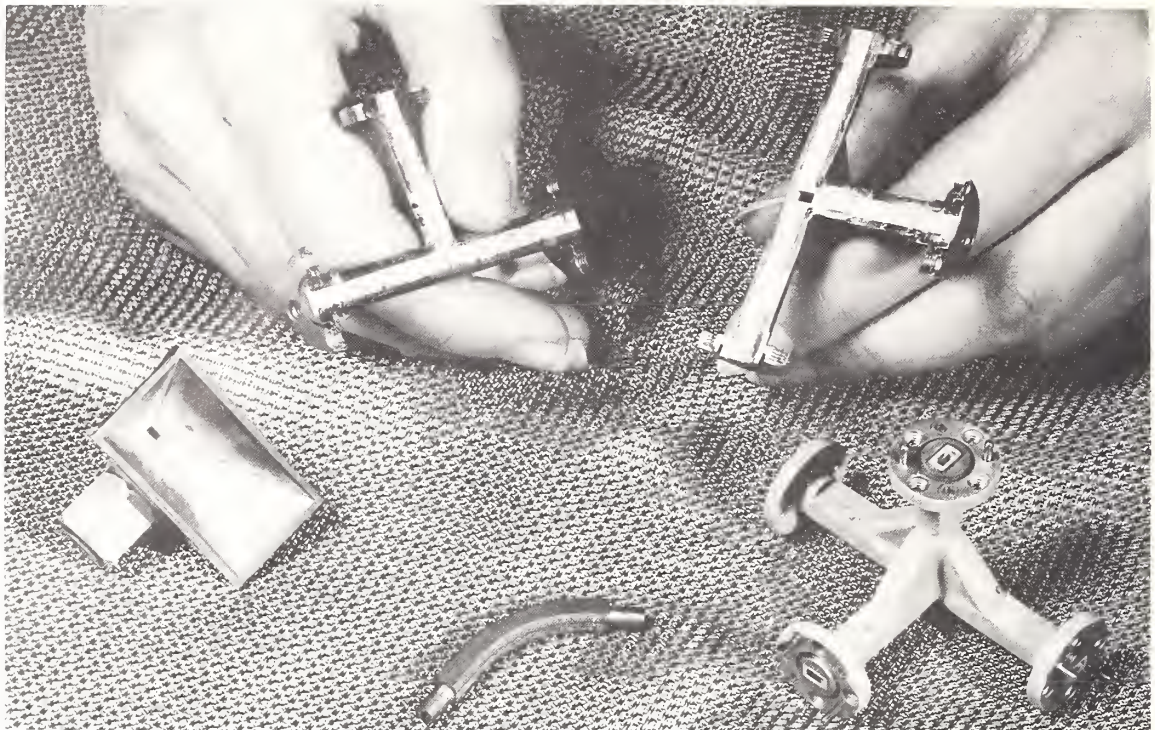

*Microwave components in millimeter wavelength sizes electroformed by NBS—connector flanges not electroformed. In foreground cutaway models of hybrid T-junctions in 6-mm wavelength size. Upper left is horn antenna, upper right an E-bend, both in 3-mm wavelength size. Silver was used for electroforming, with added copper layer for increased strength.*

circular cross-section was superior. Precision of the cross-section and straightness of the cylindrical bore has been achieved over the years by a honing process. Positioning of the moving probe or pickup coil has been with a precision lead screw, at first, hand-driven, and later, motor-driven. Readout of the position of the probe (which provides a calibration of the attenuator as a reading in decibels of attenuation) went through a series of different mechanical designs over a period of more than two decades. These included revolution counters, segmented linear scales of "step blocks" (10 decibel steps) plus continuous control from the lead screw, and optical-type readouts.

Over the many years of development a number of persons contributed to the refinements of design and construction of these waveguide below-cutoff attenuators. Among these persons after the initial developments, were C. McKay Allred, Clarence C. Cook, and David H. Russell. Although those at NBS did not conceive the principle of this type of

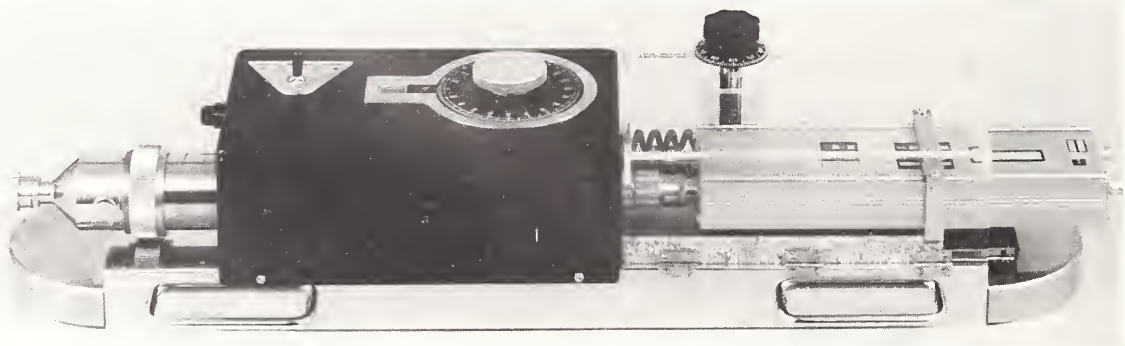

*One of the more recent progenies of the lineage of waveguide below-cutoff attenuators developed at NBS. Many refinements are featured in this model, including the added 30-dB amplifier unit (right). The precision attenuator operates at 30 MHz over a range of 60 dB. Position of the receiving coil by a motor-driven precision-screw movement is observed with a revolution counter and dial readout.*

attenuator, they brought the instrument that has served so well as a laboratory standard of attenuation to a very high state of mechanical and electrical precision. These attenuators became the model for others to copy, and the various stages of design have served as prototypes for the construction of limited numbers to serve as laboratory standards by NBS and by others.

Use of the piston attenuators as laboratory standards was largely based upon the design of measurement systems by many, but mainly by Allred and Cook, and by Russell for coaxial equipment, and by Wilbur Larson for waveguide equipment above 1 GHz [10,11].<sup>34</sup>

During the last several years of the 1950's Allred and Cook were engaged in the pioneer development of an attenuation measurement system of very high precision for the Electronic Calibration Center. Designed for the calibration of coaxial attenuators, the frequency selected was 30 MHz, with an attenuation range upwards of 150 dB. Increased stability and sensitivity were obtained by the use of a very accurate piston attenuator and a precision phase shifter, combined for a null observation. The combination of a constant signal source of very high magnitude with a new type of mode-launching system provided the great attenuation range. This system proved its worth and success by the fact that it has been in continuous use to the present time.

<sup>34</sup> Allred received the Department of Commerce Silver Medal for Meritorious Service in 1964 "for outstanding personal contributions to the science of high frequency measurements, particularly in the field of attenuation; for effective project management and program development; and for exemplary leadership in the field."

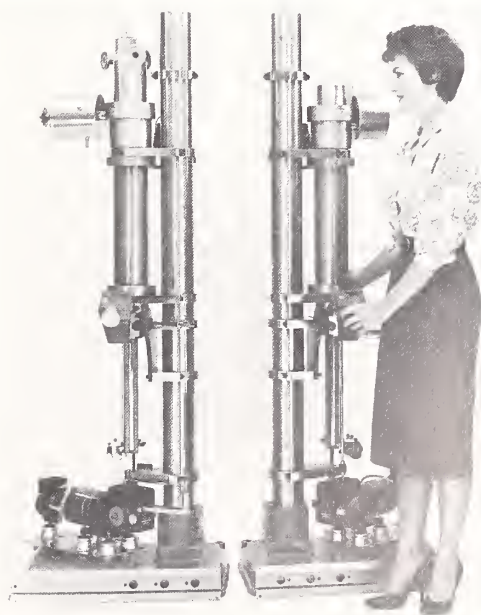
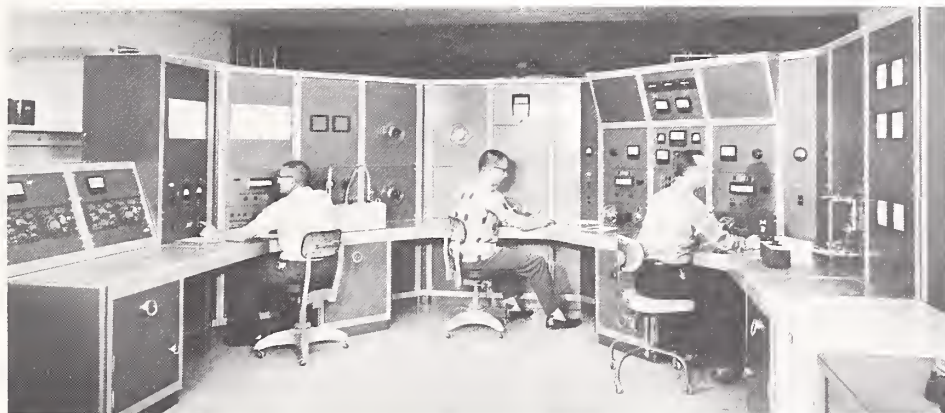

*A console-equipped facility for calibration of attenuators fitted with coaxial connectors, in the frequency range from 1 MHz and extending into the microwave range of 10 GHz and higher. Much of the specialized measurement equipment was developed and constructed within the Boulder Laboratories. As examples are the two large piston attenuators used as standards at 60 and 100 MHz shown in accompanying photograph taken in 1960.*

#### c) A STUDY OF ATTENUATORS PAYS OFF

In 1963, during the calibration of six rotary-vane attenuators of similar construction, Wilbur Larson observed a variability in calibration that was traced to eccentricity in the rotating mechanism. This type of attenuator was described in 1950 by Southworth (formerly of the Radio Section) as a development of the Bell Telephone Laboratories. It was further developed by B. P. Hand as a manufactured product of the Hewlett-Packard Co.

Since 1963 Larson has made an extensive study of this type of attenuator, improving upon its design and indicating how it can be calibrated with a low degree of uncertainty by taking careful account of several kinds of errors. His study has resulted in a number of publications and, "for major contributions to development of precision attenuation measurements in the course of a fruitful career," he was awarded the Department of Commerce Bronze Medal for Superior Service.<sup>35</sup>

W. E. Little, W. Larson, and B. J. Kinder have developed a rotary-vane attenuator with an optical readout that overcomes the shortcomings of a gear mechanism [12]. Such an attenuator follows the theoretical cosine-squared law of attenuation to within 0.002 dB up to 20 dB of attenuation. Recent development by Larson and Eugene Campbell of a series substitution system (contrasted to the i.f. substitution method with the piston attenuator) gives a very high order of resolution and stability to an attenuation measurement system [13].

A series of international comparisons with nine other laboratories of a group of waveguide attenuators serving as transfer standards at 10 GHz, beginning in the middle 1960's, has resulted in some highly satisfactory agreement among the various laboratories. A comparison in 1973, carried out by Larson using the rotary-vane attenuator and the new measurement system, showed a difference in measured values of a transfer standard of but 0.0017 dB with that of a United Kingdom laboratory. It can be stated frankly that NBS has come a long way in the art of precision measurement at microwave frequencies since the late 1940's.

#### d) IN PURSUIT OF OTHER METHODS OF MEASURING ATTENUATION

The number of different methods developed for measuring attenuation at high radio frequencies has not been found wanting, both within and outside of NBS.

As a means of increasing the accuracy of measurement at low attenuation values, in 1959 Glenn F. Engen and Robert W. Beatty of the Microwave Circuit Standards Section used a modified dc substitution method (with one signal source) incorporating Engen's self-balancing bolometer bridge (see p. 375). Essentially, the technique was that of bolometric measurements. Calibration of a rotary-vane attenuator indicated uncertainty of measurement as low as 0.0001 dB at low attenuation—a value that was better than the precision of the attenuator settings.

Early in 1960 George E. Schafer and Ronald R. Bowman began the development of an attenuation measurement system using but one signal source (the i.f. system requires two signal sources) yet retaining the wide dynamic range of the i.f. substitution method.<sup>36</sup> The result was a system called the "modulated subcarrier technique," with modulation at an audio frequency, using a ratio transformer as the attenuation standard [14]. Although the method was well adapted for measurements involving a change of attenuation (as obtained with a variable attenuator), it was not well adapted for the precision measurement of insertion loss where the attenuator must be inserted and then removed from the system. However, with modifications, an English laboratory has had good success with the system.

Another attenuation measurement system was conceived by David H. Russell, which he called "an unmodulated twin-channel microwave attenuation measurement system." Designed primarily for coaxial equipment, the system had the added advantage of simultaneously measuring phase shift. However it did not prove to have the value of supplanting other systems at the Boulder Laboratories.

<sup>35</sup> The Bronze Medal was presented to Larson by NBS Director Roberts at the Boulder Laboratories on February 19, 1974 (the Medal had been awarded in November 1973).

<sup>36</sup> Later, in 1964, Schafer was awarded the Department of Commerce Silver Medal for Meritorious Service "for work underlying national standards of microwave attenuation and phase shift, for excellence in administration of Radio Standards Engineering (division), and for meritorious authorship in the field of microwave measurements."

By modifying some of the features of the multihole directional coupler, Wilbur Larson was able to design a waveguide component that had very stable characteristics as an attenuation standard. The input and output ports were so aligned that the device could be inserted and removed from a measurement system without altering the position of any sections of the system's waveguide components. As such, it became known as an "inline waveguide attenuator."

Still another development that came in the earlier years after World War II was that of a unique type of attenuator developed by Frank Reggia which, for a period of time, was referred to as the "NBS Magnetic Attenuator," and named as such in the *Technical News Bulletin* of August 1951.<sup>37</sup> Later, it became known as a "U.H.F. magnetic attenuator." Certain ferromagnetic materials show lossy characteristics above 30 MHz which can be controlled by a magnetic field. Reggia made use of this property in a coaxial attenuator by controlling the magnetic field with an electromagnet. Although the device had a variety of potential uses, it did not reach the status of a marketed item.

Beatty, formerly chief of the Microwave Circuit Standards Section and later a Senior Research Scientist in the Electromagnetics Division, made many contributions by his published papers on attenuation measurements at radio frequencies.<sup>38</sup> One of these papers was an extensive discussion on the subject as an *NBS Monograph* [15]. Other papers related to definitions of attenuation (subject of many interpretations), the effect of connectors and adapters on measurements, mismatch errors, and various papers on measurement techniques.

An exotic method of measuring attenuation that can serve as an independent standard is being developed at NBS Boulder. The development was first reported in May 1972 by R. A. Kamper, M. B. Simmonds (of Cryogenics Division); and R. T. Adair, C. A. Hoer (of Electromagnetics Division). The method is based upon the now familiar Josephson effect.<sup>39</sup> It provides a self-calibrating system based upon a fundamental constant of nature, thus offering an attenuation standard that is independent of the piston attenuators used by NBS over many years. At the core of the system is the Superconducting Quantum Interference Device (SQUID) that has been adapted by NBS for various applications.

### 3. Impedance—Its measurement the essential ingredient to radio metrology

In the simplest terms, impedance is usually defined as the total opposition offered by a circuit element to the flow of alternating current. A common usage of the term is that of "matching" the impedance of a load with that of an energy source to obtain the greatest transfer of power to the load. In reality, its expression and its measurement may not be simple. Impedance information, including that of matched conditions of a transmission system, is very essential in the accurate measurement of power, voltage, attenuation, field strength, and other quantities. Thus, the small group, beginning in 1945, and later, the High Frequency Standards Section and the Microwave Standards Section, made an early start toward the accurate measurement of impedance over a very wide frequency range.

The development of slotted lines or standing-wave machines before and during World War II, and their easy procurement after the war, provided the means for NBS to get an early start on the measurement of impedance at high radio frequencies and up into the microwave region (X-band, at 10,000 MHz). However, a growing experience with the slotted-line method of impedance measurement, with its variations in design and technique, brought on a degree of pessimism that high accuracy of measurement would never be attained because of the inherent limitations, both mechanical and electrical. Thus new approaches to the problem of gaining greater accuracy became the objective, rather than

<sup>37</sup> Frank Reggia entered the Radio Section on September 19, 1945. Choosing not to move with the CRPL to Boulder, Colo. in 1954, Reggia transferred to the Diamond Ordnance Fuse Laboratories, later known as the Harry Diamond Laboratories.

<sup>38</sup> In 1963 Beatty was awarded the Department of Commerce Silver Medal for Meritorious Service "for outstanding contributions to the field of microwave circuit standards."

<sup>39</sup> The ac Josephson effect was first predicted theoretically in 1962 by Brian Josephson of Cambridge University. It occurs when two superconductors are weakly coupled and cooled below their transition temperature (becoming superconducting). On July 1, 1972, NBS adopted a method of using the ac Josephson effect for maintaining the U.S. legal volt. Thus the volt is based upon a fundamental constant of nature rather than upon the mean EMF of a reference group of standard cells.

further refinements to the slotted-line technique. Those closely associated with these early efforts included Eldred C. Wolzien,<sup>40</sup> Howard E. Sorrows, Robert C. Ellenwood,<sup>41</sup> and Everett H. Hurlburt.

#### a) THE REFLECTOMETER IN DEVELOPMENT

Late in 1952 Alan C. MacPherson and David M. Kerns<sup>42</sup> of the Microwave Standards Section took a new approach in the measurement of impedance in waveguide. The method was a measurement of voltage standing-wave ratio (VSWR) by use of a three-arm waveguide junction, sometimes referred to as the phaseable-load technique.<sup>43</sup> By now Kerns could apply rigorous theoretical analysis to the properties of waveguide junctions, benefiting from his earlier studies of symmetrical waveguide junctions published in 1951. Their technique was that of connecting a generator and a detector (with measurement of output from a bolometer) to two arms of a three-arm junction. In the third arm was placed a sliding load from which phase relations could be observed that yielded a value of the VSWR presented. Such loads could be used as standards. Although MacPherson and Kerns first reported their work in April 1953, their paper was not published until the summer of 1956 [16].

Earlier to the development of the phaseable-load technique, Kerns had been analyzing half-round inductive obstacles in rectangular waveguide as a calculable impedance (reflection coefficient) standard. Later, quarter-wavelength short circuits proved to be superior as a standard for most measurement systems. Use of the half-round obstacle led directly to the next development of impedance measurements. After a number of years of work with coaxial equipment in the Microwave Standards Section, Beatty began to participate in the rigid waveguide projects. At the Conference on Electronic Standards and Measurements, August 1958 (at Boulder), Beatty and Kerns reported on new developments with impedance standards and measurements.<sup>44</sup> Beatty had developed an adjustable sliding waveguide termination for use in rectangular waveguide, and this proved valuable in a modification by Beatty and Kerns of the three-arm junction method by using a directional

---

<sup>40</sup> Eldred C. Wolzien entered the Radio Section on April 6, 1942, to work in the standard frequency broadcast group. He retired in December 1970.

<sup>41</sup> Robert C. Ellenwood entered the Radio Section on February 6, 1945. He resigned from the Microwave Standards Section in 1950.

<sup>42</sup> David M. Kerns entered the Radio Section on April 1, 1946. He has continued theoretical research at radio frequencies at NBS to the present.

<sup>43</sup> Unlike the measurement of impedance at low radio frequencies, whereby the impedance of a circuit element is usually expressed in ohms, with waveguide at microwave frequencies the impedance relations are expressed as a VSWR (voltage standing-wave ratio) value or as a reflection coefficient.

<sup>44</sup> A. C. MacPherson had transferred to the Naval Research Laboratory, Washington, D.C. upon the move of the CRPL to Boulder.

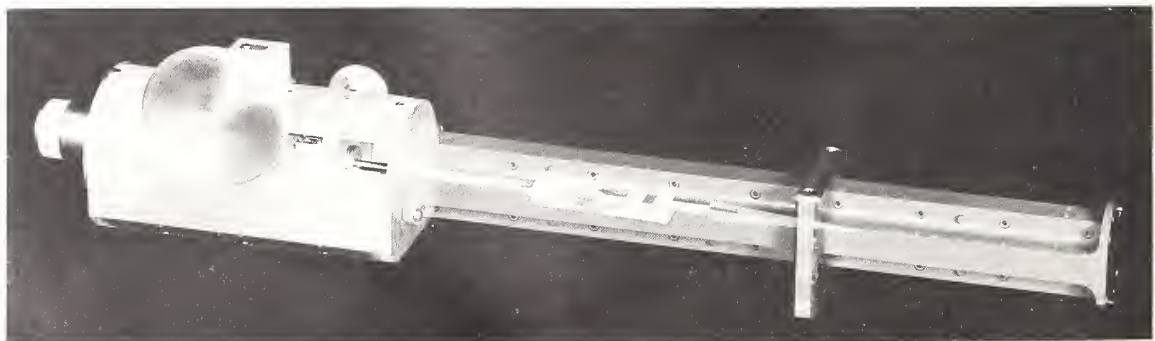

*A double exposure reveals the two moving (and essential) parts of an adjustable sliding termination, a very important component in microwave measurements. Improvements in these terminations have been a long-time Bureau development. Controls in this model independently rotate the arrow-shaped resistance vane, slide the vane relative to the short-circuiting rectangular plunger, and move the assembly along interior of the waveguide.*

coupler for impedance measurements.<sup>45-47</sup> The unprecedented accuracy led to a tuned reflectometer analysis.

In July of 1959 Glenn F. Engen and Beatty reported on a reflectometer using a pair of directional couplers, equipped with auxiliary tuners to minimize reflections and thereby minimizing errors of measurement [17]. A modified form of the reflectometer incorporated but one directional coupler, plus a calibrated attenuator. This form became a useful system at NBS. The reflectometer technique (using directional couplers) was not original with NBS, but was highly developed by the Radio Standards Laboratory for accurate impedance measurements based upon an original analysis of the errors caused by imperfect tuning. Nor was the multi-stub (or screw) tuner used in the reflectometers an original NBS development, but it has become a very valuable operating component in nearly all of the waveguide measurement systems used by NBS in more recent years. Various staff members have contributed to its high state of development.<sup>48</sup>

Wilbur J. Anson contributed to the techniques of using the modified reflectometer with the single directional coupler. Along with Beatty, they adapted the rectangular waveguide reflectometer to measurements in coaxial systems [18].

During the progressive steps of improving upon the design and reducing the error of measurement of the waveguide reflectometer, a number of contributions were made toward the development of terminations to serve as reflection-coefficient standards. Of these, the quarter-wavelength short circuit has proved to be the most useful.

In the adaptation of impedance standards to the development of equipment for calibration services in various sizes of rectangular waveguide, many contributions were made by Bill C. Yates.

By 1967 Ramon L. Jesch had succeeded in developing a reflectometer that incorporated coaxial components only. It was primarily designed to cover the frequency range of 1 to 4 GHz for use in the study of the properties of precision coaxial connectors.

#### **b) IMPEDANCE STANDARDS OF LUMPED PARAMETERS (BELOW 300 MHZ)**

Below about 300 MHz impedance measurements come into the domain of lumped-constant (or parameter) techniques, where one encounters the discrete quantities of resistance, inductance, and capacitance (as standards), that constitute the complex quantity of impedance. In the early years, beginning in 1913, the former Radio Section became involved in measurements where these quantities were of considerable magnitude (low radio frequencies require inductance and capacitance values of fairly large magnitude) (chs. II and V). By the 1950's the High Frequency Standards Section, and the later groups at Boulder, were making measurements at frequencies that required inductance and capacitance of small magnitude (and thus of small physical dimensions). Problems of connectors, stray capacitance, resistance at high frequencies, became troublesome. The team of Robert C. Powell, Robert M. Jickling, and Alfred E. Hess concluded in a 1958 paper that standards at the high radio frequencies ranging up to 300 MHz should be based upon those of capacitance standards derived from a calculable capacitor. Taking part in the development of these standards and the measurement methods were: Powell, Jickling, Hess, Raymond N. Jones, Leslie E. Huntley, Robert E. Nelson, and others [19,20]. Jones was selected to prepare *NBS Monograph 141*, "The Measurement of Lumped Parameter Impedance, a Metrology Guide," published in 1974.

---

<sup>45</sup> Previously (November 1951), Rodney E. Grantham, of the Microwave Standards Section, had published a paper on a reflectionless waveguide termination that had properties and uses quite similar to the one developed by Beatty. The design by Beatty provided for a much greater range of the voltage standing-wave ratio.

<sup>46</sup> Beatty filed for a patent on August 6, 1957. Patent 2,922,963 was issued January 26, 1960, entitled "Adjustable waveguide termination."

<sup>47</sup> An adjustable sliding termination for coaxial waveguide was described in 1964 by W. E. Little and J. P. Wakefield of the Microwave Circuit Standards Section. In principle, the device was similar to that described in 1953 by R. C. Ellenwood and W. E. Ryan of the former Microwave Standards Section, but incorporated modifications that resulted in obtaining very low values of the reflection coefficient.

<sup>48</sup> In 1964, William E. Little and Edward Niesen reported on their development of a multistub coaxial line tuner that was specially designed for use with reflectometers for operation in the range of 1 to 4 GHz. As many as 13 tuning stubs were incorporated in the device.

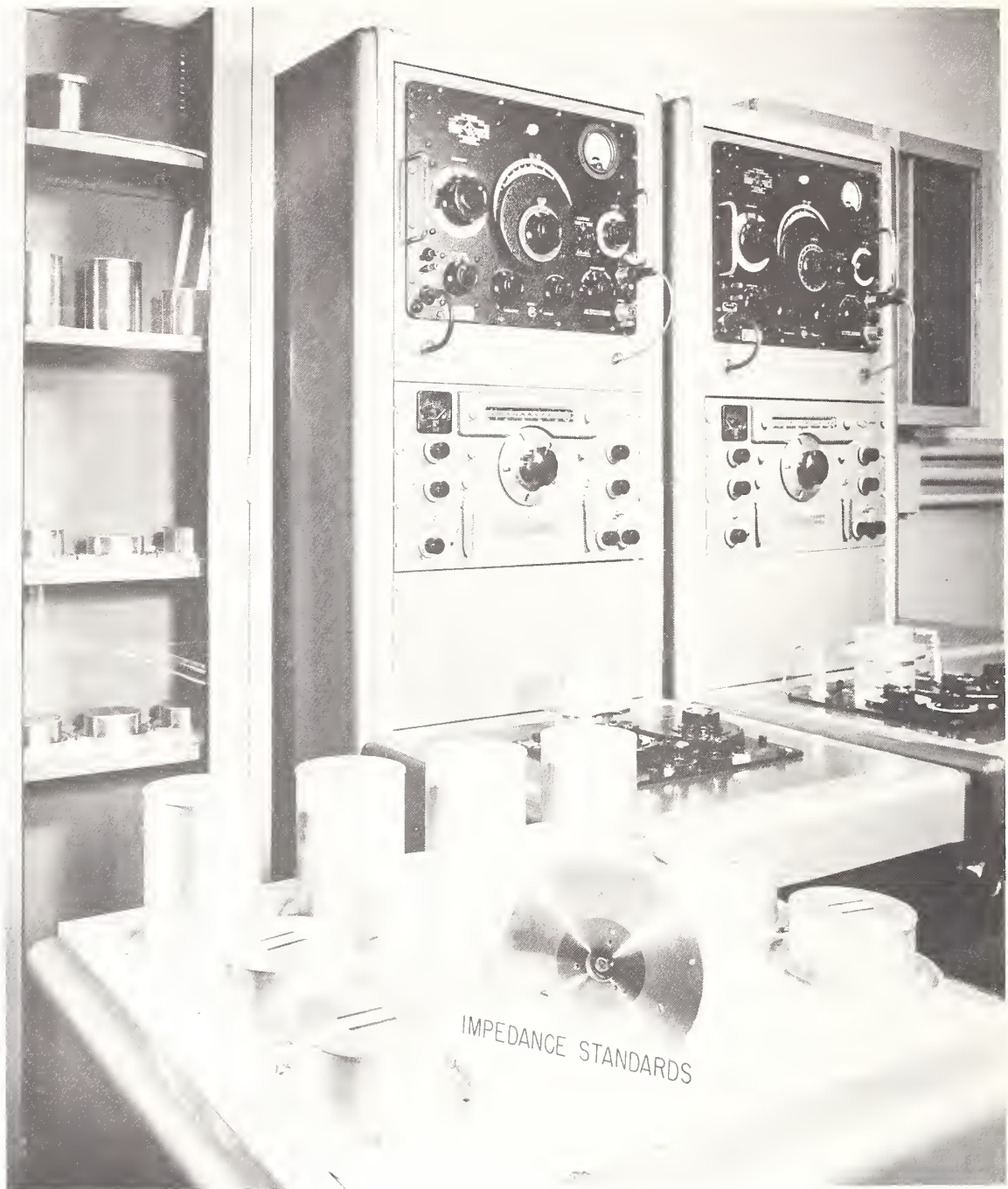

*This photograph of 1958 shows 2 of 18 consoles that were being developed in an ambitious project in the Electronic Calibration Center for the calibration of impedance bridges in the frequency range of 30 kHz to 300 MHz. In foreground is assortment of impedance standards of resistance, inductance, and capacitance, shielded in "top hat" enclosures. A specially designed connector made contact with the standard bridge. Passage of time and experience led to a simpler method of calibrating bridges.*



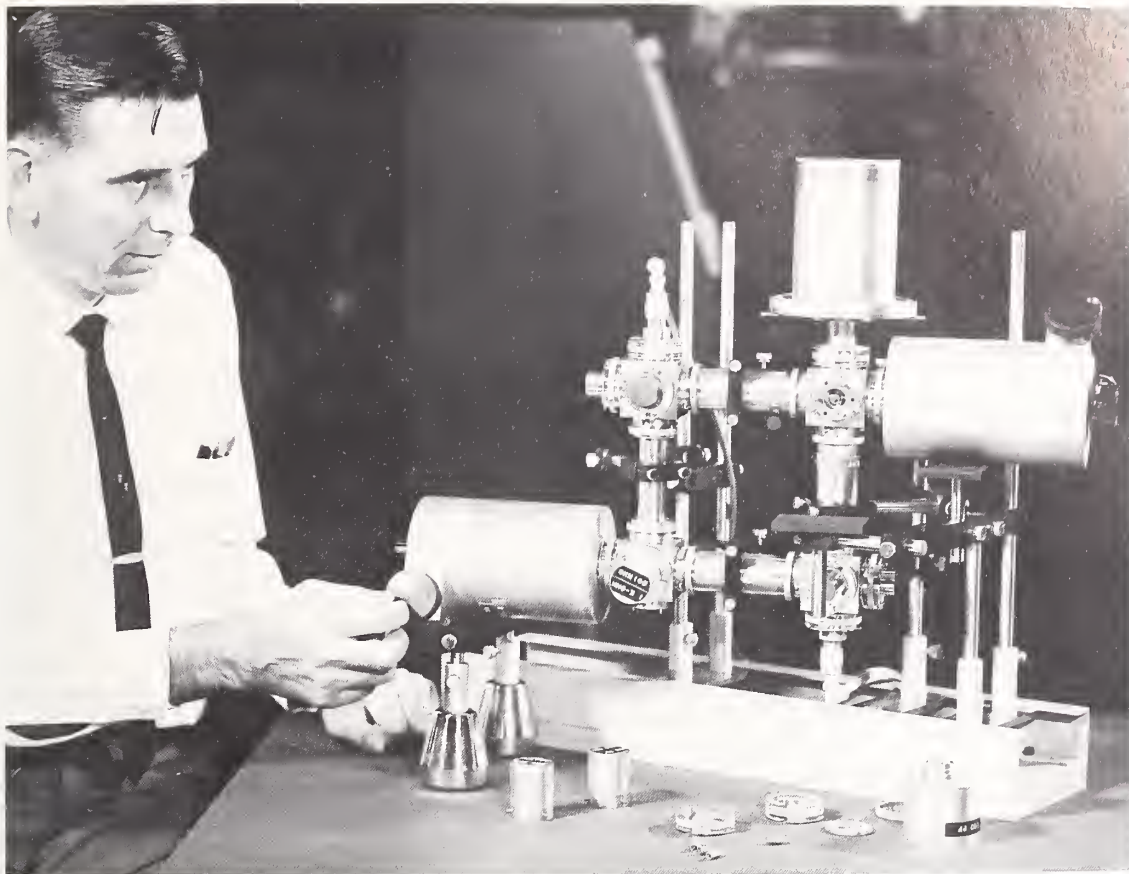

*Leslie Huntley, in 1965, operating the twin-T immittance (impedance) bridge of NBS design. Used to measure standards of conductance (resistance) and capacitance, fitted with precision-type coaxial connectors. Bridge has frequency range of 10 kHz to 10 MHz, with capacitance range to 1000 picofarads.*

#### **c) THE IN-BETWEEN FREQUENCY REGION OF IMPEDANCE STANDARDS**

Above the frequency range (above 300 MHz) of lumped parameter standards and up to the region where rectangular waveguide components have less cumbersome dimensions, laid a somewhat "in-between" or "gray area" where it was not clear what direction to take in developing impedance standards. Many of the developments in components for standards and in measurement techniques in this frequency range have taken place outside of NBS. Within NBS, precision, coaxial, air-dielectric transmission lines were designed and constructed, in terms of length of measurements, to serve as reference standards. By using slotted-line and reflectometer measurement techniques, these standards have served to measure impedance in terms of reflection-coefficient magnitude, VSWR, phase angle, and other impedance characteristics. Many of the studies have been those of determining the electrical characteristics of precision coaxial connectors. Much of the effort went into development of impedance measurement facilities of the Electronic Calibration Center. Taking part in these developments were: Powell, Jesch, Jickling, Jones, Huntley, Little, John Wakefield, and others.<sup>49</sup>

#### **4. Power—Its precision measurement became a long and difficult study**

Measurement of power is fundamental in the art of RF measurements, and the availability of accurate power standards is a prime necessity. Power measurements are required to determine the performance of oscillators, transmitters, receivers, communication systems, radar, navigation systems, microwave relays, and the like. Power measurement is especially important in the determination of operational (distance) range.

<sup>49</sup>In 1964 Powell received the Department of Commerce Silver Medal for Meritorious Service "for outstanding contributions and exemplary leadership in the science of radio and electronic measurements and instrumentations."

### a) EARLY PLANNING AND GETTING STARTED

Plans were underway during the first half of 1945 by those associated with the Radio Measurements and Standards Project in the development of standards of power and voltage, "using a multiplicity of methods for cross-checking the accuracy of results obtained."<sup>50</sup> This tenet of "using a multiplicity of methods" became a guiding factor in the development of power standards as the means of gaining confidence in the accuracy of measurement.

At the lower radio frequencies the early measurement of power served primarily as a means for the development of voltage standards, the measurement of voltage having greater appeal (use of the vacuum-tube voltmeter) and need at the time. The nature of electromagnetic fields in hollow waveguide at microwave frequencies dictated the measurement of power only—voltage measurement being meaningless.

For the early development of power standards at microwave frequencies, the group benefited from the developments by the Radiation Laboratory at MIT during World War II. Following in the steps of the Radiation Laboratory, the path appeared clear toward the further development of bolometric techniques for measurement of microwave power at low levels (less than 10 milliwatts).<sup>51</sup> Initially, there was enthusiasm to construct the bolometers in the laboratory and equipment was procured for this operation. But the highly specialized skill for this fabrication was not at hand, nor was anyone inclined to develop the skill, and the enthusiasm waned as sources of procurement became available.

By early 1948 a study was underway on improvement of bridge circuits used with bolometers in order to increase the accuracy of power measurements. A better understanding of the behavior of the dc bolometer bridge was gained from an analysis published in 1949 by D. M. Kerns.

<sup>50</sup> Quoted from the Monthly Report on Radio Measurement Standards Project for July 1945.

<sup>51</sup> Bolometers are of two types, the barreter and thermistor. The barreter element is a very short length of Wollaston wire suitably mounted to terminate a coaxial line or hollow waveguide. Resistance of the wire increases when heated by absorbing radio energy. Power measurement is made by observing the change in resistance in terms of substituted dc power to keep the resistance constant. Thermistors consist of a semiconductor enclosed in a small glass bead and mounted much like that of a barreter element. In contrast, the resistance decreases upon heating of the semiconductor.

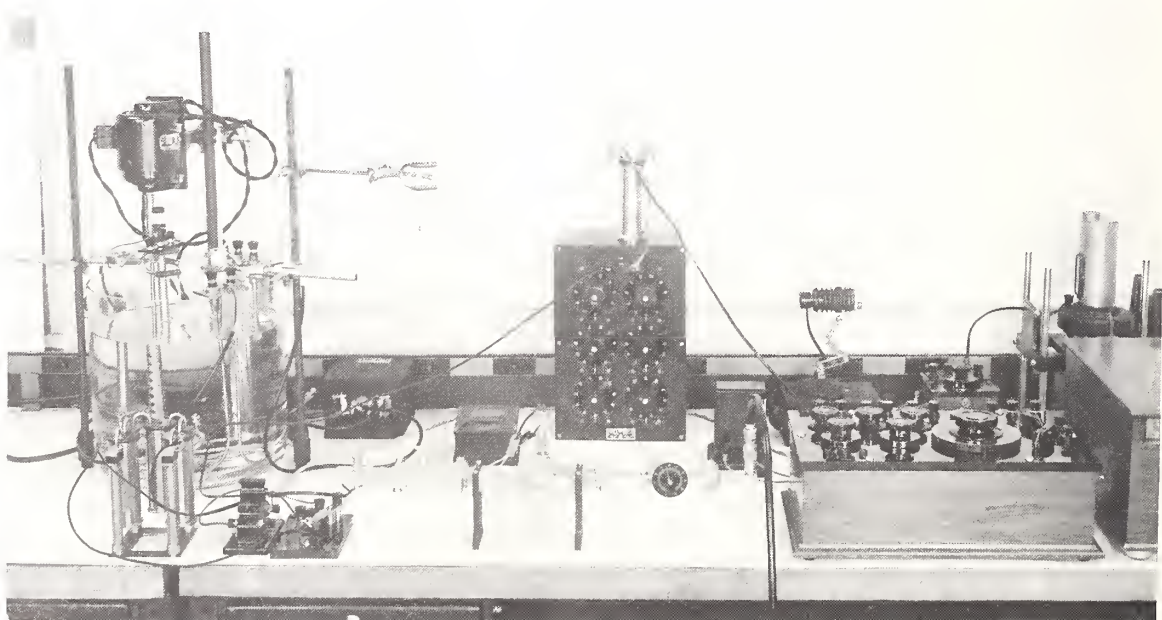

*Microwave power measurements in 1946, using a thermistor mounted in coaxial power mount. Control of ambient temperatures of mount was by a makeshift 10-gallon constant temperature water bath with a stirring device. Sophisticated types of oil and water baths were to come later. Microwave power was in terms of equivalent DC power, using standard resistors, a standard cell, and potentiometer for measurement.*

## b) TWO ROADS TO SUCCESS WITH POWER STANDARDS AT MICROWAVE FREQUENCIES

In retrospect, we learn that in the period of time spanning the few years before and after 1950, two developments were underway in the Microwave Standards Section that would lead to success in the precision measurement of power at microwave frequencies. Moreover, the two independent approaches yielded excellent results in cross-checking. However, success, in terms of the many refinements that evolved, came slowly and spanned more than a decade, but resulted in accomplishments of a high order. There was a note of pessimism in the CRPL Annual Report of FY 1950, to quote:

. . . There has been a lack of agreement among different groups (in and out of NBS—author) making power measurements in the microwave region and no really good power standards are available. The problem of developing suitable power standards is a difficult one but is fundamental to the entire microwave field.

### 1) The impedance measurement approach

Not long after entering the Bureau (1946), Kerns became interested in the application of network equations to waveguide problems, resulting in a paper published in 1949. During this period Kerns and others in the Microwave Standards Section were wrestling with the problems associated with power standards. A new approach was taken by Kerns, that of treating a bolometer unit (or mount) as a transducer with the properties of a four-terminal network. A bolometer unit (consisting of the bolometer element and its waveguide mounting) could serve as an accurate power standard if its efficiency were known.<sup>52</sup> The

<sup>52</sup> Bolometer unit efficiency is the ratio of the microwave power dissipated within the bolometer unit to the microwave power incident upon the bolometer unit. Knowing the efficiency (which takes into account power losses in the waveguide structure) to be applied as a correction factor, the unit can be used as an accurate power standard.

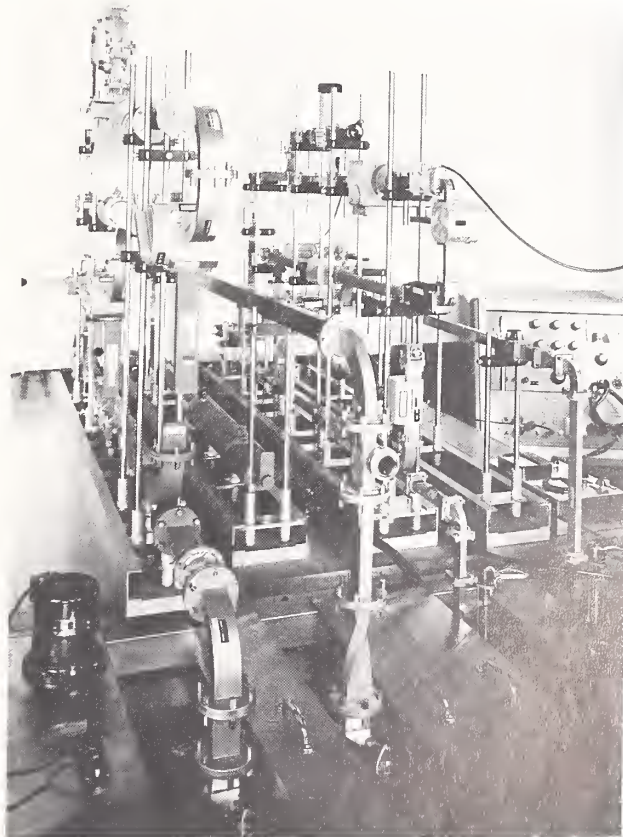

*This assembly of waveguide and supports, with a maze-like appearance, forms much of the apparatus used to measure low-level power (1 milliwatt) at microwave frequencies in two large waveguide sizes. Bolometer units calibrated by impedance method are contained within sealed housings submerged in temperature-controlled oil baths (foreground).*

method developed by Kerns yielded the value of efficiency from impedance information taken at the entry surface of the waveguide flange or coaxial connector. This basic paper that opened up a wholly new and independent method of using bolometer units as power standards was published in June 1949 [21].<sup>53</sup>

By 1955 Beatty and Reggia had improved upon the method developed by Kerns, whereby greater accuracy of power measurement in coaxial systems was obtained. Engen's association with Beatty on the development of microwave reflectometer techniques led to his application of these techniques to the measurement of efficiency of bolometer units with greatly increased accuracy (accuracy of better than 0.5%). Engen's paper was published in 1961 [22]. Use of the reflectometer techniques would prove to be useful in later years in the calibration of bolometers as a regular service.

## 2) Development of the microwave microcalorimeter

The second basic approach to power measurement at microwave frequencies by an absolute method (by known dc voltages and resistances, traceable to base quantities) taken at NBS was by the calorimetric method. Initial planning began in the spring of 1948. From the initial concept, this would be a calorimeter that would operate with a few milliwatts, to be comparable in power level with that of bolometer units and allowing for direct comparison. At the suggestion of the Bureau's Thermodynamics Section the instrument was of the Joule twin-type to obtain good sensitivity with small heating loads. The first design used polyiron as the absorbing load for microwave power, but was soon supplanted by the more logical choice of using a bolometer element (barreter or thermistor) as the absorbing load, the bolometer unit terminating the waveguide system furnishing the microwave power.<sup>54</sup> MacPherson and Kerns reported on their success with this newly developed instrument, operating at 9315 MHz (X-band), at a Washington meeting in April 1952, with publication of a paper in 1955 [23]. Initial accuracy of measurement was better than 1 percent.

The microcalorimeter designed by MacPherson and Kerns served its purpose well as an accurate and independent means of calibrating bolometer units. A scheme was devised whereby the bolometer unit could be removed from the calorimeter and thus serve as a reference standard for the calibration of other bolometer units by a comparison procedure. Development of the microcalorimeter provided an independent means of cross-checking measurements obtained by the impedance method.

After a lapse of several years and the move to Boulder, Engen took on the project of improving upon the design of MacPherson and Kerns, with the objective of obtaining greater accuracy of measurement with the microcalorimeter. The result was a fivefold improvement in accuracy in the determination of effective efficiency.<sup>55</sup> No less than five steps were taken by Engen to improve upon the design of the original microcalorimeter. The design of the microwave microcalorimeter has been reproduced by laboratories of several foreign countries.

In total, NBS has developed microwave microcalorimeters in five waveguide sizes, beginning with WR90 or X-band (8.2-12.4 GHz) and proceeding to the smaller sizes to WR15 (50-75 GHz). Another was developed for coaxial bolometer circuits. Morris E. Harvey has designed and evaluated the more recent microcalorimeters. The microcalorimeter does not lend itself readily for practical design in the larger waveguide sizes.

---

<sup>53</sup> In contrast with the success of the impedance method with bolometer units incorporating barreters, for some reason(s) that has not been satisfactorily explained, the method has not been successful with thermistors.

<sup>54</sup> The general design of the microcalorimeter has remained the same through the years, but with refinements for achieving greater accuracy of power measurement. Two identical bolometer units are used, one serving as the absorber of microwave power, the other as a dummy load, serving as the reference point for measurement of temperature rise. Temperature difference between the two loads is by observation of the EMF from a multi-junction thermopile connected between the two loads which, in the first model, was 0.2 °C for an input of 10 milliwatts. DC power supplied to the bolometer is used for calibration. The first microcalorimeter operated in a 45-gallon oil bath.

<sup>55</sup> The effective efficiency is the ratio of the substituted dc power in the bolometer unit to the microwave power dissipated within the bolometer unit.

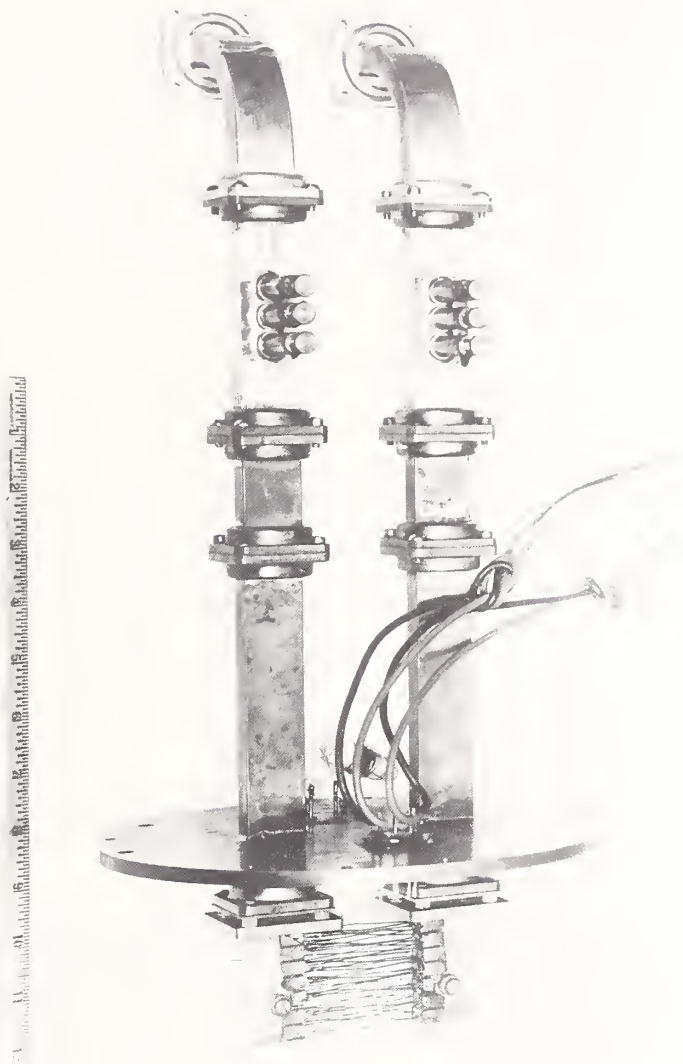

*Waveguide section of the first of a series of microwave microcalorimeters (Joule twin type) developed by NBS, this one by Macpherson and Kerns, beginning in 1948. Earliest model used polyiron as the absorbing load at about 1 milliwatt of RF power; replaced in later models with a bolometer unit. A dummy load served as the temperature reference for the multi-junction thermopile (lowest portion of photograph). Tuning stubs (upper portion) provided impedance matching of X-band assembly at 9315 MHz. Entire unit was temperature controlled in a 45-gallon oil bath.*

**c) MANY FACETS ENTER INTO THE MEASUREMENT OF MICROWAVE POWER AT NBS**

The mainstay of the microwave power measurement program through the years at NBS has been the bolometer, and continues to be the subject of much study. Each of two developments in bridge circuits for use with bolometers came from different sections within the Radio Standards Division shortly after the move to Boulder. These circuits served as a means of balancing the bolometer bridge without manual control. Each bridge was covered by a patent.<sup>56,57</sup> With much simplification in design of Engen's instrumentation, plus some novel circuitry, N. T. Larsen and F. R. Clague, many years later, developed what came to be

<sup>56</sup>The team of Myron C. Selby, Charles M. Allred, Paul A. Hudson, and Ira S. Berry filed for a patent on September 6, 1957. Patent 2,883,620 was issued April 21, 1959, entitled "High frequency power measuring bridge circuit."

<sup>57</sup>G. F. Engen filed for a patent on July 7, 1958. Patent 2,997,652 was issued August 22, 1961, entitled "Self-balancing D. C. bolometer bridge." Engen's design also led to the development of a constant-current generator. Both of these instruments were manufactured commercially. The self-balancing bridge also led to Engen's development of a means of amplitude stabilization of a microwave signal source.

known as the NBS Type II power measurement system for use with bolometers.<sup>58</sup> Thus came a series of three bolometer bridges developed by NBS.

In addition to the developments by Engen related above, his name is associated with other developments in the measurement of microwave power.<sup>59</sup> At one time he studied the dc-RF substitution error of coaxial-type bolometer units. In the mid-1960's he tackled and solved the problem of calibrating coaxial power meters with a waveguide power standard [24]. At the time this was a knotty problem that was solved by a novel procedure. The problem was related to others, that were also solved by Engen, in the transfer process of calibrating power meters.

More recently, Engen's interests have led him to take a new approach to the problems in the measurement of power transfer (also attenuation and impedance measurements) by what he has termed "power equations" [25].<sup>60</sup> Engen's approach should solve most of the problems associated with evaluating mismatch corrections of measurements involving waveguide systems, plus minimization of the problems associated with the requirements for precision connectors and uniform waveguide in performing precision measurements at microwave frequencies.

It was with enthusiasm that the CRPL Annual Report of FY 1948 stated, "Development and construction of the most precise microwave power measuring console in existence was largely completed." But success, as judged by a satisfactory and accurate power measurement, proved to be elusive. Not until November 1952 was the first power meter (fitted with coaxial connectors) calibrated (frequency range of 1000 to 3000 MHz), and it was

<sup>58</sup> Neil T. Larsen and Frederick R. Clague filed for a patent on March 17, 1970. Patent 3,611,130 was issued October 5, 1971, entitled "Power measuring and leveling system using a self-balancing bridge."

<sup>59</sup> Early in 1961 Engen was awarded the Department of Commerce Silver Medal for Meritorious Service "for very valuable contributions to the field of microwave power standards and measurements; the development of an extremely stable and accurate d-c instrumentation for bolometric measurement of power, resulting in the U.S. taking the lead in accuracy of microwave power measurements, and the ability of NBS to offer a new calibration service for microwave power measuring instruments where no previous service existed."

<sup>60</sup> The initial study resulted in the material for his doctor's dissertation.

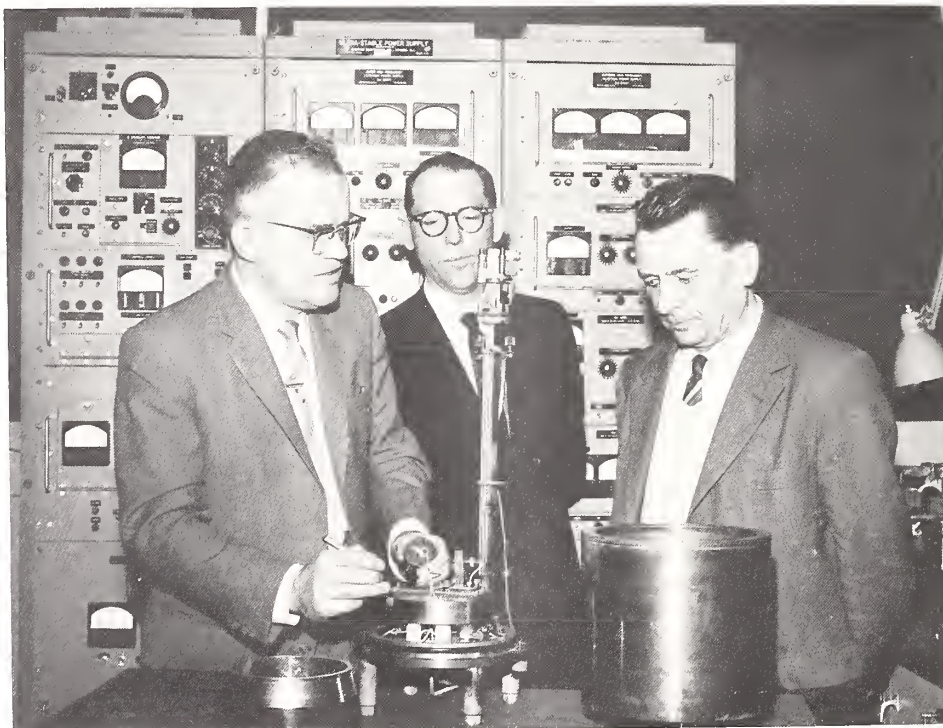

*Glenn Engen (left) explains the features of advanced model of microwave microcalorimeter to Dr. Schaffeld (right) of the Physikalisch Technische Bundesanstalt (counterpart of NBS, Western Germany). At rear, George Schafer, chief of the Radio Standards Engineering Division. Engen improved upon the design of Macpherson and Kerns to obtain much greater accuracy of microwave power measurement. Klystron power supply at rear was one of three specially designed by manufacturer for NBS use. Photographed February 1963.*

February 1953 before the first X-band bolometer unit was calibrated for efficiency. Not until around 1960 was a calibration service firmly established for power calibrations at microwave frequencies. The statement of 1950 that, "The problem of developing suitable power standards is a difficult one . . . ," was prophetic, indeed (see p. 373).

The Bureau had the opportunity to make its first international comparison of microwave power standards in December 1957. On this occasion the comparison was made at the Boulder Laboratories with a Japanese bolometer unit.<sup>61</sup> This was the first of a series of international comparisons on power standards that have been made to the present time. Laboratories of a number of nations have joined in the program. These comparisons had been arranged by URSI (International Scientific Radio Union) by action taken when Beatty was chairman of Commission I, Radio Measurements Methods and Standards, of the U.S. National Committee.

#### d) MEASUREMENT OF POWER AT THE LOWER RADIO FREQUENCIES

Beginning in 1945 and to as recently as several years ago, a group, separated from microwave groups, was responsible for the development of power standards at the lower radio frequencies. This group was not faced with the problems associated with microwaves and the use of hollow waveguide created during World War II. However, with the passage of time, this group pushed the upper limit of the lower frequency standards and measurement techniques into the microwave region with the use of coaxial components.

##### 1) The early developments in power standards

Early in 1946 Myron C. Selby<sup>62</sup> and Lewis F. Behrent made use of a power measurement bolometer bridge as a means of determining RF voltage with considerable accuracy. After the move to Boulder in 1954, when it appeared there was a growing need for a power calibration facility at the lower radio frequencies, steps were taken to develop power standards and measurement methods. First, came the development by Paul A. Hudson and Ira S. Berry of a thermistor bridge with new features and having a power range of 100 microwatts to 100 milliwatts. The bridge was in operation by early 1956.

By 1956 a large-scale program was set into motion to provide adequate power measurement facilities for the Electronic Calibration Center. Initially, the planning was rather ambitious—a power range from  $10^{-6}$  to  $10^6$  watts. Later it was concluded that a high-power facility was impractical at the Boulder Laboratories.

##### 2) Calorimeters in development

A step in a different direction in the Bureau's development of RF power standards was that of a dry, static calorimeter, although the principle of operation was not original with the Bureau.<sup>63</sup> A calorimeter, with a range up to 10 watts, was a development by Hudson and Allred, for which they received a patent [26].<sup>64</sup> The instrument would serve for a time as a reference standard until one of another type and with superior features became available.

With several types of calorimeters at hand that could be used as reference standards, Hudson devised an instrument that served as a useful means of transferring standard values of power to power meters by a routine calibration. He chose to call the instrument a precision RF power transfer standard. Three calibrated directional couplers feeding into a series of thermoelements allowed high-level power to be measured with instrumentation operating at low-level power. Later, in 1966, Hudson published a paper on a design of coaxial couplers with very high directivity. The couplers were particularly suited for precision power measurements.

<sup>61</sup>The recommendation of an international comparison of power standards was the result of a long-standing resolution within the International Scientific Radio Union (URSI) made more than 10 years before the first comparison was performed.

<sup>62</sup>Myron C. Selby entered the Radio Section on October 21, 1941. He retired in 1968 but continued on as a rehired annuitant and a guest worker until November 1973.

<sup>63</sup>"Dry" in the sense that the calorimeter involves no liquid; "static" in the sense that the absorbing load (a thin-film, metallic disk) remains fixed in position, unlike that of the power-absorbing liquid in liquid-flow calorimeters. Later, this instrument was called a dry-load calorimeter.

<sup>64</sup>Paul A. Hudson and Charles M. Allred filed for a patent on November 9, 1959. Patent 2,995,708 was issued August 8, 1961, entitled "Dry static calorimeter for RF power measurement."

Refining the design of a dual-load flow calorimeter (original design outside of NBS), Myron L. Crawford and Hudson, in 1966, came up with a reference standard for RF power at fairly high levels (5 to 100 watts) [27]. A threefold increase in accuracy was obtained, with operation up to 4 GHz. It was now possible to gain greater confidence in the NBS reference standards by intercomparing the older dry, static calorimeter with another type of calorimeter incorporating many differences in operating features.

To decrease the time required for calibration, and for other reasons, Crawford developed a dual-dry-load calorimeter in which the reference dc input power is automatically controlled, with a distinct advance in operating features over older types. It was now possible to have digital read-out of the measured power level. Crawford's paper was published in 1968 [28].

## 5. Voltage—The useful measurement at the lower radio frequencies

As with power, voltage is an active quantity and its measurement between conductors of open-wire lines and in coaxial circuits is of primary importance. Certain performance features of signal generators, receivers, field-strength meters, radar equipment, and communication equipment in general, can be evaluated in terms of voltage measurement. It was the development of the vacuum-tube voltmeter for use at radio frequencies by Moullin (England) in 1922 that first provided the means of measuring voltage without unduly altering the impedance (and voltage condition) of RF circuits.

### a) A BEGINNING ON VOLTAGE STANDARDS

Although the vacuum-tube voltmeter was a useful instrument in the Radio Section over a period of many years, it was not until early 1945 that serious consideration was given to developing voltage standards at radio frequencies. A program was initiated in combination with that on power standards "using a multiplicity of methods for cross-checking the accuracy of results obtained." (See p. 372 and footnote 50.) *NBS Circular 481*, "High-frequency Voltage Measurement" (September 1, 1949), prepared by Selby, discussed the operating principles of "a multiplicity of methods" of voltage measurements at radio frequencies. Of the many methods discussed, only a few were actively studied and developed for precision measurement.

In April 1949 Selby had reported in the *Technical News Bulletin* on a "primary high-frequency voltage standard" that made use of a thermistor bridge calibrated by direct current. He obtained a voltage range from 20 millivolts to 1.5 volts up to a frequency of 800 MHz, with an accuracy of 1 percent. Over much of the frequency range Selby was able to cross-check the voltage standard by independent methods including a cathode-ray oscilloscope, thermoelements, and an electrostatic voltmeter. A detailed account of the use of a bolometer bridge as a voltage standard was published by Selby and Behrent in 1950 [29].

### b) MICROPOTENTIOMETERS—A NEW APPROACH TO KNOWN RF VOLTAGES AT MICROVOLT LEVELS

In the CRPL Quarterly Report of April-June 1949 the High Frequency Standards Section reported on the development of a device to obtain known voltages at microvolt levels at frequencies up to 300 MHz by use of a straight-through type of thermojunction and a thin platinum disk resistor. The next quarterly report stated that "The basic idea is simply to tap the output impedance of voltage generators at a point a fraction of an ohm above ground." The benefits were: (1) measurement of voltage to the device at sufficiently high level to obtain high accuracy, and (2) a voltage source of extremely low internal impedance. The device overcame the problems associated with attenuators and the variable output impedance of signal generators. Thus came into existence the very useful device developed



by Selby which he called the micropotentiometer in the technical press or in laboratory jargon it became known as a "micropot."<sup>65</sup>

---

<sup>65</sup>The micropotentiometer is a quite simple device. A small metallic enclosure serves to shield a thermojunction or thermoelement (combination of a heater and thermocouple) and an annular ring across the center and outer conductor of a coaxial fitting (connector). The conducting ring is formed by metal deposition and has a resistance rated in milliohms, thus providing a voltage source of very low impedance. A series of these rings of various resistance provides for a range of known voltages. The device was first described in the *Technical News Bulletin*, and later by Selby in the technical press [30,31]. Selby was issued two patents on the device which became a manufactured article.\*

\*M. C. Selby filed for a patent on June 29, 1951. Patent 2,782,377 was issued February 19, 1957, entitled "Micropotentiometers." A second patent (a division of the initial patent) was issued April 14, 1959, under the same title, with the patent number 2,882,501.



*Myron Selby in 1956 observes his recent development of the micropotentiometer for accurate measurement of RF voltage at frequencies ranging up to 1000 MHz. At right is rack of interchangeable disc resistor assemblies that give the "micropot" a range from 1 microvolt to 0.1 volt.*

### c) THE AT VOLTMETER

To meet the need of accurate measurement of RF voltages up to several hundred volts and frequencies up to 1000 MHz, Selby and Behrent came up with the novel idea of combining a relatively simple piston or waveguide below-cutoff attenuator with a thermoelement, plus a dc millivoltmeter for reading the direct current developed by the thermocouple of the thermoelement. Reading of RF voltage is in terms of the attenuator reading (by a micrometer) and the millivoltmeter setting. The device derived the name of AT voltmeter from the full name of Attenuator-Thermoelectric High-Frequency Voltmeter, under which name a patent was issued to Selby and Behrent.<sup>66</sup> The instrument was described in the February 1956 issue of the *Technical News Bulletin*.

Selby's design of a novel type of "tee" connector permitted accurate calibration of RF voltmeters, by comparison with the AT voltmeter at frequencies up to 1 GHz. This auxiliary device for calibration of voltmeters at high radio frequencies was patented by Selby.<sup>67</sup>

---

<sup>66</sup> Myron C. Selby and Lewis F. Behrent filed for a patent on December 5, 1956. Patent 2,933,684 was issued April 19, 1960, entitled "Attenuator-thermoelectric high-frequency voltmeter."

<sup>67</sup> M. C. Selby filed for a patent on October 22, 1965. Patent 3,354,411 was issued November 21, 1967, entitled "Coaxial transmission line T-junction having rectangular passageway dimensioned beyond cutoff for higher order modes."

#### d) ADAPTING A MEASUREMENT TECHNIQUE TO LINE PRODUCTION CALIBRATION

To meet the need of rapid, yet accurate, calibration of RF voltmeters by the newly organized Electronic Calibration Center, Selby, Behrent, and Francis X. Ries, designed a calibration console to meet this need. The AT voltmeter became the principal feature of the calibration system as the working standard. A grouping of the consoles provided calibration at 12 discrete frequencies up to 700 MHz at voltages ranging from 0.2 volt to several hundred volts. RF generators of high stability and purity of output were contained within the consoles. The calibration system of considerable complexity was patented on the basis of the many novel features.<sup>68</sup> It has proven to be a very useful piece of instrumentation over the many years since 1957.<sup>69</sup>

#### e) THE BOLOVAC

Following in the chain of devices patented by Selby came his patent of the "Bolovac," the name being coined by Selby from the more complete term "Bolometric voltage and current mount."<sup>70</sup> In essence, the Bolovac consists of a disk-type conducting film, split in two sections, placed across a coaxial line, and serves as a standard for both voltage and current at radio frequencies up to 20 GHz. However, because of technical problems in producing satisfactory thin films, the device has not had the popularity of coming into widespread laboratory use as has the micropotentiometer and the AT voltmeter.

### 6. Other RF standards and measurements advance on a broad front

Following in the train of the early development (beginning in 1945) of standards at radio frequencies for the fundamental electrical quantities of attenuation, impedance, power, and voltage, there came an advancing stream of development of standards in many other electrical quantities of the radio art.

#### a) THE MEASUREMENT OF CURRENT

Strangely, the earliest measurements at radio frequencies, other than those of wavelength, were of current (usually in the antenna circuit), yet measurement of current gradually fell into disuse and never has regained its former popularity. In 1913 Dellinger studied RF ammeters as subject matter for his doctor's thesis, published in 1914 as a Bureau paper (see ch. II, p. 43). The subject was revived early in 1949 to provide a calibration service for RF current meters, and specifically those of the thermoelement type.

For a reference standard of RF current, Max Solow, of the High Frequency Standards Section, developed a theoretical treatment and a design for a current meter of the electrodynamic type, using a short-circuited ring suspended within a coaxial resonator. The principle dates back to 1887, but Solow adapted it to a wide frequency range up to 300 MHz. However, the project was fraught with many technical problems and was phased out in 1953 without the completion of an entirely successful model. Peter H. Haas also took part in this project.

Again, the subject of the development of an RF current standard was revived, after a lapse of almost 20 years after initiating the earlier project. Nolan V. Frederick succeeded in the design, construction, and evaluation of a short-circuited-ring electrodynamic ammeter (current standard) that was an improvement over the design by Solow. Frederick reported on the standard at the June 1968 Conference on Precision Electromagnetic Measurements, indicating a range of 1 to 100 amperes over the frequency range of 1 MHz to 1 GHz, with an uncertainty of 0.5 percent [32].

Following the successful development of an RF current standard suitable as a reference standard, Winston W. Scott, Jr. of the HF Impedance Standards Section came up with a very ingenious idea for a transfer or interlaboratory standard of RF current, which he called

---

<sup>68</sup> Myron C. Selby, Lewis F. Behrent, and Francis X. Ries filed for a patent on May 19, 1959. Patent 3,041,533 was issued June 26, 1962, entitled "RF voltmeter calibration console."

<sup>69</sup> In 1960 Selby was awarded the Department of Commerce Silver Medal for Meritorious Service for "outstanding scientific achievement in radio standards and radio measurement techniques."

<sup>70</sup> Myron C. Selby filed for a patent on August 4, 1967. Patent 3,487,305 was issued December 30, 1969, entitled "Electrothermic instruments for measuring voltage and current."

a coaxial RF-dc ammeter. In essence, the device consists of an elliptic-cylinder silver reflector of infrared energy with a thick-film heater along one focus and a thermopile along the other focus. Measurement of current in a 50-ohm coaxial line can be made over a frequency range from direct current to 1 GHz and a current range from 0.25 to 2.5 amperes, with a measurement uncertainty of about  $\pm 2$  percent. For his paper, published in November 1970, Scott received the 1971 Boulder Scientist Award from the Boulder Branch of the Scientific Research Society of America (RESA) [33]. This unique device has not been manufactured and along with the electrodynamic current standard, remains laboratory equipment that has been "shelved."<sup>71</sup> The ammeter was patented in 1971.<sup>72</sup>

## b) NOISE—AN ATTRIBUTION OF NATURE—AND ITS MEASUREMENT

### 1) Developments at NBS Washington

Noise, associated with radio, can be and is defined under various categories. Noise, in terms of a standard of an electrical quantity and measured in the laboratory, is the thermal noise caused by the random process of thermal agitation of charges in a conducting medium and is a function of the absolute temperature. However, for noise-source standards, this is extended to the noise in plasmas in gas-discharge tubes, and the shot noise of emission-limited thermionic diodes. These standards are calibrated in terms of noise temperature (kelvins) and are used as references for the measurement of noise figure (or factor) of amplifiers, radio receivers, and radar systems. As such, one obtains a knowledge of the sensitivity, signal-to-noise ratio, and the dynamic range and overall performance of a detection, telemetering, or communication system.

The measurement of noise and the development of noise standards was not indicated specifically among the objectives of the Radio Measurements and Standards Project in 1945. Concurrent with the organization of the CRPL (May 1, 1946), the Quarterly Report by the Microwave Standards Section stated: "theoretical studies on noise measurements were initiated." The project resulted in two papers by J. J. Freeman relating to the properties of thermionic diodes as noise generators. However, there were limitations to the use of thermionic diodes as a noise standard at microwave frequencies.

In the spring of 1948 Freeman made plans for the calibration of noise sources at microwave frequencies by utilizing thermal noise as a standard. This resulted in the design and construction of a noise comparator, based on a variation of the Dicke radiometer used for the measurement of thermal radiation at microwave frequencies. For the noise standard Freeman (assisted by Whilden G. Heinard) used a piece of carborundum mounted in X-band waveguide and heated to around 1000 °C, serving as a "black body" radiator of known noise power. The comparator remained in the development stage in 1954 when Freeman elected not to accompany the CRPL to Boulder.<sup>73</sup>

In the fall of 1948 the High Frequency Standards Section initiated a program of measuring the noise figure of radio receivers at the lower frequencies up to 300 MHz. By 1951 Max Solow and his assistants had developed a noise-figure standard which used a temperature-limited noise diode as the source of known noise power. The result was a calibration service for noise figure in the range of 500 kHz to 30 MHz. By 1954 a noise comparator had been completed for operation up to 300 MHz.

### 2) Developments at NBS Boulder

After the move to Boulder (1954) the noise program at frequencies below 300 MHz (later below 1000 MHz) entered a spell of inactivity for several years. Not until 1959 was it reactivated when C. McKay Allred took a new approach to the method of comparing an unknown noise source to a standard source by using a correlation technique, thus overcoming some of the problems encountered by Freeman and others. A patent was issued

<sup>71</sup> The Bolovac also serves as an RF current standard, covering a range from 5 milliamperes to 10 amperes (see p. 380). It, too, has had a fate-dogged existence and is not being used as an RF current standard.

<sup>72</sup> Winston W. Scott, Jr. filed for a patent on January 20, 1970. Patent 3,609,541 was issued September 28, 1971, entitled "Radio frequency coaxial ammeter with thermal compensation."

<sup>73</sup> In February 1954 J. J. Freeman transferred to the Naval Research Laboratory, Washington, D.C., where he continued his interest in electrical noise. His treatise on the subject, *Principles of Noise*, was published in 1958 by John Wiley and Sons, New York.

to Allred on this new approach to noise measurement.<sup>74</sup> Allred based the technique on a well-developed theoretical approach. The result was an instrument that was a sum-and-difference correlation radiometer, with a mode of operation quite different from Dicke's radiometer technique used by Freeman [34]. M. Gerald Arthur incorporated the instrument with his development of a high-frequency noise measurement system to provide a service for the calibration of coaxial noise generators, beginning in 1968 [35]. Arthur's experience with noise measurements led to his being selected to write *NBS Monograph 742*, "The Measurement of Noise Performance Factors, a Metrology Guide," published in 1974.

Before the move to the Boulder Laboratories the noise program at microwave frequencies was taken over by Charles R. Greenhow. During the next several years improvements were made on the noise comparator developed by Freeman at X-band, with some development at S-band (2.60-3.95 GHz). Like the high-frequency noise project, there came a lull in the activity of noise measurement at microwave frequencies for a short period after Greenhow resigned in June 1957. But the need for precision noise measurement and the calibration of noise standards for other laboratories had increased considerably during the 1950's.

Emerging from the renewed program was the development by a team headed by Arthur J. Estin of an improved Dicke-type radiometer (previously modified by Freeman at NBS) that incorporated both a reference standard and a working standard, plus the noise source being calibrated [36]. During the next several years a team under the guidance of Joseph S. Wells, along with William C. Daywitt and Charles K. S. Miller, made further improvements on the radiometer and its ancillary equipment. Operating at several frequencies in X-band, the equipment was subject to much experimentation and evaluation of errors in the measurement of effective noise temperature of noise-source standards.<sup>75</sup> The team reported

<sup>74</sup>C. M. Allred filed for a patent on April 19, 1962. Patent 3,192,372 was issued June 29, 1965, entitled "Signal-level comparing system."

<sup>75</sup>Two slightly different combinations were used as reference standards operating at temperatures of more than 1000 °C: one, a combination of a silicon-carbide load in a gold waveguide; the other, a combination of zinc-titanate load in a platinum-rhodium alloy waveguide. The working standard is usually an argon gas-discharge tube; the same type of tube is usually used for transfer standards submitted for calibration.



By 1962 a microwave noise source operating at more than 1000 °C, suitable as a reference standard, was achieved. One combination of elements was a silicon carbide load resistor termination (lower left) with a gold waveguide (lower center). Another combination was a zinc titanate load with a platinum-rhodium alloy waveguide (upper center). Each was contained within a graphite heat distributor, coated with zirconium dioxide (upper).

on its study at the 1962 IRE International Convention, with later publication [37]. By early 1963 a microwave noise-source calibration service was announced at three frequencies in the 8.2 to 12.4 GHz range. The range has since been extended to a number of other frequency bands (waveguide sizes). As a featured component of the noise measurements system, Miller, Daywitt, and Eugene Campbell reported on the development of an interlaboratory or transfer noise standard at the 3rd International Measurement Conference held in Stockholm, Sweden in 1964.

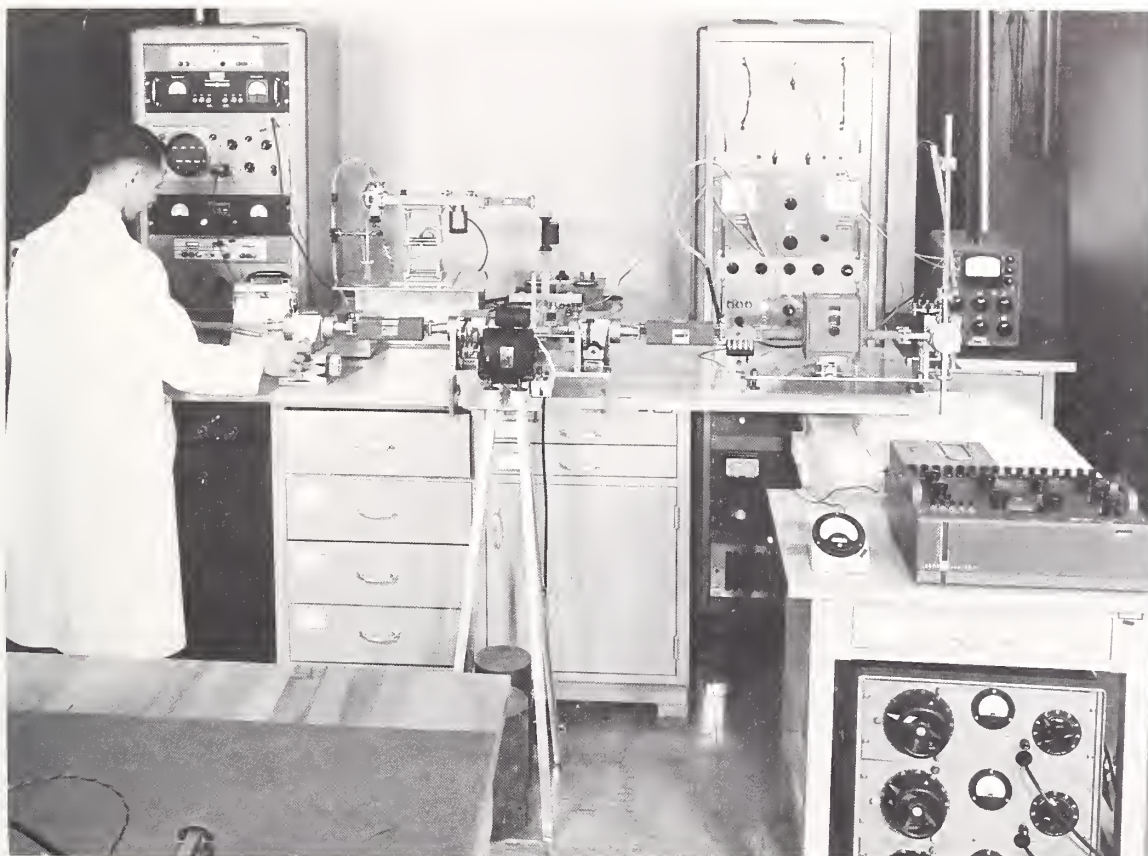

*Microwave radiometer in X-band (8.2-10.4 GHz) developed by 1962 to measure the noise temperature of gas-discharge noise sources for use as interlaboratory standards.*

A number of various developments and studies in the area of noise measurements at microwave frequencies have been made in the Electromagnetics Division in recent years. Among these was a low-temperature microwave noise standard operating in a cryogenic environment, developed by a team headed by Charles L. Trembath. Many novel features entered into the design for operation at temperatures of 4.2 K (boiling point of helium) and 77 K (boiling point of nitrogen). Uncertainty of noise temperature was about  $\pm 0.1$  K.

Another development was a planned excursion into automated measurements, in this instance, the measurement of effective input noise temperature of 55-65 GHz receivers. The five-man team, headed by Don R. Boyle, made use of: a bolometric Y-factor measurement (ratio of two noise powers at output of transducer, in this case a microwave receiver), a working noise standard (developed by Miller, Daywitt, and Campbell), and a minicomputer system with control for sequence of operation. The print-out gives a noise figure for the receiver being evaluated.

In June 1973 this automated noise measurement system bore fruit in the evaluation of an Army satellite communications system located at Camp Roberts (between Monterey and San Luis Obispo, Calif.). Here, a team of four from the Electromagnetics Division measured the gain-temperature ratio, G/T, that can be considered a figure-of-merit to express the performance rating of a communications receiver system. Into the observation was cranked the noise of a radio star and the noise from "cold" space, each, in turn, serving as a standard noise source.

The result was an automated field-site measurement involving much complexity of instrumentation and computation that reduced the measurement time to a period that was reasonable by contrast to what otherwise would have been intolerably long.

### c) GETTING TO KNOW ELECTROMAGNETIC FIELDS

There is the need to know the magnitude or field strength of electromagnetic fields in order to evaluate the performance, signal coverage, efficiency, and interference potentialities of transmitting stations. Measurements are made with field-strength meters which must be calibrated under conditions of a known or standard field. The measurement of antenna gain is also of interest with directional antennas at microwave frequencies.<sup>76</sup>

Field-intensity measurements had their beginning in the Radio Section in 1926, first in the frequency range of broadcasting stations—550 to 1500 kHz (see ch. V, p. 111). A calibration service for field-strength meters was made available, first to the Government and later to the public. By the end of World War II the initial development of equipment for measurements up to 160 MHz was completed. By 1946 a service for the calibration of field-strength meters, fitted with loop antennas, was made available from 200 kHz to 19 MHz.

#### 1) From 1946—Refinement and adaptation of the two methods of calibrating field-strength meters

After reorganization of the Radio Section to form the CRPL (May 1, 1946), a new group took over the further development and refinement of the two methods of measurement for the calibration of field-intensity meters. One method, known as the standard-field method, serves for calibration up to 30 MHz, the other, known as the standard-antenna method, serves for calibration above 30 MHz. The two methods are independent of each other but allow for intercomparison. Associated with this program were Frank M. Greene and Max Solow, and later Clarence C. Cook. During the period from 1950-1952, five papers were published between the members of this team [38,39]. From 1950 to 1954 field-strength meters were calibrated at a field laboratory located at Hybla Valley (a multipurpose site, including an experimental airfield), southwest of Alexandria, Va.<sup>77</sup> Upon moving to Boulder a field site was selected toward the rear of the Bureau grounds and was referred to as the "Canyon" site. It had the advantage of considerable shielding against unwanted signals by the hilly terrain. Here, the calibration group occupies a site of relatively permanent quality.

By 1957 Greene, Harold E. Taggart, and others became occupied in the development, design, and fabrication of equipment for the new Electronic Calibration Center, where, later, Taggart supervised the calibration service. With further development, it became possible to calibrate dipole antennas up to 1 GHz and the several types of calibrations on field-strength receivers to 10 GHz.

---

<sup>76</sup> Simply defined, antenna gain is the ratio, expressed in decibels, of standard antenna input power to directional antenna input power that will produce the same field strength in the desired direction.

<sup>77</sup> At one time, back in the early 1930's, the Hybla Valley site was being considered as a western terminus for transatlantic rigid airship flights for passenger service.

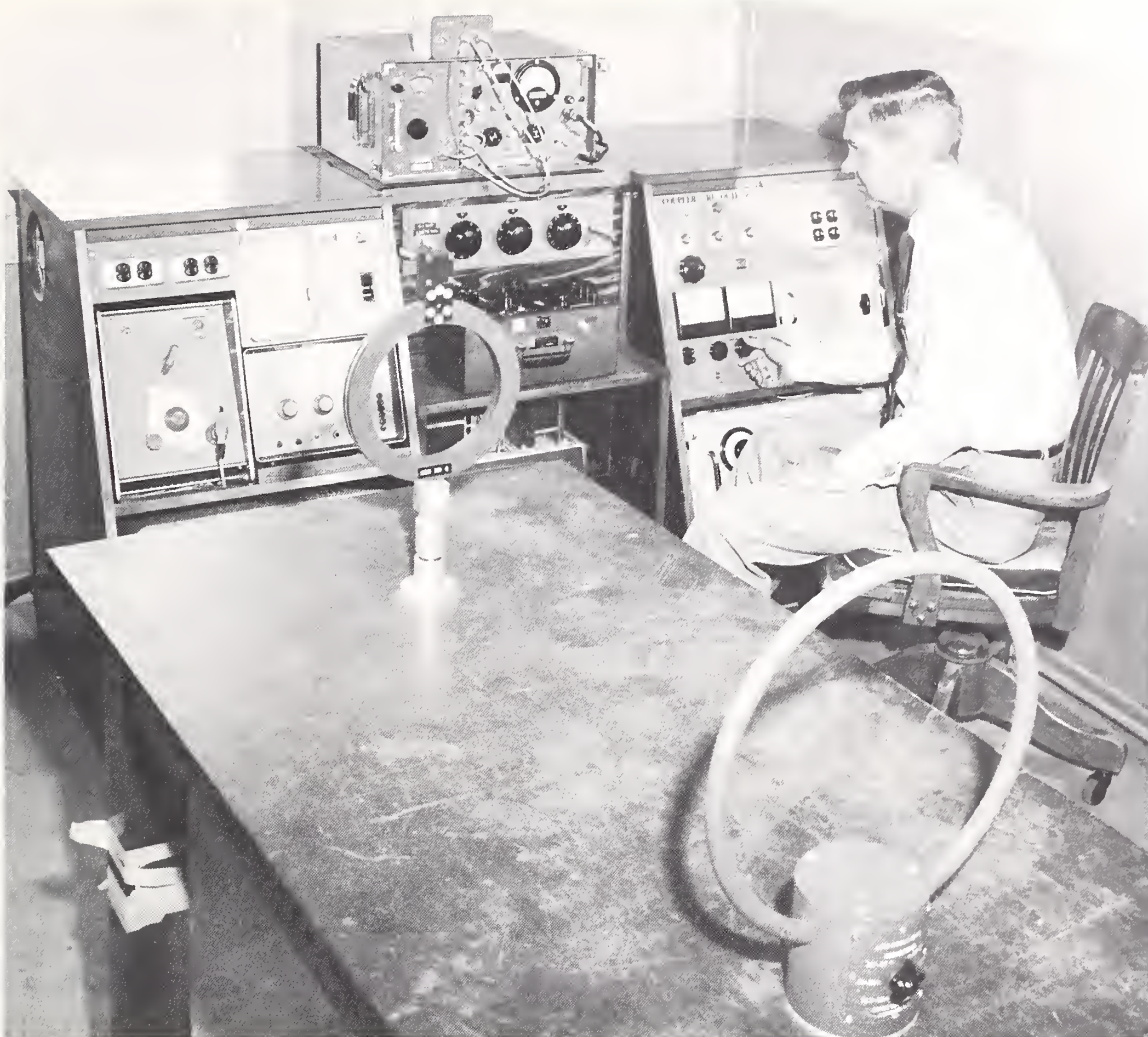

*In 1964 Harold Taggart of the Electronic Calibration Center calibrates a loop antenna (used with field-strength meters) by the standard-field method. The standard antenna (rear loop) consists of a single turn of wire of known radius and carries a known current, giving a known magnitude field. The method is used in frequency range of 30 Hz to 30 MHz; at higher frequencies the standard-antenna method makes use of a dipole of known electric field.*

## **2) Further developments in field-strength measurements below 1 GHz**

Except for possible improvements in accuracy below 1 GHz, by the early 1960's the conventional types of field-strength measurements had reached a plateau of development at NBS. In 1963 a contract with the Field Command of the Defense Atomic Support Agency (DASA) brought on a new development, that of an improved method of making near-zone measurements at high levels of field strength. The result was a field-strength meter developed by Greene operable up to 1000 volts per meter, with a remote indicator unit connected to the antenna unit by a semi-conducting transmission line [40].<sup>78,79</sup> On the same DASA contract, Gerome R. Reeve further improved the meter by using selective tuning providing for a direct readout range of 40 dB.

<sup>78</sup> This project was undertaken to evaluate the hazards of electromagnetic radiation to electroexplosive devices that may detonate prematurely under conditions of high-level fields.

<sup>79</sup> The unique use of a semi-conducting transmission line minimized both the perturbation of the field in the vicinity of the dipole antenna and RF current induced in the transmission line.

### 3) Antenna measurements above 1 GHz

Almost from the beginning of the use of high-power microwave radar and other microwave equipment there has been concern over the hazard of exposure by operators and others to radiated energy. There has been wide divergence of opinion of the level of energy density that is considered hazardous. The situation was complicated further by the difficulty of measuring, with a reasonable degree of accuracy, the level of energy density in the complex electromagnetic field that exists in the vicinity of the source of radiation (near field). A project set up within the EM Fields and Antennas Section in the fall of 1968 led to an extensive study of the measurement of these complex fields.<sup>80</sup> Several models of electromagnetic hazard meters were developed in this project that adequately meet the need of a measurement instrument. Success was achieved by the use of a field sensor consisting of three mutually orthogonal dipoles of small dimensions, incorporating diode detectors, and connected to a nearby readout meter by means of a high-resistance transmission line (to minimize perturbation of field). The instruments were initially designed for measurement around 1 GHz; later extended in range from 10 MHz to 5 GHz, and with an extended range of sensitivity. This instrument was recognized by the periodical, *Industrial Research*, as one of the 100 most significant new products for the year 1973. Along with Ronald R. Bowman and Paul F. Wacker, working on this project were Donald R. Belsher and Ezra B. Larsen.

The increased use of microwaves for space communication, extending into the millimeter wavelengths, brought on a wide interest in the design and accurate measurement of directive antennas for operation at very short wavelengths. Performance of these directive antennas is usually specified in terms of power gain and polarization in the direction of maximum radiation (usually in the form of a narrow beam). Accurate measurement (0.1 dB or better for gain) of this performance continues to be the concern and study of an antenna group since the middle 1960's. The use of anechoic chambers falls short in obtaining the higher accuracies of gain measurement now desired. Thus, several other courses of measurement have been pursued by the group in recent years.

Two measurement techniques have been developed and reported by the antenna group since 1970, both of them being based upon pioneer work by Kerns and referred to as the "plane-wave scattering-matrix theory of antennas and antenna-antenna interactions." A method of determining far-field antenna patterns from near-field measurements by a planar scan-deconvolution technique was developed for antennas by Kerns by correcting for the effects of the antenna probe [41]. With this approach, the group succeeded in determining the antenna pattern and power gain of several types of directive antennas from near-field measurements [42]. Another method, known as the extrapolation technique, is used primarily to determine on-axis gain and polarization. This method is based upon individual theoretical work by Kerns and Wacker. It became possible to make these measurements without reference to a known antenna by measurement of amplitude and phase as a function of distance, using three unknown antennas [43]. The method provides means of correcting for proximity effects, for multiple reflections between the antennas, and for ground reflections.<sup>81</sup>

---

<sup>80</sup>The project was partially supported by the Bureau of Radiological Health, Food and Drug Administration.

<sup>81</sup>Two antenna ranges were developed for measurement at reduced distances—a 5-meter indoor range and a 50-meter outdoor range. On the outdoor range each of a pair of antennas is mounted on its own tower that is moved in relation to the other along an accurately aligned set of rails. A computer is used to analyze the data taken from the many observations that are possible and required for the antenna calibrations.





*Outdoor 50-meter antenna extrapolation range located at edge of mesa at rear of the Boulder Laboratories site. On-axis antenna gain is measured by using two antennas, each mounted on its own movable tower. Towers can be separated at known distances by moving on accurately aligned rails. Measurements are recorded in the van and a computer analyzes the observations.*

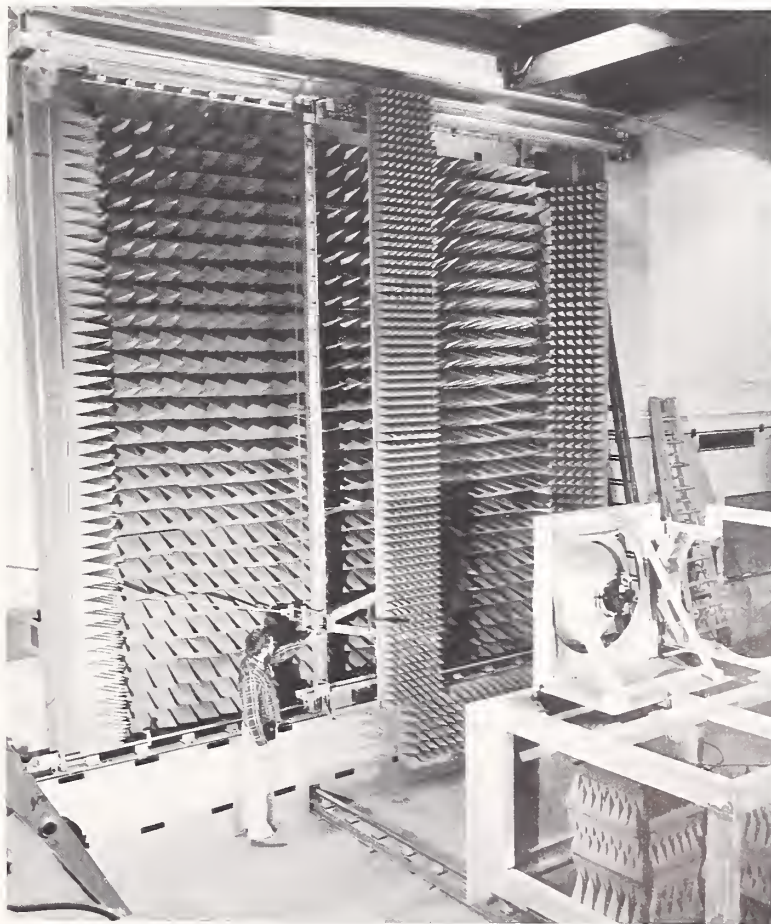

*Automated computer controlled near-field scanner developed in 1973-1974 for measuring microwave antenna fields. John Greene of the Fields and Antenna Section points to the movable probe. Antenna assembly in mounting at right foreground.*

Taking part in this fruitful program were Kerns, Wacker, Allen C. Newell, Ronald R. Bowman, and others, all under the guidance of Ramon C. Baird who gave direction to the several projects.<sup>82</sup>

#### d) THE PULSE DOMAIN

Standards and measurement techniques for electric pulses was a Johnny-come-lately development at NBS—a number of years after the early developments for CW power and voltage at radio frequencies. Pulse technology had much of its introduction in the development of radar, and is now much employed in telemetry, computers, and communication systems.

By 1962 the team of Paul A. Hudson, Warner L. Ecklund, and Arthur R. Ondrejka of the High Frequency Electrical Standards Section had developed an accurate method of measuring the peak-pulse power of an RF carrier. The technique was that of sampling the RF pulse by means of a specifically designed coaxial solid-state switch with a sample of a similar portion of a CW signal of known power level [44]. In 1965 service for the calibration of peak-pulse power meters in a frequency band centering near 1 GHz was initiated.

Pulsing techniques often require the accurate measurement of pulse voltages (baseband pulses) and it was a natural sequence that the peak-power pulse measurement development should be followed by that for peak pulse voltage. By 1965 Ondrejka and Hudson had developed two independent methods of measuring peak pulse voltage of a duration as short as 10 nanoseconds that could be intercompared [45]. Shortly thereafter a calibration service was initiated.<sup>83</sup>

During 1966 a new program became a part of the Radio Standards Engineering Division—a study of pulses in depth and in variety of circuit conditions. Norris S. Nahman of the University of Kansas joined the Division, bringing along with him three of his graduate students from the Department of Electrical Engineering.<sup>84</sup> An intensive program in short-period pulses (less than a nanosecond) got underway in a group that became the Pulse and Time Domain Section. Out of this program have come several projects that have advanced the art of pulse-measurement techniques. Included were the time and frequency characteristics of a superconducting coaxial transmission line, and the development of a method of generating pulsed wave forms of a known predicted shape using Debye dielectric dispersion. The latter was accomplished with a uniform long transmission line filled with one of several types of suitable liquids and activated by a special type of pulse generator [46]. Although large in its dimensions, work has continued on a more compact model for use in laser technology. Connected with these projects have been William D. McCaa, Jr., Donald R. Holt, James R. Andrews, and Robert M. Jickling.

#### e) THE MEASUREMENT OF PHASE SHIFT

The observation, accurate measurement, and application of phase relations of two or more ac waveforms are of much practical importance, whether at a 60-Hz power frequency or at microwave frequencies. At radio frequencies calibrated phase shifters serve to set and measure phase relations in systems used for navigation, radar tracking, and in the adjustment of phase-array antennas.

---

<sup>82</sup> In 1973 David M. Kerns was awarded the Department of Commerce Gold Medal for Exceptional Service, with the citation "for outstanding contributions to electromagnetic theory basic to important antenna measurement methods and for creative participation in the application of the theory."

In October 1974 Paul F. Wacker was awarded the Department of Commerce Silver Medal for Meritorious Service, with the citation "outstanding contribution to electromagnetic theory basic to antenna measurements and creative leadership in their application."

<sup>83</sup> In 1966 Hudson received the Department of Commerce Silver Medal for Meritorious Service "for extremely competent performance of his duties in development and construction of the Nation's standards for CW and pulse power, and pulse voltage."

<sup>84</sup> Nahman had been associated with the University of Kansas for 11 years, where he was director of the Electronics Research Laboratory and in charge of Project Jayhawk (a pulse study sponsored by the National Security Agency). In coming to the Boulder Laboratories, he was employed as a scientific consultant and later placed in charge of the Pulse and Time Domain Section. He was also an adjunct professor at the University of Colorado. Nahman resigned from the Electromagnetics Division on July 31, 1973, to teach at the University of Toledo. He returned to the Boulder Laboratories in June 1975.

A 1958 paper revealed a new approach to waveguide phase shifters for the precision measurement of phase shift that was followed up by the Microwave Circuit Standards Section.<sup>85</sup> George Schafer of the section developed a modulated subcarrier technique of measuring phase shift at microwave frequencies in waveguide (X-band waveguide). Schafer and Beatty made an error analysis of the phase shifter used as a standard. In preparation for a calibration service, Doyle A. Ellerbruch evaluated several phase-measurement systems which resulted in a system set up in the Microwave Calibration Service Section that used a balanced modulator (double sideband modulation with suppressed carrier) [47]. It differed somewhat from Schafer's system, with the attainment of superior operation.<sup>86</sup> By 1969 calibration services for phase shifters were made available in three waveguide sizes.

An unmodulated twin-channel attenuation measurement system developed by David H. Russell in the mid 1960's for coaxial attenuators over a wide frequency range was readily adaptable for the calibration of coaxial phase shifters and was set up for this purpose.

#### **f) STUDYING THE INTERACTION OF ELECTROMAGNETIC WAVES ON MATTER—EM CHARACTERISTICS OF MATERIALS**

The program on the electromagnetic characteristics of materials that had its apogee of activity during the early 1960's had its antecedents in the Bureau back to as early as 1918.<sup>87</sup> The first Bureau papers in this subject area were published by Dellinger and Preston in 1922 and 1923 (see ch. V, p. 106). The interest at the time was that of the properties of insulating materials brought on by the radio broadcasting industry. The measurements were those of phase difference (power loss) and dielectric constants.<sup>88</sup>

##### **1) Probing the dielectric properties at microwave frequencies of many substances—In the gaseous, liquid, and solid states**

Beginning in the spring of 1946, as an immediate fallout from the Bureau of Ship's "Phantom" project (see ch. IX, p. 337) came the development within the Microwave Standards Section of a method of observing the dielectric properties of a gas at microwave frequencies. For almost a decade the initial "fallout" project spawned a number of closely related projects under the leadership of George Birnbaum that led to no less than 14 published papers.

Among the first of these papers to be published by Birnbaum was that in 1949 on the dielectric constant and loss tangent of several solids and liquids by a cavity perturbation method. This was followed by a number of papers on the dielectric properties of water vapor and other gaseous substances. Evolving from the earlier measurements was a recording microwave refractometer, an instrument of multiple uses [48].<sup>89</sup> Associated with Birnbaum in some of these studies were Samuel J. Kryder and others, including several foreign guest workers.

<sup>85</sup> A paper by Milton Magid of the Hughes Aircraft Co. presented at the 1958 Conference on Electronic Standards and Measurements, at the Boulder Laboratories.

<sup>86</sup> A method that had been devised by the Bell Telephone Laboratories in 1949.

<sup>87</sup> Although initial studies of the electromagnetic characteristics of materials at radio frequencies began in the Radio Section in 1918, it is interesting to note that work on the "high frequency electric properties of materials" was conducted at NBS by the U.S. Signal Corps as early as 1912.\* Space in the West Laboratory (West Building, one of the four existing buildings) was occupied by the Signal Corps for several years for the experimental operation of both spark and arc transmitters, and to conduct research.

\*From an NBS brochure, dated September 10, 1912 (Boutell Collection).

<sup>88</sup> Later, in February 1925, J. L. Preston and E. L. Hall published a paper in the amateur periodical, *QST*, entitled "R. F. properties of insulating materials." In 1931, a paper published by A. B. Lewis, E. L. Hall, and F. R. Caldwell, in the *NBS Journal of Research*, gave the results of a fairly extensive measurement program suggested by the U.S. Bureau of Mines on the RF properties of domestic and foreign micas. Measurement of the dielectric constant and power factor were made in the frequency range of 100 to 1000 kHz.

Again, E. L. Hall found himself measuring the power factor of mica, this time during World War II. The war had cut off the supply of foreign mica, particularly the superior mica from India. It was desirable now to determine the suitability of domestic mica for radio equipment. In a *Proc. IRE* paper, published in July 1944, Hall described some of the more updated equipment that he used for the measurement of power factor of mica. (See ch. IX, p. 339.)

<sup>89</sup> A sweep frequency generator provided resonance responses in two similar cavities, one the reference cavity, the other the test cavity. A frequency difference between the two cavities when a gas was introduced into the test cavity provided a measurement of the dielectric constant of the gas.

In 1958 M. C. Thompson and M. J. Vetter, of the Radio Propagation Engineering Division, developed a compact variation of Birnbaum's microwave refractometer that was suitable for small aircraft use.

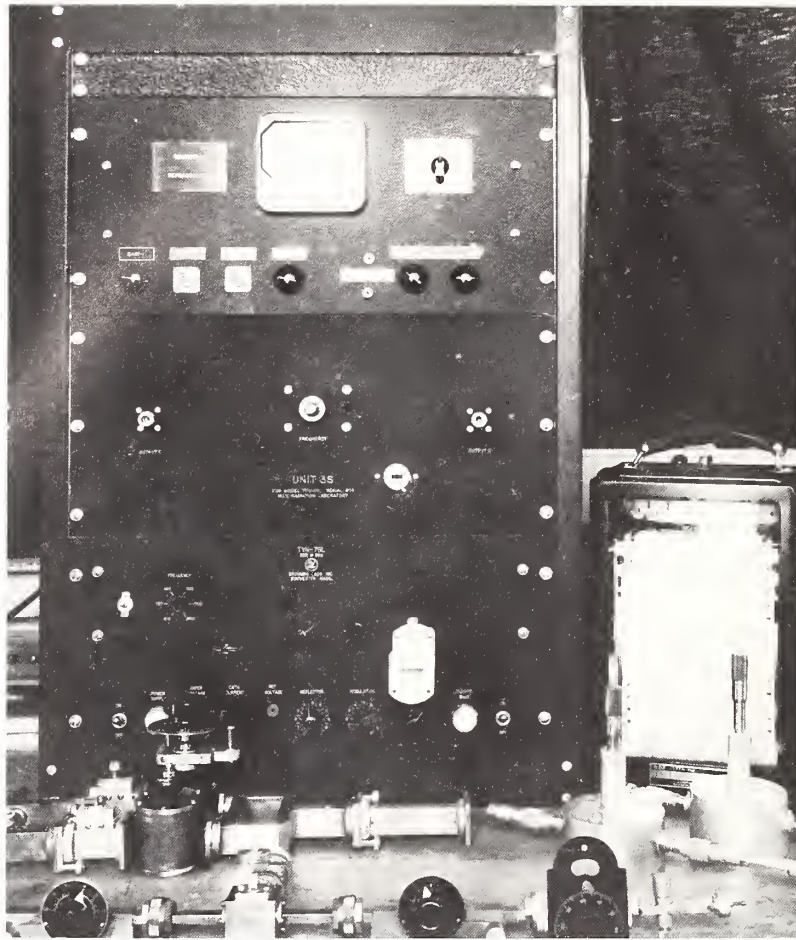

Early form of the recording microwave refractometer developed by George Birnbaum of the Microwave Standards Section during latter 1940's. Initiated by a defense project, this instrument became useful for dielectric studies and particularly for continuous measurement of refractive index of the atmosphere for propagation studies.

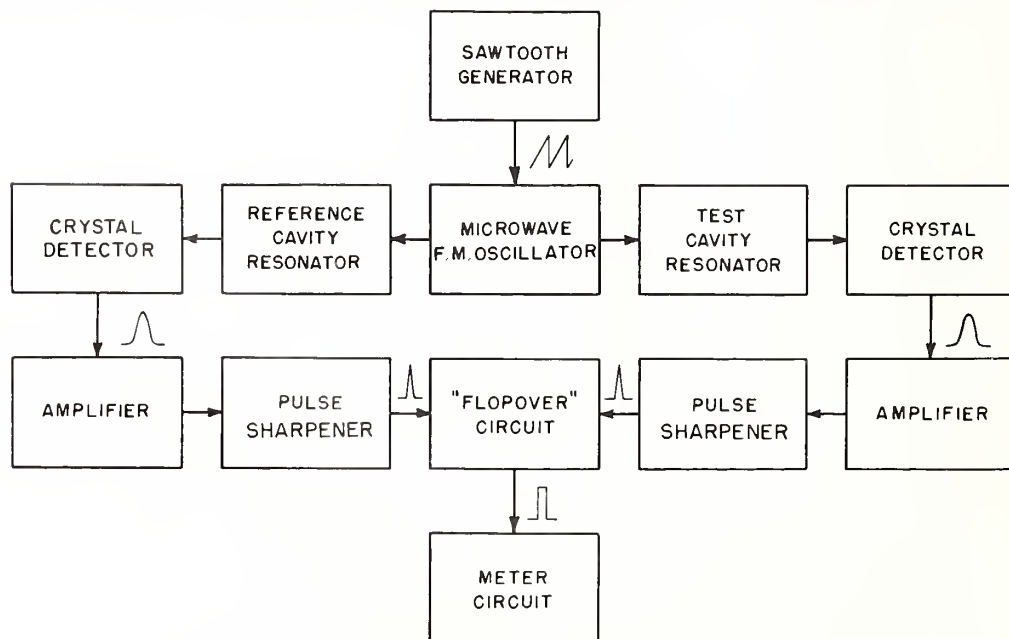

Original circuitry for microwave refractometer utilized two cavity resonators, one as a reference, the other as the test cavity for sampling gases. A difference frequency between the two cavities, obtained by a sweep-frequency technique, gave an indication of the dielectric constant, or change of constant, of substances. Later developments by CRPL personnel and others have simplified the design.

An interesting application of the recording microwave refractometer was a study by Birnbaum and Howard E. Bussey of variations in the refractive index (square root of dielectric constant) of the atmosphere during the early 1950's. The first observations were made at building height on the Bureau grounds. The next observations were made from a 420-foot tower at the Brookhaven Laboratory on Long Island, N.Y.; and finally from an airplane to an altitude of 10,000 feet over Chesapeake Bay.

## 2) Measurement of dielectric properties of materials—From 30 kHz up into the microwave frequencies

In the fall of 1946 the first step was taken to develop a service for the measurement of the dielectric constant and power factor (loss tangent) of solids used as insulation in RF equipment. Almost from the beginning, in 1946, John L. Dalke, then of the High Frequency Standards Section, would be associated with this and related programs for the next 25 years. The first step was the construction of four coaxial-type re-entrant cavity resonators for the range of 50 to 300 MHz, following designs of the MIT Laboratory for Insulation Research and others. These cavities also served to hold the dielectric sample being measured. Other equipment, including several types of bridges and other measurement circuitry, temperature-controlled capacitor-type sample holders, and RF generators were purchased or constructed, and the program was underway. Dalke was soon joined by James H. Beardsley on the project. Later Robert C. Powell joined the project. The first dielectric samples were measured in the fall of 1948 as a "round robin" study by an IRE committee, over a frequency range extending from 1 to 500 MHz.

During the early stages of this program the section initiated a modest program, at the request of the U.S. Bureau of Mines, on measuring the dielectric constant and loss tangent of petroleum deposits such as: oil sands, and oil-impregnated deposits. The expectancy was that such information would assist petroleum engineers in oil prospecting and in production of petroleum derivatives.

Early in the 1950's two improvements in instrumentation came from the dielectric program, each an improvement over innovations developed by others. One was the introduction of regeneration into the susceptance-variation method of measuring power factor in order to measure the very low values in materials such as polystyrene and teflon. The other was a redesigned re-entrant cavity for dielectric measurements at lower frequencies, and fitted with features of improved electrical and mechanical design.

Much later, around 1960, when the Radio Standards Laboratory was encountering problems of measurement with many of the newer kinds of materials that were coming on the market (semiconductors, high permittivity materials, etc.), new methods of measurement were being sought. Powell and Alvin L. Rasmussen developed a radio frequency permittimeter that solved some of these measurement problems. In contrast to the method of placing the dielectric sample between two electrodes, with its attendant problems, the sample is formed into a ring which becomes a circular electric field as the secondary of an RF transformer connected to an impedance bridge [49]. Various contributions have been added by Howard E. Bussey, particularly in the microwave region.<sup>90</sup> For many years Edwin C. Bamberger took part in the development of the instrumentation and in the performance of difficult measurements.

In 1964 Bussey headed up an international seven-man team from three laboratories to compare measurements on three dielectric samples. The results showed reasonably good agreement among the three laboratories but with some discrepancies of disturbing magnitude.

## 3) Sallying forth into the magnetic domain at radio frequencies

At the beginning of a new fiscal year, in the summer of 1950, a new project titled "Magnetic Measurements and Standards," was initiated in the High Frequency Standards Section and activated by Peter H. Haas, a new member of the section. His first task was to investigate the literature in magnetic measurements at radio frequencies and to evaluate

---

<sup>90</sup>In 1960 Bussey received the Department of Commerce Silver Medal for Meritorious Service "for very valuable contributions to the science and technology of electromagnetic parameter measurements associated with the interactions of electromagnetic waves and matter at microwave frequencies."

the methods of measurement. Evolving from this initial study came the first of a number of instruments and measurement techniques developed by NBS for use in magnetic measurements and as magnetic standards at radio frequencies. This first instrument, developed by Haas, was to serve as the NBS primary standard of RF permeability and loss factor, with the inherent capability of measurement in terms of length. However, the measurement method suffered from a number of drawbacks as a practical instrument and did not reach a stage of publication beyond a description in the *Technical News Bulletin*.

A more useful laboratory instrument was devised by Haas in 1952, called a radio-frequency permeameter [50].<sup>91</sup> The instrument was a high-frequency design of one described in 1927 for use at power and audio frequencies. Permeability measurement was made by inserting a toroidal core of the test material into the short-circuited secondary of a transformer whose primary was attached to an RF bridge or Q meter. This design was to perform yeoman service in the frequency range of 100 kHz to 50 MHz, both within and outside of NBS in the years to come. Improvements were made from time to time for increased accuracy, frequency range, and ease of application, also adaptation for the measurement of permeability temperature coefficient. An adaptation of the variable length coaxial transmission line (the primary standard) to a re-entrant cavity by Robert D. Harrington, Powell, and Haas provided for measurement of complex permeability to 180 MHz [51].

Beginning in November 1952, the Navy's Bureau of Ships sponsored a program of investigating the magnetic characteristics of powdered iron cores, a program that would continue for about 3 years under the direction of Alvin L. Rasmussen. Measurements were made on 141 samples submitted by 12 manufacturers of the cores. This program was followed in 1955 by another, to extend until 1959, on an investigation of ferrites, again under the direction of Rasmussen.<sup>92</sup> As before, the results of the investigation were intended for preparation of military specifications, purchase testing, and the evaluation of other investigations.

During the 1950's there was a rapidly growing interest in the electrical properties of materials and especially so in the area of the ferromagnetic materials.<sup>93</sup> This interest drew the Navy's Bureau of Ships into giving partial support to increased research programs in this field by the Radio Standards Laboratory. By the early 1960's the small group of the middle 1950's had grown to as many as 30 in the section organized in 1959 as the Radio and Microwave Materials Section within the Radio Standards Laboratory. The section was headed by John Dalke, as chief, for the 9 years as a large group organized for the study of properties of materials at radio frequencies.

During a period of about 10 years there was a multiplicity of projects that were formed and reformed to carry on the initiation, development, and phasing out of the many research programs in the magnetic studies of materials.<sup>94</sup> Much in the way of specialized instrumentation was procured or developed within the section. For example, as an improved means of determining the saturation magnetization of ferromagnetic materials, Nolan V. Frederick reported in 1960 on his combining the good features of two types of magnetometers (previously developed outside of NBS). Both this version, as well as one of

---

<sup>91</sup> In 1954 Haas was awarded the Department of Commerce Silver Medal for Meritorious Service for his work on the radio frequency permeameter.

<sup>92</sup> Ferrites are ferromagnetic materials of ferric oxide and other oxides of a ceramic-like nature, and characterized by very high electrical resistivity.

<sup>93</sup> The magnitude of this subject can be judged by a statement made by John Dalke in 1961 (Mountain States Navy Research and Development Clinic held at Raton, N. Mex.) on the subject of "Problems and Prospects in Electrical Properties of Materials."

In part, Dalke stated:

The literature in any one of these three areas (permittivity, permeability, and conductivity) has become so vast that it is necessary to rely on summarizing talks and articles; and, in many cases, even a full length book to bring us up to date in the fields outside of the narrow areas in which we are doing research. Such reviews often require books to present the various aspects of a given subject. In contrast, a generation ago one could read nearly all the current papers in any one of these three areas without much difficulty. . . .

<sup>94</sup> Because of the many facets to the nature of this magnetic study of materials, it is possible to give only a very sketchy treatment in this account.

the original designs, was used in the magnetic materials research. For both methods Frederick developed a simple calibration technique. Another instrument development was that by Rasmussen and Powell of a Maxwell bridge for low-loss magnetic measurements on toroidal-shaped materials in coaxial circuitry down to as low as 1 kHz.

Out of the manifold yet related projects came a variety of research programs on the magnetic characteristics of powdered irons, ferrites, garnets, and similar material used throughout the radio frequency spectrum. Measurement frequencies ranged from direct current (for static properties) to well up into the microwave region. The effort of the total program was directed toward the development of measurement techniques, plus a definitive study of the magnetic characteristics of the materials of interest. Where useful in interpreting the investigations, dielectric and conductivity measurements were also made. Calibration services in the many areas of measurement were developed to the benefit of both the military and the public.



*In 1962 Alvin Rasmussen, Radio and Microwave Materials Section, examines a re-entrant cavity (250-950 MHz) used for measuring complex permittivity of dielectric samples. Two wheels at top change and measure separation of capacitor plates between which sample is inserted. Mechanism at bottom tunes cavity to desired frequency. Measurement reveals characteristics and suitability of dielectrics for RF equipment.*

Viewed in after years, one finds that the total program was categorized into a number of areas of activity, largely determined by the electric quantity or characteristic being measured. Some measurements fell into line with the more conventional types of magnetic measurements; others were based on the most recent solid-state research. Of the former were those associated with complex permeability, namely: initial permeability, reversible permeability, and the temperature coefficient of permeability. Associated with the phenomenon of ferromagnetic resonance were measurements of linewidth and gyromagnetic ratio, also tensor permeability. Other projects included the study and measurement of saturation magnetization, hysteresis loops, total loss, Curie temperature, and other phenomena associated with studies in solid-state physics.

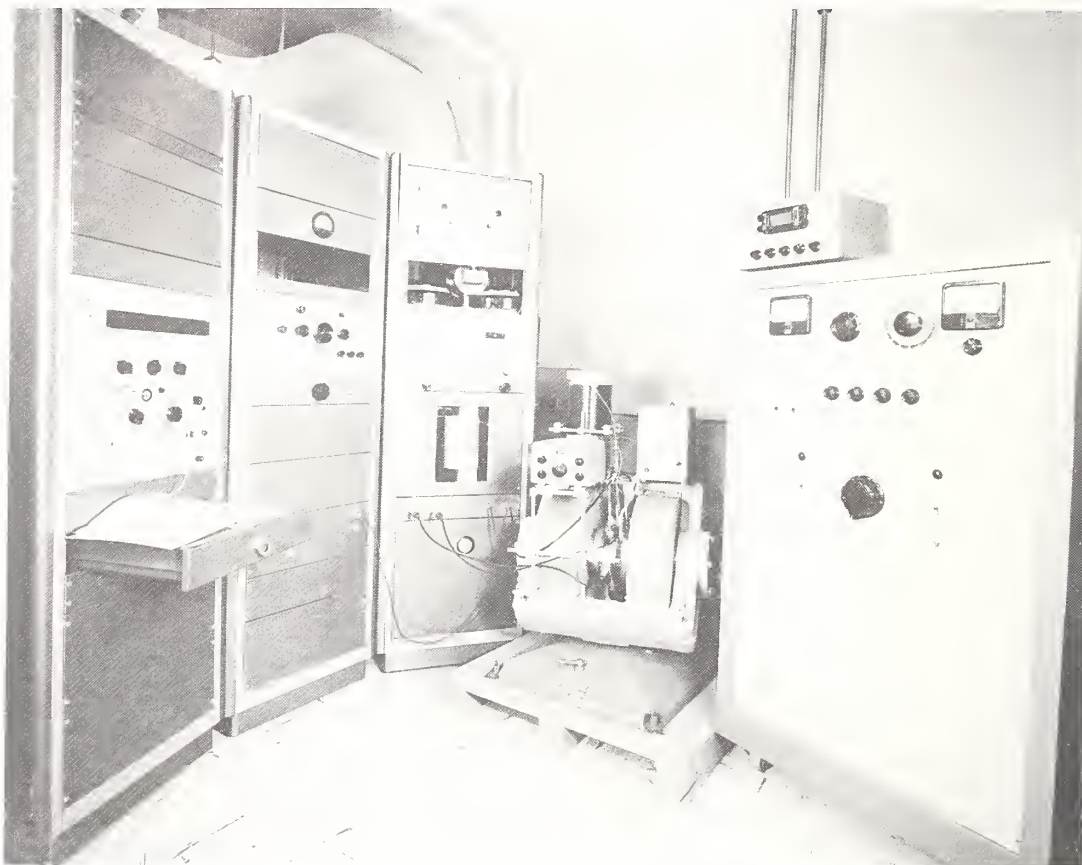

*Equipment used in early 1960's for measurement of tensor permeability properties of ferrites at 3100 MHz by the Radio and Microwave Materials Section. The ferrite material was placed in cavity between pole pieces of strong electromagnet (center). Signal generators, detectors, and other electronic equipment are at left. Ferrites have found many uses in RF equipment.*

Out of this many faceted program came many reports and publications. NBS Reports (primarily for the Bureau of Ships) were very numerous, both as progress reports and for elucidation of techniques and measurement data. Much of the information was published in the technical literature, with descriptions of new instrumentation, measurement techniques, research results, and theoretical discussions.

Many people were associated with the overall program, some to stay for a short time, others for a period of several years, and others to remain at the Boulder Laboratories to the present time. Those taking principal roles in the program, with quite a number as project leaders, were: Dalke, chief of the Radio and Microwave Materials Section, Virgil E. Bottom, Howard E. Bussey, William E. Case, Nolan V. Frederick, Robert D. Harrington, Cletus A. Hoer, Robert J. Mahler, Lawrence M. Matarrese, Robert L. Peterson, Alvin L. Rasmussen, Allan S. Risley, Leonard B. Schmidt, and Leon A. Steinert.



g) A SASHAY INTO LOW-FREQUENCY INSTRUMENTATION AND MEASUREMENTS

After a request by the Air Force early in the planning stages for the Electronic Calibration Center, the decision was made to include low-frequency (dc to 30 kHz) services into the total calibration program. In keeping with the general policy throughout the center, there was opportunity for the operating personnel to engage in development programs to improve or devise new instrumentation and measurement techniques. Thus, over the period of the low frequency calibration program, from 1958 to 1966, a number of original contributions emerged from the Low Frequency Calibration Services Section under the guidance of Frank D. Weaver, the section chief. Weaver, along with Thomas L. Zapf and David Ramaley, had been on the staff of the Electricity Division at NBS Washington.

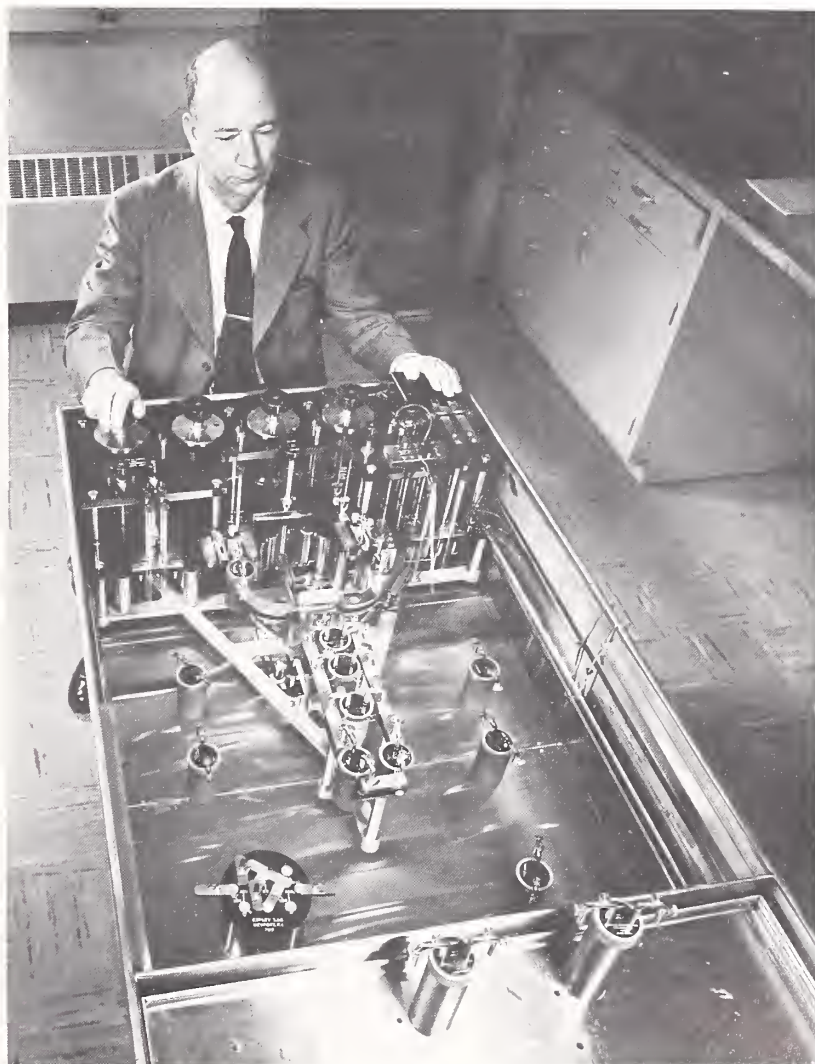

*Photograph (1958) of Frank Weaver, head of Low Frequency Unit, Electronic Calibration Center, operating precision bridge used to calibrate standard resistors with uncertainty of less than one part per million. The bridge was a development in 1918 by Dr. Frank Wenner of the Electricity Division, and a small number have been manufactured through the years. Originally called the NBS Precision Bridge, it became better known as the Wenner Bridge. All parts of bridge, except control knobs, are submerged in oil at constant temperature of 25 °C.*

The first contribution to the technical literature from these low frequency developments was a step-up technique of calibrating variable air capacitors from a single fixed capacitance, developed by Zapf. His paper, published in the *NBS Journal of Research*, was followed by another a short time later that described improved methods of calibrating inductance standards by the Maxwell-Wien bridge.



*This photograph in "Rembrandt lighting" taken of Thomas Zapf during second year of operation of the Electronic Calibration Center (1959). A calibration is being performed with a highly refined type of capacitance bridge developed by the combined effort of two instrument manufacturers.*

Ramaley specialized in the areas of resistance measurements, the calibration of laboratory-type potentiometers, and in the use of universal ratio sets. This experience led him to the improvement of measurement methods with the result of five published papers in this area.

The establishing of a standards laboratory at Boulder gave NBS a rare opportunity to develop maintenance programs at widely distant locations with virtually independent sets of some of its most precise and accurate standards, namely those of electrical resistance and voltage (standard cells). The result, over a period of several years, was most gratifying, leading to a publication by Weaver on the subject of measurement agreement [52].<sup>95</sup>

Zapf became quite interested and involved in further improvements in the calibration of inductive voltage dividers.<sup>96</sup> He, along with several colleagues, published several papers

<sup>95</sup> Weaver concluded, in part, in his paper:

... it appears that close measurement agreement has been achieved between the two laboratories (NBS Washington and NBS Boulder). The achievement of the Electronic Calibration Center in this area can be closely approached by another laboratory. Some laboratories already have a long history of comparisons on their standards by NBS. It would seem that another laboratory, in a period of a few years, could establish a volt and ohm that closely approaches the value of the volt and ohm maintained at NBS.

Another standards laboratory with well-trained personnel having a determination to make the best measurements and working with high quality standards and facilities can achieve near measurement equality with the National Bureau of Standards. . . . The time can be foreseen when a number of laboratories will reach this objective.

<sup>96</sup> Inductive voltage dividers belong to a class of precise measuring equipment that have tapped windings on toroidal cores of very high magnetic permeability. Decade inductive dividers are useful as ratio arms in precision bridges, as accurate voltage dividers, and as standards for calibrating other dividers by a comparison method.

on advancing the art of calibrating inductive voltage dividers (calibration with uncertainty of a few parts in  $10^7$ ). Later, within the HF Impedance Standards Section, Cletus A. Hoer and Walter L. Smith developed an inductive voltage divider (2:1 ratio) for operation at 1 MHz with an error of less than 1 part in  $10^7$ .<sup>97</sup> Still later, Donald N. Homan and Zapf, in the same section, developed a two-stage inductive voltage divider for operation at 100 kHz [53].

A useful piece of instrumentation that came out of the Low Frequency Calibration Services Section was the development by Patrick H. Lowrie, Jr. of two large oil baths for temperature control of a large number of saturated standard cells. These were a marked improvement over the oil baths used previously by NBS. Temperature variations were found to be less than  $0.002^\circ\text{C}$  per day.

---

<sup>97</sup>In the summer of 1972, Walter L. Smith was awarded the Department of Commerce Bronze Medal, the citation reading, "for outstanding support to division and NBS programs as a manager, technician, teacher, and humanitarian."



*Controlled-temperature oil bath, for saturated standard cells, developed in 1960 by Patrick Lowrie (in photo) of the Electronic Calibration Center. This bath of advanced design combined many novel features for temperature control, ease of handling and circulating the nearly 100 gallons of mineral oil, and easy means of inserting and removing standard cells. Two baths were constructed, one for operation at  $28^\circ\text{C}$ , the other at  $35^\circ\text{C}$ . Control of oil temperature was within  $\pm 0.002^\circ\text{C}$  per day. In 1966 the two baths were transferred to the Electricity Division at NBS Gaithersburg.*

Many of the papers published by this section were reprinted in *NBS Special Publication 300*, "Precision Measurement and Calibration; Vol. 3, Electricity—Low Frequency."

## h) THEORETICAL WORK AS BACKGROUND TO STANDARDS AND MEASUREMENTS

Any large research organization is fortunate to have high-caliber theoreticians on its staff to provide idealized concepts to the experimental work and to provide explanations for discovered phenomena, based on sound physical principles. The RF standards and measurements programs, and particularly at microwave frequencies since World War II, have been fortunate to have had a fair share of quality personnel to carry on the theoretical work.

David M. Kerns joined the Microwave Standards Section in 1946 and has had a productive career in his theoretical studies since the time of his entry when NBS was first beginning to delve into microwaves. Kerns' first general study in microwaves was the application of network equations to waveguide problems, published in 1949 [54]. Previously, this subject was not treated by others in its general aspects. Kerns stated in his introduction that "The primary purpose of the present paper is to provide a systematic and basic formulation of the technique in question." The technique was that of treatment of a transducer concept to that of waveguide and defining suitable variables characterizing the terminal fields. The treatment was essentially that on what has commonly come to be known as "four-terminal networks."

Kerns' doctoral dissertation in 1951 was published in the *NBS Journal of Research* under the title "Analysis of symmetrical waveguide junctions" [55]. This paper was concerned with the fuller utilization of group-theory mathematics in the formulation of an improved and general technique for the analysis of symmetrical waveguide junctions (previous work by others had made but limited use of the theory of group representations, and was limited to nondissipative junctions). Structural symmetry places restrictions on the form of the impedance, admittance, and scattering matrices of a waveguide junction, and forces some of the matrix elements to vanish.

During the ensuing years Kerns was much occupied with theoretical problems associated with impedance and power standards (see these sections earlier in this chapter).<sup>98</sup>

In 1965 Kerns and Beatty jointly produced a text entitled, *Basic Theory of Waveguide Junctions and Introductory Microwave Network Analysis*, published by Pergamon Press as one of an International Series of Monographs in Electromagnetic Waves [56]. The usefulness of the text can be judged by a portion of the foreword by A. L. Cullen, an editor of the Series:

This monograph is a most useful addition to the literature on microwave networks. It is of special value for two main reasons. In the first place, the foundations of the theory are laid with greater thoroughness than usual. Secondly, the theory is formulated with application in mind, and the principle results are presented in a form which the experimentalist as well as the theoretician will find convenient.

Among the many contributions by the Radio Standards Laboratory to the *Proc. IEEE* Special Issue on Radio Measurement Methods and Standards of June 1967 (see p. 359), Kerns authored a paper with a theoretical slant [57]. In setting the tone of his paper, Kerns stated: "This paper is concerned with the meaning of the quantities being measured rather than with methods of measurement." The quantities were those associated with the scattering matrix treatment of waveguides and waveguide junctions.

In a revision of his doctoral dissertation, Beatty prepared an *NBS Monograph* entitled, "Applications of Waveguide and Circuit Theory to the Development of Accurate Microwave Measurement Methods and Standards" [58].<sup>99</sup> Beatty stated in the preface that the purpose of the monograph was to show how microwave waveguide and circuit theory was formulated and applied to the development of accurate measurement methods and standards at the NBS during the period of 1948-1968.

---

<sup>98</sup> In 1960 Kerns was awarded the Department of Commerce Silver Medal for Meritorious Service for "outstanding performance in the development of national microwave standards and measurement techniques."

<sup>99</sup> Beatty earned a doctor's degree in the Department of Electronic Engineering of the University of Tokyo at Tokyo, Japan, while a guest worker for 15 months (1970-1971) with the Electrotechnical Laboratory at Tanashi, Tokyo, Japan.

An NBS Monograph (dated October 1969) was prepared by Engen based upon a doctor's dissertation submitted to the University of Colorado entitled, "A New Concept in Microwave Measurement Techniques" [59]. The new concept was the elimination of precision waveguide and connector requirements for many types of accurate measurement methods.

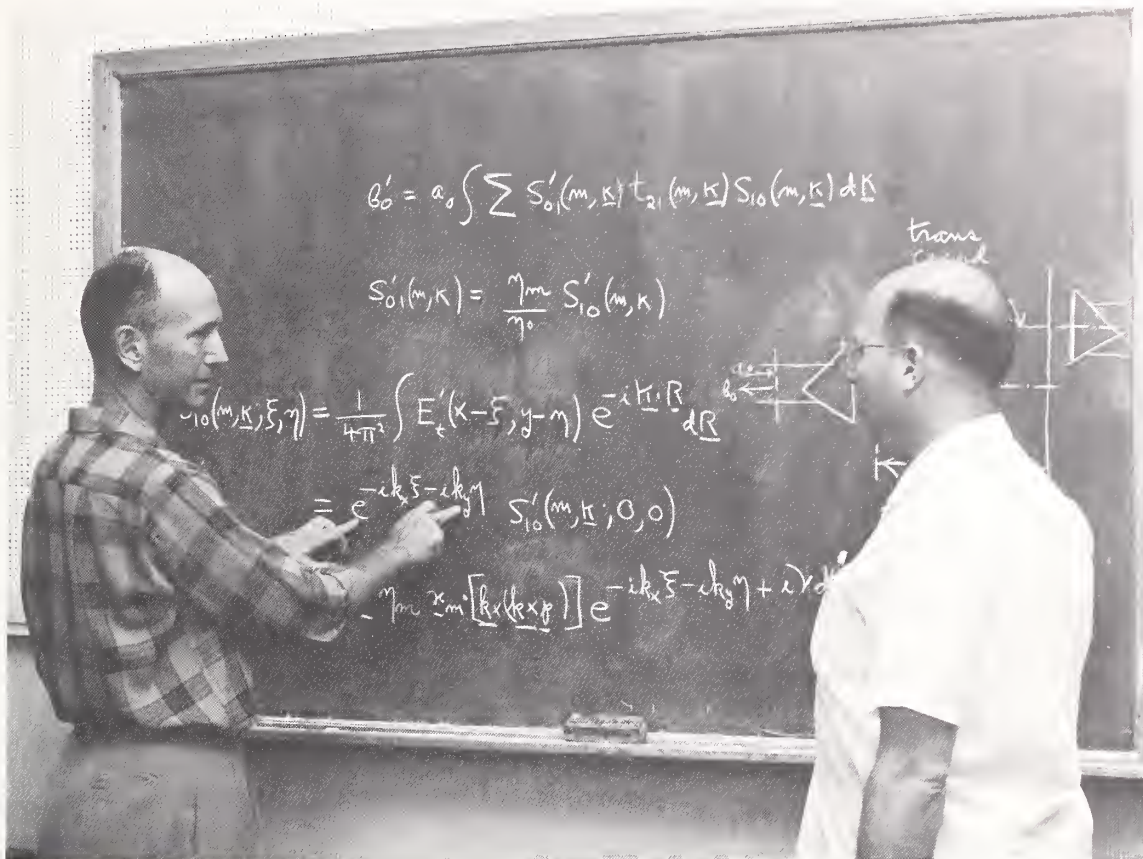

Two physicists delve into a mathematical treatment; together, they have 55 years experience at NBS with theoretical studies of radio standards. David Kerns (left) points out to Paul Wacker some of the terms in equations expressing near-field relations of two antennas.

#### i) THE COAXIAL CONNECTOR—PROBLEMS AND SOLUTIONS

In the rapid development of radio technology during and after World War II that extended the useful frequency range up into the microwave region, the development of transmission lines took two courses, the coaxial line (both rigid and the flexible cable) and the hollow or uniconductor waveguide. By its electrical nature, a coaxial transmission line is limited to the lower radio frequencies, although in more recent years, with improved understanding and construction of the lines and connectors, the usable frequency has been extended well up into the microwave region (30 GHz and higher).

Because of the Bureau's involvement in the development of standards and precision measurement techniques that included coaxial equipment, there existed the interest, as well as the responsibility, to become involved in the improvement of coaxial connectors—the connectors being the weak link in precision measurement systems involving coaxial lines and components. Concern over this weak link had been growing in the measurement community.

The type "N" connector had come into wide use in coaxial systems of low power requirements but its design and specifications were of a dimensional nature rather than that of an exacting performance. Consequently the connector left much to be desired as a precision component of a measurement system. Being aware of these limitations and the requirements of the new Electronic Calibration Center (as well as for the reference standards programs), during 1956 a group within the Radio Standards Division studied the

problem. One of the conclusions reached was that a universal type of connector was impractical for precision measurements. During the next several years, under the guidance of Robert C. Powell, three or four types of laboratory-type connectors evolved within the Radio Standards Laboratory. All were designed for the 50-ohm matching of coaxial lines and standards, with a definable plane of cleavage, with the outer conductor of 3/4-inch internal diameter, but with much variation in method of coupling, both mechanically and electrically.

Interest in precision coaxial connectors grew in other measurement laboratories and among several manufacturers, with the result that at the 1960 Conference on Standards and Electronic Measurements, at Boulder, a group of about 25 persons met to form a committee which resulted in definitely limiting itself to the study of laboratory-type precision coaxial connectors. Active on the Committee for the Standardization of High Precision Coaxial Connectors of 12 members were 4 from the Radio Standards Laboratory.<sup>100</sup> At the start the group was a part of the AIEE committee structure, later the parent committee became the IEEE G-IM Technical Committee on High-Frequency Instruments.

After 4 years and a number of meetings the committee came up with requirements and parameters for precision connectors in 14- and 7-mm sizes.<sup>101</sup> In 1968 the committee reported on an IEEE Standard for Precision Coaxial Connectors. More recently, studies have been made by the committee on the small 3.5-mm connector to extend coaxial measurement techniques far up into microwave frequencies (at least 26.5 GHz).

Over the intervening years since the late 1950's, the impedance groups within the Radio Standards Laboratory (and later divisions) have been making extensive studies of precision coaxial connectors, both of their own design and those designed by several manufacturers. The Bureau's own designs of laboratory-type connectors have been used in the various measurement systems used for calibrations. Thus, many measurements require the use of special precision-type adapters in order to accommodate the variety of connectors found on equipment submitted for calibration.

Among those who have taken part in committee work and the laboratory study of coaxial connectors have been Powell, Beatty, Little, Wakefield, Anson, Lance, Leslie Huntley, Raymond Jones, Robert Jickling, and Ramon Jesch.

## REFERENCES

- [1] A. V. Astin, "The National Bureau of Standards," *Physics Today*, Vol. 6, No. 6, June 1953, pp. 12-13.
- [2] E. L. Hall, "Diathermy generators," *Archives of Physical Medicine*, Vol. 33, Jan. 1952, pp. 28-36.
- [3] George C. Southworth, *Forty Years of Radio Research*, Gordon and Breach, New York, 1962.
- [4] George C. Southworth, *Principles and Applications of Waveguide Transmission*, D. Van Nostrand Co., New York, 1950.
- [5] Beverly Smith, Jr., "The measurement pinch," *The Saturday Evening Post*, Vol. 233, No. 11, Sept. 10, 1960, pp. 36, 102-104.
- [6] M. C. Selby, "The system of electromagnetic quantities of 30 kHz to 1 GHz," *Metrologia*, Vol. 2, No. 1, Jan. 1966, pp. 37-45.
- [7] R. W. Beatty, "The system of electromagnetic quantities above 1 GHz," *Metrologia*, Vol. 2, No. 1, Jan. 1966, pp. 46-54.
- [8] J. J. Freeman, "Theory and design of a cavity attenuator," *J. Res. Nat. Bur. Stand. (U.S.)*, Vol. 40, No. 3, Mar. 1948, pp. 235-243.
- [9] R. E. Grantham and J. J. Freeman, "A standard of attenuation for microwave measurements," *AIEE Trans. (Communication and Electronics)*, Vol. 67, June 1948, pp. 329-335.
- [10] C. M. Allred and C. C. Cook, "A precision RF attenuation calibration system," *IRE Trans. Instr.*, Vol. I-9, No. 2, Sept. 1960, pp. 268-274.
- [11] David Russell and Wilbur Larson, "RF attenuation," *Proc. IEEE*, Vol. 55, No. 6, June 1967, pp. 942-959.
- [12] W. E. Little, W. Larson, and B. J. Kinder, "Rotary-vane attenuator with optical readout," *J. Res. Nat. Bur. Stand. (U.S.)*, Vol. 75C (Eng. and Inst.), No. 1, Jan.-Mar. 1971, pp. 1-5.
- [13] Wilbur Larson and Eugene Campbell, Microwave Attenuation Measurement System (Series Substitution), *Nat. Bur. Stand. (U.S.)*, *Tech. Note 647*, Feb. 1974, 28 pages.
- [14] G. E. Schafer and R. R. Bowman, "A modulated sub-carrier technique of measuring microwave attenuation," *Proc. IEE (London)*, Vol. 109, Part B, Supplement 23, 1962, pp. 783-786.

<sup>100</sup> The four NBS members of the original committee included: Wilbur Anson, Robert Beatty, Harvey Lance, and Robert Powell.

<sup>101</sup> By 1964 two more from the Radio Standards Laboratory had been added to the committee: William Little and John Wakefield.

- [15] Robert W. Beatty, Microwave Attenuation Measurements and Standards, *Nat. Bur. Stand. (U.S.), Monogr. 97*, Apr. 3, 1967, 49 pages.
- [16] A. C. MacPherson and D. M. Kerns, "A new technique for the measurement of microwave standing-wave ratios," *Proc. IRE*, Vol. 44, No. 8, Aug. 1956, pp. 1024-1030.
- [17] G. F. Engen and R. W. Beatty, "Microwave reflector techniques," *IRE Trans. Microwave Theory and Techniques*, Vol. MTT-7, No. 3, July 1959, pp. 351-355.
- [18] R. W. Beatty and W. J. Anson, "Application of reflectometer techniques to accurate measurements in coaxial systems," *Proc. IEE (London)*, Vol. 109B, July 1962, pp. 345-348.
- [19] R. C. Powell, R. M. Jickling, and A. E. Hess, "High-frequency impedance standards at the National Bureau of Standards," *IRE Trans. Inst.*, Vol. I-7, Nos. 3 and 4, Dec. 1958, pp. 270-274.
- [20] L. E. Huntley and R. N. Jones, "Lumped parameter impedance measurements," *Proc. IEEE*, Vol. 55, No. 6, June 1967, pp. 900-911.
- [21] David M. Kerns, "Determination of efficiency of microwave bolometer mounts from impedance data," *J. Res. Nat. Bur. Stand. (U.S.)*, Vol. 42, No. 6, June 1949, pp. 579-585.
- [22] G. F. Engen, "A bolometer mount efficiency measurement technique," *J. Res. Nat. Bur. Stand. (U.S.)*, Vol. 65C (Eng. and Inst.), No. 2, Apr.-June 1961, pp. 113-124.
- [23] Alan C. MacPherson and David M. Kerns, "A microwave microcalorimeter," *Rev. Sci. Instr.*, Vol. 26, No. 1, Jan. 1955, pp. 27-33.
- [24] Glenn F. Engen, "Coaxial power meter calibration using a waveguide standard," *J. Res. Nat. Bur. Stand. (U.S.)*, Vol. 70C (Eng. and Inst.), No. 2, Apr.-June 1966, pp. 127-138.
- [25] Glenn F. Engen, "Power equations: a new concept in the development and evaluation of microwave systems," *IEEE Trans. Inst. Meas.*, Vol. IM-20, No. 1, Feb. 1971, pp. 49-57.
- [26] P. A. Hudson and C. M. Allred, "A dry, static calorimeter for RF power measurement," *IRE Trans. Inst.*, Vol. I-7, Nos. 3 and 4, Dec. 1958, pp. 292-296.
- [27] M. L. Crawford and P. A. Hudson, "A dual-load flow calorimeter for RF power measurement to 4 GHz," *J. Res. Nat. Bur. Stand. (U.S.)*, Vol. 71C (Eng. and Inst.), No. 2, Apr.-June 1967, pp. 111-117.
- [28] M. L. Crawford, "A new RF-dc substitution calorimeter with automatically controlled reference power," *IEEE Trans. Inst. Meas.*, Vol. IM-17, No. 4, Dec. 1968, pp. 378-384.
- [29] Myron C. Selby and Lewis F. Behrent, "A bolometer bridge for standardizing radio-frequency voltmeters," *J. Res. Nat. Bur. Stand. (U.S.)*, Vol. 44, No. 1, Jan. 1950, pp. 15-30.
- [30] "Radio frequency micropotentiometer," *Nat. Bur. Stand. (U.S.), Tech. News Bull.*, Vol. 35, No. 3, Mar. 1951, pp. 33-34.
- [31] Myron C. Selby, "Accurate radio-frequency voltages," *AIEE Trans. (Communications and Electronics)*, Vol. 72, No. 6, May 1953, pp. 158-164.
- [32] Nolan V. Frederick, "A new high-frequency current standard," *IEEE Trans. Inst. Meas.*, Vol. IM-17, No. 4, Dec. 1968, pp. 285-290.
- [33] Winston W. Scott, Jr., "New coaxial RF-DC ammeter," *IEEE Trans. Inst. Meas.*, Vol. IM-19, No. 4, Nov. 1970, pp. 318-323.
- [34] M. G. Arthur, C. M. Allred, and M. K. Cannon, "A precision noise-power comparator," *IEEE Trans. Inst. Meas.*, Vol. IM-13, No. 4, Dec. 1964, pp. 301-305.
- [35] M. G. Arthur, "A precision HF noise power measurement system," *ISA Trans.*, Vol. 10, No. 3, 1971, pp. 264-268.
- [36] A. J. Estin, C. L. Trembath, J. S. Wells, and W. C. Daywitt, "Absolute measurement of temperatures of microwave sources," *IRE Trans. Inst.*, Vol. I-9, No. 2, Sept. 1960, pp. 209-213.
- [37] J. S. Wells, W. C. Daywitt, and C. K. S. Miller, "Measurement of effective temperatures of microwave noise sources," *IEEE Trans. Inst. Meas.*, Vol. IM-13, No. 1, Mar. 1964, pp. 17-28.
- [38] Frank M. Greene, Calibration of Commercial Radio Field-Strength Meters at the National Bureau of Standards, *Nat. Bur. Stand. (U.S.), Circ. 517*, Dec. 1951, 5 pages.
- [39] Frank M. Greene and Max Solow, "Development of VHF field-intensity standards," *Proc. IRE*, Vol. 40, No. 5, May 1952, p. 573; also *J. Res. Nat. Bur. Stand. (U.S.)*, Vol. 44, No. 5, May 1950, pp. 527-547.
- [40] Frank M. Greene, "A near-zone electric-field-strength meter," *J. Res. Nat. Bur. Stand. (U.S.)*, Vol. 71C (Eng. and Inst.), No. 1, Jan.-Mar. 1967, pp. 51-57.
- [41] D. M. Kerns, "Correction of near-field antenna measurements made with an arbitrary but known measuring antenna," *Electronic Letters*, Vol. 6, No. 11, 28th May 1970, pp. 346-347.
- [42] R. C. Baird, A. C. Newell, P. F. Wacker, and D. M. Kerns, "Recent experimental results in near-field antenna measurements," *Electronic Letters*, Vol. 6, No. 11, 28th May 1970, pp. 349-351.
- [43] Allen C. Newell, Ramon C. Baird, and Paul F. Wacker, "Accurate measurement of antenna gain and polarization at reduced distances by an extrapolation technique," *IEEE Trans. Ant. Prop.*, Vol. AP-21, No. 4, July 1973, pp. 418-431.
- [44] P. A. Hudson, W. L. Ecklund, and A. R. Ondrejka, "Measurement of RF peak-pulse power by a sampling-comparison method," *IRE Trans. Inst.*, Vol. I-11, Nos. 3 and 4, Dec. 1962, pp. 280-284.
- [45] A. R. Ondrejka and P. A. Hudson, "Measurement standards for low and medium peak pulse voltages," *J. Res. Nat. Bur. Stand. (U.S.)*, Vol. 70C (Eng. and Inst.), No. 1, Jan.-Mar. 1966, pp. 13-18.
- [46] W. D. McCaa, Jr. and Norris S. Nahman, "Generation of reference waveforms by uniform lossy transmission lines," *IEEE Trans. Inst. Meas.*, Vol. IM-19, No. 4, Nov. 1970, pp. 382-390.
- [47] Doyle A. Ellerbruch, "Evaluation of a microwave phase measurement system," *J. Res. Nat. Bur. Stand. (U.S.)*, Vol. 69C (Eng. and Inst.), No. 1, Mar. 1965, pp. 55-65.
- [48] George Birnbaum, "A recording microwave refractometer," *Rev. Sci. Instr.*, Vol. 21, No. 2, Feb. 1950, pp. 169-176.
- [49] R. C. Powell and A. L. Rasmussen, "A radio-frequency permittimeter," *IRE Trans. Instr.*, Vol. I-9, No. 2, Sept. 1960, pp. 179-184.

- [50] Peter H. Haas, "A radio-frequency permeameter," *J. Res. Nat. Bur. Stand. (U.S.)*, Vol. 51, No. 5, Nov. 1953, pp. 221-228.
- [51] R. D. Harrington, R. C. Powell, and P. H. Haas, "A re-entrant cavity for measurement of complex permeability in the very-high-frequency range," *J. Res. Nat. Bur. Stand. (U.S.)*, Vol. 56, No. 3, Mar. 1956, pp. 129-134.
- [52] Frank D. Weaver, "Achievement of measurement agreement among electrical standards laboratories," *Instruments and Control Systems*, Vol. 36, No. 7, July 1963, pp. 128-131.
- [53] Donald N. Homan and Thomas L. Zapf, "Two-stage, guarded inductive voltage divider for use at 100 kHz," *ISA Trans.*, Vol. 9, No. 3, 1970, pp. 201-209.
- [54] David M. Kerns, "Basis of the application of network equations to waveguide problems," *J. Res. Nat. Bur. Stand. (U.S.)*, Vol. 42, No. 5, May 1949, pp. 515-540.
- [55] David M. Kerns, "Analysis of symmetrical waveguide junctions," *J. Res. Nat. Bur. Stand. (U.S.)*, Vol. 46, No. 4, Apr. 1951, pp. 267-282.
- [56] David M. Kerns and Robert W. Beatty, *Basic Theory of Waveguide Junctions and Introductory Microwave Network Analysis*, Pergamon Press, New York, N.Y., 1967.
- [57] David M. Kerns, "Definitions of  $v$ ,  $i$ ,  $Z$ ,  $Y$ ,  $a$ ,  $b$ ,  $\Gamma$ , and  $S$ ," *Proc. IEEE*, Vol. 55, No. 6, June 1967, pp. 892-900.
- [58] R. W. Beatty, Applications of Waveguide and Circuit Theory to the Development of Accurate Microwave Measurement Methods and Standards, *Nat. Bur. Stand. (U.S.) Monogr. 137*, Aug. 1973, 322 pages.
- [59] Glenn F. Engen, An Introduction to the Description and Evaluation of Microwave Systems Using Terminal Invariant Parameters, *Nat. Bur. Stand. (U.S.) Monogr. 112*, Oct. 1969, 27 pages.



## Chapter XI

### THE WORLD AS A LABORATORY

#### INTRODUCTION<sup>1</sup>

Twenty years in time separated the rumblings of another world war from the time of the Armistice of the World War of 1914-1918. During those 20 years the technology of radio communication advanced rapidly, particularly in the development of broadcasting. During the second decade of the 20-year period there came an increased understanding by British and American scientists of the ionosphere as a transmission medium for radio waves. It was during this decade that the Radio Section made significant advances in the knowledge of: the relationship of vertical and oblique incidence reflections from the ionosphere, maximum usable frequencies, critical frequency, diurnal and seasonal characteristics of the ionosphere, relation to sunspot numbers, ionospheric disturbances, modes of propagation, and absorption of energy in the sky waves; and in the development of: ionosphere observation equipment and stations, continuous recording of field intensities, and radio transmission charts.

Thus, by 1939, when hostilities opened in Europe, the Radio Section found itself with a considerable grasp on an understanding of the ionosphere and with a method of predicting several months in advance its usefulness as a propagation medium (see concluding section of ch. VII). As the United States became more threatened by the war in Europe, first in an isolationist role, then as a lend-lease participant, and after Pearl Harbor as an active combatant, steps were taken by the National Defense Research Committee (NDRC) to contract for scientific work and development of devices relating directly to war (see ch. IX, p. 316). In October 1940 Dellinger was appointed to the Communications Section of the Communications and Transportation Division (later known as Electrical Communication, Div. 13).

Two negotiating events occurred in January 1941 between the NDRC and NBS that would have a marked effect upon the Radio Section during World War II and upon the radio work of NBS for the next 25 years. First, was a contract for preparation of a "handbook" that was issued January 1, 1942 with the title, Radio Transmission Handbook, Frequencies 1000 to 30,000 KC. Later, on June 1, 1942, a supplement<sup>2</sup> was issued by the Radio Section,

<sup>1</sup>Because of the rapid development of radio propagation studies and prediction services in the early period of World War II, followed by the organization of the Interservice Radio Propagation Laboratory (IRPL) within the Radio Section in 1942, the author has gone into considerable detail to write of this period. It was the formative period for the organization of the Central Radio Propagation Laboratory (CRPL) in 1946 that would grow to six technical divisions by 1965 (later a seventh division), after which time much of the organization was separated from NBS to join the Weather Bureau and the Coast and Geodetic Survey in forming the Environmental Science Services Administration (ESSA), an agency of the Department of Commerce.

<sup>2</sup>The Radio Transmission Handbook was prepared by members of the Radio Section under the guidance of Dellinger and Newbern Smith for use by the armed services, and was classified Restricted and thus had limited circulation. The Introduction stated, in part:

The purpose of this Handbook is to show the conditions under which the different radio frequencies are usable in actual practice. The relations among frequency, distance, time, and location of transmission path, are complicated, but it has been possible to reduce the principal facts to a set of graphs presented in this Handbook. The data given herein are for winter time only (November through February, 1941-1942); it is expected to issue supplements giving the data for other seasons. . . .

These two printed items were the predecessors of the monthly reports with world charts for predictions that first appeared in the March 1942 report on "High Frequency Radio Transmission Conditions," and at a later period appeared under the name of "Radio Propagation Conditions," and still later as the IRPL-D series, "Basic Radio Propagation Predictions."

entitled Supplement to Radio Transmission Handbook, and was applicable to the period of May through August of 1942.<sup>3</sup>

By making use of additional ionospheric information, gathered from other laboratories, the Radio Section was able to construct charts that provided, for the first time, the prediction of maximum usable frequencies for sky-wave transmission and different latitudes over the world's surface. The method would be refined at a later time when data from many more stations became available and provided for greater reliability in the prediction service. Also developed during this period was the prediction for distances greater than 2500 miles by the "two-control-point" method.<sup>4</sup>

It was during this period of the early part of the war that the Radio Section had access to ionospheric observations from but six locations in the world: Washington, D.C. (from the section's own observations); Slough, England; Huancayo, Peru; Watheroo and Sydney, Australia; and Christchurch, New Zealand; and information on a regular schedule from but three of these locations. However, exigencies of war on a worldwide scale would soon provide observations from many parts of the world.

The second negotiating event of January 1941 was the initiation of a series of contracts with the Radio Section by the NDRC relating to direction-finder projects. Because of the German submarine menace early in World War II, the importance of the use of radio-direction finders as a method of detecting and locating surfacing submarines soon became evident. Yet there remained unsolved problems associated for many years with the use of direction finders. Among these problems was the effect upon the accuracy of direction bearings by waves reflected from the ionosphere. The several projects were for study of the correlation of direction-finder errors with ionospheric conditions.<sup>5</sup> Initial plans called for systematic observations in the range of 2 to 30 MHz. Studies were begun in July 1941, with the cooperation of the Navy and the Federal Communications Commission in furnishing data taken at infrequent intervals at their direction-finder stations. As the projects progressed other stations on the North American Continent were added to the program.<sup>6</sup>

## THE INTERSERVICE RADIO PROPAGATION LABORATORY (IRPL)<sup>7</sup>

### 1. An "air disaster" in the European theatre of war

This caption or phrase can be found in a number of writings referring to the World War II period of NBS, although its actuality as a single and large-scale "event" leaves room for

(Continued)

Note: The "High Frequency Radio Transmission Conditions" had been published in one form or another in the *Proc. IRE*, beginning with the September 1937 issue. The series was discontinued after the December 1941 issue due to the U.S. entrance into World War II (see ch. VII, pp. 236-237). However, the information continued to be available as mimeograph copies to groups related to defense of the country.

In addition to explanatory material on radio transmission by the ionosphere, the Handbook contained 62 figures (plus additional figures in the Supplement) giving the maximum usable frequency, lowest useful high frequency, distance range, and skip distance, for various radiated powers, time of day, azimuths, and places on the Earth. Data were included so that approximate calculations could be made for any transmission path anywhere on the Earth.

<sup>3</sup> A bound copy of these two printed items is in the Department of Commerce Library, Boulder, Colo.

<sup>4</sup> Although the method of propagation was not well understood, these predictions were based upon a reflection point at a distance of 1250 miles from each station (based upon the maximum usable frequency for 2500 miles), plus the path at various distances between the two points that extended the total distance beyond 2500 miles.

<sup>5</sup> Other direction-finder projects on contract by the NDRC with the Radio Section are noted in chapter IX, pp. 317-319.

<sup>6</sup> Added to the project were direction-finder stations at Stanford University, University of Puerto Rico, Harvard University, and the Carnegie Institution laboratory at College, Alaska.

<sup>7</sup> Information on the IRPL was found among the following sources:

1. Documents deposited at National Archives (NN365-90, Box 36).
2. Reports and minutes of sessions and committee meetings of International Radio Propagation Conference at NBS, April 17-May 5, 1944. Copy in Department of Commerce Library, Boulder, Colo., catalog number QC661, U51.
3. Document, dated April 30, 1953, placed in cornerstone of Radio Building, Boulder Laboratories, entitled "Radio Research and the Central Radio Propagation Laboratory." Copy in Department of Commerce Library, Boulder, Colo., catalog number QC661, U5.
4. IRPL Radio Propagation Handbook (Part 1), Nov. 1943.

doubt.<sup>8,9</sup> Nevertheless, the seriousness of such possible incidents had a considerable bearing upon the establishing of the Interservice Radio Propagation Laboratory (IRPL) at the National Bureau of Standards.

## 2. The predecessor to the IRPL

Early in 1941 the British government (the Admiralty) set up the Inter-Services Ionosphere Bureau (ISIB) at the Great Baddow Research Laboratories, near Chelmsford, Essex, England to improve direction-finder operational techniques and to improve military communications by predicted optimum frequencies. From the beginning, the Bureau was a successful operation toward improvement of radio operations by the military.<sup>10,11</sup>

## 3. Instituting the Interservice Radio Propagation Laboratory

The success of the ISIB in England was expounded by a mission to the United States from the United Kingdom in the spring of 1942. Growing from this mission, steps were taken by order of the U.S. Joint Chiefs of Staff by direction of the Wave Propagation Committee of the U.S. Joint Communications Board to establish a radio propagation laboratory in the National Bureau of Standards that would serve as a centralizing agency for the analysis of radio transmission data and the issuance of predictions.<sup>12,13</sup> This agency,

(Continued)

5. Annual Report of Section 3 (Regular Propagation Measurements Section, organized as a section May 1, 1946), Division 14, 1946.
6. Lyman J. Briggs, NBS War Research—The National Bureau of Standards in World War II, issued Sept. 1949 (no NBS publication classification).
7. Newbern Smith and Richard Silberstein, "Radio propagation work at the National Bureau of Standards." *QST*, Vol. 30, No. 5, May 1946, pp. 45-50.
8. J. H. Dellinger and Newbern Smith, "Development in radio sky-wave propagation research and applications during the war," *Proc. IRE*, Vol. 36, No. 2, Feb. 1948, pp. 258-266.

<sup>8</sup>In essence, the accounts have stated that early in the war a British bombing squadron on the return from a mission over Germany encountered poor visibility. A magnetic storm disturbed their radio communications and they lost their bearings. Some planes landed safely at various locations in England. Others became lost and were never heard from again (one account stated "the loss of a flight of bombers over the North Sea because of radio failure"; another account stated "that on account of uncertainties of radio conditions and weather the British lost 46 bombers in one night over Berlin").

<sup>9</sup>It was the author's (WFS) curiosity about this "event" that led to some unexpected findings. Scanning several books on the operations of the British R.A.F. (Royal Air Force) during World War II yielded nothing by way of further information.

Inquiring of the Library of The Royal Air Force Museum, London, and of the Ministry of Defense, London, yielded no further information on this air disaster. At the suggestion of Newbern Smith (formerly chief of CRPL, now of Environmental Data Service, Department of Commerce, Boulder), the author corresponded with A. M. Humby of Amersham (Buckinghamshire), England. Humby was Officer-in-Charge of the British Inter-Services Ionosphere Bureau (ISIB) during World War II. Humby had visited the IRPL during the War. In his letter of January 8, 1974, Mr. Humby stated that it was his opinion, and of several others he conferred with, that there was no particular, large-scale "air disaster" in the Royal Air Force during the early part of the war due to magnetic storms that was associated with the inability of bombing squadrons to have radio communications at the required low frequencies.

<sup>10</sup>A somewhat similar organization, known as the Australian Radio Propagation Committee (ARPC), was set up in Australia to furnish radio propagation data and a prediction service for the Southwest Pacific area.

<sup>11</sup>Germany had a somewhat similar organization known as Zentralstelle für Funkberatung. At the end of the war it was located at the town of Ried in northwest Austria, east of Munich, Germany.

<sup>12</sup>Shortly after the Japanese attack on Pearl Harbor the American and British military leaders formed the Combined Chiefs of Staff, consisting of the U.S. Joint Chiefs of Staff and the British Chiefs of Staff as the body to assist and advise on the direction and conduct of the war. Organized within the Combined Chiefs of Staff was the Washington Communications Board, later named the Combined Communications Board, and served by a Wave Propagation Committee (F. G. Kear, formerly of the Radio Section, became chairman). Organized within the Joint Chiefs of Staff was the U.S. Joint Communications Board, also served by a Wave Propagation Committee. The IRPL operated as a U.S. Government organization, yet had close relationship with the Combined Communications Board and its Wave Propagation Committee.

<sup>13</sup>On May 2, 1942, Dellinger sent a memo (classified Confidential) to Briggs, director of NBS, via Crittenden, chief of the Electricity Division, which opened,

I have been asked to discuss some plans with Navy representatives which will probably lead to definite proposals in a couple of weeks involving considerable expansion of the work on radio wave transmission.

organized within the Bureau's Radio Section by the summer of 1942, was named the Interservice Radio Propagation Laboratory (IRPL). This group (or agency) within the Radio Section came under the general supervision of Dellinger as chief, and Newbern Smith as assistant chief, holding the same positions in the Radio Section.

The IRPL, although operating under the planning and direction of the Wave Propagation Committee, guided its own course of action during the 4 years of its existence. The operation was patterned much after that of the British ISIB (see "functions" in footnote 13). During the formative stage, the NDRC expressed the opinion that, although it had

(Continued)

After explaining the operations of the British ISIB, Dellinger stated, in part:

The American Navy now desires to establish a service similar to that provided by the British Ionosphere Bureau. They recognize that it is mainly a matter of the very kind of work we have been doing on the ionosphere at the N.B.S., and have indicated that they desire us to do a large share of the planning and, if we are willing, the operation, of the service.

The plans are being developed with the cooperation of British Navy representatives. I was asked to attend a conference on the matter at the Navy Dept. on April 13. The principal business was to determine locations throughout the world for 13 additional ionosphere stations for which the British have prepared equipment. Complete interchange of data between all British, Canadian, and American stations is to be arranged. The Russians are also to be invited into the arrangement; they have four ionosphere stations.

In a memo (classified Confidential) to Briggs, dated May 22, 1942, Dellinger wrote on the progress that had been made since his memo of May 2, and stated that he had presided at a planning meeting on May 21, attended by Navy and Army representatives and by Newbern Smith of the Radio Section. Of particular interest to NBS, he stated in the memo:

The task is a large one. For its initial stages we shall have to double our present radio propagation group of 25 persons; I expect the Navy will transfer \$100,000 for this initial stage. Within a year the project will probably grow to twice that; it certainly will if we succeed in attaining the ultimate goal of providing data hourly instead of daily. . . .

The initial problem will be to find and train personnel. . . .

The work will be given general direction by an Interservice Propagation Committee, of which I have been asked to serve as Chairman. The Committee will have its first meeting June 5. It has been proposed that our laboratory be called the Central Radio Propagation Laboratory.

Author's (WFS) note: Not until 1946 was the group known by this name when the laboratory became a division within NBS.

Minutes of the planning meeting of May 21 to organize an Interservice Radio Propagation Committee (IRPC) show that a plan of action on how the new laboratory would function was well in hand. The plan was based largely on "Notes of Cosmic Data Project" that explained the British operation and suggested features of a U.S. operation. Growing out of the committee's actions was a statement of the functions of what came to be called the Interservice Radio Propagation Laboratory. Some of the functions were direct carryovers of the British operation. These functions were:

1. Centralize data on radio propagation and related effects, from all available sources. Keep continuous current record of ionosphere layer heights, critical frequencies, maximum useable frequencies, skip distances, absorption, ionospheric storminess, fadeouts, solar conditions, etc.
2. Prepare weekly or daily summaries and predictions of ranges of useful frequencies and distances of transmission, for all parts of the world and all hours of the day.
3. Perform such experimental and research work as necessary to effectively supplement existing sources of data.
4. Furnish information as above to the armed forces, and provide instant information of the same type on call.
5. Prepare and circulate each month general predictions in such form and for such times in the future as IRPL determines.
6. Cooperate with British Inter-Services Ionosphere Bureau.
7. Train personnel of the armed forces in related work, especially operation of ionosphere stations.

Author's (WFS) notes: Information contained in this footnote taken from NN365-90, Box 36, history of the IRPL. Copies of some of this material are also contained in the NBS Historical File (NBS Gaithersburg) and show that Dellinger once marked the material "Official Genesis of the Laboratory" (the IRPL).

During the several years of operation, the functions of the IRPL changed to some extent to meet new situations, such as the establishment and operation of the field station at Sterling, Va.

supported the Radio Section in the earlier research on direction-finder errors, its funds were not available to the section (wave propagation group) for the planned program of the IRPL which was considered to be purely operational. Initially, the IRPL was supported by Navy and NBS funding, and then assisted by the Army. After 1943 support for the operation was continued wholly by the Army and Navy. In the early planning much importance was given to that of sources of ionospheric data, both from existing stations and projected new stations. In the summer of 1942 ionospheric data were available from 12 sources; with 16 new stations projected.<sup>14</sup> The Radio Section and its IRPL had embarked on a bold program.

#### 4. The IRPL in operation

Beginning in the summer of 1942 and continuing for the next 4 years, the IRPL developed a fivefold program in the prediction of useful radio frequencies for sky-wave transmission over any path across any part of the world, the prediction services being available to the Allied Armed Forces.

##### a) IONOSPHERIC DATA ON A WORLDWIDE BASIS

From a modest beginning of obtaining basic ionospheric data on a regular schedule from three stations, by the end of the war data were received regularly from 44 stations

<sup>14</sup>Of the existing stations, five were in the United States, one in Canada, three in Great Britain, one in Peru, and two in Australia. For the projected new stations, four would be operated by the United States in locations outside of the continental United States, one by Russia, one by Canada, one by Australia, and nine by the British Admiralty in scattered locations over the globe.

In addition, planning was for that of obtaining distance range and absorption data from 8 field-intensity recording stations, from about 100 radio amateurs in the United States. and from commercial radio traffic stations. Solar, geomagnetic, and auroral data would be obtained from a number of observatories scattered around the world.

The five stations in the United States that furnished ionospheric data and field-intensity observations were:

Washington, D.C. (Meadows, Md.), NBS  
Fairbanks, Alaska, Carnegie Institution of Washington  
San Francisco, Calif., Stanford University  
Baton Rouge, La., Louisiana State University  
Puerto Rico, University of Puerto Rico

The four stations other than at Washington, D.C. had been operated on contract with NBS for observations of the ionosphere in connection with the direction-finder error program conducted by the Radio Section for the NDRC during the earlier period of World War II.



*Road construction for development of a new NBS field station at Sterling, Va., northwest of Washington, D.C. (34 miles by automobile from Bureau grounds). Construction started during February 1943 and completed by June. NBS was forced to surrender the site of the Meadows, (Md.) field station during World War II for development of the Andrews Air Force Base. The U.S. Army Engineers procured 450 acres of flat farming land in Loudoun County, Va., as a new site for the Radio Section's propagation research that had been conducted at the Meadows station for a number of years.*

*In its move to Boulder, Colo., the CRPL slowly abandoned activities at the Sterling field station and, again, aviation took over an NBS field facility, this time the site to become the Dulles International Airport.*



*An official visit to the new field station at Sterling, Va. on May 14, 1943 (May can be chilly in the Washington area). Standing at the entrance to the Administration Building, left to right, are:*

*Col. C. Renshaw, district engineer, Office of U.S. Army Engineers*

*E. C. Crittenden, chief, Electricity Division, NBS*

*Dr. L. J. Briggs, director, NBS*

*Major R. R. Furman, contracting officer in charge, Office of U.S. Army Engineers*

*R. D. Porter, project manager for W. B. Avery, contractor*

*Dr. J. H. Dellinger, chief, Radio Section, NBS*

*S. E. Reymer, radio engineer, Radio Section, NBS*

*Roads, buildings, electric power facilities at the Sterling field station were constructed under the direction of the U.S. Army Engineers.*

scattered over the world.<sup>15</sup> Data on the ionosphere, available for the first time for worldwide coverage, yielded added information on variations of ionosphere characteristics with time of day and year, sunspot numbers, latitude, and with the "longitude effect."<sup>16</sup>

With new understanding of the ionosphere it became possible to predict, with considerable accuracy, its characteristics as a radio transmission medium several months in advance and to prepare world charts on transmission performance. The world charts first appeared in the April 1942 issue of the monthly reports (restricted circulation) prepared by the Radio Section, entitled "High-Frequency Radio Transmission Conditions." However, the data were based upon observations taken in North America only. Beginning September 1, 1944, the radio predictions were issued in reports of the IRPL-D series, titled "Basic Radio

<sup>15</sup>The three stations were among the 12 noted in footnote 14, namely: the NBS field station at Meadows, Md. (in 1943 the station was moved to Sterling, Va.); and stations of the Carnegie Institution of Washington (Department of Terrestrial Magnetism) at Huancayo, Peru and at Watheroo (near Perth), Western Australia. By June 30, 1946, under CRPL operation, the number had grown to 55 locations.

<sup>16</sup>The so-called "longitude effect" is actually a dependency of the ionosphere, to a great extent, upon the geomagnetic latitude. With the newly gained understanding of this effect, the prediction charts were constructed with three longitude zones for world maps, called East (E), West (W), and Intermediate (I), zones.

Author's (WFS) note: Of historical interest on prior knowledge of the "longitude effect" by the Japanese, see account in "Radio wave propagation during World War II," Kenneth A. Norton, *Proc. IRE*, May 1962, pp. 701-702.

Propagation Predictions.”<sup>17</sup> Observations of the ionosphere were now available from many parts of the world.

#### b) IMPROVING THE PREDICTION METHOD OF MAXIMUM USABLE FREQUENCY

Although the method of predicting sky-wave transmission was being developed effectively by the Radio Section over a period of years beginning in 1936, there was need for greater reliability and more rapid preparation of the predictions of the maximum usable frequency brought on by exigencies of the war. This was accomplished by development of the “two-control point” method for predictions at distances greater than 2500 miles.<sup>18</sup> In addition, overall improvement of the prediction method was attained by taking into account the propagation effects of the “sporadic-E” layer.<sup>19</sup>

#### c) SUCCESS IN THE CALCULATION OF FIELD INTENSITY

In developing an improved and more reliable prediction service there was much need for the prediction of distance ranges and the lowest useful high frequency (see footnote 18). This need led to that of calculating sky-wave field intensities. The observation of sky-wave field intensity had been an investigative program of the Radio Section for a number of years (see ch. VII). With the many new ionospheric stations, advantage was taken of this situation by outfitting them with field-intensity recorders which permitted observations to be taken at a number of locations for various transmission paths. Concurrently, new theoretical studies of ionospheric absorption were undertaken that would hopefully yield the calculation of sky-wave field intensity. The project was marked by success, the absorption values of transmission paths being calculated from observed quantities.

#### d) SOLVING THE PROBLEM OF MINIMUM FIELD INTENSITY

For successful radio-wave communication, the signal-to-noise ratio must be greater than or above a certain value (or threshold) for the received signal, and depends upon the type of communication service involved. Thus, for a successful prediction service, it was necessary for the IRPL to be able to determine the minimum field intensity required for satisfactory communication in overcoming noise (at sky-wave frequencies the principal noise is

---

<sup>17</sup> Tables, charts, and nomograms of the IRPL-D series were an outgrowth of the earlier charts, “Radio Propagation Conditions,” produced and first issued by the Radio Section on April 6, 1942 (the early issues were titled, “High-Frequency Radio Transmission Conditions”). Beginning with the February 1942 issue, the monthly reports became a supplement to the “U.S. National Bureau of Standards Radio Transmission Handbook, 1000-30,000 KC.” Primarily, these reports contained information on maximum usable frequencies and skip distances for sky-wave transmission, observed for the previous month and predicted for several months in advance. Earlier, the Radio Section had been publishing graphs in the *Proc. IRE* and *QST* for predictions and observed conditions of the ionosphere, the reports dating back to September 1937 (see ch. VII, pp. 236-237).

The IRPL-D series (restricted circulation) continued through June 1946 (when the IRPL operation was terminated) and then became the *CRPL-D* series, beginning with the July 1, 1946, issue. This series continued until December 1962, with the *CRPL-D* 220 issue terminating the long series.

Beginning with the January 1963 issue, the series was renamed “Central Radio Propagation Laboratory Ionospheric Predictions.” In 1965, upon the formation of ESSA (Environmental Science Services Administration) with its several Institutes, the prediction series was named “*Institute for Telecommunication Sciences and Aeronomy Ionospheric Predictions*,” beginning with the December 1965 issue. Again, upon further Department of Commerce reorganization, the name was changed to “Office of Telecommunications Ionospheric Predictions,” beginning with the November 1970 issue. Publication ceased with the October 1971 issue.

<sup>18</sup> The prediction method had its basis in the development of the “transmission curve” method by Newbern Smith (see ch. VII, p. 237). From observed critical frequencies, the maximum usable frequencies could be obtained, as well as predicted in advance. However, for distances greater than 2500 miles the “two-control point” method (see p. 409, this chapter) was devised to overcome the inadequacies of the more simple method used for shorter distances.

In the prediction of sky-wave (or ionospheric) radio propagation (usually considered to be in the frequency range of 0.5 to 30 MHz) the transmission over a fixed distance is confined between the two frequency limits of: the “maximum usable frequency” and the “lowest useful high frequency.” At a fixed frequency, sky-wave transmission is confined between two distance limits of: the “skip distance” and the “distance range.” The frequency and distance limits depend upon a number of factors including time of day, the season, sunspot cycle (numbers), and location of transmission path over the Earth’s surface.

<sup>19</sup> Previously, predictions were based upon the fairly well understood propagation by the normal F<sub>2</sub>-layer. The greater abundance of observations that became available from the war emergency led to further study of the vagaries of sky-wave transmission, and it was found that variations of any specific “normal” sky-wave transmission were caused largely by the sporadic E layer.

atmospheric noise; often called "static"). Again, a satisfactory solution to the problem was forthcoming, and a nomogram procedure was developed whereby the lowest useful high frequency could be determined for satisfactory communication at different levels (grades) of atmospheric noise.<sup>20</sup>

#### e) FORECASTING IONOSPHERE STORMS

Because radio communications in the North Atlantic are subject to disruption by ionosphere storms, and more so than in many other parts of the world, it became very desirable to establish a warning service for such interruptions. The North Atlantic had become an important theater of war operations that called for extensive radio communication and navigation. In collaboration with the Carnegie Institution of Washington (Department of Terrestrial Magnetism) a weekly forecast service for ionospheric disturbances was set up, based upon observations of the Sun.

A more effective warning service was established by observing the behavior of radio direction-finder bearings (as affected by ionospheric reflections). An advantage was gained due to the fact that very specific ionospheric disturbances (and disruptions to communications) could be forecast a few hours in advance. This short-time warning service became available to the public after World War II by transmissions from WWV and later from WWVH (see ch. VIII, p. 473 and p. 475).

#### f) "PUBLICATIONS" IN LIMITED CIRCULATION

War conditions stifled publication by the Radio Section to but several items during the period of 1942-1945, and these had but incidental value to the war effort. The last published item on prediction of propagation, after the Pearl Harbor attack, was in the January 1942 issue of *QST* as an NBS item entitled, "Predicted distance ranges for amateur radio communication in January, February, March 1942."<sup>21,22</sup> The Radio Section had prepared these prediction reports on a regular schedule for publication in *QST* since September 1940 (see ch. VII, p. 234). Because these prediction reports could have been useful to the enemy, it was necessary to cease their publication until the cessation of hostilities.

However, during the war period printed material in considerable quantity was produced by the IRPL for limited distribution (with Restricted classification), primarily to the armed services. Of much importance was the handbook, *IRPL Radio Propagation Handbook*, issued November 15, 1943.<sup>23</sup>

---

<sup>20</sup> With reliable methods of calculating the maximum usable frequency and the lowest useful high frequency, the IRPL could provide a prediction service that prescribed a frequency band within which satisfactory communication could be obtained over a given transmission path under a given set of conditions of time of day, season, and other factors.

<sup>21</sup> The last publication after Pearl Harbor on propagation was a Letter to the Editor in the March 1942 issue of *Terrestrial Magnetism and Atmospheric Electricity*, entitled "Critical frequencies and virtual heights of the ionosphere observed by the National Bureau of Standards at Washington, D.C., October to December 1941." This quarterly feature had been contributed to the periodical for several years.

<sup>22</sup> The first publication by the Radio Section (IRPL) after World War II was in the April 1946 issue of *QST*, written by T. N. Gautier, Jr., and entitled "The NBS-ARRL radio observing projects, and the WWV observing project." Gautier reported on three Confidential projects in cooperation with the American Radio Relay League, the projects being a wartime operation by the IRPL to obtain basic radio propagation data that were unavailable by any other method. The operation was a successful venture in the war effort of the IRPL.

<sup>23</sup> The Introduction stated, in part:

The purpose of this Handbook is to provide a radio operator or a radio communications officer with a working knowledge of the principles underlying the propagation of radio waves from a transmitting antenna to a receiving antenna. . . . The purpose is also to give an outline of methods for calculating the field intensity to be expected, at any place in the world, produced by a transmitter in any other part of the world, and for evaluating the results in terms of whether the received intensity is great enough to be useful.

Part 1 of the Handbook was completed; other parts had been planned but were not written. However, some of the planned material appeared in a 1948 publication by the CRPL, entitled "Ionospheric Radio Propagation," (see p. 440).

In January 1944 the Handbook became the principal textbook for a 2-week training course given at NBS to a group of Army, Army Air Corps and Navy officers and enlisted personnel, along with a few civilians. Members of the IRPL staff and others working on radio propagation conducted the 25 lectures and the problem sessions.



Three supplements, issued on a monthly schedule, followed the Handbook. Of these, the IRPL-D series on "Basic Radio Propagation Predictions" (predictions for 3 months in advance) was of much importance for radio communication operations of the armed services.<sup>24</sup>

**g) AN "INTERNATIONAL" RADIO PROPAGATION CONFERENCE**

An international radio propagation conference for "Allied Nations" only was held on the Bureau grounds during the period of April 17 through May 5, 1944. Invited to the conference were 88 representatives of armed services and propagation laboratories of Australia, Canada, Great Britain, New Zealand, and the United States (see ch. XVII, p. 663).<sup>25</sup> Of the many recommendations that came from this conference was the first set of international definitions of symbols and terminology for ionospheric use.

**h) RESEARCH DURING A WAR PERIOD**

The IRPL was primarily an operational organization for analysis of radio transmission data and issuance of predictions to the armed services. Its operation occupied the time and talents of a very large segment of the Radio Section personnel.<sup>26</sup> Yet the Radio Section effectively continued its radio propagation research.

Two main areas of propagation research were carried into, and continued during, the war period, namely: (1) radio wave intensity observations, and (2) study of ionospheric phenomena. Continuous or intermittent recordings of signal intensity were made throughout the war period on 15 or more transmitting stations at distances ranging from 25 (WWV) to 8400 km, and at frequencies from 600 to nearly 20,000 kHz. Recordings were made at the Beltsville and Meadows field stations, and later at the Sterling station. Scaling of the field-intensity records yielded absorption values of the ionosphere under various conditions. Also observed, by vertical- and oblique-incidence methods, were layer heights, critical frequencies, maximum usable frequencies, diurnal and seasonal variations, and trend of the sunspot cycle (the minimum of the sunspot cycle was observed early in 1944).

Spectacular ionosphere storms were observed by Radio Section personnel on two occasions during the war period, on September 18, 1941, and again, beginning on December 16, 1944.<sup>27</sup>

<sup>24</sup>The other two monthly supplements were:

1. IRPL-E series of 1-month predictions.
2. IRPL-F series, Part A—Ionospheric Data, Part B—Solar Geophysical Data, "to keep research workers abreast of the major particulars of solar activity and the associated ionospheric radio propagation and other geophysical effects." This series that began September 1944 was published by the CRPL until October 1965.

Other publications by the IRPL included:

1. IRPL-A series, Recommended Frequency Bands for Ships and Aircraft in the Atlantic and Pacific.
2. IRPL-B series, Recommended Frequency Bands for Submarines in the Pacific.
3. IRPL-H series, Frequency Guide for Operation Personnel.
4. IRPL-J series, semi-weekly, later weekly radio propagation forecasts.
5. IRPL-K series, Best Radio Frequencies for Aircraft and Ground Stations in the Atlantic.
6. IRPL-M series, Frequency Guide.
7. IRPL-R series, A series of unscheduled reports with useful information to scientists working in field of radio propagation.

<sup>25</sup>"The purpose of the Conference was to determine ways and means of increasing the usefulness of radio propagation information for the Services. . . ."

(Taken from report of the International Radio Propagation Conference, held under auspices of the Wave Propagation Committee, Combined Communications Board.)

<sup>26</sup>Prior to the IRPL, before 1942, only five or six of the Radio Section staff were working full time on propagation research projects. Then, within a short time, nearly 50 persons were engaged in the IRPL operation and, by 1945, the number had increased to 80 (the total number in the Radio Section reached 135 in 1945).

<sup>27</sup>In the case of the September 1941 storm, no vivid auroral display of comparable magnitude had previously been observed in Washington by the Radio Section since the beginning of the ionosphere studies in 1930 (see ch. VII, pp. 227-229). (Alvin G. McNish, who became chief of the Basic Ionospheric Research Section of the CRPL in August 1946, wrote at considerable length on this storm in the December 1941 issue of *Terrestrial Magnetism and Atmospheric Electricity*, while a staff member of the Department of Terrestrial Magnetism, Carnegie Institution of Washington.) The second ionosphere storm, beginning on December 16, 1944, although not as severe as the one in 1941, was characterized by disturbances on several of the preceding days, as noted by observations at the Sterling station.

#### i) LABORATORIES ASSOCIATED WITH THE IRPL OPERATION

Associated directly with the operations of the IRPL in order to obtain propagation data on a broad geographical scale were the laboratories of Stanford University, Palo Alto, Calif.; Louisiana State University, Baton Rouge, La.; University of Puerto Rico, San Juan, P.R.; Harvard University and Massachusetts Institute of Technology, both at Cambridge, Mass. Also, valuable aid was received from the Department of Terrestrial Magnetism of the Carnegie Institution of Washington which maintained observatories at various locations.

#### j) THOSE WHO DIRECTED, AND WHO WERE IMPORTANT TO OPERATION OF THE IRPL

Of the more than 80 people who staffed the IRPL, recognition should be given to those who contributed largely to its success as a wartime agency for basic aid to radio communication. The very large contingent of workers of the Radio Section that formed the CRPL was under the direction of Dellinger as chief, and Newbern Smith as assistant chief. Each of these men made individual contributions in basic ideas to the development of methods of forecasting conditions of the ionosphere as a medium for radio communication over long distances. Another member of the staff that gave significant support in this area was Theodore R. Gilliland who had pioneered much of the early investigations of the ionosphere by the Radio Section (see ch. VII).

Assisting in the development work were: Thomas N. Gautier, Frederick R. Gracely, J. Virginia Lincoln, Sidney M. Ostrow, William E. Owen, Marcella L. Phillips, Minadora PoKempner, and Richard Silberstein. Others who were important to the operation included: Reginald W. Bours, Mary B. Harrington, Lawrence Heilprin, Harren A. Miklofsky, Ernest A. Pizzurro, Stephen E. Reymer, and Edna L. Shultz. And one cannot overlook the "indispensable" services to the IRPL of "ANKie" (Adeline N. Kincheloe), the section's secretary.<sup>28</sup>

#### k) "CONVERSION OF IRPL PROJECTS FROM WAR TO PEACE"

Such was the heading of a portion of the November 1945 Monthly Report of the Radio Section. The October Report had stated: "With the recent declassification of radio wave propagation data it is now possible to include in this report the activities of another large group in the Radio Section"—namely, the IRPL. The November Report listed in considerable detail the conversion of IRPL projects from wartime procedure to that for peacetime.<sup>29</sup>

---

<sup>28</sup> This list of personnel who made valuable contributions to the success of the IRPL was evaluated largely by Newbern Smith in answer to the author's (WFS) memo of February 7, 1977.

<sup>29</sup> In a self-evaluation the Radio Section stated:

Development of the procedure for these predictions (of useful radio propagation frequencies) was such that these were and continued to be probably the most precise predictions ever made of any geophysical quantity.

Also, in commenting upon and forecasting on the future of research in radio propagation, the Radio Section stated:

Time allocated to their type of work during wartime was only that where the result could be rapidly obtained and put into almost immediate operational use. A tremendous amount of rough analysis went into the production of the predictions of useful radio frequencies which were issued. Finer analysis of the trends exhibited by basic ionospheric data, of which the laboratory possessed the greatest quantity ever assembled in one place, correlation of these with other physical phenomena, and improvements of the techniques of prediction and of solution of radio propagation problems were expected to constitute one of the greatest peace-time projects for the laboratory.

In retrospect, one might judge the above statement as a fairly modest one in evaluating the IRPL and in predicting its future as the Central Radio Propagation Laboratory which was to follow.

# THE CENTRAL RADIO PROPAGATION LABORATORY

## 1. Extending the need for a centralizing laboratory

### a) THE NEED IS FORESEEN

Shortly after V-E Day (May 8, 1945) in a memorandum, dated 24 May 1945, to the director of NBS, the Joint Communications Board of the U.S. Joint Chiefs of Staff (in a statement prepared by the Wave Propagation Committee) referred to the past, present, and FY 1946 financing of the IRPL. Taking a look into the future of the IRPL after the cessation of hostilities, the Joint Communications Board requested that the work of the IRPL be supported in FY 1947 by direct Congressional appropriation to the NBS, the financing to be at the FY 1945 rate of \$380,000 per annum.<sup>30</sup> The viewpoint of the Board was:

The success of the work of the IRPL in this war has demonstrated that its continuation will be indispensable to the military services as well as to the other government agencies and to civilian communication interests.

Also, the Board suggested that additional funding be provided for six ionospheric observatories that had been supported on contract by military funds. The additional observatories would be operated and maintained by NBS. (NARG 167, NBS Blue Folder Box 24, 674.)

### b) IMPLEMENTING TO FULFILL A NEED

September 2, 1945, was acclaimed as V-J Day and World War II came to an end. The operations of the IRPL continued until the close of FY 1946, after which its functions were absorbed by the Central Radio Propagation Laboratory (Div. 14 of NBS) that had been established 2 months previously.

In November 1945, 2 months after cessation of hostilities, the Army Signal Corps called several meetings for discussion of the future of radio propagation research and a prediction service, particularly in relation to its importance to the Armed Forces.<sup>31</sup> These discussions led to recommending to Secretary of Commerce Wallace, in a letter dated December 26, 1945, that a centralizing laboratory be established in the National Bureau of Standards and be responsible for basic research in radio propagation.<sup>32</sup> Thus the first formal step had been taken to establish the Central Radio Propagation Laboratory (CRPL).

<sup>30</sup> Cost of operating the IRPL had been:

Fiscal Year	
1943	\$165,000
1944	210,000
1945	445,000
1946	420,000*

\*This fiscal information became available after the CRPL was established.

<sup>31</sup> By December 1, 1945, planning had been carried out to the extent that a detailed listing of the many functions of the planned organization became available for study, plus a detailed listing of the many projects that would be initiated or continued from the war period. However, no definite conclusion had been reached on incorporation of the measurement standards programs of the Radio Section into an organization that would be essentially a radio propagation laboratory. Several months passed before the matter was resolved, with the result that the standards programs became a part of the new centralizing laboratory.

<sup>32</sup> The letter of December 26, 1945, signed by G. B. Myers, Secretary, Joint Communications Board of the Joint Chiefs of Staff, to Henry A. Wallace, Secretary of Commerce, stated:

Experience in the war amply demonstrated the importance of radio propagation information to the efficient conduct of military communications and for the efficient use of military electronics devices. It is also recognized that non-military agencies, both Government and private, require radio propagation information for the efficient conduct of their business. Thus, the national security dictates that the military requirements in this field be met, and the public interest dictates the desirability of meeting the non-military requirements for propagation information.

The Joint Communications Board is of the opinion that if basic work common to the several agencies in the radio propagation field is centralized in a laboratory to be established in the National Bureau of Standards the needs of the Army and Navy can be met.

It is recognized that such a central laboratory will not be able to carry out all of the work in the radio propagation field, and that certain work particularly applicable to the Army and Navy and

On January 9, 1946, the Secretary of Commerce sent letters to the Secretary of the Navy and the Secretary of War informing the Departments that he had authorized the director of NBS to proceed toward establishing a centralizing laboratory within the Bureau.<sup>33</sup> The letter stated:

In accordance with informal recommendations made to this Department by representatives of a number of interested agencies, I am asking the Director of the National Bureau of Standards to establish within that Bureau a central radio propagation laboratory. This laboratory will centralize for the nation the basic aspects of research and prediction service in the field of radio propagation.

It is desired that the Department be assisted in the conduct of this laboratory by a Radio Propagation Executive Council which shall guide the activities of the laboratory, including the preparation of the general program of work, establishment of the priority of jobs, and (after this year) preparation of the budget prior to presentation to the Bureau of the Budget. I therefore request you to designate a representative on this Council. (NN 365-90, Box 32.)

Thus, the initial steps had been taken to establish the CRPL as a Government organization. With a dedicated mission, it would have a useful and relatively long life, extending for nearly 20 years to 1965.

During January Dr. Condon, director of NBS, convened a meeting of a group of representatives from other agencies to plan for the centralizing laboratory. At the suggestion of the Joint Communications Board, the Secretary of Commerce invited the agencies to designate representatives to the advisory Radio Propagation Executive Council.<sup>34</sup>

At the Winter IRE Technical Meeting held late in January (1946), Dellinger and N. Smith took the occasion to present a paper on the functions and accomplishments of the IRPL during World War II. It was the first public disclosure before a large group of its operations. However, publication of the paper in the *Proc. IRE* was delayed for 2 years (February 1948) because of the backlog of papers from the war period.

In continuing the gathering of basic ionosphere data from field stations, the IRPL was gradually taking over operation of various stations maintained during the war by the Army and the Navy and by the Department of Terrestrial Magnetism of the Carnegie Institution of Washington. An assist in this direction came from the American Radio Relay League via their periodical *QST*. In the March 1946 issue appeared the headline, "Hams Needed," with

---

(Continued)

to other interested agencies must be done by those agencies. However, it is considered desirable that the central laboratory be made responsible for the basic research in this field common to the several agencies and for radio propagation studies of general applicability.

An executive council, through which various user interests can express their requirements, is regarded as a prime factor in the organization and operation of a central laboratory of this character.

The Joint Communications Board from a military point of view therefore endorses the idea of such a "Radio Propagation Executive Council" to guide the activities of the proposed laboratory, including the preparation of the general program of work, establishment of the priority of jobs, and preparation of the budget prior to presentation to the Bureau of the Budget. It is recommended that the executive council be formed as soon as practicable including representation from the Army and Navy. (NN365-90, Box 32).

<sup>33</sup> Letters were also sent to the Secretary of the Treasury, the chairman of the FCC, and to the chairman of the Radio Technical Planning Board (Haraden Pratt, formerly of the Radio Section, was the chairman of this Board that represented industry).

<sup>34</sup> The need for a "Council" was to insure coordination of the work of the laboratory with the needs of users and with propagation work carried on by other laboratories. The council would guide the new laboratory's establishing priorities of tasks, preparing the annual budget, and reviewing the technical programs.

a short account of the need by the IRPL.<sup>35</sup> Engineers and operators were recruited from among various groups to man the CRPL field stations.

## 2. The CRPL established

In a memorandum to NBS division and section chiefs, dated April 19, 1946, Condon, director of NBS, informed the Bureau that:

Effective May 1, 1946, there is established the Central Radio Propagation Laboratory as Division XIV of the National Bureau of Standards. All activities now conducted by the Radio Section of the Electricity Division are transferred to the new division.

The National Bureau of Standards has been requested by the Joint Communications Board and other interested Government agencies to enlarge this activity. It will be carried on with advice and guidance of the Radio Propagation Executive Council, made up of representatives of interested Government agencies.<sup>36</sup>

On May 1, 1946, the Central Radio Propagation Laboratory came into existence, to remain under this name until abolished as an organization, on October 13, 1965.<sup>37,38</sup> As an

---

<sup>35</sup> The two paragraphs concluding the short account stated:

Men with appropriate engineering and administrative experience are needed immediately to fill the positions of engineer-in-charge and assistant engineer. Other men will be required as station operators. It is expected that personnel will serve a minimum of 18 months on the job at the overseas locations and that living quarters and transportation for families will be available at some locations.

Here is a chance for hams (and others) to get in on some interesting work. For further details write Radio Section, National Bureau of Standards, Washington 25, D.C.

<sup>36</sup> The memorandum stated that the Laboratory would be responsible for all radio work in the Bureau, except the electronic work of the Ordnance Development Division, but that the emphasis would be upon ionospheric research.

Note: At the time, radio research of the troposphere by the Laboratory was in the embryonic state of planning.

<sup>37</sup> An internal document stated:

The mission of the new CRPL was, in summary, to:

(1) Investigate phenomena affecting the propagation of radio waves at all frequencies, including experimental programs of world-wide scope on ionosphere measurements, radio field intensity, ionospheric absorption, radio noise, solar and geophysical effects, the structure of the atmosphere and ionosphere, extra-terrestrial relations and effects, and the influence of the ground and troposphere on radio propagation.

(2) Collect, analyze, and disseminate data and information concerning radio wave propagation and measurements, including predictions of radio propagation conditions and broadcasting of technical services such as standard frequencies and time and also radio disturbance warnings.

(3) Coordinate the centralization of information on basic radio propagation investigations in the United States and perform liaison in this field of work with other countries.

(4) Develop and have custody of the national primary standards of measurement of all electrical quantities at all radio frequencies and perform calibrations in terms of these standards.

Note: From internal document, originally dated July 15, 1950. An April 30, 1953, copy was placed in cornerstone of Radio Building, Boulder Laboratories, entitled, "Radio Research and the Central Radio Propagation Laboratory." Copy in Department of Commerce Library, Boulder, Colo., Catalog number QC661.U5. A July 15, 1950, copy is in the Radio File.

<sup>38</sup> Of interest is the origin of the name, "Central Radio Propagation Laboratory." It first appeared in Dellinger's memorandum to Crittenden and Briggs, dated May 2, 1942, when he first broached the plans of the Navy to set up a centralizing laboratory for a radio propagation prediction service (see footnote 13). At one point in the memo Dellinger stated:

It has been proposed that our laboratory be called the Central Radio Propagation Laboratory.

That laboratory was named the Interservice Radio Propagation Laboratory.

Years later, in the November-December 1962 issue of the Bureau Drawer, (NBS Boulder Laboratories) in a short sketch on the retirement of Walter Chadwick (first chief of the Regular Propagation Measurement Section, and earlier, chairman of the Wave Propagation Committee of the Joint Chiefs of Staff, and now deceased) it stated that: "It was he who suggested the name for the Central Radio Propagation Laboratory."

organizational unit of NBS it was one of the 14 technical divisions and designated as Division XIV (later 14). Although organized into nine sections, one section never became activated under its original name.<sup>39</sup> Dellinger was designated chief, and Newbern Smith as assistant chief, of the CRPL, each having held comparable positions during the 4 years of the IRPL.<sup>40</sup>

On January 14, 1946, a preliminary informal meeting was held at NBS to which were invited representatives of the different agencies that were considered to have a direct interest in the new central laboratory. On the morning of May 1, 1946, the group met at NBS constituting the Radio Propagation Executive Council, as suggested by the Joint Communications Board in its letter of December 26, 1945, to the Secretary of Commerce (see p. 413). The director of NBS, Dr. Condon, presided at this meeting.<sup>41</sup> The Council continued for 42 meetings until its last meeting on March 14, 1955, approximately a year after the major move of the CRPL to Boulder, Colo. A charter had been drawn up for a reorganized group to supersede the Council, to be named the Interdepartment Council on Radio Propagation and Standards. However, this council did not come into existence.

### 3. The CRPL through 20 years of growth

At its first meeting (May 1, 1946) the Executive Council placed on record that, "It is also agreed that every effort should be made to make sure that this laboratory was really heard about, in the technical periodicals and the newspapers." To introduce itself to the NBS the CRPL held an "Open House" late in the afternoon of May 28. On this occasion Bureau personnel were invited to learn more about the radio work of NBS and to view its operations on the Bureau grounds. However, there appears to be little evidence that a large-scale publicity program was carried out in the technical periodicals and newspapers.

As a new medium to inform its fast growing organization, the CRPL initiated an in-house publication, called CRPL News. The 15- to 30-page monthly paper covered personal and technical news of the Washington laboratory, the field stations, and the associated radio propagation laboratories. Beginning in July 1946, the paper was continued until February 1947, after which it was named the Radio Propagation Activity Report. Publication ceased with the February 1949 issue. The paper served to bind the far-flung CRPL into a more closely knit organization.

A year after organization of the CRPL a conference was called to which a number of people in various areas of specialization in radio propagation were invited to the Bureau. The 3-day meeting, called the Conference on Radio Propagation, was held at NBS during May 8-10, 1947, with 145 in attendance. Rather than a meeting for presentation of formal papers, the conference was largely that of informal discussions on the status of work in radio propagation after the close of World War II and a look into the future. Areas of discussion included: ionospheric measurement techniques and problems, ionospheric

---

<sup>39</sup>The organizational structure of the new division is shown in appendix C, p. 761. Changes in the structure to 1965 can be followed, covering pp. 761-773.

Over a period of 9 months, beginning in January 1946, the six propagation sections that were to be established were staffed with section chiefs that had been recruited from outside of NBS. The six chiefs had gained experience in radio propagation in agencies (mostly Government) other than in the wartime centralizing laboratory that had been established at NBS in 1942. Of the six, only two continued with the CRPL at the Boulder Laboratories.

<sup>40</sup>Dellinger and Smith headed the administrative unit of the CRPL which was named the Executive and Administrative Office. Also in this office was S. W. J. Welch, the administrative assistant (later, administrative officer) and Mrs. A. N. Kincheloe, chief clerk.

<sup>41</sup>At this first meeting the purpose of the Council was stated by Condon to be:

that it was intended to bring together in an advisory body the interested agencies, particularly the users of the services of the Central Radio Propagation Laboratory.

Agencies represented on the Council changed from time to time although the Departments of the Army, Navy, and Air Force had continuous representation.

Representatives of the various agencies served as chairmen of the Council over its 9-year life. S. W. J. Welch of the CRPL served as secretary for 5 years, followed by R. C. Peavey, also of the CRPL.

Much of the Council's advisory capacity was engaged in budget studies and recommendations for operation of the CRPL. Many varied views in these areas were exposed over the years by the Council, as well as by the individual representatives. (Minutes of the 42 meetings of the CRPL Executive Council are in a bound volume at Department of Commerce Library, Boulder, Colo., catalog number QC661.U48.)

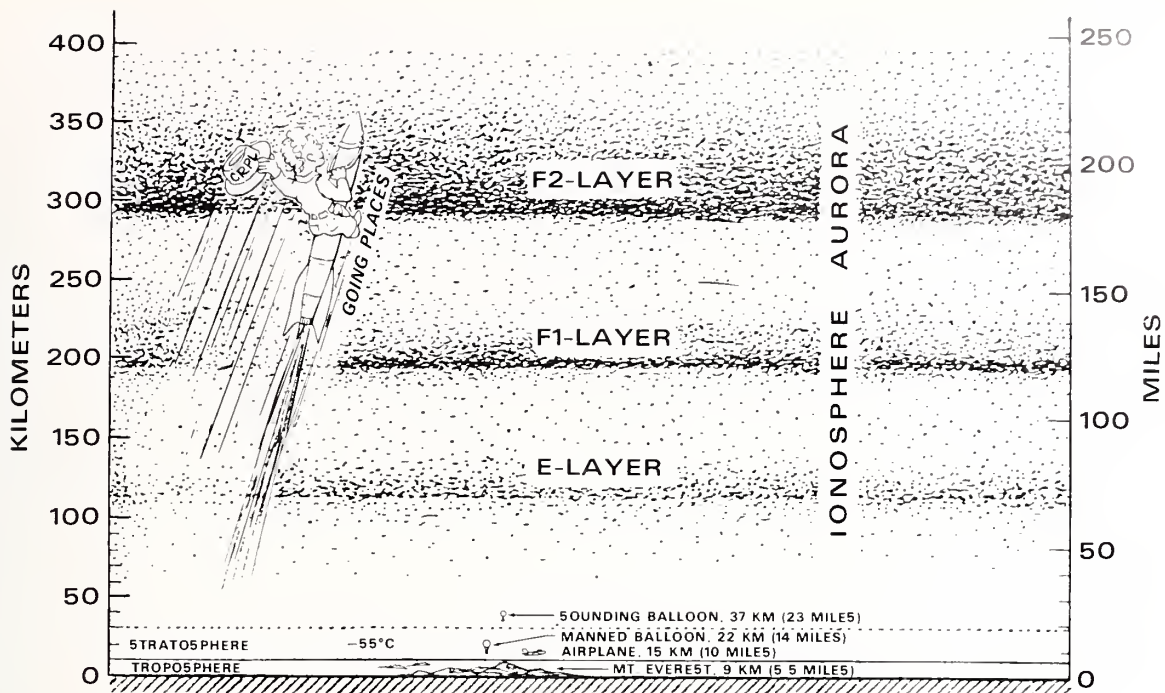

"CRPL—Going Places"

Enthusiasm expressed by the CRPL for its new organization—indicated by this sketch on front cover of announcement for the first Open House, May 28, 1946.

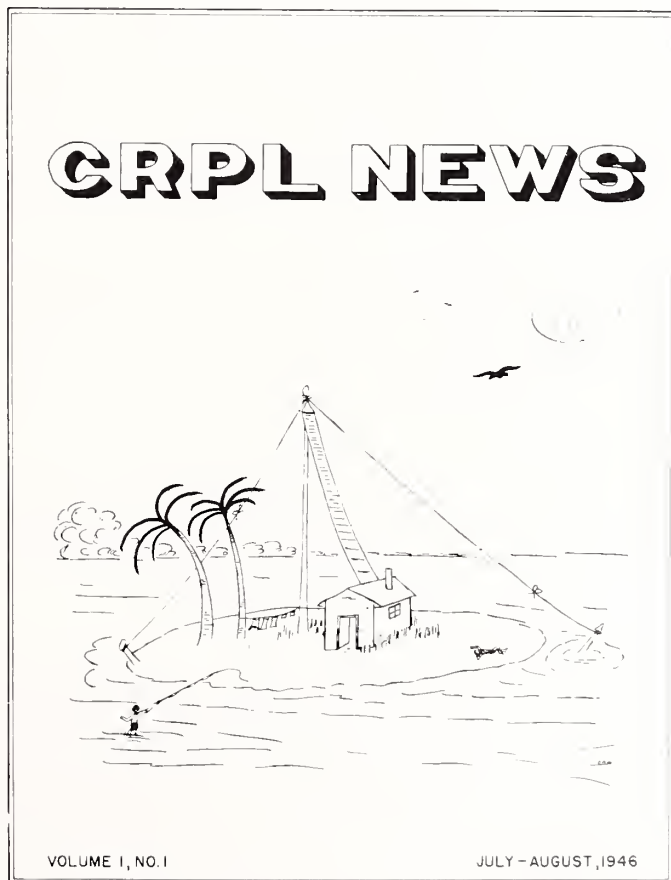

Cover page of the first issue of CRPL NEWS, circulated by the Central Radio Propagation Laboratory from July 1946 to February 1949. A 15-30 page monthly paper that covered personal and technical news of the Washington laboratory, the field stations, and the associated radio propagation laboratories.

propagation analysis and prediction, physics of the ionosphere, effects of the Sun on the ionosphere, cosmic radio noise, and propagation at VHF and higher frequencies.

Several years after the CRPL was established a new perspective of the existing situation was revealed in an internal document that read, in part:<sup>42</sup>

When the Central Radio Propagation Laboratory was established, it was thought that the major planning in the use of radio, and therefore the major uses of radio propagation research and services, would be in the peace-time development of radio and radio systems. The impetus of the research and development during the war had opened up hitherto undreamed-of regions of the radio spectrum, and vast possibilities of development not only in communications but in entertainment and industrial applications. The program of the CRPL was then shaped toward providing the necessary propagation and systems information for such purposes as:—<sup>43</sup>

Then in 1950 the picture again changed, and it was revealed further in the document that:

In the light of the deterioration of the world situation in recent years, and particularly in the last few months (the Korean incident), however, it has become apparent that the radio propagation programs of the CRPL once more must be directed toward the national defense, and is crucial for the needs of the military forces. Besides the general need for propagation information and standards in the planning and design of military radio and radar equipment, the direct applications of the program to national defense and military operations include the following: (twelve areas of research, development, and operations were listed).

In 1953 an evaluation of the CRPL came via the report of the Ad Hoc Committee for Evaluation of the Present Functions and Operations of the National Bureau of Standards, dated October 15, 1953, to the Secretary of Commerce.<sup>44</sup> The evaluation was summarized in the report under the notation of "Findings," which stated:

- A. The Central Radio Propagation Laboratory constitutes one of the finest scientific groups in Government and its operations fall within the legitimate sphere of federal activity.
- B. The work of CRPL is of immense importance to industry. However, it is inadequately supported financially in terms of national effort.
- C. The executive committee to CRPL is not performing the vital constructive function contemplated. This committee should be reconstituted to include technically competent, interested people in positions of responsibility.
- D. The planned move to Boulder is a wise one which will lead to increased efficiency.
- E. The calibration work presently carried on is not sufficient for the country's needs. It should be substantially expanded.<sup>45</sup>

---

<sup>42</sup> See reference in footnote 37.

<sup>43</sup> The "purposes" listed were (stated by short titles): Global aviation, Global or international communications, Television and frequency modulation, Commercial shipping, Atomic energy and nuclear physics, Weather, Industrial uses.

<sup>44</sup> This report, often referred to as the "Kelly Report," was a result of the AD-X2 controversy of the early 1950's (see Cochrane, *Measures for Progress*, pp. 495-497). The Ad Hoc Committee of 10 members was appointed by the National Academy of Sciences, with Dr. Mervin J. Kelly, director of the Bell Telephone Laboratories, as chairman. (Copy in Department of Commerce Library, Boulder Laboratories, catalog number 1.64-2,115 91.)

<sup>45</sup> In view of the "Findings," one might consider in retrospect what resulted from this evaluation. Certainly, the CRPL continued its good work. The CRPL moved to Boulder. There was greatly increased growth after this move. The Radio Propagation Executive Council terminated in 1955 but was not reconstituted. The calibration work was greatly expanded with the establishment of the Electronic Calibration Center in 1958.



At the time the CRPL was established on May 1, 1946, the staff totaled 160 persons. Two months later, on July 1, the new division had increased to 187. Recruitment continued during FY 1947 and by July 1, 1947, the staff totaled 236.

By early spring of 1954 the CRPL staff totaled 328, with 122 at the Boulder Laboratories (including the Facilities Division, but excluding Cryogenic Engineering Laboratory) and 152 remaining in Washington, D.C. A total of 54 was scattered among the 12 field locations, including stations WWV, WWVH, and the Radio Propagation Laboratory at Sterling, Va. By the close of 1954 the last contingents in Washington had "migrated" to Boulder, Colo. (a few remained for a time at Sterling).<sup>46</sup>

As new programs were taken up and other programs extended, the CRPL staff increased year after year until reaching a maximum by 1965 of 800 in the radio divisions (see chart). Radio work at NBS had expanded, indeed, in the 60 years or so from the

<sup>46</sup> Information based upon Telephone Directory of March 1954 which included all field station employees and the Boulder Laboratories employees.

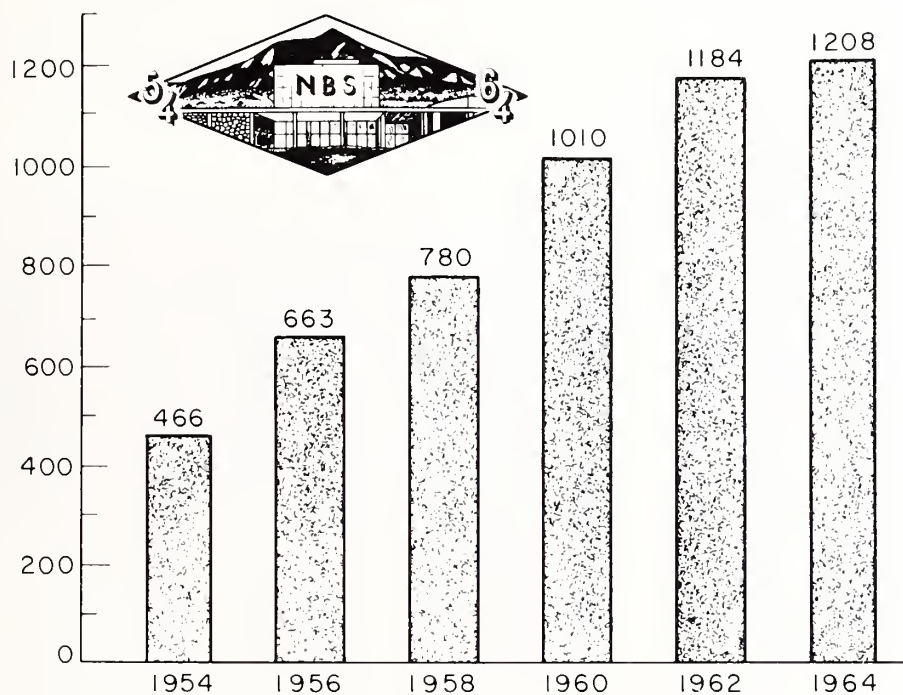

FULL-TIME PERMANENT STAFF, NBS BOULDER LABORATORIES

*This chart, reproduced from the September 1964 issue of the Technical News Bulletin, shows the very rapid growth of the Boulder Laboratories from 1954, the year of the major move from Washington, D.C. The indicated numbers included all full-time permanent staff members of the total organization which, by 1964, had grown to six radio divisions, the Cryogenics Division, the Administrative Division, and a centralized management office.*

beginning around 1912 when the Bureau employees were occupied with radio circuits (Dellinger, Kolster, and Lowell). Organizationally, by 1965 the radio work of NBS had grown to four divisions in CRPL and two divisions (later three) in the Radio Standards Laboratory (see app. C). On October 13, 1965, the four CRPL divisions were transferred to the newly established Environmental Science Services Administration (ESSA) within the Department of Commerce (see ch. XX).

## STUDIES OF THE IONOSPHERIC REGIONS<sup>47</sup>

Although significant studies were made of each of the several regions of the ionosphere during the periods of the Radio Section and the CRPL, probably none had the extensive study over such a long period of time as that made on sporadic E. For all investigators, including those of the Radio Section, the IRPL, and the CRPL, sporadic E has proven to be an elusive candidate for full and widely accepted explanations of its characteristics.<sup>48</sup>

<sup>47</sup> This section and the 15 succeeding sections of this chapter relate to selected combinations of approximately 60 CRPL ionospheric projects extending over the period of 1946 to 1965. Titles for these sections indicate general or specific areas of research or services by the CRPL. The combinations, arbitrarily selected by the author (WFS), were made in order to simplify the presentation of an unwieldy assortment of technical projects. To have made the selection on a functional basis of the CRPL organizational structure (divisions and sections) over the 20-year period would have been well nigh impossible because of the many changes of structure and of project assignments.

This chapter is limited to the CRPL projects relating to studies of the propagation characteristics, stratification, physical processes, and composition of the ionosphere—that portion of the atmosphere lying approximately between 70 and 1000 km above the Earth's surface. Also covered, are the long-term prediction and the short-term warning services provided by the CRPL, and participation in the IGY program.

<sup>48</sup> The account given here may appear out of proportion in length to other work on the ionosphere by the CRPL, but it lends itself for a matter of considerable interest. More than 30 papers were published relating specifically to sporadic E and many more contained substantial amounts of material on the subject. Papers on no other specific region of the ionosphere came close to this number.

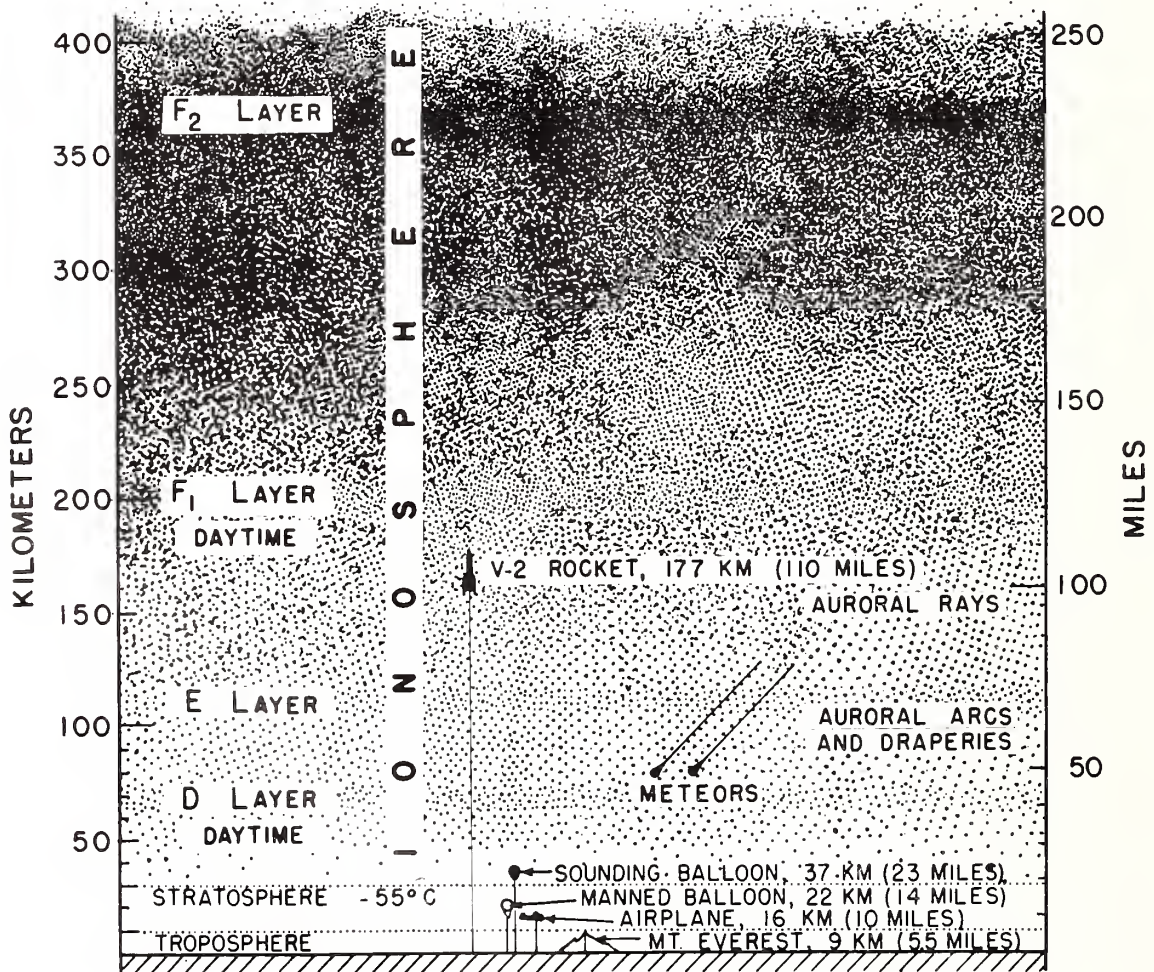

The Ionosphere.

*Pictorial concept of the ionosphere as viewed in cross section—the CRPL concept of 1946. Although the F<sub>1</sub> layer is observed only during the day, as indicated, it is now known that there are various manifestations of the D layer(s) both day and night. Density of black dots indicates relative electron density or ionization of the upper atmosphere at various heights above the earth's surface.*

# 1. The anomalous characteristics of sporadic E<sup>49</sup>

## a) THE EARLY OBSERVATIONS BY NBS

The anomalous and usually random transmissions of VHF television signals over long distances (of the order of 1000 miles) is attributable, in most instances, to reflections from rather intensely ionized areas associated with the E layer of the ionosphere (approximately 100 km above the Earth)—a phenomenon known as “sporadic E.”<sup>50-53</sup> In general sporadic-E ionization is observed in the communication band of 3 to 70 MHz. The phenomenon was observed first within several years after the pioneer work in probing the ionosphere by Breit and Tuve (see ch. VII).<sup>54</sup>

During the winter of 1932-1933 Gilliland of the Radio Section observed virtual heights of the ionosphere at a frequency of 4100 kHz with a continuous recorder (see ch. VII). His observations, made at the transmitting station at Beltsville, Md., clearly indicated the presence of sporadic E, which he reported in the July 1933 issue of the *NBS Journal of Research*, and later in the October 1933 issue of the *Proc. IRE* [1]. In his conclusions Gilliland commented primarily on the irregular strong reflections from the E layer.<sup>55,56</sup>

---

<sup>49</sup> Because the observations, studies, and publications by NBS relating to the singular phenomenon of “sporadic E” extended progressively over a period from the early 1930’s to 1965, the account is a continuum in this chapter rather than being divided with chapter VII.

<sup>50</sup> For an interesting account of the effect of sporadic E on television reception, see the paper by Ernest K. Smith in the March 1952 issue of the *Transactions of the IRE for Professional Group on Antennas and Propagation*; also a similar paper in the June 1953 issue of *Radio-Electronics*.

<sup>51</sup> The usually accepted concepts of the structure of ionized areas that cause sporadic-E reflections are: (1) a thin horizontal layer of high electron density within the regular E layer; (2) a steep gradient within the E layer that presents a sharp boundary for partial reflection of the incident waves; (3) blobs of ionization with electron density differing considerably from that of the surrounding medium. Other concepts also have been suggested over the years.

<sup>52</sup> Vertical-incidence reflections from sporadic-E regions are observed only when there are no reflections from the regular E layer, i.e., only when the frequency exceeds the E-layer critical frequency. At lower frequencies any sporadic-E reflections are masked by those from the E layer.

<sup>53</sup> The IGY definition (*Annals of the IGY, 1957*) of sporadic-E reflection ( $E_s$  reflection) is any abnormal E-region reflection characterized by one or more of the following: (1) random time of occurrence; (2) partial transparency; (3) variation of penetration frequency with transmitter power as deduced from F-region reflections; (4) uniform apparent reflection height, regardless of frequency.

Note: In *NBS Circular 582* (issued March 15, 1957), Ernest K. Smith gives an interesting account of a working definition of “sporadic E,” as to choice of a term and a definition. His definition differs considerably from that used in the IGY program (e.g., he adds that the period of reflection ranges from several minutes to several hours).

<sup>54</sup> In 1927 Appleton (England) observed the presence of two layers in the ionosphere, the lower one was later to be called the E layer. By 1929 J. P. Schafer and W. M. Goodall of the Bell Telephone Laboratories Transmitting Station at Deal, N.J. observed sharp changes and discontinuities in the E layer, particularly at sunset. In 1932 the same phenomena were reported by Ivo Banzi (Italy). Also, in 1932, Eckersley (England) reported on unusual variations of the E layer, and Appleton and Naismith (England) reported on erratic diurnal variations of the E layer.

<sup>55</sup> Gilliland did not use the term “sporadic E” in this paper. The term was apparently used first in the August 1934 Monthly Report of the Radio Section. It was first used in a publication by NBS in the July 1935 issue of the *Proc. IRE* by Kirby and Judson.

<sup>56</sup> Because of the first published comments on sporadic E in a Bureau publication and the beginning of an extended program in this area of ionospheric research by NBS, Gilliland’s conclusions in this paper are given in full below:

### III CONCLUSIONS

Of greatest interest perhaps is the reappearance of strong reflections at night from both E and F layers. Some of these reflections indicate sudden increases in ionization, while others suggest that recombination in a lower part of the region exposes the upper part where ionization is richer.

Four months after his July 1933 report, Gilliland published a note on his multifrequency automatic recorder of ionosphere heights operating in a range of 2500 to 4400 kHz. With this equipment he observed strong reflections from the E layer near sunset on some evenings. However, with manually operated equipment, his observations of abnormal reflections from the E layer were made down to 1600 kHz and later up to 11,200 kHz.

In a July 1935 paper Samuel S. Kirby and Elbert B. Judson discussed the study of 18 months of vertical-incidence recordings taken at the Meadows, Md. station (Washington, D.C.) during the period of June 1933 to November 1934, including observations of sporadic E [2].<sup>57</sup> Again, 2 years later (July 1937), a Radio Section group reported on observations of sporadic E taken at Washington, D.C., from May 1934 to December 1936 [3].<sup>58,59</sup>

## b) PROGRESS IN SPORADIC-E STUDIES DURING WORLD WAR II

With the increased knowledge of sporadic E by the time of World War II and formation of the IRPL, there began the desire, the need, and the ability to predict transmission by sporadic E several months in advance. Such a prediction by a world map was published, for restricted circulation, for the first time in the April 9, 1943, issue of the "High-Frequency Radio Transmission Conditions," later to be known as the IRPL-D series (see pp. 410-411).

---

(Continued)

Many of the changes observed are very sudden, and strong reflections from the E layer may appear at almost any hour. Various explanations have been offered in the past, including sun spots, meteor showers, and thunderstorms. Comparisons are also made between such results and changes in the earth's magnetic field. Although certain peculiarities, such as strong E reflections, are observed at magnetically disturbed times quite similar phenomena are observed when no unusual magnetic changes are in evidence. Since the changes in the ionosphere are so frequent and so rapid it is impossible, with the small amount of data at hand, to show definitely just how important each factor is.

None of the explanations yet offered seems to explain satisfactorily the extremely high ionization frequently observed at night. Although E-layer reflections appear at almost any time, they occur most frequently around the time of sunset or shortly after on this frequency during the period of these observations.

This method offers a convenient means for studying the physical properties of the upper atmosphere and should prove helpful in the solution of certain radio transmission problems. With data of this type taken over a longer period and on other frequencies it is hoped that it will be possible to obtain a more exact picture of the changes which occur in the ionosphere and to determine some of the agencies responsible for these changes.

Author's (WFS) note: In commenting upon the random yet strong E-layer reflections, little did Gilliland realize that explaining the phenomenon of sporadic E would become one of the most baffling problems faced by investigators of the ionosphere during the years to follow and to the present time.

<sup>57</sup> Kirby and Judson concluded that:

The data indicate the sporadic-E layer returns the wave to earth by reflection at a sharp boundary rather than by refraction. This layer is frequently semitransparent and shows no critical frequencies. Most of the nighttime E layer observed is of this nature. It is common at much higher frequencies during the summer than during the winter.

<sup>58</sup> The group stated in their July 1937 paper that:

. . . Sporadic-E reflections frequently control long-distance transmissions both day and night. Good sporadic-E reflections often provide intense signals at high frequencies and sometimes at ultra-high frequencies. These reflections are very common during the summer but occur at irregular intervals. The irregularities are both geographical and temporal.

<sup>59</sup> Beginning with the July 1937 issue of the *Proc. IRE* and then periodically with the September 1937 issue and continuing for the next 4 years, the Radio Section published ionospheric information based upon Washington, D.C. observations (see ch. VII, pp. 236-237). However, for sporadic-E information they stated:

. . . Curves are not plotted for the sporadic E, since its appearance was so erratic that average results would not be reasonably dependable, although it is known that sporadic E frequently determined the upper frequency limit to sky-wave transmission, especially during the summer.

Whenever observations of sporadic E were of significance, notations and comments were made in the reports. Beginning with the July 1940 issue, the sporadic-E information began to appear in tabular form, giving the approximate upper limit of frequency of strong sporadic-E reflections at vertical incidence for the days during which the reflections were most prevalent at Washington, D.C.

The map indicated the approximate percentage of total time that sporadic-E maximum usable frequencies could be expected to exceed 15 MHz during July 1943, 3 months in advance.<sup>60-62</sup>

<sup>60</sup>The information on which this and later maps were prepared was published monthly in much detail in the IRPL-F series from data gathered from various locations over the world.

<sup>61</sup>Much of the success of the ability to predict successful transmission by means of sporadic-E reflections was by deducing the relation that: the logarithm of the percentage of total time of occurrence of the upper-limit frequency,  $fEs$ , in excess of a given frequency, is approximately inversely proportional to that frequency for frequencies above approximately 3 MHz.

<sup>62</sup>The IRPL Radio Propagation Handbook, issued Nov. 15, 1943, commented on the abnormal variations in ionosphere characteristics to a considerable extent and with a considerable degree of understanding based upon the knowledge of the ionosphere as it existed at that period. Five types of abnormal variations of the ionosphere were listed, including that of sporadic E.

In *NBS Circular 462* on ionospheric radio propagation, issued June 25, 1948 (see footnote 136), the importance to transmission by sporadic E was stated, but tempered with the statement, "The nature and cause of the sporadic-E layer are not yet understood."

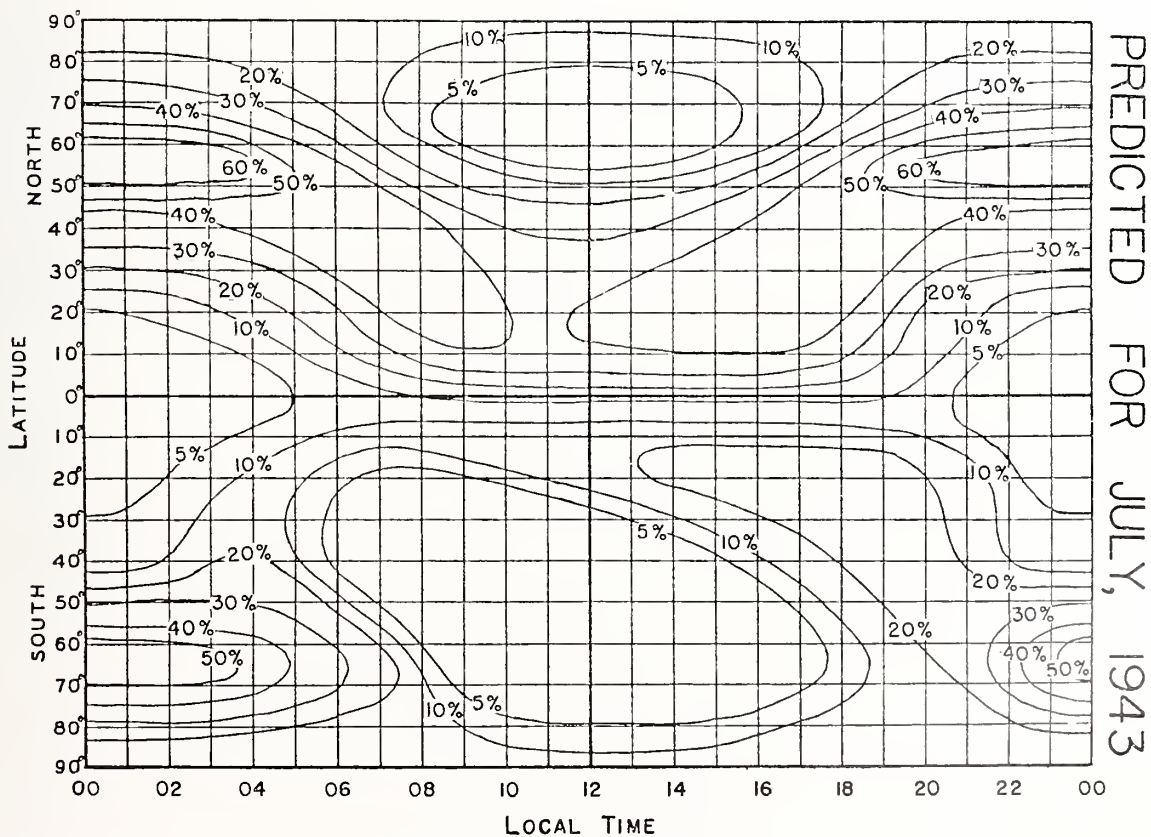

Sporadic-E distribution predicted for July. Numbers on curves are percentage of total time for sporadic-E maximum usable frequency in excess of 15 Mc.

"World map" showing relative occurrence of vertical-incidence sporadic-E reflections as predicted by the IRPL (Interservice Radio Propagation Laboratory) for July 1943. The map indicates the pattern of diurnal variation and geographical distribution (by latitude) of sporadic E for reasonably reliable radio transmission (up to approximately 15 MHz) during a summer month. Clearly indicated is the greater occurrence of sporadic E at mid latitudes, also the minimum occurrence during daylight.

In 1947 Marcella Lindeman Phillips of the Basic Ionosphere Research Section published a paper on a study of the variations in sporadic E from observations in the vicinity of Washington, D.C., made by the Radio Section over a period of nearly 12 years [4]. The data available made it possible to scale each hour of the day from May 1935, being the longest series of sporadic-E information available in 1946 for any location. Variations were investigated with respect to diurnal, seasonal, and solar activity. Much new knowledge of sporadic E was revealed by this study.

c) CAN "SPORADIC-E" REFLECTIONS COME FROM METEOR TRAILS?

During the late 1940's several investigators in England and elsewhere attributed sporadic-E reflections to meteor trails as their source. During a 5-year period (1946-1950) of observations of echoes from meteor trails at the Sterling, Va. station, Victor C. Pineo concluded, from a statistical study, that the frequency of occurrence of sporadic-E reflections is unrelated to meteor phenomena when observed with a 27.2-MHz radar (see p. 462). Sporadic-E reflections were observed with an automatic multifrequency ionosphere recorder. Pineo reported his work in several issues of *Science* [5].

d) ERNEST K. SMITH CONDUCTS A LENGTHY STUDY OF SPORADIC E<sup>63</sup>

Upon entering the CRPL in 1954 Ernest K. Smith, Jr. continued his study of sporadic E that began some years earlier.<sup>64</sup> In concluding his initial study in 1955, Smith considered his findings as exploratory only and that much remained to be learned. In this early study Smith was led to the viewpoint that a Temperate-Zone longitude effect occurs in the area south of Japan due to a high incidence of sporadic E. This viewpoint was the result of a study of ionosonde data from the existing worldwide network of stations and from oblique-incidence field-strength measurements made in Japan and in the United States.

Following the discovery of a new manifestation of F-layer scatter in the Western Pacific in 1956, to be known later as the "Far East Anomaly," the United States participated in an IGY program for further study of sporadic E in the region (see p. 483).<sup>65</sup>

During a research program on VHF forward scatter, conducted by the CRPL between 1951 and 1955, a related program was conducted on the characteristics of sporadic E (see

---

<sup>63</sup> It is quite a coincidence that two NBS personnel with the name Smith should have been so much a part of and directed research programs on the ionosphere over a period of 20 years or more. Newbern Smith's interest, in association with the Radio Section, the IRPL, and the CRPL, lay with the total ionosphere; Ernest K. Smith's interest, in association with the CRPL, ESSA, and the ITS lay with the more specific area of sporadic E.

Yet the Smiths were outnumbered by the Kirbys—three in all—who investigated communication via transmission in the ionosphere and in the troposphere. The father, Samuel S. Kirby, pioneered with the ionosphere, followed by his son, Robert S. Kirby, who became a leader associated with tropospheric transmission projects. Richard C. Kirby (no relation to the other Kirbys) administered ionospheric communication projects.

<sup>64</sup> In his Master's thesis at Cornell University, Smith had reported in 1951 on his study of the effect of sporadic E on television reception. His thesis was later published, in part, in two periodicals (see footnote 50). His Ph. D. thesis of 1955 at Cornell University, entitled "Worldwide Occurrence of Sporadic E," was published as *NBS Circular 582* (issued March 15, 1957) [6]. His study examined the areas of vertical-incidence observations and VHF transmissions over oblique-incidence paths, the material gathered from a variety of sources on a global basis.

<sup>65</sup> Following the operation of an experimental circuit between the Philippines and Okinawa for a year by the Signal Corps on contract with Page Communications Engineers, Inc. of Washington, D.C., a second experimental circuit (1347 km) was set into operation beginning in September 1957. This circuit was designed to measure sporadic E at 50 MHz as part of the U.S. participation in an IGY program. The observations were reported in several publications [7].

For the IGY program an experiment was designed to compare sporadic-E conditions in the area south of Japan (denoted as the Far East location) with that of the same latitude in the Western Hemisphere (the Caribbean). The transmission path in each area was approximately 1300 km, with nearly identical equipment used for the two paths. The IGY program continued for 1 year, beginning in the fall of 1957.

The CRPL team found from the oblique-incidence measurements, taken by a field-intensity technique, that sporadic E is three to five times more frequent in the Far East than in the Caribbean, and that diurnal and seasonal variations are more regular in the Far East. In both areas there appeared but negligible dependence of sporadic E on magnetic activity. The measurements were supplemented by observations taken at receiving stations in addition to those on the established circuits.

Planning and operational procedures were such that the sporadic-E measurements in the Far East and Caribbean could be compared to those made on the Equatorial Scatter Project (see p. 446) and the VHF Ionosphere Scatter Project over the path between Long Branch, Ill. and Boulder, Colo.. Various sponsors supported these distantly separated projects.

sec.: NBS Pioneers in Radio Communication by Ionospheric Forward Scatter). Later in 1959, R. M. Davis, E. K. Smith, and C. D. Ellyett published their analysis of the data [8]. VHF transmissions at approximately 28 and 50 MHz had been observed over a 1243-km path with the transmitter at Cedar Rapids, Iowa and the receiver at the Sterling station in Virginia. Over this particular path they found the incidence of sporadic E to be greatest from May through August. Diurnally, they found peaks of incidence around 10 a.m. and 6 p.m. Over the 5-year period they found no variation with sunspot numbers.

In 1959 J. A. Thomas and E. K. Smith published a survey paper on the knowledge of sporadic E that existed at that time [9].<sup>66</sup> In their introduction they stated:

This survey paper is an attempt to fill the need for a general summary of the present state of our knowledge of the sporadic-E ( $E_s$ ) layer of the ionosphere. At the present moment, a large amount of scattered data concerning sporadic-E reflections is available, but there is, as yet, no theory which completely explains any of the variety of types of  $E_s$  reflections found in different parts of the world. . . .

The year 1962 saw the publication of a monograph on ionospheric sporadic E by Smith, along with Sadami Matsushita, also of the CRPL [10].<sup>67</sup> The compilation contained 24 papers, many the result of IGY investigations of sporadic E. Smith's paper on "The Occurrence of Sporadic E," in the monograph, gave a brief review of the temporal and geographic variations of the occurrence of sporadic E based on knowledge previous to the IGY program.

Included in the monograph on *Ionospheric Sporadic E* was a short paper by R. W. Knecht and R. E. McDuffie of the Sun-Earth Relationships Section. The authors had analyzed the observations of equatorial sporadic E taken at seven ionospheric vertical sounding stations in the vicinity of the geomagnetic equator in Peru and Bolivia.<sup>68,69</sup> Their analysis indicated that the equatorial type of sporadic E occurs in a belt of a width of about 700 km across the geomagnetic equator. This is in close agreement with the width of the equatorial electrojet (see sec.: Geographical Nonuniformities of the Ionosphere, pp. 446-448).<sup>70</sup>

During the period of 1963-1965, John W. Wright of the Vertical Sounding Research Section proved the correctness of theory advanced by others on the explanation of variations of the sporadic-E layer caused by wind shear within the layer. His study was based upon observations by gun-launched and rocket probe trails and by ground-based ionosondes.

## 2. Observing scatter F

A manifestation of the ionosphere that first came to notice in the late 1930's is now generally known as scatter F.<sup>71,72</sup> During the 1950's there was a renewed interest in the

<sup>66</sup> J. A. Thomas was associated with the Department of Physics, University of Queensland, Brisbane, Australia, but on a fellowship at Cavendish Laboratory, Cambridge University, while preparing the survey.

<sup>67</sup> Sadami Matsushita of the High Altitude Observatory, and of the Astro-Geophysics Department of the University of Colorado, served as a guest worker in the CRPL.

<sup>68</sup> The magnetic equatorial type differs from the sporadic E found in other parts of the world in at least four characterizing features.

<sup>69</sup> This was a cooperative investigation in the IGY program including NBS; the Instituto Geofísico de Huancayo, Peru; and the University of San Andrés, Bolivia. Only data from five stations were of significance.

<sup>70</sup> Also in 1962 Robert Cohen, Kenneth L. Bowles, and Wynne Calvert of the CRPL published a paper on the nature of equatorial slant sporadic E, one of many types of sporadic-E phenomena. Their observations were by ionosonde recordings and radar reflections. Among their conclusions of the study was the indication that all sporadic-E echoes observed near the geomagnetic equator are due to a thin stratum of magnetic-field-aligned irregularities embedded in the E layer.

<sup>71</sup> In 1938 Booker and Wells of the Carnegie Institution of Washington published a paper that noted ionospheric echoes they attributed to the scattering of radio waves by the F region. These were observed on vertical sounding records taken at the Institution's observatory, located in an equatorial (magnetic) region at Huancayo, Peru. The scattering was observed at night over a wide range of frequencies.

<sup>72</sup> Indication of the presence of "spread F" by an ionogram is that of an echo pulse of long duration reflected from the  $F_2$  layer. Thus it is described in terms of the appearance of an ionogram rather than that of the physical nature of the ionosphere. It is considered to be caused by scattering of a signal from irregularities embedded in the ionosphere, both in depth and spreading out from the perpendicular from the  $F_2$  layer (spreading from the zenith when viewed from a ground-based ionosonde).

scattering of radio waves by the F region.<sup>73</sup> As an important segment of an IGY forward-scatter project, the CRPL conducted a study of spread-F phenomena over an equatorial (magnetic) region of considerable width in South America (with mid-point at Huancayo, Peru).<sup>74</sup> Robert Cohen of the Ionospheric Research Section directed the project. Many of the staff members of the CRPL, plus South American organizations and government agencies, participated in the total forward-scatter project.

Analysis and interpretation of ionograms of the spread-F observations were published by Cohen and Bowles in 1961 [11]. They found that equatorial spread F could be pictured by a number of characterizations.<sup>75</sup>

### 3. The D layer—The reflection domain of long radio waves

It is to the credit of Newbern Smith and Samuel S. Kirby of the Radio Section that observations with a field-intensity recorder led to their announcement in 1937 of finding an ionized layer below the E layer, later to become known as the D layer.<sup>76</sup>

By 1943, when the IRPL Radio Propagation Handbook (issued 1 November, 1943) became available in limited circulation, sufficient knowledge had been gained of the properties and propagation characteristics of the D region to be useful to the communication engineer.<sup>77</sup>

Following in the wake of a renewed interest in low frequency radio waves (see sec. 000), the CRPL initiated new experiments to learn more of the D region. Early in 1950 Jack N. Brown and James M. Watts of the Ionospheric Research Section<sup>78</sup> successfully obtained film recordings of vertical-incidence reflections from the D region. This was accomplished with a high-power pulsed transmitter operating at 50 kHz [12].<sup>79</sup>

With a newly developed low-frequency ionosonde, early in 1952 Watts and Brown began to make sweep-frequency observations of the ionosphere over the range of 50 to 1100 kHz. During the next several years their observations revealed many puzzling phenomena of the lower ionosphere, which were subjects of a publication in 1954 [13]. Daytime reflections indicated three distinct and sharply bounded layers extending from about 70 to 110 km in

---

<sup>73</sup> In 1960 Francis N. Glover of the Ionosphere Research Section prepared a survey paper—"spread F," published as *NBS Technical Note 82*.

<sup>74</sup> A brief account of this extensive IGY project is given in the section "Geographical Nonuniformities of the Ionosphere" (pp. 446-448). For observation of scatter F at 50 MHz a 2580-km circuit was used that crossed the geomagnetic equator with mid-point at Huancayo.

<sup>75</sup> Among the characteristics Cohen and Bowles found were that equatorial spread-F echoes could be differentiated from the more general F scatter, both forms occurring only at night. They found that the scatter F came from scattering by relatively thin sheets of irregularities in electron density which occur at the bottom of the F layer and sometimes as much as 100 km below the layer. However, the irregularities or "patches" can occur as high as 450 km. They found that a necessary condition for occurrence of spread F near the magnetic equator is that the surfaces of constant electron density be approximately parallel to the Earth's magnetic field. The patches or irregularities can extend horizontally in the magnetic east-west direction for distances of the order of 1000 km.

For a period of several years additional publications were turned out by the CRPL on scatter F, based largely on the observations made in South America. One, however, by W. K. Klemperer, related to the characteristics of spread F at the geomagnetic latitude of Ithaca, N.Y. With the advent of observations by satellites, new opportunities came for study of spread F (see section "Probing the Ionosphere From Above," pp. 503-505).

<sup>76</sup> Existence of the D layer is not readily revealed by the pulse technique of vertical-incidence ionosondes because of the inability of the region to reflect waves of a frequency greater than about 0.5 MHz. Smith and Kirby announced their observations in a Letter to the Editor, published in the May 15, 1937, issue of the *Physical Review* (see ch. VII, p. 229).

<sup>77</sup> Known or observed of the D region by 1943 was the information that: (1) a layer exists in the daytime at a height of 50 to 90 km of sufficient ionization density to absorb or reflect radio waves, depending upon the frequency, (2) the ionization density varies approximately with the amount of sunlight incident upon the D region, (3) at times of "radio fallout" (Dellinger Effect or sudden ionospheric disturbance), causing an abnormal increase in ionization and consequent increase in conductivity, there is a strengthening of the sky wave at very low frequencies.

<sup>78</sup> The adjective form, "Ionospheric Research Section" was changed in 1959 to the noun form, "Ionosphere Research Section." The section title will appear frequently in this chapter but each of the two forms appears in correct relation to the time it was used before and after the early part of 1959.

<sup>79</sup> The observations were made at the Sterling, Va. field station with a transmitter output of about 200 kW feeding into a large loop-antenna. In their brief published report Brown and Watts recorded reflections from a virtual height of approximated 80 km, with variations in the height ranging from 70 to 90 km during a 1-day period. On one occasion there was evidence of two reflections from different heights for a short period of time.



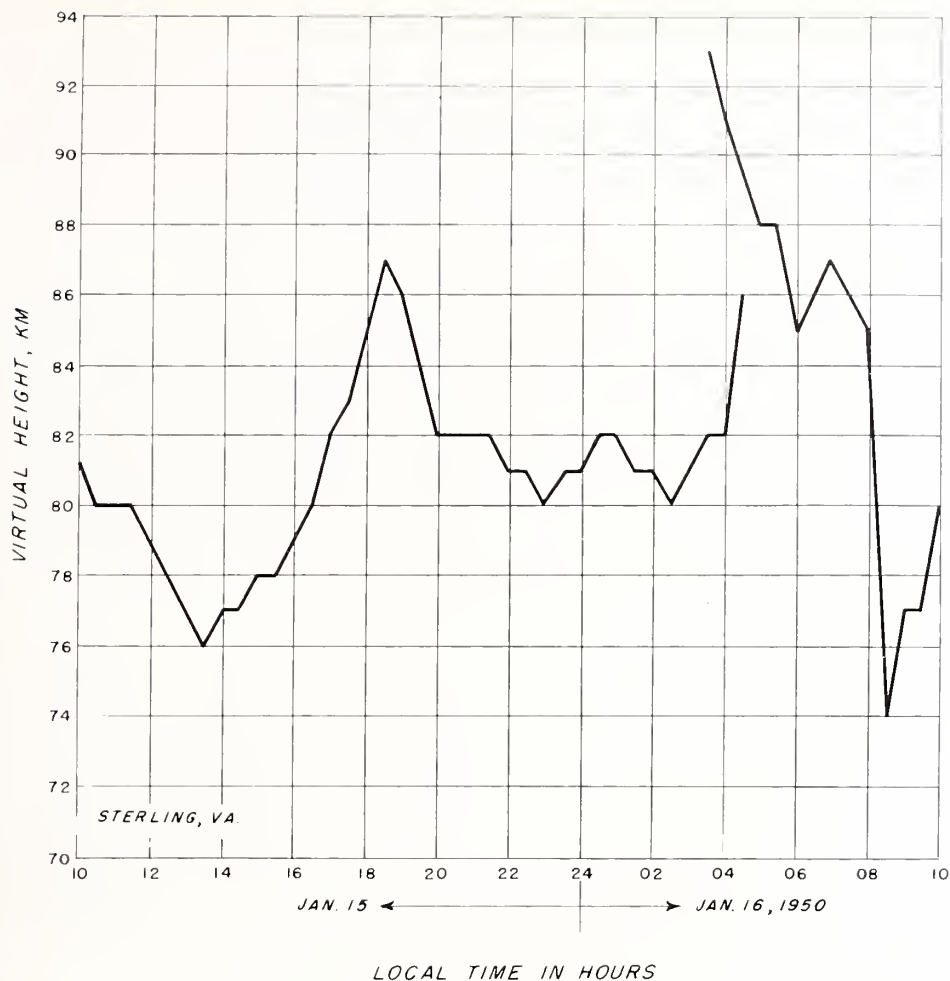

IONOSPHERE VIRTUAL HEIGHTS 50 KC/S

A pioneering experiment in early 1950 by the Ionospheric Research Section proved that it was possible to observe reflections at a frequency of 50 kHz from the lower region of the ionosphere by the vertical-incidence technique. The graphical representation summarizes determinations of virtual heights of reflections observed over a 24-hour period. Near local time of 04 there was evidence of reflections from each of two closely spaced layers.

virtual height. They discovered a nighttime layer between the E and F layers, which was erratic in its existence, but seemed to have continuity with the E layer during sunset.

Among the various ionospheric studies at low frequencies made at the Sterling field station was that of the change in polarization of reflected waves. Both plane and circular polarized 160-kHz waves showed various degrees of elliptical polarization upon reflection. Unstable polarization occurred at sunrise and sunset and at other irregular times.

In 1959 Watts, with C. D. Ellyet, published a lengthy survey paper on evidence of stratification in the ionosphere below 100 km [14].<sup>80,81</sup>

Some studies were continued by the CRPL during the early 1960's on the D region, but with the sober viewpoint that it is a region of the ionosphere that yields its secrets with experimental difficulty.<sup>82</sup> More was learned of the physical and chemical processes of the

<sup>80</sup> C. D. Ellyett was associated with the University of Canterbury, Christchurch, New Zealand. Ellyett had published a paper in 1947 on observation of echoes from the D region in the vicinity of two islands in the southern Pacific.

<sup>81</sup> Gathering their information from a number of sources, Ellyett and Watts concluded that one layer of the D region is observed consistently at about 85 km. There was evidence to indicate that other finely structured layers exist in the D region but have no long-time constancy of height and pattern. Their information was gathered largely from radio, optical, and rocket observations.

<sup>82</sup> In a paper published in 1964, James R. Wait of the CRPL stated:

One of the most challenging problems in VLF research is to obtain information on the ionosphere D layer from measured data on amplitude and phase of a distant CW transmitter.

region, along with evidence that the ionization is produced by extreme ultraviolet radiation and X rays from the Sun.

Although nonlinear processes in the ionosphere are not confined to the D region, their occurrence is more frequent in the lower ionosphere.<sup>83</sup> An international meeting, the Conference on Non-Linear Processes in the Ionosphere, cosponsored by the CRPL and the Voice of America, was held at the Boulder Laboratories on December 16 and 17, 1963. Twenty-four papers were presented at the conference.<sup>84</sup>

#### 4. The E and F layers

Because of the greater yield and less formidable means of gathering data on the E and F layers than on other regions, the Radio Section made great strides during the 1930's on probing the ionosphere and learning its secrets. Later, during the years of the CRPL, research on these layers was oriented toward scattering phenomena, height profiles of electron density, theoretical considerations of the nature of the layers, and construction of models of their make-up.<sup>85</sup> Among the more theoretical treatments of the ionosphere as a stratified media was the book published by James R. Wait in 1962, entitled *Electromagnetic Waves in Stratified Media* [16].<sup>86</sup>

#### 5. The case of the "G layer"

In several papers published during 1933 and 1934, members of the Radio Section reported on their observations of reflections of radio waves at heights much above the F<sub>2</sub> layer (see ch. VII, pp. 229-230). The more prominent and lower layer they chose to call the "G layer." But the ionosonde proved to be a rather ineffectual means of obtaining detailed knowledge of the upper ionosphere. More effective probing was by means of radar (incoherent scatter), rockets, and satellites. Moreover, treatment of the upper atmosphere leaned more in the direction of electron density and the properties of a plasma, rather than that of well-defined layers with sharp boundaries that reflect radio waves back to the Earth. Thus, the terms G and H layers have rarely appeared in the literature in more recent years.

### IMPROVING UPON THE PREDICTION SERVICES

During World War II the IRPL had met the need of the military by developing a prediction service for useful frequencies within the band suitable for ionospheric propagation. As an instruction manual for predicting from the CRPL Series D tables, charts, and nomograms, in 1947 the Regular Propagation Services Section, under Walter B.

---

<sup>83</sup>Mathematically, a nonlinear process involves quantities with squares or higher powers. In radio engineering terms a rectifier or detector involves a nonlinear process. In radio propagation, the Luxembourg Effect (cross modulation reaction between two radio waves) is a nonlinear process that takes place in the D region of the ionosphere at a height of about 75 km.

<sup>84</sup>Twenty of the papers were published as *NBS Technical Note 211* in six volumes, issued April 17, 1964, with Donald H. Menzel (Harvard College Observatory) and Ernest K. Smith, Jr. (CRPL) as editors.

<sup>85</sup>In 1962, two members of the Sun-Earth Relationships Section and a member of the Physics Department of the University of Colorado presented a paper at the International Conference on the Ionosphere (London) on a new model of the atmosphere and ionosphere in the E and F<sub>1</sub> regions [15]. Their model, based upon observations of others, encompassed a height range of 100 to 300 km. First, they prepared a model for a neutral atmosphere determined by the temperature profile, the height of the turbopause (at 110 km, for range of 100-120 km), and other factors. From this model they were able to form an ionospheric model of the E and F<sub>1</sub> regions from photoionization and other data. This model, in turn, yielded a variety of information on the processes that occur within the daytime ionosphere of the E and F<sub>1</sub> regions.

In 1964, H. Rishbeth, a consultant to the CRPL, published a paper depicting a model of the large-scale structure of the undisturbed F<sub>2</sub> layer at mid latitudes [17].\* His model considered the time-varying rates of photoionization, recombination, and diffusion. Comparison of numerical values of the model parameters with observational data was "reasonably consistent."

\*Rishbeth was on leave from the Radio Research Station at Slough, Buckinghamshire, England.

<sup>86</sup>At the time Wait was a consultant in radio wave propagation, assigned to the director's office of the Boulder Laboratories.

Chadwick, brought out *NBS Circular 465*, entitled "Instructions for the Use of Basic Radio Propagation Predictions," which stated in the Preface:

Its purpose is to explain how calculations of maximum usable frequencies and optimum working frequencies may be made for sky-wave transmission over any path for any time of day during the month in question by use of the contour charts for frequency issued monthly in the Basic Radio Propagation Predictions (CRPL Series D).

In December 1962 *NBS Handbook 90* was issued, entitled "Handbook for CRPL Ionospheric Predictions Based on Numerical Methods of Mapping." The *Handbook*, prepared by Sidney M. Ostrow, superseded *NBS Circular 465*. The team of Roger M. Gallet and William B. Jones had developed a method of numerical mapping of ionospheric characteristics by using electronic computer methods and applying the technique to the CRPL prediction service.<sup>87,88</sup> Previously, for nearly 20 years, the CRPL Series D prediction charts had been prepared by manual and graphic methods. The former Series D charts, published monthly, were replaced by a new series, the CRPL Ionospheric Predictions, with numerical prediction maps. There were two forms of maps (with tables of predicted numerical map coefficients) that could be used for predictions, one suitable for electronic computation, the other with a punched card system. The new prediction maps yielded more information and with greater accuracy than the earlier zone prediction charts. Minadora PoKempner organized the procedures used in the new prediction series.<sup>89</sup>

Two years after its establishment the CRPL was obtaining data on ionospheric observations from an international network of 58 stations. From 14 of these stations the information was received on a scheduled basis, 7 controlled directly by NBS and 7 operated in association with other agencies. By 1954 ionospheric data were being received from approximately 90 stations scattered around the world, including 8 NBS-controlled stations and 7 NBS-associated stations.<sup>90</sup> These data, as well as sunspot data, were used for prediction services and for research. By 1949 much of these data were transferred to punch cards for automatic machine calculation of statistical information.

---

<sup>87</sup> *NBS Handbook 90* was preceded by several publications, one dating back to 1960, that introduced the matter of computerizing the propagation of ionospheric maps for the CRPL worldwide prediction service. In the December 1960 issue of the *Journal Des Telecommunications*, Jones and Gallet stated that, beginning in 1957, the CRPL had activated a program for completely revising and thereby improving the forecasting method. The great increase in number of reporting ionospheric stations brought on by the IGY program, and the advent of electronic digital computers, hastened the time for revision of the forecasting method.

The process developed was ionospheric mapping by "numerical" methods; a "numerical map" being the mathematical representations of ionospheric quantities (or characteristics) such as maximum usable frequency and critical frequency as functions of the variables of latitude, longitude, and time (including diurnal variation). Jones and Gallet published papers on the subject in the July-August 1962 and November-December 1962 issues of the *NBS Journal of Research*. Later, in August 1963, Martha Hinds and Jones published *NBS Technical Note 181*, describing the computer program for ionospheric mapping by numerical methods.

<sup>88</sup> In 1965 Gallet and Jones received the Department of Commerce Gold Medal for Exceptional Service as a joint award "for the development of efficient computer programs for the description and prediction of the worldwide properties of the ionosphere."

<sup>89</sup> In 1961 Minadora PoKempner received the Department of Commerce Silver Medal for Meritorious Service "for a substantial contribution toward fulfilling the Central Radio Propagation Laboratory's mission in the fields of frequency allocation, frequency usage, and specifications for the design of communications equipment, and for faithful and intelligent service of a 14-year period."

<sup>90</sup> The NBS-controlled stations were located at: Anchorage, Alaska; Point Barrow, Alaska; Ft. Belvoir, Va.; Narsarsuaq, Greenland; Ramey Air Force Base, Puerto Rico; Ft. Randolph, Canal Zone; Guam; and Maui, Hawaii.

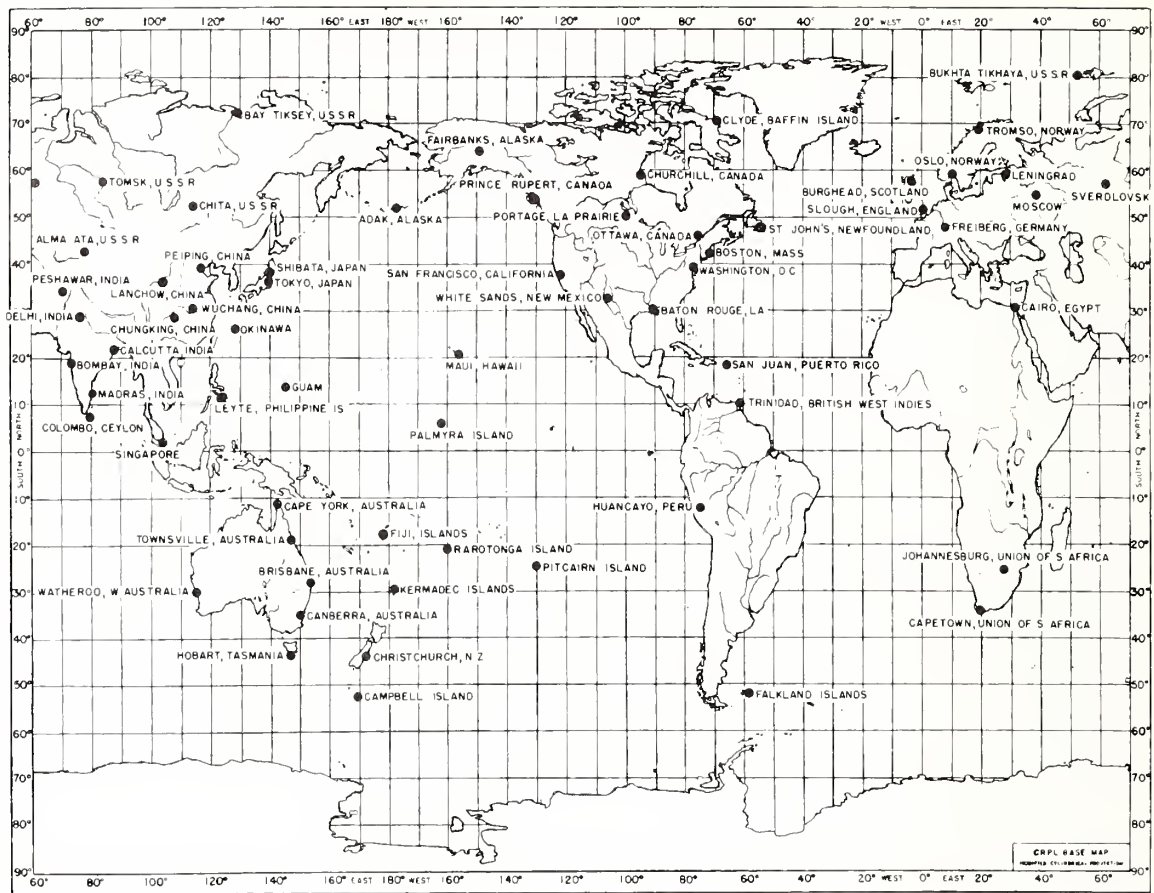

World-Wide Distribution of Observing Stations, January, 1947

Growing out of the development by the Interservice Radio Propagation Laboratory during World War II of a prediction service for radio communication via the ionosphere, thereafter the number of observing stations grew very rapidly. By January 1947 the number had reached 63, with worldwide distribution as shown on the accompanying map. Although the total number fluctuated, by 1954 ionosphere data were received from 90 stations. Seven of the stations were operated directly by the Central Radio Propagation Laboratory and another seven in association with other agencies.



*NBS moved into the vicinity of Pt. Barrow, Alaska in 1949 with equipment to study the ionosphere beyond the Arctic Circle. Over a 30-year period many types of observations have been made in this far-north region. Beginning in 1951, for a period of 2 years, and another period in the early 1960's, the facility was used as a receiving station for observations of ionospheric forward scatter. The station has served in a proton-event warning system, thus taking a vital part in the nation's manned space flight programs.*

Before moving to Boulder in 1954 a method was developed for preparing monthly ionospheric data tabulation sheets using punchcard machine methods. The punchcard method was also applied to computation of monthly medians of ionospheric data, with the result of agreement with computations made by the conventional manual method.

In the interest of improving the predictions of the long-path maximum usable frequencies, a project of several years duration was carried out before the move to Boulder. Analyses were made of traffic logs of commercial and government communication systems over paths in different parts of the world. Discrepancies were found that were a function of path length and of season and some attempts were made to set up empirical factors to bring predictions into line with observations.<sup>91</sup>

As a result of the International Geophysical Year (IGY) program, the CRPL made significant improvements in its prediction service. By the close of World War II the IRPL had developed a prediction service for the Armed Forces that was based upon vertical incidence ionospheric information from 50 stations which, however, was often quite meager from some of the stations. At the time of the formation of the CRPL (May 1, 1946) the number of reporting stations had grown to 55, and by January 1947 the number of stations around the world had increased to 63 (see accompanying map). By 1957, at the beginning of the IGY program, the number of stations had increased to 78 and at the close of the 2 1/2-year program information became available from 161 stations. Many of the added stations were located in South America, Africa, and Antarctica where, previously, ionospheric information was almost completely lacking. Thus, predictions could be based upon

<sup>91</sup> During 1947 some investigations were carried out on a radio traffic analysis project to ascertain the extent to which the F<sub>2</sub>-layer critical frequency at one station could be predicted from that observed at another. If valid, it would be possible to extrapolate observed values to areas where no ionospheric data were available. At long distances the relationship was found to be poor and predictions for maximum usable frequency based on the data would be unreliable.



*The Secretary of Commerce, Luther H. Hodges, visits NBS stations in Antarctica during November 1962. This photograph was taken at the Byrd station. On this inspection trip the Secretary also visited the NBS stations at McMurdo Sound and at the South Pole. Members of the CRPL staff, reading from left to right in the rear row are: L. D. Lewis, D. L. Vance, D. E. Patton; in the front row, H. E. Pearson (U.S. Coast and Geodetic Survey), Secretary Hodges, and R. L. Sefton.*

information that was more directly related to remote parts of the world than was previously available, hence the 3-month predictions could be made more accurately on a worldwide basis.

During the last several years of the 1950's a project known as "World Maps" was initiated and completed for producing over 500 maps as a simplified method of predictions for  $F_2$  ionospheric communication. The world maps were placed on a Greenwich mean time basis rather than local time and were prepared for 6 selected months through a calendar year. This left but one variable in preparing predictions, that of sunspot number. For a period of time a cooperative program was carried on with the Radio Research Station, Slough, England for intercomparison of world map predictions.

## OBSERVATIONS WITH THE IONOSONDE

### 1. A sequence of ionosondes, and observation by vertical-incidence signals

The "all powerful" tool for observing the ionosphere, namely, the ionosonde, was a subject of importance at the first meeting (May 1, 1946) of the Radio Propagation Executive Council. Dellinger stated:

Ionosphere stations at present are operating with different models of recorders and it is desirable to have a standardized ionosphere recorder to put all the records on a self-consistent basis.

The ionosonde was the all-important tool for observing vertical-incidence reflections for research and prediction services. It was also useful for oblique-incidence studies.

Construction of a new model of ionosonde had been started by the Radio Section in the fall of 1945 and a half year later was nearly ready for bids for construction by an outside firm. This new model became known as the CRPL Model C ionosonde.<sup>92</sup>

In 1950 the Model C-3 ionosonde was developed, and later the Model C-4. Each model had improved features over the previous model as inspired by experience gained with an earlier model. The Model C-4 was placed in service in 1957.<sup>93</sup>

---

<sup>92</sup>The Model C ionosonde was developed in two designs, both by Peter G. Sulzer (later a staff member of the CRPL for several years). The Model C-1 was an improvement over the earlier NBS designs by Gilliland. Further improvements resulted in the Model C-2 ionosonde that had a frequency range of 1 to 25 MHz. The ionosphere could be scanned over this frequency range in a time as short as 2.5 seconds to facilitate the study of short-time variation of ionospheric conditions. Observations could be made visually or recorded on 35-mm movie film. A wide-band antenna system was designed to present a fairly uniform signal over the 1 to 25 MHz range of the ionosonde. The entire operation was automatic. The prototype of the Model C-2 was completed in time for use by James M. Watts in Brazil for the May 20, 1947, total eclipse of the sun (see ch. VII, p. 218). Production models were used at a number of the NBS field stations. Some details of the Model C ionosonde can be found in the October 1947 issue of the *Technical News Bulletin*.

<sup>93</sup>A detailed account of the history of vertical-incidence ionosphere sounding at NBS is covered (to 1959) by Sanford C. Gladden of the CRPL in *NBS Technical Note 28* [18]. In addition to the historical account, Gladden described the various models of the ionosondes developed and used by the NBS, also those developed by laboratories associated with NBS in cooperative programs. He also furnished much information on the operation of the various field stations.

Over the years of the CRPL many of the staff members were engaged in vertical-incidence observations of the ionosphere with the NBS models of ionosondes at stations scattered over the globe. Their names are well noted in Gladden's *Technical Note*.



*This lady's wrist watch used with the Model C-1 ionosonde (only one instrument constructed) that was developed in 1945. There was no scale of frequency or height on the ionogram, and time of sweep and time of day were recorded for each ionogram by photographing the watch (alongside of tape record). The setting of 1:32, on this watch of historical interest, is that on a published ionogram.*

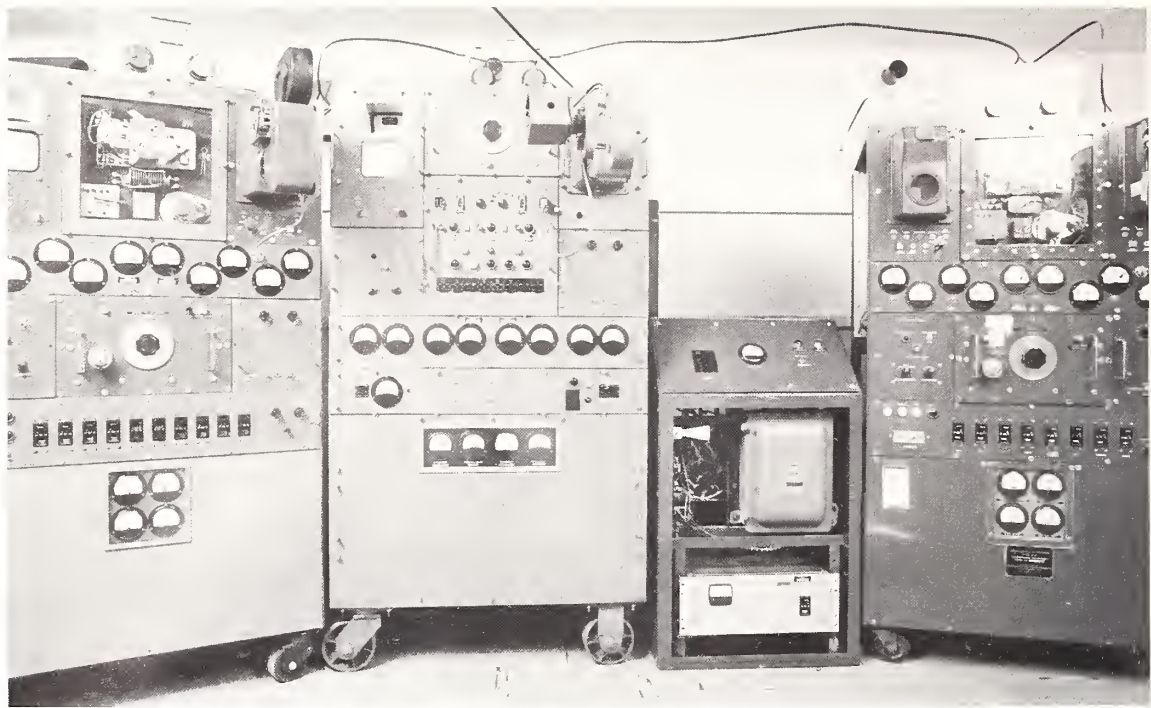

*Probably for the first time ever, NBS Model C-2, C-3, and C-4 ionosondes appeared in one photograph. The occasion was in July 1977 at the Boulder Laboratories where the units had come in for refurbishing between deployment at field sites (see adjacent photo and caption on Boulder Ionosphere Station). These ionosondes have had long service by the Environmental Data Service operation of NOAA (National Oceanic and Atmospheric Administration).*

*From left to right are: Model C-3, Model C-4, and Model C-2 ionosondes. Voltage regulator for the C-2 is to its left, Model C-4 ionosondes were used worldwide at the many recording stations of the IGY program during 1957-1958.*





*The Boulder Ionosphere Station located at the foot of Green Mountain on the spacious grounds of the Boulder Laboratories. Now operated by NOAA (National Oceanic and Atmospheric Administration) as one of many stations for continuous observation of the ionosphere, the facility was first used by the CRPL to train operators in the use of ionosondes. The facility also serves for the final testing of ionosondes brought in from time to time from the widely-scattered NOAA stations.*

During the IGY program, beginning in July 1957 and extending for several years, Model C-4 ionosondes were installed at a number of stations in South America and in Antarctica, some operated directly by the United States.

It had often been observed that vertical-incidence signals are subject to short-term fading. By 1949 a closer study was made of the fading to determine its relation to characteristics of the ionosphere. Observing instantaneous values of the field intensity at 15-second intervals in the daytime and then at night, it was found that adjacent 15-second nighttime values were quite irregular as compared with daytime values. This was interpreted to indicate that the equivalent reflecting surface was smoother during the day.

Beginning late in the 1950's there came a new interest in the vertical-incidence sounding programs of the CRPL to the extent that the Vertical Soundings Research Section was established in 1961, with John W. Wright as chief. Since vertical sounding is a foundation of ionosphere research, a mission of this section was to maintain a high grade of quality control over the world network of stations. A section project was that of developing a means of determining true heights of ionosphere layers from vertical soundings (virtual heights). A computer technique simplified the complicated calculations. True heights are desired for study of accurate electron density profiles of the ionosphere.

In the early 1960's vertical soundings were made as high as 900 km to study electron and ion densities and their ratio at high altitudes.

## 2. The case of oblique-incidence observations of the ionosphere

Unlike observation of the ionosphere by signal reflection at vertical incidence by means of an ionosonde at a single point, point-to-point radio communication by reflection from the ionosphere depends upon the oblique-incidence of signals. The result is that the maximum usable frequency for communication is higher than determined by vertical-incidence observation, and the relation is an important matter for prediction services and was studied at some length by the CRPL. Also, the phenomenon of "back scatter" became a matter of considerable study in its relation to the oblique-incidence of signals by the ionosphere.<sup>94</sup>

Initial experiments on back scatter by the CRPL were begun at the Sterling, Va. station in 1946 by William L. Hartsfield, Sidney M. Ostrow, and Richard Silberstein, using a high-power pulse transmitter at 13,660 kHz. Several methods of observing the weak signals that returned from distant points were used. In the summer of 1951 another technique was introduced by using a sweep-frequency transmitter. In the short time of a single sweep the back scatter (in terms of virtual height and skip distance) can be observed as a function of frequency [19]. The reliability of backscatter echoes for determination of maximum usable frequency was checked by observations over a 1150-km path between Sterling, Va. and St. Louis, Mo. Vertical incidence observations were made at a midpoint on the path.<sup>95</sup>

In 1953 a two-way, sweep-frequency pulsed transmission system was installed to cover the 2370-km path between Sterling and Boulder for observation of backscatter and determination of maximum usable frequency at oblique incidence. Modified Model C-3 ionosondes were used as a transmitter and a receiver at Sterling and at Boulder. Special attention was given to proper choice of the transmitting and the receiving antennas. At Carthage, Ill. a Model C-3 ionosonde was used for vertical-incidence observations at the midpoint of the path. The overall frequency range of operation was from 3 to 30 MHz. The system was used for several years for these studies, as well as for study of point-to-point communication [20]. Over a period of several years of study the percent differences between the maximum usable frequency from backscatter data and from oblique-incidence data were found to be very small (median values of differences less than 1%); the difference between vertical-incidence data and oblique-incidence data was somewhat greater. Over a period of about 5 years Richard Silberstein served as project leader on oblique-incidence studies.

Analysis of the data was extended for a period after the experimental work with the objective of improving prediction methods.

Around 1958 Vaughn Agy and Kenneth Davies studied the records that had been taken over a period of years with the sweep-frequency pulse technique of observing oblique-incidence on the 1150-km (Sterling-St. Louis) and 2370-km (Sterling-Boulder) paths. The purpose was to check on the accuracy of results of observed maximum usable frequencies with calculated values based upon use of the Smith (N. Smith of NBS) transmission curves. The discrepancy was found to be around 3 percent, a result similar to that found by other laboratories [21].

## REMOTE SENSING BEYOND THE IONOSPHERE LAYERS

### 1. A pioneering project at the Long Branch field station

Early in 1958 W. E. Gordon of the School of Electrical Engineering, Cornell University, wrote a paper that was published in the November 1958 issue of the *Proc. IRE*. Gordon was well known to Kenneth L. Bowles, chief of the CRPL's VHF (Very High Frequency) Research Section, and had informed Bowles of the possibility, by means of a powerful radar,

---

<sup>94</sup> Backscatter are weak signals returned to the transmitting point from distant ground regions via reflection from the ionosphere, particularly from the  $F_2$  layer. Observation of backscatter can yield information (both instantaneous and for prediction) on maximum usable frequency and skip distance to a distant and inaccessible point by observation from the transmitter location only.

"Back scatter" had been suggested as far back as 1927 for a possible explanation of echo signals observed in round-the-world observations of radio signals by the Naval Research Laboratory (see p. 459).

<sup>95</sup> Recordings of backscatter echoes from a considerable distance often show a complex situation, that of ground scatter reflected by the  $F_2$  layer and other layers, as well as by the E layer itself.

of studying incoherent scattering of radio waves by free electrons at all levels of the ionosphere, and also of observing radar echoes from the Sun and planets. At the time Bowles had access to equipment being assembled at Long Branch, Ill. that could serve as a radar of sufficient power and sensitivity to have marginal success in observing incoherent scattering by free electrons.<sup>96,98</sup>

During daylight hours of October 21 and 22, 1958, Bowles obtained oscillograph photographs with the makeshift radar equipment that gave evidence of incoherent electron scattering at a height of around 350 km. Bowles published his rather meager but indicative observations in the December 15, 1958, *Physical Review Letters* [22].

A few months after his initial and pioneering experiment, and after improvements in the radar operation at Long Branch, in February 1959 Bowles again made observations of incoherent scattering, this time with greater confidence in the observations and with greater yield from the information gathered. Bowles was able to observe incoherent scatter up to heights of 1500 km, extending into the exosphere, including weak incoherent scatter in the presence of the strong reflections that normally occur in the D, E, and F layers.<sup>99</sup> Bowles was able to determine electron density profiles ranging up to a height of 750 km, the basic information that was being sought. These experiments resulted in a paper published early in 1961 [23].<sup>100,101</sup>

An early spinoff from the incoherent scatter technique developed by the CRPL, was that of determining ionospheric temperatures. The method had distinct advantages over several developed by other investigators. In a paper published by Thomas E. Van Zandt and Bowles in September 1960, their data on scatter radar profiles confirmed the exponential decrease of electron density in an observed region (370-520 km) above the F layer. Their determination of temperature indicated approximately 1050 K for the F layer—a temperature that checked those observed by other investigators. Later observations at the Jicamarca Radar Observatory near Lima, Peru indicated ion temperatures ranging from 800 to 1500 K, with the higher temperatures occurring at the greater heights extending into the exosphere.

---

<sup>96</sup> Long Branch is near Havana (southwest of Peoria), Ill. It was the location of an NBS field station near midpoint on a path between Washington, D.C. and Boulder, Colo., and was established in 1956 with Edwin F. Florman in charge. The many transmitters and antennas were accommodated on a 160-acre tract about 6 miles south of Havana, and operated with the call letters WWI. Much of the operation was associated with VHF transmission research programs, including those of forward scatter by the ionosphere. The station was closed down early in 1970 after several years of operation by the Institute for Telecommunication Sciences, Office of Telecommunications, Department of Commerce.

<sup>97</sup> Early in the fall of 1958 a suitable broadside array antenna was assembled at the Long Branch station that consisted of 1034 half-wave dipoles covering about four acres, with a calculated gain of 35 decibels. A newly acquired pulse transmitter operated at 40.92 MHz, with a peak-pulse power output of 1 megawatt (earlier incorrectly rated at 4 to 6 megawatts).

The pulse transmitter had been ordered for multi-path studies in meteor burst and VHF ionosphere scatter communications, but was first pressed into service by Bowles for the incoherent scatter experiment.

<sup>98</sup> Bowles was able to check the performance of the radar, and particularly the antenna, by emission from the celestial radio (noise) source of Cygnus-A that passed through the center of the antenna beam. He found this source to have a "signal" intensity approximately 10 times that of the galactic noise background.

<sup>99</sup> The ionosphere is usually defined as the region of the Earth's atmosphere above 50 km and extending out to several Earth radii, in which free ions affect the propagation of radio waves. The exosphere is the region of the ionosphere above 500 km through which the temperature remains relatively constant at 1500 K.

<sup>100</sup> Bowles was able to confirm that the intensity of scatter was approximately the same as predicted by Gordon. However, to his surprise, Bowles found that the Doppler broadening or spectrum width of the scattering was but one-tenth that predicted by Gordon. This was confirmed at a frequency of 440 MHz in early 1960 by Victor C. Pineo (formerly of the CRPL) at the Lincoln Laboratory of MIT.

In his paper published in 1961 (cited above) Bowles gave an explanation of the more limited spectrum of Doppler broadening, based on theoretical considerations. He also explained that the scatter comes from statistical fluctuations of the electron density, the distribution of which is controlled by the positive ions.

<sup>101</sup> In 1961 Bowles received the Department of Commerce Gold Medal for Exceptional Service "for outstanding contributions to radio science by the demonstration and development of techniques involving the incoherent scatter of radio waves by electrons in the ionosphere."

## 2. A specialized radar facility on a grand scale

With the initial success of observing incoherent scatter from Long Branch, a big step was taken by Bowles and his associates of the VHF Research Section (later to become the Ionosphere and Exosphere Scatter Section, with Bowles as chief) in the Upper Atmosphere and Space Physics Division of the CRPL. The big step was the design and construction of a radar with a very powerful transmitter (5 megawatts peak-pulse power at 50 MHz) and a sensitive receiver with special features, located near Lima, Peru.<sup>102</sup> The site was in a deep valley in the foothills of the Andes and the facility became known as the Jicamarca Radar Observatory. The broadside array antenna was increased to many acres in size compared with that at Long Branch and consisted of 9216 crossed pairs of half-wave dipoles over a reflecting screen, truly a huge scatter radar installation. Construction was begun in January 1961 and completed the following year.

---

<sup>102</sup> The site near Lima, Peru was selected for several reasons. Previously, no ionosphere observations of any extent had been carried on in an equatorial region, largely being confined to the temperate or arctic regions. It was believed that observations made near the geomagnetic equator would yield more definite information on identification of the ion species existing in the magnetosphere. Also, that noise clutter due to the irregular flow of electrical currents in the ionosphere was a minimum near the magnetic equator.

The antenna array was increased in size by several stages, eventually reaching an area of 84,000 m<sup>2</sup> or nearly 21 acres.

The entire project was carried on with the cooperation of the Government of Peru through the Instituto Geofísico del Perú.



*Dipoles by the thousands (9216 crossed pairs of half-wave dipoles)—covering an area of 21 acres—that serve as a huge antenna for a scatter radar installation. Construction of the facility, known as the Jicamarca Radar Observatory, began in January 1961 at Jicamarca, a site east of Lima, Peru, located near the geomagnetic equator. This venture into new realms of radio research of the ionosphere was a cooperative project of the Central Radio Propagation Laboratory and the Instituto Geofísico de Perú.*

Even before completion of the antenna array observations were begun on incoherent scatter.<sup>103</sup> In July 1962 Bowles, Gerard R. Ochs, and John L. Green reported in the *NBS Journal of Research* that a correction factor of approximately 2 must be applied to the radar equation that was applicable to their study. Also, that the average radar cross-section per free electron is usually the theoretically predicted value of one half the classical Thomson cross-section. In the February 1, 1963, issue of *Science* Bowles published a short account of the team's observations to determine electron density profiles at heights to nearly 7000 km as added information on the ionosphere and exosphere [24].

### 3. A look at Venus

Although the large antenna array at the Jicamarca Radar Observatory was very limited in its range of declination, the 3.5 degrees deviation of the main lobe from the main axis was sufficient to track echoes from the planet Venus for 3 minutes each day. In the fall of 1962 Venus made a close approach to the earth and the Jicamarca facility was used to observe 50-MHz radar echoes from its surface. The transmitter was operated at a peak-power of 4 megawatts, with alternate pulses of 3 milliseconds and 500 microseconds at 1-second intervals and a pulse-repetition frequency of 20 Hz. Occasionally the returned signal was three times the received noise power—a very favorable condition. Observations extended over a 10-day period from November 28 to December 7, 1962.

Nearly all of the returned power of the reflected signal came from an area of less than one-fortieth of the visible disk of Venus. Also observed was libration (oscillatory) fading and other short-term characteristics of the echoes. Wilfred K. Klemperer, Ochs, and Bowles participated in the Venus project [25].

### 4. A continuing program at the Jicamarca Observatory

The out-of-the-ordinary radar installation near Lima, Peru became a much-used facility for a variety of CRPL projects for which it was uniquely suited. Beginning in the fall of 1965, the Environmental Science Services Administration continued using the facility until July 1969 when operation was turned over to the Instituto Geofisico del Peru. During most of the ensuing years the facility has been the flourishing scene of many projects, including international participation.

## GEOGRAPHICAL NONUNIFORMITIES OF THE IONOSPHERE

Studies of the ionosphere soon led to the general realization that the medium was far from uniform in the nature of its several layers, height distribution of electron density, geographical zoning, diurnal and seasonal variations, and other manifestations of inhomogeneity. With the increasing number of ionosphere sounding stations scattered over the world by the United States and other nations, it became evident that the ionosphere was characterized by many anomalies.

### 1. Mapping the ionosphere on a worldwide scale

#### a) THE JANUARY 1, 1942, WORLD MAPS

The increased knowledge gained of the ionosphere by the Radio Section in the late 1930's and into the early period of World War II was sufficient to the extent that world maps or charts could be prepared to show some of its global characteristics. These maps first became available in the Radio Transmission Handbook, Frequencies 1000 to 30,000 KC of January 1, 1942, a classified document prepared by the Radio Section under sponsorship of

---

<sup>103</sup> Although the signal-to-noise ratio in the receiver of the incoherent scatter from the F region was greater than unity, the ionization densities are much lower in the exosphere. Here the reflected power is so low that the signal-to-noise ratio was of the order of  $10^2$  to  $10^4$  and an averaging of receiver output was resorted to, and statistical procedures were used for evaluation of the reflected power from free electrons.

the National Defense Research Committee (NDRC) (see pp. 403-404).<sup>104</sup> The maps indicated, on a worldwide basis, the nature of maximum usable frequencies and lowest useful high frequencies for a certain period of time.<sup>105,106</sup>

The Handbook contained an absorption index map of the world for the period of November through February, shown with curves that indicated several values of the absorption index,  $k$ .<sup>107</sup> Also prepared for the Handbook were two maps of the auroral zones, the Northern and the Southern. Although quantitative data relating to the ionosphere were quite scarce in 1942, enough experience had been gained to indicate that absorption of energy and radio waves is high in the auroral zones during periods of disturbances. Much would be learned of the regions in later years.

In the early effort at determination of distance range by a graphical method for acceptable reception of radio signals, a number of factors were considered. Among the factors was the condition of severe atmospheric noise (or "static"). In the Supplement a map indicated areas of the world where severe noise conditions exist in the summer over or near land masses extending north and south  $40^\circ$  to  $50^\circ$  from the equator.

#### b) THE 1943 WORLD MAPS

With the organization of the Interservice Radio Propagation Laboratory (IRPL) and the intensification of the radio propagation program, more ionospheric data became available and the IRPL Radio Propagation Handbook was issued on November 15, 1943. New, in this handbook, was a gyro-frequency map of the world, with contours showing the gyro-frequencies in megacycles (ranging from 0.07 MHz near the equator in eastern South America to 1.16 MHz in the Arctic and Antarctic regions). A world map showed the auroral zones. Another world map showed the auroral zones with contours indicating the absorption index,  $k$ , ranging from 0 to 2.5. A new world map for noise was an improvement over the earlier one, as it indicated noise zones with ratings by noise grade, ranging from 1 to 5. Grade 1, the lowest noise level, typified the regions of high latitudes (beyond  $50^\circ$ ), while grade 5 typified tropical regions of high noise level.

With much increased data available from widely scattered ionosondes, it became possible to chart the critical and maximum usable frequencies of the  $F_1$ ,  $F_2$ , E, and sporadic-E layers on the basis of worldwide configuration. The 1943 Handbook contained 12 absorption index charts, one for each month, thus furnishing absorption information in more extensive seasonal detail than given in the earlier handbook.

#### c) THE 1948 WORLD MAPS

The war years and early post-war years brought a wealth of information on the ionosphere, and in 1948 the CRPL brought out another handbook, *NBS Circular 462*, entitled "Ionospheric Radio Propagation."<sup>108</sup> Available, were charts showing worldwide

---

<sup>104</sup> At the time the Handbook and its Supplement (June 1, 1942) were prepared, ionosphere and field-intensity data were available to the Radio Section from six sources associated with a cooperative project sponsored by the NDRC. Included were data obtained by the 1941 Louise A. Boyd Expedition to waters west of Greenland (see ch. VII, pp. 225-226). Other sources were three ionosphere stations operated by the Carnegie Institution of Washington, and stations operated by the Canadian and British Governments.

<sup>105</sup> Quoting from the Handbook, it was stated that the "maps" were:

. . . pseudo-maps, being like maps except that the horizontal scale is longitude difference instead of longitude. They are on a rectangular projection, which is similar to but not the same as the conventional Mercator projection of the world.

<sup>106</sup> Specific maps depicted, by curves (or contours), the predicted maximum usable frequencies and the lowest useful high frequencies (in megacycles) for radio reception at a certain time of year (November 1941 through February 1942) and at specific latitudes ( $0^\circ$  and  $40^\circ$  N) of the receiving location.

<sup>107</sup> Values of the absorption index,  $k$ , were relative to the value of unity at the sub-polar point (Earth location where Sun is directly overhead). The map was plotted in terms of latitude and local time (longitude difference) of the receiving station.

<sup>108</sup> An early task of the CRPL was the preparation of a book "to meet the need for an elementary presentation of the theory and practical use of radio-wave propagation involving the ionosphere." *NBS Circular 462*, issued June 25, 1948, was, in part, a revision of the IRPL Radio Propagation Handbook that was prepared during World War II at the request of the armed services.

distribution of critical frequencies and minimum virtual heights of the E, F<sub>1</sub>, and F<sub>2</sub> layers at the equinox and December solstice (for the year 1945). Also available, for the first time, were world contour maps that could be used to predict maximum usable frequencies with consideration of distance factors. These maps incorporated the concept of three longitude zones delineated on a world scale, named the East, West, and Intermediate Zones, plus the North and South Auroral Zones.<sup>109</sup>

A new set of noise distribution maps became available in the 1948 *NBS Circular* that indicated five noise zones, ranging from 1 to 5 for degree of severity. Four maps were available, one for each of 4 monthly groups (e.g., June-July-August).

#### d) "WORLD MAPS," AND THE 1962 WORLD MAPS

After a pilot study, a project to be known as "World Maps" was initiated in 1957 for prediction of F<sub>2</sub> ionospheric propagation on a world scale, using Greenwich mean time (G.m.t.) in place of the previously used three-zone system. The simplified system used but one variable, the sunspot number. In preparing the maps the CRPL participated in a CCIR Study program for F<sub>2</sub> prediction. Over 500 maps were produced during the course of the project (also, see p. 429).<sup>110</sup>

Updated world maps became available in *NBS Handbook 90*, entitled "Handbook for CRPL Ionospheric Predictions Based on Numerical Methods of Mapping," issued December 21, 1962 (see pp. 428-429). Previously, when *NBS Circular 462* was issued in 1948, most of the ionospheric information that can be expressed by world maps had been covered at that time.

## 2. Auroral blackouts and polar cap absorption

### a) IN THE ARCTIC

By 1950 the CRPL became interested in arctic phenomena of the ionosphere as revealed by ionosonde recordings taken at several CRPL field stations spread across northern regions of the Earth. This study was begun by Vaughn L. Agy of the Upper Atmosphere Research Section. There was general interest by radio circles, including the CRPL, in the transmission characteristics of the arctic region because of the importance to radio communication within and across arctic regions. In an early paper published in *Nature* (Mar. 6, 1954), Agy noted his findings on the "probability of blackout" of no-echo conditions of the ionosphere as affected by diurnal variation.<sup>111</sup> Later, in December 1954, the work was published in greater detail [26]. In this paper Agy's study was made of vertical-incidence observations over a 4-year period (1949-1953) from 18 stations across northern regions from Sweden to Adak Island in western Alaska. The result was a series of plots that showed diurnal variations in the occurrence of "blackout" conditions.<sup>112</sup>

(Continued)

In the Foreword, the director of NBS, E. U. Condon, stated, in part:

The sciences, and indeed all fields of human activity, depend on the contributions of many individuals, and the National Bureau of Standards is indebted to many investigators and agencies for permission to use their results in this book. In particular, the excellent work that has been done by the Radio Propagation Unit of the United States Army Signal Corps is acknowledged, especially that on atmospheric radio noise. Finally, acknowledgement is made to members of the Bureau's staff who have been responsible, under the direction of J. H. Dellinger, and Newbern Smith, chief and assistant chief, respectively, of the Central Radio Propagation Laboratory, for various chapters of this book: chapters 2, 4, and 5, A. G. McNish; chapter 3, R. Bateman, H. V. Cottony, H. P. Hutchinson, and A. H. Morgan; chapter 6, W. B. Chadwick and R. Silberstein; chapter 7, T. N. Gautier; chapter 8, J. W. Herbstreit, K. H. Norton, and Edna Shultz; chapter 9, T. N. Gautier and R. Silberstein.

<sup>109</sup> For "longitude effect" see footnote 16.

<sup>110</sup> The maps were published in two sets, the first in *NBS Technical Note 2* (April 1959) and the second in *NBS Technical Note 22* (October 1960).

<sup>111</sup> "No-echo" phenomena in the Arctic had been noted by observers in the early 1930's.

<sup>112</sup> Among the conclusions reached by Agy were: that blackouts are widespread and long lasting during periods of great magnetic disturbances and that the blackout increases with latitude and is greater during the summer months (greater sunshine). At times of moderate magnetic disturbances or quiet periods, any blackouts that occur are much less defineable. Similarities between the geographical disturbances of blackouts and auroras were noted, but time distributions could differ considerably.

Another group of observations became available to the CRPL, beginning in 1951, that of field-strength data from a chain of recording stations located along a north-south corridor between the 95th and 100th west meridians from northern United States to northern Canada. Transmitters (of several frequencies) at each end of the corridor (Bismark, N.D. and Baker Lake, Canada) provided the radio signals. The project was sponsored by the U.S. Information Agency and much of the operation was by personnel of the Canadian Department of Transport. The CRPL program was to determine, with greater accuracy than before, the location and extent of the "auroral absorption zone" and how it affects high-frequency waves in crossing the zone. Although the corridor for observations was limited geographically, compared to the whole of the northern regions of the Earth, Agy was able to draw several general conclusions from his study [27].<sup>113</sup>

The regional and causal characteristics of ionospheric absorption in northern regions were quite puzzling to observers until studies were made of the great solar flare of February 23, 1956. The effects of this flare captured the interest of Dana K. Bailey while he was associated with Page Communications Engineers, Inc. (Washington, D.C.) before rejoining CRPL, and in September 1957 he published an account of the absorption event [28]. In particular, he discussed the effect of the absorption on VHF communication circuits in high geomagnetic latitudes. Significantly, it had been observed that the absorption was accompanied by a large increase in cosmic-ray intensity, and that during the absorption period of several days there was but little evidence of magnetic disturbance or auroral activity.<sup>114,115</sup> After rejoining the CRPL, Bailey published an extensive tutorial paper in 1964 on polar-cap absorption [29]. In an interim paper Bailey outlined three distinct radio techniques for the detection and study of the solar cosmic rays associated with polar-cap absorption, including the use of riometers.<sup>116</sup>

Among the studies of polar blackouts by the CRPL that aided in an understanding of polar-cap absorption (PCA) was a 30-minute animated sound motion picture produced by Agy, depicting polar blackouts during the IGY. The picture was shown by Agy at the 5th technical meeting (Radio Wave Absorption in the Ionosphere) of the Ionospheric Research Committee of AGARD (NATO Advisory Group for Aerospace Research and Development), June 1960, at Athens, Greece, and again at the International Conference on Cosmic Rays and Earth Storms (September 1961) at Kyoto, Japan.<sup>117</sup> On each occasion Agy presented a paper on the subject of black-out characteristics.

---

<sup>113</sup> Among the conclusions were: the auroral absorption zone is centered near the center of the visual auroral zone (around 60° north latitude, in area of the chain of recording stations), the auroral absorption zone may be no more than 6° wide, and nighttime absorption is increased during magnetic disturbed periods for transmission paths that cross the auroral zone.

<sup>114</sup> Later, it became increasingly clear to investigators that two large-scale absorption phenomena occur in polar regions: (1) "auroral absorption" that occurs in general association with aurora and magnetic disturbance and is confined to the auroral belt; and (2) "polar-cap absorption" (PCA) that is now considered to be but indirectly associated with the auroral ring, and is believed to be due primarily to ionizing effects of high-energy solar protons at lower altitudes down to 50 km at a location where the atmosphere is much less conducting than at the upper ionosphere layers. Much of the effect is associated with the D region.

<sup>115</sup> In March 1959 the CRPL sponsored a Conference on Arctic Communication, held at the Boulder Laboratories. Many of the papers related to recent research of the ionosphere in arctic regions, others to the engineering aspects of arctic communication.

<sup>116</sup> The riometer (relative ionosphere opacity meter) was developed by C. Gordon Little and H. Leinbach at the Geophysical Institute, University of Alaska, College, Alaska (later, in 1958, Little joined the CRPL). The riometer measures absorption of cosmic radio noise in its passage through the ionosphere and has proven to be a valuable and relatively simple apparatus for observing polar blackouts and for observation of conjugate-point phenomena [30].

<sup>117</sup> Reception of the film at the Athens meeting was evidenced by the speaker for the Concluding Remarks of the 4-day conference, when he stated: "The progress (of Polar-Cap Absorption events) has strikingly been shown by Agy's film."



PCA EVENT OF OCTOBER 20-23, 1957  
(GMT)



Twelve frames from a 30-minute animated sound motion picture of the polar cap absorption (PCA) event of October 20-23, 1957. Against a background of land masses (gray areas) surrounding the Arctic Ocean and adjacent waters (white) are depicted, in black, the areas of extensive absorption or "blackout" of radio waves in the ionosphere. Beginning October 20, the absorption area increased to a maximum on the following day, then decreased slowly, and vanished on October 23. Most probably, the cause of PCA is the rather intense ionization effect of high-energy solar protons in the lower ionosphere.

b) IN THE ANTARCTIC

In 1959 Robert W. Knecht, chief of the Sun-Earth Relationships Section, published a report on observations of the ionosphere over the south geographic pole taken on a C-3 ionosonde placed in operation at the South Pole Station in June 1957. Knecht found that F-region ionization persists during the 6-month winter night, even in the absence of sunlight during most of the period. Also, that diurnal variations of the critical frequencies of both the  $F_1$  and  $F_2$  layers occur throughout the year.<sup>118</sup>

After a pilot experiment in the winter of 1961-1962 on conjugate point observations with riometers (see footnote 116), a study of ionospheric absorption with riometers was made by the CRPL in the Antarctic during the period of December 1962-April 1964.<sup>119,120</sup> In the May 30, 1964, issue of *Nature* Hugh J. A. Chivers and John K. Hargreaves of the High Latitude Ionospheric Physics Section reported on riometer measurements of the absorption of 30-MHz cosmic radio noise at both stations of each of three pairs of magnetically conjugated

<sup>118</sup> Knecht's report was followed in 1962 by one on studies of IGY data prepared by W. R. Piggott of the Radio Research Station, Slough, England, and A. H. Shapley of the CRPL. Their report, entitled "The Ionosphere over Antarctica," was published, among other papers on Antarctic research, by the American Geophysical Union as *Geophysical Monograph Number 7*. The report was primarily studies of the  $F_2$  layer in the Antarctic, but included studies of polar-cap absorption events.

<sup>119</sup> The concept of conjugate point studies is that of observations made at opposite ends of a given line of the geomagnetic field that permit investigation of geophysical phenomena, such as ionospheric absorption, which are propagated along the field.

<sup>120</sup> By 1963 a complex of riometer stations was in operation in eastern Canada (three operated by the CRPL, seven by the Defence Research Telecommunications Establishment of Canada) which provided a means of observing the extent and movement of absorption patches in the ionosphere. With the aid of a computer it was possible to map absorption movement with respect to time and latitude. This technique was used in mapping the large absorption events that occurred in the region during and after the period of September 26-29, 1963.

stations.<sup>121</sup> In a subsequent paper they reported that in the region of the South Pole the absorption activity followed a diurnal pattern, with greater intensity of activity at night, but of shorter duration than during the day.

Another program in the Antarctic was one of the various projects engaged in by the CRPL during the IQSY (International Geophysical Year of the Quiet Sun) of 1964-1965, that of a phase of cosmic-ray research by use of the technique of ionospheric forward scatter. This was a cooperative project of NBS with the Bartol Research Foundation of the Franklin Institute, Swarthmore, Pa. The program was directed by Dana K. Bailey of NBS and M. A. Pomerantz of the Bartol Research Foundation.<sup>122,123</sup>

<sup>121</sup> Three stations were in eastern Canada, with their three magnetically conjugate stations in the Antarctic (one at the South Pole).

<sup>122</sup> At the time, Bailey was a consultant in the Upper Atmosphere and Space Physics Division; Pomerantz was chairman of the U.S. National Committee for the IQSY.

<sup>123</sup> Bailey had been much involved in ionospheric forward-scatter research since 1951, initially, in developing a new method of radio communication and, later, using forward scatter as a rewarding means of observing phenomena associated with the ionosphere (see section on Ionospheric Forward Scatter). He authored a number of papers in this area of radio research, among them being a survey paper on the intense absorption of radio waves in the lower ionosphere, including the mesosphere, published in 1964 during the IQSY program (see [29]).



*Looking down on an area of the South Pole station on a bright day in January. The view is from the top of one of twin towers supporting ionospheric forward-scatter antennas—the tower's shadow (vertical to photo) can be seen at lower right, with the photographer's shadow at center right. The tower at upper center supports the antennas for vertical-incidence ionosphere sounding. The station was one in a chain of five for study of ionospheric forward scatter in the Antarctic during the IQSY program of 1964-1965.*

Early in 1964, during the mid-summer season in the Antarctic, Wesley B. Harding and Milton W. Woodward of the CRPL engineered the installation and activation of forward-scatter circuits at five stations on the Antarctic Continent.<sup>124</sup>

Following the 21 months of forward-scatter observations in the Antarctic, Bailey and Pomerantz published two papers on the effects of precipitation of high-energy (relativistic) particles into the lower ionosphere.<sup>125</sup> Later, in 1968, Bailey published an extensive paper that encompassed this subject, but confined the treatment to observations made in the Arctic [31]. This paper included data, and Bailey's analyses, taken by a variety of ground-based observing techniques.

<sup>124</sup>The four forward-scatter paths had terminals at three U.S. stations including the South Pole, at the United Kingdom station located on Halley Bay, and at the Vostok station operated by the U.S.S.R. (see accompanying map).

<sup>125</sup>Previous to the forward-scatter method of observing solar proton emissions in the Antarctic, observations in the Arctic had been made in the frequency range of 32 to 36 MHz. In the Antarctic, during a period of minimum solar activity, the frequency range was lowered to a narrow range between 23 and 24 MHz for increased sensitivity in observing the effects of charged particles over a greater energy spectrum.

After installation of the equipment by NBS, the forward-scatter observations in the Antarctic were made by personnel associated with the Bartol Research Foundation. The large-scale project was financed by the National Science Foundation.

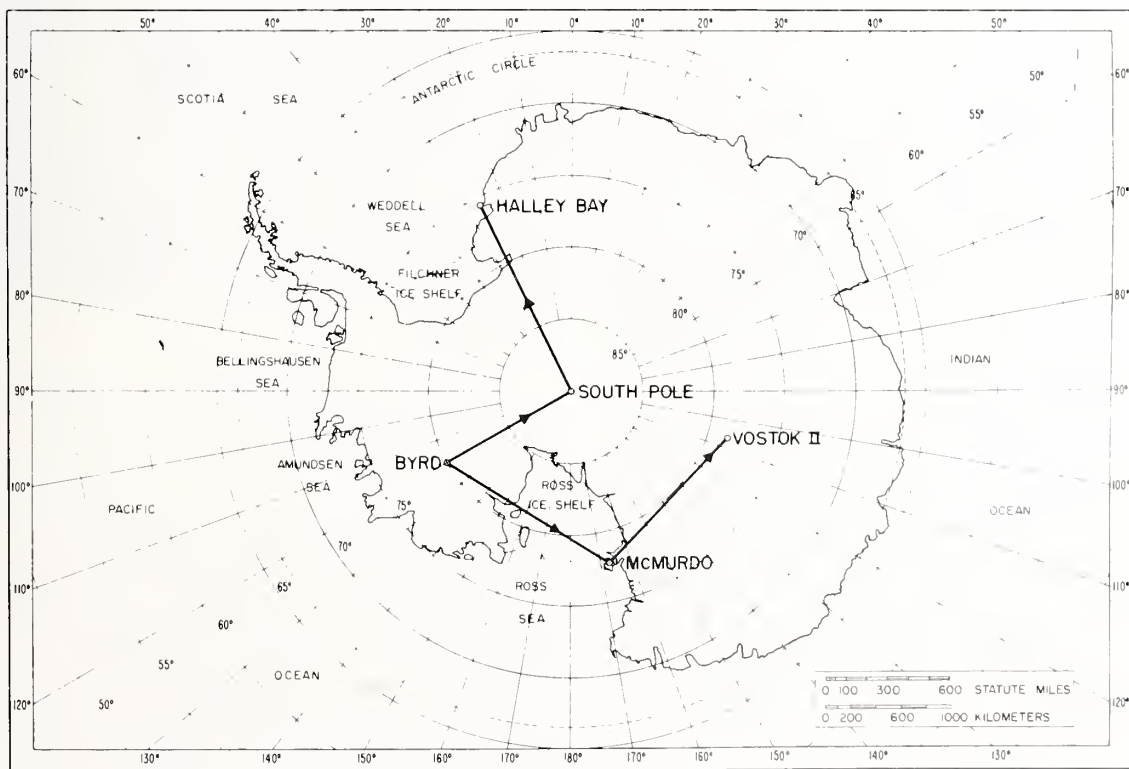

Location of transmitting and receiving stations for study of forward scatter in the Antarctic. The IQSY (1964-1965) study was a cooperative program of NBS and the Bartol Research Foundation. The Vostok II station was operated by the U.S.S.R., and the Halley Bay station by the United Kingdom.

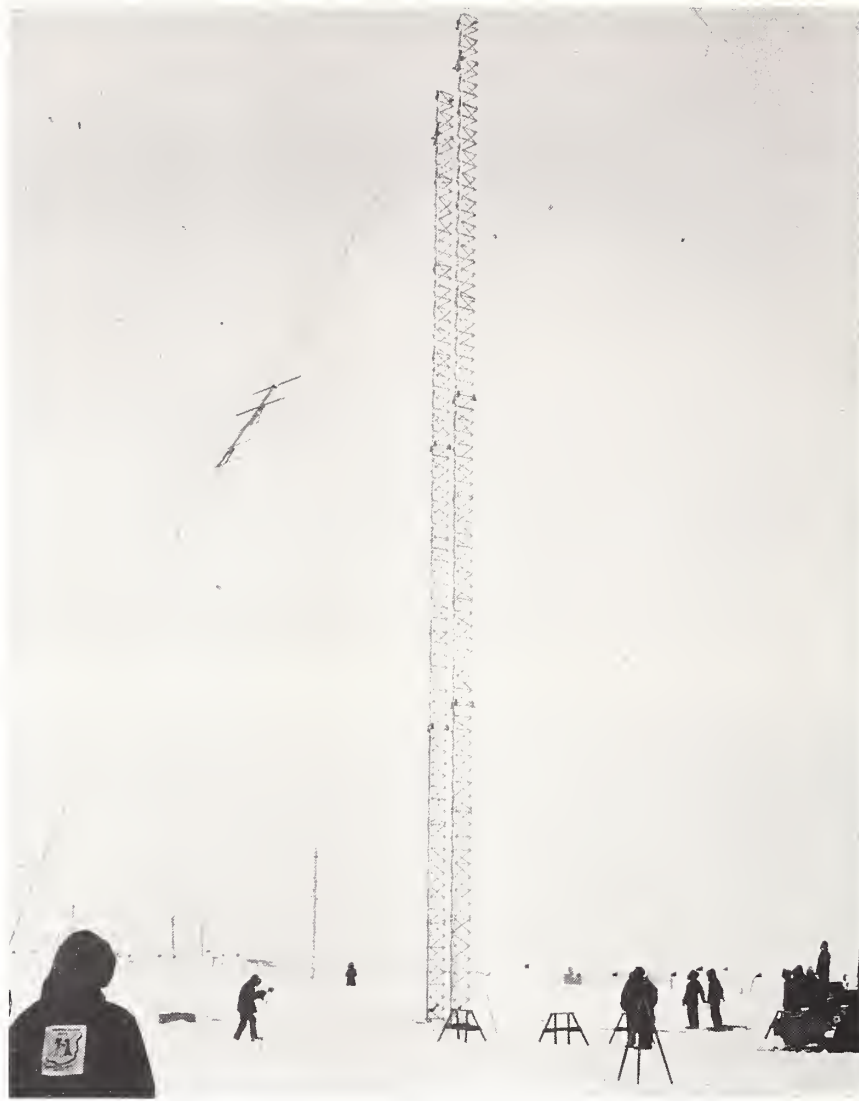

*Raising a five-element Yagi antenna for mounting at top of twin 131-ft towers at the U.S.S.R.-operated Vostock II station in Antarctica. This photograph, taken in March 1964, shows one of a group of five stations used in an IQSY (International Geophysical Year of the Quiet Sun) program of observing ionospheric forward scatter in the Antarctic. Wesley B. Harding and Milton W. Woodward of the CRPL engineered the installation and activation of the transmitters, receiving equipment, and antennas for this 2-year operation. The program led to a better understanding of the lower region of the ionosphere.*

### **3. Ionospheric observations near the geomagnetic equator**

#### **a) VHF SIGNALS ACROSS THE GEOMAGNETIC EQUATOR**

The success achieved by the CRPL in research conducted in temperate and arctic regions on ionospheric VHF forward scatter as a mode of radio communication gave impetus for continuing the research with experiments in equatorial regions or, more specifically, in the region of the geomagnetic equator.<sup>126</sup> The IGY program provided such an opportunity, both by funding and in the diversification of its ionosphere research projects. Planning for the VHF forward-scatter project began in 1955 with the guidance of Bowles and later, of Robert S. Cohen. Transmitters, receivers, and antennas for operation at 50 MHz were transported to South America and measurements conducted during a 1-year period from

---

<sup>126</sup> The reader is referred to pp. 485-498 for an account of the earlier CRPL research on ionospheric VHF forward scatter.

December 1957 through November 1958.<sup>127</sup> Additional experimentation and measurements were continued by the CRPL subsequent to the IGY program.

<sup>127</sup> Observations were made over two transequatorial paths straddling the geomagnetic equator along the west coast of South America. The shorter circuit of 1230 km was used to observe scattering effects in the lower E region of the equatorial ionosphere. Later, a path across South America, parallel to the geomagnetic equator, was operated for further studies of VHF forward scatter.



*One of four radio receiving mobile laboratories being loaded in August 1955 at the Boulder Laboratories for shipment to South America as a facility in an IGY program to study ionospheric forward scatter across the geomagnetic equator. After test runs in several locations, the trailers were barged down the Mississippi River to New Orleans, then by freighter to South America. Standing, left, by the trailer are Kenneth L. Bowles (left) and Robert S. Cohen, who were in charge of the project. The destination of this trailer was Guayaquil, Ecuador.*

Bowles and Cohen reported on this project in several publications over a period of about 8 years. A summary report was published in 1963 [32]. By 1963 a number of interesting conclusions had been reached from the research of VHF forward scatter near the magnetic equator. It was found that E-region scatter predominated and that the intense daytime scattering is largely due to the equatorial electrojet.<sup>128</sup> The weakest signals caused by scattering in the E region were comparable to the strongest signals propagated over similar paths in temperate regions. Lesser scattering was observed from the D-region and some nighttime scattering from F-region irregularities (also, see sec.: Studies of the Ionospheric Regions, 2. Observing scatter F—on spread F at the geomagnetic equator).

<sup>128</sup> The "equatorial electrojet" is the concentration of electrical currents flowing in the ionosphere in a narrow belt along the geomagnetic equator.

The work of Bowles and others in South America with incoherent scattering technique (see sec.: Remote Sensing Beyond the Ionosphere Layers) led to many observations of ionospheric characteristics in the region of the geomagnetic equator.

#### b) AFRICAN STUDIES

To further enhance the knowledge of ionospheric propagation in equatorial regions, experiments were conducted in Africa during two periods of 1961 in cooperation with the U.S. Information Agency. Transmissions of 20 and 50 MHz from Tripoli, Libya were observed by ionosonde recording at Accra, Ghana over a 3300-km path.<sup>129</sup>

The most interesting phenomenon observed was the appearance of echoes from spread F shortly after sunset. There was evidence that the reflections resulted from scattering by clouds of electrons moving rapidly along the Earth's magnetic field.

#### 4. "Far East Anomaly"

By the mid-1950's the U.S. Army Signal Corps had constructed several links of a network of stations in the Western Pacific for communication by ionospheric scatter propagation.<sup>130</sup> During the operation at 36.4 MHz of an experimental circuit between the Philippines and Okinawa in the period of May 1956 to May 1957 a new phenomenon was discovered that became known as the "Far East Anomaly."<sup>131</sup> Although Ernest K. Smith of the CRPL had been aware of a high incidence of sporadic E in the area, this previously undiscovered phenomenon was found to be associated with the F layer. Beginning in September 1957, a second circuit was placed in operation for 1 year for measurement of sporadic E at 50 MHz by the CRPL as part of the IGY program for studying the ionosphere on a worldwide scale.<sup>132</sup>

Unexpectedly, it was observed that during the evening hours the signals would often increase by 40 to 50 dB above the normal level on the 36-MHz circuit and 30 to 40 dB on the 50-MHz circuit [33,34]. The enhancement of signals reached a maximum during September and October.<sup>133</sup> Pulse-delay measurements indicated that reflection was from the F layer and, also, that the signals would usually arrive from a direction somewhat angled from the great circle path.

There was reason to believe that the anomaly is associated with equatorial spread F (see pp. 425-426).<sup>134</sup> Various speculations have come forth to explain the anomaly.

---

<sup>129</sup> Tripoli lies considerably north, while Accra lies just south of the geomagnetic equator, thus the signals crossed the magnetic equator.

<sup>130</sup> For information on the development of communication by ionospheric forward scatter see section "NBS Pioneers in Radio Communication by Ionospheric Forward Scatter" of this chapter.

<sup>131</sup> The experimental circuit of 1329-km distance was constructed and operated on contract to Page Communications Engineers, Inc. of Washington, D.C. Ross Bateman, formerly chief of the CRPL's Ionospheric Research Section, was in charge of the project.

<sup>132</sup> The second experimental circuit of 1347-km distance was placed nearly parallel to the first circuit and was constructed by the Page Company.

<sup>133</sup> A seasonal enhancement of signals appeared during the vernal equinox at 36 MHz but appeared only in 1957 for the 50-MHz signals. The enhancement of signals would usually begin in the early hours of the evening, increase rapidly, level off, and then return to normal level around midnight.

Because of its association with the evening hours, the signal enhancement is occasionally called the "evening signal anomaly."

<sup>134</sup> At no time was there any relation observed of this anomaly with the state of the Earth's magnetic field. From observations made by the CRPL in the Caribbean during the IGY ionosphere program on sporadic E there was no evidence of the Far East Anomaly.

A second expedition was made by the CRPL to the Phillipines-Okinawa area during September and October 1959 for further observation of the Far East Anomaly. During this period the 50-MHz signals were monitored at four moderately distant stations in several directions from the transmission path, with observation that the Anomaly was somewhat widespread in the Western Pacific.

# THE SUN—THE ALL-POWERFUL CONTROL OF THE IONOSPHERE<sup>135</sup>

## 1. A long-time study of solar activity

### a) TAKING ACCOUNT OF THE SUN

In an NBS publication of 1938, Smith, Gilliland, and Kirby of the Radio Section called attention to their study of the Bureau's ionosphere observations from 1933 to 1938 [35]. It was a period of increasing solar activity, from a sunspot minimum in 1933, and was accompanied by large increases in ionization of the upper atmosphere. They concluded from this study that:

. . . there is a good correspondence, and in the case of the E-layer, correlation in considerable detail, between the averages of sunspot numbers and the critical frequencies (or ionization densities) of the various ionosphere layers. This means that the averages of sunspot numbers give a good criterion of the general level of solar activity, and a good index to the general amount of the ionizing radiation emitted from the sun. Exact correlation is indeed not to be expected in detail, since sunspots and the ionizing radiation are two different manifestations of solar activity, which follow the same trend in general but not in detail.

The existence of these relations, together with the vast amount of data available on sunspot activity in the past, suggests the possibility of forecasting the average condition of the ionosphere on the descending half of this cycle, and perhaps even in future cycles. Accordingly, average radio-transmission conditions and average optimum frequencies for radio communication over different paths can be estimated, months and even years in advance.

After 1 1/2 years of operation, the IRPL issued a research paper for restricted distribution, entitled "Methods used by IRPL for the prediction of ionospheric characteristics and maximum usable frequencies," (IRPL-R4, 31 Dec. 1943). Of significance was the statement in the Introduction:

The essential basis of long-time predictions is the fact that the critical frequencies and virtual heights of the ionosphere layers are subject to regular variations diurnally, seasonally, and from year to year with the sunspot cycle. These variations repeat themselves in a sufficiently regular manner so that average characteristics can be predicted with reasonable accuracy.

Over a period of about 7 years there had evolved within the Radio Section a method of determining the maximum usable frequencies (muf) for radio transmission via the ionosphere, based upon critical frequencies from observations of virtual heights of the ionosphere layers by vertical-incidence measurements (see ch. VII). By April 1942 the Radio Section was able to produce worldwide prediction charts that were based upon time of day and year, latitude and longitude, and sunspot numbers (see pp. 407-409). In turn, these charts yielded in advance the desired information for selection of maximum usable frequencies.<sup>136,137</sup>

A later contribution to the research papers on the relation of the ionosphere to solar activity, initially issued for restricted distribution by the IRPL, was published in 1947 by

<sup>135</sup> Quoting from the First Annual Report of the Boulder Laboratories for period July 1, 1954-June 30, 1955 (p. 52), the statement was made for the Sun-Earth Relationships project, that:

It is the sun which provides all but perhaps an infinitesimal amount of energy to the earth's atmosphere and is therefore basically responsible for the ionospheric conditions which make possible and influence the propagation of radio waves over long distances.

<sup>136</sup> The method of predicting ionosphere characteristics and maximum usable frequencies, and thus successful transmission via the ionosphere, is rather complex and too detailed to cover in this treatment. The reader is referred to the IRPL Radio Propagation Handbook (November 15, 1943), the IRPL-R4 (December 31, 1943) for their

Marcella L. Phillips [36]. A study had been made of records for time variation of noonday critical frequencies of  $F_2$ ,  $F_1$ , and E layers of the ionosphere over a period of 12 years at three locations (Washington, D.C., Peru, Australia). Comparison was made with the variation of Zurich sunspot numbers over the same period. From this study the author concluded:

Because of the precision in measurement of ionospheric critical frequencies, their close correlation with solar activity, their ability to measure far lower values of solar activity than those given by sunspot-numbers, and their consistence, as demonstrated above, their use seems to afford what at present may well be our most precise measure of general solar activity.

Although the passage of time showed that this concept is generally true, there are many complicating factors involved in the complete overview of the Sun's activity as observed from the Earth platform.

#### b) PREDICTING SUNSPOT NUMBERS

In 1944 Alan H. Shapley published a short account on estimating the epoch of the coming minimum of solar activity (at year 1944.9) and the succeeding maximum (at year 1949.6).<sup>138</sup> He estimated the height at maximum activity to be at 80 (relative number  $R_M$ ). His estimates were based upon investigations of earlier sunspot cycles by others.

Following in the train of a number of investigators beginning around 1930 (and including Shapley), Alvin G. McNish and J. Virginia Lincoln of the Upper Atmosphere Research Section developed a method of predicting sunspot numbers which they published in October 1949 [37]. They developed a formula for predicting smoothed annual sunspot numbers based upon sunspot observations going back to 1834 and upon some information as far back as 1755. The importance of their work, along with that of their immediate predecessors, was, in their own words:

Until recently these predictions were largely of academic interest, but with the discovery of the close relationships which exist between radio propagation conditions and sunspot activity the prediction of sunspot numbers has assumed great practical importance.

In a subsequent publication, 5 years later (1954), they found that the formula they had developed worked quite satisfactorily for the 11-year cycle just completed, in spite of the fact that the sunspot numbers had been the highest recorded since 1834. Their method of predicting sunspot numbers has had useful application over the years to the present time.

#### c) THE SUN IN RELATION TO THE WORLD

A nearly 20-year program of Sun-Earth relationships by the CRPL had its start in the Radio Disturbance Analysis project within the Basic Ionosphere Research Section. This was

---

(Continued)

historical significance, or to *NBS Circular 462*, entitled "Ionospheric Radio Propagation" (June 25, 1948) for more complete technical accounts.

<sup>137</sup> The growing scope of knowledge of the ionosphere by members of the Radio Section permitted them to say, with assurance, in the IRPL-R4 research paper:

Since the ionosphere is produced by radiation from the sun, the variations of that radiation are related to at least some of the variations of the ionosphere. The first step in predicting ionosphere characteristics, therefore, is to predict the amount of ionizing radiation emitted from the sun. It has been found that in general, but not in detail, sunspot numbers are a measure of solar activity, and of emission of ionizing radiation. On the average, a high value of sunspot number corresponds to a high value of ionizing radiation and consequent ionization of the earth's atmosphere. Thus a prediction of the average sunspot number is the first step in making an ionosphere prediction.

Note: Changes in ionization density of the Earth's atmosphere cause changes in heights of the ionosphere layers which, in turn, determine the maximum usable frequencies for various distances of transmission.

<sup>138</sup> At the time Shapley was with the Department of Terrestrial Magnetism, Carnegie Institution of Washington, D.C. In 1947 he joined the CRPL, later to become chief of the Sun-Earth Relationship Section.



early in 1947 when Alan H. Shapley entered the CRPL as leader of the project. Later, a separate project was initiated for the more specialized field of solar-terrestrial relationships, with one of the tasks that of preparing solar-flare information for publication in the CRPL-F series, Part B on Solar Geophysical Data. Other work within the project, until the move to Boulder in 1954, was in the area of coronal-magnetic correlations, sunspot number predictions, and indices for solar activity.

With the move to Boulder, a close cooperative relationship was established with the High Altitude Observatory (HAO) of Harvard College and the University of Colorado.<sup>139</sup> For the next 10 years there were many cooperative projects between NBS and the Observatory, including joint authorships on a number of published papers. Among the projects was the preparation of the joint HAO-NBS Weekly Report on Solar Activity (later, with daily information from Sacramento Peak Observatory, New Mexico).

The early purpose of the Sun-Earth project (later to become the Sun-Earth Relationships Section, with Shapley as chief) was:

. . . to understand more fully solar activity and its effects on the earth; more particularly to study the amount, kind, and variations of solar radiation which interacts with the ionosphere, the origin in the sun of the radiation, the mechanisms of its emission, its trajectory, the mechanism of its interaction with the earth's atmosphere, and the special methods for detecting the solar effects on the atmosphere.<sup>140</sup>

In pursuing the objectives of the section's projects much of the work was slanted toward studies of the Earth's geomagnetic and ionospheric storms as a result of solar flares and other manifestations of the Sun's activity. An abundance of papers was published over a period of nearly 10 years.

In 1959 Constance S. Warwick and Marion B. Wood reported on their study of the relation of limb flares to short-wave fadeouts and radio-noise bursts [38]. Their information came from a variety of sources. Of considerable interest was their conclusion that radio-noise bursts at 2800 MHz are strongly related to the occurrence of short-wave fadeouts, an observation that had been made by other investigators several years earlier. Taking cognizance of this strong relationship, the Radio Warning Services Section initiated observation of radio-burst noise at 2800 MHz three times daily as a measure of solar activity for its radio disturbance warning service.

## 2. The Radio Disturbance Warning Service<sup>141,142</sup>

### a) REPORTING ON RADIO RECEPTION—A PREWAR SERVICE

The Radio Section first began publishing its observations of ionosphere disturbances and fade-outs on a monthly schedule through the medium of the *Proc. IRE* beginning with

---

<sup>139</sup> The High Altitude Observatory had its beginning in 1940 at Climax (on the Continental Divide, to northeast of Leadville), Colo., as a field observatory of the Harvard College Observatory. At this site was installed the Western Hemisphere's first coronagraph—a telescope for observing the Sun's corona by creating an artificial eclipse. Later the observatory was operated jointly by Harvard College (University) and the University of Colorado, with Walter Orr Roberts as its first director (see ch. XIX, p. 708). The HAO was a source of information on solar disturbances during World War II for the IRPL warning service, the information being received by telegraph and via the Carnegie Institution of Washington.

The High Altitude Observatory became a part of the National Center for Atmospheric Research (Boulder) in 1961, although much of its operations continued on the campus of the University of Colorado.

<sup>140</sup> Some years later the purpose was extended to a better understanding of solar emission of particles that cause geomagnetic and ionospheric storms, and their measurement by means of rockets or balloons.

<sup>141</sup> Considerable attention and space has been given to the topic of the Radio Disturbance Warning Service. For it was Dellinger who said in 1961 if he were asked "What was the most outstanding of all the Bureau's radio achievements in these fifty years?" he might answer ". . . it was the propagation prediction and warning service. . . ." (see app. D, p. 795).

<sup>142</sup> The reader is referred to a somewhat similar but more detailed account of the NBS Radio Disturbance Warning Service, entitled "Ionospheric Forecasting in the United States 1942-1966," prepared by J. Virginia Lincoln for presentation at a session on History of Ionospheric Forecasting at the AGARD Conference of September 1969 at Greyrocks (near St. Jovite, Quebec). The account was published (January 1970) in the *AGARD Conference Proceedings No. 49* by NATO Advisory Group for Aerospace Research and Development.

the September 1937 issue (see ch. VII, pp. 236-237).<sup>143</sup> These monthly publications were primarily reports on maximum usable frequencies, virtual heights, and critical frequencies of a previous month, but as the series progressed the reports contained information (by means of graphs) for predictions of radio transmission conditions several months in advance. Although the reports were supplemented with observations of ionosphere disturbances and fade-outs, there was no attempt to predict the occurrence of these interruptions to radio transmission. The reports continued to the time of the U.S. entry into World War II, the last issue being December 1941. Thereafter the information was made available as mimeograph copies to the armed services.

#### b) THE IRPL GIVES AID TO WORLD WAR II COMMUNICATIONS

It was the accepted belief that excessive bursts of radiation and emission of high-speed corpuscles by the Sun cause interruptions to radio transmission, and there existed the hope that these interruptions could be predicted in advance.<sup>144</sup>

Progress had been made by 1938 in rating the degree of ionospheric "storminess," both in the ionospheric "character" and the magnetic "character" by numerical ratings of severity.<sup>145</sup> Although reports on the degree of ionospheric storminess of a past month were of interest, a more useful service to the armed services would be that of forecasting ionospheric disturbances as an aid to radio communication. Beginning in 1942, a prediction service was provided by the IRPL on a weekly schedule, with the information available via IRPL-J series of classified publications (see footnote 24). Although useful, the disturbance prediction service was not as successful as that provided for selection of frequencies for ionospheric propagation.<sup>146</sup>

---

<sup>143</sup>The first NBS publication on ionospheric disturbances had appeared as a Letter to the Editor in the November 15, 1935 issue of the *Physical Review* (see ch. VII, pp. 227-228). The first NBS publication on fade-out or sudden ionospheric disturbance (SID) appeared in the October 11, 1935, issue of *Science* (see ch. VII, p. 221).

<sup>144</sup>This hope was well expressed in an unpublished IRPL report of limited circulation, entitled "Solar Variability," dated 10 January 1944 (not of the IRPL-R series). The report concluded with the paragraph:

Predictions. A perfect correlation still remains to be found but the discovery of a mechanism for the prediction of the ionospheric storms is an important first step. It is to be hoped that future studies, carried over at least a complete cycle (11-year cycle of sunspots), of all of the observable features of solar variability may enable the student to forecast storms with a reasonably high degree of precision.

<sup>145</sup>The ionospheric character figure (I) for ionospheric disturbances observed at Washington, D.C., was based on an arbitrary scale of 0 to 9, to indicate quality of radio transmission, with 9 representing the greatest disturbance. The American K-figure for magnetic character of the magnetic storm that is associated with ionospheric storms was determined by seven observatories on an arbitrary scale of 0 to 9, with 9 representing the most severe disturbance. Both numerical systems had supplanted earlier systems of different numerals.

<sup>146</sup>An evaluation of the prediction service as viewed by the IRPL after the close of hostilities can be gained from the Radio Section's Monthly Report for November 1945 (Radio File) which stated:

Warnings and forecasts of ionospheric and radio disturbances:

Monitoring service, magnetic measurements, and direction-finding measurements, principally at the Sterling, Va. station, and also at various cooperating laboratories, enabled detection of ionospheric disturbances in their early stages by means of radio propagation failures over paths crossing auroral regions and by geomagnetic abnormalities. Warnings of such storminess were given to the Armed Services and a few commercial companies. An 'alerting' service for ionospheric storminess was maintained by means of a weekly or semiweekly forecast of disturbed conditions for several days in advance. This was made chiefly on the basis of solar data, ionospheric disturbances generally being associated with solar meridian passage of pronounced sunspots or flocculi at the proper solar latitude, thus usually recurring with the 27-day solar rotation period. Forecasts of this type were effective during part of the declining solar-activity cycle, before spots of the new cycle became numerous. Fortunately, the earlier part of the war took place during this phase of the solar-activity cycle. Later forecasts were far from precise because, although sometimes advance information is given by east-limb coronal data, as yet, no good method was developed for the forecasting of new active solar areas. This work is being maintained as a peace-time service.

c) A RADIO DISTURBANCE WARNING SERVICE

1) A service to radio communications

On January 9, 1946, the Bureau's station, WWV, began broadcasting ionosphere disturbance warnings and continued the service until October 1, 1976.<sup>147</sup> Beginning in October 1965 the information for broadcasting was furnished by the Environmental Science Services Administration, and later by the Institute for Telecommunication Sciences, until the service was discontinued on October 1, 1976. Over much of this long period the short-term forecasts were broadcast at intervals ranging from once to many times each hour.

From the time that the Sterling Radio Propagation Laboratory began operations in 1943 at Sterling, Va., facilities became available for the ionosphere prediction service, including the disturbance warning service. On October 18, 1949, the prediction operation was moved to Ft. Belvoir, Va., on the grounds of the Army's Corps of Engineers, located on the Potomac River south of Washington. The station, known as the Ft. Belvoir Radio Propagation Field Station, was located at this site for 18 years until the facilities were moved to Boulder, Colo. in July 1968.<sup>148,149</sup> During nearly the entire period of operation, Edward J. Wiewara served as the engineer-in-charge.

In the fall of 1951 a similar operation was initiated at the Radio Propagation Field Station at Anchorage, Alaska, to be known as the North Pacific Radio Warning Service (in 1964 changed to CRPL High Latitude Space Environment Monitoring Station). The service covered radio communication paths extending from California through Alaska and across the Pacific to Japan. Beginning on January 5, 1954, the warnings were broadcast by WWVH in Hawaii, with coverage over the entire Northern Pacific.

---

<sup>147</sup>From 1946 to 1952 several types of coded signals were used to indicate the quality of radio transmission. Beginning on July 1, 1952, a scale of 1 to 9 was used to forecast the quality of transmission, the digit 1 denoting an impossible propagation condition and 9 an excellent condition (the digit system was reversed from that used previous to World War II). The digit scale, to become known as the CRPL radio quality figure scale, was used until 1976 when the warning service was discontinued.

From 1946 to 1971 the disturbance warnings broadcast by WWV were in the International Morse code. Beginning on July 1, 1971, the warnings were broadcast by voice announcements.

<sup>148</sup>This CRPL field station served as a collecting point for observations of radio, ionosphere, solar, and geomagnetic phenomena taken at stations scattered over much of the world. However, it did perform an important function in furnishing disturbance warnings on a scheduled basis to aid radio communication over North Atlantic paths that are subject to the severe ionosphere disturbances in the auroral belt. For this, the station's operation was known as the North Atlantic Radio Warning Service. In October 1965, upon the formation of the Environmental Science Services Administration (ESSA), the station was named the Telecommunications and Space Disturbance Service Center.

Along with facilities for receiving and transmitting propagation information by land lines and radio, the station was fitted with an automatic ionosphere recorder (ionosonde), a radio direction-finder, radio field-intensity equipment, and a means of measuring the vertical and horizontal component and declination of the Earth's magnetic field. Most of these observational techniques had been developed and used at the Sterling station in the earlier years. With this equipment, plus information obtained on sunspots, it was possible to prepare short-term (up to 12 hours) disturbance warnings. The warnings were based upon observations of reduced height of the upper ( $F_2$ ) ionosphere layer, of large variations in direction and large variations and reduced magnitude of the Earth's magnetic field (observations aided by those of the Coast and Geodetic Survey), of bearings and "bearing swings" of the radio direction-finder, and on information of sunspot activity furnished by several observatories.

In 1960-1962 the Ft. Belvoir facilities were used for an extended period in preparation for, and furnishing of, special propagation forecast information to several NASA facilities for the Project Mercury earth orbital flights. The staff of the North Atlantic Radio Warning Service was congratulated by NASA for contributing to the success of the October 1962 flight by Astronaut Shirra and the one of May 1963 by Astronaut Cooper.

<sup>149</sup>In 1959 members of the North Atlantic Radio Warning Service received the Department of Commerce Silver Medal for Meritorious Service as a group award "for outstanding dependability and extremely competent performance of duties, as a member of the International Geophysical Year Radio World Warning Group, under unusually hazardous circumstances and extreme personal hardship."

The members included:

Norbert Bender	John W. Pritting
Kent Boggs	John J. Sullivan
Lawrence A. Jones	James M. Weldon
Roger C. Moore	Edward J. Wiewara



*The Warning Service Building was one of four buildings used by the CRPL in its 16-year operation (beginning in 1949) of the Fort Belvoir field station south of Washington, D.C. The antenna structure at left of building was for the direction finder, the antenna at right was for field-intensity measurements of transatlantic circuits.*

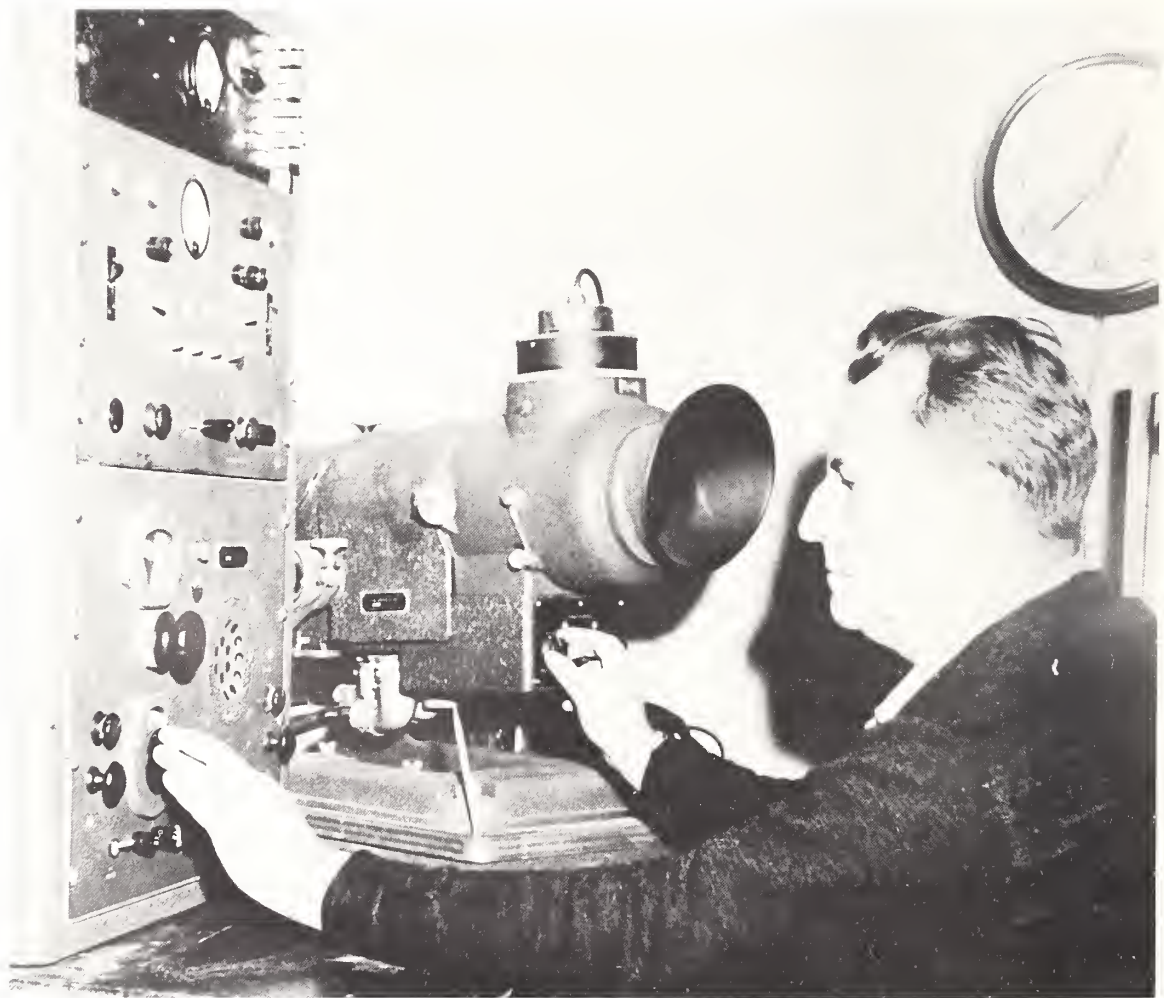

*Operator, William J. Boone, Sr., observing direction of arrival of radio waves at the Fort Belvoir field station from transatlantic stations. Deviations from normal direction indicate that ionospheric transmissions are unsettled or are much disturbed in the event of a severe magnetic storm. Also housed in the Warning Service Building was receiving equipment for recording field-intensity observations. Another building housed the several types of ionosphere recorders.*



*The Chugach Mountains form a backdrop to the North Pacific Radio Warning Station near Anchorage, Alaska, with operations beginning in 1951. The service covered radio communication paths extending from California through Alaska and across the Pacific to Japan. In 1964 the facility came and continues to be known as the High Latitude Space Environment Monitoring Station, now operated by NOAA (National Oceanic and Atmospheric Administration).*

## 2) A service to the International Geophysical Year

Although the primary function of the Ft. Belvoir station was that of operating as the North Atlantic Radio Warning Service, the station became the focal point of a worldwide communications network for issuing IGY Warning Messages during the IGY program of 1957-1959 (see p. 484). Functioning as a facility of the International IGY Committee, the world network was under the general direction of Alan H. Shapley of the CRPL. This operation of the Ft. Belvoir station was known as the IGY World Warning Agency.<sup>150</sup>

## 3) A long, long warning service

During most of the 35 years of development and operation of the ionosphere disturbance warning service the project was in charge of J. Virginia Lincoln, who entered the Radio Section on September 23, 1942, as a junior physicist.<sup>151</sup> For many years Miss Lincoln was chief of the Radio Warning Services Section. The earliest warning service was based primarily on the bearings and "bearing swings" of the radio direction-finders. From

---

<sup>150</sup> The Ft. Belvoir station was the nerve center for the worldwide dissemination of IGY Warning Messages that were issued on a daily schedule. The warnings were based on the Sun's activity that was being observed on a 24-hour daily schedule at a number of locations around the world. The Warning Messages were of two kinds: an alert to indicate a forthcoming Special World Interval (SWI) and the SWI itself which was a message that indicated a strong disturbance of the Sun. Thereafter, for a period of several days, IGY scientists the world over intensified their geophysical observations. The messages were transmitted from Ft. Belvoir over a worldwide wire and radio teletype network. Messages on the state of the IGY Alert were broadcast many times daily by stations WWV and WWVH, and by a radio station in Tokyo and one in Buenos Aires. The broadcasting of Geophysical Alerts (Geoalerts) by WWV and WWVH were continued (until October 1, 1976) after the IGY program as a service for the World Warning Agency of the International Ursigram and World Days Service (IUWDS).

Roger C. Moore initially headed the World Warning Agency, followed by James M. Weldon, then by Edward J. Wiewara.

<sup>151</sup> On October 25, 1973, Miss Lincoln was awarded the Department of Commerce Gold Medal for Exceptional Service, with the citation "for outstanding accomplishments and leadership and the development and administration of major national and international scientific data management programs."

long years of experience, best results were obtained from the forecast service when based upon observation of variation of the Earth's magnetic field and on solar flux measurements (a measure of the overall level of solar activity) taken at 2800 MHz three times daily. Although the length of the forecast periods was changed considerably over the years (ranging from several hours to 25 days), in general, the degree of success reached an 85 percent rating.<sup>152,153</sup>

## THE IONOSPHERE IN MOTION

### 1. Tidal motion

#### a) AN EARLY CRPL STUDY OF LUNAR TIDES

During the summer of 1946 Alvin G. McNish, of the newly formed Basic Ionospheric Research Section, initiated a study of the variability of noon values of  $F_2$  critical frequencies, particularly as it related to the records of a station in an equatorial region, the Huancayo Observatory in Peru.<sup>154,155</sup> For a number of years observations taken at Huancayo had indicated an anomaly in the midday  $F_2$  critical frequency that was singularly associated with the magnetic equator.<sup>156</sup> McNish's study led to the presentation of a paper at the 28th annual meeting of the American Geophysical Union in Washington, D.C., on April 29, 1947, the title of the paper being "Possible Effects of Terrestrial Magnetic Variations of Ion Density in the  $F_2$  Layer."<sup>157</sup>

In June 1949 McNish and Thomas N. Gautier published their theory of lunar effects on the midday decrease of  $F_2$  ion density in the region of the geomagnetic equator [39].<sup>158,159</sup>

---

<sup>152</sup> During the many years of development and operation of the ionosphere disturbance warning service no tutorial or extensive descriptive paper was published. However, through the years, many articles appeared in the Bureau's *Technical News Bulletin* that explained the service and announced changes and improvements.

<sup>153</sup> Beginning with the April 1960 issue of the *Journal of Geophysical Research*, Miss Lincoln has served to the present time as editor of the regularly published information on Geophysical and Solar Data, collected on a worldwide basis from many observatories.

<sup>154</sup> McNish had entered on duty at NBS on August 15, 1946, as chief of the Basic Ionospheric Research Section. Previously, he was associated with the Department of Terrestrial Magnetism and Electricity of the Carnegie Institution of Washington, where he was engaged in ionospheric research.

The Huancayo Observatory, operated by the Carnegie Institution, had been taking multifrequency ionospheric observations since 1934 at its location in the region of the Earth's magnetic equator.

<sup>155</sup> In 1960 McNish received the Department of Commerce Gold Medal for Exceptional Service "for outstanding contributions of great importance to the special fields of geomagnetism and ionospheric physics, and to the more general fields of metrology and standardization.

Note: McNish chose not to move with the CRPL to Boulder in 1954 and later became the chief of the Metrology Division, retiring from NBS in 1970.

<sup>156</sup> The anomaly was a remarkable characteristic of the diurnal variation in  $F_2$ -layer critical frequency. Instead of rising from shortly before dawn to a maximum frequency in the early or late afternoon and then falling to the predawn minimum as it does at middle-latitudes the  $F_2$  critical frequency at the magnetic equator was found to attain a maximum at about 10 a.m., then fall to a secondary minimum around noon, then rise to a second (and usually greater) maximum in the late afternoon.

<sup>157</sup> McNish explained that the ionospheric anomaly of the midday decrease in  $F_2$  ion density (manifested by the decrease in  $F_2$  critical frequency) could be accounted for by a very large diurnal variation in magnetic field at the geomagnetic equator. The full explanation came later in a published paper (see text above).

<sup>158</sup> McNish and Gautier were able to deduce from the ionospheric records of the Huancayo Observatory that the diurnal variation of the Earth's magnetic field causes a forced diffusion (movement) of ions in the  $F_2$  region, and that this diffusion could account for the midday decrease in the  $F_2$  critical frequency. There was further confirmation of the theory by their finding that when the solar and lunar magnetic diurnal variations are in phase, the midday values of the  $F_2$  critical frequency are lower than when the solar and lunar variations are out of phase. They found the maximum ion density at noon to be 60 percent greater 3 or 4 days after the quarter Moons than it is 3 or 4 days after the new and full Moons.

Later, in a Letter to the Editor (September 1949 issue of the *J. Geophysical Research*), McNish and Gautier, in commenting upon "the very large lunar effects in  $F_2$  critical frequency discovered at the Huancayo (Peru) Magnetic Observatory," stated that they had examined the ionospheric data at other low-latitude stations and found the same lunar effects. However, data from stations 20° north of the geomagnetic equator showed somewhat different

## b) A THEORETICAL TREATMENT OF IONOSPHERIC MOTION

After the CRPL moved to Boulder, a theoretical study was made of the effect of solar heating at the base of the atmosphere on the solar and lunar semidiurnal oscillations in the ionosphere. Theoretical considerations of tidal effects in the upper atmosphere agreed well with observed data at different heights. The subject was treated in several publications by Hari K. Sen and Marvin L. White of the Upper Atmosphere Research Section.

## c) A LUNAR EFFECT AT LOW FREQUENCIES

Many years after the lunar study by McNish and Gautier, A. H. Brady and D. D. Crombie of the LF and VLF Research Section studied the lunar-tide variations in the D region, using a method of VLF phase observations. Previously, no direct studies had been made of the effect of lunar tides on the apparent height of radio reflections in the D region. Brady and Crombie published their study in 1963 [40]. Because of the small number (2) of transmission paths observed, their results, and therefore their conclusions, were somewhat limited in scope.<sup>160</sup>

## 2. Ionospheric winds<sup>161</sup>

Before the development of radio and a realistic concept of the ionosphere, meteorologists had observed noctilucent clouds and their movement in the upper atmosphere.<sup>162</sup> Their height has been determined to be within a range of 75 to 90 km, with observations indicating a concentration of clouds at the 82-km level. Thus, these clouds occupy the upper half of the D region of the ionosphere (considered to develop between 50 to 90 km).<sup>163</sup> The earliest observation of their drift or horizontal motion was made in 1890. Speeds of 40 meters per second are common and have been observed as high as 200 meters per second. In northern latitudes the movement is generally in a southwest direction.

Other methods of measuring the drift or motion of the upper atmosphere (ionosphere) previous to the CRPL's interest in making such observations included: visual and radio observations of luminous trains of bright meteors, and several radio methods of measuring the drift of patches of ionization of different intensities. One of the radio methods reported by investigators was selected by the CRPL as best suited to conduct its own study of ionospheric motion. This was the radio fading method in which horizontal motions of the ionosphere are determined from motions of the diffractive pattern of reflected waves from ionospheric irregularities.

---

manifestations of the lunar effect, thus indicating a greater complexity in the lunar variations of  $F_2$  critical frequency.

<sup>159</sup> Interestingly, another investigator, D. F. Martyn of the Australian Council for Scientific and Industrial Research, had published a paper in the July 1947 issue of the *Proc. Royal Society of London* on work closely parallel in time of investigation and in subject matter to that of McNish and Gautier. The title of Martyn's paper was "Lunar tidal variations in the F region near the geomagnetic equator." Even more interesting, his investigation was based upon 3 years of data taken, also, at the Huancayo Observatory. His theory of the effect of tidal motions in the atmosphere differed somewhat from that of McNish and Gautier.

<sup>160</sup> On one path, Panama to Boulder, observed at 18 kHz, they found daytime semidiurnal variations of 0.11 km in the height of reflections from the D layer. On the 19.8-kHz Island of Oahu to Boulder path, the variations in height were found to be less.

<sup>161</sup> Not to be confused with "solar wind" which is a stream of charged particles (mostly electrons and protons) from the quiet Sun.

<sup>162</sup> The nature of noctilucent or night-luminous clouds is not clearly understood, although they have been studied since 1885. The clouds are observed in the early evening hours or near dawn when the Earth is dark but direct sunlight illuminates the upper atmosphere. They can be observed only in northern (also southern) latitudes most commonly between 50° and 70°. The "season" is usually confined to the period of June, July, and August (December, January, and February in southern latitudes).

<sup>163</sup> Another type of cloud associated with the ionosphere was described by C. Hoffmeister in Volume 11 (1961) of the *Annals of the International Geophysical Year*. These are luminous bands or "light strips" observed between 90 and 180 km, with a maximum of observations between 120 to 130 km. Thus they occupy the entire region of the E,  $F_1$ , and  $F_2$  layers of the ionosphere.

#### a) OBSERVATIONS AT THE STERLING FIELD STATION

At the beginning of FY 1950 a research project was initiated by Calvin D. Salzberg and Reynold Greenstone of the Upper Atmosphere Research Section for systematic and continuous observations of ionospheric winds at the Sterling, Va., field station.<sup>164</sup>

In a December 1951 publication Salzberg and Greenstone concluded that wind movements take place at 80- to 100-km heights [41]. There was no one prevailing direction to the winds but they observed systematic diurnal and seasonal changes. Comparison with observations made by the Cavendish Laboratory at Cambridge, England indicated that the wind movements are a part of a worldwide circulation system.

During the next several years the equipment was improved by automatically sensing and recording the phase differences of the signals received by the three antennas, with much additional data being acquired systematically. After the move of the CRPL to Boulder in 1954 the project was not reactivated.

#### b) EVIDENCE OF IONOSPHERIC WINDS FROM AN ANALYSIS OF BACKSCATTER OBSERVATIONS

From backscatter observations made at the Sterling field station around 1952, Lowell H. Tveten of the Ionospheric Research Section took the opportunity, on occasion over a period of years, to analyze the records.<sup>165</sup> At the suggestion of Richard Silberstein, in charge of the backscatter program, Tveten was able to deduce from a backscatter ripple analysis of the records that the ionosphere was in motion in the  $F_2$  region and of the magnitude observed by others during the 1950's using several different techniques. He found speeds ranging from 80 to 1000 km/h, and a direction generally toward the southeast. Tveten published his study in 1961 [42].

#### c) OBSERVING IONOSPHERIC WINDS BY A DOPPLER TECHNIQUE

The Doppler-shift technique has been used widely for measurements involving wave motion and is well adapted to the field of radio science. In 1962 Kenneth Davies of the Ionosphere Research Section published a short paper on adapting the technique to the measurement of ionospheric drifts [43,44]. Eight months previous to Davies's paper, investigators at Stanford University had published an account of their observations of large-scale ionospheric disturbances over long paths (up to 6000 km) by a Doppler-shift technique. Davies' technique permitted observations to be made over relatively short paths—20-km distance in his first experiment. Moreover, the technique was well suited to observations of vertical motions of an ionospheric disturbance.<sup>166</sup>

In his early observations Davies found 2-km vertical displacements of the  $F_2$  layer over a 15-minute period as an ionospheric cloud (irregularity) moved horizontally, indicating an undulative nature similar to a corrugated surface. Horizontal movements with velocities up to several hundred meters per second were observed.

#### d) OBSERVATIONS WITH ARTIFICIAL CLOUDS

In December 1962 John W. Wright, chief of the Vertical Soundings Research Section, participated with other agencies in an experiment of observing ionospheric winds in the E layer by rocket sounding and measuring the drift of artificially created clouds (also see pp. 459-460). The experiment was conducted in the vicinity of the Eglin Air Force Base, Florida

---

<sup>164</sup> Required for the operation was a 2.3-MHz pulse transmitter with 10-kW peak power, and three receiving antennas spaced 200 meters apart at the vertices of an isosceles triangle.

<sup>165</sup> These records, largely taken in December 1952, were mainly in the form of 16-mm motion pictures of PPI (plan position indicator) representation of a sounder technique (akin to radar) of observing backscatter. The pulsed transmitter was operated at 13.7 MHz; with a peak power of 500 kW.

<sup>166</sup> The measurement technique used by Davies had been developed several years earlier by James M. Watts and Davies as a method of rapid frequency-analysis of fading radio signals and similar observations having long-time scales and slow variations. Briefly, the technique consisted of recording, on slow-moving magnetic tape, the beat frequency produced by the received carrier and a local oscillator (with the requirement of frequency stability of the oscillator equivalent to that of the frequency-stabilized transmitter).

The beat frequency of the order of 5 Hz was converted into an audio tone by fast playback, with the speed-up factor as high as 1500. The frequency spectrum, obtained by a conventional audio-frequency analyzer, gave a measurement of drift speed.



as a COSPAR (Committee on Space Research) project on ionospheric winds. The experiment lent confirmation to a theoretical consideration that wind shear is a cause, or contributing cause, of sporadic E.<sup>167</sup>

## AROUND-THE-WORLD AND ABOVE-THE-EARTH EXPERIMENTS

### 1. Around the world on an 18-kHz wave

In 1927 the Naval Research Laboratory (NRL) observed round-the-world signals of several transmitters operating in the range from 16.5 to 20 MHz. During the winter of 1948-1949 the CRPL investigated the encircling of the world with an 18-kHz wave—a wave 1000 times longer than those used by the NRL. Special transmissions from the U.S. Naval Radio Station NSS, Annapolis, Md. (350-kW output at 18 kHz) were received at the CRPL Sterling Radio Propagation Laboratory at Sterling, Va., 50 miles to the west of Annapolis. A four-turn vertical loop, 150 feet in height and 350 feet in length, oriented east and west, served as the receiving antenna for the VLF signals.

Measurement of delay time of the round-the-world signal was by a moving-film record of an oscilloscope display of the direct-transmitted and delayed signals. Under normal ionospheric conditions the delay time was observed to be  $0.1373 \pm 0.0005$  second. Attenuation of the signals ranged from 56 to 70 decibels during encirclement of the Earth, or approximately a reduction of 1000 times in field strength. Observations made throughout the day and night indicated that the delayed signal reached a maximum in field strength during sunset in the Washington-Annapolis area.

The Earth-encircling transmissions were explained either as propagation by surfaces of the Earth and ionosphere serving as a waveguide, or by multiple reflections from the Earth and ionosphere as a geometrical-ray effect. By the ray treatment the number of hops lay between 47 and 55, depending upon the height of the ionosphere. The experiment was reported by Jack N. Brown of the Ionospheric Research Section in a December 1949 publication [45].

### 2. Observations of artificially ionized clouds in the ionosphere— Project Firefly

A 5-year project that began in 1958 involved the participation of a number of staff members of the Ionosphere Research and Propagation Division in a program of the U.S. Air Force Cambridge Research Center. This program of observing the characteristics of artificially ionized clouds in the ionosphere with ionosonde techniques was a part of a larger program being conducted by the Air Force on missiles and communications.<sup>168</sup>

The main series of experiments were carried out in the summer and fall seasons of 1959, 1960, and 1962. In most cases a vertical-incidence ionosonde (1-25 MHz frequency range) was in operation at each of four locations of the Eglin Rocket Range, including a station near the rocket launching area at the Eglin Air Force Base. With this system of ranging it was possible to determine cloud size, height and position of cloud with reference to ionosonde locations, and the vertical and horizontal drifts of the clouds. Cloud lifetime

---

<sup>167</sup> Observations were made at heights ranging from 100 to 150 km and indicated the persistence of ionospheric winds for more than 5 hours after twilight. Wind speeds ranged up to 150 m/s. This range of heights is above the region of the upper atmosphere where noctilucent clouds can be observed (see p. 457).

<sup>168</sup> Project Firefly was conducted at Eglin Air Force Base in northwest Florida by the Air Force with support from the Advanced Research Projects Agency (ARPA). Specifically, the project was to study the chemistry and physics of the upper atmosphere by perturbation of the natural composition with artificially introduced chemicals to form various species of molecules, atoms, ions, and electrons. Perturbations would be by explosive bursts or trails at heights ranging from 70 to 140 km, and would provide information on photochemical processes of the upper atmosphere, air motions, wind shear, the nature of radio signals reflected from artificial electron clouds, and the possibility of generating ionized clouds for point-to-point communications. The project was under the general direction of the Chemical Physics Branch of the Photochemistry Laboratory of the Air Force Cambridge Research Center.

The CRPL team provided technical guidance to the U.S. Army Signal Corps in operation of the several ionosondes used to observe the cloud echoes, and analyzed the ionograms to determine the character of the artificially ionized clouds.

could also be observed and in some instances was greater than 2 hours for sunlit conditions. In many cases optical observations of the clouds could be made.

In 1959 only two ionosondes were used, thus limiting the ranging observations. The 1959 series could be classed as a preliminary or "learning" series. The 1960 series consisted of 27 rocket launchings. Fourteen of these rockets were "salted" with cesium for effective electron clouds, nine for sunlit clouds (launched at dawn), and five for night clouds.<sup>169</sup> Only above 80 km were echoes observed of sunlit clouds. Although the night clouds had short lifetimes, echoes were observed for all cloud heights (94 to 138 km). Wind speeds of all clouds ranged from approximately 15 to 150 m/s. No echoes were observed from detonations of high explosives. Other types of chemical charges were used, with no significant results. In general, the cloud echoes had the appearance of sporadic E-layer echoes on the ionograms [46].<sup>170</sup>

Again, in 1962, another series of 27 launchings was carried out, with some changes in the chemical charges. In general, the conclusions reached from this series were much the same as in the 1960 series [47].

John W. Wright directed and took a very active role in the conduct of the Firefly experiments. He was aided by a number of personnel of the Ionosphere Research and Propagation Division, and especially by Garth H. Stonehocker, Edmond J. Violette, and John J. Pitts.

### 3. Observation of a nuclear explosion at the Jicamarca Radar Observatory

Because of the special features of the Jicamarca radar (see pp. 438-439) and its location near the magnetic equator, the facility was uniquely suited for observing certain features of the July 9, 1962 nuclear explosion "Starfish" above Johnston Island in the mid-Pacific.<sup>171</sup> Of particular interest was the observation of synchrotron radiation.<sup>172</sup>

In 1963 Gerard R. Ochs, Donald T. Farley, Jr., and Bowles, of the Ionosphere and Exosphere Section, reported on observations of the explosion conducted at Jicamarca [48]. They detected strong emissions immediately after the explosion, with a maximum reached about 6 minutes after the blast. At maximum, measured at 50 MHz, the intensity of the emission was 1000 times greater than the threshold of natural radiation. The measurement technique indicated that the emission was synchrotron radiation. They estimated a total of  $12 \times 10^{24}$  electrons of energies in excess of 1 MeV was trapped in the radiation belt after the explosion. By using the huge antenna in half sections they were able to observe any polarization of the radiation. They found some elliptical polarization, the character of which was partly due to the method of generation of the wave, and partly due to its passage through the ionosphere.

In 1964 Ochs reported that by September 1963 the 50-MHz radio noise had decayed to 0.115 of its maximum observed 14 months previously.

---

<sup>169</sup> Although the dawn-launched clouds were sunlit at the ionosphere heights, they permitted ground-based optical observations against a dark-sky background.

<sup>170</sup> It is interesting to note that in 1944 the Radar Countermeasures Group of the Radio Section, in cooperation with the Bureau of Ships, experimented with several chemicals in the attempt to create clouds that would serve as radar reflectors. However, unlike the Firefly clouds in the ionosphere, these clouds were formed but a few hundred feet above the surface of Chesapeake Bay. Although radar signals were reflected by the clouds this project was abandoned by the Navy. The wartime Phantom project was classified secret and was not revealed until the preparation of this historical account of radio work at NBS (see ch. IX, pp. 336-338).

<sup>171</sup> This was a project among many scientists carried out for, and supported by, the Defense Atomic Support Agency (DASA) and other agencies in connection with the 1962 series of high-altitude nuclear tests known as Operation Fish Bowl. "Starfish" was a nuclear explosion of about 1.4 megatons at 400 km above Johnston Island that created a temporary radiation belt around the Earth.

<sup>172</sup> Synchrotron radiation is the emission of radio frequency waves by highly energetic or relativistic (approaching speed of light) electrons trapped in the Earth's magnetic field. The radiation can be produced by nuclear explosions and encircles the Earth as a belt of radiation. It is called synchrotron radiation because it was first discovered in studies involving the particle accelerator known as the synchrotron.

#### 4. HANDS, across land and sea

New information revealed during the 1950's, by atomic blasts, on the nature and propagation characteristics of the ionosphere, led to a variety of detection systems for observation of nuclear testing. Beginning in FY 1964 the CRPL received support from the Advanced Research Projects Agency (ARPA) for development and evaluation of methods of detecting high-altitude nuclear detonations by continuous recording—the project being known as HANDS (High-Altitude Nuclear Detection Studies).<sup>173</sup>

Much of the HANDS project was centered on a data gathering system of sensors and computer operations whereby there was automatic reduction of observations of nuclear-explosion effects in the presence of natural backgrounds. The operational facility was located at the Table Mountain (a mesa) field station north of Boulder. Data from each type of sensor was recorded routinely every 5 seconds until an "event" (a nuclear explosion or other disturbance of interest) was detected, after which the computer would set the entire system into accelerated operation for the detailed recording of all sensors simultaneously [49].<sup>174,175</sup>

Engaged in the HANDS project within the CRPL were: A. Glenn Jean, Jack A. Kemper, Robert H. Doherty, Charles E. Hornback, James R. Winkleman, and Raymond T. Moore (NBS Washington).<sup>176</sup> The project, activated in 1963, was maintained at the Table Mountain site for several years and then was phased out.

#### METEORS—FLEETING VISITORS TO THE IONOSPHERE

Although meteors or "shooting stars" were observed by ancient man, their influence upon 20th-century radio systems was not observed until 1921 when Pickard heard a distinct hiss in direction-finding equipment as a brilliant meteor traveled across the sky. Some years later Pickard observed the enhancement of radio signals during meteor showers. From time to time others began to report the effect of meteor showers on radio signals.<sup>177</sup>

---

<sup>173</sup> HANDS was an activity within a larger ARPA project designated as Project VELA, a study of ground-based techniques for detecting geophysical effects produced by nuclear explosions at altitudes above 20 km.

<sup>174</sup> The sensors were of various types, depending upon the type of signal or phenomenon being observed. One of the various geophysical disturbances that takes place in a nuclear explosion is that in the ionosphere caused by the almost instantaneous or "prompt" production of gamma and x rays that increase the electron density of the upper atmosphere. A. Glenn Jean and Douglass D. Crombie of the CRPL had suggested earlier a means of detecting nuclear explosions by observing changes in the phase and amplitude (attenuation of signal) of coherent radio waves propagating through or near a disturbed area brought on by ionization by gamma and x rays.

Preceding the HANDS project a CRPL team had used the VLF phase-shift technique in observing long-lived effects in the D region following the high-altitude nuclear explosion of July 9, 1962 (see p. 460). With this technique they had evidence of an alternation to the effective height of reflections in the D layer brought about by radiation from radioactive debris that affected VLF transmission for at least 2 weeks following the explosion.

Another but less sensitive method of detecting the explosions is by observing changes in the amplitude of cosmic noise by means of a riometer (relative ionosphere opacity meter), (see footnote 116). Other sensing devices used at the recording facility were for observation of amplitude and directional changes of the Earth's magnetic field, deviation of Earth currents, and infrasonic disturbances in the frequency range of 0.002-1 Hz.

<sup>175</sup> The CRPL team that reported on the HANDS project in the December 1965 issue of the *Proc. IEEE* (a special issue on nuclear test detection) cited nine publications by NBS authors on research projects that related in various ways to methods of nuclear test detection. The same issue contained two additional papers by CRPL authors relating to methods of nuclear test detection.

<sup>176</sup> In 1959 Jean and Kemper received the Department of Commerce Silver Medal for Meritorious Service as a joint award "for outstanding technical accomplishments and unusual devotion to duty under severely trying conditions in the interest of National Defense, as a member of the radio propagation measurements group."

<sup>177</sup> In 1932 Appleton, Naismith, and Ingram observed reflections by pulsed radio signals in England that later proved to be caused by meteor trails. On October 10, 1946, Appleton and Naismith observed the Giacobinid meteor shower with radar equipment at the Radio Research Station at Slough (England). However, Ferrell of the U.S. had submitted a report a year earlier on his observations of meteors with radar equipment operating at 105,000 kHz (Oliver Perry Ferrell, "Meteoric impact ionization observed on radar oscilloscopes," Letter to the Editor, *Phys. Rev.*, Vol. 69, Nos. 1 and 2, Jan. 1 and 15, 1946, pp. 32-33).

## 1. Viewing the Draconids by radar—October 9, 1946

With the availability of radar equipment following World War II came the opportunity for investigators to observe the reflection of signals from the ionized trails of meteors. The big opportunity came during the period of October 7-12, 1946, when the Earth passed through the Giacobinid or Draconid meteors of the Giacobini-Zinner comet. Other radio techniques were also used to observe this meteor shower. Among the observers in the United States was a CRPL team using a war-surplus radar at the Sterling, Va. facility.<sup>178</sup>

During the next 5 years Victor C. Pineo took occasions to observe radar-type echoes of meteor trails and reported these observations in three issues of *Science*. By the end of 1948 Pineo had found sufficient evidence that radar reflections from ionized meteor trails could occur in the complete absence of sporadic-E reflections. He reached this conclusion which differed from that of some observers who held to the view that the sporadic-E layer was formed, at least in part, from ionization by meteors. Later, by a statistical study, Pineo found that the frequency of occurrence of sporadic-E reflections is unrelated to meteor phenomena when observed with a 27.2-MHz radar, a further proof of his earlier conclusion.

Beginning in November 1948 and extending for about 1 year, Pineo and Thomas N. Gautier studied the dependence upon frequency of the duration of radar-type echoes from meteor trails. For this study they used two radar frequencies, 27.2 and 41.0 MHz. They found that the duration is approximately proportional to the square of the wavelength, confirming the findings of others [51]. Duration of some echoes at 27.2 MHz exceeded 2 minutes.

---

<sup>178</sup> At the suggestion of Stanford University the CRPL team of Ross Bateman, Alvin G. McNish, and Victor C. Pineo arranged for and conducted the observations. A Signal Corps type SCR-270-D radar operating at about 107 MHz, with a peak-pulse power of about 100 kW was used.

The observations on the rainy night of October 9 were reported in the *Washington Post* on the following day. On this eventful night Dr. Condon, director of NBS, and Dr. Newbern Smith, assistant chief of the CRPL, witnessed the meteoric reflections on the radar screen during the peak (60 meteors per hour) of their occurrence. The *Washington Post* stated:

By the grace of radar, this reporter 'saw' the Giacobini-Zinner meteor show tonight, heavy rain and clouds notwithstanding.

At 8:45 p.m. a strong pip revealed a meteor train of ionized dust estimated to be 75 miles from the earth's surface. The next came at 8:50, 90 miles off. Then 8:59—70 miles; 8:59 1/2—90 miles; 9:01—70 miles.

That was the way it went, up to the time the press departed in order to make newspaper deadlines.

A few days later the observations were reported by the CRPL team in the October 18 issue of *Science* [50]. The observations of October 9, 1946, were reported also in the November 1946 issue of the *Technical News Bulletin*. *The Annual Report 1950* of NBS stated (p. 85):

Use of radar techniques to receive the reflections from the ionized trails left by meteors in the earth's upper atmosphere makes it possible to observe meteors during daylight hours as well as at night. These observations, pioneered by the Bureau as early as 1940, have yielded considerable data on diurnal and seasonal variations in the rate of arrival of meteors at the earth. . . .

There is reason to believe that the stated year "1940" is in error and should be "1946." None of the detailed records of the Radio Section or inquiries made by the author of persons who would be aware of 1940 observations has shown that observations of meteors by radio or radar techniques were made by the Radio Section earlier than in 1946.

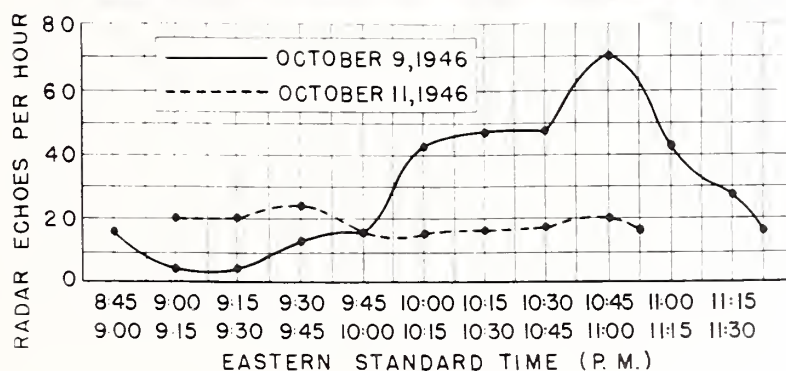
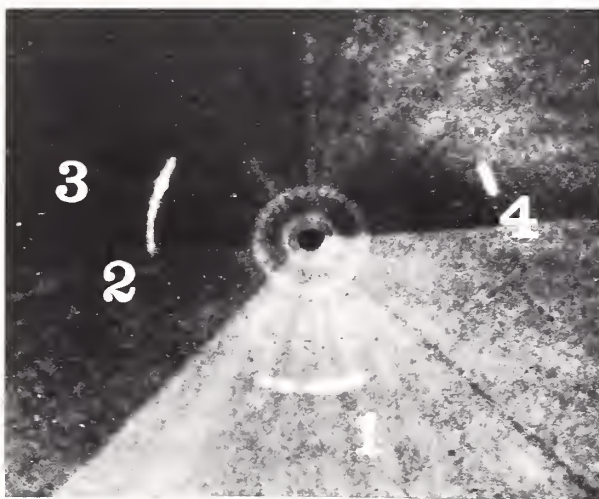
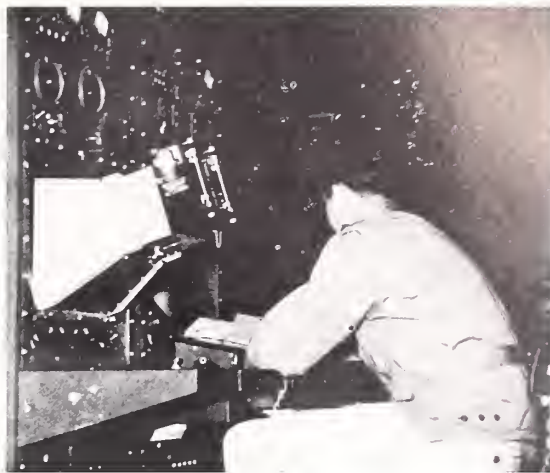
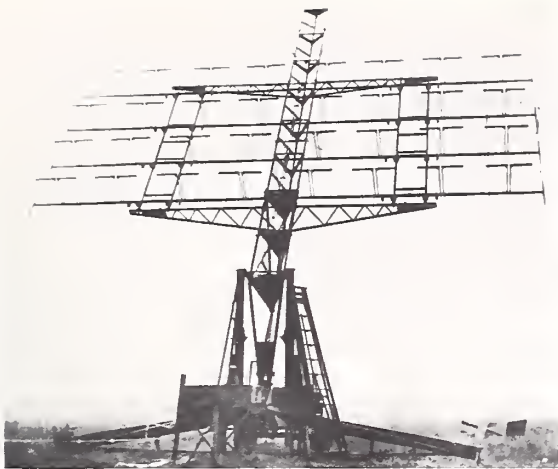

Early radar observation of meteors

On the night of October 7, 1946, a CRPL team observed radar reflections at the Sterling field station from the Draconid-meteor shower. This became possible by using a Signal Corps type SCR-270-D radar operating at about 107 MHz and with the antenna in a fixed position (azimuth of 345 degrees and elevation of 45 degrees, shown in upper left photo). Viewing of the transient radar echoes was on an A-scope (rate of reflections could be observed), with photography on a PPI-scope (plan-position indicator with a rotating time base of 2 seconds), shown in upper right photo.

Four meteor echoes appear on the screen of the PPI-scope (center photo). Trace (1) indicates approximate range (distance to meteor) of 75 miles and an echo duration of 15 seconds; (2) range 75 miles, duration 13 seconds; (3) range 100 miles, duration 1/3 second; (4) range 85 miles, duration 3 2/3 seconds.

Rates of occurrence per hour of the radar echoes on the nights of October 9 and 11 are shown by bottom plot. On night of October 9 the hourly rate reached a maximum of about 70 echoes per hour between 10:30 and 11 p.m., coinciding approximately with the astronomically predicted time of 10 p.m. for the maximum intensity of the Draconid shower. Photos and data taken from November 1946 issue of the Technical News Bulletin.

Note: Alternate vertical coordinate lines indicate 15-minute intervals of echo observations, e.g., the interval from 8:45 to 9:00 p.m.

## 2. Early CRPL experiments with meteor-burst communication

In the April 1952 issue of the *Physical Review*, Dana K. Bailey of the CRPL, along with others, reported on the effect of meteors on VHF experimental transmissions used to study the scattering of radio waves by the ionosphere (see p. 495).<sup>179</sup>

Pineo's experience with radar reflections from meteor trails, and his growing experience with the ionospheric forward-scatter system between Cedar Rapids, Iowa and the Sterling station, led him to suggest the development by the Ionospheric Research Section of a long-distance communication system that would utilize meteor reflections.<sup>180</sup>

With support from the Air Force the section team of G. Franklin Montgomery and George R. Sugar studied the feasibility of a communication system that would utilize reflections from meteor bursts [52]. In addition to a theoretical treatment, they conducted a series of experiments with teletype transmissions to determine the practicability of a planned technique. The first of these experiments was on September 18, 1953, using the Cedar Rapids-Sterling forward-scatter system (49.8 MHz) with adaptations that permitted transmission of 3200 binary digits per second—a necessary speed in order to transmit fairly lengthy messages during the very short periods of meteor ionization trails. A 100-kHz bandwidth was required in order to attain high transmission speed. Errors in transmission of signals, caused by multipath-signal distortion, were not obvious on the records but were evidenced by oscilloscope observations.

## 3. A meteor-burst communication system in successful operation

In 1954 another team was assigned to the meteor-burst project, with further experimentation being carried out. By the summer of 1955 construction was underway on a complete communication system patterned after the mode of operation developed by Montgomery and Sugar. Robert J. Carpenter of the Ionospheric Research Section was in charge of the program, assisted by Gerard H. Ochs and others. This project was sponsored by the Air Force Cambridge Research Center and was known as "Pup." Although the power output of each transmitter was but 2 kW, the radiated power was confined to a rather narrow beam by a directive antenna. Two-way tests were conducted at a 50-MHz transmitting frequency between the Sterling station and another located at Walpole, Mass. during the spring and summer of 1957. By this time the Section's facilities had been gradually moved to Boulder and the meteor-burst system was set up for operation between Kilbourne, Ill. (several miles south of Havana, Ill.) and Erie, Colo. (east of Boulder and one of the Boulder Laboratories field stations), a distance of 800 miles. A half-year testing program continued until the summer of 1958. Optimum speedup of the teletype operation during transmission of signals was found to be 40 times that of normal. Analysis showed a number of contributing causes to sources of interference and introduction of errors; nevertheless, the system was equal in performance to other long-distance systems and was relatively free from ionosphere disturbances [53]. Several years later Carpenter and Ochs studied the probable minimum limit or message element duration for meteor-burst communication. They concluded that operation with 4-microsecond signal pulses was feasible and was not affected by multipath distortion.

---

<sup>179</sup> During the early 1950's the Canadian Defence Research Board and Stanford University initiated, independently, the development of a complete communication system that used the ionization trails of meteors at heights of about 100 km for short periods of reflection of radio signals. Such a system transmits messages only during the very brief periods when meteor propagation is effective. During the much longer intervals between meteor entrances into the ionosphere the system accepts messages and stores them for subsequent transmission. Such systems took the name of meteor-burst communication systems. Early in their development they were largely shrouded in secrecy because of military application due to greater security in message transfer compared to other radio communication systems.

By March 1954 the Canadians demonstrated the practicability of their earliest meteor-burst communication system to which they gave the name JANET. They successfully transmitted teletype messages in each direction over a distance of 950 km between Ottawa and Halifax. An advantage of such a system for long distance communication at that time was applicability to the VHF band (30-300 MHz) at frequencies higher than the already overcrowded portion of the spectrum assigned to ionospheric propagation.

<sup>180</sup> Pineo made the suggestion in November 1951 by memo to Ross Bateman, chief of the Ionospheric Research Section. At the time Pineo was chief of the Radio Propagation Laboratory at Sterling, Va. (the name was usually shortened to "Sterling station").

#### 4. Further study of meteor-burst communication

A project known as Meteor-Burst Propagation Research was activated in April 1956, with Bowles as the project leader, and was continued until 1963, in the later years led by Sugar. The object was "to study the basic principles and the statistics governing the propagation of bursts of radio signals, over oblique paths, due to meteoric ionization." After some early work on determining the time correlation of signals from three transmitters, reflected from meteor bursts and received from three locations, a more extensive program was planned and set into operation in order to gain maximum information on meteor-burst propagation. The program featured a geophysical significance to the location of three transmission paths and an elaborate system for automatic data recording and reduction techniques in order to handle the large volume of data required for statistically significant results.<sup>181</sup>

After many months of preparation the observational system was set into operation in September 1959 and data were recorded until the end of June 1960 (the Long Branch—Boulder path was operated for 6 additional months). Of principal interest in the processed data was the diurnal variation of the duty cycle (fraction of time a received signal exceeds a prescribed threshold). This information was compared for the three paths, for the three frequencies, and for several antenna configurations. The general conclusion reached was that the diurnal variation of signal amplitude could be relied upon to be within a 10-decibel spread when used as a consideration for system design. In 1964 Sugar published a survey report on meteor-burst propagation that included summary results of the lengthy NBS program [54].

Although this rather extensive program of research and equipment design was initially undertaken as a classified program for potential military application, by 1958 it was largely declassified. Because of their relative complexity, meteor-burst communication systems have not had much application. However, with recent simplification of digital techniques, there is a resurgence of interest in these systems.

#### THEORETICAL STUDIES OF THE IONOSPHERE

During the 1930's when the Radio Section was gaining first-hand knowledge of the ionosphere by probing with ionosondes of its own design, further knowledge was gained by the writing of a number of papers containing theoretical analysis of the experimental data. These published papers were contributed largely by Dellinger, S. S. Kirby, and Newbern Smith. In the following years, from 1941 through 1945, the war effort curtailed further publication of research papers. Then, after several years of reorientation of the radio research programs at NBS, there began a flow of theoretical papers by the CRPL that continued to 1965, when the flow continued thereafter through the channels of ESSA and NOAA.

One can consider that the first of this long line of theoretical papers on the ionosphere, which numbered well over 100 papers during the CRPL period, was a paper by Henry G. Booker, a consultant to the CRPL.<sup>182</sup>

Booker's paper was followed shortly thereafter by another, the first of a CRPL series of theoretical papers by Joseph Feinstein. To the time of move by the CRPL to Boulder, Colo.

---

<sup>181</sup> Three transmission-reception paths were selected, all of nearly the same path length, just under 1300 km. The Norman, Okla.—Fargo, S.D. path was at right angles to the east-west Long Branch, Ill.—Table Mountain (Boulder) path, and intersection was near midpoint of each. Another, the north-south Barrow (northern Alaska)—Kenai (near Anchorage) path, was selected for comparison of meteor-burst activity in the Arctic regions with the activity in temperate regions. The Alaska operation was known as the "Arctic Wolf" project. On these several projects Ralph J. Slutz and George R. Sugar served as project leaders, with many others participating in the various laboratory developments and field operations.

Each of the three paths had a 2-kW, CW transmitter at one end and an NBS-designed receiver at the other. The transmitters operated at three frequencies, 30, 50, and 74 MHz. The receivers fed multichannel digital recorders.

<sup>182</sup> Booker's paper, entitled "Application of the Magneto-Ionic Theory to Radio Waves Incident Obliquely upon a Horizontal-Stratified Ionosphere," was published in the September 1949 issue of the *J. of Geophysical Research*. The work was started by Booker in 1938 in England, was interrupted by World War II, and completed at NBS in 1948.

in 1954, Feinstein published no less than seven theoretical papers relating to radio propagation in the ionosphere, all in outside journals.<sup>183</sup> Two other papers were on the troposphere.

In 1955 James R. Wait entered the CRPL as a theoretical physicist and served as a consultant to various projects within the CRPL until the formation of ESSA. His output of theoretical papers took on prodigious proportions.<sup>184</sup> Very many of these publications were in the area of low-frequency propagation and are covered in another section (see pp. 474-478). However, Wait's talent in theoretical research extended beyond that of radio propagation in the ionosphere and is noted elsewhere (see ch. XIII, p. 571 and p. 590). Some of Wait's papers, and those of others, were on studies of radio propagation over irregular surfaces, through inhomogeneous media, and around natural obstacles, being applicable in some cases to the ionosphere, in others to the troposphere.

Other than theoretical papers on low-frequency propagation, the preparation of theoretical papers on the ionosphere during the 1960's to the time of formation of ESSA was virtually absent.

## OBSERVING THE NIGHT SKY

### 1. An airglow program moves to Boulder

An early program established in the newly organized Radio Propagation Physics Division at the Boulder Laboratories was that on airglow and related illumination of the night sky.<sup>185</sup> The program was transferred in June 1954 from the Naval Ordnance Test Station (Inyokern, Calif.) to the CRPL, with Franklin E. Roach accompanying the program as project leader.

Two photometers were brought to Boulder from the California test station and installed at the new observatory site on Fritz Peak (9000-foot altitude) several miles south of Rollinsville (west of Boulder) and near the Peak-to-Peak Highway.<sup>186</sup> Observations were underway by January 1955.

---

<sup>183</sup> Feinstein's earliest CRPL paper was a presentation for the 1950 URSI General Assembly. In another paper, published in 1950, Feinstein showed that the ionosphere is a linear medium only to a first approximation [55]. Second-order terms of his equations expressing propagation characteristics indicated the presence of harmonics of the frequency of a wave traversing the ionosphere. Also, under certain conditions, he found that radio waves of different frequencies could give rise to sum and difference frequencies. At the time, experimental evidence of these effects was meager.

Two of Feinstein's earlier papers were reported in a new periodical at its embryonic stage, the *Transactions of the IRE Professional Group on Antennas and Propagation*. Several years later he published a paper, in two parts, in two issues of the same periodical, entitled "Some Stochastic Problems in Wave Propagation." His treatment of the problems was applicable to both ionospheric and tropospheric wave propagation. Feinstein considered that: Random variations associated with ionospheric propagation are changes of the level (height above Earth) of reflections from the ionosphere as a function of time; and among those associated with tropospheric propagation are changes in the surface of a rough sea and fluctuations in refractive index of the atmosphere.

<sup>184</sup> In 1959 Wait received the Department of Commerce Gold Medal for Exceptional Service "for highly distinguished authorship in the field of radio propagation."

<sup>185</sup> In the early 1900's astronomers observed a persistent green radiation in spectrograms of the night sky, which was called the "permanent aurora." Later, it was given the name nightglow and then, beginning in 1950, the name airglow has come into common usage. Its exact nature and cause have been a matter of considerable study, especially during the IGY program of 1957 and 1958. Except under very favorable conditions, the airglow is not visible to the human eye. There has been considerable speculation as to its cause but with no common agreement except the certainty that it is due to excitation of atoms and molecules in the upper atmosphere and apparently centered at heights around 100 km. More recently, there has been considerable belief that airglow and the aurora have a common source. Other manifestations of the night sky are the zodiacal light and its counter glow, the gegenschein, as well as that of starlight.

<sup>186</sup> A photometer suitable for airglow observations consists essentially of a small telescope that transmits the feeble glow to a photomultiplier tube, plus an amplifier and galvanometer recorder. A mechanical drive controls movement of the telescope to scan the sky. A refinement for greater accuracy of measurement is the incorporation of a birefringent filter (an optical filter of two refractive indices) that separates the emission sources of light in airglow from background such as zodiacal light. A necessary requirement is that of calibration of the photometers with a radiation standard.





*Lawrence R. Megill adjusting controls of the automatic airglow photometer mounted on top of Fritz Peak. The metal housing protects the photometer and remains open only for nighttime recordings of airglow. A closeup view of a long stretch of the Continental Divide can be had from Fritz Peak (elevation 9010 ft). On the date this photo was taken, October 2, 1957, the aspens would be in full autumnal foliage, mottling the nearby landscapes with a golden glow.*



*Franklin E. Roach of the Radio Propagation Physics Division views his airglow photometer on a cold day in 1957. Since 1955, observations of the invisible glow in the night sky from large areas of the ionosphere have been recorded on Fritz Peak, several miles south of Rollinsville (west of Boulder) and near the Peak-to-Peak Highway.*

Interest in, and importance of, the airglow program was that of obtaining improved and more extensive observational data in order to gain a better understanding of the physical and chemical processes of the upper atmosphere—or simply, to learn more about the ionosphere.

## 2. Roach and an international photometric unit for airglow

The first absolute measurement of the intensity of airglow was in 1930 by the Fourth Lord Rayleigh (R. J. Strutt, the son of J. W. Strutt who was the famous and better known Lord Rayleigh). During the early 1950's various investigators felt the need of an international unit to replace the many different units that had been used in research to express the intensity of airglow. In September 1955 Roach presented a resolution to a commission of the International Astronomical Union proposing that the unit for expressing brightness of airglow and aurora be defined as  $4\pi \times 10^6$  quanta/(cm<sup>2</sup>·s·sr), and that the unit be called the rayleigh (named after the Fourth Lord Rayleigh). A result of this action was a paper coauthored by Roach and two others, published in 1956 [56]. By the time of the IGY program international agreement had been reached on use of the rayleigh unit.

## 3. Taking a major role in the IGY airglow program

Concurrent with the early airglow observations at Fritz Peak was another airglow program—that of preparing for the coming International Geophysical Year (IGY) spanning the period of July 1, 1957, to December 31, 1958. One project of the United States participation in this program was the design by Roach and others, and construction in the shops of the Boulder Laboratories, of six photometers of advanced design.<sup>187</sup>

Taking part in the U.S. Program of the IGY, Roach served as vice-chairman for Airglow on the Aurora and Airglow Program Panel. The CRPL operated airglow stations at Fritz Peak and Rapid City, S.D., and entered into cooperative work with the Huancayo Geophysical Observatory in Peru. These 3 stations were among the total of 28 stations scattered around the world engaged in the total IGY airglow program.<sup>188</sup> Roach served as editor of the final report of the world program, which became available in 1962.<sup>189</sup> Later, Roach served as editor of the report on the Airglow program of the International Year of the Quiet Sun (IQSY), a 2-year project in the 1960's. (For more information on the IGY see ch. XVII, pp. 674-675.) For a number of years Roach was occupied with many international reviews on airglow.

During the course of the IGY program the Airglow and Ionosphere Subcenter for receiving data on a worldwide basis was established at Boulder, Colo., within the operation of the CRPL (see ch. XVII, pp. 674-675). Processing of the data was carried out at the Boulder Laboratories.

---

<sup>187</sup> The prototype for the six photometers was installed at Fritz Peak. One was used at the NBS airglow observatory for the IGY program at Rapid City, S.D. The others were furnished to stations in different parts of the world.

<sup>188</sup> Other airglow stations in the American chain were located at Thule, Greenland; Saskatoon, Canada; Sacramento Peak, N. Mex.; and Tantzantla, Peru.

<sup>189</sup> The report was Volume XXIV of the *Annals of International Geophysical Year* and titled, *Observations of the Night Airglow During the International Geophysical Year and the International Geophysical Cooperation 1959*. Not to be overlooked is the Preface to this volume, prepared by Roach. It read:

### Preface

In referring to this volume, it is proposed that the editorship be credited to all the I.G.Y. Airglow Observers who participated in the program. The list of participants is given on pages 7-8. Since it is impractical to mention all the names individually in making literature references, the participants have selected the generic pseudonym Igor Georges Yao. This has been derived from the initials of International Geophysical Year Airglow Observers, I. G. Yao.

F. E. Roach

Thus on the title page the name I. G. Yao appears as editor.

## 4. Observations from Fritz Peak

When the CRPL began its observations of airglow at Fritz Peak in 1955, the green line of oxygen (5577 angstroms) already had received much attention by earlier observers.<sup>190</sup> But there was much about the line, and airglow in general, that was unknown. By 1956 Roach and his colleagues had determined the region of airglow to be about 100 km in height above the Earth, in the region of the E layer. Observed from Fritz Peak were the large patches or cells of airglow emission across the night sky. For the first time these cells were mapped in their extent and movements [57].<sup>191</sup> These movements were indicative of strong dynamic motions of a cyclonic type in the upper atmosphere. Observations of the 5577 line showed definite seasonal changes in the intensity at various latitudes.

A comparison of a statistical study of the distribution of intensities of the 5577 line at Thule, Greenland (airglow station operated by the United States) with similar data of low-latitude stations indicated that the faint aurora and airglow are probably of common origin.

During a somewhat routine observation of airglow at Fritz Peak on the night of September 29-30, 1957, accompanied by an auroral display in the northern sky, the observer noted an unusually strong response to the red 6300 line from the zenith.<sup>192</sup> For some years thereafter Roach and his coworkers studied the mid-latitude, nonvisible auroral arcs which emit the strong monochromatic 6300 line [58]. Interestingly, the Fritz Peak observatory lies near the mid-point of the approximately 700-km width auroral arcs that sweep across the Earth near mid-latitudes with a total thickness ranging in altitude from 300 to 600 km. Although associated with the formation of the visible aurora, the invisible auroras at mid-latitudes have not been easy to explain.

A variety of other observations of airglow and, to a limited extent, of aurora emissions and of the zodiacal light, occupied the talent and a portion of time of the CRPL team, headed by Roach, from 1954 to 1965. Observations have been continued to the present time at Fritz Peak by ESSA and later by NOAA.

Nearly 40 publications came from the CRPL airglow team over a period of 10 years, a number that indicates the variety of the research areas investigated.

## 5. Refining the measurement techniques

During the Fiscal Year 1960 a simplified type of photometer was designed and several constructed in the Boulder Laboratories shops. This was for use in the zenith direction only, but allowed for fast observation in four colors of the airglow. A feature of the design was the ease of calibrating the instrument.

A definite advance in the techniques of an absolute calibration of airglow photometers was attained by 1963 in preparation for the IQSY program—an essential requirement for accurate intercomparison of measurements in a worldwide program. The primary standard was a blackbody that illuminated a magnesium oxide screen.

From 1954 to 1965 Roach served as project leader and later as section chief for the CRPL airglow program.<sup>193,194</sup> During those years the team of workers included: Jose E. Cruz, Edward Marovich, Lawrence R. Megill, Charles M. Purdy, Manfred H. Rees, and others.<sup>195</sup>

<sup>190</sup> The green 5577 oxygen (atomic oxygen) line was observed by A. J. Ångström in 1868 to be in the night sky in the absence of the aurora. In 1930 the Fourth Lord Rayleigh measured its absolute intensity.

<sup>191</sup> The airglow cells were found to be approximately 2500 km in diameter and moved with a translational velocity of 100 m/s and a rotational period of about 5 hours.

<sup>192</sup> On the same night a similar observation was made at an observatory in France by a French astronomer, Daniel Barbier, who had been studying the strong 6300 emission from overhead for several months.

<sup>193</sup> Beginning in 1954 the airglow program was associated with the office of the Radio Propagation Physics Division, and in 1958 became the Airglow and Aurora Section within the division. Later the section became a part of the Upper Atmosphere and Space Physics Division. Early in 1965 the section took on the name of Equatorial Airglow Studies and was assigned to the new Aeronomy Division.

<sup>194</sup> In 1961 Roach received the Department of Commerce Gold Medal for Exceptional Service "in recognition of outstanding contributions to upper atmosphere physics by means of studies of optical emissions from the night sky."

<sup>195</sup> In 1964 Megill received the Department of Commerce Silver Medal for Meritorious Service "for distinguished authorship on the influence of electric and magnetic fields on electron distribution functions in the upper atmosphere with particular reference to the night airglow."

## 1. Low-frequency electromagnetic waves—A recurring interest

Hertz worked in that part of the radio frequency spectrum that we now call “short waves.” Some of his experiments were performed in the neighborhood of 80 MHz or 3.75 meters. In 1901 Marconi transmitted the coded letter “S” across the Atlantic at approximately 915 meters (328 kHz). Using large-scale, high-frequency alternators operating at 50 kHz, in 1906 Fessenden carried on two-way wireless telegraphy communication across the Atlantic. By the early 1920’s greater reliability in radio communication was placed on transmitters operating in the range of 16 to 25 kHz for transoceanic and worldwide coverage. However, these stations resembled large power plants accompanied by gigantic antenna structures. Then, in the late 1920’s came a swing toward the higher frequencies for long-distance communication.<sup>197</sup> But in the late 1930’s there came a renewed interest in a better understanding of low-frequency propagation that has continued to the present time.<sup>198</sup>

Since 1911, when Austin’s investigations of long-distance radiotelegraphy resulted in the familiar Austin-Cohen formula (see ch. II, pp. 34-35), many others have contributed to expressions of the relation of field strength to distance that are applicable to frequencies below, say 500 kHz.<sup>199</sup> The Austin-Cohen formula was derived (empirically or semiempirically) from measurement of 80- and 300-kHz transmissions over seawater. In a Bureau publication, first prepared as a confidential paper in July 1917 and in 1919 as a Bureau *Scientific Paper*, Dellinger developed a more accurate transmission formula as a result of antenna studies, taking an original, theoretical, and relatively simple approach (see ch. VI, p. 115). After an extended lull in the projects pursued by the Radio Section that were slanted toward low frequencies, the subject was renewed in 1943 within the Interservice Radio Propagation Laboratory (IRPL).<sup>200</sup> It was then that Marcella L. Phillips developed two nomograms by which the field strength at distances out to 10,000 km could be

<sup>196</sup> For purpose of clarity, nomenclature for frequency bands used in this account is in accordance with the Atlantic City Radio Convention of 1947 and later modifications, as follows:

LF	Low Frequency	30-300	kHz
VLF	Very Low Frequency	3-30	kHz
ELF	Extremely Low Frequency	30-3000	Hz*
ULF	Ultra Low Frequency	0.001-300	Hz**

\*Frequency range covered by the ELF Conference of January 1960 at Boulder, Colo. was 1 to 3000 Hz.

\*\*Frequency range covered by the ULF Conference of August 1964 at Boulder, Colo.

However, the CRPL would occasionally include observations ranging up to 1 MHz within the low-frequency designation. Occasionally in this account the term low frequency is used to designate the entire spectrum up to 300 kHz.

<sup>197</sup> On June 20, 1922, at an IRE meeting in New York City, Marconi pointed out the importance of short-wave radio (1 to 20 meters) in the future (see ch. I, p. 13).

<sup>198</sup> Renewed interest in low-frequency radio transmission developed in England during the late 1930’s, and then, again, after World War II. Among the researchers were those associated with Cambridge University. Of this team, Kenneth G. Budden was a guest worker at NBS Boulder in FY 57, while on sabbatical leave.

<sup>199</sup> Louis W. Austin was associated with the Bureau of Standards but was not a staff member (see ch. II). His investigation that led to the Austin-Cohen formula (or equation) is found in the October 1911 issue of the *Bulletin of the Bureau of Standards*.

<sup>200</sup> From World War I to World War II, there were but few projects in the Radio Section related to low frequencies, although Kolster and Dunmore’s work on the radio direction finder after World War I was at 300 kHz. By 1930 the blind landing system developed by Diamond and Dunmore utilized a frequency of 93.7 MHz. Later, in the development of the radiosonde, the transmitting frequency was 185 MHz.

However, during this period between the two world wars, the Radio Section published several Letter Circulars, entitled: Distance Ranges of Radio Waves. The graphs were applicable, with the then-known understanding of radio-wave propagation, over a wide range of frequencies from 10 kHz to around 30 MHz. The graphs were particularly applicable to the low frequencies. Letter Circular 317 was issued January 25, 1932, and Letter Circular 658 (superseded LC615) was issued August 5, 1941. (See ch. VII, pp. 197-198 and accompanying graphs.)

determined at frequencies in the range of 10 to 60 kHz (within the VLF and LF range) [59].<sup>201-203</sup>

## 2. The CRPL initiates an observational study of LF propagation—At the Sterling field station

In the spring of 1947 the Experimental Ionospheric Research Section, with Ross Bateman as chief, initiated a project entitled, "Ionosphere Measurements at Low Frequencies." The project opened a new field of operation by the CRPL.<sup>204</sup> The early interest in low frequencies by the CRPL was that of increased knowledge of the lower region of the ionosphere. Later, came an interest in propagation studies for better understanding of the use of low-frequency techniques for radio navigation, long-range communication, and for greater reliability and accuracy in the reception of WWV time and frequency signals.

To study the ionosphere in its relation to low-frequency propagation it was necessary to design and construct a suitable transmitter and adapt a commercial receiver to an oscilloscope recorder. The combination unit served as a low-frequency ionosphere recorder or ionosonde, and was installed at the Sterling field station [61]. It was believed to be the first equipment designed for observing vertical-incidence (and later, oblique-incidence) reflections at low frequencies from the lower region of the ionosphere.<sup>205</sup> For ionospheric studies made with this equipment refer to the section: Studies of the Ionospheric Regions (pp. 420-428).

---

<sup>201</sup> In 1941, Kenneth A. Norton (formerly of the Radio Section and later of the CRPL, but then of the Federal Communications Commission) published a paper with equations and curves for calculation of ground-wave field intensity over land and sea [60]. His graphical method was applicable at all radio frequencies (with certain considerations) and at distances out to 2000 miles.

<sup>202</sup> The two nomograms developed by Mrs. Phillips were presented first in a classified IRPL document. Years later, in 1956, they were published in the Fourth Edition of *Reference Data for Radio Engineers*, International Telephone and Telegraph Corp., N.Y.

<sup>203</sup> In 1949 the Upper Atmosphere Research Section prepared a table of attenuation coefficients for VLF propagation for the Ninth Edition of the *Smithsonian Physical Tables*. The values of the coefficients were taken from observations of other investigators and were suitable for a revised form of the original Austin-Cohen formula.

Also in 1949 a nomographic method was devised for estimation of the number of hops compatible with observed delay times for round-the-earth echoes of LF radio signals (see p. 459 for experimental work). This material was prepared for the Provisional Frequency Board at Geneva, Switzerland (see ch. XVII, p. 664), accompanied by graphs showing diurnal, seasonal, and frequency variations of attenuation coefficients for various transmission paths at low frequencies.

<sup>204</sup> The Quarterly Report for April-June 1947 stated, in part:

The problem is to measure virtual heights and intensities of ionospheric reflections at low and very low frequencies in order to provide a basis for an adequate theory of low-frequency radio propagation. It is proposed to make some initial measurements at a frequency between 300 and 400 kc/s using an oscillator-type pulse transmitter and a modified commercial communications receiver.

<sup>205</sup> The recorder (ionosonde) was designed and constructed by J. M. Watts, J. N. Brown, and J. C. Blair of the Experimental Ionosphere Research Section, the project beginning early in 1951. The original sweep-frequency equipment operated in the range of 50 to 1100 kHz, and later was extended down to 37 kHz. Pulsed power output from the transmitter was more than 200 kW, delivered by a broad-band amplifier (by 1953 increased to nearly 1 megawatt). Many of the design features were borrowed from previously designed CRPL high-frequency ionosondes that had proved to be highly successful.

For transmission a large single-turn loop antenna was operated in a vertical plane, being 150 feet high and 350 feet long. Practical reasons ruled out the use of larger and more efficient antennas of various types. At 100 kHz the loop antenna radiated approximately 5 watts. Reception of signals was from a low and long horizontal dipole antenna, selected for minimizing vertically polarized interfering signals.

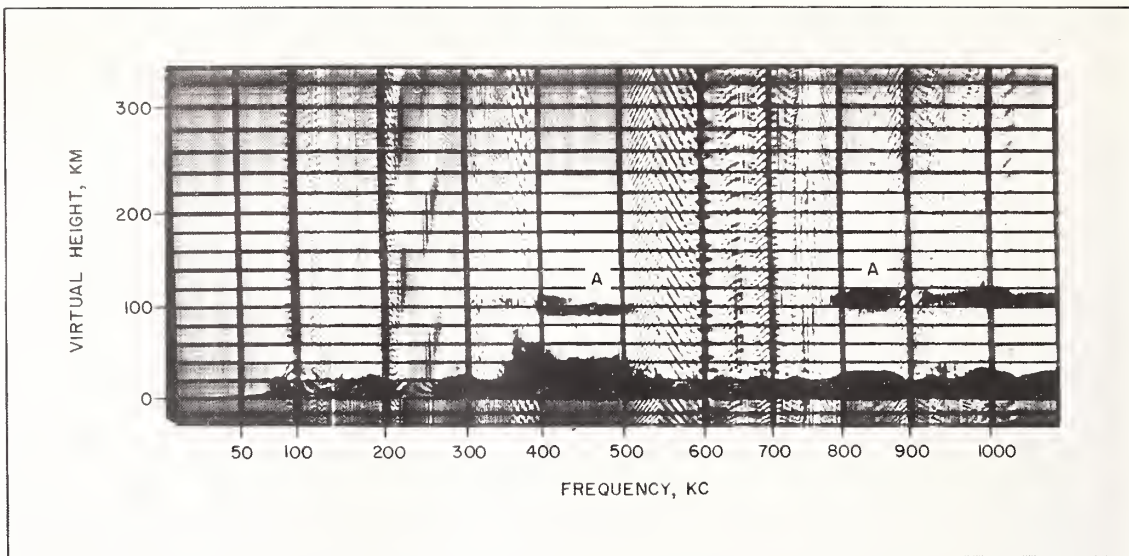

SAMPLE DAY RECORD MADE BY SWEEP FREQUENCY RECORDER MARCH 27, 1952 AT 1606

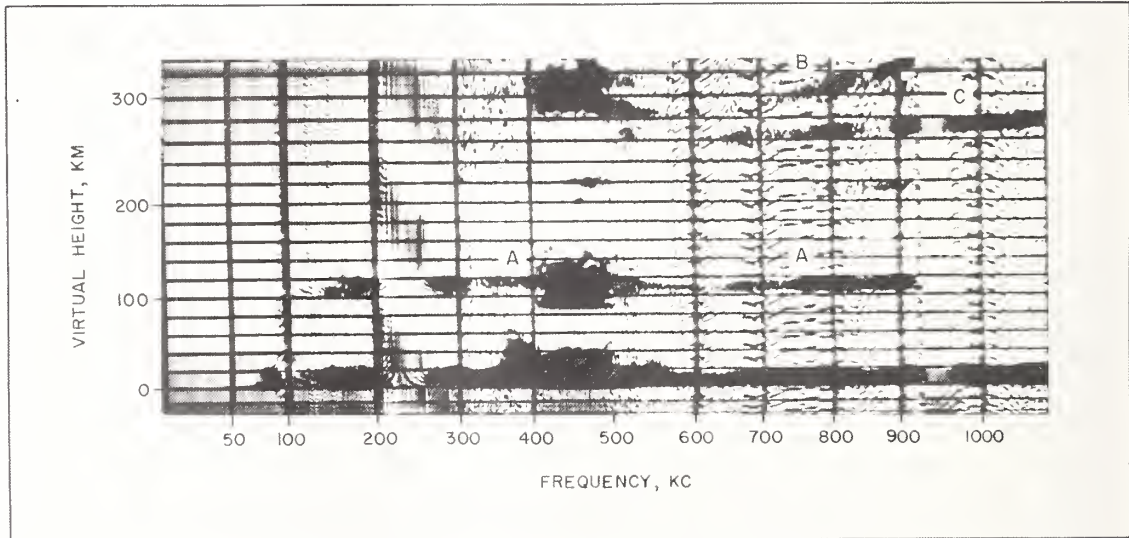

SAMPLE NIGHT RECORD MADE BY SWEEP FREQUENCY RECORDER MARCH 28, 1952 AT 0015

Early in 1950 the CRPL succeeded in obtaining 50-kHz reflections from the ionosphere at 80 km—a task difficult of accomplishment. With a specially designed ionosonde, operating in the frequency range of 50 to 1100 kHz, early in the spring of 1952 these recordings were made at the Sterling field station, probably the first time ever at these low frequencies. On the two ionograms shown here, one for day and one for night, the heavy trace at "O" height came from the direct pulse from the transmitter. Traces marked "A" indicate reflections from the E layer, and occur both day and night. The extraordinary component of the F layer, "B," and the ordinary component, "C," appear only at night. "Pattern" traces were caused by interference, mainly from broadcast stations above 550 kHz. The equipment-produced horizontal and vertical lines indicate 20-km intervals of apparent height and 100-kHz frequency intervals, respectively.

### 3. Ionospheric observations at the Sunset field station

With the move to Boulder, Colo., there came the opportunity to make use of a mountainous region to support a large antenna without huge masts. The site selected was at Sunset in Four-mile Canyon, northwest of Boulder. Here an antenna 3400 feet long was suspended between two mountain tops.<sup>206</sup>

At this new facility the sweep-frequency range of the low-frequency ionosonde was increased to 2000 kHz for correlation of measurement in the gyro-frequency range and for probing into the higher regions of the ionosphere where reflections could be received from the E and F layers, thus studying the entire ionosphere at "one fell 'sweep'." At the Sunset station, beginning in 1956, under the leadership of Watts, many observations of the ionosphere at frequencies below 2000 kHz were made for a number of years. The studies led to a better understanding of the ionosphere. In addition, the facility served as a source of observations for study of whistlers, hiss, the dawn chorus, and sferics (see sec. on: The "Sound" of Radio Waves at Very Low Frequencies, pp. 479-482). The facility also served as a source of observations for IGY programs.

<sup>206</sup> Among the projects served by the long antenna was that of an experimental installation of WWVL for the broadcasting of a standard frequency at 20 kHz, the service beginning in late 1961 (see ch. VIII, p. 278).

Advantages of the long antenna were: good radiation efficiency when used for transmitting at low frequencies, and high signal reception (high signal-to-noise ratio) when used for receiving the audio frequencies of whistlers and VLF emissions. As a receiving antenna it operated as a very large vertical loop antenna with an area of 110,000 m<sup>2</sup>.

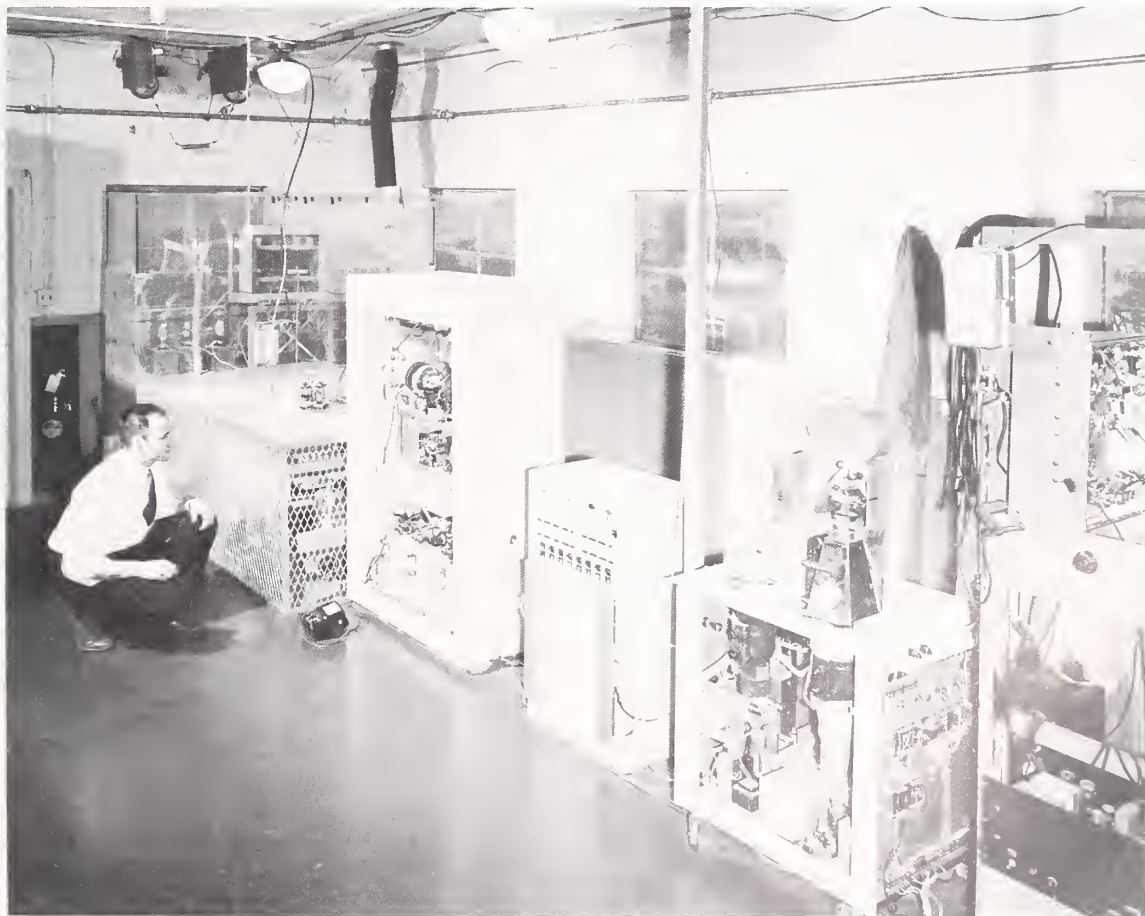

*Beginning in 1956, this "one-of-a-kind" ionosonde with a sweep-frequency range of 50 kHz to 2 MHz was used for a number of years for studying the ionosphere at low frequencies. Located at the Sunset field station northwest of Boulder, RF power was radiated efficiently by a very long antenna stretched across Four-mile Canyon and anchored at each end to a mountain top. William S. Hough is shown ready to push a button that started the cycle of operation.*

#### 4. Theoretical approaches toward the understanding of radio propagation at low frequencies

Beginning in 1949 a more intensive theoretical approach was taken by the CRPL in the general study of the ionosphere, including some areas of study that came within the range of low frequencies (pp. 465-466).<sup>207</sup>

By 1955 others had entered the CRPL to pursue theoretical investigations of low-frequency propagation in the ionosphere. Three VLF Propagation Studies projects were initiated during FY 1956 within the Upper Atmosphere Research Section. At the time, Thomas N. Gautier was chief of the section. Within a year two of the projects were combined and named VLF Propagation Theory. Entering the CRPL in 1955, James R. Wait served as a consultant to various projects.<sup>208</sup> He was engaged in theoretical studies of low-frequency propagation for many years thereafter, making many outstanding contributions to the somewhat specialized field.

Theoretical research by the CRPL in the area of low frequencies branched into several lines of investigation spread over several divisions and sections because of the diversity of its application to problem areas in radio communication.<sup>209</sup>

One of the early papers by Wait (and Howe) was *NBS Circular 574* that furnished graphical values of amplitude (microvolts per meter) and phase (lag) of electric field as a function of distance for groundwave propagation out to 1500 miles for the band of 200 to 500 kHz. The values were based upon radiation from a short vertical antenna over a curved stratified earth, the subject of a previous paper by Wait. This set of low-frequency transmission curves as a function of distance was one of the many that had been prepared by various investigators over a long period of years, including those that were derived from the Austin-Cohen equation from as far back in time as 1911.<sup>210</sup>

The application of waveguide-mode theory to VLF ionospheric propagation was the subject of a short paper by Wait and Howe in 1957 [63]. They considered the ionosphere as a sharply-bounded isotropic medium at frequencies below 16 kHz. This paper was followed by a number of papers prepared by Wait (some with coauthors) for the VLF Symposium of January 1957. Three of Wait's papers were published in the special issue (June 1957) of the 1957) of the *Proc. IRE* [64-66].<sup>211</sup>

<sup>207</sup> During the period of 1950-1954 Joseph Feinstein of the Upper Atmosphere Research Section published a number of theoretical papers on the ionosphere, including a summary report entitled "Ionospheric Wave Propagation at Low Frequencies." The full-length paper was prepared for presentation at the 1950 General Assembly of URSI held in Zurich, Switzerland, the summary report being published in the *Proceedings*. Feinstein found that ray-theory treatment of the ionosphere was inadequate where large gradients in electron density at reflection boundaries occur within the wavelengths of low frequencies. Using wave-theory principles and treating the ionosphere as an inhomogeneous medium at low frequencies, in a 1953 publication Feinstein was able to explain satisfactorily the polarization experiments carried out at the Sterling field station (see p. 471) [62].

<sup>208</sup> A group consisting of Wait, H. Herbert Howe, and A. Glenn Jean was formed to carry out theoretical studies on VLF propagation.

<sup>209</sup> The several lines of investigation included: the development of various theoretical models for better understanding of propagation, using geometric-optical and waveguide-mode methods for the models; calculation of propagation paths for pulsed transmissions; attenuation of ground wave and sky wave with distance; propagation of sferics; VLF antenna studies, and others.

<sup>210</sup> In an "Introduction to the VLF Papers" published in the June 1957 issue of the *Proc. IRE* (13 were selected from the 45 papers presented at the 1957 VLF Symposium at Boulder), Wait said:

The propagation at VLF was understood surprisingly well as long ago as 1911. At this time, the famous empirical formula of Austin-Cohen was proposed. This formula does have some theoretical justification, although it is now known that it is only applicable for frequencies near 25 kc. Despite the fact that VLF waves propagate to great distances with small attenuation, their use has been neglected for many years. Recently, however, with the pressing need for long range navigation systems, world-wide communication systems, and tracking of atmospheric storms and hurricanes, the desirable transmission properties of VLF are again being utilized.

<sup>211</sup> In one of the papers, Wait and Anabeth C. Murphy calculated the field strength of a VLF transmitter by geometrical optics, considering reflection from the ionosphere with a sharp lower boundary. They found that curves of theoretical field strength as a function of distance compared favorably with experimental data taken by another investigator for daytime paths over the Pacific Ocean at 16.6, 18.6, and 19.8 kHz.

In another paper Wait considered the space between the Earth and the ionosphere as a waveguide with sharply bounded walls (a somewhat similar mode-theory approach was given by K. G. Budden in 1951, and again at



## 5. The Boulder Laboratories hosts VLF, ELF, and ULF symposiums

Considering the date of the January 1957 VLF Symposium as a time base, published papers proliferated for a number of years thereafter from the low-frequency (below 300 kHz) projects within the CRPL. Most numerous of the papers were those published individually by Douglass D. Crombie, J. Ralph Johler, Kenneth A. Norton, and James R. Wait, and occasionally with coauthors. Interspersed among periods of preparation and publication of these many papers were three additional symposiums, all hosted by the CRPL at Boulder, the last being held in 1964. Many of the presentations by these authors at the several symposiums were published in various journals.

The first of the four symposiums was held January 23-25, 1957, with Wait as chairman of the Steering and Coordinating Committee, assisted by many CRPL staff members.<sup>212</sup> The symposium was limited to the VLF range, the contemporary-important range of frequencies from 3 to 300 kHz. Three hundred physicists and radio engineers were in attendance. The 3-day meeting was sponsored jointly by the Boulder Laboratories and the IRE Professional Group on Antennas and Propagation.<sup>213</sup>

The second symposium, labeled Conference on Propagation of ELF Electromagnetic Waves, was held on January 26, 1960.<sup>214</sup> This time the meeting was limited to the frequency range below 3 kHz, and was sponsored by the CRPL only. Wait and Arthur D. Watt moderated the two sessions.

The third symposium was a 3-day meeting held August 12-14, 1963, and once again was called a VLF Symposium after a lapse of 6 years from the first.<sup>215</sup> Again, the symposium was sponsored by the CRPL. Like the first symposium in 1957, 300 were in attendance. It was on the occasion of this meeting that the new NBS standard frequency and time transmitting stations near Ft. Collins were officially opened for service (see ch. VIII, p. 280).

The fourth symposium, called the Symposium on Ultra Low Frequency Electromagnetic Fields was held during August 17-20, 1964.<sup>216</sup> The 4-day meeting had a six-way

---

the 1957 Symposium). Again, Wait found that calculation of field strength at great distances agreed with experimental values stated in his geometrical-optics paper (Wait and Murphy), but with the consideration of the effect of a finite conductivity of the ground.

In the third paper Wait presented a waveguide-model treatment of the dependence of attenuation of VLF radio waves upon frequency, indicating compatibility with experimental data between 1 and 30 kHz.\*

\*This paper was based largely on remarks by Wait during the discussion periods at the 1957 Symposium.

<sup>212</sup>The first of the four symposiums held in Boulder, the 1957 VLF Symposium, has been noted previously in this chapter, and is noted in chapter XVIII. An account of the symposium was published in the May 1957 issue of the *Technical News Bulletin*. A publication record, in four volumes, of the 45 papers and the panel discussions was made available by NBS.

<sup>213</sup>It was at the 1957 Symposium that W. D. George, acting chief of the Radio Standards Laboratory, presented a "Proposal for Standard Frequency Broadcast at Very Low Frequency." This proposal followed the suggestions of investigators during the previous several years that it was feasible to obtain worldwide coverage from a single transmitter that would yield received signals with a very high precision (of the order of one part in  $10^{10}$ ) from the transmitted standard frequency. George's proposal was "to establish and continuously operate, night and day, one high-power (20 kW radiated) 10-kc standard-frequency station to serve the whole world." Two years later, in the July-August 1959 issue of the *NBS Journal of Research*, Arthur D. Watt and Robert W. Plush of the Radio Propagation Engineering Division presented their analysis of requirements for a VLF transmitter such as suggested by George and others.\* They concluded that a minimum of radiated power from 10 to 100 kW in the vicinity of 20 kHz would be required for worldwide coverage.

The result was that, somewhat more than 6 years later, the NBS had two stations near Ft. Collins, Colo., operating at 20 kHz and at 60 kHz, that furnished standard frequencies to much of the world. Several years later the CRPL was able to show from a 5-year study that it was possible to attain precision of the order of one part in  $10^{10}$  for received standard-frequency signals from VLF stations controlled by atomic frequency standards.

\*Arthur D. Watt was a staff member of the CRPL for a number of years, contributing extensively to the study of VLF propagation and engineering. In 1962 he became chief scientist of DECO Electronics, Boulder, Colo., and in 1967 published a lengthy and noteworthy treatise, entitled *V.L.F. Radio Engineering*. This volume was one of four authored by NBS staff members and published by Pergamon Press on a series of subjects in Electromagnetic Waves (see ch. X, ref. [56], ch. XI, ref. [10], and ref. [16]).

<sup>214</sup>The conference was reported in the May 1960 issue of the *Technical News Bulletin*. Wait reported on the Conference in the Correspondence of the September 1960 issue of the *Proc. IRE*.

<sup>215</sup>The symposium was reported by Crombie in the October 25, 1963, issue of *Science*.

<sup>216</sup>The symposium was reported by the two guest editors of the August 1965 issue of *Radio Science*.

cosponsorship.<sup>217</sup> Three of the four sessions were given over to tutorial-type papers. The papers were primarily on electromagnetic signals by natural causes in the frequency range between 30 Hz and 0.0001 Hz. Again, as in previous symposiums, approximately 300 were in attendance.

## 6. A proliferation of low-frequency papers

The proliferation of papers relating to low frequencies, mentioned earlier, resulted in more than 80 papers, published or in preparation, by 1965 when propagation projects were separated from NBS and became associated with ESSA. Because of the sheer immensity of the number of papers, these cannot be treated or even listed individually in this account.<sup>218</sup> Only the earliest (of a line of research), the more significant, and general interest papers are noted. During the period to 1965 much of the support for the many low-frequency programs came from the Cambridge Research Laboratories of the U.S. Air Force and from the Advanced Research Projects Agency (ARPA).

## 7. Field strength vs. distance—Contributions by the CRPL

Wait followed his 1957 Symposium paper on "The Mode Theory of VLF Ionospheric Propagation for Finite Ground Conductivity" (see footnote 211) with a "working formula" that yielded field-strength values in terms of distance. He expressed these values graphically as transmission-loss vs. distance curves [67].<sup>219</sup>

About a year after publishing transmission-loss curves for a VLF range of 10 to 20 kHz, Wait (with Nancy F. Carter) published field strength calculations that were applicable to an ELF range of 50 to 1600 Hz.<sup>220</sup>

In the January 1953 issue of the *Proc. IRE* Norton called attention to advantages of the use of the concept of "transmission loss" in studies of radiowave propagation. This he followed in 1959 with *NBS Technical Note 12* as a sequel to the previous paper, using the title "Transmission Loss in Radio Propagation: II" for the second report. Although the subject area covered frequencies from 10 kHz to 100,000 MHz, Norton set aside one section of his report to the VLF region. Using a method described earlier by Wait (references [65] and [66]), Norton calculated transmission-loss curves for distances out to 40,000 km at frequencies ranging between 8 and 22 kHz.

An added publication to the growing numbers on the relation of field strength and phase to distance (transmitter to receiver) was *NBS Technical Note 60*, issued June 1, 1960,

---

<sup>217</sup> Cosponsors of the 1964 Symposium were: NBS, the National Center for Atmospheric Research, the American Geophysical Union, the Office of Naval Research, the Air Force Cambridge Research Laboratories, and the International Association of Geomagnetism and Aeronomy.

<sup>218</sup> Most of the CRPL papers published through 1960 were listed by Wait in *NBS Technical Note 58*, entitled "A Survey and Bibliography of Recent Research in the Propagation of VLF Radio Waves;" also by Wilhelm Nupen in *NBS Technical Note 84*, entitled "Bibliography of Ionospheric Propagation of Radio Waves (1923-1960)," and included annotations. All of the publications by the CRPL on radio-wave propagation for the period from 1954 through 1964 (and for several years thereafter as ESSA papers) were included in several Publications Listing(s) for limited circulation.

<sup>219</sup> Wait chose a theoretical model of the ionosphere as a sharply bounded homogeneous ionized medium. His "working formula" and reception of signals in the frequency range of 10 to 20 kHz were from short vertical antennas. Conductivities of land and sea water were considered.

<sup>220</sup> This 1960 publication, *NBS Technical Note 52*, by Wait and Nancy F. Carter, was a numerical supplement to Wait's paper entitled, "Mode Theory and the Propagation of ELF Radio Waves" [68]. Wait considered the radio energy being transmitted as a waveguide mode with the bounding surfaces being the Earth and the lower edge of the ionospheric E region. Because of the excessively long wavelengths at ELF, near-field effects must be considered at short transmitting distances.

The *Technical Note* presented formulas for calculation of attenuation and phase constants, accompanied by graphical curves to indicate the magnitude and phase of the electric and magnetic fields out to 2000 km, based on a 90-km height for the bounding surface of the ionosphere.

In the January 1962 issue of the *Proc. IRE*, Wait followed several of his previous papers with a more simple formula for expressing the relation of average field strength with distance in the VLF range.

with the title "Amplitude and Phase of the Low- and Very-Low-Radiofrequency Ground Wave."<sup>221</sup>

As a contribution to the *IEEE Transactions on Antennas and Propagation*, in the January 1963 issue, Wait (with Lillie C. Walters) published a set of curves for ground waves over mixed land and sea paths, for frequencies of 20, 100, and 1000 kHz.<sup>222</sup>

## 8. An experimental study at LF

Because of great variations in ground conductivity in arctic regions, the attenuation of low-frequency radio waves is subject to marked changes on many propagation paths. During the summer of 1957 the Radio Propagation Engineering Division carried out a series of experiments at low frequencies in the Labrador to Greenland area to determine the magnitude of variation in change of field intensities (or attenuation) over arctic regions [69].<sup>223</sup>

## 9. Experimental studies at VLF and ELF

Two avenues of experimental study of low-frequency propagation are open, one, by using CW signals from VLF transmitters located at various points over the Earth. These stations are usually powerful sources of VLF radiation. The other source of available signals comes from a natural cause, that of lightning discharges, received as "atmospherics" or "sferics." Differing from manmade signals, their exact location is not well known at long distances. Although their energy occupies a large bandwidth, they are most useful as ELF signals in the range below 3 kHz where CW transmitters do not exist.<sup>224</sup>

### a) ATTENUATION RATES

Use of lightning discharges for study of low-frequency propagation began in the mid 1950's. At the 1957 VLF Symposium at Boulder, William L. Taylor of the Upper Atmosphere Research Section described a method of receiving and of analyzing the frequency spectrum of sferics. Thereafter, for several years, Taylor, with others, published several papers on the use of atmospheric waveforms for study of VLF propagation, particularly that of attenuation rates [70].<sup>225</sup>

---

<sup>221</sup> In 1956 J. R. Johler, W. J. Kellar, and L. C. Walters published *NBS Circular 573* wherein they presented various formulas for the numerical evaluation of amplitude and phase of low frequency ground waves as a function of distance. Information on phase was of particular importance for newly developed LF radio-navigation systems. Graphical curves were furnished for distances out to 10,000 miles at frequencies in the range of 20 to 1000 kHz.

With the availability of additional theoretical investigations and of electronic computers, J. R. Johler, L. C. Walters, and C. M. Lilley increased the scope of their initial work and in 1960 brought out *NBS Technical Note 60*. The graphs and tables indicated amplitude and phase in the frequency range from 100 Hz to 1000 kHz, for distances out to 5000 miles.

<sup>222</sup> Two values of conductivities for land were given, and one for sea water. Most of the curves showed the well-known "recovery effect" which occurs beyond the coast line for propagation from land toward the sea.

<sup>223</sup> Field strength measurements were made by airplane flights over several 1400-mile paths extending from Goose Bay, Labrador to Thule, Greenland. Attenuation of signals was much greater over land and ice areas than over open sea, and there was much greater loss of signal strength than would be indicated by simple inverse-distance reduction. Also, there was much variation in signal strength in the vicinity of coastlines, an effect studied by Wait in a series of theoretical papers.

<sup>224</sup> The spectra of signals from lightning discharges usually have a peak region between 5 and 20 kHz. This fairly broad spectra narrows to 3 to 5 kHz at distances greater than several thousand kilometers.

<sup>225</sup> During the summer of 1958 the amplitudes of atmospheric waveforms in the bandwidth of 3 to 30 kHz were observed simultaneously up to distances of 10,000 km from Boulder, Colo.; Salt Lake City, Utah; Palo Alto, Calif.; and Maui, Hawaii. Daytime attenuation was found to be about 7 to 9 dB per 1000 km at 6 kHz, and decreased to about 1 to 3 dB per 1000 km above 10 kHz. Also, that the difference in attenuation rate of west-to-east propagation relative to east-to-west propagation was about 3 dB per 1000 km less for frequencies below 8 kHz and 1 dB per 1000 km at frequencies above 10 kHz.

The difference in attenuation rate between west-to-east and east-to-west directions had been observed in 1957 by Douglass D. Crombie in New Zealand (Crombie joined the CRPL in 1962). In 1958 and again in 1961 Crombie published theoretical papers that gave explanation to the nonreciprocal relation in the direction of propagation of VLF radio waves perpendicular to the magnetic meridian (parallel to magnetic equator), a condition to be found at all magnetic latitudes except at a magnetic pole.

Arthur D. Watt's (Radio Communication and Systems Division) study of ELF electric fields from thunderstorms led to a further study of the attenuation rate of ELF radio waves, that by A. Glenn Jean and others of the CRPL [71].<sup>226</sup>

#### b) PHASE CHARACTERISTICS

The four atmospheric recording stations used for studying attenuation rates at VLF also served in a study of phase characteristics in the propagation of radio waves at VLF. Jean, Taylor, and Wait found that the relative phase velocity at 4 kHz for long distances is about 3 percent greater than the velocity of light, and decreases to about 1 percent at 8 kHz [72]. This dispersion in phase velocity agreed closely with that predicted by the mode theory of propagation.

#### c) A STUDY IN VLF FADING

The rather common phenomenon of fading of radio signals received at long distances is characterized in the VLF band by fairly pronounced fading at sunrise and to a lesser extent at sunset. During 1962 Crombie of the LF and VLF Research Section studied the fading characteristics over two long-distance paths and arrived at a new and different explanation for sunrise and sunset fading—that the variations in amplitude and phase are due to multimode propagation in the nighttime region of the transmission path [73].<sup>227</sup>

### 10. Theoretical studies in the 1960's

Associated with the publications prepared by the CRPL staff relating to the determination of amplitude and phase of the field of a radiation source as a function of distance and frequency, were many other theoretical papers that would serve to explain low-frequency propagation and that would be useful in the solution of engineering problems. Many of these papers can be categorized into several groups that depict their nature. No doubt, many, or even most, of the situations that involved long-distance transmission were best treated by the waveguide-mode theory and by 1965 many papers had been published by the CRPL staff in this area. Wait's (with coauthors) contributions in this area were fruitful. Wait also included papers that treated the ionosphere as a nonhomogeneous ionized medium of stratified layers.

Another, and often useful, treatment was that by geometric-optical theory, with the consideration of reflection from a sharp boundary of the ionosphere. Here the application of magneto-ionic theory (superposition of the Earth's magnetic field on the ionic motion) offered explanation of nonreciprocity of east-west and west-east propagation. Various papers by Crombie, Johler, and Wait, along with coauthors, came within this area.

Because of the usefulness of theory to a better understanding of radio-navigation systems operating with low-frequency pulsed transmissions, several papers were published on the transient characteristics of such transmissions.

### 11. Writing for the sake of "general interest"

Beginning in 1958, several survey and tutorial-type publications, relating to low-frequency propagation were written by CRPL staff members, including a book by Wait. These publications gave evidence of the familiarity with, and depth of understanding of, low-frequency propagation at NBS.<sup>228</sup>

---

<sup>226</sup> During the spring of 1960 simultaneous recordings of atmospheric waveforms were made of thunderstorms on great-circle routes between Boulder, Colo.; Fairbanks, Alaska; and Maui, Hawaii. Propagation attenuation rates were calculated from the waveform spectra and found to be about 1 dB per 1000 km at 75 Hz and increasing to 3 dB per 1000 km at 200 Hz for east-to-west propagation.

<sup>227</sup> Observations of fading were made at Boulder of 19.8-kHz signals from Hawaii, and at Frankfurt, Germany (by the Battelle Institute) of 18.0-kHz signals from the Canal Zone. From his studies Crombie was able to formulate a model that satisfactorily explained the fading phenomenon in its various aspects.

<sup>228</sup> Among the several papers presented by CRPL staff members at the International Conference on Electromagnetic Wave Propagation at the 1958 Brussels International Exhibition was a lengthy survey paper by Norton, entitled "Low and Medium Frequency Radio Propagation." In 1960 all of the conference papers were published in book form, including the five CRPL papers by Norton, Wait (three as author or coauthor), Alyce M. Conda, and Bradford R. Bean.

# THE "SOUNDS" OF RADIO WAVES AT VERY LOW FREQUENCIES

## 1. Early observations of the "sounds" of radio waves

Following the organization of the CRPL after World War II there came an increasing interest in the propagation of radio waves below 1000 kHz, both within NBS and elsewhere. By 1950 several projects at the lower frequencies were in progress within the Ionospheric Research Section (see sec.: From 300 kHz Down, Down, Down). In the study of propagation at LF (low frequency, 30-300 kHz) and VLF (very low frequency, 3-30 kHz), quantitative data were needed for radio-navigation systems, communication systems, worldtime signals, radio noise studies, and studies of the reflection properties of the ionosphere and surface of the Earth.

By the early 1950's a new observational technique in radio science was recognized that could, and would, offer a new means of studying radio propagation at low frequencies. This field of observation took on the name "whistlers," but in its more general usage carried with it such terms as "sferics" (contraction for atmospherics or the pulses of radio waves emitted by lightning flashes) and VHF emissions.<sup>229</sup>

(Continued)

Johler's tutorial paper "Propagation of the Low-Frequency Radio Signal" was solicited for publication in the April 1962 issue of the *Proc. IRE*. In particular, Johler treated the case of the propagation of a ground-wave pulse. His paper was based upon the use of mathematical rigor.

Johler's paper was followed within 2 months by another tutorial paper solicited by the IRE, this one by Wait, entitled "Introduction to the Theory of VLF Propagation," published in the July 1962 issue of the *Proc. IRE*.

In his book, *Electromagnetic Waves in Stratified Media*, published by Pergamon Press, Oxford, in 1962, Wait wrote in the Preface:

Much of the subject matter is based on the author's own investigations. Some of these have been published previously in *Technical Notes* and in the *Journal of Research* of the National Bureau of Standards over the period 1956-1962. . . .

The subject matter was, essentially, that of a theoretical treatment of the propagation of VLF and ELF radio waves.

A listing of chapter titles indicates the nature of this book, which is both a reference book and a textbook. Also, these titles indicate the nature of many of Wait's papers published during the period of 1956-1962:

- Reflection of EM waves from horizontally stratified media
- Reflection of EM waves from inhomogeneous media with special profiles
- Approximate methods for treating reflections from inhomogeneous media
- Propagation along a spherical surface
- Fundamentals of mode theory of wave propagation
- Characteristics of the modes for VLF propagation
- Propagation in stratified magneto-plasma media
- VLF propagation-theory and experiment
- ELF propagation-theory and experiment
- Asymptotic development for guided wave propagation
- Superrefraction and the theory of tropospheric ducting\*

\*Although this chapter is primarily that of propagation of UHF waves in the troposphere, Wait states that the general theory is quite similar to that of VLF waves in the ionosphere.

<sup>229</sup> A good reference text on whistlers and other sounds of radio waves is *Whistlers and Related Ionospheric Phenomena* by Robert A. Helliwell (Stanford University Press, 1965), in which the author sketches the historical background of whistlers and gives a technical treatment of the subject.

Whistlers on telephone lines were observed as far back as 1886, usually during magnetic storms. In 1925 Eckersley (Marconi Wireless Telegraph Co., England) described the musical nature of atmospheric disturbances heard on some radio circuits. Much later, in 1953, Storey (Cambridge University) reported on a study of the nature of whistlers, a study that became quite extensive.

Whistlers can be heard after the voltage they induce in an antenna is amplified and applied, without frequency conversion or rectification, to a headphone. They glide downward from a high frequency above the audible range to around 1000 Hz, but at times they will take on a different character such as rising in frequency. Although usually associated with lightning discharges, even at great distances, their source can be from disturbances such as nuclear explosions. In lightning discharges the electrical disturbance can follow magnetic lines of force to the opposite side of the Earth, and has been observed to oscillate back and forth a number of times.

Another type of "sound" in radio waves is that known as VLF emission, and that probably has its source in the outer ionosphere (exosphere) when under excitation of streams of ionized particles. Although the characteristics of the sound have been classed into many types, as a group the sound is usually called the "dawn chorus." Because the sounds are most prevalent at or near local dawn, this name is associated with bird songs of early morning or,

## 2. The CRPL studies sferics

Beginning in July 1954 the CRPL received support from the Department of the Air Force for the recording of sferics as a study in VLF propagation. This project was an outgrowth of the low frequency propagation project of the Ionospheric Research Section and was located for a time in both Washington, D.C. and Boulder. Edwin F. Florman served as the project leader. Stanford University cooperated in the project. Waveforms of sferics were observed at Ft. Belvoir, Va. (near Washington, D.C.), at Boulder, and at Palo Alto, Calif. during the late summer of 1954. Initially, because of the difficulty of the study, little of value resulted in the way of propagation information. But bolder plans came into being and several projects were initiated to attack the problems, including theoretical studies of low frequency propagation.

A new facility that would serve a variety of VLF projects during the coming years was an antenna 3400 feet long suspended between two mountain tops bordering Four-mile Canyon at Sunset, to the west of Boulder.<sup>230</sup> The antenna was 800 feet above the canyon floor where the transmitters and receivers were housed.

## 3. Observing VLF emissions

The facilities of the Sunset field station had a propitious introduction to the observation of "hiss" as a VLF emission on February 26, 1956. For nearly 4 days there had been a very strong solar disturbance. When the recording equipment was turned on during the evening of the 26th a strong hiss was noted by James M. Watts. Six days later, after the equipment was given extensive tests, another recording of the hiss indicated an exceptionally high signal level. Analysis of the hiss showed a center frequency around 3 kHz over a total bandwidth to about 8 kHz but frequently of a bandwidth that varied with period of observation. There were periods when the hiss was accompanied by gliding tones [74].

For the next several years the Sunset facility was used for the recording of VLF emissions that became the subject of considerable analysis by Roger M. Gallet and Donald L. Jones. Analyses of the spectrograms evolved through several methods and were first reported in 1957.

By 1963 a rather sophisticated form of "Hiss Recorder" was developed within the Upper Atmosphere and Space Physics Division for the continuous observation of VLF emissions. By the use of very slow recording speeds over long periods of time, characteristics of the emissions that had not been observed before now became apparent.

In 1963 Jones and Gallet, along with Watts and Donel N. Frazer, published an "Atlas of whistlers and VLF emissions," as *NBS Technical Note 166*, that resulted mainly from observations taken at the Sunset field station from January 1956 to June 1957. The observations were recorded on magnetic tapes, and later were monitored aurally and analyzed as spectrograms by means of a sound spectrograph. The many and varied types of spectrograms composed the "Atlas." Gallet and Jones had reported on this systematic classification of VLF emissions 6 years earlier at the May 1957 meeting of URSI in Washington, D.C.

## 4. The CRPL reports to the 1957 NBS Symposium on Propagation of VLF Radio Waves

By the end of 1956 the fairly extensive program being carried on by the CRPL on whistlers and related ionospheric phenomena at VLF was ready for initial reporting. And the opportune occasion came during the January 23-25, 1957 Symposium on Propagation of VLF Radio Waves staged at the Boulder Laboratories (see p. 475).

---

(Continued)

sometimes, with that of spring peepers (frogs). Oftentimes the sound will be that of a more or less steady hiss, a band of noise several kilohertz wide. More recently this entire group of sounds has been called VLF emissions.

For the reader interested in the subject, again, reference is made to Helliwell's book, especially Chapter One (Introduction) and Chapter Two (History).

<sup>230</sup> See footnote 206.

A method for calculating the complex ionospheric reflection coefficient at VLF using spheric waveforms was presented by A. Glenn Jean, L. Jerome Lange, and James R. Wait.<sup>231</sup> Reflection coefficients determined from observations of sferics were compared with those calculated by using an ionospheric model. Observations of sferics were made simultaneously by a coordinated system of two stations, one station at Boulder (Gunbarrel Hill site), the other operated by Stanford University near Palo Alto, Calif. Success of the method depended largely upon the type of antenna and equipment used in order to separate the vertically polarized ground wave of the lightning discharge from the elliptically polarized sky waves.<sup>232</sup> Later, in 1957, the authors published their investigation in an international periodical [75].

William L. Taylor reported on his study of the spectrum analysis of sferics, both at the Boulder and the Stanford University sites. A special system of interconnected oscilloscopes, as well as interconnection of the two receiving sites, resulted in obtaining the desired results (the equipment was the same as used by Jean, et al., noted above). Of particular interest was Taylor's observation that the spectra of the sferics that precede whistlers are of a different character than those for non-whistlers, in that they show lower frequencies and an indication of much greater energy in the disturbance. Taylor's work led to a paper published in 1958, coauthored by Helliwell (Stanford University), Jean, and Taylor [76].<sup>233</sup>

Gallet and Helliwell reported on a theory they had developed on the production of VLF noise (dawn chorus) by traveling-wave amplification in the exosphere. In a summary of their work they stated:

It is the purpose of this paper to suggest a mechanism for the generation of hiss and constant tones based on selective traveling-wave amplification of noise energy arriving from the sun or elsewhere and to suggest its extension to the dawn chorus. Energy for the amplification process is provided by streams of ionized particles which come from the sun and travel along lines of the earth's magnetic field. . . . The mechanism of amplification is assumed to be similar to that in ordinary traveling-wave tubes . . .

The traveling-wave theory (if proven correct) will provide a powerful new tool for the study of the dynamics of the outer ionosphere . . .

Later, in 1959, the authors published their theory in the *NBS Journal of Research* [77]. Shortly before this publication, Gallet published a tutorial-type of paper in the February 1959 issue of the *Proc. IRE* on VHF emissions, entitled "The very-low-frequency emissions generated in the earth's exosphere." This was a Special Issue on the "Nature of the Ionosphere—an IGY Objective."

Also reporting at the symposium was Watts on the early investigation of VLF emissions that he had conducted at the Sunset field station (described on p. 473 of this chapter).

## 5. Taking part in the IGY whistler program

Although the CRPL had no direct responsibility in the operation of the IGY whistlers program, it did furnish data from Boulder observations to the World Data Center for Whistlers at Boulder during the period of July 1957 through December 1959. These data, reduced to the form of thousands of spectrograms, were obtained on a regular schedule at

---

<sup>231</sup> In its simplest form the ionospheric reflection coefficient can be expressed as the ratio of the amplitude of a wave reflected from the ionosphere to the amplitude which would be reflected in the absence of dissipated attenuation within the ionosphere.

<sup>232</sup> In analyzing the sferics waveforms, four quantities were required to characterize the incident wave. These were obtained by the use of three antennas at each station—one vertical antenna and two cross-loop antennas. The azimuth angle was determined from the ground-wave portion of the sferic as observed at Boulder and at Palo Alto, using broad-band direction-finding equipment.

<sup>233</sup> The authors arrived at three conclusions:

- 1) A characteristic waveform usually is associated with the impulse that produces a whistler, as previously noted by Taylor.
- 2) Whistlers appear more frequently over sea than over land paths.
- 3) Time of origin of a whistler should not be calculated from the Eckersley law of dispersion.

the Sunset field station under Watts' supervision. During much of the period simultaneous observations were taken at the Anchorage, Alaska field station.

Early in 1957 Donald L. Jones and Gallet had prepared a preliminary atlas on whistlers and VLF emissions for distribution to technical groups preparing the IGY whistler program. Later, the atlas became *NBS Technical Note 166* (1963).

## 6. Further investigations

Other programs and refinements of earlier programs for whistlers and VLF emissions were to follow in the wake of the investigations of the mid-1950's. The programs were supported by several Government agencies in the interest of gaining more information on the use of VLF communications and the study of propagation characteristics in the frequency range of 1 to 100 kHz.

The study of sferics from lightning discharges began with simultaneous observations from two stations. The network of stations gradually grew and by 1961 included the original stations of Boulder and Palo Alto, Calif., plus stations in Utah, New Mexico, Maui (Hawaii), three stations in Florida, a mobile station in Wyoming and another in Oklahoma. The Florida stations were selected for study of sferics near sea level. Taylor served as project leader for the various projects. Two papers by the team of Jean and Taylor were of significance [78,79].

Although the studies of whistlers and VLF emissions yielded information on the electron density and the nature of high-energy particles in the exosphere, much additional information was to be learned from the more direct means by rockets and satellites. (It was with these devices that the existence of the Van Allen radiation belts in the outer exosphere was revealed.)

## CRPL PARTICIPATION IN THE IGY PROGRAM

The general aspects of the International Geophysical Year (IGY) program as engaged in by the CRPL are delineated in chapter XVII (On the International Scene, see sec.: NBS Contributes to the International Geophysical Year, pp. 674-675).

### 1. Probing the ionosphere by vertical sounding

The first step taken by the CRPL to implement the technical projects of U.S. participation in the IGY program was in the latter part of 1954. It was then that Harry G. Sellery, engineer-in-charge of CRPL field operations, and James M. Watts of the Ionospheric Research Section, prepared specifications and let bids for procurement of a number of new-type Model C-4 ionosondes for the IGY program.<sup>234</sup> This procurement, as well as most of the technical projects for U.S. participation in the IGY program, were sponsored by the National Science Foundation.

During the IGY program NBS operated or cooperated with other agencies in the operation of 34 ionospheric vertical sounding stations in North and South America, in the Pacific, and in the Antarctic (five stations). These stations were fitted with NBS-designed ionosondes, including the recently designed Model C-4. This program was under the direction of Alan H. Shapley, Robert W. Knecht, and Harry G. Sellery. Five stations in South America were clustered closely in the vicinity of the geomagnetic equator for study of equatorial sporadic E. Observations from these stations indicated a rather high occurrence

---

<sup>234</sup>The First Annual Report of the Boulder Laboratories stated:

New automatic ionosphere recorders, utilizing latest electronic techniques, must be procured in time for the mounting of the International Geophysical Year program. The equipment not only must be superior to present equipment in order to obtain the most useful scientific data, but must also be exceptionally reliable for a wide range of climatic conditions.

. . . It (IGY Vertical Soundings Project) will play a key part in the United States participation in the synoptic program in ionosphere physics planned for the IGY, including important phases in the planning of ionosphere sounding stations, the procurement of specialized equipment, and the training of technical personnel for locations ranging from the tropics to the Antarctic.



of sporadic E during daylight hours within a narrow belt along the geomagnetic equator (see p. 425).

Another IGY study was a true height electron density analysis of vertical ionospheric soundings taken at seven stations near the 75° West meridian from Chimbote, Peru, to Ft. Monmouth, N.J.

The IGY program gave the first opportunity to study the ionosphere over the Antarctic Continent in considerable detail. Among the dozen or so ionospheric vertical incidence stations, five were operated by the United States. The observations were analyzed by several of the CRPL staff, including Knecht's study of data taken at the CRPL's South Pole Station (see pp. 443-445).

## 2. Radio noise data on a worldwide scale

During FY 1956 the IGY radio noise program was set into action by the procurement of additional NBS-designed Model ARN-2 atmospheric radio noise recorders (see ch. XIII, pp. 557-561).<sup>235</sup> The NBS supervised the worldwide noise program, under the direction of William Q. Crichlow, utilizing a network of 16 recording stations scattered over the globe. Upon completion of the initial IGY noise project in December 1958, the CRPL supervisory group published *NBS Technical Note 18* [80]. Continuation of the project for a number of years resulted in a series of quarterly *NBS Technical Notes*, entitled "Quarterly Radio Noise Data," the last being published in the spring of 1965.

## 3. Geophysical correlation of sporadic-E and F-scatter studies

Ionospheric studies associated with the IGY program offered the opportunity of a further study of sporadic E on a larger geographical scale. Coupled with this opportunity was another, that of a further study of the newly discovered ionospheric phenomenon in the Western Pacific, soon to be called the "Far East Anomaly." Under the direction of Ernest K. Smith, the several studies involving oblique-incidence techniques were supported by the IGY program. Geographically, these studies were staged with communication networks on islands in the Western Pacific, in the Caribbean area, and in continental United States (see sec.: Studies of the Ionospheric Regions, pp. 424-425; and sec.: Geographical Nonuniformities of the Ionosphere, pp. 446-448).<sup>236</sup>

## 4. VHF forward scatter experiments near the geomagnetic equator— And in the Antarctic

Still another opportunity came from the IGY program, that of ionospheric forward scatter experiments in the vicinity of the geomagnetic equator. The various projects in these studies were made under the leadership of Robert S. Cohen and Kenneth L. Bowles. Two transequatorial paths of different lengths were operated across the geomagnetic equator in Western South America for these studies. In addition to the forward-scatter experiments there came the opportunity to study scatter-F phenomena in the vicinity of the geomagnetic equator (see sec.: Studies of the Ionospheric Regions, pp. 425-426; and sec.: Geographical Nonuniformities of the Ionosphere, pp. 443-448).

Another VHF forward-scatter project followed in the wake of the overall IGY program, a project in the Antarctic during the IQSY of 1964-1965.<sup>237</sup> This was a cooperative project between the National Bureau of Standards and Bartol Research Foundation of the Franklin Institute. Observation of ionospheric forward scatter over four paths in the Antarctic was

---

<sup>235</sup> Recordings were taken on Model ARN-2 recorders at an effective bandwidth of 150 to 300 Hz over the frequency range of 13 kHz to 20 MHz.

Radio noise from atmospherics and manmade noise is the basic limitation to radio reception. Radio reception in tropical and semi-tropical regions is often handicapped by atmospherics.

<sup>236</sup> Literature references to these studies are noted in the sections cited above. A somewhat detailed report on the correlation of the sporadic-E and F-scatter studies was prepared as an *NBS Technical Note* by James W. Finney and E. K. Smith [81].

<sup>237</sup> Two terms have been associated with the acronym IQSY, namely: (a) International Geophysical Year of the Quiet Sun, (b) International Years of the Quiet Sun.

used as a technique to achieve a better understanding of the effect of high-energy particles in the lower region of the ionosphere. This project was directed by Dana K. Bailey of NBS and M. A. Pomerantz of the Bartol Research Foundation (see sec.: Geographical Nonuniformities of the Ionosphere, pp.444-445).

## 5. Observing airglow

The CRPL's airglow studies, begun in 1954, had the opportunity to expand on a worldwide scale with the coming of the IGY program. Franklin E. Roach was selected as vice-chairman of the IGY Technical Panel on Aurora and Airglow. The two airglow stations operated by the CRPL at Fritz Peak (near Boulder) and at Rapid City, S.D., were among the 28 stations scattered around the world engaged in the total IGY airglow program (see sec.: Observing the Night Sky, p. 468).

The Boulder Laboratories, one of the IGY World Data Centers, became the subcenter for the data from airglow stations of the Western Hemisphere, New Zealand, and Australia (see ch. XVII).

## 6. Observing Sputnik I

In October 1957 the flight of Sputnik I became a dramatic part of the IGY program. The CRPL's early observations of the satellite are related in the section: Probing the Ionosphere from Above (see pp. 499-500).

## 7. The IGY World Warning Agency

The IGY was selected to coincide with a period of maximum activity of the solar atmosphere—maximum sunspot period—and this activity became the source of constant observation. The CRPL was assigned responsibility of alerting IGY scientists the world over to periods of unusual Sun activity. This service was maintained by the IGY World Warning Agency operated from the North Atlantic Radio Warning Service station located at Fort Belvoir, Va. (see pp. 453-455).<sup>238</sup>

## 8. International Geophysical Calendars

Developing from the IGY program came a worldwide coordination of geophysical observation programs and data exchange that became the International World Day Service (IWDS), established by the International Council of Scientific Unions (ICSU). By 1959 the CRPL was requested to prepare the International Geophysical Calendar, thus continuing the processing of the regular world days and world meteorological intervals of the IGY Calendar Record. Later, this Calendar Record became the International Geophysical Calendar.<sup>239</sup>

## 9. The CRPL contributes to IGY publications

The day-to-day coordination of IGY observations was administered by the IGY World Days and Communications Program. In this IGY operation Shapley served as the CSAGI (Comité Spécial de l'Année Géophysique Internationale) Reporter. An early product by Shapley was the preparation and 1956 issuance of the *IGY Instruction Manual, Part I:*

---

<sup>238</sup> During the IGY (18 months) there were Special World Intervals (SWI) declared, totaling 45 days of unusual solar activity, and usually followed by magnetic disturbances. Only four of the SWI's were not followed by magnetic disturbances.

<sup>239</sup> When initiated, the purpose of the International Geophysical Calendar was to designate (in calendar format for each year):

some special days and intervals for special attention for geophysical experiments and analysis. The Calendar serves to encourage world-wide coordination of observation or analysis of those geophysical phenomena which vary significantly during the course of a year.

These Calendars were prepared by Alan H. Shapley and J. Virginia Lincoln in consultation with various agencies such as URSL. Shapley served as chairman of the IWDS (later IUWDS) Steering Committee. The Calendars were published in a number of scientific journals and continue to be published to the present time.

*World Days and Communications*. Later, for the International Years of the Quiet Sun (1964-1965), Shapley prepared the *IQSY Manual for World Days Program*.

The September 1957 issue of the *Technical News Bulletin* gave a five-page account of "NBS Participation in the International Geophysical Year," stating in the opening sentence, that:

The National Bureau of Standards is playing an active, many-faceted role in the International Geophysical Year of 1957-58. From observation stations widely scattered over the globe, the Bureau is collecting and analyzing data on many phases of upper atmospheric physics and radio propagation. . . .

The February 1959 issue of the *Proc. IRE* was given entirely to the publication of 26 papers on the ionosphere and the IGY program. Included among the authors were five CRPL staff members: Roger M. Gallet, C. Gordon Little, Franklin E. Roach, Alan H. Shapley, and Dana K. Bailey (at the time with Page Communications Engineers).

Several months after the close of the initial IGY program, David M. Gates of the Radio Propagation Physics Division prepared a summary report of the Bureau's participation in the IGY program, with preliminary results as deduced from the observational data [82]. Thereafter, there was no large-scale compilation made of the entire IGY program as conducted by NBS. Over a period of a number of years the results of the Bureau's participation in the IGY program appeared in a variety of scientific publications.<sup>240</sup>

As a part of the URSI National Committee (U.S.) Report to the XIV General Assembly, published in the May 1964 issue of *Radio Science*, Robert W. Knecht described the objectives of the U.S. IQSY program, the 10 U.S. synoptic programs, and the 9 U.S. programs of special experiments. Implementation of these programs began with the CRPL and continued into the operations of ESSA.

## NBS PIONEERS IN RADIO COMMUNICATION BY IONOSPHERIC FORWARD SCATTER

### 1. Some evidence of ionospheric scatter

In his two publications of 1929 and 1932, T. L. Eckersley (England) postulated on the scattering of radio waves in the E region to account for some of the effects that he had observed in taking direction-finder bearings. Other observations at relatively short waves (frequency range of 6 to 22 MHz) indicated the frequency dependence of the scattering effect upon various types of signals. From his observations Eckersley developed a theory of ionospheric scattering.

In 1933 Ratcliffe and Pawsey (England) published a paper suggesting that a major cause of fading of received radio signals could be that by the interference of waves scattered in the ionosphere. Although scattering of short waves by the ionosphere was apparent, it appears that no one over a period of several decades considered the possibility of taking into account the scattering effect as Nature's means of serving as a communication medium over comparatively long distances. In fact, at VHF (30 to 300 MHz) it was not believed possible to communicate much beyond a line-of-sight distance. However, in a paper published in 1932, Marconi had expressed the belief that it would be possible to transmit with short waves much beyond the optical line of sight.

---

<sup>240</sup> One cannot but be surprised at the magnitude of publications output of the IGY program and the succeeding IGC and IQSY programs. As a sample of the publication "explosion" in the area of geophysics that resulted much from the international programs, is that revealed by the extent of bound volumes of the *J. of Geophysical Research* in the Boulder Laboratories Library of the U.S. Department of Commerce.

The 26 years of publications in 26 volumes from 1932 through 1958 (to close of IGY) occupy one shelf-width; whereas, the 18 years of publications in 58 large volumes from 1959 to 1977 occupy a total of five shelf-widths.

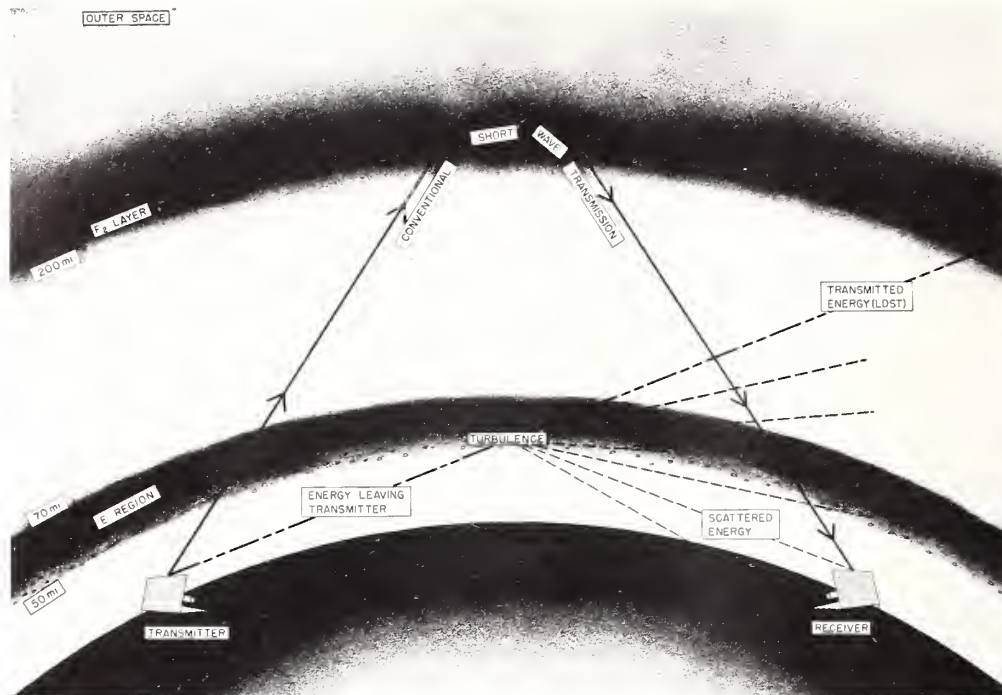

In conventional transmission, short waves (in range of 25 to 60 MHz) are propagated beyond the visible horizon by reflection from the upper layers or F region of the ionosphere. In propagation by ionospheric forward scatter the energy of radio waves is scattered by turbulence in the lower portion of, and below, the E layer, providing for reception of signals much beyond the line of sight.

This diagram, taken from the January 1956 issue of the NBS Technical News Bulletin, used the term "turbulence," whereas use of the term "scattering" of radio waves by small irregularities in the ionization of the lower ionosphere is more correct and has had wider usage.

## 2. The initial experiment by NBS

During the evening of January 23, 1951, NBS personnel discovered that it was possible to receive a VHF signal at 49.8 MHz over a distance of 1243 km (773 miles), on this occasion from Cedar Rapids, Iowa to the Sterling field station (just outside of Washington, D.C.). Although there had been credence of its possibility, heretofore no one had designed an experiment that would utilize ionospheric forward scatter as a means of communication. A series of events led up to this successful type of transmission.<sup>241</sup>

In 1950 a classified project, known as Troy, was established at the Massachusetts Institute of Technology by the Department of State for a study of technical communication problems being encountered by the Voice of America. NBS was requested to participate in this project and Dana K. Bailey of the Upper Atmosphere Research Section was selected as the representative. One of the technical problems was that of devising a medium-distance (1000 miles) communication system of very high reliability under all conditions of transmission conditions, and one that would be effectively immune to jamming. Early in November, at one of the weekly technical conferences in Boston, the matter of such a communication system was discussed. On this occasion Bailey made the suggestion that a system using the scatter mechanism of the E layer was a distinct possibility in meeting the need of the Department of State.<sup>242</sup>

<sup>241</sup> Many of the events leading up to and following this discovery were related to the author (WFS) by Dana K. Bailey in a recorded interview on December 8, 1977, at Boulder, Colo. Bailey had taken a major role in the ionospheric forward scatter project from 1950 to 1955 while a staff member of the Upper Atmosphere Research Section and as a consultant in the CRPL. However, much of this account is documented by published and unpublished papers.

<sup>242</sup> Back in 1944 Bailey and Newbern Smith (then, assistant chief of the IRPL) had informally discussed the possibility of a communication system that would make use of the scatter mechanism of the lower ionosphere. Seven years later, in 1951, their contemplated system became a reality.

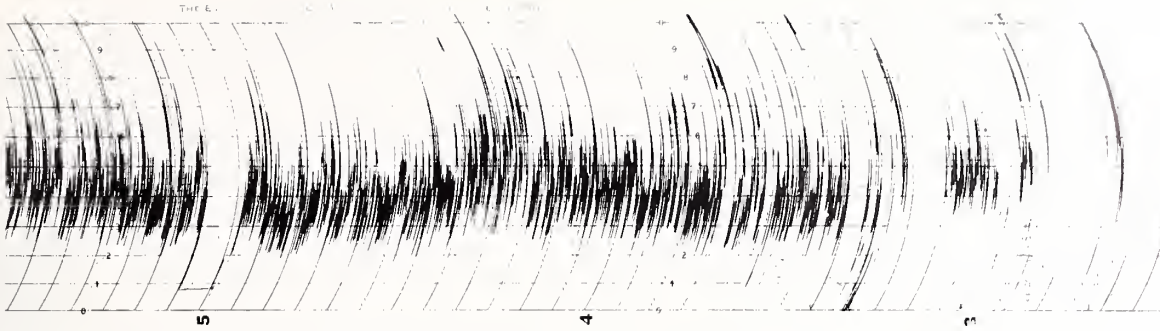

Chart tracing of VHF signals observed for the first time by ionospheric forward scatter. On the evening of January 23, 1951, signals were transmitted from Cedar Rapids, Iowa and received at the NBS Sterling field station over a 1243-km path. After preliminary adjustment of the equipment, a signal trace was received at 2250 (10:50 p.m.) and, then upon further adjustment, signals were received continuously from 2255 until mid morning of the following day (January 24). The reading speed was at 1 ft per hour, the tape moving from right to left. The initial trace is approximately 3 1/2 divisions to the right of "3," then follows the more continuous tracing beginning about 1 division to the right of "3." At "5" and continuing for 1 division is an indication of the noise level, which was substantially less than the signal level. The signal tracings are on an arbitrary scale. However, subsequent observations showed signal levels ranging from 10 to 25 decibels above 1 microvolt.

In December (1950) a Troy Project team, under the direction of E. M. Purcell of Harvard University considered Bailey's suggestion worthy of a try and set a crash program into action.<sup>243</sup> Fortunately the Collins Radio Co. at Cedar Rapids, Iowa, had a transmitter suitable for the crash program that was being readied for delivery to the Navy. With permission, the company was allowed to retain the 50-kW transmitter for a half-year period and modify it to the extent of being suitable for the forward-scatter experiment. With the transmitter at Cedar Rapids, the NBS Sterling field site was selected as the receiving station, being 773 miles (1243 km) from Cedar Rapids, a desirable distance for conducting the experiment.<sup>244</sup> NBS personnel directed the project.<sup>245</sup>

<sup>243</sup> Members of this team included:

E. M. Purcell, Harvard University  
 D. K. Bailey, NBS  
 L. V. Berkner, Carnegie Institution of Washington  
 H. G. Booker, Cornell University  
 A. G. Hill, Massachusetts Institute of Technology  
 J. R. Pierce, Bell Telephone Laboratories  
 W. W. Salisbury, Collins Radio Co.  
 J. B. Wiesner, Massachusetts Institute of Technology

<sup>244</sup> At a frequency of 49.8 MHz the transmitter delivered approximately 23 kW to the antenna. In the initial experiment only continuous-wave emission was used (a number of modulation methods would be tried during the next 5 years). Identical horizontal rhombic antennas were used for transmitting and receiving, with legs of 500-foot length and mounted about 41 feet above the ground. In order to "capture" the maximum scattering volume in the E layer, the main lobe axis was adjusted for radiation and reception at a 7-degree elevation angle for the distance of 1243 km.

In advance of the initial experiment, the Troy team had speculated, from theoretical considerations, on the level of signal power that might be received at the Sterling station. They developed a transmission equation, based upon a paper by Booker and Gordon published earlier in 1950, and deduced from it that the received power would probably be about  $2 \times 10^{12}$  watt, a quite favorable level above the expected noise. In the early experiments the power level ranged from about  $4 \times 10^{15}$  to  $2 \times 10^{13}$  watt, considerably below the expected value but still a usable signal above the noise level (10 to 25 dB above 1 microvolt and approximately the same 10 to 25 dB above the noise level).

Modifications to a high-quality, commercial-type receiver provided for a bandwidth of 3 kHz and a noise figure of 3 to 6 dB. The signals were recorded automatically, using an averaging circuit with a time constant of 12 seconds in order to smooth the rapidly fluctuating fading of signals, thus facilitating the reduction and analysis of data.

<sup>245</sup> NBS personnel participating in the initial experiment included: Bailey; Ross Bateman, chief of the Ionospheric Research Section and in charge of the Sterling field station; G. Franklin Montgomery and Peter G. Sulzer who assembled and operated the receiving equipment.

### 3. Learning about ionospheric forward scatter as a means of radio communication

#### a) OBSERVATIONS AT THE STERLING FIELD STATION

The initial success on the first evening (January 23, 1951) of transmission by ionospheric forward scatter evolved into a year's observation of signals received at the Sterling station from Cedar Rapids. Under study during that period were the effects of season, time of day, geomagnetic disturbances, and meteor activity on the transmitted signals.<sup>246</sup> In the meantime, studies of geographical position, length of path, variation with frequency, and antenna and modulation studies, were planned and set into action. During the year of observation at the Sterling station the CRPL learned, primarily, that the mechanism of ionospheric forward scatter could be relied upon as a mode of radio communication heretofore not exploited.

<sup>246</sup> A number of characteristics of ionospheric forward scatter came to light during the first year of observations: (1) The received signals exhibit a broad maximum near midday. A minimum is reached from 8 to 10 p.m. local time at path midpoint and thereafter the signals increase slowly during the remainder of the night. (2) In general, signals were weakest in late winter and strongest in June and again in mid-winter daytime. However, there was considerable variation, dependent upon the hour of the day when the maximum and minimum signals were observed. (3) There was much variation of the signal due to rapid fading characteristics, enhancement by reflection from meteor ionization trails (accompanied by Doppler-caused whistlers), and by sporadic-E reflection. (4) Most interesting, however, was the enhancement of signals during periods of severe magnetic disturbances and during high-frequency radio fadeouts (sudden ionospheric disturbances or SID's)—matters of importance for consideration of communication reliability, especially in high latitudes.

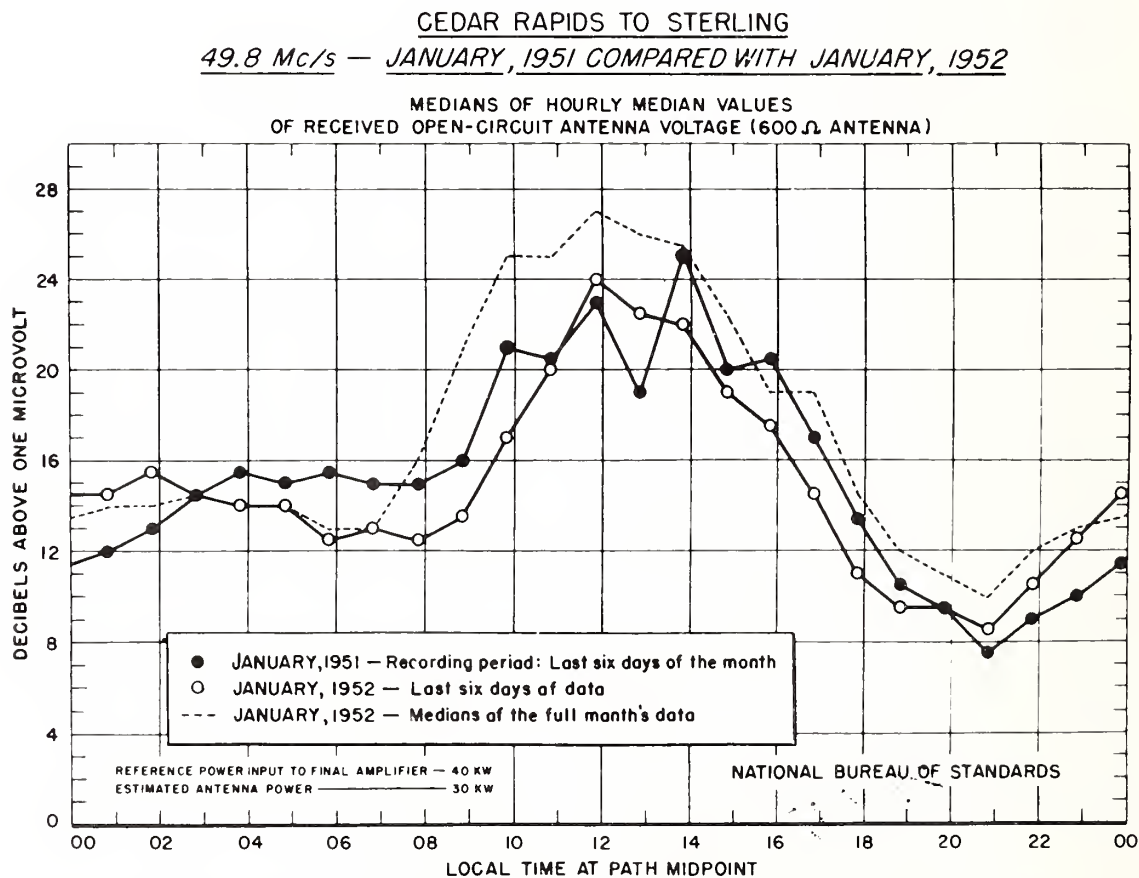

Signal level at Sterling field station of transmission by ionospheric forward scatter from Cedar Rapids, Iowa. The curves indicate dependable signal strength (approximately 10 to 25 decibels above noise level) during two successive January periods. Noticeable is the strongest signal strength during early afternoon (local time at path midpoint) and a minimum between 8 and 10 p.m. Data taken throughout the year indicated various seasonal characteristics.

## b) SOME DISTANCE EXPERIMENTS

Added to the team working at the Sterling station were James M. Watts and Victor C. Pineo. Watts, on another assignment to Bermuda, in the summer of 1951, had facilities to observe the signals from Cedar Rapids, at a distance of 2601 km (a distance more than twice that of Sterling). Watts used a specially designed five-element Yagi for his antenna. Most of the time no 49.8-MHz signals were received from Cedar Rapids. Signals received were attributed to sporadic-E propagation.

Pineo conducted a series of observations in Florida during February and March of 1952, at three locations ranging from 1725 to 2088 km distance from Cedar Rapids. Pineo used two Yagi antennas, one at 40-foot height, the other at 100-feet. In general, signal levels decreased with distance from Cedar Rapids, and increased with height of antenna. Unlike the Bermuda observations, the Florida locations were within the distance range of the forward-scatter signals.

## c) ANOTHER TRY AT LONG DISTANCE

Three years after the Cedar Rapids-to-Bermuda experiment over a path distance of 2601 km which resulted in no signals being received by ionospheric forward scatter, another try was made for long distance reception, this time at 2271 km over an all-water route. On the selected path from St. Johns, Newfoundland to Terceira Island in the Azores advantage was taken of high-elevation sites for both the transmitter and the receiver.<sup>247</sup> Beginning in October 1954, observations were made at 36.0 MHz for 1 year at the Terceira Island receiving site with acceptable signal strength. Compared to the Cedar Rapids-Sterling signals there was almost complete absence of diurnal and seasonal maxima.

## d) VARIATION OF EXPERIMENTAL CONDITIONS

During the year's observations over the Cedar Rapids-Sterling path a number of operating conditions were varied in order to gain a better understanding of forward-scatter transmission. A frequency of 418 MHz was tried with the result that only strong meteor bursts were observed. Use of a frequency of 107.8 MHz resulted in signals that were relatively weak compared with those received simultaneously at 49.8 kHz, but measurable.

Various antennas were tried at the Sterling receiving station, including a five-element Yagi and several helical antennas. No particular advantage was found in using any of these antennas over that of a rhombic antenna.<sup>248</sup>

These experiments led to the study of large corner-reflector antennas which soon were to replace the rhombic antennas for certain practical applications. These antennas had a gain of nearly 20 decibels relative to half-wave dipoles, occupied much less space than rhombic antennas, and had other desirable features. They could be constructed with wire reflecting surfaces to reduce cost and wind resistance. The antenna studies were conducted by Herman V. Cottony of the Ionospheric Research Section and were continued at Boulder (see ch. XIII).

During the first year of experimentation, and extending for several more years, various types of modulation were tried, each with its advantages and disadvantages.

## e) STUDIES OF IONOSPHERIC FORWARD SCATTER AT HIGH LATITUDES

Soon to be realized by the NBS team, as a result of the Troy Project, was the fact that magnetic disturbances and sudden ionospheric disturbances (SID's) had no deleterious effect on the Cedar Rapids-Sterling transmissions. Even more surprising, the disturbances actually enhanced the transmissions on many occasions. Thus, there appeared at hand, a newly discovered means of reliable radio transmission across the auroral zone and in the arctic region where auroral storms and polar blackouts were a serious problem to arctic

---

<sup>247</sup> A pair of Yagi antennas stacked vertically was used at each site. The antenna at St. Johns was 880 feet above sea level, at Terceira Island 2240 feet. The geometry of the antenna heights and lobe patterns, the path distance, and the curvature of the Earth, indicated that lower levels of the scattering region at about 70 km were not effective in the reception of signals—only the region above about 85 km being effectively used.

<sup>248</sup> A study of gain of rhombic antennas made over the Fargo-Churchill path (see 3.e) gave some unexpected and not completely understood results. The gain varied between 9 and 19 dB, both for the transmitting and the receiving antenna, depending upon the received signal strength—strong signals yielding high values of gain.

communications. With this potentiality in view, steps were quickly taken to install experimental communication circuits in the higher latitudes of North America.

Two transmission paths were selected; one with the transmitter at Fargo, N.D., and the receiving station at Churchill, Manitoba (western shore of Hudson Bay); the second with the transmitter near Anchorage, Alaska, and the receiving station at Barrow, Alaska.<sup>249</sup>

<sup>249</sup>The Fargo-Churchill path of 824 miles (1326 km) terminated with the receiving station (Churchill) in the zone of maximum auroral occurrence. This station was operated by the NBS. The 49.7-MHz transmitter at Fargo was operated under contract with NBS. Identical rhombic antennas were used for both transmitting and receiving. This path was operated from late August 1951 through March 1953.

The Anchorage-Barrow path of 718 miles (1156 km) crossed the zone of maximum auroral occurrence near the half-way point of the path somewhat to the northwest of Fairbanks. The receiving station at Barrow, operated by NBS, and its location at 71.3° North, allowed for typical observations associated with the Arctic. The 49.9-MHz transmitter near Anchorage (Elmendorf Air Force Base) was operated under contract with NBS. For this path too, rhombic antennas were used. This operation was carried on from late August 1951 through June 1953.

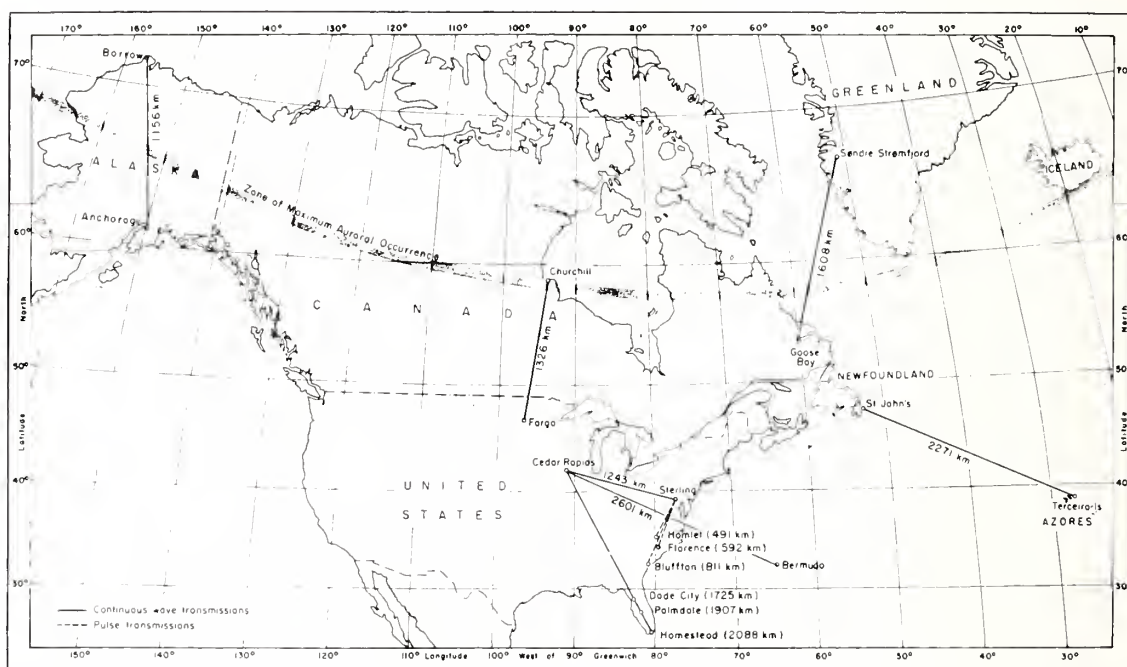

*Experimental paths used by NBS in the study of radio transmission by ionospheric forward scatter. Two paths crossed the zone of maximum auroral occurrence, another path (Fargo to Churchill) terminated at the zone. These two paths were used in special studies of ionospheric forward scatter at high latitudes. Signals were observed for the first time on January 23, 1951, at Sterling, Va., over a 1243-km path from Cedar Rapids, Iowa.*

Much on the nature of ionospheric forward scatter was learned from observations taken over these two paths. Both paths being nearly equivalent to the Cedar Rapids-Sterling path, any effects due to differing lengths of the three paths were essentially eliminated. Based upon equivalent systems parameters, in general, the signal strength at Churchill was 5 to 10 dB greater than that at Sterling, while the signal strength at Barrow lay between the two other levels. There was a variety of small-scale differences of signal characteristics among the three paths as dependent upon time of day and year and upon disturbed conditions of the ionosphere. In general, it was concluded by June 1952 (NBS Report 8A111, now declassified) that at frequencies near 50 MHz, VHF signals propagated by ionospheric forward scatter are most intense when HF propagation conditions (by reflection from F layers) are poorest as during magnetic disturbances, and especially in the Arctic. In



contrast, however, when HF propagation is good, VHF signals may be weaker than usual but usable.<sup>250,251</sup>

#### 4. NBS leads the way toward a successful ionospheric forward scatter communication system

With the increased optimism expressed by the NBS team on ionospheric forward scatter as Nature's provision of a mechanism for a communication system in high latitudes, the U.S. Signal Corps first, and then the U.S. Air Force, expressed much interest in such a project.

During 1951 the U.S. Air Force requested and gave support to establish such a program. The objective was that of a highly dependable communication system to supplement or be used in place of HF or LF systems. The first phase was an experimental one-way transmission path from Goose Bay, Labrador to Søndre Strømfjord in southwestern Greenland, across the mouth of Davis Strait.<sup>252,253</sup> The over-water path was 999 miles (1608 km) distance, with the 48-MHz transmitter at Goose Bay and the receiving station in Greenland. Operation as an experimental communication system began on April 1, 1952. This was the only link ever built which employed vertical polarization.

Again, optimism mounted as the one-way experimental path proved successful. Then came the big step, that of a two-way communication system from the United States to the Air Force Base at Thule, Greenland. In May 1952, after 2 months of evaluating the

---

<sup>250</sup> By mid-1952 the NBS team of Bailey, Bateman, and Kirby\* had stated in NBS Report 8A111 that:

In view of the present state of affairs in the point-to-point radio communications field it seems likely that the propagation mechanism under consideration can be used particularly effectively for communications in the Arctic, and elsewhere where its characteristics offer special advantages. For certain arctic situations . . . it is considered likely that circuit reliability for frequency-shift radioteletype will be superior to that obtainable with existing HF and LF systems of comparable cost.

\*Richard C. Kirby had joined the NBS team in July 1951.

<sup>251</sup> In addition to the usually observed rapid-rate (several cycles per second) fading of forward scatter signals, there was observed in the auroral region a type of fading with a very rapid rate of several hundred cycles per second. It was particularly in evidence at the Barrow receiving station. This characteristic of the signal was labeled "sputter" because of the audible effect when listening to even a CW signal. Upon study, the effect was attributed to rapid motion of scattering centers in the E layer accompanying auroral activity.\*

\*It was a coincidental event that on January 23, 1951, the day ionospheric forward scatter signals were first received by NBS at the Sterling station, the editor of the *J. of Geophysical Research* received a paper, submitted for publication, which gave evidence somewhat unknowingly that, indeed, there could be transmission of radio waves by scatter by the ionosphere. The paper by R. K. Moore of Cornell University, entitled "A V.H.F. Propagation Phenomenon Associated with Aurora," was published in the March 1951 issue.

Beginning in the 1930's, amateurs had reported unusual propagation at VHF during periods of aurora displays (including daytime reception at periods associated with nighttime displays). This phenomenon was given the name "auroral propagation." One of the characteristics usually reported was the very rapid fading rate, so much so that voice communication would be unintelligible. To quote from Moore's paper:

Until more exact data on the fading rate encountered in "auroral propagation" are available, there is little point in attempting to ascribe this phenomenon to some particular cause. Data at hand now indicate, however, that the signals are scattered by some means in the ionosphere, rather than being reflected. If the fading is due to a doppler phenomenon, and if one is to believe the reports of the fading rate, the velocities involved must be considerably higher than those which have been reported for ionospheric winds and turbulence.

Viewed in retrospect after the publication of a comprehensive paper by Bailey, Bateman, and Kirby in 1955 (see reference [87]), one is led to an understanding of the "auroral propagation." Based upon their own observations and those of others, the authors state that this mode of reception, characterized by fast rates of fading that cause "sputtering" effects, is caused by reflection from ionized regions of the aurora and is not the result of forward scatter by ever-present irregularities of ionization in the lower ionosphere.

<sup>252</sup> The decision between the U.S. Air Force and NBS to proceed with this experimental circuit was made on August 17, 1951. A contract was negotiated on October 5, 1951, and work began a month later on November 6, 1951. By March 5, 1952, signals were received at the Søndre Strømfjord station and on January 26, 1953, four-channel multiplex teletype tests were under way on this experimental path. During the experimental period many tests were conducted, particularly on the characteristics of the antenna systems.

<sup>253</sup> Often the name Søndre Strømfjord was contracted to Sondrestrom.

experimental system, the decision was made to proceed with the longer three-link system because of pressing operational requirements for reliable communication between the United States and the Thule Air Force Base. For this project NBS contracted with the U.S. Air Force to take the responsibility for setting up such a system. NBS took a dual role in the project, that of further research and of carrying out its contractual obligations.<sup>254</sup> Engineering design and installation of the system was subcontracted by NBS to the firm of E. C. Page Consulting Radio Engineers, Washington, D.C., the firm that had designed and installed the experimental link.<sup>255</sup> By this time the venture became known as Project Bittersweet.

The system was designed for operation in the frequency range of 30 to 40 MHz. From the research and experimental tests there was evidence that use of lower frequencies (below 48 MHz) would result in greater signal strength, greater signal-to-noise ratio, and fewer problems from spurious meteoric signals. After much study, the decision was reached to utilize horizontal polarization throughout the system.

The system, which began operation in December 1953, had the capacity of four-channel multiplex radio teletype, with two-way communication. Later, this was increased to 16-channel operation. During the first year, traffic utilization was achieved 91 percent of the time, a bit short of the expected 95 percent. None of the infrequent outages could be attributed to propagation conditions.

---

<sup>254</sup> This large-scale contract of several million dollars with the U.S. Air Force was one of the largest ever engaged in by the National Bureau of Standards.

<sup>255</sup> The completed chain of stations, known as the USAF North Atlantic VHF ionospheric scatter system, was initially composed of three links: Loring AFB (near Limestone in northern Maine) to Goose Bay, Labrador; Goose Bay to Søndre Strømfjord, Greenland; and Søndre Strømfjord to the Thule AFB, Greenland. Later, the U.S. terminal was moved to Westover AFB, north of Springfield, Mass., in order to gain the advantage of a more optimum communication distance with Goose Bay.

An extension was later added to the system in two links, the first from Søndre Strømfjord to Keflavik, Iceland, the second from Keflavik to Kingston Wood north of London, England. A still later system was established by the North Atlantic Treaty Organization (NATO) connecting France with Turkey via Italy.

By 1957 a chain of seven links was established by the U.S. Army by island hopping from Hawaii to the Philippines and Okinawa, the distance from the West Coast to the Hawaiian Islands being too great to span by ionospheric forward scatter.

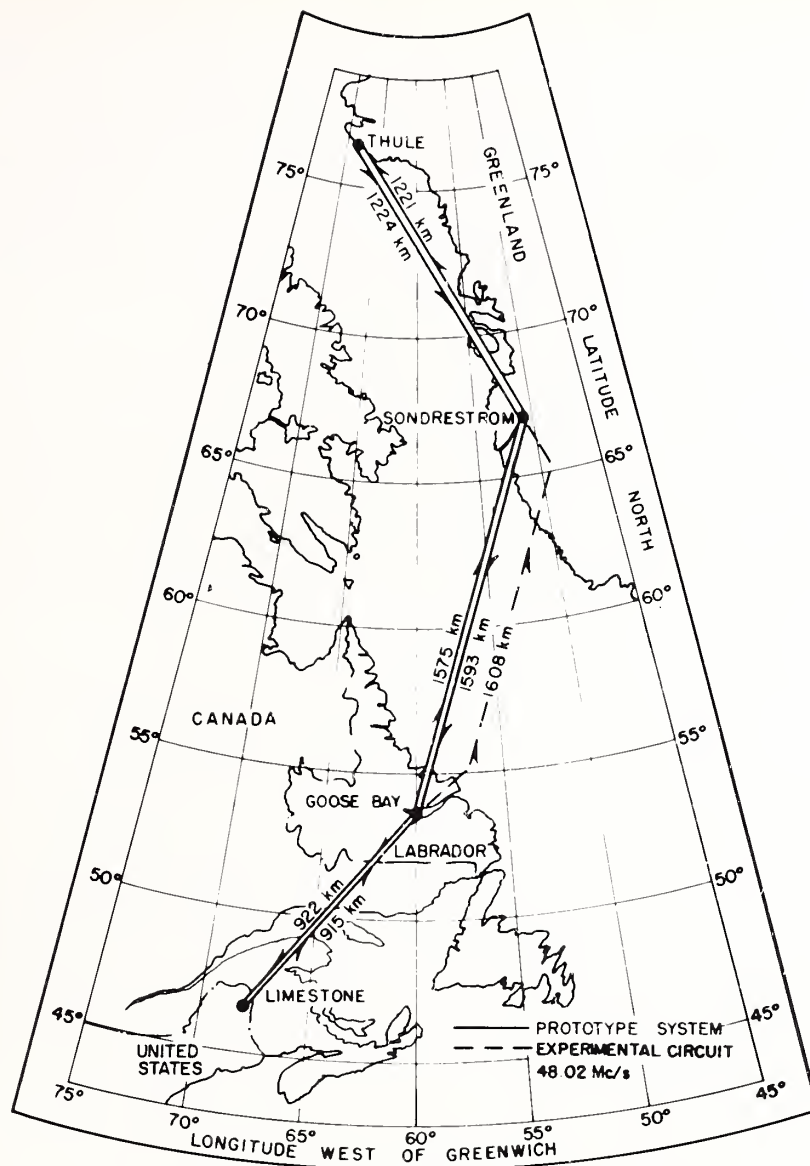

LOCATIONS OF TERMINALS AND PATHS FOR THE PRELIMINARY EXPERIMENT AND COMPLETE PROTOTYPE SYSTEM.

*A communication system by ionospheric forward scatter. An experimental circuit between Goose Bay, Labrador and Sondrestrom, Greenland was successfully operated, beginning April 1, 1952. By December 1953 a complete system of three links was in operation from Maine to Thule AFB in northwest Greenland.*

## 5. The unexpected occurs—On February 23, 1956

Recordings of transmissions over experimental paths, beginning in January 1951, and, later traffic over the established communication system, met with the hoped for and expected success of reliability, often with indications of enhancement of signals during periods of SID's and other geophysical effects. Then, on February 23, 1956, occurred an uncommon event—that of a very intense solar flare on the western limb of the Sun, accompanied by a very large ground-level cosmic ray increase. The flare and its effects were observed worldwide, and were of great magnitude. For several days for periods of several hours during daylight, no signals were received over links passing through Søndre Strømfjord. Other paths also recorded loss of signals but to a lesser degree. Heretofore, nothing like this had occurred over the U.S.-to-Thule system. This surprising and completely unexpected event indicated that the newly developed communication system was, indeed, subject to one of Nature's pranks, though seemingly of rare occurrence. Bailey studied this

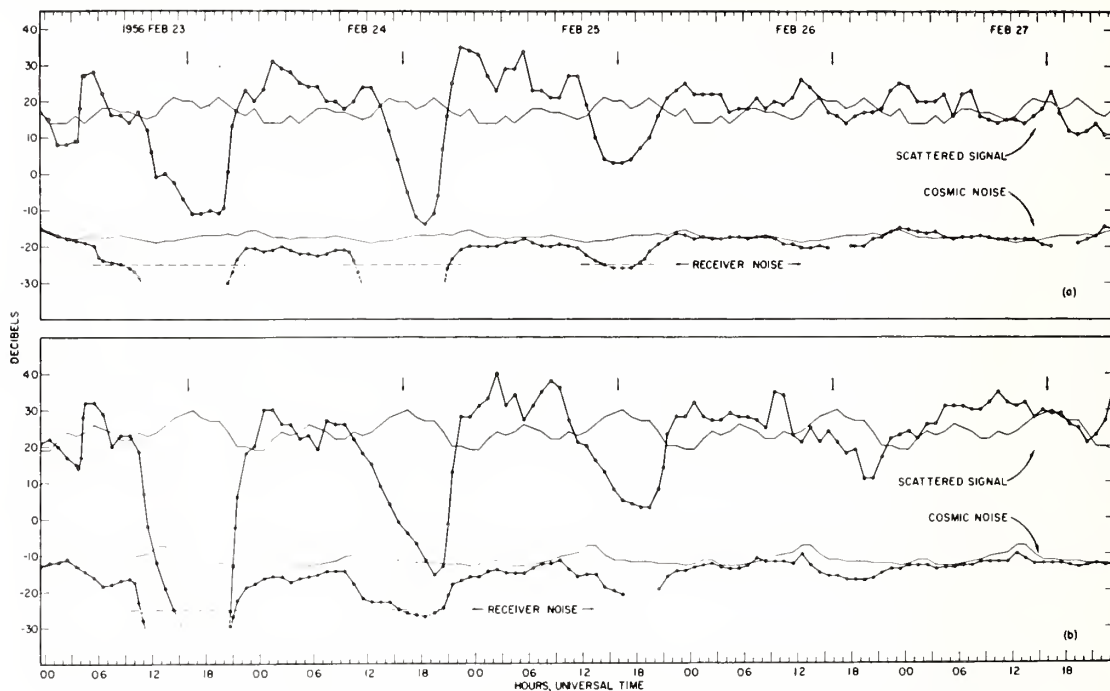

Observed variations with time of intensity of signals and background cosmic noise at the same frequency with the same antenna. Normal variations indicated by the thin line. Vertical arrows indicate local apparent noon at path midpoint.  
 (a) Observations at Søndre Strømfjord, Greenland, of signals from Thule, Greenland, and background cosmic noise, at 31.5 Mc/s.  
 (b) Observations at Søndre Strømfjord of signals from Goose Bay, Labrador, and background cosmic noise, at 32.2 Mc/s.

Signal level (decibels from 1 microvolt) for radio transmission by ionospheric forward scatter over the Air Force communication system (U.S.A. to Thule, Greenland) during and after the great solar flare of February 23, 1956. During daylight on the day of the flare there was such great absorption of energy over the Søndre Strømfjord-to-Goose Bay path that the signal level fell far below the receiver noise. During daylight on each successive day the signal level, as well as the level of cosmic noise, gradually increased and reached normal by the fourth day (February 27) after the flare occurred.

Note: Local noon at the midpoint of each path is indicated for each day by a small vertical arrow.

event in much depth and published two papers on the phenomenon [83,84].<sup>256</sup> Bailey theorized and explained the communication "blackouts" as resulting from very high absorption at heights below the scattering region at high geomagnetic latitudes caused by heavy ions thrown off from the Sun during the solar flare. In his later paper (1959), Bailey accounted for the blackout in communication after the 1956 flare as being caused by collisional ionization of the lower ionosphere when bombarded by streams of solar particles (mostly protons) with near cosmic-ray energies. Events of this type have since 1956 come to be known as PCA (Polar-Cap Absorption) events, or SPE's (solar-proton events).

## 6. A new discovery, but problems of publication

Within 20 days after NBS personnel had observed ionospheric forward scatter signals during the evening of January 23, 1951 at the Sterling field station, Bailey had produced a

<sup>256</sup> During the flare and several hours thereafter, all of the communication paths lay in the dark hemisphere. Bailey learned primarily from U.S. Air Force records, that an enhancement of signals developed for several hours with approaching dawn. Then, beginning with the sunlight on the ionosphere, and extending in time until evening darkness, the signal strength rapidly decreased until lost in receiver noise. The loss of signals was accompanied by a decrease in cosmic noise (normally about 5 to 10 dB above receiver noise). Bailey estimated that on the first day the signal strength decreased by as much as 48 dB—far into the receiver noise. With the coming of darkness the signal strength of the cosmic noise returned to near normal levels, but the scatter signal exhibited strong enhancement. This diurnal pattern repeated itself with decreasing amplitude for three successive days.

printed report but with Secret classification, so their discovery had to remain unannounced.<sup>257</sup>

In the April 15, 1952, issue of *The Physical Review* appeared the first public announcement of the new discovery via publication [85]. The paper had received very limited circulation at an earlier date (September 28, 1951) as an NBS Report.<sup>254,255</sup> Significantly, although the team of authors made known their discovery, no divulgence of the importance to military communications was given.

Later in 1952 there appeared in the October issue of the *Technical News Bulletin* a somewhat popularized account of the paper published by the team of authors in the earlier issue of *The Physical Review* [86]. Thus, the discovery was announced to a more diversified audience.

On June 30, 1952, the NBS released a classified (Confidential) report, NBS Report 8A111, authored by Bailey, Bateman, and R. C. Kirby. This extensive report, together with nine appendices, brought up to date (at mid-1952) a coverage of the research experiments being carried out by the NBS team leading toward development of a communication system utilizing ionospheric forward scatter.<sup>260</sup>

It was not until October 1955 that a comprehensive and definitive paper by the NBS team appeared on the subject of ionospheric forward scatter, on this occasion as one of many papers in a special issue on scatter propagation in the *Proc. IRE* [87].<sup>261</sup> This special issue was to serve the definite purpose of placing emphasis on information for the design of systems employing the new scatter propagation techniques.<sup>262</sup> However, the NBS team was not without problems in the publication of its paper—a matter of publishing some of the

<sup>257</sup> The Secret document, Report CRPL-S1, was entitled "Preliminary Results on a New Method of Achieving Long-Distance Radio Communication." In part, the abstract read:

. . . These experiments were suggested by certain views as to the possibility of scatter of the radio waves by irregularities in the ionospheric E-layer. . . .

The probable importance of the new results for application to the improvement of North Atlantic and other communications, notably Arctic, is pointed out as indicating the urgency of carrying on further experiments.

<sup>258</sup> NBS Report 1172 was entitled, "A New Kind of Radio Propagation at Very High Frequencies Observable over Long Distances," and was listed with eight authors, some of whom had been on the Troy Project team. The authors and their affiliations were:

D. K. Bailey, National Bureau of Standards  
R. Bateman, National Bureau of Standards  
L. V. Berkner, Carnegie Institution of Washington  
H. G. Booker, Cornell University  
G. F. Montgomery, National Bureau of Standards  
E. M. Purcell, Harvard University  
W. W. Salisbury, Collins Radio Company  
J. B. Wiesner, Research Laboratory of Electronics,  
Massachusetts Institute of Technology

<sup>259</sup> In February 1952 Dana K. Bailey received the Department of Commerce Silver Medal for Meritorious Service "for unusual and outstanding contributions to science, particularly in the field of radio wave propagation."

<sup>260</sup> Covered in the report, entitled "Regular VHF Ionospheric Propagation Observable Over Long Distances," were more than a year of observations on the Cedar Rapids-Sterling path, and a half year each of observations on the Fargo-Churchill path and the Anchorage-Barrow path. Also extensively covered were experiments carried out at the Sterling field station on the performance characteristics in many variations of the parameters of design features and operating techniques of a communication system.

<sup>261</sup> In 1956 Bailey, Bateman, and Kirby received the Department of Commerce Gold Medal for Exceptional Service as a group award "for major contributions to the advancement of the science of radio propagation and long distance radio communications during the extensive elucidation of the defining features of a new kind of propagation."

<sup>262</sup> The selected editors, Kenneth A. Norton (NBS) and Jerome B. Wiesner (MIT and Troy Project) stated, in the opening paragraph on introducing the special issue, that:

In selecting papers for this issue, we have attempted to present an over-all picture of the present theoretical and experimental state of the techniques of scatter propagation. Particular emphasis has been laid on information that will facilitate system design employing these new propagation techniques. Recent experiments have demonstrated that it is possible to achieve very reliable "beyond-the-horizon" (scatter) radio communication in both the VHF and UHF regions of the spectrum. There has been, therefore, extensive re-examination of existing data, as well as increasing propagation research, primarily to provide necessary information for the design of scatter communication systems.

material that had been classified Confidential for several years. The problem and its "solution" can best be related by the footnote given below.<sup>263</sup>

A companion paper intended to complement the published IRE paper was issued August 1, 1955, as NBS Report 1R103, entitled "A New Communication System of High Reliability Using Ionospheric Scattering at VHF," and was at the time classified Confidential.<sup>264</sup> This paper was largely a treatment of the engineering aspects of the communication system from the U.S. to the Thule Air Force Base.

By 1955 the NBS team of Bailey, Bateman, and Kirby had a well developed understanding of the scattering and other processes that occur in the lower ionosphere and they were permitted to reveal much of this advanced knowledge in their IRE paper of October 1955. By this time they had learned that the scattering process takes place almost entirely within the D region and is centered most effectively for communication by forward scatter in the region around a height of 85 km. On occasion sporadic-E propagation dominated the transmissions. The authors attributed ionization in the scattering region to solar photon radiation, corpuscular radiation (of solar origin), and meteors. Detailed coverage of their lengthy paper is much beyond the scope of this writing, but a short summary is added in the following footnote<sup>265</sup> to that given above.

---

<sup>263</sup> On page 1231 of the October 1955 issue of the *Proc. IRE* appeared the unusual "Message" on the page following the lengthy paper by the NBS team of Bailey, Bateman, and Kirby.

#### A Message to the Readers

The authors regret that certain basic results of interest and importance are omitted from the above paper as a consequence of revisions and deletions and the withdrawal of a companion paper imposed by policy decisions of the U.S. Government. It is the authors' considered opinion that publication of the paper in its present form is not desirable and it was their expressed request that the paper be withdrawn.—D. K. Bailey, R. Bateman

The Editor shares the authors' disappointment regarding the withdrawals and deletions of materials from this issue.

The foregoing paper was published in its present revised form upon authorization of the Director of the National Bureau of Standards and over the objections of the authors to the revisions. The Editor took this unusual step because of his firm conviction that withdrawal of this important paper from this issue would be a disservice to the IRE, to the profession, and to the authors themselves.—*The Editor*.\*

Of the total 34 papers on scatter propagation published in this issue, 11 were authored by NBS staff members.

\*The result of this difference in viewpoint on publication of NBS work on the ionospheric forward scatter project in the *Proc. IRE* was the resignation of Bailey and Bateman from NBS in October 1955. Both Bateman and Bailey joined Page Communications Engineers, Inc.; however, Bailey returned to NBS in 1959.

<sup>264</sup> This paper was authored by Bateman, Bailey, and J. A. Waldschmitt (Page Communications Engineers, Inc., Washington, D.C.). In the Foreword the authors stated, in part:

The report which follows is a technical and historical summary of the first long-distance communication system (Project Bittersweet) using ionospheric scattering at VHF, established on a trial basis by the United States Air Force. Prepared jointly by the National Bureau of Standards and Page Communications Engineers, Inc., this report was originally intended and submitted for publication in the October 1955 number ("Scatter Propagation" issue) of the Proceedings of the Institute of Radio Engineers. On request of the Department of Defense the report was withdrawn from unclassified publication. The account is published in its present form on behalf of the sponsoring service. . . .

<sup>265</sup> The authors introduced their subject with a short account of the then existing theories on scattering. Their 4 1/2 years of observations revealed many new and interesting features of the ionosphere, and its effects on the VHF signals. Thus they investigated the strength and nature of received signals as functions of the time of day, season, geographical position of the transmission path, length of path, frequency, scattering angle, and level of solar activity. Many of their studies related to the role of antennas on the behavior of received signals. The performance of various types of antennas was observed in relation to: radiation patterns, elevation angle, antenna gain, siting, polarization, and a space diversity system for receiving. Various considerations of system design were covered, including: useful range of frequencies, bandwidths, channel separations, and modulation techniques.\* Also discussed were the effects of: sporadic-E propagation, meteors, sudden ionospheric disturbances (SID's), polar blackouts, auroral sputter, and the limited effects of tropospheric propagation.

\*Several years later the Radio Communication and Systems Division conducted rather extensive studies of frequency dependence and modulation techniques in the design of ionospheric forward scatter communication systems (see ch. XIII, p. 572).

Within a few weeks after publication of the lengthy IRE paper, Kirby presented a long paper at the November 1955 Symposium on Communications by Scatter Techniques, entitled, "VHF Propagation by Ionospheric Scattering—A Survey of Experimental Results."<sup>266</sup> Again, there were classification restrictions on what could be stated.

<sup>266</sup> This symposium was sponsored by the IRE Professional Group on Antennas, Propagation and Communication Systems, together with the George Washington University (where the symposium was held). Kirby's paper was published in the IRE Professional Group's *Transactions* [88].

At the same symposium H. V. Cottony of the Ionospheric Research Section presented a paper, entitled "High-Gain Antennas for VHF Scatter Propagation," which was published later by the IRE [89]. Because of classified material, Cottony could reveal only certain aspects of the antenna studies on this occasion.

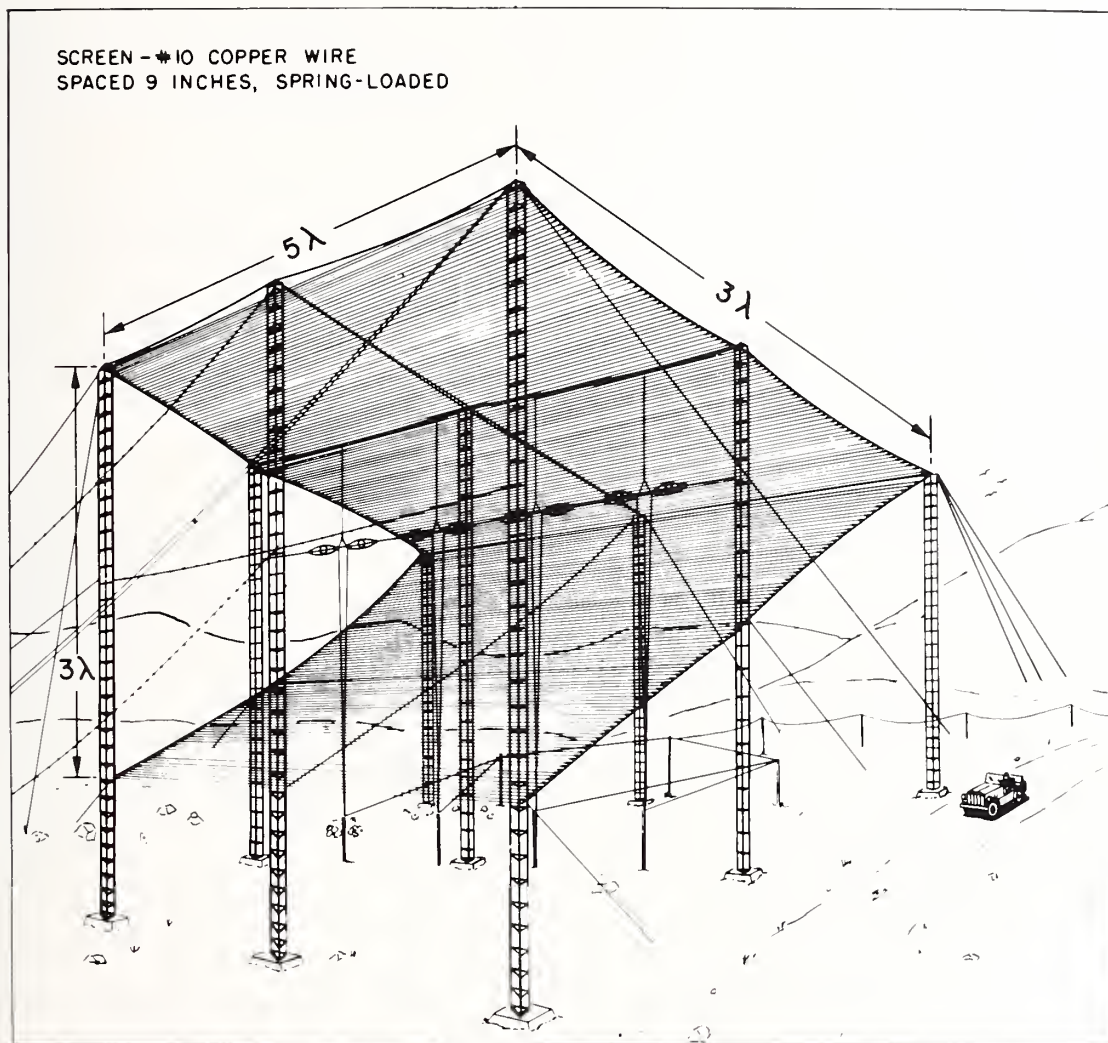

*Line drawing of horizontally polarized, collinear, 60-degree, corner-reflector antenna used for the Maine to Thule AFB communication system. The 60-degree opening of the two reflecting surfaces had an aperture dimension of 3 by 5 wavelengths. The antenna was energized by radiation from a horizontal string of half-wave dipoles at the midpoint between the two reflecting surfaces.*

Two other publications resulted from the early period of study of ionospheric forward scatter by the NBS, one by Victor C. Pineo, the other by George R. Sugar both of the Ionospheric Research Section [90,91].<sup>267</sup>

In 1960 a further paper was published in which 5 CRPL personnel participated, along with 10 others, as a report by the Joint Technical Advisory Committee on "Radio Transmission by Ionospheric and Tropospheric Scatter."<sup>268</sup> A considerable portion of the report was based upon published accounts of work performed by a number of CRPL staff members.

## 7. Forward-scatter observations along the geomagnetic equator and in the Antarctic

The IGY program brought an interest for further study of ionospheric forward scatter, selecting a project for observations in the vicinity of the geomagnetic equator in South America. Planning for the project began in 1955 under the guidance of Bowles of the Ionospheric Research Section, later to be directed by Robert S. Cohen.<sup>269</sup>

## 8. Denouement?

Today, communication by ionospheric forward scatter is almost completely replaced with communication systems incorporating radio transmission by aid of satellites. Forward-scatter circuits serve only as backup in case of outages with satellite systems. Yet the forward-scatter systems served a timely need during the 1950's. Moreover, research with forward-scatter techniques led to the revelation of much new knowledge of the ionosphere.

# PROBING THE IONOSPHERE FROM ABOVE

## 1. Early probing of the upper ionosphere

Until the development of techniques for probing the upper ionosphere, the nature of the region above  $F_2$  layer was a matter of reckoning from observations of the lower ionospheric region above the  $F_2$  layer was a matter of reckoning from observations of the lower ionospheric region.<sup>270</sup> Peacetime use of technology growing out of World War II brought on the means to probe the upper ionosphere with rockets bearing advanced electronic gear, also with radar, and then, with the satellites that brought on the space age.<sup>271,272</sup> Of primary interest to the investigators was the determination of electron-density profiles.

<sup>267</sup> During November 1952 and January 1953 Pineo conducted a series of oblique-incidence measurements over an 810-km path from the Sterling station to a receiving location near Bluffton, S.C. The purpose was to determine the height at which ionospheric scattering of VHF radio waves occurs in order to gain a better knowledge of the scattering processes and to gather information for the engineering design of a communication system. With a pulsed transmitter operating at 49.8 MHz at the Sterling station, measurements were made at the receiving location of the difference in time of arrival between the tropospheric and sky-wave components of the signal pulses. Measurements indicated an approximate height of 86 km for nighttime transmissions and 70 km for midday transmissions, each region of scatter being within the D region.

Sugar's paper was one of the many papers included in the special October 1955 issue of the *Proc. IRE* on scatter propagation. His paper was a study of some of the short-time fading characteristics of signals received over the Cedar Rapids-Sterling transmission path. Five years later, Sugar (with Kenneth W. Sullivan) published a paper as *NBS Technical Note 79*, that covered 7 years of observations at various periods over the Cedar Rapids-Sterling, Fargo-Churchill, and the Anchorage-Barrow transmission paths. The purpose was to publish basic signal-strength data for ready availability to investigators for further study of ionospheric forward scatter propagation.

<sup>268</sup> The Joint Technical Advisory Committee (JTAC) was formed in 1948 by the IRE and Electronic Industries Association to give expert advice to the FCC on frequency allocation and utilization matters. The above paper was published in the January 1960 issue of the *Proc. IRE*. At the time, the five CRPL members of JTAC were: D. K. Bailey, H. V. Cottony, R. C. Kirby, K. A. Norton, and R. J. Slutz.

<sup>269</sup> See section "CRPL Participation in the IGY Program," p. 482; section "Studies of the Ionospheric Regions," p. 420; and section "Geographical Nonuniformities of the Ionosphere," p. 439.

<sup>270</sup> The line of demarcation (not a sharp boundary) between the lower side and the upper side ("topside") of the Earth's ionosphere is usually associated with the height of maximum electron density in the F region. The boundary is typically 300 km above the Earth's surface.

<sup>271</sup> In a Secret document, dated 1 January 1945 (4 months before V-E Day), the IRPL was informed by an excerpt from an Intelligence Report that it was believed that the Germans were using rockets to study solar ultraviolet



## 2. CRPL observes Sputniks

### a) OBSERVING THE EARTH'S FIRST ARTIFICIAL SATELLITE—SPUTNIK I

With the unexpected and successful orbital flight of the Russian satellite, Sputnik I, after launching on October 4, 1957, there came world excitement that introduced the Space Age. The excitement experience included the CRPL.<sup>273-275</sup> On January 31, 1958, the United States successfully boosted its first satellite (Explorer I) into Earth orbit, culminating in the discovery of the Van Allen radiation belts surrounding the Earth.

---

radiation at heights up to 100 km. Although ionosphere sounding was not mentioned, the possibility of a study of radio control of rockets was noted. \* \*\*

After reading reports in the open literature about the heights to which V-2 rockets could travel, and apparently after seeing the 1 January document, an IRPL engineer, Richard Silberstein, prepared a classified document which described a kind of rocket-ionosonde technique. This document, dated 28 February 1945, bore the title: A Proposal For The Use of Rockets For The Study of The Ionosphere. The proposal was prepared for dissemination to agencies that would have an interest in such projects. Silberstein's proposal suggested taking air samples at designated heights and using on-board radio equipment to reemit ground-transmitted signals that would reveal various properties of the ionosphere during passage of the rocket.

\*The Secret document on the subject of Rockets, Ionosphere and Stratosphere Research was furnished to the Countermeasures Committee and the Wave Propagation Committee of the Joint Communications Board.

\*\*Documents in Rockets folder of NN365-90, Box 14, at the National Archives.

<sup>272</sup> In 1946 the Naval Research Laboratory began using rockets for upper atmosphere research, including ionosphere measurements. Other groups in the United States soon joined in with the use of rockets. Two methods of radio observation with rockets evolved, (1) that of frequency dispersion using two tracking systems operating on different frequencies, and (2) the Faraday rotation method. On September 20, 1956, the Ionosphere Research Laboratory of Pennsylvania State University made electron-density measurements up to an altitude of 800 km. On February 21, 1958, a Russian measurement was made to about 550 km. Many other rocket flights for electron-density measurements followed.

Concurrently with rocket studies, others were able to measure the total electron density of the ionosphere by utilizing radio echoes from the Moon, with the advantage that observations could be extended over lengthy periods of time compared with the short periods of rocket flights.

<sup>273</sup> Within 24 hours after learning that Sputnik I (sputnik, Russian for satellite) was in orbit and was transmitting radio signals at two frequencies, 20 and 40 MHz, the Radio Propagation Physics Division went into action and was observing the orbital flight and recording the "beeping" tones. Fortunately a "listening post" was in operation at the Table Mountain field site for observing radio energy emitted by the star Cygnus-A (see below). With some alterations, it was fairly simple to tune in on the 20- and 40-MHz signals coming from the Russian satellite. Several CRPL staff members had listened to the beeping tones of the satellite on shortwave receivers before the special Table Mountain equipment could be modified for reception of the signals.

A project had been initiated in May 1956, under the leadership of Robert S. Lawrence, known as Ionospheric Radio Astronomy—Radio Star Scintillations. Over a period of nearly 10 years the project was assigned to one of several sections and divisions, finally to become a section named for the project. In general, the objective of the project was "to observe and study the effects of the ionosphere upon extraterrestrial waves which pass through it." Emission from the star Cygnus-A was used as the source of extraterrestrial radio waves. This study of several years resulted in a paper published in the summer of 1961 [92]. Among the many results obtained was that of observing slow angular variations in the apparent position of the source, which was attributed to large lens-like irregularities (of the order of 200 km) in the ionosphere. The authors explained that this irregular structure of the ionosphere, commonly observed in the daytime, would result from a variation of a few percent in the electron content per unit vertical column from the mean value.

<sup>274</sup> Two other CRPL groups entered into the excitement of observing Sputnik I by radio observation. One group measured the field intensity of the 20- and the 40-MHz transmitters and found the radiated power to be about 1 watt (later confirmed by Soviet scientists). The other group used a phase-difference measuring technique that was developed several years earlier for studying atmospheric turbulence in the troposphere. This technique yielded information on various characteristics of the ionosphere and proved to be useful in future projects that involved satellites as radiation sources.

<sup>275</sup> Concurrently with the CRPL, James W. Warwick of the High Altitude Observatory (University of Colo.) also observed the radio signals from Sputnik I. The Observatory was equipped with a radio interferometer, located north of Boulder, that was suitable for receiving the 20-MHz signal from Sputnik I. From his observations, Warwick was able to determine the satellite's orbital characteristics. Periodic fading effects of the signal, caused by satellite spin, were also an item of study by Warwick.



*On October 9, 1957, Robert Lawrence (right) of the CRPL informs Gordon Allott, U.S. Senator from Colorado, on the use of a radio telescope for observing Sputnik I. The 40-ft paraboloid reflecting antenna was one of two placed 475 meters apart to form a Ryle radio interferometer. After the launching of Sputnik I on October 4, alterations were quickly made on the equipment to receive the 20- and 40-MHz signals radiated by the Russian satellite. The interferometer was being used to study the perturbations imposed upon radio waves penetrating the ionosphere by observing the emission from radio stars, and particularly from Cygnus A.*

Seventeen days after Sputnik I was put into orbital flight, Bowles of the CRPL was successful in his experiment at the Long Branch (Ill.) field station in the first recording of incoherent scattering by free electrons in the upper ionosphere, leading to a new method of determining electron-density profiles (see pp. 436-437).

#### **b) OBSERVING SPUTNIK III AND NASA SATELLITES**

Sputnik II was launched November 3, 1957, a month after the first artificial satellite. On May 15, 1958, Sputnik III was launched by the Russians and this satellite, with its 40- and 20-MHz signals, became the means for extensive studies of the ionosphere by the CRPL and other groups.<sup>276</sup>

<sup>276</sup> By the spring of 1958 the CRPL had completed the construction of facilities for conducting interferometer, Doppler, and polarization measurements of satellite signals to determine ionosphere electron content per unit column up to the height of a satellite. Observations on Sputnik III, by using a Faraday-rotation fading technique, yielded electron density information and indicated a technique for observing irregularities in the ionosphere [93]. Observed spatial dimensions of the irregularities ranged from 100 to 500 km.

Sixteen months (September 1958 to December 1959), of Faraday-rotation observations of Sputnik III (20-MHz signal) by the CRPL and Stanford University during the peak of the solar cycle indicated that at locations near 40° latitude there are large diurnal and seasonal variations in the total electron content of the ionosphere. Seven years later, for a 2-year period in 1965 and 1966 near the sunspot minimum, R. Gregg Merrill and Lawrence of the CRPL made further observations of electron content in the Boulder area. For this they used the 40- and 41-MHz signals from NASA Explorer 22 (also known as S-66, Polar Beacon Ionosphere Satellite), and applying an analysis of the differential Faraday-rotation of the signals, computed the total columnar electron density. In comparison with measurements made 7 years earlier, they found that the vertical columnar electron content during diurnal cycles in the minimum of the solar cycle was about one-fifth the content of those in the maximum of the solar cycle.

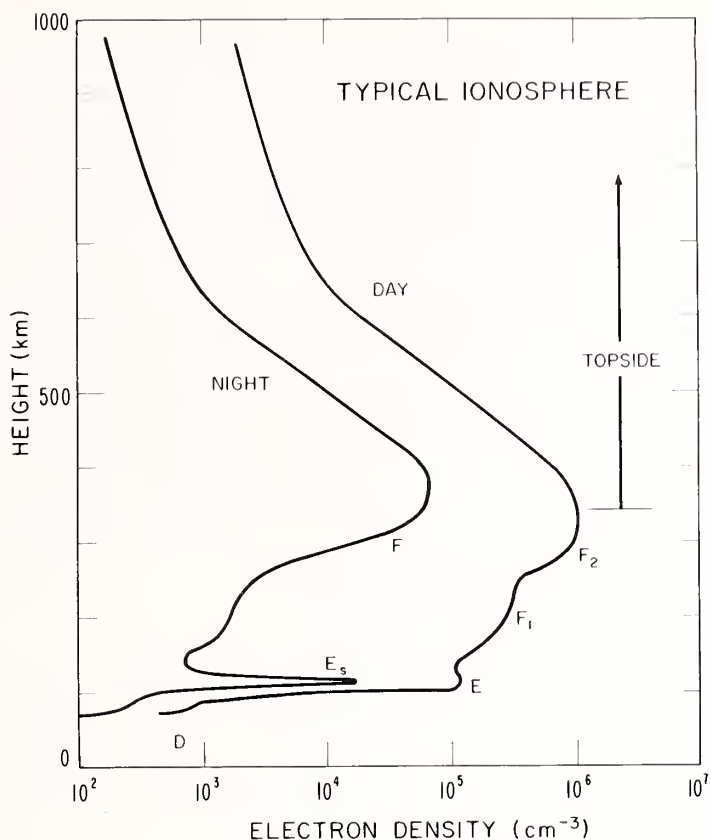

Vertical profile of electron density in the typical ionosphere. From the D region the electron density increases with height in a series of layers (E, the nighttime sporadic E, F<sub>1</sub>, and F<sub>2</sub>), reaching a maximum near 300 km. Beginning with rockets, and in the late 1950's with satellites, the ionosphere above maximum electron density, or "topside," has been explored from above in contrast to the sounding of the lower ionosphere with earthbound ionosondes.

The orbital passes of Sputnik III in the Boulder area offered a variety of data for the study of variations in large-scale irregularities of the ionosphere. Eighteen months of observations by Ralph G. Merrill, Robert S. Lawrence, and Nathaniel J. Roper resulted in a publication in 1963 [94]. Their study included the flight of another satellite, Cosmos I, plus a variation of observational technique that yielded information on the vertical profiles of ionospheric irregularities.<sup>277</sup>

### 3. Electron-density data for the Space Age

Associated both with the IGY program that began on July 1, 1957, and the Space Age that can be said to have started 3 months later with the launching of Sputnik I on October 4, 1957, was a CRPL program that would prove its worth in the solution of practical

<sup>277</sup> In their observations of Sputnik III, Merrill, Lawrence, and Roper used the Faraday-rotation technique in observing the plane of linear polarization of the 20-MHz signal.

Relatively few observations were made of the short-lived Cosmos I Satellite (also designated 1962, θ<sub>1</sub>), that was launched on March 16, 1962, with a perigee of 135 miles and an apogee of 609 miles. Vertical profiles of irregularities in the ionosphere were obtained from data taken at three stations which were so located that their alignment was parallel to the plane of the satellite's path on some of its passes in the Boulder area. Analysis of data from the two satellites showed that ionospheric irregularities ranged from 50 to 400 km in spatial extent (averaging 300 km), occurred mostly at night, and showed seasonal variations. Also, it was found possible to show graphically the vertical profiles of the irregularities, with contours showing percent deviations of electron density from the mean value.

problems.<sup>278</sup> The total program was the group of electron-density data studies of the ionosphere first begun in 1957 by the Sun-Earth Relationship Section and later continued by the Vertical Soundings Research Section. The studies were supported by a variety of sponsorships.

An early product of the program was a model of the region above the peak density of the F<sub>2</sub> layer, described by John W. Wright in a January 1960 publication [95]. Although sounding of the upper atmosphere with satellites was but a few years away, Wright's model of extrapolated profiles above the F region out to 1000 km served as an interim measure for useful knowledge of the upper ionosphere.<sup>279,280</sup>

Another product of the electron-density data program in the late 1950's was that of further development of Budden's (Cambridge University) method of determining true height of the profiles from vertical soundings of the ionosphere. This was accomplished by the application of high-speed digital calculations. The original objective of the project was to determine true height electron-density profiles in preparation of the reduction of satellite observations by the CRPL and others. The method became very useful in supplying information to Government agencies and others for rocket probe, missile guidance, and the tracking of objects in space flight.

#### 4. CRPL joins a NASA satellite program

In March 1959 the National Aeronautics and Space Administration (NASA) requested the NBS to study the scientific merit and engineering feasibility of conducting satellite experiments to sound the upper ionosphere. The study was made by Robert W. Knecht, Thomas E. Van Zandt, and James M. Watts, of the Radio Propagation Physics Division, and by June the group made its recommendations to NASA on the engineering approach to the problem and what scientific information could be expected.<sup>281</sup>

---

<sup>278</sup>The need for such a project was well expressed in NBS Report 6076, Fifth Summary Report of Boulder Laboratories for Year Ending June 30, 1959, which stated:

The application of electron density data directly to practical problems is a relatively new field, due partly to the comparatively recent development of rapid computing facilities, but primarily to the greatly increased demand for such data in the fields of missile, satellite, and space probe technology. Accurate radio guidance and tracking of rockets and satellites in or above the ionosphere requires a detailed understanding of the height profile of electron density. Except at the very highest frequencies, communication with deep space may also require taking rather precise account of the earth's ionosphere. Numerous agencies of the federal government and its contractors have received electron density data for calibration of missile and satellite tracking stations; other agencies have requested larger amounts of similar data for use in their specialized programs.

It seems clear that all aspects of upper atmosphere and radio propagation research and engineering will benefit in coming years from the availability of ionospheric electron density data. The particular importance of NBS projects in this field is a result of the developed capacity for supplying such data promptly and in necessary quantity for application to the needs of scientific and defense agencies.

<sup>279</sup>The model selected by Wright was a series of profiles of plasma frequencies extending to the F region, calculated from ground-based soundings of NBS-associated field stations in the vicinity of the 75° West meridian and extending from 40° North to 10° South latitude. Extrapolations of the profiles were made to 1000 km.

Several years later Wright was able to improve upon the accuracy of the model by adopting some correction factors developed by A. K. Paul of Ionosphere Institute of Breisach, Germany.

<sup>280</sup>In 1961 Wright received the Department of Commerce Silver Medal for Meritorious Service "for important contributions in improving methods of computing the height profile of electron density in the ionosphere."

<sup>281</sup>An international cooperative program was established under the sponsorship and general guidance of NASA for a study of the upper ionosphere with satellite-borne sounders, and was known as International Satellites for Ionospheric Studies (ISIS). Participating with NASA were: NBS (in 1965, ESSA), the Defence Research Telecommunications Establishment (Ottawa, Canada), and the Radio and Space Research Station of the United Kingdom (Slough, England).

The first meeting of the Working Group for the Topside Sounder Project was held January 19, 1960, at NASA Goddard Space Flight Center with Shapley, Van Zandt, and Watts of the CRPL attending, along with NASA and Canadian representation. Also in attendance were representatives of the Airborne Instruments Laboratory of Long Island, N.Y., the company that was selected to construct radio instrumentation for rocket sounders, and later to

#### a) TESTING THE TOPSIDE SOUNDING SYSTEM WITH ROCKETS

The Topside Sounder contract (see footnote 281) with NASA (the project to become known as TOPSI—for Topside Sounder, Ionosphere) was carefully planned for experimentation, first with rockets, to test a small-size ionosonde for radio reflections of the ionosphere from above. Since 1928 the NBS had been observing the lower ionosphere with ground-based equipment. Now, NBS would go topside. The first rocket was launched June 24, 1961, from Wallops Island, Va., to an altitude of 1060 km.<sup>282</sup> The launch was at a time of "quiet" condition of the ionosphere.

#### b) CRPL OBSERVES THE UPPER IONOSPHERE WITH THE CANADIAN ALOUETTE I TOPSIDE SOUNDER SATELLITE

The total NASA investigation of the upper ionosphere involved a number of satellite and rocket programs, each with its specialized type of satellite or rocket, and each with its specialized sounding system.<sup>283</sup> The CRPL became associated with the observational program of the Canadian-operated Alouette I Satellite, and directed the program with the Fixed-Frequency Topside Sounder (Explorer XX).<sup>284</sup>

The Canadian Alouette I Topside Sounder Satellite was launched September 29, 1962, from the Pacific Missile Range, Point Arguella, Calif., on a nearly circular orbit.<sup>285</sup> Knecht and Van Zandt first reported on their observations of the upper ionosphere with Alouette I in the February 16, 1963, issue of *Nature* [96].<sup>286</sup> From 2 weeks of observations taken by the NASA telemetry station at Blossom Point, Md., Knecht and Van Zandt interpreted the ionograms to indicate the presence of spread F almost always at magnetic dip greater than 75° and rarely present below 70°. Also, the spread F was equally prevalent during the mid-morning and the evening periods. Later, in 1964, Wynne Calvert and Charles W. Schmid of the CRPL published a more extensive account of spread-F observations by Alouette I satellite [97]. Other publications by the CRPL gave further coverage of observations by Alouette I. Alouette I passed over the Boulder area once a week at a height of about 1000 km.

---

construct Explorer XX Topside Sounder for operation by NBS. Later, the group became known as the ISIS Working Group.

Note: Information on this first meeting of the Working Group was furnished by Edward R. Schiffmacher (NOAA), who preserved much of the records taken of the Sputnik flights and the CRPL satellite program when he was associated with the Radio Propagation Physics Division.

<sup>282</sup> The rocket contained two pulsed, fixed-frequency transmitters operating at 4.07 and 5.97 MHz and radiating about 3 watts from a 32-foot dipole. The objective of the experiment was to test the sounding system being planned for the satellite-borne, fixed-frequency topside sounder to be launched several years later. The sounding observations were telemetered to several ground stations. Film records indicated a satisfactory sounding system. A second rocket was launched on October 13, 1961, under conditions of a "disturbed" ionosphere. These flights were of approximately 13 minutes duration in the ionosphere. The second rocket flight indicated that spread-F conditions noted in bottomside measurements actually extend into the upper ionosphere to an altitude of at least 1000 km.

<sup>283</sup> Among the NASA satellites were: the Ionosphere Direct Measurement Satellite Explorer VIII, the Ariel Satellite, the Beacon Satellite, plus a variety of rockets.

<sup>284</sup> The name "Alouette" is the French word for a bird—the lark.

<sup>285</sup> The Alouette satellite was designed with a swept-frequency sounder (similar to the usual ionosonde) to observe radio reflections from the topside of the F region of peak density over a frequency range of 0.5-11.5 MHz. Soundings were made at a nearly uniform satellite height of 1000 km over an horizontal distance of about 125 km (one frequency sweep). The end result was an ionogram much like that taken by a ground-based ionosonde of the lower side of the ionosphere.

<sup>286</sup> The Canadian and English research stations each reported in this issue of *Nature*. The Defence Research Telecommunications Establishment of Canada had published a brief report on some early Alouette I soundings in a Letter to the Editor in the November 1962 issue of the *Canadian Journal of Physics*.

<sup>287</sup> Indication of the presence of "spread F" by an ionogram is that of an echo pulse of long duration reflected from the F<sub>2</sub> layer. Thus it is described in terms of the appearance of an ionogram rather than that of the physical nature of the ionosphere. It is considered to be caused by scattering of a signal from irregularities embedded in the ionosphere, both in depth and spreading out from the perpendicular to the F<sub>2</sub> layer (spreading from the zenith when viewed from a ground-based ionosonde).

Alouette II was launched in November 1965. During the previous month NBS had transferred the satellite observational program to the Environmental Sciences Services Administration (ESSA) at Boulder.

### c) CRPL DIRECTS THE PROGRAM FOR EXPLORER XX

After long planning by the CRPL and careful design and construction by the Airborne Instruments Laboratory of Long Island, N.Y., the NBS-directed Fixed-Frequency Topside Sounder, Explorer XX (initially named Ionosphere Explorer I Satellite), was successfully launched on August 25, 1964, at the Pacific Missile Range, Point Arguello, Calif., in an approximately circular polar orbit at an altitude ranging from 866 to 1010 km.<sup>288</sup> The satellite encircled the Earth every 104 minutes in the range of 80 degrees North to 80 degrees South.

The "home-based" data collecting station for Explorer XX or TOPSI was located at the Gunbarrel Hill field site to the northeast of Boulder. A steerable frame was erected and mounted with eight yagi antennas for reception, plus a helix antenna for transmission of radio commands to the satellite. The station was manned by a number of operators from the Ionosphere Research and Propagation Division.

---

<sup>288</sup> Unlike Alouette I, the sounding system of Explorer XX was designed to indicate almost instantly the vertical electron-density distribution beneath the satellite, thus revealing the depth structure of the ionosphere from topside within a horizontal distance of less than 1 km. This was accomplished with the six pulse-modulated sounder frequencies: 7.22, 5.47, 3.72, 2.85, 2.00, and 1.50 MHz (in the order of sounding sequence). Peak pulse power output of the transmitter ranged from 8 to 45 watts. The three sounding dipole antennas were two of 62 feet and one of 122 feet in overall length.

The satellite had no information storage capability and the data were received only when the telemetry transmitter of 136 MHz was within range of the 13 ground telemetry stations scattered over the Earth. Explorer XX weighed 97 pounds, had a diameter of 26 inches, and its length of 32 inches terminated in two conical sections. At the apex of one of the cones was a spherically-shaped plasma probe for obtaining direct measurement of electron density. The sounder power supply consisted of 2400 P/N solar cells and 23 nickel-cadmium storage cells.

Explorer XX was designed and then orbited under a handful of names, starting with Ionosphere Explorer I; also, Ionosphere Explorer A (before launch), S-48 (a NASA designation), Fixed-Frequency Topside Sounder Satellite, TOPSI, 1964 51A (after launch), and Explorer XX (after launch).

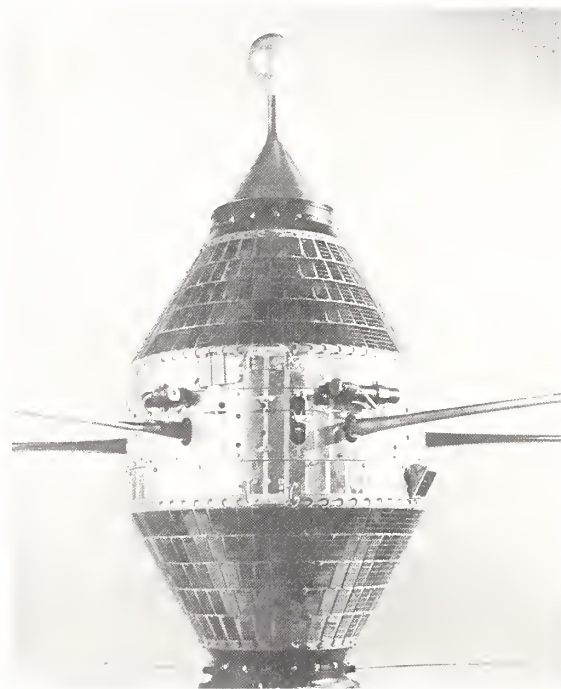

*The NBS-directed Fixed-Frequency Topside Sounder that became known as Explorer XX after launching at the Pacific Missile Range, Point Arguello, Calif. on August 25, 1964. Shown here, are the base segments of the long sounding antennas; at bottom is the turnstile telemetry antenna for transmitting information to ground-based stations. At the upper apex is the spherically-shaped plasma probe for obtaining direct measurement of electron density of the ionosphere. With a mid-section diameter of 26 in, the overall weight was 97 lb. Data collected by the satellite were received by radio at the NBS "home base" located on Gunbarrel Hill northeast of Boulder.*



*The sun has set behind the foothills to the west of Boulder when this photograph was taken late in the summer of 1964. The steerable antenna was used for tracking Explorer XX (TOPSI sounder) from Gunbarrel Hill. The dual-purpose assembly received signals from the satellite with eight cross-polarized Yagi antennas and transmitted radio commands by the single helix antenna.*

Less than 2 months after launch of Explorer XX, Calvert, Knecht, and Van Zandt published a description of, and the CRPL's early observations with, the satellite, selecting the periodical *Science* for their early report [98]. These observations were made at Boulder and at South Point, Hawaii. There was evidence of penetration of signals through several ionosphere layers and even to the ground. As observed earlier with Alouette I, there was considerable evidence of plasma resonances (plasma frequency equal to sounder frequency) being excited in the electron gaseous medium by the sounder transmitter of Explorer XX.<sup>289</sup> Ionograms processed from the magnetic tape telemetry recordings showed many unusual patterns of resonances that were the result of modulations and interference patterns caused by spin and roll of the satellite in the Earth's magnetic field.<sup>290</sup>

There was much evidence of spread F in the Explorer XX observations, as was found with the Alouette I satellite, also, evidence of direct-ducted echoes or ducted spread-F echoes.<sup>291</sup>

---

<sup>289</sup> Previously, in September 1961, Knecht, Van Zandt, and S. Russell, in their first report on sounding the upper atmosphere with a rocket (see ref. [99]), stated, that as a first-time observation:

Enlarged views of the topside "exit" phenomena are shown in Figure 3. On both frequencies unusual effects of "splashes" (which may be a kind of plasma resonance effect) are observed as the sounder emerges from the topside of the ionosphere and passes through levels corresponding to the three reflection levels. . . .

<sup>290</sup> By the mid-1960's it was well recognized among investigators of the upper ionosphere that the region offered a nearly ideal medium for study of plasma phenomena—there are virtually no boundaries to the medium and it is essentially uniform over large distances.

<sup>291</sup> Previously, in March 1962, in their report on sounding the upper atmosphere with the rocket launch of October 13, 1961, Knecht and S. Russell noted the evidence of direct-ducted echoes. Their observations indicated that ducting occurred along magnetic-field-aligned irregularities as the rocket sounder emerged from the topside of the ionosphere until it reached the apogee of flight. They suggested that the same type of ducting occurs on the bottom-side of the ionosphere, causing spread F.

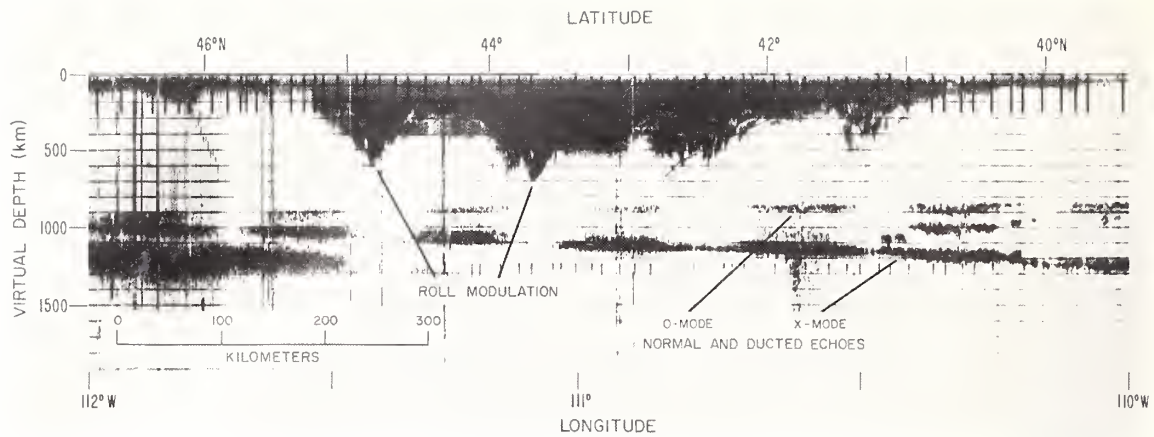

From a 1961 rocket launch, CRPL personnel had observed a plasma resonance phenomenon in the upper ionosphere caused by the radiated signals. Later satellite observation showed further evidence of plasma resonance in the ionosphere (see pp. 504-506 of text for explanation). This recording, taken from Explorer XX observations of September 1, 1964, shows several of the effects associated with plasma resonance that occurred while sounding down into the upper ionosphere when the satellite was passing through the region north of Salt Lake City, Utah. This sample, made during radiation of the ionosphere by the sounder transmitter at 2.0 MHz, shows the effect of interference patterns and out-of-phase modulation on the recorded ionosphere echoes at a plasma resonance of twice the gyrofrequency,  $2f_H$ .

Upon further study of ionograms processed from the data generated by Explorer XX in its orbiting journey, Calvert and Van Zandt gathered information for a 1966 publication on plasma resonances that first had been observed in the rocket launch of June 24, 1961 (see p. 503 and accompanying footnote) [100]. Plasma resonances on rocket and Alouette records were of only a tenth of a second in excitation, whereas on Explorer XX records the resonances ranged from 15 seconds to several minutes in excitation. These longer resonances introduced Calvert and Van Zandt to some newly observed phenomena of the upper ionosphere. Characteristics of nearly all of these lengthy resonances was a pattern of interference-like fringes that are modulated in spacing and intensity by the spin of a satellite in relation to the Earth's magnetic field. Also, it was found possible to derive the gradient of electron concentration along the orbit of the satellite.<sup>292</sup>

Many personnel of the Ionosphere Research and Propagation Division and, later, the Aeronomy Division, took part in the Explorer XX program. On February 14, 1965, a group was awarded the Department of Commerce Gold Medal for Exceptional Service, with the citation: "The success of CRPL Topside Sounder Group in using rockets and satellites to explore the inaccessible upper side of the ionosphere has resulted in outstanding contributions to upper atmosphere physics and plasma physics."<sup>293</sup>

<sup>292</sup> Two years after the launching of Explorer XX, Calvert published a somewhat popular article in the October 14, 1966, issue of *Science*, entitled "Ionospheric Topside Sounding." The article was a review of the NASA international satellite program for the upper ionosphere, pointing out the newly acquired knowledge of the "topside."

In 1964 Van Zandt and Knecht contributed a long chapter, entitled "The Structure and Physics of the Upper Atmosphere," to *Space Physics*, a book published by John Wiley and Sons. However, it did not benefit from the knowledge that was gained with Explorer XX beginning in August 1964.

<sup>293</sup> The group award included: Wynne Calvert, the project leader for the Topside Sounder satellite program, and nine colleagues, Earl E. Ferguson, Georganna B. Goe, Richard B. Green, Robert W. Knecht, Robert S. Lawrence, Leray LaBaume, Alan H. Shapley, Thomas E. Van Zandt, and James M. Watts.



#### d) THE OGO'S

By 1963 the CRPL joined in a cooperative program, sponsored by NASA, that involved satellites to become known as Orbiting Geophysical Observatories (OGO). The OGO's were filled with pay loads to conduct a large number of diversified geophysical experiments, among which was the CRPL measurement of electron density over an extensive range into the exosphere. The CRPL experiments were initiated by the Ionosphere Radio Astronomy Section under the leadership of Lawrence and were continued by ESSA after 1965.<sup>294</sup>

---

<sup>294</sup> The two OGO satellites used by the CRPL were known in the design stage as S-49 and S-50 Orbiting Geophysical Observatories, and after launching were designated as OGO 1 and OGO 3, respectively. For the electron-density experiments they were fitted with a radio-beacon transmitter operating at 40.01 MHz, with a phase-coherent ninth harmonic of 360.09 MHz for determination of Faraday rotation of the two linearly polarized waves. The OGO 1 satellite was launched on September 4, 1964, from Cape Kennedy, with a very eccentric orbit, initially with a perigee of 175 km and an apogee of 92,875 km. The period of orbit was 64 hours. The OGO 3 satellite was launched on June 6, 1966.

In May 1967 the OGO 1 satellite was used to observe the response of ionospheric and exospheric electron contents to a partial solar eclipse.

### REFERENCES

- [1] T. R. Gilliland, "Continuous measurements of the virtual heights of the ionosphere," *Proc. IRE*, Vol. 21, No. 10, Oct. 1933, pp. 1463-75.
- [2] Samuel S. Kirby and Elbert B. Judson, "Recent studies of the ionosphere," *Proc. IRE*, Vol. 23, No. 7, July 1935, pp. 733-751.
- [3] T. R. Gilliland, S. S. Kirby, N. Smith, and S. E. Reymer, "Characteristics of the ionosphere and their application to radio transmission," *Proc. IRE*, Vol. 25, No. 7, July 1937, pp. 823-840.
- [4] M. Lindeman Phillips, "Variations in sporadic-E ionization observed at Washington, D.C.," *Trans. Amer. Geophysical Union*, Vol. 28, No. 1, Feb. 1947, pp. 71-78.
- [5] V. C. Pineo, "A comparison of meteor activity with occurrence of sporadic E reflections," *Science*, Vol. 112, July 14, 1950, pp. 50-51.
- [6] Ernest K. Smith, Jr., Worldwide Occurrence of Sporadic E, *Nat. Bur. Stand. (U.S.) Circ. 582*, Mar. 15, 1957, 278 pages.
- [7] Ernest K. Smith, Jr., and James W. Finney, "Peculiarities of the ionosphere in the Far East: A report on IGY observations of sporadic-E and F-region scatter," *J. Geophys. Res.*, Vol. 65, No. 3, Mar. 1960, pp. 885-892.
- [8] R. M. Davis, Jr., E. K. Smith, and C. D. Ellyett, "Sporadic E at VHF in the USA," *Proc. IRE*, Vol. 47, No. 5, May 1959, pp. 762-769.
- [9] J. A. Thomas and E. K. Smith, "A survey of the present knowledge of sporadic-E ionization," *J. Atmospheric and Terrestrial Physics*, Vol. 13, 1959, pp. 295-314.
- [10] Ernest K. Smith, Jr., and Sadami Matsushita, *Ionospheric Sporadic E*, Pergamon Press, Inc., New York, N.Y., 1962.
- [11] Robert Cohen and Kenneth L. Bowles, "On the nature of equatorial spread F," *J. Geophys. Res.*, Vol. 66, No. 4, Apr. 1961, pp. 1081-1106.
- [12] J. N. Brown and J. M. Watts, "Ionosphere observations at 50 kc," *J. Geophys. Res.*, Vol. 55, No. 2, June 1950, pp. 179-181.
- [13] J. M. Watts and J. N. Brown, "Some results of sweep-frequency investigation in the low frequency band," *J. Geophys. Res.*, Vol. 59, No. 1, Mar. 1954, pp. 71-86.
- [14] C. Ellyett and J. M. Watts, "Stratification in the lower ionosphere," *J. Res. Nat. Bur. Stand. (U.S.)*, Vol. 63D, No. 2, Sept.-Oct. 1959, pp. 117-134.
- [15] R. B. Norton, T. E. Van Zandt, and J. S. Denison, "A model of the atmosphere and ionosphere in the E and F<sub>1</sub> regions," *Proceedings of the International Conference on the Ionosphere*, pp. 26-34, published by Institute of Physics and the Physical Society (London), 1963.
- [16] James R. Wait, *Electromagnetic Waves in Stratified Media*, Pergamon Press, Oxford and New York, 1962.
- [17] H. Rishbeth, "A time-varying model of the ionospheric F<sub>2</sub> layer," *J. Atmospheric and Terrestrial Physics*, Vol. 26, June 1964, pp. 657-685.
- [18] Sanford C. Gladden, A History of Vertical-Incidence Ionosphere Sounding at the National Bureau of Standards, *Nat. Bur. Stand. (U.S.) Tech. Note 28*, Sept. 1949, 140 pages.
- [19] Richard Silberstein, "High-frequency scatter sounding experiments at the National Bureau of Standards," *Science*, Vol. 118, Dec. 25, 1953, pp. 759-763.
- [20] R. Silberstein, "The use of sweep-frequency backscatter data for determining oblique-incidence ionospheric characteristics," *J. Geophys. Res.*, Vol. 63, No. 2, June 1958, pp. 335-351.
- [21] Vaughn Agy and Kenneth Davies, "Ionospheric investigations using the sweep-frequency pulse technique at oblique incidence," *J. Res. Nat. Bur. Stand. (U.S.)*, Vol. 63D, No. 2, Sept.-Oct. 1959, pp. 151-174.

- [22] K. L. Bowles, "Observation of vertical-incidence scatter from the ionosphere at 41 Mc/sec.," *Physical Review Letters*, Vol. 1, No. 12, Dec. 1958, pp. 454-455.
- [23] Kenneth L. Bowles, "Incoherent scattering by free electrons as a technique for studying the ionosphere and exosphere: some observations and theoretical considerations," *J. Res. Nat. Bur. Stand. (U.S.)*, Vol. 65D, No. 1, Jan.-Feb. 1961, pp. 1-14.
- [24] K. L. Bowles, "Measuring plasma density of the magnetosphere," *Science*, Vol. 139, No. 3553, Feb. 1, 1963, pp. 389-391.
- [25] W. K. Klemperer, G. R. Ochs, and K. L. Bowles, "Radar echoes from Venus at 50 Mc/sec.," *The Astronomical J.*, Vol. 69, No. 1, Feb. 1964, pp. 22-28.
- [26] Vaughn Agy, "Geographic and temporal distribution of polar blackouts," *J. Geophys. Res.*, Vol. 59, No. 4, Dec. 1954, pp. 499-512.
- [27] Vaughn Agy, "The location of the auroral absorption zone," *J. Geophys. Res.*, Vol. 59, No. 2, June 1954, pp. 267-272.
- [28] D. K. Bailey, "Disturbances in the lower ionosphere observed at VHF following the solar flare of 23 February 1956 with particular reference to auroral-zone absorption," *J. Geophys. Res.*, Vol. 62, No. 3, Sept. 1957, pp. 431-463.
- [29] D. K. Bailey, "Polar-cap absorption," *Planetary and Space Science*, Vol. 12, Pergamon Press, New York, 1964, pp. 495-541.
- [30] C. G. Little and H. Leinbach, "The riometer—a device for the continuous measurement of ionospheric absorption," *Proc. IRE*, Vol. 47, No. 2, Feb. 1959, pp. 315-320.
- [31] D. K. Bailey, "Some quantitative aspects of electron precipitation in and near the auroral zone," *Reviews of Geophysics*, Vol. 6, No. 3, Aug. 1968, pp. 289-346.
- [32] Robert Cohen and Kenneth L. Bowles, "Ionospheric VHF scattering near the magnetic equator during the International Geophysical Year," *J. Res. Nat. Bur. Stand. (U.S.)*, Vol. 67D, No. 5, Sept.-Oct. 1963, pp. 458-480.
- [33] R. Bateman, J. W. Finney, E. K. Smith, L. H. Tveten, and J. M. Watts, (Bateman of Page Communications Engineers, Inc.; others of the CRPL), "IGY observations of F-layer scatter in the Far East," *J. Geophys. Res.*, Vol. 64, No. 4, Apr. 1959, pp. 403-405.
- [34] See reference [7].
- [35] Newbern Smith, Theodore R. Gilliland, and Samuel S. Kirby, "Trends of characteristics of the ionosphere for half a sunspot cycle," *J. Res. Nat. Bur. Stand. (U.S.)*, Vol. 21, No. 6, Dec. 1938, pp. 835-845.
- [36] M. Lindeman Phillips, "The ionosphere as a measure of solar activity," *Terrestrial Magnetism and Atmospheric Electricity*, Vol. 52, No. 3, Sept. 1947, pp. 321-332.
- [37] A. G. McNish and J. V. Lincoln, "Prediction of sunspot numbers," *Trans. Amer. Geophys. Union*, Vol. 30, No. 5, Oct. 1949, pp. 673-685.
- [38] C. Warwick and M. Wood, "A study of limb flares and associated events," *Astrophysical J.*, Vol. 129, No. 3, May 1959, pp. 801-811.
- [39] A. G. McNish and T. N. Gautier, "Theory of lunar effects and midday decrease in  $F_2$  ion-density at Huancayo, Peru," *J. Geophys. Res.*, Vol. 54, No. 2, June 1949, pp. 181-185.
- [40] A. H. Brady and D. D. Crombie, "Studying the lunar tidal variations in the D region of the ionosphere by means of very-low-frequency phase observations," *J. Geophys. Res.*, Vol. 68, No. 19, Oct. 1, 1963, pp. 5437-42.
- [41] C. D. Salzberg and R. Greenstone, "Systematic ionospheric winds," *J. Geophys. Res.*, Vol. 56, No. 4, Dec. 1951, pp. 521-533.
- [42] Lowell H. Tveten, "Ionospheric motions observed with high frequency backscatter sounders," *J. Res. Nat. Bur. Stand. (U.S.)*, Vol. 65D, No. 2, Mar.-Apr. 1961, pp. 115-127.
- [43] Kenneth Davies, "The measurement of ionospheric drifts by means of a doppler shift technique," *J. Geophys. Res.*, Vol. 67, No. 12, Nov. 1962, pp. 4909-13.
- [44] "Measuring drift of ionospheric clouds by doppler techniques," *Nat. Bur. Stand. (U.S.), Tech. News Bull.*, Vol. 47, No. 4, Apr. 1963, pp. 62-63.
- [45] Jack C. Brown, "Round-the-world signals at very low frequency," *J. Geophys. Res.*, Vol. 54, No. 4, Dec. 1949, pp. 367-372.
- [46] J. W. Wright, Ionosonde Observations of Artificially Produced Electron Clouds: Firefly 1960, *Nat. Bur. Stand. (U.S.), Tech. Note 135*, Apr. 1, 1962, 108 pages.
- [47] J. W. Wright, "Ionosonde studies of some chemical releases in the ionosphere," *Radio Science*, Vol. 68D, No. 2, Feb. 1964, pp. 189-204.
- [48] G. R. Ochs, D. T. Farley, Jr., K. L. Bowles, and P. Bandyopadhyay, "Observations of synchrotron radio noise at the magnetic equator following the high-altitude nuclear explosion of July 9, 1962," *J. Geophys. Res.*, Vol. 68, No. 3, Feb. 1963, pp. 701-711.
- [49] A. G. Jean, C. E. Hornback, R. H. Doherty, J. R. Winkleman, and R. T. Moore, "Techniques for detection of high-altitude nuclear explosions," *Proc. IEEE*, Vol. 53, No. 12, Dec. 1965, pp. 2088-98.
- [50] Ross Bateman, A. G. McNish, and Victor C. Pineo, "Radar observations during meteor shower 9 October 1946," *Science*, Vol. 104, 18 Oct. 1946, pp. 434-435.
- [51] V. C. Pineo and T. N. Gautier, "The wave-frequency dependence of the duration of radar-type echoes from meteor trails," *Science*, Vol. 114, 2 Nov. 1951, pp. 460-462.
- [52] G. F. Montgomery and G. R. Sugar, "The utility of meteor bursts for intermittent radio communication," *Proc. IRE*, Vol. 14, No. 12, Dec. 1957, pp. 1684-93.
- [53] R. J. Carpenter and G. R. Ochs, "The NBS meteor-burst communication system," *IRE Trans. Communication Systems*, Vol. CS-7, No. 4, Dec. 1959, pp. 263-271.

- [54] George R. Sugar, "Radio propagation by reflection from meteor trails," *Proc. IEEE*, Vol. 52, No. 2, Feb. 1964, pp. 116-136.
- [55] J. Feinstein, "High-order approximations in ionospheric wave-propagation," *J. Geophys. Res.*, Vol. 55, No. 2, June 1950, pp. 161-170.
- [56] D. M. Hunten, F. E. Roach, and J. W. Chamberlain, "A photomatic unit for the airglow and aurora," *J. Atmospheric and Terrestrial Physics*, Vol. 8, 1956, pp. 345-346.
- [57] F. E. Roach, E. Tandberg-Hanssen, and L. R. Megill, "The characteristic size of airglow cells," and "Movements of airglow cells," *J. Atmospheric and Terrestrial Physics*, Vol. 13, Dec. 1958, pp. 113-121, 122-130.  
Note: Tandberg-Hanssen, High Altitude Observatory, Boulder, Colo.
- [58] "Auroral arc in mid-latitudes," *Nat. Bur. Stand. (U.S.), Tech. News Bull.*, Vol. 46, No. 3, Mar. 1962, pp. 42-46.
- [59] See: *Reference Data for Radio Engineers (fourth edition)*, International Telephone and Telegraph Corp., Stratford Press, Inc., New York, 1956, pp. 710-713, nomograms by Mrs. M. Lindeman Phillips, CRPL, *Nat. Bur. Stand.*
- [60] K. A. Norton, "The calculation of ground-wave field intensity over a finitely conducting spherical earth," *Proc. IRE*, Vol. 29, No. 12, Dec. 1941, pp. 623-639.
- [61] "A low-frequency ionosphere recorder," *Nat. Bur. Stand. (U.S.), Tech. News Bull.*, Vol. 37, No. 4, Apr. 1953, pp. 60-62.
- [62] Joseph Feinstein, "Wave propagation in an anisotropic inhomogeneous medium," *J. Geophys. Res.*, Vol. 58, No. 2, June 1953, pp. 223-230.
- [63] J. R. Wait and H. H. Howe, "The waveguide mode theory of VLF ionospheric propagation," *Proc. IRE (correspondence)*, Vol. 54, No. 1, Jan. 1957, p. 95.
- [64] J. R. Wait and A. Murphy, "The geometrical optics of VLF sky wave propagation," *Proc. IRE*, Vol. 45, No. 6, June 1957, pp. 754-759.
- [65] J. R. Wait, "The mode theory of VLF ionospheric propagation for finite ground conductivity," *Proc. IRE*, Vol. 45, No. 6, June 1957, pp. 760-767.
- [66] J. R. Wait, "The attenuation vs frequency characteristics of VLF radio waves," *Proc. IRE*, Vol. 45, No. 6, June 1957, pp. 768-771.
- [67] James R. Wait, "Transmission loss curves for propagation at very low radio frequencies," *IRE Trans. Communications Systems*, Vol. CS-6, Dec. 1958, pp. 58-61.
- [68] James R. Wait, "Mode theory and the propagation of ELF radio waves," *J. Res. Nat. Bur. Stand. (U.S.)*, Vol. 64D, No. 4, July-Aug. 1960, pp. 387-404.
- [69] A. D. Watt, E. L. Maxwell, and E. H. Whelan, "Low-frequency propagation paths in arctic areas," *J. Res. Nat. Bur. Stand. (U.S.)*, Vol. 63D, No. 1, July-Aug. 1959, pp. 99-112.
- [70] W. L. Taylor, "Daytime attenuation rates in the very low frequency band using atmospheric," *J. Res. Nat. Bur. Stand. (U.S.)*, Vol. 64D, No. 4, July-Aug. 1960, pp. 349-355.
- [71] A. G. Jean, A. C. Murphy, J. R. Wait, and D. F. Wasmundt, "Observed attenuation rate of ELF radio waves," *J. Res. Nat. Bur. Stand. (U.S.)*, Vol. 65D, No. 5, Sept.-Oct. 1961, pp. 475-479.
- [72] A. Glenn Jean, William L. Taylor, and James R. Wait, "VLF phase characteristics deduced from atmospheric wave forms," *J. Geophys. Res.*, Vol. 65, No. 3, Mar. 1960, pp. 907-912.
- [73] "VLF signals: sunrise and sunset fading," *Nat. Bur. Stand. (U.S.), Tech. News Bull.*, Vol. 49, No. 2, Feb. 1962, pp. 32-33.
- [74] J. M. Watts, "An observation of audio-frequency electromagnetic noise during a period of solar disturbance," *J. Geophys. Res.*, Vol. 62, No. 2, June 1957, pp. 199-206.
- [75] A. Glenn Jean, Jr., L. Jerome Lange, and James R. Wait, "Ionospheric reflection coefficients at VLF from sferics measurements," *Geofisica Pura E Applicato (Milano)*, Vol. 38, 1957, pp. 147-153.
- [76] R. A. Helliwell, A. G. Jean, and W. L. Taylor, "Some properties of lightning impulses which produce whistlers," *Proc. IRE*, Vol. 46, No. 10, Oct. 1958, pp. 1760-62.
- [77] R. M. Gallet and R. A. Helliwell, "Origin of very-low-frequency emissions," *J. Res. Nat. Bur. Stand. (U.S.)*, Vol. 63D, No. 1, July-Aug. 1959, pp. 21-27.
- [78] W. L. Taylor and A. G. Jean, "Very-low-frequency radiation spectra of lightning discharges," *J. Res. Nat. Bur. Stand. (U.S.)*, Vol. 63D, No. 3, Sept.-Oct. 1959, pp. 199-204.
- [79] A. Glenn Jean, William L. Taylor, and James R. Wait, "VLF phase characteristics deduced from atmospheric wave forms," *J. Geophys. Res.*, Vol. 65, No. 3, Mar. 1960, pp. 907-912.
- [80] W. Q. Crichlow, C. A. Samson, R. T. Disney, and M. A. Jenkins, Radio Noise Data for the International Geophysical Year July 1, 1957-December 31, 1958, *Nat. Bur. Stand. (U.S.), Tech. Note 18*, July 27, 1959, 235 pages.
- [81] J. W. Finney and E. K. Smith, Jr., Report on the IGY Oblique-Incidence Sporadic-E and F-Scatter Program, *Nat. Bur. Stand. (U.S.), Tech. Note 48*, Mar. 1960, 94 pages.
- [82] David M. Gates, "Preliminary results of the National Bureau of Standards radio ionospheric observations during the International Geophysical Year," *J. Res. Nat. Bur. Stand. (U.S.)*, Vol. 63D, No. 1, July-Aug. 1959, pp. 1-14.
- [83] D. K. Bailey, "Disturbances in the lower ionosphere observed at VHF following the solar flare of 23 February 1956 with particular reference to auroral-zone absorption," *J. Geophys. Res.*, Vol. 62, No. 3, Sept. 1957, pp. 431-463.
- [84] D. K. Bailey, "Abnormal ionization in the lower ionosphere associated with cosmic-ray flux enhancements," *Proc. IRE*, Vol. 47, No. 2, Feb. 1959, pp. 255-266.
- [85] D. K. Bailey, R. Bateman, L. V. Berkner, H. G. Booker, G. F. Montgomery, E. M. Purcell, W. W. Salisbury, and J. B. Wiesner, "A new kind of radio propagation at very high frequencies observable over long distances," *Phys. Rev.*, Vol. 86, No. 2, Apr. 15, 1952, pp. 141-145.

- [86] "A new kind of propagation at very high frequencies," *Nat. Bur. Stand. (U.S.), Tech. News Bull.*, Vol. 36, No. 10, Oct. 1952, pp. 148-149.
- [87] D. K. Bailey, R. Bateman, and R. C. Kirby, "Radio transmission at VHF by scattering and other processes in the lower atmosphere," *Proc. IRE*, Vol. 43, No. 10, Oct. 1955, pp. 1181-1230.
- [88] R. C. Kirby, "VHF propagation by ionospheric scattering—a survey of experimental results," *IRE Trans. Communication Systems*, Vol. CS-4, No. 1, Mar. 1956, pp. 17-27.
- [89] H. V. Cottony, "High-gain antennas for VHF scatter propagation," *IRE Trans. Communication Systems*, Vol. CS-4, No. 1, Mar. 1956, pp. 56-63.
- [90] V. C. Pineo, "Oblique-incidence measurements of the heights which ionospheric scattering of VHF radio waves occurs," *J. Geophys. Res.*, Vol. 61, No. 2, June 1956, pp. 165-169.
- [91] G. R. Sugar, "Some fading characteristics of regular VHF ionospheric propagation," *Proc. IRE*, Vol. 43, No. 10, Oct. 1955, pp. 1432-36.
- [92] R. S. Lawrence, J. L. Jespersen, and R. C. Lamb, "Amplitude and angular scintillations of the radio source Cygnus-A observed at Boulder, Colorado," *J. Res. Nat. Bur. Stand. (U.S.)*, Vol. 65D, No. 4, July-Aug. 1961, pp. 333-350.
- [93] C. Gordon Little and Robert S. Lawrence, "The use of polarization fading of satellite signals to study the electron count and irregularities in the ionosphere," *J. Res. Nat. Bur. Stand. (U.S.)*, Vol. 64D, No. 4, July-Aug. 1960, pp. 335-346.
- [94] R. G. Merrill, R. S. Lawrence, N. J. Roper, "Synoptic variations and vertical profiles of large-scale ionospheric irregularities," *J. Geophys. Res.*, Vol. 68, No. 19, Oct. 1963, pp. 5453-59.
- [95] J. W. Wright, "A model of the F region above  $k_{\max} F2$ ," *J. Geophys. Res.*, Vol. 65, No. 1, Jan. 1960, pp. 185-191.
- [96] R. W. Knecht and T. E. Van Zandt, "Some early results from the ionospheric top-side sounder satellite," *Nature*, Vol. 197, Feb. 16, 1963, pp. 641-644.
- [97] Wynne Calvert and Charles W. Schmid, "Spread-F observations by the Alouette topside sounder satellite," *J. Geophys. Res.*, Vol. 69, No. 9, May 1, 1964, pp. 1839-52.
- [98] W. Calvert, R. W. Knecht, and T. E. Van Zandt, "Ionosphere Explorer I Satellite: first observations from the Fixed-Frequency Topside Sounder," *Science*, Vol. 146, Oct. 16, 1964, pp. 391-395.
- [99] R. W. Knecht, T. E. Van Zandt, and S. Russell, "First pulsed radio soundings of the topside of the ionosphere," *J. Geophys. Res.*, Vol. 66, No. 9, Sept. 1961, pp. 3078-82.
- [100] W. Calvert and T. E. Van Zandt, "Fixed-frequency observations of plasma resonances in the topside ionosphere," *J. Geophys. Res.*, Vol. 71, No. 7, Apr. 1, 1966, pp. 1799-1813.

## Chapter XII

### RADIO WAVES IN THE LOWER ATMOSPHERE

#### INTRODUCTION

Transmission of radio waves at frequencies beginning at about 60 MHz and extending upwards into the microwave region and beyond, is essentially through the lower atmosphere. This portion of the Earth's atmosphere was aptly described by Thomas J. Carroll of the Bureau's Central Radio Propagation Laboratory in an unpublished lecture of July 1946<sup>1</sup> as

. . . the troposphere, the name given by meteorologists to the lowest 7 miles or so of the earth's atmospheric envelope, the region in which clouds form and convection occurs.

Stephen S. Atwood of the University of Michigan gave a more extensive description in a summary paper in the *Proc. IRE*:

The term Tropospheric Propagation refers to the effects of the earth's lower atmosphere on the field strengths of radio waves, with particular attention being given to the VHF, UHF, and SHF frequencies, and also to various atmospheric conditions that produce nonstandard types of refraction.<sup>2</sup>

The wide range of frequencies transmitted and the large number of telecommunication services in these frequency ranges make tropospheric propagation an important field of study. Early theories of tropospheric propagation envisioned a path no longer than that of light waves—in other words, to the optical horizon (line-of-sight), or slightly beyond when radio waves are bent downward around the Earth's surface by atmospheric refraction. This gave rise to a hypothetical value of  $4/3$  the radius of a smooth Earth in equations for estimating the received field strength of signals at varying distances from the transmitter. As early as 1931-32, Marconi found that propagation at a wavelength of 60 cm was at least five times the optical distance, in contradiction to this theory.<sup>3</sup> This phenomenon has been the subject of much research, both theoretical and experimental, through the years.

The first extensive quantitative propagation measurements over land and sea were reported in 1902 by Captain Henry B. Jackson of the British Royal Navy (later Admiral Sir and First Sea Lord of the Admiralty) (*Proceedings, Royal Society of London*, Vol. 70, July 8, 1902, pp. 254-272). Observations were made from Naval vessels in the Mediterranean between 1895 and 1902. These observations formed the basis of his pioneering study of the effects on transmission of radio waves (approximately 1400 kHz, much below the frequency range considered in this chapter) by atmospheric conditions, such as barometric pressure, winds, and dust or salt particles in the atmosphere; by topography, such as obstacles of different land formations; and by atmospheric radio noise.

At NBS, Diamond and Dunmore used ultra high frequency (UHF) equipment for the blind landing system in the early 30's (ch. VI) and Dunmore later experimented with UHF circuits and antennas. However, they did not study the propagation characteristics to any extent.

<sup>1</sup> Lecture for the Interdepartmental Lecture Program in Electronics, July 11, 1946. Manuscript in Radio File (modified Dewey classification R 112.2a).

<sup>2</sup> Quoted from a paper by Stephen S. Atwood, "Radiowave propagation between World Wars I and II," *Proc. IRE*, Vol. 50, No. 5, May 1962, p. 691.

<sup>3</sup> Chapter I, year 1931, p. 16.

Requirements for radar and communications in World War II quickly extended into these frequencies. Following the war, commercial communication systems, aircraft communications, FM (frequency modulation) radio, television (TV), microwave relay links, and other uses created a mushrooming demand for frequency assignments in this range.

A great need arose for basic information on the behavior of radio waves in the troposphere and several institutions initiated research on tropospheric propagation. The Bureau's Central Radio Propagation Laboratory was among the early entrants into this field. When CRPL was organized on May 1, 1946, the organizational structure provided for two sections dealing with "microwave research." One of these, Basic Microwave Research, was activated in the summer of 1946, with its functions defined as "research on radio propagation at VHF and microwave frequencies with particular emphasis on the effects of the lower atmosphere." The second, Experimental Microwave Research, was activated a year later. The two were consolidated on February 1, 1949, and the new section was named Tropospheric Propagation Research. Activities in this area expanded rapidly and continued at NBS until CRPL was transferred to the Environmental Science Services Administration (ESSA) in 1965 (ch. XX), and are still being conducted in the Institute for Telecommunication Sciences of the National Telecommunications and Information Administration.

Even before the organization of CRPL, interest was being shown at NBS in tropospheric propagation, as evidenced by the Monthly Reports of the Radio Section. For example, some excerpts from the Report of November 1945 read that a survey of the status of work in tropospheric propagation continued; that emphasis was being placed on methods and experimental equipment for obtaining the distribution refractive index with height and interpretation of data so obtained; and that visits were made to the Weather Bureau for information on radio meteorology. This is the first reference in the Monthly Reports to tropospheric propagation, probably because prior to that time the projects were classified and therefore not included. Notations of various studies continued in these Reports until CRPL was organized in May 1946.

In the early years of CRPL, a number of theoretical papers were written by members of the staff, giving formulas and equations for predicting the strength of signals at varying distances from the transmitter. Such information was needed by the Federal Communications Commission, the Air Navigation Development Board, the military services, and others to aid in assigning frequencies so that transmitting stations would be spaced far enough apart to provide minimum interference.

## RESEARCH ON TROPOSPHERIC PROPAGATION GETS UNDERWAY

### 1. Early projects

The first completed project in tropospheric propagation was the compilation and publication of a "Survey of Meteorological Instruments Used in Tropospheric Propagation Investigations" by Morris Schulkin and Dwight L. Randall (Report CRPL-2-1, July 21, 1947).<sup>4</sup>

Significantly, the Preface of this survey states:

The Central Radio Propagation Laboratory of the National Bureau of Standards is inaugurating a program of tropospheric propagation research. In order to evaluate the data with regard to weather, it is necessary to obtain detailed meteorological information,

and the Introduction adds that its purpose was to

survey instruments in use at the present (March 1947) and those under development which measure meteorological elements affecting microwave propagation in the lowest 5,000 feet of the atmosphere. Measurements of these elements are necessary to compute the refractive index and the liquid water attenuation of the air for microwave radio propagation.

---

<sup>4</sup>The principal instruments and methods surveyed were for measuring temperature, pressure (altitude), humidity, wind, and liquid water.

In March 1947, the National Defense Research Committee (NDRC) Wave Propagation Group at Columbia University transferred its library of reports on tropospheric radio propagation to CRPL. This group had previously compiled bibliographies of these reports (the latest in 1945) and an early mission of CRPL was to bring the bibliography up to date. Schulkin compiled a "Bibliography of Reports on Tropospheric Propagation" (Report CRPL-2-3, July 23, 1948), in which some changes were made in subject classifications to represent advances in the area of tropospheric research. The most significant was the addition of two new major classifications—"Radar siting and calibration" and "Cosmic and solar radio noise." The latter was particularly appropriate because CRPL had recently inaugurated cosmic radio noise studies, although no CRPL reports on this subject had yet been issued.

In the same year, Jack W. Herbstreit and Kenneth A. Norton contributed chapters to the book *Advances in Electronics, Vol. 1* (Academic Press Inc., New York, 1948) on subjects related to tropospheric propagation. Herbstreit wrote on "Cosmic radio noise" and Norton on "Propagation in the FM broadcast band." (See ch. XIV, footnote 6.)

Herbstreit gave a summary review of cosmic noise research up to that time, including results of NBS research. He described the methods used, details of antennas and receivers, and discussed observations made on 25 MHz and 110 MHz, commenting that the intensity of the incident radiation decreased with frequency, at least in the 25- to 110-MHz range.

Norton presented a state-of-the-art review of the propagation factors related to transmission in the FM broadcast band, which had recently been moved by the Federal Communications Commission from below 50 MHz to the range of 88 to 108 MHz. Among these factors were the effects of radio noise on broadcast reception, the effects of antenna height and terrain, the effects of irregularities in the terrain, and the systematic effects of terrain and of tropospheric ducts. He also covered tropospheric waves resulting from reflection of atmospheric boundary layers and the combined effects of ducts and of random tropospheric waves. Finally he discussed the calculated service and interference ranges of FM broadcast stations, the efficient allocation of facilities to FM broadcast stations, and the optimum frequency for an FM broadcast service.

In May 1947, CRPL called a Conference on Radio Propagation which was a successor to several types of meetings that had been held during the war; among these was a series of semiannual conferences on tropospheric propagation held under the auspices of the National Defense Research Committee (NDRC). Two sessions pertained specifically to topics in tropospheric propagation: "Cosmic radio noise" and "Propagation at VHF and higher radio frequencies." The Conference was marked by informal discussions and exchange of views, rather than by presentation of formal papers, in order to determine the most desirable lines that should be followed in the future by government, university, and industrial laboratories.

Almost from the beginning of CRPL, theoretical and experimental research was started for making observations and obtaining data on the behavior of radio waves at very high frequency (VHF), ultra high frequency (UHF), and microwave frequencies. Climate, meteorological conditions in the troposphere, and terrain irregularities were known to play important roles and early investigations were concentrated in these areas.

Results of such programs come slowly because long periods of time are required to obtain data which reflect diurnal, seasonal, and climatic variations. For example, it was considered desirable to make observations over a variety of transmission paths for periods of a year or longer to determine seasonal factors, effects of atmospheric variables, and year-to-year variations. This was confirmed in practice, as indicated in CRPL Annual Reports for the years 1951 and 1952 when it was stated that "some knowledge of the repeatability of propagation phenomena from year to year in a particular geographical location was obtained," and "several paths studied for periods of two years or more show up variations in the year-to-year repeatability."

## **2. Valuable meteorological and climatological data come from the U.S. Weather Bureau and other agencies**

The earliest research efforts utilized available data on natural conditions which affect tropospheric propagation. Among these was a pioneering study by Schulkin of variations of atmospheric refraction of radio rays with height and meteorological conditions [1]. He

devised a practical method for computing refraction through an atmosphere of known refractive index, utilizing U.S. Weather Bureau records.

The Weather Bureau had recently published radiosonde data of temperature, pressure, and relative humidity for the North American network of stations from Alaska to the Caribbean. Schulkin used these data for computing ray bending due to atmospheric refraction at locations representative of a range of climatological conditions and selected Fairbanks, Alaska, in April; Washington, D.C., in October; and San Juan, Puerto Rico, in July for detailed study. Fairbanks and San Juan were selected because they showed extremes of ray bending (with Fairbanks a minimum and San Juan a maximum), while Washington showed average.

He found that the refraction approximations in use at the time (based on a  $4/3$  Earth's radius) were not adequate for all seasons, geographical locations, or very high altitudes, the actual air refraction in the lower atmosphere deviating considerably from theoretical calculations.

A little later, a pilot study was made by Randall to investigate the relationship of surface refractive index to radio field strength [2].<sup>5</sup> An FM station in Richmond, Va., at a frequency of 96.3 MHz, was continuously recorded for a three-week period in the summer of 1947. The propagation distance was 97 miles (121 km) and a terrain profile of the path (drawn with a  $4/3$  Earth's radius) showed that the receiver was beyond the radio horizon, or in the diffraction zone. Variations in the radio field strength were therefore considered to be the result of changes in the meteorological conditions over the path.<sup>6</sup> This pilot study confirmed that there seemed to be a relation between air-mass-type surface refractivity and signal strength.

Subsequent studies and investigations have expanded from these earlier studies into a new field of radio meteorology covered in a later section of this chapter (pp. 17-25).

### 3. Suppression of microwaves by zonal screens

In line-of-sight microwave transmission, destructive interference between the direct and ground-reflected rays may occur. A method for reducing interference from the ground-reflected ray, based on optical theory, was developed by Howard E. Bussey [3]. It makes use of a blocking screen set on the ground at the "reflection point" in the path in such a way that the reflected ray at the receiver will in theory disappear almost entirely, and in practice to an extent which depends mostly on the smoothness of the ground plane.<sup>7,8</sup>

The experiments confirmed the theory and indicated that trouble with a strong reflected wave can be eliminated by erecting small screens in the path or, when possible, by taking advantage of an obstacle already present.

### 4. Survey of research in tropospheric propagation, 1948-1956

At about the time that CRPL moved to Boulder (1954), a survey of research in tropospheric propagation for the period 1948 to 1954 with which CRPL was directly concerned was prepared as an NBS Report (an internal report not circulated outside NBS). It was first prepared as a bibliography, then expanded to include abstracts of each listed publication, and ultimately included, as "supplements," condensations or reprints of some

---

<sup>5</sup> Also, see Chapter XIII, pp. 579-583.

<sup>6</sup> Weather data consisted of the Daily Weather Maps and the Hourly Airway Weather Teletype Reports from Richmond and Washington. The atmospheric refractive index was computed from temperature, pressure, and water-vapor (from dew-point observations) data given in the Airway Weather Reports.

<sup>7</sup> In the experiments, Bussey used a variety of shapes and placements of the screens. One of the wave suppressors was an opaque quarter-circle, erected on the ground at a point along the transmission path where the reflected ray from the transmitter strikes the ground. Another was composed of two triangular screens whose edges were 7.3, 6.6, and 5.4 feet (2.5, 2.0, and 1.6 m), placed in a suitable position along the path.

For the study, a 4500-MHz transmitter was placed 800 ft (244 m) from the receiver and 14.3 feet (4.4 m) above the ground; the antennas at each end were 4 by 6-in (10.16 by 15.24-cm) horns. The receiver could be elevated up and down a 50-foot (15.2-m) tower.

<sup>8</sup> Bussey filed for a patent on Nov. 28, 1951. Patent No. 2,763,001 was issued on Sept. 11, 1956, entitled "Reflected-ray eliminators."



papers not otherwise available and selected portions of longer articles (many of these "supplements" were subsequently published as journal articles or in the NBS series of publications). The research contained in the report was sponsored in part by the U.S. Army Signal Corps and the Air Navigation Development Board (ANDB).

This compilation, extended to 1956, was published as *NBS Technical Note 26*, dated Sept. 1959, by J. W. Herbstreit and P. L. Rice [4]. The technical note contained 313 abstracts, including 174 progress reports by sub-contractors; gave a short description of the then current projects, facilities, and compilations of data; and presented 22 "supplements" (as described in the preceding paragraph). It was in effect a digest of tropospheric propagation research from the beginning of CRPL to the establishment of the Boulder Laboratories.

## TRANSMISSION LOSS

### 1. Definitions

#### a) TRANSMISSION LOSS

The concept of transmission loss in describing the characteristics of tropospheric radio propagation was introduced by Kenneth A. Norton, Chief of the CRPL Frequency Utilization Research Section, in an internal unpublished report of the Central Radio Propagation Laboratory in October 1952 and published in the January 1953 issue of the *Proceedings of the Institute of Radio Engineers* [5].<sup>9</sup> He defined the transmission loss of a radio system as the dimensionless ratio of the total power radiated from a transmitting antenna to the resulting radio frequency signal power which would be available from an equivalent loss-free receiving antenna. Transmission loss is usually expressed in decibels, which is 10 times the logarithm to the base 10 of this ratio.

#### b) BASIC TRANSMISSION LOSS

In order to separate the effects of the transmitting and receiving antenna gains from the effects of the propagation, a basic transmission loss (sometimes called path loss) was defined as the loss expected between fictitious loss-free isotropic transmitting and receiving antennas at the same location as the actual transmitting and receiving antennas.

#### c) SYSTEM LOSS

In a later report (1959) Norton defined system loss of a radio circuit consisting of a transmitting antenna, receiving antenna, and the intervening propagation medium as the dimensionless ratio of the radio frequency power input to the terminals of the transmitting antenna, to the resultant radio frequency signal power available at the terminals of the receiving antenna [6]. System loss is also usually expressed in decibels.

#### d) HOURLY MEDIAN TRANSMISSION LOSS

The study of long-term variations in transmission loss considers the hourly mean value as the basic unit. The hourly mean value constitutes a measure of the field or power exceeded for 50 percent of each hour of recording. Such values are determined from commercial recorder charts and time-totalizer records at receiving sites.

### 2. Formulas and graphs

Norton derived formulas for computing transmission loss, basic transmission loss, and system transmission loss from chart and time-totalizer records.

### 3. Extensive transmission loss data summarized and published

A summary of VHF and UHF tropospheric transmission loss data, prepared by Dorothy A. Williamson, Vivian L. Fuller, Anita G. Longley, and Philip L. Rice, was published as *NBS*

<sup>9</sup> Kenneth A. Norton, Chief of the CRPL Radio Propagation Engineering Division, Boulder Laboratories, was awarded the Department of Commerce Gold Medal for Exceptional Service on Feb. 14, 1962. He was recognized

for outstanding contributions and leadership in the field of radio propagation research.

*Technical Note 43* [7]. In the report cumulative distributions of hourly basic transmission loss were presented for 135 beyond-line-of-sight radio paths in the United States.

In order to obtain information regarding factors that affect transmission loss, a long-term program of measurements was conducted by CRPL with the assistance of the Federal Communications Commission, several universities, and other agencies. Whenever possible, transmission loss was recorded over particular paths for at least a year to determine seasonal and diurnal variations. A number of paths were studied for much longer periods of time to determine variability from year to year.

This long-term program yielded a large amount of data, including nearly a million hourly median values of transmission loss. In order to allow for seasonal trends, the year was divided into a summer period (May through October) and a winter period (November through April). The number of hourly medians and the basic transmission loss exceeded 1, 10, 50, 90, and 99 percent of all hours recorded during the winter months and summer months were computed and tabulated for each path.

Graphs were prepared showing the cumulative distributions of winter and summer hourly median values of basic transmission loss (predicted and observed) with time for 103 of the paths studied. They were divided into groups: paths with two or more complete years of recording; paths with more than one season of recording; and paths with only one season of recording. In addition, two curves were included for predicting long-term variability for winter and summer; readings from these curves were the basis for predictions appearing in the cumulative distributions.

#### 4. Transmission loss predictions

Transmission loss predictions for tropospheric communication circuits were published as an *NBS Technical Note* (in two volumes) by Rice, Longley, Norton, and Albrecht P. Barsis in 1965 [8]. (This technical note is one of a series of nine, each of which is based on a chapter of the U.S. Air Force Manual of Standards for Tropospheric Communication Circuits Handbook, "*Tropospheric Performance Standards for the U.S. Air Force*," a classified document (FY 1961) prepared for the U.S. Air Force by the CRPL Radio Propagation Engineering Division.)<sup>10</sup>

Volume I presents a detailed and comprehensive compilation of the many aspects of tropospheric propagation studied by the staff of the CRPL Radio Propagation Engineering Division that affect transmission loss. These are covered in 10 chapters, most of which include several subdivisions.

Volume II consists of five annexes, each of which includes several subdivisions. For most computations both a graphical method and formulas suitable for a digital computer are presented.

---

<sup>10</sup> The nine *Technical Notes*, with authors, titles, and dates issued, are:

*TN95*, R. S. Kirby, P. L. Rice, and L. J. Maloney, Characteristics of Point-to-Point Tropospheric Propagation and Siting Considerations, Oct. 1961.

*TN96*, E. J. Dutton, On the Climatology of Ground-based Radio Ducts and Associated Fading Regions, June 1961.

*TN97*, E. J. Dutton and G. D. Thayer, Techniques for Computing Refraction of Radio Waves in the Troposphere, Oct. 1961.

*TN98*, B. R. Bean, J. D. Horn, and L. P. Riggs, Synoptic Radio Meteorology, Oct. 1962.

*TN99*, R. E. McGavin, A Survey of the Techniques for Measuring the Radio Refractive Index, May 1962.

*TN100*, E. F. Florman and J. J. Tary, Required Signal-to-Noise Ratios, RF Signal Power, and Bandwidth for Multichannel Radio Communications Systems, Jan. 1962.

*TN101*, P. L. Rice, A. G. Longley, K. A. Norton, and A. P. Barsis, Transmission Loss Predictions for Tropospheric Communication Circuits—Volumes I & II, Mar. 1965.

*TN102*, A. P. Barsis, K. A. Norton, P. L. Rice, and P. H. Elder, Performance Predictions for Single Tropospheric Communication Links in Tandem, Aug. 1961.

*TN103*, A. F. Barghausen, F. O. Guiraud, R. E. McGavin, S. Murahata and R. W. Wilber, Equipment Characteristics and Their Relation to System Performance for Tropospheric Communication Circuits, Jan. 1963.

Several of these *Technical Notes* were used to supplement lectures on these subjects included in the NBS Courses in Radio Propagation, given in the summers of 1961 and 1962 (ch. XVIII).

## ANGULAR DISTANCE

A parameter described by the term "angular distance" was introduced by Norton at the West Coast Annual Meeting of the Institute of Radio Engineers at San Francisco, Calif., in August, 1953 [9]. Angular distance, designated by the Greek letter  $\theta$ , was defined as the angle between the horizon rays in the great circle plane from the transmitting and receiving antennas as determined for a radio standard atmosphere, i.e., with an effective radius of the earth  $4/3$  of its actual value. Expressed more directly, over a smooth spherical earth the angular distance is equal to the distance between the radio horizons of the transmitting and receiving antennas divided by the effective radius of the earth. The actual radius of the earth was taken as 3960 miles (6373 km), so that for determining angular distance, the effective radius ( $4/3$  actual value) was 5280 miles (8417 km). Angular distance is expressed in milliradians.

The angular distance,  $\theta$ , is positive for receiving antennas below the horizon ray from the transmitting antenna (line-of-sight, or within the horizon), is equal to zero for receiving antennas on the horizon ray, and is negative for receiving antennas above the horizon ray (beyond the horizon).

In 1959, Bradford R. Bean and Gordon D. Thayer reported that an exponential decrease with height appeared to be more representative of the true structure of the atmosphere and yielded more reliable estimates of refraction effects than the linear decrease assumed by the effective Earth's radius theory. They also developed a model of atmospheric radio refractivity, designated as the "CRPL Exponential Atmosphere," which was applicable for long-range transmission paths, forward-scatter predictions, or radar tracking at high altitudes (see sec. 3c, p. 521).

## RADIO METEOROLOGY

### 1. Introduction

Meteorological research is basic to all tropospheric propagation studies, and its importance has been noted earlier in this chapter (p. 512). Radio meteorology was centered in the Tropospheric Propagation Research Section of CRPL until the organization of the Boulder Laboratories. A section, Radio Meteorology, was then formed in the CRPL Radio Propagation Engineering Division of the Boulder Laboratories. A comprehensive report, entitled Radio Meteorology (423 pp.), was published as *NBS Monograph 92*, by Bean and Evan J. Dutton [10].

### 2. The radio refractive index

#### a) ITS IMPORTANCE

The significance of the refractive index of the atmosphere in the study of tropospheric propagation was emphasized in the First Annual Report of CRPL (1947) which stated that:

index of refraction values are basic to the study of atmospheric refraction of radio waves in the troposphere. They are usually calculated from the measured values of temperature, pressure, and humidity, . . .

The index of refraction is expressed by an equation which relates these values and experimentally determined constants. Ernest K. Smith, Jr., and Stanley Weintraub made a study of the constants and, on the basis of their work and the work of others making use of improved techniques in microwave measurements, concluded that the values of the constants should be revised. Through consideration of these various experiments they arrived at an equation considered good to 0.5 percent in the refractive index of air for frequencies up to 30,000 MHz and normally encountered ranges of temperature, pressure,

and humidity [11].<sup>11</sup> This equation and its terminology have become standards for use in radio refractive index studies and are referred to frequently in this chapter.

#### b) DEVICES FOR SIMPLIFYING SOLUTION OF THE EQUATION FOR RADIO REFRACTIVE INDEX

Computation with such a complex equation can be quite cumbersome and time-consuming, especially when a large number of observations such as might be made over an extended period of time need to be reduced. Several devices were designed in CRPL for simplifying the operation.<sup>12</sup>

One, developed by Weintraub, utilized two slide rules for computing refractive index from temperature, pressure, and humidity data [12]. The method attained good precision with relative ease of calculation.

Another was an analogue computer devised by Walter E. Johnson, with dials for introducing the variables of the equation, and giving a direct reading of the refractive index [13]. Average operational time for a computation was reduced to approximately 10 seconds. The comment was made in *NBS Technical Note 26* (Sept. 1959), Abstract No. 130, that the computer was in use at CRPL and had superseded other methods of calculating the radio refractive index.

#### c) THE MICROWAVE REFRACTOMETER

One of the most useful and far-reaching instruments to come from CRPL was the recording microwave refractometer [14].<sup>13</sup> It was developed originally by George Birnbaum of the Microwave Standards Section for measuring dielectric constants of gases, liquids, and solids, in turn, as part of the program in microwave spectroscopy. However, it was soon adapted for direct measurement of the refractive index of the atmosphere.

Initial experiments for observing fluctuations in atmospheric refractive index were conducted by Birnbaum and associates in late 1950 with the refractometer mounted on the roof of an NBS building in Washington, D.C. [15]. Birnbaum, Bussey, and Richard R. Larson next made observations in August 1951 with refractometers and meteorological equipment installed on two levels of a 420-foot (128-m) tower at the Brookhaven National Laboratory, Long Island, N.Y. [16]. (See sec. d, below.) Later, Bussey and Birnbaum used the refractometer as an airborne instrument (with modifications for mounting on the aircraft) in a flight over Chesapeake Bay [17]. Observations were made at heights up to 10,000 feet (3048 m) and, when flying through cumulus clouds, they noticed increases of refractive index on entering the clouds and intense fluctuations within the clouds.

After the Cheyenne Mountain experiment in Colorado became operational in the Tropospheric Propagation Research Section (see pp. 525-533), a need arose for refractometers to measure radio refractive index at the receiving locations. A contract was awarded to the Denver Research Institute for two instruments to be used on a 500-foot (152-m) meteorological tower which was constructed at Haswell, Colo., in 1952-53.<sup>14</sup>

---

<sup>11</sup> The Smith-Weintraub equation is

$$N = (n-1)10^6 = \frac{77.6}{T} (p + 4810 \frac{e}{T})$$

in which

- N = refractivity of air
- n = refractive index of air
- T = absolute temperature = °C + 273
- p = partial pressure of water vapor in millibars
- e = total air pressure in millibars.

<sup>12</sup> The devices given here are also described in chapter XIII, p. 588, under the heading "a) Computation of the refractive index of the atmosphere."

<sup>13</sup> This instrument is described in chapter X (p. 389, footnote 89), but the description bears repeating here:

a sweep frequency generator provides resonant responses in two similar cavities, one the reference cavity, the other the test cavity. A frequency difference between the two cavities when a gas was introduced into the test cavity provided a measurement of the dielectric constant of the gas.

<sup>14</sup> Haswell was 96 miles (154 km), and at ground level just beyond radio line-of-sight, from the summit transmitter on Cheyenne Mountain; the top of the 500-foot (152-m) tower was within the radio line-of-sight.

In the meantime, research continued in efforts to build an improved instrument, supported in part by the U.S. Air Force and the U.S. Army Electronic Proving Ground at Fort Huachuca, Ariz. In 1956 Moody C. Thompson, Jr., and Maurice J. Vetter designed a modified Birnbaum refractometer for operation in a small aircraft whose flight characteristics such as maneuverability and lower air speeds were often desirable [18].<sup>15</sup> Space, weight, and power requirements were prime considerations, but improved instrument performance was also obtained.

Among problems connected with microwave refractometers were slight variations in volume of the metallic cavities caused by thermal change of dimensions. These in turn produced variations in resonance frequencies which affected the measured values of refractive index. Experiments with ceramic cavities coated with an electrically conducting material resulted in cavities having expansion coefficients very close to zero over limited temperature ranges. Hence the resonance frequencies could be held constant despite temperature variations [19].<sup>16</sup>

Vetter and Thompson later developed a refractometer which they termed "absolute" and in which considerable improvement in calibration stability and simplicity of operation were obtained over earlier instruments [20].<sup>17,18</sup>

In 1962, the first of a new generation of microwave refractometers was constructed by CRPL.<sup>19</sup> The essentially different feature of this instrument was that it eliminated the second cavity, making use of a single cavity for the measurements.<sup>20,21</sup>

Further improvements in microwave refractometers were made after CRPL was transferred from NBS to the Environmental Science Services Administration in 1965, but they can only be mentioned here as the program was no longer an NBS project (see ch. XX).

#### d) REFRACTIVE INDEX INHOMOGENEITIES

An extensive series of observations was obtained by Birnbaum, Bussey, and Larson with two refractometers and meteorological equipment installed on various levels of a 125-m (410-foot) tower of the Brookhaven National Laboratory, Long Island, N.Y. [21]. One of the refractometers was equipped with a multiple-cavity unit for the study of correlation between two positions in the horizontal direction.

The amplitudes of the refractive index variations were correlated with various meteorological conditions. From the experimentally determined cross-correlation coefficient, and assuming that its variation with distance is given by the exponential form (the so-called Taylor exponent), scales (mean eddy size) in the neighborhood of 60 m (197 feet) were obtained. This result seemed to agree generally with values reported from aircraft observations and stellar scintillations.

A detailed investigation of the errors arising from ventilation of the cavity and its exposure to the atmosphere indicated that these (cavities) had been made sufficiently small

---

<sup>15</sup> Designed specifically for the L-20 "Beaver," a light, single-engine plane then used by the U.S. Army.

<sup>16</sup> Moody C. Thompson, Jr., Frank E. Freathy, and Donald M. Waters filed for a patent on Dec. 15, 1958. Patent 2,981,908 was issued Apr. 25, 1961, entitled "Cavity resonator."

<sup>17</sup> The term "absolute" was used because the measurement is made by comparing the refractive index of the sample with the refractive index of a vacuum, which by definition is unity. The comparison is made in terms of frequency, and the calibration is made through the use of frequency standards. A precisely calibrated reference cavity is made to track the frequency changes of the sampling cavity by means of a tuning probe and servo-mechanism.

<sup>18</sup> The probe was the subject of a patent for which Maurice J. Vetter filed on May 10, 1962. Patent 3,158,825 was issued on Nov. 24, 1964, entitled "Movable resonant cavity tuning probe in dielectric sleeve having nonuniform outer surface."

<sup>19</sup> This was built for Bell Laboratories, the first microwave refractometer built for a non-government laboratory (another first for the CRPL microwave refractometer program).

<sup>20</sup> This was accomplished by placing a sample of gas in a multi-mode resonant cavity operating simultaneously in a fundamental and a harmonic mode, and then measuring the difference between the output signals obtained at each of the two modes.

<sup>21</sup> Moody C. Thompson, Jr., and Maurice J. Vetter filed for a patent on May 13, 1965. Patent 3,400,330 was issued Sept. 30, 1968, entitled "Refractometer that measures the difference in refractive indices of a gas at two frequencies." The application was filed shortly before CRPL was transferred to the Environmental Science Services Administration, and it was several years later that the patent was issued.

so that the refractometer accurately measured variations in atmospheric refractive index. With simultaneous measurement of temperature, fast variations of water vapor density could be determined.

### 3. Atmospheric bending of radio waves

#### a) ATMOSPHERIC DUCTS

An atmospheric duct is defined as occurring when a radio ray originating at the Earth's surface is sufficiently refracted during its upward passage through the atmosphere that it either is bent back toward the Earth's surface or travels in a path parallel to the Earth's surface. It was noted by early research workers in tropospheric propagation that the seasonal cycle of VHF radio field strengths recorded far beyond the normal radio horizon was highly coordinated with the refractive index. Further examination by Bradford R. Bean of CRPL, and by scientists in Japan, showed that the correlation was about 0.9 when both variables were taken on a monthly mean basis, but decreased rapidly for shorter mean periods [22].<sup>22</sup>

As noted earlier, the radio refractive index of air ( $n$ ) is a function of atmospheric pressure, temperature, and humidity, and may be expressed more conveniently by the term, refractivity ( $N$ ), according to the Smith-Weintraub equation (see p. 517 and footnote 11). Bean noted a systematic dependence of refractivity upon station elevation and concluded that it would be necessary to consider a method of expressing refractivity in terms of an equivalent sea-level value, in order to understand more clearly the actual climatic differences of the various parts of the world. Three of the normal meteorological elements used to specify climate are thereby combined into one parameter, not an easy task when hundreds of observations must be analyzed [23].<sup>23</sup>

Using weather records from the National Weather Records Center in Asheville, N.C., he carried out a systematic study of the variability of the radio refractive index during different seasons of the year and in differing climatic regions. For this purpose, 3 to 5 years of radiosonde data typical of a tropical, temperate, and arctic climate were analyzed. The tropical location was Swan Island, West Indies (a tropical maritime climate); the temperate location, Washington, D.C.; and the arctic location, Fairbanks, Alaska. The data from four months of each year, February, May, August, and November, were examined by means of a digital computer for the occurrence of ducts.

Annual maximums of radio refractive index were observed in the winter for the arctic and in the summer for the tropics. The maximum observed incidence of ducts was determined as 13 percent in the tropics, 10 percent in the arctic, and 5 percent in the temperate zone. The arctic ducts arise from ground-based temperature inversions with the ground temperature less than  $-25^{\circ}\text{C}$  while the tropical ducts are observed to occur with slight temperature and humidity time lapse when the surface temperature is  $30^{\circ}\text{C}$  and greater. In the temperate climate, the ducts are associated with the common radiation inversion and accompanying humidity lapse.

The maximum thickness of observed limiting layers is such as to trap radio waves with frequencies greater than about 500 MHz at all locations for at least 50 percent of the observed ducts.

---

<sup>22</sup> Bradford R. Bean was awarded the Department of Commerce Silver Medal for Meritorious Service on Feb. 14, 1963. Bean was recognized

for outstanding contributions and leadership in the field of radio wave refraction.

<sup>23</sup> Prompted by reports in the literature of possible errors in the value of refractivity arising from lag of the sensing elements of radiosondes, Bean and Dutton made a study of the time lag of the temperature and humidity sensors on the computed values of refractivity [23]. Their study indicated that a correction to the humidity reading alone is insufficient; a correction to the temperature reading is also necessary. This latter correction yields a twofold correction to the value of refractivity due to the actual error in temperature and a correction to vapor pressure resulting from the more correct estimate of the true saturation vapor pressure (which is a function of temperature). They pointed out that ignoring sensor time lag tends to underestimate ducting incidence; correcting only for humidity sensor lag tends to overestimate ducting incidence. Thus they concluded that if studies of refractive index profile are to include sensor lag correction, allowance should be made for both temperature and humidity lags, regardless of climate.

## b) RADIO REFRACTIVE INDEX DATA CENTER

Because of a rapid increase in the amount of research effort on the utilization of standard weather observations for radio propagation studies, a meeting of government agencies engaged in radioclimatology was held at the NBS Boulder Laboratories on January 15, 1958 [24]. The data obtained from such research are basic to any radio meteorological or radioclimatological study.

Agenda for the meeting included: Non-overlapping geographic coverage in climatological calculations; uniform calculations of basic parameters and presentation of data; and free exchange of data between groups, or the establishment of a central data pool.

It was decided that an immediate listing should be made of past data that were then available for general use, and that the most workable method was for each group to submit a listing of their data to the Radio Meteorology Section of the CRPL Radio Propagation Engineering Division. CRPL then would compile the individual lists and issue a report on all available data. Future data would be recorded in the same fashion. Since the National Weather Records Center (NWRC) did not keep the punched cards with the calculated values of refractivity beyond 6 months, it was agreed to request that all such cards be sent to CRPL.

It was further recommended that minimum calculations necessary to define the climatology of a station would be 5 years of daily observations during the months of February, May, August, and November.

This meeting marked the beginning of the Radio Refractive Index Data Center at NBS. By 1961, the Center had recorded and referenced data on more than 7,000,000 punched cards. These data were being received from more than 300 stations in the United States and in South Africa, Antarctica, Saudi Arabia, Cyprus, Germany, Greenland, Japan, Korea, Morocco, Newfoundland, the Panama Canal Zone, Tripoli, and from weather ships stationed in the Atlantic and Pacific Oceans [25].

The goal of the Center was to collect sufficient data to survey and plot radio refractive index profiles for the atmosphere of the entire Earth.

The ready accessibility of this information from a central source simplified the computations required, for example, in evaluating missile tracking (p. 545) and guidance systems, in establishing error corrections for height-finding radars, in predicting transmission loss in tropospheric propagation studies (see p. 516), and in estimating radio-wave field strengths for many types of radio propagation.

Note: As a useful working tool the Radio Refractive Index Data Center essentially has ceased to exist. Information of this nature can be obtained from other sources.

## c) CRPL EXPONENTIAL REFERENCE ATMOSPHERE

Studies of atmospheric refraction of radio waves have shown that an exponential decrease of refractive index with height is more representative of the true structure and yields more reliable estimates of refraction effects than the linear decrease assumed by the effective Earth's radius theory.

As a result, various exponential models of atmospheric radio refractivity were introduced to replace the standard 4/3 Earth treatment for applications involving long-range transmission paths, forward scatter predictions, or radar tracking at high altitudes. One of these models, developed at CRPL and called "CRPL Exponential Reference Atmosphere," was adopted for use by the National Bureau of Standards in predictions of refraction phenomena [26].

Bean and Gordon D. Thayer found that the rate of exponential decrease with height may be specified by surface conditions alone. As a result, surface value of refractivity at the transmitting point was specified as the basic predictor of refraction effects as used in the exponential reference atmosphere.

Several important advantages accrue from this particular choice of model, among which are:

- (1) The profiles involved proved to be a fairly good representation of the average refractive index structure over the first 3 km above the surface, a critical range for refraction effects at low angles to the horizon.

(2) The resulting relationship between the gradient of refractivity near the surface and surface refractivity is found to be very close to the observed average relationship (for 5-yr mean profiles), being within  $\pm 3$  percent over the normally encountered range of surface refractivity. This agreement is a requirement for the successful prediction of average refraction effects at elevation angles close to the horizontal.

(3) The resulting profiles and their associated gradients are continuous functions of height and are in reasonably good agreement with the actual observed refractivity at all heights at frequencies sufficiently high so that the refractivity is not influenced by the ionization in the ionosphere.

#### **d) REFRACTION OF RADIO WAVES AT LOW ANGLES WITHIN VARIOUS AIR MASSES**

The refractive-index structure and bending of radio rays within air masses of non-exponential refractive-index-height structure were treated by Bean, James D. Horn, and Lowell P. Riggs in terms of the value expected in an average atmosphere of exponential form [27]. They demonstrated that refraction differences within air masses arise from departures of refractive-index structure from the normal exponential decrease with height. The effect upon radio-ray refraction of these departures from the normal exponential refractive-index structure is most pronounced for small initial angles of the radio ray.

The work of Schulkin (see p. 513) and others has shown that characteristic total bending differences in radio-ray refraction exist between various air masses. This study extended Schulkin's conclusion by identifying abnormal bending of radio rays with departures of refractive-index structure from average in the lowermost layers of the air masses. Consideration of departure of both ray bending and refractive-index structure from their value in a standard exponential atmosphere results in a suitable method of cataloging air masses in terms of either refractive-index structure or bending characteristics. In making their analysis they made use of values derived from an examination of nearly 2,000,000 individual observations of refractivity at the Earth's surface from all parts of the United States.

#### **e) REFRACTION IN AN EXPONENTIAL ATMOSPHERE**

A formula was derived by Thayer for the radio-ray-refractive angle by integration of the approximate differential equation for the case where the refractivity decreases exponentially with height above the surface of a smooth, spherical Earth [28].

The solution represented a relatively accurate and concise formulation for the ray bending in an exponential atmosphere. It has the advantage of being in terms of well-tabulated functions which can be easily programmed on digital or analogue computers. When the accuracy of the formula was checked against published results obtained by the CRPL Exponential Reference Atmosphere (see sec. c, p. 521), the largest errors found were about 4 percent, and these were for a profile with a very strong refractivity gradient.

#### **f) GRAPHICAL DETERMINATION OF RADIO RAY BENDING**

A simple engineering method for calculating the amount of bending undergone by a radio ray passing through an exponential atmosphere was devised by Carol F. Pappas, Lewis E. Vogler, and Rice [29]. The amount of bending is measured by the refraction angle and is important in such problems as the accurate determination by radar of the range and height of flying objects, the location of extraterrestrial radio noise sources in radio astronomy, and the analysis of radio communication systems.

This refraction angle may be expressed in an integral form, the solution of which is quite complicated for hand calculation. A numerical integration method has been used by coworkers, but the method is only practical through the use of a large-scale computer.

In some cases (when the initial take-off angle is large), the refraction angle may be calculated by a formula which is quite simple and accurate. However, in other cases (where the initial take-off angle is small), this engineering method was developed to provide a quick and practical means to obtain the refraction angle. The method made use of a few graphs and a few calculations, and gave values of the refraction angle which compared quite well with values of the CRPL Exponential Reference Atmosphere.



#### **g) CORRELATION OF MONTHLY MEDIAN TRANSMISSION LOSS AND REFRACTIVE INDEX PROFILES**

A comparison of transmission losses at 100 MHz recorded over 21 paths with various refractivity-gradient differences from the surface to 3 km revealed that the surface value of the refractive index yields as good a correlation as any of the refractive index differences due to the high correlation between the surface values and these differences; therefore the more accessible surface values can be effectively substituted for the differences [30].

The radio data used in this study by Bean and Burgette A. Cahoon were the 100-MHz monthly mean transmission losses for 21 transmission paths in the continental United States. These data represented climatic conditions ranging from those of New England to the central and southeastern seaboard, the Gulf States, the Great Lakes, the high plains, and the Pacific coast. Although the study encompassed only a small portion of the United States, several of the more important climates of the World are represented by the 21 paths. It is considered likely that the general pattern of the mean profile of a climatic area would repeat itself, regardless of its location on the Earth's surface.

Correlations of transmission loss recorded for one year versus that recorded in another year for the same radio path followed the same order as those obtained from meteorological data alone. The very practical result—inexpensive meteorological data may be used to predict the seasonal variation of radio fields as accurately as expensive radio-path measurements.

### **4. Climatology**

#### **a) CLIMATIC VARIATION OF ABSOLUTE HUMIDITY**

Bean and Cahoon prepared maps to show the variation of absolute humidity over the United States for the values exceeded, 1, 50, and 99 percent of the time during the months of February and August [31].

It was emphasized that the contours on these maps were derived by linear interpolation between station points and thus were not modified to terrain variations. An example of such a modification would be an increase in gradient to the west of the Pacific coastal mountain ranges with a resultant decrease in gradient east of the ranges.

The characteristics of the distribution of absolute humidity were examined for nine climatically diverse stations. These distributions were obtained from the daily observations of absolute humidity at the local times corresponding to 0300 and 1500 G.m.t. during the months of February, May, August, and November, 1951 and 1952. Thus, each of these cumulated distributions represents 120 samples of absolute humidity for each month.

In addition, regression equations were derived to enable one to estimate the values of absolute humidity exceeded 1 and 99 percent of the time at any location for which average values are available.

#### **b) STUDIES OF A CONTINENTAL POLAR AIR MASS**

The synoptic variation of the atmospheric radio refractive index, evaluated from standard weather observations, was examined during an outbreak of polar continental air [32]. It was found that the reduced-to-sea-level value of the refractive index was quite sensitive to the humidity and density structure of the storm under study while the station elevation dependence of the station value tended to mask synoptic changes. The reduced-to-sea-level value changed systematically with the approach and passage of the polar front. The storm system showed a consistent increase of the reduced value in the warm sector of the wave and a marked decrease behind the cold front.

Thus, if the refractivity is reduced to sea level, the refractive index is a sensitive indicator of large-scale weather systems when considered on a daily weather-map basis.

This work was extended by considering if the air mass properties associated with a typical winter-time outbreak of polar air were reflected in the refractive-index structure [33].

#### **c) WORLDWIDE CLIMATOLOGY**

A study of the radio-refractive-index climatology on a worldwide basis was made by Bean, Horn, and Anton M. Ozanich, Jr., with the assistance of other members of the Radio

Meteorology Section [34]. Data were obtained from 306 weather stations, worldwide, in order to give reasonable geographic coverage, using the United Nations monthly publication, "*Climatic Data of the World*." In general, 5 years of records were obtained for each station for the period 1949 through 1958, preference being given to the year's 1954 through 1958.<sup>24</sup> Because no meteorological observing stations existed for the oceans, estimates of temperature and humidity were made from available atlases, and pressure from average winter and summer pressure charts.<sup>25</sup>

The climatic data were calculated to values of refractivity from the Smith-Weintraub equation, using the analog computer designed by Johnson.<sup>26</sup> Surface values of refractivity were evaluated from surface weather observations at each station, and these values were then reduced to sea-level refractivity. It was found that comparisons could be more readily made and with four to five times greater accuracy when sea-level values were used.

Although the study was aimed primarily toward worldwide variations, the U.S. data better illustrated the height dependence of surface refractivity. It was noted that the coastal areas displayed high values, while the inland areas had lower values. There were low values corresponding to the Appalachian and Adirondack Mountains, a decrease with increasing elevation of the Great Plains until the lowest values were observed in the Rocky Mountain region and the high plateau area of Nevada. A corresponding gradient was observed from the West coast eastward.

A detailed analysis of the altitude dependence of refractivity was made in terms of the "dry" and "wet" components, and an exponential equation was derived for determining sea-level values.<sup>27</sup>

Mean sea-level values were calculated at each of the 306 selected stations, and charts were prepared for each month of the year. Comparison of these monthly charts showed definite trends for various terrain features such as maritime coastal areas, deserts and high plateaus, and mountain chains. Such pronounced climatic details as Indian monsoons were also indicated. The annual variation was indicated by differences between the maximum and minimum monthly means, and it was noticeable how clearly climatic differences were evidenced. For example, relatively small annual ranges were observed over the west coasts of North America and Europe, where there is a prevailing transport of moist maritime air inland. The largest annual ranges were observed in the Sudan of Africa and in connection with the Indian monsoons.

The annual cycle of sea-level values of refractivity at each station was examined for the purpose of deriving similarities of climatic pattern. As one form of climatic classification, the annual mean value at each station was plotted versus the annual range at the station. When this was done, several distinct groupings of data seemed evident. These groupings are as follows: Type I, midlatitude-coastal; type II, subtropical-savanna; type III, monsoon-Sudan; type IV, semiarid-mountain; type V, continental-polar; and type VI, isothermal-equatorial.<sup>28</sup>

---

<sup>24</sup> Only 1 year of data (IGY) was available for Russia, reported in the United Nations monthly publication, "*Climatic Data of the World*."

<sup>25</sup> Temperature was estimated from sea surface isotherms found in the "*World Atlas of Sea-Surface Temperatures*," a publication of the U.S. Navy Hydrographic Office. Humidity was estimated from charts of seasonal average depression of the wet-bulb temperature in the "*Atlas of Climatic Charts of the Oceans*," a publication of the U.S. Weather Bureau.

<sup>26</sup> See footnote 11 for the Smith-Weintraub equation and p. 518 for a description of the Johnson analog computer.

<sup>27</sup> The simplified equation is

$$N_0 = (D_s + W_s) \exp. (0.1057 h)$$

where  $N_0$  is the sea-level value of refractivity,  $D_s$  and  $W_s$  represent the surface values of the "dry" and "wet" components, obtained from equations relating temperature, pressure, and humidity and from contour maps of these values; and where  $h$  is the station height in kilometers.

<sup>28</sup> The location, characteristics, and a typical station of each type are given here.

Type I—Midlatitude—coastal.

Near the coast or in lowlands on lakes and rivers, in latitude belts between 20° and 50°. Generally marine or modified marine climate—Washington, D.C.

It was concluded from this study that: (1) The radio refractive index varies in a systematic fashion with climate, and different climates may be identified by the range and mean values of the refractive index. (2) It is four or five times more accurate to estimate the station value of the index from charts of the reduced-to-sea-level value. This improved accuracy results from using a method that allows height dependence to be accurately taken into account. (3) Identically equipped tropospheric communications might be expected to vary as much as 30 decibels in monthly mean signal level in different climatic regions, and the annual range of monthly mean field strength could be as high as 20 decibels in the Sudan of Africa and as low as 0 to 6 decibels in the high plains of the western United States.

## THE CHEYENNE MOUNTAIN EXPERIMENTS

### 1. Background and preliminary preparations

Operations in Colorado began with tropospheric propagation experiments from Cheyenne Mountain, near Colorado Springs, in June 1950, almost a year before the first CRPL employees arrived in Boulder to begin setting up the CRPL units of the NBS Boulder Laboratories.

The Cheyenne Mountain project was an extension of air-to-ground and air-to-air studies which were already underway by CRPL at Washington, D.C. In August 1949, CRPL proposed to the Radio Propagation Executive Council "a coordinated program of research at tropospheric frequencies to determine air-to-ground and air-to-air propagation characteristics." In the following month, the agencies interested in the program (Air Force, Army, Navy, and CRPL) reached agreement on a course of action on various phases of the program.

In effect, this would extend the frequency range of approximately 100 to 1000 MHz of an existing CRPL research program on the measurement of air-to-ground and air-to-air propagation. The extended frequency range would be in a band 1000 to 3000 MHz. Two closely related projects were carried out concurrently and, essentially, by the same personnel—Propagation Experiments at Cheyenne Mountain, 100 to 1000 MHz, sponsored by NBS; and Propagation Experiments at Cheyenne Mountain, 1000 to 3000 MHz (and more specifically, 960 to 1000 MHz for an air navigation and traffic control system) sponsored by the Air Navigation Development Board (ANDB).

The Quarterly Report of CRPL for the period October-December 1949 stated that the initial effort in the ANDB program would be to conduct a series of field-intensity studies using a high-powered continuous-wave transmitter located on a mountain site to simulate low-angle air-to-ground conditions.

---

(Continued)

Type II—Subtropical-savanna

Lowland stations between 30°N and 25°S latitude, rarely far from the oceans. Definite rainy and dry seasons, typical of savanna climate—Miami, Fla.

Type III—Monsoon-Sudan

Monsoon, generally between 20° and 40°N latitude; Sudan, across central Africa from 10° to 20°S latitude. Seasonal extremes of rainfall and temperature—Jodhpur, India.

Type IV—Semiarid-mountain

In desert and high steppe regions as well as mountainous regions above 3000 ft (914.4 m). Year-round dry climate—Denver, Colo.

Type V—Continental-Polar

In middle latitudes and polar regions. (Mediterranean climates are included because of the low range resulting from characteristic dry summers.)—Oslo, Norway.

Type VI—Isothermal-equatorial

Tropical stations at low elevations between 20°N and 20°S latitude, almost exclusively along seacoasts or on islands. Monotonous rainy climates—Canton Island, South Pacific Ocean.

Note that for a given classification of refractive-index climate, diverse meteorological climates and geographical regions may be represented.

Experimental locations in the Denver-Colorado Springs area of Colorado were inspected and a suitable location at Colorado Springs (Cheyenne Mountain) was selected [35]. Cheyenne Mountain rises abruptly from the plains to a height of approximately 2800 feet (853 m) above the plains, approximately 6000 feet (1829 m) above sea level. The shear face of the mountain provided a location closely approaching an airborne transmitter. Two transmitter sites were selected on the mountain (see sec. 2. below), both of which were available by an all-season motor road.



*Antenna tower at "base site," Cheyenne Mountain. Colorado Springs is in the center background and the plains extend to the horizon and beyond.*

The program progressed rapidly and by March 1950 a lease had been negotiated for temporary quarters to house the transmitter in the Cheyenne Mountain Lodge, located at the summit of the mountain. An office was established in downtown Colorado Springs in June and by December construction work had been completed except for an 80-foot (24-m) tower at the base site (see sec. 2. below). A test of the transmitter gave detectable signals at a distance of 150 miles (241 km) from the tower of the summit site.



*Transmitting and receiving facilities of the Cheyenne Mountain experiments. High power VHF and UHF transmissions originating on Cheyenne Mountain and Pikes Peak were received at monitoring stations both within and far beyond the radio horizon to determine the effects of the terrain and the atmosphere on radio propagation. Characteristics of VHF and UHF for air-to-ground and ground-to-ground navigation, communications, and guidance systems were studied. Some of the earliest tropospheric forward scatter research was carried out with these facilities.*

George R. Chambers was the first member of the CRPL staff transferred from Washington, D.C. to Colorado. Pioneering work with the Cheyenne Mountain program was acknowledged in two early reports on the project. The first, an internal NBS report (not circulated outside NBS) by Chambers, Herbstreit, and Norton dated July 23, 1952, cited the contribution of James H. Chisholm, another early member of the Cheyenne Mountain program:

Special mention should be made of the extensive contribution of J. H. Chisholm to this project. Mr. Chisholm was responsible for most of the details of planning connected with the choice of transmitting and receiving sites and the choice and design of the 1000-Mc transmitting and receiving equipment; he was the leader of the group responsible for the procurement, installation, and operation of the 1000-Mc system and remained with the project through November 1951, at which time preliminary observations had been made at 1000 Mc to distances of several hundred miles.

Chambers and Chisholm were both recognized in the second of these, a published report, *NBS Circular 554* (referenced above).<sup>29</sup>

The early contributions to the Cheyenne Mountain project by G. R. Chambers and J. H. Chisholm, both of whom have now left the National

<sup>29</sup> When the Cheyenne Mountain projects became operational, Kenneth O. Hornberg was assigned the position of engineer-in-charge. Professional personnel associated with the projects over a period of several years and who later had extensive service with CRPL in Boulder included: Alfred F. Barghausen, Albrecht P. Barsis, Martin T. Decker, Arthur J. Estin, Robert W. Hubbard, Harris B. Janes, Raymond E. McGavin, Charles J. Roubique, Moody C. Thompson, Jr., and Paul I. Wells.

The Cheyenne Mountain projects were directed by Jack W. Herbstreit, Chief of the Tropospheric Propagation Section.

Bureau of Standards, are acknowledged. They were largely responsible for the design, procurement, and installation of the major items of equipment in current use.

## 2. Transmitter locations

Transmissions only were made from Cheyenne Mountain and from two additional nearby sites: At Fort Carson on the plains near the base of the mountain, and at the summit of Pikes Peak, a short unobstructed distance to the west.

The Cheyenne Mountain transmitters were placed near the summit (designated the "summit site"), approximately 8700 feet (2652 m) above sea level, and at a point about half-way up the mountain ("base site"), approximately 7500 feet (2286 m) above sea level. The Fort Carson transmitter was 6200 feet (1890 m) and the summit of Pikes Peak is 14,110 feet (4300 m) above sea level. The Pikes Peak installation was available only during the summer months when the road was open; all the others could be used year-round.

Transmissions were made in the 100- and 200-MHz ranges (VHF) from both summit and base sites, and at 1046 MHz (UHF) from the summit. Later experiments included a number of additional frequencies for specialized investigations.

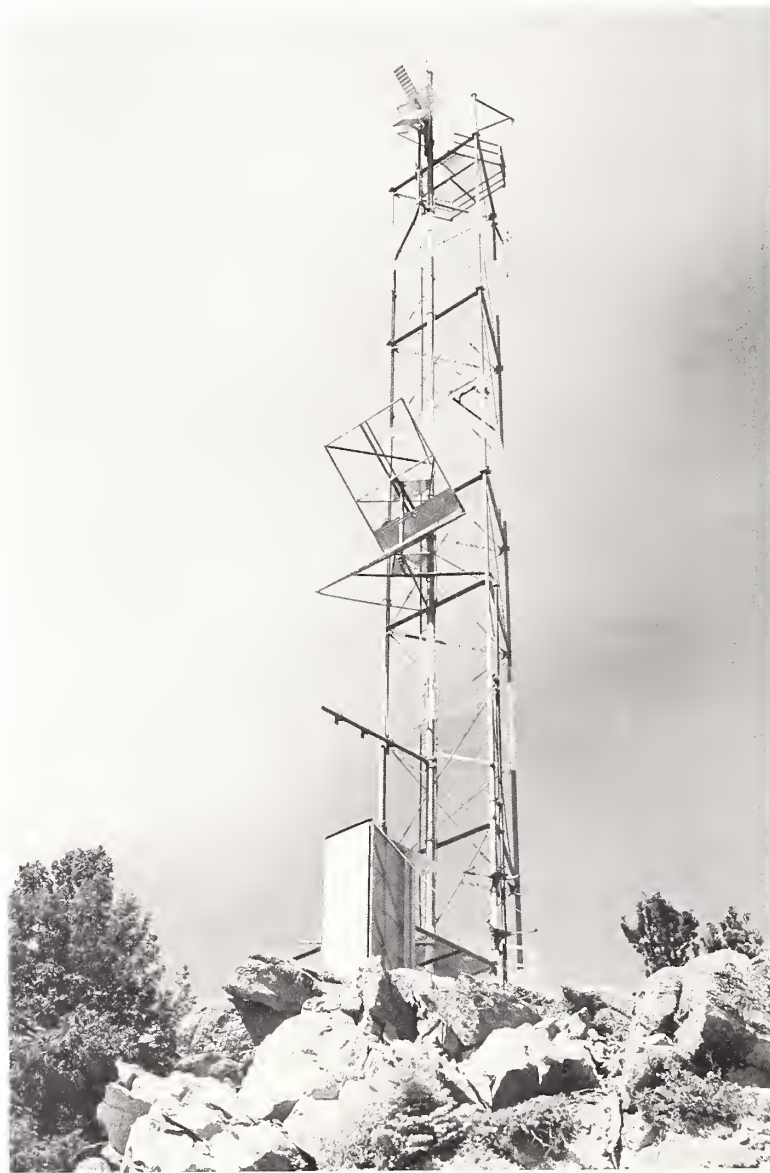

*Transmitting antennas on tower at "summit site," Cheyenne Mountain.*



*Lower section of antenna tower at "summit site," Cheyenne Mountain. Also, visible are antennas installed later for additional research projects.*



*Closeup view of antenna tower at "base site," Cheyenne Mountain, showing details of the 92-MHz and 210.4-MHz (later modified to 236 MHz) transmitting antennas. The structure housing the transmitters is at the left.*

### 3. Receiving locations

Receiving facilities were installed at six fixed and semi-mobile sites in the plains of eastern Colorado, western Kansas, and in Arkansas. These sites were chosen along a radial of about 105 degrees east of true north from the transmitters. The 105-degree direction roughly intersects the Arkansas River Valley in eastern Colorado and western Kansas. This alignment was chosen to permit similar orientation of all transmitting antennas to produce maximum usable power at all receiving sites.

Four fixed receiving sites were at Kendrick (49.3 miles, 79 km from the summit transmitter), Karval (70.2 miles, 113 km), Haswell (96.6 miles, 155 km), all in Colorado, and Garden City, Kans. (226.5 miles, 364 km). Continuous recordings of these stations were made on frequencies of 100 and 192.8 MHz beginning in early March 1952. Semi-mobile installations were at Anthony, Kans. (393.5 miles, 633 km) and Fayetteville, Ark. (617.7 miles, 994 km). Short-term recordings were obtained at these distant stations in February 1952. The 1046-MHz transmission was recorded at the four fixed sites beginning late in March 1952.



*The receiving tower at Haswell, Colo., 96.6 miles (155 km) from Cheyenne Mountain. Provision was made for mounting antennas and meteorological instruments at various levels on the 500-foot tower. The base of the tower is beyond the horizon from the summit transmitter on Cheyenne Mountain; the top is within-the-horizon.*



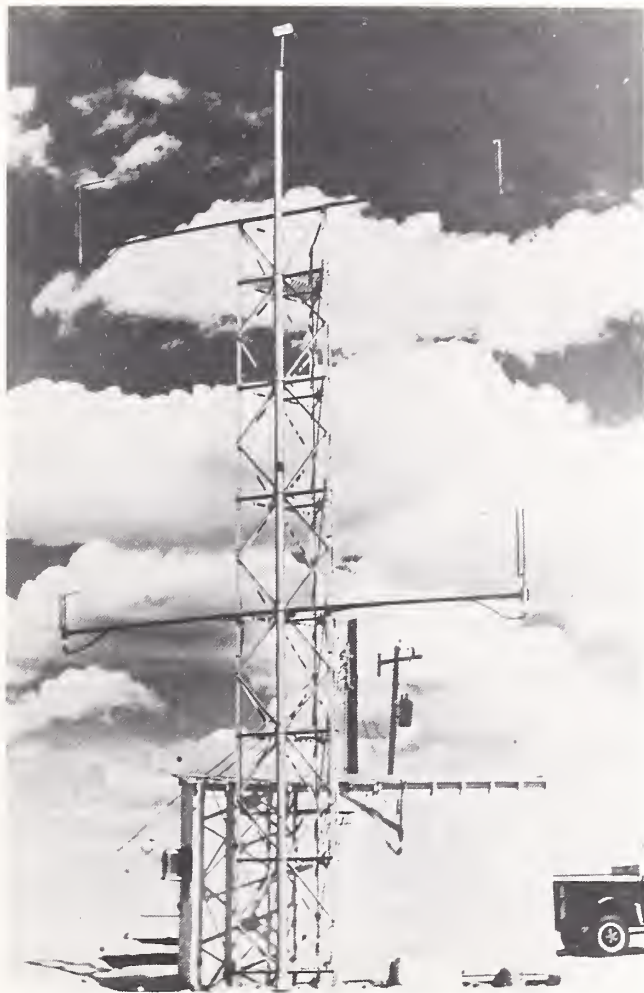

*A typical "fixed" receiving site in the chain extending eastward from the Cheyenne Mountain transmitters. Installations were located at Kendrick, Haswell, and Karval, Colo., and at Garden City, Kans.*

Kendrick and Karval are within the radio horizon of the summit, Haswell is just beyond. Garden City, Anthony, and Fayetteville are well beyond the radio horizon and considered out of the refraction region and in the scattering region (see p. 552) for reception.

One of the principal objectives of the Cheyenne Mountain experiments was an investigation of radio fields produced near and far beyond the radio horizon. The four fixed receiver-recording sites were chosen to provide propagation measurements over paths that were: (1) radio optical, (2) near the radio horizon, (3) just beyond the horizon, and (4) far beyond the horizon.

Because the nature of UHF propagation beyond the horizon was not well understood, a mobile receiver-recording system was designed and constructed for additional investigations of field strengths well beyond the horizon. This unit was placed at fixed points for several days at a time and progressively moved to more distant locations as indicated by the reception of recordable signals.

The receiver location at Kendrick, Colo., was typical of the four fixed sites where the terrain was essentially bare rolling hills departing from a smooth spherical earth by only a few hundred feet. Even such small irregularities, however, were of major importance in the propagation of 1000-MHz (UHF) signals for which the wavelength is only about 1 foot (30 cm). The distant portions of the path through Kansas become progressively much smoother, but finally become rougher at a distance of approximately 600 miles in the Boston Mountains of northwestern Arkansas. The terrain slopes from a ground elevation of approximately 6000 feet (1829 m) above sea level at the base of Cheyenne Mountain to approximately 1500 feet (457 m) above sea level in western Arkansas.



*Mobile receiving equipment was used for additional measurements at locations other than the "fixed sites" in eastern Colorado and western Kansas.*

## **4. Facilities and equipment**

### **a) GENERAL**

The objectives of the Cheyenne Mountain program required a carefully monitored transmission and receiver-recording system, which was divided into three equipment classes: (1) Transmission, (2) reception, and (3) data recording.

### **b) TRANSMISSION**

Transmitting facilities at the Cheyenne Mountain fixed sites included four commercial FM transmitters for the VHF range and one UHF transmitter. The UHF transmitter operated on a frequency of 1046.4748 MHz, one commercial (VHF) transmitter operated on a frequency of 100 MHz, and one somewhat modified commercial transmitter (VHF) operated on 192.8 MHz. All were installed and operated at the summit site. The base site housed similar VHF transmitters operated on 92 and 210.4 MHz. After several years of operation, because of an increased number of commercial television stations in the area, the transmitters in the 200-MHz range were modified to operate at 230 MHz at the base site and 236 MHz at the summit site.

#### **1) UHF transmitter—1046 MHz**

The 1046-MHz UHF transmitter was designed and specially built for the National Bureau of Standards. It was designed to meet the rigid specifications of the narrow-band, cw radio propagation system for Cheyenne Mountain. This transmitter met the essential requirements of radiating a high-power, essentially monochromatic, stable, continuously

monitored radio-frequency signal at 1046.4748 MHz. It was unique in having the highest continuous power output of any 1000-MHz transmitter in the country. The transmission system consisted of four major components: (1) Crystal driver unit, (2) 4 kW-klystron power amplifier, (3) direct-current power supplies, and (4) the antenna systems.

## 2) VHF transmitters

The 92-MHz transmitter at the base site and the 100-MHz transmitter at the summit site were conventional commercial 3-kW FM-broadcast transmitters with provision for the use of a high-stability crystal-controlled frequency source and primary voltage regulation.

The 192.8-MHz transmitter at the summit site and the 210.4-MHz transmitter at the base site were adaptations of conventional commercial FM transmitter driver circuits with the addition of a final power amplifier and frequency doubler.

The antennas were corner-reflector types and had directivity patterns such that only a small amount of the radiated energy would strike the mountain behind and below them.

In addition to the VHF transmitters described above, a 1-kW commercial-type FM transmitter was installed in a van-type truck. This semi-mobile transmitting system was used at the Fort Carson and Pikes Peak sites. Its power-output, voltage-regulating, and frequency-control systems were essentially the same as for the fixed installations.

## c) RECEPTION

The four fixed receiving stations received and recorded all five frequencies continuously. The Anthony and Fayetteville sites were semi-permanent and recorded for desired periods on two or more frequencies. The permanent sites utilized dipole receiving antennas; the more distant sites used rhombic or parabolic reflector-type antennas to obtain higher gain.

### 1) UHF receivers

The 1046-MHz receivers were designed and constructed with major considerations for narrow-band characteristics, extreme frequency stability, and high-gain stability.

### 2) VHF receivers

The VHF receivers were constructed particularly for this program. Special features were utilized to improve gain and to obtain a very narrow recording channel bandwidth.

### 3) Special receiving equipment

In order to observe and record rapid and within-the-hour signal variations at the receiving sites within the optical horizon, a combination of a special gain-stable receiver and a differential-voltage recorder was employed.

## d) RECORDING DEVICES

The data recording equipment used with all receivers consisted of a clock-driven chart recorder and a 10-channel time-totalizing recorder. The time-totalizer recorder, driven from the voltage output of each receiver, consisted of 10 channels, each of which included a direct-current amplifier and a bistable multiplier that actuated a fast acting relay. The relay in turn operated a motor which drove a revolution counter. The multivibrators were adjusted to operate relays at various levels of input voltages from the dc amplifiers. Thus, the revolution counter indicated the total time that the signal exceeded a preset level. Hourly readings of the counters were made with an automatically actuated 35-mm camera.

## TERRAIN EFFECTS

The objective of this program was stated in the Second Annual Report of the Boulder Laboratories (1956) as:

to determine by experimental and theoretical studies the effects that an irregular, finitely conducting ground boundary has on radio propagation and to provide methods for predicting these effects in terms of radio propagation theory.

## 1. Reflection coefficient at grazing angles

An experimental determination of the reflection coefficient over irregular terrain was made by Raymond E. McGavin and Leo J. Maloney [36]. This study consisted of a series of aircraft flights over transmission paths of the Cheyenne Mountain system in eastern Colorado and western Kansas. Three paths were investigated: One originated at the Cheyenne Mountain transmitting site, passed through Haswell, Colo., and continued beyond; another from Pikes Peak through Haswell; and a third from Fort Carson through Haswell.<sup>30</sup> The mean ground elevation of these paths varied from 6200 feet (1890 m) relative to mean sea level near Cheyenne Mountain to 4200 feet (1280 m) in western Kansas. The object of the flights was to investigate the distribution of received field strengths along these paths at an operating frequency of 1046 MHz, using horizontal polarization.

The reflected signal received over rough terrain is considered to be made up of two components, one that is a specular component and the other a Rayleigh-distributed component.<sup>31</sup> When one terminal is low, the Rayleigh component is considered to be small with respect to the specular component but increases in relative magnitude as the height of the lower terminal increases. A terminal height is reached where the specular component is no longer significant, and the reflected energy is essentially Rayleigh distributed.

A terminal height is quickly reached above which the mean value of the reflected energy is relatively constant, of a low value, and independent of the grazing angle (defined as the angle between the incident wave and the tangent to an approximately smooth surface at the point of reflection when it is less than 5°).

## 2. VHF measurements in the Rocky Mountain area

Radio propagation at VHF over irregular terrain is subject to many variations and uncertainties. In order to evaluate terrain effects, a series of measurements was made over various irregular-terrain paths in the Colorado Rocky Mountain region north of Denver by Robert S. Kirby, Harold T. Dougherty, and Paul L. McQuate [37].

The area due north of Denver, Colo., affords an excellent opportunity to study the effect of irregular terrain. This is an area where the Rocky Mountains rise abruptly out of the

<sup>30</sup> The flights were made in a B-17 aircraft supplied by the Wright Air Development Center of the Wright-Patterson Air Force Base, Dayton, Ohio.

Seven flights were made: Two over the Pikes Peak path, at 7000 feet (2134 m) and 10,000 feet (3048 m); three over the Cheyenne Mountain path, at 7000, 10,000, and 15,000 feet (4572 m); and two over the Fort Carson path, at 10,000 and 15,000 feet.

<sup>31</sup> The Rayleigh distribution is a normal distribution of two uncorrelated variates with the same variances (statistical).



*Mobile unit for tropospheric propagation research.*

plains, providing propagation paths over terrain which, in the space of a few miles, ranges from relatively smooth open country, free from trees and other obstructions, to rough and wooded mountains. Using three Denver VHF broadcasting stations as sources of signals, mobile field-strength measurements were made over four routes running generally east and west.

Two television stations located on Lookout Mountain just west of Denver and an FM station to the east were used. The locations were 26 miles apart. The "aural broadcasts" of the TV stations were 59.75 MHz and 191.75 MHz, and the elevations were 7420 and 7615 feet (2262 and 2321 m) above sea level, respectively. The FM station operated at 95.7 MHz and its elevation was 5660 feet (1725 m).

The recording routes, approximately 20, 35, 46, and 62 miles (32, 46, 74 and 100 km) north of the transmitters, extended roughly between meridians running through the most easterly and most westerly transmitters. Each route was characterized by mountainous terrain at the west and relatively smooth terrain at the east end.

Analysis of the data showed the effect of frequency and terrain on the correlation of sector median values of transmission loss. When the paths of transmission are the same, even though the frequencies are widely separated, the values of transmission loss are closely correlated. When the paths diverge in direction, even though the frequency separation is not great, the correlation is much less. It appears from this study that correlation in VHF propagation is primarily a function of the terrain—particularly in the vicinity of the lower of two terminal antennas—and is not particularly frequency selective, at least as regards small sector medians.

### **3. Pikes Peak in obstacle-gain experiments**

#### **a) THE OBSTACLE**

Pikes Peak, Colo., was used as an obstacle in two separate obstacle-gain experiments. In one, the transmission was from Lookout Mountain (near Denver) to a number of receiving locations approximately 100 miles (161 km) to the south where observations were made with a mobile receiver. One transmission path was directly over Pikes Peak. In the second experiment, a fixed transmitter was located south of Pikes Peak, at the hamlet of Beulah, and the transmission path was across Pikes Peak to the Table Mountain receiving site of the Boulder Laboratories (north of Boulder).

#### **b) FROM THE NORTH**

In a series of experiments signals were transmitted from Lookout Mountain (west of Denver) and measured at a number of locations approximately 100 miles (161 km) to the south. These locations were along a line running east and west in the Arkansas River Valley. They included a transmission path directly over the summit of Pikes Peak (14,110 feet, 4298 m) [38].

Observations were made by Kirby, Dougherty, and McQuate with a mobile receiver at selected fixed locations where the signal traveled directly over the summit of the peak, and to the east and west of this point. Interestingly enough, early measurements showed that the lowest transmission loss was not observed at the point selected as being directly in line with Pikes Peak. Investigation revealed that there was a discrepancy in the maps used which had not been corrected. When allowance was made for this discrepancy and measurements made at the corrected location directly behind the peak (approximately 4000 feet, 1219 m, to the west), the basic transmission loss was observed to be several decibels less (see below).

When transmission was directly over the summit of Pikes Peak, the signals were much higher than they were on either side of the peak. Very little fading was observed in this location and pronounced lobing was evident, indicating the presence of strong ground reflections. Theoretical values of transmission loss calculated for a knife-edge in place of Pikes Peak and, accounting for ground reflections, gave results which compared very closely to the observed values both in the value of transmission loss and the position of the lobes.

c) FROM THE SOUTH: BEULAH—PIKES PEAK—TABLE MOUNTAIN PATH

As a continuation of the study of knife-edge-type diffraction phenomena, NBS established a 223 km (139 miles) test path in eastern Colorado. The path extended in a roughly north-south direction along the Front Range of the Colorado Rockies, from Beulah, across Pikes Peak, to the NBS Table Mountain field site north of Boulder [39]. Again, Pikes Peak, 77 km (48 miles) north from Beulah and visible from both terminals, provided the diffracting knife-edge-type obstacle. A path profile was drawn, based on an equivalent Earth's radius of 9000 km (5592 miles) which is 1.41 times the actual radius, computed from the surface refractivity.

Frequencies of 100 MHz and 751 MHz were used. The southern and transmitting terminal was at Beulah; the northern and receiving terminal was at the Table Mountain field site. An additional receiving site was operated for short periods on top of Pikes Peak, using horizontal half-wave dipole antennas on both frequencies. These antennas were mounted about 6 m (20 ft) above ground.



*Antenna array at the CRPL Table Mountain field site north of Boulder, including a pair of 60-foot-diameter parabolic antennas. The antennas shown here were located at one corner of the almost level surface of a mesa (approximately 1 mile  $\times$  2 miles) (Table Mountain) which formed the field site.*

The purpose of the experiment was to obtain a better understanding of long-term signal and fading characteristics. Transmission loss measurements were analyzed by Barsis and Kirby in terms of diurnal and seasonal variations in hourly medians and in instantaneous levels.

Operation on 751 MHz was during a 10-month period (December to September) and on 100 MHz for 2 months (August-September). Data were recorded continuously during 5-day periods at the rate of one period each month with more frequent operation in June and August. The site on top of Pikes Peak was operated during two 5-day periods in August.

Analysis of 751-MHz data from a long obstacle-gain path showed principally that the distribution of hourly medians of field strength on basic transmission loss may be approximated by the convolution of cumulative distributions for two line-of-site paths in tandem which have the obstacle as a common terminal. These long-term fading

characteristics were quite different (substantially less) from the ones observed for tropospheric scatter propagation paths over comparable distances. No significant diurnal variation in propagation characteristics was observed on the obstacle-gain path, and the indication is that seasonal variations are small.

Due to the limited width of the obstacle, knife-edge approximation by a semi-infinite plane, or half-cylinder, may not be entirely appropriate, although a somewhat arbitrary assumption of curvature leads to theoretical values of transmission loss equivalent to observed values.

The outstanding advantages of obstacle-gain paths are that the signal level is significantly higher than expected for scatter paths of comparable length, and the amplitude of rapid Rayleigh fading components is substantially reduced. However, the received field strength was lower than values calculated using the idealized knife-edge theory. This was probably due to the profile through the obstacle, which represented a rounded knife-edge, and to reflections and contributions from other terrain features.

These and similar measurements showed that relatively high signal strengths are consistently observed behind mountain ridges. Thus it is unlikely that mountain ranges can always be relied upon to shield potential interference. Special consideration to these phenomena should be given in locating radio astronomy installations or space-communication terminals.

#### 4. Over-water paths in the California coast region

##### a) SAN NICOLAS ISLAND—CALIFORNIA COAST

Tropospheric radio wave propagation measurements over two paths between San Nicolas Island and the California coast near Point Mugu were made by Barsis and Fred M. Capps and correlated with the characteristics of refractive-index profile determined at the path terminals simultaneously with the radio measurements [40].<sup>32</sup>

The transmitting terminal was on San Nicolas Island, approximately 60 miles (96.6 km) off the southern California coast, with the antenna at an elevation of 866 feet (264 m) above mean sea level. The two receiving locations were in the same general direction as seen from the transmitter. One was on Laguna Peak, 1400 feet (426.7 m) above mean sea level, and the other on the roof of one of the buildings of the U.S. Naval Air Missile Test Center, Point Mugu, 60 feet (183 m) above mean sea level.

From the transmitting antenna the terrain drops rapidly to sea level within less than 2 miles (3.2 km). The face of Laguna Peak is quite steep. The San Nicolas Island-Laguna Peak path is a within-the-horizon path, and a specular reflection point on the surface of the ocean was assumed to exist approximately 27 miles (43.5 km) from the transmitting antenna. The terrain in front of the lower receiving site (designated as Bldg. 50) is flat and marshy, and the path reaches the open ocean within approximately 1 mile (1.6 km). The receiving terminal was slightly below the radio horizon for normal refraction.

They found that the existence of super-refractive layers (either ground-based or elevated) favors the occurrence of prolonged space wave fadeouts for the within-the-horizon path, and increased the short-term fading range for the beyond-the-horizon path. It was also found that the base and top of a super-refractive layer, and the magnitude of the refractive-index gradient within the layer have a noticeable effect on various characteristics of the received signal for both paths.

From their observations and analysis Barsis and Capps concluded that the hourly median basic transmission loss and the fading range observed for the San Nicolas-Bldg. 50 path appeared to be closely related. It was also shown that the small fading range observed concurrent with the linear profile corresponds to a high median transmission loss value (low field strength) whereas a low median transmission loss value (high field strength) is associated with considerably deeper fades.

---

<sup>32</sup> This work was supported by the U.S. Naval Air Missile Test Center, Point Mugu, Calif., which provided the transmitting and receiving installations and operating personnel. The actual receiving, recording, and calibrating equipment was furnished by the National Bureau of Standards. Data analysis and evaluation were performed by NBS with the support of the U.S. Naval Air Missile Test Center. Meteorological data were procured and supplied by the Point Mugu Naval Air Station.

The study also established that basic transmission loss, fading range, and prolonged space-wave fadeouts may, on the average, be considered functions of the refractive-index profile characteristics, based on measurements made over relatively short within- and below-the-horizon over-water paths in the Pacific coast region.

The results derived above were also in agreement with similar studies by others as far as the dependence of transmission loss or layer height for beyond-the-horizon paths was concerned. However, the experiment extended this type of analysis to the study of fading range for beyond-the-horizon paths as well as to the study of the dependence of transmission loss and prolonged space-wave fadeouts for within-the-horizon paths on refractive index profile characteristics.

## 5. Fading phenomena

### a) PROLONGED SPACE-WAVE FADEOUTS

Barsis and Mary Ellen Johnson analyzed measurements of short-term fading characteristics observed over within-the-horizon paths at frequencies between 100 and 1250 MHz [41]. Four paths were chosen for study. Two were in eastern Colorado, which represents a continental, dry climate: Cheyenne Mountain-Karval, and Beulah-Pikes Peak-Table Mountain (see sec. 3,c, p. 536). Two were along the coast in southern California, which represents a maritime climate with almost constant refractive-index refraction: Mt. Wilson-Point Loma (data furnished by U.S. Navy Electronics Laboratory, San Diego, Calif.), and San Nicolas Island-Laguna Peak (see sec. 4,a, p. 537).

Signal variations of the type observed over such paths have been termed "prolonged space-wave fadeouts." They are analyzed as a function of carrier frequency, path characteristics, and meteorological parameters. The study also included an evaluation of fadeouts observed over the Beulah-Pikes Peak-Table Mountain path where Pikes Peak acted as a diffracting knife-edge obstacle between transmitter and receiver.

Principal results show a stronger diurnal trend of fadeout incidence in continental climates than in maritime climates. A significant dependence of the fadeout characteristics on the refractive-index structure was observed in maritime climates.

In general, fadeouts tend to be more frequent but of shorter duration for higher frequencies. These results confirm the dependence of fadeout phenomena on ground-based ducts. Observed differences between continental and maritime areas are due to the difference in thickness of layers, their height above ground, and the diurnal and seasonal trends in their occurrence. Fadeout phenomena appear to be, at least indirectly, a function of climate.

There are also indications that the occurrence of fadeouts is well correlated on vertically-spaced antennas. Thus, conventional space-diversity techniques may not be effective to increase the reliability of systems operating over within-the-horizon paths.

### b) MEASUREMENTS AT 418 MHZ WELL BEYOND THE RADIO HORIZON

A series of transmission-loss measurements was made during a period of approximately a year and a half over a 134-mile (216-km) path between Cedar Rapids, Iowa, and Quincy, Ill. [42]. The transmitter was located at Cedar Rapids and was operated by the Collins Radio Co. under contract with NBS. The receiving and recording equipment was installed and operated by Harris B. Janes, Jack C. Stroud, and Martin T. Decker of NBS.

Space on a 750-foot (229-m) tower was obtained through the cooperation of radio station WTAD-FM in Quincy, and the receiving antennas were mounted on this tower at heights ranging from 30 to 655 feet (9 to 200 m) above ground. The transmitting antenna was 39 feet (11.9 m) above ground.

The principal purpose of the experiment was to study: (1) the hourly, diurnal, and seasonal variations in basic transmission loss experienced in transmissions well beyond the radio horizon; (2) the corresponding long-term variability of height-gain; (3) the comparison of measured transmission loss and height-gain with predicted values; and (4) the correlation of vertically and horizontally-spaced antennas.

The equipment was operated for 13 recording periods, each of approximately 2 to 3 weeks duration. During each period, continuous recordings of basic transmission loss were made simultaneously at three to five different antenna heights.



The data output was reduced to hourly distributions of instantaneous signal levels obtained from time-totalizing recorders or, in some instances, from paper-chart recordings. The hourly median basic transmission loss and the fading range (ratio, in decibels, of levels exceeded 10% and 90% of the hour) were read from these distributions.

The angular path distance ranged from 20.3 to 15.7 milliradians for the 30- and 655-foot (9.1- and 199.6-m) receiving antenna heights, respectively. Insofar as the long-term basic transmission loss measured over paths having angular distances of this order (i.e., greater than 10 milliradians) agreed quite well with values predicted from scatter theory, this might be considered to be a tropospheric scatter propagation path.

However, further analysis of the data revealed that for significant percentages of the time (especially during the night), mechanisms other than scattering appear to be important. It seems that this path is in a transitional region between the shorter paths where processes such as diffraction and ducting may provide most of the signal power and longer paths where scattering is the principal contributing factor.

### c) WITHIN-THE-HOUR FADING

Fading range is defined as the ratio in decibels of the signal levels exceeded 10 percent of the hour to the level exceeded 90 percent of the hour. Short-term fading is defined as those fluctuations in instantaneous signal level that occur within a period of an hour's recording. The two principal factors of interest in studying short-term fading are the extent or range of fading and the rate at which these variations occur.

An analysis was made by Janes of the fading range of 100- to 1000-MHz transmissions received both within and beyond the radio horizon. Measurements were made over the various Cheyenne Mountain field station paths and over the Cedar Rapids, Iowa—Quincy, Ill. path [43].

An attempt was made to show for the particular frequencies and paths, and for the time of the year (August), the variation of fading range with time of day and the angular distance (see p. 517).

The data showed that beyond the region where diffraction is considered to be the dominant mechanism, the received signal level distributions closely resembled a Rayleigh distribution in both fading range and general shape. Deviations from the fading range of a Rayleigh distribution were thought to be due to changes in the average signal level during the hour.

## PROBLEMS OF PHASE STABILITY IN TROPOSPHERIC PROPAGATION

### 1. Introduction

An early project in the Tropospheric Propagation Research Section, Radio Propagation Engineering Division, was a series of studies of phase stability in tropospheric propagation. This rather extensive program was sponsored by the Ballistic Missile Division of the U.S. Air Force and was initiated in November 1954. At an early stage nine persons were involved in the program. Although the objectives changed over nearly a decade, propagation phase stability was at the core of all investigations.<sup>33</sup> In 1956 the program was assigned to the newly-formed Tropospheric Analysis Section and in 1959 to the Lower Atmosphere Physics Section.

<sup>33</sup> Initially, in 1954, the project, titled Tropospheric Propagation Phase Stability Studies, had as its objective:

to investigate the phase stability of radio frequency signals propagated through the troposphere and received simultaneously on a number of spaced antennas.

Two years later, the project title had changed to Phase Stability Analysis, and the objective had changed:

to reduce and analyze data obtained in connection with the study of the phase stability of radio frequency signals propagated through the troposphere over short line-of-sight paths.

With a broader scope to the program, another section of the division, the Tropospheric Measurements Section, became involved with the specific objective in a project (Tropospheric Propagation Measurements):

to provide basic information on the propagation of radio waves contained in the VHF, UHF, and microwave portion of the frequency spectrum.

## 2. Phase measurements over paths of varying length

Measurement of the effects of inhomogeneities in the atmosphere due to variations of refractive index on the stability of the electrical path length (phase of arrival relative to the transmitted phase) of electromagnetic waves as they pass through the lower regions of the atmosphere was made as a group endeavor of the Tropospheric Propagation Research Section, Radio Propagation Engineering Division and reported by Jack W. Herbstreit and Moody C. Thompson, Jr. [44].<sup>34,35</sup> Three paths were studied: (1) Cheyenne Mountain to Fort Carson, approximately 3.5 miles (5.6 km); (2) Pikes Peak to the Garden of the Gods (Colorado Springs, Colo.), approximately 10 miles (16 km); (3) Pikes Peak to Kendrick, Colo., approximately 60 miles (96 km). Transmissions were made on two frequencies, 172.8 MHz and 1046 MHz.

---

(Continued)

The work is basic in nature and of prime importance to the design of radio inertial guidance systems for the ballistic missile program (U.S. Air Force).

This specific project was conducted on the Island of Maui, Hawaii, in a climate where greater changes in phase variations would be encountered compared to those associated with Colorado atmospheric conditions.

By FY 1958 the objective for the Phase Stability Analysis project remained the same, but a corollary project to the one on the Island of Maui was set up in the division office and titled, Radio Geodetic Research, with the objective:

to investigate the performance of distance-measuring techniques and to determine what limitations are imposed on such systems by atmospheric turbulence.

The matter of phase stability as a property of atmospheric turbulence was at the core of the project in determining the accuracy of a distance-measuring system based upon observation of elapsed time of propagation and of the speed of radio waves at microwave frequencies through the lower atmosphere.

By FY 1959 the Phase Stability Analysis project was on a continuing basis to perform phase stability analysis for several programs.

The Radio Geodetic Research project was now assigned to the newly-formed Lower Atmosphere Physics Section and had as its new objective:

to study the effects of atmospheric turbulence and similar phenomena on the accuracy of electronic distance measuring systems.

A year later (FY 1960), another project, titled Low-Level Phase Stability, had for its objective:

to study atmospheric-induced time variations in the electrical lengths of line-of-sight propagation paths.

In the following year (FY 1961) another project, of wider scope, replaced the Low-Level Phase Stability project. It was titled, Radio Tracking Accuracy, which had as its objective:

to study the effects of the troposphere on radio tracking systems.

This project was geared to electronic tracking and guidance systems, for various uses, as affected by varying conditions in the lower atmosphere and by the parameters of the system itself. Later, the objective was to be somewhat more explicit:

to study the effects of atmospheric turbulence and similar phenomena on the accuracy of electronic distance measuring systems.

This project and the Radio Geodetic Research project were to continue for several years in the Lower Atmosphere Physics Section, Radio Propagation Engineering Division.

<sup>34</sup> Jack W. Herbstreit was awarded the Department of Commerce Gold Medal for Exceptional Service on Feb. 15, 1966. Herbstreit was recognized

for outstanding contributions to the Nation in the field of high precision radio tracking and guidance systems.

<sup>35</sup> Moody C. Thompson, Jr., was awarded the Department of Commerce Silver Medal for Meritorious Service on Feb. 14, 1962. Thompson was recognized

for his research on the physics of the troposphere and its application to precise radio distance measuring and missile guidance techniques.



*Portable receiving equipment used in line-of-sight propagation path between Pikes Peak (left center) and the Garden of the Gods, Colorado Springs, Colo. This path (approximately 10 miles) offered an excellent opportunity to observe both ends of the path and changes, such as cloud formations, taking place in the intervening distance.*



*Portable radio receiving antenna (right) and meteorological and photographic equipment (in and atop the van), as used in line-of-sight experiments between Pikes Peak and Garden of the Gods, Colorado Springs, Colo. The equipment was part of a study of the effects of atmospheric turbulence on the stability of the electrical length of a radio path.*

Instrumentation was developed to measure variations in the phase difference of the radio waves at the two ends of a single path and, simultaneously, variations in the phase difference between the waves arriving over the first path and those arriving over a different path. In addition, instrumentation previously developed was used to measure the very small changes in the amplitude of the received field which occur within the radio horizon. These three sets of simultaneous measurements provided valuable data for study of the nature of refractivity variations of the atmosphere.

### 3. Phase stability over low-level tropospheric path

A knowledge of the statistics of atmosphere-induced variations in the phase of the received signal (i.e., variations in electrical path length) is essential in evaluating the reliability of any system using radio waves for measuring distance and/or velocity. Thompson and Janes<sup>36</sup> conducted a series of experiments to study the instability of the phase of VHF, UHF, and microwave radio signals transmitted over line-of-sight paths [45].

One such experiment was made at 9400 MHz over a path of 9.4 miles (15.1 km) from Green Mountain Mesa, about 0.5 mile (0.8 km) west of the NBS Boulder Laboratories to the Table Mountain field site, north of Boulder. Both terminals were at approximately the same elevation. Each antenna was located at the forward edge of a steep slope to avoid ground reflections in the immediate vicinity. The path passed over two valleys which slope downward from west to east and are separated by a relatively flat mesa. This mesa contained a small lake and appeared to constitute the major ground-reflection area.

The data consisted of: (1) 40 hours of continuous recording of long-term variations in the phase of the radio signal; (2) 40 hours of continuous atmospheric temperature, pressure, and relative humidity recordings; and (3) 21 samples (each approximately 5 min long) of short-term phase variations.

Analysis of these data consisted of: (1) estimation of the power-density spectrum of the phase variations, using both long-term and short-term recordings; (2) estimation of the power-density spectrum of the corresponding variations in radiofrequency of the received signal; and (3) correlation of the long-term variations in electrical path length (from the phase records) and surface refractivity measurements (from the meteorological records) made at the path terminals.

Variations in the phase of the received signal represent variations in the electrical length of the path, which is proportional to the atmospheric refractivity integrated along the path. The long-term changes in refractivity measured at a point on the path should be correlated with the long-term changes in electrical path length as deduced from the phase records. It was found that the two variables were not only closely correlated (correlation coefficient: 0.915), but their fluctuations agreed in magnitude as well.

### 4. Path-length stability of ground-to-ground links

A series of eight experiments was conducted by the Lower Atmosphere Physics Section, Radio Propagation Engineering Division to study the time variations in the electrical lengths of nearly horizontal, ground-to-ground, line-of-sight radio links [46].<sup>37</sup> These were conducted under a variety of environmental conditions such as might be encountered in the operation of electronic-guidance, tracking, and direction-finding systems. The purpose of the experiments was to study the statistical properties of the apparent path-length variations and their dependence on various meteorological parameters.

Each of the eight experiments was termed a "run" to simplify the description. Runs 1 and 2 were made over a 15.2-km (9.4-mile) path near Boulder. The principal objective of the first run was to study path-length variations at 9400 MHz over a path having little or no ground reflection, using both horizontal and vertical polarization. The second run was a

---

<sup>36</sup> Harris B. Janes was awarded the Department of Commerce Silver Medal for Meritorious Service in 1964. Janes was recognized

for outstanding contributions to the fields of precise radio distance measuring and missile guidance techniques.

<sup>37</sup> Sponsored, in part, by the U.S. Air Force Ballistic Missile Division (Contract Number AF 04(647) - 134).

continuation of the same type of measurements, but narrower beam antennas were used and the run was continued for a longer time to more adequately study day-to-day variations.

The third run was made at 9400 MHz using a 713-m (2339-foot) path across a portion of the nearly level surface of the Table Mountain field site near Boulder. Simultaneous path-length (phase) variation recordings were made on two paths having one terminal in common, and the other terminals separated vertically, one near maximum and the other near minimum of the height-gain pattern. The purpose of this run was to study the effect of ground reflections on phase stability.

The fourth run was made at 9400 MHz over a 3.2-km (2-mile) path which extended the 713-m path to the edge of the mesa forming the nearly level surface of the Table Mountain field site. This run supplied information on path-length stability over a longer path, but one having the same flat terrain and low antenna heights, thereby ensuring the existence of ground reflections.

The fifth run used the same 15.2 km as the first two runs. Simultaneous 9400 MHz and 100 MHz path-length stability recordings were made to test the feasibility of using the lower frequency and also to provide a comparison of stability recordings made under different ground-reflection conditions.

The remaining runs were made on or near the Air Force Missile Test Center at Cape Canaveral, Fla., to gather data under the same climatic conditions under which actual systems are operated. The sixth run was made at 9400 MHz over a 7.7-km (4.8-mile) path over flat terrain and at approximately grazing incidence to foliage on the path. The seventh run was made over the same path but with path-length variations observed simultaneously at vertically spaced antennas at one of the terminals; with one antenna placed to provide a path slightly above, and the other slightly below, grazing incidence.

The eighth run was made over a 17.1-km (10.6-mile) path extending from Cape Canaveral to a point north of Cocoa, Fla. The purpose was to study the effect of increased path length. Vertically spaced antennas were used at one terminal, one providing a path at approximately grazing incidence with the foliage, and the other below grazing incidence. The upper antenna, 19 m (62 feet) above ground, was located at or very near the radio horizon; the lower one, separated vertically by 7 m (23 feet), was probably well below the radio horizon.

Analysis of their data indicated that the long-term variations in phase (apparent path length) were well-correlated with refractivity (computed from standard meteorological data recorded at the path terminals).

The spectral density of phase variations may vary by as much as an order of magnitude during a 24-hour period, being generally low at night and high during the day (diurnal variations observed in Colorado were much smaller than those observed in Florida). Best correlation appeared between the spectral density and the wind speed averaged from both terminals.

The spectra of phase variations have slopes (on a log-log graph) of approximately  $-2.2$ . This slope did not appear to vary significantly from day to night, or from Florida to Colorado.

In the same region of fluctuation frequencies, the intensity of refractivity variations may vary as much as two orders of magnitude between day and night (the daytime values were higher, and this effect was much more pronounced in Florida than in Colorado).

The form of the refractivity spectra showed little effect of time or location.

Any dependence of the phase-variation data on radio-signal frequency was believed to be the result of the existence of multipaths, which introduced a frequency-dependent mechanism.

## 5. Hawaii experiment

The NBS Radio Propagation Engineering Division performed a series of experimental measurements on the Island of Maui, Hawaii, designed to study the statistics of time variations in the phase of microwave transmissions propagated over a line-of-sight path [47]. The purpose of the experiment was twofold: (1) To provide information useful in determining the error or noise contributed by a turbulent troposphere to any radio system

using phase comparison as a means of position location; and (2) to furnish statistics valuable in formulating and testing tropospheric propagation theories.

The measurements were made over a 15.46-mile (24.88-km) path extending from the 10,000-foot (3048-m) summit of Mount Haleakala to the airport at Puunene, at an elevation of 100 feet (30.5 m). A major consideration in the selection of this location was that, because of relatively large variations in radio refractive index here, these data would form a valuable supplement to similar measurements made in Colorado.

Analysis was made of time variations in: (1) the phase (relative to a stable phase reference) of a 9414-MHz signal transmitted over the path (single-path phase data); (2) the phase observed at one receiving antenna relative to that observed at an adjacent antenna (phase-difference data); (3) atmospheric refractivity as recorded by a microwave refractometer located at the Haleakala terminal; (4) wind velocity at both ends of the path; and (5) surface atmospheric refractivity measured at five stations located on or near the path.

The analysis of the phase data consisted of determining the total variance, serial correlation function, and power spectrum for samples taken from approximately four days of almost continuous recording. The extent to which the total variance and power spectrum are functions of baseline length, long-term variability in atmospheric conditions (as evidenced by analysis of the meteorological data), and length of data sample was determined.

Transmission was made from the summit of Haleakala to an array of receiving antennas at Puunene. One antenna was placed at the receiving end of the propagation path and seven additional antennas were placed along a baseline that was approximately normal to the propagation path and that had a total length of 4917 feet (1499 m).<sup>38</sup>

Meteorological instrument shelters were located at both path terminals and at three intermediate points as near to the path as possible. They were at altitudes of 3000 feet, 7000 feet, and 8000 feet (914, 2133, and 2438 m). Continuous recordings of atmospheric pressure, relative humidity, and temperature were made at each shelter. Continuous recordings of short-term variations in refractive index were also made at both path terminals (data from Puunene unreliable and not included in analysis).

To record cloud activity on or near the path, a 16-mm motion picture camera was mounted at each path terminal and aimed toward the opposite terminal. A special timing device was used to operate the shutter at the rate of one exposure every 5 seconds.

Time variations in the phase of arrival of the 9414-MHz signals propagated over the line-of-sight path and the time variations in the phase differences of signals originating at the common antenna and received at two points on the horizontal baseline normal to the propagation path were determined. By pairing different antennas, phase differences for different distances could be measured.<sup>39</sup>

The time variations were analyzed in terms of their serial correlation functions and power-density spectra for different times of day, and for several baseline lengths varying from 2.2 to 4800 feet (0.67 to 1463 m).

The slope of the power spectra and the total variance of phase difference variations were shown to be dependent upon baseline length. The slope of the phase spectra appeared to be independent of time of day or meteorological conditions. In some instances there was evidence of a diurnal cycle in total variance of both phase and refractive index, with larger variances during the daytime, but in other instances the diurnal effect was not detectable.

The long-term variations in single-path phase were well correlated with variations in the mean value of refractive index measured at five points along the path.

---

<sup>38</sup> The receiving antenna at the end of the propagation path was designated B. Antenna A was 3003 feet (915.3 m) north of B; the other antennas were south of B as follows: C-D, 18 feet (5.5 m); E, 67 feet (20.4 m); F, 109 feet (33.2 m); G, 1181 feet (360 m); H, 1914 feet (533.4 m). An additional antenna for 1046 MHz transmission (not designated by a letter) was 31 feet (9.4 m) south from B. The antenna designated C-D was actually a system of two 9414-MHz antennas with an effective horizontal separation of 2.2 feet (0.67 m) normal to the path.

<sup>39</sup> Three combinations of paired antennas, identified by the letter designations of the antennas (footnote 38), were ABH, BGH, and BEF.

## 6. Tracking missiles through the wild blue yonder

### a) THEORETICAL CONSIDERATIONS

In missile tracking systems, the position of the missile is determined by measuring the times required for radio signals to travel from each of several antennas (arranged on an orthogonal set of baselines) to the missile and back. The MISTRAM baseline missile tracking system, built by the General Electric Company for operation near Patrick Air Force Base in Florida, utilizes this principle [48].

Translating transit times to distances (and, hence, to position) requires a knowledge of the speed with which the radio signals travel through the atmosphere. This speed is a function of the composition of the atmosphere along the signal paths. Tracking inaccuracies result from variations in the Earth's atmosphere along these paths. The variations consist of both large-scale changes, caused by air-mass movements, and short-term changes, resulting from turbulence. Such tracking errors, introduced by variations in atmospheric refractive index, affect the accuracy of tracking systems.

### b) METEOROLOGICAL EFFECTS

The Radio Propagation Engineering Division of CRPL was requested to provide estimates of the nature and extent of the atmospheric effects and to derive correction factors to be programmed into the computer of MISTRAM. The problem was approached by means of two separate studies, the long-term and the short-term fluctuations.

A theoretical description of long-term variations of the refractive index for both the homogeneous and inhomogeneous atmosphere was developed by members of the Radio Meteorology Section. This was done by analysis of all the radiosonde data available in CRPL's Radio Refractive Index Data Center (see p. 521). Application of statistical methods to the pool of information made possible a systematic correction of tracking data, based on readily available meteorological data, in a form suitable for use in the MISTRAM computer.

### c) SIMULATED TRACKING SYSTEM

Experimental measurements were made by Janes and Thompson to study atmospheric-induced errors in microwave baseline tracking systems [49].<sup>40</sup> The ground-to-air configuration was simulated by baselines on level ground east of Boulder, Colo., and a fixed target antenna on a mountain top west of Boulder at a range of 15.5 km and a path elevation angle of 44 milliradians.

The accuracy of distance measurements made by observing the transit time (or phase) of radio signals over the distance in question is affected by space and time variations of the radio refractive index of the atmosphere. In this study certain features of an orthogonal baseline tracking system were simulated in order to isolate and study the errors contributed by the lower atmosphere in tracking an elevated target.

Considerations in selection were: (1) A target located on a mountain with terrain dropping off sharply in the direction of the baseline site and as high as possible consistent with all-weather accessibility; and (2) baselines located on nearly level ground at an altitude low relative to the target, and situated so as to permit an unobstructed view of the target with no obvious sources of anomalous multipath effects. The target site was near the summit of Green Mountain, west of the Boulder Laboratories, at an altitude 2240 m (7349 feet) above sea level. The baseline site was along Boulder Creek east of the city and a horizontal distance of about 15.5 km (9.6 miles) from the target.

Two baselines were used. One, 380 m (1247 feet) long, was nearly perpendicular to the propagation path and was designated the normal baseline. The other, 520 m (1706 feet) in length, extended from the northerly end of the normal baseline in a generally easterly direction and more nearly parallel to the propagation path (actually it formed an angle of approximately 30° with the path). It was called the "parallel" baseline.

For the measurements the radiofrequency was 9.4 GHz. Continuous recordings were made of variations in apparent range, range differences, and refractive index. The data were analyzed in terms of power spectra.

<sup>40</sup> This study was sponsored by the Air Force Missile Test Center, U.S. Air Force Systems Command, under contract No. AF08(606)-3776 with the General Electric Co.

Correlation between range and surface-refractivity variations and the correlation of range variations on adjacent paths were analyzed carefully in order to study the errors contributed by the lower atmosphere in tracking an elevated target.

**d) OVER-WATER MEASUREMENTS OF PHASE AND AMPLITUDE**

A microwave signal transmitted over a fixed line-of-sight path through the troposphere will exhibit time variations in both phase-of-arrival and amplitude. Such variations are caused by fluctuations in the three-dimensional structure of the atmospheric refractive index along the radio path. Phase-of-arrival variations have been investigated in CRPL experiments using predominantly over-land paths and, although they were not designed to study amplitude variations, the signals were observed to undergo occasional deep and prolonged fading on paths of the order of 15 km (9.3 miles) in length. Two questions which these experiments left unanswered were: (1) How will the signal phase and amplitude behave on an over-water path? and (2) To what extent will the phase and amplitude variations be correlated in two signals separated in frequency?

At the request of the Air Force Missile Test Center, propagation measurements at 9.4 and 9.2 GHz were made over a 47 km (29 miles) line-of-sight, over-water path at the MISTRAM installation on Eleuthera Island, British West Indies (in the Bahamas) by Janes, Albert W. Kirkpatrick, Donald M. Waters, and Dean Smith [50].<sup>41,42</sup> The purpose was to study the signal amplitude and phase variations at the two radio frequencies, and in particular, the variations in the phase difference and amplitude ratio ("differential amplitude") of the two frequencies.

The baseline microwave link chosen for the measurements at Eleuthera Island extended from the MISTRAM central site (near the auxiliary Air Force Base) in a southerly direction to the Powell Point site at the southwestern tip of the island. Except for the immediate foreground at each end, the entire path was over water.

The results included power spectra of phase and phase difference variations, and cumulative distributions of amplitude, differential amplitude, and phase difference.

**e) SIMULATED EARTH-TO-SPACE LINKS**

An experimental study was made (in June and July 1964) by Janes and Thompson of the time and space statistics of the phase-front distortion of microwave signals sent from a ground terminal to an elevated terminal [51]. Phase-front characteristics are important in systems involving phase measurements between a ground station and a moving airborne or space terminal. To isolate atmospheric errors from random motion of the upper terminal, the latter was simulated by a series of mountain-top antenna arrays.

The objective of the experiment was to obtain a detailed statistical description of time and space variations in the phase-front to serve as a basis for predicting atmospheric errors in microwave range and/or angular position measurements involving a moving upper terminal.

In principle, the best experimental arrangement would have included a moving terminal (an aircraft or a satellite) sweeping with a perfectly determined trajectory across the sky to measure the phase-front characteristics of a ground-based signal. However, this possibility was ruled out for technological reasons.

It was decided to substitute an array of fixed mountain-top antennas for the moving terminal, and to make phase-of-arrival and phase-difference recordings at several points on the array simultaneously. This arrangement isolated the purely atmospheric effects from the random motion of any practical airborne terminal and permitted the collection of statistically large data samples of phase-front behavior.

---

<sup>41</sup> An essential part of the MISTRAM precision missile trajectory measurement system installed on the Atlantic Missile Range consisted of microwave links which transmitted phase information from the outlying terminals of two baselines to a central station where it was converted to target position and velocity information. Each link involved the simultaneous transmission of two signals in the neighborhood of 8 GHz separated by 256 MHz. The successful operation of the system required that the phase and amplitude variations of one signal relative to the other remain below certain limits.

<sup>42</sup> This work was supported by the U.S. Air Force Missile Test Center (MTDRM).



The site chosen was on the Island of Maui, Hawaii, with propagation paths extending from a point 25 m (82 feet) above sea level at the abandoned Puunene airport to an array of four antennas approximately 3000 m (9843 feet) above sea level at the summit of Mount Haleakala. (This site had been used by CRPL for other experiments several years earlier; see p. 543). The paths were from 24.5 to 24.9 km (15.2 to 15.5 miles) in length and were tilted at an angle of 7 degrees from the horizontal.<sup>43</sup> All phase measurements were made at a radio frequency of 9.4 GHz.

Phase-front distortion was analyzed in terms of time variations in radio range on a single path and in first- and second-range differences from pairs of paths. The cross-correlations of range variations on adjacent paths, and range-difference variations on both adjoining and separated pairs of paths, were investigated, including the strong dependence of correlation on the portion of the power spectrum included in the data. The effect of the mountain-top terrain on the spatial homogeneity of the phase-front was found to be insignificant. A diurnal pattern in the variance of 15-minute range-difference samples was observed, with minimum variance in the early morning hours. This pattern was not observed in the range variances, nor were the range and range-difference variances significantly correlated with refractive index, air temperature, pressure, or wind-speed data at the lower terminal.

## SPACE COMMUNICATIONS

### 1. Interference between surface and space communication systems

Estimates of the mutual interference expected to occur between the ground terminals of space communication systems and surface point-to-point systems were prepared by William J. Hartman and Martin T. Decker in a form suitable for engineering applications.

The prediction method used was that developed earlier by NBS scientists for tropospheric scatter propagation [52]. The method was designed to predict the median value of hourly median basic transmission loss, and to give a distribution of the medians. The median basic transmission loss is defined in terms of the ratio of the power radiated from the transmitting antenna to the available power at the receiving antenna, when isotropic antennas are used at both ends of the path. The method is applicable for any path configuration. Most of the data were over conventional scatter paths with the antennas directed at the horizon in the great circle path.

Measurements were made over a test path of 165 miles (263.5 km) between the Table Mountain site near Boulder and Haswell, Colo. Pertinent parameters of this path were: Frequency, 409.9 MHz; the angular distance with both antennas directed at their respective horizons was 33 milliradians; the fixed transmitting antenna was a 14-foot-diameter parabolic dish, and the receiving antenna (which could be elevated) was a 60-foot-diameter parabolic dish.

Two cases were considered. First, the interference from an earth-terminal transmitter to a point-to-point relay receiver; and second, the interference from a point-to-point microwave-relay transmitter to the earth-terminal receiver of a satellite system.

After careful theoretical analysis of their data, it was concluded that space-communication systems and surface systems of the conventional microwave-relay type could share the same frequencies if care was used in locating the possible interfering sources. Separation distances of from 100 miles (161 km) to 150 miles (241 km) usually suffice, and under ideal conditions, distances of less than 100 miles could give adequate protection.

Estimates have been made for other systems such as high-powered radar and these indicate that harmful interference should not be experienced if the radar and earth terminals are separated by 500 miles (805 km) or more.

The data represented times when aircraft were not present in the propagation path, and although the data agreed with the predicted values for the assumed condition, the estimates may not be accurate for some paths when aircraft are present.

<sup>43</sup> The experiment was divided into 9 "runs" or periods of continuous recording activity, each approximately 24 hours long. Each run was characterized by a particular arrangement of the four antennas at the upper site. The several arrangements were chosen to give as wide a variety of path separation as possible (the maximum separation was 790 m, 2592 feet).

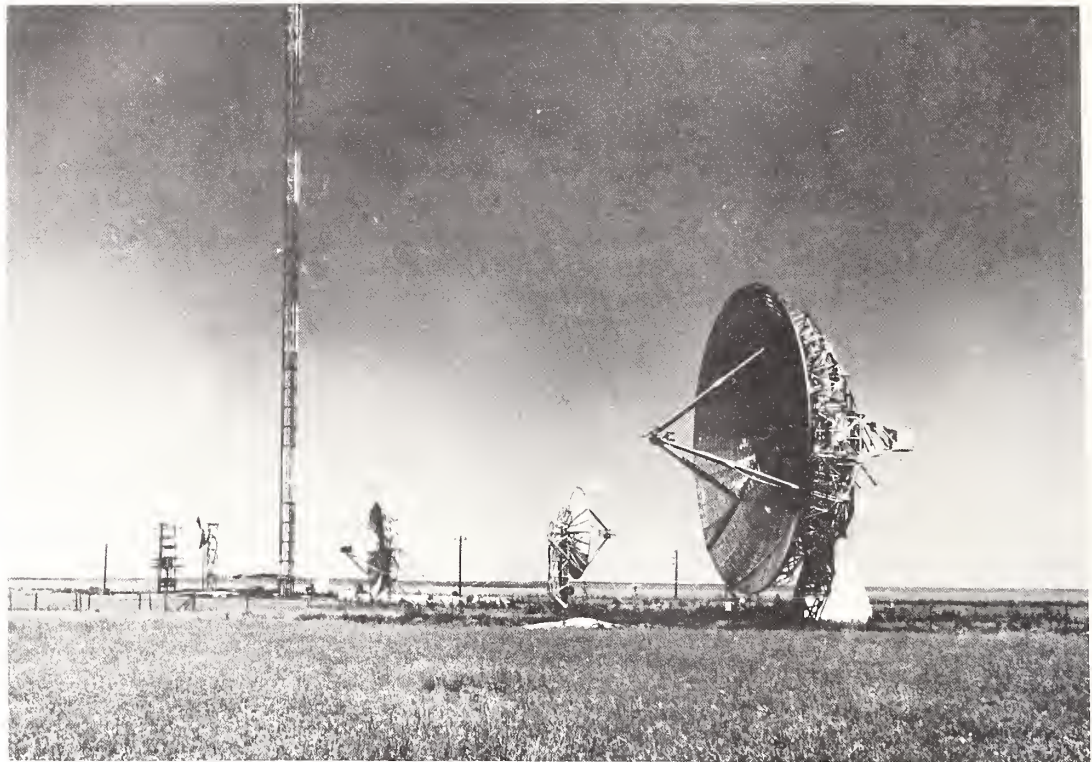

*Antenna array and meteorological tower at Haswell, Colo. Besides being a key installation of the Cheyenne Mountain project, Haswell was well situated for a wide variety of other experiments.*



*Two 60-foot-diameter parabolic antennas at the NBS Table Mountain field site, north of Boulder. Differences in azimuth and elevation allowed measurement of phase differences (and differences of electrical length) in the arrival of radio waves. The antennas could be moved  $90^\circ$  in elevation between the vertical position (left) and the horizontal (right), and could be rotated  $360^\circ$  in azimuth.*

# TROPOSPHERIC FORWARD SCATTER

## 1. Introduction

Although radio propagation theory indicated that radio waves above about 60 MHz would travel through the lower atmosphere (troposphere) no farther than light waves, i.e., to the optical horizon (line of sight) or slightly beyond (the rays are bent downward by atmospheric refraction), it was observed in practice that radio signals were being received at much greater distances.

To allow for this bending and for the practical purpose of calculating distances, a hypothetical value for the effective radius of the Earth was adopted as  $4/3$  of its actual value. Even then distances much farther than the calculated values were observed. This led to questions such as "why?" and "how?" and to research that would help in answering these questions.

It was recognized that climate, weather, and terrain irregularities played important roles in determining the strength of a tropospheric signal and the distance it would be propagated. In April 1950 two scientists at Cornell University, H. G. Booker and W. E. Gordon, published "A theory of radio scattering in the troposphere," in the *Proceedings of the Institute of Radio Engineers*. The Booker-Gordon scatter theory postulates that inhomogeneities in the refractivity of the atmosphere (p. 519 and footnote 11), generally referred to as "blobs," cause a scattering in all directions of radio energy that strikes them, but predominantly forward—therefore the designation forward scatter.

## 2. Special issue of *IRE Proceedings*

A special issue of the *Proc. IRE* (Vol. 43, No. 10, Oct. 1955) was devoted to the topic—Scatter Propagation.<sup>44,45</sup> The editor's Foreword reads, in part,

The nature of scatter propagation and its practical significance are fully described in the following pages. Suffice it to note here that the material in these pages, released for publication just in the last three or four months, presents the results of over four years of intensive work on the subject.

The special issue editors stated:

. . . Recent experiments have demonstrated that it is possible to achieve very reliable "beyond-the-horizon" (scatter) radio communication in both the vhf and uhf regions of the spectrum. There has been, therefore, extensive re-examination of existing data, as well as increasing propagation research, primarily to provide necessary information for the design of scatter communication systems.

This collection of papers discusses two distinctly different modes of transmission which have been announced recently. The first mode, *ionospheric*, is communication by means of radio waves scattered, it is believed, from the lower *E*-layer of the ionosphere. The phenomenon permits communication in the frequency range from 25 to approximately 60 mc, and over distances extending from approximately 600 to 1200 miles. Such circuits have so far been limited to use with teletype or voice intelligence. The second mode, *tropospheric*, is propagation by means of the scattering of electromagnetic waves by the troposphere. This phenomenon is, to a first approximation, independent of frequency; it appears to be useful for communication purposes over the frequency band extending from 100 to at least 10,000 mc.

---

<sup>44</sup> Publication of the issue was under the joint sponsorship of the IRE Professional Group on Antennas and Propagation (PGAP) and the Joint Technical Advisory Committee (JTAC) of the Electronic Industries Association and the Institute of Radio Engineers.

<sup>45</sup> Jerome B. Wiesner, Director of the Research Laboratory of Electronics at the Massachusetts Institute of Technology, organized the issue and Kenneth A. Norton, Chief of the Radio Propagation Engineering Division, CRPL, shared in planning the contents and procuring, reviewing, and selecting the material.

Although it has been commonly believed that vhf and uhf radio transmission were limited to the line-of-sight distances, evidence to the contrary had been noted by early workers. In retrospect, Eckersley's work anticipated the ionospheric scatter effect, and Marconi found evidence in his short-wave experiments which led him to believe that with adequate power and a more sensitive receiver he could transmit beyond the optical line of sight. In December 1932 Marconi wrote, in a paper published in the Proceedings of the Royal Institution of Great Britain, "In regard to the limited range of propagation of these microwaves, the last word has not been said. It has already been shown that they can travel round a portion of the earth's curvature, to distances greater than had been expected, and I cannot help reminding you that at the very time when I first succeeded in proving that electric waves could be sent and received across the Atlantic Ocean in 1901, distinguished mathematicians were of the opinion that the distance of communications, by means of electric waves, would be limited to a distance of only about 165 miles." The propagation field has now caught up with Marconi's vision.

Speculations which led to the discovery of the ionospheric scatter communication were actually stimulated by discussions in 1950 regarding the use of tropospherically scattered signals. Thus the two completely separate techniques developed simultaneously.

Even though the existence of the scatter signals at great distances is well established, common agreement is lacking on the physical mechanism by which they are propagated. In the case of the tropospherically propagated uhf signals, most investigators attribute the presence of these fields, whose strengths greatly exceed the expected diffraction fields, to scattering from turbulent "blobs" in the atmosphere. However, some theorists believe that a partial reflection from a smooth atmosphere, the density of which varies with height, would by itself account for such signals. Unfortunately, the mathematical problems involved in obtaining an analytical solution of this model present great difficulty, and the conflict between these two points of view has not been completely resolved.

The newly exploited propagation techniques discussed in these papers make possible extremely reliable communication over distances of 100 to 1000 miles, distances formerly considered too short for good ionospheric propagation and too long for conventional vhf or uhf transmission.

Kenneth A. Norton and Jerome B. Wiesner

### 3. CRPL research on tropospheric forward scatter

#### a) IT GETS STARTED

At about the time that the Booker-Gordon theory was announced, CRPL began a systematic study of tropospheric forward scatter [53].<sup>46</sup> It included not only conventional techniques but also advanced concepts designed to explain and define observed scatter phenomena. Specific activities in the field included investigations of such quantities as fading rate, transmission loss, fading range, phase variations, angular distance, and obstacle gain (all of which are described in various sections of this chapter).

A program at CRPL which led directly to studies of tropospheric forward scatter began in January 1949 (this was a year before the Booker-Gordon theory was announced). CRPL entered into contracts with the Federal Communications Commission, several universities, broadcasting companies, and other organizations to measure the field strengths of a number of FM and TV stations. By the end of 1951 long-term measurements were being obtained

---

<sup>46</sup> A comprehensive summary of tropospheric forward scatter research by CRPL up to 1956 was given in the February 1956 issue of the *NBS Technical News Bulletin* (see reference [53]).

over more than a hundred propagation paths in all parts of the United States. Data were supplied to CRPL by these contractors in the form of hourly median values of field strength and were recorded over some paths for several years. These data were transferred to punched cards in order to make them more readily available, and became the basis of several comprehensive reports (for example *Technical Note 101*, see footnote 10).

## b) MATHEMATICAL STUDIES

Among the earliest research on tropospheric forward scatter at CRPL were mathematical studies by several members of the staff.

Norton derived "a formula for the transmission loss of space waves propagated over irregular terrain" (an unpublished NBS report dated June 16, 1952, not circulated outside NBS). Norton also introduced the concepts of transmission loss (p. 515) and angular distance (p. 517).

Harold Staras investigated the scattering of electromagnetic energy in a randomly inhomogeneous atmosphere, and the effect of scattering by a turbulent atmosphere on the received field deep in the shadow region [54]. He derived an integral expression for this scattered power based on first-order perturbation. This expression was identical with those used by Booker and Gordon (p. 549) and earlier by C. L. Pekeris at Columbia University (Feb. 1947). However, instead of a space-correlation function of refractive-index variations Staras used a time-correlation function which permitted a formal evaluation of the time-average scattered power. He found that for large-scale turbulence, the frequency and scattering-angle dependence of the scattered energy was greatly affected by the time-correlation function chosen.

Staras presented a paper entitled "The Statistics of Scattered Radiation," at the Conference on Radio Propagation and Standards, held during the Dedication of the Boulder Laboratories, National Bureau of Standards (Sept. 1954).<sup>47</sup> The paper was based on his Ph.D. thesis at the University of Maryland [55,56]. He derived explicit mathematical expressions for many of the statistical parameters that appear in scattering theory, assuming isotropic turbulence. Among the statistical properties included were the statistical distribution of the received signal, the correlation of signals received on spaced antennas, and the correlation of signals as a function of the separation of the carrier frequencies.

Joseph Feinstein of the CRPL Tropospheric Propagation Research Section made a study of the persistent anomalous field strengths measured far beyond the horizon, which he explained on the basis of partial reflections produced by the atmospheric gradient of refractive index [57]. When he evaluated these partial reflections on the basis of a hybrid-wave and ray theory, he observed that calculated signal strengths were of the order of magnitude of those measured. In addition, the wavelength, distance, and angular dependence appeared to be in agreement with observation. Feinstein developed a mathematical treatment which accounted for these reflections and presented the results graphically [58].

He further proposed that, for a refractive-index distribution which is an analytic function of height, the total effect of a gradient is of the order of the effective earth-radius modification of the uniform-atmosphere theory. When a discontinuity in any order derivative is present, an inverse-distance power-law signal dependence is obtained in which the magnitude of the power is a function of the order of the derivative possessing the discontinuity [59,60].

After making a few formal observations concerning wave propagation through an inhomogeneous medium, George Hufford suggested a modification of Kirchoff's formula and derived an integral equation which gave an estimate of the error made in the usual approximate methods [61]. Applications were indicated to the equivalent Earth's radius model and to the flat-Earth modified-index model.

---

<sup>47</sup> Harold Staras had resigned from NBS and was with the Engineering Products Division, Radio Corporation of America, Camden, N.J., in Sept. 1954. He had started work on his Ph.D. thesis while with CRPL.

## 4. Scatter measurements near the radio horizon

Measurements of small variations in 100-MHz field intensity within and just beyond the radio horizon were made by Janes and Paul I. Wells, in order to increase basic knowledge of the scattering mechanism and to evaluate the effect of scattering in certain practical applications involving line-of-sight transmission [62]. The transmission paths used in the measurements were from the summit transmitter of the Cheyenne Mountain field site to three of the Cheyenne Mountain Project receiving sites in eastern Colorado—Kendrick, Karval, and Haswell (see p. 531).

Both the transmitting and receiving antennas had rather broad beams and therefore for each of the transmission paths, the parameters of the scattering integral were determined almost entirely by the scattering elements themselves.

The measured fields were considered to be the resultant of two field components, one having a constant amplitude and the other being a rapidly-fading scattered component. The purpose of the analysis was to determine the relative magnitude of each of these two components.

## REFERENCES

- [1] M. Schulkin, "Average radio-ray refraction in the lower atmosphere," CRPL Report 2-2, August 11, 1947; *Proc. IRE*, Vol. 40, No. 5, May 1952, pp. 554-561.
- [2] D. L. Randall, "A study of some of the meteorological effects on radio propagation at 96.3 Mc between Richmond, Va., and Washington, D.C.," *Bull. Amer. Meteorological Soc.*, Vol. 35, No. 2, Feb. 1954, pp. 56-59.
- [3] Howard E. Bussey, "Reflected ray suppression," *Proc. IRE* (Correspondence), Vol. 38, No. 12, Dec. 1950, p. 1453. Also "Suppression of microwaves by zonal screens," *Nat. Bur. Stand. (U.S.) Tech. News Bull.*, Vol. 36, No. 1, Jan. 1952, pp. 6-7. U.S. Patent No. 2,763,001, issued Sept. 11, 1956.
- [4] J. W. Herbstreit and P. L. Rice, Survey of Central Radio Propagation Laboratory Research in Tropospheric Propagation 1948-1956, *Nat. Bur. Stand. (U.S.) Tech. Note 26*, Sept. 1959, 127 pages + 22 supplements of varying page lengths and including numerous figures, a total of 380 pages and 224 figures.
- [5] Kenneth A. Norton, "Transmission loss in radio propagation," *Proc. IRE*, Vol. 41, No. 1, Jan. 1953, pp. 146-152.
- [6] Kenneth A. Norton, "System loss in radio wave propagation," *J. Res. Nat. Bur. Stand. (U.S.)*, Vol. 63D, No. 1, July-Aug. 1959, pp. 53-73.
- [7] D. A. Williamson, V. L. Fuller, A. G. Longley, and P. L. Rice, A Summary of VHF and UHF Tropospheric Transmission Loss Data and Their Long-Term Variability, *Nat. Bur. Stand. (U.S.) Tech. Note 43*, Mar. 1960, 37 pages + 137 figures.
- [8] P. L. Rice, A. G. Longley, K. A. Norton, and A. P. Barsis, Transmission Loss Predictions for Tropospheric Communication Circuits, Vol. I and Vol. II, *Nat. Bur. Stand. (U.S.) Tech. Note 101*, Vols. I and II, May 7, 1965 (reissued May 1, 1966 and Jan. 1, 1967), Vol. I, 188 + VI pages; Vol. II, 202 + VI pages.
- [9] K. A. Norton, P. L. Rice, and L. E. Vogler, "The use of angular distance in estimating transmission loss and fading range for propagation through a turbulent atmosphere over irregular terrain," *Proc. IRE*, Vol. 43, No. 10, Oct. 1955, pp. 1488-1526.
- [10] B. R. Bean and E. J. Dutton, Radio Meteorology, *Nat. Bur. Stand. (U.S.) Monogr. 92*, March 1, 1966, 435 pages.
- [11] Ernest K. Smith, Jr., and Stanley Weintraub, "The constants in the equation for atmospheric refractive index at radio frequencies," *J. Res. Nat. Bur. Stand. (U.S.)*, Vol. 50, No. 1, Jan. 1953, pp. 39-41; also *Proc. IRE*, Vol. 41, No. 8, Aug. 1953, pp. 1035-1037.
- [12] Stanley Weintraub, "Slide rule computes radio refractive index of air," *Electronics*, Vol. 26, No. 1, Jan. 1953, pp. 182, 186, 190, 194, 196, 198, 200.
- [13] Walter E. Johnson, "An analogue computer for the solution of the radio refractive index equation," *J. Res. Nat. Bur. Stand. (U.S.)*, Vol. 51, No. 6, Dec. 1953, pp. 335-342.
- [14] George Birnbaum, "A recording microwave refractometer," *Rev. Sci. Instr.*, Vol. 21, No. 2, Feb. 1950, pp. 169-176.
- [15] George Birnbaum, "Fluctuations in the refractive index of the atmosphere at microwave frequencies," *Phys. Rev. (Letter to the Editor)*, Vol. 82, No. 1, Apr. 1, 1951, pp. 110-111.
- [16] George Birnbaum, Howard E. Bussey, and R. R. Larson, "The measurement of variations in atmospheric refractive index," *IRE Trans. Antennas and Propagation*, Vol. PGAP-3, Aug. 1952, pp. 74-78.
- [17] Howard E. Bussey and George Birnbaum, "Measurement of variations in atmospheric refractive index with an airborne microwave refractometer," *J. Res. Nat. Bur. Stand. (U.S.)*, Vol. 51, No. 4, Oct. 1953, pp. 171-178.
- [18] M. C. Thompson, Jr., and M. J. Vetter, "Compact microwave refractometer for use in small aircraft," *Rev. Sci. Instr.* Vol. 29, No. 12, Dec. 1958, pp. 1093-1096.
- [19] Moody C. Thompson, Jr., Frank E. Freathy, and Donald M. Waters, "Fabrication techniques for ceramic X-band cavity resonators," *Rev. Sci. Instr.* Vol. 29, No. 10, Oct. 1958, 865-868. U.S. Patent No. 2,981,908, issued April 25, 1961.

- [20] M. J. Vetter and M. C. Thompson, Jr., "Absolute microwave refractometer," *Rev. Sci. Instr.* Vol. 33, No. 6, June 1962, pp. 656-660. U.S. Patent No. 3,400,330, issued Sept. 30, 1968 (see footnote 21).
- [21] George Birnbaum and H. E. Bussey, "Amplitude, scale, and spectrum of refractive index inhomogeneities in the first 125 meters of the atmosphere," *Proc. IRE*, Vol. 43, No. 10, Oct. 1955, pp. 1412-1418.
- [22] Bradford R. Bean, "Climatology of ground-based radio ducts," *J. Res. Nat. Bur. Stand. (U.S.)*, Vol. 63D, No. 1, July-Aug. 1959, pp. 29-34.
- [23] B. R. Bean and E. J. Dutton, "Concerning radiosondes, lag constants, and radio refractive index profiles," *J. Geophys. Research*, Vol. 66, No. 11, Nov. 1961, pp. 3717-3722.
- [24] B. R. Bean, "First meeting on radio climatology," *Proc. IRE (Letter to the Editor)*, Vol. 46, No. 7, July 1958, pp. 1425-26.
- [25] "Radio Refractive Index Data Center," *Tech. News Bull. Nat. Bur. Stand. (U.S.)*, Vol. 46, No. 1, Jan. 1962, p. 5.
- [26] B. R. Bean and G. D. Thayer, CRPL Exponential Reference Atmosphere, *Nat. Bur. Stand. (U.S.) Monogr. 4*, Oct. 29, 1959, 67 pages. See also B. R. Bean and G. D. Thayer, "CRPL Exponential Reference Atmosphere," *J. Res. Nat. Bur. Stand. (U.S.)*, Vol. 63D, No. 3, Nov.-Dec. 1959, pp. 315-317.
- [27] B. R. Bean, J. D. Horn, and L. P. Riggs, "Refraction of radio waves at low angles within various air masses," *J. Geophys. Research*, Vol. 65, No. 4, Apr. 1960, pp. 1183-1187.
- [28] G. D. Thayer, "A formula for radio ray refraction in an exponential atmosphere," *J. Res. Nat. Bur. Stand. (U.S.)*, Vol. 65D, No. 2, Mar.-Apr. 1961, pp. 181-182.
- [29] C. F. Pappas, L. E. Vogler, and P. L. Rice, "Graphical determination of radio ray bending in an exponential atmosphere," *J. Res. Nat. Bur. Stand. (U.S.)*, Vol. 65D, No. 2, Mar.-Apr. 1961, pp. 175-179.
- [30] B. R. Bean and B. A. Cahoon, "Correlation of monthly median transmission loss and refractive index profile characteristics," *J. Res. Nat. Bur. Stand. U.S.*, Vol. 65D, No. 1, Jan.-Feb. 1961, pp. 67-74.
- [31] B. R. Bean and B. A. Cahoon, "A note on the climatic variation of absolute humidity," *Bull. Am. Meteorol. Soc.*, Vol. 38, No. 7, Sept. 1957, pp. 395-398.
- [32] B. R. Bean and L. P. Riggs, "Synoptic variation of the radio refractive index," *J. Res. Nat. Bur. Stand. (U.S.)*, Vol. 63D, No. 1, July-Aug. 1959, pp. 91-97.
- [33] B. R. Bean, L. P. Riggs, and J. D. Horn, "Synoptic study of the vertical distribution of the radio refractive index," *J. Res. Nat. Bur. Stand. U.S.*, Vol. 63D, No. 2, Sept.-Oct. 1959, pp. 249-254.
- [34] B. R. Bean and J. D. Horn, "Radio-refractive-index climate near the ground," *J. Res. Nat. Bur. Stand. (U.S.)*, Vol. 63D, No. 3, Nov.-Dec. 1959, pp. 259-271. See also B. R. Bean, J. D. Horn, and A. M. Ozanich, Jr., Climatic Charts and Data of the Radio Refractive Index for the United States and the World, *Nat. Bur. Stand. (U.S.) Monogr. 22*, Nov. 25, 1960, 178 pages.
- [35] A. P. Barsis, J. W. Herbstreit, and K. O. Hornberg, Cheyenne Mountain Tropospheric Propagation Experiments, *Nat. Bur. Stand. (U.S.) Circ. 554*, Jan. 3, 1955, 39 pages.
- [36] Raymond E. McGavin and Leo J. Maloney, "Study at 1046 megacycles per second of the reflection coefficient of irregular terrain at small grazing angles," *J. Res. Nat. Bur. Stand. (U.S.)*, Vol. 63D, No. 2, Sept.-Oct. 1959, pp. 235-248.
- [37] R. S. Kirby, H. T. Dougherty, and P. L. McQuate, "VHF propagation measurements in the Rocky Mountain region," *IRE Trans. Vehicular Communications.*, Vol. VC-6, July 1956, pp. 13-19.
- [38] R. S. Kirby, H. T. Dougherty, and P. L. McQuate, "Obstacle gain measurements over Pikes Peak at 60 to 1046 Mc," *Proc. IRE*, Vol. 43, No. 10, Oct. 1955, 1467-1472.
- [39] A. P. Barsis and R. S. Kirby, "VHF and UHF signal characteristics observed on a long knife-edge diffraction path," *J. Res. Nat. Bur. Stand. (U.S.)*, Vol. 65D, No. 5, Sept.-Oct. 1961, pp. 437-448.
- [40] A. P. Barsis and F. M. Capps, "Effect of super-refractive layers on tropospheric signal characteristics in the Pacific coast region," *I.R.E. Wescon Conv. Record*, Vol. 1, part I, 1957, pp. 116-133.
- [41] A. P. Barsis and Mary Ellen Johnson, Prolonged Space-Wave Fadeouts in Tropospheric Propagation, *Nat. Bur. Stand. (U.S.) Tech. Note 88*, Feb. 8, 1961, 40 pages + 30 figures.
- [42] H. B. Janes, J. C. Stroud, and M. T. Decker, An Analysis of Propagation Measurements Made at 418 Mc Well Beyond the Radio Horizon, *Nat. Bur. Stand. (U.S.) Tech. Note 6*, May 1959, 84 pages.  
See also a digest of this *Tech. Note* (same authors, same title, "—a digest"), *J. Res. Nat. Bur. Stand. (U.S.)*, Vol. 64D, No. 3, May-June 1960, pp. 255-257.
- [43] H. B. Janes, "An analysis of within-the-hour fading in 100- to 1000-Mc transmissions," *J. Res. Nat. Bur. Stand. (U.S.)*, Vol. 54, No. 4, Apr. 1955, pp. 231-250.
- [44] J. W. Herbstreit and M. C. Thompson, "Measurements of the phase of radio waves received over transmission paths with electrical lengths varying as a result of atmospheric turbulence," *Proc. IRE*, Vol. 43, No. 10, Oct. 1955, pp. 1391-1401.
- [45] M. C. Thompson, Jr., and H. B. Janes, "Measurements of phase stability over a low-level tropospheric path," *J. Res. Nat. Bur. Stand. (U.S.)*, Vol. 63D, No. 1, July-Aug. 1959, pp. 45-51.
- [46] M. C. Thompson, Jr., and H. B. Janes, Radio Path Length Stability of Ground-to-Ground Microwave Links, *Nat. Bur. Stand. (U.S.) Tech. Note 219*, Nov. 15, 1964, 17 pages + 50 figures.
- [47] K. A. Norton, et al (10 co-authors), An Experimental Study of Phase Variations in Line-of-Sight Microwave Transmissions, *Nat. Bur. Stand. (U.S.) Monogr. 33*, Nov. 1, 1961, 90 pages.
- [48] "CRPL aids missile tracking," *Nat. Bur. Stand. (U.S.) Tech. News Bull.* Vol. 46, No. 3, Mar. 1962, pp. 46-47.
- [49] H. B. Janes and M. C. Thompson, Jr., "Errors induced by the atmosphere in microwave range measurements," *J. Res. Nat. Bur. Stand. (U.S.)*, Vol. 68D, No. 11, Nov. 1964, pp. 1229-1235.
- [50] H. B. Janes, A. W. Kirkpatrick, D. M. Waters, and D. Smith, Phase and Amplitude Diversity in Over-Water Transmissions at Two Microwave Frequencies, *Nat. Bur. Stand. (U.S.) Tech. Note 307*, Apr. 12, 1965, 18 pages + 44 figures.

- [51] H. B. Janes and M. C. Thompson, Jr., Observed Phase-Front Distortion in Simulated Earth-to-Space Microwave Transmissions, *Nat. Bur. Stand. (U.S.) Tech. Note 339*, May 12, 1966, 19 pages + 73 figures + 4 tables.
- [52] William J. Hartman and Martin T. Decker, "Mutual interference between surface and satellite communication systems," *J. Res. Nat. Bur. Stand. (U.S.)*, Vol. 65D, No. 5, Sept.-Oct. 1961, pp. 433-436.
- [53] "Forward scatter of radio waves, Part II. Tropospheric forward scatter," *Tech. News Bull. Nat. Bur. Stand. (U.S.)*, Vol. 40, No. 2, Feb. 1956, pp 24-27.
- [54] Harold Staras, "Scattering of electromagnetic energy in a randomly inhomogeneous atmosphere," *J. Appl. Phys.*, Vol. 23, No. 10, Oct. 1952, pp. 1152-1156.
- [55] H. Staras, "The statistics of scattered radiation," Abstract 99, and H. Staras, "A mathematical study of beyond-the-horizon scatter transmissions," Abstract 100, *Nat. Bur. Stand. (U.S.) Tech. Note 26*, Sept. 1959, pp. 45-46 (see reference 4).
- [56] H. Staras, "A mathematical study of beyond-the-horizon scatter propagation," dissertation submitted to the Graduate Faculty, University of Maryland, in partial fulfillment of the requirements for the Ph.D. degree (1955). See also Harold Staras, "Forward scattering of radio waves by anisotropic turbulence," *Proc. IRE*, Vol. 43, No. 10, Oct. 1955, pp. 1374-1380.
- [57] J. Feinstein, "The role of partial reflections in tropospheric propagation beyond the horizon," *IRE Trans. Antennas and Propagation*, Vol. PAGP-2, March 1952, pp. 2-8.
- [58] J. Feinstein, "Tropospheric propagation beyond the horizon," *J. Appl. Phys.* (Letter to the Editor), Vol. 22, No. 10, Oct. 1951, pp. 1292-1293.
- [59] J. Feinstein, "The nature of gradient reflections," *IRE Trans. Antennas and Propagation*, Vol. PGAP-4, Dec. 1952, pp. 2-13.
- [60] "New theory on UHF radio wave propagation," *Tech. News Bull. Nat. Bur. Stand. (U.S.)*, Vol. 36, No. 2, Feb. 1952, p. 17-18.
- [61] George A. Hufford, "A note on wave propagation through an inhomogeneous medium," *J. Appl. Phys.*, Vol. 24, No. 3, Mar. 1953, pp. 268-271.
- [62] H. B. Janes and P. I. Wells, "Some tropospheric scatter propagation measurements near the radio horizon," *Proc. IRE*, Vol. 43, No. 10, Oct. 1955, pp. 1336-1340.



## Chapter XIII

### ENGINEERING FOR RADIO PROPAGATION<sup>1</sup>

#### INTRODUCTION

With the formation of the CRPL on May 1, 1946, there came an outburst of planning and setting the stages for many projects that would continue within NBS, at least in their broader aspects, until 1965 when the functions of the CRPL became a part of ESSA (Environmental Sciences Services Administration). Of considerable significance were some of the "engineering" projects inaugurated by the Frequency Utilization Research Section during the fall of 1946.<sup>2</sup> These projects included: A study of radio navigation systems, studies of radio noise (however, studies of radio noise, both atmospheric and cosmic, remained within the Experimental Ionospheric Research Section for several years), antenna research, the study of a systematic error in phase-type distance measuring equipment (a system later to be used for measurement of speed of radio waves), and studies relating to color television.

#### NOISE—THE LIMITING FACTOR TO RADIO RECEPTION

##### 1. The IRPL studies the effect of atmospheric noise

Interest at NBS in the nature and effect of atmospheric noise ("static") on radio reception began in the early 1920's with the investigations by Louis W. Austin (in residence at NBS—see ch. II). Years passed before any further effort was made toward taking into account the effect of atmospheric noise on radio reception. It was noted to a very limited extent in the IRPL's (Interservice Radio Propagation Laboratory) Radio Transmission Handbook, Frequencies 1000 to 30,000 KC of January 1, 1942, and Supplement of June 1,

---

<sup>1</sup>This title is oriented to that of radio communication technology and covers CRPL projects not directly related to the study of propagation characteristics of the ionosphere and the troposphere. These projects were in the areas of noise, antennas, modulation, radio navigation systems, utilization of the frequency spectrum, and others. In February 1949, these projects were distributed among the several sections comprising the newly-formed Systems Research Laboratory of CRPL (see app. C). During 1951 the systems research activities were transferred to Boulder, Colo. Upon expansion of CRPL research after the move to Boulder in 1954, these "engineering" projects were spread among the two radio propagation divisions (see app. C). The *NBS Annual Report for 1955* stated acutely:

The ultimate objective of NBS work in radio propagation engineering is the more efficient use of the radiofrequency spectrum. This objective can be attained only to the extent that the nature of radio-wave propagation, together with the characteristics and effects of radio noise and interference upon various signals, are known qualitatively and quantitatively.

By 1956 they became part of the new Radio Propagation Engineering Division which also included research and development in tropospheric communication. By 1959 the engineering projects were spread over both the Radio Propagation Engineering Division and the newly formed Radio Communication and Systems Division. However, the Radio Propagation Engineering Division continued to be largely oriented to tropospheric propagation research and development.

<sup>2</sup>The Frequency Utilization Research Section was organized on October 1, 1946, by the newly appointed chief, Kenneth A. Norton, a former member of the Radio Section. The three early members of this section, Norton, William Q. Crichlow, and Jack W. Herbstreit, would take important roles in the future work of the CRPL relating to engineering for radio propagation.

1942 (see ch. XI, pp. 403-404).<sup>3</sup> The topic was discussed in some detail in the IRPL Radio Propagation Handbook, issued November 15, 1943 (see ch. XI, p. 410), indicating the importance of noise level in communication systems.<sup>4,5</sup> However, much of the information had been obtained from the British Inter-Services Ionosphere Bureau (ISIB).<sup>6</sup>

<sup>3</sup> In his "Milestones" lecture of October 24, 1974, Newbern Smith (former chief of CRPL) stated that the year 1941 was significant in the Radio Section for the beginning of a study of noise effects on radio reception.\* This study was reflected early, first in the 1942 Handbook (in Supplement) and to a greater extent in the IRPL Handbook of 1943.

\*Taking part in the celebration of the 100th Anniversary of Marconi's birth, the Department of Commerce Boulder Laboratories sponsored the Marconi Centennial Series of four lectures, beginning in September 1974. The series of the four Marconi lectures was one facet of the 20th Anniversary of the establishment of the Boulder Laboratories. The lectures were:

"Marconi" by Charles Süsskind, September 12, 1974

"International Aspects of Radio" by Jack W. Herbstreit, October 10, 1974

"Marconi's Impact on Radio" by George Millington, October 14, 1974

"The History of Radio in the Department of Commerce" by Newbern Smith, October 24, 1974

<sup>4</sup> Of significance, the 1943 Handbook stated:

In order to interpret calculated received field intensities in terms of their usefulness for communication, it is necessary to know the minimum value of field intensity required for reception. This is a function primarily of the noise level at the receiving location, although the factors of antenna directivity and operator's skill also enter in. The type of service desired (phone, CW, direction finding, etc.) also must be considered.

<sup>5</sup> Contained in the 1943 Handbook were world maps indicating noise zones of atmospheric noise (primarily lightning discharges) in 5 noise grades. As one would expect on the basis of thunderstorm prevalence, grade 1 was associated with arctic regions where thunderstorms are at a minimum, while grade 5 was associated with certain tropical areas where thunderstorms are most prevalent. Corresponding to the 5 noise zones were 5 sets of graphs depicting the required field intensities (microvolts per meter) for acceptable phone reception over the frequency range of 20 kHz to 40 MHz. The several curves in each graph indicated the field intensity for local time (afternoon and early evening hours requiring the highest field intensity). The graphs indicated that CW reception required but one-tenth the field intensity of phone reception.

<sup>6</sup> Research that led to information on noise given in the 1943 Handbook was initiated in 1942 at the Inter-Services Ionosphere Bureau by Dana K. Bailey and J. S. Kojan of the Army Signal Corps (Bailey joined the CRPL in 1948).

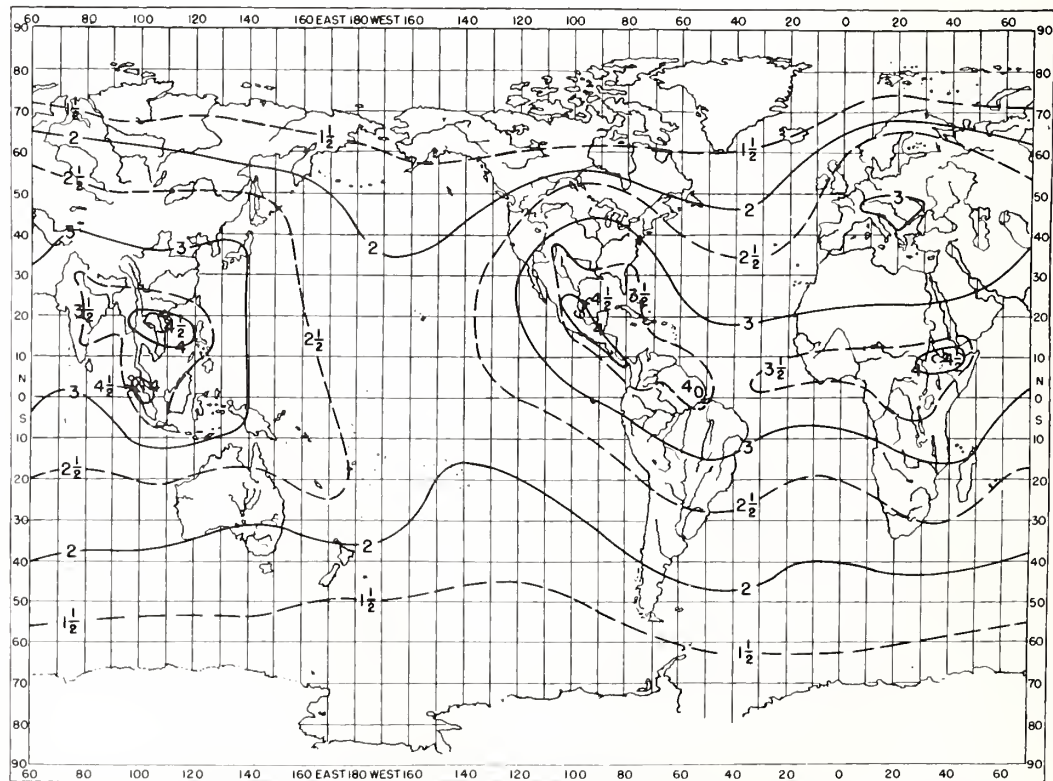

*Atmospheric radio noise distribution for period June-July-August (one of the four periods equally divided over the year). Such maps show distribution of noise grades throughout the world for each season. Areas in which thunderstorms are frequent are indicated by the high noise grades to 5. Areas remote from thunderstorms in which low noise levels occur, even by way of long distance sky-wave propagation, are indicated by low noise grades.*

Based upon experience gained during the war years of 1942 through 1945, the IRPL was able to add to its store of information by gathering further data on the effect of atmospheric noise on radio reception. By 1945 a cooperative program among three centralizing agencies resulted in a project of collecting noise data on atmospheric radio noise from 17 stations scattered over the world. By the end of 1947 an analysis of these data was published by Edna L. Shultz of the Basic Ionospheric Research Section [1].<sup>7</sup>

Upon publication of *NBS Circular 462* entitled, "Ionospheric Radio Propagation," in 1948, more information became available to the radio engineer for estimation of required field intensity for intelligible signal level in the presence of radio noise.<sup>8</sup>

## 2. The CRPL initiates a noise measurement program

Among the projects activated in 1946 by the CRPL's Experimental Ionospheric Research Section was

work on the improvement of the sensitivity of present types of equipment used to measure atmospheric radio noise and the design of instruments for automatic radio noise measurements over wide frequency ranges with discrimination in azimuth and vertical angles of arrival.<sup>9</sup>

The several years of experience by the IRPL had definitely shown that noise is the limiting factor to radio reception, and particularly by atmospheric noise on communication systems operating below 30 MHz. Thus it was desirable to study the characteristics of this noise in relation to thunderstorm activity to enable the prediction of noise levels.

During 1946 an early step was taken in the project to improve the sensitivity of the then existing equipment that was developed in England for noise measurement. A program in noise measurements had been in progress for several years at the National Physical Laboratory in England, and this led to a cooperative project being formulated between the two laboratories. Herman V. Cottony guided the project to improve the measurement equipment.

In the spring of 1949 the atmospheric noise project was transferred to the Frequency Utilization Research Section and placed in charge of William Q. Crichlow. A broader objective of the radio noise studies soon came to the fore, that of

. . . the accurate prediction and forecast of the intensity of atmospheric radio noise at any geographic location, radio frequency, time of day, season, and phase of the sunspot cycle.

During the following year steps were taken to make experimental recordings of atmospheric noise levels, the project being set up at the Sterling (Va.) field station.<sup>10</sup> In the interest of an improved noise prediction service, a continued analysis of noise data received from other sources was carried on concurrently with the development and use of the noise recording equipment.

---

<sup>7</sup>This program was initiated in 1943 by the Wave Propagation Committee of the Combined Communications Board, Combined Chiefs of Staff (see ch. XI, p. 405). Cooperating in the program were the three centralizing agencies: National Physical Laboratory (England), Australian Radio Propagation Committee, and the CRPL. Observations were in the frequency range of 2.5 to 20 MHz, but mainly at 2.5 and 5 MHz. Although there were large differences in noise levels among the stations, there appeared to be a linear decrease in average noise level (logarithmic value of noise level in microvolts) with increasing latitude in the northern hemisphere. Noise levels were in fair agreement with predictions by the U.S. Army Signal Corps.

<sup>8</sup>Much of the information in *NBS Circular 462* became available to the CRPL from work by the Radio Propagation Unit of the United States Army Signal Corps.

<sup>9</sup>Concurrent with activation of the atmospheric noise project was a closely related project with the objective of measurement of the intensity and frequency distribution of cosmic (galactic) noise in the VHF band (see ch. XIV, pp. 596-597).

<sup>10</sup>The recordings of noise levels were made over a 1-kHz bandwidth centered on 539 and 2180 kHz (near the lower and somewhat above the upper limit of the broadcast band), resulting in average values of the envelope of the atmospheric noise voltage.

By 1952 the CRPL had a program in progress for recording atmospheric noise levels on a worldwide coverage, including the development of automatic recording equipment designed for this specialized objective.<sup>11</sup> The noise program was now partially supported by the Army Signal Corps. Noise recording stations were established at Front Royal, Va. and on Gunbarrel Hill near Boulder, Colo.<sup>12</sup>

<sup>11</sup> During the course of development there evolved recording receiver equipment that covered a frequency range of 15 kHz to 20 MHz operating on eight fixed-frequency channels that provided measurement of the average noise power (within effective noise bandwidths of 150 to 300 Hz) relative to a known level at the antenna. The equipment became known as the ARN-2 Atmospheric Radio Noise Recorder. A number of recorders were manufactured on contract, following the development of the prototype model, for use at several recording sites and, several years later, for the extensive noise project of the IGY program.

<sup>12</sup> These two recording stations were fitted with a "standard" antenna consisting of a 21.75-foot vertical whip in the center of an elevated ground plane of 90 radial conductors (wire) 100 feet in length, mounted 8 feet above the surrounding terrain. The ground plane served to stabilize the antenna impedance and increase its efficiency.

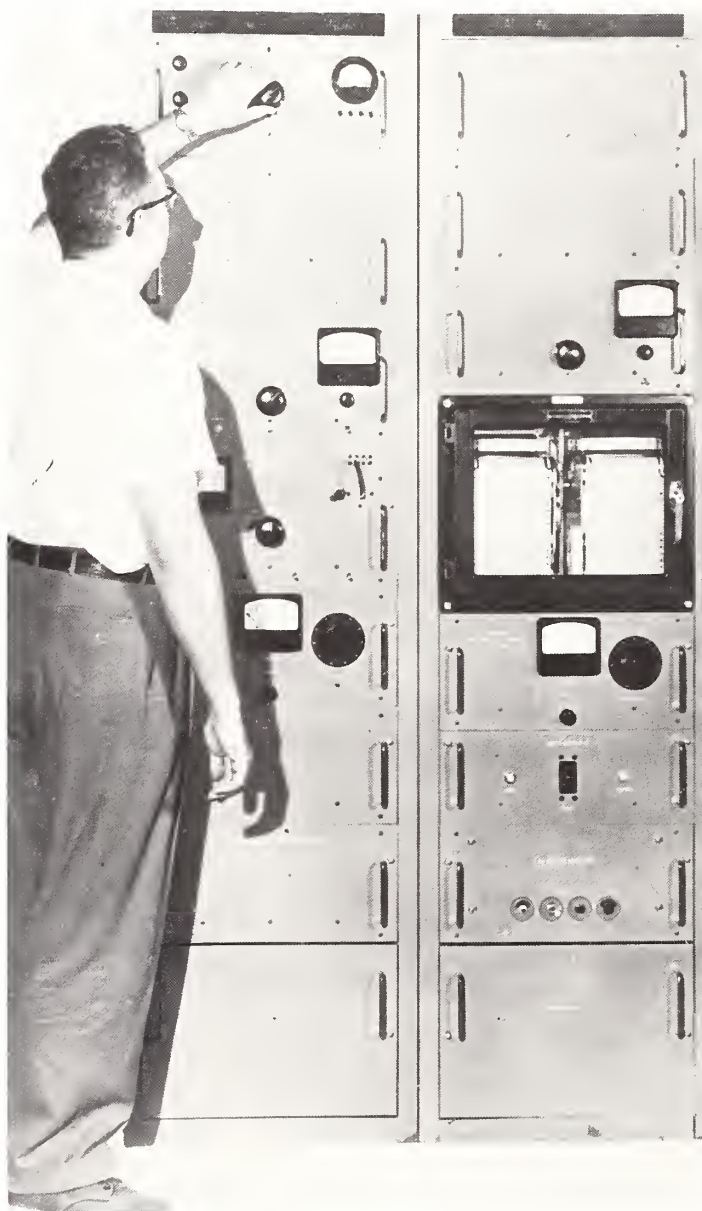

*Robert T. Disney at controls of the NBS Model ARN-2 Atmospheric Radio Noise Recorder. This equipment covers a frequency range of 15 kHz to 20 MHz, operating on eight fixed-frequency channels. A number of these recorders were manufactured on contract for use in the IGY noise measurement program of 1957-1958 that was supervised by NBS personnel.*

In order to obtain noise recordings in an area free of manmade radio noise, a mobile recording unit was used to survey an extensive region in eastern Wyoming for such a location. A location was found in an area near Bill (north of Douglas), Wyo., a local community with a population of 10.<sup>13</sup> A field station, operated by the CRPL, was located here from 1955 until 1965.

Emerging from the noise program was the publishing in 1955 of *NBS Circular 557* that discussed the characteristics of radio noise, noise predictions, and analysis of measurements [2]. Noise data were available from the Front Royal station, the Boulder station, and an English operated station at Tatsfield, England. Two years later Crichlow published a paper giving an overview of the CRPL atmospheric noise project [3].<sup>14,15</sup>

By 1955 the objective of measurement of radio noise by a worldwide network as a basis for noise predictions was in the early stages of being attained, with data becoming available from four recording stations. Robert T. Disney had been assigned to the radio noise program and began to take a very active role in its operations, continuing through the years of ESSA and until his retirement from ITS (Institute for Telecommunication Services).

### 3. NBS supervises the IGY noise program

By 1955 the CRPL's planning and preparation for the IGY (International Geophysical Year) program of 1957-1958 was getting into full swing. The worldwide nature of the IGY program gave a timely opportunity to NBS for support and establishment of a chain of radio noise recording stations scattered over the globe (see ch. XI, sec. "CRPL Participation in the IGY Program"). Through specifications of an improved type of the ARN-2 Radio Noise Recorder, NBS arranged for the manufacture of a sufficient number of the recorders to outfit 16 stations that would take part in the IGY program.<sup>16</sup> NBS engineered the installation of the recorders and training of personnel to the point where they could be operated by local staffs of the cooperating agencies.

---

<sup>13</sup> At this location the noise level was about 40 dB below the manmade noise level at Boulder. The level was but 2 dB above the thermal noise level of the receiver.

<sup>14</sup> Although Crichlow's paper was titled "Noise Investigation at VLF by the National Bureau of Standards," the frequency coverage was much beyond that of the VLF band. The paper had been presented at the Symposium on Propagation of Very-Low-Frequency Electromagnetic Waves held in January 1957 at Boulder.

<sup>15</sup> Crichlow called attention to the Bureau's participation with the British in preparing predictions of worldwide atmospheric noise levels for the International Radio Consultative Committee (CCIR). The report was adopted by the VIII Plenary Assembly of the CCIR at Warsaw, Poland in September 1956.

<sup>16</sup> With improvements in the equipment design it was now possible to obtain a more comprehensive picture of the nature of radio noise. In addition to the continuous recording of average noise power, some of the stations were outfitted to record the average envelope voltage and the average logarithm of the envelope voltage, the three measurements comprising three statistical moments of the noise observations.

Four members of the Radio Noise Section developed a means whereby the three statistical moments could be treated by a graphical method to determine the amplitude-probability distribution of atmospheric radio noise. The simplified result yielded the relation of signal voltage to percentage of time the signal level exceeded a given level. In turn, this relation could be used to predict the performance of a radio communication system in the presence of atmospheric noise of a certain locality and season of the year. (A simplified version of the published paper was prepared for the January 1960 issue of the *Technical News Bulletin* under the title of: "Graphical Method for Determining Radio Noise Characteristics.")



*The NBS noise recording station located on Gunbarrel Hill northeast of Boulder, Colo. A whip antenna extends vertically above the center of an elevated ground plane consisting of wires radiating horizontally from the base of the antenna. Such a ground plane stabilizes the antenna impedance. This station was one of 16 scattered over the World for the IGY noise program of 1957-1958, 5 of the stations being operated by the NBS.*

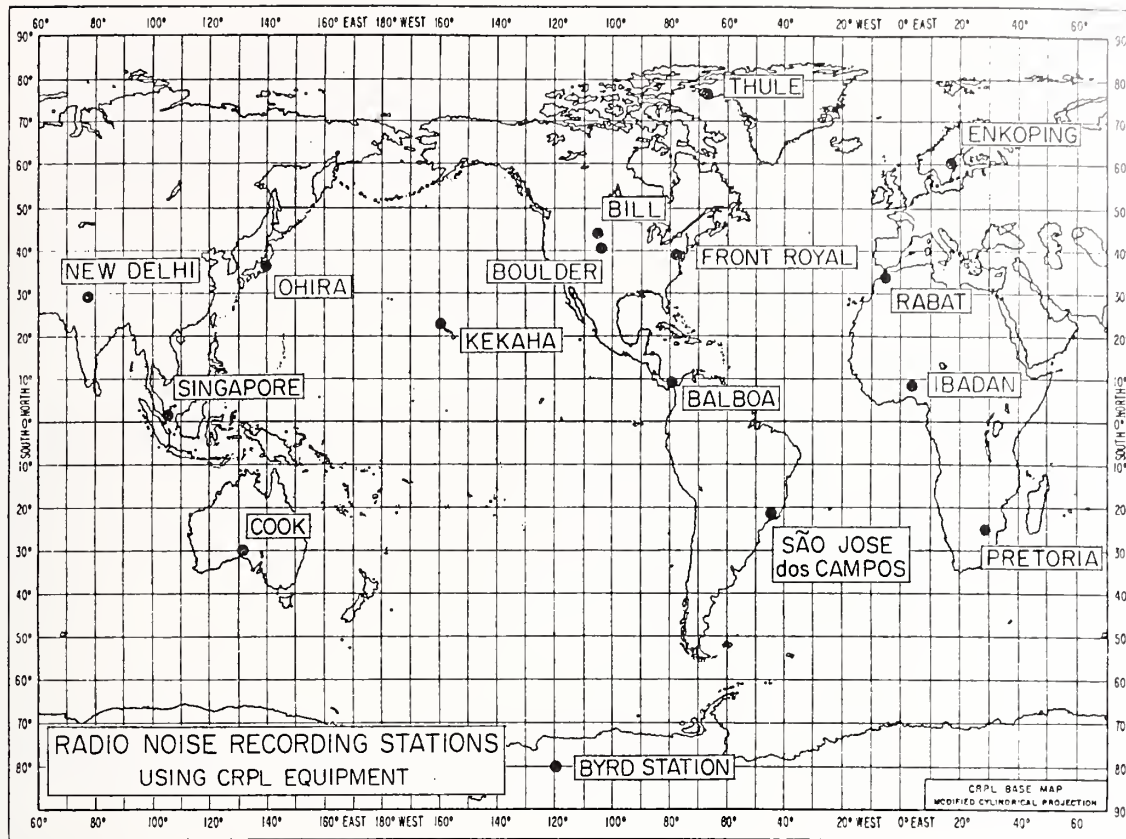

Locations of the 16 radio noise recording stations comprising the worldwide network in operation during the International Geophysical Year, 1957-1958. Each station was equipped with an NBS-designed ARN-2 Atmospheric Radio Noise Recorder, and NBS supervised the IGY noise program.

Early in 1958 the Radio Noise Section, under Crichlow's leadership, brought out NBS Report 5558 summarizing 6 months of observations that included the early months of the IGY program. Only a few of the 16 planned stations were in operation to be covered by this report.

Shortly after the close of the IGY program (July 1, 1957-December 31, 1958) the Radio Noise Section published *NBS Technical Note 18*, summarizing the data that had been recorded by the 15 stations supervised by NBS during the 18 months of observations [4].<sup>17,18</sup> No interpretation of data was given in this publication, only the noise data of the stations by frequency, month, and hour of the day. Tables showing grouping of observations by seasons (3 months each) were also given.

Beginning with the IGY program, supervision of the worldwide network of noise recording stations was continued by NBS until taken over by the Environmental Science Services Administration (ESSA) in 1965. During the years of 1957 to 1965 the noise data were garnered for publication in a continuation of the *NBS Technical Note 18* series that appeared quarterly. The final copy covered the period of March, April, May 1965 as *NBS Technical Note 18-26*. By 1963 the number of stations had grown to 18, with 7 being operated by NBS.

<sup>17</sup> Five of the stations were operated by NBS, at: Bill, Wyo.; Boulder, Colo.; Byrd Station in the Antarctic; Front Royal, Va.; and Kekaha, Hawaii. The U.S. Army Signal Corps, that had a long-time interest in the prediction of radio noise levels, operated stations at Balboa, Canal Zone and Thule, Greenland. Each of eight other stations was operated by an agency of the respective country. India did not have its station at New Delhi in operation until 1959, and then took part in the continuing program.

<sup>18</sup> The total program was a cooperative achievement of NBS with the Signal Corps Radio Propagation Agency, the Bureau of Ships, the U.S. Air Force, the National Science Foundation (which gave support to the United States participation in the IGY program), and with each of the foreign governments that took part in the global program.

#### 4. Improving the techniques of noise measurement

After much experience with the ARN-2 Radio Noise Recorder, attention was turned in 1959 to the design, experimentation with, and construction of, an Energy Spectrum Recorder. The objective was to provide an instrument for scanning the noise spectrum below 550 kHz by small increments of bandwidth in order to obtain a better understanding of noise characteristics at low frequencies.<sup>19</sup> Heretofore, atmospheric noise had had only meager study at the low portion of the radio-frequency spectrum.

As an adjunct to the noise analyzing facilities a specialized magnetic-tape system was developed for recording atmospheric noise to provide samples for reduction to a variety of statistical studies. With computer assistance, these studies could provide information on a given communication system to determine performance in the presence of atmospheric or manmade noise.

An interesting application in the early 1960's of the noise-measurement systems developed by the Radio Noise Section was that of measurement of manmade noise (as well as atmospheric noise) in the vicinity of Minuteman missile sites. Presence of radio noise was an important consideration in the performance of the launch-control system for the missile. The CRPL mobile radio noise recorder, designed for a variety of field measurements, was used in the vicinity of the missile sites.

#### 5. Cooperating with the CCIR and with URSI

In 1956 the Radio Noise Section participated in a report to the CCIR (International Radio Consultative Committee) for the prediction of worldwide atmospheric noise levels.<sup>20</sup> Later, with the application of computer assistance and the growth of the CRPL-sponsored worldwide noise-recording network, the CCIR Worldwide Prediction Charts became more useful and reliable.

During the course of the following 7 years to 1963, the Radio Noise Section was attaining its objective of "furnishing the telecommunications engineer with information on the (noise) interference environment relative to frequency, time, and location, so that design of terminal facilities will promote best utilization of the electromagnetic spectrum." By 1963 the section had completely revised its previous reports to the CCIR and submitted Report 322, entitled "World Distribution and Characteristics of Atmospheric Radio Noise." This report incorporated revisions based upon extensive investigations carried out by the section during a decade of research. The report was adopted by the Xth Plenary Assembly of the CCIR in 1963 at Geneva.

In reports of the U.S. National Committee to the General Assembly of URSI (International Scientific Radio Union) in 1960 and in 1963, Crichlow and others of the Radio Noise Section prepared information relating to atmospheric noise investigations conducted in the United States.<sup>21</sup>

#### 6. Some noteworthy observations

Observation of atmospheric radio noise led to the conclusion that the ionosphere transmits the noise of lightning discharges over considerable distances, at least in certain bands of the noise spectra. An aspect of this transmission by the ionosphere was observed in two nuclear explosions at high altitude over Johnston Island (about 700 miles southwest of the Island of Kauai, Hawaii) on August 1 and 12, 1958 [5]. For these observations use was made of the Bureau's radio noise recording station at Kekaha, Kauai. In the frequency range from 50 kHz to 2.5 MHz there was absorption in the ionosphere as a result of the

---

<sup>19</sup> The instrument was developed to scan at 200-Hz bandwidth for periods of 2.5 minutes at each of 2750 frequencies, thus requiring nearly 5 days to cover the frequency range of 200 Hz to 550 kHz. Radio signals were also scanned during the noise observations. The instrument proved to be useful in a variety of applications.

<sup>20</sup> The use of the term "predictions" has not been entirely that of forecasting future radio noise conditions but, rather, presentations of past data in summarized forms, mainly by world maps. However, the maps have shown the diurnal and seasonal characteristics of radio noise on a world scale.

<sup>21</sup> The scope of the 1963 report to the XIV General Assembly can be ascertained from the subjects covered in the report, published in the May 1964 issue of *Radio Science*—too detailed for inclusion here.



explosions that decreased the transmission of atmospheric noise by more than 30 decibels. The absorption lasted for several days after each explosion. Johnston Island was in the direct transmission path of noise recorded at Kekaha from thunderstorms in the vicinity of southeast Asia or Indonesia. With noise data collected from various stations of the Pacific area during several subsequent years, it was found that anomalies had existed in the observations of these explosions which did not lend themselves to explanation.

In 1962 the opportunity came to make atmospheric radio noise observations over extensive water areas during cruises lasting up to 80 days from South America to Antarctica. The floating radio noise station was provided by the National Science Foundation's Floating Antarctic Research Station, the USNS *Eltanin* with an ARN-2 Radio Noise Recorder on board.

## ANTENNA RESEARCH

Antenna research and development at NBS extends back to a period before 1920. During the World War I period Dellinger developed a better understanding of loop antennas, while Willoughby and Lowell developed a submarine antenna (see ch. VI). Dunmore developed some novel types of antennas. After the mid-1920's and until the formation of the CRPL in 1946, very little effort was given to antenna design and measurement, the Radio Section being much oriented during that period to propagation studies, radio aids to air navigation, and frequency standards. But the diverse and expanded fields entered upon by the CRPL brought on problems associated with antennas.

### 1. Antennas for vertical-incidence ionosondes

Among the many projects taken up by the newly formed CRPL was that of developing a more effective antenna for vertical-incidence ionospheric sounding equipment, and particularly for the NBS Model C-2 ionosphere recorder. The double rhombic antenna had been found relatively ineffective as a transmitting antenna for vertical-incidence ionospheric observations. The problem was primarily that of designing an antenna, along with the associated transmission line, with relatively constant impedance over the 1- to 25-MHz frequency range of the ionosonde. Also important was efficient radiation in the vertical direction. The first step to be taken by the Experimental Ionospheric Research Section (later known as the Ionosphere Research Section—see ch. XI, footnote 78) was the design of an instrument for measurement of the antenna impedance.<sup>22</sup>

During the course of development of an efficient transmitting antenna, various types of broad-band antennas were tested at the Sterling (Va.) field station. Full-scale antennas were used in the early experiments. Scaled-down models were used in later experiments, with scaling factors ranging up to 85. Evolving from these investigations were two types of transmitting antennas, each developed upon modifications of basic designs by other laboratories.<sup>23</sup> The development program was under the guidance of Harold N. Cones. It was a design, known as the 600-ohm multiple-wire delta antenna, that became widely used by the CRPL for its vertical-incidence ionosonde installations.

### 2. Corner-reflector antenna measurements

#### a) STUDIES AT THE STERLING FIELD STATION

The Bureau's pioneering work in the development of a radio-communication system utilizing ionospheric forward scatter led to studies of antennas that were suitable for such a

---

<sup>22</sup>Herman V. Cottony reported on the balanced recording impedance meter on March 6, 1947, at the IRE Technical Meeting in New York City, the paper entitled "A Method of Rapid Continuous Measurement of Antenna Impedance over a Wide Frequency Range." The equipment was described in several NBS publications on antennas in subsequent years.

<sup>23</sup>The earlier modification by the NBS team was that of a vertical double-W antenna that required rather large dimensions to extend the frequency down to 1 MHz. The later modification was that of a delta antenna incorporating multiple wires in various configurations in its design. The mean impedance of the multiple-wire delta antenna was well matched to the 600-ohm transmission line from an ionosonde [6].

system (see section entitled "NBS Pioneers in Radio Communication by Ionospheric Forward Scatter," ch. XI). These studies were given over largely to design variations of rhombic, corner-reflector, and Yagi antennas. The initial study was reported in 1953 by Peter P. Viezbicke, Jr. and Herman V. Cottony of the Ionospheric Research Section, the study being made on corner-reflector antennas at the Sterling field station.<sup>24</sup>

Cottony paralleled the study of corner-reflector antennas with investigations of rhombic and Yagi antennas. By 1955 the ionospheric forward scatter project was partially declassified and Cottony reported his studies to an IRE symposium (November 1955, see ch. XI, p. 497) [7]. The corner-reflector and Yagi antennas were far more compact than the rhombic antennas, a desirable feature for use in the forward scatter project. Cottony found that a particular design of a 60-degree corner-reflector had a gain of 20 decibels, a sought-after and necessary feature for transmission and reception of the weak signals transmitted by forward scatter in the ionosphere. The corner-reflector antenna became the choice for the operational communication systems built for the U.S. Air Force.

---

<sup>24</sup>This study was covered in an NBS Report entitled "Experimental Investigation of a Corner-Reflector Antenna," dated August 17, 1953. At the time it was not revealed in the report that the antenna was being studied for use in a classified project, that of the development of communication by ionospheric forward scatter.



*Large corner-reflector antenna erected at the Sterling field station for study of antennas suitable for communication by ionospheric forward scatter. The sheet-aluminum reflector surfaces could be set at various aperture angles, shown in the photo of October 1953 at 90°. Barely distinguishable near the vertex is the single half-wave dipole radiator (for operation at 400-MHz measurement frequency) at one of the two positions. Measurements of antenna gain were made as a function of aperture angle and different widths and lengths of reflector surfaces (in terms of wavelengths). Photo shows reflector size of 25 ft length and 12 1/2 ft width (across vertex).*

## b) STUDIES AT BOULDER

Antenna research at the Sterling field station was gradually moved to the Boulder Laboratories over a period of several years, beginning with the major move of the CRPL during 1954.<sup>25</sup> At Boulder studies were continued on the corner-reflector antennas, the measurements being made at the Table Mesa antenna range (later, known as the Table Mountain field station), north of Boulder.<sup>26</sup> Cottony and Alvin C. Wilson participated in the project. The antenna and apparatus for gain measurements were scaled for operation at 400 MHz, whereas operation of the ionospheric forward scatter communication system developed for the U.S. Air Force was around 50 MHz, and involved large-scale antennas. Much flexibility was incorporated into the design and constructional features of the corner-reflector antenna in order to determine the relation of antenna gain to a variety of combinations of the antenna parameters [8].<sup>27</sup>

The gain measurements were followed by a series of measurements on radiation patterns of a corner-reflector antenna. The antenna model was scaled for measurements at 2000 MHz. The model was placed on a ground-based table that could be rotated on a vertical axis for determination of the radiation patterns in the E- and H-planes. Various combinations were made of widths and lengths of the reflecting surfaces, with the aperture angle set to maximize the gain. Of particular importance was the determination of sidelobe radiation, which was found to be more than 40 decibels below the main lobe—a required performance for the antennas used in the ionospheric forward scatter communication systems [9].

<sup>25</sup> For a period of time the research activities were carried on at both locations, with personnel of the Ionospheric Research Section that were associated with antenna research being stationed at each of the two locations. With the formation of a new division in January 1959, the group was organized into the Antenna Research Section within the newly formed Radio Communication and Systems Division, with Cottony as chief of the section.

<sup>26</sup> Two steel turntables, the larger 34 feet in diameter, were installed at the Table Mountain field site for rotating both small model and full-scale antennas.

<sup>27</sup> Gain measurements were made by techniques described by Cottony in *NBS Circular 598*, entitled *Techniques for Accurate Measurement of Antenna Gain* (Dec. 1958).

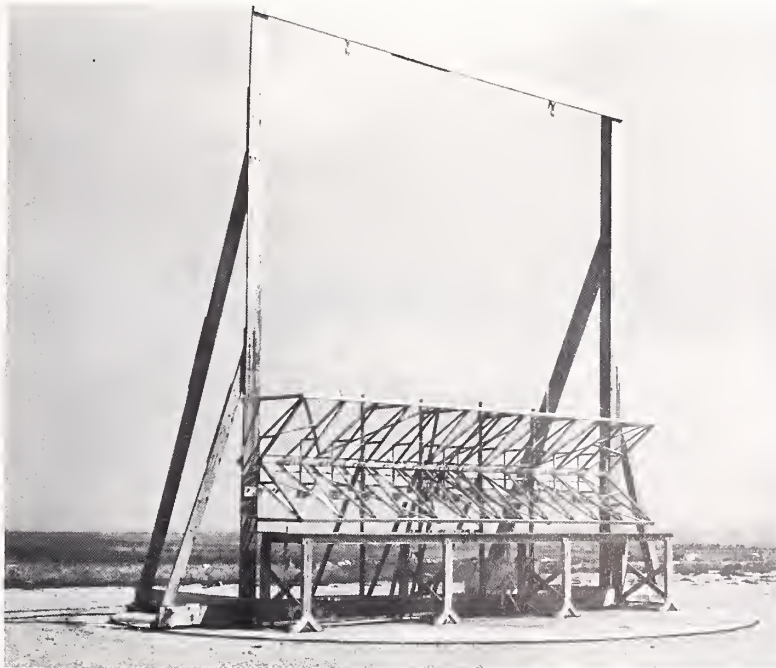

*Experimental model of corner-reflector antenna mounted on turntable at the Table Mountain field station located north of Boulder, Colo. The antenna was designed to restrict width of the main lobe to  $10^\circ$  in the E plane, and to reduce secondary-lobe radiation to greater than 40 dB below the main lobe. Reflector surfaces consisted of two planes of small diameter wires at a selected spacing. A collinear array of half-wave dipole radiators was a feature to obtain the narrow beam. The model antenna was operated at 400 MHz with a scaling factor of 10; full-scale antennas to be used in systems for communication by ionospheric forward scatter and by meteor bursts.*

In a corollary project Wilson improved upon the performance of corner-reflector antennas, increasing the gain and reducing further the side-lobe radiation. By current phasing of the feed system to the collinear array of half-wave dipoles, he was able to slew or change the directional pattern of the main lobe.

### 3. Similitude with scaled-down antennas

The design and construction of a model antenna range at the Sterling field station was, in effect, an exercise in similitude. Scaled-down models of antennas, with a corresponding increase in the operating frequency, permitted measurements to be made with comparative ease that otherwise presented problems with full-scale antennas. The model range was designed, initially, for study of antennas for ionosphere-sounding equipment (3 to 30 MHz). The range featured a large inverted V-shape structure that supported a small self-contained transmitter at the apex [10].<sup>28</sup> By the law of reciprocity, the transmitter (at apex of V-frame) and a simple receiver mounted on the model antenna (at center of ground plane) allows measurement of the antenna's radiation pattern as if a transmitter energized the antenna directly.

The model range, developed by Cottony in 1951, proved useful for measurement of radiation (or reception) patterns of many types of antennas. Later, the model range was moved to Boulder and occupied a site on the edge of the Green Mountain Mesa. Occasionally the elevated V-structure was a source of wonderment to nearby residents.

---

<sup>28</sup> The inverted V-shape structure was formed of two truss beams joined together at the apex (60-degree angle) at a point more than 50 feet above a ground plane. The beams were of plywood sections joined together without metal in order to form a nonconducting structure. The V-frame could be pivoted through an arc of 180 degrees which, in combination with orientation of the model antenna at the center of a ground plane, permitted measurements to be made of radiation patterns in a vertical plane.



*Model antenna range at the Sterling field station near Washington, D.C. The site is now occupied by Dulles International Airport. Designed to measure antenna radiation patterns in the vertical plane, the antenna is placed at the center of an oval-shaped metallic ground plane. The inverted V-frame of plywood carries a self-contained target transmitter at the apex and can be moved through a 180° arc. Photo taken in July 1951 shows V-frame at the 90° position. Using the model technique, this model permits measurements to be made in the frequency range of 60 to 1500 MHz, simulating antennas that operate in the range of 1 to 25 MHz.*

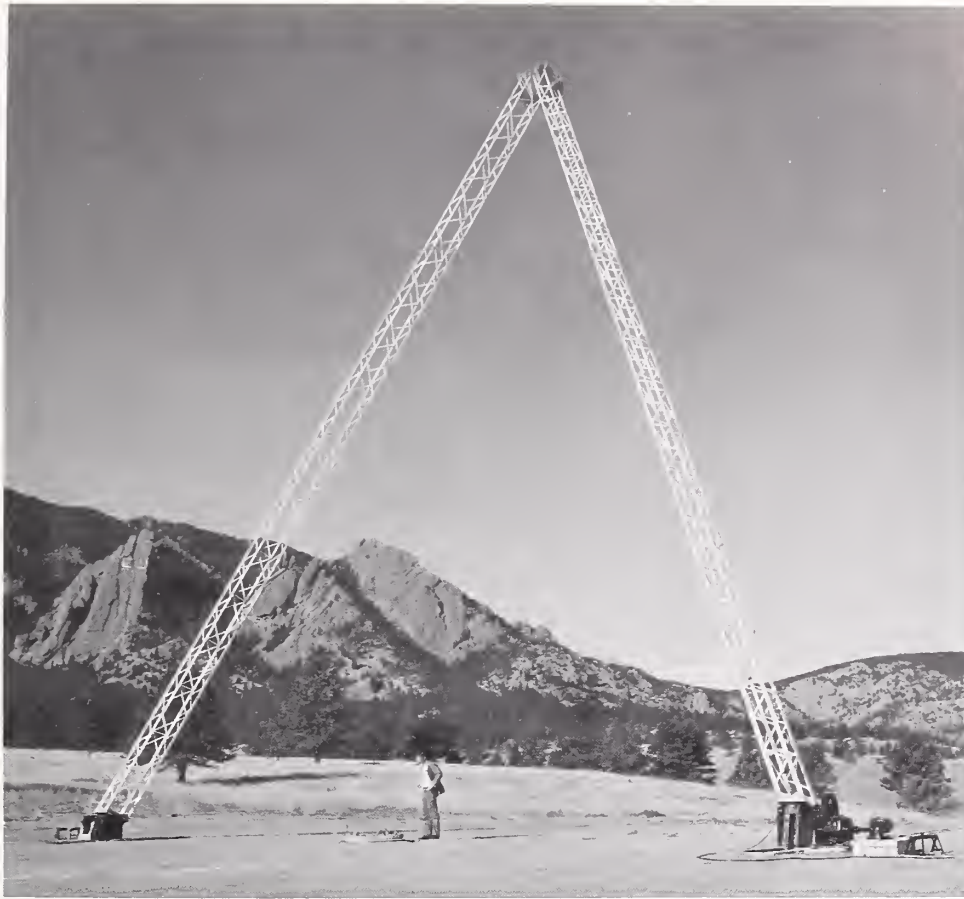

*Model antenna range located on Green Mountain Mesa at base of the Flatirons, Boulder. The inverted V-frame of improved design replaced the one brought from the flatlands of Sterling, Va. Being measured for antenna patterns, as shown in this photo of 1962, is a model of the National Science Foundation's Antarctic research ship USNS Eltanin fitted with several types of model antennas, located on ground plane in front of observer.*

#### **4. Yagis on parade—Electronically-scanned antenna arrays**

The development of a communication system by ionospheric forward scatter fostered further research of the ionosphere. There was interest and the need to know of the path structure of transmission via forward scatter. Thus came into the program of the Antenna Research Section in 1959 an experimental investigation to determine the feasibility of a receiving antenna array incorporating electronic scanning. A frequency of 41 MHz was selected in the VHF band of ionospheric forward scatter. By June 1960 the system, developed by Cottony and Wilson, was in operation with satisfying results at the Table Mountain antenna range north of Boulder. A 5.8-degree-wide beam could be swept over a 42-degree azimuth sector at a rate of 20 scans per second [11].<sup>29</sup> For the first time it was possible to observe the paths of reflections of ionospheric forward scatter. The system was also useful for observing the direction of meteor-trail reflections and sporadic-E layer reflections, the latter being a source of strong reflections.

---

<sup>29</sup> For the initial experiment seven Yagi antennas (five elements) were aligned on masts and directed toward the NBS transmitter at Long Branch field station near Havana, Ill., 1295 km distance. A complex electronic system controlled phasing of the antennas for directive reception of signals over a narrow and sweeping beam. An oscilloscope, synchronized to the incoming signals, gave direct viewing and photographing of the display of direction of maximum signal response.

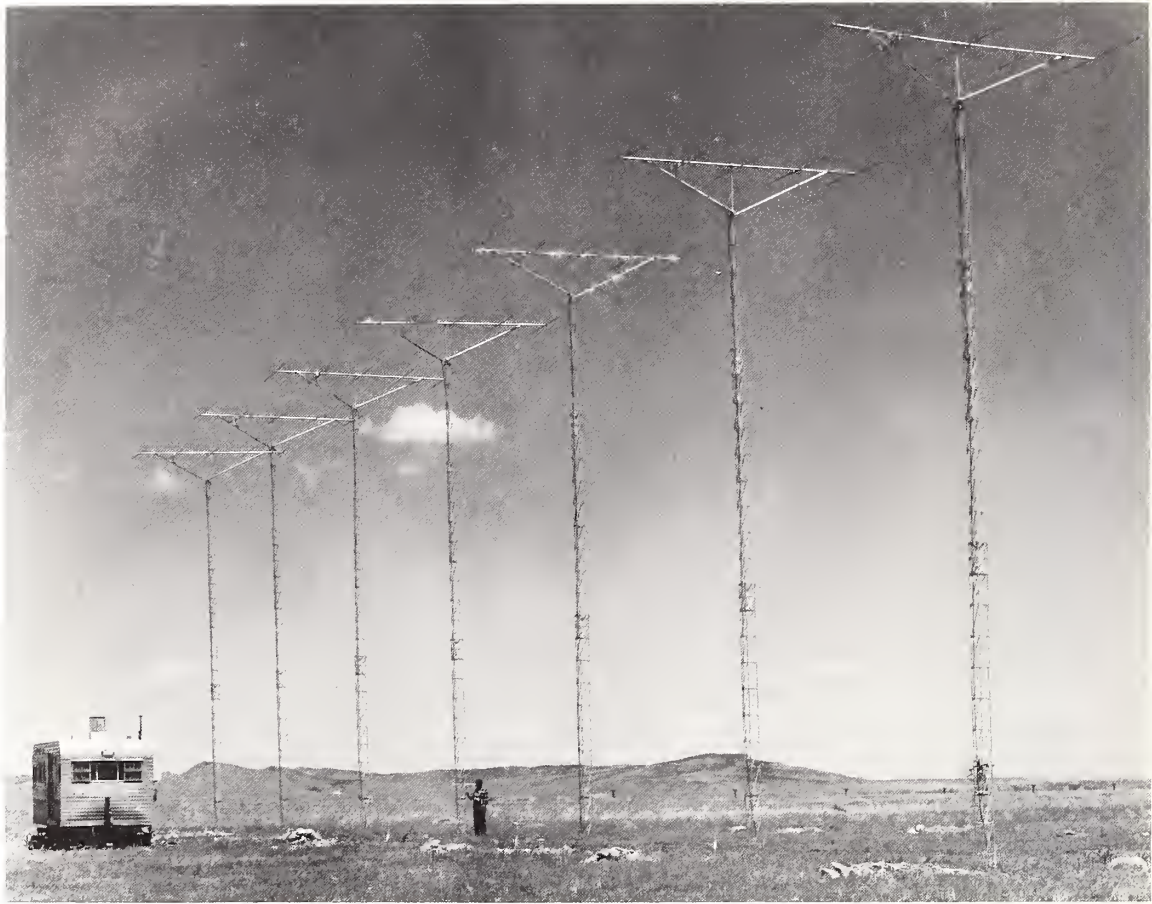

Yagis on Parade

*Electronically-scanned antenna array in operation beginning June 1960 at the Table Mountain field station north of Boulder, Colo. Designed by the Antenna Research Section, its initial use was that of studying the phenomenon of ionospheric forward scatter, receiving signals from the NBS transmitter at the Long Branch field station near Havana, Ill., 1295-km distance. The seven Yagi antennas (five elements) scanned with a 5.8-degree beam over a 42-degree azimuth sector. Later, the array was extended to 25 Yagi antennas, obtaining a beam width of 1.5 degrees.*

With this initial success, it was but a matter of increasing the number of Yagi antennas in the broadside array to improve the angular resolution by decreased bandwidth. This was accomplished in 1961 by increasing the number of Yagi antennas to 25, with the result of obtaining a 1.5-degree width of the main lobe. However, this improvement added to the complexity of the electronic scanning [12].<sup>30</sup>

With the added success of the 25-Yagi-antenna array, a similar array for operation in the 12- to 25-MHz range was completed in May 1962. This array, which used log-periodic dipole antennas (13 elements), became useful for directional back-scatter observations. Added to this array for horizontal scanning, was another for scanning in the elevation plane within the frequency range of 12 to 25 MHz.<sup>31</sup>

---

<sup>30</sup>In 1961 Cottony received the Department of Commerce Silver Medal for Meritorious Service "for sustained outstanding leadership leading to advancement of accurate methods for measurement of antenna characteristics and for the development of an important and novel technique for high resolution electronic scanning for the radiation pattern of a directive antenna array which allows an essentially unlimited scan rate."

<sup>31</sup>Ten log-periodic dipole antennas (13 elements) were arrayed at 16-meter intervals on a 152-meter tower. Again, electronic scanning was used. This array supplemented the azimuth scanning of the 25-antenna array in order to obtain a more extensive "picture" of transmission paths in the ionosphere.



*Combination (upper left) of two electronically-scanned antenna arrays of high resolution for simultaneous horizontal and vertical scanning to study the ionosphere in the frequency range of 12 to 25 MHz, including the effects of ionospheric irregularities on radio-signal propagation over long distances. The array for horizontal scanning (lower photo) consists of 25 masts, each mounted with a log-periodic dipole antenna of 13 elements. In the close-up skyward view (upper right) can be seen 8 of the 10 log-periodic dipole antennas (13 elements) for vertical scanning, mounted at 16-meter intervals on the 152-meter tower. This combination of two antenna arrays is one of many specialized facilities located at the Table Mountain field station, beginning in 1954.*

## 5. A miscellany of antenna projects

A miscellaneous assortment of antenna problems, mainly from military sources, came to the attention of, and then with subsequent attack by, the Antenna Research Section. The problems were concerned primarily with designs of specialized antennas and out-of-the-ordinary measurements. Also, the section's consulting services were in considerable demand.

One of the more unusual antennas studies was a monopole array for the U.S. Air Force. The principal feature was steering of the main lobe in a complete circle by phase change of currents feeding the 30 quarter-wave monopoles (in 2 concentric circles of 10 and 20 each) surrounding the center monopole antenna. Although in practice the array would serve as a transmitting antenna, the pattern was measured as a model of a receiving antenna mounted on a large turntable and positioned by small angle changes toward a distant target transmitter [13].

During the period of July 9 to 11, 1963, the PTGAP International Symposium on Space Telecommunications was held at the Boulder Laboratories. The event was sponsored by the IEEE Professional Technical Group on Antennas and Propagation (PTGAP), with the technical program under the chairmanship of Cottony of NBS. The symposium was attended by nearly 500 scientists and engineers from industry, universities, and Government agencies.<sup>32</sup>

---

<sup>32</sup>The technical sessions covered the subjects of: space telecommunications, propagation, feeds and reflectors for antennas, surface waves, broad-band antennas, aperture synthesis of antennas, electromagnetic theory of radio propagation, antenna arrays, and the theoretical and experimental determinations of plasma effects on radio propagation.



*Carriage-and-track mounting designed by the Antenna Research Section for positioning a dipole antenna in three mutually perpendicular directions along three orthogonal axes, with the measurements related to those of a second dipole in a fixed position (not shown). Subsequent computer processing of the measurements yields the amplitude, phase, and angles of arrival of the multipath field components in this aperture-synthesis method. Photo shows the experimental system located at the Bureau's elevated site on Green Mountain Mesa, with a view to the northeast overlooking Boulder.*



## 6. Theoretical approaches to antenna designs

During the period from 1956 to 1960, James R. Wait published a number of papers relating to theoretical approaches to antenna design problems. Serving in a consulting capacity to several groups within the Boulder Laboratories, his mathematical solutions solved problems associated with slot antennas and similar radiators. Later, in the 1960's, Wait published several papers on antennas "immersed" in a plasma, such as found on rockets.

### MODULATION RESEARCH<sup>33</sup>

Interest in modulation research by the former Radio Section was minimal. However, in 1924, C. B. Jolliffe developed a rather simple type of modulation meter (see ch. V, p. 110). Not until several years after the formation of the CRPL were there projects initiated that related primarily to modulation research and engineering.<sup>34</sup> The first recorded interest within the CRPL was that of studying the modulation system of Loran equipment, the project being associated with the Frequency Utilization Research Section in 1947.

#### 1. The CRPL initiates modulation research

In the spring of 1949 a project with the title FM Modulation Study was assigned to the Frequency Utilization Research Section.<sup>35</sup> Its function was for:

Experimental and theoretical studies of frequency modulation systems, with special consideration for spectrum band-width requirements and for interference-reduction possibilities.

#### 2. Progress in modulation research

In June 1951 Arthur D. Watt joined the Frequency Utilization Research Section as leader of the modulation research project and was associated with this work for a number of years. The project was one of the earliest to be moved to Boulder, Colo.—nearly 3 years before the "big" move by the CRPL in 1954. In Boulder new laboratory facilities were established for modulation research. The CRPL Annual Report for FY 1953 stated, in part, for modulation research:

Because of the scarcity of space in the radio-frequency spectrum and the necessity for more reliable communications, a study of the efficiency of various types of modulation and methods of communication over radio paths has been undertaken.<sup>36</sup>

As an introductory project at Boulder, frequency spectra (including information) were obtained for a large number of modulation waveforms. These spectra provided a means of determining both the bandwidth necessary for adequate reception of signals and the interference caused by adjacent transmission channels. In 1953 an extensive study was started on the reduction of adjacent-channel interference caused by keying waveforms of

---

<sup>33</sup>The two words "modulation research" became a common term in CRPL and NBS reports. In 1956 the term became the title of the Modulation Research Section; initially the name was Modulation Systems Section. By 1965 the name was changed to Information Transmission Section.

<sup>34</sup>Many types of modulation are used today, although in their simplest forms they are usually known as amplitude, frequency, and phase modulation of continuous wave (CW) radio transmissions.

<sup>35</sup>Three other projects related to modulation research had been activated earlier. These were: (1) Study of required signal-to-noise ratio for different types of communication services for the Provisional Frequency Board in Geneva, Switzerland; (2) Analysis of the ratio of desired-to-undesired telegraph signals for interference tests being conducted by the Signal Corps laboratory at Ft. Monmouth, N.J. in cooperation with the CRPL; (3) Tests conducted with a large number of CRPL staff members in judging degradation of television pictures by (visual) noise interference, the tests being conducted for the Federal Communications Commission.

<sup>36</sup>Although the term "modulation" generally is applicable to an entire communication system, it is often restricted to the transmitter yet covers, as well, the demodulation techniques associated with receiver circuits.

transmitters. This project yielded much information on the suppression of widely spaced frequency components (extending from the carrier frequency) that can be of considerable amplitude. The study resulted in five publications over a period of 5 years, with a concluding paper in 1958 [14].<sup>37</sup>

Concurrent with the early work by Watt and others at Boulder were investigations at Washington by G. Franklin Montgomery on several types of modulation.<sup>38</sup> One study was a comparison of the effectiveness of frequency-shift, and on-off amplitude modulation methods of binary-coded messages as a function of noise and carrier fading [15]. Another study resulted in a publication on the errors of binary-coded signals that occur in diversity methods of reception of frequency-shift-keyed modulation.

During the 1950's the newly developed NBS system for transmission by ionospheric forward scatter was subject to much study by Dana K. Bailey and others. During the first half of 1958 the Modulation Research Section became involved in the study, to determine the efficiency of several types of modulation under different conditions of transmission. The transmission facilities of the Long Branch field station were used, with reception of signals at the Table Mountain field site north of Boulder, the distance being 1295 km.<sup>39</sup> The first experiments were at 49.6 MHz, at which frequency the transmissions were not affected by long-delayed multipath signals caused by  $F_2$ -layer propagated backscatter. Three types of modulation and two kinds of antennas were used in the experiments.<sup>40</sup> Binary error-rate tests gave information on signal-to-noise requirements. Under conditions of fading, voice signals by FM were good but voice signals by SSB were poor. The study was published in a lengthy paper by J. Wesley Koch, chief of the Modulation Research Section [16]. Later, during the spring of 1959, experiments were made at frequencies of 30 and 40 MHz under conditions of  $F_2$ -layer backscatter where multipath conditions exist. It was found that FM voice signals were poor whereas voice signals by SSB modulation suffered but little from the backscatter delays [17].

### 3. Studies in advanced modulation techniques

With much experience behind the Modulation Research Section, by the early 1960's members of the section were investigating advanced methods in transmitting and receiving information over radio paths. By 1960 communication by digital coding was receiving considerable attention in the section. In particular, both theoretical and experimental studies were being made of digital error distributions, with the objective of determining data for optimum performance design of error-detecting and error-correcting codes. From this point the section moved into the ESSA organization (see app. C).

## RADIO NAVIGATION

Navigation by radio had its roots within NBS back to the pioneering work by Kolster, beginning in 1913 (see ch. VI). Over a period of 5 years from 1916, Kolster developed the radio compass. At the time of cessation of hostilities of World War I, Kolster began experimenting with blind landing of airplanes. By the close of 1920 Engel and Dunmore began experimenting with the crossed-field pattern of two loop antennas that led to the development of the airway beacon system. With the added development of the blind landing system by Diamond and Dunmore, by 1931 NBS had an all-radio air navigation system in

---

<sup>37</sup> The papers described the possibilities and the methods of filtering keying waveforms of linear amplitude-modulation transmitters and frequency-shift-keyed transmitters. There was sizeable reduction of interfering sideband components as predicted by frequency-spectra analysis and indicated by experimental measurements.

<sup>38</sup> Montgomery was on loan for a period of time to the Frequency Utilization Section by the Ionospheric Research Section.

<sup>39</sup> For information on the Long Branch field station see chapter XI, footnote (96); for detailed information see the August 1958 issue of the *Technical News Bulletin*.

<sup>40</sup> Binary coded signals were transmitted with frequency-shift-keyed modulation; voice transmission by FM and by SSB (single sideband) modulation. Antennas were paired for transmitting and receiving, a pair of dual-diversity rhombic antennas for one series of experiments and a pair of quadruple-diversity Yagi antennas for the other.

successful operation (see ch. VI). Thereafter, by the middle 1930's and until near the close of World War II, NBS was not active in radio navigation.<sup>41</sup>

## 1. Involvement in Loran

### a) EARLY LORAN STUDIES

NBS was introduced to the Loran system of navigation early in 1945 when requested on January 19 by the Bureau of Ships, Department of the Navy "to study certain transmitter and receiver problems directly applicable to the design of Loran equipment."<sup>42</sup>

Shortly after joining the CRPL in 1946, William Q. Crichlow prepared a report on the comparative accuracy of several existing and proposed radio navigation systems, including Loran.<sup>43,44</sup> The purpose of this study, made by the Frequency Utilization Research Section, was to assist interested groups in choosing optimum systems for worldwide use on ships and aircraft. A report indicated that low-frequency Loran (typically 100 kHz) gave the greatest accuracy of position, both night and day at long distances, for the three systems that were analyzed. Crichlow's report was followed by one prepared by Kenneth A. Norton, chief of the Section, on the technical factors involved in the choice of a carrier frequency for a worldwide low frequency Loran system. Norton's study was prepared primarily for distribution at the 1947 Atlantic City World Telecommunications Conference.

### b) INVOLVEMENT IN CYTAC

After the 1946 studies of Loran by the Frequency Utilization Research Section, there was a long lull in this activity. During the middle 1950's the newly organized Navigation Systems Section, with Gifford Hefley as chief, engaged in low-frequency propagation studies for the Cytac development program by the U.S. Air Force.<sup>45</sup> The CRPL study resulted in several classified documents relating to low frequency propagation of radio waves. In 1956 J. Ralph Johler and his associates published *NBS Circular 573*, entitled "Phase of the Low Radiofrequency Ground Wave", which was of considerable importance to the project. Also reported by the section was the observation that the phase of discrete long-range, sky-wave reflections is very stable, indicating that a navigation system using such waves was quite feasible. Various low-frequency propagation studies were continued or renewed well into the 1960's.

Although further development of the Cytac system was laid aside by the Air Force, the U.S. Navy became interested in Cytac for a long-range, high-accuracy, radio navigation system, particularly for operation in the Atlantic. The U.S. Coast Guard also had an interest in Cytac. By 1958 the Navigation Systems Section was providing consulting services to the Coast Guard in a relocation and reconstruction of the earlier Air Force System.<sup>46</sup>

---

<sup>41</sup> An interesting account of NBS research in navigation was published in the June 1950 issue of the *Technical News Bulletin*.

<sup>42</sup> In response to the Navy's request the IRPL (Interservice Radio Propagation Laboratory) of NBS studied the problem, with conclusions that spectrum bandwidth could be reduced considerably without impairment of usefulness of the complete system. The study was reported October 10, 1945, in the document, IRPL-R24, entitled "Relations Between Band Width, Pulse Shape, and Usefulness of Pulses in the Loran System."

<sup>43</sup> Loran is the acronym for LOnG RAnge Navigation. It is a hyperbolic type of radio navigation system using pulsed signals from two pairs of ground stations of known location, and determining position from analysis of time intervals. The first system was developed by the MIT Radiation Laboratory early in World War II.

<sup>44</sup> Previously, Crichlow had been a member of the Operational Research Staff of the Office of the Chief Signal Officer and had been associated with Loran projects. Jack W. Herbstreit of the Operational Research Staff also joined the CRPL in 1946.

<sup>45</sup> Cytac was to be an all-weather, long-range, ground-based, tactical bombing system using radio navigation at a frequency around 100 kHz. It was a pulsed system wherein several types of pulse sampling could be used. After its early development by the U.S. Air Force, the system was abandoned on the decision of no further development of a land-based bombing system.

<sup>46</sup> The new system, converted from the earlier Cytac system, was called East Coast Loran-C. The master station was located at Cape Fear, N.C., and the two slave stations at Martha's Vineyard, Mass., and Jupiter Inlet, Fla. The chain of three stations of the Cytac system had been the source of many observations by the CRPL during the period of 1955-1956 from many locations in the eastern half of the United States.

### c) DEVELOPMENT OF THE LORAN-C CLOCK

Latent within the Loran-C system of navigation resided the capability of a time-distribution system and a new and very accurate means of synchronizing clocks over relatively long distances. Such had been possible using the high-frequency signals of WWV but with a limited accuracy of about 1 millisecond, although considerably better with VLF signals. Use of a Loran-C system indicated the possibility of synchronization of clocks to within 1 microsecond, plus a new time-distribution system that would greatly advance the accuracy over existing systems. Working toward these goals, the Navigation Systems Section became much involved in a project that began in 1957 and extended for a number of years. Instrumentation for Loran-C to gain the added features of time distribution and synchronization of clocks had its genesis in the development of a high-speed device for recording accurately the time of arrival of transient signals.<sup>47</sup> By 1959 the section was engaged in the development of equipment, to become known as the Loran-C clock, for improved missile range timing on the Atlantic Missile Range.<sup>48</sup> The clock had a visual readout from 1 microsecond to 399 days. An account of its development by the section was published in 1960 by Thomas L. Davis and Robert H. Doherty [18]. The authors pointed out a variety of applications of the system.

<sup>47</sup> This device, developed by the section, was a film-recording system in which a randomly occurring event, such as a spheric, and the time of the occurrence would be recorded simultaneously. The main feature was an unambiguous binary time readout with a range from 10 microseconds to 31 days.

<sup>48</sup> This development was sponsored by the U.S. Air Force Eastern Ground Electronics Engineering Installation Agency (GEEIA) Region.

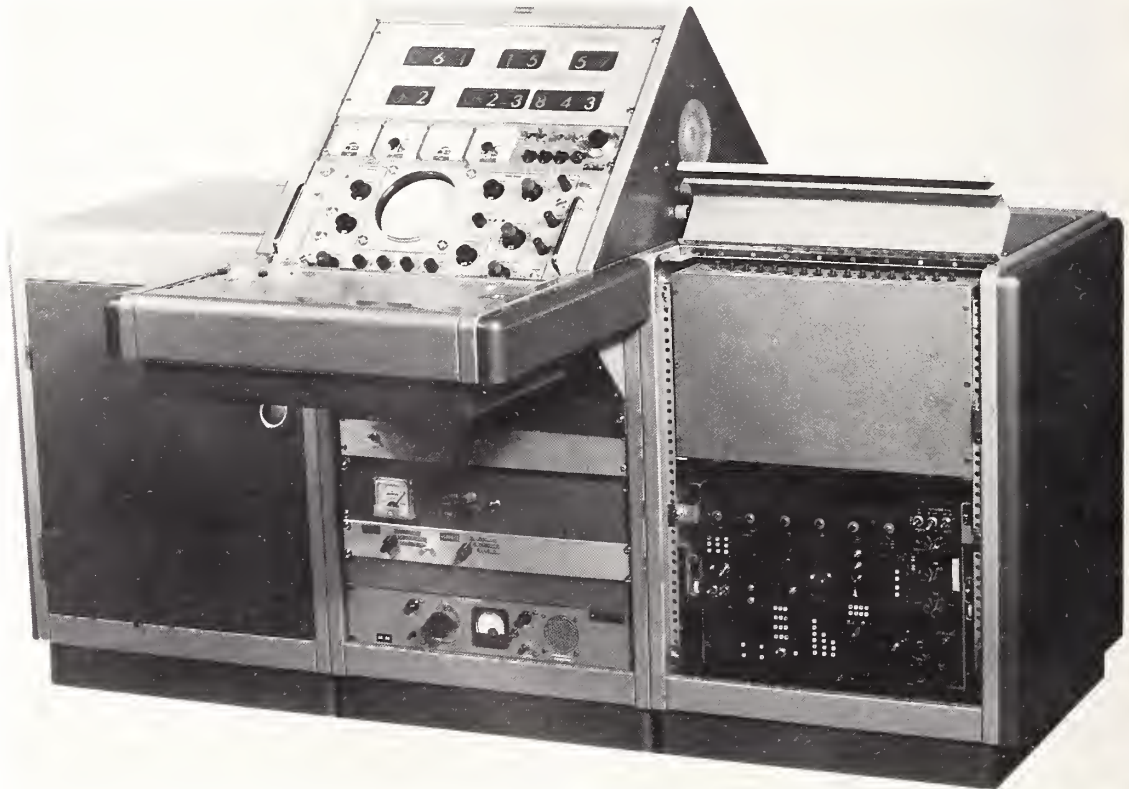

*Console of an advanced development model (1961) of the Loran-C clock used to synchronize time (to within 1 microsecond) and frequency at widely separated locations. Receiver equipment in cabinet at right. Electronic circuitry of the Loran-C clock housed in cabinet at left. Above the monitor oscilloscope in center section is the readout that contains a 15-digit visual display covering 1 microsecond to 1000 days.*

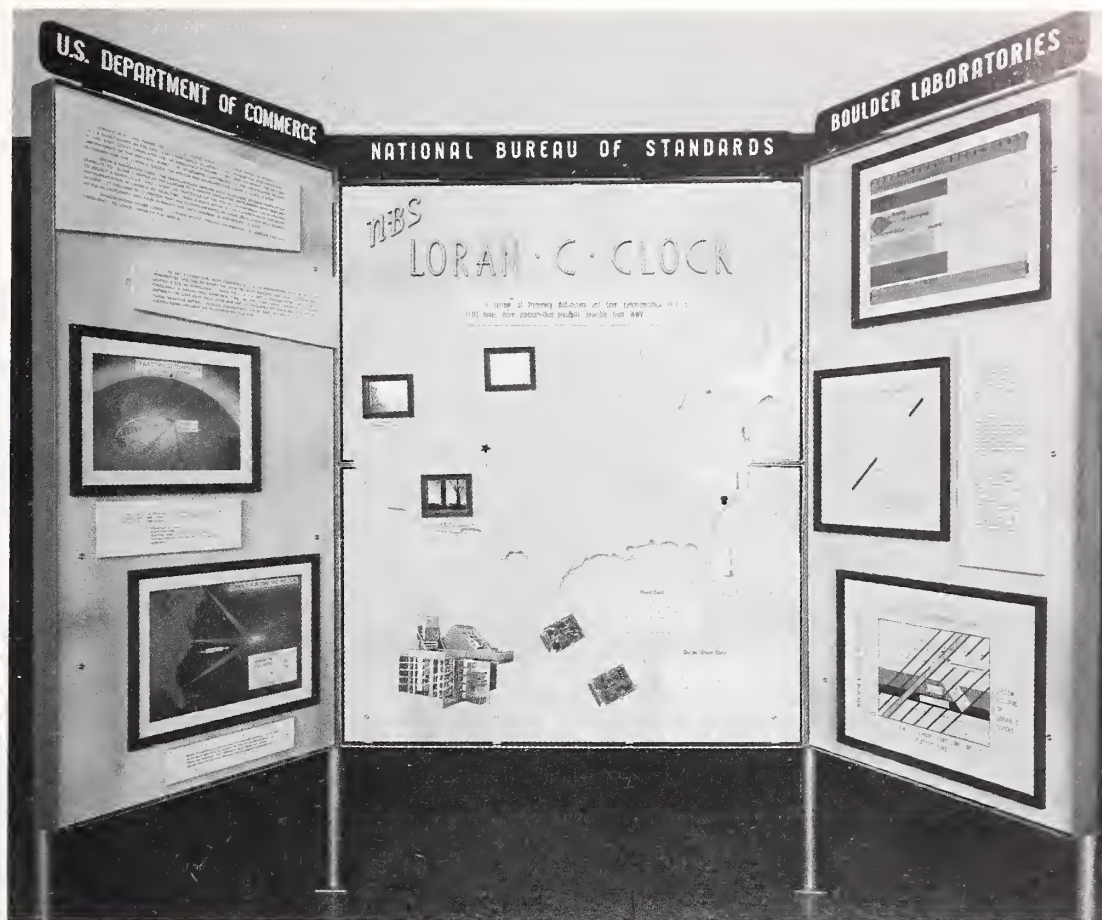

A pictorial display of the NBS Loran-C clock, set up in the Radio Building lobby and photographed on May 21, 1960. The clock's potential uses were illustrated for the viewer's interest.

During October 1960 the section demonstrated the timing potentials of the Loran-C on the Atlantic Missile Range, obtaining accurate timing over the system to 1 microsecond [19]. A UHF time-distribution system for serving facilities in close proximity to the master or a slave station was also demonstrated.

On November 1, 1961, the section took part in demonstrating the synchronization of clocks to 1 microsecond over a distance of approximately 1000 miles. The clocks were at the Naval Observatory at Washington, D.C. and at Richmond, Fla. (near Miami). In pointing out this accomplishment, the *Technical News Bulletin* listed in its February 1962 issue nine applications of this newly devised system for accurate navigation and timing [20].<sup>49,50</sup> By 1972 eight worldwide chains, involving 34 stations, were in operation by the U.S. Coast Guard, with close synchronization to the U.S. Naval Observatory.

Following the development of the Loran-C clock and its application to Loran-C for timing distribution and synchronization of clocks, other related projects claimed the attention of the Navigation Systems Section.<sup>51</sup> The projects related primarily to further study of the propagation characteristics of 100-kHz radio waves used in Loran-C systems.

<sup>49</sup> In 1962 Hefley received the Department of Commerce Silver Medal for Meritorious Service "for the innovation and leadership of development of the 'Loran-C Clock', a radio technique enabling one microsecond synchronization of widely separated clocks."

<sup>50</sup> In 1972 Hefley published an *NBS Monograph*, giving an historical account of the development of Loran-C navigation and timing, primarily as participated in by NBS [21].

<sup>51</sup> In the spring of 1962 the name was changed to the Radiodetermination Section.

## 2. Investigations of air navigation systems—Tacan

The spheres of knowledge and of experience that had been gained from the VHF-UHF air-to-ground and air-to-air communications studies during the late 1940's for the Department of Defense (see sec. 4. under Spectrum Engineering) were soon to find application to the investigations of air navigation systems. There had been a growing need for increased accuracy and reliability of these systems.

During the fall of 1949 the Air Navigation Development Board (ANDB) requested NBS to initiate a comprehensive study of propagation characteristics of a band of frequencies in the region of 1000 MHz (later to be extended over a much wider frequency range).<sup>52</sup> This band had been designated by the FCC for development of the Common Systems of Air Navigation and Air Traffic Control. The primary purpose of this study was determination of minimum distance spacings between transmitters operating on the same or adjacent frequencies to prevent interference beyond permissible levels. This initial study resulted in the very extensive tropospheric propagation program carried out over a period of years with transmitters located on Cheyenne Mountain near Colorado Springs (see ch. XII).

Beginning in the fall of 1950, several investigations were made for the Radio Technical Commission for Aeronautics (RTCA), primarily on interference problems relating to air navigation systems.<sup>53</sup> Previous studies served as sources of information for allocation of frequencies and for determining distance spacings of transmitters. One investigation related specifically to the VOR navigation system.<sup>54</sup>

Under the sponsorship of the Air Navigation Development Board the CRPL began an investigation in 1955 of coverage and channel requirements of the Tacan navigation system, used exclusively by the Department of Defense.<sup>55</sup> With the Tacan system operating at approximately 1000 MHz, NBS was especially proficient in conducting the investigation because of its recent research in propagation of radio waves at this and other frequencies at the Cheyenne Mountain facility. From the investigation made under the leadership of Martin T. Decker of the Radio Systems Application Engineering Section, various factors were pointed out to the Board for estimating the coverage to be expected in the air space surrounding the ground facility and on the number of channels required for implementing the system in continental United States. The study resulted in a published report which included a map for the required ground facilities to cover eastern United States [22].

### A MEASUREMENT OF THE SPEED OF EM WAVES

Among the studies of several radio-navigation systems undertaken by the CRPL during 1946 was a project soon to become labeled Differential Phase Variation at Low Frequencies. The purpose of this project was "to find out to what extent radio-propagation effects vitiate the phase readings of low-frequency radio navigation systems." The initiating team included Richard Silberstein, Edwin R. Florman, and Andrew Tait, to be continued later by Florman and Tait, then in a spin-off project by Florman alone.

#### 1. Discovering a source of error in phase measurements

Development of the complex measurement equipment required to study the validity of a navigation system resulted in an improved type of direct-reading electronic phasemeter operating in the range of 100 to 5000 Hz. Evaluation of the phase measuring system was

---

<sup>52</sup> The ANDB was administratively under the Civil Aeronautics Administration.

<sup>53</sup> The RTCA is an advisory group for coordinating the application of radio, electronics, and telecommunications in aeronautical operations. During the 1950's CRPL representatives served in various capacities on several special subcommittees of the RTCA (see ch. XVI, p. 650). Dellinger served as chairman of the RTCA for 17 years, beginning in 1941 (see app. D, p. 789).

<sup>54</sup> The VOR (VHF Omnidirectional Range) navigation system operates within the band of 108-118 MHz and provides bearing information for aircraft at all azimuths within its service area.

<sup>55</sup> Tacan (TACTical Air Navigation) is a radio air navigation system of the polar-coordinate type and provides aircraft with an indication of bearing and distance from a selected ground facility.



*This motor caravan was assembled in 1947 to study the validity of an LF radio navigation system, and 6 years later (1953) was used by Edwin F. Florman in Arizona to determine a new value for the speed of electromagnetic waves. The photo, taken in the summer of 1947, shows the four vans in line along the east side of the South Building at NBS Washington. Andrew Tait, a supervisor of the measurement group, stands (right) by the control and measurement van. The two receiver vans follow in the line, with the transmitter van bringing up the rear; each of these three vans with its power-unit trailer. The ivy-covered South Building was the location in 1911 where Dellinger performed the first calibration of an instrument (wavemeter) at radio frequencies at NBS (see ch. II, pp. 38-39).*

over a period of several years and resulted in a hitherto undiscovered source of error in such systems.<sup>56</sup>

## 2. Preparations for measurement of the speed of EM waves

Use of this measurement method for observing phase-differential variation of a low-frequency navigation system indicated its potential use for measurement of the speed of EM waves, and by the close of 1950 a modification program was underway to realize this potential.<sup>57</sup> After considerable searching, a suitable site for conducting such a project was found at an abandoned airport.<sup>58</sup> At this location preliminary tests with a scaled-down field model were made of the modified system to learn of: sources of systematic errors, reliability of operation, and phase stability of the equipment. Of importance was further confirmation that the measurement method was susceptible to large phase errors if there were reflections from nearby objects such as power lines or even the trees of a forest.

## 3. A radio interferometer measurement of the speed of EM waves

To minimize chances for phase errors due to reradiation from various objects, a site in the nature of a dry lake bed was selected in southeast Arizona, near the town of Wilcox.

<sup>56</sup> The evaluation was conducted at the Patuxent Game Preserve (near Beltsville, Md., the location of WWV) which provided a strip of land several miles in length. Equipment housed in four mobile vans served as two receiving stations (2.4 miles apart), a measurement station, and a 300-kHz roving transmitter. Errors of measurement were traced to certain paths traversed by the transmitter and were found to be caused by reradiating structures such as power lines or telephone lines. The phase-change errors were in orders of  $2\pi$  radians, and could exist in integer multiples thereof. A paper was published in the June 1950 issue of the *Proc. IRE*.

<sup>57</sup> The numerical value of the speed of light, associated with propagation of radio waves, is a very important physical constant. The constant appears in many expressions of physical phenomena, including the familiar equation  $E=mc^2$  of the relativistic transformation of mass into radiant energy.

<sup>58</sup> The abandoned airport, known as the Blue Ridge Airport, was near Willard, Va., not far from the NBS Sterling field station. Today, the land of the abandoned airport forms the central area of Dulles International Airport.

Here the nearest reradiating objects (except for the equipment vans) were more than 4 miles distant. At this location during a 3-week period in April and May, 1953, Florman conducted a series of measurements that yielded a value of  $299,795.1 \pm 3.1$  km/s for free space phase velocity (or, simply velocity) of VHF (172.8 MHz) waves [23].<sup>59,62</sup> Later, further field tests were conducted, this time at the Sterling field station, to determine sources and magnitude of possible errors.

## SPECTRUM ENGINEERING

### 1. Introduction

In the *NBS Annual Report* for 1955 the CRPL stated that:

The ultimate objective of NBS work in radio propagation engineering is the more efficient use of the radio frequency spectrum. . . .

This objective was being followed by studying the nature of radiowave propagation and the effects of radio noise and interference and of modulation waveforms on radio signals.

Over a period of many years the Radio Section, and then the CRPL to a greater extent, provided services to Government departments and independent agencies on the matters of frequency utilization of the radio spectrum.<sup>63</sup> Closely related to the matter of frequency utilization is that of service area of radio transmitters, usually expressed in terms of field-strength measurements.<sup>64</sup>

---

<sup>59</sup> Although the term "velocity" of light (EM waves) had been used consistently in the past by physicists, within the past several decades the more correct term "speed" has come into fairly common usage, both within NBS and elsewhere. Correctly used, the term velocity is a vector quantity, with the meaning of speed in a particular direction. Florman used the term velocity, or rather phase velocity in his publication.

<sup>60</sup> The radio interferometer method used by Florman consisted of two receiving stations separated by accurately surveyed distances (1500 meters for most experiments, 850 for some). Two transmitters were located, one on each side of an extension of a straight line through the receivers (use of two stationary transmitters simplified the earlier method of using one roving transmitter). Phase observations were made at a control-unit van where equipment received UHF signals from the two receiver stations. These signals carried phase-difference information which, with the known distance between the receivers, yielded the velocity of EM waves.

<sup>61</sup> Speed of light measurements were not new to NBS. In 1907 Rosa and Dorsey of the Electricity Division published their experimental value of the ratio of the electromagnetic to the electrostatic unit of electricity, which is the speed of light (see ch. V, p. 91). In actuality, the value for the speed of light depends upon the relation of forces between electrical charges at rest and in motion with respect to the system of reference.

Of unusual interest was the account published in the January 1955 issue of the *Technical News Bulletin*, under the title of "Velocity of Light Redetermined." The article covered both Florman's determination of the speed of EM waves and Earle K. Plyler's (Radiometry Section) determination of the speed of light by the molecular-constants method using infrared lines of the carbon monoxide molecule. These two projects were carried on concurrently within NBS. Plyler's value was  $299,792 \pm 6$  km/s.

More recently, in 1972, two groups within NBS (within the Quantum Electronics Division and the Joint Institute for Laboratory Astrophysics) announced a new and far more accurate value for the speed of light— $299,792.4562 \pm 0.018$  km/s—using laser techniques (see ch. XV, pp. 634-637). This 1972 value for the speed of light compared very favorably with a value of greater uncertainty, adopted by URSI at its XII General Assembly in 1957—a value of  $297,792.5 \pm 0.4$  km/s. In retrospect, one finds that Florman's value by the radio interferometer method, was approximately 2.5 km/s greater in speed than the NBS value by laser techniques in 1972.

<sup>62</sup> In 1956 Florman received the Department of Commerce Silver Medal for Meritorious Service "for an outstanding contribution to a more precise knowledge of the velocity of propagation of radio waves at very high frequencies."

<sup>63</sup> In 1928 Dellinger, chief of the Radio Section, was on leave of absence from NBS to serve the Federal Radio Commission (FRC) as its first chief engineer (see ch. XVI, pp. 645-646). Thereafter, NBS served the FRC in various capacities and, beginning in 1934, the successor agency, the Federal Communications Commission (FCC). Other groups to be served were: the Interdepartment Radio Advisory Committee (IRAC), the International Telecommunication Union (including the International Radio Consultative Committee), and various international committees and conferences. Also to be served were various branches of the military establishment.

<sup>64</sup> Because of their close relationship, the subjects of frequency utilization, service area, and field-strength are combined into this section of chapter XIII.



## 2. The indispensable field strength meter

Beginning in the 1920's, the field-intensity meter (later termed field strength meter) became a mainstay for various measurements related to radio propagation; first in fading studies and later in measurement of radiated output of transmitters (see ch. V, pp. 111-112). During the period of 1951-1953 Gail E. Boggs of the Ionospheric Research Section directed the development of an improved meter, to be known as the GS-4 field strength recorder.<sup>65</sup> Later, more sophisticated models were developed, designed for automatic operation and with recording by magnetic tape. A 10-channel output could be adjusted to record the time in minutes that field strength exceeded different preset levels. This equipment and commercial models of receivers and field-strength meters, plus various types of small antennas, were used by the CRPL during the 1950's in the field for propagation studies. Over the years several mobile research units were designed and constructed for measurement of field strength. These units could be used, both in motion or stationary, and could be taken to remote areas.

## 3. Gauging transmission utilization—Service area

### a) EARLY WORK BY NBS

As far back as 1931 the former Radio Section had taken an interest in the service area of radio transmitters in terms of the lowest field intensity for "practical" or "useful" reception (see ch. VII, pp. 197-199).<sup>66</sup> In the IRPL Radio Propagation Handbook issued on November 15, 1943, the Radio Section listed a number of "Correction Factors for Various Types of Service" which gave the ratio of required field strength for type of service under consideration to that for barely satisfactory commercial telephony. With more experience and a greater amount of data becoming available, on June 25, 1948, the CRPL issued *NBS Circular 462* that extended the scope of information on minimum required field intensities.<sup>67</sup>

### b) THE RISING TIDE OF FM AND TV BROADCASTING—CRPL EFFORTS TO KEEP PACE

Coincident with the rapid growth of the CRPL after its formation in 1946 was the rapid growth of FM and TV broadcasting and the interest in color television. The frequency range of these communication services of public interest was in the VHF (30-300 MHz) and UHF (300-3000 MHz) bands where the properties of the troposphere and the nature of the terrain have predominating effects on propagation. The CRPL Annual Report for FY 1948 stated, in part:

As more and more field-intensity measurements at frequencies at the VHF and UHF portion of the spectrum are made, it has become increasingly evident that the existing theories of radio wave propagation at these frequencies are inadequate in describing the field intensity to be expected at a given distance from the transmitter. . . .

---

<sup>65</sup>The GS-4 model field strength recorder incorporated several features to attain a high degree of amplitude (or gain) stability, such as a logarithmic attenuator and an amplifier with several types of negative feedback. The equipment could be used as a radio-frequency voltmeter or as a power meter. These features were the subjects of five publications by Boggs.

<sup>66</sup>On January 25, 1932, the Bureau released Letter Circular 317, "Distance Ranges of Radio Waves," including two graphs that indicated distance ranges in relation to frequency range, for day or night and summer or winter reception. Practical reception was based upon a field intensity of 10 microvolts per meter in the broadcast frequency range—a rather low level in comparison with today's desire for high quality reception. The material was updated in 1940 with Letter Circular 615.

<sup>67</sup>*NBS Circular 462* contained six graphs from which minimum required field intensities could be determined to assure satisfactory radio telephone communication 90 percent of the time in the presence of atmospheric and cosmic noise. The six graphs indicated the field intensity levels at 4-hour intervals of local time throughout a 24-hour day. Each graph consisted of a set of curves indicating several noise grades at the receiving location for both summer and winter conditions. In addition, a table was furnished for "type of service factor, T", where T was defined as the ratio of minimum radiated power required for radiotelephone service (double sideband with 100% modulation, 90% intelligibility—as the reference of unity) to that required for the type of service actually used. Sixteen types of radio communication services were listed, but did not include television services.

On a much larger scale was the involvement of the CRPL in a total tropospheric propagation program, beginning in 1946 (covered in ch. XII). The magnitude of this program can be ascertained by a review of *NBS Technical Note 26* which was a survey of CRPL research in tropospheric propagation for the 8-year period of 1948-1956 [24]. A total of 313 NBS publications and progress reports (prepared by subcontractors) was listed (including abstracts) in this *Technical Note*. Of this number, a sizeable share covered subjects related to the subject of service areas of radio transmitters. Many of the publications were prepared by Kenneth A. Norton, chief of the Frequency Utilization Section and, later, chief of the Radio Propagation Engineering Division.

A significant contribution to use of the VHF band by FM broadcasting stations (limited to the narrower band of 88-108 MHz) was by Norton in 1948 as a section, entitled "Propagation in the FM Broadcast Band," published in Volume I of *Advances in Electronics* [25]. By means of a table, Norton suggested an idealized allocation of FM stations on a common frequency channel (or channels) for serving a large area such as the United States.<sup>68</sup> He closed his lengthy 1948 account by stating:

It is desirable to point out that we are just beginning to learn a little about the characteristics of radio propagation in the FM band and much further experimental and theoretical research is indicated. One kind of data which is considered to be of utmost value in connection with such research is continuous recordings of the field intensities of FM and television broadcast stations. Such data should be collected for a wide variety of meteorological and terrain characteristics in various parts of the country. . . .

It was such a program, as suggested by Norton, that would occupy the talents of many CRPL staff members for many years to come.

In 1948 the Federal Communications Commission (FCC) appointed an Ad Hoc Committee to study the characteristics of VHF propagation.<sup>69</sup> After publication in 1949 of available and applicable propagation data, the committee recommended that an extensive program of measurements be undertaken to increase the fund of knowledge on VHF propagation. The result was a long-time cooperative program by the CRPL, the FCC, four universities, and several other agencies, with assistance by the Department of Defense. The early CRPL field studies were made in several areas of the United States.<sup>70</sup> In later years observations of tropospheric propagation were extended to other parts of the world. The program, as a whole, had many ramifications and grew as time progressed. There was the

---

<sup>68</sup> In his account Norton wrote on a variety of topics related to FM broadcasting in the VHF band such as, the effects of: noise, of antenna height, irregular terrain, refraction by the atmosphere, reflection from atmospheric boundaries, and direct transmission. To study these effects on service range, Norton directed a project in 1947 over a Richmond, Va. to Washington, D.C. transmission path of 96.6 miles at a frequency of 96.3 MHz, the transmitter being located at Richmond. Over the 2-month period of observations, the fading and diurnal effects of long-distance VHF transmission were noted, caused by changes of atmospheric conditions. It was also evident that transmission can extend far beyond the line-of-sight at times, and that this factor must be considered in the service and interference ranges of FM broadcasting stations. Norton's study was also covered in an article in the April 1948 issue of the *Technical News Bulletin*.

Concurrent with publication of his early work on FM broadcasting, Norton contributed a proposal to accompany a report on fading, submitted by the U.S. participants of Study Group 2 (Radio Propagation) to the Fifth Meeting of the International Radio Consultative Committee (CCIR) at Stockholm. His memorandum, entitled "The Effect of Fading on the Desired-to-Undesired Signal Ratio Required to Provide a Specified Grade of Service for a Given Percentage of a Specified Period of Time," stated the factors involved in determining the allowance for fading which must be made in the allocation of two stations operating on the same or adjacent radio frequencies under specified conditions. Although the experimental observations for this study were made at 15 MHz, the proposal was applicable to a wider range of frequencies.

<sup>69</sup> Norton, chief of the Frequency Utilization Research Section, and Thomas J. Carroll, chief of the Basic Microwave Research Section served as NBS representatives on the FCC Ad Hoc Committee for two terms, the first beginning December 2, 1948, the second beginning May 31, 1949.

The raison d'être of this Committee, although not indicated by title, was that of evaluation of the radio propagation factors concerning the television and frequency modulation broadcasting services in the frequency range between 50 and 250 MHz.

<sup>70</sup> In the spring of 1950 Robert S. Kirby and Frederick M. Capps conducted a twofold project in the Washington, D.C.-Baltimore, Md. area, using a mobile van unit with field-strength recorder and a telescopic mast to vary the

need to measure additional parameters in order to furnish experimental data for new theoretical approaches to the problems associated with VHF and UHF propagation.

In 1953 Norton pointed out in a published paper the advantage of using a specific definition (among several) of "transmission loss" in radio propagation analyses [26].<sup>71</sup> The superior aspect of this specific definition of transmission loss was utilized by Philip L. Rice and Frances T. Daniel of the Radio Propagation Engineering Division in an analysis of approximately 159,000 hours of median field-strength observations. Those in the frequency range of 90-110 MHz, taken over a period of several years, were the result of the program suggested by the FCC in 1949, and were distributed geographically across the whole of the United States. The results of this analysis showed: (1) less distance-attenuation than previously reported by the FCC Ad Hoc Committee in 1949, (2) rapid increase in variance of transmission loss with time as the distance was increased out to 120 miles, and (3) at great distances a freedom from diurnal and seasonal changes in transmission loss [27]. Later, Rice and Daniel, with William V. Mansfield and Pius J. Short, reported on radio transmission loss versus angular distance and antenna height at 100 MHz.<sup>72</sup> Much of the data used for the previous paper was used in this report and comparisons made of the two methods of treatment.

In 1960 appeared *NBS Technical Note 43* that summarized 700,000 hourly median values of VHF and UHF tropospheric transmission loss data into the two periods of summer and winter [28]. The data came from observations on 135 beyond-line-of-sight radio paths in the United States. The long-term variability of observed hourly medians was compared with predicted variability based on empirical curves prepared earlier by Rice, Anita G. Longley, and Norton.

#### c) A NEW APPROACH TO SERVICE AREAS

Experience indicated that the method used by the FCC to define service area for television broadcasting was not satisfactory and in 1950 Norton and Leon Gainen of the CRPL suggested an improvement—a service defined by total areas, each of specified field strength, rather than by two zones delineated by a circular contour enclosing the transmitter.<sup>73</sup> In a paper published in 1957, Robert S. Kirby of the Radio Systems Applications Engineering Section described a method, following the suggestion by Norton and Gainen, whereby the measurement of service area for television broadcasting could be

---

height of a loop antenna above ground level. One project involved the measurement of field strength (reduced to transmission loss) along a path perpendicular, at midpoint, to a line joining VHF stations, one at Washington, the other at Baltimore. The two FM stations were at nearly the same frequency. Thus interference between the stations could be studied, plus correlation (simultaneous increase and decrease of signals) of transmission over two paths in opposite directions. No significant correlation was observed. The second project was that of observations of signal strength along a circular path of approximately 37-mile radius from two VHF stations radiating signals with approximately 20-MHz separation from the same antenna (by diplexing). The terrain covered by the circular path was quite varied, consisting of a metropolitan area, farm land, heavily wooded areas, and open water. The result was that of significantly high correlation of transmission at two frequencies differing by 20 MHz.

The same equipment was used in 1951 by Kirby, John M. Taff, and Holmes S. Moore to study the effect of irregular terrain on VHF and UHF transmission and the effect of directive antenna patterns. Measurements were made on circular paths at distances of 0.4, 10, and 30 miles from antennas at Fort Dix, N.J. Four transmitters were used at frequencies of 49, 142, 239, and 460 MHz. The result was to find variations of considerable magnitude in signal strength along the circular paths, due to the irregular terrain and different heights of the receiving antenna. Also noted, in many instances, was the distortion of the radiated pattern of the directive transmitting antennas by irregular terrain and large-scale obstacles.

<sup>71</sup>This specific definition of "transmission loss" was given by Norton as the ratio of the power radiated from the transmitting antenna to the resulting signal power available from a loss-free receiving antenna.

<sup>72</sup>The use of angular distance (defined as the vertical angle between the ray from the transmitting antenna through its radio horizon and a ray from the receiving antenna through its radio horizon) minimizes the problem of defining antenna height over irregular terrain compared to use with the parameter of distance between transmitting and receiving antenna.

<sup>73</sup>Experience had shown that, especially in irregular terrain, a circular contour could include many locations where reception was at less than specified field strength and beyond the contour there would be locations where reception was at a field strength greater than estimated.

improved [29].<sup>74</sup> Kirby listed seven advantages for the new method in comparison with that of the method that had been used for a number of years by the FCC.<sup>75</sup>

<sup>74</sup> Also described in the August 1957 issue of the *Technical News Bulletin*.

<sup>75</sup> As a means of making the measurements, Kirby suggested one method whereby an equal number of field-strength observations (30, for example) be taken on each of a number of circular contours surrounding a transmitter. From this distribution an estimate could be made of the percentage of locations on each contour that would receive service in several grades. By joining together estimates of each grade, an estimate could be obtained that would give the area around the transmitter for each grade of specified service (in terms of field-strength levels).

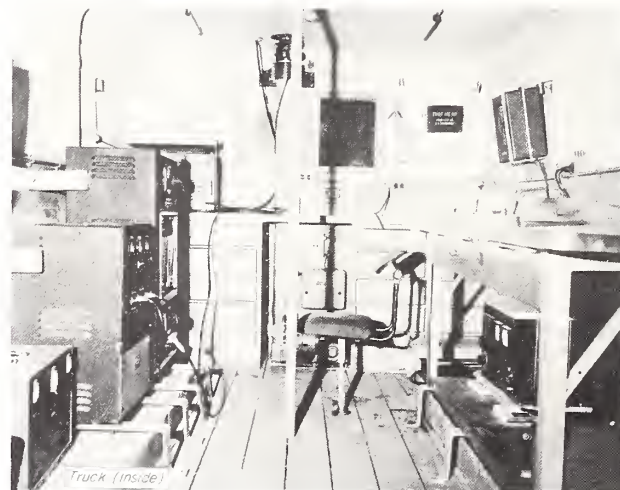
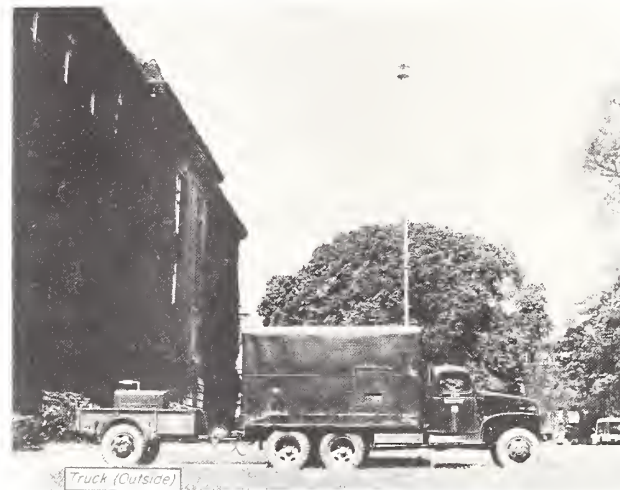

*Mobile equipment used by the CRPL to measure field strength and to study radiation patterns of VHF stations in the Washington, D.C. region and in New Jersey during 1950-1951. The top photo, taken on driveway near the South Building, NBS Washington, shows the laboratory truck with receiving antenna erected to maximum height of 30 ft. The trailer carries the gasoline engine and generator to supply electric power for the measurement equipment. The lower photo pictures the interior of the mobile laboratory.*

#### **d) THE SERVICE AREA OF A FLYING TV TRANSMITTER**

In his lengthy account on Propagation in the FM Broadcast Band in Vol. I of *Advances in Electronics*, Norton suggested in 1948 that:

. . . The efficient utilization of FM channels would thus appear to be promoted best by the utilization of the highest transmitting antennas available. In this connection, it would appear that "stratovision," i.e., the systems of broadcasting involving cruising in the stratosphere might well offer considerable advantages." (See [25], p. 414.)

Eleven years later this suggestion by Norton came into existence as a proposal for a nationwide educational TV network—a study by the CRPL was requested and supported by the Ford Foundation.

Martin T. Decker of the Radio Propagation Engineering Division was assigned to the project, directing a study of the service area of an airborne TV station at altitudes of 7500, 10,000, and 15,000 meters and at frequencies of 575 and 785 MHz within the UHF band. Performance was in terms of “system transmission loss,” as developed by Norton.<sup>76</sup> *NBS Technical Note 35* described the study [30].<sup>77</sup> *NBS Technical Note 134*, published by Decker in 1962, treated the more complex situation of airborne television coverage in the presence of co-channel interference.

Tests during the period of 1961 to 1964, under the direction of Purdue University, led to abandonment of the project.<sup>78</sup> Today, television via satellite transmission is much more practicable.

#### 4. Exploring frequency bands for communications services— Air-to-ground, air-to-air

Following some early measurements by the Air Materiel Command at Wright Field, a conference was held on August 14, 1947, at the request of the U.S. Air Force, for further study of radio communication in the VHF (30-300 MHz) and UHF (300-3000 MHz) bands.<sup>79,80</sup> Of primary interest was communication from air-to-ground, and from air-to-air, particularly in the proposed aircraft communications band from 225-400 MHz. During the next several years this study area of tropospheric propagation would be covered by several sections within the CRPL and thereafter grew into the broad and extensive programs to be developed in Colorado, and particularly at the higher frequencies with the aid of the Cheyenne Mountain facility (see ch. XII).

In a series of letters to the Air Materiel Command at Wright Field, Norton and Herbstreit of the Frequency Utilization Research Section reported individually on an analysis of the Wright Field measurements.<sup>81</sup> The analysis resulted in somewhat of a complexity of conclusions in comparisons at 138 and 328 MHz of the VHF-UHF service range tests for air-to-ground and air-to-air communications. Further measurements were suggested.

---

<sup>76</sup> See: Kenneth A. Norton, “System loss in radio wave propagation,” *J. Res. Nat. Bur. Stand. (U.S.)*, Vol. 63D, No. 1, July-August 1959, pp. 53-57.

<sup>77</sup> A large collection of the curves given in this publication could be summarized by the curves of two graphs (one for each frequency) that indicated the percent of locations that would receive a 99 percent grade of service as a function of distance from the transmitter being flown at three different altitudes. Sufficient information was furnished by multiple curves to indicate the variable of system transmission loss as determined by different equipment parameters.

<sup>78</sup> The scheme of flying a TV transmitter was quite practical technically and a request was made of the FCC to regularize the license. The FCC declined to do so, primarily because the large coverage from the airborne transmitter would alter their plan of frequency assignments. However, the FCC did recommend such service to a band near 1.4 GHz, but the plan did not materialize.

<sup>79</sup> Participants in the conference at NBS were representatives of CRPL, the Department of the Air Force (Air Materiel Command), and the Department of the Navy. Note: These two Departments of the Department of Defense had been renamed from the U.S. Air Force and the U.S. Navy less than 1 month previously (July 26, 1947).

<sup>80</sup> The term “communication” was used in a broad sense of application, that of: voice and code communications for aeronautical (mobile) services, aeronautical radio navigation systems, and air traffic control systems (including use of radar).

At the close of World War II communication systems used by the armed services and by commercial aircraft operated at frequencies within the 100- to 156-MHz band. Because of the great demand for frequency assignments for other types of services within this band, plus the growing requirements for additional communication channels, the FCC was taking steps toward moving military aircraft communications to higher frequencies, in the 225- to 400-MHz band. Later, the propagation characteristics of still higher frequencies would be explored for aircraft communications.

<sup>81</sup> These reports, in a format known as the “Wright Field Letters,” are contained in Supplement XIX of *NBS Technical Note 26*, Sept. 1959—a voluminous report entitled, “Survey of Central Radio Propagation Laboratory Research in Tropospheric Propagation 1948-1956.”

The "further measurements" were forthcoming. During 1948 and 1949, members of the CRPL participated in flight evaluation tests conducted by the Navy at the U.S. Naval Air Test Center, Patuxent River, Md. The overall result of these measurements was the publication in 1952 of two papers, one a tutorial paper by Kirby, Herbstreit, and Norton, on service range [31], the other, by Norton and Rice, for determining by calculations an optimum ground-station antenna height for use in air-to-ground communications [32].

In the tutorial paper the authors came to the general conclusion that: "The propagation problems involved in the service ranges for air-to-ground and air-to-air communications are primarily the result of lobes caused by interference between the direct and ground-reflected rays as well as a systematic decrease in free-space maximum range with increasing frequency." In commenting on the use of a higher frequency band for aircraft communications, the authors stated: "If the limitations in spectrum space require the use of higher frequencies, the methods outlined in this paper should prove beneficial in improving coverage." Further research and, the many years of operation in the higher frequency bands, proved that the conclusions and deductive comments of Kirby, Herbstreit, and Norton were well founded.

## 5. The matter of frequency allocation—Contributions by the CRPL

### a) THE CRPL AIDS IN MATTERS OF FREQUENCY ALLOCATION

During the early months of the Frequency Utilization Research Section, organized in the fall of 1946 with Norton as chief, an important assignment was that of analyzing technical data for frequency allocations. This work gave assistance to the U.S. Delegation in preparation for the International Telecommunication Conference held in 1947 at Atlantic City (see ch. XVII, p. 659).<sup>82</sup>

Although the main thrust for consideration by the FCC Ad Hoc Committee (see p. 580) was that of service areas for radio transmitters, the matter of frequency allocation was an inseparable subject. It was during the functioning period of this committee in 1949 and 1950 that Norton and Thomas J. Carroll were involved with problems associated with frequency allocation.

In his address to the Boulder Laboratories, "Fifty years of radio at the National Bureau of Standards," on March 3, 1961 (Dellinger's address, 1961), Dellinger pointed out that:

. . . At various times we worked on application of propagation data to the subject of the basic allocation of the frequency spectrum to different services. One of the results of this was the 1952 book put out by the JTAC called *Radio Spectrum Conservation*, and that kind of work is continued in your present Division 83 (Radio Propagation Engineering).

This book referred to by Dellinger, *Radio Spectrum Conservation*, had the subtitle, "A Program of Conservation Based on Present Uses and Future Needs." Published in 1952, it was the report of the Joint Technical Advisory Committee (JTAC) [33].<sup>83</sup> The chapter on "Propagation Characteristics of the Radio Spectrum" was compiled by Dellinger.<sup>84</sup>

---

<sup>82</sup> An outgrowth of the Atlantic City Conference was the International Administrative Aeronautical Radio Conference held in Geneva in 1948. This meeting of several months was attended by Thomas N. Gautier of the Upper Atmosphere Research Section (see ch. XVII, p. 664). Because of the rapid growth of the aviation industry and the use of radio navigation for planes, years later, in 1964, the Extraordinary Administrative Radio Conference for the Aeronautical Service was held in Geneva. Attending this lengthy conference was Allen Barnabei, the Communications Liaison Officer with the Department of Commerce, and George W. Haydon of the Radio Systems Division (see ch. XVII, p. 665).

In 1948 at Mexico City and in 1950 at Rappola, Italy, Herbstreit attended meetings of long duration of the High Frequency Broadcasting Conference as a technical advisor—meetings related to the Provisional Frequency Board set up at the Atlantic City Conference (see ch. XVII, p. 664).

<sup>83</sup> The JTAC was a joint committee of the Institute of Radio Engineers (IRE) and the Radio-Electronics Manufacturers Association (REMA). The latter organization changed its title a number of times over a relatively short period.

<sup>84</sup> This lengthy chapter of over 100 pages was compiled several years after Dellinger had retired from NBS. He was assisted in its preparation by Thomas N. Gautier of the CRPL, and Marcella L. Phillips, formerly of the CRPL. The book also contained a chapter on "History of the Allocation of the Radio Spectrum," prepared under Dellinger's supervision.

In 1964 a much larger edition was published by the JTAC. The book bore the title of *Radio Spectrum Utilization*, with the subtitle, "A Program for the Administration of the Radio Spectrum" [34].<sup>85</sup> The chapter on "Propagation and Technical Factors in Radio Spectrum" was prepared by CRPL staff members.<sup>86</sup> This chapter was a distillation of a very extensive subject area that covered nearly the whole field of radio science.

#### b) A CONTRIBUTION TO TASO

At the request of the FCC, an organization was formed in 1956 to be called the Television Allocations Study Organization (TASO) and consisting of representatives of the television industry. Among the 6 panels established for technical studies was one named "Analysis and Theory," chaired by Herbstreit of NBS. Later the panel received the assistance of Robert S. Kirby and Albrecht P. Barsis, also of NBS. Resulting from this organizational study was a report to the FCC entitled, *Engineering Aspects of Television Allocations*, published in 1959 as a book of over 700 pages. The acknowledgement stated that:

The National Bureau of Standards furnished invaluable data on tropospheric propagation and also contributed to the analysis of these data.

#### c) WRITINGS ON SPACE COMMUNICATION

With the burst of interest in satellites and space vehicles during the late 1950's there came the accompanying interest in space communication. This brought on the inevitable problem of allocation of new and shared bands in the already crowded frequency spectrum. Relative to this problem, George W. Haydon of the Radio Communication and Systems Division published a paper early in 1960 on the selection of frequencies for space communication [35].<sup>87,88</sup> Later, in 1961, William J. Hartman and Martin T. Decker of the Radio Propagation Engineering Division published a paper that treated the problem of mutual interference between "earthbound" and satellite communication systems [36].<sup>89</sup>

#### d) A WRITING ON EFFICIENT USE OF THE RADIO SPECTRUM

In 1962 Norton published *NBS Technical Note 158* that outlined some relatively simple principles slanted toward a more efficient use of the radio spectrum, particularly in the range of TV frequencies where a large segment of the total spectrum was being occupied [37].<sup>90,91</sup>

<sup>85</sup> This publication had been preceded in 1961 by a report by JTAC, entitled *Frequency Allocations for Space Communications*. Herbstreit represented NBS on the subcommittee that prepared the report. Much of the material in this report was contributed by NBS.

<sup>86</sup> This lengthy chapter of 178 pages was prepared by a subcommittee of the JTAC, with Jack W. Herbstreit as chairman, assisted by 14 members of the CRPL staff.

<sup>87</sup> Hayden based his published paper on material presented to, and adopted by, the CCIR at the IX Plenary Assembly at Los Angeles in April 1959. At the time of the Assembly he was with the Radio Frequency Engineering Office, Department of the Army, Washington, D.C. Later, in 1959, he joined NBS at the Boulder Laboratories as a consultant in the Radio Communication and Systems Division. In 1962 Haydon was appointed chief of the newly organized Frequency Utilization Section.

<sup>88</sup> Because of the low power of space transmitters that could be foreseen for the early years of space communication, Haydon's sole criteria for frequency selection was based on signal-to-noise ratio. Optimum frequencies came within the wide range of 70 to 6000 MHz. For the space vehicles, frequency selection was largely based upon permissible size and minimum beamwidth of the antenna. At the time of writing, little was known for selection of optimum frequency for communication between space vehicles.

<sup>89</sup> In their investigation, based upon the work of Rice, Longley, and Norton on the predicted behavior of transmission loss in tropospheric propagation (referred to on p. 581), Hartman and Decker concluded that under suitable conditions common frequencies can be shared by "earthbound" and satellite communication systems without material interference. On this basis, accommodation of earth-space communication systems lessens the problem imposed upon the overcrowded frequency spectrum.

<sup>90</sup> Norton summarized his findings by stating several conclusions. As one prerequisite for satisfactory operation of a telecommunication system, such as a TV system, sufficiently high power should be used to achieve a satisfactory grade of service at all times. Satisfactory grade of service was primarily that of maintaining a high signal-to-noise ratio by use of high transmitter power. He stressed the point that various techniques should be applied to minimize mutual interference between transmitters. Some of these techniques were analyzed.

<sup>91</sup> In 1962 Norton received the Department of Commerce Gold Medal for Exceptional Service "for outstanding contributions and leadership in the field of radio propagation research."

## e) APPLICATION OF COMPUTER TECHNIQUES

During the early 1960's and extending to the time of the formation of the Environmental Science Services Administration (ESSA) in 1965, considerable effort was directed by the CRPL toward rather extensive use of computer techniques in solving the problems associated with utilization of the frequency spectrum (see sec. 5).

## f) AN EPILOGUE TO THE MANY WRITINGS

One matter of importance that extended timewise beyond the amalgamation of the CRPL with the newly formed ESSA organization in 1965 was that of CRPL staff members taking part in the preparation of a noteworthy document entitled, *Spectrum Engineering—The Key to Progress*. This huge volume, published in 1968, as a report by the Joint Technical Advisory Committee bore the subtitle, "A Report on Technical Policies and Procedures for Increased Radio Spectrum Utilization." A task group headed by Herbstreit and later by Haydon was responsible for the preparation of material in the Supplement entitled, "Unintended Radiation."<sup>92</sup>

# DATA PROCESSING

## 1. Introduction

The development of SEAC (National Bureau of Standards Eastern Automatic Computer) by NBS during the period of 1948 to 1950, and its later installation in the Radio Building (NBS Washington), could not help but cast its spell upon the CRPL's need for speeding up the processing of data.<sup>93</sup> But this would not happen overnight—it was a number of years before electronic computers would be effectively used by the CRPL.

---

<sup>92</sup>This material related to manmade radio noise and was of considerable detail. Participating in the preparation were six other staff members of the former CRPL who became associated with the Institute of Telecommunication Sciences and Aeronomy of ESSA.

<sup>93</sup>With the success of ENIAC (Electronic Numerical Integrator and Automatic Computer), the world's first electronic computer, developed by the University of Pennsylvania during World War II, many institutions, including NBS, became intensely interested in this new computer technology of seemingly unbounded potentialities. (And so it proved with the passage of time.) Development of electronic digital computers began at NBS in 1946, both from the interest by NBS and that of the Bureau of the Census. It began with a 2-year program for the development of improved components for digital computers. The program was conducted jointly by the Electronics Division (ordnance development supported by Department of the Army) and the Applied Mathematics Division.

By late 1948 an electronic digital computer was under development and construction by the Electronics Division to serve the needs of NBS for an interim period until several computers designed by NBS could be supplied by contractors. In May 1950 NBS had a full-fledged computer in operation, and it continued in operation until 1964. During its early life the computer served not only as an operational facility but as a complete system for further research and particularly for further development of memory systems. SEAC was not used by the CRPL, although facilities of the Computation Laboratory were used for early production of contour maps of the ionosphere.

Joining NBS in 1948, Ralph J. Slutz became associated with the Electronic Computers Section (Samuel M. Alexander, chief) and served as the assistant chief from 1949 until he became assistant chief of the CRPL in 1954 and, later, chief of the Radio Propagation Physics Division. For a number of years, beginning in 1948, Slutz took a major role in the development and applications of SEAC. He was one of the many recipients who, in 1951, received the Department of Commerce Gold Medal as a group award for Exceptional Service for the development of SEAC.

Originally, in the spring of 1950, the entire assembly of SEAC had been set up in the Electronics Laboratory (Electronics and Ordnance Division). Late in 1954 SEAC was moved to the Radio Building which had been evacuated by the CRPL during the spring and summer in its move to Boulder, Colo. The office space used by Dellinger for many years became a portion of the space occupied by SEAC. Never before were there so many vacuum tubes in operation in the Radio Building—in its fully developed stage SEAC operated with 1300 electron tubes (a real heat problem), plus 16,000 germanium diodes. Nor previously had there been so much complex electronic circuitry in the building. For a number of years the building was occupied by the Data Processing Systems Division (five sections) and it took on the name Computer Laboratory.

Note: Over a period of years a number of articles appeared in the *Technical News Bulletin* relating to SEAC and its progenies. *NBS Circular 551*, published in 1955, was entitled "Computer Development (SEAC and DYSEAC) at the National Bureau of Standards, Washington, D.C." In a ceremony on February 24, 1965, "vital" parts of SEAC were presented as items of historical interest to the Smithsonian Institution. A "retirement" ceremony had been held on April 23, 1964, attended by Slutz.



## 2. Automatic data analysis

Early in 1950 the Upper Atmosphere Research Section initiated a project "for automatically processing data from the radio propagation field stations."<sup>94</sup> In its earliest stage this was a punch-card method with sorting by a relatively simple machine process, but an improvement over previously used manual methods of handling the data. Further improvement came slowly for lack of a better method of machine sorting. Late in 1950 the project was transferred to the Regular Propagation Services Section, with the project's title changed to "Ionosphere Data Mechanography."

Not until the spring of 1956, when the Radio Propagation Physics Division at the direction of Ralph Slutz (chief) leased a high speed IBM data processor (type 650), was there a marked improvement in handling data from the 10 ionosphere stations being channeled into the Boulder Laboratories for automatic processing.<sup>95,96</sup>

## 3. Expansion of computer program

In the fall of 1959 a mathematician, John J. Sopka, Jr., joined the Boulder Laboratories as a consultant to develop the computer program. A year later, a larger scale and higher speed computer was procured, the CDC (Control Data Corporation) model 1604 binary computer. This was operated by the Mathematics Group and Computation Facility under the direction of Sopka.

Needed expansion of computer services brought on the construction of Wing 5 to the Radio Building, the last wing to be built to complete the original design. Installed late in the fall of 1962, a new IBM 7090 computer was ready to take on a host of services to meet the rapidly developing computer needs of the Boulder Laboratories. In May 1965, a computer of greater capability yet less expensive to operate, the CDC 3600, replaced the former computer after 3 years of operation.<sup>97</sup>

An important use of the large electronic computer by the CRPL was that of theoretical calculations of transmissions in the frequency range of 10 to 10,000 MHz using the diffraction method of radio propagation (see ch. XII, pp. 535-537). By 1965 automatic reduction and tabulation of all data from the NBS worldwide network of ionospheric recording stations was performed on the electronic computer. Computer techniques were also used in the study of meteor-burst communication (see ch. XI, pp. 461-465).<sup>98</sup>

## 4. Data reduction for tropospheric propagation research

Beginning in the early 1950's, data relating to tropospheric research were compiled at such a rapid rate that relief from laborious calculations was a dire necessity. By late summer of 1956 a new section was organized within the Radio Propagation Engineering

---

<sup>94</sup> Data processed included:

Critical frequencies and minimum virtual heights of the  $F_2$ ,  $F_1$ , and E layers, maximum usable frequency-factors for these layers, and the top frequency and minimal virtual height of  $E_s$  reflections.

<sup>95</sup> Maurice A. Kistner, an experienced tabulator, was employed as a tabulator machine supervisor. His services in computer operations have continued to the present (now with NOAA).

<sup>96</sup> Among the early users of this data processor were William B. Jones and Roger M. Gallet of the Upper Atmospheric Research Section who used it for the development of ionospheric mapping by numerical methods (see ch. XI, p. 429). Other uses were for the processing of airglow data, studies of HF oblique incidence, analysis of amplitude scintillations of radio stars (see ch. XIV, p. 603), the ionospheric prediction services, and the processing of noise data.

<sup>97</sup> After the formation of ESSA and, later, of NOAA, replacements of the CDC 3600 computer for use by the Department of Commerce Boulder Laboratories were, in sequence, a CDC 3800 in 1967, a second CDC 3800 in 1972, and a CDC 6600 in 1975. With the formation of ESSA in 1965, and later of NOAA, John D. Harper, Jr., was appointed chief of Computer Services.

<sup>98</sup> In 1965 George R. Sugar received the Department of Commerce Silver Medal for Meritorious Service "for outstanding contributions to the research program of the Central Radio Propagation Laboratory through his skillful and creative design and development of equipment for the digitization of field data" (relating to meteorburst communication).

Division, to be called the Data Reduction Instrumentation Section, with Walter E. Johnson as chief.<sup>99</sup> Previously, a start had been made toward development of instrumentation for simplifying refractive-index calculations.

#### a) COMPUTATION OF REFRACTIVE INDEX OF THE ATMOSPHERE

Knowledge of the refractive-index gradient (or profile) of the atmosphere is essential in studies of radio propagation in the troposphere. Computation of the refractive-index equation is tedious but can be simplified by use of nomograms. The process was further simplified by the development of two slide rules in 1952 by Stanley Weintraub of the Tropospheric Propagation Research Section [38].<sup>100</sup>

For further simplification and greater accuracy of computation of the refractive index of the atmosphere, Johnson devised an analogue computer [39]. The computer was a specially designed bridge circuit, fitted with several dials to introduce the variables of the refractive-index equation, plus a null indicator showing bridge balance. Average operational time for a computation was approximately 10 seconds.

#### b) INSTRUMENTING FOR DATA REDUCTION

By 1957 the newly organized Data Reduction Instrumentation Section had assembled a 12-channel, magnetic-tape system for recording the various parameters of phase stability measurements being made on tropospheric propagation studies at Colorado Springs, Colo., and Maui, Hawaii. For the next several years other magnetic-tape recorders, plus magnetic-tape data reduction systems, were added to the increasing assemblage of equipment for data reduction.

In addition to having access to the large CRPL electronic computer, the section developed several special-purpose computers for use in tropospheric propagation studies. These developments were described by Johnson in *NBS Technical Note 111* [40].<sup>101</sup>

### 5. Selection of optimum frequencies by electronic computer

Early in 1961 a program was started within the Radio Systems Division to computerize the prediction of maximum usable frequency (MUF), optimum traffic frequency (FOT), lowest useful high frequency (LUF), and other information (e.g., signal-to-noise ratio) to aid in the rapid selection of frequency allocations and circuit design of ionospheric (sky wave) communication systems. This project, under the guidance of George W. Haydon, resulted in an NBS Report.<sup>102,103</sup> The automated system, using an electronic computer, had particular application in frequency assignments for U.S. Navy communication services.

<sup>99</sup>The functions of the new section were:

Research on data reduction techniques; development of instrumentation for automatic data recording and processing; development of instrumentation to achieve better efficiency and accuracy in data reduction.

<sup>100</sup>The slide-rule method of calculation was suggested by Howard E. Bussey of the Microwave Standards Section. Both slide rules are used for a calculation of refractive index, each for a separate term in the refractive-index equation; the data based on the parameters of air pressure, temperature, and relative humidity.

<sup>101</sup>*NBS Technical Note 111*, by Johnson, described several of these special-purpose computers. One was a Spectrum Analyzer that is useful for the analysis of data taken in the measurement of phase stability over low-level tropospheric paths (see ch. XII, p. 542). Another was a Correlation Computer designed for continuously performing the multiplication and integration required in solving normalized correlation equations associated with message errors on single-sideband transmissions at UHF. Another was an analysis system, called an Automatic Amplitude Distribution Analyzer, for determining the principal statistical parameters of time varying propagation data. This system made it possible to analyze data at the rate of 100 times the speed at which it is recorded, with digital printout for computation. Still another instrument was a Distribution Analyzer which computes the percentage of time the amplitude of signals exceeds various preset levels, such as the distribution of fade rate and fade-rate duration.

<sup>102</sup>See p. 585 and footnote (87) on Haydon's earlier work in the CRPL.

<sup>103</sup>This document covered the technical considerations in the selection of optimum frequencies, taking into account the many variables that enter into the design and operation of a sky-wave communication system.

The document was reprinted in June 1969 as *ESSA Technical Report ERL 113-ITS 81*, entitled "Technical Considerations in the Selection of Optimum Frequencies for High Frequency Sky-Wave Communication Services," and authored by George W. Haydon, Donald L. Lucas, and Rodney A. Hanson. From time to time the same authors had prepared NBS Reports on high frequency propagation predictions for the National Aeronautics and Space Administration (NASA).

## A DIVERSITY OF PROJECTS

### 1. Consideration of conductivity in groundwave propagation

The consideration of ground conductivity in the propagation of radio waves goes back to 1909 when Sommerfeld of Germany published a paper on "The Propagation of Waves in Wireless Telegraphy."<sup>104</sup>

In 1932 Samuel S. Kirby and Kenneth A. Norton of the Radio Section published an account of their field-strength measurements taken over distances ranging from 1 to nearly 600 km, and in a frequency range of 285 to 5400 kHz that included the broadcast band (see ch. V, pp. 111-112) [41]. With the aid of graphical information published 2 years earlier (1930) by Bruno Rolf of Sweden, Kirby and Norton were able to calculate from their measurements the average values of conductivity over several long transmission paths.<sup>105</sup>

Within the broad scope of problems relating to the allocation of radio-frequency channels to broadcasting services and extending into the VHF band, were those problems associated with conductivity in relation to groundwave propagation.<sup>106</sup> For a number of years this study area was listed in the project structure of the CRPL under the title of "Terrain Effects on Propagation."<sup>107</sup> Early in this period (1951-1959) NBS was requested by the Federal Communications Commission (FCC) to essay a correlation of conductivity with type of soil. If the correlation were possible, the result of measurements in the form of maps would be of considerable value to the FCC and the consulting radio engineers. A 2-year study was summarized in the form of maps in *NBS Circular 546*, entitled "Effective Radio Ground-Conductivity Measurements in the United States" [42].<sup>108,109</sup>

The information compiled in *NBS Circular 546* became embodied in the 1956 FCC "Standards of Good Engineering Practice Concerning Standard Broadcast Stations" and has remained as such to the present time.

A more hopeful approach to the correlation problem (effective ground conductivity with soil type) was taken by the section group in 1954, this time using a more simple classification of soil types—that of a system of 39 types used by the Civil Aeronautics Administration for airport design. This study continued on an irregular schedule for nearly 5 years, with the conclusion reached that the insufficient correlation that was found would only provide for a poor engineering practice.

<sup>104</sup> In his paper (*Annalen der Physik*, Vol. 28, Mar. 16, 1909) A. Sommerfeld took into account the three Earth constants of conductivity, dielectric constant, and permeability.

<sup>105</sup> Kirby and Norton determined the conductivity to be  $3.35 \times 10^{-14}$  emu (or 3.35 millisiemens per meter) along a propagation path to the southwest across New Jersey, and considered this value to be typical for areas east of the Allegheny Mountains that approximate the latitude of New Jersey. They determined the conductivity to be  $1.07 \times 10^{-13}$  emu (or 10.7 millisiemens per meter) along a propagation path to the east of Chicago, Ill., and considered this value to be typical for areas near Chicago.

Later, in 1941, Norton published a paper, while a staff member of the Federal Communications Commission, in which he used the values of  $9 \times 10^{-14}$  and  $5 \times 10^{-14}$  emu for conductivity of land in his examples of a graphical method of determining groundwave field intensity.

<sup>106</sup> The importance of the subject can be ascertained from the statement made in the 1953 CRPL Annual Report that: "Ground conductivity plays a dominant role in the transmission of low frequencies in the 550-1600 kc region" (broadcast band).

<sup>107</sup> This project was assigned first to the Tropospheric Propagation Research Section and later to the Radio Systems Application Engineering Section.

<sup>108</sup> This project, under the guidance of Robert S. Kirby (son of Samuel S. Kirby), had its basis in the preparation of a catalog of measurements of effective ground conductivity obtained from files of the FCC (cataloging was started in 1947). By 1953 a total of 7237 ground-conductivity measurements made of 621 broadcast stations operating in the frequency range of 540 to 1600 kHz had been collected and cataloged by the Tropospheric Propagation Research Section, the project being completed in Boulder, Colo. These "Proof of Performance" measurements had been taken over a period of years for the FCC by consulting engineers.

The measurements were studied statistically by the section staff to determine the most probable values and the probable range of values of ground conductivity for 243 soil types classified in the Department of Agriculture *Atlas of American Agriculture*. The study showed some correlation between effective ground conductivity and surface soil type (composition) but insufficiently so to preclude the correlation method to be a means of predicting conductivity for estimating groundwave radio transmission.

Because of this lack of correlation of effective conductivity with soil type, another approach was taken to provide useful information to the radio engineer for future analysis of radiation fields of transmitters, as based upon past measurements. The result was *NBS Circular 546*. Information was delineated by 81 sectional maps

Beginning around the mid-1950's, a number of CRPL papers on propagation at LF and VLF considered the effect of ground conductivity, with assigned values ranging from 1 to more than 20 millisiemens per meter, and for "ideal" propagation a value of infinity. Most of these papers were theoretical treatments of propagation characteristics, particularly those by James R. Wait. Ground conductivity was also considered in the study of propagation of sferics over long distances.

## 2. A bout with color television

Although the dream of color television probably came as early as that of television itself, the art was not demonstrated in the United States until 1929, when on June 27 the Bell Telephone Laboratories demonstrated a wire communication system to the press. Eleven years later, on September 4, 1940, the Columbia Broadcasting System broadcast (from a New York City station) the first experimental color pictures, using the field-sequential method with a rotating mechanical color disk. Beginning in 1945, following World War II, the rapid strides in further development of color television brought on a batch of problems soon to be faced by the Federal Communications Commission (FCC).<sup>110</sup>

Hearings on color television, conducted by the FCC, began on December 9, 1946 and, at intervals, extended into the early 1950's. It was in a climate of intense technical rivalry among the protagonists of the television industry that the National Bureau of Standards was drawn into the controversies that developed. Coming within the scope and functions of the U.S. Senate Committee on Interstate and Foreign Commerce (to which the FCC reported), the chairman, Senator Edwin C. Johnson (Colorado) requested Edward U. Condon, director of NBS to serve as chairman of a Senate Advisory Committee on Color Television that would give the Senate Committee "sound, impartial, scientific advice" on the problems of national scope that were affecting both the television industry and the general public.<sup>111-113</sup>

---

(Continued)

covering 48 sectors (each sector 5 degrees latitude and 5 degrees longitude) of the United States. Shown on the maps were the effective ground conductivities (one or more, with values in milliohms) on each of 8 or more radials over which field-strength measurements had been made (to obtain effective ground conductivity), plus frequency and call letters of each broadcast station. More than 7000 measurement radials were associated with the 621 stations described.

<sup>109</sup> In the September 1954 issue of the *Proc. IRE*, Harry Fine of the Federal Communications Commission published a map adopted by the FCC, entitled "Effective Ground Conductivity Map for Continental United States." It was stated:

This map represents estimates (of ground conductivity) based on measurements over approximately 7000 paths throughout the country which were submitted to the FCC. The previous ground conductivity map had been promulgated in 1938 and based upon relatively few measured paths plus the soil type map. Subsequent measurements had shown that the estimates of conductivity provided by this 1938 map were appreciably in error for various parts of the country. For this reason a more accurate map was considered desirable in the allocation of standard broadcast stations and the present map was adopted by the FCC for use as of April 5, 1954.

Estimated effective ground conductivities ranged from 0.5 to 30 millisiemens per meter, plus 5000 for sea water.

Much credit was given to R. S. Kirby who "was extremely helpful in supplying the subsoil correlation analysis and the map overlays, which represented an enormous amount of labor by himself and other CRPL personnel."

<sup>110</sup> These problems were mainly those of operating standards, channel width, compatibility of color with black-and-white pictures, and the three systems of transmission, viz., field sequential, line sequential, and dot sequential.

<sup>111</sup> Senator Johnson was well known to Condon; at the time he was becoming involved in the selection of a new location for the Central Radio Propagation Laboratory (see ch. XIX).

<sup>112</sup> In a letter to Condon, dated May 20, 1949, Senator Johnson stated, in part:

The question of the present-day commercial use of color television has been a matter of raging controversy within the radio world for many months. There is a woeful lack of authentic and dependable information on this subject.

Hundreds of applicants for television licenses, as well as those now operating television stations are vitally affected by its settlement. . . .

The Advisory Committee on Color Television submitted a report to the Senate Committee in February 1950. This initial report was primarily one on the problem of frequency allocation for television service. The committee submitted its final report—*Senate Document 197*—after its concluding meeting of July 5-6, 1950. Thereafter, with the permission of Senator Johnson, the complete report was published in the September 1950 issue of the *Proc. IRE* [43].<sup>114,116</sup>

In 1950, after 62 days of testimonies from many witnesses, on October 11 the FCC decided to adopt the standards for the incompatible (with monochrome television) field-sequential system. Public broadcasts using this system were inaugurated by the Columbia Broadcasting System in New York City on June 25, 1951. But opinion of the television industry as a whole, and the RCA (advocating the dot-sequential system) in particular, was overwhelmingly opposed to the FCC decision. Yet after review by the U.S. Supreme Court, the FCC's decision was sustained. Time took its toll on the inadequacy of the FCC's choice

---

(Continued)

The Federal Communications Commission has declined to authorize commercial licensing of color television. It seems reluctant to indicate when and if it will act with respect to authorizing commercial licensing of color. . . .

My objective, and the objective of the Senate Committee on Interstate and Foreign Commerce, is to encourage development of the radio act and to press for a nationwide, competitive television service in the public interest. . . .

I am particularly concerned with resolving once and for all the charges that have been made that the advance of color television has been held up by the Commission for reasons difficult for us to understand, and I feel certain that a committee headed up by so eminent a scientist as you will help resolve these doubts and questions which have been tossed about. . . .

<sup>113</sup>In making a selection of members for his small committee, Condon chose persons well known in the communications field: Stuart L. Bailey, William L. Everitt, Donald G. Fink, and Newbern Smith (chief of the CRPL).

<sup>114</sup>The final report was confined to technical factors of color television, expressed as far as possible in nontechnical terms. The committee based its report on three basic conclusions that were:

1. A 6-Mc radio frequency channel is adequate for color television service, and represents a compromise between quality and quantity of service.
2. The three systems of color television herein described (line-sequential, field-sequential, and dot-sequential systems) comprise all of the basic systems of color television which need be considered for a 6-Mc channel.
3. The three systems are mutually exclusive. One, and only one, of these systems must be chosen in advance of the inauguration of a public color television service.

The conclusions were reached after members of the committee had witnessed demonstrations of each of the three systems. Added to the report were two "Annexes," reports of tests performed by NBS, one on flicker in color television, the other on fidelity of color reproduction of two of the systems. The tests were performed by the Photometry and Colorimetry Section.

<sup>115</sup>Following publication of the report in the September 1950 issue of the *Proc. IRE*, a year later, in the October 1951 issue, the Institute of Radio Engineers brought out a "special issue" entitled, "Color Television." It contained 20 papers, many of which covered important developments in the then very rapid growth of color television. This was the first of many special issues covering a variety of subjects in the field of radio and electronics that have been published in the *Proc. IRE* (later, *IEEE*).

<sup>116</sup>A few months after publication of the Advisory Committee's final report, the *Scientific American* published a paper prepared by Newbern Smith entitled, "Color Television," which appeared in the December 1950 issue [44]. This paper clearly stated the problems faced by the FCC. To quote from Smith's paper, which was published after the FCC had reached a decision in the controversy, he stated:

The FCC decision has not ended the controversy; indeed, the differences between the contending interests have been brought to the stage of action in the law courts and in the court of public opinion. Because the ultimate judgment of the issue will be made by public opinion, it is important that the public have some understanding of the underlying technical problems and issues involved. They will be summarized here as they were analyzed by the Senate Advisory Committee on Color Television on which the writer served . . . The Advisory Committee made no recommendation as to which of the competing systems should be adopted, since such a decision "must include consideration of many social and economic factors, factors not properly the concern of the technical analyst."

Smith presented the committee's assessment of the three competing systems by means of a chart. By means of practical diagrams he explained the working principles of each of the three systems.

and on December 17, 1953, the FCC approved the use of the compatible dot-sequential system and color television in the United States soared into popularity beyond all expectations.<sup>117</sup>

### 3. A radio system for investigating sferics—Ephi

The facilities and expertise of the Navigation Systems Section were uniquely suited in 1958 to develop a versatile direction-finding system for automatic azimuthal detection and analysis of sferics (lightning discharges)—a project requested by the Air Force Cambridge Research Center.<sup>118</sup> Evolving from this project was the development of a new system of radio direction finding, operating in the VLF range (3-30 kHz) that had greater accuracy than other systems such as those using crossed-loop techniques.<sup>119</sup> The system minimized siting and polarization errors, these errors being disadvantageous to crossed-loop techniques. The project, under leadership of Gifford Hefley, was reported in a 1961 publication [45].

<sup>117</sup> Much credit for the trend of opinion that changed the viewpoint and finally changed the decision by the FCC must be given to operations of the second National Television System Committee (NTSC) whose membership consisted of a large number of highly qualified television engineers. This committee, which functioned over a 5-year period (1949-1953), had its origin in the first committee that was formed during the period of 1940-1941 by the Radio Manufacturers Association (RMA) for evaluation of standards for monochrome television.

<sup>118</sup> Measurement data of sferic observations are useful for radio propagation studies, ground-conductivity determination, distance measurements, thunderstorm and tornado location and tracking, and the like, all to be gained from direction finding and complex spectrum measurement.

<sup>119</sup> The new system was named "Ephi" ( $E-\phi$ ) because the bearing of the transient signal was determined from the relative phase,  $\phi$  (phi), of the vertical electrical field,  $E$ , received at spaced antennas. The system required three antennas located at the vertices of an equilateral triangle. In the development system, located 30 miles east of Boulder near Brighton, Colo., the three antennas were 125-foot towers spaced approximately 4 miles apart. Phase detectors, delay lines, and coincidence circuits were used to obtain directional coding in preset directional sectors, with an accuracy in direction of less than 1 degree. The electronic equipment had capability for counting the number of sferics in a given time interval, and counting the number of sferics arriving simultaneously from several different directions. Also, the sferic waveforms could be photographed automatically for analysis, as stills or motion pictures.

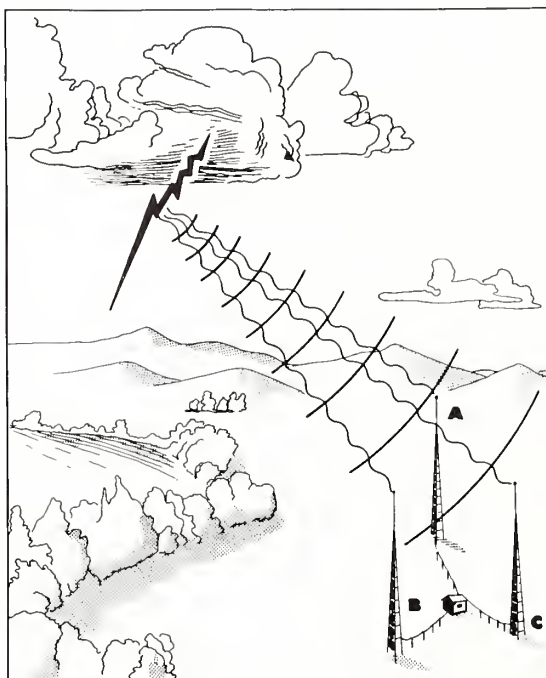

*Pictorial diagram illustrating the principle of "Ephi," a direction-finding system for automatic azimuthal detection and analysis of lightning discharges (sferics). Developed in 1958 by the Navigation Systems Section, the Ephi system was located near Brighton, Colo. Sferic signals received by each of three 125-ft (height) antennas, located 4 miles apart at the vertices of an equilateral triangle, are fed by coaxial cables to a centrally located recording station. At this station, time differences (of the order of several microseconds) between the three signals are processed by electronic circuits to indicate accurately the direction of an electrical storm. Two such stations located several hundred miles apart can accurately fix the position of a storm at distances of thousands of miles.*

## REFERENCES

- [1] E. L. Shultz, "Comparison of predictions of atmospheric radio noise with observed noise levels," *Trans. Amer. Geophysical Union*, Vol. 28, No. 6, Dec. 1947, pp. 854-860.
- [2] W. Q. Crichlow, D. F. Smith, R. N. Norton, and W. R. Corliss, Worldwide Radio Noise Levels Expected in the Frequency Band 10 Kilocycles to 100 Megacycles, *Nat. Bur. Stand. (U.S.), Circ. 557*, Aug. 25, 1955, 36 pages.
- [3] William Q. Crichlow, "Noise investigation at VLF by the National Bureau of Standards," *Proc. IRE*, Vol. 45, No. 6, June 1957, pp. 778-782.
- [4] W. Q. Crichlow, C. A. Samson, R. T. Disney, and M. A. Jenkins, Radio Noise Data for the International Geophysical Year July 1, 1957-December 31, 1958, *Nat. Bur. Stand. (U.S.), Tech. Note 18*, July 27, 1959, 235 pages.
- [5] C. A. Samson, "Effects of high-altitude nuclear explosions on radio noise," *J. Res. Nat. Bur. Stand. (U.S.)*, Vol. 64D, No. 1, Jan.-Feb. 1960, pp. 37-40.
- [6] H. N. Cones, H. V. Cottony, and J. M. Watts, "A 600-ohm multiple-wire delta antenna for ionosphere studies," *J. Res. Nat. Bur. Stand. (U.S.)*, Vol. 44, No. 5, May 1950, pp. 475-488.
- [7] H. V. Cottony, "High-gain antennas for VHF scatter propagation," *IRE Trans. Communications Systems*, Vol. CS-4, No. 1, Mar. 1956, pp. 56-63.
- [8] H. V. Cottony and A. C. Wilson, "Gains of finite-size corner-reflector antennas," *IRE Trans. Antennas and Propagation*, Vol. AP-6, No. 4, Oct. 1958, pp. 366-369.
- [9] A. C. Wilson and H. V. Cottony, "Radiation patterns of finite-size corner-reflector antennas," *IRE Trans. Antennas and Propagation*, Vol. AP-8, No. 2, Mar. 1960, pp. 144-157.
- [10] "NBS model antenna range," *Nat. Bur. Stand. (U.S.), Tech. News Bull.*, Vol. 35, No. 12, Dec. 1951, pp. 173-175.
- [11] H. V. Cottony and A. C. Wilson, "A high-resolution rapid-scan antenna," *J. Res. Nat. Bur. Stand. (U.S.)*, Vol. 65D, No. 1, Jan.-Feb. 1961, pp. 101-110.
- [12] H. V. Cottony, "Current development in an electronically scanned antenna," *Electromagnetic Theory and Antennas*, Pergamon Press, London, 1963, pp. 1289-1294.
- [13] "NBS studies radiation pattern of monopole array," *Nat. Bur. Stand. (U.S.), Tech. News Bull.*, Vol. 47, No. 1, Jan. 1963, pp. 6-7.
- [14] A. D. Watt, V. J. Zurick, and R. M. Coon, "Reduction of adjacent-channel interference components from frequency-shift-keyed carriers," *IRE Trans. Communication Systems*, Vol. CS-6, No. 2, Dec. 1958, pp. 39-47.
- [15] G. Franklin Montgomery, "A comparison of amplitude and angle modulation for narrow-band communication of binary-coded messages in fluctuation noise," *Proc. IRE*, Vol. 42, No. 2, Feb. 1954, pp. 447-454.
- [16] J. W. Koch, "Factors affecting modulation techniques for VHF scatter systems," *IRE Trans. Communication Systems*, Vol. CS-7, No. 2, June 1959, pp. 77-92.
- [17] J. W. Koch, W. B. Harding, and R. J. Jansen, "FM and SSB radio-telephone tests on a VHF ionospheric scatter link during multipath conditions," *IRE Trans. Communication Systems*, Vol. CS-8, No. 2, Sept. 1960, pp. 183-186.
- [18] T. L. Davis and R. H. Doherty, "Widely separated clocks with microsecond synchronization and independent distribution systems," *IRE Trans. Space Electronics and Telemetry*, Vol. SET-6, No. 3-4, Sept.-Dec. 1960, pp. 138-146.
- [19] R. H. Doherty, G. Hefley, and R. F. Linfield, "Timing potentials of Loran-C," *Proc. IRE*, Vol. 49, No. 11, Nov. 1961, pp. 1659-1673.
- [20] "Loran-C clock timing system," *Nat. Bur. Stand. (U.S.), Tech. News Bull.*, Vol. 46, No. 2, Feb. 1962, pp. 20-21.
- [21] Gifford Hefley, The Development of Loran-C Navigation and Timing, *Nat. Bur. Stand. (U.S.), Monogr. 129*, Oct. 1972, 144 pages.
- [22] Martin T. Decker, "Tacan coverage and channel requirements," *IRE Trans. Aeronautical Navigational Electronics*, Vol. ANE-4, No. 3 Sept. 1957, pp. 135-143.
- [23] Edwin F. Florman, "A measurement of the velocity of propagation of very-high-frequency radio waves at the surface of the earth," *J. Res. Nat. Bur. Stand. (U.S.)*, Vol. 54, No. 6, June 1955, pp. 335-345.
- [24] J. W. Herbstreit and P. L. Rice, Survey of Central Radio Propagation Laboratory Research in Tropospheric Propagation 1948-1956, *Nat. Bur. Stand. (U.S.), Tech. Note 26*, Sept. 1959, 211 pages.
- [25] Kenneth A. Norton, "Propagation in the FM broadcast band," *Advances in Electronics*, Vol. I, Academic Press, New York, 1948, pp. 381-423.
- [26] Kenneth A. Norton, "Transmission loss in radio propagation," *Proc. IRE*, Vol. 41, No. 1, Jan. 1953, pp. 146-152.
- [27] P. L. Rice and F. T. Daniel, "Radio transmission loss versus distance and antenna height at 100 Mc," *IRE Trans. Antennas and Propagation*, Vol. AP-3, No. 2, Apr. 1955, pp. 59-62.
- [28] D. A. Williamson, V. L. Fuller, A. G. Longley, and P. L. Rice, A Summary of VHF and UHF Tropospheric Transmission Loss Data and Their Long-Term Variability, *Nat. Bur. Stand. (U.S.), Tech. Note 43*, Mar. 1960, 174 pages.
- [29] Robert S. Kirby, "Measurement of service area for television broadcasting," *IRE Trans. Broadcast Transmission Systems*, Vol. BTS-7, Feb. 1957, pp. 23-30.
- [30] M. T. Decker, Service Area of an Airborne Television Station, *Nat. Bur. Stand. (U.S.), Tech. Note 35*, Oct. 1959, 43 pages.
- [31] R. S. Kirby, J. W. Herbstreit, and K. A. Norton, "Service range from air-to-ground and air-to-air communications at frequencies above 50 Mc," *Proc. IRE*, Vol. 40, No. 5, May 1952, pp. 525-536.
- [32] Kenneth A. Norton and Philip L. Rice, "Gapless coverage in air-to-ground communications at frequencies above 50 Mc," *Proc. IRE*, Vol. 40, No. 4, Apr. 1952, pp. 470-474.
- [33] *Radio Spectrum Conservation*, a report of the Joint Technical Advisory Committee, IRE-RTMA, McGraw-Hill, New York, 1952.

- [34] *Radio Spectrum Utilization*, a report of the Joint Technical Advisory Committee of the Institute of Electrical and Electronics Engineers and the Electronic Industries Association, published by the IEEE, 1964.
- [35] George W. Haydon, "Optimum frequencies for outer space communication," *J. Res. Nat. Bur. Stand. (U.S.)*, Vol. 64D, No. 2, Mar.-Apr. 1960, pp. 105-109.
- [36] William J. Hartman and Martin T. Decker, "Mutual interference between surface and satellite communication systems," *J. Res. Nat. Bur. Stand. (U.S.)*, Vol. 65D, No. 5, Sept.-Oct. 1961, pp. 433-436.
- [37] Kenneth A. Norton, Efficient Use of the Radio Spectrum, *Nat. Bur. Stand. (U.S.)*, *Tech. Note 158*, Apr. 1962, 77 pages.
- [38] Stanley Weintraub, "Slide rule computes radio refractive index of air," *Electronics*, Vol. 26, No. 1, Jan. 1953, pp. 182,190,194,196,198,200.
- [39] Walter E. Johnson, "An analogue computer for the solution of the radio refractive-index equation," *J. Res. Nat. Bur. Stand. (U.S.)*, Vol. 51, No. 6, Dec. 1953, pp. 335-342.
- [40] Walter E. Johnson, Data Reduction Instrumentation for Radio Propagation Research, *Nat. Bur. Stand. (U.S.)*, *Tech. Note 111*, July 1961, 32 pages.
- [41] S. S. Kirby and K. A. Norton, "Field-intensity measurements at frequencies from 285 to 5400 kilocycles per second," *Proc. IRE*, Vol. 20, No. 5, May 1932, pp. 841-862. (Also published in *J. Res. NBS.*)
- [42] R. S. Kirby, J. C. Harman, F. M. Capps, and R. N. Jones, Effective Radio Ground-Conductivity Measurements in the United States, *Nat. Bur. Stand. (U.S.)*, *Circ. 546*, Feb. 26, 1954, 87 pages.
- [43] "The present status of color television," a report by the Senate Advisory Committee on Color Television, E. U. Condon, S. L. Bailey, W. L. Everitt, D. G. Fink, and Newbern Smith, *Proc. IRE*, Vol. 38, No. 9, Sept. 1950, pp. 980-1002.
- [44] Newbern Smith, "Color television," *Scientific American*, Vol. 183, No. 6, Dec. 1950, pp. 13-17.
- [45] G. Hefley, R. F. Linfield, and T. L. Davis, "The Ephi system for VHF direction finding," *J. Res. Nat. Bur. Stand. (U.S.)*, Vol. 65C, No. 1, Jan.-Mar. 1961, pp. 43-49.



## Chapter XIV

### BEYOND THE IONOSPHERE<sup>1</sup>

#### COSMIC RADIO NOISE

##### 1. From earthborn static to the stars

Both within NBS and outside, the science of radio astronomy had its genesis in rather intensive studies of the limitations on radio communication caused by noise external to the receiver. In 1932, at the Bell Telephone Laboratories facility at Holmdel, N.J., Karl G. Jansky observed a low intensity background noise while measuring the directional properties of atmospheric noise at 20.5 MHz (14.6 m). He concluded that this hiss-type of background noise was of extraterrestrial origin, to be called later "cosmic" or "galactic" radio noise [1,2].<sup>2</sup> (See ch. I, year 1932.)

Strangely, Jansky's work did not excite the curiosity of other radio engineers or the astronomers, except that of a radio engineer and amateur living in a suburban town west of Chicago, Wheaton, Ill. Grote Reber, using his own resources, single-handedly constructed a 31.4-foot diameter paraboloidal directional antenna which he set up in the backyard of his home. He designed and built a special receiver to observe cosmic noise at 160 MHz (1.87 m), much higher in frequency than that selected by Jansky. Reber constructed this, the world's first radio telescope, during the summer of 1937 and published his first observations in 1940, with more extensive papers in 1942 [3,4]. Based upon theoretical considerations of astronomy, Reber was able to evaluate the intensity of radio emission from interstellar space.

In 1944 Reber was able to plot with considerable accuracy the positions of sources of cosmic noise in the Milky Way, including those of the constellations of Sagittarius, Cygnus, and Cassiopeia.

Termination of World War II engendered rapid interest in radio astronomy—and time recorded that Jansky and Reber opened up new avenues of scientific exploration of the Universe. Today, radio telescope installations, great and small, are found in many spots throughout the World. Much has been written on the revelation of Nature's secrets of distant galaxies and stars.

##### 2. Grote Reber joins the CRPL

In the spring of 1947 Grote Reber entered on duty in the Experimental Ionospheric Research Section. The NBS purchased his cosmic radio noise measurement apparatus and had the entire radio telescope moved from Wheaton, Ill. and installed at the Sterling, Va., field station. Here it remained for radio astronomy studies until 1952 when it was

---

<sup>1</sup> The reader will find overlapping subjects within chapters XI and XIV. Ground-based observations of the ionosphere are covered in chapter XI, plus added material on observations by rockets and satellites, also some exploration of the exosphere. Chapter XIV was written 5 years later with the intention of letting chapter XI remain intact. Chapter XIV includes subjects "Beyond the Ionosphere," such as: Radio astronomy projects, the conjugate point program, the exosphere, and space communications.

<sup>2</sup> With his directional antenna, Jansky first thought that the hissing noise was from an unidentified carrier modulated by noise within the receiver. Then he attributed it to radiation from the Sun. But he soon found that the source was from the Milky Way and primarily from the region of the constellation Sagittarius. Jansky pursued his study of galactic noise for several years thereafter and then the project was terminated.

disassembled and taken to Boulder, Colo. On an indefinite loan basis, it was rebuilt in 1957 at the National Radio Astronomy Observatory near Green Bank, W. Va.<sup>3</sup>

---

<sup>3</sup>The National Radio Astronomy Observatory, supported by the National Science Foundation and administered by Associated Universities, Inc., was located on a large tract of land near Green Bank, W. Va., in 1957. It is now equipped with many types of radio telescopes, some of gigantic dimensions. Grote Reber's original telescope is preserved here primarily as an item of historical interest, but is used from time to time as an operable device serving several functions.

Unfortunately Jansky's original directional antenna was dismantled and cast aside. A full-scale replica is now located at the Green Bank facility.

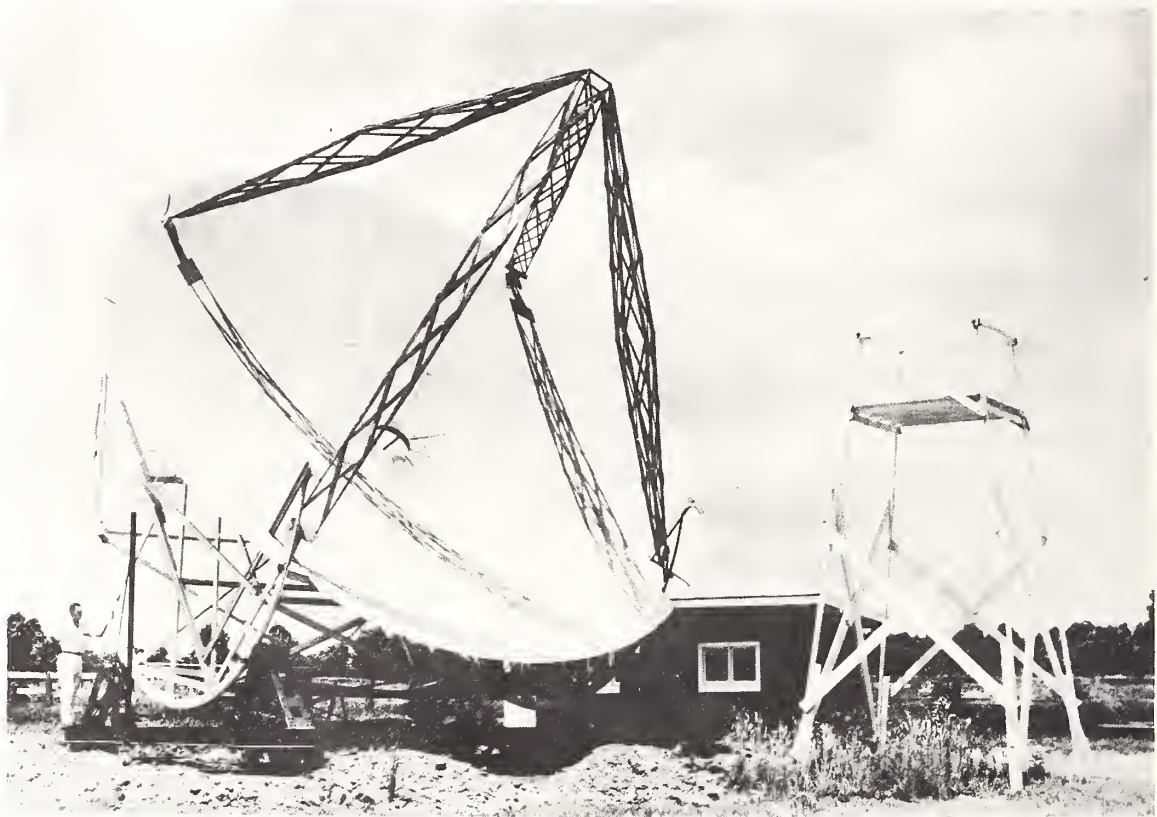

*The world's first radio telescope, built by Grote Reber at Wheaton, Ill. It became the property of NBS and is pictured at the Sterling, Va., field station. The telescope, now located at the National Radio Astronomy Observatory near Green Bank, W. Va., serves both as a historical item and occasionally as a working instrument.*

### 3. The CRPL studies cosmic radio noise

Of the several new projects to be initiated soon after formation of the CRPL on May 1, 1946, was one to be labeled for a number of years as "cosmic radio noise." The Quarterly Report for the period of April-June 1946 stated:

Experimental recording of radio noise from the stars (sometimes called cosmic noise) at 100 Mc, using a dipole antenna at ground level, was begun. It is expected that this project will lead to an accurate determination of the

limiting field intensities for useful results in any radio services in the VHF range, such as FM broadcasting.<sup>4</sup>

Thus began an extensive program at NBS that included the measurement of cosmic noise, studies of solar noise, and observations associated with the fast expanding field of radio astronomy. Radio work at the NBS would now reach beyond the ionosphere.

The new field station near Sterling, Va., was well suited for measurement of cosmic and solar noise, the area being relatively free from man-made noise at radio frequencies. It was at this field site that Jack W. Herbstreit, assisted by Herman V. Cottony, William Q. Crichlow, and J. Ralph Johler, set up their measurement equipment. During the earlier years, the project was within the Experimental Ionospheric Research Section.

Specially designed stable and very sensitive receivers (field-strength recorders) with very low noise figures were constructed. Measurements were begun at 110 MHz, using a half-wave dipole antenna placed one-quarter wavelength above the ground. The axis of the dipole was oriented both in the east-west and north-south planes to compensate for the Earth's rotation so as to adapt to the general direction of the strongest cosmic noise (from the constellation Sagittarius in the Milky Way). During the next several years, measurements were made at discrete frequencies ranging from 25 to 110 MHz. It was soon learned that the cosmic noise intensity varies in inverse proportion to a 2.4 power of the frequency.<sup>5</sup> In 1948 Herbstreit published an account of the earlier work on the cosmic noise project [5].<sup>6</sup>

At a Conference on Radio Propagation at NBS during the period of May 8-10, 1947, there was a session on cosmic radio noise, with Karl G. Jansky as chairman. Newbern Smith was general chairman of the Conference. About 75 persons attended.

Beginning in March 1948, Cottony and Johler made a 2-year study of cosmic noise at the Sterling field station, largely following Herbstreit's measurement technique, with the addition of automatic recording [6]. They chose, however, to orient their dipole antennas in an east-west direction only for stronger radiation from both constellations, Sagittarius and Cygnus. Measurements were made at 25, 35, 50, 75, and 110 MHz. They found that the intensity in terms of temperature of equivalent black-body radiation in kelvins varies as the 2.3 power of the frequency, and as the 0.15 power in terms of the electric field strength.

The normal cosmic radio noise is characterized by its constant level. However, occasionally it is affected by sudden bursts of solar radio noise that is manifested by sudden ionosphere disturbances (SID). Cottony and Johler concluded that normal cosmic radio noise may be the limiting factor to communication in the VHF band up to approximately 200 MHz.

By the spring of 1952 the galactic radio noise study was phased out. Studies of solar radio noise were to continue for many years within the CRPL.

<sup>4</sup> Later, in the *Annual Report of the NBS, 1948*, a fuller statement was made that embraced the growing field of radio astronomy.

Cosmic and solar radio waves reaching the earth from outer space are manifested audibly as frying or hissing noises in a receiver at the higher frequencies. These forms of radio noise limit the range and minimum usable signal levels for frequency-modulation broadcasting, television, and communication and radio navigation services in the very-high-frequency range. In order to obtain a more complete understanding of these phenomena, a program in radio astronomy has been instituted.

For the study of radio propagation conditions, it is important that the characteristics of cosmic radio noise be determined in regard to its directional properties, absolute magnitude, and frequency dependence. In addition these determinations will undoubtedly provide valuable information regarding the nature of the universe.

Author's notes (WFS): See appendix D, footnote 40, for a realization of the prognostication in this concluding remark.

By convention, the term cosmic radio noise sometimes includes both the solar radio noise from the Sun and the galactic radio noise from interstellar space.

<sup>5</sup> Herbstreit and Johler reported on "Frequency variation of the intensity of cosmic radio noise" in the April 3, 1948 issue of *Nature*. Measurements had been made at 25 and 110 MHz. Their measurements were expressed in terms of an external noise factor,  $\bar{E}\bar{N}$ , a term suggested by Norton in the previous year (1947).

<sup>6</sup> The series of volumes on *Advances in Electronics* is a continuous annual publication by Academic Press and was edited for many years by Dr. L. Marton of NBS. Herbstreit and Kenneth Norton were selected to write sections of the first volume. Norton's paper, entitled "Propagation in the FM broadcast band" was cross-referenced with Herbstreit's paper, as the two papers had intertwining subject matters.

## 4. An engineering viewpoint

In the First Annual Report of the Boulder Laboratories (FY 1955) the subject of absorption of cosmic noise in the ionosphere was examined in view of investigation by methods of radio astronomy measurements.<sup>7</sup> Significant, were statements on the importance of increased knowledge of the magnitude and characteristics of the absorption. It was stated that:

Quantitative knowledge of ionospheric absorption, its temporal and geographical variations, besides having considerable worth in contributing to understanding of the physics of the upper atmosphere, merits pursuit by the laboratory (CRPL) as one of the three basic ingredients involved in the solution of practical radio propagation problems in engineering of communication systems and frequency allocations.<sup>8</sup>

Such was the engineering viewpoint of cosmic noise absorption in FY 1955 by the CRPL.

## SOLAR RADIO NOISE<sup>9</sup>

### 1. Preparations for a study program

Credit is usually given to George C. Southworth and to Grote Reber as the first observers of solar radio noise. Southworth, a research engineer of the Bell Telephone Laboratories, observed radiation from the Sun at three microwave frequencies at wavelengths between 1 and 10 centimeters. This was reported in January 1945 [7]. He stated that the energy appears substantially that predicted by black-body radiation theory. Later, in December 1946, Reber reported on the observation of solar radiation at 480 MHz (0.63 m), apparently independently of Southworth, although he was in communication with Southworth [8]. These observations were with his radio telescope at Wheaton, Ill. Reber attributed the radiation to a presumable temperature of about one million K.<sup>10</sup> On several occasions he observed radiation of considerable intensity due to sunspot activity. Later, in January 1948, Reber reported additional observations in the *Proc. IRE*.

On January 20, 1947, the Experimental Ionospheric Research Section made its first attempt of measuring the intensity of solar noise. Two types of collectors were used: a half-wave dipole used in the cosmic noise measurements, and an SCR-270 radar antenna (for a mobile Signal Corps early warning radar at about 106 MHz). With the radar antenna beamed toward the Sun, 17-percent more noise power was observed than when directed away from the Sun. On January 25, an 8-fold increase in power was observed. Later, it was learned that this observation coincided with a period of high solar activity.

<sup>7</sup> Although cosmic noise was stated in the Report, as a deterrent to communication systems, equal magnitude of cosmic or solar noise would have approximately the same deleterious effect.

<sup>8</sup> The other two principal aspects of predicting frequency-utility relationships in radio engineering were stated as being: "the practical relationship of oblique-incidence MUF to critical frequency at vertical incidence, and the intensity and distribution of atmospheric radio noise and its limiting effects on intelligibility of reception."

<sup>9</sup> The study of solar noise was assigned to various sections and projects within the CRPL from 1947 to 1965. It started within the Experimental Ionospheric Research Section in January 1947, which soon assimilated a project from the Basic Microwave Research Section (see app. C, footnote 17), named "Radiometer at 1000 Mc." Upon entry of Grote Reber to the Section in the spring of 1947, the name "Radio Astronomy" was assigned to a general project under Reber, with a subtitle of "Radiometer at VHF," and then an added "UHF Radiometer." During a reorganization of the CRPL on February 1, 1949, the cosmic radio noise and solar radio noise projects were transferred to the Upper Atmosphere Research Section.

Reber resigned from NBS in September 1951 and the Radio Astronomy project was continued under the leadership of Vernon H. Goerke until 1956. With the move to Boulder, the Radio Astronomy project became a part of the Ionosphere Research Section. In 1956 the project was headed by Robert S. Lawrence, and by 1959 the project was absorbed into the Radio Astronomy and Arctic Propagation Section under C. Gordon Little. Thereafter, studies in radio astronomy continued within the Ionosphere Radio Astronomy Section under the leadership of Lawrence until the formation of ESSA in 1965.

<sup>10</sup> In 1944 Reber reported that he had observed some evidence of solar radiation at 160 MHz but he was hesitant to accept his observations as fact. He had to wait two more years before he would be certain he was observing solar radiation at radio frequencies.

During the spring of 1947 the CRPL procured two antennas from the Signal Corps that were components of captured German Würzburg radars. The paraboloidal "dishes," with specialized receiving and recording equipment added, were to serve as radiometers for observation of solar noise.<sup>11</sup> The first installed equipment operated at 480 MHz, the second at 160 MHz. Later, a third Würzburg radar was installed for operation at 53 MHz. These operational frequencies were changed slightly from time to time.

---

<sup>11</sup> These 8-ton paraboloidal antennas, of 25-foot diameter, were mounted on 70-ton concrete bases at the Sterling field station. The paraboloids operated on an equatorial mounting so they could track the Sun automatically in its path across the sky. Specially designed equipment for recording solar noise completed the installation.

Later, a third Würzburg (Giant) radar antenna was added to the installation at Sterling.



*Two of the three Würzburg (Giant) antennas installed at the Sterling, Va., field station, northwest of Washington, D.C. The 25-foot diameter paraboloidal "dish" antennas were developed by the Germans during World War II for long-range search radars. The antennas were brought to Sterling for a study of solar radio noise.*

Late in the spring of 1948, the 480-MHz radiometer was in operation, and the first observations of solar radio noise at this frequency were made at the Sterling field station. A regular measurement schedule was initiated. Soon the other two radiometers were in measurement operation.

Reber's radio telescope, purchased by NBS, completed the radio astronomy equipment at the Sterling field station.

In 1952 the three Würzburg antennas, with associated measurement equipment, were disassembled and shipped to Boulder. At Boulder they were installed on leased land, in an area known as Gunbarrel Hill, to the northeast of Boulder. The antennas were painted, one in red, one in white, and one in blue.

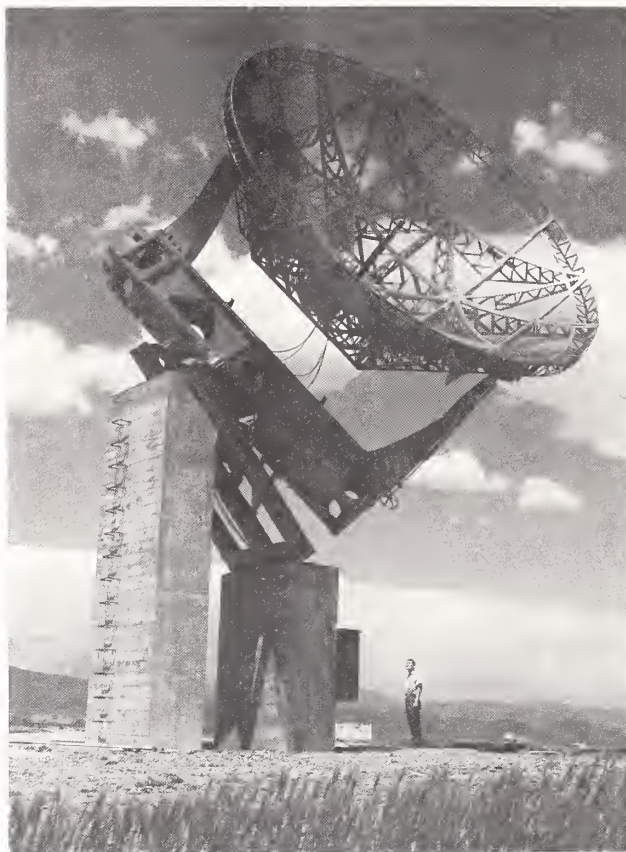

*During 1952 the three Würzburg (Giant) antennas were moved from Sterling, Va., to Colorado and installed on Gunbarrel Hill, northeast of Boulder. They served for many years as "collectors" for the study of solar radio noise. Such an antenna is geared to track the Sun in its daily path across the sky.*

## 2. Observing the 1950 total eclipse of the Sun

Reber and Emanuel A. Beck participated in the Naval Research Laboratory Expedition to Attu Island, Alaska, to observe the total eclipse of the Sun on September 11, 1950. Observation was by a small radio telescope during a severe rainstorm (see ch. VII, year 1950 for details) [9].

## 3. A theory of solar noise bursts

By 1951 observations were in progress to study the nature of solar "pips" as observed on one or more of the solar radiometers. These pips result from solar bursts or flares of greatly increased activity in radiation at radio frequencies. This initiated a theoretical study of the origin of solar noise bursts.

At the time, there was general acceptance that the steady background of solar noise was thermally produced at temperatures approaching one million K. But this would not account for the solar radio noise bursts of a magnitude several orders greater. Dr. Joseph Feinstein of the CRPL came up with an acceptable explanation of the source of radiation for the solar bursts, which he published in the January 1, 1952, issue of *The Physical Review*. A more popular account was published in the Bureau's *Technical News Bulletin* [10].<sup>12</sup>

<sup>12</sup> Feinstein theorized that streams of high-velocity ionized gases emanated into the Sun's corona as a plasma with the result that the kinetic energy of motion is converted into radiant energy at radio frequencies. The mechanism was analogous to the electrical oscillation produced by the interaction of two electron beams in the then newly-developed traveling-wave tubes.

Over a period of several years Dr. Hari K. Sen, also of the CRPL, published several papers that followed in the footsteps of Feinstein's studies of solar bursts. These related to "enhanced radiation" by plasma oscillations emanating from sunspot areas and causing radio waves with circular and elliptical polarization. Sen developed a theory of shock-wave propagation in the ionized solar gases reacting with a superposed magnetic field. This could be characterized in the solar radio noise.

#### 4. A long series of solar observations

By 1951, under the leadership of Vernon H. Goerke, a 5-day per week schedule was begun on recording the measurement of solar radio noise intensity at 53.160 and 480 MHz.<sup>13</sup> This constituted a routine "solar patrol" from sunrise to sunset. A daily report was given to the CRPL Radio Warning Service (see ch. XI, pp. 453-455) to note any unusual solar activity that might disrupt communication services.<sup>14</sup> The information was also reported to the International Astronomical Union for its *Quarterly Bulletin of Solar Activity*.

<sup>13</sup> In 1958 Goerke received the Department of Commerce Gold Medal for Exceptional Service as a participant in a group award "for infrasonic systems and research." The project was not directly related to research in the CRPL.

<sup>14</sup> Activities of the CRPL solar patrol on solar noise began in 1947 and continued until 1959 (at end of IGY program), thereafter on a reduced scale. On a larger scale, the solar patrol furnished information on solar-flare activity and sudden ionosphere disturbances (SID) obtained from various sources. This information was published in the CRPL-F series on Ionospheric Data. The series began in 1944 (with IRPL) and continues to the present time as Solar-Geophysical Data, a service now provided by the National Oceanic and Atmospheric Administration (NOAA).



Recording equipment in the Solar Patrol building on Gunbarrel Hill, northeast of Boulder, Colo. Radio waves received from the Sun at two frequencies (167 and 470 MHz) are amplified and recorded on continuous charts. Wesley I. Nodine is the observer.

During the International Geophysical Year, this equipment was in an "alert" status for unusual solar activity. The alert information was transmitted to the CRPL's North Atlantic Radio Warning Service, stationed at Fort Belvoir, Va., for the IGY Warning Service Agency to alert IGY scientists the world over on periods of unusual solar activity.

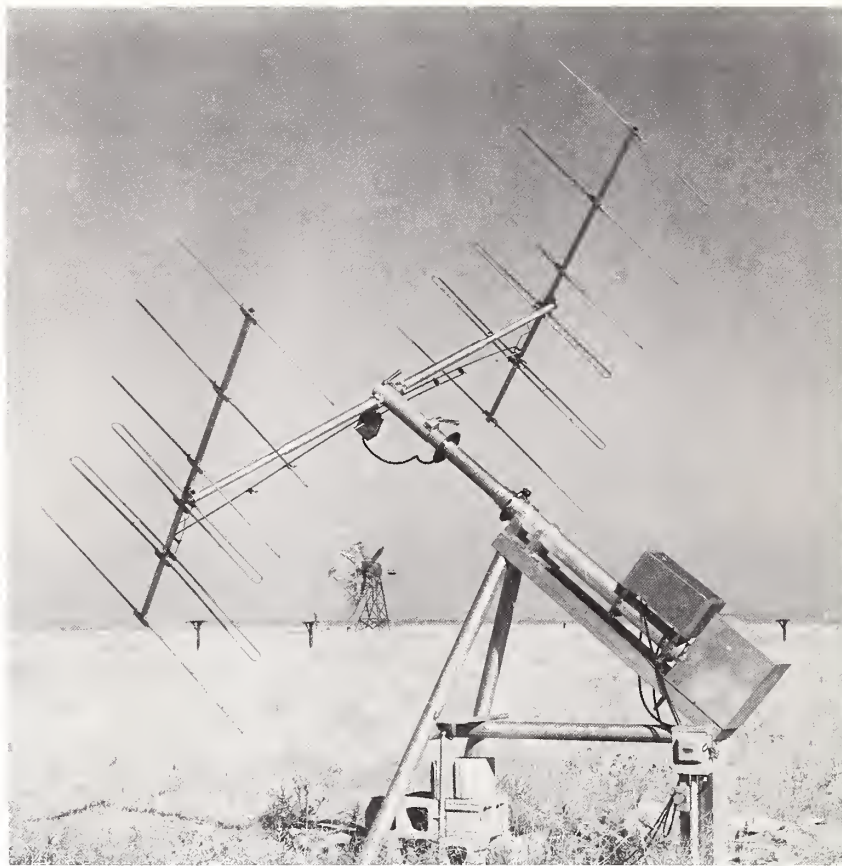

Following the IGY Program, there was opportunity for simplifying operations of the Solar Patrol facility. Solar radio waves were observed at one frequency only (approximately 108 MHz). The Table Mountain field site, north of Boulder, was selected for the newly equipped facility. A simple, equatorially mounted Yagi antenna, shown in the photo, replaced the large Würzburg antennas formerly used at the Gunbarrel Hill site. Receiving equipment requiring less maintenance and less frequent calibration was an added feature.

On June 9, 1959, an unusual solar event occurred. Later, the *Technical News Bulletin* reported in its August 1960 issue that:

The unusual solar event of June 9 (1959), completely at variance with the experience of many years, has caused the Bureau to question the validity of some of what were considered to be established relationships.

As soon as the severity of the blackout of June 9 became apparent, radio and optical observations were intensified. [11]

Although there were large radio noise outbursts at a number of frequencies, accompanied by a severe radio blackout, there was no solar flare. Heretofore, NBS had observed that prominent solar flares normally accompanied such radio disturbances. Indeed, here was an anomaly!<sup>15</sup>

## 5. Matters of publication

Grote Reber was quite productive in published papers relating to radio astronomy in periods before joining the NBS, during his 4 years at NBS, and after leaving NBS.<sup>16</sup> These papers were published in a variety of journals. In the September 1949 issue of the *Scientific*

<sup>15</sup> Location of the ionizing emission and the optical emission (H-alpha spectral line) areas were accurately located on the Sun's disc, but there was no solar flare. The absence gave rise to a number of problems concerning the understanding of solar-terrestrial relationships. The disturbance was not followed by the usual geomagnetic and ionospheric storms. Other manifestations of a solar disturbance were also lacking.

<sup>16</sup> Many of his publications, but not all, are referenced in his paper entitled "Early radio astronomy at Wheaton, Ill.," in the special issue on Radio Astronomy published in the *Proc. IRE* for January 1958 (Vol. 46, No. 1).



*American* was a paper by Reber, entitled "Radio Astronomy."<sup>17</sup> The paper was translated by the State Department in seven languages and published in its Voice of America booklets. Interestingly, no papers by Reber are found in NBS publications.<sup>18</sup>

## "TWINKLING" STARS

### 1. Early observations of star scintillations

During the early 1950's there were a number of papers published on the scintillation of radio stars, especially in British journals.<sup>19</sup> At the Xth General Assembly of URSI, meeting in Sydney, Australia, in 1952, the British National Committee reported on British work in radio astronomy since 1950. A large segment of the work was on observations of the characteristics of radio stars. The report spurred further interest on the subject.

The scintillations, observed as perturbations in extraterrestrial radio noise, are fluctuations of intensity (or flux) and of position that were attributed to irregularities in electron density during passage of the radio waves through the ionosphere to ground level. The phenomenon is analogous to the twinkling of visible stars. The early investigators believed that careful observation of the scintillations could be an important method of studying irregularities in electron density of the ionosphere. However, questions on various characteristics of the scintillations remained unanswered. This was the situation in 1956 when the CRPL initiated its own program of investigating scintillations of radio stars.<sup>20</sup> The project was sponsored by the U.S. Air Force, with Robert S. Lawrence of the Ionospheric Research Section as the project leader.

### 2. A method of observation

Equipment for observation of scintillation of radio stars called for the construction of a Ryle-type radio interferometer at the Table Mountain field site. This equipment served as a phase sweeping interferometer. Two 40-foot, equatorially mounted paraboloidal reflecting antennas were mounted at the ends of a 475-m base line in an east-west direction. Specially designed equipment, including digital data-recording systems, was used to observe "amplitude scintillations" (for intensity fluctuations) and "phase scintillations" (for position fluctuations). Reception of extraterrestrial noise was at 53, 108, and 470 MHz. An ionosonde for sweep-frequency, vertical-incidence soundings was located at Ellsworth, Neb., 300 km from Boulder. Here the ionosphere could be observed at a geographical location where it would affect the scintillations of the intense radiation from the star, Cygnus-A, as well as from other radio stars, that could be observed in Boulder.

---

<sup>17</sup> Reber gave a popular account of his work and that of other pioneering studies in radio astronomy. The article was illustrated with large pictures of Reber's own radio telescope at Wheaton, Ill., and a "German Würzburg" radar used as a radio telescope at the NBS Sterling field station.

<sup>18</sup> Nor did Goerke, during his many years of association with the CRPL Radio Astronomy project, write any papers for NBS publication. He wrote one paper on the subject, the result of a lecture given at Yosemite, Calif., before the Seventh Western Amateur Astronomers' Conference entitled, "Solar Radio Astronomy at the National Bureau of Standards." It was published in the *Proceedings* of the 1956 Convention.

No copy of this lecture (in the *Proceedings*) could be found in library listings of the United States. After considerable searching by Jane Watterson of the Department of Commerce Library, Boulder Laboratories, a copy was located in private hands in Stockton, Calif. A reproduced copy is now in the Department of Commerce Library, Boulder Laboratories, Call No. QB479.U5.N2.1955.

<sup>19</sup> Among these papers were several by C. Gordon Little of the University of Manchester who joined the CRPL in 1958 and, later, to become chief of the CRPL.

<sup>20</sup> The immediate specific objective of the project was "to determine the frequency dependence, zenith-angle dependence, and statistical properties of radio-star scintillations." There was a need for predicting the effects of the ionosphere upon radio signals traveling between the ground and high-flying vehicles.



*Two 40-ft diameter paraboloidal antennas at the Table Mountain field site, north of Boulder. These two "dishes" are mounted at the ends of a 475-m base line to form a Ryle-type radio interferometer for studying signals emitted by non-terrestrial radio sources, especially from Cygnus-A and Cassiopeia-A. The project mechanic, standing to the right of the nearby support structure, indicates the large size of the steerable antennas.*

### 3. Interruptions by Sputniks

Hardly had the equipment been in operation when the program was interrupted by the launching of Sputnik I on October 4, 1957. Quick modifications on one of the radio telescopes permitted "listening in" on Sputnik I (for details, see ch. XI, p. 499), and later on Sputnik II and Sputnik III.<sup>21</sup> The high angular velocity of satellites, such as the Sputnik series, makes them particularly useful for studies of intermediate-sized irregularities in the ionosphere. Interest in "twinkling" stars would move on to studies of the ionosphere by means of satellites.

---

<sup>21</sup> With the launching of Sputnik II, Lawrence and his group observed its passages over Boulder with the radio interferometer at the Table Mountain field site. Recordings were made of the 20- and 40-MHz signals emitted by the satellite. A digital method was used to analyze a single passage on November 8, 1957, at a height of 214 km. Without accurate information of the satellite's path, only limited deductions could be made of the ionosphere's structure. In summary, it was concluded that the ionospheric irregularities observed occur in a thin layer and are not strongly aligned along the Earth's magnetic field.

James W. Warwick of the High Altitude Observatory, University of Colorado, teamed up with Lawrence in the analysis. They reported their work to the Vth General Assembly of the CSAGI (Comité Spécial de l' Année Géophysique Internationale) at Moscow in July 1958. Their paper was titled, "The use of interferometer observations of satellites for measurement of irregular ionospheric refraction." It was published in Vol. XII-Part I, of the *Annals of the International Geophysical Year*.

The 20-MHz transmissions of Sputnik III were recorded for about a year. Four parameters of the signal, viz: Frequency, amplitude, polarization, and direction of arrival, were measured as a function of time throughout a satellite pass over the Boulder area. This study prompted the addition and use of vertically- and circularly-polarized antennas to the equipment at the Table Mountain field site for observation of signals from satellites.

A paper, which could be classed as "preliminary," was written by Lawrence for publication for the special issue on Radio Astronomy in the January 1958 issue of the *Proc. IRE* [12]. Very few observations of scintillations were noted at this time.<sup>22</sup>

#### 4. An observational program by the CRPL

After the Sputnik episode of observing high heights of the ionosphere, the radio star scintillation group (later to be the Ionosphere Astronomy Section) began an intensive measurement program covering the period from February 1958 through February 1959. Observations were recorded at 53 and 108 MHz. The result was an extensive paper published in the summer of 1961 by Lawrence, James L. Jespersen, and Robert C. Lamb [13].<sup>23</sup> It was a study of the correlation between scintillations recorded at Boulder and various parameters scaled from the ionograms taken at Ellsworth, Neb. The experimental relationship between amplitude and phase scintillations was used to determine the approximate distance to irregularities in the ionosphere that cause the scintillations. They found correlation between amplitude scintillations and sporadic-F regions, but no significant correlation with sporadic-E regions. They found that slow irregular variations in the apparent position of Cygnus-A were due to large lens-like ionospheric irregularities as large as 200 km in extent. Variations in electron content of vertical columns in these irregularities were estimated at a few percent.<sup>24</sup> Edward R. Schiffmacher, Howard H. Erickson, and Richard F. Carle conducted the observations.

Using three pairs of Yagi antennas, at stations in a triangular arrangement, Jespersen and George Kamas observed scintillations of signals from a navigational satellite (Transit 4A) during passages in the vicinity of Boulder [14]. These signals were at frequencies of 54 and 150 MHz. The objective was to study F-region irregularities of the ionosphere. Observations made in 1962 showed that the average height of the irregularities changed with magnetic latitude. They found that, in agreement with other observers, the intensity of scintillations increases to the north, due to increasing thickness of the layer containing the irregularities and to an increase in the electronic density variations in the layer. It could be said that a manmade earth satellite served as an "artificial star." In the course of such studies, the refractive index of the ionosphere along the path of radio waves emitted by a satellite could be determined. Also, absorption of the radio waves in the ionosphere could be measured.

### "SIGNALS" FROM JUPITER

#### 1. Early observations

Radio emission from the planet Jupiter was discovered by Burke and Franklin of the Carnegie Institution of Washington in 1955. This influenced Roger M. Gallet, a newcomer to the CRPL in 1955, to make further investigations.<sup>25</sup>

---

<sup>22</sup> A short account of the CRPL program was given by Lawrence at a Conference on Radio Noise at the Harvard College Observatory in April 1958. It was published as a chapter, entitled "Ionospheric scintillation of radio waves of extraterrestrial origin" in a report of the Conference, entitled *The Radio Noise Spectrum*, edited by Donald H. Menzel, and published by the Harvard University Press, 1960.

<sup>23</sup> The same authors wrote a corollary paper, published in conjunction with the referenced paper. It was entitled, "Digital methods for the extraction of phase and amplitude information from a modulated signal." They described three methods how this could be accomplished.

<sup>24</sup> The reader is referred to chapter XI, footnote 273, for a very short account of the same observation and the deductions associated with the radio interferometer method of probing the ionosphere.

<sup>25</sup> The Second Annual Report of the Boulder Laboratories (FY 1956) stated:

At the suggestion of R. M. Gallet, a project to observe radio emissions from the planet Jupiter was initiated late in November 1955. Gallet had pointed out that the emissions from Jupiter would prove an interesting method of studying ionospheric phenomena under conditions somewhat different from those on earth. Thus, the observations would both add to knowledge about Jupiter and the physical processes causing the emission and would lead to a better understanding of the earth's atmosphere.

The project was started in the Upper Atmosphere Research Section.

Gallet enlisted Kenneth Bowles to design a pair of phase-shifting interferometers to be placed with their antenna arrays in very close proximity to each other. One interferometer received at 18 MHz, the other at 20 MHz, with the two equipments operating simultaneously during reception of Jupiter's "signals." Two types of recordings were made, one at slow speed for synoptic records, the other at high speed to delineate fine structure of the pulse-type signals emitted by Jupiter.

Observations over a period of 2 years yielded new information on Jupiter [15]. Analysis of the data showed that Jupiter has an ionosphere with a critical frequency in the neighborhood of 15 MHz. Its ionosphere appears to change with the solar sunspot cycle in much the same way as the Earth's ionosphere. The data indicated that Jupiter's rotational period is 9 hours, 55 minutes, 29.7 seconds. Also, that a rigid core exists beneath the optically opaque atmosphere and is the source of the radio emissions. Speculation existed on the true cause of the emissions.

## 2. Observations of emissions at 8.9 and 10 MHz

In 1963, the Ionosphere Radio Astronomy Section, under Lawrence, initiated a project to survey the northern sky at a relatively low frequency (for radio astronomy), that at 10 MHz. The objective was actually a multifold one. The initial main objective, that of a survey of the northern sky for sources of cosmic noise, was never completed nor were some of the other objectives completely pursued. One objective, that of a further study of the "signals" from Jupiter at 8.9 and 10 MHz, received considerable attention and effort. Two doctoral students of the University of Colorado, Thomas A. Clark, employed by NBS, and George A. Dulk of the University of Colorado, were engaged in the project. Out of this study each achieved a Ph.D. dissertation.

The Table Mountain field site was equipped with a Mills cross antenna array with accompanying electronic circuitry to perform different functions with the array.<sup>26,27</sup>

The further study of radio emissions from Jupiter was carried out at two frequencies, 8.9 MHz and 10 MHz. The 8.9-MHz observations were made with a radio interferometer with a base line of 932 m, the property of the High Altitude Observatory of the University of Colorado, and located near the Table Mountain field site. The 10-MHz observations were made with the Mills cross antenna at the Table Mountain field site. The project resulted in a published paper by Dulk and Clark, plus several papers presented by Clark at scientific meetings [16].<sup>28</sup>

Dulk and Clark, in reporting on their observations of Jupiter from July 1964 to April 1965, stated that the radio emissions were dependent upon Jupiter's longitude (field line) and upon Io's (Jupiter's innermost satellite) position. At both 8.9 and 10 MHz the emission was almost continuously present at low intensity levels (flux level sensed by high sensitivity levels of the sensing equipment).<sup>29</sup>

---

<sup>26</sup> The Mills cross antenna is a large-aperture, scanning radio telescope antenna with very high resolving power, consisting of two dipole arrays arranged in a cross. The fan-shaped response pattern of each dipole array results in a pencil-beam response for the crossed array. (See ch. I, year 1953.)

<sup>27</sup> The Mills cross antenna used at the Table Mountain field site was designed for operation at 10 MHz. It consisted of several configurations of dipoles in a north-south and an east-west arrangement in order to accomplish several types of observations.

<sup>28</sup> Two papers given by Clark at the 120th meeting of the American Astronomical Society, December 27-30, 1965, Berkeley, Calif., were entitled: "Observations of Jupiter at 8.9 and 10 MHz," and "Flux measurements on several of the brighter radio sources at 10 MHz."

Another paper by Clark was entitled, "Electronic scanning for large radiotelescopes," presented at the 1963 PTGAP International Symposium on Space Telecommunications, July 9-11, 1963, Boulder, Colorado (see p. 615).

<sup>29</sup> Dulk and Clark found that the satellite, Io, affects the 8.9- and 10-MHz emissions probabilities and intensities to a lesser extent than at higher frequencies. It appeared that the excitation of the Io-related emission is controlled by the satellite, while the frequency and beaming of the emission is controlled by the set of Jupiter's field lines on which radiation is generated.

## 1. Early stages of the program

Studies by many investigators during the 1950's, and especially during the IGY program, revealed much new knowledge of the upper ionosphere and the exosphere. Probably most noteworthy was the discovery of the Van Allen radiation belts that extend into the exosphere.

This outer region is the rendezvous of whistlers, VHF emissions, and other radiations, also, several types of particles entrapped in one way or another by the Earth's magnetic field (see ch. XI). By 1960 much of the phenomena was observed and explained, but fertile areas of investigation remained.

Before joining the CRPL in 1958, C. Gordon Little (and a colleague, H. Leinbach) at College, Alaska, made measurements of high latitude ionospheric absorption characteristics of the Arctic ionosphere in a region of abundant aurora [17]. The team was associated with the Geophysical Institute at the University of Alaska. Two methods of measurement were used, involving both fixed and continuously rotating antennas. They found regions of anomalous absorption to be more than 100 km in extent. The absorption was confined

---

<sup>30</sup> The term conjugate in expressions such as conjugate regions and conjugate points has usage in geomagnetism in denoting the point of contact with the Earth of each end of a magnetic field line. In the more specialized usage, hereunder, the term applies to the simultaneous observation of radio waves at both ends of a magnetic field line. One station of a pair of conjugate points would be to the north of the magnetic equator, the other to the south.

<sup>31</sup> To inform the reader of certain terms used in this section as well as throughout the chapter, usage of the following expressions is explained:

- (1) Cosmic (or galactic) noise has the same meaning as first used, historically, by Jansky and by Reber—noise from radio waves generated by constellations, galaxies, and more specifically by radio stars.
- (2) Solar noise has the same meaning as first used by Southworth and by Reber, and later by others—noise from radio waves generated by thermal production by the Sun, and accompanied with other electromagnetic radiation including x-rays, ultraviolet light, and visible light. The production is much enhanced by solar flares accompanied further by cosmic ray particles and magnetic storm particles consisting of protons and electrons (see below).
- (3) Extraterrestrial noise has the meaning, generally, of all noise generated by radio waves from all sources in the Universe, including radiation of electromagnetic waves from the Sun. However, and frequently, this same meaning is given to cosmic noise alone as being all inclusive, regardless of the sources of radiation.

By 1960 it was generally accepted that solar radio waves impinging upon the Earth's atmosphere from outside were also accompanied by charged particles of a wide range of energies thrown off by the Sun. The Sun continuously emits a stream of low energy protons and electrons that constitute the solar wind. Solar flares give an enhanced emission of charged particles, often with extremely high energy content. When these particles reach the vicinity of the Earth they are influenced by its magnetic field and tend to travel along the lines of the terrestrial magnetic field. They move along the magnetic lines in spirals that become tighter with translational movement of the particles as they approach the surface of the Earth. Finally, the spiral movement reverses and the particles move back along the magnetic field lines and with increasing speed. The action repeats itself as the particles approach the other ends of the field lines. This action will continue itself many times as the particles oscillate back and forth from conjugate points. One can consider that the particles are entrapped by the Earth's magnetic field and this is the case for the Van Allen radiation belts. But during solar disturbances the solar wind brings dense streams of high energy particles into the Earth's atmosphere at high latitudes, accompanied by the production of aurora and other phenomena, including radio blackouts.

Author's (WFS) note: In a coverage of the CRPL conjugate point program in this chapter, the author has taken the occasion to use the term "extraterrestrial noise" where, otherwise, most of the CRPL participants have used the term "cosmic noise." He has taken this liberty due to the fact that the antennas generally used by the CRPL in the more or less remote regions of the Earth were types that had fairly large beamwidths (for example, 60° at half power points) as radio-noise collectors, and they were zenithally directed and were not steerable. Such antennas normally receive both cosmic noise and solar noise (during the daytime) and, although the ratio is very small, it could change throughout daytime reception in response to the antenna position in relation to the Earth's rotation (i.e., the Sun's position). Nevertheless, such antennas could be subject to fairly high noise levels of radio waves from the Sun during strong solar disturbances.

As a passing remark of a somewhat whimsical nature, it was during the preparation of this chapter in the latter part of 1982 that the little-used expression "extraterrestrial" suddenly took on far-flung usage. Coincidental, was the popularity of the movie "E.T.," the title simply being the initialism for "The Extra Terrestrial."

mainly to the E region. The team believed that the absorption was associated with bombardment of the upper atmosphere by the corpuscular streams emitted by the Sun that produce the aurora.

Out of this absorption study, the duoteam developed the riometer (*rio*—relative ionospheric opacity-meter) [18]. (Also noted in ch. XI, p. 442.) The instrument provides for routine measurement of ionospheric absorption by cosmic-noise measurement and was used in the IGY program.<sup>32</sup> Later, a transistorized model of the riometer was developed and evaluated in the CRPL by Edward R. Schiffmacher. Redesigned, the instrument had greater reliability, much less power consumption, and simpler operation.

Following the IGY program much worldwide interest continued in learning more about the ionosphere and the exosphere. Included in this interest was that by the CRPL.<sup>33</sup> Both theoretical and experimental studies of the ionosphere by the CRPL came in abundance. The auroral zones came in for much investigation. Among these was a conjugate point installation between New Zealand and Alaska for observation, by VLF signals, of the effects of high-altitude nuclear tests and solar-magnetic storms.

## 2. A fortuitous start in the conjugate point program

After several years of ionospheric observations in the Arctic region, with much effort given to studies of absorption of radio waves, operations of the IGY program permitted continued utilization of the Antarctic Continent as an enormous “laboratory” for further geophysical investigations. As a huge area it was the Earth’s last great “frontier.” As a part of Antarctic programs sponsored by the National Science Foundation, the CRPL set up a facility in the Antarctic to study ionospheric absorption in the southern auroral zone. With the acceptance by the U.S.S.R. of the suggestion that America undertake this absorption program at their Mirnyy Base on an exchange scientist basis with the American Byrd Base, the facility was fitted with a 30-MHz riometer. The Mirnyy Base was 10° inside the Antarctic auroral zone and 23° from the South Pole.

C. Stewart Gillmor, Jr., served as the observer, measurements being taken with the riometer during 1961. Out of this project came three published papers by Gillmor (including co-authors), plus a book chapter by Hugh J. A. Chivers that included Gillmor’s observations. After a year’s observation of extraterrestrial noise absorption at the Mirnyy Base, it was learned that the Norwegian Telecommunications Administration had operated similar equipment during the same period at Longyearbyen on the island of West Spitzbergen, about halfway between Norway and the North Pole. The two stations, one in the Arctic, the other in the Antarctic, were within about 400 km of geomagnetic conjugacy. Both stations were within auroral zones. Unknown to each other, the two stations had similar types of observations over a common period, a circumstance that was, indeed, a fortuitous one.

In his first published paper, Gillmor reported that the (1961 polar cap) absorption of extraterrestrial (cosmic, by Gillmor) radio waves, measured by the radio-noise technique, was nearly the same at the two stations when they were under similar conditions of solar illumination [19]. This would indicate similarity of the incoming particle flux at conjugate points. Using data from both stations, the day-to-night ratio of absorption was found to have a median value of 5.3 during magnetically-quiet periods.

Gillmor’s second paper was co-authored with John K. Hargreaves of the CRPL [20]. They found much similarity in the short-duration absorption events at the two stations. The

---

<sup>32</sup> The riometer is a self-balancing receiving system in which a local noise source is continuously made equal to the noise power from the antenna. In the absence of ionospheric absorption, a condition that is approached with a “quiet” ionosphere, the riometer indicates the intensity of cosmic noise incident to regions beyond the ionosphere. However, as is the case of several other methods of measuring ionospheric absorption by cosmic noise, the riometer has its limitations. During times of severe solar flares that are accompanied by the emission of radio waves (usually in the frequency range of 30 MHz to 10 GHz) from the Sun, these strong “signals” can override the noise power of the more constant but weak cosmic noise. Unfortunately this can occur at the very occasion when one desires to learn more about the absorption phenomenon. There are methods of minimizing this shortcoming of the measurement technique, primarily, by the directional properties and orientation of the antenna. Other limitations are of less consequence.

<sup>33</sup> A plethora of published papers and books on many aspects of the ionosphere followed for a period of a number of years after the IGY program. These were not found wanting in numbers by those prepared by CRPL personnel.

diurnal distributions of the absorption events were found to change with the season, the majority occurring by night in the winter, but by day in the summer. Most of the events occurred simultaneously at the two stations. Other comparisons of less significance were reported also.

In a combined authorship with K. W. Eriksen of the Norwegian Telecommunications Administration, Gillmor and Hargreaves published a paper related to their previous one [21]. Again it was reported that some of the absorption events occur in both the northern and southern hemispheres but others in one hemisphere only. They were reconciled to the situation that their data were too few to support any general conclusions on global movement of absorption-producing disturbances.<sup>34</sup>

### 3. The conjugate point program in the making

In October 1962 Chivers became Chief of the High Latitude Ionospheric Physics Section, a newly formed section to expand the investigation of radio propagation in the Polar and near-Polar Regions.<sup>35</sup> The observations made at the U.S.S.R. Mirnyy Base in the Antarctic stimulated further research on a conjugate point program. The first phase of an extended program was a conjugate point project with a station in the Antarctic and a conjugate point station in Canada.<sup>36</sup> The program was supported by the National Science Foundation.

The station set up in the Antarctic was 15° from the South Pole. It was given the code name Eights station. The conjugate point selected was just to the north of the city of Quebec, Canada, and was given the code name, Quebec Center. For the purpose of checking experimentally the calculated conjugate point in the vicinity of the Quebec Center station, two extra stations were placed, respectively, north and south of this station at distances of 80 km. All four stations were equipped with 30-MHz riometers, fitted with zenithally-directed antennas with half-power bandwidth of 60° in both the E and H planes [22].<sup>37,38</sup>

---

<sup>34</sup> Their conclusion stated, in part:

- (1) The existence of two kinds of absorption events at high altitude in the ionosphere, each exhibiting distinct diurnal distribution, with dependency on season.
- (2) Apparent changes in longitudinal extent of absorption activity could be explained by the rotation of the Earth.
- (3) There was evidence of time delays between the occurrence of related events at different places.

<sup>35</sup> This section came within the Upper Atmosphere and Space Physics Division, headed by E. K. Smith, and formerly headed by Little, who became chief of the CRPL at the time of the October 1962 reorganization. Gallet continued as chief of the Upper Atmosphere and Plasma Physics Section, within the same division.

<sup>36</sup> It had been stated in the 1962 Annual Report of the Project that the objective was:

To conduct a series of related observations at magnetically conjugate points in order to study in a comprehensive manner variations in the ionosphere occurring at the two ends of a high-latitude magnetic field line. The primary experiment will involve the riometer (cosmic noise absorption) technique to study the ionospheric absorption at the two sites.

On the importance of the project it was stated, in part, that:

The disturbed nature of the high latitude ionosphere is primarily due to corpuscular bombardment effects. As yet, no attempt has been made to determine, in detail, the relationship between the upper atmosphere phenomena occurring simultaneously in the two hemispheres. This project envisions a coordinated, systematic program employing three of the important observational techniques for studying these ionospheric perturbations.

<sup>37</sup> All stations were equipped with magnetometers to monitor magnetic activity during the program. In addition, the Eights station and Quebec Center station were equipped with receivers to observe VLF emissions, and with ionosondes for vertical sounding of the ionosphere.

<sup>38</sup> Two Canadian stations, fitted with riometers, operated by the Defense Research Telecommunication Establishment, made their records available to the CRPL during the observational program. These stations were located quite some distance from Quebec in a southwesterly and in a northeasterly direction.

The program was in operation for a 54-day period in December 1961 and extending into February 1962.<sup>39</sup> Enough was learned in this preliminary program to encourage setting up a more extended program.

#### 4. The conjugate point program on a grander scale

Early in 1963 the conjugate point program expanded from one pair of conjugate stations to three pairs of stations.<sup>40</sup> This larger program was also supported by the National Science Foundation, along with the cooperation of several Canadian groups, plus the U.S. Navy Support Force in the Antarctic.<sup>41</sup>

The program was carried through much of 1964 and resulted in a number of papers being published on the research. A popular account was published in the February 1964 issue of the *Technical News Bulletin* [23]. Two short papers by Chivers and Hargreaves had early publication in *Nature* [24,25].<sup>42</sup>

The program was not yet completed. Nor was the program completed when Chivers reported on its progress at the Eighth Meeting of the AGARD (NATO Advisory Group for Aeronautical Research and Development) Ionospheric Research Committee, meeting at Athens, Greece, in July 1964. This paper appeared in the *Proceedings* as a chapter in a book entitled, *Arctic Communications* [26].<sup>43</sup>

Not to be overlooked are the added features of the Baie St. Paul station in the Province of Quebec. In addition to the vertically-directed antenna of 60° half-power point beamwidth, was a four-way corner reflector antenna with beams inclined to the vertical in order to

---

<sup>39</sup> Sufficient observations were made to indicate that correlation of conjugate points changed from absorption event to event. Movement of conjugate areas was believed to be due to changing latitude of the location at which particles from solar emanations enter the Earth's atmosphere. Magnitude of absorption was greater in the winter hemisphere even under similar conditions of solar illumination in the two hemispheres.

<sup>40</sup> The Antarctic Eights station of 15° geographic latitude, was retained for the expanded program. The conjugate point was selected at Baie St. Paul on the St. Lawrence River about 100 km northeast of the city of Quebec. These two stations were each fitted with a full complement of instruments including: 30-MHz riometers (5 at Baie St. Paul), a receiver for reception of VLF emissions, a magnetometer, instrument for observing magnetic micropulsations, and a photometer for measuring the intensity of optical emissions of the sky.

The Byrd station, about 10° latitude in the Antarctic, and its conjugate point location near the village of Great Whale River on Hudson Bay, were near the maxima of the two auroral zones. The third pair, with the South Pole station at one point, had its conjugate point at the village of Frobisher Bay on Baffin Island near Hudson Strait. These four stations had less instrumentation, but each had a riometer with its accompanying antenna.

<sup>41</sup> In the May 1963 issue of *The Bureau Drawer* and the June 1963 issue of *The NBS Standard* were short articles describing the expanded conjugate point program with the following notice by Chivers:

The problem we now face is to find new qualified people to take over the duties of operating the Antarctic and Canadian stations during 1964. We need physicists with a knowledge of electronics who are willing to take training for several months in Boulder before leaving on their one year assignments. Given such people, we may expect to continue getting worthwhile results from our conjugate point research program in 1964.

These new recruits were to be replacements for personnel at the Antarctic stations, plus personnel to man the Canadian stations.

Stephen S. Barnes of the Upper Atmosphere and Space Physics Division became the Coordinator for all programs in the Antarctic. Robert T. Frost, Administrative Officer for the CRPL, was appointed CRPL Coordinator for Antarctic and for the IQSY program.

<sup>42</sup> In their first paper, Chivers and Hargreaves found that the ratio of absorption at the northern hemisphere site to that at the southern site, for each of the three conjugate pairs, was not constant throughout the day. They also observed rapid fluctuations of the absorption ratio on which, at the time, they had to speculate as to the cause of the fluctuations—they could be attributed to oscillations in the magnetosphere (in the exosphere).

In their second paper, three months later, Hargreaves and Chivers commented further upon the fluctuations in ionospheric absorption events. Their observations were in reasonable agreement with those of other investigators who attributed the cause of absorption fluctuations to hydromagnetic oscillations in the exosphere.

Note: These two papers in *Nature* are referenced and commented upon in chapter XI, p. 443, in relation to auroral blackouts and polar-cap absorption in the Antarctic.

<sup>43</sup> In this paper, which is partially a progress report, Chivers summarized the earlier Mirny station program on ionospheric absorption, then the first conjugate point project, and, third, a progress report on the conjugate point program involving three pairs of stations.



study ionospheric absorption patterns at locations in four different directions. Comparisons of the four simultaneous observations indicated the extent and movement of absorbing irregularities or patches in the ionosphere.<sup>44</sup>

This phase of the conjugate point program was reported by Chivers and Hargreaves at a Symposium on High Latitude Particles and the Ionosphere, at Alpbach, Austria in 1964. The paper appeared in the *Proceedings* of the symposium as a chapter in a book entitled with the symposium title [27].<sup>45</sup>

In a later paper, published in March 1966, Chivers and Hargreaves commented on the fluctuation characteristics of auroral absorption in the ionosphere [28].<sup>46</sup>

## THE EXOSPHERE

### 1. An introduction

The conjugate point program, related in the previous section, is associated with the physical realm that encompasses the Earth's magnetic field—the realm of the exosphere.<sup>47</sup> To a limited extent the exosphere, per se, was studied by the CRPL. As a title for a project within the CRPL organizational structure the term, Exosphere, was not used until the Sixth Summary Report of Boulder Laboratories for the Fiscal Year 1960. The project, titled Exosphere Physics, was one of six projects within the Upper Atmosphere and Plasma Physics Section, headed by Gallet who also served as the leader of the project.

Research in the CRPL previous to the Exosphere Project was probing the exosphere by remote sensing techniques. These research projects related to the study of whistlers, VLF propagation, VLF emissions, hiss, conjugate points, and observations of the upper atmosphere by the incoherent scatter technique developed by Bowles. (See ch. XI for details on these subjects.) In 1959 Gallet used the term exosphere in the title of a paper on VLF emissions [29].<sup>48</sup>

---

<sup>44</sup> This unusual four-way antenna was designed by Louis D. Breyfogle of the Ionosphere Radio Astronomy Section. The corner reflectors were of parallel wire construction, and fed by half-wave dipoles. The composite antenna fed four riometers. The radiation reception beams were directed to be geographic north, south, east, and west at an elevation angle of 45° with a 90° half-power point beamwidth. Along with the nearly vertically directed antenna and its riometer, five absorption records could be taken simultaneously to observe irregularities in the ionosphere overhead.

<sup>45</sup> The authors stated that the absorption over Baie St. Paul often indicated large horizontal gradients in the ionosphere, and that absorption to the north was three times greater than that to the south. To the north would be in the direction of the auroral region. An appendix to their paper explained the connection that is necessary for absolute values of absorption for riometer observations for antenna beamwidth and the obliquity in the use of the specifically designed four-way antenna.

<sup>46</sup> This paper is best summarized in the author's own words, as follows:

In summary, we would say that the slow fluctuations in auroral absorption observed between conjugate points are a common feature at times of large absorption, though with some preference for night and for the higher latitudes. They appear to be evidence for an inter-hemispheric phenomenon, sometimes becoming so strong that the absorption alternates between the conjugate stations. The scale of coherence is neither very large nor very small. These and other features of absorption in conjugate regions are being further investigated.

By publication date, March 1966, the CRPL had become a part of ESSA.

<sup>47</sup> The exosphere was considered (and defined) in 1960 by the CRPL to be a region of the Earth's atmosphere above the F<sub>2</sub> layer of the ionosphere, beginning at an elevation of about 500 km and extending out to a level of 6 to 8 Earth radii (about 50,000 km). At lower levels the exosphere consists largely of helium ions and at higher levels of hydrogen ions and electrons. Most of the gas within this region is influenced by the Earth's magnetic and gravitational fields. As an alternative, the exosphere is called the magnetosphere.

<sup>48</sup> By 1959, when Gallet published this paper, it was generally accepted that the VLF emissions are somewhat similar to whistlers, in that they have the same propagation mode—that is, produced in the ionized exosphere and the Earth's magnetic field. Gallet likened the excitation mechanism in the production of VLF emissions to that of the operation of a traveling-wave tube. He used several models to explain the VLF emissions theory. (Also, see ch. XI, p. 481, in reference to the same paper.)

The Seventh Summary Report of Boulder Laboratories for the Fiscal Year 1961 delineated a rather extensive program of studies of the exosphere and their importance to a greater knowledge of the region of space that surrounds the Earth.<sup>49</sup>

## 2. An experimental project at the Sterling station

An experimental phase to the Exosphere Project was reported by Gallet and William F. Utlaut in 1961 [30]. This was a cooperative project that bridged two divisions. In the preliminary experiment the duoteam learned of some interesting phenomena of the exosphere. There was evidence that the exosphere has a propagation mode whereby radio waves are guided along magnetic lines of force by a relatively small gradient of electron density transverse to the magnetic field—showing a laminar nature of the exosphere.<sup>50</sup>

## 3. Reporting on the exosphere to URSI

Research on the exosphere became a matter of interest to the many-faceted interests of URSI. At the XII General Assembly of URSI at London in 1960, James M. Watts of the the Upper Atmosphere and Space Physics Division reported on The Exosphere, a portion of the report of U.S. Commission 4 for Radio Noise of Terrestrial Origin. In turn, this report came within the Report of the United States of America National Committee. The report covered studies on "Theories of the Exosphere," and projects on "Experiments in the Exosphere," all being conducted in the United States.

At the XIII General Assembly of URSI at Tokyo in 1963, Commission IV had been renamed Magnetosphere. On this occasion Gallet reported on VLF and ELF noise in the Report of the U.S. National Commission for Commission IV, Magnetosphere. The report covered research in the United States on "The VLF Emissions—Their Relations with Whistlers and High Energy Particle Phenomena."

## 4. Phenomena associated with the exosphere

The exosphere includes the entire region in which whistlers are greatly dispersed; and in which VLF emissions, hiss, and geomagnetic micropulsations are considered to originate. It is also a region where the Earth's trapped radiation tends to linger. Some of these

---

<sup>49</sup> The Seventh Annual Report stated:

The objective of this project is to develop the knowledge of the physics of the earth's atmosphere above the ionosphere and up to six or seven earth's radii, in a realm where until now our knowledge has been slight. Emphasis is placed on plasma properties: Wave propagation, production and motions of high speed electrons and ions through the plasma, interaction between the particles and electromagnetic waves, the structure of the magnetic field in this region, and its relation to the plasma properties of the medium. The existence of the program is based primarily on the need for an understanding of the physical phenomena in the exosphere. With the increasing development of satellite and space probe experiments, a theoretical understanding of this region is becoming more and more important. Since the IGY, very rapid progress has been made in this expanding field, and much new experimental information is being produced. As a consequence, new problems are arising at a very high rate.

<sup>50</sup> This experiment was performed over a period of 2 months in the spring of 1961 at the Sterling, Va., station. Use was made of a radar with 100-kW peak-pulse power output at a frequency near 14 MHz. To aid identification of the signal in its long distance of travel and its many reflections at the Earth, the radar was pulsed as a pulse group of two one-millisecond pulses separated in time by 8 milliseconds at a group repetition rate of 2.5 Hz. The magnetic conjugate point of reflection was in the South Pacific. A very sensitive specially designed receiver was used to observe the signals. Two antennas of Yagi configuration were used, one for transmitting, the other for receiving, each slanted 71° to the horizontal for alignment with the Earth's magnetic field. The total traverse or total propagation path distance of a pulsed signal received at Sterling was estimated at more than 55,000 km. Echoes of the signal were recorded for a period of more than 50 minutes on occasion. It was estimated that the transmission loss for the train of echoed signals was greater than 200 decibels.

The experiment revealed interesting characteristics of the exosphere and pointed out techniques for observation of associated phenomena that were unanticipatedly revealed. But the experimental project came to a close. The land of the Sterling station became the Dulles International Airport and the radar transmitter was dismantled. Although the project was reestablished at Boulder, it did not have the former success and the guided exospheric propagation project was discontinued beginning July 1963.

phenomena are treated in an earlier chapter—chapter XI.<sup>51</sup> In total, these manifestations of Nature, that can be observed with specially developed equipment, were studied by the CRPL in different organizational units, and occasionally in cooperative projects. In several instances, outside groups took part in the investigations.

To a limited degree, a program was initiated to explore, theoretically, the nature of ionosphere regions on some of the planets of the Solar System. Several papers on the subject resulted from this program.

## SPACE COMMUNICATION<sup>52</sup>

### 1. The matter of frequency selection

The progression from rockets to satellites to space vehicles brought on the urgent need for communicating in space. With the launching of Sputnik I by the U.S.S.R. on October 4, 1957, the World entered the Space Age (see ch. I, year 1957). In 1959 the CRPL entered upon a program that was modestly geared to space communication and space travel.<sup>53</sup>

As a very early contribution to the program was a paper published by George W. Haydon, entitled "Optimum frequencies for outer space communication," [31]. The paper resulted from an earlier pioneering study by Haydon.<sup>54</sup> To engineer the design of a space communication system, Haydon's study indicated the necessity of arriving at a set of compromises in order to optimize for an operating frequency, at a frequency based upon the choice of an operation condition among several operating conditions.<sup>55</sup>

In June 1961 the Joint Technical Advisory Committee (JTAC) of the IRE and the EIA (Electronic Industries Association) published a report in the *Proc. IRE* on the subject of

---

<sup>51</sup>In chapter XI the reader will find the subjects of whistlers located on pp. 479-482, VLF emissions on p. 480, and hiss on p. 480. In chapter XV the reader will find the subject of laboratory plasma investigations treated on pp. 625-626, that were, in part, related to the exosphere.

<sup>52</sup>This section of chapter XIV narrates engineering features of CRPL projects that were "BEYOND THE IONOSPHERE." It is closely related to the subject matter of chapter XIII.

<sup>53</sup>In a reorganization of the CRPL in January 1959 a new division was formed, to be known as the Radio Communication and Systems Division, with Richard C. Kirby as Chief. The Systems Analysis Section, one of eight sections within the division, was organized to:

. . . provide analytical studies of overall radio system problems, especially development of new radio system concepts, frequency utilization, and system performance studies. . . .

More specifically, in relation to space communication:

The objectives of the program have been to investigate the problems of communication between space vehicles and between space vehicles and earth, as they apply to communication system design and to the allocation of frequencies for space communication use.

Initially, Donald W. Patterson served as the acting chief of the new section, followed later by William C. Coombs as chief.

The space communication study program was to provide fundamental propagation and modulation information for exploiting new bandwidths of channel space, and new regions of the frequency spectrum for space vehicles and relay systems. The first phase of the extensive program was a literature survey, plus a national effort to determine the state-of-the-art in a broad field of space communication. But by FY 1962 there were changes in emphasis in the program structures within the Division and the Systems Analysis Section with its extensive program was phased out. The modulation research portion of the broad program became the primary project.

<sup>54</sup>Haydon joined the CRPL in June 1959 to serve as a consultant in the newly formed Radio Communication and Systems Division. Previously, he was a member of the U.S. Army Radio Frequency Engineering Office, Office of Chief Signal Officer. It was in this association that Haydon had made a study of the optimum frequencies for space communication. His report was adopted by the International Radio Consultative Committee in April 1959, and designated as CCIR Report 115, "Factors affecting the selection of frequencies for telecommunication with and between space vehicles."

<sup>55</sup>For communication between Earth and a space vehicle, the choice of an operating frequency lay within the band of 70 to 6000 MHz (above the upper limit of ionospheric propagation frequencies and below the lower frequency limit of absorption by rain and snow in the troposphere). The selection of an operating frequency within this band was dependent upon: background noise levels of cosmic and receiver noise, and the requirements of transmitting and receiving antennas to assure tracking. Beyond the Earth's atmosphere, the environmental conditions for communication between space vehicles was largely unknown at the time of the study but would not be affected by the Earth's atmosphere. Tracking problems would be the principal concern.

"Frequency allocations for space communications."<sup>56</sup> Herbstreit of the CRPL served on the Ad Hoc Subcommittee of the Joint Committee in preparation of the report. In compiling the many sectors of the report, the Subcommittee relied extensively on the services of the CRPL, also on the services of the Stanford Research Institute.

Development of space communication systems, with the accompanying problem of frequency allocations, was also accompanied by the problem of radio interference. A project, sponsored by the Joint Technical Advisory Committee (noted above), was conducted by William J. Hartman and Martin T. Decker of the Radio Propagation Engineering Division. Although completed by Nov. 1961, their *NBS Technical Note 126* was not published until August 1963 [32].<sup>57</sup>

## 2. Toward a decision of historical significance

On April 20, 1961, President Kennedy wrote a memorandum to the Vice President, Lyndon Johnson, that stated:

In accordance with our conversation I would like for you as Chairman of the Space Council to be in charge of making an over-all survey of where we stand in space.

Financed by the Congress, the wheels of American technology at the frontiers of science were put to spinning and on July 20, 1969, somewhat more than 8 years after Kennedy's memorandum, the first human stepped on the surface of the Moon from the landing vehicle, *Eagle*. The peoples on the Earth watched and heard Astronauts Armstrong and Aldrin, during their rendezvous on the Moon. Navigation of the mothership, *Columbia* (command module), and the landing vehicle, *Eagle* (lunar module), plus communication with the Earth, was a supreme achievement in telecommunication technology. The flight of Apollo 11 was a realization far beyond that of Jules Verne's dream and story, *From the Earth to the Moon* (1865).

## 3. Radio communication on the Moon

Spread about the CRPL in the early 1960's were various projects relating to space communication and space flight. One of the projects, in the Radio Propagation Engineering Division, was titled, "Point-to-point communication on the Moon." Lewis E. Vogler and his associates tackled the problem on how best to communicate on the Moon between a base site and an exploring party, possibly in situations beyond line-of-sight. The earlier stages of development of this project were well delineated in the September 1962 issue of the *Technical News Bulletin* [33]. The project was sponsored by the Jet Propulsion Laboratory (Pasadena, Calif.) and became the source material for several publications [34,35].<sup>58</sup>

Vogler's first paper, in the *NBS Journal of Research*, was a preliminary study of point-to-point communication systems on the surface of the Moon. The mode of propagation was assumed to be by ground wave over a lunar model that was a smooth sphere of homogeneous material in free space. The result was an engineering conception of a communication system that would be adequate for use on the Moon.<sup>59</sup>

<sup>56</sup> Two major sets of recommendations emerged from this report: (1) Findings and recommendations of the JTAC regarding frequency allocations for space communications, (2) Recommendations for experiments and investigations needed to provide technical data for satellite communication relays.

<sup>57</sup> Refer to chapter XII, p. 547, for a fuller account of this project.

<sup>58</sup> Vogler's paper published in the *NBS Journal of Research* was akin, in large measure, to one published as a chapter in the book, *Technology of Lunar Exploration* (Academic Press, 1963). The book contained a selection of papers presented at the American Rocket Society Lunar Missions Meeting, Cleveland, Ohio, July 17-19, 1962. The book was Volume 10 of the series, *Progress in Astronautics and Aeronautics*.

<sup>59</sup> Design consideration for the system called for a Beverage (or wave) antenna for transmitting toward a vertical dipole on the receiver. The Beverage antenna can be as simple as a single conductor laid on the Moon's surface with its far end terminated in its characteristic impedance by means of a resistor. Such an antenna is quite directive, thus increasing its gain in a selected direction. Assuming a relative dielectric constant of near unity (near that of free space) and a very low conductivity ( $10^{-4}$  mhos/m) as parameters for the Moon's surface material, and an operational frequency of 100 kHz, with a modulation bandwidth of 6 kHz, Vogler arrived at a 16-W power input to the transmitting antenna to cover a distance of 100 km with an adequate signal-to-noise ratio.

In *NBS Monograph 85* [35], published in 1964, Vogler reiterated much of the considerations of his first paper [34], and then added discussions on the effects of layered materials in the Moon's subsurface, and the effects on propagation of possible lunar ionospheres. The monograph was amply illustrated with 94 sets of graphical representations of the relation of various parameters. Vogler indicated a series of further studies, both theoretical and experimental, for more exact information on the Moon's natural features and on engineering choices for optimum performance of a communication system.

#### 4. An international symposium

By mid-1963 the Nation's space program was well into the progressive steps. On May 16, 1963, Mercury Faith 7 (Astronaut Cooper), a manned space vehicle was launched and completed 22 orbits of the Earth. On July 26 Syncom 2 was launched, to become the first synchronous communication satellite, taking a fixed location 22,300 miles (35,680 km) above the Earth. This U.S. satellite was fitted with microwave equipment to receive signals from Earth-based transmitters, amplify the signal, then transmit it back to the Earth at another frequency. Between these two events, radio scientists and engineers of the IEEE Professional Technical Group on Antennas and Propagation (PTGAP) held an International Symposium on Space Telecommunications at the Boulder Laboratories during the period of July 9-11, 1963. Over 400 were in attendance and 61 technical papers were presented, with 9 papers by NBS personnel. Gordon Little and James Watts chaired two of the nine technical sessions.<sup>60</sup>

#### 5. A tutorial paper appears

As a result of increasing interest in, and the application of, earth-space communication, Lawrence, Little, and Chivers published a tutorial paper in 1964 on the ionospheric effects upon earth-space radio propagation [36].<sup>61</sup> Based upon the findings of many investigators (62 literature citations), the authors, primarily, showed the frequency dependence and order of magnitude for various ionospheric effects upon radio waves from sources beyond that penetrate the Earth's ionosphere.<sup>62</sup>

### SAFETY IN SPACE TRAVEL

#### 1. Evaluating the hazard of solar cosmic rays

During the early years in planning for space exploration, and particularly for space travel by man, there was considerable concern over the probable hazards to both the instrumentation and the well-being of humans on board space vehicles. The concern centered around possible ill effects caused by solar cosmic rays during periods of intense solar flares. At the time it was accepted fact that solar cosmic rays consist almost entirely of protons covering a broad range of the energy spectrum.

---

<sup>60</sup> To indicate the scope of the symposium, the subjects of the technical sessions were: Space communications, propagation, feeds and reflectors (antennas), surface waves, broad-band antennas, aperture synthesis (antennas), electromagnetic theory, antenna arrays, and plasmas.

Jack Herbstreit served as chairman of the Steering Committee, assisted by Ernest Smith as vice chairman. Herman Cottony served as chairman of the Technical Program Committee.

<sup>61</sup> In 1964 C. Gordon Little was awarded the Department of Commerce Gold Medal for Exceptional Service with the citation,

for highly distinguished contributions and leadership in the physics of radio propagation and the organization and administration of significantly important research programs in radio science.

<sup>62</sup> In summary, the authors found from their survey that: (1) Although absorption in the ionosphere does occur above the usually considered frequency of penetration (very approximately, 15 MHz), the effect upon amplitude diminishes rapidly with increased frequency and becomes unimportant above 100 MHz. (2) Irregular structure of the ionosphere does produce amplitude scintillation effects and other more subtle effects upon the radio waves. (3) Angle of arrival of radio waves at the Earth's surface is modified by stratification and masses of irregularities in the electron density of the ionosphere. (4) Due to Faraday rotation of radio waves by the ionosphere, there can be a marked effect upon propagation by a communication system that uses linear polarization.

In view of his investigations associated with radio propagation in high latitudes as affected by solar cosmic radiation, it became a natural for Dana K. Bailey, consultant to the Upper Atmosphere and Space Physics Division, to make a study of radiation hazard in space. The result was a 1962 publication [37].<sup>63</sup> Bailey concluded that the peak radiation hazard had been over-estimated previously by a factor of several hundred times or more. The conclusion is borne out during the past 2 decades of manned space flights.

## 2. Safeguarding the orbital flights of Mercury spaceships

On September 17, 1960, NBS and the National Aeronautics and Space Administration (NASA) signed a Memorandum of Agreement to enter into an arrangement for a period of time whereby NBS would furnish special forecasts of radio propagation conditions for the coming Mercury orbital flights. This service became known as Project Mercury Radio Warning Service operated by the CRPL's Ionosphere Research and Propagation Division and, more specifically, by the Radio Warning Services Section. For the next few years Martin E. Nason served as the project leader.

The center of operations for the warning service was located at Fort Belvoir, Va., the location of the already established North Atlantic Radio Warning Service, operated by the CRPL (see ch. XI, p. 455). The nature of the project was well stated in the objective:

Systematic forecasts of short time variations in the ionosphere will be made specially for the Project Mercury ground communications network. Prior to a launch, the communications officer in charge of the network will be given special forecasts and interpretations of the forecasts as may be required. Advice regarding the more likely periods for undisturbed conditions will be made available to NASA officials charged with setting dates for launching.

The purpose of the warning service was to secure reliability of radio communications within the Mercury network which was worldwide in scope. A riometer and other special equipment were installed at the Fort Belvoir station for the most advanced means of observing potential disruption of radio communication in the frequency bands used in the network system.

The successful performance of Project Mercury during 1962 and 1963 orbital flights was reported in a summarized form in *The Annual Report 1963* of NBS.<sup>64</sup> The CRPL was very much a part of the system of NASA's Mercury program.

<sup>63</sup> A summary of Bailey's paper can best be stated by quoting from *The Annual Report 1962* of NBS, which stated:

An understanding of the variation with time of the energy spectrum of solar cosmic rays near the earth is essential for estimating radiation hazards in nearby space. A study based on the results of continuous radio observations of the effect of solar cosmic radiation on the very low ionosphere at high latitudes was completed and published. These observations were combined with the direct determinations of the solar cosmic-ray fluxes and energy spectra made with balloons, rockets, and satellites during the past three years. This investigation indicates that solar cosmic radiation near the earth is not the severe hazard predicted by earlier estimates. Such studies have a significant impact on the design of the radiation shielding used in spacecraft.

<sup>64</sup> We will let Project Mercury Radio Warning Service give its report as was stated in 1963, under the title, "Assistance of Project Mercury:"

During the orbital flights of Astronauts Shirra and Cooper, special efforts were made by the staff of the North Atlantic Radio Warning Service located at Ft. Belvoir, Va., to keep Project Mercury headquarters informed of current and anticipated radio propagation conditions. Special forecasts of radio propagation conditions were issued every hour during the flights, specifically for the high-frequency circuits which comprise the Project Mercury ground communications network. The forecasts were made available to the NASA Communications Director and the Propagation Analyst at the Goddard Space Flight Center Communications Center. During the periods between orbital flights, forecasts were issued by the Warning Service staff weekly, with daily updating as necessary. Reliable forecasts were made possible by associating reports of observed propagation conditions on each Project Mercury circuit with reports of observed solar, geomagnetic, and ionospheric activity occurring at the same time.

.....

## REFERENCES

- [1] Karl G. Jansky, "Directional studies of atmospherics at high frequencies," *Proc. IRE*, Vol. 20, No. 12, Dec. 1932, pp. 1920-32.
- [2] Karl G. Jansky, "Electrical disturbances apparently of extraterrestrial origin," *Proc. IRE*, Vol. 21, No. 10, Oct. 1933, pp. 1387-98.
- [3] Grote Reber, "Cosmic static," *Proc. IRE*, Vol. 28, No. 2, Feb. 1940, pp. 68-70.
- [4] Grote Reber, "Cosmic static," *Proc. IRE*, Vol. 30, No. 8, Aug. 1942, pp. 367-378.
- [5] Jack W. Herbstreit, "Cosmic radio noise," *Advances in Electronics*, Vol. I Academic Press, New York, 1948.
- [6] H. V. Cottony and J. R. Johler, "Cosmic radio noise intensities in the VHF band," *Proc. IRE*, Vol. 40, No. 9, Sept. 1952, pp. 1053-60.
- [7] G. C. Southworth, "Microwave radiation from the Sun," *J. Franklin Inst.*, Vol. 239, No. 1, Jan. 1945, pp. 285-297.
- [8] Grote Reber, "Solar radiation at 480 Mc/sec," *Nature*, Dec. 28, 1946, p. 945.
- [9] "Alaska eclipse expedition," *Nat. Bur. Stand. (U.S.) Tech. News Bull.*, Vol. 35, No. 2, Feb. 1951, pp. 17-19.
- [10] "Solar radio noise bursts," *Nat. Bur. Stand. (U.S.) Tech. News Bull.*, Vol. 36, No. 5, May 1952, pp. 65-67.
- [11] "Unusual solar disturbance," *Nat. Bur. Stand. (U.S.) Tech. News Bull.*, Vol. 44, No. 8, Aug. 1960, pp. 138-139.
- [12] Robert S. Lawrence, "An investigation of the perturbations imposed upon radio waves penetrating the ionosphere," *Proc. IRE*, Vol. 46, No. 1, Jan. 1958, pp. 315-320.
- [13] R. S. Lawrence, J. L. Jespersen, and R. C. Lamb, "Amplitude and angular scintillations of the radio source Cygnus-A observed at Boulder, Colorado," *J. Res. Nat. Bur. Stand. (U.S.)*, Vol. 65D, No. 4, July-Aug. 1961, pp. 333-350.
- [14] J. L. Jespersen and George Kamas, "Satellite scintillation observations at Boulder, Colorado," *J. Atmospheric and Terrestrial Physics*, Vol. 26, April 1964, pp. 457-473.
- [15] Roger M. Gallet, "Radio observations of Jupiter," Chapter 14, *Planets and Satellites*, pp. 500-533, Vol. III of *The Solar System Series*, G. P. Kuiper, Editor, University of Chicago Press, 1961.
- [16] George A. Dulk and Thomas A. Clark, "Almost-continuous radio emission from Jupiter at 8.9 and 10 MHz," *Astrophysical J.*, Vol. 145, No. 3, Sept. 1966, pp. 945-948.
- [17] C. G. Little and H. Leinbach, "Some measurements of high-latitude ionosphere absorption using extraterrestrial radio waves," *Proc. IRE*, Vol. 46, No. 1, Jan. 1958, pp. 334-348.
- [18] C. G. Little and H. Leinbach, "The riometer—a device for the continuous measurement of ionospheric absorption," *Proc. IRE*, Vol. 47, No. 2, Feb. 1959, pp. 315-320.
- [19] C. S. Gillmor, Jr., "The day-to-night ratio of cosmic noise absorption during polar cap absorption events," *J. Atmospheric and Terrestrial Physics*, Vol. 25, May 1963, pp. 263-266.
- [20] C. S. Gillmor and J. K. Hargreaves, "The occurrence of short-duration cosmic noise absorption events inside the southern auroral zone," *J. Atmospheric and Terrestrial Physics*, Vol. 25, June 1963, pp. 311-318.
- [21] K. W. Eriksen, C. S. Gillmor, and J. K. Hargreaves, "Some observations of short-duration cosmic noise absorption events in nearly conjugate regions at high magnetic latitude," *J. Atmospheric and Terrestrial Physics*, Vol. 26, Jan. 1964, pp. 79-90.
- [22] C. G. Little, E. R. Schiffmacher, H. J. A. Chivers, and K. W. Sullivan, "Cosmic noise absorption events at geomagnetically conjugate stations," *J. Geophys. Res.* Vol. 70, No. 3, Feb. 1965, pp. 639-648.
- [23] "Conjugate point phenomena," *Nat. Bur. Stand. (U.S.) Tech. News Bull.* Vol. 48, No. 2, Feb. 1964, pp. 34-36.
- [24] H. J. A. Chivers and J. K. Hargreaves, "Ionospheric absorption in conjugate regions and possible oscillation of the exosphere," *Nature*, Vol. 202, May 30, 1964, pp. 891-893.
- [25] J. K. Hargreaves and H. J. A. Chivers, "Fluctuations in ionospheric absorption events at conjugate stations," *Nature*, Vol. 203, Aug. 29, 1964, pp. 963-964.
- [26] H. J. A. Chivers, "Conjugate point observations at a variety of high geomagnetic latitudes," Chapter 2, *Arctic Communications*, Proceedings of the Eighth Meeting of the AGARD Ionospheric Research Committee, Athens, Greece, July 1933, Pergamon Press, London, 1964.
- [27] H. J. A. Chivers and J. K. Hargreaves, "The use of multiple antennas in studies of absorption at conjugate points," a chapter in book, entitled *High Latitude Particles and the Ionosphere*, a Proceedings of a Symposium of the same title, held at Alpbach, Austria, March 19-26, 1964, pp. 257-264, Logos Press, London, 1965.
- [28] H. J. A. Chivers and J. K. Hargreaves, "Slow fluctuations between conjugate points in the auroral absorption of cosmic noise," *J. Atmospheric and Terrestrial Physics*, Vol. 28, March 1966, pp. 337-342.

---

(Continued)

The propagation forecasts supplied by the North Atlantic Radio Warning Service enabled the Mercury ground communications center to anticipate problems that might be encountered and select alternative frequencies or circuits to insure unbroken communications. This reliability of communication was required in obtaining information from the astronaut and spacecraft equipment, which was telemetered to the tracking stations and relayed to the Mercury Control Center at Cape Canaveral. The same reliability was required for transmission of decisions from the Mercury Control Center to the tracking stations and the capsule itself, to insure the safety of the astronaut and the success of the mission. The staff of the North Atlantic Radio Warning Service received congratulatory telegrams from the National Aeronautics and Space Administration for its role in making the missions successful.

- [29] Roger M. Gallet, "The very low-frequency emissions generated in the Earth's exosphere," *Proc. IRE*, Vol. 47, No. 2, Feb. 1959, pp. 211-231.
- [30] R. M. Gallet and W. F. Utlaut, "Evidence on the laminar nature of the exosphere obtained by means of guided high-frequency wave propagation," *Phys. Rev. Letters*, Vol. 6, No. 11, June 1, 1961, pp. 591-594.
- [31] George W. Haydon, "Optimum frequencies for outer space communication," *J. Res. Nat. Bur. Stand. (U.S.)*, Vol. 64D, No. 2, March-April 1960, pp. 105-109.
- [32] William J. Hartman and Martin T. Decker, Mutual Interference between Surface and Satellite Communication Systems, *Nat. Bur. Stand. (U.S.) Tech. Note 126*, Aug. 1, 1963, 50 pages.
- [33] "Lunar radio communications studied," *Nat. Bur. Stand. (U.S.) Tech. News Bull.* Vol. 46, No. 9, Sept. 1962, pp. 124-125.
- [34] L. E. Vogler, "Point-to-point communication on the Moon," *J. Res. Nat. Bur. Stand. (U.S.)*, Vol. 67D, No. 1, Jan.-Feb. 1963, pp. 5-21.
- [35] L. E. Vogler, A Study of Lunar Surface Radio Communication, *Nat. Bur. Stand. (U.S.) Monograph 85*, Sept. 14, 1964, 126 pages.
- [36] R. S. Lawrence, C. G. Little and H. J. A. Chivers, "A survey of ionospheric effects upon earth-space radio propagation," *Proc. IEEE*, Vol. 52, No. 1, Jan. 1964, pp. 4-27.
- [37] D. K. Bailey, "Time variations of the energy spectrum of solar cosmic rays in relation to the radiation hazard in space," *J. Geophys. Res.*, Vol. 67, No. 1, Jan. 1962, pp. 391-396.



## Chapter XV

### EXIT RADIO STANDARDS PHYSICS, ENTER QUANTUM AND PLASMA PHYSICS

#### INTRODUCTION

#### 1. Microwave spectroscopy for measurement standards<sup>1</sup>

##### a) THE AMMONIA ATOMIC CLOCK

Soon after the Central Radio Propagation Laboratory was established, a program of "microwave spectroscopy for measurement standards" was started in the newly organized Microwave Standards Section. The purpose was to investigate microwave spectral lines that might be used in a microwave frequency standard and in an "atomic clock."

The 23,870.1-MHz absorption line of ammonia was being investigated by Harold Lyons and his associates, but it appeared that the atomic and molecular vibrational states of a number of other chemical substances might be useful for frequency standards. (For example, the possibility of using deuterated ammonia instead of ordinary ammonia was proposed and a quantity of pure  $\text{ND}_3$  was obtained from the Texas State Research Foundation.) Work on the ammonia clock progressed rapidly, and on August 12, 1948, the World's first atomic clock was given its initial run and on January 6, 1949, a public announcement was made to the press.

Professor Charles H. Townes of the Radiation Laboratory at Columbia University was engaged by the Microwave Standards Section as a consultant in microwave spectroscopy and continued with NBS until after the move to Boulder (see ch. VIII, p. 298, footnote 87). Townes presented an invited paper entitled "The Confluence of Spectroscopy and Radio Engineering" at the Dedication Scientific Meetings (Radio Conference), held in connection with the dedication of the NBS Boulder Laboratories, September 8-14, 1954. He emphasized the remarkable application of atomic and molecular resonance to the precise control of radio frequency and thus to highly accurate time standards. Townes was also chairman of one of the four Conference sessions on Microwave Techniques and Applications.

##### b) SPECTRAL LINES OF DEUTERATED AMMONIAS

The deuterated ammonias were never used in the atomic clocks, but the research provided approximately 125 lines of  $\text{ND}_3$ ,  $\text{ND}_2\text{H}$ , and  $\text{NDH}_2$  in the region from 2000 to 17,000 MHz. The results were published in the *Physical Review* in 1951 [1]. Deuterated ammonia, however, was used in the gas cell or absorption-line filter of a frequency standard as well as in a frequency divider in the range of 3000 to 9000 MHz.

##### c) STARK-CELL MICROWAVE SPECTROGRAPH

In connection with this work, a Stark-cell microwave spectrograph was developed and constructed for operation over a frequency range of less than 900 MHz to above 17,000 MHz. Although some features had been developed by others, this spectrograph was adapted for the lower frequencies by incorporating coaxial equipment [2]. A further modification was reported about a year later [3].

---

<sup>1</sup> Most of the contents of this section have been covered in somewhat greater detail in various sections of chapter VIII, but they are repeated here for continuity of the chapter.

## 2. Microwave spectra tables

### a) *CIRCULAR 518* (1952)

As a project in the microwave spectroscopy program, Townes, with co-worker Paul A. Kisliuk, a graduate student at Columbia University, made a compilation of all known molecular microwave spectra lines, which was published first in the *NBS Journal of Research* [4]. Later the compilation was expanded and published as *NBS Circular 518* [5]. Microwave spectra are useful in identification of compounds and in qualitative and quantitative chemical analysis.

### b) *MONOGRAPH 70* (1964-1969)

More than a decade later, after the advent of modern computer techniques, the tables were brought up to date and published as a five-volume set over a period from 1964 to 1969 (*NBS Monograph 70*, Vols. I-V) [6-10].<sup>2</sup> Volumes I and II were completed under the supervision of Paul F. Wacker. Later, L. Yardley Beers assumed general supervision of the project and Marian S. Cord was appointed project leader for the remaining three volumes. The original volume by Townes and Kisliuk included 99 molecules (as distinct from isotopic species). *Monograph 70* listed 296 molecules.

## 3. Experiments with oxygen line

Another spectral line which offered promise and seemed to have some advantages over ammonia as a frequency standard was the oxygen line of 60,435 MHz. Because the move to Boulder was already in the planning stages, an oxygen spectrometer was built by John M. Richardson and set up first in temporary quarters in the National Guard Armory at Boulder [11].<sup>3</sup> When the Radio Building was completed in 1954, the spectrometer was one of the first pieces of equipment moved into the new quarters. It was of such a size (25 feet long) that the laboratory occupied the space of several normal-sized rooms, and the end of the instrument extended through an opening in the wall into an adjacent room. The oxygen line was never used experimentally to control a frequency standard because of advances with another technique—the cesium beam frequency standard.

## 4. Cesium beam atomic clock

Shortly after the ammonia-cell clock was announced, work began on an atomic-beam clock which used a beam of cesium atoms. This clock was completed and operated in Washington, then disassembled and moved to Boulder. Several years later it became the NBS-I Atomic Frequency Standard (see ch. VIII, p. 299).

A Model 2 ammonia clock was constructed in Washington, and a Model 3 ammonia clock was in the planning stages when the move was made to Boulder. The Model 2 clock was disassembled for the move and was never reassembled. In view of advances with the cesium beam as an atomic-frequency standard, the limitations of accuracy did not warrant further study of the ammonia clock.

---

<sup>2</sup> Volume I of *Monograph 70* was one of the most complex works prepared up to that time for printing from a computer output. The data were first prepared on cards which were sent through a card reader, then through an IBM output writer which produced photo-ready tables for printing. Volumes II-V were prepared for printing from punched paper tape. The Seventh Summary of Research at Boulder Laboratories (FY 1961) included the following explanation of procedures involved:

Input and output formats for the tables were devised, and programming for intensity computations was begun. An electric typewriter was modified to read punched paper tape. (Data are to be recorded first on magnetic tape and then transferred to punched paper tape.)

<sup>3</sup> The Scientific Research Society of America (RESA), affiliated with the Society of Sigma Xi, established a chapter at NBS-BL in 1955. One of RESA's first activities at BL was the establishment of an award, to be made each year, for the best paper reporting original research in physics in the Boulder area. John M. Richardson received the first RESA publication award for his paper, "Experimental evaluation of the oxygen microwave absorption as a possible atomic frequency standard," published in the *Journal of Applied Physics* (see [11]).

## MILLIMETER-WAVE RESEARCH

### 1. Purpose

The purpose of this research was described in the Third Annual Report of the Boulder Laboratories:

to develop techniques for . . . measurements in the millimeter and submillimeter wavelength region and to explore and exploit applications of the shorter microwaves to precision measurements such as time, length, certain molecular resonances, and the velocity of light.

Earlier Boulder Laboratories Annual Reports had used the title "Extreme High Frequencies" for this research.

Another change in title appeared in later Reports, "Millimeter-Wave Interferometry." With this change came an expanded statement of objectives:

(1) to investigate and develop the special techniques required for the transmission, generation, detection, measurements, and use of millimeter wavelengths with particular reference to the development of radio standards for these wavelengths; (2) to explore and exploit the unique applications of such short wavelengths to research problems such as atomic and molecular resonances; and (3) to develop more precise methods such as millimeter-wave interferometry for highly accurate and precise measurements of physical constants such as the velocity of light, and for the measurement of length.

Microwave versions of the Michelson and Fabry-Perot optical interferometers were developed and studied at the NBS Boulder Laboratories with a view to providing such highly accurate and precise measurements [12]. Microwave interferometry forms an effective bridge between conventional radio and electronic methods, and purely optical techniques.

Original work was carried out by Richardson and George E. Schafer. Later, William Culshaw, Ramon C. Baird, and staff assistants joined the project.

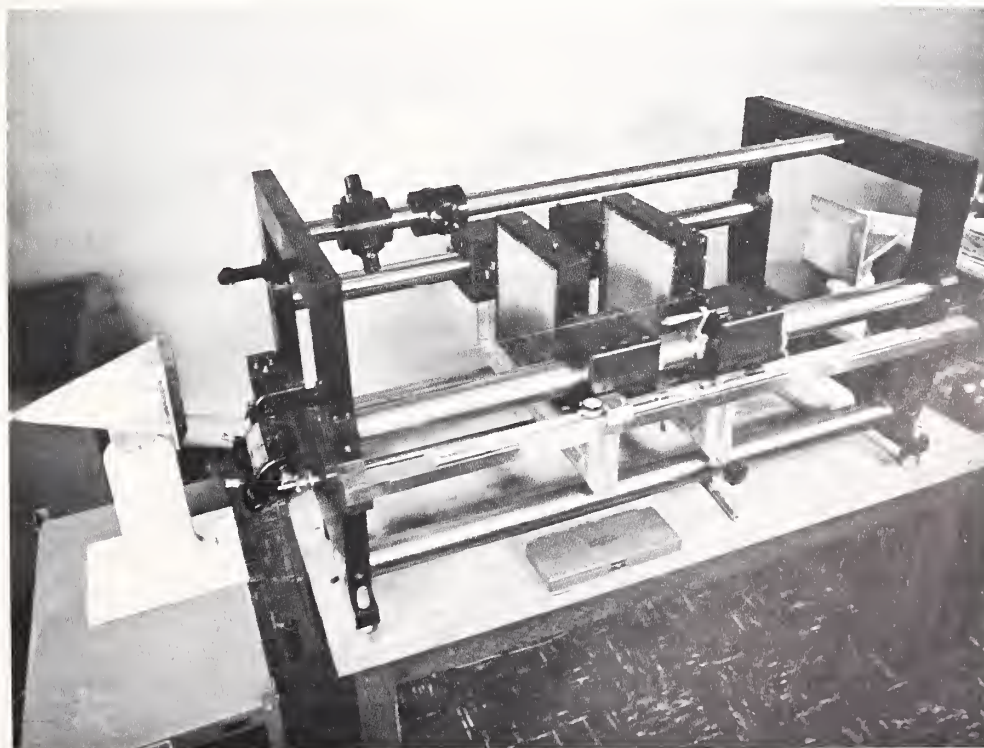

*Millimeter-wave Fabry-Perot interferometer.*

## 2. Microwave Michelson interferometer

### a) PILOT MODEL

A pilot model of the Michelson interferometer was set up and operated at 6 mm to study the errors in such an instrument. After satisfactory experience with this pilot model, design and construction of a final instrument followed.

### b) CONSTRUCTION

The design of the instrument involved a number of unique features. The reflector was a block of aluminum 5 ft<sup>2</sup> with an extremely smooth surface, fabricated by the Naval Gun Factory, Washington, D.C. The Gun Factory also fabricated the carriage which allowed the reflector to be moved approximately 1 m on ball bearings. Displacement of the reflector was measured by a meter bar supported by ball bushings on a steel rod, which could be swung into position to measure the displacement. All of this was mounted on a block of granite for stability.<sup>4</sup>

Electromagnetic horn radiators with matched dielectric lenses provided stable radiating apertures of dimensions 60 cm<sup>2</sup> and 30 cm<sup>2</sup>.

## 3. Microwave Fabry-Perot interferometer

The initial design of the microwave Fabry-Perot interferometer began about 1957, with particular attention being given to the reflector design. Various designs were tried and improved reflectors were developed [13]. This work resulted in improved performance, ease of adjustment, and convenience of fabrication [14]. By 1961 the instrument had been used to measure the length of millimeter waves to accuracies better than 0.04 percent.

## 4. Diffraction computations

In the application of precision microwave interferometry to the determination of the speed of light and to metrology, a diffraction correction to the wavelength measured on the interferometer must be considered. David M. Kerns and Edward S. Dayhoff made a detailed study of diffraction theory in microwave interferometry and derived a rigorous mathematical treatment of formulas for deriving diffraction corrections to be applied in measurements made with the microwave Michelson interferometer [15].

## THEORETICAL ASTROPHYSICS

### 1. Solar atmosphere studies

A program entitled "Solar Atmospheric Studies" was initiated in Fiscal Year 1956 for the purpose of providing a strong representation of this area in the general NBS program on Measurements and Standards in Plasma Physics and Astrophysics. It was in the Office of the Director, Boulder Laboratories, under Richard N. Thomas.

The objectives of the project were given in the Fourth Summary Report of the Boulder Laboratories:

- (1) Research and consulting activities in studies of the solar atmosphere and general stellar atmospheres, and (2) the relationship of these studies to phenomena in high-temperature gaseous ensembles. In addition to these activities, the aim of the program is to provide extensive working liaison in the field between Boulder Laboratories, the High Altitude Observatory, the Sacramento Peak Observatory, and other groups in this field, both in the

---

<sup>4</sup> When this assembly arrived in Boulder, a portion of the outside wall of the Radio Building was removed for its installation.

United States and abroad.<sup>5</sup> The work is partially supported by the Air Force Cambridge Research Center.

The program continued into a second year with the same title. Joining the project during the year were John T. Jefferies<sup>6</sup> (on leave from the Commonwealth Scientific and Industrial Research Organization of Australia) visiting the NBS-HAO-SPO group, and guest workers from several cooperating laboratories and observatories who took part in a variety of research investigations.

Projects included a collaborative investigation by Jefferies and Thomas of the behavior of the radiative source function in a non-confined gaseous atmosphere (see [16]) and the distribution of emergent energy in spectral-line profiles. In general, results of these studies differed very appreciably from those obtained under the assumption of Local Thermodynamic Equilibrium (LTE), this assumption having been frequently and incorrectly applied in other solar work.

Two guest workers, John H. Waddell III from the Sacramento Peak Observatory in New Mexico, and Anne B. Underhill of the Dominion Astrophysical Observatory, Victoria, British Columbia, Canada, computed *f*-values for the first-order Stark components of the Lyman, Balmer, Paschen, Pfund series of hydrogen, using the IBM 650 computer. This work was published as *NBS Circular 603* [17].

## 2. A change of project title—Theoretical Astrophysics

### a) EXPANDED OBJECTIVES

In the next year, the title of the project was changed to "Theoretical Astrophysics: Non-Equilibrium Phenomena in Gaseous Atmosphere," and in following years to "Theoretical Astrophysics." The statement of objectives was also expanded:

(1) research and consulting activities into the study of the configuration of a gaseous atmosphere where cyclic processes in the energy balance occur, so that significant departures from a configuration of Local Thermodynamic Equilibrium exist; (2) investigation of the interrelation between such non-LTE configurations of the gaseous atmosphere and the field of aerodynamic motions which may exist in the atmosphere, with particular interest in the relative importance of energy and momentum from such velocity fields to the state of the atmosphere; (3) particular application of these studies to the solar atmosphere and, conversely, utilization of the detailed data from solar atmosphere studies to gain general insight into the general theoretical problems posed by these studies; (4) to provide a strong representation of this area of study in the general NBS program on Measurements and Standards in Plasma- and Astrophysics.

### b) RESEARCH PROJECTS

Jefferies and Thomas continued the investigation of the behavior of the radiative source function in a non-LTE gaseous atmosphere [16]. They also made a study of the effect of applying a theory of a source function which does not include non-LTE effects on the interpretation of observed spectral-line profiles in terms of velocity fields. An application of these methods to the general problem of ionization equilibrium was initiated, and the case for hydrogen was solved in collaboration with Stuart R. Pottasch [18]. Extension to helium and more highly ionized metals was undertaken and application to the analysis of the

---

<sup>5</sup>This explanatory note, not a part of the quotation, was inserted at this point by the author (CLB). The High Altitude Observatory (HAO), with facilities at Boulder and Climax, Colo., was operated by the University of Colorado until 1960, when it became a unit of the National Center for Atmospheric Research in Boulder (NCAR). NCAR is operated by the University Corporation for Atmospheric Research.

The Sacramento Peak Observatory (SPO) is a facility of the U.S. Air Force at Sunspot, N. Mex. (near Holloman AFB, Alamogordo).

<sup>6</sup>Jefferies and Thomas acted as thesis directors for S. R. Pottasch, who received the first Ph.D. granted in the Department of Astrogeophysics, University of Colorado (June 1958). Pottasch then joined the BL staff full-time in the Sun-Earth Relations Section of the Radio Propagation Physics Division of CRPL.

structure of the solar chromosphere was made in collaboration with Pottasch and others. A general methodology was developed for treating radiative dissipation of energy in the non-LTE atmosphere and its variation through the atmosphere.

Additional research effort was conducted with guest workers from organizations in the United States and abroad. Some of these programs, those taking part, and the laboratory or observatory with which they were affiliated, included: studies of negative atomic ions with Harold R. Johnson, HAO, and Fritz Rohrlich, University of Iowa; the general problem of line-formation in non-LTE configurations and its effect on interpretation of observed spectral-line profiles from stellar atmospheres with Jean-Claude Pecker, Observatoire de Meudon; general methodology for treating radiative dissipation of energy in non-LTE atmospheres and its variation through the atmosphere; and a study of atomic cross-sections with Rohrlich and S. N. Milford, St. Johns University, Queens, N.Y.; H. Mendlowitz, NBS Washington; and Harold R. Johnson, HAO [19]. Milford served as a consultant on the study of hydrogen Balmer lines in the Sun with Charlotte Pecker, Institut de Astrophysique, Paris, and E. V. P. Smith, SPO, thus linking NBS with his program at St. Johns University of computations of inelastic collision cross-sections between excited levels of hydrogen.

William A. Rense, University of Colorado, with consultants Rohrlich and Charlotte Pecker, conducted an investigation of spectroscopic configurations found in rocket ultraviolet observations of the Sun. J. B. Zirker (SPO) collaborated in the study of a link between the methodology of these problems and that of source-function studies. Work was done with D. C. Morton and K. G. Wilding (Naval Research Laboratory) in connection with NRL rocket observations in the ultraviolet.

Zirker and Thomas conducted investigations on an atmospheric shell of finite capacity, such an atmosphere being the kind producing the solar rocket spectra.

A strong collaborative program existed with groups at Institut de Astrophysique Observatoire de Meudon and on atomic parameters of astrophysical interest applied to stellar atmospheres with a group at University College, London.

J.C. Pecker investigated the application of source-function methodology to an atmosphere containing a system of aerodynamic motions; and Zirker, the application of the same methodology to a discussion of the solar atmosphere.

### 3. *Technical Note 30: Aerodynamic Phenomena in Stellar Atmospheres*

A bibliography of aerodynamic phenomena in stellar atmospheres was prepared by collaboration of astrophysicists from Canada, Great Britain, Belgium, France, Germany, the USSR, Japan, and the Scandinavian countries, and edited by Thomas. L. L. House of the Department of Astrogeophysics, High Altitude Observatory, assisted in the program. This bibliography was published September 15, 1959, as *NBS Technical Note 30*, to provide a working bibliography for particular use in preparation for the Fourth Symposium on Cosmical Gas Dynamics, Aerodynamic Phenomena in Stellar Atmospheres [20].

### 4. *Physics of the Solar Chromosphere—a book*

Thomas and R. Grant Athay (High Altitude Observatory) collaborated on a book, *Physics of the Solar Chromosphere*, published in 1961 by Interscience Press, New York [21].

## PLASMA PHYSICS

### 1. Introduction

The interaction of radio waves and plasma has been a subject of much theoretical and practical interest. Therefore a study of radio plasmas was initiated in the Director's Office of the Boulder Laboratories in 1959. The goal was to develop precise measurement techniques and basic data on the fundamental properties of ionized gases.

A major initial project was the radio probing of a dense, highly magnetized, and bounded plasma by using the British thermonuclear machine ZETA. A detailed description of this program is given in section 2 below.

Other work in this field included the development of diagnostic methods based on microwave techniques and the development of stable and uniform plasmas.

## 2. A team from Boulder goes to England to use the British thermonuclear machine ZETA

In the summer of 1958, Roger M. Gallet suggested to the International School of Physics at Varenna, Italy, that the "whistler" mode of propagation might be reproduced with the dense plasmas of a thermonuclear research machine such as the British ZETA. At the same time, he held preliminary discussions with the director of the British Atomic Energy Research Establishment at Harwell, England, for using the machine. After formal details were completed, a team of five (consisting of Roger M. Gallet, John M. Richardson, Bernard Wieder, Gray D. Ward, and Malcolm M. Anderson) spent several months at Harwell performing a series of carefully designed experiments.

A large amount of equipment (about 2 tons) was assembled at Boulder and shipped to Harwell. It included microwave transmitters and receivers, antennas, and auxiliary equipment. One member of the team (Anderson) was a microwave technician who went along to install and operate the equipment, and to keep it in working order.

Gallet had previously done work with the naturally occurring phenomenon known as "whistlers," a mode of propagation which originates at very low frequencies in the Earth's exosphere and travels over paths several Earth radii long.<sup>7</sup> His theory was that the "whistler" mode could be established in the laboratory if conditions were right.

Previously, all attempts at radio-wave probing of the dense plasma of thermonuclear machines had tried to use frequencies above the natural plasma frequency. This required equipment operating in the millimeter portion of the microwave spectrum at the extreme upper frequency limit of the techniques of the time. Probes at these frequencies were still unable to penetrate the densest regions of the plasmas.

However, studies of the atmospheric "whistlers" had shown that radio waves would propagate through a plasma at frequencies below the natural plasma frequency of electrons in the magnetic field which is present. For "whistlers" in the Earth's exosphere, this means that frequencies of the order of 10 kHz will propagate; for a large thermonuclear machine such as ZETA, the corresponding frequency is of the order of 3000 MHz.

It was demonstrated that the radio waves do propagate successfully as predicted, and interference effects were demonstrated between the outputs of two receiving antennas spaced along different paths from the transmitting antenna. The time variation of the internal magnetic field was also measured from the onset and cessation of the propagation mode. The demonstration of interference effects showed that interferometer techniques can be used to measure the wavelength of a radio signal in the plasma.

Through making such measurements on varying frequencies, and because the propagation of the radio signal is confined to a narrow cone along the line of force of the magnetic field, it became possible to measure the local electron density within the plasma, to map the internal magnetic field in intensity and in direction, and to determine the local temperature of the electrons. The results also indicated that Cerenkov radiation could be used to detect high-velocity particles moving through the hot plasma [22,23].<sup>8</sup>

This project was supported by the Air Force Cambridge Research Center.

## 3. Upper atmosphere plasma physics

In Fiscal Year 1960, a new division was formed in CRPL, the Upper Atmosphere and Space Physics Division. A section within this division, the Upper Atmosphere and Plasma Physics Section, was headed by Gallet. A series of experiments in plasma physics was performed under his direction to duplicate in the laboratory the phenomena occurring when bursts of plasma enter and perturb the media surrounding the Earth. The radio properties of similar perturbations can be studied in detail in the laboratory by controlled and reproducible experiments using diagnostic techniques.

---

<sup>7</sup> See chapter XI, section entitled, "The sounds of radio waves at very low frequencies," p. 479.

<sup>8</sup> A report by Wieder, entitled "Microwave propagation in an overdense bounded magnetoplasma," was submitted in partial fulfillment of the requirements for a Ph.D. at the University of Colorado.

#### a) CYLINDRICAL SHOCK WAVES FROM EXPLODING WIRES

Shock waves from exploding wires were used in the laboratory by Donald L. Jones, Kenneth B. Earnshaw and associates to produce a dense, highly ionized plasma [24]. The objectives of the project were the production and study of the ionization, temperature, and velocity of high-energy blast waves. The principal purpose of the project was to obtain and study interaction between electromagnetic waves and the plasma in the blast wave.

The systematic study of shock waves from exploding wires in air involved a wide range of wire sizes, pressures, and energy inputs. Quite critical optimum conditions were found in which nearly half of the energy available from the capacitor bank went into the shock. Unexpected ionization, far in advance of the shock front, was detected and studied. Hydromagnetic interactions were observed between the expanding shock front and a strong magnetic field parallel to the wire axis [25,26].

#### b) RADIATION PRODUCED FROM A PLASMA

Plasmas produced by a high-velocity shock wave traveling at speeds in excess of Mach 100 in helium were studied in the laboratory in the presence of a transverse magnetic field by Earnshaw and associates [27,28]. Radio frequency radiations resulting from the hydromagnetic interaction between the shock wave and the magnetic field were observed.

Creation in the laboratory of electromagnetic radiation from plasmas was considered a major step towards duplicating under controlled conditions electromagnetic processes which occur in the upper atmosphere.

#### c) HIGH-SPEED CAMERA FOR PLASMA PHYSICS RESEARCH

A high-speed framing-type camera was perfected for use in connection with the experiments in laboratory plasma physics. The work on this project was performed by Earnshaw and associates in the Upper Atmosphere and Plasma Physics Section, "with very important help in camera design and photographic techniques from Charles M. Benedict, Thomas L. Theotokatos, and Felix H. Dunbar of the Photographic Laboratory." (Quoted from Seventh Summary of Research at Boulder Laboratories.) The original design of a camera developed by M. Sultanoff at the Army's Aberdeen (Md.) Proving Ground was modified and improved to enable the camera to be used for streak photographs, stroboscopic-effect photographs, and single-exposure photographs [29].

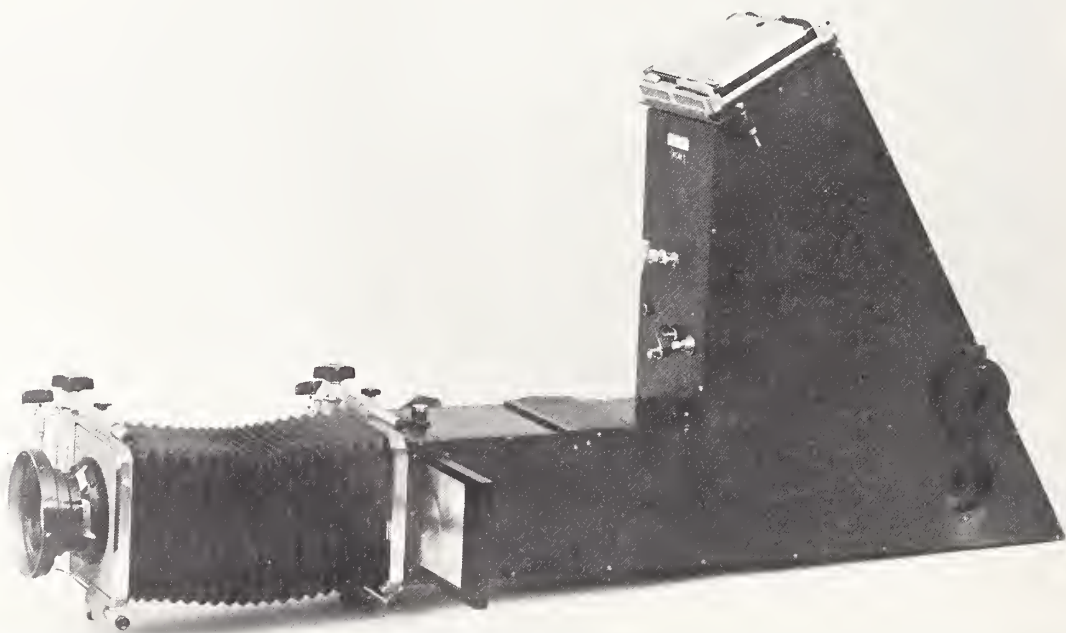

*This high-speed camera was developed for photographing shock waves in a plasma tube. The camera was adapted from a design originally described by Sultanoff of the Army's Aberdeen Proving Ground.*



The precision and flexibility of this laboratory instrument permitted diagnostic analysis of the behavior and characteristics of the luminosity front in a strong shock wave. These studies were basic to understanding of shock-wave effects in a hot plasma and the mechanism leading to the generation of radiofrequency radiation by a plasma.

#### 4. Radio Plasma

A section designated Radio Plasma was formed in the Radio Standards Physics Division in 1962 (the division, in the Radio Standards Laboratory, was first called Radio Physics). The section incorporated projects that had previously been in a group formed under the chief of the Radio Standards Laboratory as a part of an NBS program on Measurements and Standards for Plasma Physics and Astrophysics. Karl-Birger Persson was named chief of the section.

##### a) BRUSH-CATHODE PLASMA

A novel cold-cathode discharge—the brush-cathode plasma—was developed by Persson<sup>9</sup>, who conducted an extensive investigation of this plasma, with assistance from members of the section. He stated in a report in the *Journal of Applied Physics*, Oct. 1965, [30]:

The field of experimental plasma physics has need for a well-behaved plasma. A well-behaved plasma is a plasma whose parameters such as the electron density, electron temperature, and significant collision frequencies can be varied in a controllable manner. . . . The plasma should. . . be sufficiently stable to study under steady-state conditions. . . .

The brush-cathode plasma is both stable and uniform, and is characterized by a distinctive negative glow. This negative glow constitutes a well-behaved medium (no instabilities and no striations) which makes it ideal for a whole series of investigations in plasma-physics spectroscopy.

The name brush-cathode plasma comes from the design of the cathode, which resembles a brush. It consists of a collection of metal wires that are brazed end-on to a common base plate. The wires do not touch each other and are electrically as well as mechanically connected only through the base plate. The free ends of the wires were etched electrolytically, producing a set of very sharp needle-like points located in essentially the same plane. The set of brushes used in Persson's investigation were made of 0.025-inch tungsten wires, 1-3/4 inches long and spaced 1/16 inch apart, soldered to an invar base plate.

### JOINT INSTITUTE FOR LABORATORY ASTROPHYSICS

#### 1. Organization

The National Bureau of Standards and the University of Colorado (CU) collaborated in the establishment in 1962 of the Joint Institute of Laboratory Astrophysics (JILA) on the CU campus in Boulder, Colo.<sup>10</sup> JILA was established as a unique permanent academic unit

<sup>9</sup> Karl-Birger Persson was awarded the Department of Commerce Silver Medal for Meritorious Service on Feb. 14, 1967. Persson was recognized

for contributions to the study of plasma mechanisms and the technology of plasma measurements.

<sup>10</sup> The historical background of JILA goes back to 1960, when the Space Science Board of the National Research Council adopted a resolution stating, in part:

The Board foresees that a strong limitation to progress in physical interpretation of experiments and observations of the terrestrial, planetary, solar and stellar atmospheres is the lack of sufficient understanding of basic physics of atoms and molecules in the environment which they encounter in these atmospheres. The Board feels that basic work on atomic cross sections, reaction rates and interaction with radiation fields both individually and cooperatively should be encouraged wherever interest exists or may be stimulated.

NBS responded to this need by establishing a coordinated group of laboratories (in both Washington and Boulder) for astrophysical and plasma research, which encompassed the activities of about 100 senior staff members. JILA's initial staff was drawn from this group.

devoted to research and advanced training of students in areas of physics and astrophysics vital to the U.S. space program. Laboratory astrophysics emphasizes laboratory research and theoretical investigations rather than the acquisition of astronomical observations via observatories, rockets, balloons, and other means.

Lewis M. Branscomb, chief of the Atomic Physics Division of NBS Washington, was largely responsible for the concept of JILA and worked closely with authorities of the University of Colorado and of the National Bureau of Standards to perfect details of this University-Federal Government cooperative activity. He transferred to JILA when it was organized and was named chief of the NBS group in the Institute.

JILA is closely allied with the CU Physics Department. A number of CU faculty members are Fellows of JILA. A group of CU scientists, headed by Wesley Brittin, then Chairman of the Physics Department, became part of the initial professional staff. Several areas of CU research fit into the Institute program, including plasma physics, space physics, astrogeophysics, and nuclear physics. Academically, JILA, in cooperation with the CU Physics and Astrogeophysics Departments, trains graduate students in atomic physics, astrophysics, and astrogeophysics.

JILA is an integral part of the NBS Boulder Laboratories. It works in close cooperation with extensive research programs in astrophysics, atomic and molecular research, and plasma physics in both the Washington (Gaithersburg) and Boulder laboratories. The initial staff consisted of nine atomic physicists from Washington and two from Boulder (Thomas<sup>11</sup> and Jefferies).

JILA, as explained above and as its name implies, is a joint operation of NBS and the University of Colorado.<sup>12</sup> However, for administrative purposes within NBS, the NBS group of employees was established in 1962 as a technical unit of the Boulder Laboratories. In 1964 the Bureau was restructured into four institutes and the JILA group of NBS employees was designated as the Laboratory Astrophysics Division (JILA) in the NBS Institute for Basic Standards. Branscomb remained as chief of the Laboratory Astrophysics Division and continued in that position until he became director of the National Bureau of Standards in 1969. In 1977 the name was changed to Quantum Physics Division (in the Institute for Basic Standards).

JILA is housed in its own 10-story building on the campus of the University of Colorado, a part of the Duane complex of buildings. The Duane complex also houses the University's Department of Physics and Astrophysics and the Department of Astrogeophysics, as well as the Laboratory for Atmospheric and Space Physics (LASP). In addition to the 10-story tower, the JILA building includes a laboratory wing with a large isolated underground research bay and an auditorium. Offices and laboratories for staff and students, a reading room, workshops, and other support facilities are located in the building.

JILA maintains a support staff<sup>13</sup> to provide assistance in the design and fabrication of research equipment, and for numerical analysis and computer programming. JILA has a high-speed terminal to the University's computer and access to the computing facilities of the National Oceanic and Atmospheric Administration (NOAA) of the Department of Commerce.

---

<sup>11</sup> Richard N. Thomas was awarded the Department of Commerce Gold Medal for Exceptional Service on Feb. 14, 1963. Thomas was recognized

for pioneering a new approach to our understanding of the atmosphere of stars as well as for his delight in scientific daring and intolerance of mediocrity, and for his vision and enthusiasm which led to the creation of JILA last year.

<sup>12</sup> Arthur R. Hauler, Executive Officer, Laboratory Astrophysics Division (JILA), was awarded the Department of Commerce Silver Medal for Meritorious Service on Feb. 15, 1965. Hauler was recognized

for contributions of great value to administration in the development of new patterns of Federal-State cooperation in research, through service as Executive Officer of the Joint Institute for Laboratory Astrophysics of the National Bureau of Standards and the University of Colorado.

<sup>13</sup> Carl E. Pelander of the support staff was awarded the Department of Commerce Silver Medal for Meritorious Service on Feb. 15, 1966. Pelander was recognized

for a high order of originality and competence in developing and operating a system of technical support for a large experimental research program at the Joint Institute for Laboratory Astrophysics of the National Bureau of Standards and the University of Colorado.



*The building of the Joint Institute for Laboratory Astrophysics (JILA) on the campus of the University of Colorado at Boulder. JILA is a joint operation of the National Bureau of Standards and the University of Colorado. The view is looking northeast through an arch of a neighboring campus building.*

## **2. Research activities**

A wide variety of research programs at JILA, both experimental and theoretical, are directed primarily toward basic problems in atomic and molecular interactions, linear and nonlinear radiative processes of atoms and molecules, radiative transfer, spectral line broadening, and the determination of fundamental physical constants. Substantial attention is also given to the development of applications, including, for example, the search for more efficient combustion and chemical processes, the development of stabilized laser systems, and their application to precision measurements for solid earth geophysics.

Astrophysical research at JILA is directed largely toward the observation and understanding of atomic and molecular spectra of astronomical objects, including solar and stellar chromospheres, stellar interiors, interstellar matter, cosmic x-ray sources, and quasars.

### 3. Atomic Collision Data Center

JILA maintains an Atomic Collision Data Center whose mission is the collection and critical evaluation of data on low-energy collisions of electrons, photons, ions, atoms, and molecules.<sup>14</sup> Evaluated data and critical reviews are the major products. These are issued as JILA Data Center Reports, as NBS publications, or as publications in recognized technical journals. The JILA Data Center is affiliated with the National Standard Reference Data System, coordinated by NBS.

The Center provides evaluated data for modeling ionized gases in the areas of astrophysics, gas discharges including gas lasers, CTR (controlled thermonuclear reaction) and MHD (magnetohydrodynamic) plasmas, atmospheric physics, and aeronomy. The Center is compiling and evaluating low energy transport cross sections and rate data, and atom-ion transfer collisional energy transfer rates.

### 4. Measurements of excitation of multiply charged ions

Measurement techniques and apparatus developed at JILA have been combined with ion-source facilities at Oak Ridge National Laboratory in a collaboration to make the first-ever measurements of cross sections for electron-impact excitation of multiply charged ions. The technique, which uses crossed beams of electrons and ions, was used to measure cross-section data for triple-charged carbon ions ( $C^{+3}$ ) and four-times charged ionized nitrogen ( $N^{+4}$ ) [31].

Such data are needed for impurity diagnostics on large-scale controlled fusion experiments such as with Tokamaks, since the measured cross sections combined with observations on Tokamaks can tell how much impurity is present. The impurities can lead to failure of the fusion process by disrupting the conductivity of the plasma and giving rise to instabilities or by radiating away excessive amounts of energy. Impurity concentrations near the walls can also stop proper refueling of the fusion reactor.

Carbon and nitrogen are generally the most prevalent impurities present, and metal ions from wall materials are also commonly present.

Because of the large variety of ions of ultimate use in plasma applications, it will be impossible to measure all of them, and theory will have to be relied upon. The new measurements, besides being of direct use, are the first direct tests of theoretical methods used to calculate cross sections for multiply-charged ions.

### 5. E. U. Condon closes career at JILA

Edward Uhler Condon, who was director of the National Bureau of Standards (1945-1951) and who played a leading role in establishing the NBS Boulder Laboratories (ch. XIX, p. 706), was appointed a JILA fellow in 1963. Upon his retirement in 1970, he became Professor Emeritus in the Department of Physics and Astrophysics at the University of Colorado and was given the title of "Fellow Emeritus" by his colleagues in JILA.

At JILA he resumed research on the theory of atomic spectra with Halis Odabasi, who received the Ph.D. from the University of Colorado while working at JILA with Condon.

Frederick Seitz, president of the Rockefeller University, New York, N.Y., wrote in the Foreword to *Topics in Modern Physics A Tribute to Edward U. Condon* (Colorado Associated University Press, Boulder, Colo., 1971, 360 pages),

. . . . Condon, who never really got the western blood drained from his veins, . . . achieved a position of longitude less than one degree east of the site of Alamogordo, New Mexico, where both he (1902) and the first atomic bomb (1945) were born. He is nominally retiring...as this volume goes to press. We shall see just what such retirement consists of.

---

<sup>14</sup> A Group Department of Commerce Gold Medal for Exceptional Service was awarded to Gordon H. Dunn, Lee J. Kieffer, and Stephen J. Smith, Laboratory Astrophysics Division (JILA) on Oct. 21, 1970. They were recognized

for exceptional contributions in the establishment of criteria for valid atomic collision measurements.

The volume consists of a collection of papers prepared as a tribute to Condon by his associates in the University of Colorado and in JILA, upon his retirement. It was edited by Wesley Brittin of the University of Colorado and JILA (sec. 1, above) and by Halis Odabasi (above, this section), who co-authored one of the papers.

## LASER RESEARCH

### 1. Development of laser program at Boulder Laboratories

A pulsed ruby laser—the first at the Boulder Laboratories—was built by Donald A. Jennings of the Atomic Frequency and Time-Interval Standards Section in 1962. A laser had not been included in the BL budget and therefore Jennings tapped other funds for its construction. L. Yardley Beers, chief of the Radio Standards Physics Division, has described this first laser as a “bootlegged” project and pointed out that the start of laser work was delayed because of budgetary problems and conditions in the labor market.

The *Annual Report of the National Bureau of Standards for 1962* stated, in essence:

this laser was powered by powerful xenon flash lamps, had a coherent light output at a wavelength of 6943 Å, and can be focused by means of an ordinary lens to provide a high-energy density of optical radiation, making feasible experiments that a few years ago were impossible.

Two helium-neon (He-Ne) gas lasers were also reported to be under construction.

The pulsed ruby laser was used in an experiment on anthracene fluorescence, described in an internal NBS Report not available for general distribution.

In subsequent years, when a program of laser research was funded, Jennings continued with the development of lasers. As the program expanded, additional personnel joined the staff and further development of lasers proceeded. Applications of newer and existing lasers were investigated.

When JILA was established in 1962, several of the first NBS scientists came with backgrounds in laser technology and a number of laser programs were inaugurated. These programs and the personnel involved are discussed in sections that follow.

### 2. Laser intensity stabilizer

A laser intensity stabilizer, developed by John L. Hall and James J. Snyder of JILA, was listed among the I-R 100 (the top 100 technical products selected by *Industrial Research* magazine) in 1975 [32].<sup>15</sup>

The laser intensity stabilizer provides a means of continuously controlling and stabilizing the intensity of a laser beam within narrow limits. It is built as a separate unit, rather than being incorporated into the laser itself. Thus, the unit can be used with practically any laser desired, and subsequently switched to another laser without major modifications.

The high-speed laser intensity stabilizer uses an extraordinarily fast electronic servo-system to sense fluctuations in the laser's intensity and rapidly change the transmission coefficient of an active element to compensate. The result is a beam of laser light that contains far less broadband noise than before and allows more accurate calibration of power levels, more sensitive spectroscopy, and elimination of lengthy experimental runs to check for power-level drift.

Most users of lasers require some degree of stability in power output. Such uses as precision measurements, laser spectroscopy, and calibration of power meters and transfer standards require stability (freedom from noise at high and low frequencies) far in excess of that available from most lasers without the intervention of the operator. The new device allows the operator to simply set the power level and then concentrate on the measurement, rather than have to constantly adjust the power output manually.

<sup>15</sup> John Lewis Hall, Laboratory Astrophysics Division (JILA), was awarded the Department of Commerce Gold Medal for Exceptional Service on Oct. 14, 1969. He was recognized

for research on laser technology, with emphasis on stabilization of lasers for ultimate use as tools in length measurements and in the study of the structure of atoms and molecules.

### 3. Sensitive seismometer housed in abandoned gold mine

One of the World's most sensitive earth-movement detectors, developed and operated by members of the Quantum Electronics Division and JILA, was housed in the abandoned tunnel of an old gold mine in the mountains near Boulder, Colo. [33].

The mine, known as the Poorman's Mine, was opened by a prospector in 1878 but was abandoned in 1953 when the costs of mining exceeded returns. The tunnel was reopened by NBS about 1961 for studies on the speed of light because that experiment required a quiet, stable environment.



*A laser interferometer, 30 m long, in the Poorman's Mine (an abandoned gold mine in the mountains west of Boulder) served as a laser-seismograph to measure vibrations in the Earth's crust.*

The instrument detected infinitesimal vibrations in the Earth's crust using a 30-m (100-foot) laser interferometer. It was capable of detecting vibrations in the Earth as small as  $5 \times 10^{-13}$  m in amplitude (equivalent to 20 trillionths of an inch). The instrument measured these changes at frequencies ranging from 100 Hz down to one cycle per year.

The high sensitivity of the device was due to the highly stable laser beam transmitted through the unusually long interferometer built especially for use in the mine. The wavelength of light used was in the near-infrared portion of the spectrum and is not visible to the eye. The ends of the interferometer were mirrors anchored to the solid rock of the mine floor by piers. As the rock moved slightly in response to Earth tremors or the passage of the Moon and Sun overhead, the mirrors also moved, causing the light's self-interference to vary. The variation was then detected with light-sensitive crystals, which convert infrared light to electrical currents for amplification and recording. Two independent helium-neon lasers were operated simultaneously; one to sense the variation in length of the interferometer, and the second to serve as a standard of frequency/wavelength for comparison with the first.

The interferometer was an adaptation of the Fabry-Perot interferometer. Its main characteristic was that the intensity of infrared laser light transmitted through its partially transmitting mirrors and emerging from the other end was a periodic function of the distance between the mirrors; maximum intensity was obtained whenever the mirrors were separated by an integral number of half-wavelengths. If the mirror separation varied with time, as when the mirrors were moved by vibrations in the Earth's crust, then the intensity would vary.

A photodiode sensed this variation in intensity and drove a servomechanism which tuned the laser's frequency enough to bring the intensity back to maximum. Thus, the laser's frequency variations were made to "track" the interferometer's length variations.

Frequency variations in the interferometer-laser were measured by comparing the output with another laser whose frequency was highly stable. This stabilization was accomplished by locking the second laser's output to the constant frequency of a saturated absorption line in methane gas. Frequency fluctuations in this stabilized laser amount to less than a few parts in  $10^{12}$ , though this was not the ultimate stability one could expect from this type of device. Sensitive enough to detect vibrations in the Earth that change the interferometer spacing by only a few parts in  $10^{12}$ , the system was also fast enough to record such changes at frequencies up to 50 Hz, while retaining the stability to measure vibrations at frequencies of less than one cycle per year.

Laser-seismograph development opens new areas of research in the fields of seismology and geophysics. One field of investigation concerns the long-term buildup of strain in the subterranean rocks. If the strain, or deformation, in a particular area accumulates to the point where it exceeds the elastic limit of the crustal material, an earthquake may be generated when the crust ruptures or slips to relieve the strain. Thus, monitoring of the strain buildup as a function of time may provide some indication of where an earthquake might be imminent.

#### 4. Laser electron paramagnetic resonance

Electron paramagnetic resonance between two levels of ground state oxygen ( $N=3$ ,  $J=4$ ,  $M=-4$ , and  $N=5$ ,  $J=5$ ,  $M=-4$ ) was found to equal the HCN laser frequency of 890 GHz in a magnetic field of about 16.4 kG. A group consisting of Kenneth M. Evenson, Joseph S. Wells, Herbert P. Broida, and Robert J. Mahler of the Quantum Electronics Division and Masataka Mizushima of the University of Colorado made the first paramagnetic resonance absorption between these levels and the first laser electron paramagnetic resonance (LEPR) absorption in a gaseous sample. The observations were made utilizing a specially constructed LEPR spectrometer [34].

The technique of the measurement involved focusing of the beam of an HCN laser on a small hole (0.75 mm) in the mirror of a Fabry-Perot interferometer. The interferometer was centered in a uniform external magnetic field. The radiation was monitored by a Golay cell through a 0.75-mm hole in the opposite side of the interferometer. Conventional field modulation and phase-sensitive detection apparatus completed the spectrometer.

A few torr of oxygen gas was placed in the interferometer and the magnetic field was swept. Any absorption of energy by the oxygen gas was then detected by the Golay cell.

As the program progressed, Wells and Evenson introduced an improvement by making the oxygen absorption cell an integral part of the laser [34].

#### 5. Laser power and energy measurements

The field of laser power and energy measurements presented a wide variety of relatively new problems. Among the staff involved in design and construction, as well as testing and calibration of measuring devices, were Jennings and Evenson of the Quantum Electronics Section, and Estal D. West, Alvin L. Rasmussen, William E. Case, Leonard B. Schmidt, and William R. Simmons of the Laser Measurement Technology Section [35].<sup>16</sup> Measurements were required for wavelengths from 400 nm to 30  $\mu\text{m}$ , for power levels from

<sup>16</sup> Donald A. Jennings was awarded the Department of Commerce Gold Medal for Exceptional Service on Oct. 21, 1970. Jennings was recognized

for contributions in quantum electronics and in the development of absolute laser power and energy standards and measurement techniques.

$10^{-6}$  to  $10^{12}$  watts (peak pulsed power), for energies from  $10^{-3}$  to  $10^3$  joules, and for operating conditions ranging from single pulses through repetitive pulses to continuous wave.

Measuring devices which were relatively insensitive to wavelength were desirable because the greater the useful range, the fewer the devices which are needed. Calorimeters, which convert radiant energy to heat and measure the quantity of heat, offered a great advantage because they could be designed to operate over a large range of wavelengths [35].

The large ranges of power and energy to be measured required a considerable number of devices because the range of any one device is relatively limited. Large power levels presented a special problem because of possible damage to the measuring device. Damage apparently results not only from thermal effects but also from the large electrical fields due to the coherence of the radiation.

Operating conditions also affect the measurement. Single pulses usually require an energy measurement. The output of cw and most repetitively pulsed lasers can be measured either continuously as power or as energy by letting the beam into the calorimeter for a known time.

## SPEED OF LIGHT BY LASER

### 1. Speed of light

A new value for the speed of light, announced in 1972, was determined from direct frequency and wavelength measurements of a methane-stabilized helium-neon (He-Ne) laser at  $3.39 \mu\text{m}$  (88 THz) [36]. These measurements were made against the respective primary standards—the NBS cesium beam frequency standard and the krypton length standard.

The frequency measurements were made by Evenson, Wells, F. Russell Peterson, Bruce L. Danielson, and Gordon W. Day of the Quantum Electronics Division. The wavelength measurements were made at JILA by Richard L. Barger of the Quantum Electronics Division and Hall of the Joint Institute for Laboratory Astrophysics (JILA).<sup>17</sup>

Multiplying the values of frequency and wavelength gave a value for the speed of light,  $299\,792\,456.2(1.1)$  m/s, in good agreement with and about 100 times less uncertain than the previously accepted value. The uncertainty of this measurement of the speed of light was 4 parts in  $10^9$ , judged by the Consultative Committee for Definition of the Meter (CCOM) of the International Committee for Weights and Measures (CIPM). See reference [42]. The main limitation was asymmetry in the krypton line defining the meter.

#### a) FREQUENCY MEASUREMENTS

Evenson had scored a breakthrough in laser frequency measurements in 1969 when he and coworkers (Wells, Lawrence M. Matarrese, and Lyman B. Elwell) made the “highest frequency measurements as yet reported” [37].<sup>18,19</sup> A water-vapor laser was used. A few

---

<sup>17</sup> A Group Department of Commerce Gold Medal Award for Exceptional Service was presented to Richard L. Barger, Bruce L. Danielson, Gordon W. Day, Kenneth M. Evenson, John L. Hall, F. Russell Peterson, and Joseph S. Wells on Oct. 30, 1974. They were recognized

for contribution to the wavelength and frequency measurement of the methane stabilized HeNe laser resulting in 30 times more accurate determination of the speed of light having an impact on international standards.

<sup>18</sup> In describing the importance of Evenson's achievement, Lewis M. Branscomb, Director of the National Bureau of Standards, said:

Ever since Albert Einstein showed that time can be considered the fourth dimension of the space in which we live, scientists have looked forward to the possibility of using one gage—one “yardstick” so to speak—not only for the three dimensions of space but for the fourth dimension of time as well. To interchange clocks and rulers scientists must know the speed with which light travels, which is equal to its wavelength times its frequency. With this demonstration that both the space (wavelength) and time (frequency) dimensions of a single light source can be measured with prodigious accuracy, this goal is now within our grasp.

<sup>19</sup> Kenneth M. Evenson was awarded the Department of Commerce Silver Medal for Meritorious Service on Oct. 28, 1971. Evenson was recognized

for contributions in infrared frequency measurements and infrared molecular spectroscopy.



months later, absolute frequency measurements were extended to still higher values (again reported as "highest cw frequency measurements as yet reported"), using the CO<sub>2</sub> laser [38]. These measurements led in turn to the He-Ne laser cited in ref. [36] above [39].

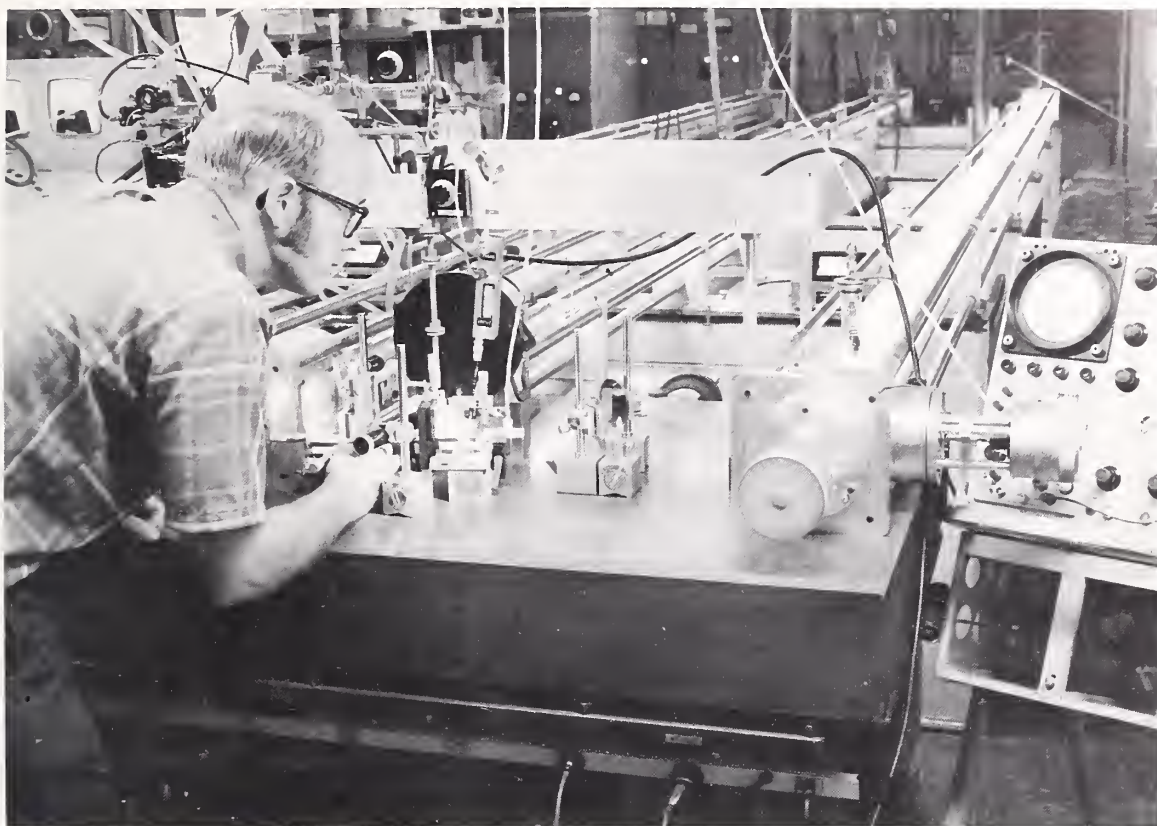

*Laser research at NBS Boulder has improved the determination of the speed of light by 100-fold. Kenneth M. Evenson is adjusting lasers used in the project.*



*Laser used in the speed-of-light determination.*

Measuring the frequency was done in steps. With suitable point-contact mixer diodes (tungsten-nickel point-contact "catwhisker" diodes), a chain of stabilized lasers and klystron frequency sources allowed direct harmonic generation and frequency mixing from the NBS cesium beam frequency standard upward to the carbon dioxide (CO<sub>2</sub>) laser at 29 THz (10.3 μm) and thence upward to the methane-stabilized laser at 88 THz (3.39 μm). Five different types of lasers and five klystrons were used in the three-step measurement process.

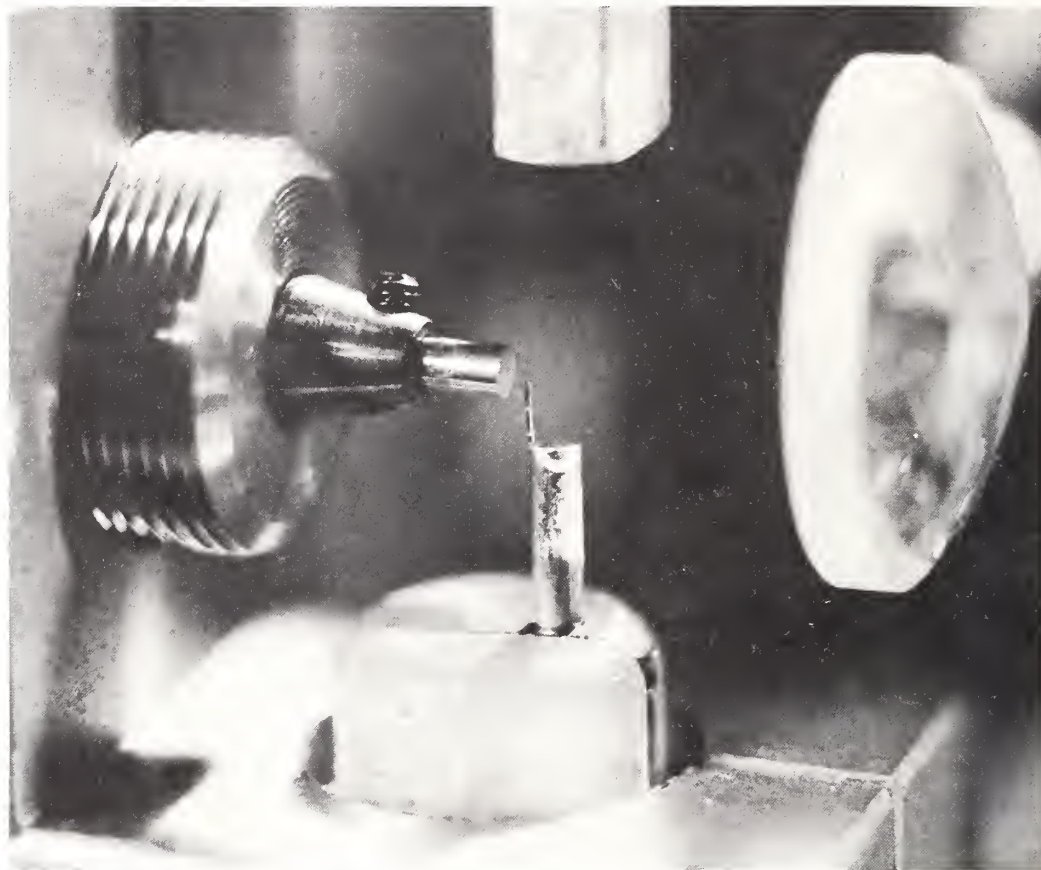

*A tungsten-nickel ("catwhisker") diode serves as a harmonic generator and mixer in the three-step measurement of frequencies. The diode multiplies lower known frequencies to higher unknown frequencies.*

A low-frequency infrared hydrogen-cyanide (HCN) laser was compared with the cesium frequency standard. Harmonics of that laser were then compared to a water-vapor (H<sub>2</sub>O) laser of higher frequency, and harmonics of the H<sub>2</sub>O laser to a still higher-frequency carbon-dioxide (CO<sub>2</sub>) laser. One of the CO<sub>2</sub> laser lines was measured and compared to the helium-neon (He-Ne) laser, which was locked to the methane-absorption line (88.38 THz). Thus, the higher frequency was measured in terms of known lower frequencies, and the chain of measurements was extended to higher and higher frequencies.

#### **b) WAVELENGTH MEASUREMENT**

The wavelength measurement consisted of an interferometric comparison of the methane-stabilized He-Ne laser and the krypton (86 Kr) lamp, the International Standard of Length.

After the 86 Kr transition at 6057 Å was adopted as the International Standard of Length in 1960, it was discovered that this line is slightly asymmetric. Because of the intrinsic asymmetry of the krypton standard line (which is very small), it is necessary to specify the point on the line profile to which the defined wavelength is applied. Barger and Hall found that it simplified presentation of their numerical result to adopt the arbitrary convention that the defined wavelength be applied to the center of gravity of the krypton line.

### c) NEW STANDARDS ENVISIONED

The relationship "wavelength times frequency = speed of light ( $c$ )" puts equal emphasis on the measurement accuracy of both components. As the frequency measurement is about 10 times more accurate than the wavelength measurement, it seems desirable to improve the length standard, either by replacing it with a stabilized laser or defining the value of  $c$ . The first would permit more accurate determinations of  $c$ . The second alternative, defining  $c$ , would enable an experimentalist to use a frequency standard to accurately establish the length of the meter. The combined frequency-length standard would suffice for both kinds of measurement. Thus, it would be possible to eliminate the need for a separate length standard.

### d) INTERNATIONAL RECOGNITION

The value for "speed of light" determined by the NBS Boulder group, 299, 792, 458 (1.2) m/s, was included in the report of the Task Group on Fundamental Constants, Committee on Data for Science and Technology (CODATA), International Council of Scientific Unions, and adopted by CODATA on August 10, 1973.<sup>20</sup> This Task Group report was published in the *J. Phys. Chem. Ref. Data* and the full CODATA report in *CODATA Bulletin No. 11* (Dec. 1973).<sup>21</sup> A summary was given in *NBS Dimensions* (Jan. 1974) [40,41,42].

Quoting from *Dimensions*:

The "1973 adjustment" of the fundamental constants is the outcome of a review and analysis of all the experimental and theoretical data that bear on determination of their numerical values. In the case of the speed of light, all older determinations were discarded in favor of the recent measurements using lasers, whose uncertainty is smaller by a factor of about 75. The analysis also took into account the uncertainties in the standards of measurement as maintained by various national laboratories.

At almost the same time (Oct. 1973) another international committee, the Consultative Committee for the Definition of the Meter (CCDM), recommended consideration of two wavelengths generated by lasers to the International Committee of Weights and Measures [43]. One of these was the wavelength of the helium-neon laser stabilized by methane as developed by the NBS Boulder group; the other, the wavelength of a helium-neon laser stabilized by locking to absorption lines of iodine-129, developed by a group at NBS Gaithersburg. The CCDM also recommended the value of the speed of light as determined by the Boulder group.

The 15th General Conference on Weights and Measures, meeting in Paris May 27-June 3, 1975, adopted two resolutions pertaining to wavelengths as standards. The first gave official recognition to the successful efforts to develop gas lasers whose wavelengths are stabilized to an absorption line. The Conference decided, however, in the second resolution, that to redefine the meter in terms of lasers that were then available would be premature because there was a good chance that further research would soon produce even better lasers for the purpose.

---

<sup>20</sup> The Task Group on Fundamental Constants, E. Richard Cohen (Rockwell International) and Barry N. Taylor (NBS Institute of Basic Standards, Gaithersburg), made a critical survey and evaluation of the "fundamental constants" and determined "best values" of the constants on the basis of accumulated experimental data. Financial support was shared among Rockwell International, the NBS Institute for Basic Standards, and the NBS Office of Standard Reference Data.

<sup>21</sup> The report as published in *CODATA Bulletin No. 11* states, in summary:

For the great bulk of physical and chemical data, whose consistency of usage and traceability are perhaps as important as accuracy (and with the recognition that absolute accuracy is a prize that will always elude our grasp), these values should serve as a standard reference set for the next several years.

## LUNAR RANGING EXPERIMENT (LURE)

### 1. Procedure

Lunar ranging involves measuring the distance between points on the Earth and the Moon by timing the roundtrip journey of a pulse of light returned to Earth by retroreflectors on the Moon. This distance has been measured with extreme accuracy, using a pulse of laser light, by a team of scientists from the National Bureau of Standards (JILA); Princeton University; the Universities of Texas, California, Hawaii, and Maryland; the National Aeronautics and Space Administration (NASA); and the Jet Propulsion Laboratory (JPL) of the California Institute of Technology. The name of the group was the Lunar Ranging Experiment (LURE). James E. Faller of JILA was chairman of the team and Peter L. Bender, also of JILA, was a member.

For the experiment, retroreflectors (mirrors) of a special kind were placed at different sites on the Moon's face by the astronauts of Apollo 11, Apollo 14, and Apollo 15. These retroreflectors serve to return the light from a laser beam precisely on its own path back to Earth. The retroreflectors are not flat like ordinary mirrors, but consist of an array of one hundred to three hundred corner reflectors mounted in frames.

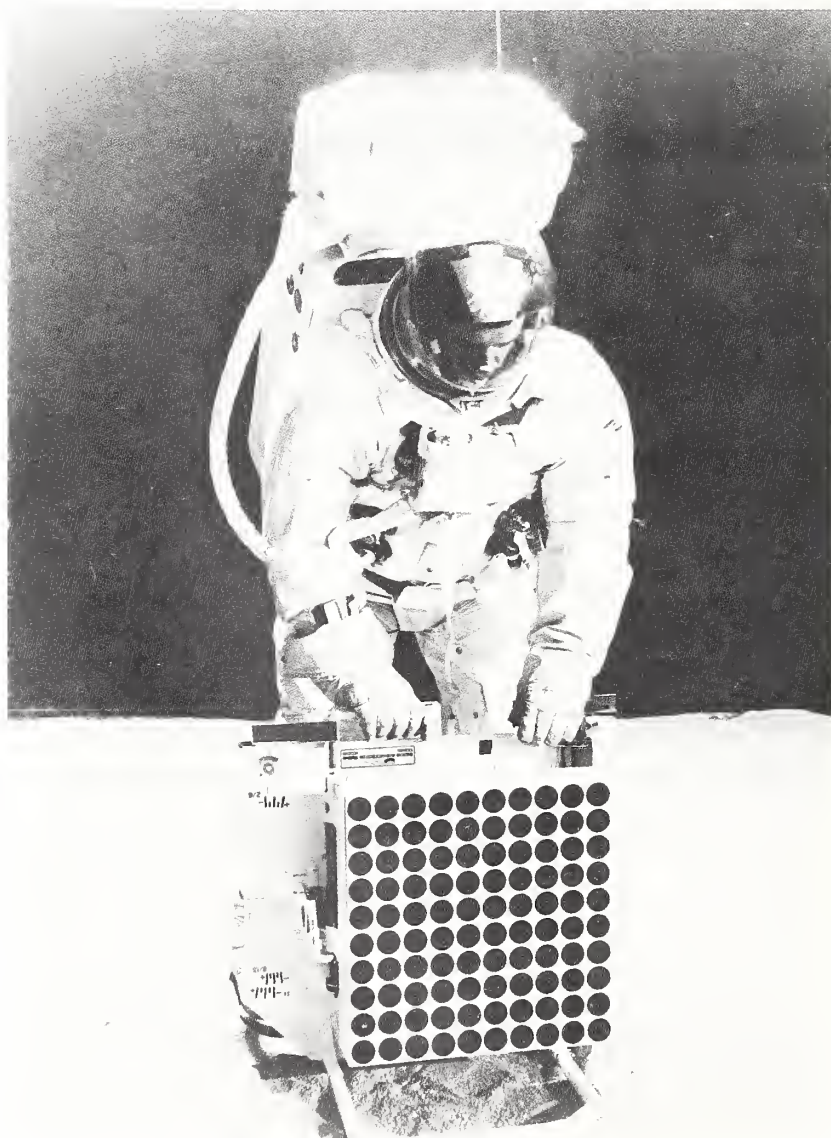

*Retroreflectors were placed on the Moon by the astronauts of Apollo 11, Apollo 14, and Apollo 15. They consist of 100 (as shown) to 300 corner reflectors mounted in a frame and serve to reflect a beam of laser light back to Earth precisely on its own path.*

The laser beam, generated by a high-powered ruby laser, is directed at the retroreflector array by a large telescope and arrives at the Moon in about 1.25 seconds. When it reaches the Moon, astronomical "seeing" of the beam has a diameter in the range of 3 to 6 km. It is then reflected toward the sending telescope by the reflector array. By the time it returns to Earth, it has spread to a diameter of more than 15 km. Because the reflector and telescope, respectively, intercept only a small portion of the beam, the light received by the telescope is only a very small portion of the original laser pulse (one part in a billion billion).

A clock, capable of measuring the elapsed time to a billionth of a second, starts to run at the instant the pulse leaves and is stopped electronically when the pulse returns. The pulses are sent once every 3 seconds of a 10-minute period, in order to get enough data to be statistically significant. By averaging many pulses, more accurate results can be obtained.

Initial measurements were made at the Lick Observatory, Mt. Hamilton, Calif., until facilities for a long-term program were set up at the McDonald Observatory, Ft. Davis, Texas. McDonald was responsible for almost all of the data obtained during the first 8 years of the LURE program, or until a telescope, designed specifically for the program, was placed in operation.

When the Lunar Ranging Experiment began in 1969, Faller was professor of physics at Wesleyan University, Middletown, Conn. He moved to JILA in 1972 where he continued work which he had started at Wesleyan.

## 2. The lunar telescope

One of Faller's projects was a telescope of special design for receiving the light reflected back to the Earth by one of the retroreflectors on the Moon. At Wesleyan a senior student had worked with Faller in designing a telescope that would take maximum advantage of the lunar retroreflectors.<sup>22</sup> The student worked over the summer in a basement workshop and developed a mockup of such a telescope, which he submitted as a senior (honors) thesis.

Construction of the telescope began at Wesleyan, with the assistance of the director of the University's physics machine shop. However, when Faller transferred to JILA, he brought with him the unfinished "bits and pieces" of his new telescope. With the aid of the machine shops at JILA, NBS Boulder, and the University of Colorado, the telescope was completed and assembled in the JILA building on the University campus.<sup>23,24</sup>

The design of the LURE telescope is quite different from that of the traditional astronomical telescopes which must accommodate a broad range of astronomical activities and, as a result, are massive and quite expensive.

The LURE telescope is designed specifically for lunar ranging, that is, to look effectively at a point source which requires a large aperture but only a narrow field of view. Instead of having one large optical element, it has an array of 80 elements (lenses), each 19

---

<sup>22</sup> The student was Michael P. Sulzer, the son of Peter Sulzer, a former employee of the Central Radio Propagation Laboratory at NBS Washington. Peter Sulzer was a member of the Ionospheric Research Section which remained temporarily in Washington when CRPL moved to Boulder. (See app. C, p. 763, footnote 37). He resigned before the group moved to Boulder. Michael did not come to JILA with Faller, his professor, and was never employed by NBS.

<sup>23</sup> Funds and/or other support for completing the telescope came from NASA, Wesleyan University, the Alfred P. Sloan Foundation (Faller was a Sloan Fellow in 1972), and NBS.

<sup>24</sup> The telescope was assembled in a large room on the first floor of the JILA building. The original intention was to remove the front, back, and end plates from the telescope in order to get it out of the JILA building, but the internal workings became too complex and it had to be moved as a single unit. Faller explained that the 2.5-metric-ton telescope just barely squeezed through the JILA doors and hallways with the assistance of professional movers. It was driven to San Francisco in 1976, placed aboard a freighter for Honolulu, taken by barge to the Island of Maui, and finally trucked to its observatory site on Mt. Haleakala.

cm in diameter.<sup>25</sup> (The lens arrangement resembles, biologically speaking, the eye of a fly; it has therefore acquired the nickname "fly's eye telescope." [44])

### 3. The Hawaiian Observatory

A site in Hawaii, the summit of Mt. Haleakala (3000 m) on the Island of Maui, was selected as the location of an observatory to house the telescope.<sup>26</sup> Hawaii was chosen for several reasons. At the time, the McDonald Observatory in Texas was the only station regularly obtaining range measurements from the lunar retroreflectors. A second station at another location was desirable in order to increase the amount and type of data and to improve the accuracy of the scientific results by permitting the analysis to take full advantage of the ranging accuracy (2 to 6 cm).

Hawaii was considered because, among other reasons, it is on the Pacific tectonic plate rather than the continental U.S. plate. If one or both plates are moving, this could be determined from differences in the ranging data obtained at the two stations.

Faller said that the purpose of the LURE program is to provide better data on the relative motions of the Earth and Moon. The information can then be used to study continental drift, to measure the wanderings of the Earth, and to determine the mass distribution of the Moon.

---

<sup>25</sup> The telescope contains an array of 80 lenses, each 19 cm in diameter. At the back is a matching array of 0.13 mm pinholes (which limits the angular field of view to no more than 11 sec of arc) and a system of mirrors that directs the 80 beams through a common focus. The resultant beam is then split and detected by 2 photomultiplier tubes. The output of each tube goes to a dual-channel multievent timer. (A variable pinhole at the common focus can reduce the angular field to as little as 3 sec of arc.) This minimum field covers an area on the Moon about 6 km in diameter.

Successful operation of the telescope depends on the various apertures remaining aligned when the telescope points to different parts of the sky. To ensure this, the front and back plates are solidly connected together by the side panels and the framework to which these attach. The telescope's construction and light weight give it great rigidity as it lifts and turns to intercept and follow the Moon.

The telescope has so little flexure that aiming it by visual setting is not necessary—it should point to within a few seconds of arc of the direction to which it is set. Lunar ephemeris data have a comparable uncertainty. Thus, when performing up to the specifications of all its components, the telescope has within its field the lunar ephemeris coordinates entered on the elevation and azimuth controls.

The capability for "blind" pointing makes possible fully automated operation. Through shaft encoders on the telescope's elevation and azimuth axes, a computer continuously aims the telescope. The same computer checks the range electronics, records and stores the data, and corrects the preprogrammed angle ephemeris for possible flexure and encoder zero error. Running the telescope by computer eliminates operator-related expenses, and results in a considerable saving over the lunar ranging program's expected 10-year lifetime.

<sup>26</sup> The laser transmitter was constructed by the University of Hawaii, and the University of Maryland provided the electronics work.

## REFERENCES

- [1] Harold Lyons, L. J. Rueger, R. G. Nuckolls, and M. Kessler, "Microwave spectra of deuterio-ammonias," *Phys. Rev.* (Letter to the Editor), Vol. 81, No. 4, Feb. 15, 1951, pp. 630-631.
- [2] L. J. Rueger, Harold Lyons, and R. G. Nuckolls, "A high-temperature, broad-band Stark cell for microwave spectroscopy," *Rev. Sci. Instr.* (Laboratory and Shop Note), Vol. 22, No. 6, June 1951, p. 428.
- [3] L. J. Rueger and R. G. Nuckolls, "A broad-band coaxial Stark cell for microwave spectroscopy," *Rev. Sci. Instr.*, Vol. 23, No. 11, Nov. 1952, p. 635.
- [4] Paul Kisliuk and Charles H. Townes, "Molecular microwave spectra tables," *J. Res. Nat. Bur. Stand. (U.S.)*, Vol. 44, No. 6, June 1950, pp. 611-641.
- [5] Paul Kisliuk and Charles H. Townes, Molecular Microwave Spectra Tables, *Nat. Bur. Stand. (U.S.)*, *Circ. 518*, June 23, 1952, 127 + vi pages. See also "Molecular microwave spectra tables," *Tech. News Bull., Nat. Bur. Stand. (U.S.)*, Vol. 36, No. 3, Mar. 1952, pp. 44-45.
- [6] Paul F. Wacker, Masataka Mizushima, Jean D. Petersen, and Joe R. Ballard, Microwave Spectral Tables, Vol. I, Diatomic Molecules, *Nat. Bur. Stand. (U.S.) Monogr. 70, Vol. I*, Dec. 1, 1964, 144 pages.
- [7] Paul F. Wacker and Marlene R. Pratto, Microwave Spectral Tables, Vol. II, Line Strengths of Asymmetric Rotors, *Nat. Bur. Stand. (U.S.) Monogr. 70, Vol. II*, Dec. 15, 1964, 338 pages.
- [8] Paul F. Wacker, Marian S. Cord, Donald G. Burkhard, Jean D. Petersen, and Raymond F. Kukol, Microwave Spectral Tables, Vol. III, Polyatomic Molecules With Internal Rotation, *Nat. Bur. Stand. (U.S.) Monogr. 70, Vol. III*, June 1969, 265 pages.
- [9] Marian S. Cord, Jean D. Petersen, Matthew S. Lojko, and Rudolph H. Haas, Microwave Spectral Tables, Vol. IV, Polyatomic Molecules Without Internal Rotation, *Nat. Bur. Stand. (U.S.) Monogr. 70, Vol. IV*, Oct. 1968, 418 pages.
- [10] Marian S. Cord, Matthew J. Lojko, and Jean D. Petersen, Microwave Spectral Tables, Vol. V, Spectral Line Listing, *Nat. Bur. Stand. (U.S.) Monogr. 70, Vol. V*, June 1968, 533 pages.
- [11] John M. Richardson, "Experimental evaluation of the oxygen microwave absorption as a possible atomic frequency standard," *J. Appl. Phys.*, Vol. 29, No. 2, Feb. 1958, pp. 137-145.
- [12] W. Culshaw, J. M. Richardson, and D. M. Kerns, "Precision millimeter wave interferometry at the U.S. National Bureau of Standards," *Proc. Symp. on Interferometry, National Physical Laboratory, Teddington, Middlesex, England*, June 9-11, 1959, pp. 330-349. Also *Nat. Bur. Stand. (U.S.) Handbook 77*, Paper 4-3, "Precision Measurement and Calibration," Vol. 1, Feb. 1, 1961, pp. 756-775.
- [13] W. Culshaw, "Reflectors for a microwave Fabry-Perot interferometer," *IRE Trans. MTT*, Vol. 7, No. 2, Apr. 1959, pp. 221-228.
- [14] William Culshaw, "High resolution millimeter wave Fabry-Perot interferometer," *IRE Trans. MTT*, Vol. 8, No. 2, Mar. 1960, pp. 182-189.
- [15] D. M. Kerns and E. S. Dayhoff, "Theory of diffraction in microwave interferometry," *J. Res. Nat. Bur. Stand. (U.S.)*, Vol. 64B, No. 1, Jan.-Mar. 1960, pp. 1-13.
- [16] For continuity of subject matter, this sequential series of four related reports by the same authors is being listed as a single reference. John T. Jefferies and Richard N. Thomas, "Source function in a non-equilibrium atmosphere. II Depth dependence of source function for resonance and strong subordinate lines," *Astrophys. J.* Vol. 127, No. 3, May 1958, pp. 667-675.  
 John T. Jefferies and Richard N. Thomas, "Source function in a non-equilibrium atmosphere. III The influence of a chromosphere," *Astrophys. J.*, Vol. 129, No. 2, Mar. 1959, pp. 401-407.  
 Richard N. Thomas, "The source function in a non-equilibrium atmosphere. IV Evaluation and application of the net radiative bracket," *Astrophys. J.*, Vol. 131, No. 2, Mar. 1960, pp. 429-437.  
 J. T. Jefferies and R. N. Thomas, "The source function in a non-equilibrium atmosphere. V. Character of the self-reversed emission cores of Ca<sup>+</sup> H and K," *Astrophys. J.*, Vol. 131, No. 3, May 1960, pp. 695-704.
- [17] Anne B. Underhill and J. H. Waddell III, Stark Broadening Functions for the Hydrogen Lines, *Nat. Bur. Stand. (U.S.) Circ. 603*, May 1, 1959, 94 pages.  
 Author's (CLB) Note: This was the last (and highest numbered) *NBS Circular* issued. The series began with *Circ. 1* in 1925, and was discontinued July 1, 1959. *Circulars* were superseded by *NBS Monographs*, which are usually contributions to the technical literature too lengthy for publication in the *Journal of Research*. They often provide extensive compilations of information on subjects related to the Bureau's technical program.
- [18] Stuart R. Pottasch, "The extent of H II regions," *Astrophys. J.* (Note), Vol. 132, No. 1, July 1960, pp. 269-271.
- [19] S. N. Milford, "Approximate cross-sections for inelastic collisions of electrons with atoms, I Allowed transitions," *Astrophys. J.*, Vol. 131, No. 2, Mar. 1960, pp. 407-412.
- [20] R. N. Thomas (editor), Aerodynamic Phenomena In Stellar Atmospheres—A Bibliography, *Nat. Bur. Stand. (U.S.) Tech. Note 30*, Sept. 1959, 89 pages.
- [21] Richard N. Thomas and R. Grant Athay, *Physics of the Solar Chromosphere*, Interscience Publishers, Inc., 250 Fifth Ave., New York, N.Y., 1961.
- [22] R. M. Gallet, J. M. Richardson, B. Wieder, and G. D. Ward and G. N. Harding (Atomic Energy Research Establishment, Harwell, England), "Microwave whistler mode propagation in a dense laboratory plasma," *Phys. Rev. Letters*, Vol. 4, No. 7, Apr. 1, 1960, pp. 347-349.
- [23] Bernard Wieder, "Microwave propagation in an overdense bounded magnetoplasma," *Phys. Fluids*, Vol. 7, No. 7, July 1964, pp. 964-972.
- [24] D. L. Jones and K. B. Earnshaw, A Wire Exploder for Generating Cylindrical Shock Waves in a Controlled Atmosphere, *Nat. Bur. Stand. (U.S.) Tech. Note 148*, May 1962, 6 pages.

- [25] Donald L. Jones, "Precursor electrons ahead of cylindrical shockwaves," *Phys. Fluids*, Vol. 5, No. 9, Sept. 1962, pp. 1121-1122.
- [26] Donald L. Jones and Roger M. Gallet, "Microwave Doppler measurements of the ionization front in cylindrical shock waves from exploding wires," *Exploding Wires*, Vol. 2, pp. 127-144, Plenum Press, N.Y., 1962.
- [27] Y. Nakagawa and K. B. Earnshaw, "Experiments on self-ionizing shock waves in a magnetic field," *Proc. Vith International Conference on Ionization Phenomena in Gases*, Paris, 1963. S.E.R.M.A., Paris, Vol. IV, 1963, pp. 303-309.
- [28] Yolande Boublil and Kenneth B. Earnshaw, "Propagation of a reflected shock wave in a transverse magnetic field," *Phys. Fluids*, Vol. 7, No. 6, June 1964, pp. 876-881.
- [29] Kenneth B. Earnshaw and Charles M. Benedict, "An ultra-high-speed image dissecting camera for photographing strong shock waves," *J. Res. Nat. Bur. Stand. (U.S.)*, Vol. 66C, No. 4, Oct.-Dec. 1962, pp. 297-311.
- [30] Karl-Birger Persson, "Brush cathode plasma—A well-behaved plasma," *J. Appl. Phys.* Vol. 36, No. 10, Oct. 1965, pp. 3086-3094.
- [31] P. O. Taylor, D. Gregory, G. H. Dunn, R. A. Phaneuf, and D. H. Crandall, "Absolute cross sections for 2s-2p excitation of  $C^{3+}$  by electron impact," *Phys. Rev. Letters*, Vol. 39, No. 20, 14 Nov. 1977, pp. 1256-1259.
- [32] "The I-R 100 for 1975," *Industrial Research*, Vol. 17, No. 10, Oct. 1975, pp. 65-66.
- [33] J. Levine and J. L. Hall, "Design and operation of a methane absorption stabilized laser strainmeter," *J. Geophys. Res.*, Vol. 77, No. 14, May 1972, pp. 2595-2609.
- [34] K. M. Evenson, H. P. Broida, J. S. Wells, R. J. Mahler, and M. Mizushima, "Electron paramagnetic resonance absorption in oxygen with the HCN laser," *Phys. Rev. Letters*, Vol. 21, No. 15, 7 Oct. 1968, pp. 1038-1040.
- See also J. S. Wells and K. M. Evenson, "A new LEPR spectrometer," *Rev. Sci. Instr.*, Vol. 41, No. 2, Feb. 1970, pp. 226-227.
- [35] D. A. Jennings, "Calorimetric measurement of pulsed laser output energy," *IEEE Trans. Inst. Meas.*, Vol. IM-15, No. 4, Dec. 1966, pp. 161-164.
- D. A. Jennings, E. D. West, K. M. Evenson, A. L. Rasmussen, and W. R. Simmons, Laser Power and Energy Measurements, *Nat. Bur. Stand. (U.S.) Tech. Note 382*, Oct. 1969, 64 pages.
- E. D. West, W. E. Case, A. L. Rasmussen, and L. B. Schmidt, "A reference calorimeter for laser energy measurements," *J. Res. Nat. Bur. Stand. (U.S.)* Vol. 76A, No. 1, Jan.-Feb. 1972, pp. 13-25.
- [36] K. M. Evenson, J. S. Wells, F. R. Petersen, B. L. Danielson, G. W. Day, R. L. Barger, and J. L. Hall, "Speed of light from direct frequency and wavelength measurements of the methane-stabilized laser," *Phys. Rev. Letters*, Vol. 29, No. 19, 6 Nov. 1972, pp. 1346-1349.
- [37] K. M. Evenson, J. S. Wells, L. M. Matarrese, and L. B. Elwell, "Absolute frequency measurements of the 28- and 78- $\mu\text{m}$  cw water vapor laser lines," *Appl. Phys. Letters*, Vol. 16, No. 4, 15 Feb. 1970, pp. 159-162.
- [38] K. M. Evenson, J. S. Wells, and L. M. Matarrese, "Absolute frequency measurements of the  $\text{CO}_2$  cw laser at 28 THz (10.6  $\mu\text{m}$ )," *Appl. Phys. Letters*, Vol. 16, No. 6, 15 Mar. 1970, pp. 251-253.
- [39] K. M. Evenson, G. W. Day, J. S. Wells, and L. O. Mullen, "Extension of absolute frequency measurements to the cw He-Ne laser at 88 THz (3.39  $\mu\text{m}$ )," *Appl. Phys. Letters*, Vol. 20, No. 3, 1 Feb. 1972, pp. 133-134.
- [40] "Specifications of the physical world," *Nat. Bur. Stand. (U.S.) Dimensions*, Vol. 58, No. 1, Jan. 1974, pp. 3-6, 15.
- [41] *CODATA Bulletin No. 11*, Dec. 1973.
- [42] E. Richard Cohen and B. N. Taylor, "The 1973 least-squares adjustment of the fundamental constants," *J. Phys. Chem. Ref. Data*, Vol. 2, No. 4, 1973, pp. 663-734.
- [43] "World Conference updates vocabulary of measurement science," *Nat. Bur. Stand. (U.S.) Dimensions*, Vol. 59, No. 10, Oct. 1975, pp. 225-227.
- [44] "The fly's eye telescope," *Nat. Bur. Stand. (U.S.) Dimensions*, Vol. 62, No. 4, Apr. 1978, pp. 2-7.



## Chapter XVI

### IN A CONSULTANT CAPACITY

#### IN THE SERVICE OF THE GOVERNMENT

Although advisory services by the National Bureau of Standards to Government agencies were not specifically stated in basic legislation by Congress until 1950, the Bureau, from the beginning in 1901, offered its expertise to the Federal Government.<sup>1</sup> By 1911 Rosa, chief of the Electricity Division, increasingly became aware of the rapidly expanding technology of wireless telegraphy and of the problems being faced by the Bureau of Navigation of the Department of Commerce (until March 1913, the Department of Commerce and Labor).

Responsibility of enforcing radio regulations fell to the lot of the radio inspectors of the Bureau of Navigation (Radio Service Division) and, in turn, this Bureau called upon the Bureau of Standards for technical assistance.<sup>2</sup> Thus, Kolster, an experienced radio engineer, was brought into the Electricity Division in December 1911 to meet up with the problems of wireless telegraphy facing the Bureau of Standards and the Bureau of Navigation. Little was it realized then, by the Electricity Division, that within another decade, beginning in 1921, the Department of Commerce would increasingly be faced with the much greater problems created by radio broadcasting.

#### 1. Service to the Department of Commerce

##### a) IN THE EARLY YEARS OF THE RADIO SECTION

Using Kolster's design of the direct-reading decimeter in 1912 (see ch. V, p. 104), the Bureau of Navigation had a group of the instruments manufactured under Kolster's guidance. The radio inspectors were now equipped with a combination decimeter and wavemeter of superior quality that would serve as a useful instrument in their hands until spark transmitters phased out in the 1920's (the Army and the Navy also equipped their communication facilities with these superior instruments of the Kolster design). In later years the Bureau of Navigation strengthened its technical capabilities and became less dependent upon the Radio Section.

As early as 1913 Kolster, and later others of the Radio Section, took leading roles in a program with the Bureau of Lighthouses of "radio fog signalling" that would continue for a decade. By 1920 the system was successfully demonstrated in the Lower New York Bay area whereby a ship could locate its position in a fog solely by direction finding with radio signals. The result was a successful method of promoting safety at sea and the development of the Kolster radio compass.

---

<sup>1</sup> See: Cochrane, appendix C, "Basic legislation relating to organization, functions, and activities of the National Bureau of Standards," *Measures for Progress*, p. 550, "Act of 22 July 1950, SEC. 2, (e) Advisory service to Government agencies on scientific and technical problems."

The Act of 3 March 1901, to establish the National Bureau of Standards (Cochrane, p. 541) did not specifically note the function of an advisory service to Government agencies.

<sup>2</sup> On July 1, 1911, the Radio Service (division) was established within the Bureau of Navigation in order to cope with the inspection of wireless transmitters and provide a degree of regulation to a fast developing communications field. In 1927 Radio Service was separated from the Bureau of Navigation to become the Radio Division whose chief was under the supervision of the Secretary of Commerce. On July 20, 1932, the division was abolished and its functions transferred to the Federal Radio Commission.

Also, beginning in 1913 and continuing for several years, the Radio Section assisted the Coast and Geodetic Survey in developing radio communication systems that were useful to the special requirements of this agency of the Department of Commerce.

#### **b) BROADCASTING THROTTLES THE DEPARTMENT OF COMMERCE**

The early development of wireless telegraphy in the United States is associated with the first decade of the present century during which period there was no Federal control to regulate the frequency and power of transmitters. Regulation began with the Act of August 13, 1912, that required operators of commercial stations to be licensed by the Secretary of Commerce and Labor, and required the stations to designate their operating wavelengths. Control of the regulation came within the dominion of the radio inspectors of the Radio Service (division) of the Bureau of Navigation.

Dramatically, on November 2, 1920, the Presidential election returns (Harding, Cox) were broadcast by Station KDKA, Pittsburgh, Pa. A listening public was created and for the next 6 years the Department of Commerce found itself enmeshed in the problems of station allocations. By November 1922, 2 years after the "pioneer" broadcast, 584 stations were on the air in the United States. Interference among the transmitters was creating serious problems and the situation continued to worsen without apparent remedy. The Bureau and the Radio Section became enmeshed with the technical problems that were generated.

To cope with the oncoming problems, Herbert Hoover, then Secretary of Commerce, called the Department of Commerce Conference on Radio Telephony (later known as the First National Radio Conference) at Washington, D.C. for February 27 and 28, 1922. The Bureau's director, Dr. Stratton, served as chairman of the Conference. (For more information on this and three successive conferences, see ch. IV, pp. 94-95.) The problems would not give way to helpful solutions and three more conferences were held, the last being on November 9, 10, and 11, 1925. Secretary Hoover addressed the 1925 Conference with considerable enthusiasm for the future of broadcasting. By 1925 the Radio Section was taking an active part in the technical remedial programs. Dellinger served on the General Allocations of Frequency Committee, and C. B. Jolliffe on the Interference Committee. Dellinger was active at all four conferences in preparing agenda and in the writing of reports.

But the Department's optimism for combating the problems was dimmed in July 1926 by the opinion rendered by the Attorney General that the regulatory powers of the Department had been exceeded in controlling the situation. As a result of the decision, the situation became more drastic—new stations crowded the frequency spectrum and increased transmitter power caused even greater interference. Finally, Congress reacted and on February 23, 1927, authorized the establishment of a new agency, the Federal Radio Commission, to exercise a more effective control of the broadcasting industry.

#### **c) CONTINUING TO SERVE THE DEPARTMENT OF COMMERCE**

By the mid-1920's both the Radio Section and the Department of Commerce increasingly were becoming involved in the aeronautics field; the Radio Section with a radio beacon navigational system, the Department with the many faceted problems of the aviation industry and of the airways. The Air Commerce Act led to the creation of the Aeronautics Branch in the Department of Commerce in July 1926. The research operation of the Radio Division of the Aeronautics Branch became a facility of the Bureau's Radio Section. Dellinger served as chief of this operation from 1926 until the development programs of the Aeronautics Branch were phased out in July 1934.

During the period of 1926-1934 Dellinger served on five Government-oriented committees that related to research in aeronautics, and particularly aeronautical radio, that included:

- U.S. Government Committee on Aircraft and Fog Flying Research
- U.S. Government Liaison Committee on Aeronautic Radio Research
- Department of Commerce Executive Committee on Aeronautic Radio
- Department of Commerce Special Committee on Air Transport Radio
- National Advisory Committee of Aeronautics, Subcommittee on Communications

## 2. Service to the Federal Radio Commission

With the establishment of the Federal Radio Commission in 1927, Dellinger was called upon to serve as its first chief engineer, taking a leave of absence of 4 months from the Bureau, beginning August 1, 1928.<sup>3</sup> His services to the Engineering Division of the Commission extended considerably beyond the period of his leave of absence. Among his tasks was reorganization of the Engineering Division. Accompanying Dellinger, and also on loan to the Commission, was Gerald C. Gross, a junior physicist in the Radio Section. Gross resigned from the Bureau and transferred to the Commission.<sup>4</sup>

In this new yet transient position Dellinger had the opportunity to put his expert knowledge and his experience to the advantage of a Government agency in helping to solve a communication problem of national and even international scope. By September 15, 6 weeks after Dellinger joined the Commission, he submitted a manuscript to the Institute of Radio Engineers for publication. Entitled "Analysis of broadcasting station allocation," the allocation plan was in accordance with the Commission's Order of September 7, 1928, and in compliance with the 1928 Amendment to the Radio Act (of 1910 and 1912) [1]. In brief, Dellinger evaluated the broadcasting situation in terms of the authorized allocation plan. Ninety channels in the frequency range of 550 to 1500 kHz were available for the United States. The Order provided for equalization of the number of stations among the zones and states; also, that no existing station should be abolished. Stations were classed in three categories of radiated power, with due consideration of reception in rural areas with substantially free heterodyne interference. Suffice to say, the new allocation became a workable plan and its basic principles remain in use today.

Within a year Dellinger again published a paper in the *Proc. IRE*, this time with the viewpoint of reasonable success with the allocation plan inaugurated in September 1928 [2].<sup>5</sup> His paper was one of six of a symposium on broadcasting.<sup>6</sup>

On March 1, 1930, Jolliffe transferred to the Federal Radio Commission, entering the position of chief engineer. He remained with the Commission as chief engineer until 1935 (then the Federal Communications Commission) when he joined the Radio Corporation of America, later to become vice president and technical director. On December 16, 1934, Kenneth A. Norton resigned from the Radio Section to join the Federal Communications Commission as a radio engineer assigned to the Technical Information Section. He remained

---

<sup>3</sup> Previously, in April, Dellinger had presided at a meeting of the Federal Radio Commission at which time a group of radio engineers submitted a plan of frequency allocation for broadcast stations. The matter was also the subject of a hearing before the Commission. Within a few months the allocation plan became effective.

<sup>4</sup> Gerald C. Gross entered the Radio Section on July 16, 1926, and resigned August 31, 1928, to join the Federal Radio Commission. He remained with the Commission until 1945, serving a portion of the 17 years as assistant chief engineer. During the period 1958-1966 Gross served as Secretary General of the International Telecommunication Union at Geneva, Switzerland. Later he became president of Telecommunication Consultants International, Inc., Washington, D.C.

<sup>5</sup> The essentials of Dellinger's viewpoint of the broadcasting situation in 1929 can be gained by quoting from his November 1929 paper:

In order to provide rural service 40 channels are each used by one station exclusively. The stations on the exclusive channels not only serve very great areas but deliver a more satisfactory intensity at every point within those areas. Their service is better for all concerned, the greater power they use. This fact is not commonly understood by other than radio engineers. . . .

There is some hope that the limitations of power and service of the non-exclusive channels may be overcome. . . .

. . . In spite of their vagaries, radio phenomena are subject to known engineering principles. Violation of such engineering principles in radio would sooner or later reduce the service of radio to the public.

Summarizing, the regulation of radio broadcasting involves extensive and difficult problems. These arise largely from certain outstanding facts or principles. . . . Finally, radio wave transmission is characterized by extreme vagaries. The facts and implications of each of these principles are subject to constant revision as radio progresses. Such facts constitute the natural limitations of radio regulation and legislation.

<sup>6</sup> A symposium, entitled "Technical achievements in broadcasting and its relation to national and international solidarity," prepared by IRE members for the World Engineering Conference, Tokyo, Japan, October 1929. None of the six authors attended the Conference, the papers being presented by an IRE delegate.

with the FCC until 1942 and returned to the Bureau in 1946 to join the Central Radio Propagation Laboratory (CRPL).

The Communications Act of 1934 abolished the Federal Radio Commission and established the Federal Communications Commission (FCC). The new agency was authorized to regulate communications far beyond that of broadcasting and commercial radio to the extent of:

to make available, so far as possible, to all people of the United States a rapid, efficient nation-wide and world-wide wire and radio communications service with adequate facilities at reasonable charges.

Gradually this field, commonly called telecommunications, now covers radio broadcasting, television, telephone and telegraph systems, and the ever increasing use of computer networks.

### 3. Interdepartmental relations in radio

#### a) IN THE EARLY YEARS OF WIRELESS TELEGRAPHY

Within 2 1/2 years after Marconi had successfully spanned the Atlantic with a radio signal (December 12, 1901), President Theodore Roosevelt appointed a board of five members representing four Departments

to consider the entire question of wireless telegraphy in the service of the National Government and submit for the consideration of the board the accompanying papers upon which he desires a report in full.<sup>7,8</sup>

A fairly extensive report was prepared by the board under the title of "Wireless Telegraphy—Report of the Inter-Departmental Board Appointed by the President to Consider the Entire Question of Wireless Telegraphy in the Service of the National Government." It was printed by the Government Printing Office and dated 1904. Such was the beginning of the important interdepartmental relations in the development and application of radio communications in the U.S. Government.

The Report was couched in many ramifications of conclusions and recommendations of areas of responsibility for the several Government departments. Needless to say, the situation has remained fluid and changing after more than 70 years when first approached.<sup>9</sup>

---

<sup>7</sup>The board consisted of one representative each of the Departments of Commerce and Labor, War, Agriculture, and two of the Navy.

<sup>8</sup>The request for a report was issued June 24, 1904, by the White House, signed by Wm. Loeb, Jr., Secretary to the President.

<sup>9</sup>Typical of the many conclusions and recommendations were the following that would influence the future use of wireless telegraphy:

That the science of wireless telegraphy has been advanced by the able and persistent work of the Signal Corps of the Army and the Weather Bureau of the Department of Agriculture as well as by the experimental work of the Navy Department.

That wireless telegraphy is of paramount interest to the Government through the Navy Department, and that its use by the Signal Corps of the Army for communication between military posts of the Army and other necessary links will be necessary both in peace and war, and that such use shall be unrestricted. . . .

That the best results can be obtained from stations under jurisdiction of one Department of the Government only. . . .

. . . the Board concludes that the Government must take the necessary steps to regulate the establishment of commercial wireless telegraph stations among the States and between nations.

. . . the Board believes that the Department of Commerce and Labor should have the duty of issuing licenses in such cases under such regulations as will prevent interference with stations necessary to the national defense. All private stations in the interior of the country should also be under supervision of the Department of Commerce and Labor.

To prevent the control of wireless telegraphy by monopolies or trusts, the Board deems it essential that any legislation on this subject should place the supervision of it in the Department of Commerce and Labor.

Years later, in 1916, Dellinger, in the capacity of a consultant representing the Bureau of Standards, gave assistance to the Interdepartmental Board on Radio Legislation on preparing a new bill to regulate communication.

**b) A VIGNETTE OF IRAC (INTERDEPARTMENT RADIO ADVISORY COMMITTEE)**

By 1911 and 1912 many of the recommendations of the presidential five-man board of 1904 had been put into action and had become guidelines, and were established practice during the following decade. Then came the broadcast boom spawning many new problems, such as interference. In such an atmosphere on December 8, 1921, a conference was held at the Bureau of Standards attended by representatives of the Bureau of Navigation (Commerce), Post Office Department, Bureau of Markets and Crop Estimates (Agriculture), and the Bureau of Standards. These were Government agencies directly concerned with the problems of broadcasting, either in their own station operation or in exercising a degree of control over the operating wavelengths.

After the First National Radio Conference in February 1922, the chairman, Dr. Stratton, director of the Bureau, suggested to Herbert Hoover, Secretary of Commerce, that a committee of departmental representatives be designated to find means of making maximum effective use of the wavelengths being used for Government broadcasting.

Dellinger immediately became very active in the formation of the new committee approved by the Secretary of Commerce, and on June 1, 1922, the first meeting was held under the name of the Interdepartment Advisory Committee on Governmental Radio Broadcasting. Twelve representatives of Government departments and agencies made up the membership during the first year. Dr. Stratton of the Bureau was elected chairman and Dellinger secretary. Stratton found it necessary to resign the following December when he resigned from the Bureau.<sup>10</sup> Dellinger served on this Committee for 15 years, from 1933 to 1948, as the representative of the Department of Commerce, including two terms as chairman, 1941-1943 and 1947-1948. During the 1920's he had served intermittently as an alternate to the representative of the Department of Commerce. Dellinger also served on the important Subcommittee on Technical Problems, and as chairman at various times.

Dellinger's 26 years of association with this Committee was followed by Kenneth Norton of CRPL, being appointed as the Department of Commerce representative, beginning in the spring of 1948 and continuing for a short time.

Within a short time the Committee's scope was extended much beyond the problems of broadcasting to include all radio communication matters of interdepartmental interest. Thus the name was changed to the Interdepartment Radio Advisory Committee (IRAC), which is retained to the present time. In 1927, at the request of President Coolidge, IRAC took the responsibility on behalf of the President of advising him on frequency assignments for the entire Government.

During the 1930's IRAC became involved in the preparation of proposals for international conferences. Early in the 1930's IRAC took up the problems of frequency allocations for television and aeronautical service. World War II brought on the military need for many new Government frequency allocations and IRAC became an important committee of the Board of War Communications until after the war.<sup>11</sup>

Since World War II the relation of IRAC to the Executive Branch of the Government has been one of a changing nature but always in an advisory capacity.<sup>12</sup> In 1970 IRAC was

<sup>10</sup> Dellinger served for 1 year as secretary, followed by Whittemore (formerly of the Radio Section) for 2 years. Gerald Gross (formerly of the Radio Section) served as secretary during the period 1933-1941 as a representative of the Federal Communication Commission.

<sup>11</sup> During 1930 and 1931 Dellinger served on an independent interdepartmental committee, appointed by special direction of President Hoover, that studied and made recommendations on the reduction of radio service duplication by the Army and Navy. Known as the Committee on Coordination of Government Communication Facilities, the group also dealt with the competition between Government communication facilities and private communication companies.

<sup>12</sup> In 1960 Allen Barnabei, a long-time employee of the Department of Commerce, was appointed Communications Liaison Officer and assigned to the director's office of the NBS Boulder Laboratories, but stationed at the Department of Commerce in Washington, D.C. In this capacity Barnabei served until 1965 as the Department's representative on IRAC as well as on several subcommittees within IRAC. He also served on other Government committees relating to telecommunications.

In 1956 Barnabei received the Department of Commerce Silver Medal for Meritorious Service "for sustained outstanding performance for many years in the highly technical and specialized field of telecommunications."

designated to assist the Director of the Office of Telecommunications Policy within the Executive Office of the President, assistance being given to the formulation of long-range programs for future Federal use of the radio spectrum and in related programs. There has been a close relationship between IRAC and the FCC in meeting up with common problems, with much coordination, yet each operating with much independence within its area of responsibility.

#### **4. Service to the Armed Forces**

##### **a) TRIALS, WITH SOME SUCCESSES**

In the early years of development of wireless telegraphy, the Army and Navy were quite dependent upon the ingenuity of engineers and the products of neophyte manufacturers for communication equipment. With the introduction of radio technology into the Bureau's program, the Army and the Navy not only stationed personnel on the Bureau grounds, but sought assistance of Kolster, Dellinger, and others. Thus, beginning in 1917, and for some years to come, the Navy, the Signal Corps (Army), the U.S. Coast Artillery (Army), and the Army Air Service, came to the Radio Section for aid. The information and aid they were seeking concerned: direction finders, location of planes by radio, underwater antennas, coil (loop) antennas for transmission, and guidance of planes, all by means of radio waves. Some methods were successful, others came up short (see chs. III and VI).

##### **b) THE WORLD WAR II PERIOD**

The consultant role of the Radio Section and the cooperative programs with the Army and Navy that centered in the period around 1920 did not return until the time of World War II. In the summer of 1942 the Interservice Radio Propagation Laboratory (IRPL) was established within the Radio Section by order of the U.S. Joint Chiefs of Staff, acting through the Wave Propagation Committee of the U.S. Joint Communications Board. In the next 4 years this operation of centralizing radio propagation data and furnishing the information to the Armed Services was under the direction of Dellinger and Newbern Smith. A large staff was recruited to perform this operation. Later this staff formed the core of the Central Radio Propagation Laboratory (CRPL) in 1946 (see ch. XI, pp. 415-416).

A year after hostilities opened in Europe that precipitated World War II, Dellinger was designated a member of Sec. C-1 (Communications) of Division C of the National Defense Research Committee (NDRC). Jolliffe, a former member of the Radio Section, was chairman of Sec. C-1 (see ch. IX, p. 316). Harry Diamond and Wilbur Hinman were selected to serve as consultants to a committee on ordnance (Sec. A).<sup>13</sup> Two months later, in December 1940, Dellinger was appointed Department of Commerce representative on the Radio Communication Committee of the Defense Communications Board, and served on this committee until 1947. Thus began the Radio Section's involvement in the technology of modern warfare that became so important in World War II.

Upon formation of the IRPL in 1942, Dellinger and Newbern Smith were selected to serve on the Wave Propagation Committee of the Combined Communications Board of the Joint Chiefs of Staff. The IRPL and, later, the CRPL, had close affinity with this committee.

##### **c) THE POSTWAR PERIOD**

World War II brought on a proliferation in design and manufacture of microwave communication and radar equipment to which certain groups within the Radio Section became exposed, both during the war period and immediately thereafter. These groups sat in on a Joint Army-Navy Conference on Microwave Test Equipment held at the Bureau on January 29, 1946. This exposure helped to spark a standards and measurements program in microwaves that continues to the present time within NBS.

---

<sup>13</sup> Diamond and Hinman, and personnel from other divisions, including Allen V. Astin, Robert D. Huntoon, and Chester H. Page, became very much involved in the development of the radio proximity fuze within NBS during World War II (see ch. IX, pp. 319-320).

Harold Lyons, as chief of the Microwave Standards Section in the newly organized CRPL (Division 14), sustained liaison with the Aeronautical Board and the Joint Communications Board and was elected chairman of the Special Committee on Instrumentation Standardization for Antenna Measurements. Lyons also was appointed a member of the Panel on Radiating Systems of the Joint Research and Development Board (Army-Navy). In this capacity he conducted an extensive survey for the panel of methods used for measurement of performance of radiating systems (antennas).

In another area of rapid development—that of frequency standards—W. D. George, chief of the High Frequency Standards Section, was appointed a member of the Sub-Panel on Frequency Control Devices of the Joint Research and Development Board.

## **5. Service to Government agencies when radio was newly fledged**

### **a) THE POST OFFICE DEPARTMENT'S INTEREST IN FLYING THE MAIL**

The last week of July 1918 (with the United States in full conflict with Germany) found Post Office Department officials in conference with Kolster on the possibility of using radio to land a plane in fog or darkness. The Department was much concerned for the safety of its Aerial Mail Service. On the day the Armistice was signed (November 11, 1918), Kolster had a degree of success in simulating the landing of a plane, not by radio waves, but by an electrical induction method. Success by radio waves had to wait until 1931 when Diamond and Dunmore, under the general direction of Dellinger, succeeded in the blind landing of an airplane (see ch. VI). By the late 1920's the Department of Commerce had become vitally interested in the safety of flight.

### **b) MARKET NEWS BY RADIO INTERESTS THE DEPARTMENT OF AGRICULTURE**

In the fall of 1920 the Department of Agriculture, through its Bureau of Markets, sought out the expert guidance of the Radio Section on a means of disseminating market news via radio. The Section gave early assistance to the Department by setting up a 2-kW spark transmitter, operating under the call letters of WWV, and sending out the market news in code for a period of 4 months. Thereafter, for a period of time, the Bureau of Markets provided news through radio assistance of the Post Office Department (see ch. IV, p. 78).

### **c) EXPERTISE FOR A FEDERAL BOARD**

By June 1924 the 65th technical committee had been organized within the structure of the Federal Specifications Board, this one to be known as the Technical Committee on Radio Apparatus. As the Bureau's expert in radio equipment, Dellinger was selected to be chairman of the committee, and remained so until 1934.<sup>14</sup> Of principal concern to the new technical committee were specifications for the purchase of electron tubes by various Government groups, and particularly for "standard" tubes (to minimize types of tubes and maintain quality of operation).

Dr. Jolliffe of the Radio Section took an active part in the testing of electron tubes to establish performance criteria, and served as chairman of a subcommittee on tube performance specifications. Although specifications evolved for a "standard" type of receiving tube, for several types of low-power transmitting tubes, and for a more positive type of contact for a tube base and socket, nothing appears to have materialized in the form of widely-used products for Government applications.

With time, the Federal Specifications Board was moved to the Treasury Department, and in 1949 became an operation within the Federal Supply Service of the General Services

---

<sup>14</sup> By 1925 the operating functions of the Federal Specifications Board (organized in 1921 within the Bureau of the Budget) consisted of 72 technical committees of which 26 were chaired by staff members of the Bureau of Standards, each being an expert in his field. The Board itself was composed of one representative from each of the various executive departments and independent agencies that purchase supplies under specifications. It was a coordinating board that was responsible to and cooperated with the Bureau of the Budget. The chairman and the secretary was a staff member of the Bureau of Standards. The Bureau conducted many research programs in relation to performance specifications for supplies and equipment purchased by the Government. For a time many Federal Specifications were issued as *Bureau Circulars*.

Administration. Over the years the Military Services became interested in, and absorbed the function of preparing specifications for reliability and quality control of electron tubes.

#### **d) SERVICE TO THE STATE DEPARTMENT**

Several decades after the Radio Section began to develop its consulting capacities to the Government and when radio grew to be an international communication medium, Dellinger was selected to serve as chairman of a technical committee within the State Department. From 1944 to 1948 Dellinger was chairman of the Technical Subcommittee of the Telecommunications Committee, the committee being largely a planning and coordinating group with interests in international telecommunications.

In 1946 the State Department was instrumental in planning for the establishment of the Radio Technical Commission for Marine Services. Dellinger was appointed chairman of the Commission in 1947 and continued in this post until 1957.

### **A GOVERNMENT INDUSTRY RELATION—DELLINGER'S ROLE WITH THE RADIO TECHNICAL COMMISSION FOR AERONAUTICS**

Many of the problems associated with the rapid expansion of aeronautics in the late 1920's and early 1930's were channeled through the Bureau of Air Commerce in the Department of Commerce, including those related to the application of radio to aeronautics. To fill a common need, both within the Government and in the aviation industry, the Radio Technical Committee for Aeronautics was organized by the Bureau of Air Commerce in 1935 as an advisory group for coordinating the activities of all organizations concerned with the applications of radio, electronics, and telecommunications in aeronautical operations.<sup>15</sup> Dellinger participated in planning the organization and was made a member of the Committee in August 1935.

After serving for 6 years on the Committee, Dellinger was elected chairman in January 1941, a position that he occupied for 17 years. With a new plan by Dellinger for reorganization, the name was changed to Radio Technical Commission for Aeronautics (RTCA). Approximately 120 U.S. aeronautical telecommunication organizations became members of the RTCA Assembly with 14 represented on the Executive Committee.

On January 10, 1950, Dellinger, as chairman, received for the Commission the Collier Trophy for the year 1948, the presentation being made by President Truman.<sup>16</sup> The citation read:

To the Radio Technical Commission for Aeronautics for the establishment of a guide plan for the development and implementation of a system of air navigation and traffic control to facilitate safe and unlimited aircraft operations under all weather conditions.

On September 26, 1957, Dellinger was feted at a dinner for the membership of the Radio Technical Commission for Aeronautics on his retirement as chairman after 17 years of service in guiding the organization. Among the several gifts and mementos received by Dellinger was a plaque bearing the inscription:

With sincere appreciation and gratitude to Dr. J. Howard Dellinger from the membership of the Radio Technical Commission for Aeronautics for his

---

<sup>15</sup> Later, when organized as a Commission, its constitution read:

Its objective shall be to advance the art and science of aeronautics through the investigation of all available or potential applications of the telecommunication art, their coordination with allied arts, and the adaptation thereof to recognized operational requirements. . . .

Its activities shall include the study of existing and proposed systems of aids to navigation, communication, and traffic control to determine their suitability, and the fostering of new developments to meet aeronautical operating requirements. It shall serve as a means of coordinating government and industry views on matters within its purview and shall formulate recommendations on the basis thereof.

<sup>16</sup> The Collier Trophy had been awarded each year since 1911 by the National Aeronautic Association "for the greatest achievement in aviation in America, the value of which has been demonstrated by actual use during the preceding year."



outstanding leadership and dedicated service as Chairman from January 1941 to October 1957.

On this occasion Dellinger was made lifetime Technical Advisor for the RTCA.

## RELATIONS WITH INDUSTRY

### 1. Filling an urgent need

As a result of the Nation's initiation to radio broadcasting in the fall of 1920, by spring of 1921 the Radio Section was the target of many inquiries seeking information where receiving sets could be obtained. In June of 1921 a conference was held in New York, convening to discuss the manufacture of receiving sets.<sup>17</sup> Dellinger was on a European mission and the conference was attended by Laurens Whittmore and John L. Preston of the Radio Section. The conference resulted in Letter Circular 66, with the title: "List of manufacturers and sole U.S. distributors of radio receiving equipment." The publication permitted the Bureau to answer impartially the many inquiries on sources for procurement of receiving sets.

Involved as it was, with the public and industry seeking information, the Radio Section made the effort to supply information and to develop testing methods. The result was the issuance of four Letter Circulars during the period of December 1922 to September 1923 on the testing of receivers. Later the material became available as a Bureau *Technological Paper* [3]. Testing methods were described for frequency range, vibration tests, sensitivity, and selectivity. Previous to these publications, back in May 1921, the Bureau had released a notice whereby industry was encouraged to provide testing facilities in order to relieve the Bureau as much as possible in performing the more routine types of tests of radio apparatus.<sup>18</sup> The experience described has been fairly common throughout the life of the Bureau.

### 2. Radio "standardization"

By the summer of 1923 there was much clamor for "standardization" of radio terms, nomenclature, testing methods, interchange of components, and the like. Industry and trade associations looked to the Bureau for aid. A preliminary meeting of many groups was held in New York City on September 27, 1922, with a much larger and more comprehensive meeting on January 12, 1923, to thrash out the many problems coming to the fore because of the broadcasting boom. (The resulting situation is amply discussed in ch. IV, pp. 94-96.)

---

<sup>17</sup>The Radio Section had called an informal conference of manufacturers of radio receiving apparatus to discuss suitability of equipment for receiving market reports supplied by the Bureau of Markets (Department of Agriculture) for dissemination in telegraphic code by the Post Office Air Mail Service network of radio transmitters. Engineers and company presidents of approximately 20 manufacturing firms attended the conference on June 17, 1921, at the headquarters of the AIEE. Although the conference was called to discuss the testing of receivers designed for a specific purpose, it would soon result in the Radio Section's interest in the more general field of receivers for broadcast reception.

<sup>18</sup>Testing of Radio Apparatus—May 24, 1921

The increase in the use of radio apparatus and the development of methods of testing and rating such apparatus has resulted in a considerable need for additional agencies to perform such tests and calibrations. The radio laboratory of the Bureau of Standards is anxious to assist commercial testing laboratories and other organizations in equipping themselves for performing tests and making calibrations of wavemeters, condensers, detectors, transmitting and receiving sets, and other radio apparatus which manufacturers, schools, amateurs, commercial companies or others may desire to submit. Information regarding the methods and apparatus developed by the Bureau of Standards is at the disposal of any organization which may desire to undertake the work. The provision of radio testing facilities outside of the Bureau of Standards will relieve the latter organization of some routine work, and thus enable it to devote more attention to the improvement of standards and testing methods.

### 3. Standards for electron tubes

World War I brought on an introduction to electron tubes to the Radio Section and an early development of measurement and testing methods, particularly by John Miller. As a result, came a series of conferences early in 1921 of the Radio Section with representatives of electron tube manufacturers, the Navy, and the Signal Corps. This cooperative effort led to much further work in the Section on measurement methods and the study of tube applications.

In January 1925, Jolliffe was appointed chairman of the Subcommittee on Electron Tubes of the newly organized Sectional Committee on Radio of the American Engineering Standards Committee (later to be known as the American Standards Association, and now the American National Standards Institute).<sup>19</sup> Later he was replaced by Dellinger, Jolliffe becoming secretary of the Sectional Committee.

## THE RADIO SECTION CONTRIBUTES TO TECHNICAL SOCIETIES

### 1. To the Institute of Radio Engineers

Within the Radio Section there was concern over the growing problem of radio terminology and nomenclature. The matter was discussed at length in May 1919 at a specially called section meeting. In the following March a trio of section personnel (Kolster, Dellinger, Whittemore) was appointed to serve on the Committee on Standardization of the Institute of Radio Engineers (IRE).<sup>20</sup> A reappointed committee in 1922 included only Dellinger and Whittemore. The committee published its report on definitions of terms and of standard graphic symbols as a supplement to the *Proc. IRE*. In 1929 Dellinger was appointed chairman of the Standardization Committee (later known as the Standards Committee), a post that he held for several years. During his incumbency two former members of the Radio Section were on the Committee—Haraden Pratt and Whittemore.

In the summer of 1925 Jolliffe was appointed a member of the Standardization Committee's Subcommittee on Radio Telephone Transmitter and Receiver Terminology, an indication that specialization was becoming necessary for the Committee. Shortly thereafter, Dellinger was appointed chairman of the Subcommittee on Receiving Sets, followed later by Harry Diamond as a member of the Subcommittee. This was followed later by a more specialized committee, this on Aircraft Receivers, of which Diamond became a member.

In 1928 Jolliffe was appointed chairman of the Subcommittee on Vacuum Tubes. In 1929 both Dellinger and Jolliffe served on the Committee on Bibliography.

During the decade of the 1930's the Radio Section entered a "doldrums" period in the advancement of measurements and standards (see ch. V, p. 110). Also, the broadcasting boom was over and the spirit of advancing equipment technology seemed to have slackened in the Radio Section—those in industry and with commercial interests needed less help from a Government laboratory. And, thus, activity in committee work slackened, with several exceptions. In 1937 Dellinger was appointed chairman of the IRE Committee on Radio Wave Propagation. He, as well as others in the Radio Section, had come to the fore in the study of radio propagation. In the same year, Diamond was appointed a member of the Technical Committee on Radio Receivers and on the Technical Committee on Transmitters and Antennas. The project on radio navigation of airplanes brought Diamond into close company with this area of radio technology.

### 2. To the American Institute of Electrical Engineers

Among the diversified fields of electrical engineering is that of communications, be it of telegraphy, telephony, radio, or television. The Radio Section's association with committee

---

<sup>19</sup>The Sectional Committee on Radio consisted of 26 members, representing various producing, distributing, and consuming groups associated with radio broadcasting.

<sup>20</sup>Upon organization of the IRE in 1912 a standardization committee was appointed on which the three founders of IRE (Goldsmith, Hogan, Marriott) served. A new committee was formed in 1915, on which Kolster served as a member (also Louis W. Austin and Louis Cohen), that issued a sizable report published for the IRE.

programs of the American Institute of Electrical Engineers (AIEE) came later than with the IRE. Not until 1926 was there committee membership, when Dellinger was appointed to the Subcommittee on Telephone, Telegraphy, and Radio of the Standards Committee.

Years later, in 1947, Howard Sorrows was selected as a member of the Subcommittee on Radiation Measurements above 200 Mc/s. At the same time Harold Lyons, then chief of the Microwave Standards Section, was appointed to membership on the newly organized Subcommittee on High Frequency Measurements. He became chairman of the committee shortly thereafter. Beginning in 1948, this subcommittee carried on a cooperative program with a comparable group of the IRE as the Joint AIEE-IRE Committee on High Frequency Measurements to stage a series of biennial conferences in Washington, known as the Conference on High Frequency Measurements. In 1963 the AIEE and IRE joined forces to become The Institute of Electrical and Electronic Engineers.

## A MEDLEY OF COMMITTEES

Requests during World War I initiated development of methods of measuring the properties of insulating materials. In 1920 John L. Preston was appointed a member of the Insulating Materials Committee of the American Society for Testing and Materials.

In 1921 Dellinger had an early introduction to committee work related to radio wave propagation when he was appointed a member of the Committee on Earth Currents and Polar Lights of the Section on Terrestrial Magnetism and Electricity, American Geophysical Union. Several years later Dellinger became vice chairman of the Committee.

Dellinger was called upon in 1935 to serve on the Science Advisory Board's Committee on Signalling for Safety at Sea. Promoting safety at sea engaged the early developers of wireless telegraphy and became a major project in the Radio Section beginning in 1919 (see ch. VI).

Reentry into the area of definitions came in 1947 when Elmer L. Hall was appointed to the Committee on Radio Electrical Coordination, within the committee structure of the American Standards Association. Years before, in 1932, Hall had limited service on the IRE Technical Committee on Fundamental Units and Measurements.

## INCREASED CONSULTANT CAPACITY BY PROLIFERATION OF COMMITTEES WITHIN THE CRPL

World War II and its aftermath brought on many new developments in telecommunications with the accompanying need for standards and their adaptation for both practical use and scientific investigation. Meeting new demands brought on a proliferation of committees within the Central Radio Propagation Laboratory (CRPL) after its organization in 1946. Exclusive of the large number of committees of an international nature, beginning in 1946 and until separation of the radio propagation and related programs from NBS in 1965, a total of approximately 175 committees had been active in CRPL.<sup>21</sup> About 50 were added to the radio standards, electromagnetics, and time and frequency programs at the Boulder Laboratories after 1965, thus making a total of approximately 225 committees.<sup>22</sup> Over the 30 years, the consultative services given by CRPL and NBS, to be shared with industry, professional societies, and the Federal Government, bulked large.

---

<sup>21</sup> Committees of an international nature, such as within URSI (International Scientific Radio Union), CCIR (International Radio Consultative Committee), and the IEC (International Electrotechnical Commission) are treated in chapter XVII and its accompanying appendix.

<sup>22</sup> These committees and the NBS committee members are listed in appendix A, entitled Committee Memberships relating to the general subject of radio in Technical Groups, Professional Societies, and Government Sponsored Committees from the time of formation of the Central Radio Propagation Laboratory, May 1, 1946 to 1975. This listing was prepared to indicate the magnitude, nature, and diversification of subject matter of committee work of the CRPL and later work by the Boulder Laboratories of NBS. The listing also offers opportunity to credit individuals with their committee work.

## 1. Increased service to professional societies

### a) AN AMBITIOUS PROGRAM TO KEEP ABREAST OF THE STATE-OF-THE-ART

Although three members of the former Radio Section served on an IRE committee as early as 1920, it was not until around 1948 that committee activity entered into a variety of fields. Early in the 1960's, in 1962 to be exact, a rather ambitious committee program and one of far-flung proportions was initiated within the IRE under the leadership of Myron C. Selby of the Radio Standards Laboratory. At the time Selby was chief of the High Frequency Electrical Standards Section. This program evolved out of work of the IRE Subcommittee on Basic Standards and Calibration Methods of the Measurements and Instrumentation Committee. The parent group was the IRE Standards Committee, the earliest technical committee of the IRE organization.<sup>23</sup> The objective of the new program was "the collection and dissemination of state-of-the-art information concerning the accuracy attainable in electrical measurements" [4]. The program called for the classification of accuracy determination and statement of accuracy at three levels or echelons, the highest associated with that obtained by a national laboratory, the lowest associated with the user of a measurement instrument at the workbench or in field service.

In getting the program into operation the technical backgrounds and qualifications of about 1000 members of the technical profession were checked. These persons represented a broad spectrum of measurement activity within industry, government laboratories, and among professional societies. Approximately 250 were invited to take part in the 22 Task Force Groups set up to undertake the program. Each Task Force Group would have at least five members, with each member specially qualified in a certain area of competence; for example, the research, development, and design of standards and methods of measurement in one of the three echelons of accuracy. An example of a Group (later called subcommittee) was No. 3 with the title, "Power, CW, Sinusoidal, Hollow Waveguides."

By 1966 this ambitious program was well underway, although only one technical report had been published, that on "State-of-the-Art of Measuring Sine-Wave Unbalanced RF Voltage." By 1971, 20 of the 22 subcommittees were active, with about 100 participating members, and 5 technical reports were completed. The overall program was one of considerable magnitude. With a slow phasing out of activity in retiring from NBS by Selby, leadership of the committee was taken up by George Schafer and Wilbur Anson in 1971, the two serving as co-chairmen.<sup>24</sup> The committee took on new status within the IEEE and became known as Technical Committee on Electromagnetic Measurements State-of-the-Art. In 1974 committee leadership passed from NBS.<sup>25</sup>

### b) THE SCOPE OF COMMITTEE PARTICIPATION

By the very nature of the Institute of Radio Engineers, the CRPL and NBS successor groups gave more of their expertise and shared more of their information with the large committee structure of the IRE (later the IEEE) than with any other professional group. The titles of committees ranged alphabetically all the way from Antennas to Z (impedance). Over a period of 30 years, beginning in 1946, NBS has been involved with approximately 60 technical radio-related committees within the IEEE. Over this same period the CRPL and NBS successor groups have had representation on a number of committees within the American Standards Association (now American National Standards Institute), and within the American Society for Testing and Materials.

---

<sup>23</sup>The IRE Standardization Committee published its first report in 1913, a year after the Institute of Radio Engineers was founded.

<sup>24</sup>George Schafer had left the Boulder Laboratories in 1970 to become Technical Director of the U.S. Army Electronic Proving Ground at Fort Huachuca, Ariz. Wilbur Anson was chief of the EM Technology Information Center at Boulder Laboratories.

<sup>25</sup>More recently, within NBS and elsewhere, there has been a growing trend toward statistical control and measurement assurance programs in the calibration and achievement of compatibility of standards among laboratories.

c) **SERVICE TO SCIENCE**

The CRPL was active on a number of committees within the structure of the National Academy of Sciences. Some of these were especially effective in their relation to the program of the International Geophysical Year of 1957-1959.

**2. Service to the country's defense**

Over the 30 years, since 1946, of radio research at NBS there has been considerable consultative activity with the Department of Defense through committee operations. Except for some specialized committees, these services are channeled through the Joint Chiefs of Staff, and the Departments of the Army, Navy, and the Air Force. The service given to the DoD has varied over a wide range of subject matter.

**REFERENCES**

- [1] J. H. Dellinger, "Analysis of broadcasting station allocation," *Proc. IRE*, Vol. 16, No. 11, Nov. 1928, pp. 1477-85.
- [2] J. H. Dellinger, "Radio broadcasting regulation and legislation," *Proc. IRE*, Vol. 17, No. 11, Nov. 1929, pp. 2006-10.
- [3] J. L. Preston and L. C. F. Horle, "Some methods of testing radio receiving sets," *Tech. Papers Bur. of Stand.*, No. 256, Mar. 26, 1924.
- [4] "A program to provide information on the accuracy of electrical measurements," *Proc. IRE*, Vol. 51, No. 4, Apr. 1963, pp. 569-574, prepared by Subcommittee 25.1 on Basic Standards and Calibration Methods.



## Chapter XVII

### ON THE INTERNATIONAL SCENE

#### THE INTERNATIONAL TELECOMMUNICATION CONFERENCES

##### 1. Early conferences

Radio waves know no national boundaries and the former Radio Section in its early years became conditioned to the international aspects of radio communication. Among the first assignments given to Kolster after his entry into the Bureau of Standards was to attend the (Second) International Radiotelegraph Conference that met in London during June and July of 1912 (Kolster entered the Bureau on December 18, 1911).<sup>1,2</sup> Kolster served as an observer and as a technical advisor to one of the U.S. delegates to the conference. The *Titanic* disaster of April 14, 1912, had a profound effect upon this conference.<sup>3</sup>

##### 2. The Washington Conference of 1927

Eighty countries were represented at the (Third) International Radiotelegraph Conference held in Washington, D.C. during the fall of 1927.<sup>4</sup> Three members of the Radio

<sup>1</sup>In 1903 a Preliminary International Conference on Wireless Telegraphy was held in Berlin, Germany. Kaiser Wilhelm of Germany was concerned with the monopolistic attitude of the Marconi interests and proposed holding an international conference to counter this pressure. It was followed in 1906 by a second conference, also held in Berlin, during which the International Radio Telegraph Union was created. These International Conferences, which continue to the present time, constitute the plenipotentiary conferences of the International Telecommunication Union (ITU), an organization that had its beginning with the International Telegraph Union in 1865. In 1932 the International Telegraph Union and the International Radio Telegraph Union (founded in 1906) combined to form the ITU. Today, the ITU includes more than 140 member countries and is involved with many and diversified functions, including the International Radio Consultative Committee (CCIR) on which many NBS personnel have served (see app. B).

A descriptive and illustrative account of the International Telecommunication Union is found in the book, entitled *From Semaphore to Satellite*, published in 1965 by the ITU on the occasion of its centenary. It was prepared under the direction of Gerald C. Gross, Secretary General of the ITU for a number of years (1958-1966) and a former member of the Bureau's Radio Section [1]. Also refer to G. A. Coddling, Jr. [2].

<sup>2</sup>Louis W. Austin was 1 of the 12 delegates representing the United States at the 1912 Conference in London. Later he was to become very active in the International Scientific Radio Union (URSI). Although not a member of the Radio Section, but closely associated with the Bureau for 28 years, there is reason to believe that Austin first became acquainted with wireless telegraphy while engaged in research at the University of Berlin during 1901-1902.

<sup>3</sup>A more detailed account of the London Conference will be found in chapter II.

<sup>4</sup>Three events relating to radio communication and to functions of the ITU occurred during the period (1912-1927) between the London Conference and the Washington Conference that were international in scope and largely in consequence of World War I, with personnel of the Radio Section participating in each event. The first was the Inter-Allied Radio Conference held in Paris in 1919 and attended by Kolster representing the Bureau of Navigation of the Department of Commerce. Representatives of the Allied Nations of World War I initiated modifications to pacts of the 1912 London Conference, largely based upon wartime developments and the growing field of radio technology.

In the summer of 1921, Dellinger, as a representative of the Department of Commerce, attended a meeting in Paris of the Inter-Allied Provisional Radio Technical Committee. A preliminary Communications Conference had been held in Washington in October 1920 in preparation for the 1921 Paris Conference, and on this occasion the radio laboratory was visited by the British, French, Italian, and Japanese delegations. This Inter-Allied Committee, with representatives from Great Britain, France, Italy, Japan, and the United States, gave attention to the technical problems involved in international agreements since the 1912 London conference.

In the capacity of experts in international use of radio, Dellinger and another member of the Radio Section were appointed to and served on the technical staff of the American delegation to the Conference on the Limitation of Armaments, held in Washington, D.C. during the winter of 1921-1922.

Section served as technical advisors to the American Delegation.<sup>5</sup> An important action was setting up the International Radio Consultative Committee (CCIR) on which many NBS members would serve in the future. The concept of the allocation of frequency bands over the radio spectrum for specific uses came before these conferences and was well accepted, but problems remained.

The Radio Section had the rare opportunity on this occasion to exhibit and demonstrate its laboratory facilities to the conference delegation.<sup>6</sup>

---

<sup>5</sup> Reporting to NBS on the Washington Conference, Dellinger stated on the work of the technical advisors:

The Radio Section was represented in the Conference by Dr. Jolliffe, Mr. Pratt, Mr. Gross, and myself. Mr. Gross serving as one of the interpreters, the other three of us being designated as Technical Advisors. My work was largely on the Technical Committee of the Conference. Dr. Jolliffe served as Secretary of the Technical Committee of the American Delegation and also as Secretary of one of the subcommittees of the Technical Committee of the Conference. Mr. Pratt kept in touch with all matters affecting aeronautical uses of radio. Dr. Jolliffe and Mr. Pratt were both active in the preparations by the American Delegation during the summer before the Conference. Mr. Hall also participated in the preparatory work during the summer on questions of frequency and standardization. (NN365-25, Box 1)

<sup>6</sup> On display in the Radio Building were models of directive beacons under development for air navigation, field-intensity measuring apparatus and fading recorders, and equipment for precision frequency measurement. In front of the Radio Building was parked the panel truck that served as a mobile radio laboratory.



*Delegates to International Radio Conference, Washington, D.C. in fall of 1927, inspecting the mobile radio laboratory at the Bureau of Standards. The laboratory truck was used in various parts of the country to make field measurements of fading and intensity of radio signals.*



### 3. The later conferences—After Washington

Dellinger served as technical advisor on the American Delegation to the International Radiotelegraph Conference held in Madrid, Spain in the fall of 1932.<sup>7</sup> It was at this conference that the name International Telecommunication Union was selected for the organization that was formed by combining the International Radio Telegraph Union and the International Telegraph Union.

No one of the Radio Section was in attendance at the 1938 International Telecommunication Conference in Cairo, Egypt. However, Dellinger assisted the U.S. Delegation in preparing for the conference. Both Dellinger and T. R. Gilliland took major roles in a CCIR Committee in preparation for the Cairo Conference.

In the fall of 1946 Dellinger attended the Five-Power Preliminary Telecommunications Conference in Moscow that met to prepare for an ITU plenipotentiary conference in 1947.<sup>8</sup> During the winter of 1946-1947 Dellinger was kept busy on preparations for the 1947 International Telecommunication Conference scheduled for that summer in Atlantic City, preceded by the Administrative Radio Conference of the International Telecommunication Conference. It was at this preliminary conference that Dellinger served as spokesman for the U.S. Delegation on technical radio regulations in relation to the revision of telecommunication agreements. Coming from the preliminary conference was the drafting of the operation of a frequency board, which the later conference approved as a Provisional Frequency Board and the more permanent International Frequency Registration Board. The latter board has the power of allocating frequency bands on a worldwide basis. The work of the CRPL on radio propagation was of much use, particularly in committee meetings, at both the preliminary and the plenipotentiary conferences, and was accepted as a basic source of such information. Dellinger served as a delegate of the U.S. Delegation at both conferences and served on a number of the committees at each conference. Dr. Newbern Smith served as an advisor to the U.S. Delegation at the preliminary conference.<sup>9</sup>

---

<sup>7</sup>Mrs. A. N. Kincheloe ("ANKie"), secretary to the Radio Section, served as stenographer to the American delegation.

<sup>8</sup>The Five-Power countries that emerged from World War II were China, France, Russia, the United Kingdom, and the United States.

<sup>9</sup>Published during the sessions of the 1947 Conferences were 84 issues of *THE MORNING ELECTRON*, a small newspaper that succinctly brought news events and information of the conferences to the participants. The final issue, dated 3 October 1947, summed up the major accomplishments of the conferences as follows:

We have broken new ground in the radio field in three important respects:

First, we have adopted a world-wide frequency allocation table extending up to 10,500,000 kilocycles.

Second, we have planned practical machinery for putting this new allocation table into effect.

Third, we have provided for a permanent board of experts, the International Frequency Registration Board which will consider every future assignment to determine whether it will cause international interference.

Together we have taken another step toward the ultimate goal of successful world-wide cooperation. Successful international relations between the nations of the earth is a mosaic made up of good working arrangements in the various specific fields where nations have relations with each other.

The finis to this last issue reveals the nature of the paper and probably that of its general manager.

#### THE LATEST NEWS

*THE MORNING ELECTRON* which, for five months, has been the acknowledged paper of the happy few, of the elite of an international intelligentsia, has never been the mouthpiece of the Trusts, the Banks, or of Big Money. It served ideas, ideals; it never served interests. This may explain why *THE MORNING ELECTRON* has been at the same time successful and unsuccessful.

As the number of its readers has diminished appreciably since last evening, the General Manager has decided to stop further publication of this remarkable and brilliant daily. It may reappear in 1952 in Buenos Aires, with the new shining title of "*EL ELECTRON DEL MANANA*." . . . (NN365-90, Box 24)

In the wake of the Atlantic City Conference the Provisional Frequency Board moved into action. The project was set up in Geneva, Switzerland, and the Board was in session for 25 months. The CRPL played a major role in supplying expertise and radio propagation data to the U.S. Delegation at the Geneva sessions. Newbern Smith, assistant chief of the CRPL, initiated the trips by CRPL personnel to Geneva, starting at the beginning of 1948. At various intervals, yet maintaining continuity of service to the U.S. Delegation, others that served as technical advisors were K. A. Norton, D. K. Bailey, and R. C. Kirby. Dellinger had been appointed chairman of the Washington Provisional Frequency Board Liaison Committee, a committee of CRPL staff members serving as the "home team" to provide technical information to the U.S. Delegation at Geneva.

In 1952 the CRPL gave assistance to the U.S. Preparatory Committee for the Plenipotentiary Conference of the ITU that met at Buenos Aires, Argentina, but no staff member was in attendance at Buenos Aires. Later plenipotentiary conferences were held at Geneva (1959) and Montreux, Switzerland (1965), and the Malaga-Torremolinos Conference was held in Spain in 1973.<sup>10</sup>

By the 1950's, relations of NBS with the International Telecommunication Union were almost entirely through participation in the technical activities of the International Radio Consultative Committee (CCIR), particularly in the Study Groups (see section below and app. B).

## THE INTERNATIONAL RADIO CONSULTATIVE COMMITTEE (CCIR)<sup>11</sup>

The concept of a technical committee within the structure of the International Telecommunication Union, to be known later as the International Radio Consultative Committee (CCIR), originated in 1920. However, it was not until action was taken at the 1927 Washington Conference of the International Radiotelegraph Conference that the committee came into existence as an organization. Its duties were: "to study technical radio questions and operating questions, the solution of which depends principally on considerations of a technical radio character and to issue recommendations on them." The primary objective was to promote the utilization of the radio spectrum in the most efficient way by the different radio services. The Netherlands Government was charged with the task of organizing the first meeting.

### 1. The CCIR becomes a functioning organization: The first meeting—At The Hague, 1929

The first Plenary Assembly of the CCIR convened in September 1929 at The Hague, Netherlands. Preparations by the U.S. representatives for this meeting were conducted within the structure of the Interdepartment Radio Advisory Committee (IRAC). The report, "Material submitted by technical experts of the United States of America for discussion at the meeting of the CCIR at The Hague in September 1929," was prepared by the Drafting Committee and approved by IRAC, then submitted by the State Department to the various governments represented on the CCIR. Dellinger, as a technical advisor, served on the Drafting Committee and was chairman of the CCIR Committee on Frequency Maintenance. Jolliffe, also a technical advisor, was chairman of the Committee on Transmitter Interference. Following World War II the CCIR met in Stockholm, Sweden and the modern Study Group structure was established. Originally 14, the study groups now number 11, plus 2 related groups that are chaired by the CCIR.

---

<sup>10</sup> George W. Haydon, consultant in the Radio Communications and Systems Division, attended the 1959 Geneva Conference as a U.S. delegate and the NBS representative to the conference.

<sup>11</sup> The abbreviation CCIR comes from the French *Comité Consultatif Internationale des Radiocommunications*, French being the original official language of the ITU.

## 2. Meetings after The Hague—Before World War II

The 1931 meeting at Copenhagen, Denmark was attended by Dellinger as the delegate and Charles G. McIlwraith as the technical advisor representing NBS for the United States Delegation.<sup>12,13</sup>

Dellinger served as chairman of the American Delegation to the Third Plenary Assembly meeting at Lisbon, Portugal in the fall of 1934. He served as chairman of the Committee on Definitions and Standards, one of the five committees. Twenty-five subject categories were discussed at the Lisbon meeting, most of them of a technical nature.

<sup>12</sup> McIlwraith entered the Radio Section on September 15, 1928, and transferred to the Coast and Geodetic Survey on December 28, 1931.

<sup>13</sup> Initially, the span between plenary meetings was to be 2 years. After the Copenhagen meeting the span was usually 3 years.



*Chairmen of delegations attending Third Plenary Assembly of International Radio Consultative Committee (CCIR) at Lisbon, Portugal in fall of 1934. Photo taken at Belem, a suburb of Lisbon, where delegation was received by Antonio O. de F. Carmona, president of Portugal (front row, under arch, holding silk top hat). Dellinger is sixth from right, in formal morning attire, with cane, gloves, and Homburg hat.*

Three years later, in 1937, Dellinger again served as chairman of the American Delegation to the CCIR meeting at Bucharest, Rumania, and as a vice chairman of the assembly. Again, he served as chairman of the Committee on Definitions and Standards through which the conference functioned.<sup>14</sup> Within a few months Dellinger sailed across the ocean again, this time to attend a meeting in London as a follow-up to committee work in Bucharest on radiowave propagation. More of the work was in preparation for the ITU Conference in Cairo in 1938 and much was based upon the Radio Section's intensive study of radio propagation. On this occasion Dellinger had the opportunity of visiting several of the well-known radio laboratories in England.

Early in 1939 Dellinger was designated by the State Department as chairman of the U.S. Preparatory Committee for the CCIR Assembly to be held at Stockholm, Sweden in June 1940. For assistance on the various subcommittees, Dellinger enlisted the aid of others of the Radio Section including H. Diamond, T. R. Gilliland, and E. L. Hall. But war broke

<sup>14</sup> Indicative of the operation of a CCIR meeting in the mid-1930's, the Bucharest meeting was 19 days in session and was attended by approximately 200 delegates from the principal countries of the world. The result was 21 recommendations to be published as a source of information on the understanding of radio propagation and indicating the best of radio engineering practices; also, as recommendations to the ITU.

out in Europe on September 1, 1939, and the preparatory work was stopped shortly thereafter. There was no 1940 meeting in Stockholm and CCIR activities ceased until after World War II.

### 3. Meetings after World War II

The next Plenary Assembly after World War II took place in 1948 at Stockholm, 8 years after being initially scheduled. N. Smith and D. K. Bailey represented NBS on the U.S. Delegation.<sup>15</sup> In preparing for the Stockholm meeting a larger number of staff members of the CRPL, for the first time, began to participate actively in CCIR operations.

After the Stockholm meeting, CCIR Plenary Assemblies were held in Geneva, Switzerland in 1951, 1963, and 1974. The others were in London (1953), Warsaw (1956), Los Angeles (1959), Oslo (1966), and New Delhi (1970).<sup>16,17</sup>

Knowledge of the general nature of the CCIR organization and the manner in which it tackled the technical problems of telecommunications by 1965 can be gained from the nature of its Study Group structure. The year 1965 is selected because at that time the problems associated with radio propagation were phased out of the National Bureau of Standards following the transfer of the Central Radio Propagation Laboratory from the NBS to the Environmental Science Services Administration (ESSA) in October 1965. However, ESSA remained with the Department of Commerce. Details of the Study Group structure are given in the footnote below.<sup>18</sup> This structure came in for major changes after 1965 and particularly in 1970 largely due to the advancing technology of space communications.

## THE EXPERT'S ROLE AT INTERNATIONAL AND INTER-AMERICAN CONFERENCES

### 1. Taking part in an assortment of international conferences

#### a) TO THE TIME OF FORMATION OF THE CRPL

In 1921 Dellinger made the first of his many trips to Europe. His first trip was to Paris in relation to the Inter-Allied Provisional Radio Technical Committee. His second trip, during the summer of 1927, covered a large area of Europe with visits to eight countries during the course

---

<sup>15</sup> Dellinger had retired from Government service on April 30, 1948, and attended the July 1948 Conference of the CCIR as an industrial counselor. After retirement Dellinger became associated with RCA, serving as a consultant with the RCA Frequency Bureau.

At the Stockholm meeting Dellinger was elected chairman of the Study Group on Ionospheric Propagation, a post he held until 1956. Dellinger attended subsequent Plenary Assemblies of the CCIR in 1951, 1953, and 1959, missing the 1956 Conference at Warsaw. At the inaugural ceremony of the 1951 Conference at Geneva, Professor van der Pol, director of the CCIR, in his welcoming address stated:

I recently looked up the lists of those present at former C.C.I.R. meetings, and I think I am right in saying, that there are here present this morning three gentlemen who so far have attended *all* previous plenary assemblies of the C.C.I.R. They are: Dr. Dellinger of the United States delegation, Mr. Gross, the Assistant Secretary General of the Union, and myself. Mr. Gross and I are now on the staff of the Union and so it is to Dr. Dellinger, as a delegate, that it falls to be our doyen by virtue of service if not yet by virtue of age.

<sup>16</sup> Because of the increased participation in CCIR activities by NBS staff members after World War II, detailed delineation of their participation is noted in appendix B, beginning at the time of organization of the CRPL (May 1, 1946).

<sup>17</sup> In 1966, Jack Herbstreit was elected director of the CCIR, a post that he occupied for 8 years. This top administrative position of the CCIR is with the ITU at the headquarters in Geneva, Switzerland. In the reorganization of Boulder Laboratories during October 1965, Herbstreit was transferred from the NBS (deputy director of CRPL) to the Institute of Telecommunication Sciences and Aeronomy within ESSA, with the position of deputy director.

Herbstreit was followed in the directorship of CCIR in 1974 by Richard C. Kirby, who at the time of his election was an associate director of the Office of Telecommunications, Department of Commerce.

<sup>18</sup> The Study Group structure within the CCIR in 1965 was as follows: I, Transmitters; II, Receivers; III, Fixed services; IV, Space systems and radioastronomy; V, Tropospheric and ground wave propagation; VI, Ionospheric propagation; VII, Standard-frequencies and time-signals; VIII, International monitoring; IX, Radio-relay systems; X, Broadcasting; XI, Television; XII, Tropical broadcasting; XIII, Mobile services; and XIV, Vocabulary.

of 3 months. The multiple-purpose trip took Dellinger to radio stations, laboratories, museums, Government offices, international conferences, and to many airfields for study of radio navigation of airplanes (see ch. VI, p. 159).<sup>19</sup> In Prague he attended the Third General Meeting of the International Geophysical Union as a delegate of the United States. This meeting included a symposium on radio. Again, as a U.S. delegate, he attended a meeting of the International Electrotechnical Commission at Bellagio, Italy.

In 1928 the Bureau had the opportunity to inform the aviation industry, on an international scale, of the aeronautical research and airway development being conducted at NBS. The occasion was the International Civil Aeronautics Conference held in Washington in December.<sup>20</sup> Dellinger served as a representative of NBS at the conference. At a technical session on aeronautical research, Dr. L. J. Briggs (assistant director, and later, director of NBS) presented a paper describing aeronautical research at NBS including development of a directive radio beacon system. At another session, Dellinger described the system in detail in a paper entitled, "Uses of radio as an aid to navigation on fixed airways." Thus the aeronautical world was informed of the radio beacon system that had been developed by the Radio Section and that already was being used on an experimental basis on an airway (see ch. VI).

During the summer of 1930 Dellinger was occupied with committee work in Denmark, Sweden, and Norway as a representative of the Institute of Radio Engineers at the Seventh Plenary Meeting of the International Electrotechnical Commission (IEC). He also served as a delegate for the U.S. National Committee of the IEC in areas relating to radio. This trip was a 2-month period of committee work.

During the decade of the 1930's Dellinger's trips to Europe were concerned entirely with activities in the International Telecommunication Conferences such as CCIR meetings.<sup>21</sup> Then in 1939 came World War II and international scientific meetings ceased for the duration of the war. However, in 1944, exigencies of the war effort brought on a meeting in Washington of international scope, at least for the Allies (or United Nations). Representatives of Great Britain, Australia, New Zealand, and Canada, along with a large contingent of U.S. representatives and observers, attended the 3-week International Radio Propagation Conference in the spring of 1944. The conference was held on the Bureau's grounds under the auspices of the Wave Propagation Committee of the Combined Communications Board (military), with 88 in attendance.

---

<sup>19</sup> Dellinger's trip report (Radio File R080d) reads like Jason, the Argonaut, sailing in the *Argo* in search of the Golden Fleece, except that Dellinger sailed on two ships in search of radio ken, the S.S. *Leviathan* to Southampton, and returned on the S.S. *Roma* from Naples. On board the two ships he took the opportunity of studying the radio equipment. In all, Dellinger visited approximately 40 laboratories, stations, offices, and airfields.

<sup>20</sup> This conference was called at the suggestion of President Coolidge "to provide an opportunity for an interchange of views upon problems pertaining to aircraft in international commerce and trade, and suitably to commemorate the twenty-fifth anniversary of the first flight of the Wright brothers."

<sup>21</sup> In 1936, members of the Radio Section, T. R. Gilliland, S. S. Kirby, N. Smith, and S. E. Reymer, prepared a paper for the International Association of Terrestrial Magnetism and Electricity for the Edinburgh Assembly in September 1936. This paper, entitled "Averages of critical frequencies and virtual heights of the ionosphere, observed by the National Bureau of Standards, Washington, D.C., 1934-1936," was presented at the Edinburgh meeting but none of the authors was in attendance.



*International Conference on Radio Propagation held at National Bureau of Standards, April 17-May 5, 1944, under auspices of Wave Propagation Committee of Combined Communication Board (military). Staff members of the Interservice Radio Propagation Laboratory (IRPL), who hosted the Conference, that can be identified in the photograph (taken in front of Radio Building) are: J. H. Dellinger, F. R. Gracely, N. Smith, S. M. Ostrow, E. Lundquist, F. F. Craig, M. McGavok, T. N. Gautier, W. E. Owen, M. B. Harrington, L. Gillespie, R. Silberstein, J. V. Lincoln, A. N. Kincheloe, and M. L. Phillips.*

*Others in the photograph who later joined the IRPL and CRPL are: D. K. Bailey, A. H. Shapley, J. Herbstreit, and T. J. Carroll.*

#### **b) AFTER FORMATION OF THE CRPL<sup>22</sup>**

In support of the Provisional Frequency Board set up at the Atlantic City Radio Conference of 1947 were seven conferences meeting in the period of 1948 to 1951, that were to formulate a new International Frequency List of operating frequencies in the band of 10 kHz to 30 MHz. It fell to the lot of the CRPL to become actively engaged in several of these conferences. Assigned as a technical advisor on propagation matters to the U.S. Delegation to the International Administrative Aeronautical Radio Conference was T. N. Gautier. This meeting of several months duration was held in Geneva in 1948. J. W. Herbstreit was designated technical advisor to the U.S. Delegation for the High Frequency Broadcasting Conference held in Mexico City from October 1948 to April 1949. Sixty-nine countries were represented at this important conference that wrestled with the problems of broadcast frequency assignments the world over. In spite of the enormous amount of work expended in the seven conferences that met from 1948 to 1951, not all was accomplished that had been hoped for and finally the parent group—the Provisional Frequency Board—was disbanded. During the next several years more was accomplished in subsequent conferences that brought about a degree of harmony in communication services and frequency assignments among the contending nations. In 1950 the High Frequency Broadcasting Conference reconvened at Rappolo, Italy and was again attended by Herbstreit as a technical advisor.

By 1949 the United Nations organization was becoming active in many quarters and the Second National Conference of UNESCO (UN Educational, Scientific, and Cultural Organization) was held in Cleveland, Ohio. On this occasion A. H. Shapley represented the CRPL in a presentation of the radio propagation research being conducted by NBS.

In March of 1959 an important conference of somewhat an international flavor convened at the Boulder Laboratories. Called the Conference on Arctic Communication, the objective of the conference was to review the results of recent Arctic radio research and to discuss current research and operational problems. Forty-six original papers were presented to the conference, plus the 11 papers of the review session [3].

The use of rockets and satellites for space research had advanced far enough by 1959 to discuss programs on an international basis and the First International Space Science Symposium was scheduled during the latter part of the year at Nice, France. The

---

<sup>22</sup> Research programs of an international nature involving the cooperation of nations and of scientific groups within nations are noted in chapters where these specific programs are covered.

symposium was sponsored by the Committee on Space Research (COSPAR) within the International Council of Scientific Unions (ICSU). Three staff members of the CRPL attended the symposium, R. S. Lawrence, A. H. Shapley, and R. M. Gallet, with Lawrence presenting a paper written by him in collaboration with C. G. Little.

To provide all of the facets of telecommunications in space research required a new look at the frequency spectrum in order to update frequency allocations for this new service. A. Barnabei, the Communications Liaison Officer with the Department of Commerce, was appointed to the U.S. Delegation to the Extraordinary Administrative Radio Conference for Space Telecommunications which met in Geneva in the latter part of 1963 in company with delegations from 69 other nations. The outcome of the conference was a carefully considered allocation of frequencies to be assigned for space-related activities.

During the 16 years after the International Aeronautical Radio Conference of 1948, the aviation industry and the radio navigation of planes had advanced so far that a revision on a world basis of frequency allocations was in order. To this task was called Barnabei, along with G. W. Haydon of the Radio Systems Division, to serve for a period of time at the Extraordinary Administrative Radio Conference for the Aeronautical Service held in Geneva early in 1964. The result was improved frequency allocations to serve aviation on a global scale.



*Attending as a U.S. delegate to the Extraordinary Administrative Radio Conference for the Aeronautical Mobile Service (International Telecommunications Union) at Geneva, Switzerland in early 1964, George W. Haydon (left front) listens in on the proceedings. At the time, Haydon was a consultant in the Radio Systems Division, with specialization in frequency utilization.*

## **2. International conferences called for the Americas**

Along with taking part in European conferences, beginning in the early 1920's, the Radio Section became involved in various ways with radio conferences that were staged in the Western Hemisphere. The earliest of these conferences in which the Radio Section took part was the Pan American Communications Conference of 1924 held in Mexico City. Under

the auspices of an interdepartmental committee appointed by the State Department, members of the section were active in the preparations for this conference. However, none attended the meeting in Mexico City. Of primary consideration by the conference was the allocation of very low frequencies for the high-power radio stations in the Americas.

Nine years after the 1924 Conference another one was held in Mexico City in 1933 under the name of North American Radio Conference. The meeting was called primarily for the allocation of broadcasting frequencies in North America. Dellinger was appointed chairman of a U.S. Committee that assisted the State Department and the Federal Radio Commission studying the problems associated with frequency allocations in the range of 150 to 1700 kHz and at transmitting distances up to 5,000 km. Wave phenomena work by the Radio Section was the principal source of data on received signal intensities used by the committee in its report.<sup>23</sup>

Between the time of the 1932 Madrid Conference and the 1938 Cairo Conference of the ITU, a conference was held in Havana, Cuba in 1937 that became known as the First Inter-American Radio Conference, followed later, in 1940, by the Second Inter-American Radio Conference in Santiago, Chile. The purpose of these conferences was to resolve questions of radio communications that especially concerned the two Americas. Although the Radio Section did not become involved in either of the two conferences, Dellinger was appointed vice chairman of the U.S. Delegation that took part in the Third Inter-American Radio Conference, held in Rio de Janeiro in 1945. The conference was attended by representatives of 22 American nations. The outcome was, in effect, a treaty that formed a basis of regulating communications among the American nations.

The Fourth Inter-American Radio Conference convened in 1949 in Washington, D.C. T. N. Gautier of the Upper Atmosphere Research Section, and W. Q. Crichlow of the Frequency Utilization Research Section, CRPL, served as technical advisors to the U.S. Delegation.

## URSI—FULFILLMENT IN INTERNATIONAL SCIENTIFIC COOPERATION<sup>24</sup>

### 1. What is URSI?

The acronym URSI became a familiar "name" to the Radio Section, the CPRL, and NBS over the many years from the early 1920's.<sup>25</sup> It has served almost as a synonym for the organization whose name is International Scientific Radio Union (later changed to International Union of Radio Science).

---

<sup>23</sup> The report, entitled "Report of Committee on Radio Propagation Data," was published in the October 1933 issue of the *Proc. IRE*.

<sup>24</sup> Dellinger, in a paper entitled "The work of the International Union of Scientific Radio Telegraphy" published in the April 1923 issue of the *Proc. IRE*, stated in part:

It is believed that radio is unique among the few fields having special adaptability to a large-scale international research program. The phenomena that must be studied are world-wide in extent, and yet are in large measure subject to control of the experiments. . . .

It (URSI) is organized:

1. To promote the scientific study of radio communication.
2. To aid and organize researches requiring cooperation on an international scale and to encourage the discussion and publication of the results of such researches.
3. To facilitate agreement upon common methods of measurement and the standardization of measuring equipment.

<sup>25</sup> Dellinger, in the opening paragraph of his banquet address "Almost Fifty Years of URSI" given at the December 1960 URSI-IRE Meeting at Boulder, said:

URSI—if I were Professor Kennelly, I would automatically say "URSI, the bears". Although a professor of electrical engineering, being a Harvard professor, Kennelly could not forget his Latin, so to him URSI was always the bears. That remarkable man was one of the early presidents of URSI; was the discoverer of the ionosphere (some of you have heard of the "Kennelly-Heaviside layer") and was the father of the coded Ursigrams [4].



The International Scientific Radio Union was established in 1919, shortly after World War I, but its roots go back to 1913.<sup>26</sup> It was not until 1922 at the General Assembly in Brussels that URSI became organized functionally in the form that has existed essentially the same to the present time.<sup>27</sup>

## 2. The U.S. joins URSI

On October 26, 1920, a meeting was held in Washington under the auspices of the National Research Council to organize an American Section of URSI. Eight people attended this meeting by invitation, including Kolster, chief of (Radio) Section 6b, and Dr. Austin who was stationed at NBS and headed the U.S. Naval Radio Research Laboratory located at NBS.<sup>28</sup> General Gustave Ferrié of France, one of the organizers and the first president of URSI, was in attendance at the Washington meeting. At a meeting of the Executive Committee of the American Section on January 19, 1921, Austin was elected chairman and

---

<sup>26</sup> A capsule summary of the origin of URSI can be found in the introductory paragraph to a short article by Millet G. Morgan entitled "The International Scientific Radio Union—URSI," in the June 1967 issue of the *Proc. IRE*, p. 742. It reads:

URSI is one of fifteen international scientific unions organized under the International Council of Scientific Unions. Its history dates from 1913 when a group of scientists from six European countries, meeting in Brussels on October 27, decided to establish an International Commission of Scientific Wireless Telegraphy. World War I intervened before the Commission began to function, but after the war it was reformed as the International Union of Scientific Radio Telegraphy and was established in 1919, with three other Unions in astronomy, geophysics and chemistry, under the auspices of the International Research Council which subsequently became the International Council of Scientific Unions. In 1928, the Union on radio telegraphy dropped the word "telegraphy" from its name and took the name International Scientific Radio Union. It soon became known by the pronounceable acronym, URSI, from the French version of its name (Union Radio Scientifique Internationale).

In 1969 the English name was changed to International Union of Radio Science.

Note: Louis W. Austin (very active with URSI affairs for many years) in a Communication to the National Research Council in 1931 stated that:

It (URSI) originated from a conversation in Paris in October 1912, between Dr. R. B. Goldschmidt of Brussels and Professor H. Schmidt of Halle (Belgium). Their plan was to organize an international body for arranging and coordinating investigations on radio wave propagation, and for study of other scientific problems of radio telegraphy.

R. B. Goldschmidt became the first general secretary of URSI.

<sup>27</sup> At the international level URSI holds meetings called General Assemblies. Beginning with the Brussels meeting of 1922, 18 General Assemblies have been held, 2 in the United States, at Washington, D.C. in 1927 and at Boulder, Colo. in 1957. Many hundreds of participants attend these meetings in different parts of the world at which papers are presented and symposia are held on the latest developments in radio science.

Technical work of URSI is conducted on a continuing basis by internationally constituted bodies called Commissions. Four were established during the 1919-1922 period, namely: I, Measurement Methods and Standardization; II, Wave Propagation; III, Atmospheric Disturbances; and IV, Cooperation with Radio Amateurs. (The founding fathers apparently valued the observations of propagation made by radio amateurs as did the NBS Radio Section in the early 1920's. See ch. VII.) Later, Commission IV was called Cooperation with Other Sciences; then it was dropped as an operating body.

In more recent times (up to 1972) the international commissions have been organized to keep abreast of growth in radio science as follows:

- I. Radio Standards and Measurements
- II. Radio and Troposphere—Propagation
- III. Ionospheric Radio—Propagation
- IV. Radio Noise of Terrestrial Origin
- V. Radio Astronomy
- VI. Radio Waves and Circuits
- VII. Radio Electronics

In the United States a third operational group is the U.S. National Committee of URSI, organized under the National Research Council. It holds national meetings for discussion and promotion of radio science. Hence, it is quite common to see the combination abbreviation USNC/URSI, which for sake of brevity is used for United States National Committee/International Union of Radio Science.

<sup>28</sup> In 1920 the Radio Section was divided in two subsections: Section 6a, Radio Research and Testing, headed by Dellinger; and Section 6b, Radio Development, headed by Kolster (see. ch. IV, p. 71).

Dellinger technical secretary, a position he held until 1933.<sup>29</sup> These officers also served the American Section. Almost immediately the Radio Section (reorganized February 1, 1921) became active in URSI-related research by conducting experiments "on a method of stray and atmospheric disturbances especially at short wave lengths." By the summer of 1921 Dellinger was attending meetings of URSI at an international level when he was serving as a Department of Commerce representative at a meeting in Paris of the Inter-Allied Provisional Radio Technical Committee. On this occasion the young URSI organization was taking part in the Inter-Allied Committee (see p. 657, footnote 4).

### 3. The American Section grows—And matures

By 1923, 2 years after the American Section was organized, six committees or commissions were functioning within the American Section. Austin was designated chairman of the Committee on Radio Wave Transmission Phenomena, and Dellinger was chairman of the Committee on Methods of Measurement and Standards. Gregory Breit, formerly of the Radio Section, was designated chairman of the Committee on Radio Wave Direction. These assignments continued for a period of years.

After organization of the American Section, annual meetings were held in Washington, D.C. in April for presentation of progress reports by chairmen of the technical committees and for general discussion. Beginning in 1926 these meetings were enlarged in scope, including the presentation of papers by those taking an active part or interest in URSI. At the 1926 2-day meeting three members of the Radio Section presented papers.

The Fourth Annual Convention of the Institute of Radio Engineers (IRE) was held in Washington on May 13 to 15, 1929.<sup>30</sup> Dr. Jolliffe of the Radio Section was chairman of the Convention Committee. On May 15, the third day of the convention, a joint meeting of the IRE and URSI was held at the Mayflower Hotel, the convention headquarters. Thus began the close relationship of the two organizations for joint meetings that has continued over the years to the present time [5]. At the 1929, and first joint meeting, Dellinger reported on "Current developments in radio measurement research," and Austin on "Current developments in radio wave propagation research."<sup>31</sup> Over the many years these joint meetings have been held in the "springtime in Washington" in close time association with meetings of the American Physical Society, American Geophysical Union, National Academy of Sciences, and other scientific societies.

Dellinger continued to be technical secretary of the American Section until 1933 at which time he was elected vice chairman. In 1940 he was elected chairman and held the post until 1949. Samuel S. Kirby was elected technical secretary and treasurer of the section in 1934 and held the position until his death in 1941. Newbern Smith served as secretary-treasurer, and later as vice president, beginning in 1947 and continuing to 1953.

At a banquet during the Fall Meeting of the U.S. National Committee (formerly the American Section) of URSI at Boulder, Colo. in December 1960, Dellinger was presented with a citation for long and meritorious service to the organization.

### 4. The American Section stages two General Assemblies

The American Section (later known as the U.S. National Committee) has had the opportunity of hosting two General Assemblies of URSI, the IInd Assembly held in Washington, D.C. in the fall of 1927, and the XIIth Assembly held in Boulder, Colo., August 22 to September 5, 1957.

---

<sup>29</sup> On January 31, 1921, Kolster took a year's leave of absence from NBS and did not return (see ch. IV, p. 71). He took no active part in URSI after the initial meeting.

<sup>30</sup> Although the IRE was then 17 years in existence, the National Conventions for presentation of technical papers did not begin until 1926. Formerly, the annual meetings were largely for conducting the annual business affairs of the organization.

<sup>31</sup> Dellinger in the Radio Section's Monthly Report of April 1934 and the Annual Report of FY 1934 refers to the 1934 annual meeting of URSI in Washington as the first joint meeting with the IRE rather than the second. Dellinger may have taken the viewpoint of URSI inviting the IRE into joint session, whereas in 1929 the IRE had invited URSI into joint session. Dellinger presided at the 1934 meeting.

Austin and Dellinger were two of the five official delegates representing the American Section at the 1927 Assembly. Austin, chairman of the American Section, presided at the opening session on October 10.<sup>32</sup> Five papers were presented by NBS personnel or former NBS personnel, namely: Dellinger, Kolster (in 1927 chief engineer, Federal Telegraph Co., Palo Alto, Calif.), Haraden Pratt, Austin (with Miss I. J. Wymore), and E. B. Judson, the papers ranging in subjects from frequency standards to vagaries of radio transmission.

By 1957 the CRPL was well established at the Boulder Laboratories and could effectively stage the XIIth Assembly. Dellinger, an Honorary President of URSI and an active and long-time member of the U.S. National Committee, was selected to serve as chairman of the General Arrangements Committee. K. A. Norton and A. H. Shapley served as chairmen of the Local Arrangements Committee, with about 30 NBS staff members making up the committee. Approximately 880 people attended the Assembly—including over 300 family members—making it the largest, at the time, of any General Assembly. The nearly 500 delegates and observers represented 22 countries.<sup>33</sup>

<sup>32</sup>The record of this Assembly shows that 35 people attended the opening session and nearly half of this number were NBS or NBS-related persons. In contrast, nearly 500 delegates and observers attended the 1957 Assembly in Boulder.

<sup>33</sup>The presence of so large a group of scientists was a notable event in Boulder. The Plenary Opening Session on August 26 was chaired by H. W. Wells, chairman of the U.S. National Committee. A short address by Quigg Newton, president of the University of Colorado, opened the meeting, followed by a welcome by the Mayor of Boulder, Leo C. Riethmayer. The assembly was greeted by F. W. Brown, director of the Boulder Laboratories. Detlev W. Bronk, president of the National Academy of Sciences, addressed the Assembly, followed by a response by Father Lejay, S.J., president of URSI.



*Delegates, observers, and families attending the XIIth General Assembly of the International Scientific Radio Union (URSI) held at Boulder, August 22 to September 5, 1957. Photo taken in the Mary Rippon Theatre, University of Colorado, best known as the locale of the annual Shakespeare Festival. Officers of URSI and others associated with staging the XIIth Assembly can be identified in the center of the front row.*



*Executive Committee of URSI at the XIIth General Assembly, Boulder. Photo taken August 22, 1957, on day of opening ceremonies.*

- |                                |                                |
|--------------------------------|--------------------------------|
| <i>Sitting, left to right*</i> | <i>Standing, left to right</i> |
| <i>Dellinger</i>               | <i>Martyn</i>                  |
| <i>van der Pol</i>             | <i>Berkner</i>                 |
| <i>Appleton</i>                | <i>Decaux</i>                  |
| <i>Burrows</i>                 | <i>Harang</i>                  |
| <i>Lejay</i>                   | <i>Dieminger</i>               |
| <i>Herbays</i>                 | <i>Sterky</i>                  |
| <i>Coutrez</i>                 | <i>?</i>                       |
| <i>Tellegen</i>                | <i>Wells</i>                   |
|                                | <i>McKinley</i>                |
|                                | <i>?</i>                       |
|                                | <i>Manneback</i>               |
|                                | <i>Smith-Rose</i>              |
|                                | <i>?</i>                       |
|                                | <i>?</i>                       |
|                                | <i>Goldman</i>                 |
|                                | <i>Gerber</i>                  |
|                                | <i>?</i>                       |
|                                | <i>Koga</i>                    |
|                                | <i>Ellyett</i>                 |
|                                | <i>Ratcliffe</i>               |

*\*Identified by Dellinger (Box 4, Papers of J. H. Dellinger, NN365-25)*

During the Assembly 311 reports and papers were submitted, organized around the 7 major fields of activity (the 7 permanent commissions). Many social events, tours, technical field trips, and ladies' and children's programs were provided for the Assembly participants.<sup>34</sup> A banquet was held in Dellinger's honor, at which time he was presented a citation for his long and meritorious service to URSI.

At the Plenary Closing Session, Lloyd V. Berkner, the incoming president, in his address of acceptance epitomized the accomplishments of URSI during its 40 years of

<sup>34</sup> An item of interest was noted following the Assembly by Dellinger in his letter of October 17, 1957, to the URSI organization. He stated, in part, in his commendations:

. . . The program for ladies and children was extraordinarily complete in plan and meticulous in execution; it will be the model (or ideal) for international meetings for a long time to come.

Mrs. Kenneth A. Norton was chairman of the Ladies' Program Committee of approximately 60 ladies.

existence: "No one can assume leadership of a really great organization without a feeling of humbleness, and the URSI is great. It has become great for many reasons."<sup>35</sup>

## 5. Reaching the international level

In 1932 Austin was elected to the presidency of the international URSI just a few months before his death on June 27, 1932.<sup>36,37</sup> He had been a vice president since 1921.<sup>38</sup> Dellinger served as a vice president for the period of 1934-1952. In 1952 Dellinger was appointed Honorary President of URSI, a post that is held for life. Lloyd V. Berkner, a former member of the Radio Section (1928-1933), was elected to the presidency of URSI in 1957 and served for 3 years.<sup>39</sup> He had been a vice president during the period of 1954-1957.

As members of the U.S. Delegations to General Assemblies of URSI, NBS-related personnel have served at most of the international meetings, beginning with Austin at the

---

<sup>35</sup> In brief, Berkner's enumeration of the many reasons was:

First, we live in great times—times to which the U.R.S.I. and its members have made a substantial and even major contribution. . . .

Second, U.R.S.I. is great because the subject with which it deals is at the very heart of science. Radio and electronics provide the nerve systems for scientific observations in essentially every field of science in our day. . . .

Third, U.R.S.I. is great because of the strength of its organization. . . .

Fourth, U.R.S.I. is great because of its vitality and its ability to evolve with the growth of its science. . . .

Fifth, U.R.S.I. is strong because it has been the forum that has brought together men of great intellectual capacity. . . .

Finally, and above all, U.R.S.I. is strong because of the strength and vision of its leaders throughout the history of U.R.S.I.'s growth. Among the early presidents appear the leading names in radio science. . . .

<sup>36</sup> At its annual meeting on April 27, 1933, the American Section of URSI featured a commemoration of the life and work of Austin.

<sup>37</sup> In the Proceedings of the General Assembly of URSI of 1934 (London), the following was stated under the report of the Secretary-General, in commenting on Austin's death (by first referring to the death of General Ferrié, founder and first president of URSI, who had died on February 16, 1932):

. . . This great loss was suffered by U.R.S.I. and its Secretary-General soon after the 4th General Assembly.

It was necessary to find a successor capable of taking up his work. The U.S.A., in the high personality of Dr. L. W. Austin, replied to our appeal. Vice-President of U.R.S.I., endowed with the scientific authority which his name evoked immediately throughout the world, Dr. Austin agreed to be for us a competent guide, full of clairvoyance and solicitude.

Alas, hardly had he taken over the supreme direction of our Union when he fell also, June 27, 1932.

We regret this greatly, not only for himself—the most precious of friends of U.R.S.I.—but also the profound knowledge which he brought to us and the precision of the far-seeing spirit which directed his work.

And now, turning again to the U.S.A., we asked Prof. A. E. Kennelly to take over the heavy responsibility of the double succession. He hesitated a long time, but after our insistence he acquiesced.

<sup>38</sup> Each General Assembly elects an additional vice president.

<sup>39</sup> Berkner had the unusual distinction of being president of URSI (1957-1960), president of the International Council of Scientific Unions (1955-1958), president of the American Geophysical Union (1959-1962), and president of the IRE (1961).

first Assembly in Brussels in 1922. Dellinger served as a voting delegate to nine of the Assemblies and was chairman of the U.S. Delegation at the Stockholm Assembly in 1948.<sup>40</sup> During the period of 1950 to 1960 Dellinger was chairman of the Publications Committee for URSI operations.

During the organizational period of URSI (1919-1922), Austin became the first chairman of the Commission on Wave Propagation, a position that he held until his death in 1932.<sup>41</sup> During those years much of the work that he carried on in the Laboratory for Special Radio Transmission Research (a special group within the Electricity Division, NBS) was conducted in the interest of URSI (see ch. II, pp. 35-38 and ch. VII, pp. 175-176). Following Austin's death in 1932, Dellinger became chairman of the Commission on Radio Wave Propagation (slight change in title), a position that he held until 1948 at the time he retired from Government service. Newbern Smith was vice chairman of the Commission for 1 year in 1948.

As knowledge of the radio transmission medium progressed, other propagation commissions were established. Thomas J. Carroll, a former member of CRPL (1946-1951), was secretary of the Radio and Troposphere Commission during 1954-1957. Berkner was vice chairman of the Ionospheric Radio Commission from 1954 until 1961. In 1963, and continuing for several terms, Jack W. Herbstreit and Robert W. Knecht became secretaries of Commission II, Radio and Troposphere, and Commission III, Ionosphere, respectively.

At the time of his retirement in 1948 Dellinger became chairman of Commission I on Radio Measurements and Standards, a post that he held until 1952. William D. George became vice chairman of this commission in 1954 and remained so until his death in 1963, at which time Robert W. Beatty of the Radio Standards Division continued the term of office until 1964. In 1972 Helmut M. Altschuler of the Electromagnetics Division was elected vice chairman of Commission I and in 1975 became chairman. From 1963 to 1969 Beatty served as scientific editor of Commission I. Recently the name of the commission was changed to that of Commission I-A-Electromagnetic Metrology (including radio standards and biological reactions).

Beginning in 1951 URSI has been represented at General Assemblies of the CCIR and has sustained the URSI Committee for CCIR Work for study of questions posed by the CCIR. Dellinger was the first chairman of this committee, beginning in 1954 and continuing until his death in 1962.<sup>42</sup>

---

<sup>40</sup> A tabulation of *voting delegates* to URSI General Assemblies by NBS-related personnel follows:

I	Brussels, 1922	Austin	X	Sydney, 1952	Dellinger
II	Washington, 1927	Austin, Dellinger	XI	The Hague, 1954	Dellinger
III	Brussels, 1928	Austin, Taintor Parkinson	XII	Boulder, 1957	Dellinger
IV	Copenhagen, 1931	Austin, Dellinger	XIII	London, 1960	Dellinger
V	London, 1934	Dellinger	XIV	Tokyo, 1963	-----
VI	Venice, 1938	S. S. Kirby	XV	Munich, 1966	-----
VII	Paris, 1946	-----	XVI	Ottawa, 1969	-----
VIII	Stockholm, 1948	Dellinger	XVII	Warsaw, 1972	-----
IX	Zurich, 1950	Dellinger	XVIII	Lima, 1975	-----

Berkner, formerly of the Radio Section, was a delegate to the 1957 Boulder and 1960 London Assemblies, and was president of the London Assembly.

<sup>41</sup> The name "chairman" of a commission is sometimes interchanged with the name "president" in URSI documents.

<sup>42</sup> In a letter to Dellinger dated 5 February 1962, R. L. Smith-Rose, president of URSI, stated in part:

I would like to take this occasion of expressing on behalf of U.R.S.I., our appreciation of the outstanding work you have carried out over many years in securing a very effective measure of liaison between U.R.S.I. and C.C.I.R., particularly in the field of radio-wave propagation on which you have such expert scientific and practical knowledge. I am sure that the close connection between these two bodies which you have effected will be very beneficial to their continuing work in the international field. (NN365-25, Box 4)

## 6. International intercomparison of laboratory standards

The acronym URSI connotes to most people the gaining of knowledge and the making of observations of radiowave propagation, and to a much lesser extent the use of standards and conducting measurements in the laboratory. Yet from the beginning of URSI, Commission I was assigned the cognizance of radio measurements and standards. At the VIIth General Assembly at Paris in 1946 it was recognized by Commission I that international comparison of standards at radio frequencies would probably have to be conducted with equipment designed for specific electrical quantities at selected radio frequencies rather than by the process of derived quantities from the more basic electrical quantities (such as dc standards). Yet it was not until the XIIth General Assembly at Boulder in 1957 that a strong resolution evolved from Commission I to proceed with an international comparison of power standards at specific radio frequencies (3000 to 10,000 MHz).<sup>43</sup>

In 1957 Japanese delegates to the General Assembly at Boulder brought with them an X-band (8.2-12.4 GHz) bolometer unit for comparison with an NBS power standard. There was initiated a series of intercomparisons of microwave power standards to extend for several years with Japan and later with the United Kingdom. In the 1960's these intercomparisons of power standards were extended to Canada, the U.S.S.R., and East Germany. Close agreement was attained in the intercomparisons indicating sound approaches in the measurement methods, with an assurance of uniformity in measured value of radio-frequency power on an international basis. The extensive program was carried on under the direction of Glenn F. Engen of the Radio Standards Laboratory. Intercomparisons of attenuation and noise standards and dielectric measurements at microwave frequencies have also been conducted.

---

<sup>43</sup>The period from 1946 to 1957 was seemingly a decade of vacillation on the part of Commission I through six General Assemblies in arriving at a specific program of the intercomparison of power standards involving several national laboratories. At the Zurich Assembly in 1950, Commission I stated:

It is the general feeling (of Commission I) that to organize and carry out a real comparison program would not yield new information sufficient to justify the large effort required.

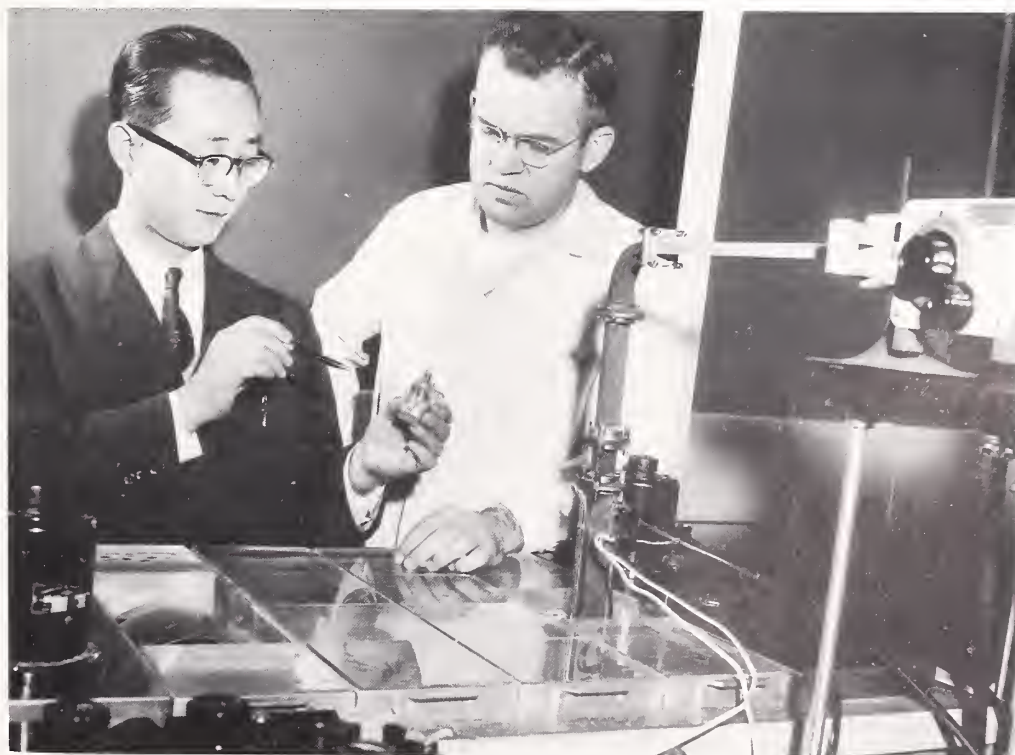

*Glenn Engen of the Microwave Circuit Standards Section and Dr. Ishikawa of Japan examine an X-band bolometer unit in preparation for an international comparison of microwave power standards in March 1958.*

## 7. NBS contributes to the International Geophysical Year

The Radio Section took a somewhat minor role in the Second International Polar Year of 1932-1934 (see ch. VII, p. 220). However, its newly developed multifrequency recorder had recently become available for measurement of virtual heights of the ionosphere layers and the measurements made under the direction of S. S. Kirby were a contribution to the Polar Year program.

At the suggestion made in 1950 by Lloyd V. Berkner, formerly of the Radio Section, there developed within the next 6 years the program for the International Geophysical Year (IGY), an international scientific project of immense proportions.<sup>44</sup> So vast was the program that it encompassed the Earth, took in the solar system, and required the cooperation of 66 nations and 30,000 scientists to bring the project to fruition. The result was a tremendous gain in knowledge of the Earth's environment.

At the Xth General Assembly of URSI at Sydney in 1952 the URSI-IGY Committee was formed to deal with the radio investigations of the IGY and to work in close cooperation with the CSAGI (see footnote 44). In 1955 the committee met in Brussels at which time a subcommittee was formed with Alan H. Shapley of the CRPL as chairman. This committee became known as the World Wide Soundings Subcommittee and was responsible for the detailed planning of the IGY vertical ionospheric soundings program. More than 170 stations scattered over the Earth became involved in this project (CRPL became responsible for the operation of 37 of these stations). Shapley also became one of the three U.S.A. members to serve on the international CSAGI.

At the national level Shapley was selected to serve as vice chairman of the U.S. National Committee and was a member of the Executive Committee that was now taking a major role in development of the IGY program. Shapley became very much of a "world traveler" as the IGY project accelerated in activity. With time he became more involved in the project and was the international coordinator for the IGY World Days program.<sup>45</sup> Shapley also served on the Arctic and Antarctic Committees and on Technical Panels on Ionospheric Physics, Solar Activity, and World Days and Communications.

As the entire project got into full swing an estimated 100 or more of NBS personnel became involved. Taking a more active part in the committee functions of the U.S. National Committee were: Franklin E. Roach, vice chairman of the Technical Panel on Aurora and Airglow; Ralph J. Slutz, a member of the Technical Panel on Ionospheric Physics, and also A. Glenn Jean who served as a consultant on the Panel.<sup>46</sup>

---

<sup>44</sup> This suggestion was made by Berkner, then of the Carnegie Institution of Washington, at a social gathering on April 5, 1950, at the home of James Van Allen (of Van Allen Belts fame) in Silver Spring, Md., honoring Sydney Chapman (then a professor of physics at Oxford University). The proposal was that of a Third International Polar Year and this was submitted to the mixed Commission on the Ionosphere (a group formed in 1947 with representation of four Scientific Unions, including URSI). At the General Assembly of URSI at Zurich in September 1950 the proposal was endorsed by the Assembly and by Commission III, Ionospheric Radio. The proposal also came before the International Council of Scientific Unions out of which was set up the Comité Spécial de l'Année Géophysique Internationale (CSAGI). It was this special committee headed up by Sydney Chapman, and with Berkner as a member, that steered the course of the development of the IGY program during the next 6 years. See: Walter Sullivan, *Assault on the Unknown*, Ch. 3, "Global Plans," McGraw Hill, New York, 1961.

<sup>45</sup> These were special days or intervals selected by NBS to alert scientists around the world to the more frequent and more intensive observations from a global network of observatories and laboratories. The NBS nerve center for this warning program was operated at the radio station, Ft. Belvoir, Va., just south of Washington. The international communication network involved many facilities including military, commercial, and the Bureau's own WWV and WWVH stations.

<sup>46</sup> During the period of July 30-August 9, 1958, a group from the CRPL attended the International Geophysical Year meeting (sponsored by the CSAGI) at Moscow, Russia and included Alan Shapley, Virginia Lincoln, David Gates, and Franklin Roach.



IGY as a "year" project covered the period of July 1, 1957, through December 1958.<sup>47</sup> It was a period of maximum sunspot activity which was anticipated and taken into consideration. At least 15 major scientific programs were planned and pursued. Of these, NBS became directly involved in ionospheric studies, scatter propagation, radio noise, whistlers, and airglow. To preserve and provide easy access to the recorded information, three IGY World Data Centers were established, that for the Western Hemisphere at Washington, D.C. However, the actual records for the Washington Center were stored at 15 locations or centers in the United States, each assigned to a particular discipline of the IGY program. Records for the airglow, ionosphere, and solar activity were stored with CRPL at Boulder.<sup>48</sup>

What was achieved in this greatest of all nonpolitical international cooperative programs? Certainly the world learned that international cooperation is possible, at least in the scientific realm. The satellites launched during the program led to the discovery of the Van Allen Belts, a region of intense particle radiation that surrounds the Earth out at a considerable distance. It was during the IGY period that the first artificial satellites were launched, the Russian Sputnik I on October 5, 1957, and the U.S. Explorer I on January 31, 1958. And last, a tremendous amount of information was gathered and slowly digested that led to a vast increase in knowledge of the physical world and its relation to the solar system.

## 8. Reflections of URSI

Although the periodical now known as *Radio Science* began as an NBS publication in 1959, URSI joined in its sponsorship in 1964. In July 1959, Section D (Radio Propagation) of the *NBS Journal of Research* was launched as the fourth section following a trend of sectionalizing the *Journal* into broad areas of subject matter. Section D would:

serve primarily as a medium for the reporting of research activities of the NBS Central Radio Propagation Laboratory relative to its mission of obtaining, analyzing, and disseminating information on the propagation of radio waves.

James R. Wait of the CRPL was selected as the first editor.<sup>49</sup> The periodical became a joint venture of NBS and the U.S. National Committee of URSI in 1964 with C. G. Little as the NBS editor and L. A. Manning of Stanford University as the URSI editor. After 1965 the NBS sponsorship changed to ESSA (Environmental Science Services Administration). Beginning in January 1969 *Radio Science* became solely the journal of the U.S. National Committee of URSI, published by the American Geophysical Union.

On June 1, 1931, NBS entered into a cooperative program with URSI to supply information on the ionosphere for radio broadcasts and for a weekly publication. This service became a part of the American URSIgram service, with publication of URSIgrams by Science Service of Washington, D.C. (For a more detailed account see ch. VII, pp. 234-237, in relation to NBS preparing ionosphere information for the Nation.)

Action taken at the XIIth General Assembly of URSI in Boulder (1957) led to the initiation at the London Assembly (1960) of a "series of lectures dedicated to those whose

---

<sup>47</sup>The "year" was extended 1 additional year for some observations and meetings and was known as the International Geophysical Cooperation of 1959. Five years later solar activity would be at a minimum and another international project was underway, The International Year of the Quiet Sun, a 2-year project directed by the International Committee for Geophysics.

Following close in the path of the IGY program was a Conference on Arctic Communication held at the Boulder Laboratories in March 1959 and sponsored by the CRPL. About 275 persons attended representing universities, the Department of Defense and other Government agencies, and several foreign countries. The objectives of the conference were to review results of recent Arctic radio research and to discuss current research and operational problems.

<sup>48</sup>The World Data Center at Boulder was first under the supervision of Walter B. Chadwick and Sidney M. Ostrow.

The solar activity center is now called the World Data Center A for Solar Terrestrial Physics, located at Boulder, with Virginia Lincoln as the director.

<sup>49</sup>For a period David M. Gates, also of CRPL, served as editor and then Wait took over again.

works and devotion have contributed to increase the prestige and standing of U.R.S.I.”<sup>50</sup> In 1966, at the General Assembly in Munich, the “John Howard Dellinger Memorial Lecture” was given by Millet G. Morgan, chairman of the U.S. National Committee, in which he reviewed the many accomplishments of Dellinger. A booklet entitled *Dellinger Memorial Lecture* was published by the Secretary General of URSI [6].<sup>51</sup>

In 1965 the U.S. National Committee provided for the awarding of the Dellinger Gold Medal at each General Assembly to a scientist who had distinguished himself in the field of radiowave propagation. The Gold Medal was first awarded to John H. Chapman at the Munich Assembly in 1966 for his outstanding achievements in radio propagation, and especially for his association and observations of the Alouette I spacecraft, a topside ionosphere sounder. In accepting the Dellinger Gold Medal, Chapman, of the Defence Research Telecommunications Establishment of Canada, addressed the Assembly on his work with the Alouette satellite.<sup>52</sup>

Dellinger’s viewpoint and evaluation of URSI was well expressed in his “History of U.R.S.I.” written as a chapter for the *U.R.S.I. Golden Jubilee Memorial* published in 1963 after his death on December 28, 1962 [7]. His concluding remarks to the historical account were:

The history of U.R.S.I. has been one of steady growth, of effort to coordinate the international scientific foundations of the fantastically extending roles of radio and electronic applications. Our domain extends over the earth, throughout the solar system, and out among the galaxies. A historical account is not the place to examine the future. But we can be sure of one thing: when man reaches the outermost limits of the observable universe he will be materially assisted by means of radio for communications, navigation, and control using the electromagnetic waves envisaged by the genius of Clerk Maxwell a hundred years ago.

The rapid advances in space communications during the next decade after Dellinger’s assertion more than bore out his prediction.

## **9. The proliferation of international committees within the CRPL— Then divergence**

After organization of the Central Radio Propagation Laboratory in 1946 there was increasing involvement of its staff members with committee work on an international scale. This was particularly the case with CCIR and URSI involvement and later with the IGY program. In total number of international committees and in time given to committee work,

---

<sup>50</sup>The first lecture was given at the London Assembly in 1960 in memory of Robert Goldschmidt, founder and first Secretary General of URSI. The second lecture was given at the Tokyo Assembly in 1963 at which time the Professor Balth. van der Pol Gold Medal was first awarded for researches contributing to the development of one of the fields of URSI activities.

<sup>51</sup>The booklet was dedicated to the memory of Dellinger and read:

This booklet is dedicated to the memory of Dr. J. H. Dellinger who has been one of the most distinguished and devoted supporters of the International Scientific Radio Union. We are expressing the hope that many young scientists will follow the way he has shown in the research and work he has realized and in the fulfillment of the various offices held in URSI as Honorary President and Vice-President of the Union, as well as Chairman of Commissions and Committees.

Morgan’s concluding remark to the Dellinger Memorial Lecture was:

“ . . . Dellinger’s interest in radio history, and his energy to delve into it, continued to the end of his life.”

<sup>52</sup>The second award of the Dellinger Gold Medal was to Professor H. M. Barlow of the University of London for his outstanding work on the development of waveguides and on the characteristics of surface waves.

the activity probably peaked around 1960. Then came the very sharp decrease in NBS-related involvement with radio propagation committees in 1965 with the transfer of CRPL to the newly organized Environmental Science Services Administration. Thereafter, only a small number of international committees relating to radio projects remained within NBS.<sup>53</sup>

---

<sup>53</sup> The international committees and their membership that existed in 1946 and that were formed thereafter within the CRPL are listed in appendix B entitled, "Committee Memberships, relating to the general subject of radio associated with International Organizations and Conferences from the time of formation of the Central Radio Propagation Laboratory May 1, 1946, to 1975." This listing was prepared to indicate the magnitude, nature, and diversification of subject matter of committee work of the CRPL. The listing also offers opportunity to credit individuals with their committee work.

## REFERENCES

- [1] Anthony R. Michaelis, *From Semaphore to Satellite*, International Telecommunication Union, Geneva, Switzerland, 1965.
- [2] George Arthur Coddington, Jr., *The International Telecommunication Union*, E. J. Brill, Leyden, The Netherlands, 1952.
- [3] R. C. Kirby and C. G. Little, "Conference on Arctic Communication," *J. Res. Nat. Bur. Stand. (U.S.)*, Vol. 64D (Radio Propagation), No. 1, Jan.-Feb. 1960, pp. 73-80.
- [4] J. Howard Dellinger, "Almost fifty years of URSI," *J. Res. Nat. Bur. Stand. (U.S.)*, Vol. 65D (Radio Propagation), No. 4, July-Aug. 1961, pp. 317-320.
- [5] J. H. Dellinger, "International cooperation in radio research—URSI and IRE," *Proc. IRE*, Vol. 44, No. 7, July 1956, pp. 866-872.
- [6] *Dellinger Memorial Lecture* (Munich, Sept. 7, 1966), published by Secretary General of URSI, Brussels, Belgium, 1967.
- [7] *U.R.S.I. Golden Jubilee Memorial*, published by Secretary General of URSI, Brussels, Belgium, 1963.



## Chapter XVIII

### THE PRECURSOR ROLES

“I’ll show thee a precedent”

—Shakespeare

“What was now a path has become a highroad”

—Martial, Epigrams A.D. 90

### TAKING A PROFESSIONAL STANCE

#### 1. The Bureau’s early publications on radio

All of the early publication efforts within the NBS relating to subject matter at radio frequencies were limited to the Bureau’s earliest publication medium, *Scientific Papers*.<sup>1</sup> Not until a paper by Kolster appeared in Volume I, 1913, of the *Proc. IRE* did any of the papers appear in outside periodicals (see sec. 2, below).

The earliest papers published by a staff member of NBS on a radio subject were two *Scientific Papers* by Louis W. Cohen entitled, “The influence of frequency on resistance and inductance,” (December 1907), and “The theory of coupled circuits,” (May 1909).<sup>2</sup> Cohen was a member of the Electricity Division (see ch. II).

Dellinger’s doctoral dissertation (1913), Princeton University, was published as a Bureau *Scientific Paper* in January 1914 with the title, “High frequency ammeters” (see ch. II). His second paper on a radio subject was published as a *Scientific Paper* in December 1919 and was titled, “Principles of radio transmission and reception with antennas and coil aeriels” (see ch. VI).<sup>3</sup>

Shortly after Dellinger’s thesis appeared as a Bureau *Scientific Paper*, Kolster published a paper on his development of a direct-reading logarithmic decimeter combined with a wavemeter, a measurement instrument for which he gained considerable recognition

---

<sup>1</sup>The *Scientific Papers* were published by the Bureau during the period of November 1904 to July 1928 when the Bureau’s research papers began to appear in the new *Journal of Research*. Previous to July 1919 the *Scientific Papers* were called Reprints, and in bound volumes (previous to volume 15) were known as the *Bulletin of the Bureau of Standards*. Beginning with volume 15 and extending to and including volume 22, which last appeared in 1928, the bound volumes were known as the *Bureau of Standards Scientific Papers*.

<sup>2</sup>An important consideration that should not be overlooked in discussing the earliest papers and lectures that emerged from the Radio Section (Laboratory) by 1918 is the fact that Louis Austin had published 40 papers on radio subjects by the end of 1918. Moreover, many of these papers, and especially his earlier papers dating back to 1905, were published as Bureau papers in Bureau publications. However, during this period (1905-1918) Austin was not a Bureau employee; during most of the period he was an employee of the Navy Department but stationed on the Bureau grounds (see ch. II).

One other paper that appeared as a Bureau *Scientific Paper* on the subject of radio was that by A. Hoyt Taylor, published in November 1919. Again, like Austin, Taylor was not a member of the Bureau staff but was associated with a Navy installation on the Bureau grounds, the Naval Aircraft Radio Laboratory. His paper was titled, “Variation in direction of propagation of long electromagnetic waves,” and is a matter of considerable discussion in chapter VII.

<sup>3</sup>Dellinger is credited with two other *Scientific Papers* between 1914 and 1919 that were related to the overall program of the Electricity Division. These were titled, “Calculation of Planck’s constant  $c_2$ ,” and “International system of electric and magnetic units.” The latter is of considerable historic value in view of the Bureau’s adoption of the SI units in the spring of 1964 and the country’s more recent acceptance of the Metric System.

as an inventor, along with his radio compass of a few years later (see chs. V and VI). The paper was published in May 1915 as a Bureau *Scientific Paper* entitled, "A direct reading instrument for measuring the logarithmic decrement and wave length of electromagnetic waves."

One other member of the Radio Section, John M. Miller, had two *Scientific Papers* published before the close of World War I, titled, "Effect of imperfect dielectrics in the field of a radiotelegraphic antenna" (March 1916), and "Electric oscillations in antennas and inductance coils" (October 1918).

## 2. The Radio Section addresses professional societies and other groups—And publishes

The first paper (of which there is a record) presented before a scientific society by a member of the Radio Section was by Kolster in February (probably) 1913, before the Institute of Radio Engineers in Fayerweather Hall, Columbia University (see ch. V, p. 00 and footnote 2). The second paper, also by Kolster, was presented before the newly organized Washington Section of the Institute of Radio Engineers on February 5, 1914. On this occasion Kolster described his newly designed direct-reading decremeter and wave meter (also, see ch. V, pp. 104-105).

The first paper on radio by Dellinger (of which there is a record) presented before a scientific society was given on March 2, 1918. This paper, entitled "The principles of electrical measurements at radio frequencies," was given before the Philosophical Society of Washington [1]. The paper was delivered during World War I, and shortly thereafter, on May 10, 1918, at the request of the Army Signal Corps, Dellinger addressed the Radio School at College Park, Md. The title of his lecture was "Theory of antennas and closed coil radiators."<sup>4</sup> Later in the year (September 25, 1918) Dellinger addressed the Interdepartmental Radio Conference at Washington on the same subject matter, but with a change in title.

In the following spring came the presentation of eight papers by the Radio Section before the American Physical Society at its meeting in Washington, April 25-26, 1919. This meeting "was given over entirely to special papers and exhibits of apparatus illustrating the application of physical principles to the solution of problems arising from war conditions."<sup>5</sup>

An event that should not be overlooked was that of the first lecture (of which there is a record) to be given by a member of the Radio Section beyond the environs of Washington, D.C. The occasion was a lecture by Dellinger at the Physics Club of Philadelphia on December 14, 1918. For the title of his lecture, Dellinger selected "The present status of radio research." A year later (November 29, 1919), John M. Miller read the Radio Section's first invited paper at a symposium. This event was the 100th meeting of the American Physical Society in Chicago, the symposium being of "unusual importance on the Electron Tube."<sup>6</sup> Well-known physicists and radio engineers appeared on the program.

---

<sup>4</sup> Records in the Radio File indicate that Dellinger was working with Kolster as early as 1915 on a study of coil antennas for use as direction finders.

<sup>5</sup> This 97th meeting of the American Physical Society was held at the Bureau of Standards. The published account of the meeting stated:

This meeting which was attended by about three hundred members and visitors, was perhaps the most interesting and important which the Society has ever held. It is doubtful whether such an amount of important scientific work has ever before been presented at any scientific meeting in this country. . . . [2].

Two papers by the Radio Section were given in their entirety, six others were read by title only. Lengthy abstracts of five of the papers were published in the August 1919 issue, *Physical Review*. Those of the section participating in the presentations were: Kolster, Dellinger, Whittemore, Willoughby, Lowell, Preston, Breit, and Hull. The subject matter of these papers covered a wide range of World War I research at radio frequencies, such as: apparatus for submarine communication, applications of the cathode-ray oscillograph, and the landing of airplanes.

<sup>6</sup> Among the eight contributors to this symposium "of unusual importance" were those whose names were well known in radio and in the electron-tube industry, including: Langmuir, Arnold, Hazeltine, Morecroft, and Armstrong. Miller's paper was titled, "Theory of action of electron tubes as amplifiers."

The theme of antennas remained with Dellinger for quite a period of time. After several earlier presentations of the subject he presented two papers on antennas in the same month (October 1919), one before the Philosophical Society of Washington, the other before a joint meeting of the IRE and the AIEE in New York City. During 1919 his papers on the subject of antennas appeared in three publications, the *Journal of the Franklin Institute*, the *Bureau of Standards Scientific Papers*, and the *Proceedings of the American Institute of Electrical Engineers* [3].<sup>7</sup>

Ten papers by members of the Radio Section were given before the American Physical Society at its 1921 spring meeting in Washington.<sup>8</sup> One of these must have been of considerable interest in its day, a paper by Dellinger and Whittemore entitled, "The radio research field." Today, in retrospect, the short paper makes for interesting reading.<sup>9</sup>

## THE EARLY ROLES WITH THE INSTITUTE OF RADIO ENGINEERS (IRE)

### 1. In the wake of the beginning

Within less than 1 month after the organization of the Institute of Radio Engineers on May 13, 1912, Kolster, of the Electricity Division, joined the IRE on June 3, 1912, as its 57th member.<sup>10</sup> A former staff member of the Electricity Division, Louis Cohen, joined the same day but was placed alphabetically ahead of Kolster as the 52d member. Austin, then head of

---

<sup>7</sup>In a section of his long Bureau paper, Dellinger took considerable pains to correct the fallacies that existed in textbooks and discussions over the difference between an induction field and a radiation field. He gave a lucid account of the distinction between the two fields and the matter of equivalence of the electrostatic and magnetic fields of a radiated wave.

In his paper before the IRE and AIEE Dellinger stated, in part:

A great many questions and hazy ideas on the behavior of radio waves are cleared up by the study which was made and here presented.

The investigation has opened up a large and most interesting field for further research and progress in the utilization of radio waves.

<sup>8</sup>These spring meetings in the latter part of April at the Bureau of Standards were always a delight to the Society members for it is then that Washington is in its finest spring garb and the azalea displays at the former grounds of NBS were particularly beautiful. Other scientific societies often schedule their meetings in Washington during this same period.

<sup>9</sup>Some of Dellinger and Whittemore's thoughts of 1921 as found in the paper are given below:

Radio communication is a rapidly growing subject both technically and commercially. It was given a great stimulus by the war and is now becoming widely used for government, commercial and private communication.

Much has been learned about the principles of radio communication and the behavior of radio circuits since the use of the electron tube has made precision measurements possible. The Radio Laboratory of the Bureau of Standards has been attempting to serve in this connection by the development of methods of measurement and the study of fundamental principles as well as by encouraging the use of radio communication and radio methods for many purposes.

During the course of work on this subject suggestions continually arise for further research and it is obviously impossible for a limited staff to conduct work on all of them. The Bureau has cooperated with other investigators in the past by suggesting suitable research projects, and has prepared a classified list of radio research projects with the hope that it may be suggestive to many who are anxious to contribute to the development of this field of knowledge. Radio methods offer a convenient avenue of approach to many problems in electric waves outside the strictly radio field. The instruments and methods of radio research are so diversified as to offer a broad training to the research worker.

<sup>10</sup>The Institute of Radio Engineers was organized May 13, 1912, in New York City by the joining together of two engineering wireless societies, the Society of Wireless Telegraph Engineers, and The Wireless Institute.

the U.S. Naval Radio-Telegraphic Laboratory, yet closely associated with the Bureau and located on the Bureau grounds, was the 115th member, joining on January 22, 1913. Dellinger did not join the IRE until 10 years after Austin, on March 1, 1923.<sup>11</sup>

## 2. Taking leading roles in the IRE

Austin became the third president of the IRE, serving the 1914 term. Dellinger was elected vice president for the year 1924 and president in the following year (1925).<sup>12</sup> Two other members of the Radio Section were elected to the presidency of IRE but not until a number of years after they left the section. They were Haraden Pratt who served in 1938, and Lloyd V. Berkner who served in 1961. Pratt also served a very long term as secretary, from 1943 through 1962; and as treasurer during 1941-1942. Laurens E. Whittemore, who transferred to the Department of Commerce in 1923, was vice president in 1928.

Staff members of the Radio Section serving on the Board of Directors of the IRE, either while active in the section or after they left NBS, are listed below, with their terms of office.

Louis W. Austin	1914-1917
J. Howard Dellinger	1924-1931
Laurens E. Whittemore	1926-1929, 1935-1937
Frederick A. Kolster	1933-1935
Haraden Pratt	1935-1962*
Charles B. Jolliffe	1936-1937, 1944
Lloyd V. Berkner	1957-1963

\*Pratt was declared Director Emeritus in 1966.

Those associated with the early work in radio at the Bureau of Standards soon became active on various IRE committees. By 1913 Kolster was serving on the Committee on Papers, and by 1914 he was on the Committee for Standardization. During 1914, when he was president, Austin served as an ex officio member of no less than four committees. In 1915 Kolster was placed on a reorganized Committee on Standardization, along with Austin and Cohen. A few years later Dellinger and Whittemore joined the committee and, later, Whittemore became chairman. For several years Austin and Kolster were on the Committee for Wave Length Standardization.

---

<sup>11</sup> No record of the date of Dellinger's joining the IRE was found in records at the National Archives or in any of the Radio Files and other sources of information at NBS. However, upon inquiring of the IEEE headquarters the reply was, in part, "Our records show that J. H. Dellinger joined the IRE on March 1, 1923." This date came as a real surprise to the author (WFS) in view of Dellinger's early prominence in the radio field. Within 9 months after joining the organization Dellinger became vice president (1924 term), within 21 months he became president (1925 term)—most unusual in a technical society.

<sup>12</sup> Dellinger had the distinction of addressing, as president, the first convention of the IRE. Although organized in 1912, the Institute had held no annual meeting (or convention) for the presentation of technical papers until the one that convened in New York City on January 18 and 19, 1926. In later years these conventions, held in March of each year, became international in scope, with thousands in attendance, and with hundreds of new and novel products in the radio and electronics field on exhibit.

It was on the occasion of the first convention that Dellinger addressed the Institute as the retiring president. A few excerpts from his address catch the flavor of the times in the field of radio engineering.

This is the day of the radio engineer. In the past three or four years there has been widespread popular mystification over how radio is done. People have been inclined to classify it along with acts of the conjurer or in some cases to link it closely with the deeds of the Almighty. The miracles of radio, actually and in the truest sense, are produced not from batteries, coils and electrons, but from the brain of the radio engineer and when the processes of the radio are analyzed they are no more mysterious than any other familiar process. This is the day of the radio engineer in still another sense. Progress in radio has been up to the present by empiricism. Its foundations have now been laid. The outlines of its major forms of service to humanity now appear and the task of perfecting this service and its instrumentalities is the task of the radio engineer. He must and he can apply the principles of science and technology to advance beyond the empirical foundations of the subject and obtain from it, by both logical and laborious procedure, all of its possibilities.

The chief concerns of radio engineering just now are: perfection of broadcasting, and the penetrating of the mysteries of radio wave propagation. . . . There has been great progress and fine achievement in both of them during the past year.



After his term as president in 1925, Dellinger became very active on numerous committees including chairmanship of the Committees on Standardization, on Meetings and Papers, and on Revision of the Constitution. In 1937 he became chairman of the Committee on Radio Wave Propagation. Diamond and Jolliffe also took part in IRE committee work during this period.

It is interesting to note that Bureau authors were among the first to have papers published in the *Proc. IRE*—in the second issue, dated April 1913, and notated as Vol. I, Part II. Kolster's paper was titled, "The effect of distributed capacity of coils used in radio-telegraphic circuits." Austin's (as head of the U.S. Naval Radio-Telegraphic Laboratory) was titled, "The relation between effective resistance and frequency in radio-telegraphic condensers." A number of pages of published discussion followed each of these papers. These two papers were the vanguard of hundreds to follow by NBS authors in the *Proc. IRE* and in the Professional Group publications.

It would be amiss not to call attention to the names of those that have been associated with radio work at the National Bureau of Standards that have received IRE (and later IEEE) Awards, both the earliest of the workers and the more recent workers. Without doubt the IRE (now the IEEE) has been the engineering and scientific society that is held in the highest esteem by workers in radio engineering and radio science the world over. To be the recipient of one of its awards is a distinct mark of achievement. The Awards recipients are listed in the footnote below, as noted by the IEEE.<sup>13</sup>

### 3. The Washington Section of the IRE

The Washington Section of the IRE was the first local section to be organized within the IRE, and was organized in January 1914.<sup>14</sup> The early members of the section, and particularly the early officers, were largely associated with the Navy and War Departments rather than with scientific or technical organizations. Among the early officers, as chairman of the section, was Major General George O. Squier who became the Chief Signal Officer of the Army.

During World War I the Washington Section became somewhat inactive and for a period of time its technical meetings were supplanted by meetings of the Interdepartment Radio Conference. By the summer of 1919 the Washington Section of the IRE had revived itself.

Austin was a member of the executive committee for several years, beginning in 1919. For 1 year, in 1926, Taintor Parkinson, an associate of Austin, was secretary-treasurer. Not until the election of Jolliffe in 1929, as chairman of the Washington Section, did a staff member of the Radio Section become an officer or a member of the executive committee. After 14 years of existing as the Washington Section of the IRE this was a rather unusual circumstance considering the status held of the Radio Section and its staff members in the field of radio. Dellinger, an adept from his term as president of the IRE, became chairman of the section for the period 1932-1933.

---

<sup>13</sup>IRE Award recipients:

*Medal of Honor*

L. W. Austin, J. H. Dellinger, Haraden Pratt,  
George C. Southworth, Charles H. Townes

*Founders Award*

Haraden Pratt

*Harry Diamond Memorial Prize Award*

Allen V. Astin, William Culshaw, J. W. Herbstreit, W. S. Hinman, Jr.,  
David M. Kerns, K. A. Norton, Newbern Smith, James R. Wait

*Morris N. Liebman Memorial Prize Award*

G. Southworth, C. H. Townes

*David Sarnoff Award*

Charles H. Townes

<sup>14</sup>The New York Section was not organized until 1942. Previously, the New York City meetings were considered to be Institute meetings and not of local status.

During the formative years the Washington Section found its meeting places in a variety of locations—there was no one designated spot. These included: the University Club, Commercial Club, Washington Public Library, Harvey's Restaurant (famous for its seafood), the Continental Hotel, and the Department of Commerce Building.

## PRECURSOR ROLES IN THE EVOLVEMENT OF NATIONAL CONFERENCES

### 1. Conference on Precision Electromagnetic Measurements (CPEM)

#### a) THE 1949 CONFERENCE ON HIGH FREQUENCY MEASUREMENTS

In 1947 and 1948 there existed within the American Institute of Electrical Engineers (AIEE) the AIEE Subcommittee on High Frequency Measurements, the parent committee being the AIEE Committee on Instruments and Measurements. Dr. Harold Lyons, Chief of the Microwave Standards Section of the CRPL, was a member of this subcommittee of nine members. It was an enthusiastic group that believed the time had come that a national conference could be staged relating primarily to measurements and instrumentation at high frequencies (above the audio range), including the microwave range (considered at the time to be from 300 MHz upwards to the millimeter wavelengths). This subcommittee met in New York City in the spring of 1948 to initiate planning of a national conference on high frequency measurements. The result was a joint effort of the AIEE, The Institute of Radio Engineers (IRE), and the National Bureau of Standards, with the AIEE Subcommittee assuming the leading role. Washington, D.C. was selected as the location of the conference, with Lyons in charge of the Local Arrangements Committee.<sup>15</sup>

The 3-day meeting, called the Conference on High Frequency Measurements, was held on January 10, 11, and 12, 1949. Quoting from the conference program, it was stated:

Washington has been chosen as the location for this conference largely on the basis of the presence of the many Government Laboratories and of the great interest in the subject in that area. This conference is the first to be held on a national basis that is devoted solely to the field of high-frequency measurements and instrumentation. It has been arranged in line with the current AIEE policy of sponsoring conference-type meetings covering thoroughly a limited field.

The conference was a success much beyond expectations. The quality of the technical program was high, and there were 549 registrants in attendance.<sup>16</sup> Thus was initiated the first of a series of biennial conferences on precision electromagnetic measurements that continues to the present time, in which NBS has taken a leading role.

---

<sup>15</sup> Frank J. Gaffney of the Polytechnic Research and Development Co. was chairman of the AIEE Subcommittee on High-Frequency Measurements and served as chairman of the conference.

<sup>16</sup> This first conference of its kind was held in the auditorium of the New Building of the Department of the Interior in the downtown area of Washington; fortunately so, for the Bureau facilities would have been inadequate to accommodate the unexpectedly large attendance. Technical papers were divided among four sessions, namely: Measurement of Frequency, Measurement of Power and Attenuation, Measurement of Impedance, and Measurement of Noise and Antenna Measurements. Half-day inspection trips were made to the Naval Research Laboratory, the Naval Ordnance Laboratory, and the National Bureau of Standards. A luncheon at the Roger Smith Hotel provided for a social gathering.



Conference on High Frequency Measurements  
Washington, D.C.

January 10, 11, 12, 1949

Luncheon at Roger Smith Hotel, headquarters

*Invited guests, members of AIEE Subcommittee on High Frequency Measurements, and members of Committee on Local Arrangements.*

*Seated facing camera, left to right*

?  
?  
?

<i>E. U. Condon</i>	<i>Director, NBS</i>
<i>F. J. Gaffney</i>	<i>Polytechnic Research and Development Co.</i>
<i>Everett S. Lee</i>	<i>President, AIEE</i>
<i>Newbern Smith</i>	<i>NBS</i>
<i>Hugh Odishaw</i>	<i>NBS</i>

*Standing, back row, left to right*

<i>H. R. Meahl</i>	<i>General Electric Co.</i>
<i>E. F. Felch</i>	<i>Bell Telephone Laboratories</i>
<i>F. A. Hamburger</i>	<i>Johns Hopkins University.</i>
<i>Hugh E. Webber</i>	<i>Sperry Gyroscope Co.</i>
<i>Ivan G. Easton</i>	<i>General Radio Co.</i>

<i>J. Howard Dellinger</i>	<i>NBS</i>
<i>E. C. Crittenden</i>	<i>NBS</i>
<i>Harold Lyons</i>	<i>NBS</i>
<i>Wilbert F. Snyder</i>	<i>NBS</i>

## b) THE 1951 CONFERENCE ON HIGH FREQUENCY MEASUREMENTS

The second Conference on High Frequency Measurements was planned well in advance with a somewhat different organizing structure than the first conference. The IRE Professional Group on Instrumentation had been organized in March 1950. Thereafter, a Joint AIEE/IRE Committee on High Frequency Measurements was organized with Professor Ernst Weber, Polytechnic Institute of Brooklyn, as chairman. The Joint Committee consisted of the AIEE Subcommittee that functioned at the first conference. Lyons was now chairman of the subcommittee. The IRE group of the Joint Committee was formed from the Professional Group on Instrumentation. Preparing for and conducting the

second conference was a combined effort of the Joint Committee and NBS. Again, Lyons was chairman of the Local Arrangements Committee. The second conference was again held in Washington, with a repetition of the same dates as the first conference, January 10, 11, and 12—2 years later. Attendance was approximately the same as the first conference.<sup>17</sup>

#### c) THE THIRD AND FOURTH CONFERENCES

Attendance at the Third Conference proved to be greater than either the first or second, a total of 669 registering for the 3-day meeting. Again, the conference was held in January (January 14-16, 1953) and the biennial event appeared to be firmly established, with Washington as the place of meeting. And again the conference was under the joint sponsorship of the AIEE, IRE, and NBS, and with NBS largely taking care of the local arrangements. For the first time an international touch was placed on the conference by the presence of Louis Essen of the National Physical Laboratory located at Teddington, England. Essen was invited to present a paper on the precise measurement of the velocity of electromagnetic waves.

The Fourth Conference was held in Washington and again, January (1955) selected as the time of meeting. However, conditions had changed. Personnel of NBS who had taken leading roles in staging the earlier conferences had been transferred to the new Boulder Laboratories in Colorado. Moreover, possibly there was a waning interest in the conferences. But whatever the reasons, the Fourth Conference was disappointing by comparison with the earlier conferences, especially so in the fall-off in registration. Rejuvenation would come 3-1/2 years later in Boulder, Colo.

#### d) THE CONFERENCE MOVES FROM WASHINGTON TO BOULDER

With a renewed interest, coming mainly from Boulder Laboratories personnel, in restaging the High Frequency Conferences, steps were taken in 1957 and early 1958 to plan for a conference in the summer of 1958. A planning group met in January 1958 at the Boulder Laboratories and a General Arrangements Committee was organized with Bernard M. Oliver (Hewlett-Packard Co.) as chairman, representing the IRE Professional Group on Instrumentation. Ivan Easton (General Radio Co.) represented the AIEE and served as chairman of the Technical Program Committee. Once again it was a cooperative effort of the AIEE, the IRE, and NBS. An intensive publicity effort was soon underway to alert thousands who were considered to be potential attendees of such a conference.

A new name selected for the conference, a Conference on Electronic Standards and Measurements, covered a wide scope of research and the measurement art. The frequency range would be less restricted, beginning with direct current (zero frequency) and extending into the millimeter wavelengths of the electromagnetic spectrum. And the locale would be shifted from Washington, D.C. to Boulder, Colo.—a totally new environment from the preceding conferences.

Unlike the apparent waning interest of the Fourth Conference, meeting in Boulder was a "shot-in-the-arm" to a renewed interest in the conference. The expected 400 registrants swelled to more than double, reaching 870. With families, the entire assemblage reached 1200. Combining a vacation with attendance at the conference drew many families to the Boulder meeting. The logistics of housing the unexpected overflow became quite a problem but was successfully solved by using additional facilities provided by the University of Colorado.

---

<sup>17</sup> This conference was one of a number scheduled in Washington during 1951 as a part of the celebration of the Semicentennial of the National Bureau of Standards. A feature of the Second Conference was an evening of demonstration lectures, staged in the auditorium of the Department of Interior. Two of the three demonstrations were presented by personnel of the Bureau's Microwave Standards Section, one on microwave spectroscopy, the other on a recording microwave refractometer, neither lending itself to easy and simple demonstration.

The subject matter of the four technical sessions was much the same as the previous conference, yet showed an abundance of new research in a fast growing field.

The 3-day conference was held at the Boulder Laboratories on August 13, 14, and 15, 1958. The first morning was given over to the dedication ceremony for the new Electronic Calibration Center (see ch. X, pp. 351-355). Thereafter followed six sessions of the technical program.<sup>18</sup> The conference was a marked success and served to continue the four earlier conferences dating back to 1949, and presaged the biennial conferences of a similar nature to come in the ensuing years.

#### e) A CONFERENCE SPAWNS ANOTHER CONFERENCE

Embarking on the outstanding success of the 1958 Conference at Boulder, the next conference was held again at Boulder during the period of June 22-24, 1960.<sup>19</sup> Again, sponsorship was a joint effort of the AIEE, the IRE, and NBS. Ivan Easton, representing the AIEE, was chairman of the General Arrangements Committee, and George E. Schafer, of the Radio Standards Laboratory, NBS, was chairman of the Technical Program Committee.

Subject matter of the six technical sessions was much the same as the 1958 Conference with at least one modification, that of scheduling a session titled, "Current and Future Problems in Standards and Electronic Measurements."<sup>20</sup> At this first session, Harvey W. Lance, chief of the Electronic Calibration Center at the Boulder Laboratories, presented a paper entitled, "The Nation's Electronic Standardization Program: Where Do We Now Stand?" Most significant of the topics discussed by Lance in his paper, at least when viewed in the light of the passage of time, was his statement relating to "a serious need for an association of standards laboratories." (This topic is treated in considerable detail in a following section, see pp. 690-694.)

As a result of the two highly successful conferences held in Boulder, there emanated from the 1960 Conference a permanent organizational committee to ensure a continuity for future conferences. The committee consisted of the chairman of the AIEE Instrument Division, the IRE Professional Group on Instrumentation, the chief of the Radio Standards Laboratory (NBS), and the senior and junior past-chairmen of the 1960 Conference.

#### f) THE 1962 CONFERENCE BECOMES INTERNATIONAL

The 1962 Conference took on a new complexion, that of international participation. The name changed once again, that to, "International Conference on Precision Electromagnetic Measurements," and has remained so to the present time (except that the word "International" was replaced in 1964 with the year of the conference, and continues to be so named to the present). An even dozen international papers were presented at the conference, coming from five countries. Four of the 10 technical sessions were chaired by registrants from 3 other countries. Partial support of the conference to provide the international participation came from a grant by the National Science Foundation.

Appearing for the first time in the title of a technical session was the subject of "Quantum Electronics." It would be a common subject at future conferences.

---

<sup>18</sup>The titles of the technical sessions are indicative of the subject matter covered in the 37 papers presented and show the increased span of interest that was covered compared to the previous conferences. The session titles were:

- The Relationship of Standards to Physical Constants
- Frequency and Time Interval Standards
- Direct Current and Low Frequency Standards
- Radio Frequency Standards
- Microwave Standards
- The Organization and Operation of Standards Laboratories

The NBS Boulder Laboratories, being host to the conference, were responsible for handling the many details for such a meeting. The operation was under the skilled guidance of Harvey W. Lance, chairman of the Local Arrangements Committee, Lance being chief of the Electronic Calibration Center.

For those attendees who were not acquainted with the Colorado Rockies a new experience was offered, that of attending a chuckwagon dinner held outdoors at the Stanley Hotel in Estes Park. The evening of Western atmosphere was given a further touch with an illustrated lecture on "Historic Mining and Ghost Towns of Colorado," presented by Mrs. Francis Wolle of the University of Colorado. Special events and programs for the ladies and children were featured throughout the conference.

<sup>19</sup>There was a slight change in name of the 1960 Conference, that from "Conference on Electronic Standards and Measurements" in 1958 to "Conference on Standards and Electronic Measurements" for 1960.

<sup>20</sup>A session on "Methods of Measurements for Materials" was also a new subject at this conference.

For the 1962 Conference, as well as for the two previous conferences at Boulder, a well-organized and large-scale "Open House" of the Boulder Laboratories was staged. Demonstrations and explanations of measurement techniques were made available to the conference registrants and visitors in many rooms of the Radio Building and the Cryogenic Engineering Laboratory. Unlike the guided tours of the previous conferences, this "Open House" was conducted on the plan of the individual's selection of laboratory exhibits.

John M. Richardson, chief of the Radio Standards Laboratory, was chairman of the General Arrangements Committee. George Birnbaum, formerly of NBS, was chairman of the Technical Program Committee.



*General Arrangements Committee for 1962 International Conference on Precision Electromagnetic Measurements, Boulder, Colo.*

*Left to right: W. D. George, publicity; L. M. Matarrese, treasurer; J. M. Richardson, chairman; C. Peterson (NBS Washington), international affairs; G. Birnbaum, technical program; J. F. Brockman, executive secretary. All members of NBS staff (Birnbaum, formerly). G. B. Hoadley (North Carolina State University) not present for photo.*

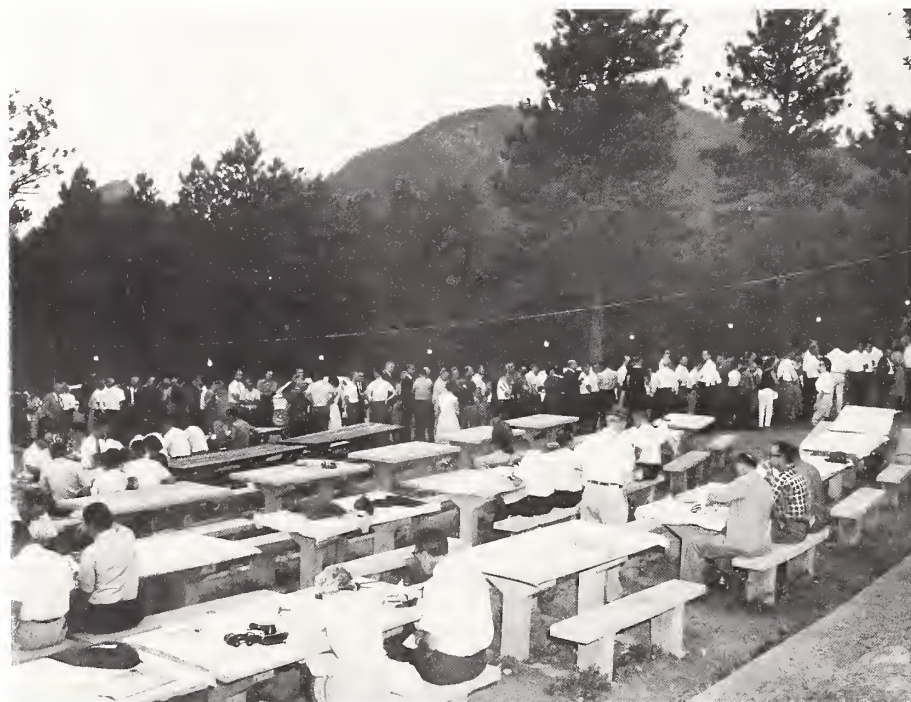

*Not all is the digesting of technical papers at a Conference on Precision Electromagnetic Measurements. At the 1962 Conference the conferees and their families line up for a chuck wagon dinner during an August evening on top of Flagstaff Mountain from which there is a panoramic view of Boulder and its environs. Green Mountain in background.*

#### g) THE CONFERENCE BECOMES FIRMLY ESTABLISHED

The 1964 Conference on Precision Electromagnetic Measurements met in Boulder during the period of June 23-25. By 1964 Boulder became the accepted locale for the biennial event. The event also became associated with the alphabet letters "CPEM," thus coining a new initialism. For the first time since the 1949 Conference, sponsorship of the series of conferences changed. The Institute of Electrical and Electronics Engineers (IEEE) had formed by 1963 with the combination of the AIEE and the IRE, and the newly formed Professional Technical Group on Instrumentation and Measurement was now the organization interested in the affairs of the CPEM. Sponsorship of the 1964 Conference came from the IEEE Professional Group noted above, the NBS, and U.S. Commission I (Radio Measurement Methods and Standards) of the International Scientific Radio Union (URSI).

At the 1964 Conference papers on lasers first appeared on the technical program.<sup>21</sup> Electromagnetic measurements were being pushed up into, and being reported on, the optical region.

For the first time there appeared in the program booklet a list of names constituting an Honorary Committee for the Conference. This would be repeated in all later conferences. The 1964 listing contained 29 persons, most of whom were associated with precision electromagnetic measurements.

The 1966 Conference was highlighted by the presence of Dr. J. Terrien, director of the International Bureau of Weights and Measures, Sèvres, France, who gave the Keynote Address.<sup>22</sup> Later he took part in an evening program of an informal panel discussion on the national measurement systems of various countries. The discussion was moderated by Lance of the Boulder Laboratories. Eleven participants representing nine countries took part on the panel. John Richardson, chief of the Radio Standards Laboratory, represented the United States. Each spoke on the national measurement system and the national laboratory of his respective country [5].

One evening was set aside at the 1968 Conference for a discussion on international comparisons of standards and measurements. The program was chaired by Dr. Chester H. Page, chief of the Electricity Division, NBS. Again, Dr. Terrien of the International Bureau of Weights and Measures took part in the meeting. Three countries were represented in this special program.

By the time of the 1972 Conference (June 26-29) a cooperating sponsor had been added to the "old guard" of the IEEE, the NBS (the Institute of Basic Standards), and the U.S. National Committee (formerly only U.S. Commission I) of URSI. Joining in sponsorship was the international organization of URSI, the Union Radio-Scientifique Internationale.

#### h) THE CONFERENCE GOES ABROAD

After eight conferences, held biennially in Boulder from 1958, and the four earlier conferences in Washington, D.C., the international step was taken to hold the 1974 Conference in London, England. Added to the sponsors of the 1972 Conference were: the Royal Society and the Institution of Electrical Engineers; plus three cooperating sponsors: the Institution of Electronic and Radio Engineers, the National Physical Laboratory, and the Scientific Instrument Manufacturers' Association, all England-based organizations.

Of a total of 136 papers presented at the conference, 38 came from the United States, with 11 each from NBS Washington and NBS Boulder. In all, papers came from a number of countries scattered around the world.

The 1976 Conference returned to Boulder, Colo. with the salutatory theme:

"CPEM 76 Salutes NBS  
National Standards—75 Years of Progress"

---

<sup>21</sup> A paper on the optical maser was presented at the 1962 Conference.

<sup>22</sup> The title of Terrien's address was "The work of the Bureau International des Poids et Mesures concerning electromagnetic units and measurements." [4]

## i) SUCCESS BREEDS SUCCESS

The unexpected success of the First Conference, in 1949, held in Washington, has continued through 14 conferences to the present time. By 1960 a permanent committee, later to be called the Executive Committee, was organized in order to establish continuity and sound planning from one conference to the next. From the beginning NBS, and particularly the "radio" (and later the "electromagnetics") personnel, have taken a prominent role in preparing for and staging the conferences. All but one (the London Conference) have been within the environs of NBS, and 10 at the Boulder Laboratories. Throughout its existence the CPEM has been closely associated with NBS.<sup>23</sup>

## 2. A new conference meets a need—The National Conference of Standards Laboratories (NCSL)

### a) A NEED—AND A NEW CONFERENCE IS ORGANIZED

The first session of the 1960 Conference on Standards and Electronic Measurements at Boulder had for its theme the current and future problems in standards and electronic measurements. In relating to this theme, Harvey W. Lance, chief of the Electronic Calibration Center at the Boulder Laboratories, presented a paper entitled, "The Nation's Electronic Standards Program: Where Do We Now Stand?" As stated earlier, in a commentary of the 1960 Conference (see p. 687), Lance's suggestion of "an association of standards laboratories" was a somewhat bold yet wise course to be followed, when viewed in retrospect. On that occasion he stated:

. . . there is a serious need for an association of standards laboratories. This association might be a new and distinct organization or it might be made a part of an existing professional or technical group. There are many needs which such an association could fulfill. Specifically, it could take the initiative in working out and setting up standard procedures in its member laboratories. In this way a high degree of uniformity could be obtained, even though the absolute accuracy might be subject to question. Later on, with accurate standards available, the procedures used to insure uniformity still would be applicable.

The suggestion by Lance gave rise to considerable discussion which was continued at a previously unscheduled meeting the following day (June 23, 1960) at a time 1 hour earlier than the scheduled technical session of the morning. Approximately 125 were in attendance of the nearly 800 persons that were attending the 1960 Conference, indicating an enthusiastic interest in such an association as proposed by Lance. After further discussion, with Lance serving as chairman pro tem, it became the consensus of the group that an ad hoc committee be appointed by the Conference Committee. The Ad Hoc Committee of approximately 20 members met on 3 occasions during the next 12 months and then on September 21, 1961, in a meeting at Los Angeles, a definite course was set up to follow in organizing an association. The result was a vote of acceptance by the Ad Hoc Committee of a resolution prepared and presented by Lance who was serving on the committee. A General Committee was appointed for the newly named National Conference of Standards

---

<sup>23</sup>The reader may wonder why a comparable conference of staying quality did not develop among the wave propagation groups within the CRPL in cooperation with outside organizations. Indeed, there was such a start but did not develop beyond the initial conference. The Quarterly Report for April-June 1947 of the CRPL stated:

. . . the Division sponsored a Radio Propagation Conference on May 8, 9, and 10, attended by 145 persons, including some English and Canadians who are working on radio propagation problems. The meeting was highly successful—the Conference is but the first of a continuing series that the Division expects to sponsor.

But there were no more of these conferences. It appears, in retrospect, that the various meetings of URSI sufficed the need for such conferences.



Laboratories (NCSL). Lance became corresponding secretary of the committee.<sup>24</sup> Thus, on this date (September 21, 1961), a new technical organization came into existence on the American scene.

Shortly after the NCSL was organized, at its request NBS agreed to be a sponsor of the organization. This was a practice followed by the Bureau in its relation with a number of technical groups.

b) **WHAT IS NCSL?**<sup>25</sup>

The NCSL defines itself as:

A continuing, nonprofit laboratory-oriented organization to promote cooperative efforts toward solving the common problems faced by standards laboratories in their organization and operation. . . . Its membership consists of academic, scientific, industrial, commercial, or governmental laboratories concerned with the measurement of physical quantities, the calibration of standards and instruments, and the development of standards of practice. It provides a liaison with technical societies, trade associations and educational institutions interested in these activities.

“Great oaks from little acorns grow.” So it is that this organization, now of 238 standards laboratories, grew from a “seedling” dropped as a suggestion by Harvey Lance at the 1960 Conference on Standards and Electronic Measurements.

c) **THE NCSL BECOMES A SUCCESSFUL ORGANIZATION**

The National Conference of Standards Laboratories met at the Boulder Laboratories for its first national meeting during the 3-day period of August 8-10, 1962. More than 600 persons representing approximately 200 laboratories were in attendance. Dr. Astin, director of NBS, was the conference chairman, indicating the desire on the part of NBS to exercise its sponsorship of the new organization by encouragement and assistance. In his welcoming remarks Astin indicated the “great interest” of NBS in the work of the conference. A review of the titles for the nine sessions “indicates the nature of the first NCSL Conference and the subject matter presented and discussed.”<sup>26</sup>

Proceedings of the 1962 Standards Laboratory Conference were published by NBS as a *Miscellaneous Publication* [6].

---

<sup>24</sup> William A. Wildhack, associate director of NBS, was a member of the General Committee of 12 members, Lloyd B. Wilson of the Sperry Gyroscope Co. was chairman. The committee membership was well balanced between leading representatives of industrial standards laboratories and of government standards laboratories.

During the following year 13 committees were set up to pursue various operations within the new organization in order to place it upon a firm and useful basis. Later, the membership of these committees was increased.

<sup>25</sup> A caption borrowed from the NCSL Directory of later years.

<sup>26</sup> Titles of the nine sessions of the 1962 Standards Laboratory Conference were:

Session:

1. National Bureau of Standards Service to Industry
2. Error Analysis of Measurement Systems
3. National Conference of Standards Laboratories Business and Information
4. Corporate Measurement Standards Programs
5. Measurement Agreement Comparisons Among Standardization Laboratories
6. Training of Measurement Personnel
7. Calibration Recycle Analysis and Work Load Control
8. NCSL Relations to and Cooperation with Technical Societies
9. Recommended Practices for Standards Laboratories

In total, there were 34 papers presented, plus 6 panel discussions on subjects relating to 6 of the sessions.



*General Committee of the National Conference of Standards Laboratories (NCSL) meeting at Boulder Laboratories, 1962 Standards Laboratory Conference. Left to right: C. E. Johnson (Boeing Co.), vice chairman and technical program chairman; L. B. Wilson (Sperry), chairman of General Committee; H. W. Lance (NBS), corresponding secretary, and chairman of conference administration committee; C. White (Avco), recording secretary and treasurer; W. A. Wildhack (NBS), representative for NBS.*

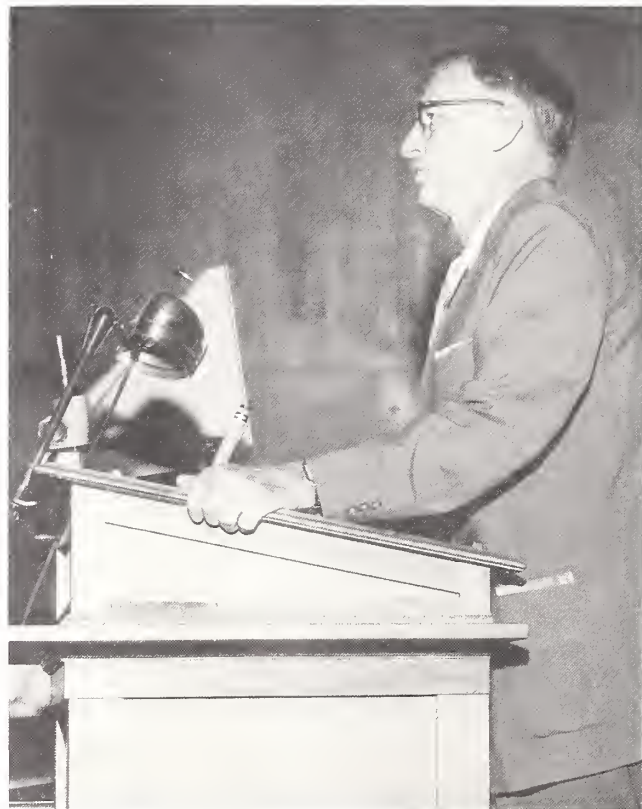

*A. V. Astin, director of NBS, and chairman of the 1962 Standards Laboratory Conference of the NCSL, delivering the introductory remarks of the Conference.*

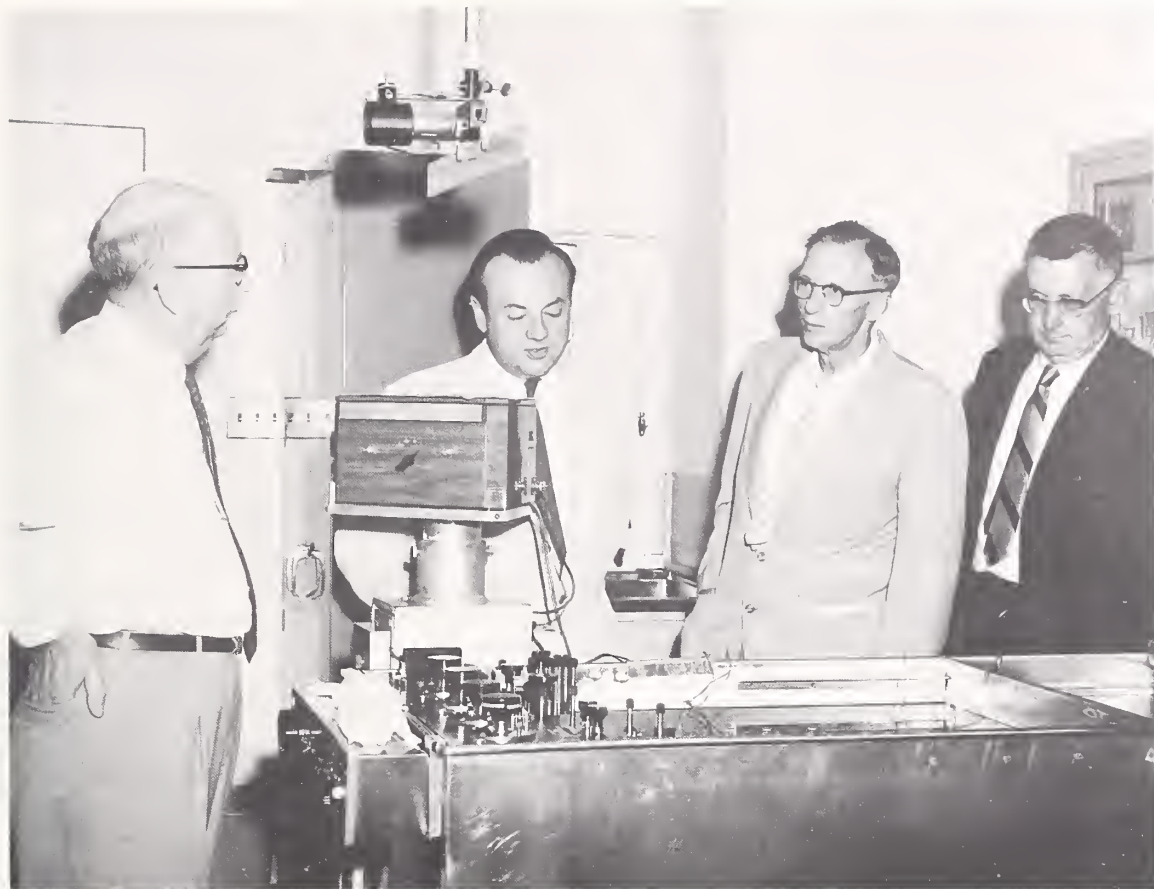

*On the 2 days (August 6 and 7) preceding the 1962 Standards Laboratory Conference of the NCSL, J. Herbert Holloman, Assistant Secretary for Science and Technology, Department of Commerce, made his first visit to Boulder Laboratories.*

*Left to right: F. D. Weaver of the Electronic Calibration Center explains operation of Wenner bridge to Holloman; A. V. Astin, director of NBS; and F. W. Brown, director of Boulder Laboratories.*



*Boulder Laboratories auditorium with participants of the 1962 Standards Laboratory Conference of the NCSL. W. A. Wildhack of NBS presiding at session on "National Bureau of Standards Service to Industry."*

In 1964 the NCSL chose to join forces with the Instrument Society of America, and particularly with its Measurement Standards Instrumentation Division, at the ISA 19th Annual Conference in New York City. Also joining was the Precision Measurements Association, another fledgling group. By now the NCSL was caught up in the mounting interest of many groups, institutions, technical societies, and Government agencies in standards, precision measurements, and calibration services.

The year 1966 saw the NCSL convening at the Gaithersburg facility of NBS, a half year before the Dedication (November 15, 1966). By now nearly 150 standards laboratories had joined the organization.

The 1968 meeting of NCSL was a return to Boulder, where the organization had come into being, at least as a conception. A theme was chosen for this conference, that of "Making Valuable Measurements."<sup>27</sup> During the preceding years Lance had been a vice chairman of the NCSL Board of Directors, and then became chairman for the ensuing year. During this period he was Assistant Chief for Program Planning and Development of the Radio Standards Laboratory.

Following its biennial schedule, the conference returned to NBS at Gaithersburg in 1970, and on this occasion chose the theme, "Innovative Metrology—Key to Progress." The 1972 Conference, held at Boulder, was a joint meeting with five other societies and had the keynote of "The Role and Value of Measurements."<sup>28</sup> The NCSL conducted its own conference at NBS, Gaithersburg, Md. in 1973. The 1974 Joint Conference was held at Gaithersburg with seven societies joining forces.<sup>29</sup> The theme of this meeting was "Measurement Science in Transition." Upon a return to Boulder in 1975 the NCSL conducted its own conference. The year 1976 found the NCSL back in Gaithersburg, Md. in celebration of the 75th Anniversary of NBS, the Nation's Bicentennial, and the 15th year of the NCSL. The theme for the conference (or symposium) was "The National Measurement System—Today and Tomorrow."

## EXERCISING THE LEARNING PROCESS—BY SCHOOLING, BY SHARING TECHNICAL KNOWLEDGE WITH OTHERS

### 1. A book approach to learning in time of war

Advances in radio technology, plus the early discovered usefulness of radio communication in World War I, fostered a need for both instructional material and advance treatises in radio engineering. Thus, at the request of the Army Signal Corps, two books, *NBS Circular 74* (Radio Instruments and Measurements), and *The Principles Underlying Radio Communication* were written by the Radio Section, each gaining widespread recognition and acclaim.<sup>30</sup> (See ch. III, pp. 52-56.)

Twenty-five years later, World War II fostered a repeated request for a document that would aid in the training of personnel to meet adequately the application of radio communication in modern warfare. First (in 1942), the National Defense Research Committee (NDRC) requested a handbook that resulted in the Radio Section preparing the

---

<sup>27</sup> In his address to the conference, NCSL Chairman Charles E. White stated:

The theme of our Conference is "Making Valuable Measurements." It was not chosen by the Program Committee in a light manner. Rather, it is a reflection of the concern with which we view the whole structure of controlled measurements. It reflects the continuing displays, in a majority of U.S. industries, of the non-serious and non-appreciative attitude displayed by top management toward the impact upon the quality of products and goods of uncontrolled or poorly controlled measurements.

(Shades of Ralph Nader—the Author (WFS))

<sup>28</sup> Joining forces with the NCSL were: the American Society of Quality Control, IEEE Group on Instrumentation and Measurement, ISA Metrology Division, NBS Institute for Basic Standards, and the Precision Measurements Association.

<sup>29</sup> The Scientific Apparatus Makers Association joined as the seventh sponsor for the 1974 Joint Conference.

<sup>30</sup> The request for a textbook, later to be called *The Principles Underlying Radio Communication*, came from the Training Section of the Signal Corps. The book was written to replace the former Signal Corps circular *Radiotelegraphy* and some of the wartime pamphlets on certain radio subjects.

Radio Transmission Handbook, Frequencies 1000 to 30,000 KC, and, second (in 1943), the Joint Communications Board requested a handbook that became the IRPL Radio Propagation Handbook. (See ch. XI, pp. 403-404.) Following World War II a considerably more sophisticated version of the handbook was prepared by the Central Radio Propagation Laboratory with the title, "Ionospheric Radio Propagation," (*NBS Circular 462*).

## 2. A handbook series bogs down

A Bureau-wide project on producing an eight-volume "NBS Handbook of Physical Measurements," initiated by Director Condon in 1946, became a limited project within two CRPL standards sections. The initial product was the "Outline," a mimeographed copy that appeared in December 1946. Of the 117 pages in the outline, the High Frequency Standards Section and the Microwave Standards Section contributed 6 pages. Later, a portion of the text on radio measurements was completed. But the project encountered a variety of problems, bogged down, and was never completed.<sup>31</sup>

## 3. In-house education at NBS

### a) THE EARLY PERIOD OF THE NBS GRADUATE SCHOOL

In-house education at NBS is primarily that of graduate courses conducted within the Bureau organization and has functioned over many years under the name of the National Bureau of Standards Graduate School. Within a few years after the Bureau was established (1901), several of the younger staff members felt the need of furthering their education and encouraged the director, Dr. Stratton, to provide for graduate courses on the Bureau grounds. Harvey L. Curtis of the Inductance and Capacity Section (Electricity Division) was the "prime mover" among the staff members to urge for the graduate study. This early action took place in 1908 and in the fall of 1908 Dr. Rosa, chief of the Electricity Division, introduced a course in experimental methods of electrical measurements. But an urgent mission to Europe left his students stranded, without an instructor. To fill the void, three students of the Electricity Division, Dellinger, Curtis, and Paul G. Agnew, stepped in and conducted the laboratory course.<sup>32</sup> Then, beginning in January 1909, Rosa gave lectures for a course in advanced electrical measurements. Thus, at the very beginning of the NBS Graduate School, Dellinger found himself in the vanguard, both as a student and as an "instructor."

Years later (1948), after he retired, Curtis wrote an account of the early period of the NBS Graduate School for publication in the *Journal of the Washington Academy of Sciences* [7]. This school was the first and became the model of similar graduate schools among U.S. Government agencies in the Washington area.

After Rosa's introduction of electrical courses into the Graduate School curriculum there followed a fairly steady stream of electrical and radio courses for the next 35 years to the time of the organization of CRPL in 1946.<sup>33</sup>

---

<sup>31</sup> For an overall account of the "Handbook" project see Cochrane, *Measures for Progress*, pp. 487-488.

<sup>32</sup> Within a few years all three of these student "instructors" of the measurement course earned their doctorates. Dellinger became chief of the Radio Section, Curtis became chief of the Inductance and Capacitance Section, and Agnew became executive secretary of the American Engineering Standards Committee (renamed American Standards Association in 1928).

<sup>33</sup> Courses in electricity and magnetism at graduate level were taught by Dorsey, Silsbee, Curtis, Snow, and Astin, all of the Electricity Division. During the academic year of 1917-1918 Silsbee introduced electromagnetic waves into his course. During the same year, Dr. Louis Cohen, then associated with the Signal Corps and formerly of the Electricity Division, taught a course in electrical oscillations. During the following year Dellinger taught a course in electricity with emphasis on principles of radio.

Beginning in 1929, and for a period of several years, Cohen taught courses in Heaviside's electrical circuit theory (using Cohen's textbook), advanced radio theory, and theory of electrical oscillations with applications to radio. Later (1935-1936), L. P. Wheeler of the Naval Research Laboratory presented a course in radio wave propagation. By the time of World War II, courses in electronics became available to advanced students.

Author's (WFS) note: Records of courses taught in the NBS Graduate School were well preserved by the Educational Committee in a bound volume "1908-1960," deposited in the NBS Library.

By long-time understanding, dating back to the inception of an educational program at NBS, section and division staff meetings and the weekly Scientific Staff Meetings have been a significant part of the program. The first meeting of the radio staff was reported for the week of February 18 to 23, 1918. Attendance included 14 members of the Radio Section and the division chief and his technical assistant. The Weekly Report stated: "It is intended to hold such meetings monthly, to report on the work in progress here and elsewhere." The staff meetings became a regularly scheduled event of the section for many years thereafter.

#### b) IN-HOURS COURSES IN THE EARLY CRPL PERIOD

With the lifting of restrictions on microwaves and radar near the end of World War II the subjects could be discussed with openness except for projects and equipment that remained classified. Among several groups within the CRPL, informal talks and discussions were conducted to learn more of this new area of radio technology. To fill the need for credit in the Graduate School, Jacob J. Freeman of the Microwave Standards Section lectured for a course in "Microwave Techniques" early in 1947. This was followed by a second term given by David M. Kerns who stressed a theoretical approach to microwave measurement techniques.

#### c) THE GRADUATE SCHOOL AT BOULDER LABORATORIES

The move to Boulder severed connections with the Educational Committee at Washington, making it necessary to establish a completely new committee. This was accomplished in July 1954 by Dr. Frederick W. Brown, director of the Boulder Laboratories. A group of five constituted the first Educational Committee.<sup>34</sup> A survey by means of a questionnaire sent to the 350 staff members indicated that one-fifth of the staff was interested in degree study at the college and graduate levels—an unexpectedly high percentage.

Within a few years a well-established educational program was in full swing at the Boulder Laboratories, with a variety of subject matter comprising the courses. Among the specialized courses was one taught by Robert Beatty, chief of the Microwave Circuit Standards Section. This course, known as Microwave Measurements, was accepted into the curriculum of Electrical Engineering at the University of Colorado, being the first of its kind in the curriculum.

Beginning in 1961 the Boulder Laboratories embarked on a specialized educational program that was to extend for the next 6 years. The program was a joint effort of the NBS Graduate School and the Bureau of Continuing Education of the University of Colorado. The courses provided advanced and specialized training for persons involved in radio communications and in measurements and standards programs. Certificates of training were given to those who completed a course. The first course was one in radio propagation given in late summer of 1961. The 3-week course terminated with the presentation of 218 certificates. The Radio Propagation Course was repeated in 1962, with 250 in attendance and including representatives of a number of foreign countries. The first course in electromagnetic measurements and standards was given by members of the Radio Standards Laboratory in the summer of 1963 at which time nearly 200 participants received certificates. The highly successful 2-week Electromagnetic Measurements and Standards Course was repeated in 1965 and again in 1967 to meet the need of advanced training for personnel who were staffing the many new electronic standards laboratories coming into existence during the early 1960's.

---

<sup>34</sup> The Educational Committee consisted of: R. B. Jacobs, D. M. Kerns, J. M. Richardson, F. E. Roach, with R. W. Stockwell serving as secretary.



*George Schafer, chief of the Radio Standards Engineering Division, Boulder Laboratories, presents certificates to foreign participants of the 1963 Electromagnetic Measurements and Standards Course sponsored by the NBS Graduate School in association with the University of Colorado. John Richardson (fourth from left), chief of the Radio Standards Laboratory, presided at the presentation. Foreign participants came from Canada, England, Free China, India, and Sweden.*

Two areas of training not directly related to the Graduate School should not be passed by without some recognition. In one, the precursor role was not taken by the CRPL or by the Radio Standards Laboratory, but each had a participating scientist in the new Department of Commerce Science and Technology Fellowship Program, inaugurated on September 9, 1964. Robert S. Kirby was assigned for 9 months to the Coast and Geodetic Survey, and George E. Schafer was assigned for a similar period as a special assistant to the director of NBS. The purpose of the program was to broaden the scientific, technical, and management abilities of the participants. Others of the Boulder Laboratories have followed in the train of Kirby and Schafer in the Fellowship Program.

The other area of advanced training has been the Joint Education Program for Non-Professional Training offered to Department of Commerce employees at Boulder. Career Technician Certificates were first awarded in April 1970 to three employees who completed the 4-year study program, and an advanced Career Technician Certificate to an employee who completed the 8-year program.

Author's (WFS) Note:

Other sectors of the educational program at the Boulder Laboratories (but not unique to the former Radio Section or to the CRPL in precursor roles, as these sectors have had Bureau-wide origins) include a variety of education and training programs as: research associates program, postdoctoral research associates, administrative intern programs, summer aides, apprentice programs for instrument makers, and Civil Service Commission courses. However, to include these sectors, other than by noting, would tend to lessen the significance of "The Precursor Roles."

#### 4. Colloquia, symposia, seminars, conferences—Or by any other name

##### a) AN EARLY CRPL COLLOQUIUM

The name colloquium or seminar was rarely, if ever, used by the Radio Section, and rarely did such groups get together for conference and discussion, except for section or division meetings. Yet such meetings for discussion were considered to be a part of the total education program for the Bureau. After the formation of the CRPL, Harold Lyons, chief of the Microwave Standards Section, provided the motivating force to initiate a colloquium program which came to be called the Radio and Electronics Colloquium. The first meeting was on November 14, 1947, with David M. Kerns lecturing on "Some Recent Developments in Microwave Circuit Theory." These meetings became popular throughout the Bureau and drew large crowds when a particularly appealing topic was discussed. The program spanned a period of several years with meetings scheduled at intervals of several weeks.<sup>35</sup>

##### b) CONFERENCES, SYMPOSIA, SEMINARS AT BOULDER LABORATORIES

Conferences came in for early staging at the new Boulder Laboratories, the first one being scheduled at the time of the Dedication events. The 3-day Conference on Radio Propagation and Standards was held during the period of September 8-10, 1954. It was a one-of-a-kind conference, mostly geared to contemporary radio research, and was not intended to perpetuate itself in further conferences or as a conference organization. The eight invited papers were by authorities in their specialized fields. The 75 contributed papers covered a wide range of radio subjects. Chairmen of the 15 sessions were selected largely from universities across the country.

Little time was allowed to slip by before renewing the colloquium on radio and electronics of previous years back in Washington. Renamed the Radio Standards Research Seminar, the first meeting was on December 17, 1954, with Paul F. Wacker speaking on "Microwave Line Shape Studies." These seminars "provided a review of new work, current literature, research problems, and creative new ideas relating to all topics in the field of radio measurements, including related background and basic subjects." However, the seminar plan of meetings was rather short lived.

The Conference on Electronic Standards and Measurements of August 1958 at the Boulder Laboratories served as the catalyst to the later biennial Conferences on Precision Electromagnetic Measurements (see pp. 686-690).

The intensive interest during the late 1950's and early 1960's to establish programs of standards and precision measurements within Government agencies, industry, and the space programs, brought on the need of conferences to discuss mutual problems. The Boulder Laboratories with its new Electronic Calibration Center became a focal point for such conferences. Much planning, preparation, and conducting the conferences and seminars by personnel of the Radio Standards Laboratory went into this effort. The first scheduled event by the center was a Microwave Workshop held in the spring of 1961. Approximately 40 technical supervisors from Department of Defense laboratories were in attendance. Late in the summer of 1961, 50 invited personnel from the same laboratories attended a Low Frequency Workshop. Several years later, in May 1968, a Microwave Calibration Workshop was conducted for 50 representatives of industry and government laboratories.

Beginning in November 1962, a series of eight seminars was staged over a period of 18 months by Myron Selby of the Radio Standards Laboratory, with the assistance of Professor Edmund D. Ayres of the E. E. Department of Ohio State University. Ayres was a summer

---

<sup>35</sup> Shortly after arrival in Boulder of the Microwave Standards Section in the summer and fall of 1954, the Washington-based colloquium was revived within the newly organized division relating to high frequency and microwave standards, to be called the Radio Standards Division Research Seminar. The seminar remained active for several years and then gradually faded from the Boulder scene.

Concurrent during the activity of the Standards Seminar were two other groups that stimulated interest within the two other radio divisions at NBS Boulder, the Radio Propagation Physics Journal Club and the Radio Propagation Engineering Journal Club. But these, also, faded to obscurity.



employee in the RSL. These seminars were conducted by personnel of industries on contract with space programs and the Department of Defense. It was a new and different point of view for NBS staff members to receive—that of obtaining first-hand information on technical problems faced by industry in precision measurement programs.

In the early 1960's various technical sections of NBS began sponsoring seminars for those interested in specialized measurement programs. These 2-day to 5-day seminars and symposia continue to the present time. Those related to the Bureau's measurement programs at radio frequencies began in March 1966 with seminars in High Frequency and Microwave Noise, and in High Frequency and Microwave Field Strength. In 1967 a seminar was held on Phase Shift Measurements. Two seminars were held in 1968, one on High Frequency and Microwave Attenuation, the other on Frequency and Time.

An early symposium convening at the newly established Boulder Laboratories was held in January 1957 under the title of the Propagation of Very-Low Frequency Radio Waves and was sponsored jointly by the Boulder Laboratories and the IRE Professional Group on Antennas and Propagation. James R. Wait of the Radio Propagation Engineering Division served as chairman. Subject area of the 3-day meeting was confined to the frequency range of 3 to 300 kHz. Signals in this narrow band of electromagnetic waves have useful applications and serve as an effective means of studying space phenomena. The broad interest in this frequency band was evidenced by the nearly 300 physicists and radio engineers that attended the symposium.

In February 1960 a first-time meeting known as the In-House Symposium on Plasma and Astrophysics met in Boulder as a cooperative effort of NBS Boulder and NBS Washington. A contingent of over 40 people came from NBS Washington. Among these was Dr. Lewis M. Branscomb of the Atomic and Radiation Physics Division, who served as coordinator of the symposium. Some years later, in 1969, Branscomb became director of NBS. "Anchor man" at Boulder for the symposium was Dr. Richard N. Thomas, consultant for astrophysics in the director's office. Although earmarked as the "first annual" with the expectancy that others would follow in a regular series, these conferences never got into the swing of scheduled events.

A symposium that drew nearly 500 participants to the Boulder Laboratories was the 1962 PGMTT National Symposium of the IRE Professional Group on Microwave Theory and Techniques, meeting during the period of May 22-24. The event was planned and conducted almost entirely by Boulder Laboratories personnel. George Schafer was the Symposium chairman and Robert Beatty chairman of the Technical Program Committee. James Brockman was chairman of the Local Arrangements Committee. John Richardson, chief of the Radio Standards Laboratory, gave the keynote speech in which he stressed "the reciprocal relation between the National Bureau of Standards and the microwave profession" [8]. The PGMTT celebrated its tenth anniversary at this meeting.

Another symposium, one that drew 300 scientists from 8 countries to the Boulder Laboratories in August 1964, was the Symposium on Ultra-Low Frequency Electromagnetic Fields. The Bureau served as host to the multi-sponsored meeting. The subject matter pertained to electromagnetic fields from 30 Hz down to the unusually low frequency of 0.001 Hz—a frequency region that is exceptionally low.<sup>36</sup>

Other colloquia of less organized natures came and went with the years. Other than initial announcement of beginnings, little is found in the records of the existence or success.

## **5. Professional groups of the region that had their origin within the Boulder Laboratories**

### **a) THE BOULDER BRANCH OF RESA**

The Scientific Research Society of America, or RESA, was formed nationally in 1947 to be the industry- and government-related scientific research society of Sigma Xi. Early in January of 1955, a short time after the move to Boulder, a small group of Sigma Xi members took initial steps to ascertain the interest of their colleagues in the formation of a Boulder branch of RESA. On June 28, 1955, a small group was nominated to proceed with organizing

<sup>36</sup> Further accounts of these low frequency symposiums (four, in total), sponsored by the CRPL, will be found in chapter XI (pp. 475-476).

a branch, with Edwin L. Crow as temporary president and John Richardson as temporary secretary, plus a temporary Committee on Admission.

By early fall of 1955 all the necessary steps had been taken to organize a local branch of RESA. At a business meeting on September 22, 1955, the following officers were elected:

President: Thomas N. Gautier

Vice-President: Harold A. Thomas

Secretary: Wilbert F. Snyder

Treasurer: Edwin L. Crow

The installation ceremony took place on October 17, 1955, following a banquet at the Memorial Center, University of Colorado. Dr. Wallace R. Brode, national chairman of RESA and an associate director of NBS, presented the charter to the Boulder Branch.

In April 1956 the Boulder Branch awarded for the first time in a continuing series an annual prize for the best exhibit at the annual Colorado-Wyoming Science Fair for junior and senior high school students. The prize was a log-log vector slide rule.

In 1958 the Boulder Branch sponsored its first RESA Boulder Scientist Award to the resident or former resident of the Boulder area for the outstanding scientific publication or series of publications appearing in the calendar year 1957 and based on research carried out in the Boulder area. Of the many papers that were submitted, the one by Harold A. Thomas, entitled "Microwave Power Measurements Employing Electron Beam Techniques" was given first choice by the judging committee. Dr. Thomas, formerly chief of the Radio Standards Division, received the \$50 award and the inscribed plaque in absentia.

More recently Sigma Xi and RESA have become a united organization at the national level. The Boulder organization continues to be a thriving chapter.

#### **b) BOULDER-RELATED PROFESSIONAL GROUPS OF THE IEEE**

The rapid and diversified growth of CRPL after the move to Boulder, plus the gain in popularity of IRE Professional Groups being organized in various parts of the country, brought on the desire to organize such groups within the boundaries of the Denver Section of the IRE. These groups are organized within the IRE (now IEEE) along lines of technical specialization of the members.

The first of such groups to be organized by NBS personnel in the Boulder area was the Boulder-Denver Chapter of the IRE Professional Group on Antennas and Propagation, officially chartered on May 23, 1955. Ernest K. Smith of the Radio Propagation Engineering Division served as the organizer and as chairman during the first year. He was followed by James R. Wait, and then by Herman V. Cottony. Cottony became a member of the Administrative Committee of the group at the national level and also became associate editor for the group's publications.

The second IRE Professional Group to be organized by Boulder Laboratories personnel was the Boulder-Denver Chapter of the Professional Group on Microwave Theory and Techniques. The chapter was formally established on October 10, 1957. Moody C. Thompson of the Radio Propagation Engineering Division was chosen as the first chairman, and William Culshaw of the Radio Standards Laboratory as the first secretary-treasurer. Beginning in 1963, Robert W. Beatty of the Radio Standards Laboratory served as editor of the *Transactions* for a period of 3 years, followed by 3 years as associate editor. During the mid-1960's Beatty served as vice chairman at the national level, and Helmut M. Altschuler, of the Radio Standards Laboratory, as vice chairman and as chairman.

The third Professional Group to be organized in the Boulder-Denver area through efforts of Boulder Laboratories personnel was a combining of two group interests, that of electromagnetic compatibility (radio-frequency interference) and that of instrumentation and measurement. John J. Tary of the Institute for Telecommunication Sciences served as organizer, a petition being submitted to IEEE Headquarters on March 15, 1972. Approval of the new chapter was given by the IEEE Executive Committee on May 1, 1972, the name to be the Boulder-Denver Chapter of the IEEE Professional Group on Electromagnetic Compatibility—Instrumentation and Measurement. Harold E. Taggart served as the first chairman and Ramon L. Jesch as the first secretary-treasurer, both of the Electromagnetics Division. Harvey W. Lance served as vice chairman of the Administrative Committee of the Instrumentation and Measurement Group at the national level for 2 years in 1960-1961 and George E. Schafer as chairman for 3 years in 1965-1967.



George C. Southworth (right), retiree of Bell Telephone Laboratories, attends Tenth Anniversary meeting of the IRE Professional Group on Microwave Theory and Techniques (PGMTT), Boulder, 1962. Dr. Southworth was a staff member of the former NBS Radio Section during World War I. He became well known as the author of *Principles and Applications of Waveguide Transmission*, published in 1950, a treatise that has become a classic.

At left, admiring the Tenth Anniversary birthday cake, is Tore Anderson, Chairman of the PGMTT Administrative Committee.

The fourth and most recent IEEE Professional Group to be organized by staff members of the Boulder Laboratories is the Denver-Boulder Chapter of the Vehicular Technology Group. A petition for establishing a chapter was initiated by John F. Shafer of the Electromagnetics Division. The petition was approved by IEEE Headquarters on March 11, 1975.

## REFERENCES

- [1] J. H. Dellinger, "The principles of electrical measurements at radio frequencies," *J. Washington Academy of Sciences*, Vol. VIII, No. 9, May 4, 1918, pp. 293-294. A lengthy abstract.
- [2] Proceedings of the American Physical Society. Minutes of the Ninety-Seventh Meeting, *Phys. Rev.*, Vol. XIV, No. 2, Aug. 1919, pp. 152-200.
- [3] J. H. Dellinger, "Principles of radio transmission and reception with antenna and coil aeriels," *Bur. Stand. Sci. Paper*, Vol. 15, 1919-1920, pp. 435-495.
- [4] J. Terrien, "The work of the Bureau International des Poids et Mesures concerning electromagnetic units and measurements," *IEEE Trans. Inst. Meas.*, Vol. IM-15, No. 4, Dec. 1966, pp. 140-145.
- [5] Harvey W. Lance, "The national measurement systems of various countries," *IEEE Trans. Inst. Meas.*, Vol. IM-15, No. 4, Dec. 1966, pp. 397-403.
- [6] Proceedings of the 1962 Standards Laboratory Conference, *Nat. Bur. Stand. (U.S.), Misc. Publ. 248*, Aug. 16, 1963, 254 pages.
- [7] Harvey L. Curtis, "Science education—Establishment of graduate study courses at the National Bureau of Standards," *J. Washington Academy of Sciences*, Vol. 39, No. 11, Nov. 15, 1949, pp. 351-355.
- [8] John M. Richardson, "Standards and the microwave profession," *IRE Trans. Microwave Theory and Techniques*, Vol. MTT-10, No. 6, Nov. 1962, pp. 413-415.



## Chapter XIX

### “GO WEST YOUNG MAN”<sup>1</sup>

#### A NEW SITE FOR RADIO RESEARCH

#### 1. The Central Radio Propagation Laboratory encounters space problems

On the day (May 1, 1946) that the Radio Section was organized as a division of the Bureau, to become known as the Central Radio Propagation Laboratory (CRPL), the Radio Propagation Executive Council held its first meeting.<sup>2,3</sup> At this meeting Dellinger brought attention to the situation of inadequate space for the new division and to the fact that plans were underway for a new and large building to be erected on the Bureau grounds. Shortly thereafter a budget request was made for a new building.

Within a year the CRPL realized that new field facilities were required for its research that would be reasonably free of radio interference and manmade noise at radio frequencies. Also desirable for propagation studies was a greater variety of terrain than that found in the Washington area. A new building on the Bureau grounds would not be a complete answer to the facility problem. By 1948 the interest in a new and large building on the Bureau grounds was waning in favor of a totally new and complete facility, removed

---

<sup>1</sup>This well-known American saying aptly connotes the “migration” made in a westerly direction from Washington, D.C. by 250 NBS employees in 1954. A vanguard from Washington began to arrive in Boulder, Colo. late in the spring of 1951, although this group had been preceded by another group at Colorado Springs that was recruited to initiate work in 1950 on the Cheyenne Mountain project (see ch. XII, pp. 525-533). The destination was 1700 miles away, and travel would be by automobile, train, and plane. None was near retirement age and all were young in spirit.

The complete saying, “Go West, young man, and grow up with the country,” was used by Horace Greeley, editor of the New York *Tribune*.\* However, Greeley borrowed the phrase “Go West, young man, go West” from John B. L. Soule and gave credit to him after Soule used it in 1851 in an editorial for the *Terre Haute (Indiana) Express*.

Literally, the NBS personnel who migrated in 1954 from Washington became a contributing sector of “. . . and grow up with the country.” Since 1954, Boulder has nearly tripled in population.

\*The city of Greeley, Colo., about 45 miles northeast of Boulder, was named after Horace Greeley. The city was an outgrowth of a cooperative enterprise known as the Union Colony.

<sup>2</sup>Sources of material for this chapter came primarily from:

National Bureau of Standards CRPL Executive Council Minutes, May 1, 1946-Mar. 14, 1955.  
Department of Commerce, Boulder Laboratories Library, Ref. QC661.U48.

Files of the Boulder Chamber of Commerce

Files in library of the Boulder *Daily Camera*

Report of Site Selection Board, December 12, 1949

Quarterly and Annual Reports of the CRPL

<sup>3</sup>A preliminary informal meeting had been held on January 13, 1946. Dr. Edward U. Condon, director of NBS, chaired the May 1 meeting and outlined the purpose of the Council, stating:

that it was intended to bring together in an advisory body the interested agencies, particularly the users of the services of the Central Radio Propagation Laboratory. . . .

Twenty were in attendance at this first meeting.

entirely from the Washington area.<sup>4,5</sup> The desperate need for a new location came at a time during the Truman administration when there was much consideration given, and policy actions taken, toward the *dispersal* of Government facilities to and beyond the fringes of the Washington area, plus the more complete movement of *decentralization* to other regions of the United States.<sup>6</sup>

## 2. Slowly turn the wheels for funding a new facility

On that memorable day of May 1, 1946, when the Radio Section became a technical division of the Bureau, Dellinger informed the CRPL Executive Council at its first meeting that "Plans have been started for a large new building to accommodate the whole laboratory. There is ample area on the Bureau grounds for it." Eight years later the laboratory staff moved into the "large new building," not on the Bureau grounds in Washington, but on 217 acres of land at that time on the outskirts of Boulder, Colo. The wheels had turned slowly to provide for a new building.

At the August 13, 1946 meeting of the Executive Council, Samuel W. J. Welch, Administrative Officer of CRPL, reported that a new radio building was one of five buildings being requested by the Bureau and that the Department of Commerce would specifically support the request for a radio building in its budget.<sup>7</sup> Thus, the wheels started turning.

In January 1947 the Bureau of the Budget approved a new radio building with part of the funding scheduled for FY 1948 to get construction underway. By 1948 there was considerable feeling among the section chiefs that selection of a locality away from Washington for adequate field sites and close proximity to a suitable university was the direction to follow for a new location of the CRPL. Then a period of dormancy seems to have settled down on the whole matter relating to a new building and multipurpose field sites.

In May 1949 Condon reported to the Executive Council "that the question of the new CRPL building is being actively taken up by the Senate Committee on Interstate and Foreign Commerce." A bill (S.443) had been introduced in the Senate that would authorize the construction of a radio laboratory for NBS and this bill was referred to the Senate

---

<sup>4</sup> A new building on the Bureau grounds would probably have been constructed on 36th Street to the north of the existing Materials Testing Building.

<sup>5</sup> Quarters used by the CRPL on the Bureau grounds before the move to Boulder, Colo. included: the Radio Building, a portion of the 3d floor of the Northwest Building, the reconditioned Stucco Building, the former Vapor Lock Building (to be known as "Lower Slobovia"), and an assortment of rooms in other buildings. Other locations included the 2d floor of the Barber and Ross Building in downtown Washington, a portion of a building (Potomac Annex) near the intersection of Connecticut Avenue and Florida Avenue, and the nearby field stations at Beltsville, Md., and Sterling and Ft. Belvoir, Va.

<sup>6</sup> A confidential policy instruction to Government agencies issued by President Truman early in 1949, directing that no more major Government buildings be constructed in the District of Columbia—a policy based upon the hazard of possible nuclear guided missile attacks on Washington. As a result of this instruction the Atomic Energy Commission built its headquarters near Germantown, Md., and the Central Intelligence Agency built its headquarters on the Virginia side of the Potomac River at a considerable distance upstream from the concentration of Federal buildings in Washington. Late in 1949 NBS chose the action of *decentralization* in locating its major radio facility a long distance from Washington.

<sup>7</sup> Samuel W. J. Welch served as secretary to the CRPL Executive Council from the time of its first meeting (May 1, 1946) until 1951. He was a member of the Council, representing the CRPL as its administrative officer. Welch entered the Bureau on April 15, 1946, as an administrative assistant to give immediate attention to the transition of the Radio Section to a division. Shortly thereafter he was named the administrative officer for the CRPL and retained the position until 1951 when he transferred to the Bureau's Missile Development Division at the time that it was moved to Corona, Calif. In the spring of 1954 Welch returned to the CRPL to become its executive officer and chief of the administrative division of the Boulder Laboratories. Welch retired in January 1967, and died May 29, 1971, at Pensacola, Fla.

Roswell C. Peavey was named secretary to the CRPL Executive Council in 1951 to fill the position vacated by Welch. He continued as secretary until March 14, 1955, when the Council was dissolved. Peavey entered the Bureau as an administrative assistant on April 8, 1946, just 7 days before Welch's entry. For several years he was associated with the CRPL and then served as a technical aide with the Atomic and Radiation Physics division. He returned to the CRPL to take the position of administrative officer, vacated by Welch in 1951. After the move of the CRPL to Boulder, Peavey served for a period of time to head the Washington Liaison Office of the CRPL.

Committee, with the strongly stated suggestion by Secretary of Commerce Sawyer that such a building be located elsewhere than in the environs of the District of Columbia.<sup>8</sup>

Bill S.443 would authorize the expenditure of \$4,475,000 for construction of a new radio building (exclusive of cost of land).<sup>9</sup> Yet the road ahead would prove to be a rocky one. Action on bills introduced into Congress usually comes slowly. In October of 1949 the Senate and then the House of Representatives authorized the expenditure of \$4,475,000 for construction and equipment of a radio laboratory, the site to be selected by the Secretary of Commerce and the director of NBS.<sup>10</sup> The bill was signed by President Truman. For a number of months it had been an "open secret" that Boulder, Colo. might be the site of the new laboratory.

At the next session of Congress, in 1950, and 6 months after Boulder was selected as the location for the new laboratory building, and after land had been purchased by the citizens of Boulder and dedicated to the Federal Government for the building site, the Senate tempered its financial support by a smaller cash appropriation and contract authority for the building than provided by the House. This action led Colorado Senators Johnson, chairman of the Interstate and Foreign Commerce Committee, and Millikin, of the Finance Committee, to "fight" to have the full appropriation restored.<sup>11</sup> By September 1950 an amount to the extent of \$4,275,000 for the building was restored by both houses of Congress through an omnibus appropriation bill. A crisis was surmounted, and by October designing of the building was underway.

---

<sup>8</sup> On February 24, 1949, Secretary of Commerce Sawyer informed Senator Edwin C. Johnson (Colorado), Chairman of the Committee on Interstate and Foreign Commerce, that:

. . . the activities to be carried out in this proposed laboratory are critical in the entire field of radio communication, of particular value to American aviation, and of vital importance to the armed forces. Members of my staff have therefore discussed the matter of the location of this site with the National Military Establishment, the National Security Resources Board, and the Bureau of the Budget. In accordance with these discussions, I am of the opinion that this building should not be located in the metropolitan area of the District of Columbia and therefore recommend that amendatory language be provided in S.443 to authorize the procurement of a site elsewhere. . . .

(Contained in Report No. 787, Senate Calender No. 768, 81st Congress, 1st Session, July 26, 1949.)

<sup>9</sup> An interesting note on a site location was contained in Report 787 (see footnote 8), which stated:

Site for the construction of the laboratory has not yet been selected. While authority for purchase of land is contained in the bill amended, the Department is of the opinion that land already the property of the Federal Government, or other public institution, may be procured without cost. The Department has in mind the possibility of acquiring sufficient land to permit expansion of facilities, even to the extent of shifting the entire Bureau of Standards in an emergency.

Author's (WFS) note: Certain aspects of this opinion came true within a short time, as was the case of certain phases of the development of the hydrogen bomb which brought on construction of several buildings on the Boulder site in advance of construction of the Radio Building. Over the years other NBS operations have been considered for the Boulder site.

<sup>10</sup> In part, the act read:

Public Law 366—81st Congress  
S.443

Be it enacted by the Senate and House of Representatives of the United States of America in Congress assembled, That there is hereby authorized to be constructed and equipped for the National Bureau of Standards a suitable radio laboratory building, together with necessary utilities, and appurtenances thereto, under a limit cost of \$4,475,000. . . .

<sup>11</sup> In a telegram, dated July 13, 1950, sent by Senators Johnson and Millikin to Francis W. "Franny" Reich, secretary-manager of the Boulder Chamber of Commerce, they stated:

Happy to advise you we were able to get Senate to recede from amendment striking funds, for Boulder radio laboratory and got approval for \$1,360,000 to start construction. Remaining funds undoubtedly will be obtainable next year but meanwhile work can go forward. Best regards.

In a second telegram, dated July 14, 1950, Johnson said to Reich,

Senator Millikin was tower of strength in this crisis. Hope you thank him.

Eventually the required funding came through, but it was by a slow and painful process.

### 3. Relocating the Central Radio Propagation Laboratory

#### a) COULD THE LOCATION BE BOULDER, COLO.?

In his letter of February 24, 1949, Secretary of Commerce Sawyer informed Senator Johnson of Colorado, chairman of the Committee on Interstate and Foreign Commerce, that a new radio building should not be located in the metropolitan area of the District of Columbia (see p. 705, footnote 8). Yet it was not until October 1949 that Congress gave authority to the Secretary of Commerce, along with the director of NBS, to select the location for a new radio building. During the 8 months that intervened between February and October (1949) much in the way of informal discussions, suggestions, and the passing along of rumors, took their course among many groups that had an interest in a new location of the CRPL.

What can be called a happenstance meeting of three scientists in a mountainous region west of Denver, Colo., in June 1949, was to be the circumstance from which the National Bureau of Standards would be establishing a new and large-scale facility in nearby Boulder several years later. The occasion was the Echo Lake Cosmic Ray Symposium that was held June 23 to 28, at Idaho Springs, Colo.<sup>12</sup>

Attending the symposium as participants, were Dr. Condon, director of NBS, and Dr. Donald H. Menzel, then associate director of solar research, Harvard University (later, director of the Harvard College Observatory).<sup>13,14</sup> Menzel had come to present a paper at the symposium. Condon and Menzel were housed in the Echo Lake Lodge and had considerable opportunity to converse with each other. Condon was seeking suggestions for the location of a new site for the Central Radio Propagation Laboratory, and Menzel was a very understanding listener. Menzel's suggestion was Boulder, Colo. as the best place in the country for this new facility.

---

<sup>12</sup>The symposium was the second to be sponsored by the Office of Naval Research, the Atomic Energy Commission, and The Research Corporation (a private foundation for support of research in physical sciences). The purpose of the symposium was for presentation and discussion of papers by those working in the rapidly changing field of cosmic radiation.

The particular region was selected because of the proximity of the Mountain Laboratories on top of Mt. Evans and at Echo Lake of the Inter-University High Altitude Laboratory for study of cosmic radiation. The Laboratory was associated with six universities. As an added institution, the University of Denver served as host.

Meetings were held in the auditorium of the high school at Idaho Springs. Participants of the symposium were housed in several motels, a small hotel, and at the Echo Lake Lodge some distance away at the base of Mt. Evans. A banquet was held at the Teller House in Central City, after which the symposium participants attended a dress rehearsal of "Die Fledermaus" at the nearby Opera House.

Among the approximately 115 participants listed in the Proceedings of the Symposium were: Professor W. B. Pietenpol, professor of physics, University of Colorado, and Dr. David M. Gates, assistant professor of physics, University of Denver.\*

\*Later, Gates became associated with the CRPL at Boulder. He deposited a copy of the Proceedings of the Echo Lake Cosmic Ray Symposium with the NBS Library, Boulder, now cataloged QC485.E2.

<sup>13</sup>Condon could consider himself as a "westerner." He was three generations removed from a family that settled at Wray, in northeastern Colorado. He was born in Alamogordo, N. Mex. "His father, William Edward Condon, was an early western railroad builder (civil engineer), and in consequence the son grew up 'nearly everywhere west of Denver' as his father took on different railroad locations and construction jobs." (quoted from Brattain and Odabasi, Preface, p. xxi; Topics in Modern Physics, a Tribute to Edward U. Condon, Colorado Associated University Press, Boulder, Colo., 1971). He attended high school in Oakland, Calif., and college and graduate school at the University of California, Berkeley. Beginning in 1941, he became associated with the atomic bomb project and later as scientific advisor of the Senate Committee that led to the establishment of the U.S. Atomic Energy Commission (AEC). It was on the Senate Committee that Condon became acquainted with Senators Johnson and Millikin of Colorado who, several years later, were to extend their influence and give assistance in bringing NBS to Boulder. The AEC was one of the three sponsors of the Echo Lake Cosmic Ray Symposium. Thus it was that Condon found himself at Idaho Springs in June 1949, but listed as director of NBS (NBS had engaged but very little in cosmic ray research).

<sup>14</sup>Dr. Donald H. Menzel grew up in the West. He was born in Florence, a town in south central Colorado. He received the A.B. and A.M. degrees at the University of Denver. Later, when a professor at Harvard University and associated with the Harvard College Observatory, Menzel was chairman of the Radio Propagation Committee of the Joint and Combined Chiefs of Staff during the period 1943-1945. He was a member of the Bureau's Statutory Visiting Committee during the period 1949-1954, and chairman 1953-1954. For a number of years he was a consultant to the Boulder Laboratories. Menzel died December 14, 1976, at the time the author (WFS) was completing the "Boulder Laboratories story."





*Echo Lake Lodge at base of Mt. Evans, southwest of Idaho Springs, Colo. It was here during the period of June 23-28, 1949, at the Echo Lake Cosmic Ray Symposium that Dr. Condon, director of NBS, had occasion to enter into conversations with Dr. Menzel of the Harvard College Observatory. The topic of a new location for the Central Radio Propagation Laboratory led to Menzel's suggestion that the best place would be Boulder, Colo. Also entering into the conversations was Dr. Roberts of the High Altitude Observatory at Climax, Colo. Thus Echo Lake Lodge can be considered to be the "birthplace" of the NBS Boulder Laboratories.*

*Courtesy of Denver Public Library  
Western History Department\**

*\*Municipal Lodge, better known as Echo Lake Lodge, is the property of the City of Denver. The photo is a copy of a printed picture in the July-August 1930 issue of Municipal Facts, published by the City and County of Denver.*



*View to west across lake from Echo Lake Lodge, southwest of Idaho Springs, Colo. In the distance, between the portico columns, can be seen several mountain peaks on the Continental Divide.*

*Courtesy of Denver Public Library  
Western History Department\**

*\*This photo taken in 1938. See accompanying photo of Echo Lake Lodge.*

A visitor (not listed as a participant) to the symposium was Dr. Walter Orr Roberts, who was well known to Menzel. Roberts was superintendent of the High Altitude Observatory, University of Colorado, located at Climax, Colo. (later, Roberts was director of the Observatory), and was well acquainted with Boulder. The conversations on a new location for the CRPL soon extended to Roberts, and he invited Condon to visit Boulder. Condon had never been in Boulder nor had he been back in Colorado for 30 years, so he took the opportunity to visit the University of Colorado campus.<sup>15</sup>

Later in the summer of 1949 Condon again had the opportunity to converse with Menzel when they were attending the Goethe Bicentenary celebration at Aspen, Colo., a part of the first-year program of the Aspen Institute for Humanistic Studies. It was the occasion when famed Albert Schweitzer was invited to the United States to participate in the celebration.

By the following December the location of a new NBS facility was selected from among a large number of suggested places by due process of a site selection board. The selection was announced publicly on December 15 (see pp. 709-710).

Years later, on two occasions widely separated in time, Condon related how Boulder came to be selected as the site for a new NBS facility. To the listeners it was an interesting story.<sup>16,17</sup>

---

<sup>15</sup> In an article, entitled "Boulder's Peppery Physicist," by Olga Curtis, published in the April 18, 1973, issue of *Empire Magazine*, *Denver Post*, Condon is quoted on p. 12 as saying:

I hadn't seen Colorado for more than 30 years until I came out in 1949 for a cosmic ray conference in Idaho Springs . . . I toured the state, did a little fishing and visited friends at C.U.

<sup>16</sup> In August 1960, Condon, in addressing a Cryogenic Engineering Conference at Boulder, stated how the cryogenic facilities at the Boulder Laboratories came about:

In the summer of 1949 I came out to Colorado for a Navy-sponsored cosmic ray conference at Idaho Springs. On a visit here (Boulder) I soon fell under the spell of this charming college community. Largely as a result of the contagious enthusiasm of Walter Orr Roberts, the brilliant director of the High Altitude Observatory, it became clear that this part of the country was the ideal location for the radio propagation research of the National Bureau of Standards. (Quoted from the Aug. 24, 1969, Boulder *Daily Camera*.)

It was on this occasion when Condon "fell under the spell of this charming college community" (of Boulder) that he made a phone call back east. He reached Newbern Smith at State College, Pa., who, along with Alan Shapley and Alvin McNish, were attending a 3-day (June 27-29, 1949) Conference on Ionospheric Research (McNish presented a paper on radio reflections from meteor trails). Condon urged them to fly to Denver, thence to Boulder, to view a promising site for relocation of the CRPL. The trio, with an added member of the CRPL, S. W. J. Welch, enjoyed the 4th of July holiday period in the Boulder area, including a visit to the High Altitude Observatory at Climax. It probably was not difficult for Condon, Menzel, and Roberts to convince these representatives of the CRPL that Boulder was "the site" for resettlement of the Central Radio Propagation Laboratory.

<sup>17</sup> The second occasion was an invitational luncheon on February 22, 1974, in connection with the celebration of the 25th Anniversary of the Bureau's development of the atomic clock. Condon, an invited guest and speaker, talked very informally of the events that led to the selection of Boulder as the site for relocation of the CRPL. Condon, in his usual and characteristically salty remarks, described the progressive steps that took their course toward the final selection of Boulder.\*

\*Author's (WFS) note: At this luncheon the author took some brief notes of Condon's informal remarks. After the luncheon he asked Condon for an interview within several months in order to obtain more details of the events that led to the selection of Boulder, an interview which Condon very gladly offered. But Condon died a month later. Thereafter, the Boulder Laboratories has regretted often that a recording had not been made of Condon's remarks, remarks that were of historical interest and among his last relating to the Boulder Laboratories. Because of this turn of events, the author has found it necessary to search into various sources for information, including personal reminiscences listed below.

Private communication of November 29, 1971, Dr. Donald H. Menzel to Dr. Lewis M. Branscomb, director of NBS.

Telephone conversation of September 7, 1976, of Charles L. Bragaw with Dr. Mario Iona, professor of physics, University of Denver.

Telephone conversation of September 13, 1976, author with Dr. Byron E. Cohn, professor of physics (retired), University of Denver.

Professors Iona and Cohn coordinated the symposium functions at Idaho Springs and elsewhere, and arranged for hosting the participants.

b) **BOULDER SELECTED FOR RELOCATING THE CRPL**

As a means of advising the director of NBS and, in turn, recommending to the Secretary of Commerce, on a new location for the Central Radio Propagation Laboratory, four staff members of the CRPL were appointed by Dr. Condon, director of NBS, "to study and make recommendations for the location of major laboratory facilities for the National Bureau of Standards." Although the initial need was for the CRPL, consideration was to be given to the suitability of the site for other needs of the Bureau. Appointed to this committee, known as the Site Selection Board, were:

Newbern Smith, chief of the CRPL, chairman  
Alvin G. McNish, assistant chief, CRPL  
Kenneth A. Norton, assistant chief, CRPL  
S. W. J. Welch, administrative officer, CRPL

There is no reason to doubt that the Board conducted its study within an atmosphere of impartiality of site selection; nevertheless it operated, yet not by choice, within the "shadow" of rumors that Boulder, Colo., would be a likely location.

At the onset the Board agreed that certain requirements of a new site should be met, consisting of the following:

- (1) The Laboratory should be located in a town or small city;
- (2) the town should contain an adequate university;
- (3) it should be within a reasonable distance of a large city;
- (4) it should be in a noncongested area;
- (5) it should be in a region of moderate climate;
- (6) it should be in a region of diverse terrain;
- (7) it should be accessible.

In their report the Board members commented at considerable length on explaining those requirements.

On the basis of location in a small city and proximity to an adequate university, 28 locations in the country were selected that met these two requirements.<sup>18</sup> Of the 28 locations so chosen, ratings were made of the degree that these localities met the other five requirements.<sup>19</sup> Seven of the 28 small cities met all requirements to a moderate degree and 3 met all requirements. These three were: Boulder, Colo.; Charlottesville, Va.; and Palo Alto, Calif. These three were given numerical ratings on the degree that they met the requirements. The outcome of the numerical rating was extremely close, that of 11, 12, and 13, in the order of the cities cited above (lowest number indicating first preference). Each location had some strong and some weak considerations, and all were further and more carefully analyzed. Yet another factor entered the selection process—Boulder, by its Chamber of Commerce, had formally offered a suitable tract of land as a building site.<sup>20</sup> Thus the Board came to the conclusion:

Because of this offer of a tract for the Laboratory and the general suitability of Boulder for the location of the Laboratory, a detailed study of the Boulder location has been conducted. It has been found that the tract offered is admirably suited to the Laboratory's requirements and to the probable needs of the National Bureau of Standards for a considerable time

---

<sup>18</sup>Twenty-one communities had less than 50,000 population, seven less than 100,000; although there were 53 universities that were considered to be adequate, some in very large cities.

<sup>19</sup>Two localities, other than the 28 cities, considered by the board, had offered tracts of land, but these locations were considered unsuitable for various reasons. However, the very knowledge that such offers had been made spurred the Boulder Chamber of Commerce to greater efforts in offering a tract of land to the Federal Government for a building site.

<sup>20</sup>The Site Selection Board considered carefully the acceptance of the offer of a building site by the Boulder Chamber of Commerce. This was evidenced by a telegram, dated November 17, 1949, by Newbern Smith (chief of the CRPL and chairman of the Site Selection Board) to Francis Reich of the Boulder Chamber of Commerce. The telegram stated, in part:

. . . it is essential that we have definite description (of) tract as described in land records of county and firm statement bearing signatures of you and other officers of Chamber of Commerce that you now hold options on this land and that decision reached to establish laboratory in Boulder this tract will be dedicated to Federal Government for that purpose . . . subject to above considerations Site Selection Board disposed to consider favorably Boulder as site.

to come if it should be decided subsequently to transfer the activities of the National Bureau of Standards to this location. Housing conditions, water supply, sanitary facilities, and all other considerations entering into a decision of this magnitude have been carefully explored. There seems to be no impediment on these grounds for the location of the Laboratory at Boulder.

#### Recommendation

In view of the above considerations it is recommended that the Laboratory be located at Boulder, Colo., and that the tract of land offered for the Laboratory by the Boulder Chamber of Commerce be accepted.

In an office memorandum, dated December 12, 1949, the members of the Site Selection Board reported to Dr. Condon on their selection of Boulder, Colo. as the site for the proposed radio propagation laboratory building. On December 15 Secretary of Commerce Sawyer officially announced the selection.<sup>21-23</sup>

---

<sup>21</sup> The Boulder Chamber of Commerce received notice of the selection on the morning of the day before (December 14) by Senator Johnson of Colorado in a telegram that stated:

Congratulations on the selection of Boulder as site of the new Bureau of Standards laboratory.  
Best wishes.

<sup>22</sup> On December 16 the Site Selection Board met in Boulder to study planning for the new laboratory and discuss with the Chamber of Commerce the problems that might be encountered in moving NBS personnel to Boulder.

On occasion the Site Selection Board was more simply called by its initials, the SSB. These letters were sometimes reverted, facetiously, to the name, "Society for the Selection of Boulder."

<sup>23</sup> Reactions to the selection of Boulder, Colo. as the location of a new CRPL facility ran the gamut among staff members. One high-level scientist was quoted by a Washington, D.C. newspaper as saying that Boulder was a "Scientist's Siberia." The passage of time has proved how far wrong the statement was, for the Boulder area has become the home of several dozen research organizations, and the community serves as host to an almost steady stream of scientific conferences and meetings that converge upon Boulder throughout the year. Instead of a "Siberia," Boulder attracts scientists from "the four corners of the Earth."



*Photo, published by the Boulder Daily Camera on December 15, 1949, of cattle grazing on a snow-covered pasture that would soon become the site for a radio building and cryogenic engineering buildings for a new facility of the NBS. On the same day Secretary of Commerce Sawyer announced that Boulder, Colo. was to be the location of the new facility. At the time this photo was taken the now much travelled South Broadway was a narrow gravel road. The Flatirons in the background, the "trademark" of Boulder, would serve as a dramatic backdrop to the NBS buildings that were to be constructed on the site.*

*Photo by Boulder Daily Camera*

### c) BOULDER MEETS A CHALLENGE

During the early summer of 1949 there were "signs in the wind" that Boulder, Colo. might be selected as the site of a new radio laboratory for the NBS. After returning from a trip to Washington, D.C., secretary-manager Francis Reich informed the board of directors of the Boulder Chamber of Commerce on October 24 of Boulder's chance of being selected as the site of the radio laboratory as a result of Congressional action. The board voted "to leave no stone unturned to secure the laboratory and to notify Federal officials that Boulder stands ready to provide a site if necessary."<sup>24</sup>

On February 27, 1950, a group of the Boulder Chamber of Commerce, known as the Bureau of Standards Committee, initiated plans to raise funds to the extent of \$70,000 to purchase a 217-acre tract (a combination of two tracts) of land west of Marshall Road and south of Green Mountain Cemetery.<sup>25</sup> An option for purchase of the tract had been negotiated earlier by the Chamber of Commerce. A campaign to raise the money was set to

<sup>24</sup>Two days later, on October 26, an account in the *Denver Post* stated, under the headline of "Big Ed Sees Radio Lab for Boulder," that: "chances now are very good that Boulder, Colo., will be chosen as the site of a new multimillion dollar government radio laboratory building, it was announced Wednesday by U.S. Senator Ed C. Johnson." But the NBS Site Selection Board was still to make the bulk of its study, and not to report its selection until December 12, with the public announcement on December 15 by Secretary of Commerce Sawyer. During these many weeks Boulder was basking in a contemplative air of great expectations.

<sup>25</sup>Although size of the tract of land was given as 210 acres in the option negotiations, and in publicity, the purchase was for approximately 217 acres.



On March 2, 1950, the three "influential boosters" for Boulder as the new location for the Bureau's Central Radio Propagation Laboratory met with the committee that was to raise funds for a site. Meeting with Vergyl H. Reynolds (left), president of the Boulder Chamber of Commerce, is the trio (left to right), Dr. Donald H. Menzel, director of the Harvard College Observatory for Solar Research, Dr. Edward U. Condon, director of the National Bureau of Standards, and Dr. Walter O. Roberts, director of the High Altitude Observatory at Climax, Colo. The Chamber of Commerce was the prime mover in raising funds for purchase of land for the NBS site.

Photo by Boulder Daily Camera

start on April 10. The Chamber of Commerce announced on March 2 that James J. Yeager, of a Boulder business establishment, had accepted chairmanship of the campaign to raise the \$70,000.<sup>26</sup> By early April, Yeager had a large group of Boulder citizens organized for the Boulder Chamber of Commerce-U.S. Bureau of Standards Radio Laboratory Fund Campaign.

Although originally announced to start on April 10, the campaign got underway at the "zero hour" of 7:30 a.m. on April 11.<sup>27</sup> Before, during, and at the close of the campaign, coverage of progress was spread across full pages of Boulder's newspaper, the *Daily Camera*.<sup>28</sup> On April 18 success of the campaign was announced in the *Daily Camera* by the Chamber of Commerce as a full-page spread under the headline, "Congratulations Boulder, You've Done It Again."<sup>29</sup> A victory breakfast was held on April 20, addressed by Senator Ed Johnson. He hailed Boulder with a great future as a scientific center. By April 25 contributions to the fund totaled \$90,407.40, as announced by the Chamber of Commerce.<sup>30</sup>

#### 4. NBS extends its facilities

##### a) NBS OWNS THE BOULDER SITE

The April 18, 1950, issue of the Boulder *Daily Camera* had spread across the full-page notice of the successful fund raising campaign the large block letters in red ink "O.K. UNCLE, SHE'S ALL YOURS." On June 14, 1950, at a brief yet impressive ceremony in the Boulder Chamber of Commerce office, the deed to the tract of 217 acres for the NBS site was

---

<sup>26</sup> On the same day of March 2, three "influential boosters" of Colorado, and particularly of Boulder, for a new NBS site, met with Vergyl H. Reynolds, president, and others, of the Boulder Chamber of Commerce. It was the same group that brought its influence upon many others that Boulder was the "ideal" location for a new NBS facility; namely, Dr. Condon of NBS, Dr. Menzel of the Harvard College Observatory, and Dr. Roberts of the High Altitude Observatory at Climax, Colo.

Previous to Reynold's term of office, John F. Allardice had been president of the Chamber of Commerce and was active in the early stages when Boulder was being considered as a site to extend the facilities of NBS.

<sup>27</sup> Start of the funding campaign was signalled by a breakfast, the workers being addressed enthusiastically by Elmore Peterson, dean of the Business School, University of Colorado. Dean Peterson was an avid supporter of the campaign. President Robert L. Stearns of the University spoke briefly.

<sup>28</sup> As a stratagem to relate the size of the contributions to the land that was being purchased, a \$350 contribution was equivalent to 1 acre of land. Amounts were so cited in publicizing the contributions, thus \$100 was also designated (1/4 acre).

<sup>29</sup> Boulder had succeeded in 1874 in getting the University of Colorado to be located in Boulder through the intensive efforts of several of its citizens. Thus, in 1950, Boulder did it again, and on this occasion initiated a trend that has resulted in an influx of scientific and technical organizations to the Boulder community that continues to the present time. The first to join this trend on a big scale was the U.S. Atomic Energy Commission which announced on March 23, 1951, that it would construct a \$45,000,000 facility at Rocky Flats, 7 miles south of Boulder.

Author's (WFS) note: In a recent publication, entitled "Boulder in Perspective," John B. Schoolland, a long-time resident of Boulder and a professor of the University of Colorado, used as a subtitle to his tome, "From Search for Gold to the Gold of Research" It was, indeed, the National Bureau of Standards that in 1950 initiated the trend that would result in "the Gold of Research" in the Boulder Community.

<sup>30</sup> The total of the contributions far exceeded the goal of \$70,000 set at the beginning of the fund-raising campaign, and the \$63,000 expended for purchase of the tract of land donated to the United States as a site for a radio building. The excess of funds was used later to purchase a tract of land on Arapahoe Road (Avenue) east of Boulder for use as an industrial area (Boulder Industrial Park). Much of this tract of land was occupied later by the Ball Brothers Research Corporation.

The largest contribution was \$10,000, made by the Boulder Elks, No. 566. All contributions from \$100 (1/4 acre) upward were recognized by public announcement. Later, the names of these contributors were inscribed on a metal plaque placed on the stone wall of the lobby entry to the Radio Building.

On September 14, 1964, the Tenth Anniversary Open House of the Boulder Laboratories was "Dedicated to the Citizens of Boulder, in particular those who expended their time, energy, and cash to make possible the establishment of the Boulder Laboratories."

transferred by the Boulder Chamber of Commerce to the United States of America.<sup>31,32</sup> S. W. J. Welch, administrative officer of the CRPL, accepted the deed to the property, representing the NBS and the U.S. Government. Fifteen were in attendance at the ceremony.

#### b) PLANNING FOR A BUILDING—AND INTERIM QUARTERS

Time was not lost by the CRPL in a preliminary design of the radio laboratory on the basis of a simple functional design with maximum amount of laboratory and office space within the limits of the appropriation. The architect selected, Frank W. Cole, Washington, D.C., had a descriptive design prepared by December 1950. Shortly thereafter the architectural and engineering firm of Pereira, Luckman, and Stanton of Los Angeles, Calif. and an associate architect, Robert W. Ditzen of Boulder, were selected for the detailed design of the new radio building.<sup>33</sup> The design, released for public review on March 12, 1952, called for a reinforced concrete structure with stone facings in the main entrance area. The six wings were one-story structures (with clerestory roof design), three on each side of a central spine.<sup>34</sup> The central unit or spine was four stories high in front and two at the rear, shaped to a sloping terrain. A library and an auditorium were located astride the main entrance. Construction was under direction of the Public Buildings Service of the General Services Administration.

There was no prospect that the new building could be started until 1952 or completed until 1954, yet a "Colorado" project had been set up by the CRPL in the Colorado Springs area in the spring of 1950—the Cheyenne Mountain project of studying tropospheric propagation (see ch. XII, p. 525). In the spring of 1951 the Bureau negotiated for, and occupied, the Colorado National Guard Radar Armory on the Foothills Road (now North Broadway) on the north side of Boulder. Later the Armory warehouse was added to the facility.<sup>35</sup>

---

<sup>31</sup> The deed recorded in Boulder County under Reception No. 491, 297, June 14, 1950, Book 860, page 465.

<sup>32</sup> On the preceding day, June 13, purchase of the Callahan parcel of 137 acres was completed. Previously the Kohler parcel of 80 acres had been purchased, making a total of 217 acres for the tract for the NBS site south of Boulder. In January and February (1950), a topographical map and a soil survey by test holes had been made of the tract by the Bureau of Public Roads, Department of Commerce.

Over the years various acreages have been noted, possibly somewhat perfunctorily, of the total tract that was transferred to the U.S. Government in June 1950, ranging from 210 to 220 acres. Added to the original tract of 217 acres, on March 1, 1951, a triangular plot of 2.81 acres (bordering on Broadway) was purchased by the U.S. Government from the Kohler estate for \$1000.

On October 2, 1951, the NBS property was annexed to the City of Boulder.

Since 1951 small segments of the property have been transferred, to each party, between NBS and the City of Boulder and between NBS and the Green Mountain Cemetery. In 1968 a Boulder land surveying firm determined the total area of the NBS property to be 205.56 acres.

<sup>33</sup> The firm of Pereira, Luckman, and Stanton received a 1954 Award of Merit from The American Institute of Architects for the design of the radio building.

<sup>34</sup> The initial conception of the laboratory building resulted in a resemblance to "classical design." Upon the suggestion of Hugh Odishaw, assistant to Condon, a design began to be formulated that would bring the building into becoming a part of the landscape—terraced sets of low-profiled wings spreading out from a central spine and set upon the sloping terrain with a backdrop of spectacular foothills (the Flatirons). That is what we see today—thanks to Odishaw.

With the six wings, three on each side of the central spine, the ground-floor plan was quite similar to that of the shape of a papal cross. When first constructed, with only four wings, the plan was that of the shape of a patriarchal cross.

<sup>35</sup> The Radar Armory became known as the North Site. Later, with the construction of the Radio Building and occupancy of the cryogenic buildings on Marshall Road (later Broadway) this location became known as the South Site. The two sites retained these names until all personnel and equipment were moved to the new building in the spring of 1954.

THIS DEED. Made this 13th day of June, in the year of our Lord one thousand nine hundred and fifty, between Boulder Chamber of Commerce,

a corporation duly organized and existing under and by virtue of the laws of the State of Colorado, of the first part, and United States of America,

WITNESSETH, That the said party of the first part, for and in consideration of the sum of One Dollar to the said party of the first part in hand paid by the said party of the second part, the receipt whereof is hereby confessed and acknowledged, hath remised, released, sold, conveyed and QUIT CLAIMED, and by these presents doth remise, release, sell, convey and QUIT CLAIM unto the said party of the second part, its assigns forever, all the right, title, interest, claim and demand which the said party of the first part hath in and to the following described parcels of land situate, lying and being in the County of Boulder and state of Colorado, to-wit:

The Northwest quarter of the Southeast quarter (NW1/4SE1/4), the Northeast quarter of the Southwest quarter (NE1/4SW1/4) and Lot six (6) of Section six (6), Township one (1) South, Range seventy (70) West of the 6th Principal Meridian, and All of that part of the Northwest quarter of the Southwest quarter (NW1/4SW1/4) of Section five (5), Township one (1) South, Range seventy (70) West of the 6th Principal Meridian which lies Westerly of the county road, the right of way for which was conveyed to the Board of County Commissioners of the County of Boulder, Colorado, by The Colorado and Southern Railway Company by a deed which is of record in Book 698 at page 159 of the public records of the County Clerk and Recorder of Boulder County, Colorado, and The Northeast quarter of the Southeast quarter (NE1/4SE1/4) and the Southeast quarter of the Northeast quarter (SE1/4NE1/4) of Section six (6), Township 1 South, Range 70 West of the 6th Principal Meridian, saving and excepting, however, all of that part of the said Southeast quarter of the Northeast quarter of the said Section six (6), containing 1/4 acres, more or less, which lies Easterly of the county road, the right of way for which was conveyed to the Board of County Commissioners of the County of Boulder, Colorado, by The Colorado and Southern Railway Company by a deed which is of record in Book 698 at page 159 of the public records of the County Clerk and Recorder of Boulder County, Colorado,

TO HAVE AND TO HOLD the same, together with all and singular the appurtenances and privileges thereunto belonging, or in anywise thereunto appertaining, and all the estate, right, title, interest and claim whatsoever, of the said party of the first part, either in law or equity, to the only proper use, benefit and behoof of the said party of the second part, its assigns forever.

IN WITNESS WHEREOF, The said party of the first part hath caused its corporate name to be hereunto subscribed by its Vice-President, and its corporate seal to be hereunto affixed, attested by its Secretary, this day and year first above written.

Attest: F. W. Reich Secretary. Boulder Chamber of Commerce By Frank S. Henderson Vice-President

STATE OF COLORADO, County of Boulder.

The foregoing instrument was acknowledged before me this 13th day of June, 19 50 by Frank S. Henderson as Vice President and F. W. Reich as Secretary of Boulder Chamber of Commerce a corporation.

My commission expires May 10, 1953. Witness my hand and official seal. William T. Paddock Notary Public

Copy made from a microfilm of Quit Claim Deed recording the transfer from Boulder Chamber of Commerce to the United States of America of parcels of land that became the site of the Boulder Laboratories, National Bureau of Standards. In 1956 the original deed, dated June 13, 1950, could not be located among the files of several Government agencies, thus this photo copy was made from a certified copy taken from microfilm repositied with the records of the Boulder County Clerk and Recorder.





The "North Site"

*View to the northwest of the Colorado National Guard Radar Armory (and warehouse) along the Foothills Road (now North Broadway) on the north side of Boulder. In the spring of 1951 NBS negotiated for occupancy of the Armory for office and laboratory space until completion of facilities at the "South Site." The move across town was made during the spring of 1954.*

In the spring of 1951, on March 28, the NBS announced that a cryogenics laboratory would be built on the new Bureau site in Boulder.<sup>36</sup> This was but 5 days after the announcement of the large facility of the Atomic Energy Commission (AEC) to be constructed at Rocky Flats south of Boulder. (See footnote 29.)

#### c) CONSTRUCTION PROCEEDS ON THE RADIO BUILDING

Three large buildings were now on the new Bureau site, even before bids were opened for construction of the Radio Building, the *première raison d'être* for the site. However, the Bureau already had exercised its purpose that the Boulder site would be used for other activities in addition to that of radio propagation studies and radio standards. On May 22, 1952, bids were opened in Washington, D.C. for the new Radio Building. After some adjustments in the bids, the contract was awarded on June 2 to the Olson Construction Co. of Denver, Colo. at \$3,920,000. Two of the six wings of the building were eliminated as an economy measure, leaving a gross area of approximately 172,800 ft<sup>2</sup>.

---

<sup>36</sup> Later in the spring of 1951 construction began on the cryogenics laboratory building, funded by the AEC, to be known as the Liquefier Building or Building "A," and used for a highly classified project for the AEC. Shortly thereafter a second building, known as Building "B," was constructed as a laboratory facility associated with the same project. The two buildings housed the Cryogenic Engineering Section, later to become a division of NBS, and to be known as the Cryogenic Engineering Laboratory. A third building, a very large frame building to become known as the "Camco" Building, was constructed by the AEC for use by the Cambridge Corp., a private contractor. Later it became known publicly that these facilities served for certain operations of the AEC hydrogen-bomb project.

In 1964 an addition to Building "B" was completed. On the occasion of the 10th Anniversary celebration (September 14, 1964) of the Boulder Laboratories this new wing was dedicated by the director, Dr. Astin. Former U.S. Senator Ed Johnson (Colorado), who played a major role in bringing the CRPL to Boulder, was an honored guest and was the first to enter the doors of the new addition after the ribbon-cutting ceremony. One can well imagine that he had a feeling of great satisfaction that his intensive efforts and predictions back in 1949 and the early 1950's bore fruit in the establishment of the Boulder Laboratories.

Although excavation for the Radio Building began in late June, the ground-breaking ceremony took place on July 21, 1952, with the director, Dr. Astin, "informing" the contractor to proceed with the construction. The building was essentially completed in March 1954. Later, the two remaining wings of the original design were added, completing the structure.<sup>37</sup>

---

<sup>37</sup> Construction of Wing 6, to house the Electronic Calibration Center was started in June 1956. Its design for a special-purpose building was by a Boulder architect, James Hunter. This wing was dedicated in August 1958 (see ch. X, pp. 352-353). Wing 5 had a lengthy period of coming into existence from the time of the appropriation to final construction and occupancy in 1962. This wing was a 3-story structure plus a large-size fallout shelter as a subbasement. Computer facilities for the Boulder Laboratories became a large-scale operation in this wing.



*View of the area now occupied by the Radio Building, Boulder Laboratories, as it appeared on July 15, 1952, a few weeks after ground was broken for construction. The photo was taken in the vicinity of the present Plasma Physics Building (Building 24) and the view is in a northeasterly direction. The elevated grade of the Denver-Boulder Turnpike crosses the view nearly horizontally at mid distance. Early housing of Highland Park appears between the Turnpike and the nearer Marshall Road (now Broadway). Smokestacks of the Valmont Power Plant appear in the distance at right.*



*The site of Boulder Laboratories as it appeared on July 15, 1952, a few weeks after ground was broken for construction of the Radio Building. The tiled drain in foreground is located just to the north of the auditorium section of the Radio Building that was completed in the spring of 1954. In mid distance can be seen the Liquefier Building and the Camco Building, both constructed during 1951. Occupying the horizon at center is Bear Mountain, that provides a spectacular backdrop for the Boulder Laboratories in a southwesterly direction. Buildings of the National Center for Atmospheric Research now occupy the hilltop (known as Table Mesa) to the left and front of Bear Mountain.*



*An aerial survey view (west toward top of photo) taken by the Air Force in 1956, with the land occupied by the National Bureau of Standards centered in the photo. Broadway stretches diagonally across the view from center on right to the lower left corner. The Radio Building, with four wings, is adjacent to and above Broadway to the right of center. At top are the Flatirons as they appear looking down from a high altitude, appearing quite differently from a viewpoint at ground level. Baseline Road, which straddles the 40th parallel, is the vertical line to the right of the Radio Building.*

#### **d) CAMPUS FEATURES AND PERIPHERAL FACILITIES**

With the passage of time, other buildings and features began to dot the “campus” of the Boulder Laboratories. The last major building to be constructed on the Boulder site was the Plasma Physics Building, completed in 1967. The building was designed at a time when the plasma physics projects were in an accelerating stage of activity. In 1967 the 10-story (with laboratory wing) JILA building on the University of Colorado campus was dedicated. The Institute for Laboratory Astrophysics (JILA) was established in 1962 as a cooperative institute of the University of Colorado and the National Bureau of Standards (see ch. XV, pp. 627-631).

Further development of the Boulder campus on a large scale has never come to fruition—that of a new Radio Standards Laboratory building, a central functions building, and other large structures. Although the planning phase was essentially completed, no appropriation was made by Congress for the construction of the first units (see ch. X, pp. 355-356). However a Campus Development Plan was delivered by the architects and engineers in 1963.<sup>38</sup>

In 1958 the roads and driveways on the campus were assigned names after Nobel Prize winners in physics. The roster of names included: Anderson, Appleton, Compton, Curie, Kusch, Lawrence, Marconi, Millikan, and Wilson.<sup>39,40</sup>

For a number of years the staff of the Boulder Laboratories believed that the robust-looking apple tree growing so gracefully near the stone-wall facing of the Library of the Radio Building was truly a scion of the famous Newton apple tree.<sup>41</sup> But by 1977 the tree became a disillusionment—the tree proved to be an ornamental crab apple and not a scion of the “Pride of Kent” apple tree under which Newton had sat when he first contemplated seriously upon the laws of gravity.<sup>42</sup> Although the tree has been allowed to remain in its time-honored location, it now has a companion, located close to the stone-and-concrete wall fronting the nearby Auditorium. This sapling, purported to be a true descendant of the original Newton apple tree, was planted in the spring of 1978, with the hope that someday it will bear “Newton apples” of the variety of the Pride of Kent.<sup>43</sup>

Other plantings at the Radio Building since construction are the “outside” and “inside” groups of plants at the lobby entrance. The inside group, surrounded on three sides by glass, consists of less hardy plants that do not withstand the winter temperatures of Boulder. Many of the plants are “natives” from the Gardens of the Blue Ridge (a commercial plant nursery) in North Carolina and were procured by S. W. J. Welch.

---

<sup>38</sup> National Bureau of Standards, Boulder, Colo., Campus Development Plan. See U.S. Department of Commerce Boulder Laboratories Library Ref. Q183.H8.

<sup>39</sup> In a memorandum, dated November 17, 1952, to Paul S. Ballif (then in charge of facilities at NBS Boulder), John L. Swinnerton, chief of Engineering and Drafting Office, Plant Division, stated, in part:

The naming of streets after Nobel Prize winners in the physical sciences is a suggestion for your consideration.

Surprisingly, an extensive search of NBS Boulder records has not yielded information on how the choice was made of naming streets on the Bureau grounds after Nobel Prize winners, nor does anyone seem to know when the first signs were erected (the best estimate is 1958).

<sup>40</sup> Of the nine names selected, Appleton and Marconi had been awarded Nobel Prizes for work in radio. Kusch was a consultant to the NBS on the atomic clock program during the period 1948-1955 (see ch. VIII, p. 299).

Two men, Walter H. Brattain and Charles Townes, associated with NBS in the past, had also been awarded Nobel Prizes in physics. Townes was a consultant to NBS on the atomic clock program during the period 1948-1955 (see ch. VIII, p. 298). Brattain was a staff member of the former Radio Section during the period 1928-1929 (see ch. VIII, p. 253).

Author's (WFS) note: These two NBS-related Nobel Prize winners would be fitting selections for naming new roads on the Boulder campus.

<sup>41</sup> The story of the apple tree in relation to Newton's contemplation on the laws of gravity upon seeing an apple fall from the tree has been a matter of considerable discussion and writing since the event of 1665 or 1666. The first telling of the story in print is usually credited to the French philosopher, Voltaire, in a book that he published in 1727. However, the story was told directly by Newton to William Stukeley on April 15, 1726, who noted the historical event of the falling apple in his *Memoirs of Sir Isaac Newton's Life*.

<sup>42</sup> In 1977 Deloris (Dee) Belsher of the Program Information Office (Boulder Laboratories) suspected that the “Newton apple tree” was not a true scion of the original. Considerable research led to the conclusion that her suspicions were, indeed, correct—the tree could not have descended from the original Newton apple tree for it was not bearing apples of the Pride of Kent variety, but crab apples. Mrs. Belsher submitted an account of her findings to the Boulder Laboratories Suggestion Program, for which she received a monetary award and a Certificate of Award for a valuable suggestion. Her suggestion led to the planting of a tree that could be accepted as a true scion of the original Newton apple tree.

<sup>43</sup> The Newton apple tree planted at the Boulder Laboratories in the spring of 1978 comes from a long line of descendants from the original tree at Newton's birthplace and country home, Woolsthorpe Manor, near Grantham in southwestern Lincolnshire—an account of lineage too detailed to be given here.

# BOULDER SITE PLAN

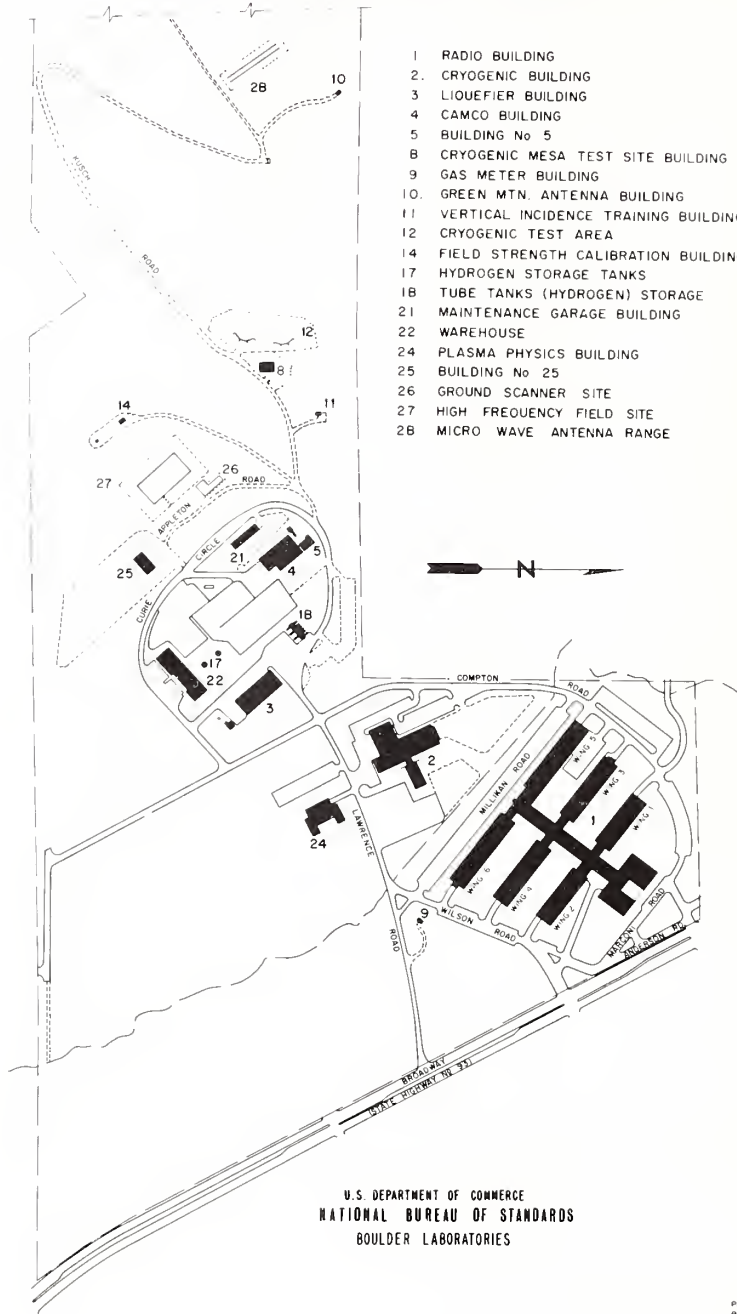

Site plan (1972) of the Boulder Laboratories. No buildings of significance have been added since 1972. Orientation of the Radio Building, the largest building on the 217-acre site, is such that the central spine connecting the six wings is at an angle of  $37^{\circ} 37'$  east of north.



*A 1973 view to southwest from helicopter over Highland Park subdivision east of Broadway (across lowest portion of photo). Spread across the middle portion of photo can be seen nearly the entire tract of the 217 acres of land on which have been constructed a number of buildings of the National Bureau of Standards at Boulder, Colo. In the foreground is the large Radio Building with six wings extending from the central spine.*

*Take interest, I implore you, in those sacred dwellings which one designates by the expressive term: laboratories. Demand that they be multiplied, that they be adorned. These are the temples of the future—temples of well being and of happiness. There it is that humanity grows greater, stronger, better.*

*Louis Pasteur*

*The Flatiron Mountains form a dramatic backdrop to the scene, with Bear Peak at left and Green Mountain at right. At the base of Bear Peak can be seen the buildings of the National Center for Atmospheric Research, high on a mesa (Table Mesa) overlooking the southern area of Boulder.*

The Boulder region is well suited for field sites of a variety of terrain for the study of radiowave propagation. "Where the plains meet the mountains" offers nearly all geographical features but an ocean, plus an agreeable climate, if one overlooks the occasional strong (and sometimes very strong) winds. The first occupied site was in June 1950, on Cheyenne Mountain, southwest of Colorado Springs. One transmitter site was just below the summit of 9445 feet above sea level, another site was located about halfway up the precipitous east face of the mountain. The Great Plains extend for hundreds of miles to the east. This location was well suited as a site to simulate radio communication between aircraft and ground at distances out to several hundred miles on the plains. A series of five field sites extending to the east into Kansas provided for reception of radio signals from the Cheyenne Mountain transmitters. Mobile units operated out to 600 miles. The field site at Haswell, in eastern Colorado, was later fitted with special transmitters for several tropospheric propagation projects. (See ch. XII.)

By 1952 two tracts of land near Boulder were leased for special radio studies, an 80-acre tract 7 miles east, and a 100-acre tract on Gunbarrel Hill northeast of Boulder. Three giant Wurzburg "dish" antennas or radio telescopes were erected on the latter tract for study of

radio emission from the Sun. Later, in 1961, came the acquisition of 1800 acres, north of Boulder, to be known as the Table Mountain Field Site. The major portion of this butte is very flat and is uniquely suited for many radio experiments. To maintain quiet conditions, no radio transmissions are conducted at the site.



Table Mountain Field Site

*Aerial view (toward the west southwest) of Table Mountain, located north of Boulder, Colo. about 11 1/2 miles from the Boulder Laboratories. This area of 1800 acres, elevated above the surrounding terrain, has a uniform 2 percent slope. It has been used since 1954 (acquired in 1961), first by NBS and now by ITS (Institute for Telecommunication Sciences), solely as a receiving site and is admirably suited for many propagation and other radio research projects.*

The Green Mountain mesa at the rear (toward the foothills) of the 217-acre campus has been used primarily for antenna studies. The grounds of the campus as a whole have been used for antenna installations, both transmitting and receiving, since the time the tract of land became NBS property. The roof of the Radio Building has served as the mounting platform for many types of antennas.

Other field sites located in the vicinity of Boulder have been that at Sunset, in Four-mile Canyon, northwest of Boulder, used for transmission of a standard frequency at 20 kHz (see ch. VIII, p. 278); and at Fritz Peak near the Peak-to-Peak Highway south of Rollinsville, used for observing night airglow (see ch. XI, pp. 466-469). At a further distance from Boulder is the location of the time and frequency broadcast stations WWV, WWVB, and WWVL near Ft. Collins, Colo. (see ch. VIII). Not to be overlooked in noting are the many field sites and field stations scattered in this country and in various parts of the world and operated by the CRPL from the time of World War II to 1965, and some to continue operation by ESSA, and later by NOAA and the ITS.



## 5. The migration to Boulder

### a) THE VANGUARD

If the question were asked, "Who led the migration from NBS Washington to NBS Boulder?"—the answer could well be "Ed Condon." Without much doubt, the selection of Boulder, Colo. as the new location for CRPL operations can be traced back to a point in time of a "beginning" with Dr. Condon's visit to Idaho Springs, Colo. in the early summer of 1949 (see pp. 706-708). This visit headed the vanguard to the CRPL staff's migration in 1954. Thereafter, Condon made a number of visits to Boulder and in 1963 took up residence in the city when he joined the teaching staff of the University of Colorado. On several occasions before 1954 Condon had the opportunity of speaking before Boulder organizations on subjects relating to the NBS.

On the day following the announcement of December 15, 1949, by Secretary of Commerce Sawyer that Boulder, Colo. had been selected for the site of the proposed radio propagation laboratory, the Site Selection Board visited Boulder and the selected location. Thereafter, for a period of time, each of the members of the Board (Smith, McNish, Norton, and Welch) had specific needs to visit Boulder as a representative of the CRPL or the Government.

In the spring of 1950 the Cheyenne Mountain project of studying tropospheric propagation was set up at Colorado Springs and the first transfer of a CRPL staff member from Washington to Colorado was initiated.<sup>44</sup> On May 24, 1950, Condon announced at a Washington meeting that between 250 and 350 NBS employees would be transferred to Boulder in about 2 years (the 2 years became 4 years).

On March 8, 1951, the first of several memoranda was circulated in the division relating to the move to Boulder. A contract had just previously been awarded by the Public Buildings Service for a design of the new building, with the expectancy that the division could be moved during the fall of 1953. A memorandum a year later was circulated to ease the minds of CRPL staff members on problems of housing in Boulder caused by "uneasiness and restlessness on the part of a large number of staff members." The memo stated that the Boulder Chamber of Commerce and other groups were trying "to arrive at a satisfactory solution of the housing problem before it is (was) necessary for personnel to transfer."

It was not until the spring of 1951 that the first transfer was made to Boulder. On May 22, 1951, Jessie B. Berkley arrived in Boulder to take up duties as the liaison officer to assist in the transfer of CRPL staff members.<sup>45</sup> Mrs. Berkley had been chief of the Operations Section of the Personnel Division. A month later Kenneth A. Norton, assistant chief of the CRPL, transferred to Boulder to take charge of all CRPL operations in Colorado. Following Norton, in July, Jack Herbstreit transferred to take charge of the tropospheric projects as chief of the Tropospheric Propagation Research Section.<sup>46</sup>

Gradually the ranks of the Boulder staff began to be filled in, both by transfers from Washington and by recruitment in Colorado. The migration from Washington continued at a slow rate, not getting into full swing until 1954. Early in August 1952 Paul S. Ballif, chief of the Shops Division, transferred to Boulder to become chief of the Facilities Division. In April 1953 Barton F. Betts transferred to take charge of the "Central Office" for matters relating to personnel, procurement, information, and other operations.

---

<sup>44</sup>The first CRPL staff member to transfer or "migrate" from NBS Washington to Colorado was Arthur J. Estin, formerly of the Ionospheric Research Section, who joined the tropospheric group being stationed at the facility on Cheyenne Mountain southwest of Colorado Springs. This transfer occurred in April 1950, about 4 months after Boulder was selected as the future location for the laboratories of the CRPL.

<sup>45</sup>Years later, Mrs. Berkley was placed in charge of management planning for the Boulder Laboratories. In 1965 she received the Department of Commerce Silver Medal for Meritorious Service "for extreme competence in performance of official duties over a long period of time."

<sup>46</sup>By late spring of 1951 a large portion of the Tropospheric Propagation Research Section had moved to Boulder, occupying the Colorado National Guard Radar Armory. Field operations were carried on at the Cheyenne Mountain field station and elsewhere.

In February 1954 Dr. Frederick W. Brown, technical director of the Naval Ordnance Test Station, Inyokern, Calif., was appointed director of the Boulder Laboratories.<sup>47,48</sup> At the same time Dr. Ralph J. Slutz, was appointed an assistant chief of the CRPL, to be transferred to Boulder. S. W. J. Welch rejoined the CRPL in April as the executive officer of the Boulder Laboratories, having been with the NBS Missile Development Division in Corona, Calif. since 1951. The vanguard had moved into Boulder over a period of several years. In May 1954 the migration of the CRPL staff was in full swing toward Boulder, to continue through the summer.

#### b) PREPARATIONS FOR THE MIGRATION

Within the CRPL several committees were set up to cope with the many problems of moving a large NBS division across the country for a distance of 1800 miles. It was a logistics project of considerable magnitude. A Steering Committee gave guidance to subcommittees. Among the subcommittees was the CRPL Resettlement Committee of 10 staff members under the chairmanship of Eldred C. Wolzien of the High Frequency Standards Section. Formed in July 1953, the committee was in action until after the move to Boulder during 1954. The committee performed in areas such as: assembling and maintaining a library of information on Boulder and Boulder real estate, gathering information on Government moving regulations and on moving companies, a survey to indicate the added load to the Boulder school system, up-to-the-minute information on temporary housing, and other information associated with moving a large group of workers and their families. The committee, as well as the CRPL, had the benefit of a Boulder Chamber of Commerce group, known as the Boulder Liaison Committee, that kept the CRPL informed on many subjects relating to the move to Boulder.

On October 27, 1953, Dr. Astin, director of NBS, addressed the "Washington staff" of the CRPL on the move to Boulder.<sup>49</sup> Astin took the opportunity of discussing "two very major factors leading to possible uncertainty about the future of Division 14, and . . . to dispel any unfounded rumors and give . . . assurance the Division has a very solid and substantial future."<sup>50</sup>

---

<sup>47</sup> NBS Administrative Bulletin No. 54-9 of February 26, 1954, stated, in part:

Dr. Frederick W. Brown is appointed Director of the Boulder Laboratories of the National Bureau of Standards. He will direct the research, development, and standards programs of the NBS Central Radio Propagation and the NBS-AEC Cryogenic Engineering Laboratories, and the Boulder Facilities Division.

.....

Mr. Samuel W. J. Welch is appointed Executive Officer of the Boulder Laboratories of the National Bureau of Standards, where he will serve as the principal administrative assistant to Dr. Brown. . . .

<sup>48</sup> Dr. Newbern Smith, chief of the CRPL, had requested to be relieved of his duties as chief and serve as a consultant, and later resigned from NBS in 1954 to take a position with the University of Michigan. For a period of time Dr. Robert D. Huntoon (associate director for physics) served as acting chief of the CRPL; to be followed by Dr. Wallace R. Brode (associate director for chemistry) as acting chief until the arrival of Dr. Brown in June 1954.

<sup>49</sup> Condon had resigned from NBS on September 30, 1951, with Dr. Allen V. Astin becoming the acting director until named director on May 30, 1952 (date confirmed by Senate).

<sup>50</sup> The "two major factors" were the projected move to Boulder, and the question of a permanent division chief. As "facts" on the move to Boulder, Astin stated:

. . . The move is definitely going ahead, there is no good reason for changing these long-established plans to move the radio laboratory. Furthermore the move of the Division to Boulder has the full and complete endorsement of the Kelly Committee. One of the findings of this Committee is that the planned move to Boulder is a wise one and should increase the effectiveness of the CRPL. The move to Boulder has many advantages, the primary one being that there will be available a fine new laboratory building. When we get into it, Division 14 should become the best equipped and housed laboratory in the Bureau, instead of the worst.\*

.....

As to the future of the CRPL itself, I think the Kelly Committee report, if its recommendations are carried out, provides a very positive assurance on a strong sound future for the Laboratory. The report recognizes that the activity is a very appropriate function of the Bureau.

In his remarks, Astin noted the cooperative efforts of the Boulder community in preparing for the large influx of new residents. Six months later, in April 1954, 36 citizens, representing the Boulder community, made a "Good Neighbor Trip" to Washington, D.C. to visit the Bureau and to meet many of the staff members who were being assigned to the Boulder facility. It was a timely visit by the CRPL's fellow-townsmen-to-be, for within several weeks the westward migration was underway.

**c) THE "MOVING DAY" OF MANY WEEKS**

"Moving day" in Boulder for transportation of equipment from the North Site (Radar Armory) to the South Site (Radio Building) began on April 29, 1954, with the operation accomplished in about a week's time. In contrast, the "moving day" for the Washington-to-Boulder operation began on about the same date but continued until late summer. A total of 52 large moving vans was required for this operation, the total weight of laboratory equipment reaching 512 metric tons. O. Russell Dallman, of the Supply Division (NBS Washington), coordinated the moving operation and chose to transfer to the Boulder Laboratories. Packing of some of the laboratory equipment taxed the skill of the movers. Taking no chances with commercial movers, the four quartz crystals of the National Primary Frequency and Time Standard were hand carried by Bureau personnel to and from the Washington and Denver airports, and relied upon air transportation between the two cities (see ch. VIII, p. 275).

**d) THE BIG "MIGRATION"**

By the spring of 1954 the vanguard of NBS staff members transferring to Boulder had totaled over 30 from the CRPL and other divisions (largely from the Shops Division) at NBS Washington. By early May the migration west came into full swing and continued throughout the summer. The Regular Propagation Services Section completed its transfer in May, the first to be reestablished in the move westward. It was not until September that the Microwave Standards Section completed its transfer, bringing up the "rear guard," but with a few stragglers transferring as late as November. By the time of the dedication (September 14) of the new radio building, the staff totaled 466, including the 101 employees stationed at field stations in various parts of the world. Of the total of 466 persons, 396 were assigned to the 3 divisions of the CRPL and the Administration Division, the remaining 70 forming the Cryogenic Engineering Division.

The year 1954 was the year of the "long, hot summer." The all-time heat records were broken that summer (to the present time of 1976) for two of the mid-continent states, and the records were nearly broken for several other states.<sup>51</sup> Even Boulder did not escape; the all-time record of 104 °F was reached on June 24 and again on July 11. Travel by automobile across the Mississippi Valley was an ordeal on occasion, during the summer. The "migrants" who chose plane or train transportation escaped the "ordeal by heat." The new residents of Boulder found it to be a hot and parched land during the early fall of 1954. Dust storms

---

(Continued)

.....

There is further evidence of the interest of the town of Boulder in your coming there. The Boulder *Daily Camera* probably gave the Kelly Committee report the best press notices of any paper in the United States. . . . Since two areas of the report dealt with the activities at Boulder, the Cryogenics Laboratory and the CRPL, the newspaper had considerable opportunity to point with pride at local achievement. I think this is indicative of the sort of treatment you will get from the Boulder community when you are living there.

\*The Kelly Committee was an ad hoc committee appointed by the National Academy of Sciences to evaluate the functions and operations of NBS in relation to the current national needs. It was under the direction of Dr. Mervin J. Kelly, director of the Bell Telephone Laboratories. The Committee, an outgrowth of the AD-X2 (battery additive) controversy, made its formal report on October 15, 1953 (see Cochrane, *Measures for Progress*, pp. 495-500).

<sup>51</sup> The Missouri record of 118 °F was reached on July 14, 1954, and the Illinois record of 117 °F on the same date.

were a new experience to some. But it is reasonably safe to say that all were enchanted by the beautiful mountain setting that was to be their new home.<sup>52</sup>

## 6. Dedication of the Boulder Laboratories

### a) PREPARATIONS FOR A BIG EVENT

By the end of the summer of 1954 the CRPL was housed in its new building—8 years after it found need for larger quarters. The NBS was proud of its new facilities and it became fitting that the Boulder Laboratories should be dedicated with a considerable degree of formality. To meet up with the occasion the organization of committees began in early June, with Dr. Brown, director of the Boulder Laboratories, heading the all-important Dedication Program Committee.<sup>53</sup> In total, 10 committees were set into motion to plan for and steer a series of events that were set for a week in September 1954. Charles L. Bragaw of the Office of Scientific Publications, NBS Washington, was designated to coordinate the entire program and came to Boulder early in August.

From the beginning of the planning there was the choice and hope that President Eisenhower would head the list of dignitaries invited to the ceremonies and that the President would give the dedication address. Eisenhower had a great love for Colorado and selected the state for summer vacations. For recreation he chose trout fishing in the streams of the Fraser River system on the Western Slope. Public announcement was made on August 25 that the President had accepted to take part in the dedication ceremony on September 14. Never before had Boulder been visited by an incumbent President.

### b) SCIENTIFIC CONFERENCES COME TO THE BOULDER LABORATORIES

Thoughtful planning of introducing the Boulder Laboratories to selected segments of national scientific and technological fields resulted in the staging of conferences on cryogenic engineering and on radio propagation and standards.<sup>54</sup> These two conferences were held simultaneously, during the period of September 8-10, as an introduction to the dedication event on September 14. The Cryogenic Engineering Conference was the first of its kind held on a national scale and was the predecessor of many to follow in later years. A number of persons, both within NBS and outside, who were well known in various specialized fields of cryogenic engineering and radio were invited to chair the many sessions of the two conferences. In total, 151 invited and contributed papers filled the 3-day conferences.<sup>55</sup>

---

<sup>52</sup> Near the end of the calendar year 1955 the Boulder Chamber of Commerce requested the NBS Boulder Laboratories to conduct a survey on the employees "on how BL personnel liked Boulder." The questionnaire was based upon items relating to advantages and disadvantages of living in Boulder. Of 75 replies returned on 450 questionnaires, the result was summarized as 41 favorable to Boulder, 21 neutral, and 13 unfavorable. Very high in ratings in the categories listed under advantages was Boulder's climate and location (natural beauty, mountains, etc.). High in ratings in the categories listed under disadvantages were Boulder's poor streets and its high prices. Poor climate was given a very low rating.

(The detailed listing was recorded in the minutes of the December 1, 1955, meeting of the Boulder Laboratories' Management Council.)

<sup>53</sup> Other members of the Dedication Program Committee were:

- S. W. J. Welch, executive officer, Boulder Laboratories
- R. C. Peavey, Washington liaison officer, Boulder Laboratories
- F. W. Reich, manager, Boulder Chamber of Commerce
- F. A. Rohrman, director of engineering, experiment station, University of Colorado
- R. Hislop, assistant business manager, University of Colorado

<sup>54</sup> Three co-chairmen served as the Scientific Program Committee, namely: M. M. Reynolds, representing the Cryogenic Engineering Laboratory (CEL); and T. N. Gautier and J. W. Herbstreit, representing the CRPL. B. W. Birmingham of the CEL was chairman of the Scientific Sessions Committee.

<sup>55</sup> F. G. Brickwedde, chief of the Heat and Power Division of NBS, and well known in the field of cryogenics, presented an invited paper on the beginnings of cryogenic engineering at the Boulder Laboratories. Others of NBS presented papers on new developments in cryogenics at NBS.

George C. Southworth, of the Bell Telephone Laboratories and a member of the Radio Section of NBS in 1917-1918, presented an invited paper on "Early History of Radio Astronomy." In a session of invited papers on radio subjects, the speakers were: W. R. Hewlett, president of the IRE; Merle A. Tuve, Carnegie Institution of Washington, and developer along with Gregory Breit (NBS, 1918-1921) of ionosphere sounding by radio pulses; James C. W. Scott of the Defence Research Board (Canada); Walter O. Roberts, director of the High Altitude

Other scheduled events occupied the conferees, NBS staff members, and visitors during the week preceding the dedication event.<sup>56</sup>

### c) PRESIDENT EISENHOWER DEDICATES THE BOULDER LABORATORIES

Two events that had special appeal to people of the Boulder region accompanied the dedication of the Boulder Laboratories. On several days preceding the "big event" was "open house" for the several laboratory buildings. People were given the opportunity to view the laboratory interiors and the scientific equipment used for radio research. At last, after several years of anticipation, they could see the "inner works" of the new structures located at the south edge of Boulder. The second event was the unveiling of an aluminum plaque at

---

Observatory of Harvard University and the University of Colorado at Climax, Colo.; and C. H. Townes, Columbia University, consultant to NBS in microwave spectroscopy; indeed, a selection of talented men in their respective fields.

Dr. Donald H. Menzel, director of the Harvard College Observatory and one of the three "influential boosters" of Boulder for the new NBS site (see p. 706) presented a semi-popular lecture as an evening event on the subject, "The Sun and Radio Communications."

<sup>56</sup> Several field trips were made available to visitors during the conference and dedication week including: the Cheyenne Mountain Field Station, the Climax High Altitude Laboratory, and the Inter-University High Altitude Laboratories on Mt. Evans and at Echo Lake.

Social events of the week included: a chuckwagon dinner on Flagstaff Mountain, a conference banquet at the University of Colorado Memorial Center, and special events and trips as a part of the family programs.

The conference banquet on the evening of September 9 was of special significance. Dr. J. D. Gillaspie, mayor of Boulder, served as the toastmaster for the evening. Attending, by invitation, were dignitaries of Federal, State, and local governments; also the presidents of Colorado universities and colleges, each of whom extended greetings to the Boulder Laboratories. Of particular interest to the CRPL staff members was the reading by W. D. George (chief of the High Frequency Standards Section) of two letters, one from J. Howard Dellinger (former chief of the CRPL), the other from Newbern Smith (also, former chief of the CRPL, following Dellinger). Neither of the two men found it possible to attend the banquet and dedication events.

Interesting statements in Dellinger's letter were:

. . . I saw the Bureau's radio laboratory grow from a one-man concern in 1911 to a 250-person organization when I retired from it in 1948.

.....

Even a summary of these years of growth would fill a large book. I think the word I should give you at this time is one of appreciation for opportunity; the opportunity which I shared and which is certainly available to the present and future workers in the Boulder Laboratories.

To the scientist these days, any scientist, is given great opportunity . . .

Not only the scientists but all the participants in the work of the National Bureau of Standards can have this satisfaction of sharing in an enterprise of undoubted good to humanity. . . .

Of all the Bureau's work, it is in our own field of radio-electronics-telecommunication that the opportunity is and has been maximum.

.....

The members of this laboratory are fortunate not only in that its principal field is one of such dynamic progress, but also in that its work is on the more basic aspects of the field. Radio standards and propagation research are fundamental to all radio work and to much of electronics and telecommunication.

.....

I have emphasized that we who work or have worked in the Bureau and in this particular laboratory, looking out upon the world, find ourselves among the more fortunate of people. The world, looking at us, is entitled to find that we realize our privilege and that we have the humility and the good will of workers in behalf of mankind. . . . (Radio File, R005.3d)

Among the interesting comments in his letter, Newbern Smith said:

.....

When I entered the Bureau in 1935 the "wave propagation group" of the Radio Section consisted of three persons besides myself. The propagation studies themselves consisted largely of manual ionosphere sweep measurements on one day a week, and some field strength recordings. . . .

.....

The recognition and encouragement of the Bureau's work on radio propagation was mostly due to Dr. Dellinger, the Chief of the Radio Section, whose long experience in frequency allocation

the lobby entrance of the Radio Building, upon which were inscribed the names of contributors to the fund for purchase of the 217-acre site.<sup>57</sup>

At the request of the Presidential party, made quite in advance of the visit to Boulder, it was necessary to maintain a very tight schedule (on a minute-to-minute basis) in timing the laboratory tour and the dedication ceremony. "Trial runs" were made to determine the timing of laboratory visits by the Presidential party. The tour was limited to the Cryogenic Liquefier Building (Bldg. A) and the Radio Building, with complete tour limited to but 26 minutes including photography. At 10:35 on the morning of Tuesday, September 14, 1954, President Eisenhower mounted the wooden platform built over the flower bed and side walk at the main entrance to the Radio Building. The President was greeted by a crowd of about 10,000 (some estimates were less) in a hot September Sun and to the martial strains of "Hail to the Chief" by the Lowry Air Force Base Band.<sup>58</sup>

Dr. Brown, director of the Boulder Laboratories, introduced Sinclair Weeks, Secretary of Commerce, who, in turn, introduced Rev. A. E. Ostlund, president of the Boulder Ministerial Alliance, for the invocation. Secretary Weeks then introduced Dr. Astin, director of NBS, whose remarks touched upon the NBS facilities in Boulder. Then Secretary Weeks introduced the President of the United States. At several places in his prepared address President Eisenhower added remarks that, on the spur of the moment, fit the occasion (his verbatim address of 14-minutes length is given below).<sup>59,61</sup> The large-lettered headline to the front page of the Boulder *Daily Camera* (September 14) stated: "Ike Hails Vast Importance of Boulder Laboratories."

---

(Continued)

and utilization led him to appreciate the benefits which would accrue to all users of radio from the acquisition and use of radio propagation information. . . .

From four persons in 1935, the Bureau's propagation group grew to 80 by the end of the war. . . .

With its establishment in the fine new laboratory at Boulder, the radio work of the Bureau enters a new era. I am sure that the new CRPL will continue to forge ahead on the forefront of progress in radio science and in radio engineering—from the frontier of microwave techniques to the frontier of radio signals from distant galaxies—in the vital fields of radio spectrum conservation and utilization. (Radio File R005.3e)

Although Dr. E. U. Condon, former director of NBS, was scheduled to give some remarks at the banquet session, last-moment circumstances prevented his coming to Boulder. Dr. A. V. Astin closed the session with a response to other speakers and with summary statements of events at the Boulder Laboratories.

<sup>57</sup> This ceremony was in the morning of the day (September 13) preceding the dedication, with unveiling of the plaque by James J. Yeager, chairman of the Boulder Laboratory Campaign. The aluminum plaque was prepared by NBS Washington. All persons, organizations, and business firms that contributed to the Campaign Fund in amounts of \$100 (\$100 equivalent to 1/4 acre) or more were listed on the plaque.

<sup>58</sup> Comments on the front page of the Boulder *Daily Camera* of September 14 stated:

Only a few clouds were in the sky, and the throng broiled in the sun.

Two women fainted and were taken to a first aid tent on the grounds. . . .

Boulder schools were dismissed for the morning. . . .

The area was well filled by 9 a.m. and jammed an hour later.

Eight motion picture cameras—representing newsreel companies and four major television networks—were lined up on a platform facing the presidential platform.

Newspaper cameras by the dozen and private individual's cameras by the hundreds were in evidence.

<sup>59</sup> Seated on the platform with Eisenhower, Brown, Weeks, Ostlund, and Astin were:

James C. Worthy, Assistant Secretary of Commerce  
Dan Thornton, Governor of Colorado  
Gordon Allott, Lt. Governor of Colorado  
Cliff Clevenger, Congressman from Ohio  
William S. Hill, Congressman from Colorado (Ft. Collins)  
Byron G. Rogers, Congressman from Colorado (Denver)  
Don Brotzman, State Senator, Colorado  
Quigg Newton, Mayor of Denver  
Dr. John Gillaspie, Mayor of Boulder  
Dr. Ward Darley, President, University of Colorado

(Continued)

Dr. Donald Menzel, Director of Harvard College Observatory  
Dr. Robert Huntoon, Associate Director for Physics, NBS  
Nicholas Golovin, Associate Director for Administration, NBS

<sup>60</sup> From Eisenhower's address:

Mr. Secretary, Dr. Astin, My Friends: For the past 30 minutes or so, I have had the great privilege of a personally conducted tour through certain of the facilities of these new laboratories.

Now, the things that the layman sees in these laboratories are not to be understood by him. He grasps, though, that something of the most tremendous significance is proceeding here—significant not only to the scientist, to industry, or to the facility that may use the products of that science and the discoveries which the scientist makes, but significant also to our Nation and to each of us, to our children, to the progress toward security and prosperity that each of us so desperately longs for.

It seemed to me, as I went through with Dr. Astin, that here we have a new type of frontier. This spot only a few short decades ago was inhabited by Indians and by buffalo, and, later, by trappers and miners. It became the center of a great mining and agricultural region, which has meant so much to the United States in the past—and indeed does now.

But the frontier days when we could go out and discover new land—new wonders of geography and of nature—have seemed largely in the past. Here today, inside this building, we have a frontier of possibly even greater romantic value, as well as greater material value to us, than were some of the discoveries of those days.

Another thought came to me as I went through these laboratories. In recent years, scientists have produced so much that terrifies us with its destructive force, that we begin to think of science as only something to destroy man, and not to promote his welfare, his happiness, his contentment—his intellectual and spiritual growth.

But I believe, if we think of it this way, we will drop such thoughts from our minds: Almost everything that man has discovered in his long, long journey from darkness toward the light has been capable of two uses; one good, one evil.

Way back, long before history was started, man discovered fire, and without fire we wouldn't be warm, we couldn't cook—we would still be in the depths of savagery.

Yet look how destructively fire can operate.

Again, take dynamite. We think of dynamite as a weapon of war, yet how much of it has been used in hills here, in the great lead, zinc, silver, and gold mines that have made Colorado famous and rich.

I submit that every discovery of science can be used in one of two ways. It is not the fault of science, if it is used wickedly. It is within ourselves.

And therefore, in the words of him who gave our invocation, possibly each one of us is a laboratory, to discover what we can contribute toward the growth of that kind of spirit among men that will make all of the discoveries of these dedicated scientists become assets to us, as we try to develop for ourselves and our children a better life, a richer life, one that gives us more opportunity to grow intellectually and spiritually.

It is, then, in those terms that we should look on the growth of science, as we think of the men laboring in this building, of the scientists in our universities, in the National Bureau of Standards in Washington—in the great laboratories and factories of our Nation.

And I think that if each one of us does his part, then we will steadily go down the ages as a people more prosperous, more happy, more secure, more confident in peace.

Now those are the thoughts that occurred to me as I walked through these buildings. We believe this region of the United States is fortunate in having this facility here, to remind you day by day, and so that you may, at least in a sense, become a part of some of the great discoveries that will be so useful to mankind—now, and through all the years yet to come.

I have now two little duties to perform. The first, most pleasurable, is to thank you—each of you—for your welcome to me, for the cordiality of your reception.

The second is that I am privileged to push a button—of course, this dedication must be scientifically done—you couldn't do it by just pulling a cord. When I push this button, I am told that I am going to release a veil over the cornerstone.

In so doing, it is my high privilege to dedicate this facility of the National Bureau of Standards to the welfare of humanity—in America and throughout the world.

<sup>61</sup> President Eisenhower's remarks were published in the November 1954 issue of the *Technical News Bulletin of NBS*, p. 165 (Vol. 38, No. 11). The report of eight pages (164-171) gives a rather detailed account of the Boulder Laboratories and the events associated with the dedication.

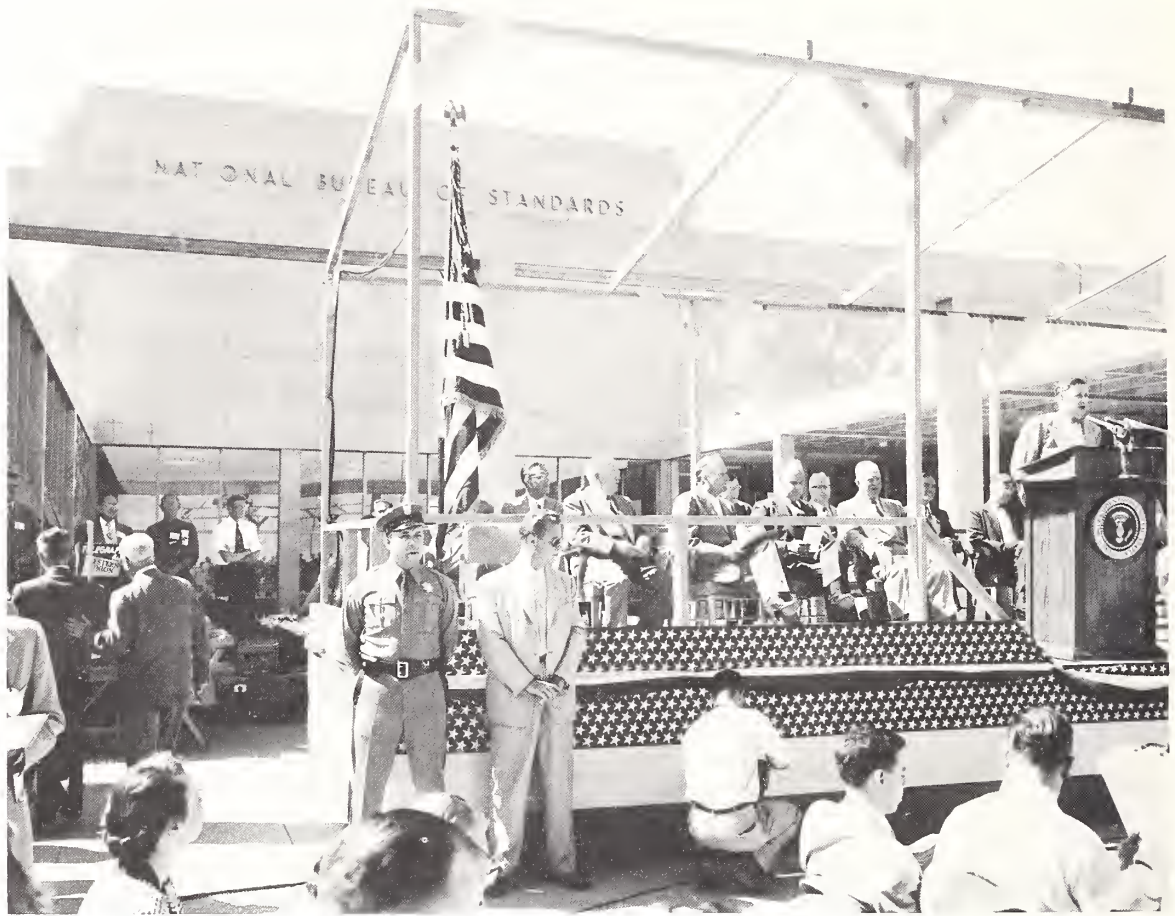

*The Dedication ceremony (September 14, 1954) of the Boulder Laboratories is opened by Dr. Frederick W. Brown, director, who introduced Sinclair Weeks, Secretary of Commerce. President Dwight D. Eisenhower is to the left of the speaker's podium, and Secretary Weeks to the left of the President.*

*Newspaper and magazine reporters are in foreground. Motion-picture cameras of newsreel companies and television networks are out of the picture, being located at some distance in front of the platform.*



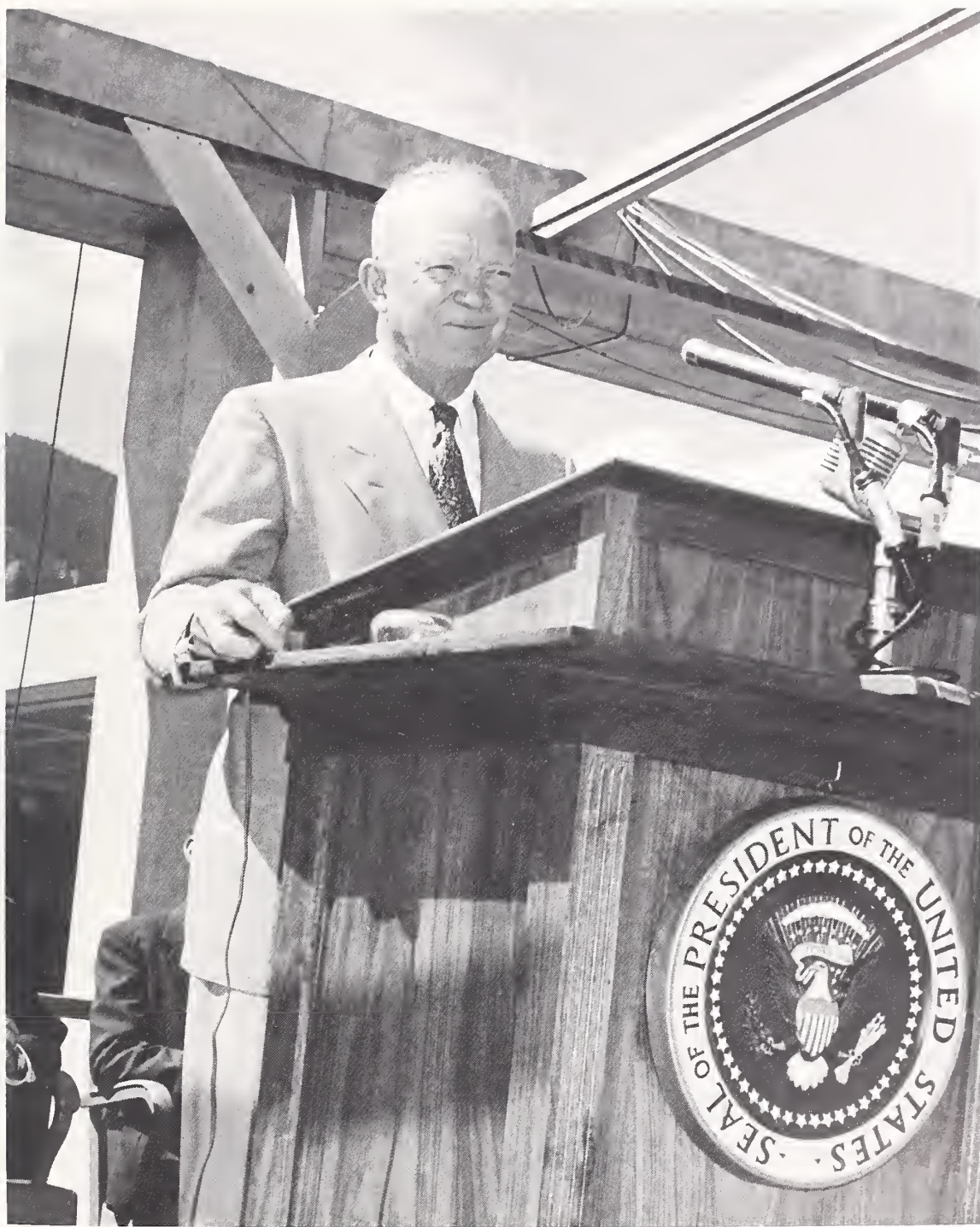

*In closing his remarks at the Dedication, President Eisenhower pushed a button with his right hand to unveil the cornerstone of the Radio Building, and then declared,  
. . . it is my privilege to dedicate this facility of the National Bureau of Standards to the welfare of  
humanity—in America and throughout the world.*

As Eisenhower pronounced the statement of dedication he pushed a button that unveiled the cornerstone to the Radio Building.<sup>62,63</sup>

The National Anthem by the band closed the program and at 11:01 President Eisenhower left the platform and walked to a waiting car.<sup>64,65</sup>

---

<sup>62</sup> The cornerstone had been placed in position without ceremony several months before the dedication. In actuality, the "cornerstone" is not a block of stone that was laid at a corner of the Radio Building, but is a slab of granite set in the stone wall near the lobby entrance. Engraved on the slab are the names of high Government officials, and architects and builders of the Radio Building. Sealed behind the slab in a container are 15 publications and documents on radio work at NBS. A listing of these publications and documents is in the Department of Commerce Library, Boulder, Colo., under the catalog number QC661,U5.

<sup>63</sup> Unknown but to only a few, was an emergency system to unveil the cornerstone in case of malfunction of the electrical system. Lloyd Burroughs of the Engineering Services Section, and chairman of the dedication Finance Committee, was "at the ready" to pull a cord in case of an "emergency." Fortunately, his service was not required.

<sup>64</sup> As a sequel to the Boulder event the presidential party drove to Brighton, Colo. for inspection of the Great Western Sugar Co. beet-sugar factory and for a visit to a nearby sugar-beet farm.

<sup>65</sup> An after-event of the dedication ceremony was a luncheon hosted by Dr. Ward Darley, president of the University of Colorado. About 30 invited guests attended the social event at the president's campus home. Early planning called for President Eisenhower to attend the luncheon, but deference was in favor of Colorado's sugar-beet industry.

## Chapter XX

### L'ENVOI

#### INTRODUCTION

On October 11, 1965, the Central Radio Propagation Laboratory was transferred from the National Bureau of Standards to join the United States Weather Bureau and the Coast and Geodetic Survey in a new scientific agency of the Department of Commerce, the Environmental Science Services Administration (ESSA). With the transfer, CRPL lost its identity as such, after 20 years as an integral part of the National Bureau of Standards, and was renamed the Institute for Telecommunication Sciences and Aeronomy (ITSA). This was one of four Institutes for Environmental Research in ESSA, the others being Earth Sciences, Oceanography, and Atmospheric Sciences.<sup>1</sup>

Dr. C. Gordon Little, who had been director of CRPL in NBS, and Jack Herbstreit, who had been associate director, continued as director and associate director of ITSA after the transfer.

The transfer of CRPL to ESSA did not mean a move from Boulder, because Boulder was selected as the headquarters for the Institutes of Environmental Research. Neither did it mean that the National Bureau of Standards was leaving Boulder. Although CRPL disappeared from the scene, all other units of NBS then in Boulder remained. The Boulder Laboratories, National Bureau of Standards, thus became the Boulder Laboratories, U.S. Department of Commerce.

---

<sup>1</sup>Dr. C. Gordon Little, then Director of CRPL, in an article for the 10th Anniversary of the NBS Boulder Laboratories (September 1964) entitled "CRPL—The Next Ten Years" [1] wrote, in part,

. . . To predict the future of an organization such as the Central Radio Propagation Laboratory for a period as long as ten years is most difficult. A comparison of ten years ago should illustrate this point. Who in September 1954 would have predicted that by 1964, CRPL would have doubled in size, and would have grown to an organization of four technical divisions. . . ?

(See app. C.)

A little more than a year later, Dr. Little wrote, in an article for internal distribution in the Environmental Science Services Administration (ESSA NEWS, Vol. 1, No. 9, Oct. 19, 1965),

On October 11, the Central Radio Propagation Laboratory was transferred from the National Bureau of Standards to the Environmental Science Services Administration and acquired a new name: Institute for Telecommunication Sciences and Aeronomy.

The technical divisions of CRPL were designated laboratories in ITSA.

Dr. Little described in some detail the mission of ITSA and the four laboratory units and then continued,

. . . Not only does the new title more accurately reflect the mission of the organization than its old title of Central Radio Propagation Laboratory, but it makes for a clearer understanding of its relationship to its three sister Institutes, the Institute for Earth Sciences, the Institute for Oceanography, and the Institute for Atmospheric Sciences. Together these four Institutes form the ESSA Institutes for Environmental Research.

Looking to the future, it is expected that the transfer of CRPL into ESSA will improve in important ways its ability to meet its mission of enhancing the telecommunication and space-disturbance-forecasting capabilities of the nation. Essentially all of ITSA's programs involve one or more aspects of man's geophysical environment; it therefore seems clear that ITSA scientists and engineers should be able to meet their goals more readily than before, because of more immediate and complete access to the environmental sciences and services available elsewhere in ESSA. In addition, it is expected that ITSA will contribute in major ways to the vital missions of other components of ESSA through application of remote probing and other telecommunication techniques. The creation of a single administration dealing with the solid, liquid, gaseous, and electromagnetic components of man's geophysical environment offers new and exciting opportunities for environmental research and services; the staff of ITSA looks forward to participating effectively in these efforts.

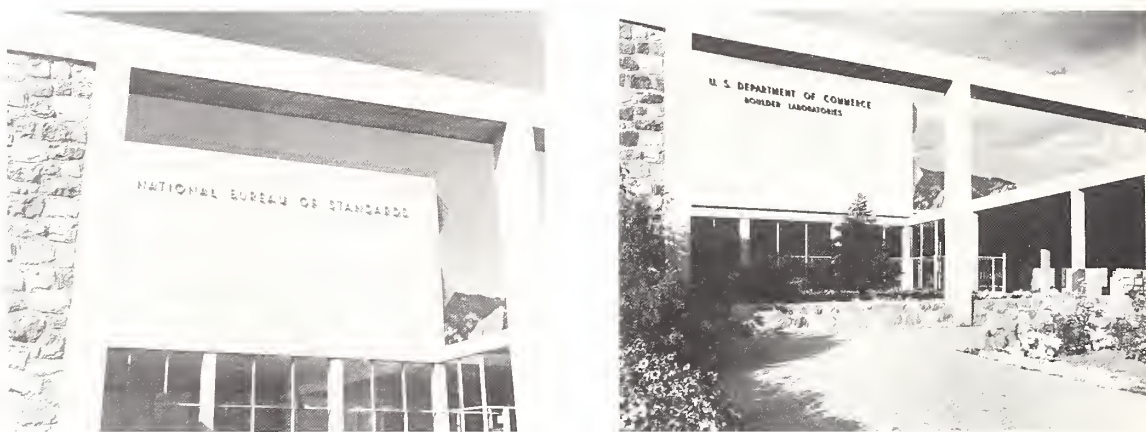

*When the Radio Building of the NBS Boulder Laboratories was first occupied in 1954, the identification on the front read National Bureau of Standards (top and, closeup, lower left). After ESSA was established in 1965, the identification was changed (lower right) to reflect the larger scope of the Boulder Laboratories.*

# THE MISSION OF ESSA

## 1. Functions of constituent organizations

The Environmental Science Services Administration was created by Presidential Order to provide, in the words of President Lyndon Johnson,

a single national focus for our efforts to describe, understand, and predict the state of the oceans, the state of the lower and upper atmosphere, and the size and shape of the earth.

Bringing together in one agency all the environmental science service activities of the Department of Commerce permitted a coordinated attack on many important environmental problems and challenges facing the Nation. The three constituent organizations were active in meteorology, seismology, geodesy, geomagnetism, hydrology, oceanography, telecommunication sciences, aeronomy, and solar physics.

### a) CENTRAL RADIO PROPAGATION LABORATORY

The Central Radio Propagation Laboratory brought a research effort dealing principally with the lower and upper atmosphere, the space environment, and solar physics as they affect electromagnetic propagation; the national responsibility for issuing warnings in connection with radio blackouts, for predicting radio wave propagation conditions, and for forecasting space environment disturbances in support of our growing space activities.

### b) WEATHER BUREAU

From the Weather Bureau came the responsibility for studies of the lower atmosphere and the interface between the air and sea; for forecasts of the weather and warnings of floods, tornadoes, and blizzards.

### c) COAST AND GEODETIC SURVEY

The Coast and Geodetic Survey's mission included oceanography, seismology, geomagnetism, studies of the size and shape of the Earth, the interaction between land and sea, the Nation's seismic sea wave warning services, preparation of nautical and aeronautical charts, and basic geodetic controls used in topographic mapping.

## NBS AND ESSA SHARE BUILDINGS AND SUPPORT FUNCTIONS

### 1. Buildings

When the NBS radio laboratories moved to Boulder in 1954, one building was sufficient to house the entire operation. Through the years, as operations expanded, two wings were added, one for the Electronic Calibration Center (Radio Standards Laboratory), the other for a computer facility. This building came to be known as the Radio Building.<sup>2</sup>

The Institute for Telecommunication Sciences and Aeronomy continued to occupy the space in the Radio Building formerly occupied by CRPL. In December 1965, ground was broken for a new \$600,000 building on the grounds of the Boulder Laboratories. Known as the Plasma Physics Building, it was planned to house units of both NBS and ITSA, but it was not designed for large-scale occupancy by either agency.

The move of additional units of the Institutes for Environmental Research (later reorganized as the ESSA Research Laboratories, contracted to ERL) to Boulder created a need for larger quarters. Therefore, in 1967 a building on the campus of the University of Colorado was leased from the University, and a large portion of ITSA moved to this building, which also housed the headquarters and other units of ERL. In 1969, another move was made to a larger building on the campus, also leased from the University.

---

<sup>2</sup>In the telephone directory of the Boulder Laboratories dated January 1955, the building was designated CRPL. Beginning with the directory dated January 1956 and thereafter, it has been designated Radio.

## 2. Administrative and support functions

With the formation of ESSA and the designation of Boulder as the headquarters of the Institutes for Environmental Research, some of the support services which had previously been provided by the National Bureau of Standards could be shared by the two organizations. Personnel of those services which were being provided by ESSA were transferred to ESSA; personnel of those provided by NBS remained in NBS.

Services retained by the National Bureau of Standards were the Instrument Shops; the Plant Division (including maintenance of buildings and grounds; plant services such as electricity, plumbing, heating, ventilating, and air conditioning; and custodial); and Administrative Services Division. Personnel providing these services remained in NBS.

Services provided by the Environmental Science Services Administration included the Library, Personnel Division, and the computer facility. Personnel in these units were transferred to ESSA.

Each organization provided its own administrative and management offices.

## EPILOGUE

### 1. Subsequent changes in ESSA

#### a) ESSA RESEARCH LABORATORIES (ERL)

In 1967, the ESSA Research Laboratories (ERL) replaced the Institutes for Environmental Research. Twelve laboratories and one facility were established. One laboratory retained the designation Institute, the Institute for Telecommunication Sciences (ITS), to maintain continuity as the central Federal agency for research and services in support of the telecommunication industry of the United States.

#### b) ITS SEPARATED FROM ESSA

The Institute for Telecommunication Sciences (ITS) was transferred by a Department order to the Commerce Department's Office of Telecommunications on September 20, 1970.<sup>3</sup> There were now units of three agencies making up the Boulder Laboratories, Department of Commerce.

The Office of Telecommunications was elevated to the status of a new operating component within the Department to meet a wide range of responsibilities for economic and social analysis, as well as technical research in telecommunications. The purpose of the transfer of ITS was to broaden the scope of its programs, especially in systems analysis, engineering, measurement, and standards, and in topics on efficient use of the electrospace or electromagnetic spectrum.

### 2. NOAA supersedes ESSA

The National Oceanic and Atmospheric Administration (NOAA) came into being on October 3, 1970, through an Executive Order implementing a major reorganization plan.<sup>4</sup> NOAA brought together the functions and major elements of the Environmental Science

---

<sup>3</sup>The name of the Office of Telecommunications was changed on March 27, 1978, to National Telecommunications and Information Administration (NTIA).

<sup>4</sup>Secretary of Commerce Maurice H. Stans stated,

The establishment of the National Oceanic and Atmospheric Administration in the Department of Commerce marks a significant consolidation of research, exploration, development, conservation, monitoring, and educational activities as they relate to the oceans and the atmosphere. The intelligent use of the oceans, which constitute three-fourths of the earth's surface, is vital . . . . In many respects we are more familiar with the surface of the moon than we are with the ocean depths of our own planet. Until now, in spite of sincere efforts, government has failed to organize itself to meet effectively the challenge and opportunities of operating in an ocean environment. Instead of 23 departments and agencies of government competing for various parts of the Federal mission in the ocean and the atmosphere, we will now have a single agency providing a unified national thrust in delivering on both the promise and potential of this last great frontier on earth.

Services Administration (ESSA) and a group of Federal agencies dealing with marine and oceanic services. These agencies had been previously located in several different departments and services of the Federal Government.<sup>5</sup>

Elements of CRPL remaining in NOAA are included in the Space Environment Laboratory, the Aeronomy Laboratory, and the Wave Propagation Laboratory, all of the Environmental Research Laboratories,<sup>6</sup> and in the Solar-Terrestrial Physics Division of the Environmental Data and Information Service.

Many CRPL programs and personnel were carried over into the Institute for Telecommunication Sciences in ESSA, and later in the Office of Telecommunications (now the National Telecommunications and Information Administration).

By the time that NOAA was established, the term "radio" had disappeared from the organizational structure of the three Department of Commerce agencies on the Boulder campus. The only remaining use of this term is in identifying the principal building on the Boulder site as the "Radio Building" (see footnote 2).<sup>7</sup>

## REFERENCE

- [1] C. Gordon Little, "CRPL—The next ten years," *Nat. Bur. Stand. (U.S.), Tech. News Bull.*, Vol. 48, No. 9, Sept. 1964, pp. 167-168.

---

<sup>5</sup> Among these agencies were the Bureau of Commercial Fisheries, the Marine Game Fish Program, and the Marine Minerals Technology Center, all of the Department of the Interior; the National Oceanographic Data Center and the National Oceanographic Instrumentation Center, administered by the U.S. Navy; National Data Buoy Development Project of the U.S. Coast Guard, Department of Transportation; National Sea Grant Program of the National Science Foundation; and elements of the U.S. Lake Survey of the Army Corps of Engineers.

<sup>6</sup> Formerly the ESSA Research Laboratories.

<sup>7</sup> Earliest use of the term "radio" in an NBS publication was by Austin in 1908 and then again in 1911. Dellinger first used the term in an NBS publication in 1913 and Kolster in 1914. However, it would be expected that a term "radio" as a gradual change from "wireless" occurred in less formal usage by Bureau personnel during the early 1900's. It was the trend of the times.





## APPENDIX A—To Chapter XVI

### Committee Memberships relating to the general subject of radio, in Technical Groups, Professional Societies, and Government Sponsored Committees from the time of formation of the Central Radio Propagation Laboratory, May 1, 1946, to 1975.\*

#### \*Explanatory Notes:

1. Information on the organization sponsor, committee title or function, and name of committee member was obtained from a variety of sources including:

- a. NBS Directories of Committee Membership for 1962, 1969, 1973, and 1975
- b. CRPL Quarterly and Annual Reports for 1947, 1950, 1951, and 1952
- c. Annual Reports of Boulder Laboratories 1955-1961
- d. Other sources including personal interviews

Because of their complexity and the lack of uniformity in preparing the NBS listings, and the author's (WFS) occasional difficulty in interpreting and cross referencing the listings, some errors and omissions probably exist in this tabulation.

2. The sponsoring organization is listed at the extreme left-hand margin, followed on an indented lower line by the committee or parent committee, then by any subsidiary committee(s) on a lower line(s), further indented.

3. Regular abbreviations are: Comm, for committee, and SC for subcommittee; C for chairperson, VC for vice-chairperson, and S for secretary.

4. In listing the names of members of committees the earliest membership is furthest to the left (as early as 1946) and the latest to the furthest right (as late as 1975). To give the exact span of membership by calendar years would have been an impossible task from the information available. The position of a member's name in the horizontal direction gives a very approximate indication of his membership tenure within the 1946-1975 span. Thus, to far left, would indicate membership in the late 1940's or early 1950's, to the far right in the 1970's, in the midsection in the period between approximately 1950 and 1970.

5. Stacking of names in a vertical direction indicates concurrent, or approximately concurrent membership of two or more persons on the same committee.

6. Asterisks (\*) denote that archival records indicate the existence of membership on a committee but the member's name was not recorded. This is particularly true in Annual Reports.

7. Committees that were essentially administrative in nature are omitted from this listing, although some of this nature are noted in chapter XVIII.

### Technical and Professional Society Committees

#### Organization and Committee

#### Committee Membership

Acoustical Society of America

Standards Comm. Biological Effects of Ultrasound

T. L. Zapf

Aeronautical Flight Test Radio

Coordinating Council

A. Barnabei

American Assoc. of Variable Star Observers

Solar Division

A. H. Shapley

American Astronomical Society

F. E. Roach

American Geophysical Union		
Executive Comm.	A. G. McNish	A. H. Shapley
Cosmic Terrestrial Relationships		A. H. Shapley
Geomagnetism and Aeronomy		F. E. Roach
Upper Atmosphere Panel	*	F. E. Roach
Planning Comm. on Planetary Science		A. H. Shapley
Special Comm. on Time Signal Services	W. D. George	
American Institute of Electrical Engineers (later IEEE)		
Instruments and Measurements Comm.		
SC on Radiation Measurements above 200 Mc/s	H. E. Sorrows	
SC on High Frequency Measurements	H. Lyons, C.	
Joint Comm. on High Frequency Measurements (with IRE)	H. Lyons	
Technical Operations Dept.		
Standardization of High Precision Coaxial Connectors		H. W. Lance
Communications Division		
Broadcasting Comm.		K. A. Norton
Instrumentation Division		
Fundamental Electrical Standards		T. L. Zapf
American Physical Society		
American Society for Testing and Materials		
Standards on Insulating Materials Comm. (later D-9 Electrical Insulating Materials)		R. C. Powell
C-21 Ceramic Whitewares and Related Products		
SC B-Nonmetallic Magnetic Materials		R. C. Powell
C-25 Ceramics		
SC6, (09) Nonmetallic Magnetic Materials	H. E. Bussey J. L. Dalke	J. L. Dalke H. E. Bussey J. L. Dalke, C.
D-9/SC 5, Ceramic Properties		H. E. Bussey
D-9/SC 12, Electrical Tests		H. E. Bussey
F1, Electronics		
SC02 Laser Materials		J. L. Dalke R. L. Smith, V. C. H. S. Boyne
TG Properties of Lasers		R. L. Smith
American Standards Assoc. (later, American National Standards Institute)		
C16, Sectional Comm. on Radio	*	
C63, Sectional Comm. on Radio Electrical Coordination	E. L. Hall	R. C. Baird F. M. Greene
Radio Noise and Field Strength		
SC1, Techniques and Developments		F. M. Greene
SC2, Definitions and Terminology		F. M. Greene
SCID, EMC Instrumentation		H. E. Taggart

C95, Standardization in the Field of Radio Frequency Electromagnetic Radiation Hazards		F. M. Greene R. C. Baird	
C39 Electrical Measuring Instruments			
SC7, Electronic Analog Voltmeters		P. H. Lowrie	
C16, Radio and Electronic Equipment		M. C. Selby	M. C. Selby
U.S. National Comm. of the International Electrotechnical Commission			J. L. Dalke
Associated Public Safety Communications Officers Engineering and Research Comm.			H. E. Taggart
Boeing Aircraft Company			
Radio Launch Control System Steering Comm.		K. A. Norton	
Clarkson College of Technology			
Interdisciplinary Conference on Electromagnetics Scattering Organizing Comm.		J. R. Wait	
Electronic Industries Assoc.			
P-5.3.1 on RF Connectors and Cables			R. L. Jesch
Electronic Industries Assoc. and IEEE Joint Technical Advisory Comm.		R. C. Kirby	
Ad Hoc SC on Space Telecommunications		J. W. Herbstreit	
SC on Radio Spectrum Conservation		K. A. Norton	
Institute of Radio Engineers (beginning in 1963, Institute of Electrical and Electronics Engineers)			
Radio Wave Propagation Comm.	T. J. Carroll	R. J. Slutz J. R. Wait	F. M. Greene
SC on Theory and Application of Ionospheric Propagation	*		
Radio Wave Propagation and Utilization Comm.	K. A. Norton		
Technical Comm. on Transmitters			
SC on Circuits and Advanced Developments	R. Bateman		
Standards Comm.	*		J. L. Dalke P. A. Hudson G. E. Shafer
Circuits Comm.	*		
Industrial Electronics Comm.			
SC on Dielectric Measurements	J. L. Dalke, C.		
Piezoelectric (and Ferroelectric Crystals) (14)	W. D. George	W. D. George	
Piezoelectric Measurements (14.2)		W. D. George	
Navigation Aids Comm.	*		
SC on Standard Direction-Finder Measurements	R. Silberstein, S.		
SC on Detection, Location, and Navigation	*		
SC on Pulse Modulation Transmitters	*		
Antennas and Waveguides		H. V. Cottony	
Standards on Methods of Testing Antennas		K. A. Norton	

Measurements and Instrumentation Comm. (25)	*	J. L. Dalke M. C. Selby	
SC on Field-Intensity Measurements	*	M. C. Selby	
Basic Standards and Calibration Methods (25.1)		M. C. Selby, C. E. C. Wolzien W. D. George P. A. Hudson	J. L. Dalke P. A. Hudson W. W. Scott
Dielectric Measurements (25.2)	J. L. Dalke	J. L. Dalke, C.	J. L. Dalke
Magnetic Measurements (25.3)	P. H. Haas	R. C. Powell J. L. Dalke	J. L. Dalke
Instrumentation and Measurements Professional Group (before 1962, Instrumentation, Professional Group)		H. W. Lance, C. C. M. Allred G. E. Schafer W. J. Anson	
SC on Network Analyzer			C. M. Allred
Low Frequency Instruments and Measurement		H. W. Lance	
High Frequency Instruments and Measurement		R. W. Beatty	R. W. Beatty
HF Immittance Measurements		R. L. Jesch R. W. Beatty	
HF Attenuation Measurements		D. Russell	
HF Pulse Techniques		N. S. Nahman	N. S. Nahman
HF Power Measurements		R. F. Desch	
Standards for High Precision Coax Connectors		R. C. Powell J. P. Wakefield, S.	J. P. Wakefield, S.
Signal Generators			G. Rebuldela
Waveguide Flanges, 26.5—110 GHz			B. C. Yates
Fundamental Electrical Standards		T. L. Zapf	T. L. Zapf
Frequency and Time		J. A. Barnes	J. A. Barnes J. L. Jespersen
Frequency Stability		J. A. Barnes	J. A. Barnes
Time			J. L. Jespersen
Electromagnetic Measurements, State-of-the-Art Comm. (formed from 25.1 Comm.—Basic Standards and Calibration Methods)		M. C. Selby, C. C. M. Allred P. A. Hudson G. E. Schafer W. F. Snyder E. C. Wolzien	G. E. Schafer, C. W. J. Anson, C.
Liaison EMM Comm. to IEEE Standards Comm.		M. C. Selby	M. C. Selby
SC1 and 2, Power, CW, Lumped Constants, Trans. Lines		P. A. Hudson, C.	P. A. Hudson, C. M. L. Crawford
SC3, Power, CW, Waveguide		G. F. Engen A. Y. Rumfelt	
SC4 and 7, Pulsed Power, Current, Voltage		L. B. Elwell	
SC5, High Power, CW and Pulsed		L. B. Elwell	L. B. Elwell
SC6, Voltage, Pulsed, Unbalanced Line		N. S. Nahman, C. D. M. Stonebraker	
SC8, Attenuation, Unbalanced, Lumped Constants		D. H. Russell, C. C. M. Allred W. W. Scott P. H. Lowrie	C. M. Allred
SC9, Attenuation, Unbalanced Transmission Lines		C. M. Allred, C. D. H. Russell	C. M. Allred

SC10 and 12, Attenuation, Waveguide	G. E. Schafer, C. D. A. Ellerbruch, C.	
SC11, Pulse Distortion in Trans. Lines	N. S. Nahman, C.	
SC13, Impedance, Unbalanced, Lumped Constants	A. E. Hess	
SC14, Impedance, Unbalanced, Trans. Lines	R. C. Powell, C. R. L. Jesch	
SC15, Impedance, Waveguide	G. E. Schafer, C. W. E. Little	B. C. Yates, C.
SC16, Noise, Thermal, Trans. Line and Waveguide	M. G. Arthur, C.	
SC17, 18, Field Strength, CW	R. R. Bowman F. M. Greene	
SC19, 20, Field Strength, Pulsed	R. R. Bowman, F. M. Greene	
SC21, Phase, below 1 GHz	D. H. Russell	
SC22, Phase, above 1 GHz	D. A. Ellerbruch, C.	
Microwave Theory and Techniques, Standards, Coordinating Comm.	R. W. Beatty, C.	
SC on Waveguides	G. E. Schafer	
SC on RF Connectors	R. C. Powell	R. L. Jesch
Radio Frequency Interference Technical Advisory Comm.	W. Q. Crichlow	
Joint Technical Advisory Comm. with Radio Electronics Television Manufacturing Assoc.		
SC on Forward Scatter Transmission	D. K. Bailey H. V. Cottony R. C. Kirby K. A. Norton R. J. Slutz	
Wire Communication		
Cable Television Task Force Group		R. L. Jesch
Instrument Society of America		
Environment for Standards	W. F. Snyder, C.	W. F. Snyder, C.
Laboratories, Comm. RP52		
Electrical Measurement Standards	F. D. Weaver, VC. T. L. Zapf	
High Frequency Standards	R. C. Powell, C.	T. L. Zapf
Joint Industry Research Comm. for Standardization of Miniature Precision Coaxial Connectors		J. P. Wakefield, Technical Advisor
National Academy of Sciences, National Research Council		
Ad Hoc Panel on Electromagnetic Propagation, Office of the President	M. C. Thompson	
Atmospheric Sciences	C. G. Little	
Panel on International Exchange of Geophysical Data	A. H. Shapley, C.	
Polar Research	D. K. Bailey A. H. Shapley	
Upper Atmosphere Panel	D. K. Bailey, C. A. H. Shapley	
Radio Frequency Allocation for Scientific Research	A. Barnabei	

Space Science Board		A. H. Shapley
Ad Hoc Comm. on Astronomy and Radio Astronomy		R. M. Gallet
Ad Hoc Comm. on Satellite Ionospheric Meas.,		
VLF Study Group		C. G. Little, C.
Comm. on Atmospherics of Earth and Planets		A. H. Shapley, C. C. G. Little
Conference on Electrical Insulation	*	
National Cable Television Association		
Special Task on 75-ohm Connectors		R. L. Jesch
National Communications Systems (Federal Communication Standards Committee)		D. Halford
Performance Standards for Telecommunications Systems		G. R. Sugar
National Council of Radiation Protection and Measurement		
Scientific Comm.		R. C. Sangster
Office of Defense Mobilization		
Telecommunications Planning Comm.	*	
Radio Manufacturers Association		
SC on UHF Propagation	*	
Society of Automotive Engineers		
Comm. on EM Compatability		H. E. Taggart
EMI Standards and Test Methods		W. J. Alspach
Television Allocations Study Organization	*	
University of Alaska		
Geophysical Institute Advisory Comm.		A. H. Shapley

## Government Sponsored Committees

### Defense Atomic Support Agency

Ionization Panel

K. Davies

### Department of Commerce

National Bureau of Standards and  
Department of the Air Force

Joint Working Group on Standards

W. D. George  
H. W. Lance, S.

In-Service Electronics Training  
Program Steering Comm.

R. Silberstein

### National Bureau of Standards

Engineering and Information  
Processing Standards Council

J. L. Dalke

Joint Industry Research Comm. for  
Standardization of Miniature  
Precision Coaxial Connectors

J. P. Wakefield

J. P. Wakefield,  
S. and  
Technical  
Advisor

### U.S. Joint Chiefs of Staff (after Aug. 10, 1949 noted hereunder as Department of Defense)

#### Aeronautical and Joint Communications Board

Aircraft Radio and Electronics Comm.

Joint Test Equipment SC

H. Lyons

Antenna SC

H. Lyons

Interference Reduction SC

H. Lyons

#### Joint Communications Board

Wave Propagation Comm.

J. H. Dellinger  
N. Smith

Subpanel on Propagation

A. G. McNish

Standardization Comm.

H. Lyons

#### Joint Communications Electronic Comm.

Wave Propagation Panel

\*

#### Range Commanders Conference

Inter-Range Instrumentation Group

Working Group on Telemetry

\*

Working Group on Telecommunications

\*

Working Group on Electromagnetic

R. S. Lawrence

Wave Propagation Refraction

B. R. Bean

Corrections

#### Research and Development Board

Comm. on Electronics

Panel on Basic Research

N. Smith  
A. G. McNish

Panel on Frequency Control  
Devices

W. D. George

Panel on Test Equipment

\*

Panel on Interference Reduction

V. L. Agy

Panel on Antennas and Propagation

A. G. McNish

Panel on Radiating Systems

H. Lyons

Subpanel on Antenna

H. Lyons

Instrumentation

Comm. on Guided Missiles	*
Electronic Trajectory Instrumentation Working Group	*
Panel on Geomagnetism and Electricity	A. G. McNish
Panel on Land Navigation	A. G. McNish
Arctic Ionospheric Advisory Comm., Signal Corps	*
Department of Defense	
Advisory Group on Electronic Parts	
Working Group on Frequency Control Devices	W. D. George, Observer
Calibration Coordination Group	R. F. Desch
Consultative Comm. on Measurement Standards	H. W. Lance
Joint Comm. on Electronics Communication	
Joint Spectrum Evaluation Group	
Ad Hoc Group to consider establish- ment of a Joint Services microwave radio-meteorological research facility	J. W. Herbstreit K. A. Norton
Technical Advisory Group	
EM Compatibility Measurements	F. M. Greene
Metrology Engineering Projects	
SC on Microwaves	D. H. Russell
Inter-Range Instrumentation Group	
Telecommunication	R. L. Fey J. L. Jespersen
U.S.-U.K.-Canada Technical Sub-Group on Radar Techniques	
Working Panel on Noise Measurements for Low Noise Receivers	J. W. Wells
Department of the Air Force	
Radio Launch Control System	
Steering Comm. for the Confidence Test Program	M. Coon K. A. Norton
Scientific Advisory Board	
Ad Hoc Comm. on Ionospheric Modification	A. H. Shapley
Department of the Army	
Geodesy, Intelligence and Mapping Research and Development Agency	
Panel for Geodetic Satellite Research Evaluation	M. C. Thompson
Technical Program Comm.	D. Halford
Department of the Navy	
Polaris Command Communications Comm.	*
National Defense Research Comm.	
Comm. on Standard Direction Finder Measurements	R. Silberstein



Department of State

Aeronautical Preparatory Group  
for Appendix 26

A. Barnabei

Panel of Experts Advisory Comm.

A. Barnabei  
G. W. Haydon

Telecommunications Coordinating Comm.

A. Barnabei  
F. W. Brown

Ad Hoc Comm. on Outer Space  
Communications

A. Barnabei

U.S. International Telegraph and  
Telephone Consultative Comm.

A. Barnabei

Executive Office of the President

Office of Emergency Planning

Interdepartment Radio Advisory  
Committee (IRAC)

J. H. Dellinger, C.  
K. A. Norton

A. Barnabei  
E. E. Estes (alternate)

Frequency Allocations

A. Barnabei  
R. C. Kirby (alternate)  
G. W. Haydon (alternate)  
R. S. Kirby (alternate)

Frequency Assignment

A. Barnabei, VC.  
E. E. Estes (alternate)

Special Task Group

R. J. Slutz

Telecommunications Planning Comm.

Executive Comm.

F. W. Brown  
A. Barnabei (alternate)

Panel I

A. Barnabei  
E. E. Estes (alternate)

Panel II

D. W. Patterson  
E. E. Estes (alternate)

Panel III

A. Barnabei  
E. E. Estes (alternate)

President's Science Advisory Comm.

R. J. Slutz, Consultant

Space Science Panel

L. M. Branscomb

Federal Communications Commission

Ad Hoc Comm.

\*

Analysis Industry Advisory Comm.

P. L. Rice

Color Receiver Distribution Comm.

\*

Observation and Measurements  
Industry Advisory Comm.

W. C. Coombs

Radio Propagation Advisory Comm.

F. W. Brown

Interservice Coordination of Calibration  
Services

Standardization of Nomenclature

W. F. Snyder, C.

National Aeronautics and Space Administration

Space Sciences Steering Comm.

C. G. Little

Ionospheric Physics

C. G. Little, Consultant

Working Group on Satellite  
Ionospheric Beacons

C. G. Little

Rocket and Satellite Research Panel

\*

Topside Sounder Working Group

A. H. Shapley

Technical Advisor to United Nations Ad Hoc Comm. on Peaceful Uses of Outer Space	*	
Radio Technical Commission for Aeronautics (RTCA)		
Executive Comm.	J. H. Dellinger, C.	A. Barnabei
SC Long Distance Aids to Navigation	*	J. W. Herbstreit (alternate)
SC Testing Program for Long-Range Navigation Facilities	*	
SC Implementation of the VHF Utilization Plan and Review of Transition Period Communication Requirements	*	
SC High Altitude Grid Plan for VOR/DME Frequency Pairing	*	
SC-92, Frequency Utilization Plan for the Band 108-136 Mc		M. T. Decker
Radio Technical Commission for Marine (RTCM) Services		
SC on Comparison of LF Loran and LF Omnidirectional Range	J. H. Dellinger, C. K. A. Norton	G. Hefley
Special Comm. 46	K. A. Norton	
Sub-Panel C-10, Frequencies and Tolerances		A. Barnabei, C.
Senate Advisory Comm. on Color Television		
	E. U. Condon, C. N. Smith	
United States Information Agency		
Voice of America Science Advisory Group		R. C. Kirby E. K. Smith
Antennas		E. K. Smith
Modulation		E. K. Smith
Propagation and Dwindling Spectrum		E. K. Smith, C.

## APPENDIX B—To Chapter XVII

### Committee Memberships relating to the general subject of radio, associated with International Organizations and Conferences from the time of formation of the Central Radio Propagation Laboratory, May 1, 1946, to 1975.\*

\*Explanatory Notes:

See Explanatory Notes of Appendix A

Added Notes for Appendix B:

8. Listing includes staff members of Joint Institute for Laboratory Astrophysics (JILA)—NBS Group
9. Members of committees who became staff members of the Environmental Science Services Administration (ESSA) in October 1965 are not carried in this listing beyond the time they were transferred to ESSA.
10. Some of the information on CCIR participation came from published reports of the CCIR.

### Government Sponsored Committees

Organization and Committee	Committee Membership		
Department of Interior			
Marine Engineering Comm. of the U.S.-Japan Cooperative Program of Natural Resources			
Panel on Marine Electronics and Communications			R. W. Beatty
Department of State			
International Radio Consultative Committee (CCIR) Study Groups (S.G.) (members served primarily on the U.S. Preparatory Committees for CCIR)			
Executive Comm.		D. K. Bailey F. W. Brown	
S.G. I, Transmitters	H. J. Sullivan	J. C. Carroll W. B. Harding M. C. Selby	M. C. Selby
S.G. II, Receivers	H. V. Cottony W. Q. Crichlow	J. C. Blair W. C. Coombs M. C. Selby	C. M. Allred M. C. Selby
S.G. III, Fixed Service Systems	K. A. Norton R. Silberstein H. J. Sullivan	J. L. Auterman H. V. Cottony W. Q. Crichlow G. W. Haydon R. C. Kirby R. S. Kirby M. Nesenbergs K. A. Norton W. F. Utlaut A. C. Wilson	
S.G. IV, Surface Wave Propagation; later, Space Systems and Radio Astronomy	R. Bateman K. A. Norton, C. S. M. Ostrow M. L. Phillips	B. R. Bean W. C. Combs H. V. Cottony K. Davies	L. E. Gatterer

SC L-7, Radio Propagation, Coverage, Interference		T. N. Gautier L. E. Gatterer J. W. Herbstreit G. W. Haydon R. S. Kirby R. W. Knecht R. S. Lawrence K. A. Norton S. M. Ostrow P. L. Rice R. J. Slutz M. C. Thompson A. C. Wilson	
S.G. 4, Special Studies			
S.G. V, Tropospheric Propagation	T. J. Carroll, C. K. A. Norton S. M. Ostrow	M. T. Decker G. W. Haydon, C.  A. P. Barsis B. R. Bean T. N. Gautier J. R. Jöhler J. W. Herbstreit R. S. Kirby K. A. Norton P. L. Rice M. C. Thompson C. C. Watterson J. R. Wait  B. R. Bean	
SC on Radio Climatology			
S.G. VI, Ionospheric Propagation	R. Bateman W. B. Chadwick T. N. Gautier J. W. Herbstreit E. Klapper S. M. Ostrow M. L. Phillips A. H. Shapley N. Smith, C.	V. L. Agy D. K. Bailey, C. (also International C.) J. C. Blair W. B. Chadwick W. Q. Crichlow R. M. Davis, Jr. R. H. Doherty T. N. Gautier G. W. Haydon J. W. Herbstreit R. C. Kirby R. W. Knecht J. V. Lincoln K. A. Norton A. H. Shapley R. J. Slutz E. K. Smith (International VC.) L. H. Tveten W. F. Utlaut	
S.G. VII, Standard Frequencies and Time Signals	W. D. George	D. W. Allan D. H. Andrews J. A. Barnes R. E. Beehler W. W. Brown R. L. Fey L. E. Gatterer W. D. George D. Halford G. Hefley G. E. Hudson J. L. Jespersen R. E. Larson J. B. Milton A. H. Morgan M. C. Selby P. P. Viezbicke	D. W. Allan J. A. Barnes R. E. Beehler B. E. Blair R. L. Fey L. E. Gatterer D. Halford J. L. Jespersen R. E. Larson J. B. Milton J. T. Stanley P. P. Viezbicke
S.G. VIII, International Monitoring	H. V. Cottony W. Q. Crichlow	M. C. Selby	M. C. Selby

S.G. IX, General Technical Questions, later, Radio Relay Systems	H. J. Sullivan	R. S. Kirby C. C. Watterson
S.G. IXB, Radio-Relay Systems Tropo- spheric, and Line-of-Sight Radio Communication Systems		E. F. Florman
S.G. X, Broadcasting	H. V. Cottony H. J. Sullivan	J. L. Auterman J. C. Carroll H. V. Cottony A. C. Stewart W. F. Utlaut A. C. Wilson
S.G. XI, Television	W. Q. Crichlow K. A. Norton	W. C. Combs R. G. Merrill K. A. Norton R. K. Salaman
S.G. XII, Tropical Broadcasting		V. L. Agy G. W. Haydon
S.G. XIII, Operating Questions		R. H. Doherty
S.G. XIV, Vocabulary		B. A. Kingsbury
Stockholm, 1948 Conference U.S. Preparatory Group	J. H. Dellinger, C. W. B. Chadwick W. D. George A. H. Morgan K. A. Norton S. M. Ostrow R. C. Peavey A. H. Shapley	
Washington Meeting of CCIR Study Group VI, Ionospheric Propagation	W. B. Chadwick T. N. Gautier H. P. Hutchinson E. Klapper S. M. Ostrow M. L. Phillips A. H. Shapley N. Smith, U.S. Spokesman	

## CCIR Plenary Assemblies

	1948 Stockholm	1951 Geneva	1953 London	1956 Warsaw
Plenary Assemblies, NBS Participants in U.S.A. Delegation*	D. K. Bailey J. H. Dellinger <sup>†</sup> N. Smith	D. K. Bailey W. Q. Crichlow J. H. Dellinger <sup>†</sup> W. D. George	D. K. Bailey J. H. Dellinger <sup>†</sup> W. D. George R. C. Kirby	D. K. Bailey W. Q. Crichlow W. D. George J. W. Herbstreit
	1959 Los Angeles	1963 Geneva	1966 Oslo	1970 New Delhi
	V. L. Agy D. K. Bailey B. R. Bean W. Q. Crichlow J. H. Dellinger <sup>‡</sup> T. N. Gautier W. D. George J. W. Herbstreit R. C. Kirby K. A. Norton R. Silberstein R. J. Slutz E. K. Smith A. D. Watt	D. K. Bailey W. D. George G. W. Haydon J. W. Herbstreit J. V. Lincoln K. A. Norton P. L. Rice E. K. Smith	D. K. Bailey B. R. Bean J. W. Herbstreit G. E. Hudson R. C. Kirby R. S. Lawrence M. Leftin J. V. Lincoln P. L. Rice E. K. Smith	D. K. Bailey T. DeHaas H. T. Dougherty R. C. Kirby E. K. Smith

\* As representative of the U.S. Government in conducting international relations, operations of the U.S. Groups of CCIR required endorsement of the Department of State.

Because of incompleteness of information, and the complexity of delineating the information, there is no indication of those that served as chairperson, spokesman, or heads of various Groups.

<sup>†</sup> Dellinger was a Government retiree; consultant for RCA Corporation.

<sup>‡</sup> Dellinger served as a private citizen.

Notes: In 1956, Warsaw and 1959, Los Angeles, D. K. Bailey was not an employee of NBS at time.

In 1966, Oslo, only G. E. Hudson represented NBS, all others from ESSA but formerly of NBS.

In 1970, New Delhi, no one attended from NBS, others from ESSA but formerly of NBS.

In 1974, Geneva, D. K. Bailey represented NOAA, all others the Institute of Telecommunication Sciences. R. C. Kirby served as deputy head of the U.S.A. delegation.

## International Committees

Organization and Committee	Committee Membership	
International Astronomical Union		R. M. Gallet C. G. Little F. E. Roach A. H. Shapley R. N. Thomas
Inter-Union Commission on Solar and Terrestrial Relationships		D. K. Bailey, S. A. H. Shapley
Commission 10, Solar Activity	A. H. Shapley	A. H. Shapley
Working Group on Solar Flare Criteria		J. V. Lincoln
Commission 12, Radiation and Structure of Solar Atmosphere		
12a, Eclipses of the Sun		R. N. Thomas
Commission 14, Fundamental Spectroscopic Data		L. M. Branscomb
Commission 21, Brightness of the Sky		F. E. Roach
Commission 22, Meteors and Meteorites		R. N. Thomas
Commission 29, Stellar Spectrums		
29a, Theories of Stellar Atmospheres		R. N. Thomas
Commission 40, Radio Astronomy	G. Reber	A. H. Shapley
International Comm. of Weights and Measures (CIPM)		
Consultative Comm. for Definition of Meter		J. L. Hall
Consultative Comm. for Definition of Second		J. A. Barnes
International Council of Scientific Unions		
Mixed Commission on the Ionosphere	N. Smith	
International World Day Service Steering Comm.		A. H. Shapley
Space Research		
Working Group 3, Data and Publications		A. H. Shapley
International Electrotechnical Commission		
U.S. National Comm.		W. D. George      R. C. Powell
Experts Comm. on Ferrite Magnetic Materials		J. L. Dalke      J. L. Dalke
SC 40-6, Parts Made of Ferro-Magnetic Materials, Electronic Measuring Equipment		J. L. Dalke      J. L. Dalke
SC WG 3, Bridges and Meters		W. E. Little, S.

International Geophysical Year (IGY)

U.S. National Committee		A. H. Shapley, VC.	
Data Processing Comm.		R. J. Slutz	
Executive Comm.		A. H. Shapley	
Advisory Comm. on Education		A. H. Shapley	
Interdisciplinary Research Comm.		A. H. Shapley	
Special Research Grants Comm.		A. H. Shapley, C.	
Arctic and Antarctic Comm.		A. H. Shapley	
Aurora and Airglow Panel		F. E. Roach, VC.	
Earth Satellite Program Panel		A. H. Shapley	
Working Group on Satellite		R. J. Slutz	
Ionospheric Measurement		C. G. Little	
Ionospheric Physics Panel		A. H. Shapley, C.	
Solar Activity Panel		A. H. Shapley	
World Days and Communications Panel		A. H. Shapley, C.	
International Scientific Radio Union (URSI)			
International Level	J. H. Dellinger, VC.		
Canadian Commission 3		C. G. Little	
Central Comm. on URSIgrams		J. V. Lincoln, S.	
International Comm. on Geophysics		A. H. Shapley	
Special Comm. on International		C. G. Little	
Geophysical Year		A. H. Shapley	
Commission I, Radio Measurements	J. H. Dellinger, C.	R. W. Beatty, VC., Ed.	H. M. Altschuler, C.
Methods and Standards	W. D. George, VC.	W. D. George, VC.	R. W. Beatty
Commission II, Tropospheric Radio		G. E. Shafer	J. L. Hall
Commission III, Ionospheric Radio			H. Hellwig
Commission V, Radio Astronomy		A. H. Shapley	
Comm. on Space Radio Research		J. W. Herbstreit, S.,	
International World Days Services		R. W. Knecht, S.	
Special Comm. on World-Wide		A. H. Shapley	
Sounding		A. H. Shapley	
Comm. on Exosphere		A. H. Shapley, C.	
R.F. Allocations for Scientific		J. V. Lincoln, S.	
Research		A. H. Shapley, C.	
U.S. National Committee		C. G. Little	
Commission I, Radio Measurements	N. Smith, S., VC.	R. S. Lawrence	
Methods and Standards	J. H. Dellinger	R. W. Beatty	H. M. Altschuler
		W. Q. Crichlow	R. W. Beatty
		W. D. George	
		C. G. Little	
		A. H. Shapley	
		H. M. Altschuler	
		R. W. Beatty, C.	
		H. E. Bussey	H. M. Altschuler
		G. F. Engen	R. W. Beatty
		W. D. George	M. C. Selby
		D. M. Kerns	
		N. S. Nahman	
		G. E. Schafer, S.,	
		M. C. Selby	
		M. C. Thompson	



Commission II, Tropospheric Radio Propagation	T. J. Carroll K. A. Norton	A. P. Barsis B. R. Bean J. W. Herbstreit H. B. Janes R. S. Kirby K. A. Norton P. L. Rice M. C. Thompson J. R. Wait
Commission III, Ionospheric Radio Propagation	N. Smith, C., A. G. McNish	V. L. Agy D. K. Bailey K. L. Bowles W. H. Campbell H. J. A. Chivers R. S. Cohen W. Q. Crichlow K. Davies J. H. Dellinger R. T. Disney T. N. Gautier A. G. Jean R. C. Kirby R. W. Knecht R. S. Lawrence C. G. Little, C., S. Matsushita A. G. McNish J. H. Pope C. A. Samson A. H. Shapley R. J. Slutz E. K. Smith G. R. Sugar J. R. Wait J. M. Watts J. W. Wright
Commission IV, Magnetospheric Radio (initiated in 1962-63)		D. K. Bailey K. L. Bowles R. M. Gallet C. G. Little R. J. Slutz
Commission V, Radio Astronomy (formerly Extraterrestrial Radio Noise)	A. H. Shapley J. W. Herbstreit G. Reber	R. S. Lawrence E. R. Schiffmacher A. H. Shapley
Commission VI, Radio Waves and Circuits		H. V. Cottony J. R. Wait
Commission VII, Electronics		---
Commission VIII, Terrestrial Radio Noise (formerly Commission IV)	H. V. Cottony W. Q. Crichlow	W. Q. Crichlow, C., A. G. Jean A. D. Watt
International Scientific Radio Union and International Union of Geodesy and Geophysics		
Inter-Union Comm. on Radio Meteorology		B. R. Bean
International Union of Geodesy and Geophysics		
Special Study Group, No. 19, Electronic Distance Measuring Ground Instruments		H. B. Janes M. C. Thompson

International Association of Geomagnetism  
and Aeronomy

Comm. 1, Terrestrial Magnetism and  
Electricity

A. G. McNish  
H. F. Johnston

Comm. 2, Aurora and Airglow

F. E. Roach

Comm. 3, High Atmosphere

F. E. Roach  
L. M. Branscomb

Comm. 4, Secular Variation and  
Paleomagnetism

H. H. Howe

Comm. 6, Lunar Variations

H. H. Howe

Comm. 9, Characterization of Magnetic  
Activity

H. H. Howe  
J. V. Lincoln

Inter-Union Comm. on Solar Terrestrial  
Relations

A. H. Shapley

**APPENDIX C**  
**ORGANIZATION AND ADMINISTRATION**  
**OF**  
**RADIO SCIENCE, TECHNOLOGY, STANDARDS,**  
**AND MEASUREMENT PROGRAMS**  
**AT THE**  
**NATIONAL BUREAU OF STANDARDS<sup>1</sup>**

**1901**

**Director: S. W. Stratton, 1901-1922<sup>2</sup>**

**1901**

**ELECTRICITY DIVISION**

**E. B. Rosa, 1901-1921<sup>3</sup>**

**1913**

**Radio Section**

**F. A. Kolster, 1913-1919<sup>4,6</sup>**

---

<sup>1</sup>The format of this appendix is copied somewhat after that used by Cochrane in appendix J (NBS Administrative, Scientific, and Technical Staff Chiefs, 1905-1960), *Measures for Progress*. However, it differs from Cochrane's treatment (organization at certain years, spread at intervals) in that significant changes in the organizational structure are indicated as they occurred in point of time. Numerous footnotes are used for explanation and to indicate changes of personnel or titles of organizational units at interim periods between the tabulated information. Usage of the term "Division" at NBS to designate technical groups generally denotes an organizational unit that embraces a technical field. The term "Section" generally denotes an organizational unit that is a subdivision of a technical field. Throughout appendix C the title of a section is in smaller type and displaced to the right of the title of a division. In order to minimize the repetitive use of the words "Division" and "Section," these terms do not appear in the tabulations under their respective columns although they appear frequently in footnotes.

The names of consultants, senior scientists, or some of the special officers are not noted in this tabulation, most of whom are covered as contributors to the technical programs.

Sources of information were: Monthly and Annual Reports of the former Radio Section (to 1946); from a large collection of telephone directories; the organizational directory listings in Annual or Summary Reports of Boulder Laboratories (1955-1961); from in-house publications, The Bureau Drawer (NBS Boulder) and the NBS Standard; and, more recently, from NBS Administrative Bulletins and NBS-IBS/Boulder Administrative Bulletins.

<sup>2</sup>Professor Samuel W. Stratton appointed first director of NBS by President McKinley, March 1901. After 21 years of organizing the Bureau and initiating technical programs, he resigned on the last day of 1922 to become president of the Massachusetts Institute of Technology on January 1, 1923. He died on October 18, 1931, at a time when he was chairman of the corporation of MIT.

<sup>3</sup>Dr. Edward B. Rosa was the first person selected by Stratton to head an organizational unit (Electricity) for the new scientific bureau of the Federal Government (see Cochrane, pp. 62-65). Rosa continued in this capacity until his death on May 17, 1921 (see Cochrane, p. 233). It was after the coming of Louis Austin to the Bureau in 1904 that Rosa began to sense the need of establishing facilities within Electricity (division) to study and develop methods of measurement for the new field of wireless telegraphy.

<sup>4</sup>Kolster entered Bureau December 18, 1911; resigned July 31, 1921.

<sup>5</sup>During World War I the much expanded Radio Section was organized into a large number of projects, with the organizational structure sharply delineated (see accompanying diagrams).

<sup>6</sup>In the early years and into the 1920's the Radio Section was sometimes referred to as the Radio Laboratory and, again, as the Radio Communications Section. Always, until May 1, 1946, it was designated as Section I-6 of the Electricity Division.

ORGANIZATION OF RADIC SECTION.

Chief of Section (F.A. Koester) ————— { Cooperation with military and other organizations.

Research assistant (J.H. Dellinger) ————— { Programs of researches  
Reports  
Publication

- (F.A. Koester) { Closed-coil transmission
  - (Hough)
  - Submarine radio
    - (Wilkinson)
    - (Lowell)
  - Closed-coil applications
    - Triangulation
  - Airplane landing
    - (Voorhaes) (Sade)
    - (Hough) (Wilkinson)
    - (Lowell)
  - Fog signalling

- (F.A. Koester) { Coil constants
  - (Whittaker)
  - (Brait)
  - (Clarenbach)
  - Oscillographic equipment
    - (Whittaker)
    - (Hall)
    - (Clarenbach)

- (J.N. Miller) { Vacuum tubes
  - Methods of testing
    - (Merriam)
  - Power tubes
    - (McDowell)
    - (Boitz)
  - Amplifiers
    - (Cottrill)

- (J.H. Dellinger) { Antenna constants
- Radio instruction
  - (Pamplin)
- Insulating materials
  - (Preston)
  - (Smith)
  - (Mansgony)
- (J.H. Dellinger) { Fractional wave lengths
  - Comparison of  $\lambda$  and  $\lambda_0$  voltage
  - Measurement based circuits
  - Measure at very small currents
  - Beta for long and short  $\lambda$

Business assistant  
(L.E. Whittlemore)

{ Follow-up of section  
business.  
Building up all files.

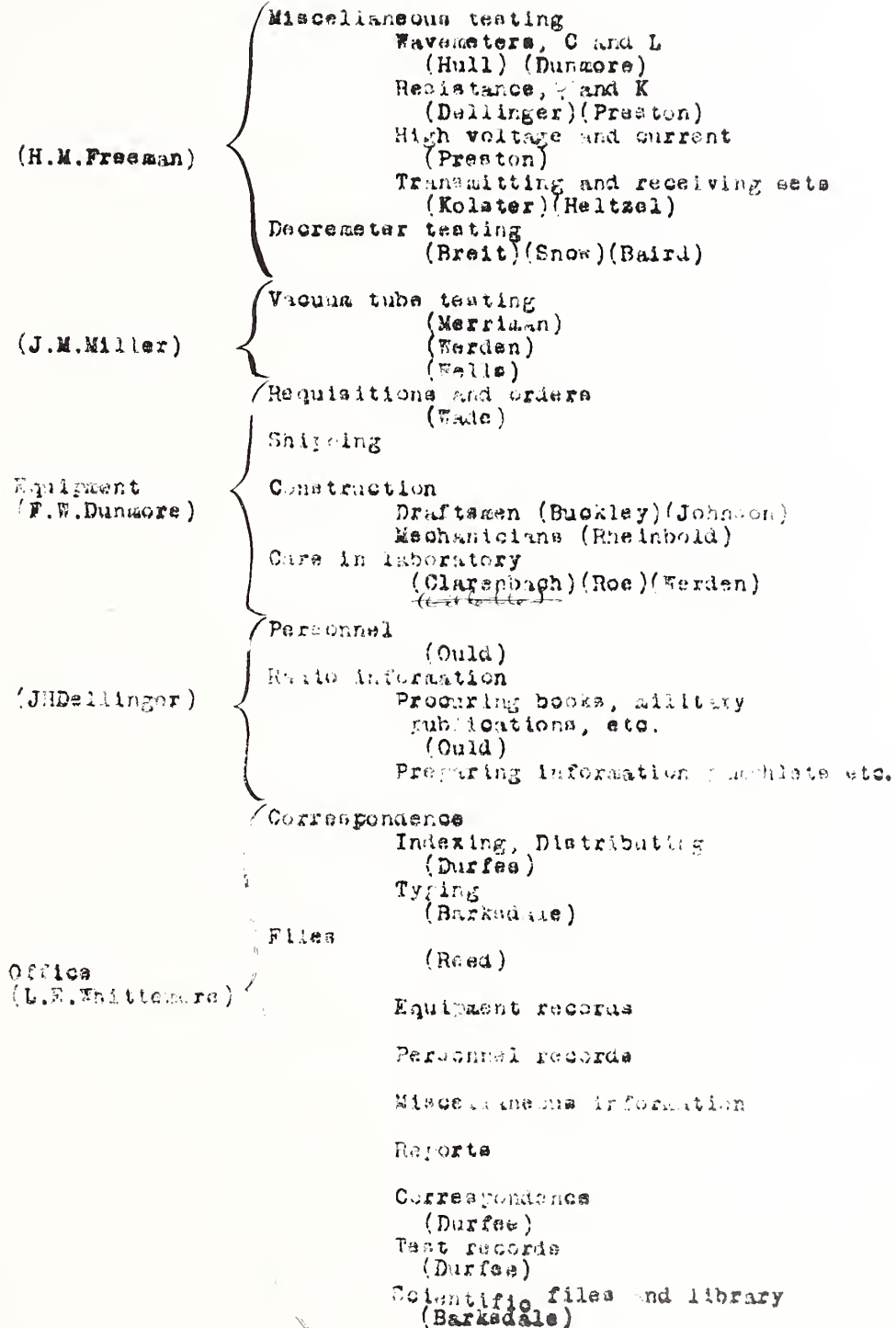

Chart showing organization on October 26, 1918, at time of moving of the Radio Section into the new Radio Building and about 2 weeks before the Armistice ending World War I. (The chart was attached to the Report of Radio Laboratory, October 21 to 28, 1918.) The initials, JHD:MWB, in the upper left-hand corner indicate that the chart must have been prepared under Dellinger's direction, and that Martha W. Barksdale was the typist. Miss Barksdale was a clerk in the Radio Section from 1918 to 1928.

Note: Many of the names on this chart, as well as the projects noted, will be found associated with chapters II through VI.

## 1919

### Radio Section<sup>7,8</sup>

#### I-6 Radio Section

6a Radio Research & Testing

J. H. Dellinger, 1919-1921

6b Radio Development

F. A. Kolster, 1919-1921

## 1921

### I ELECTRICITY DIVISION

E. C. Crittenden, 1921-1946<sup>9</sup>

I.6 Radio Communication Section  
(later, in 1920's, Radio Section)<sup>11</sup>

J. H. Dellinger, 1921-1946<sup>10</sup>

## 1923

**Director: G. K. Burgess, 1923-1932<sup>12</sup>**

## 1933

**Director: L. J. Briggs, 1933-1945<sup>13</sup>**

---

<sup>7</sup> Partly as a measure to cope with an expanded staff during World War I, and to set the section on a business-like basis, a reorganization kept Kolster as the chief, Dellinger as the research assistant, and L. E. Whittemore as the business assistant (see ch. III, p. 65).

<sup>8</sup> Beginning in August 1919 the Radio Section was organized into two subsections, and retained this structure until February 1, 1921 (see ch. IV, p. 71).

<sup>9</sup> Eugene C. Crittenden entered Electricity (division) in 1904. Crittenden's 25 years as chief of the Electricity Division continued as an assistant director of the Bureau; later to become an associate director. On May 1, 1946, Dr. Francis B. Silsbee became chief of the Electricity Division.

<sup>10</sup> The two subsections were reorganized as a single section on February 1, 1921, with Dellinger as chief and to continue as chief for 25 years, until May 1, 1946, when the section became a division, to be known as the Central Radio Propagation Laboratory. During the 1920's the section gradually reverted to its former and simpler name—the Radio Section.

<sup>11</sup> At the time of the Armistice on November 11, 1918, the Radio Section had grown to 40 members. Thereafter the number diminished to 18 by 1924, and then built up slowly to 44 by June 1933, much of the increase due to the development program by the Department of Commerce for radio aids to air navigation. The severe personnel cutbacks in 1933, brought on by budget cuts caused by the Great Depression, again brought the section to a low level of but 17 by October 1933, just 4 months after the June peak.\*

\*In the September 1951 issue of the *Scientific Monthly* (pp. 166-173), Lyman J. Briggs, director emeritus of NBS, stated, in part:

The untimely death of Dr. Burgess at his desk in July 1932 ended a career of great service to his country. My own responsibility for directing the bureau's work thus began in the depths of the depression and ended with the close of World War II. The first act of the incoming Roosevelt administration was summarily to reduce, by one half, the appropriations of the government scientific bureaus. History shows that the promised economics of the new administration did not go much beyond this point. It was a bitter experience for us. More than one third of our staff was dropped on a month's notice, . . .

But we carried on. . . . Extensive studies were made of the effect of certain changes in the ionosphere on radio communication. Sunspots were found to produce radio blackouts. The radiosonde was developed for making meteorological measurements up to 60,000 feet or more. Carried by a small balloon, this little instrument radios back in code the temperature, pressure, and the humidity of the air as it ascends. It is now used daily by the Weather Bureau at many stations.

<sup>12</sup> After Stratton's resignation, with Dr. Fay C. Brown (technical assistant to Stratton) serving as acting director for a period of about 4 months, Dr. George K. Burgess became director of the Bureau on April 21, 1923, to serve until his death on July 2, 1932. Burgess entered the Bureau in 1903 in Heat and Thermometry (division), and later became chief of the Metallurgy Division.

<sup>13</sup> Dr. Lyman J. Briggs came to the Bureau from the Department of Agriculture in 1917 during World War I, and became chief of the Mechanics and Sound Division in 1922. Upon the untimely death of Burgess in 1932, Briggs became acting director of the Bureau until his appointment was confirmed by the Senate as director on June 23, 1933, nearly a year later. He retired in November 1945, shortly after the close of World War II.

1945

Director: E. U. Condon, 1945-1951<sup>14,15</sup>

1946

**XIV CENTRAL RADIO PROPAGATION LABORATORY<sup>16</sup>**  
(Division XIV, later 14.)

J. H. Dellinger, 1946-1948<sup>17</sup>

1. Basic Ionospheric Research
2. Basic Microwave Research
3. Regular Propagation Services
4. Frequency Utilization Research
5. Experimental Ionospheric Research
6. Experimental Microwave Research
7. Regular Propagation Measurements<sup>19</sup>
8. Ionospheric Measurement Standards<sup>20</sup>
9. Microwave Standards

A. G. McNish<sup>18</sup>  
T. J. Carroll  
W. B. Chadwick  
K. A. Norton  
R. Bateman  
(activated later)  
H. P. Hutchinson  
W. D. George  
H. Lyons

1949

**14 CENTRAL RADIO PROPAGATION LABORATORY**  
(Reorganization of February 1, 1949)

N. Smith<sup>21,23</sup>

Asst. chief

A. G. McNish

Asst. chief

K. A. Norton

Administrative Officer

S. W. J. Welch

**Ionospheric Research Laboratory**

- .1 Upper Atmosphere Research
- .5 Ionospheric Research<sup>24</sup>
- .7 Field Operations<sup>25</sup>

A. G. McNish  
R. Bateman  
H. P. Hutchinson

<sup>14</sup> Dr. Edward U. Condon became director of NBS on November 7, 1945, coming from the Westinghouse Electric Corp. He resigned September 30, 1951.

<sup>15</sup> In 1949 Condon took a very active part in suggesting Boulder, Colo. as a suitable place to relocate the CRPL (see ch. XIX).

<sup>16</sup> As a war measure, during the summer of 1942 the Interservice Radio Propagation Laboratory was established within the Radio Section by order of the U.S. Joint Chiefs of Staff (see ch. XI, pp. 405-407). As a result of this new operation and other wartime projects, the Radio Section increased to 160 members by the spring of 1946 (April 30, 1946).

<sup>17</sup> As a result of the increased and diversified activity, and the very large number of its staff, the Radio Section was given division status on May 1, 1946, based upon Bureau Order No. 46-7, dated April 19, 1946. Dellinger was named chief, and Newbern Smith assistant chief, of Division XIV. The new division organization contained nine sections, each of a size that followed good management practice (one section, Experimental Microwave Research, never became activated by that name).

<sup>18</sup> Alvin G. McNish entered duty on August 15, 1946, as chief of the Basic Ionospheric Research Section, replacing Mrs. M. L. Phillips who had served as acting chief beginning May 1, 1946.

<sup>19</sup> Later, Section 7 was renamed Field Operations.

<sup>20</sup> Later, Section 8 was renamed High Frequency Standards.

<sup>21</sup> In accordance with Bureau Order No. 49-14, the CRPL was reorganized on February 1, 1949, with Dr. Newbern Smith as chief, following the retirement of Dellinger in 1948. Division 14 "was reorganized in order to promote better coordination of the research program of the Division," with three subdivisions or branches (Laboratories) being formed. The Basic Ionospheric Research Section was renamed the Upper Atmospheric Research Section. The Experimental Microwave Research Section (never activated) was renamed Tropospheric Propagation Research Section, and the work of the Basic Microwave Research Section was consolidated with it.

<sup>22</sup> Later, N. Smith requested to be relieved of his duties as chief of the CRPL and to serve as a consultant. He resigned from NBS in 1954.

<sup>23</sup> For a period of time, beginning in the summer of 1953, Dr. R. D. Huntoon (associate director for physics) served as acting chief of the CRPL; to be followed by Dr. W. R. Brode (associate director for chemistry) as acting chief until the arrival of Dr. Frederick W. Brown in June 1954. During this period Dr. R. J. Slutz served as the assistant chief of the CRPL.

<sup>24</sup> The adjective form, "Ionospheric Research Section," was changed in 1959 to the noun form, "Ionosphere Research Section."

<sup>25</sup> In the spring of 1950 the work of the Field Operations Section was transferred to a group operation in the Upper Atmospheric Research Section.

## Systems Research Laboratory

- .3 Regular Propagation Services<sup>26</sup>
- .4 Frequency Utilization Research
- .6 Tropospheric Propagation Research<sup>27</sup>

W. B. Chadwick  
K. A. Norton  
J. W. Herbstreit

## Measurement Standards Laboratory

- .8 High Frequency Standards
- .9 Microwave Standards

W. D. George  
H. Lyons

## 1952

Director: A. V. Astin, 1952-1969<sup>28</sup>

## 1954

### BOULDER LABORATORIES<sup>29</sup> (Organization of July 1954)

F. W. Brown<sup>30</sup>

#### 80 ADMINISTRATION<sup>31-35</sup>

- .10 Washington Liaison Office
- .30 Personnel
- .40 General Services
- .50 Engineering Services

S. W. J. Welch<sup>36</sup>  
R. C. Peavey  
R. W. Stockwell  
B. F. Betts  
P. S. Ballif

#### 81 CRYOGENIC ENGINEERING

- .10 Cryogenic Equipment
- .20 Cryogenic Processes
- .30 Properties of Materials
- .40 Gas Liquification

R. B. Scott  
B. W. Birmingham  
P. C. Vander Arend  
R. J. Corruccini  
V. J. Johnson

<sup>26</sup> In 1951 the Regular Propagation Services Section, with W. B. Chadwick as chief, was set up as another Laboratory within the CRPL structure, making a total of four laboratories within the CRPL.

<sup>27</sup> The Tropospheric Propagation Research Section was formerly called the Experimental Microwave Research Section. Beginning February 1, 1949, certain of the projects were transferred to 14.1, the Upper Atmosphere Research Section. The remaining projects were the precursors of many projects to be associated with CRPL tropospheric propagation and engineering projects in future years.

<sup>28</sup> Upon the resignation of Condon in 1951, Dr. Allen V. Astin became acting director until confirmation by the Senate as director, May 30, 1952. Astin came to the Bureau as a research associate in 1930, and joined the staff in 1932. He became associate director in 1951. Astin retired from the Bureau, as director, on August 31, 1969.

<sup>29</sup> In accordance with Administrative Bulletin No. 54-39, dated June 30, 1954, four technical divisions were organized at the Boulder Laboratories. Although not related in technical projects to the three radio divisions of the Boulder Laboratories, the Cryogenic Engineering Division is added to this listing to indicate the complete organizational structure at the Boulder Laboratories in 1954.

Initially, Dr. Brown served as acting chief of the Radio Standards Division until the appointment of Dr. Harold A. Thomas. Many of the section chiefs in the four technical divisions were appointed first in an acting capacity (not indicated in listing), and later were given permanent status.

<sup>30</sup> Dr. Frederick W. Brown was appointed director of the Boulder Laboratories, February 26, 1954, but did not come on duty at Boulder until late June 1954. Previously, Brown had been technical director of the Naval Ordnance Test Station, Inyokern, Calif.

<sup>31</sup> When the CRPL was organized in 1946 several field stations came within its sphere of administration. By 1954 the number had increased to 12.

<sup>32</sup> Previous to the establishment of the Administration Division (80) (later changed to Administrative Division) at the Boulder Laboratories, a Facilities Division had been established, with P. S. Ballif as chief, that included shop operations, plant services, and a purchasing office. All technical operations were administered from Washington-based CRPL.

<sup>33</sup> A new office, that of the Fiscal Office (80.20), was made a part of the Administration Division soon after the five divisions were organized at Boulder. H. C. Stansell headed the office.

<sup>34</sup> A new office, that of Management Planning (80.10), was made a part of the Administrative Division in 1958. Mrs. J. Berkeley headed the office.

<sup>35</sup> In October 1955 the Washington Liaison Office was phased out, having completed its operation for the CRPL move to Boulder. Mrs. A. N. Kincheloe had replaced R. C. Peavey.

<sup>36</sup> S. W. J. Welch returned to the CRPL in April 1954, after serving as the administrative officer of the Naval Ordnance Laboratory, Corona, Calif., beginning in 1951.



## 82 RADIO PROPAGATION PHYSICS

- .10 Upper Atmosphere Research
- .20 Ionospheric Research
- .30 Regular Propagation Services

R. J. Slutz  
T. N. Gautier  
R. Bateman<sup>37</sup>  
W. B. Chadwick

## 83 RADIO PROPAGATION ENGINEERING

- .40 Frequency Utilization Research
- .60 Tropospheric Propagation Research

K. A. Norton  
K. A. Norton (acting)  
J. W. Herbstreit

## 84 RADIO STANDARDS

- 84A High Frequency Standards Branch<sup>39</sup>
  - .10 High Frequency Electrical Standards
  - .20 Radio Broadcast Service
  - .30 HF Impedance Standards
- 84B Microwave Standards Branch
  - .60 Extreme High-Frequency and Noise
  - .70 Microwave Frequency & Spectroscopy
  - .80 Microwave Circuit Standards

H. A. Thomas<sup>38</sup>  
W. D. George  
M. C. Selby  
A. H. Morgan  
(vacant)<sup>40</sup>  
H. Lyons  
D. M. Kerns  
G. Birnbaum  
R. W. Beatty

1956

### Extension of organization of the three technical divisions of the CRPL, late summer of 1956

#### CENTRAL RADIO PROPAGATION LABORATORY<sup>41</sup>

F. W. Brown (acting)

#### 82 RADIO PROPAGATION PHYSICS<sup>42</sup>

- .10 Upper Atmosphere Research
- .20 Ionospheric Research
- .30 Regular Propagation Services
- .40 Sun-Earth Relationships

R. J. Slutz  
T. N. Gautier  
R. C. Kirby  
W. B. Chadwick  
A. H. Shapley

#### 83 RADIO PROPAGATION ENGINEERING<sup>43</sup>

Asst. division chief for Research and Development  
Asst. division chief for Engineering Logistics, and

K. A. Norton  
J. W. Herbstreit

Technical Administration

- .10 Data Reduction Instrumentation
- .20 Modulation Systems
- .30 Navigation Systems
- .40 Radio Noise
- .50 Tropospheric Measurements
- .60 Tropospheric Analysis
- .70 Radio Systems Application Engineering

K. O. Hornberg  
W. E. Johnson  
A. D. Watt  
G. Hefley  
W. Q. Crichlow  
C. F. Peterson  
P. L. Rice  
R. S. Kirby

<sup>37</sup>The Ionospheric Research Section continued to operate for several years, largely from the Sterling, Va. field station. R. Bateman resigned in late summer of 1955 and R. C. Kirby became chief of a reestablished Ionospheric Research Section at Boulder. Kirby continued to direct the work at the Sterling station for a period of time. The station operated thereafter until 1961, under the Field Operations Section.

<sup>38</sup>H. A. Thomas, chief of the Radio Standards Division, resigned in September 1956 and was replaced by W. D. George who served as acting chief for the next 5 years (until the spring of 1960).

<sup>39</sup>The branch organizational structure of the Radio Standards Division was dropped in July 1955 after the resignation of H. Lyons from NBS.

<sup>40</sup>In early 1956 J. L. Dalke was appointed to head the HF Impedance Standards Section.

<sup>41</sup>In a new organizational structure the two propagation divisions were grouped together as a "Laboratory" unit, which retained the name of Central Radio Propagation Laboratory. F. W. Brown served as acting chief of the unit.

<sup>42</sup>In 1957 Section 82.50, VHF Research, was added to the Radio Propagation Physics Division, with K. L. Bowles as chief.

<sup>43</sup>In 1957 Section 83.80, Radio Meteorology, was added to the Radio Propagation Engineering Division, with B. R. Bean as chief.

## RADIO STANDARDS LABORATORY<sup>44</sup>

W. D. George (acting)

### 84 Division

Asst. chief for Radio Frequencies<sup>45</sup>

W. D. George (acting)

Asst. chief for Microwave Frequencies

D. M. Kerns

.10 High Frequency Electrical Standards

M. C. Selby

.20 Radio Broadcast Service

A. H. Morgan

.30 High Frequency Impedance Standards

J. L. Dalke

.50 Calibration Center<sup>46</sup>

H. W. Lance

.70 Microwave Physics

D. M. Kerns<sup>47</sup>

.80 Microwave Circuit Standards

R. W. Beatty

## 1959

### CENTRAL RADIO PROPAGATION LABORATORY

F. W. Brown (acting)

(Reorganization to form an additional division January 1959)

### 82 RADIO PROPAGATION PHYSICS

R. J. Slutz

Asst. chief

D. M. Gates

Asst. chief

A. H. Shapley

.10 Upper Atmosphere Research

R. M. Gallet

.20 Ionosphere Research

E. K. Smith

.30 Regular Prediction Services

W. D. Chadwick

.40 Sun-Earth Relationships

R. W. Knecht

.50 VHF Research

K. L. Bowles

.60 Radio Warning Services

J. V. Lincoln

.70 Airglow and Aurora

F. E. Roach

.80 Radio Astronomy and Arctic Propagation

C. G. Little

### 83 RADIO PROPAGATION ENGINEERING

K. A. Norton

Asst. chief for Research & Development

J. W. Herbstreit

Asst. chief for Engineering, Logistics, and Technical Administration

K. O. Hornberg

.10 Data Reduction Instrumentation

W. E. Johnson

.20 Modulation Systems<sup>48</sup>

A. D. Watt

.40 Radio Noise

W. Q. Crichlow

.50 Tropospheric Measurements

C. F. Peterson<sup>49</sup>

.60 Tropospheric Analysis

P. L. Rice

.70 Radio Systems Application<sup>50</sup>

R. S. Kirby

.80 Radio Meteorology

B. R. Bean

.90 Lower Atmosphere Physics

M. C. Thompson

<sup>44</sup>By NBS Administrative Bulletin 56-25, May 1, 1956, the title "Laboratory" as an alternative to "Division" was applicable to Division 84. Later, in 1960, the title "Radio Standards Laboratory" was used in an administrative structure that included one, and later, three divisions.

<sup>45</sup>Remnants of the former branch structure of the division (see footnote 39) were retained by designating branch chiefs as assistant division chiefs, each being responsible for a defined frequency region.

<sup>46</sup>In the spring of 1958 the name of the Calibration Center was changed to Electronic Calibration Center at the suggestion of Dr. Astin, director of NBS.

The term "electronic" in an organizational name at NBS appears to have been introduced by the Ordnance Development Division during World War II, with the section name "Electronic Engineering." Cochrane states in *Measures for Progress*, p. 249, footnote 83, that the phrase, "investigations in electronics," was used in NBS Annual Report 1918. He states:

This appears to be one of the first uses of the word "electronics" (by NBS), although not in its present connotation. It did not come into general use until just before World War II.

<sup>47</sup>D. M. Kerns was later assigned to the Division Office and was replaced by J. M. Richardson as chief of the Microwave Physics Section.

<sup>48</sup>Section 83.20, Modulation Systems, was discontinued by 1960.

<sup>49</sup>Early in 1961 C. F. Peterson transferred to the Federal Aviation Agency and was replaced by M. T. Decker.

<sup>50</sup>The title of Section 83.70 was changed to Propagation-Terrain Effects by 1960.

## 85 RADIO COMMUNICATION AND SYSTEMS

Asst. chief

- .10 LF and VLF Research
- .20 HF and VHF Research
- .30 UHF and Super HF Research
- .40 Modulation Research
- .50 Antenna Research
- .60 Navigation Systems
- .70 Systems Analysis
- .80 Field Operations

R. C. Kirby  
D. W. Patterson  
A. G. Jean  
R. Silberstein  
(not activated)  
J. W. Koch  
H. V. Cottony  
G. Hefley  
W. C. Coombs  
H. G. Sellery

1960

### Organizational structure of Boulder Laboratories (exclusive of Cryogenic Engineering Laboratory) at close of 1960.<sup>51</sup>

## 79 DIRECTORS OFFICE, BOULDER LABORATORIES<sup>52</sup>

F. W. Brown<sup>53,54</sup>

## 80 ADMINISTRATIVE<sup>55</sup>

- .10 Management Planning
- .20 Fiscal Office
- .30 Personnel
- .40 Supply
- .50 Engineering Services
- .60 Office Services

S. W. J. Welch  
Mrs. J. Berkley  
H. D. Stansell  
R. W. Stockwell  
B. F. Betts  
P. S. Ballif  
R. G. Bulgin

## CENTRAL RADIO PROPAGATION LABORATORY

F. W. Brown (acting)

## 82 IONOSPHERE RESEARCH AND PROPAGATION<sup>56</sup>

Asst. chief

Asst. chief

- .10 LF and VLF Research
- .20 Ionosphere Research
- .30 Prediction Services
- .40 Sun-Earth Relationships
- .50 Field Engineering
- .60 Radio Warning Services

E. K. Smith  
T. N. Gautier  
R. W. Knecht  
A. G. Jean  
K. Davies  
W. B. Chadwick  
R. W. Knecht  
H. G. Sellery  
J. V. Lincoln

<sup>51</sup>The rapid increase in scope of propagation work at the Boulder Laboratories, along with increased number of personnel, necessitated many changes in the fluid-like organizational structure that existed. Four divisions were formed in the CRPL, transferring sections and establishing new sections in order to reorient groups among the several technical fields (divisions). Space-age projects hastened the need of reorientation.

<sup>52</sup>The Director's Office was staffed with a number of persons engaged in special activities, including: five (and more) consultants on special assignments, the Technical Information Officer, the Librarian, and several liaison personnel.

<sup>53</sup>In 1961 Brown received the Department of Commerce Gold Medal for Exceptional Service "for exceptional skill and achievement in the administration of major scientific research programs."

<sup>54</sup>Dr. Brown, director of the Boulder Laboratories from 1954, transferred to the State Department, November 1962, on an assignment to Argentina as a science attache. Although planning to return to the NBS, he later joined the Environmental Science Services Administration in Washington, from which he retired in 1967. He died October 24, 1970.

<sup>55</sup>In the spring of 1962 two sections were added to the Administrative Division: .70 Plant Engineering Section, with E. A. Yuzwiak as chief; .80 Shop Section, with J. L. Hutton as chief.

<sup>56</sup>In 1961 another section was added, the .70 Vertical Sounding Research Section, with J. W. Wright as chief.

### 83 RADIO PROPAGATION ENGINEERING

Asst. chief for Research and Development

- .10 Data Reduction Instrumentation
- .40 Radio Noise
- .50 Tropospheric Measurements
- .60 Tropospheric Analysis
- .70 Propagation-Terrain Effects
- .80 Radio Meteorology
- .90 Lower Atmosphere Physics

K. A. Norton  
J. W. Herbstreit  
W. E. Johnson  
W. Q. Crichlow  
W. T. Decker (later)  
P. L. Rice  
R. S. Kirby  
B. R. Bean  
M. C. Thompson

### 85 RADIO SYSTEMS<sup>57</sup>

Asst. chief

- .20 HF and VHF Research
- .40 Modulation Research
- .50 Antenna Research
- .60 Navigation Systems
- .70 Space Communications

R. C. Kirby  
D. W. Patterson  
R. S. Silberstein<sup>58</sup>  
J. W. Koch<sup>59</sup>  
H. V. Cottony  
G. Hefley  
W. C. Coombs

### 87 UPPER ATMOSPHERE AND SPACE PHYSICS

Asst. chief

- .10 Upper Atmosphere & Plasma Physics
- .50 Ionosphere & Exosphere Scatter
- .70 Airglow and Aurora
- .80 Ionospheric Radio Astronomy

C. G. Little  
D. M. Gates  
R. M. Gallet  
K. L. Bowles  
F. E. Roach  
R. S. Lawrence

### 84 RADIO STANDARDS LABORATORY<sup>60</sup>

Asst. chief for Radio Frequencies

Asst. chief for Microwave Frequencies

Asst. chief for Technical Planning and Coordination

- .10 HF Electrical Standards
- .20 Radio Broadcast Service
- .30 Radio and Microwave Materials
- .40 Atomic Frequency and Time Standards
- .50 Electronic Calibration Center
- .70 Millimeter-Wave Research
- .80 Microwave Circuit Standards

J. M. Richardson<sup>61</sup>  
W. D. George  
D. M. Kerns  
E. C. Wolzien  
M. C. Selby  
A. H. Morgan  
J. L. Dalke  
R. C. Mockler  
H. W. Lance  
W. Culshaw<sup>62</sup>  
R. W. Beatty

---

<sup>57</sup> In 1961 a new section was added, .10 Applied Electromagnetic Theory, with J. R. Johler as chief.

<sup>58</sup> In 1961 R. Silberstein transferred to the Department of the Army and was replaced by W. F. Utlaut.

<sup>59</sup> In 1961 J. W. Koch was replaced by W. C. Coombs, and the .70 Space Communications Section discontinued.

<sup>60</sup> In 1960 a "Laboratory" organizational structure, known as the Radio Standards Laboratory, was established that served as an administrative unit; first, for a single standards and measurement division, then two, and finally three divisions. The "Laboratory" structure was discontinued in 1968.

<sup>61</sup> Dr. John M. Richardson became chief of the Radio Standards Laboratory in the late spring of 1960. Prior to this assignment he had been head of the Gaseous Physics Group within the Director's Office, a group involved in plasma physics research.

<sup>62</sup> Late in 1961 W. Culshaw resigned and was replaced by L. Y. Beers.

1962

**90 RADIO STANDARDS LABORATORY**

(Reorganization to form two divisions, January 26, 1962)

Asst. chief for Planning and Coordination

J. M. Richardson

E. C. Wolzien

**91 RADIO PHYSICS<sup>63</sup>**

- .20 Radio Broadcast Service
- .30 Radio and MW Materials
- .40 Atomic Frequency and Time Interval Standards
- .60 Radio Plasma
- .70 Millimeter-Wave Research

L. Y. Beers  
A. H. Morgan<sup>64</sup>  
J. L. Dalke  
R. C. Mockler  
B. Wieder (acting)<sup>65</sup>  
R. W. Zimmerer (acting)

**92 CIRCUIT STANDARDS**

Asst. chief

- .10 HF Electrical Standards
- .30 HF Impedance
- .50 Electronic Calibration Center
- .80 Microwave Circuit Standards

G. E. Schafer<sup>66</sup>  
H. W. Lance  
M. C. Selby  
R. C. Powell  
W. F. Snyder (acting)<sup>67</sup>  
R. W. Beatty

**92 CIRCUIT STANDARDS**

(Reorganization, April 1962)

Asst. chief

- .10 HF Electrical Standards
- .20 HF Calibration Services
- .30 HF Impedance Standards
- .70 MW Calibration Services
- .80 Microwave Circuit Standards
- .90 LF Calibration Services

G. E. Schafer  
  
H. W. Lance  
C. M. Allred  
R. C. Powell (acting)<sup>68</sup>  
R. C. Powell  
R. E. Larson  
M. B. Hall  
F. D. Weaver

**95 JOINT INSTITUTE FOR LABORATORY**

**ASTROPHYSICS (JILA)—NBS GROUP**

(Established April 1962. A joint operation of NBS and  
the University of Colorado, a technical unit of the Boulder Laboratories)<sup>69</sup>

L. M. Branscomb,  
chairman<sup>70</sup>

<sup>63</sup> At a later time W. D. Goring was appointed to serve as assistant chief for Technical Planning and Coordination.

<sup>64</sup> Later, a new section related technically to .20 Radio Broadcast Service, named .10 Frequency-Time Dissemination Research, was formed with A. H. Morgan as chief. D. H. Andrews was appointed chief of the renamed .20 Frequency-Time Broadcast Service Section.

<sup>65</sup> B. Wieder was later replaced by K-B. Persson.

<sup>66</sup> George E. Schafer was appointed chief, and Harvey W. Lance assistant chief, of the Circuit Standards Division at the time of the reorganization of the Radio Standards Laboratory on January 26, 1962. Later, Schafer took an extensive leave of absence on a teaching assignment and Lance served as acting chief of the Division.

<sup>67</sup> W. F. Snyder served as acting chief of the Electronic Calibration Center until the spring of 1962 when the center was organized as three sections, designated as Calibration Services sections. At this time Snyder was designated Coordinator of Calibration Services.

<sup>68</sup> R. C. Powell served as acting chief of the HF Calibration Services Section; later the position was filled by K. R. Wendt.

<sup>69</sup> Later, in March 1963, the NBS Laboratory Astrophysics Group, identified organizationally as Division 95.00, was established as a part of the Joint Institute for Laboratory Astrophysics (JILA), and became a division within the NBS Institute of Basic Standards.

<sup>70</sup> Dr. Lewis M. Branscomb had previously been chief of the Atomic Physics Division at NBS Washington. He was appointed chief of the NBS Laboratory Astrophysics Division at Boulder and retained the position until 1969 when he was appointed director of NBS.

## BOULDER LABORATORIES

R. B. Scott named acting  
director  
October 18, 1962<sup>71,72</sup>

### CENTRAL RADIO PROPAGATION LABORATORY (Reorganization of October 1962)<sup>74</sup>

Asst. chief

Admin. officer

- .10 Chief, CRPL Liaison and Program Development
- .20 Consultant, Radio Wave Propagation

C. G. Little<sup>73</sup>

J. W. Herbstreit  
R. T. Frost  
A. H. Shapley  
J. R. Wait

### 82 IONOSPHERE RESEARCH AND PROPAGATION

Asst. chief

- .05 Ultralow Frequency Research
- .10 LF and VLF Research
- .20 Ionosphere Research
- .30 Prediction Services
- .40 Sun-Earth Relationships
- .50 Field Engineering
- .60 Radio Warning Services
- .70 Vertical Sounding Research

R. W. Knecht  
T. N. Gautier  
W. H. Campbell  
A. G. Jean  
K. Davies  
M. PoKempner (acting)<sup>75</sup>  
H. J. Smith  
H. G. Sellery  
J. V. Lincoln  
J. W. Wright

### 83 RADIO PROPAGATION ENGINEERING<sup>76</sup>

Asst. chief for Research and Development

- .10 Data Reduction Instrumentation
- .40 Radio Noise
- .50 Tropospheric Measurements
- .60 Tropospheric Analysis
- .70 Spectrum Utilization
- .80 Radio Meteorology
- .90 Lower Atmosphere Physics

K. A. Norton  
R. S. Kirby  
W. E. Johnson  
W. Q. Crichlow  
M. T. Decker  
P. L. Rice  
A. P. Barsis  
R. E. McGavin<sup>77</sup>  
M. C. Thompson

<sup>71</sup> Russell B. Scott was named acting director of the Boulder Laboratories to replace Brown who had taken a 2-year assignment with the State Department. (See footnote 54.)

<sup>72</sup> In August 1963 Dr. Astin, director of NBS, announced that Scott's position as acting director of Boulder Laboratories was changed to manager of Boulder Laboratories. The position was abolished October 1965 at time of transfer of the CRPL to the Environmental Science Services Administration (ESSA). Scott retired from his position as consultant to the Cryogenics Division on November 30, 1965. Scott continued his position as professor-adjunct in the Department of Chemical Engineering at the University of Colorado. He died September 24, 1967.

<sup>73</sup> Dr. C. Gordon Little, appointed chief of the CRPL, replaced Brown who had served for 8 years as acting chief of the CRPL, but was now leaving NBS on a State Department assignment. Little joined NBS in 1958 to head the Radio Astronomy and Arctic Propagation Section.

<sup>74</sup> An interesting headline and article appeared on the first page of the November-December 1962 issue of The Bureau Drawer (a Boulder Laboratories in-house publication) announcing the October reorganization of the CRPL. The reader was introduced to the subject of the many personnel changes by reading:

#### CHAIN OF CHANGES SWEEPS BOULDER LABORATORIES

##### Changes in CRPL

Remember October? It was the month of the big hail in Boulder and the autumn gust that shook the high branches of the BL organizational trees. Most of the leaves went up.

There was the appointment of Dr. C. Gordon Little as first permanent chief of the Central Radio Propagation Laboratory, and the establishment of a numerical division 89.00, for the personnel attached to his office. . . .

<sup>75</sup> Walter B. Chadwick retired at the time of this reorganization. He had been chief of the Propagation, or Prediction, Services Section since the organization of the CRPL in 1946.

<sup>76</sup> Later, Division 83 was renamed Tropospheric and Space Telecommunications Division. (See footnote 87.)

<sup>77</sup> Later, B. R. Bean replaced R. E. McGavin as section chief, McGavin remaining in the section.

## 85 RADIO SYSTEMS

Asst. chief

Asst. chief

- .10 Applied Electromagnetic Theory
- .20 HF and VHF Research
- .30 Frequency Utilization
- .40 Modulation Research
- .50 Antenna Research
- .60 Radiodetermination

R. C. Kirby  
D. W. Patterson  
W. F. Utlaut  
J. R. Johler  
W. F. Utlaut<sup>78</sup>  
G. W. Haydon  
C. C. Watterson  
H. V. Cottony  
G. Hefley

## 87 UPPER ATMOSPHERE AND SPACE PHYSICS<sup>79,81</sup>

- .10 Upper Atmosphere and Plasma Physics
- .20 High Latitude Ionospheric Physics
- .50 Ionosphere and Exosphere Scatter
- .70 Airglow and Aurora
- .80 Ionospheric Radio Astronomy

E. K. Smith  
R. M. Gallet  
H. J. A. Chivers  
K. L. Bowles  
F. E. Roach  
R. S. Lawrence

## 1963

### 79 MANAGER'S OFFICE

R. B. Scott

## 1964

In early February, 1964, Department Order No. 90 brought a sweeping change at NBS in the organizational structure for administration of the technical programs. Four Institutes were established, each covering a broad range of technical fields. The four divisions of the CRPL constituted an Institute, with Dr. C. Gordon Little as director. The two radio standards divisions, the Laboratory Astrophysics Division, and eight divisions at NBS Washington constituted the Institute for Basic Standards, with Dr. Robert D. Huntoon as director. (The Cryogenics Division at NBS Boulder became one of six divisions within the Institute for Materials Research.)

### 200 INSTITUTE FOR BASIC STANDARDS (IBS)

(224 Laboratory Astrophysics Division, 250 Radio Standards Laboratory, 251 Radio Standards Physics Division, and 252 Radio Standards Engineering Division were NBS Boulder technical units of IBS)

R. D. Huntoon<sup>82,83</sup>

### 560 CENTRAL RADIO PROPAGATION LABORATORY (An Institute of NBS)

Deputy director

Admin. officer

- .10 Chief, CRPL Liaison and Program Development
- .20 Consultant, Radio Wave Propagation

C. G. Little (director)

J. W. Herbstreit  
R. T. Frost  
A. H. Shapley  
J. R. Wait

---

<sup>78</sup> Upon the appointment of W. F. Utlaut as assistant chief of the division, L. H. Tveten was appointed chief of the HF and VHF Research Section.

<sup>79</sup> Later, F. L. Taylor was appointed assistant chief of the Upper Atmosphere and Space Physics Division.

<sup>80</sup> Later, the Upper Atmosphere and Plasma Physics Section was discontinued.

<sup>81</sup> In the fall of 1963 a new section was created in the division, known as Atmospheric Collision Processes, with Eldon E. Ferguson as chief.

<sup>82</sup> Dr. Merrill B. Wallenstein, a physical chemist, entered the Institute for Basic Standards in July 1964 and later served as deputy director and acting director. He died July 1, 1968.

<sup>83</sup> In 1967 Huntoon was appointed to head the Office of Program Development and Evaluation in the Office of the Director. He retired from NBS in July 1968.

**582 IONOSPHERE RESEARCH AND PROPAGATION<sup>84</sup>**

Asst. chief

Asst. chief for Technical Planning and Administration

- .01 Boulder Magnetic Observatory
- .05 Ultralow Frequency Research
- .10 LF and VLF Research
- .20 Ionosphere Research
- .30 Prediction Services
- .40 Sun-Earth Relationships
- .50 Field Engineering
- .60 Radio Warning Services
- .62 North Atlantic Radio Warning Services
- .63 North Pacific Radio Warning Services
- .70 Vertical Sounding Research

R. W. Knecht  
 T. N. Gautier  
 J. A. Kemper  
 A. J. Bilik  
 W. H. Campbell  
 D. D. Crombie  
 K. Davies  
 M. Leftin<sup>85</sup>  
 T. E. Vanzandt (acting)  
 H. G. Sellery  
 J. V. Lincoln  
 E. J. Wiewara  
 (vacant)<sup>86</sup>  
 J. W. Wright

**583 TROPOSPHERE AND SPACE TELECOMMUNICATIONS** R. S. Kirby  
 (The division organization remained essentially the same as of October 1962, with changes indicated in footnotes.)<sup>87,88</sup>

**585 RADIO SYSTEMS**

R. C. Kirby

(The division organization remained essentially the same as of October 1962.)

**587 UPPER ATMOSPHERE AND SPACE PHYSICS**

E. K. Smith

(The division organization remained essentially the same as of October 1962.)

**INSTITUTE FOR BASIC STANDARDS**

R. D. Huntoon

**224 LABORATORY ASTROPHYSICS (JILA)—NBS Group**

L. M. Branscomb

**250 RADIO STANDARDS LABORATORY<sup>89</sup>**

Asst. chief for Program Evaluation and Development

Asst. chief for Technical Planning and Coordination

J. M. Richardson

H. W. Lance

E. C. Wolzien

**251 RADIO STANDARDS PHYSICS<sup>90</sup>**

Asst. chief

Asst. chief for Technical Planning and Coordination

- .01 Frequency-Time Dissemination Research
- .02 Frequency-Time Broadcast Services
- .03 Radio and MW Materials
- .04 Atomic Frequency and Time Interval Standards
- .06 Radio Plasma
- .07 Microwave Physics

L. Y. Beers

G. F. Hudson

W. D. Goring

A. H. Morgan

D. H. Andrews

J. L. Dalke

R. C. Mockler

K.-B. Persson

R. W. Zimmerer (acting)

<sup>84</sup> Previously, in the summer and fall of 1963, a number of changes had been made in the Ionosphere Research and Propagation Division. These were retained in the division structure of 1964 when the CRPL became an Institute.

<sup>85</sup> Mrs. Margo Leftin was formerly Margo (Minadora) PoKempner, chief of the Prediction Services Section.

<sup>86</sup> Later, the position was filled by L. W. Honea as the engineer-in-charge of the Anchorage, Alaska field station.

<sup>87</sup> Administrative Bulletin 63-5 of March 27, 1963, announced the change of name of the Radio Propagation Engineering Division to the Troposphere and Space Telecommunications Division.

<sup>88</sup> In the summer of 1964 K. A. Norton was appointed consultant to the director of CRPL, and R. S. Kirby became chief of the Troposphere and Space Telecommunications Division.

<sup>89</sup> With the establishment of the Institute for Basic Standards and with the existence of the Radio Standards Laboratory (unit) for several years, there were now two levels in the echelon of administration and of planning operations that had not existed previously in NBS administration. Changes several years later brought a discontinuance of the "Radio Standards Laboratory" level in the echelon of administration.

<sup>90</sup> Administrative Bulletin 63-5 of March 27, 1963, announced the change of name of the Radio Physics Division to the Radio Standards Physics Division.



**252 RADIO STANDARDS ENGINEERING<sup>91</sup>**  
 Asst. chief for Technical Planning and Coordination  
 .11 LF Calibration Services<sup>93</sup>  
 .21 HF Calibration Services  
 .22 HF Electrical Standards  
 .23 HF Impedance Standards  
 .31 MW Calibration Services  
 .32 Microwave Circuit Standards

G. E. Schafer<sup>92</sup>  
 W. J. Anson  
 F. D. Weaver  
 K. R. Wendt  
 C. M. Allred  
 R. C. Powell  
 R. E. Larson  
 M. B. Hall

## 1965

Early in 1965 another wave of changes and reorganization came over much of the organizational structure of the Boulder Laboratories, and mainly to the CRPL and to the administration of the Boulder Laboratories. Changes in the CRPL became effective February 1, 1965 to meet new space-age responsibilities of the Institutes of NBS. Organizational structure of the RSL remained essentially the same.

**160 OFFICE OF THE MANAGER, BOULDER LABORATORIES** R. B. Scott<sup>94</sup>  
 Asst. manager for Planning and Facilities S. W. J. Welch

**161 ADMINISTRATIVE SERVICES**  
 .30 Fiscal H. D. Stansell<sup>95</sup>  
 .40 Supply T. M. Rizzi  
 .50 Office Services B. F. Betts  
 .60 Photo and Printing Services R. G. Bulgin  
 .70 Drafting Services C. M. Benedict  
 J. C. Harmon

**162 SHOPS** F. P. Brown (acting)<sup>96</sup>  
 Asst. chief R. S. Perrill

**163 PLANT**  
 .10 Design and Construction E. A. Yuzwiak  
 .20 Plant Services G. M. Musick (acting)<sup>97</sup>  
 .30 Maintenance and Operation R. J. Stadlbauer  
 E. G. Clark

**500 CENTRAL RADIO PROPAGATION LABORATORY** C. G. Little (director)  
 Deputy director for Program Planning and Liaison J. W. Herbstreit

<sup>91</sup> Administrative Bulletin 63-5 of March 27, 1963, announced the change of name of the Circuit Standards Division to the Radio Standards Engineering Division.

<sup>92</sup> In September 1964 Schafer entered a 1-year fellowship program of the Department of Commerce. Dr. Helmut M. Altshuler joined NBS to serve as acting chief of the Radio Standards Engineering Division during Schafer's absence.

<sup>93</sup> In the spring of 1966 the operations of the Low Frequency Calibration Services Section were phased out and the measurement equipment moved to Gaithersburg, Md. where the calibration services were continued by the Electricity Division.

<sup>94</sup> See footnotes 71 and 72.

<sup>95</sup> Herbert D. Stansell died December 5, 1965.

<sup>96</sup> Although F. P. Brown was chief of the Shops Division at NBS Washington, he served also for a period of time as acting chief of the Shops Division at NBS Boulder. Later, Rodney S. Perrill was appointed chief of the Shops Division at Boulder.

<sup>97</sup> G. M. Musick was later replaced by W. L. Arnold.

## 510 IONOSPHERIC TELECOMMUNICATIONS<sup>98,99</sup>

Asst. chief

- .10 ELF to MF Propagation Branch
  - .11 VLF/LF Research Section
  - .12 Radiodetermination Section
  - .13 Electromagnetic Theory Section
    - .19 HF Propagation Group
- .20 HF and VHF Propagation Branch
  - .21 Ionospheric Radar Section
    - .28 HF Propagation Theory Group
    - .29 Radar Facility Group
- .30 Ionosphere Predictions Branch
  - .31 Prediction Services Section
  - .32 Field Engineering and Operations Section
    - .39 Prediction Research Group
- .40 Communications Technology Branch
  - .41 Frequency Utilization Section
  - .42 Information Transmission Section
  - .43 Antenna Section
    - .49 Systems Group

R. C. Kirby  
D. W. Patterson  
D. D. Crombie  
D. D. Crombie  
R. L. Gallawa  
J. R. Johler  
K. Davies  
W. F. Utlaut  
L. H. Tveten  
K. Davies and L. A. Berry  
J. C. Carrol  
T. N. Gautier  
M. Leftin  
H. G. Sellery  
T. N. Gautier  
D. W. Patterson  
G. W. Haydon  
C. C. Watterson  
H. V. Cottony  
D. W. Patterson

## 520 TROPOSPHERIC TELECOMMUNICATIONS

- .10 Data Reduction and Instrumentation
- .20 Atmospheric Spectroscopy
- .30 Optical Propagation
- .40 Electromagnetic Interference Environment
- .50 Millimeter Wave Propagation
- .60 Tropospheric Propagation Predictions
- .70 Spectrum Utilization Research
- .80 Radio Meteorology
- .90 Tropospheric Physics

R. S. Kirby  
W. E. Johnson  
B. R. Bean (acting)  
R. S. Lawrence  
W. Q. Crichlow  
M. T. Decker  
P. L. Rice  
A. P. Barsis  
B. R. Bean  
M. C. Thompson

## 530 SPACE ENVIRONMENT FORECASTING

Asst. chief for Technical Planning and Administration

Research Programs<sup>100</sup>

- High Altitude Nuclear Detection Studies
- Solar Flare Detection Techniques
- Radio Phase Studies
- High Latitude Ionosphere Physics
- Magnetoionic Storm Theory
- Numerical Forecasting Techniques
- Solar Proton Event Detection
- Infrasonics
- Ionosphere Responses
- Solar Radio Astronomy
- Solar Activity
- Boulder Magnetic Observatory
- Space Environment Data Services
- Space Environment Forecasting Services
- High Altitude Disturbance Detection

R. W. Knecht  
J. A. Kemper  
  
A. G. Jean  
A. G. Jean  
K. Davies  
G. C. Reid  
R. J. Slutz  
R. J. Slutz  
D. K. Bailey  
V. W. Goerke  
L. R. Megill  
W. K. Klemperer  
C. S. Warwick  
A. J. Bilik  
J. V. Lincoln  
J. V. Lincoln  
H. J. A. Chivers

<sup>98</sup> The Ionospheric Telecommunications Division was organized from various segments of the several divisions that constituted the CRPL just previous to the reorganization of February 1, 1965. The name Telecommunications was defined as: "the transfer of information of any type for any purpose over distances greater than the range of the human voice."

<sup>99</sup> In order to maintain clarity in the names of the technical units and in the echelon structure that evolved in the complexity of reorganization of this division, it was necessary to use the terms Branch, Section, and Group after each of the several kinds of technical units, contrary to the format used elsewhere by the author in this appendix.

<sup>100</sup> Division 530 chose to designate its technical units as "Research Program" areas rather than use the long-used NBS name of "Section" with the accompanying numerical designation.

## 540 AERONOMY

Deputy division chief

- .03 Geomagnetism Group
- .07 Equatorial Airglow Studies
- .09 Instrumentation Group
- .20 Laboratory Plasma Physics
- .30 Atmospheric Collision Processes
- .40 Rocket and Satellite Experiments
- .50 Ionosphere and Exosphere Physics  
(Jicamarca Observatory)
- .60 Ionospheric Structure
- .70 Optical Aeronomy
- .80 Ionosphere Radio Astronomy

E. K. Smith  
F. E. Roach  
W. H. Campbell  
F. E. Roach  
G. R. Sugar  
C. K. McLane  
Eldon E. Ferguson  
W. Calvert

D. T. Farley  
J. W. Wright  
M. Gadsden  
R. S. Lawrence

On October 13, 1965 the Central Radio Propagation Laboratory, with the four technical divisions, was formally transferred to the newly-established Environmental Science Services Administration (ESSA), within the Department of Commerce. (Refer to ch. XX.)<sup>101,102</sup>

## 1966

In the late summer of 1966 a number of new appointments were made in organization of the Radio Standards Laboratory as a result of new sections being established, new appointees to the Department of Commerce Science and Technology Fellow Program, and several persons serving in consultant positions.

### 250 RADIO STANDARDS LABORATORY

Chief (and deputy director for Radio Standards,  
Institute for Basic Standards, NBS Washington)  
Asst. chief for Program Evaluation and Development  
Asst. chief for Planning and Coordination

J. M. Richardson<sup>103,104</sup>  
H. M. Altschuler (acting)

H. W. Lance  
E. C. Wolzien

### 251 RADIO STANDARDS PHYSICS

- .01 Frequency-Time Dissemination Research
- .02 Frequency-Time Broadcast Services
- .03 Radio and MW Materials
- .04 Atomic Frequency and Time Standards
- .05 Quantum Electronics
- .06 Radio Plasma

L. Y. Beers  
A. H. Morgan  
D. H. Andrews  
J. L. Dalke  
J. A. Barnes  
D. A. Jennings (acting)  
K.-B. Persson

---

<sup>101</sup> Previously, on July 13, 1965, the Reorganization Plan consolidating the Weather Bureau and the Coast and Geodetic Survey to form ESSA became effective, with the CRPL to be transferred to the new agency of the Department of Commerce at a later time.

<sup>102</sup> Some services at Boulder Laboratories, such as Library services, Personnel services, and Computer services, were transferred to ESSA.

<sup>103</sup> John M. Richardson was named deputy director for Radio Standards of the NBS Institute for Basic Standards in December 1965.

<sup>104</sup> John M. Richardson, chief of the Radio Standards Laboratory (and deputy director for Radio Standards, IBS), was granted leave of absence to attend Harvard University Graduate School of Public Administration. In the fall of 1967 Richardson was appointed director of the Office of Standards Review, a newly established unit in the Department of Commerce. In the summer of 1976 Richardson was named director of the Office of Telecommunications, Department of Commerce, after association with the office since 1970.

## 252 RADIO STANDARDS ENGINEERING

Asst. chief for Technical Administration and Coordination

Asst. chief for Program Planning and Development

- .21 HF Calibration Services
- .22 HF Electrical Standards
  
- .23 HF Impedance Standards
  
- .31 MW Calibration Services
- .32 MW Circuit Standards
- .42 Electromagnetic Field Standards

H. M. Altschuler  
C. M. Allred (acting)  
P. H. Lowrie  
A. J. Estin  
K. R. Wendt  
C. M. Allred  
P. A. Hudson (acting)  
R. C. Powell<sup>105</sup>  
A. E. Hess (acting)<sup>106</sup>  
R. E. Larson  
M. B. Hall  
R. C. Baird

## 1967

A separation of technical disciplines in the Radio Standards Physics Division resulted in the formation of two divisions on September 24, 1967. The three frequency and time sections constituted the new Division. The other three sections remained unchanged and constituted the Radio Standards Physics Division. The Radio Standards Laboratory, as an organizational unit with three divisions, continued for but a few months thereafter.

## 253 TIME AND FREQUENCY

Asst. chief

- .01 Frequency-Time Dissemination Research
- .02 Frequency-Time Broadcast Services
- .04 Atomic Frequency-Time Standards

J. A. Barnes  
R. D. Harrington<sup>107</sup>  
A. H. Morgan  
P. P. Viezbicke (acting)  
R. E. Beehler

## 1968

### INSTITUTE FOR BASIC STANDARDS

E. Ambler<sup>108</sup>

For a period of several months, and with completion by the end of the fiscal year on June 30, 1968, many changes were made in the organizational structure of the Boulder Laboratories of NBS. Department Order 90-B, dated May 15, 1968, established the position of deputy director, Institute for Basic Standards at Boulder.<sup>109</sup> All NBS organizational units at Boulder Laboratories were placed within the Institute for Basic Standards (IBS) and unified under single and local management in the Office of Deputy Director.<sup>110</sup>

### INSTITUTE FOR BASIC STANDARDS, AT BOULDER

#### 270 OFFICE OF DEPUTY DIRECTOR

- .01 Office of Program Development<sup>111</sup>
- .02 Office of Management<sup>112</sup>

B. W. Birmingham  
R. M. Flynn  
R. W. Stockwell

<sup>105</sup> Robert C. Powell participated in the Department of Commerce Fellowship Program, assigned to the Office of the Assistant Secretary of Commerce for Science and Technology.

<sup>106</sup> Alfred E. Hess served as acting chief of the HF Impedance Standards Section, followed by Cletus A. Hoer as acting chief. In turn, Hoer was followed by Leslie E. Huntley as chief of the section.

<sup>107</sup> Previously, Robert D. Harrington had participated in the Department of Commerce Science and Technology Fellowship Program, being assigned to the Environmental Science Services Administration.

<sup>108</sup> Dr. Ernest Ambler was named director of IBS early in 1968. Previously, Ambler was chief of the Inorganic Materials Division. Later, Dr. Robert J. Corruccini was appointed assistant director of IBS and, in September 1968, was appointed deputy director. He retired in December 1972.

<sup>109</sup> Previously, beginning January 1, 1968, Bascom W. Birmingham, chief of the Cryogenics Division, was designated Executive Officer at the Boulder Laboratories, as an additional duty. This action was taken by Astin due to the retirement of Welch (Executive Officer) at the close of 1967 and the abolishment in October 1965 of the position of manager of Boulder Laboratories. During the period of January-May 1968, the executive officer had a broader area of activity than previously and served as the NBS spokesman for the Boulder Laboratories.

<sup>110</sup> Effective July 1, 1968, the code numbers of NBS Boulder divisions were changed to those given in the organizational structure indicated hereafter.

<sup>111</sup> Later, known as Office of Program Coordination.

<sup>112</sup> Later, known as Office of Executive Assistant.

**271 RADIO STANDARDS PHYSICS<sup>113</sup>**

- .01 Solid State Electronics
- .05 Quantum Electronics<sup>115</sup>
- .06 Plasma Physics

H. S. Boyne (acting)<sup>114</sup>

R. J. Mahler  
D. A. Jennings  
K.B. Persson

**272 RADIO STANDARDS ENGINEERING**

Asst. chief for Technical Administration and Coordination

Asst. chief for Program Planning and Development

- .21 HF Calibration Services
- .22 HF Electrical Standards
- .23 HF Impedance Standards
  
- .31 MW Calibration Services
- .32 MW Circuit Standards
- .42 Electromagnetic Field Standards

H. M. Altschuler

P. H. Lowrie  
A. J. Estin  
K. R. Wendt  
C. M. Allred  
R. C. Powell  
C. A. Hoer (acting)<sup>116</sup>  
R. E. Larson  
M. B. Hall  
R. C. Baird

**273 TIME AND FREQUENCY**

Asst. chief

- .01 Frequency-Time Dissemination Research
- .02 Frequency-Time Broadcast Services
- .04 Atomic Frequency and Time Standards

J. A. Barnes

R. E. Beehler  
J. L. Jespersen  
P. P. Viezbicke  
D. W. Halford

**274 LABORATORY ASTROPHYSICS (JILA)**

Deputy chief

L. M. Branscomb<sup>117</sup>

S. J. Smith

**275 CRYOGENICS**

D. B. Chelton

**281 ADMINISTRATIVE SERVICES**

B. F. Betts<sup>118</sup>

**282 INSTRUMENT SHOPS**

R. S. Perrill<sup>119</sup>

**283 PLANT**

E. A. Yuzwiak

---

<sup>113</sup> Later, in October 1969, a new section was established, Laser Measurement Techniques, with Dr. Estal D. West as chief. Also, the Solid State Electronics Section was consolidated with the Quantum Electronics Section.

<sup>114</sup> Later, in June 1969, Dr. Harold S. Boyne was made chief of the Radio Standards Physics Division, after serving for several years as acting chief. Thomas W. Russell was designated to serve as associate chief for Programs.

<sup>115</sup> In July 1972 the Quantum Electronics Section was renamed Gaseous Electronics Section and Dr. Thomas A. Dillon named as acting chief (later as chief).

<sup>116</sup> Later, Leslie E. Huntley was appointed chief.

<sup>117</sup> On September 1, 1969, Dr. Lewis M. Branscomb became director of NBS. Dr. Stephen J. Smith became acting chief of the Laboratory Astrophysics Division, and later served as chief.

<sup>118</sup> In June 1971 J. S. Roettenbacher became acting chief of the Administrative Services (later, Supply Services) Division, and later was appointed chief of the division.

<sup>119</sup> In 1969 Perrill was replaced by William A. Wilson.

## 1969

### 272 RADIO STANDARDS ENGINEERING<sup>120</sup>

- .21 HF Calibration Services
- .23 HF Impedance Standards
- .24 RF Transmission and Noise
- .25 RF Power and Voltage
- .31 MW Calibration Services
- .32 MW Circuit Standards
- .42 Electromagnetic Field Standards

R. C. Sangster<sup>121</sup>  
K. R. Wendt  
L. E. Huntley  
C. M. Allred  
P. A. Hudson  
R. E. Larson  
G. E. Schafer<sup>122</sup>  
R. C. Baird

**Director: L. M. Branscomb, 1969-1972<sup>123</sup>**

## 1970

### 272 RADIO STANDARDS ENGINEERING<sup>124-126</sup>

Asst. chief for Technical Affairs

Manager, Technical Liaison

Manager, Resources and Administration

- .10 Senior Research Scientists<sup>128</sup>
- .20 Pulse and Time Domain
- .30 Automation<sup>129</sup>
- .40 Circuit Standards
- .50 Power-Current-Voltage Standards
- .60 Noise and Interference
- .70 Fields and Antennas
- .80 Systems and Instrumentation
- .90 Electromagnetic Metrology Information Center

R. C. Sangster  
A. J. Estin  
R. E. Larson  
P. H. Lowrie<sup>127</sup>  
  
N. S. Nahman  
C. M. Allred  
L. E. Huntley  
P. A. Hudson  
M. G. Arthur  
R. C. Baird  
N. T. Larsen  
W. J. Anson

<sup>120</sup> In January 1969 two new sections were established in the Division, the RF Transmission and Noise Section, and the RF Power and Voltage Section. At the same time the High Frequency Calibration Services Section and the High Frequency Electrical Standards Section were abolished.

<sup>121</sup> Dr. Raymond C. Sangster became chief of the Radio Standards Engineering Division on May 1, 1969. Prior to entering NBS to become a division chief, Sangster was director of research at the Bayside Laboratory of General Telephone and Electronics Laboratories, Inc., L.I., New York.

<sup>122</sup> G. E. Schafer replaced M. B. Hall, with Hall being appointed to serve as a senior research scientist in the Radio Standards Physics Division.

<sup>123</sup> Dr. Lewis M. Branscomb became director of NBS on September 1, 1969, on the day following Dr. Astin's retirement. Previously, Branscomb had been chief of the Laboratory Astrophysics Division at Boulder, also chairman of the Joint Institute for Laboratory Astrophysics (JILA) at Boulder. He had been nominated to the position of director by President Nixon on June 17, 1969.

<sup>124</sup> This reorganization, effective May 3, 1970, reflected the new program orientation of the division. During 1969 the HF Calibration Services Section was phased out and in November 1969 the name of the MW Calibration Services Section was changed to MW Measurement Applications. The calibration services provided by the two former sections were assigned to various sections of the reorganized division. Also, in November 1969 the name of the MW Circuit Standards Section was changed to MW Standards, and the name of the EM Field Standards Section to EM Fields and Antennas Section.

<sup>125</sup> The name of the Radio Standards Engineering Division was changed to Electromagnetics Division, effective June 30, 1970, by Department Organization Order 30-2B.

This action was preceded by a memo by the deputy director, IBS/Boulder, to the director of IBS that stated, in part:

I wish approval for change of the name of Division 272 from "Radio Standards Engineering Division" to "Electromagnetics Division."

As noted above, the use of the word "radio" as a term in the name of an NBS organizational unit came to an end on June 30, 1970, yielding to the broader term "electromagnetics." Concurrent with this change was the change in name of the Radio Standards Physics Division to Quantum Electronics Division.

<sup>126</sup> On July 1, 1971, R. E. Larson was designated associate chief of the Division, A. J. Estin as assistant chief for Technical Affairs, and D. H. Russell as assistant chief for Resources and Administration.

<sup>127</sup> Later, Lowrie was replaced by David H. Russell.

<sup>128</sup> A group of five high-level research scientists constituted the Division's "think-tank."

<sup>129</sup> On July 1, 1971, the Automation Section and the Systems and Instrumentation Section were combined as the 272.55 Systems, Automation and Instrumentation Section, with George R. Sugar as chief. In April 1972 Sugar and N. T. Larsen were designated co-chiefs of the section.

**270 OFFICE OF THE DEPUTY DIRECTOR OF IBS/BOULDER** B. W. Birmingham<sup>130</sup>  
 Office of Measurement Services J. L. Dalke  
 Program Coordinator Services Office R. D. Harrington  
 Program Information Office J. F. Brockman<sup>131</sup>  
 Executive Officer<sup>132</sup> A. R. Hauler

**1972**

**Acting director: L. M. Kushner, May 1972-February 1973**<sup>133</sup>

**273 TIME AND FREQUENCY**<sup>134</sup>

Assoc. chief

Program Teams:

Quantum Electronic Frequency Standards

Atomic Time Standards

Frequency-Time Measurement Methods

.01 Frequency-Time Dissemination Research

.02 Frequency-Time Broadcast Services

J. A. Barnes

R. E. Beehler<sup>135</sup>

J. A. Barnes<sup>136</sup>

D. W. Allan

D. Halford

J. L. Jespersen<sup>137</sup>

P. P. Viezbicke

**1973**

**Director: R. W. Roberts, 1973-1975**<sup>138</sup>

**272 ELECTROMAGNETICS**<sup>139</sup>

Asst. chief, Resources and Administration

Asst. chief, Technical Affairs

.10 Senior Research Scientists (five)

.20 Pulse and Time Domain

.40 Circuit Standards

R. C. Sangster

D. H. Russell

R. E. Larson<sup>140</sup>

N. S. Nahman<sup>141</sup>

A. J. Estin<sup>142</sup>

<sup>130</sup> In September 1970 the Office of the Deputy Director was reorganized, with certain positions abolished and others established. Other changes were made in March 1971.

<sup>131</sup> In March 1971 Brockman was replaced by Ralph F. Desch, in charge of the Program Information Office.

<sup>132</sup> The Executive Officer was assigned supervision of IBS/Boulder central service organization in support of the technical programs of IBS/Boulder and ESSA Research Laboratories, including the Administrative Services, Instrument Shops, and Plant divisions; also several staff units.

<sup>133</sup> Upon the resignation of Branscomb, director of NBS, in April 1972, Dr. Lawrence M. Kushner served as acting director of NBS until Dr. Richard W. Roberts became director on February 3, 1973. Kushner had been deputy director since May 1969. Formerly, he had been director of the Institute for Applied Technology.

<sup>134</sup> Effective November 1, 1972, the Atomic Frequency and Time Section (273.04) was abolished, with the research programs divided among three program teams under the leadership of Barnes, Allan, and Halford.

<sup>135</sup> Roger E. Beehler had been named associate chief of the division in October 1970.

<sup>136</sup> In January 1973 Dr. Helmut Hellwig was appointed to replace Barnes in this position.

<sup>137</sup> In September 1973 George Kamas was appointed acting chief of the section for the 10-month absence of Jespersen who had been designated a Commerce Science Fellow.

<sup>138</sup> Dr. Richard W. Roberts became director of NBS on February 3, 1973. Roberts was the seventh director of NBS and the second to have been selected from outside the ranks of NBS personnel (Condon was the first; Stratton had been selected to establish NBS). However, Roberts served a year at NBS in 1959-1960 as a National Academy of Science Postdoctoral Fellow.

Previous to coming to NBS, Roberts held high-level positions at the General Electric Co., Schenectady, N.Y., his latest having been manager of Materials Science and Engineering at the G. E. Research and Development Center.

<sup>139</sup> Over a period of 7 months, from July 1972 through January 1973, a number of staffing assignment changes were made in the division, resulting in the organization indicated.

<sup>140</sup> Previously, R. E. Larson had been Manager, Technical Liaison.

<sup>141</sup> In July 1973, Nahman resigned to teach at Toledo University. The Pulse and Time Domain Section (272.20) was abolished and its functions absorbed in the Power-Current-Voltage Standards Section.

<sup>142</sup> Previously, Estin had served as assistant chief of the Division for Technical Affairs.

.50	Power-Current-Voltage Standards	P. A. Hudson
.55	Systems, Automation, and Instrumentation Programs	
	Automation	G. R. Sugar
	Systems and Instrumentation	N. T. Larsen
	Automatic Network Analyzer Applications	W. E. Little
.60	Noise and Interference	C. K. S. Miller
.70	Fields and Antennas	R. C. Baird
.90	Electromagnetic Metrology Information Center	W. J. Anson

## 271 QUANTUM ELECTRONICS<sup>143</sup>

H. S. Boyne

(Effective July 1, 1973, the three sections of the Quantum Electronics Division were abolished, with the research programs divided among five program teams, each team with a designated leader.)

### Program Teams:

Laser Parameter Measurements	E. D. West
Optical Electronics	R. J. Phelan
Gaseous Electronics	T. A. Dillon
Laser Metrology Development	J. Levine
Laser Wavelength and Frequency Measurement	D. A. Jennings

## 1974

### INSTITUTE FOR BASIC STANDARDS

A. O. McCoubrey<sup>144</sup>

Beginning in the summer of 1974, the technical programs of the Quantum Electronics Division were transferred to the Electromagnetics Division and to the Time and Frequency Division, with the Quantum Electronics Division phased out by March 1975 as an organizational unit. By early 1975 realignment of the two divisions had been completed.<sup>145</sup>

## 276 ELECTROMAGNETICS<sup>146</sup>

H. S. Boyne<sup>147,148</sup>

Deputy chiefs, Technical Programs

R. A. Kamper

C. M. Allred

Asst. chief, Resources and Administration

D. H. Russell

Optical Electronics Group

R. J. Phelan

.10 Laser Parameter Measurement Group

R. L. Smith

.40 Circuit Standards

A. J. Estin

.50 Power-Current-Voltage Standards

P. A. Hudson

.55 Systems, Automation, and Instrumentation

N. T. Larsen

Automated Measurements Applications

W. E. Little

.60 Noise and Interference

C. K. S. Miller

.70 Fields and Antennas

R. C. Baird

.90 Electromagnetic Metrology Information Center

W. J. Anson

<sup>143</sup> The name of the Radio Standards Physics Division was changed to Quantum Electronics Division, effective June 30, 1970, by Department Organization Order 30-2B.

<sup>144</sup> Dr. Arthur O. McCoubrey joined NBS on March 18, 1974, to serve as director of the IBS, succeeding Ambler who had been named deputy director of NBS. Previously, he had been vice president of Frequency and Time Systems, Inc., Danvers, Mass.

Upon the retirement of Corruccini at the close of 1972, Dr. David T. Goldman became deputy director of the IBS.

<sup>145</sup> At the time of the transfer, the two divisions were renumbered.

<sup>146</sup> New program emphasis in the reorganized division was on Cryoelectronic Metrology and Measurement Assurance Programs.

<sup>147</sup> Dr. Raymond C. Sangster, former chief of the Electromagnetics Division, was assigned to the position of Program Manager for Strategic Planning, an NBS-wide project.

<sup>148</sup> Initially, acting status.



## 277 TIME AND FREQUENCY

Office of Program Development

- .03 Precision Laser Metrology
- .04 Frequency-Time Standards
- .05 Gaseous Electronics
- .06 Time and Frequency Services<sup>150</sup>

J. A. Barnes  
R. J. Mahler  
D. A. Jennings<sup>149</sup>  
H. Hellwig  
E. W. Smith<sup>149</sup>  
R. E. Beehler

1975

Acting director: E. Ambler, July 1975-<sup>151</sup>

## 276 ELECTROMAGNETICS

H. S. Boyne

Effective July 1, 1975, the section structure of the Division was abolished and a Program structure established, with designated personnel as Program Chiefs (later, the Programs were assigned numbers as an aid in tabulating or noting the 10 Program titles). The positions of two associate chiefs of Technical Programs were retained in the reorganized Division.

Associate chiefs, Technical Programs

- .01 Microwave Metrology Services
- .02 Power, Current, and Voltage Standards
- .03 Microwave Circuit Parameters
- .04 Time Domain Analysis
- .05 Antennas and Fields
- .06 Noise and Interference
- .07 Remote Measurement Science
- .08 Laser Power and Energy
- .09 Systems and Instrumentation
- .10 Electromagnetic Metrology Information Center

R. A. Kamper  
C. M. Allred  
D. J. Russell  
P. A. Hudson  
A. J. Estin  
N. S. Nahman  
R. C. Baird  
C. K. S. Miller  
W. E. Little  
R. L. Smith  
N. T. Larsen  
W. J. Anson

## 274 LABORATORY ASTROPHYSICS<sup>152</sup>

P. L. Bender<sup>153,154</sup>

<sup>149</sup> Jennings and Smith, each concurrently, requested to be relieved of administrative duties as chiefs of their respective programs (or sections) in order to engage more fully in research, including laboratory work. On March 4, 1976, Dr. M. M. Hessel became acting chief of both the Precision Laser Metrology and the Gaseous Electronics Programs (or Sections). Later, Jennings was designated acting chief of .03 Precision Laser Metrology, and Smith acting chief of .05 Gaseous Electronics.

<sup>150</sup> Effective on January 5, 1975, the Time and Frequency Services Section was established, a combination of two former sections, Frequency-Time Dissemination Research and Frequency-Time Broadcast.

<sup>151</sup> Dr. Ernest Ambler became acting director of NBS on July 1, 1975, being designated to the position by the Assistant Secretary of Commerce for Science and Technology. Ambler filled the vacancy left by Roberts who transferred to the Energy Research and Development Administration as assistant administrator for Nuclear Energy. Ambler had been serving as deputy director of NBS.

<sup>152</sup> Effective February 27, 1977, the Laboratory Astrophysics Division was renamed Quantum Physics Division.

<sup>153</sup> In August 1975 Dr. Peter L. Bender was designated acting chief of the division. The chief, Dr. S. J. Smith, participated in the Commerce Science and Technology Fellowship Program, returning during the summer of 1976 to the position of chief of the division.

<sup>154</sup> Effective September 1, 1976, S. J. Smith was appointed acting associate director for Research Coordination, Institute of Basic Standards. He had served as chief of the Laboratory Astrophysics Division and was replaced by G. H. Dunn as acting chief on January 1, 1977.

1977

276 ELECTROMAGNETICS

Effective July 1, 1977, by Administrative Order 77-51

Associate chiefs, Technical Programs

- .01 Guided Wave Metrology
- .02 EM Sensing Metrology
- .03 EMI/Radiation Hazards
- .04 Signal Waveform Metrology
- .05 Antenna Systems Metrology

H. S. Boyne

R. A. Kamper  
C. M. Allred  
R. A. Kamper (acting)  
W. E. Little<sup>155</sup>  
C. K. S. Miller  
C. M. Allred (acting)  
R. C. Baird

Author's (WFS) note: One cannot help but be struck by the similarity of the frequent and significant changes that have taken place during recent years in the organizational structures of the technical units of NBS Boulder Laboratories with the description given by Toffler in his 1970 book, *Future Shock* (Alvin Toffler, *Future Shock*, Random House, New York, 1970). In Chapter 7, Organizations: The Coming Ad Hococracy, under the section titled "The Organizational Upheaval," Toffler stated:

There was a time when a table of organization—sometimes familiarly known as a "T/O"—showed a neatly arranged series of boxes, each indicating an officer and the organizational sub-units for which he was responsible. Every bureaucracy of any size, whether a corporation, a university, or a government agency, had its own T/O, providing its managers with a detailed map of the organizational geography. Once drawn, such a map became a fixed part of the organization's rule book, remaining in use for years at a time. Today, organizational lines are changing so frequently that a three-month-old table is often regarded as an historic artifact, something like the Dead Sea Scrolls.

Organizations now change their internal shape with a frequency—and sometimes a rashness—that makes the head swim. Titles change from week to week. Jobs are transformed. Responsibilities shift. Vast organizational structures are taken apart, bolted together again in new forms, then rearranged again. Departments and divisions spring up overnight only to vanish in another, and yet another, reorganization.

---

<sup>155</sup> Little transferred to Bureau of Mines, June 4, 1977; replaced by D. A. Ellerbruch, acting, June 5, 1977.

## APPENDIX D

### JOHN HOWARD DELLINGER—LONG-TIME PUBLIC SERVANT OF RADIO IN GOVERNMENT

#### PROEM

Beginning in 1907, John Howard Dellinger served the U.S. Government for 41 years as a physicist in radio science and engineering until he retired in 1948 as chief of the Central Radio Propagation Laboratory of the National Bureau of Standards.<sup>1,2</sup> This span of years covered a period that saw radio develop from a new form of communication to a new and expansive field of science and a means of worldwide communication. Dellinger became a recognized leader in the new science and technology.

---

<sup>1</sup>Information for this biography came largely from that contained in the personal papers (five boxes) of Dellinger deposited at the National Archives in 1964 by the National Bureau of Standards, under Accession No. NN365-25; also, that contained in the official files (approximately 58 cu. ft., in 51 boxes) of Dellinger deposited at the National Archives in 1965 by the Bureau under Accession No. NN365-90.

Over the years Dellinger prepared several versions of a "Professional Record of J. Howard Dellinger." The last and most extensive of these records was the one prepared for Cochrane (*Measures for Progress*), with letter of transmittal dated July 9, 1962 (6 months before Dellinger's death). This record, in tabular form, listed 97 items (plus sub-items) in 6 categories. Most numerous of these items were the 34 related to the category of Service at International Conferences, and 20 related to Additional Special Services. (NBS Historical File—Box 6.) Some material was obtained from the file on John Howard Dellinger, National Personnel Records Center, GSA (Civilian Personnel Records), St. Louis, Mo.

In contrast to the nearly 100 items tabulated by Dellinger in his professional record (1962), and to the numerous biographical sketches that were published from time to time, the sketch that was prepared for an early edition of *Webster's Biographical Dictionary* was very short. The sketch read, and has been continued to the 1974 edition, thus:

Del-'lin-ger (dĕl'-in-jĕr), John Howard, 1886-1962. American radio engineer, b. Cleveland, Ohio. Physicist. (1907), chief of radio section (1918-1946), U.S. Bureau of Standards; chief engineer, Federal Radio Commission (1928-29); chief of radio section of research division, aeronautics branch, Department of Commerce (1926-34). Author of articles on radio and electricity; special editor, *Webster's New International Dictionary, Second Edition*.

Again, what might be written of Dellinger as a long-length biography was noted in the opening paragraph of an article on his death printed in *The Bureau Drawer* (a Boulder Laboratories inhouse publication) of January 1963 which read as follows:

Dr. J. Howard Dellinger, whose achievements and honors would fill a good-sized book, died Dec. 28 in Washington, D.C., after devoting half a century to the development of radio propagation.

Alas, the author (WFS) of this historical account had difficulty in compressing a "short" biography of Dellinger into a chapter-length appendix to this book-length *Achievement in Radio*.

Other sources of information were: newspaper items, articles in periodicals, and miscellaneous sources.

<sup>2</sup>In order to keep this biographical sketch of Dellinger to a reasonable length, and to minimize repetition of material found in chapters II through X and XVI through XIX, the author has condensed the material following the World War I period that might otherwise have been included. The reader is referred to specific chapters for further information. It was the author's purpose in preparing this biography to note various segments of Dellinger's life in some detail that could not be handled, even adroitly, in chapters II through X and XVI through XIX.

## GROWING UP IN CLEVELAND

John Howard Dellinger was born July 3, 1886, in Cleveland, Ohio. His father was John P. Dellinger, of Canadian birth, naturalized as a citizen of the United States of America in 1884. His mother was a native American.<sup>3</sup>

Dellinger was educated in the public schools of Cleveland, graduating from East High School in 1903. At the age of 17 he sought out jobs that would be a source of income and by which he would gain experience with the world beyond that of his school experience. His first job, of which he made a written record, was for a 6-week period in the summer of 1903 as a signal clerk with the American District Telegraph Co. of Cleveland. The wages were \$20 per month.<sup>4,5</sup>

In the fall of 1903 Dellinger entered Western Reserve University (now Case Western Reserve University) in Cleveland, remaining through his junior year to 1907. In 1906 he was selected for Phi Beta Kappa. During the period from 1903 to 1907, he was continuously employed at one or more jobs while pursuing his academic studies. Two of these employments were on the staff of the University.<sup>6</sup>

## WASHINGTON AND THE BUREAU OF STANDARDS

The summer of 1907 brought a marked change in Dellinger's life, one that within a few years would steer him with a life's career in radio science and engineering. After taking the Civil Service examination, Dellinger was recommended by S. W. Stratton, director of the Bureau of Standards, for selection and appointment to a position of laboratory assistant at \$900 per annum. The recommendation was by letter to the Secretary of Commerce and Labor, dated July 2, 1907.<sup>7,8</sup> Dellinger could celebrate his birthday of July 3 as the day on

---

<sup>3</sup> It is strange that of the manifold effects left by Dellinger among his official and personal papers he left no record of his family history or a family tree. Seemingly, his many interests did not include genealogy. It is all the more strange because his papers and memorabilia include a variety of subjects, some being of a whimsical nature. He seemed more interested in the present and to where life would lead him than to know from whence he came.

The information on his parents came solely from a Descriptive Record, dated August 6, 1918, filed with his Personnel Record at the National Personnel Records Center, GSA (Civilian Personnel Records), St. Louis, Mo. Included with the Record was a small photo, probably taken in 1918. A description gave his height as 5'7", weight 130 lbs, and his eyes blue.

<sup>4</sup> A written summary of his many early jobs was found among Dellinger's personal papers (NN365-25, Box 4).

<sup>5</sup> Immediately following his job as signal clerk, Dellinger worked the remainder of the summer of 1903 as a collector for the well-known newspaper, the *Cleveland Plain Dealer*. For his efforts he was paid \$6 per week for a 48-hour week.

<sup>6</sup> Beginning in November 1903, Dellinger served a 2-year stint as a lamplighter for the Cleveland Lighting Department, at \$18 per month for 15 hours of work. During one summer of that period he again served as a collector for a newspaper firm, this time for the *Cleveland Leader*.

During the academic year of 1905-1906 Dellinger was a laboratory assistant in the Adelbert College of Western Reserve University. For this work he was paid \$20 per month for 15 hours of work per week. In the summer of 1906, and again in 1907, he was employed as an assistant in the engineering corps of the C. and P. Division, Pennsylvania R.R. During the academic year of 1906-1907 he was again employed by Western Reserve University, this time as a laboratory instructor in physics at \$60 per month for a 48-hour week.

<sup>7</sup> Dellinger took the Civil Service examination for the position of assistant physicist on May 8, 1907, in Cleveland. Early in June he received the Report of Rating, with an average percentage on his subjects of 80.75. This seemingly low rating could not be unexpected for he had not yet completed his junior year at college when he took the examination.

In a letter, dated June 14, 1907, Stratton wrote to Dellinger (addressed to 1855 East 101st Street, Cleveland) that he would be in Cleveland on Sunday, June 16, "and would like to confer with you regarding the work of the Bureau, and your qualifications." On June 25 Dellinger wrote to Stratton, stating that he would accept a position as a laboratory assistant. Stratton replied on June 29,

I am pleased to know you have decided to come to the Bureau and will do all I can to make your work interesting and profitable. (NN365-25, Box 4.)

<sup>8</sup> Stratton's letter used the name of John H. Dellinger. Dellinger used this name officially until 1938 when, at his request, an act of a Personnel Recommendation, dated July 25, 1938, signed by L. J. Briggs, director of NBS, changed the name on NBS records from "John H. Dellinger" to "J. Howard Dellinger." However, most of Dellinger's publications were signed "J. H. Dellinger."

which he received his appointment to the Civil Service position. He took the oath on July 16 and entered on duty the same day, serving with the National Bureau of Standards from that day in 1907 to 1948.<sup>9,10</sup>

#### FURTHER SCHOOLING AND THE BEGINNING OF A CAREER IN RADIO

Shortly after coming to the Bureau, Dellinger enrolled at George Washington University, Washington, D.C., to complete his undergraduate studies, receiving an A.B. degree a year later, in 1908. The same University honored him with a Doctor of Science degree in 1932. Beginning in 1908, Dellinger continued his physics and mathematics studies by taking courses in the Bureau of Standards Graduate School.

Upon entering the Bureau, Dellinger was assigned to the Electricity Division and during the next decade he had assignments in several of the sections. Judged by his publications and by notes that he wrote of his activities, Dellinger had the opportunity of carrying on research in a variety of areas in electricity. Within the decade he authored or co-authored 17 publications on electrical subjects.<sup>11</sup>

After 2 years in Washington, Dellinger was married on October 11, 1909, to Carol Van Benschoten of the Cleveland, Ohio area.<sup>12</sup> Their first address was in Washington, D.C., and later in Chevy Chase, Md.<sup>13</sup>

During the academic year of 1909-1910 Dellinger took a course in Theoretical Electricity in the NBS Graduate School that covered Maxwell's equations for electromagnetic waves. At the time he was assigned to the Bureau's Inductance and Capacity Section, under Harvey L. Curtis as chief.<sup>14</sup> On the basis of fundamental knowledge of radio waves derived from this course, Dellinger was selected to devise a method of calibrating a wavemeter that had been submitted to the Bureau in 1911 for "standardization." His success with the project resulted not only in the Bureau's first calibration of an instrument at radio frequencies, but introduced Dellinger to the field of radio engineering.<sup>15</sup>

One can get an insight into the rather rapid growth of interest by Dellinger in the field of radio by perusing his "Program" reports from 1909 until he resigned from the Bureau in

---

<sup>9</sup> There were two short lapses in the 1907-1948 period when Dellinger was not with NBS. The first was during academic year 1912-1913 when he attended Princeton University, the second was in 1928 when he was chief engineer of the Federal Radio Commission.

<sup>10</sup> A brief resume of the steps in Dellinger's advancement in the position of physicist from 1907 to 1948 follows:

1907-1910	Laboratory Assistant
1910-1917	Assistant Physicist, P-2
1917-1919	Associate Physicist, P-3
1919-1924	Physicist, P-4, Chief of Radio Section
1924-1928	Senior Physicist, P-5, Chief of Radio Section
1928-1943	Principal Physicist (Radio), P-6, Chief of Radio Section, (Principal Scientist, 1928-1936)
1943-1946	Head Physicist (Radio), P-7, Chief of Radio Section
1946-1948	Head Physicist (Radio), P-8, Chief of Central Radio Propagation Laboratory

<sup>11</sup> Among the published areas of his researches, as well as some of the unpublished areas, were:

- Measurement of mercury ohm (the contemporary resistance standard)
- Resistance and conductivity measurements, including measurements for copper wire tables
- Magnetic measurements
- Electrical and thermal properties of insulators
- The International System of electrical and magnetic units
- Calculation of Planck's radiation constant  $c_2$

(Dellinger's several early research papers that were not published have remained in the Radio File.)

<sup>12</sup> Carol Van Benschoten was born May 11, 1884, at Lagrange, Lorain County, Ohio, a small town southwest of Cleveland.

<sup>13</sup> When first going to Washington in 1907 Dellinger lived at 1845 Calvert St. Upon marriage the Dellingers lived for several years at 1421 Columbia Rd. They then moved to Chevy Chase, Md., first at 6607 Delafield St., then for many years at 618 Pickwick Lane in the beautiful Rollingwood section of Chevy Chase. After his retirement in 1948 they lived at 3900 Connecticut Ave. (near the Bureau), in Washington. (Information from NBS directories.)

<sup>14</sup> It was Curtis who became the "prime mover," beginning in 1908, to urge for graduate courses to be taught at the Bureau (see ch. XVIII, p. 695).

<sup>15</sup> For a more detailed account of Dellinger's first measurement at radio frequencies see chapter II, p. 38.

1912 to complete his studies for a doctor's degree.<sup>16</sup> From 1911, he increasingly became involved with radio.<sup>17</sup>

Dellinger resigned from the Bureau on October 18, 1912, to complete his graduate studies by a year's residence on a fellowship at Princeton University, and to complete his work on high-frequency ammeters for a doctor's dissertation.<sup>18</sup> Dellinger received his doctor's degree in physics in the spring of 1913. The title of his dissertation was "High-frequency Ammeters," and was published by the Bureau under the same title.<sup>19</sup> In returning to the Bureau he simply wrote a letter to the director, and he was reinstated.<sup>20</sup>

From notes and memorabilia gathered by Dellinger, there appears to have been considerable social activity at the Bureau during the period 1914-1918 (interestingly, this period spans that of World War I), and presumably before and afterwards.<sup>21</sup> Dellinger was very much a part of the scene and took an active and leading role in various events.<sup>22</sup>

From 1913 to the time that the Bureau of Standards became involved with World War I work, Dellinger's assignments in the Electricity Division and in the newly formed Radio Section were quite varied. He was much occupied in writing in the area of electrical and magnetic units, resulting in a long paper published by the Bureau as *Scientific Paper 292*, entitled "International System of Electric and Magnetic Units," with the release date of October 11, 1916. Another paper, entitled "Calculation of Planck's Constant  $c_2$ ," was published as *Scientific Paper 287*, and released August 16, 1916. An earlier paper on

---

<sup>16</sup> "Program" reports (NN365-25, Box 4). Prepared as handwritten notes by Dellinger on small-size Department of Commerce and Labor stationery.

<sup>17</sup> During the period 1909-1910 Dellinger recorded his Bureau work assignments as being in the area of electricity, with no mention of radio.

Early in 1911 he was reviewing the subject of electric (radio) waves and studying Maxwell's equations. Later in the year he was observing the nature of resistance and inductance at radio frequencies.

By September 1911 he was assigned the task of assisting the Department of Commerce and Labor in revising radio regulations for consideration at the Second International Radiotelegraph Conference at London (see ch. II, pp. 42-43).

By the close of 1911 he had improved upon his method of calibrating wavemeters and of measuring small inductances at radio frequencies. This work continued into 1912.

During 1912 Dellinger was active in a variety of tasks associated with radio, including editorial review of papers.

Minor tasks related to radio, and to electricity in general, recorded by Dellinger in these "Program" reports, were found by the author to be too numerous to note in this account. These reports reveal that Dellinger had already developed a methodical and detailed approach to recording information.

<sup>18</sup> In a letter, dated September 25, 1912, Dellinger informed Stratton of his desire to further his graduate studies in physics at Princeton University by resigning from the Bureau, but that he wished to be reinstated in June of the following year.

<sup>19</sup> *Scientific Paper 206, Bull. Bur. Stand.*, Vol. 10, No. 1, Jan. 1914, pp. 91-159. In 1915 the paper was also published in two German periodicals.

<sup>20</sup> Dellinger's letter was in longhand, and read:

Palmer Physics Laboratory  
Princeton, N.J.  
May 12, 1913

Dr. S.W. Stratton  
Bureau of Standards  
Washington, D.C.

Dear Dr. Stratton: My work in Princeton is finished, and I have attained my Ph.D. The final examinations were much sooner than I expected. I should like to return to the Bureau work whenever you can arrange for it. I shall be in Washington after next Monday, May 19.

Yours truly  
(signed) J. H. Dellinger  
(NN365-25, Box 4)

<sup>21</sup> File folder: History of Social Events and Publicity (NN365-90, Box 36).

<sup>22</sup> As a member of the Bureau of Standards Musical Association, Dellinger sang first, and also second, tenor in the Glee Club. Mrs. Dellinger sang soprano in the Ladies Chorus. Dellinger played the violin in the Bureau orchestra.

Dellinger took a leading role in staging some of the children's parties and picnics sponsored by the director, S. W. Stratton. Later, after World War I when he became chief of the Radio Section, Dellinger encouraged the staff members to engage in section picnicking.

Planck's Constant, co-authored with Edgar Buckingham of the Bureau, was published in 1911.

With the increasing activity in radio at NBS and elsewhere, by 1916 Dellinger was giving full time to the subject. His work formed a significant part of the famed *Circular of the Bureau of Standards 74*, Radio Instruments and Measurements; also the Signal Corps textbook entitled, *The Principles Underlying Radio Communication* (see ch. III, pp. 52-53 and pp. 53-54). Later, in 1919, the Bureau published Dellinger's lengthy paper on "Principles of Radio Transmission and Reception with Antenna and Coil Aerials" (*Scientific Paper 354*), the result of several years of study (see ch. VI, p. 115).

## WORLD WAR I

World War I brought on a beehive of activity within the Radio Section, and Dellinger became fully occupied with war-related projects. Yet with all of the activity, there was time for some relaxation in socializing among the many persons brought into the section by the war effort. Among these members of the section was George C. Southworth who, later, in the 1930's, became well known for his pioneer work with waveguides at the Bell Telephone Laboratories and, in 1950, for his 675-page treatise, *Principles and Applications of Waveguide Transmission*. Southworth tells of his associations with the Dellingers during the war period in his autobiography.<sup>23</sup>

During World War I Dellinger was "reached" by the draft, as was every man between the ages of 21 and 30 (later, 18 and 45), who was a U.S. citizen. Being by then a resident of Maryland, Dellinger's draft board was based at the county seat of Montgomery County, Rockville. In the summer of 1917 he was deferred by reclassification to Class III, on the basis of a statement by the Secretary of War via the Secretary of Commerce, that:

He (Dellinger) is engaged in technical researches required for the effective operation of military forces and his work is of direct and immediate military application. His services are indispensable to this Department.

In June 1918, his case was reopened. Again, he was deferred, this time on the strength of Stratton's statement to the draft board.<sup>24</sup>

---

<sup>23</sup> Quoting from *Forty Years of Radio Research* (published in 1962 by Gordon and Breach, New York), pp. 42-43, Southworth stated:

. . . life at the Bureau was extremely pleasant. The Dellingers were unusually hospitable and all of us were frequent guests in their home. I remember one evening in particular when Prof. W. F. G. Swann, recently from England, was present and played beautifully on the cello. During the evening there was much singing, including not only the old Stephen Foster standbys, but such hits of the season as: "It's a Long Long Trail," "Beautiful K-K-Katie" and "When It's Over Over There". A high point came when Professors Swann, Grover, Smith, and some other equally dignified gentlemen proceeded to barber shop some of the popular songs of the period.

Southworth's employment at the Bureau spanned the period June 30, 1917, to September 13, 1918. W. F. G. Swann was a physicist with the Bureau in 1917-1918 on war work. Later he became director of the Bartol Research Foundation and was recognized for his studies of cosmic rays. He was an accomplished cellist. F. W. Grover was from Union University, C. M. Smith from Purdue University; each was a contributor to the Signal Corps textbook prepared by the Radio Section, *The Principles Underlying Radio Communication*.

<sup>24</sup> In his letter to the Local Board, for Montgomery County, dated June 28, 1918, Stratton stated, in part:

Dr. Dellinger is working on very important military work being in charge of the preparation of textbooks which are in use and to be used in all the schools of instruction operated by the Signal Corps for the men in its radio service.

. . . Dr. Dellinger's wide acquaintance with radio instruments especially fits him for this work. . . .



*This photograph of Dellinger was attached to his Descriptive Record for civilian employees, dated August 6, 1918. This was a personnel record of 3 pages with 32 entries, to be filled in by Federal employees during World War I when Dellinger was busily engaged in the Radio Section on war work. The record is on file at the National Personnel Records Center, GSA (Civilian Personnel Records), St. Louis, Mo.*

#### **CHIEF OF THE RADIO SECTION**

World War I brought about a number of developments from the Radio Section, many of them under Dellinger's guidance (see ch. III). Following the emergency of war work, the section (or Radio Laboratory) was reorganized into two subsections, with Dellinger as head of Radio Research and Testing (Section 6a). Then, in 1921, another reorganization, and Dellinger was appointed chief of the single Radio Section, and remained so until 1946 when the section became a division (see ch. IV, p. 71). Dellinger's 25 years as a section chief is an uncommonly long period in Bureau annals.

#### **ENCOMPASSED BY BROADCASTING**

Some of the wartime radio projects were continued for a spell after World War I. Then came radio broadcasting in 1920, and for the next decade Dellinger found himself, as a Government official, to be very much a part of the phenomenal growth of a technology that would touch all people, but a technology that brought on a welter of problems.



With the country enmeshed in a tangle of problems brought on by the first years of broadcasting, Dellinger took an active role in the preparation of agenda and writing of reports for the National Radio Conferences that met yearly for four successive years beginning in 1922 (see ch. XVI, p. 644). In 1927 Congress established the Federal Radio Commission as the agency to exercise control over the swelling number of broadcasting stations. The Commission turned to Dellinger to serve as its first chief engineer. His term of office extended several months beyond the initial 4-month appointment (see ch. XVI, p. 645).

Concurrent with the problems created by the broadcasting industry and the impact upon the listening public, the Federal Government had its own problems relating to radio communication. The result was the formation in 1922 of the Interdepartment Radio Advisory Committee (IRAC), Dellinger serving as the first secretary, and taking an active role in the committee's affairs for 26 years (see ch. XVI, pp. 647-648).

Over a period of many years Dellinger was engaged in various capacities in the all-important task of solving the problems of frequency allocation of broadcasting stations. Throughout the 1920's, and particularly during the first half, Dellinger wrote many articles for the reading public on contributions being made by the Bureau of Standards to the broadcasting industry, to the area of radio measurements, and, to some extent, to the study of radio propagation. Also, by making use of the broadcasting medium, Dellinger and his associates informed listeners of the wonders of radio (see ch. IV, p. 90). In turn, there were many newspaper and magazine accounts of Dellinger's radio work and that of other members of the Radio Section.<sup>25</sup>

### THE FIRST, THEN MANY TRIPS ABROAD

In 1921 Dellinger was called upon to make his first trip abroad, the first of many such trips that he would be engaged in for the next 40 years. Going forth to a meeting in Paris of the Inter-Allied Provisional Radio Technical Committee, Dellinger was girded with the credentials of a Department of Commerce "staff pass" and a "Greeting" document, both signed by Herbert Hoover, Secretary of Commerce.<sup>26</sup>

---

<sup>25</sup> At the time of the Third National Radio Conference, in Washington, D.C., October 6-10, 1924, Dellinger was quoted by a newspaper as saying that the broadcasting of moving pictures was not an idle dream and was a certainty within 5 years. Although Dellinger's prediction came true, the 5 years had to stretch to more than 20 years before movies via radio broadcasting (TV) began to appear in American homes. The newspaper concluded its account of Dellinger's remarks by stating:

Radio sets will be reduced in size until the pocket receiving set may some day be little more bulky than the watch. A radio in every home may be replaced by a radio in every pocket.

Although development of the transistor was more than 20 years in the future, Dellinger's 1924 prediction of a pocket radio required that some day such a device would come into existence.

Five months after the 1924 National Radio Conference the *Cleveland Plain Dealer* (Magazine Section) of March 29, 1925, gave more than a full-page spread to Dellinger's work in radio, with the title, "Greater Radio Marvels Are Yet To Come," and the subtitle, "Dr. J. H. Dellinger, chief of the radio laboratory of the Bureau of Standards, says tomorrow's achievements will dwarf today's." Thus, 22 years later, the *Cleveland Plain Dealer* took the occasion to hail a native son who was one of its collectors of subscriber accounts in 1903 (see p. 782, footnote 5). Again, in this article, Dellinger predicted the coming of television within 5 years, and the magazine section headed the article with a picture of a family viewing a football game on a large screen, with the picture caption, "Imagine having a football game brought into your living room." But, again, Dellinger's prediction of 5 years had to stretch out several decades before the American people could enjoy "live" performances in their living rooms. The article enumerated many of the "radio marvels" yet to come as Dellinger, in 1925, foresaw the future of radio. (NBS Historical File-Box 6.)

<sup>26</sup> This document read:

May 31, 1921

TO ALL WHO SHALL SEE THESE PRESENTS, GREETING:

Know ye, that, reposing special trust and confidence in the integrity and ability of Dr. J. H. Dellinger, I do hereby designate him to represent the Department of Commerce at the forthcoming meeting of the Provisional Technical Committee of the International Conference on Electrical Communications to be held in Paris on June 20, 1921.

(signed) Herbert Hoover  
Secretary of Commerce

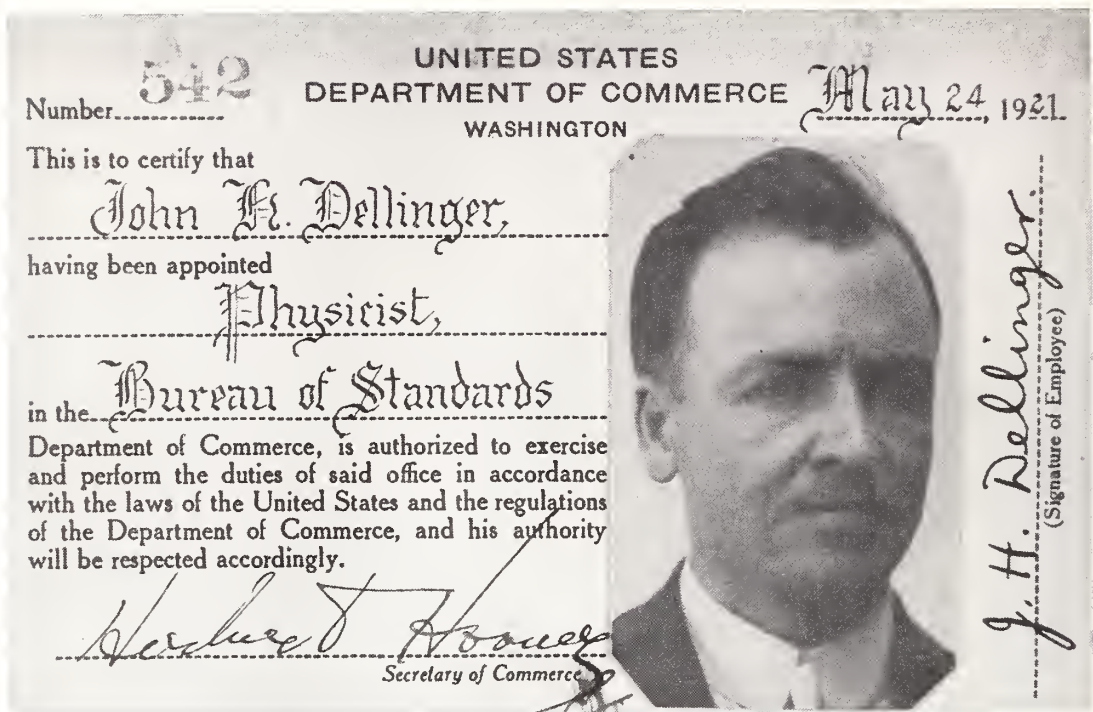

*Dellinger's "departmental staff pass" issued by the Department of Commerce, dated May 24, 1921, and signed by Herbert Hoover, Secretary of Commerce. It was issued shortly before he made his first trip abroad, as the Department of Commerce representative on the Interallied Provisional Radio Technical Committee, meeting in Paris in the summer of 1921.*

#### RADIO PROPAGATION AND THE IONOSPHERE

Dellinger's long-time interest in radio propagation appears to have begun about 1920 when the fading phenomena associated with signals on broadcast frequencies began to receive his attention. By 1925 the Radio Section was well equipped with sensitive recording equipment and began an extensive program of signal-intensity observation. Then, in 1929, Gilliland, under Dellinger's direction, initiated the section's program on direct observation of reflections from the ionosphere, a program that would expand with the years to worldwide scope (see ch. VII). In 1935 Dellinger began his series of publications on daytime radio fadeouts, usually described as sudden ionospheric disturbances (SID) and sometimes referred to as the "Dellinger effect." By 1937 he had a dozen publications on this subject, including the causal link to solar flares. Radio propagation in all its aspects became the dominating technical area in Dellinger's later career.

#### RADIO AND AERONAUTICS

Although the use of radio by the Radio Section as an aid in aeronautics dates back to before 1920, an intensive development program was not initiated until 1926 when the Air Commerce Act led to the creation of the Aeronautics Branch in the Department of Commerce (see ch. VI, p. 153). The action resulted in a program being established within the Radio Section, under Dellinger's supervision, for the Research Division of the Aeronautics Branch.<sup>27</sup> The program continued until 1934 when it was curtailed as an economy measure brought on by the Great Depression. Yet, by 1931, the Radio Section had demonstrated successfully its blind landing system; and by then its radiobeacon navigation system had been in use

<sup>27</sup> Interestingly, the noting of this supervisory duty is among the very few items given in Dellinger's own short biographical sketch listed in an early edition as well as in the latest edition (1974) of *Webster's Biographical Dictionary* (see footnote 1).

for several years on some of the airways. Dellinger, the Radio Section, and NBS, could well be proud of these accomplishments. Dellinger's publications in this area were limited to the broader aspects of the development program.

Dellinger's close association with the use of radio in aeronautics during a decade of development brought him into active participation with the the Radio Technical Commission for Aeronautics (RTCA); he took part in its establishment in 1935. It is an advisory group for coordinating the application of radio, electronics, and telecommunications in aeronautical operations (see ch. XVI, pp. 650-651). Dellinger served as chairman for 17 years, beginning in 1941, and then as Technical Advisor for life. In 1957 he was awarded a plaque bearing the inscription:

With sincere appreciation and gratitude to Dr. J. Howard Dellinger from the membership of the Radio Technical Commission for Aeronautics for his outstanding leadership and dedicated service as Chairman from January 1941 to October 1957.

Although not directly involved in the laboratory development of the radiosonde during the last half of the 1930's, Dellinger gave general supervision to this highly successful development program carried out by the Radio Section for the Navy and the Weather Bureau, initially in support of aeronautics.

### IRPL—THEN CRPL, AND RETIREMENT

With all of the diversified activities of the Radio Section over which Dellinger gave guidance, supervision, and inspiration for many years, without question his leadership was most productive in the area of radio propagation. Thus, when the United States became engulfed in World War II, shortly thereafter the Interservice Radio Propagation Laboratory (IRPL) was established within the Radio Section by the Joint U.S. Communications Board and placed under Dellinger's direction.<sup>28</sup> The IRPL served well during the next 4 years in centralizing radio propagation data, including innovative data products, and furnishing the information to the armed services. Dellinger was an indefatigable leader in a period of rapidly growing progress in describing the global ionosphere and the lower atmosphere effect on propagation on the newly exploited very high frequencies.

By 1946 the Radio Section, including the IRPL, had grown to 160 people. On May 1, 1946, a new division was created within NBS, to be known as the Central Radio Propagation Laboratory (CRPL), with Dellinger appointed as chief. This action was supported by the armed services to continue in peacetime the successful IRPL experience. Various working groups of the former Radio Section were now organized as sections. Under Dellinger's leadership the CRPL grew rapidly in staff personnel and in the diversity of its technical programs.

---

<sup>28</sup> Before the IRPL, during the last few days of 1940, development was begun by several members of the Radio Section, under Dellinger's general supervision, on a proximity fuse for nonrotating projectiles, using reflected radio waves as the triggering principle. However, the project was transferred to the newly organized Ordnance Development Division of NBS.



*Photo of Dellinger taken in 1947. An early printing appeared in the February 1948 issue of the Proc. IRE.  
From records of Office of Information Activities, National Bureau of Standards*



*Photo of Mrs. J. Howard (Carol) Dellinger, probably taken in the mid-1930's.  
From records of Office of Information Activities, National Bureau of Standards.*

Nonetheless, with all of the expectancy of a bright and productive future for the CRPL, Dellinger chose to retire from NBS and Government service, effective at close of day, April 30, 1948, exactly 2 years after becoming chief of the CRPL, and with actual service of 39 years, 4 months, 10 days.<sup>29,30</sup> He was nearly 62 years of age. Later (February 14, 1949), Dellinger was awarded the Department of Commerce Gold Medal for Exceptional Service, with the citation "for many years of outstanding scientific accomplishment in conducting and directing extensive and highly important research in radio propagation and related fields."

With retirement, Dellinger pursued a somewhat more leisurely life. A particular effort was stimulating closer technical links between two of his favorite international organizations, URSI and CCIR (see below). This interest continued until his death on December 28, 1962.<sup>31</sup> Mrs. Dellinger died March 16, 1965. They had no children.

## URSI

The international part of Dellinger's recognition as an authority in radio can be attributed largely to his long association with, and participation in, the international organization known as URSI (International Scientific Radio Union). Dellinger's introduction to URSI came early, on the occasion of the organization of the American Section in January 1921, at which time he was elected technical secretary. In the summer of 1921 he attended a meeting in Paris in relation to the International Radio Conference and at which time the young international URSI organization took part (see ch. XVII, pp. 667-668). Dellinger was a voting delegate to nine URSI General Assemblies. He was general chairman of the committee which hosted the second URSI Assembly in the United States in 1957. At the memorial lecture for the presentation of the first URSI J. H. Dellinger Gold Medal, held in 1966, the then chairman of the U.S. National Committee gave high praise to Dellinger's service to URSI (see ch. XVII, pp. 675-676).<sup>32</sup>

---

<sup>29</sup> In a letter (March 30, 1948) to Condon, director of NBS, Dellinger wrote:

I am applying for retirement from Government service effective April 30. . . .

It was extremely difficult to reach this decision. I think none has had a more pleasant and rewarding Government career than I have. The atmosphere of this Bureau has been and is one in which the mind and spirit may flourish, to a degree not matched in many other organizations. My field, radio, has been perhaps the most live and stimulating of all the lines of work of the Bureau. This field has grown and progressed amazingly during the entire period of my forty years here, so I could never feel that my work was becoming static . . . . The personal relations here have enhanced the attractiveness of the technical side of the work. . . .

<sup>30</sup> To felicitate Dr. Dellinger at time of retirement, after a rewarding career at NBS, two festive occasions were staged by the CRPL staff. On April 26, a few days before his retirement date, a Lawn Party was held for the Dellingers on the Bureau grounds, to be joined in by many Bureau personnel.

On May 17, the Dellingers were feted by friends and coworkers with a testimonial dinner at the nearby Kennedy-Warren apartment hotel dining room.

<sup>31</sup> Funeral services were held on December 31, 1962, at the All Souls Memorial Unitarian Church, Washington, D.C. Dellinger had been a member of the Board of Trustees and president of the Unitarian Laymen's League.

<sup>32</sup> On this occasion, at Munich, Germany, Professor Millet G. Morgan stated, among his many commendations of Dellinger, that:

Through all years in which he forged the constitution of our National Committee, served as chairman of the General Arrangements Committee for the General Assembly in Colorado (1957), and was writing a history of URSI, Dr. Dellinger was the ultimate authority on the affairs of our National Committee and one could not imagine carrying on without him. At our 1961 Spring Meeting, he was nominated to be our first life-time honorary member and he was subsequently appointed as such by the President of our Academy of Sciences.

Like so many of us, Dellinger combined his interest in radio science with an interest in radio engineering.

Dr. Dellinger was a Vice President of our Union from 1934-1952 and an Honorary President from 1952 until his death ten years later. . . .

## CCIR

Although his participation in the international CCIR (International Radio Consultative Committee) was not as extensive as with the nongovernmental URSI, nevertheless Dellinger took an active part in its affairs for many years, beginning with the first Plenary Assembly at The Hague, Netherlands, in 1929. Thereafter, he attended a number of Plenary Assemblies, the last in 1959; and then a Study Group meeting on Space Systems and Radio Astronomy in 1962 (see ch. XVII, pp. 660-662).

## THE IRE

For 39 years, beginning in 1923 when he joined and was selected as a Fellow, Dellinger was very much a part of the Institute of Radio Engineers (IRE). He was vice president for the 1924 term and president in 1925, then became very active on numerous committees. He served on the Board of Directors from 1924 to 1931, and was then awarded life membership.<sup>33</sup> In 1938 Dellinger was awarded the IRE Medal of Honor.

## IN RECOLLECTION—BITS OUT OF THE PAST

Residents of Washington were thrilled to view the flight of the Graf Zeppelin over the city in October 1928. However, few knew that Dellinger was selected, along with some other Government officials, to accompany Dr. Hugo Eckner, commander of the large dirigible, on a flight to the Middle West. Although the invited passengers were kept in readiness at the Lakehurst, N.J. base, the flight was finally cancelled after October 23, due to a succession of delays caused by unfavorable weather over the entire planned course.<sup>34</sup>

Disappointing as the cancelled flight probably was to Dellinger in 1928, the flights of spaceships around the Moon in 1966 and 1967 led to Dellinger's name (John H. Dellinger) being selected for designating one of the craters on the far side of the Moon.<sup>35</sup> This honor also came to five other NBS staff members.

From Dellinger's own listing of his professional publications, as well as by a listing prepared by the Department of Commerce Library, Boulder, Colo., his publications totaled

---

<sup>33</sup> In 1928, in his address at the time of being inducted as president of the IRE, Dr. Alfred N. Goldsmith in handing accolades to the former presidents, said of Dellinger:

Dr. Dellinger, who may be termed a national and international "liaison" officer in every important aspect of radio.

<sup>34</sup> In newspaper accounts of the event Dellinger was listed as a "radio expert of the Department of Commerce." (NN365-25, Box 5.)

<sup>35</sup> Selection of names for Moon craters was by the Working Group of Commission 17 of the International Astronomical Union, the report being published in *Space Science Review*, June 1971. The 513 persons so honored were mostly those who had been associated with the space sciences. In the report Dellinger's biographical data read:

Dellinger, John H. (1886-1962), USA physicist; Chief, Central Radio Propagation Lab., Nat. Bur. Stand.; radio and telecommunications, development and applications, esp. in aviation; discovered the relationship between solar flares and shortwave radio fadeouts (Dellinger effect).

140. (NN365-25, Box 3; also Radio File.) These papers covered a wide range of subject matter in the field of electricity, with the greatest number in the more specialized area of radio.<sup>36,37</sup>

Dellinger was a special editor (radio) of *Webster's New International Dictionary* during the period of 1927 to 1948. Beginning in 1921, he was listed in *Who's Who in America*, and later in *International Who's Who*. He was also listed in *American Men of Science*, and in *Webster's Biographical Dictionary*. He can almost say that, for many years in Government circles, Dellinger's name was synonymous with the word "radio." In fact, in 1911 he suggested that the word "radio" be used rather than "wireless" in relation to an international conference (see ch. II, pp. 42-43).

During his many years as chief of the Radio Section, Dellinger was involved in the processing of nearly 50 patents on inventions that were developed by his staff members. Thus, before the uniform patent policy was enacted in 1950 for Government employees, Dellinger had gained a viewpoint of his own of the nonuniform policy that existed among the various Government agencies. This was well expressed in a letter that he wrote several months before he retired in answer to an inquiry.<sup>38</sup>

---

<sup>36</sup> Dellinger's last publication came out posthumously in 1963. It was entitled, "History of U.R.S.I.," a paper that formed a portion of the *URSI Golden Jubilee Memorial*, published by Secretary General of URSI, Brussels, Belgium.

<sup>37</sup> As an insight into the scope of Dellinger's publications, one can obtain a one-man evaluation from the John Howard Dellinger Memorial Lecture by Professor Millet G. Morgan (chairman of U.S. National Committee) at the General Assembly of URSI, Munich, Germany, September 7, 1966. Professor Morgan stated:

From Dr. Dellinger's list of 140 publications, I have abstracted a few titles, arranged chronologically, in order to give you a synopsis of his interests and work during the span of his career:

- 1910 Temperature coefficient of resistance of copper
- 1913 High frequency ammeters
- 1916 International system of electrical and magnetic units
- 1918 The principles of electrical measurements at high frequencies
- 1919 Electric wave transmission formulas for antenna and coil aerials
- 1920 The radio compass
- 1921 Radio fading
- 1923 The work of the International Union of Scientific Radio Telegraphy
- 1925 Application of radio transmission phenomena to the problems of atmospheric electricity
- 1926 Presidential Address at the First Convention of the Institute of Radio Engineers
- 1926 Applications of radio in air navigation
- 1927 The possibilities of directive radio transmission
- 1928 The status of frequency standardization
- 1929 The uses of radio as an aid to navigation
- 1932 Distant ranges of radio waves
- 1935 A new radio transmission phenomenon
- 1936 Direct effects of particular solar eruptions on terrestrial phenomena
- 1939 The Sun and the ionosphere
- 1940 A radio transmission anomaly: cooperative observation between the United States and Argentina
- 1948 Developments in radio sky-wave propagation research and applications during the War
- 1952 Radio spectrum conservation
- 1961 Almost fifty years of URSI
- 1962 Space exploration

<sup>38</sup> In a letter, dated February 2, 1948, Dellinger stated, in part:

In the nature of things the Government employee is charged with a public trust. In very many cases he has more opportunities to receive the ideas of others than have non-Government people. This is more true the higher he is in authority and the more technical his work is. He therefore has not the same right to patent ideas as non-Government people. . . . The Government's policy must therefore in general be to restrict patent rights of Government employees.

In a Bureau such as this one and in the military services, and perhaps generally in the Government services, it is not equitable or expedient to allow employees to profit from patents. . . .

Dellinger then went on to state that exceptional service to the nation by Government employees, including that of inventing, should be rewarded, mainly by promotion.

In 1960, in his address at the banquet of the URSI-IRE Meeting at Boulder, Dellinger made another of his predictions on the future of radio, this time in a more sophisticated field, that of radio astronomy.<sup>39</sup> He predicted:

It seems likely that the next great step forward in science as a whole will come from our field, radio. I am thinking of what radio astronomy is doing and is leading to. I do not think men are ever going to go out among the stars in spaceships . . . But we are going out on radio waves; and with our radio telescopes farther than with optical telescopes.<sup>40</sup>

It may not be amiss to note a few of the traits that characterized Dellinger's personality as observed by his fellow workers at NBS. He was an indefatigable worker. During the morning hours he was almost unapproachable in his office except for emergencies (via "ANKie," his long-time secretary). It was during the morning that he applied himself to writing and the multitudinous tasks of administration.<sup>41,42</sup> In the afternoon he was easily approachable for discussion or to carry on the business of the day. He had an aversion to tobacco and alcoholic beverages; before World War II smoking was *verboden* in the Radio Building, and thereafter smoking was restricted to certain areas. Although with a life career

---

(Continued)

Another viewpoint expressed by Dellinger near the time of his retirement was published as an editorial in the June 1948 issue of the *Proc. IRE* under the title, "The Great Opportunity." It is given in part, below:

The Great Opportunity  
J. H. Dellinger

To be sure, the vast field of radio and electronics offers vast opportunity. It is the very symbol of progress. But there is a unique aspect of its potentialities which has not received sufficient emphasis. That is its opportunity to contribute to world friendliness, the prerequisite of world peace. . . .

Despite its constant repetition, people do not realize, at this juncture of world affairs, the awful need for real international understanding. . . .

We are privileged to work in a field which does promote international understanding. First of all, radio business and radio science provide unusually extensive contacts at the international level. . . .

The physical nature of radio phenomena requires radio scientists, engineers, and business men to think on a world scale. . . .

Radio simply could not operate without world collaboration in the control of interference. . . .

I may be pardoned for closing on a personal note. I have been especially fortunate in being associated with many aspects of radio science, engineering, and administration, and in being selected as a representative of the radio engineering profession in some of them. I have seen the forces of goodwill at work between radio men of different nations. I deeply believe that these currents of goodwill and international friendliness are by no means negligible contributions to the happier world future.

<sup>39</sup>The 1960 Fall Meeting of the U.S. National Committee of URSI in joint session with several Professional Groups of the IRE met at the Boulder Laboratories during December 12-14.

<sup>40</sup>Little did Dellinger realize in giving the 1961 address that his prognostication on radio astronomy would blossom out 4 years later with a fundamental discovery in cosmology. On May 21, 1965, the *New York Times* announced on its front page that scientists at the Bell Telephone Laboratories had observed "Signals (that) Imply a 'Big Bang' Universe." Actually, scientists at Princeton University stated the implication (see *Astrophysical Journal*, Vol. 142, 1965, pp. 414-421).

For this fundamental discovery, by means of radio astronomy, Arno A. Penzias and Robert W. Wilson of the Bell Telephone Laboratories were awarded the 1978 Nobel Prize in physics (shared with P. Kapitsa of the U.S.S.R.). They were cited for their identification of the fossil heat remaining from the "Big Bang" that created the universe, now a widely accepted theory (see *Bell Laboratories Record*, Vol. 57, January 1979, pp. 4-18).

<sup>41</sup>To organize and keep tabs on his administrative duties and to plan the technical programs, during the period of 1917 through 1938, Dellinger used 5×8-inch cards, one for each week. On these cards he noted many items of information and activities, under a number of categories, such as: Administration, Publications, Research Progress, Visitors, Personnel, and Committees. (NN365-90, Box 30.)

<sup>42</sup>Dellinger's administrative duties, committee work, and consulting activities took him to various Government buildings in downtown Washington. To ease the parking problems he was well supplied with special parking permits (16 permits found in NN365-25, Box 4).



in radio, Dellinger was not a radio ham, nor was he adept in the use of the Continental (International) Morse code. He was not a participant or spectator of sports, although he played golf for physical exercise. Speaking among themselves, he was affectionately called "Dr. D." by his staff.

In celebration of the 60th Anniversary of NBS, the Boulder Laboratories highlighted the occasion by inviting Dellinger to speak to the BL personnel. On the snowy afternoon of March 3, 1961, Dellinger reminisced and directed attention to the Bureau's achievements in radio in an informal address that he labeled, "Fifty Years of Radio at the National Bureau of Standards." In his opening remarks, Dellinger said:

It was my great privilege to lead this work for most of the fifty years, and I am highly honored to be the spokesman on this occasion.

With considerable emphasis, Dellinger stated that he considered that:

the most outstanding achievement of the Bureau's fifty years in radio has been the basic establishment of radio science, along with electronics and its other powerful offshoots, in our civilization.

Then, after a half-hour of recollecting, and revealing incidents for the first time to most of his listeners, Dellinger brought his remarks to a close with counsel befitting that of a sage on the obligations of scientists.

Dellinger's counsel was:

Let me conclude with a few words from the heart. A scientist, particularly one with the unique opportunity and authority such as we have in the Bureau, has certain obligations. One of these is to avoid letting his scientific authority slip into arrogance. The crowning virtue of humility often comes hard to a scientist. Most of us who have had the opportunity to participate in the Bureau's work for a number of years have gone through many moods: eagerness of inquiry, some disappointments, occasional elation, great gratitude, and finally perhaps humility. . . .

Thereupon Dellinger quoted from poetry by Omar Khayyam, and also from the Sanskrit poem:<sup>43</sup>

Salutation of the Dawn

Look well to this day!  
For yesterday is but a dream  
And tomorrow is only a vision;  
But today well lived makes  
Every yesterday a dream of happiness,  
Every tomorrow a vision of hope,  
Look well therefore to this day.

---

<sup>43</sup> Dellinger delighted in quoting poetry; he was a long-time member of the Shakespearean Authorship Society.



*"Dr. D" addressing the Boulder Laboratories staff, March 3, 1961, on the occasion of the 60th Anniversary of NBS. The informal address on "Fifty Years of Radio at the National Bureau of Standards" was a time of reminiscing by both Dellinger and the "old timers" in the audience.*

## APPENDIX E

### NBS RADIO PERSONNEL PATENT THEIR INVENTIONS<sup>1-3</sup>

Title	Inventor(s)	Filed <sup>4</sup>	Issued	Patent Number
The high resistance contact thermoelectric detector for electrical waves	Louis W. Austin <sup>5</sup>	Oct. 27, 1906	Mar. 5, 1907	846,081
Radio method and apparatus	Frederick A. Kolster	Mar. 31, 1916	Jul. 29, 1919	1,311,654
Apparatus for transmitting radiant energy	Frederick A. Kolster	Nov. 27, 1916	Oct. 25, 1921	1,394,560
Radio method and apparatus	Frederick A. Kolster	Jan. 30, 1919	Feb. 27, 1923	1,447,165
Radio method and apparatus	Frederick A. Kolster	May 29, 1919	Aug. 24, 1926	1,597,379
Radio signal apparatus	John A. Willoughby Percival D. Lowell	Oct. 31, 1919	Apr. 9, 1929	1,706,071
Radio receiving method and apparatus	Frederick A. Kolster	Nov. 26, 1920	Aug. 7, 1923	1,464,322
Radio apparatus	Frederick A. Kolster	Nov. 26, 1920	Dec. 7, 1926	1,609,366
Radio receiving apparatus	Francis W. Dunmore	Feb. 4, 1921	Feb. 7, 1922	1,405,905
Radio frequency transformer	Percival D. Lowell	Sep. 9, 1921	Dec. 19, 1922	1,439,563
Power amplifier	Francis W. Dunmore Percival D. Lowell	Mar. 21, 1922	Nov. 9, 1926	1,606,212
Radio receiving apparatus	Percival D. Lowell Francis W. Dunmore	Mar. 27, 1922	May 15, 1923	1,455,141
Course shift-indicator for the double-modulation type radio beacons	Harry Diamond Francis W. Dunmore	Jul. 6, 1931	Aug. 22, 1933	1,923,920
Method of adjusting radio beacon courses	Harry Diamond	Nov. 24, 1931	May 23, 1933	1,910,427
Radio beacon course shifting method	Frank G. Kear	Nov. 24, 1931	Aug. 22, 1933	1,923,934
Triple-modulation directive radio beacon system	Harry Diamond Frank G. Kear	Mar. 9, 1932	Jun. 13, 1933	1,913,918

<sup>1</sup> Personnel of the Radio Section, Central Radio Propagation Laboratory, Radio Standards Laboratory, and successor organizational units of the National Bureau of Standards at the Boulder Laboratories (see app. C). Many of the patents in this list were assembled by Dr. J. Howard Dellinger and, more recently, by the Library of the Department of Commerce Boulder Laboratories.

<sup>2</sup> E. J. Pawlikowski, Alvin J. Englert, and David Robbins of the NBS Patent Adviser staff in Gaithersburg provided valuable assistance in compiling this list and in obtaining copies of needed patents.

<sup>3</sup> Records in the Office of the NBS Patent Adviser show a total of 948 patents issued to all NBS personnel during the period covered by this tabulation (1901-1977). The 120 "radio" patents here listed represent 12.7% of this total.

<sup>4</sup> Listed in sequence of dates when applications were filed.

<sup>5</sup> These were not members of the Radio Section, but the research was done in close cooperation with the section staff.

Title	Inventor(s)	Filed <sup>1</sup>	Issued	Patent Number
Method and apparatus for a multiple course radiobeacon	Harry Diamond	Mar. 9, 1932	Feb. 26, 1935	1,992,197
Course indicator for the double and triple modulation directive radio beacons	Francis W. Dunmore	Mar. 9, 1932	June 14, 1938	2,120,245
Devimeter	Francis W. Dunmore	Apr. 12, 1932	Nov. 27, 1934	1,981,857
Radio beam and receiving device for blind landing of aircraft	Francis W. Dunmore	Aug. 5, 1932	Aug. 23, 1938	2,127,954
Method of blind landing of aircraft	Harry Diamond	Aug. 5, 1932	Nov. 14, 1939	2,179,499
Pointer type course indicator	Francis W. Dunmore	Oct. 25, 1932	Nov. 20, 1934	1,981,589
Twelve-course aural type, triple modulation directive radio beacon	Harry Diamond	Oct. 29, 1932	June 5, 1934	1,961,206
Course indicator for blind flying and landing	Francis W. Dunmore	Nov. 10, 1932	June 7, 1938	2,119,530
Radio direction finder	Wilbur S. Hinman, Jr.	Nov. 26, 1932	Dec. 16, 1941	2,266,038
Method and apparatus for radio beacon course and quadrant identification	Francis W. Dunmore	Feb. 4, 1933	Feb. 26, 1935	1,992,927
Radio transmitting and receiving system	Harry Diamond	Apr. 25, 1933	June 21, 1938	2,121,024
Directive antenna system	Harry Diamond	May 5, 1933	Sept. 12, 1939	2,172,365
Radio system for collision prevention	Francis W. Dunmore	May 11, 1933	Feb. 14, 1939	2,146,724
Radio system for azimuth indication	Francis W. Dunmore	May 16, 1933	Sept. 6, 1938	2,128,923
Visual type radio beacon	Francis W. Dunmore Frank G. Kear	July 7, 1933	May 16, 1944	2,348,730
Radio warning signal	Harry Diamond Francis W. Dunmore	July 18, 1933	Jan. 29, 1935	1,989,086
Radio detection finder	Wilbur S. Hinman, Jr.	Sept. 6, 1933	Feb. 7, 1939	2,145,876
Electrical control system	Frank G. Kear	Nov. 1, 1933	Jan. 20, 1942	2,270,308
Radio shielded plug	Melville F. Peters <sup>5</sup> Allen V. Astin <sup>5</sup>	Aug. 21, 1935	Jan. 9, 1940	2,186,039
Thermal protection and radio shielding of spark plugs	Melville F. Peters <sup>5</sup> Allen V. Astin <sup>5</sup>	Aug. 21, 1935	Apr. 16, 1940	2,197,006
Radio guidance of aircraft	Harry Diamond Francis W. Dunmore	Aug. 26, 1935	June 14, 1938	2,120,241
Multistage ultra high radio frequency amplifier <sup>6</sup>	Francis W. Dunmore Leo L. Hughes	Dec. 27, 1935	Jan. 5, 1937	2,066,674
Automatic volume control for radio receiving apparatus	Harry Diamond Francis W. Dunmore	Dec. 27, 1935	Mar. 8, 1938	2,110,761
Ultra high frequency radio amplifier	Francis W. Dunmore	Dec. 27, 1935	Oct. 4, 1938	2,132,208
Aircraft blind landing beam system	Francis W. Dunmore	Mar. 3, 1936	Jan. 4, 1938	2,104,028

<sup>6</sup>The copy of the patent found in Dellinger's files has the notation in his handwriting, "withdrawn in favor of Zotter, RCA, after interference started, Government receiving license—June 1939."

Title	Inventor(s)	Filed <sup>4</sup>	Issued	Patent Number
Radio system for automatic control of aircraft, as during landing	Francis W. Dunmore	Mar. 3, 1936	Oct. 18, 1938	2,133,285
Automatic steering system	Francis W. Dunmore	Mar. 3, 1936	Nov. 22, 1938	2,137,241
Warning system for indicating the proximity of aircraft	Francis W. Dunmore	May 10, 1937	May 9, 1939	2,157,122
Measuring cloud height and thickness	Francis W. Dunmore	May 4, 1938	Mar. 31, 1942	2,277,692
Art of radiometeorography	Harry Diamond Wilbur S. Hinman, Jr.	May 4, 1938	May 26, 1942	2,283,919
Pressure switching	Harry Diamond Wilbur S. Hinman, Jr.	May 4, 1938 <sup>7</sup>	June 22, 1943	2,322,229
Temperature measuring	Francis W. Dunmore	Dec. 22, 1938	Aug. 13, 1940	2,210,903
Humidity measuring	Francis W. Dunmore	Dec. 22, 1938	Sept. 15, 1942	2,295,570
Determining upper air wind conditions by radio direction finding	Harry Diamond Francis W. Dunmore Wilbur S. Hinman, Jr.	Dec. 22, 1938	Jan. 13, 1948	2,434,263
Pulse echo distance and direction finding	Francis W. Dunmore	Nov. 10, 1939	Jan. 22, 1952	2,582,971
Altitude measuring	Francis W. Dunmore Evan G. Lapham	Feb. 5, 1940	July 6, 1943	2,323,317
Humidity variable resistance	Francis W. Dunmore	June 8, 1940	June 9, 1942	2,285,421
Automatic weather station	Harry Diamond Wilbur S. Hinman, Jr.	Aug. 30, 1941	June 30, 1942	2,287,786
Air launched radio station	Percival D. Lowell William Hakkarinen	June 20, 1945	June 5, 1951	2,555,352
Measuring potential gradients in space	Francis W. Dunmore	Sept. 21, 1945	Mar. 8, 1949	2,463,527
Collapsible multicorner reflector for ultra high frequency radiant energy	Francis W. Dunmore Harold Lyons	Sept. 27, 1946	Feb. 28, 1950	2,498,660
Radio direction finder	Evan G. Lapham	Mar. 24, 1947	June 27, 1950	2,512,657
Atomic clock	Harold Lyons Benjamin F. Husten	Apr. 30, 1949	Jan. 11, 1955	2,699,503
Regenerative shaping of electric pulses	Ralph J. Slutz	Nov. 2, 1950	May 29, 1956	2,748,269
Holddown clamp	Edward G. Clark	Nov. 7, 1950	May 5, 1953	2,637,226
Micropotentiometers	Myron C. Selby	June 29, 1951	Feb. 19, 1957	2,782,377
Micropotentiometer	Myron C. Selby	June 29, 1951	Apr. 14, 1959	2,882,501
Magnetic microwave attenuators	Frank Reggia	Aug. 17, 1951	July 2, 1957	2,798,207
Gate circuitry for electronic computers	Robert D. Elbourn Ralph J. Slutz	Aug. 30, 1951	June 28, 1955	2,712,065
Means for minimizing pulse reflections in linear delay lines loaded with a nonlinear load	Ralph J. Slutz	Aug. 30, 1951	Dec. 13, 1955	2,727,143
Reflected-ray eliminators	Howard E. Bussey	Nov. 28, 1951	Sept. 11, 1956	2,763,001

<sup>7</sup> Original application May 4, 1938. Divided and this application November 22, 1941.

Title	Inventor(s)	Filed <sup>1</sup>	Issued	Patent Number
Superheterodyne mixer with negative feedback for stabilizing conversion gain	Gail E. Boggs	Jan. 30, 1952	July 3, 1956	2,753,449
Square-wave amplifier circuits	John H. Reaves	May 29, 1952	Feb. 26, 1957	2,783,314
Stabilized synchronous amplifiers	Richard G. Nuckolls	Oct. 17, 1952	May 22, 1956	2,747,030
Series-resonant high-voltage supply	Peter G. Sulzer	Apr. 28, 1953	June 8, 1954	2,680,830
Crystal-controlled blocking oscillators	Moody C. Thompson, Jr.	Aug. 26, 1953	Sept. 4, 1956	2,761,971
Stabilized nonlinear amplifiers	Gail E. Boggs	Oct. 7, 1953	Apr. 21, 1959	2,883,527
Oscillators	Peter G. Sulzer	Mar. 23, 1954	Sept. 25, 1956	2,764,643
Apparatus for calibrating microwave reflectivity coefficient standards	Alan C. Macpherson	June 10, 1954	Apr. 17, 1962	3,030,577
Multi-phase oscillator	Peter G. Sulzer	July 14, 1954	Jan. 22, 1957	2,778,940
Magnetic core memory having magnetic core selection gates	Ralph J. Slutz	Aug. 13, 1954	Sept. 20, 1960	2,953,774
Crystal-stabilized pulse-pair generator	Moody C. Thompson, Jr.	Apr. 21, 1955	Dec. 24, 1957	2,817,759
Automatic radio control for clocks	Theodore R. Gilliland	May 22, 1956	Feb. 18, 1958	2,824,218
Microwave calorimetric wattmeter	Alan C. Macpherson	June 29, 1956	Aug. 5, 1958	2,846,647
Attenuator-thermoelectric high-frequency voltmeter	Myron C. Selby Lewis F. Behrent	Dec. 5, 1956	Apr. 19, 1960	2,933,684
Adjustable waveguide termination	Robert W. Beatty	Aug. 6, 1957	Jan. 26, 1960	2,922,963
High frequency power measuring bridge circuit	Myron C. Selby Charles M. Allred Paul A. Hudson Ira S. Berry	Sept. 6, 1957	Apr. 21, 1959	2,883,620
Tool shaping machine	Carl E. Pelander	Mar. 4, 1958	Dec. 1, 1959	2,914,993
Tool shaping machine	Carl E. Pelander	Mar. 4, 1958	Feb. 2, 1960	2,923,209
Quartz oscillator unit for operation at low temperatures	Philip A. Simpson Catherine Barclay Francis P. Phelps	June 25, 1958	Apr. 5, 1960	2,931,924
Self-balancing dc bolometer bridge	Glenn F. Engen	July 7, 1958	Aug. 22, 1961	2,997,652
Cavity resonator	Moody C. Thompson, Jr. Frank E. Freethey Donald M. Waters	Dec. 15, 1958	Apr. 25, 1961	2,981,908
Alkali vapor frequency standard utilizing optical pumping	Peter L. Bender Earl E. Beaty	Apr. 14, 1959	June 29, 1965	3,192,472
RF voltmeter calibration console	Myron C. Selby Lewis F. Behrent Francis X. Ries	May 19, 1959	June 26, 1962	3,041,533
Automatic RF level control	Charles M. Allred Paul A. Hudson	June 3, 1959	July 4, 1961	2,991,430

Title	Inventor(s)	Filed <sup>d</sup>	Issued	Patent Number
Dry static calorimeter for RF power measurement	Paul A. Hudson Charles M. Allred	Nov. 9, 1959	Aug. 8, 1961	2,995,708
Intermittent action camera	Gifford Hefley Robert F. Linfield Robert H. Doherty Earl L. Berger	Sept. 19, 1960	Feb. 25, 1964	3,122,076
Satellite relay station using antenna diversity selection	Richard Silberstein	Oct. 28, 1960	June 25, 1963	3,095,538
Modulated subcarrier system for measuring attenuation and phase shift	George E. Schafer	Mar. 15, 1961	Oct. 26, 1966	3,281,679
Time-multiplex system for the distribution of serial pulse time codes with microsecond synchronization	Robert H. Doherty Thomas L. Davis	Aug. 17, 1961	Jan. 26, 1965	3,167,770
Distance measuring system with automatic index compensation	Moody C. Thompson, Jr.	Dec. 28, 1961	June 8, 1965	3,188,634
Atmospherics direction finding system	Gifford Hefley Robert F. Linfield Thomas L. Davis Robert H. Doherty	Feb. 26, 1962	Oct. 8, 1963	3,106,709
Signal-level comparing system	Charles M. Allred	Apr. 19, 1962	June 29, 1965	3,192,372
Movable resonant cavity tuning probe in dielectric sleeve having nonuniform outer surface	Maurice J. Vetter	May 10, 1962	Nov. 24, 1964	3,158,825
Broadband tuning transformer permitting independent matching at adjacent frequencies	Glenn F. Engen	June 4, 1962	Jan. 19, 1965	3,166,725
System for measuring peak pulse power using sampling and comparison techniques	Paul A. Hudson Warner L. Ecklund Arthur R. Ondrejka	Sept. 10, 1962	Mar. 8, 1966	3,239,758
Refractometer that measures the difference in refractive indices of a gas at two frequencies	Moody C. Thompson, Jr. Maurice J. Vetter	May 13, 1965	Sept. 3, 1968	3,400,330
Variable impedance coaxial device with relative rotation between conductors	J. E. Cruz	Sept. 13, 1965	Dec. 17, 1968	3,417,350
Distance measuring instrument using a pair of modulated light waves	Peter L. Bender James C. Owens	Sept. 17, 1965	Jan. 28, 1969	3,424,531
Coaxial transmission line T-junction having rectangular passageway dimensioned beyond cutoff for higher order modes	M. C. Selby	Oct. 22, 1965	Nov. 21, 1967	3,354,411
Electrothermic instruments for measuring voltage or current	M. C. Selby	Aug. 4, 1967	Dec. 30, 1969	3,487,305
Standard field strength meter	Robert A. Lawton Charles M. Allred	Dec. 15, 1969	June 22, 1971	3,586,973
Radio frequency coaxial ammeter with thermal compensation	Winston W. Scott	Jan. 20, 1970	Sept. 28, 1971	3,609,541
Power measuring and leveling system using a self-balancing bridge	Neil T. Larsen Frederick R. Clague	Mar. 17, 1970	Oct. 5, 1971	3,611,130

Title	Inventor(s)	Filed <sup>1</sup>	Issued	Patent Number
Double plate calorimeter for measuring the reflectivity of the plates and the energy in a beam of radiation	Alvin L. Rasmussen	June 10, 1970	Nov. 23, 1971	3,622,245
Broad-band lumped-element directional coupler	Cletus A. Hoer	May 20, 1971	Oct. 24, 1972	3,701,057
Electromagnetic field measuring device	Ronald R. Bowman Ezra B. Larsen Donald R. Belsher	Sept. 16, 1971	July 31, 1973	3,750,017
Rotary vane attenuator wherein rotor has orthogonally disposed resistive and dielectric cards	Charles D. Stelzried Tom Y. Otoshi David L. Nixon Robert W. Beatty	Oct. 29, 1971	Nov. 14, 1972	3,702,979
Color subcarrier frequency comparator	D. D. Davis	Aug. 20, 1974	May 18, 1976	3,958,269
Self-balancing dc-substitution measuring system	Neil T. Larsen Gerome R. Reeve	June 17, 1975	Feb. 22, 1977	4,008,610
Antenna with inherent filtering action	Tadeusz M. Babij Ronald R. Bowman Paul F. Wacker	June 25, 1975	Feb. 15, 1977	4,008,477
Vector voltmeter	Cletus A. Hoer Glenn F. Engen	Jan. 28, 1976	Jan. 4, 1977	4,001,681
Satellite controlled digital clock system	Joseph V. Cateora Dicky D. Davis D. Wayne Hanson	Feb. 13, 1976	Mar. 29, 1977	4,014,166
Waveform sampler	Robert A. Lawton James R. Andrews	Mar. 25, 1976	June 21, 1977	4,030,840



## APPENDIX F

### SOURCES OF INFORMATION USED IN PREPARATION OF *ACHIEVEMENT IN RADIO*

1. *Annual Reports of National Bureau of Standards*.<sup>1</sup>
2. Monthly, Quarterly (when used), and Annual Reports (dating back to 1913) for internal use, prepared by personnel of the Radio Section and by sections of the Central Radio Propagation Laboratory (from 1946 to 1954).<sup>2</sup>
3. Annual Summary Reports of Boulder Laboratories (1954-1961).
4. Publications of the National Bureau of Standards, including Letter Circulars.<sup>3,4</sup>
5. *National Bureau of Standards Technical News Bulletin (DIMENSIONS/NBS* since August 1973).
6. Publications by NBS authors in other periodicals.
7. Miscellaneous lists of publications authored by staff members of the Radio Section, the Central Radio Propagation Laboratory, the Radio Standards Laboratory, and by various divisions.<sup>5</sup>

---

<sup>1</sup>During the period 1958-1965 the annual reports were entitled, *Research Highlights of the National Bureau of Standards*; during the period 1966-1970 they were entitled, *Technical Highlights of the National Bureau of Standards*; thereafter the annual reports have had various titles.

<sup>2</sup>Much credit must be given to J. Howard Dellinger that such records were prepared, and fortunately have been preserved—a legacy to historians. Originals of typed copies of Monthly and Annual Reports of the Radio Section are located at the National Archives (Washington, D.C.) in: Record Group 167, Records of the National Bureau of Standards; General Correspondence Files, 1901-1946. Carbon copies are located in the personal records of J. Howard Dellinger, NN365-25, Box 4. Carbon copies are in binders in the Radio File (see Item 8, below).

<sup>3</sup>First use of the word “radio” (or “radio telegraphy”) in NBS publications is of historical interest. It would set a trend for use in hundreds of NBS publications for a period of more than 60 years. A survey of NBS publications revealed the following, in the order of first usage by the early authors:

1. Austin's first use was the term “radio telegraphy” in the title of *Scientific Paper 96* entitled, “On the Advantages of a High Spark Frequency in Radio-Telegraphy,” dated April 27, 1908.
2. Dellinger's first use was the term “radiotelegraphic” in the first sentence of *Scientific Paper 206*, entitled, “High-Frequency Ammeters,” dated April 3, 1913.
3. Kolster's first use was the term “radio communication” in the first sentence of *Scientific Paper 235* entitled, “A Direct-Reading Instrument for Measuring the Logarithmic Decrement and Wave Length of Electromagnetic Waves,” dated August 15, 1914.

However, Kolster, in his first paper published in the *Proc. IRE* (April 1913), used the title, “The Effects of Distributed Capacity of Coils Used in Radio-Telegraphic Circuits.”

By 1970, when the two radio divisions dropped the term “radio” from their names (see footnotes 125 and 143, Appendix C), “radio” was almost completely supplanted by other words in NBS publications (and by NBS authors in outside journals), except for the term “radio frequency” and its abbreviation, “RF.”

<sup>4</sup>A complete set of Letter Circulars is located only in the Technical Information and Publications Division, NBS Gaithersburg.

<sup>5</sup>These lists of publications had a rather limited distribution, although wide for NBS Letter Circulars. They listed publications by NBS staff members on radio subjects spanning the period from 1905 (Austin) through 1978 (to 1965

8. Unpublished papers and technical reports of the Radio Section; located in a Dewey index file, now designated as Radio File. Miscellaneous papers are also located in the Radio File.
9. Internal documents in the form of directories, administrative orders and bulletins, memorandums, reports to the file, and announcements.
10. Division and section files.
11. Material in National Archives (Washington, D.C.), primarily records of Radio Section and J. Howard Dellinger's personal records.<sup>6</sup>
12. Dellinger address, 1961 (Radio File), also (Department of Commerce Boulder Laboratories Library Call No. TK 6547. D46 1961, Archives). Address, entitled "Fifty years of radio at the National Bureau of Standards," presented by J. Howard Dellinger on March 3, 1961, at the Boulder Laboratories in celebration of the 60th Anniversary of NBS.
13. Memorabilia, including Boutell Collection.<sup>7</sup>

---

(Continued)

for the CRPL), the publications totaling approximately 3680. Other listings included papers and reports for internal distribution, for contractors, or reports that were classified.

The total of 3680 publications on radio subjects, noted above, appears for the first time as a summation of considerable interest—a surprisingly high number of publications, all in the category of open-literature citation (including *NBS Technical Notes*, feature articles in the *Technical News Bulletins*, *NBS Monographs*, etc.). The summation does not include nonreferenceable documents and reports, such as: Letter Circulars, NBS Reports, CRPL Reports, preprints, the CRPL Series D Propagation Predictions, and the earlier IRPL (alphabetical) Series. Of the more than 100 papers written by Austin, only those that appeared in NBS publications are included in the total noted above (see ch. II).

As a matter of further interest, the total noted above is divided into subtotals in four categories of considerable significance (actually, the total was obtained by simply summing the numbers (or subtotals) of publications in these four categories) which appear, as follows:

Publications by NBS staff members on radio subjects			
<i>Radio Section, period to May 1, 1946</i>			
<i>Propagation subjects</i>	173	<i>Non-Propagation subjects</i>	292
<i>CRPL, period from May 1, 1946</i>			
<i>Propagation subjects*</i>	1486	<i>Non-Propagation subjects**</i>	1617

One other category of publications should be added, that of publications by the Quantum Physics Division (presently named) of the Joint Institute for Laboratory Astrophysics (JILA) that are identified as written by NBS authors, the total being 927 publications through 1978.

\*For CRPL publications on Propagation subjects to October 13, 1965.

\*\*For Non-Propagation subjects through 1978.

Note: Various categories could have been selected to arrive at the total of 3680 publications, but the author (WFS) chose to use this system, both as a feasible means of summarizing and of yielding categories of special interest. It was necessary to resort to using a variety of publication listings in order to arrive at the totals in each of these four categories.

<sup>6</sup>Accession Numbers at the National Archives (Washington, D.C.) are: NN365-90 for records (51 boxes) of the Radio Section (compiled and deposited by J. Howard Dellinger) and NN365-25 for the personal records (5 boxes) of J. Howard Dellinger. Box numbers are associated with the accession numbers to indicate the repository of specific records. Another accession number of usefulness is NARG 167, NBS Blue Folder (plus box and document number) for NBS correspondence in the National Archives Record Group.

<sup>7</sup>This group of publications, reprints, and historical memorabilia relating to NBS and its activities was collected by Hugh G. Boutell, chief of the Information Section at NBS from the early 1920's until his retirement in 1946. After his retirement these items were selected for retention by Charles L. Bragaw, a member of the section under Boutell, and later brought to the Boulder Laboratories by Bragaw when he transferred from NBS, Washington. The material covers a period from 1876 to 1940 and includes, among other items, early lists of NBS scientific personnel (1905 and 1907) and general descriptions of the work of the National Bureau of Standards at various times during the early years. This material has been deposited with the Historical Information Collection within the Public Information Division (NBS, Gaithersburg).

14. Minutes of the Boulder Laboratories Management Council (1954-1962), Minutes of the Boulder Laboratories Administrative Council (1962-1965).
15. Minutes of the CRPL Executive Council, May 1, 1946-March 14, 1955.
16. Correspondence files.
17. Organization charts, NBS telephone directories, Boulder Laboratories telephone directories.
18. Personnel records.<sup>8</sup>
19. Interviews with persons who experienced or had knowledge of projects and events.
20. *Measures for Progress*, authored by Rexmond C. Cochrane, and the NBS Historical File (at NBS, Gaithersburg) established by Cochrane, now maintained by Walter Weinstein, historical information specialist, Public Information Division, NBS, Gaithersburg.
21. Radio Propagation Activity Report (1946-1949) a CRPL in-house publication.
22. The Bureau Drawer (March 1954 to January 1966); then as The Boulder Laboratories LAB LOG (February-March 1966 to March 1969), an in-house publication of Boulder Laboratories.
23. NBS Standard (October 1955 to present), an in-house publication.
24. Photographs:
  - a) NBS photos located at Federal Archives and Records Center, Denver, Colo. Negatives filed at Boulder Laboratories.
  - b) NBS photos located at the Records Holding Area, Suitland, Md. Negatives at the Records Holding Area.
  - c) Photo files of Institute for Telecommunication Sciences, Boulder Laboratories. Negatives filed at Boulder Laboratories.
  - d) Photo files of Electromagnetics Division, Boulder Laboratories. Negatives filed at Boulder Laboratories.
  - e) Photo files of Mary Ellen Johnson, Boulder Laboratories.
25. Magazine and newspaper accounts.
26. "Scrapbook" files of the Boulder Chamber of Commerce.
27. Boulder Laboratories "Scrapbooks."
28. The extensive resources of the Department of Commerce Boulder Laboratories Library, Boulder, Colo.; Library, University of Colorado, Boulder, Colo.; Library, National Bureau of Standards, Gaithersburg, Md.; Library of Congress; other libraries in the United States.
29. NBS Directories of Committee Membership for 1962, 1969, 1973, and 1975.
30. *The Bureau of Standards, Its History, Activities and Organization*, by Gustavus A. Weber, a publication of the Institute for Government Research Laboratories, Washington, D.C., the Johns Hopkins Press, Baltimore, Maryland, 1925. Although written with great detail in some subject areas, this publication has limited information on research of the Radio Section.

---

<sup>8</sup>Personnel records of former NBS staff members were made available from the National Personnel Records Center, GSA (Civilian Personnel Records), St. Louis, Mo., in most instances by official transcript by Walter Weinstein, Public Information Division, NBS, Gaithersburg.



## APPENDIX G

### COMMENTARY ON A RADIO TRANSMISSION PUBLICATION

This appendix was added during the period when the entire historical account was being paginated and indexed in preparation for final printing. In selecting the major portion of documents in the Radio File (see item 8, app. F) for deposition in the National Archives, one author (WFS) unexpectedly found a folder containing several typed sheets that reproduced an article published in the April 27, 1912, issue of *Electrical World* (Vol. 59, pp. 887-889) with the title, "Marconi Lecture Before New York Electrical Society." The lecture was on April 17, 1912. The typed copy was verified by searching out the original article. A much briefer account had appeared a week earlier (April 20) with the same title.

Among a number of topics covered by Marconi in his lecture were several on the observations of transmission and reception of wireless signals in east-west and north-south directions over the Atlantic Ocean. These experiments were largely made under Marconi's guidance in 1910.

It was the author's reaction when reading of these observations of 1910 that Marconi had observed much of the same phenomena of radio transmission over the Atlantic that Dellinger and Cosentino had analyzed of observations made during the period of 1935-1940 and published in the October 1940 issue of *Proc. IRE* (Vol. 28, No. 10, pp. 431-437). A short account of their study is found in chapter VII, pp. 200-201. Briefly, Dellinger and Cosentino concluded from their analyses that transmission of radio signals at broadcast frequencies in a north-south direction over the Atlantic is much superior to that in the east-west direction. They attributed this anomaly to the condition that the transmission between North America and Europe at, say, 40° and higher latitudes is greatly affected by ionospheric storms.

In much the same context, Marconi in 1912 stated of his observations that:

Recent observations reveal the interesting fact that the effects vary greatly with the direction in which transmission is taking place, the results obtained when transmitting in a northerly and southerly direction being often altogether different from those observed in an easterly and westerly one. In regard to moderate power stations such as are employed on ships, and which use wavelengths of 300 m and 600 m, the distance over which communication can be effected during daytime is generally about the same whatever the bearing of the ships to each other or to the land stations, while at night interesting and apparently curious results are obtained. Ships over 1000 miles away off the south of Spain or around the coast of Italy can almost always communicate during the hours of darkness with the post office stations situated on the coasts of England and Ireland, while the same ships when at a similar distance on the Atlantic from the westward of these islands and on the usual track between England and America can hardly ever communicate with these shore stations unless by means of specially powerful instruments.

And again:

Valuable tests have been carried out by the United States Navy Department regarding the ascertainment of the laws governing the relation of the decrease in strength of signals with distance. Marconi carried out a series of tests over longer distances than had ever been previously attempted in September and October of 1910, between the stations of Clifden (Ireland) and

Glace Bay (Nova Scotia) and a receiving station placed on the Italian steamship *Principessa Mafalda* in the course of her voyage from Italy to the Argentine. During these tests the receiving wire was supported by means of a kite, as was done in the transatlantic tests of 1901, the height of the kite varying from about 1000 to 3000 ft. Signals and messages were obtained without difficulty by day as well as by night up to a distance of 4000 statute miles from Clifden. Beyond that distance reception could be obtained only during night time. At Buenos Aires, more than 6000 miles from Clifden, the night signals from both Clifden and Glace Bay were generally good. It is rather remarkable that the radiations from Clifden should have been detected at Buenos Aires so clearly at night time and not at all during the day, while in Canada the signals coming from Clifden (2400 miles distant) are no stronger during the night than they are by day.

It can be readily assumed that all transmissions referred to by Marconi were at frequencies that are affected by the ionosphere.

Although Marconi had no explanation for the anomalies of transmission of radio signals over the Atlantic Ocean, it is rather strange that Dellinger and Cosentino made no reference to Marconi's observations. These observations, made in 1910, showed anomalies that were similar to the anomaly indicated by Dellinger and Cosentino in 1940.

# INDEX

Note: The index covers Chapters I through XX, Appendix D, and Appendix G. Material in footnotes is designated by the letter "n" after the page number.

## A

- A-battery eliminator, 85
- ABRAHAM, Henri: French Scientific Commission, 52
- absolute humidity, 523
- absolute humidity: climate variation of, 523
- absorption: in Antarctic, 444
  - of radio waves, 605
  - polar-cap, 442
- absorption event, 610n
- absorption events, 609
- absorption line of ammonia, 619
- absorption of ionosphere layer: effect on distant transmission, 239
- ac operation of electron tubes, 86n
- ac operation of electron tubes: development, 85
  - patent litigation, 87
  - patents, 87
  - premature announcement, 85, 86n
  - publications, 86
- ac operation of transmitter tubes: early development, 85
- Act of August 13, 1912 (regulation of radio stations), 644
- Act of Congress, March 3, 1901: establishment of NBS, 99
- ADAIR, Robert T., 367
- Administrative Radio Conference, ITC: Atlantic City, 1947, 659
- Administrative Services Division, NBS Boulder, 736
- Advanced Research Projects Agency (ARPA), 459n, 461, 476
- Aerial Mail Service, Post Office Department: safety of, 649
- aerodynamic phenomena in stellar atmospheres, 624
- aeronautical committees in Government, various, 644
- Aeronautics Branch, Department of Commerce, 153, 644
- aeronomy, 735
- Aeronomy Division, 506
- Aeronomy Laboratory, NOAA, 737
- Aerospace Industries Association (AIA), 349
- AGNEW, Paul G., 695, 695n
- AGY, Vaughn L., 436, 441n, 442, 442n
- AIA (see Aerospace Industries Association)
- Air Commerce Act, May 20, 1926, 153, 644
- Aircraft Receivers Committee, IRE, 652
- "air disaster": European theater of WW II, 404
- Air Force: calibration needs, 348
  - Department of Defense, 348, 351, 353, 395
- Air Force Cambridge Research Center, 625
- Air Force Missile Test Center, 546
- airglow: a simplified photometer for observation, 469
  - CRPL takes major role in IGY program, 468
  - international photometric unit for, 468
  - nature discussed, 466n
  - observations at Fritz Peak, 469, 722
- Airglow and Aurora Section, 469n
- Airglow and Ionosphere Subcenter for IGY, 468
- airglow program: established, 466
  - importance of, 468
- Air Materiel Command, Air Force, 348
- air navigation: homing device, 166
  - radio-aid patents by Radio Section personnel, 166
- air navigation by radio: WW I (*also, see* Chapter VI), 60
- Air Navigation Development Board (ANDB), 512, 515, 525, 576
- air navigation system: curtailment of program, 1933, 165
  - development for Aeronautics Branch, 153
  - early development by NBS at College Park, Md., 153
  - elimination of night effect on radio beam, 165n
  - improvements in radio beacon, 154
  - installation of radio beacon at Bellefonte, Pa., 155
  - laboratory model of beacon system, 154
  - minimization of night effect on radio beacon, 165
  - multiple-beacon course system, 157
  - multiple-beacon development, 12-course, 157n
  - night effect on radio beacon, 155
  - radio, 572
  - radio beacon, 644
  - radio beacon, aural type in operation, 157
  - radio beacon developed, for U.S. Army Air Service, 150
  - radio marker beacons, 156
  - tuned-reed visual beacon course indicator, 152, 152n
- airplane guidance system: proposal by Post Office Department, 1918, 148
- airplane landing system: by electrical altimeter, 149
  - by electrical induction method, 148, 649
  - by induction signaling, 148
  - by radiation cone, 149
- air-to-air communication: frequency-band study, 583
- air-to-air propagation characteristics, 525
- air-to-ground communication: frequency-band study, 583
- air-to-ground propagation characteristics, 525
- ALEXANDER, Samuel M., 586n
- ALLAN, David W., 301, 308
- allocation of FM stations: a method, 580
- allocation plan: of station allocations, 645
- ALLOT, Gordon (U.S. Senator, Colorado), 285
- ALLRED, C. McKay, 357, 364, 365, 365n, 377, 381, 382
- Alouette I (*see* Ionosphere, upper)
- altimeter: by radar technique, 18
- ALTSCHULER, Helmut M., 282, 356n, 672, 700
- amateur radio stations: ban lifted by FCC, 20
  - closed by FCC, 19
- Amendment to the Radio Act of 1912, 645
- American Byrd Base, 608
- American Engineering Council: Committee on Radio Broadcasting, 92
- American Engineering Standards Committee: radio standards, 92
- American Geophysical Union: Committee on Earth Currents and Polar Lights, 92
- American Institute of Electrical Engineers (AIEE), 348, 652, 684
- American Institute of Electrical Engineers: Standards Committee; Subcommittee on Telephony, Telegraphy, and Radio, 92
- American National Standards Institute, 652, 654
- American Physical Society, 680, 680n
- American Radio Association: Interference Committee, 92
- American Radio Relay League (ARRL), 172, 183, 263, 285

- American Radio Relay League (ARRL): Advisory Technical Committees, 92  
 assistance to IRPL, 414  
 cooperative program with Radio Laboratory, 93  
 cooperative project on fading, 180  
 organized, 1914, 11
- American Society for Testing and Materials, 654
- American Society for Testing and Materials: Insulating Material Committee, 92
- American Standards Association, 653
- American Telephone and Telegraph Co., 343
- American Telephone and Telegraph Co.: coaxial cable installation, 17  
 long-distance voice communication, 12
- American URSigrams Service, 675
- ammeter, coaxial RF-dc, 381
- ammeters: RF, 103
- ammonia clock, 619, 620
- ammonia clock, Model 2, 620
- ammonia clock, Model 3, 620
- ammonia inversion transition: observation of, 17
- AMPERE, Andre M., 3
- amplitude scintillations, 603, 605
- Analysis of Symmetrical Waveguide Junctions: a doctor's dissertation, 398
- Anchorage Radio Propagation Field Station, 453
- ANCKER-JOHNSON, Betsy (Assistant Secretary of Commerce for Science and Technology), 309
- ANDERSON, Malcom M., 625
- ANDREWS, David H., 281n, 292
- ANDREWS, James R., 357, 388
- A New Concept in Microwave Measurement Techniques: a doctor's dissertation, 399
- angular distance,  $\theta$ , 517,
- angular distance,  $\theta$ : defined, 517
- Annual Report, NBS*, to Secretary of Treasury Department: first, 99
- Annual Report to Secretary of Commerce*, 1917: war work, 51
- anomalies of radio wave propagation, 92
- Anomaly: "Far East", 448, 483
- ANSON, Wilbur J., 359, 369, 400, 654, 654n
- Antarctic Eights station, 609, 609n, 610n
- antenna, coil: as direction finder 115
- antenna: delta, multiple-wire, 600-ohm, 563
- antenna, parabolic reflector type: development of, 118
- antenna array, monopoles: study of, 570
- antenna arrays: electronically scanned, development of, 567
- antenna for underwater reception and transmission: patent, 96, 96n
- antenna gain: defined, 384n
- antenna impedance: measurement of, 563
- antenna measurements: comment, 110
- antenna measurements above 1 GHz: extrapolation technique, 386  
 near-field method, 386
- antenna radiation patterns: measurement of, 565
- antenna research, 44, 555, 563, 565
- Antenna Research Section, 565n, 567
- antennas, coil: studied, 115
- antennas, condenser: bedspring, 118n  
 studied, 117
- antennas, corner-reflector: measurements of, 563  
 60-degree, 564
- antennas, directive (parabolic reflector), 10-meters: designed and constructed, 118
- antennas: early, at NBS, 44  
 for vertical-incidence ionosondes, 563  
 gain measurements, 565  
 location at NBS, 115  
 model range, Boulder Laboratories, 566  
 model range, Sterling field station, 560  
 problems at NBS, 47  
 publications by Dellinger, 681  
 radiation pattern measurements, 566  
 scaled-down models, 566  
 scaled-down, similitude with, 566  
 submarine, 122  
 theoretical designs, 571  
 theoretical study, 122  
 twofold purpose of study, 118  
 types studied and used at NBS, 115
- antennas, "hybrid," 100-meters: designed and studied, 120
- antennas and coil aerials, 679
- antennas for the automobile, 118n
- antenna studies: site on Green Mountain mesa, 722
- Anthony, Kans., receiving site, 530, 531
- Apollo 10 spacecraft: color TV pictures of Moon, 24
- Apollo 11, 614
- APPLETON, E. V. and BARNETT, M. A. F., 173, 174
- APPLETON, E. V. and ECKERSLEY, T. L., 206
- APPLETON, Sir Edward V. 14, 20, 173, 173n, 175, 227  
 229n, 340
- application of graphs of usable frequency to communication problems, 240
- Applications of Waveguide and Circuit Theory to the Development of Accurate Microwave Measurement Methods and Standards: *NBS Monograph 137*, 398
- arctic ducts, 520
- "Arctic Wolf" project: Meteor-Burst Propagation Research, 465
- arc transmitter, 9
- Arecibo Ionosphere Observatory, 23
- Armed Forces, 345
- ARMSTRONG, Edwin H., 11, 12, 13, 17, 20
- Army Air Corps: stratosphere balloon flights, 122
- Army Air Force, 347
- Army Air Service: remote radio control project, 84
- Army Department, 345, 348
- Army Electronics Command, 24
- Army Signal Corps, 52, 53, 54, 56, 107, 347, 558
- Army Signal Corps Radio Laboratory, 33
- Army Signal Research and Development Laboratory, 22
- ARNOLD, Harold D., 11
- ARN-2 Radio Noise Recorder, NBS, 558n, 559, 562
- around-the-world transmissions, 459
- Arthur Fleming Award: first, 295
- ARTHUR, M. Gerald, 382
- artificially ionized clouds in ionosphere: observations of, 459
- Associated Universities, Inc., 596n
- ASTIN, Allen V., 122, 280n, 307, 319, 319n, 342, 352, 683n, 691, 715n, 716, 724, 724n, 725, 728, 728n
- Astronaut ALDRIN, 614
- Astronaut ARMSTRONG, 614
- Astronaut COOPER, 615
- ATHAY, R. Grant, 624
- atmospheric disturbances, 35
- atmospheric duct, 520
- atmospheric noise, 595
- atmospheric noise levels: automatic recording of, 558  
 recording, 558
- atmospheric radio noise, 555, 557
- atmospheric radio noise: effect on reception, 556  
 measurement of, 557
- atmospheric refraction, 520



- atmospheric refractive index, 518  
atmospheric refractive index: variations of, 519  
atmospheric variables: seasonal factors, 513  
atomic and molecular beam resonance experiments:  
    first, 18  
atomic-beam clock, 620  
atomic-beam frequency standard: cesium, first, 21  
atomic bomb project, 316  
atomic clock, 619  
atomic clock: first, 347, 619  
    first, accuracy stated, 296  
    first, described, 296  
    first, on display, 25th anniversary, 309  
    patent, 298n  
    term explained, 293  
    world's first, 20, 293  
atomic clocks: basic patent, 298  
    control by oxygen spectral line, 297  
    inversion frequency of ammonia, reported by Cleeton  
    and Williams, 293  
    NBS Model 2 Ammonia Clock, 296, 297, 298  
    NBS Model 3 Ammonia Clock, 296, 297, 298  
Atomic Collision Data Center, 630  
Atomic Energy Commission (AEC), 715  
Atomic Frequency and Time Interval Section, 308, 631  
atomic frequency standard: ammonia molecular beam  
    clock, maser principle, 300  
    cesium beam, described, 299  
    NBS cesium beam given tentative value, 277, 308  
    NBS-I, 620  
atomic frequency standards: comparison of cesium  
    beam technique with laser technique, 301  
    potentialities, 300  
atomic frequency standards program, 347  
atomic oscillators: controlled by spectral lines, 298  
Atomic Time Scale: AT(NBS), 308  
attenuation of radio waves: Norton points out error in  
    Sommerfeld formula, 112  
attenuation measurement: based upon Josephson  
    effect, 367  
    by bolometer measurement technique, 366  
    by modulated subcarrier technique, 366  
    by unmodulated twin-channel technique, 366  
    importance of, 361  
attenuation measurements: papers by Beatty, 367  
attenuator-thermoelectric high-frequency voltmeter  
    (AT voltmeter), 379  
ATWOOD, Stephen S., 511  
audibility meter, 99, 109  
auroral absorption, 611, 611n  
auroral absorption zone, 442  
auroral blackouts, 441, 610n  
"auroral propagation": an observed transmission  
    phenomenon, 491n  
AUSTIN, Louis W., 29n, 30, 30n, 31, 32, 33, 33n, 34, 35,  
    36, 38, 45, 92, 115, 172, 175, 175n, 176, 176n, 216, 470,  
    470n, 555, 657n, 667, 667n, 668, 669, 671, 671n, 672,  
    679n, 681, 682, 737n  
AUSTIN, Louis W.: accolade by IRE, 36n  
    *American Men of Science* listing, 31n  
    association with Navy Department, 33  
    association with URSI, 38  
    designation of positions, 34n  
    employment by German government, 30n  
    evaluation by Dellinger, 34n  
    insight into personality, 38n  
    list of publications, 35n  
    relation with NBS, 36n  
    resolution by URSI, on death, 38n  
    viewpoint on solar activity and radio phenomena, 36n  
Austin-Cohen transmission formula (equation), 34, 34n,  
    172, 176, 176n, 470, 470n, 474, 474n  
automated measurement systems, 356  
automated systems: for antenna measurements, 357  
    for calibration of micropotentiometers, 357  
    for calibration of power measurement devices, 357  
    time domain reflectometer, 357  
    Y-factor system for noise measurement, 357  
automatic amplitude distribution analyzer, 588n  
automatic network analyzer, 357  
automatic radio beacon transmitter for fog  
    signalling, 139  
automatic weather station, air-launched: development  
    by Radio Section, 321  
    "Grasshopper," 137  
automatic weather station: for Navy Department, 136  
    water-borne, free-floating buoy, 138  
Awards by IRE: to NBS members, 683, 683n  
AYERS, Edmund D., 698
- ## B
- backscatter: characteristics, 436  
    explained, 436n  
backscatter observations, 458  
backscatter program, 458  
Baie St. Paul, 610n, 611n  
Baie St. Paul station, 610  
BAILEY, Dana K., 442, 444, 444n, 445, 464, 484, 485,  
    486, 486n, 487, 487n, 491n, 494, 494n, 495, 495n, 496,  
    496n, 498n, 556n, 572, 616, 616n, 660, 662  
BAIN, Alexander, 3  
BAIRD, John L., 15, 16  
BAIRD, Ramon C., 388, 621  
bakelite: described, 106n  
    uses described, 106n  
BALLIF, Paul S., 719n, 723  
BAMBERGER, Edwin C., 391  
ban on amateur radio stations in U.S.: WW I, 12  
BARCLAY, Catherine, 260, 260n  
BARDEEN, John, and BRATTAIN, Walter Houser, 20  
BARGER, Richard L., 634, 634n, 636  
BARNABEI, Allen, 584n, 647n, 665  
BARNES, James A., 259, 292, 301, 308, 308n, 309n  
BARNES, Stephen S., 610n  
BARSIS, Albrecht P., 516, 536, 537, 538, 585  
Bartol Research Foundation, 444, 483, 484  
Basic Microwave Research Section, 512, 598  
*Basic Theory of Waveguide Junctions and Introductory  
    Microwave Network Analysis*: textbook, 398  
basic transmission loss, 515, 516  
BATEMAN, Ross, 441n, 448n, 462n, 471, 487n, 491n, 495,  
    495n, 496, 496n  
battery problem: of radio receivers, 85  
BEAN, Bradford R., 478n, 517, 520, 520n, 521, 522, 523  
BEARDSLEY, James H., 391  
BEATTY, Robert W., 358, 359, 366, 367, 367n, 368, 369,  
    374, 389, 398, 398n, 400, 672, 696, 699, 700  
BECK, Emanuel A., 219, 600  
BEEHLER, Roger E., 292, 293n, 301, 305, 305n, 308  
BEERS, L. Yardley, 270, 285, 620, 631  
BEHRENT, Lewis F., 377, 378, 379, 380  
BELL, Alexander Graham, 5  
BELL, Howard E., 309  
BELLINI, Ettore, and TOSI, Alessandro, 10  
Bell Telephone Laboratories, 15, 16, 18, 595, 598  
BELSHER, Deloris, 719n  
BELSHER, Donald R., 386

- Beltsville field station, 190n, 208, 209, 211, 215, 220  
 BELTZ, Howard H., 57  
 BENDER, Peter L., 638  
 BENEDICT, Charles M., 626  
 BERKLEY, Jessie B., 723, 723n  
 BERKNER, Lloyd V., 165n, 196, 196n, 197, 215, 216, 229, 670, 671n, 672, 674, 674n, 682  
 BERRY, Ira S., 354n, 377  
 BETTS, Barton F., 723  
 Beverage antenna, 614n  
 beyond-line-of-site radio paths, 516  
 Bibliography on Aircraft Radio: 89  
 Bibliography (Radio) Committee, IRE, 652  
 Big Bang theory, 24, 794n  
 BIRMINGHAM, Bascom W., 309n, 726n  
 BIRNBAUM, George, 337, 338, 389, 391, 518, 519, 688  
 black-body radiation theory, 598  
 BLAIR, Byron E., 290n, 292  
 BLAIR, James C., 471n  
 blind landing of plane: first, by radio, 16  
 blind landing system, 511  
 BMEWS, 23  
 Board of War Communications: IRAC related to, 647  
 BOGGS, Gail E., 579  
 BOGGS, Marshall S., 161  
 BOHNER, C. E. (Signal Corps), 146, 150n  
 bolometer bridge: NBS Type II, 376  
 self-balancing, 375n  
 bolometers: described, 372n  
 bolometer unit efficiency: defined, 373n  
 "Bolovac": voltage and current standard, 380  
 Booker-Gordon scatter theory, 549, 550, 551  
 BOOKER, Henry G. (consultant to CRPL), 465, 465n  
 BOOT, H. A. H. and RANDALL, J. T., 18  
 "bootleg" tubes, 81n  
 BOTTOM, Virgil E., 394  
 Boulder Chamber of Commerce, 709, 709n, 710, 710n, 711, 712, 713, 723, 726  
 Boulder Chamber of Commerce: Boulder Liaison Committee, 724  
 Bureau of Standards Committee, 711  
 Boulder citizens visit NBS Washington, 725  
 Boulder, Colo., 596, 599, 733, 735, 736  
 Boulder community, 709, 711, 712, 725  
 Boulder Laboratories, Department of Commerce, 733, 736  
 Boulder Laboratories (NBS), 348, 349, 351, 352, 356n, 358, 377, 394, 565, 624, 686, 690, 698, 715n, 718, 719, 719n, 725, 726, 726n, 727, 728, 729n, 733, 736, 736n  
 Boulder Laboratories: Campus Development Plan, 719  
 early staff, 723  
 "Open House" at conferences, 688  
 staff migration, 1954, 725  
 Boulder Laboratories dedication: contributor's plaque, 727  
 Eisenhower's address, 729n  
 "Open House", 727  
 Presidential party, 728  
 BOURS, Reginald W., 412  
 BOUTELL, Hugh G., 49n  
 BOWLES, Kenneth L., 425n, 426, 426n, 436, 437, 437n, 438, 439, 446, 447, 448, 460, 465, 483, 498, 500, 606, 611  
 BOWMAN, Ronald R., 366, 386, 388  
 BOYD, Louise A., 225, 226  
 BOYLE, Don R., 357, 383  
 BRADY, Allen H., 457  
 BRAGAW, Charles L., 726  
 BRANLY, Edouard, 5  
 BRANSCOMB, Lewis, M., 628, 634n, 699  
 Brant Rock radio station, 34  
 BRATTAIN, Walter H., 253, 253n  
 BRATTAIN, Walter H.: awarded Nobel Prize in Physics, 253n  
 BRAUN, Karl Ferdinand, 4, 6, 7  
 breakdown voltage: measurement of, 107  
 BREIT, Gregory, 173n, 202, 668, 680n  
 BREIT, Gregory, and TUVE, Merle A., 15, 173, 175, 203  
 BREYFOGLE, Louis D., 611n  
 BRICKWEDDE, Ferdinand G., 726n  
 BRIGGS, Lyman J., 37, 218, 315, 316, 319, 405n, 406n, 663  
 British Atomic Energy Research Establishment, 625  
 British Broadcasting Co., 13  
 British Inter-Service Ionosphere Bureau (ISIB), 556  
 BRITTIN, Wesley, 628, 631  
 broadcasting: development of, 403  
 effect on Radio Section, 69  
 broadcasting, first: of music and speech, 8  
 broadcasting of ionospheric propagation information, 235  
 BROCKMAN, James F., 699  
 BRODE, Wallace R., 700, 724n  
 BROIDA, Herbert P., 633  
 Brookhaven National Laboratory, 518, 519  
 BROWN, Frederick W., 696, 724, 724n, 726, 728  
 BROWN, Jack N., 426, 426n, 459, 471n  
 BROWN, William W., 280n  
 BRUNETTI, Cleo, 319  
 brush-cathode plasma, 627  
 BUDDEN, Kenneth G. (England, guest worker at NBS), 470n, 474n, 502  
 Bureau *Circulars*: information on radio for public, 81  
 Bureau (*see* National Bureau of Standards)  
 Bureau of Aeronautics, Navy Department, 323, 328  
 Bureau of Air Commerce, Department of Commerce, 650  
 Bureau of Commercial Fisheries, 737n  
 Bureau of Lighthouses: assistance to, 44  
 Bureau of Lighthouses, Department of Commerce, 643  
 Bureau of Markets: broadcast of reports by WWV, 78  
 Bureau of Markets, Department of Agriculture, 649  
 Bureau of Navigation: assistance to, 44  
 Bureau of Navigation, Department of Commerce, 244, 643  
 Bureau of Navigation, Department of Commerce: direct-reading decimeter, 105  
 radio inspectors, 97  
 Bureau of Navigation (Department of Commerce and Labor), 42  
 Bureau of Ships, Navy Department, 323, 328, 392, 573  
 Bureau of Standards (*also, see* National Bureau of Standards), 11, 12, 16  
 Bureau of the Budget, 348  
 BURGESS, George K., 69  
 BUSH, Vannevar, 316  
 BUSSEY, Howard E., 391, 391n, 394, 514, 514n, 518, 519, 588n  
 Byrd Antarctic Expedition, 1928-1930, 196  
 Byrd station, 610n

## C

- CADY, W. G. (Wesleyan University), 248, 249, 254, 260  
 CADY, W. G.: on quartz crystals, 248n  
 CAHOON, Burgette A., 523

- Calibration Coordination Group (CCG), Department of Defense, 355, 355n
- calibration facility: Boulder Laboratories, funding problems, 348
- calibration of field strength meters: service initiated, 1932, 111
- calibration of frequency standards: via color TV programs, 280
- calorimeter, dry, static: for lower radio frequencies, 377
- calorimeter (flow), dual-dry load: for lower radio frequencies, 378
- calorimeters: for laser measurements, 634
- CALVERT, Wynne, 425n, 503, 505, 506, 506n
- Cambridge Research Center, U.S. Air Force, 459, 459n, 464
- Cambridge Research Laboratories, U.S. Air Force, 476
- CAMPBELL, Eugene, 363, 383
- CAMPBELL-SWINTON, A. A., 10
- capacitance, 100
- capacitor (condenser): standard, fixed, 101  
standard, variable, 100  
standard, variable, high-voltage, 101
- CAPPS, Frederick M., 537, 580
- carbon dioxide laser, 635, 636
- carborundum crystal detectors, 10
- CARLE, Richard F., 282, 292, 292n, 605
- Carnegie Institution of Washington, 21
- Carnegie Institution of Washington, Dept. of Terrestrial Magnetism, 410, 414
- CARPENTER, Robert J., 464
- CARROLL, Thomas J., 317, 317n, 511, 580n, 584, 672
- CARTER, Nancy F., 476, 476n
- cascaded amplifiers: first, 11
- CASE, William E., 394, 633
- Cassiopeia, 595
- cathode-ray oscillographs: design and construction, WW I period, 63
- cathode-ray oscilloscope: first, 6
- cathode rays: properties of, 7
- cathode rays identified: Nobel Prize in Physics, 7
- cavity Q-meter: use of, 377
- CCIR (see footnote 11, Ch. XVII, for source of abbreviation), 660n
- CCIR Worldwide Prediction Charts: radio noise, 562
- Central Radio Propagation Laboratory (CRPL), 38, 69, 71, 73, 194, 197, 292, 343, 345, 347, 348, 403n, 406n, 410n, 412, 413, 414, 420, 420n, 424, 424n, 425, 426, 427, 428, 429, 431, 435, 436, 439, 440, 440n, 441, 442, 443, 444, 446, 447, 448, 448n, 450, 457, 459, 459n, 461, 461n, 462, 462n, 465, 466, 468, 469, 470n, 471, 474, 475, 475n, 478, 479, 480, 481, 482, 483, 484, 485, 488, 498, 499, 500, 500n, 501, 502, 503, 504, 505, 507, 511, 512, 513, 514, 516, 518, 521, 525, 555, 555n, 557, 558, 559, 563, 571, 578, 580, 583, 584, 587, 598, 599, 603, 608, 611, 613, 614, 616, 619, 646, 648, 653, 654, 655, 659, 660, 662, 664, 666, 669, 674, 675, 676, 703, 704, 706, 708, 709, 710, 713, 722, 723, 724, 724n, 725, 726, 733, 733n, 735, 737
- Central Radio Propagation Laboratory: a division of NBS, 416  
authorization of establishment, 415  
established May 1, 1946, 415  
evaluation by Ad Hoc Committee, 1953, 418  
first steps in establishment, 416  
listings of radio-wave propagation publications, 476n  
mission stated, 415n  
national defense orientation, 418  
numerical growth of staff, 419  
organizational growth, 419  
origin of name, 415n  
shaping a program, 418
- Central Radio Propagation Laboratory staff, 723
- Certificate of Merit, Franklin Institute: to Harold Lyons, 296
- cesium beam frequency standard: adoption as U.S. Frequency Standard, 302  
analysis and minimization of errors, 302  
comparison, NBS-I with NBS-II, 302  
comparison of NBS-4 with NBS-5, 303  
evaluated accuracy, 303  
NBS-I, 301, 305  
NBS-II, 301, 302, 305, 308  
NBS-III, 302, 303, 305  
NBS-4, 303, 308  
NBS-5, 302, 303  
transition frequency determined, 301
- cesium beam frequency standard (NBS), 634, 636
- CHADWICK, Walter B., 415n, 428, 441n
- CHAMBERS, George R., 527
- Chesapeake Bay Annex, Naval Research Laboratory, 324, 333, 336, 338
- Chevy Chase Experimental Station, 188
- Cheyenne Mountain, 525
- Cheyenne Mountain: transmitter site, 721
- Cheyenne Mountain experiments, 518, 525
- Cheyenne Mountain experiments: investigation of radio fields, near and far, 531  
recording devices, 533  
transmitting facilities, 532  
UHF receivers, 533  
UHF transmitter, 1046 MHz, 532  
VHF receivers, 533  
VHF transmitters, 533
- Cheyenne Mountain program, 527, 533
- Cheyenne Mountain project, 525, 713, 721, 723
- Cheyenne Mountain propagation experiments, 525
- Cheyenne Mountain receivers, 533
- Cheyenne Mountain transmitters, 532
- CHISHOLM, James H., 527
- CHIVERS, Hugh J. A., 443, 608, 609, 610, 610n, 611, 615
- Circuit Standards Division, 354
- Circuit Standards Division: of three sections, 354  
reorganization of, 1962, 354n
- Circular 74*, 100, 102, 103, 104, 110
- Circular 74*, WW I publication, 52, 53, 53n, 694
- CLAGUE, Fred R., 375
- CLARK, George H., 34, 34n
- CLARK, Thomas A., 606, 606n
- CLEETON, C. E. and WILLIAMS, N. H., 17, 293
- CLEMENTS, Alvin J. D., 290
- climatology, worldwide, 523
- climatology, worldwide: variations of, 524
- clocks: atomic, 2
- Coast and Geodetic Survey: assistance to, 44
- Coast and Geodetic Survey, Department of Commerce, 644, 733
- coaxial connectors: laboratory types, 400  
NBS involvement, 399
- COBLENTZ, William W., 124
- COCHRANE, Rexmond C.: account of Radio Section during the 1920's, 69, 70, 72, 88
- COHEN, Louis, 32, 32n, 34n, 100, 679, 681, 682, 695n
- COHEN, Louis: association with Army Signal Corps Radio Laboratory, 33  
participation in NBS educational programs, 33  
scientific papers, 33

- COHEN, Robert, 425n, 426, 426n, 446, 447, 483, 498  
coherer: Branley, 5  
coherer detector, 5n  
coil aerials (antennas): WW I development, 57  
COILE, Howard L. (Air Force), 353  
COLBY, Norman C., 346  
COLE, Frank W. (architect), 713  
College Park (Maryland) Airfield, 93  
Collier Trophy, 1948, 650, 650n  
Collins Radio Co., 487  
collision prevention of airplanes: experiments by  
Radio Section, 167n  
Colorado National Guard Radar Armory, 713  
Colorado-Wyoming Science Fair, 700  
color television, 555, 590  
color television: all-electronic system patent applied  
for, 19  
demonstration with electronic equipment to FCC, 18  
FCC decisions, 591  
first broadcasting of, 19  
standards compatible with black-and-white, 21  
standards for field-sequential system, 21  
three-color system, rotating disc: demonstrated, 18  
three-spiral scanning disc: demonstrated, 16  
color television, with electronic equipment: first  
demonstrated to public, 20  
color television system: three-gun tube, patent, 19  
Columbia, command module, 614  
Columbia Broadcasting System, 16, 18  
Committee for the Standardization of High Precision  
Coaxial Connectors, 400  
Committee on Propagation, OSRD, 317  
committee representation: proliferation within the  
CRPL, 653  
communication: early forms, 1  
communication problem: cause explained by  
Gilliland, 231  
Communications Act of 1934, 17, 646  
Communications and Transportation (Division C of  
NDRC), 316  
Communications (Section C-1 of Division C,  
NDRC), 316  
Communications Section of the Communications and  
Transportation Division (NDRC), 403  
comparison of standard clocks: by TV technique, 290  
computer facility, ESSA, 736  
computer facility, NBS Boulder, 735  
computer signals, 1  
CONDA, Alyce M., 478n  
condenser: *see* capacitor  
condenser discharge: oscillatory, mathematical  
analysis, 4, 4n  
condenser discharges: oscillatory, 3  
CONDON, Edward Uhler, 293, 295, 309, 309n, 414,  
415, 416, 416n, 441n, 462n, 590, 590n 591n, 630,  
695, 703n, 704, 706, 706n, 708, 708n, 709, 710,  
712n, 723, 724n  
CONDON, Edward Uhler: appointed JILA fellow, 630  
"Fellow Emeritus", 630  
Professor Emeritus, 630  
tribute to, 630, 631  
CONES, Harold N., 563  
Conference on Arctic Communication, 1959, 442n, 664  
Conference on Electronic Standards and  
Measurements, 1958, 368, 686, 698  
Conference on High Frequency Measurements:  
biennial conferences, 653  
Conference on High Frequency Measurements, First,  
1949, 684  
Conference on High Frequency Measurements,  
Second, 1951, 685  
Conference on High Frequency Measurements, Third,  
1953, 686  
Conference on High Frequency Measurements,  
Fourth, 1955, 686  
Conference on Non-Linear Processes in the  
Ionosphere, 1963, 428  
Conferences on Precision Electromagnetic  
Measurements, 359  
(International) Conference on Precision  
Electromagnetic Measurements, 1962, 687, 688  
Conference on Precision Electromagnetic  
Measurements, 1964, 689  
Conference on Precision Electromagnetic  
Measurements, 1966, 689  
Conference on Precision Electromagnetic  
Measurements, 1968, 380, 689  
Conference on Precision Electromagnetic  
Measurements, 1972, 689  
Conference on Precision Electromagnetic  
Measurements, 1974, 689  
Conference on Precision Electromagnetic  
Measurements, 1976, 689  
Conference on Radio Noise, Harvard College  
Observatory, 1958, 605n  
Conference on Radio Propagation, CRPL, 1947, 416,  
513, 597  
Conference on Radio Propagation and Standards,  
1954, Boulder, 551, 698, 726  
Conference on Radio Telephony, Department of  
Commerce (*see* First National Radio Conference)  
Conference on Standards and Electronic  
Measurements, 1960, 400, 687, 687n, 690, 691  
Conference on the Limitations of Armaments  
(1921-1922), 657n  
Confidential Bulletin, NBS, 65, 66  
Confidential Bulletin, NBS: purpose of, 65n  
conjugate point, 608, 609, 610n  
conjugate point program, 595n, 607n, 609, 610,  
610n, 611  
conjugate point project, 609, 610n  
conjugate points, 607n, 608, 609n, 610n, 611n  
conjugate point studies: concept, 443n  
CONRAD, Frank (Westinghouse), 120, 181  
Consultative Committee on the Definition of the  
Second, 307  
continental polar air mass: studies of, 523  
control at a distance by radio: first U.S. patent, 8  
COOK, Clarence C., 364, 365, 384  
COOLIDGE, Calvin (President), 15, 153, 647, 663n  
COOMBS, William C., 613n  
cooperative research with universities, 75  
Coordinated Study of Correlation of High Frequency  
Direction-Finder Errors with Ionospheric  
Conditions (NBS Research Project 13.2-92 for  
NDRC), 319  
Coordinated Study of Ionospheric Transmission and  
Direction Errors at High Frequencies (NBS  
Research Project C-13 for NDRC), 318  
Coordinated Universal Time, UTC(NBS), 308  
CORD, Marian S., 620  
correlation between ionosphere and radio  
transmission, 237  
correlation computer, 588n  
COSENTINO, A. T. (Ministry of Interior, Argentina),  
201, 807, 808  
cosmic noise, 595, 597, 598, 598n, 606, 607n, 608n, 613n  
cosmic noise absorption, 598

cosmic noise project, 597  
 cosmic noise research, 513  
 cosmic radio noise, 595, 596, 597, 597n, 598, 598n  
 cosmic radio waves, 597n  
 cosmic ray particles, 607n  
 cosmic ray research: by forward scatter, 444  
 Cosmos I satellite (*see* Ionosphere, upper)  
 COTTONY, Herman V., 441n, 489, 497n, 498n, 557, 563n, 564, 565, 565n, 566, 567, 568n, 570, 597, 615n, 700  
 Council of National Defense, 316  
 Countermeasures Section, Bureau of Ships, 328, 336  
 COX, Richard T., 245, 245n, 248  
 CPEM (Conference on Precision Electromagnetic Measurements): Executive Committee, 690  
 CRAIG, D. Norman, 124  
 CRAM, Ernest R. (Army Signal Corps Radio Laboratory), 33n  
 CRARY, James H., 219  
 CRAWFORD, Myron L., 378  
 credit courses by NBS, Boulder: electromagnetic measurements and standards, 358  
 CRICHLow, William Q., 483, 555n, 557, 559, 559n, 561, 562, 573, 573n, 597, 666  
 critical frequencies: measure of solar activity, 450  
   relation to sunspot numbers, 449  
   variation with sunspot cycle, 449  
 critical frequency, 598n  
 critical frequency: definition of, 209n  
 critical frequency, Jupiter, 606  
 CRITTENDON, Eugene C., 69  
 CROMBIE, Douglass D., 457, 461n, 475, 475n, 477n, 478, 478n  
 CROOKES, William, 5  
 CROW, Edwin L., 700  
 CRPL (*see* Central Radio Propagation Laboratory)  
 CRPL Building, 735n  
 CRPL Exponential Reference Atmosphere, 517, 521, 522  
 CRPL News: a monthly paper, 416  
 CRPL Radio Warning Service, 601  
 CRUZ, Jose E., 469  
 Cryogenic Engineering Conference, 1954, Boulder, 726  
 Cryogenic Engineering Division, 725  
 Cryogenic Engineering Laboratory, 716n  
 cryogenics laboratory, 715  
 crystal detectors, 4  
 crystal detectors: study in WW I period, 62  
 CULSHAW, William, 621, 683n, 700  
 CURIE, Jacques and Pierre, 5  
 current standard: RF, electrodynamic type, 380  
   RF, electrodynamic type, improved, 380  
 CURTIS, Harvey L., 695, 695n  
 CURTISS, Leon F., 122  
 CXFD equipment: development of, 328  
   flight testing, 328, 330  
   limitation today, 330  
   operational requirements, 329  
   tactical operation, 328  
 CXJX equipment: radar jammers, 331, 332, 333  
   radar reflectors, 331, 332  
   simulated search radar, 331, 332  
 Cygnus, 595, 597  
 Cygnus-A, 603, 605  
 cylindrical shock waves from exploding wires, 626  
 Cytac navigation system: defined, 573n  
   study of, 573

## D

*Daily Camera*, Boulder, 712, 725n, 728  
 DALKE, John L., 391, 392, 392n, 394  
 DALLMAN, O. Russell, 725  
 DANIEL, Frances T., 581  
 DANIELSON, Bruce L., 634, 634n  
 data processing: expanded program by computers, 587  
 Data Reduction Instrumentation Section, 588  
 data reduction systems, 587  
 DAVIES, Kenneth, 436, 458, 458n  
 DAVIS, Dicky D., 290n, 292  
 DAVIS, Robert M. Jr., 425  
 DAVIS, Thomas L., 574  
 DAY, Gordon W., 634, 634n  
 DAYHOF, Edward S., 622  
 DAYWITT, William C., 382, 383  
 DECKER, Martin T., 538, 547, 576, 583, 585, 585n, 614  
 decremeter: direct reading, by Kolster, method described, 105n  
   Kolster, direct-reading, 11, 41, 42, 104, 105, 643, 679, 680  
 decremeter, Kolster Type B, 244  
 decremeter and wavemeter, combination, 643  
 Dedication Program Committee, Boulder Laboratories, 726  
 Defense, Department of, 655  
 Defense Atomic Support Agency (DASA), 460n  
 Defense Research Telecommunication Establishment, 609n  
 Definitions and Standards Committee, CCIR, 661  
 de FOREST, Lee, 9, 10, 10n, 11, 17, 172  
 DELLINGER, J. Howard, 29n, 38, 48, 49n, 52, 53, 54, 54n, 57, 58, 61, 63, 65, 69n, 71, 73, 82, 88, 90, 91, 92, 93, 95, 95n, 96n, 100, 103, 106, 110, 115, 117, 118, 150n, 152n, 153, 159, 161n, 171, 176, 176n, 180, 181, 181n, 182, 182n, 183, 186, 187, 188, 193, 194, 200, 201, 202, 221, 222, 222n, 223, 224, 225, 230, 231, 233, 236n, 237, 241, 243, 244, 245n, 249, 254, 263, 265, 316, 317, 340, 380, 389, 403, 403n, 405n, 406, 406n, 412, 414, 415n, 416, 416n, 432, 441n, 451n, 465, 470, 563, 576n, 578n, 584, 584n, 644, 645, 645n, 647, 647n, 648, 649, 650, 651, 652, 653, 657n, 658n, 659; 660, 661, 662, 662n, 663, 663n, 666, 666n, 668, 668n, 669, 670, 670n, 671, 672, 672n, 676, 676n, 679, 679n, 680, 680n, 681, 681n, 682, 682n, 683, 683n, 695, 695n, 703, 704, 727n, 737n, 807, 808  
 DELLINGER, J. Howard: addresses NBS staff, demonstration lecture on radio, 1920, 78  
   assignment to Electricity Division, 39  
 DELLINGER, J. Howard: biographical sketch, Appendix D  
   address, NBS 60th Anniversary, 795  
   Aeronautics Branch, Department of Commerce, 788  
   at George Washington U., 783  
   at Princeton U., 784  
   at Western Reserve U., 782  
   biographical citations, 793  
   broadcasting interests, 787  
   boyhood years, 782  
   calibration of wavemeter, NBS first, 783  
   Central Radio Propagation Laboratory (CRPL), chief, 789  
   Civil Service appointment, 782  
   death, 791

- "Dellinger effect" (SID), 788  
 enters NBS, 782  
 Federal Radio Commission (FRC), chief engineer, 787  
 Institute of Radio Engineers (IRE), participation,  
     president, 792  
 Interdepartment Radio Advisory Committee (IRAC),  
     participation, 787  
 International Radio Consultative Committee (CCIR),  
     participation, 792  
 International Scientific Radio Union (URSI),  
     participation, 791  
 Interservice Radio Propagation Laboratory (IRPL),  
     chief, 789  
 marriage, 783  
 moon crater, named to honor Dellinger, 792  
 National Radio Conferences, participation, 787  
 patent policy viewpoint, 793, 793n  
 professional record, self-noted, 781n  
 publications, early, 784  
 publications, partial listing, 783n  
 publications, self-listing, 792  
 radio, career, viewpoint of, 794n  
 radio, predictions, 782n  
 radio astronomy, prediction, 794, 794n  
 Radio Section, chief, 786  
 Radio Technical Commission for Aeronautics (RTCA),  
     participation, 789  
 retirement, 791, 791n  
 social activities, NBS, early, 784  
 television, predictions, 782n  
 traits, 794  
 work assignments, early, NBS, 784n  
 WW I activities, 785
- DELLINGER, J. Howard: chief engineer of Federal  
     Radio Commission, 95  
     "Credo," of administration of Radio Section, 75  
     doctoral dissertation, RF ammeters, 43n  
     first NBS calibration of radio instrument, 40  
     lectures and writings of mid-1920's, 95  
     reports on personnel losses, FY 1920, 73  
     viewpoint, on employment of radio staff, 1922, 74  
     viewpoint, relation of radio work to government, 70  
     viewpoint in 1922, by chart, 70  
     word change, "wireless" to "radio", 43n  
 "Dellinger effect" (*also, see* sudden ionosphere  
     disturbance), 222  
 Dellinger Gold Medal (URSI), 676, 676n  
*Dellinger Memorial Lecture* (URSI), 676  
 DeMARS, P. A., 206  
 Denver Research Institute, 518  
 Department of Commerce, 345, 643, 644, 647, 649, 733,  
     735, 736, 736n, 737  
 Department of Commerce: Aeronautics Branch, 93  
     Executive Committee on Aeronautical Radio, 91  
     Liaison Committee on Aeronautical Radio  
         Research, 91  
     Special Committee on Air Transport Radio, 91  
     Supervisors of Radio, 111  
 Department of Commerce and Labor: two new  
     departments, 42n  
 Department of Commerce Conference on Radio  
     Telephony (*also, see* National Radio Conference), 94  
 Department of Commerce Conference on Radio  
     Telephony, Technical Committee, 94  
 Department of Commerce Science and Technology  
     Fellowship Program, 697  
 Department of Defense, 343, 347, 352, 354, 355  
 destructive interference in microwave  
     transmission, 514  
 detection factor, 108  
 detector: two-element vacuum tube, U.S. patent, 10  
 deuterated ammonia, 619  
 DEUTSCH, Ralph, 331, 334, 345  
 development of wireless telegraphy: Nobel Prize in  
     Physics, 1909, 10  
 Dewey Decimal Classification: of Radio Section  
     documents, 89  
     of radio subjects, 89  
 Dew Line, 2  
 DIAMOND, Harry, 93, 110, 123, 123n, 124, 128, 131, 132,  
     133, 136, 137, 155, 156, 157n, 159, 165, 165n, 166,  
     167n, 317, 319, 319n, 320n, 321, 470n, 511, 572, 648,  
     648n, 649, 652, 661  
 diathermy generators, 343  
 dielectric constant: measurement of, 106  
 dielectric loss: measurement of, 106  
 dielectric properties: development of a radio frequency  
     permittimeter, 391  
     fallout from "Phantom" project, 389  
     international comparison, 391  
     measurement with coaxial-type re-entrant cavity  
         resonators, 391  
     of petroleum deposits, 391  
 dielectrics: measurement of mechanical properties, 107  
 Differential Phase Variation of Low Frequencies  
     project, 576, 577  
*DIMENSIONS/NBS*, 66  
*DIMENSIONS/NBS*: a viewpoint, 66n  
 direction finder: tests with lighthouse tender *Tulip*,  
     1920, 139  
 Direction-Finder Committee, NDRC, 316, 317  
 direction-finder errors: correlation with ionospheric  
     conditions, 404  
 direction-finder projects, with NDRC, 404  
 direction finders: interest by Navy, 44  
     WW I development, 57  
 direction-finder system: Bureau of Standards system,  
     140, 145  
     tests, 1919, Chesapeake Bay, 140  
     tests, 1921, Lower New York Bay, 144  
 direction finding, by radio, 643  
 directive radio beacon: crossed-coil antenna, 150  
     (*see* air navigation system)  
 Director, NBS, 99  
 direct reading decimeter and wavemeter, 11  
 DISNEY, Robert T., 559  
 distance ranges for radio transmission: charts, 197  
 distress signal by wireless: first, 8  
 distribution analyzer, 588n  
 DITZEN, Robert W. (architect), 713  
 D layer: early observations by Radio Section, 229  
     initial findings by Smith and Kirby, 426  
     multiple layers, 426  
     observed by vertical-incidence reflection, 426  
 DOHERTY, Robert H., 461, 574  
 DOLBEAR, Amos E., 5  
 DOOLITTLE, James H. (Army Air Service), 159  
 DORSEY, N. Ernest, 99  
 DOUGHERTY, Harold T., 534, 535  
 Draconid meteors: observation by radar, 462  
 Drafting Committee, CCIR, 660  
 D region: characteristics of, 426, 426n  
 DUDELL, William D., 8  
 DULK, George A., 606, 606n  
 DUNBAR, Felix H., 626  
 DUNCAN, R. D., 48, 103

DUNMORE, Francis W., 71, 71n, 84, 84n, 85, 86, 87, 88, 93, 110, 117, 118, 119, 120, 124, 126, 126n, 127, 128, 131, 132, 140, 144, 145, 146, 147, 150, 150n, 151, 152, 152n, 153, 153n, 157, 157n, 159, 161n, 166, 167, 167n, 247, 265, 321, 323n, 326n, 327, 470n, 511, 563, 572, 649  
DUNN, Gordon H., 630n  
DUNWOODY, H. C., 10  
DUTTON, Evan J., 517, 520n

## E

*Eagle*, lunar module, 614  
ear: as a measuring device, 109  
early publications on radio: by NBS, 679  
EARNSHAW, Kenneth B., 626  
Earth, 521, 608, 613n, 614, 615, 638, 639, 640, 674, 675  
Earth Currents and Polar Lights Committee, AGU, 653  
earth-movement detectors, 632  
Earth's curvature: effect on distant transmission, 238  
Earth's magnetic field: effect on radio transmission in ionosphere, 239  
earth-space communication, 615  
earth-space radio propagation, 615  
Earth vibrations: detection of, 632  
EASTON, Ivan, 686, 687  
ECC (see Electronic Calibration Center)  
ECCLES, W. H., 11, 172  
Echo Lake Cosmic Ray Symposium, 1949, 706  
ECKERSLEY, T. L. (England), 172, 485  
ECKLUND, Warner L., 388  
eclipses and ionosphere: April 7, 1940, annular eclipse observed at Fort Clark, Texas, also at Meadows field station, 217  
April 28, 1930, eclipse observed at Kensington field station, 216  
August 31, 1932, eclipse observed at Washington, D.C. and Sydney, N.S., 216  
February 3, 1935, eclipse observed at Washington, D.C., 217  
January 24, 1925, eclipse, Radio Section observed radio transmissions, 216  
July 20, 1963, eclipse observed at Hanover, New Hampshire, 219  
June 19, 1936, eclipse observed at Washington, D.C., 217  
June 20, 1955, total eclipse observed at Baguio, Philippines, 219  
May 20, 1947, total eclipse observed at Bucaiuva, Brazil, 218, 219  
October 1, 1940, total eclipse observed at Patos, Brazil, 217  
October 12, 1958, total eclipse observed on Danger Islands (Pacific), 219  
September 10, 1923, eclipse observed by Austin, 216  
September 11, 1950, total eclipse observed on Attu Island, 219  
EDISON, Thomas A., 5, 5n  
EDISON, Thomas A.: comment on book, 54  
Edison effect, 5  
Educational Committee, Boulder Laboratories, 696, 696n  
effective efficiency (of bolometer units): defined, 374n  
EHRET, Cornelius D., 8  
EISENHOWER, Dwight D. (President), 726, 728, 729n, 732  
E layer: research on, 428  
Elco Division, Electric Boat Co., 336  
Electrical Communication, division of OSRD, 316  
electrical parameters of quartz plates: measurements of, 339  
electrical quantities, 100  
electric current: magnetic properties, 2  
electric hygrometer: NBS designs, 126n  
Electricity (Electrical) Division, 99, 100, 101, 352, 355, 395, 681  
electrochemical recording telegraph, 3  
electrolytic detector: U.S. patents, 7, 9  
electrolytic detectors, 31  
electromagnetic characteristics of materials (see EM characteristics of materials)  
electromagnetic induction, 3  
Electromagnetic Measurements and Standards Course, 696  
Electromagnetic Metrology Current Awareness Service, 360  
Electromagnetic Metrology Information Center, 359  
Electromagnetic Metrology Information Center: document file, 360  
literature searches, 360  
electromagnetic propagation, 735  
electromagnetic radiation from plasmas, 626  
Electromagnetics Division, 343, 355, 356, 356n, 383  
electromagnetic spectrum, 736  
electromagnetic theory of light, 3  
electromagnetic waves: experimentally verified, 5  
fundamental concept by Maxwell, 4  
*Electromagnetic Waves in Stratified Media*: a treatise by Wait, 428, 479n  
electron density: profiles, 435, 437, 439  
electron paramagnetic resonance, 633  
electron precipitation, 445  
electron tube: for current measurement, 103  
measurement of voltage amplification, 109  
electron tube characteristics: manufacturer's data used after 1924, 108n  
electron-tube detector: Bureau *Circular*, 81  
electron tubes: measurement of properties, 107  
papers, published and unpublished, WW I period, 60, 61  
power loss study, 61  
properties of, 108  
standards for, 652  
"standard" types, 649  
study by NBS during WW I, 60, 61  
study in post-WW I period, 71  
testing of, 649  
Electronic Calibration Center, 259, 347, 351, 354, 355, 358, 365, 371, 377, 380, 384, 395, 399, 698, 716n, 735  
Electronic Calibration Center: computer operations, 356  
dedication, 352, 687  
facilities, 353  
financial support, 355  
first calibration performed, 352  
functional operation phased out, 355  
magnitude of operation, 1958-1974, 355  
Electronic Computers Section, 586n  
electronic systems seminars: space and missile equipment, 358  
Electronics Division, 586  
Electron Tubes Subcommittee, American Engineering Standards Committee, 652  
ELF propagation: attenuation, 478  
ELF Symposium, 1960, 475  
ELLENWOOD, Robert C., 112, 345, 368, 368n  
ELLERBRUCH, Doyle A., 389

ELLYETT, Clifton D., 425, 427, 427n  
 ELWELL, Lyman B., 634  
 EM characteristics of materials: early studies, 389  
   "Phantom" project, 389  
 EM Fields and Antennas Section, 386  
 Enabling Act, March 3, 1901, NBS, 29  
 Energy Spectrum Recorder: NBS, 562  
 ENGEL, Francis H., 118, 120, 149, 150, 150n, 151, 152,  
   153, 247, 572  
 ENGEN, Glenn F., 357, 366, 369, 374, 375, 376, 376n,  
   399, 673  
*Engineering Aspects of Television Allocations: a report  
 to FCC*, 585  
 Engineering Division, Federal Radio Commission, 645  
 ENIAC, 19  
 Environmental Research Laboratories, 737  
 Environmental Science Services Administration  
   (ESSA), 171, 409n, 419, 439, 453, 504, 512, 555, 561,  
   662, 675, 677, 733, 733n, 735, 736, 737  
 ephemeris time: defined, 307n  
 Ephi: defined, 592  
   direction-finding system, 592  
 equation for radio refractive index: computation, 518  
 equatorial electrojet: definition, 447n  
 equivalent black-body radiation, 597  
 ERICKSON, Howard H., 605  
 ERIKSEN, K. W., 609  
 ESAKI, Lee, 22  
 Espenshied-Affel coaxial cable: patent, 16  
 ESSA: establishment by Presidential Order, 735  
 ESSA NEWS, 733n  
 ESSA Research Laboratories (ERL), 735, 736, 737n  
 ESSEN, Louis, 686  
 ESTIN, Arthur J., 382, 723n  
 Evans Signal Laboratories, 20  
 EVENSON, Kenneth M., 633, 634, 634n  
 EWEN, H. I. and PURCELL, E. M., 21  
 excitation of multiply charged ions: measurements  
   of, 630  
 Executive Order 10096: patents, 96  
 exosphere, 595n, 607, 608, 610n, 611, 611n, 612, 612n  
 exosphere: defined, 437n  
 exosphere physics, 611  
 Exosphere Project, 611, 612  
 Experimental Ionospheric Research Section, 471, 555,  
   557, 563, 595, 597, 598, 598n  
 Experimental Microwave Research Section, 512  
 Explorer I, 22, 675  
 Explorer series of satellites, 24  
 Explorer XX (see Ionosphere, upper)  
 Extraordinary Administrative Radio Conference for  
   Space Telecommunications, 1963, 665  
 Extraordinary Administrative Radio Conference for the  
   Aeronautical Service, 1964, 584, 665  
 extraterrestrial, 595, 607n  
 extraterrestrial noise, 603, 607n  
 extraterrestrial noise absorption, 608  
 extraterrestrial radio noise, 603  
 extraterrestrial radio waves, 608  
  

**F**

 Fabry-Perot interferometer: laser adaption, 633  
 Fabry-Perot interferometer, microwave, 622  
 facsimile recording: basic principles established, 3  
 facsimile transmission, 1  
 fadeouts of radio signals, 538  
 fading: an early publication by NBS, 1921, 181  
   a newspaper account by Dellinger, 1925, 182, 182n  
   a variety of observations, 1925, 1926, 186  
   conditions affecting distance range, 182  
   early tests over short distances, 1919, 180  
   large-scale cooperative testing program of 1925, 183  
   NBS-ARRL tests, general conclusion reported, 181  
   NBS-ARRL tests, patterns of fading, 181  
   NBS-ARRL tests, 1920-1921, 180  
   observations in Greenland region, 1923-1924, 180  
   observations under conditions of total solar eclipse,  
     January 24, 1925, 186  
   of radio signals, 180  
   tests of 1925, conclusions, 186n, 187n  
 fading of radio signals: cooperative program, Radio  
   Laboratory and American Radio Relay League, 93  
 fading phenomena, 538  
 fading range: defined, 539  
 FALLER, James E., 638, 639  
 FARADAY, Michael, 3, 4n  
 FARLEY, Donald T. Jr., 460  
 FARNSWORTH, Philo, 15  
 Fayetteville, Ark., receiving site, 530, 531  
 FCC Ad Hoc Committee: frequency allocation, 584  
   study of VHF propagation, 580, 581  
 Federal Airways System, 153  
 Federal Bureau of Investigation, 269  
 Federal Communications Commission (FCC), 18, 20, 21,  
   23, 131, 512, 513, 516, 580, 591n, 644, 646  
 Federal Communications Commission (FCC): color  
   television problems, 590  
   successor to Federal Radio Commission, 17  
   Federal Government, 736, 737  
 Federal Radio Commission, 91, 95, 96, 253, 645, 645n, 646  
 Federal Radio Commission: "kilohertz" introduced, 264  
   minimizing radio interference, 252  
   Order of Sept. 7, 1928, 645  
   renamed Federal Communications Commission,  
     1934, 95  
   tight control on assigned frequencies, 1932, 253  
 Federal Specifications Board, 649, 649n  
 Federal Specifications Board, Committee on Radio  
   Apparatus, 91  
 Federal Specifications Board, Technical Committee on  
   Radio Apparatus, 649  
 FEINSTEIN, Joseph, 465, 466, 466n, 474n, 551, 600, 600n  
 FELDMAN, Albert A., 363, 363n  
 FERRIE, Gustave (General), 667  
 ferrites: definition, 392n  
   investigation of, 392  
 FESSENDEN, Reginald A., 8, 8n, 9, 9n, 10, 33n, 470  
 FEY, R. Lowell, 280n, 292, 301  
 field intensity measurement equipment: calibration at  
   VHF, 112  
 field intensity measurements: 1920's through WW II,  
   general, 111  
 field intensity measuring set: for Radio Section, 111  
   for Supervisors of Radio, Department of  
     Commerce, 111  
 field strength meter: development of calibration  
   methods, 111  
   for near-zone measurements at high levels, 385  
 field strength meters, 579  
 field strength meters: calibration by standard-antenna  
   method, 384  
   calibration by standard-field method, 384  
   development for FM and TV bands, 347  
   early calibration service, 384  
 field strength recorder: GS-4 model, 579, 579n



FINN, M. E., 48  
 FINNEY, James W., 483n  
 first American radio company, 8  
 first broadcast for entertainment: 1906, 10  
 first commercial picture across Atlantic via radio, 15  
 First Conference on High Frequency Measurements, 295, 348  
 first crystal-controlled radio transmitter, 14  
 first FM transmitter: for scheduled broadcasting, 18  
 First Inter-American Radio Conference (1937), Second, Third, Fourth, 666  
 First International Space Science Symposium, 1959, 664  
 First National Radio Conference, 13, 644, 647  
 first presidential radio broadcast, 13  
 first radar "discovery", 13  
 first transatlantic transmission of photograph via radio, 14  
 first two-way messages across Atlantic: by amateurs, 14  
 Five-Power Preliminary Telecommunications Conference, 1946, 659  
 flash-over voltage: measurement, 107  
 F layer: research on, 428  
 F<sub>1</sub> layer: discovery, 20n  
 FLEMING, John Ambrose, 10  
 Fleming valve, 10  
 FLORMAN, Edwin F., 133, 133n, 134n, 437n, 480, 576, 578, 578n  
 Fort Belvoir Radio Propagation Field Station, 453, 455n  
 Fort Carson transmitter, 528  
 forward scatter: early evidence of, by others, 485  
     observations along geomagnetic equator, 498  
 forward scatter communication: at various frequencies, 492  
     blackouts, 493  
     comprehensive publication, 495  
     distance experiment over water, 489  
     distance experiments, 489  
     extended observations, 488  
     initial experiment by NBS, 1951, 486  
     problems of publication, 494  
     replaced, by aid of satellites, 498  
     studies at high latitudes, 489  
     successful system, one-way, 491  
     successful system, two-way, 491  
     summary of a published review, 496n  
     transmission explained, 496  
     two-way system 16-channel operation, 492  
     with various antennas, 489  
 Fourth National Radio Conference: Committee No. 1, General Allocations of Frequency, Dellinger a member, 95  
 Fourth National Radio Conference: Committee No. 7, Interference, Jolliffe a member, 95  
 Fourth Symposium on Cosmical Gas Dynamics, 624  
 FRAZER, Donel N., 480  
 FREATHY, Frank E., 519n  
 FREDERICK, Nolan V., 380, 392, 393, 394  
 FREEMAN, Herbert M., 244, 248, 248n  
 FREEMAN, Jacob J., 326, 327, 334, 345, 362, 362n, 381, 381n, 382, 696  
 F-region irregularities, 605  
 French Mission of 1917: electron tubes, 107  
 French Scientific Commission (or Mission), 1917, 60  
 frequency: nature of, 243  
 Frequency and Time Seminar, 1968, 699  
 frequency-band nomenclature: by Atlantic City Radio Convention, 1947, 470n  
 frequency comparisons: international, by direct radio transmissions, 1924, 254  
 frequency control: by quadrupole absorption spectra 298  
 frequency gap closed: in submillimeter range, 24, 24n  
 Frequency Maintenance Committee, CCIR, 660  
 frequency measurement: by Lecher-wire system, 247  
     early improvements in techniques, 245  
 frequency measurements: international comparisons 1925-1927, 254  
 frequency meter: Bureau of Standards Type N, quartz crystal, 251  
 frequency meters (quartz crystal): an expanded test schedule, 252  
 frequency-modulation system: complete, 17  
 frequency-modulation transmitter: 40-kW, 18  
 frequency monitoring of radio stations: a project of Radio Section, 1923, 263  
 frequency monitors: advanced type, a new test program by Radio Section, 253  
 frequency range of radio waves, 1  
 frequency spectrum: efficient use of, 585  
 frequency spectrum utilization, 578  
 frequency spectrum utilization: computer techniques, 586  
 frequency stability of signal sources: measurement of, 259  
 frequency standard: ammonia, 620  
     by use of cathode-ray oscillograph, 246  
     by use of harmonic amplifier, 246  
     portable type, advanced design by Morgan, 253  
     portable type, advanced design by Sulzer, 253  
     precision LC-circuit meters used in 1920's, 248  
 frequency standards: quartz crystal, cooperative program with other laboratories, 253, 254  
 Frequency-Time Broadcast Services Section, 292  
 Frequency-Time Dissemination Research Section, 289, 290, 292  
 Frequency-Time Standards Section, 258, 306, 308  
 Frequency Utilization Research Section, 515, 555, 555n, 557, 571, 573, 583, 584  
 Frobisher Bay, Baffin Island, 610n  
 FROST, Robert T., 610n  
 FULLER, Leonard F., 172  
 FULLER, Vivian L., 515

## G

GAINEN, Leon, 581  
 galactic noise, 595n, 607n  
 galactic radio noise, 595, 597, 597n  
 GALLET, Roger M., 429, 429n, 480, 481, 482, 485, 587n, 605, 605n, 606, 606n, 609n, 611, 611n, 612, 625, 665  
 Garden City, Kans., receiving site, 530, 531  
 GARDNER, F. G., 156  
 GATES, David M., 485, 706n  
 GATTERER, Lawrence E., 290n, 292  
 GAUSS, Karl, 171  
 GAUTIER, Thomas N. Jr., 410n, 412, 441n, 456, 456n, 457, 457n, 462, 474, 584n, 664, 666, 700  
 GEISSLER, Heinrich, 4  
 General Allocations of Frequency Committee, National Radio Conference, 1925, 644  
 General Conference on Weights and Measures, 12th, 1964, 307  
 General Conference on Weights and Measures, 13th, 1967, 24, 267, 307  
 General Conference on Weights and Measures, 15th, 1975, 637  
 geodesy, 735

- geomagnetic micropulsations, 612  
 geomagnetism, 735  
 Geophysical Institute, University of Alaska, 607  
 GEORGE, William D., 233, 253, 253n, 260n, 269, 270,  
 271, 272n, 280n, 285, 292, 334, 339, 345, 349, 361,  
 475n, 649, 672  
 GILLILAND, Theodore R., 93, 201, 202, 203, 203n, 204,  
 204n, 205, 205n, 206, 208, 209, 209n, 211, 211n, 212,  
 215, 216, 217, 226, 227, 231, 231n, 232, 236, 237, 238n,  
 240, 241, 318, 412, 421, 421n, 422, 422n, 433n, 449,  
 659, 661  
 GILLMOR, C. Stewart, Jr., 608, 609  
 GILMAN, Esther, 259  
 GLADDEN, Sanford C., 433n  
 G layer: observations by Radio Section, 229, 428  
 GLAZE, David J., 301, 303, 305, 309  
 Global Positioning System (GPS), 306  
 GLOVER, Francis N., 425n  
 Goddard Space Flight Center Communications  
 Center, 616n  
 GOERKE, Vernon H., 219, 598n, 601, 601n, 603  
 GOLDSMITH, Alfred N., 19  
 Goldstone Tracking Station, 22  
 GORDON, W. E. (Cornell University), 436, 437n  
 GRACELY, Frederick R., 201, 225, 225n, 226, 412  
 Graduate School, Boulder Laboratories, 696  
 Graduate School, National Bureau of Standards,  
 695, 695n  
 GRANTHAM, Rodney E., 362, 362n  
 graphical determination of radio ray bending, 522  
 "Grasshopper" (*see* automatic weather station,  
 air-launched)  
 GRAY, James E., 308  
 Great Whale River, Hudson Bay, 610n  
 GREEN, John L., 439  
 GREENE, Frank M., 345, 384, 385  
 GREENHOW, Charles R., 382  
 GREENSTONE, Reynold, 458  
 GROSS, Gerald C., 645, 645n, 647n  
 ground antennas: 59n  
 ground conductivity: correlation with type of soil, 589  
 early observations by Radio Section, 589  
 effect on LF and VLF propagation, 589  
 GROVER, Frederick W., 53, 53n, 100, 102, 122, 122n  
 Guggenheim Fund for Promotion of Aeronautics, 159  
 guided missile: automatic, first, 20  
 guided missiles, 316  
 Gunbarrel Hill, 599  
 GUNN, J. B., 23

## H

- HAAS, Peter H., 380, 391, 392, 392n  
 HAKKARINEN, William, 131, 137, 138, 138n, 323  
 HALFORD, Donald W., 301, 308  
 HALL, Elmer L., 106, 112, 233, 248, 248n, 257, 265, 269,  
 339, 343, 389n, 653, 661  
 HALL, John L., 631, 631n, 634, 634n, 636  
 HAMILTON, Wallace F., 290, 292  
 Handbook for CRPL Ionospheric Predictions Based on  
 Numerical Methods of Mapping: *NBS Handbook*  
*90*, 429, 441  
 HANDS: Project VELA of Advanced Research Projects  
 Agency, 461n  
 HANDS project: detection of nuclear explosions, 461  
 HANSON, D. Wayne, 290  
 HANSON, Rodney A., 588  
 HARDING, Warren G. (President), 13  
 HARDING, Wesley B., 445  
 HARGREAVES, John K., 443, 608, 609, 610, 610n, 611  
 HARMON, H. F., 118n  
 HARPER, John D. Jr., 587n  
 HARRINGTON, Mary B., 412  
 HARRINGTON, Robert D., 392, 394  
 Harry Diamond Laboratories, 320n  
 Harry Diamond Memorial Award, 320n  
 HARTMAN, William J., 547, 585, 585n, 614  
 HARTSFIELD, William L., 436  
 Harvard College Observatory, 451n  
 Harvard University, 19  
 Harvard University: cooperative effort with NBS, 306  
 HARVEY, Morris E., 374  
 Haswell, Colo., receiving site, 530, 531  
 HAULER, Arthur R., 628n  
 Hawaiian Observatory, for LURE program, 640  
 HAYDON, George W., 584n, 585, 585n, 586, 588, 588n,  
 613, 614n, 660n, 665  
 HAZELTINE, Louis A., 13  
 HAZEN, Grace, 246, 246n, 249  
 headphone receiver: measurement by, 109  
 HEATON, Vincent E., 233, 252, 252n, 253, 257, 258,  
 258n, 260n, 269, 270n, 275n, 345  
 HEAVISIDE, Oliver, 9, 35, 172  
 HEBERLING, Emory D., 298, 326, 327, 345  
 HEFLEY, Gifford, 573, 575n, 592  
 height of ionosphere: first measurements, by  
 Gilliland, 93  
 HEILPRIN, Lawrence, 412  
 HEINARD, Whilden G., 381  
 helium-neon laser, 634, 635  
 HELLIWELL, R. A. (Stanford University), 481  
 HELLWIG, Helmut W., 303, 306, 308  
 HENRY, Joseph, 3  
 HERBSTREIT, Jack W., 441n, 513, 515, 527, 527n, 540,  
 540n, 555n, 573, 583, 584, 584n, 585, 585n, 597,  
 597n, 614, 615n, 662n, 664, 665, 672, 683n, 723, 733  
 HERTZ, Heinrich, 1, 5, 5n, 29  
 Hertz (Hz): definition, 243  
 derived unit, 5n  
 HESS, Alfred E., 369  
 heterodyne reception, 8n  
 heterodyne reception: early U.S. patent, 8  
 HF Impedance Standards Section, 397  
 High-Altitude Nuclear Detection Studies  
 (HANDS), 461  
 high-altitude nuclear tests, 608  
 High Altitude Observatory, 451, 451n, 604n, 606,  
 623n, 624  
 high-energy blast waves, 626  
 high frequency alternator, 9, 9n  
 high frequency alternator: frequency standard, 244  
 high frequency ammeters, 679  
 High Frequency and Microwave Attenuation  
 Seminar, 1968, 699  
 High Frequency and Microwave Field Strength  
 Seminar, 1966, 699  
 High Frequency and Microwave Noise Seminar,  
 1966, 699  
 High Frequency Broadcasting Conference, 584n  
 High Frequency Broadcasting Conference  
 (1948-1949), 664  
 High Frequency Broadcasting Conference (1950), 664  
 High Frequency Calibration Services Section, 354n  
 High-Frequency Direction-Finder Research: NBS  
 wartime project, 317  
 High Frequency Electrical Standards Section, 388

High Frequency Measurements Subcommittee, AIEE, 653  
 high-frequency radio telephone broadcasting: an investigation for the FBI, 1935-1936, 232  
 High Frequency Standards Section, 260, 292, 345, 349, 367, 369, 378, 380, 381, 391, 695  
 High Frequency Unit of ECC, 351  
 High Latitude Ionospheric Physics Section, 609  
 high-speed framing-type camera, 626  
 high-velocity shock wave, 626  
 HINDS, Martha, 429n  
 HINMAN, Wilbur S. Jr., 110, 124, 124n, 128, 131, 136, 137, 159, 166, 319, 319n, 320n, 321, 648, 648n, 683n  
 hiss, 611, 612  
 hiss: a VLF emission, 480  
 hiss recorder, 480  
 HOER, Cletus A., 367, 394, 397  
 HOLT, Donald R., 388  
 HOMAN, Donald M., 397  
 HONEA, Leo W., 219, 275n, 282, 285  
 Honor Award Program: Department of Commerce, first, 295  
 HOOVER, Herbert (Secretary of Commerce), 15, 69, 94, 94n  
 HOOVER, Herbert (Secretary of Commerce): Fourth National Radio Conference, opening address, 95  
 HOOVER, Herbert: Secretary of Commerce, 153n, 644, 647  
 HORN, James D., 522, 523  
 HORNBACK, Charles E., 461  
 HORNBERG, Kenneth O., 527n  
 hot summer, 1954, 725  
 hourly median transmission loss, 515  
 HOUSE, L. L., 624  
 HOWE, David A., 309  
 HOWE, H. Herbert, 474, 474n  
*How Radio Is Received*, Ould, 91  
 Huancayo Observatory, 456, 456n  
 HUBBARD, Henry D., 342, 342n  
 HUDSON, Paul A., 377, 378, 388, 388n  
 HUFFORD, George, 551  
 HUGHES, David E., 5  
 HULL, Albert W., 12, 15n  
 HULL, Albert W. and WILLIAMS, N. H., 15  
 HULL, Lewis M., 54, 61, 64, 246, 680n  
 HULL, Ross, 17  
 HUND, August, 110, 250, 250n, 252, 257  
 HUNTLEY, Leslie E., 369, 371, 400  
 HUNTOON, Robert D., 280n, 724n  
 HURLBURT, Everett H., 368  
 HUSTEN, Benjamin F., 258, 298, 298n, 345  
 HUTCHINSON, Henry P., 441n  
 hydrogen-cyanide laser, 636  
 hydrogen maser: transition frequency determined, 306  
 hydrology, 735

## I

IBM Automatic Sequence Controlled Calculator, 19  
 iconoscope: patent, 14  
 IEEE Professional Group on Electromagnetic Compatibility—Instrumentation and Measurements, Boulder-Denver Chapter, 700  
 IEEE Professional Group on Vehicular Technology, Boulder-Denver Chapter, 701  
 IEEE Standard for Precision Coaxial Connectors, 400  
 ignition noise: of aircraft engines, 156  
 IGY Alert, 455

IGY noise program, 559, 561  
 IGY program, 607, 608  
 IGY program: airglow studies, 484  
   automatic ionosphere recorders, 482n  
   forward scatter experiments in the Antarctic, 483  
   forward scatter experiments near geomagnetic equator, 483  
   ionosphere studies in Antarctic, 482  
   NBS operation of vertical sounding stations, 482  
   operation of IGY World Warning Agency, 484  
   observations of Sputnik I, 484  
   prediction service improvement, 431  
   preparation of *IGY World Instruction Manual*, *World Days and Communications*, 484  
   preparation of International Geophysical Calendar, 484  
   preparation of *IQSY Manual for World Days Program*, 485  
   procurement of Model C-4 ionosondes, 482  
   publication "explosion", 485n  
   signals across geomagnetic equator, 446  
   sporadic E studies, 483  
   true height electron density study, 483  
   World Data Center for airglow, at Boulder Laboratories, 484  
   worldwide noise program, supervised by NBS, 483  
 IGY Warning Messages, 455n  
 IGY World Data Centers, 675, 675n  
 IGY World Days program, 674  
 IGY World Warning Agency at Ft. Belvoir, 455, 484  
 impedance measurement: by modified reflectometer technique, 369  
   by three-arm junction with adjustable termination, 368  
   by three-arm waveguide junction, 368  
   importance of, 367  
   slotted-line method, 367, 371  
   with reflectometer wholly of coaxial components, 369, 371  
 impedance standards: of the in-between frequency range, 371  
 impedance standards of lumped parameters, 369  
 incoherent scatter technique, 611  
 inductance, 101  
 inductance: formulas for, 101  
 Inductance and Capacity Section, 39n  
 inductive voltage dividers, 396  
 inductors: standard, 101  
   standard, Bureau of Standards design, 102  
   standard, use of, 102  
 "Industry Calibration Survey," by Quality Control Committee, AIA, 349  
 information to Armed Services: by IRPL and CRPL, 648  
 information via *NBS Circulars*, 81  
 In-house Symposium on Plasma and Astrophysics, 1960, 699  
 Institute for Atmospheric Sciences, 733, 733n  
 Institute for Earth Sciences, 733, 733n  
 Institute for Laboratory Astrophysics, Joint (JILA), 718  
 Institute for Oceanography, 733, 733n  
 Institute for Telecommunication Sciences (ITS), 453, 736, 737  
 Institute for Telecommunication Sciences, National Telecommunications and Information Administration, 512  
 Institute for Telecommunication Sciences and Aeronomy (ITSA), 733, 733n, 735

- Institute of Electrical and Electronic Engineers (IEEE), 645, 653, 654
- Institute of Radio Engineers (*also, see* IRE), 38, 92, 348, 652, 654, 682, 684
- committee participation by NBS, 682
  - formation, 11
  - Fourth Annual Convention, Washington, 92
  - Standards Committee, 92
  - Subcommittee on Bibliography, 92
  - Subcommittee on Radio Telephone Transmitter and Receiver Terminology, 92
  - Subcommittee on Receiving Sets, 92
  - Subcommittee on Vacuum Tubes, 92
  - Washington Section, 680
- Institute of Radio Engineers Convention, 1929, 668
- Institutes for Environmental Research, 733, 735, 736
- Instituto Geofísico del Perú, 438n, 439
- Instructions for the Use of Basic Radio Propagation Predictions: *NBS Circular* 465, 429
- Instrument Landing System (ILS), 151, 165, 166
- Instrument Landing System (ILS): development of, 153
- instrument landing system: automatic control in blind landing operation, 167n
- boundary marker beacon, 161
  - College Park to Newark flight, March 20, 1933, 165
  - first complete blind landing, September 5, 1931, 161
  - glide path, 161n
  - landing beam, 161
  - NBS assistance in fog landing system, 159
  - runway localizing beacon, 160, 160n
  - survey of European systems, 1927, 159
  - underground antenna, 166
- Instrument Shops, NBS Boulder, 736
- insulating material at radio frequencies: WW I period, 63
- insulating materials: electrical properties, measurement of, 106
- Insulating Materials Committee, ASTM, 653
- Intelsat 1 satellite: "Early Bird", 24
- Inter-Allied Provisional Radio Technical Committee (1921), 657n, 662, 668
- Inter-Allied Radio Conference, 1919, 657n
- Interdepartment Advisory Committee on Governmental Radio Broadcasting, 647
- Interdepartmental Board on Radio Legislation, 647
- Interdepartmental Radio Conferences, 91
- Interdepartment Radio Advisory Committee (*see* IRAC)
- Interdepartment Radio Conference, 683
- interests in radio: early, 69
- WW I period, 69
- interference: by atmospheric static, 96
- interference between surface and space communication systems, 547
- Interference Committee, National Radio Conference, 1925, 644
- interference (*see* radio interference)
- interferometer, phase-shifting, 606
- interferometer, radio, 606
- International Administrative Aeronautical Radio Conference, 1948, 584n, 664, 665
- International Amateur Radio Union, 285
- International Astronomical Union, 601
- International Atomic Time Scale (TAI), 308
- International Bureau of Weights and Measures (BIPM), 307
- International Civil Aeronautics Conference, 1928, 663
- international comparison of standards at radio frequencies, 673
- international comparisons of MW power standards, 673
- International Conference of Experts on Wetterschiessen, 335
- International Conference on Wireless Telegraphy: Preliminary, 1903, 9
- International Electrotechnical Commission (IEC), 663
- International Frequency List, 664
- International Frequency Registration Board, 659
- International Geophysical Calendar: purpose, 484n
- International Geophysical Union, 663
- International Geophysical Year (IGY), 22, 655, 674, 675
- International Geophysical Year of the Quiet Sun (IQSY): program, 444
- International IGY Committee, 455
- International Radio Consultative Committee (CCIR), 15n, 92, 562, 613n, 658, 660, 661, 662
- International Radio Consultative Committee (CCIR): American Committee on Frequency Maintenance, 92
- Committee on Transmitter Interference, 92
- International Radio Convention, 1927, 153, 155
- International Radio Propagation Conference, 1944, 340, 411, 663
- International Radio-Telegraph Conference: first, 1906, 10
- International Radiotelegraph Conference, 1912, 657
- International Radiotelegraph Conference, 1932, 659
- International Radiotelegraph Conference: first revisional conference, 1912, 11
- second revisional, 1927, 15, 38, 41
  - third revisional, 1932, 16
- Washington, 1927, 92
- Washington, 1927, Special Committee on Frequency Measurements, 92
- International Satellites for Ionospheric Studies (ISIS): a conglomerate of study groups, under NASA, 502n
- International Scientific Radio Union (URSI), (*also, see* URSI), 35, 36, 38, 92, 562, 666, 667, 670, 671, 672, 673, 675, 676
- International Scientific Radio Union (URSI): American Section of Radiotelegraphy, 92
- Committee on Methods of Measurement and Standards, 92
  - history, 676
  - origin, 667n
- International Standard of Length, 1960, 636
- International Symposium on Space Telecommunications, Boulder, 1963, 570, 606n, 615
- International System of Electric and Magnetic Units, 44
- International System of Units (SI), 243
- International Telecommunication Conference, 1938, 659
- International Telecommunication Conference, Atlantic City, 1947, 20, 584, 659
- International Telecommunication Union (ITU), 18, 657n, 659, 660
- International Union of Radio Science (formerly International Scientific Radio Union), 666, 667n
- Interservice Radio Propagation Committee (IRPC), 406n

- Interservice Radio Propagation Laboratory (IRPL),  
316, 317, 317n, 319, 404, 405, 406, 406n, 407, 409,  
410, 410n, 411, 412, 413, 413n, 414, 420, 440, 449,  
452, 452n, 470, 555, 557
- Interservice Radio Propagation Laboratory: associated  
laboratories, 412  
conversion of projects from war to peace, 412  
established, 648  
funding by Army and Navy, 407  
sources of information on, 404n
- Interservice Radio Propagation Laboratory Radio  
Transmission Handbook, 1942, 555
- Inter-Services Ionosphere Bureau (ISIB), England, 405  
investigation of ferrites, 393  
ionization equilibrium, 623  
ionized gases: fundamental properties of, 624  
ionosonde, 432  
ionosonde: CRPL Model C, 433, 433n  
Model C-3, 433  
Model C-4, 433, 435  
observation of vertical-incidence reflections, 432  
ionosphere, 171, 403  
ionosphere, Arctic, 607  
ionosphere: characteristics at South Pole, 444  
characteristics of region of geomagnetic  
equator, 447  
complexity observed during early studies, 174  
defined, 437n  
early evidence of reflection, by Naval Aircraft  
Radio Laboratory, 176  
early evidence of reflection, by NBS, 177  
early theoretical investigation, 174  
evidence from long-distance transmissions,  
1901-1902, 171, 172  
evidence from short-wave transmission,  
1924, 173  
first experimental evidence, 172  
first observed by pulsed radio waves, 15  
height determined by Appleton and Barnett,  
1925, 173  
height determined by Breit and Tuve, 1925, 173, 174  
history of early concepts, evidence, and experiments,  
171, 172, 173  
model of, E and F<sub>1</sub> regions, 428n  
model of, F<sub>2</sub> layer, 428n  
origin of names of layers, 173n  
theoretical studies of, 465  
use of term, 172n  
use of term by Radio Section, 1933, 172n  
vagaries of radio transmission by, 35  
ionosphere, Earth, 606  
ionosphere, Jupiter, 606  
ionosphere, upper: Alouette I satellite, 503  
Alouette I satellite, described, 503n  
a proposal for use of rockets for study of, 1945, 499n  
Cosmos I satellite, observations of, 501n  
CRPL directs Explorer XX program, 504  
determination of true height, electron density  
profiles, 502  
early probing, 498, 499n  
electronic density data studies, 502  
electronic density data studies, need of  
expressed, 502n  
electronic density measurements, with Orbiting  
Geophysical Observatories (OGO), 507  
evidence of plasma resonances, with Explorer  
XX, 505  
evidence of spread F, with Explorer XX, 505  
Explorer XX, 505  
Explorer XX described, 504n  
Gold Medal award to Explorer XX group, 506, 506n  
model above F region, 502  
model above F region, described, 502  
nearly ideal medium for study of plasma  
phenomena, noted, 505n  
observations of spread F with Alouette I, 505  
observations with Alouette I satellite, 505  
Orbiting Geophysical Observatories (OGO),  
described, 507n  
plasma resonance characteristics, with Explorer  
XX, 506  
Sputnik I, additional observations by CRPL, 499n  
Sputnik I, observations by High Altitude  
Observatory, 499n  
Sputnik I, observed by CRPL, 499, 499n  
Sputnik III, observations of, 500n  
Sputnik III, studied by CRPL, 501  
Topside Sounder contract with NASA (TOPSI), 503  
topside sounding, with rockets, 503  
Ionosphere and Exosphere Scatter Section, 438  
Ionosphere Astronomy Section, 605  
ionosphere data, automatic processing, 587  
ionosphere data: first time on worldwide coverage, 407  
future use related by Gilliland, 1935, 232  
ionosphere disturbance warnings: broadcast by station  
WWV, 453  
broadcast by station WWVH, 453  
ionosphere information: published in *Proc. IRE*,  
1937-1941, 236  
ionosphere Radio Astronomy Section, 598n, 606, 611n  
ionosphere recorder: Model A, 214  
Model C-2, 563  
ionosphere reporting service, 18  
Ionosphere Research and Propagation Division, 459,  
460, 504, 506, 616n  
Ionosphere Research Section, 598n  
ionosphere storms: characteristics reported by Radio  
Section, 228  
first reported by Appleton, 227  
forecasting during WW II, 410  
September 18, 1941, storm recorded at Meadows field  
station, 228  
WW II period, 411  
ionospheric absorption, 598, 608, 610n, 611  
ionospheric absorption, high latitude, 607  
ionospheric absorption events, 610n  
Ionospheric Data, CRPL, F Series, 601n  
ionospheric data tabulated by punchcard methods, 429  
ionospheric disturbances: prediction, 452  
ionospheric forward scatter: characteristics of,  
observed, 488n  
ionospheric mapping: explained, 429n  
ionospheric observations, 403  
ionospheric observations from international  
network, 429  
ionospheric phenomena: WW II studies, 411  
Ionospheric Radio Commission, URSI, 672  
ionospheric reflection coefficient: definition, 481n  
Ionospheric Research Committee, AGARD  
(NATO), 610  
Ionospheric Research Section, 464, 482, 603  
ionospheric transmission and direction-finder errors:  
coordinated studies (two) of correlation, 318-319  
ionospheric winds, 457  
ionospheric winds: evidence from analysis of  
backscatter, 458  
observation by a Doppler technique, 458  
observations at Sterling field station, 458

observation with artificial clouds, 458  
 IQSY: two terms, words of the acronym, 483n  
 IRAC (Interdepartment Radio Advisory Committee), 647  
 IRAC: advisor to Executive Branch of Government, 647  
 advisor to President, 647  
 all radio communication of interdepartmental interest, 647  
 close relationship with FCC, 648  
 involvement in WW II, 647  
 problems of frequency allocations, 647  
 proposals for international conferences, 647  
 relation with CCIR, 1929, 660  
 Subcommittee on Policy and Legislation, 91  
 Subcommittee on Technical Problems, 647  
 IRE, Washington Section, 683, 684  
 IRE Committee on Radio Wave Propagation, 202  
 IRE Professional Group on Antennas and Propagation: Boulder-Denver Chapter, 700  
 IRE Professional Group on Instrumentation and Measurement, 700  
 IRE Professional Group on Microwave Theory and Techniques: Boulder-Denver Chapter, 700  
 iron pentacarbonyl: properties of, 336  
 IRPL (*see* Interservice Radio Propagation Laboratory)  
 IRPL Radio Propagation Handbook, with supplements, 410, 695

## J

JACKSON, Henry B., 9  
 JACKSON, Henry B., British Royal Navy, 511  
 JACKSON, W. E., 157  
 JANES, Harris B., 538, 539, 542, 542n, 545, 546, 552  
 JANET: meteor-burst communication system, 464n  
 JANSKY, C. M. Jr., 182, 183n  
 JANSKY, Karl G., 16, 595, 595n, 596n, 597, 607n  
 JARVIS, Stephen, Jr., 309  
 JAVAN, A., BENNETT, W. R. and HERRIOTT, D. R., 22  
 JEAN, A. Glenn, 461, 461n, 474n, 478, 481, 482, 674  
 JEFFERIES, John T., 623, 628  
 JENKINS, C. Francis, 14, 15  
 JENNINGS, Donald A., 631, 633, 634n  
 JESCH, Ramon L., 369, 371, 400, 700  
 JESPERSEN, James L., 290n, 292, 605  
 Jet Propulsion Laboratory, Pasadena, 614  
 jet stream observation, 134n  
 Jicamarca Radar Observatory: a specialized facility, 437, 438, 439, 460  
 JICKLING, Robert M., 369, 371, 389, 400  
 Jodrell Bank Experimental Station: radio telescope, 22  
 JOHLER, J. Ralph, 475, 477n, 478, 479n, 573, 597, 597n  
 Johns Hopkins University: cooperative project on fading, 180  
 JOHNSON, Edwin C. (Senator), 590, 590n, 591, 705, 706, 710n, 712, 715n  
 JOHNSON, J. B., 15  
 JOHNSON, Lyndon B. (President), 735  
 JOHNSON, Mary Ellen, 538  
 JOHNSON, Walter E., 518, 524, 588, 588n  
 Johnson noise, 15  
 Joint AIEE-IRE Committee on High Frequency Measurements, 653

Joint Army-Navy Conference on Microwave Test Equipment, 1946, 648  
 Joint Communications Board, U.S. Joint Chiefs of Staff, 334, 343, 345, 413, 414, 415  
 Joint Education Program for Non-Professional Training, 697  
 Joint Institute of Laboratory Astrophysics (JILA), 627, 627n, 628, 630, 631, 632, 634, 638, 639  
 Joint Institute of Laboratory Astrophysics: astrophysical research, 629  
 research programs, 629  
 Joint Technical Advisory Committee (JTAC), IRE and Electronic Industries Assoc., 498n, 584, 584n  
 JOLLIFFE, Charles B., 74, 74n, 82, 83, 89, 91, 92, 95, 108, 110, 186, 316, 316n, 317, 571, 644, 645, 649, 652, 660, 668, 682, 693  
 JOLLIFFE, Charles B.: chief engineer of Federal Radio Commission, 95  
 study of regeneration, 81n  
 JONES, Donald L., 480, 482, 626  
 JONES, Raymond N., 359n, 369, 371, 400  
 JONES, William B., 429, 429n, 587n  
 JOSEPHSON, B. D., 23  
 Josephson effect, 23  
 Josephson effect: applications, 23n  
 JUDSON, Elbert B., 200, 200n, 217, 227, 229, 230, 421n, 422, 422n, 669  
 Jupiter, 605, 605n, 606, 606n  
 Jupiter: signals from, 605, 606

## K

KAMAS, George, 292, 605  
 KAMPER, Robert A., 367  
 Karval, Colo., receiving site, 530, 531  
 KATAHARA, Sadami, 286n  
 KDKA: pioneer broadcasting station, 12, 78  
 KDKA, Pittsburgh, Pa., 644  
 KDKA (Westinghouse): transmitter used for fading tests, 181, 182, 183  
 KEAR, Frank G., 157, 157n, 159, 165n  
 KELLAR, William J., 477n  
 Kelly Committee, 724n, 725n  
 Kelly Report, 418n  
 KELVIN, Lord (William Thomson), 4, 4n, 171, 243n, 244, 292, 292n  
 KEMPER, Jack A., 461, 461n  
 Kendrick, Colo., receiving site, 530, 531  
 KENNEDY, John F. (President), 23, 614  
 KENNELLY, Arthur E., 9, 26, 35, 172  
 Kennelly-Heaviside layer, 92n, 172, 173, 202, 206, 207, 208  
 Kennelly-Heaviside layer: height determined, 14  
 KENRICK, G. W., 206, 206n, 208  
 Kensington field station, 186, 188n, 193, 194  
 KENYON, Frieda, 246, 246n  
 KERNS, David M., 358, 368, 368n, 372, 373, 374, 386, 388n, 398, 398n, 622, 683n, 696, 698  
 KIEFFER, Lee J., 630n  
 kilohertz: usage of term ordered by Federal Radio Commission, 264  
 KINCHLOE, Adeline N., 73, 412, 416n  
 KINDER, Bobby J., 366  
 kinescope: demonstration, 16  
 KINNEY, James L., 161, 165  
 KIRBY, Richard C., 424n, 491n, 495, 495n, 496, 496n, 497, 497n, 498n, 613n, 660, 662n

- KIRBY, Robert S., 424n, 534, 535, 536, 580n, 581, 581n, 582, 582n, 584, 585, 589n, 590n, 697
- KIRBY, Samuel S., 112, 192, 200, 201, 215, 216, 217, 220, 224, 227, 229, 230, 233, 234, 236, 237, 238n, 240, 241, 421n, 422, 422n, 424n, 426, 426n, 449, 465, 589, 668, 674
- KIRKPATRICK, Albert W., 546
- KISLIUK, Paul A., 620
- KISTNER, Maurice A., 587
- KLEMPERER, Wilfred K., 426n, 439
- klystron: first practical, 18
- KNECHT, Robert W., 425, 443, 443n, 482, 483, 485, 502, 503, 505, 505n, 506n, 672
- KOCH, J. Wesley, 572
- KOLSTER, Frederick A., 11, 40, 41, 46, 47, 48, 49, 57, 61, 71, 71n, 91, 92, 100, 101, 104, 105, 105n, 115, 117, 139, 139n, 140, 144, 145, 145n, 146n, 159, 176, 244, 470n, 572, 643, 648, 649, 652, 652n, 657, 657n, 667, 668n, 669, 679, 680, 680n, 681, 682, 683, 737n
- KOLSTER, Frederick A.: air navigation by radio, WW I, 59, 60  
 chief of Radio Section, 43  
 employment at NBS, 40n  
 patent cases, 45  
 radio compass, 12, 57, 58
- Kolster decimeter: importance of, 42  
 series of designs, 44
- Kolster radio compass (*see* radio compass)
- KOMAREK, Ernest L., 357
- KOMPFFNER, R., 19
- KRAL, Franklin, 218
- KRUSE, Robert S., 180, 180n, 181
- KRYDER, Samuel J., 330, 338, 389
- krypton (86Kr) lamp, 636
- krypton length standard, 634
- krypton standard line: asymmetry of, 636
- KUSCH, Polykarp, 299, 299n, 305
- KUSCH, Polykarp: awarded Nobel Prize in Physics, 299n
- KUSCH, Polycarp, and PRODELL, Albert G., 21n
- L**
- laboratory astrophysics, nature of, 628
- laboratory equipment: standard inductors and capacitors, design and construction of, 44
- Laboratory for Atmospheric and Space Physics (LASP), 628
- Laboratory for Special Radio Transmission Research, NBS, 672
- laboratory space: problems of, 45
- laboratory-type coaxial connectors, NBS design, 400
- LAMB, Robert C., 605
- LANCE, Harvey W., 351, 351n, 358, 358n, 354n, 400, 687, 690, 691, 694, 700
- LANGE, L. Jerome, 481
- LANGMUIR, Irving, 11
- LAPHAM, Evan G., 124, 131, 132, 257, 257n, 269
- LARSEN, Ezra B., 386
- LARSEN, Neil T., 375
- LARSON, Richard R., 518, 519
- LARSON, Roy E., 259, 351, 354n, 356n
- LARSON, Wilbur, 365, 366, 366n, 367
- laser: coherent-light type, first, 22  
 pulse type, first, 22
- laser beam: transmission of TV signals by, 24
- laser electron paramagnetic resonance absorption, 633
- laser energy measurement, 633
- laser frequency measurements, 634
- laser intensity stabilizer, 631
- laser interferometer, 632, 633
- Laser Measurement Technology Section, 634
- laser power measurement, 633
- lasers as frequency standards, 306
- laser seismograph, 633
- LAWRENCE, Robert S., 499n, 500n, 501, 501n, 507, 598n, 603, 604n, 605, 605n, 606, 615, 665
- LC-circuit measurement of frequency, 293
- leap second: first adjustment of the UTC scale, 308  
 NBS stations add 1 second to UTC system, 287  
 second adjustment of the UTC scale, 308
- Lefax Radio Handbook*, 91
- LEINBACH, H. (University of Alaska), 442n, 607
- LESTER, Gordon H., 123, 200, 200n, 233, 269, 282, 285
- Letter Circular 66: an answer to inquiries on radio receivers, 651
- Letter Circulars: information on radio for public, 81  
 noted, 103, 107n, 108, 109
- LF propagation: attenuation over Arctic regions, 477  
 geometric-optical theory, 478  
 survey and tutorial-type publications, 478  
 waveguide-mode theory, 478
- Library, ESSA, 736
- LIFSCHUTZ, Harold (Harold Lyons), 317
- light-emitting semiconductors, 23
- LILLEY, Carlene M., 477n
- limb flares: study of, 457
- LINCOLN, J. Virginia, 412, 450, 451n, 455., 455n, 456n, 484n
- Lindbergh reception, 1927: Radio Section aids, 83
- LITTLE, C. Gordon, 442n, 485, 598n, 603n, 607, 609n, 615, 615n, 665, 675, 733, 733n
- LITTLE, William E., 357, 366, 371, 400
- LLEWELLYN, F. B., 15n
- locating airplanes by radio: by triangulation method, Kolster, 145  
 crossed-coil antenna method, 146  
 methods (three) proposed by Dunmore, 146
- LODGE, Oliver, 5n, 6n, 7
- logarithmic decrement, 105
- logarithmic decrement: definition, 105n
- Long Branch (Ill.) field station, 437n, 572
- longitude effect: explained, 408n
- LONGLEY, Anita G., 515, 516, 581, 585n
- LOOMIS, Alfred L., 18
- LOOMIS, Mahlon, 4, 4n
- Loran: defined, 573n
- Loran-C clock, 574, 575
- Loran-C navigation system: explained, 289n  
 use for standard frequency dissemination, 287n
- Loran-C system of navigation, 574
- Loran system: first, 18
- Lord Kelvin (*see* KELVIN)
- Lord Rayleigh, Fourth, 468
- Lorentz polarization term: treatment by N. Smith, 239
- Louise A. Boyd Arctic Expedition, 1941, 225, 226, 318, 440n
- Louise A. Boyd Arctic Expedition, 1941: commentary, Dellinger Address, 1961, 225
- Lowell and Dunmore patents: on ac operation of electron tubes, 88, 96
- LOWELL, Percival D., 48, 71, 85, 86, 87, 88, 122, 131, 132, 137, 138, 138n, 146, 150, 323, 563, 680n
- LOWELL, Percival D.: submarine antenna, 58, 58n, 59
- lower and upper atmosphere, 735
- Lower Atmospheric Physics Section, 539, 540n, 542

lowest useful high frequency: determined by nomogram procedure, 410  
 low frequency calibration services, Boulder Laboratories, 395  
 Low Frequency Calibration Services Section, 354n, 355, 395, 397  
 Low Frequency Calibration Services Section: facilities moved to NBS Gaithersburg, 355  
 low-frequency EM waves: early interest by CRPL, 471  
   early use, 471  
   LF ionosonde at Sterling field station, 473  
   LF ionosonde at Sunset field station, 473  
   theoretical studies, 474  
 low-frequency instrumentation and measurement techniques: development, Boulder, 395  
 low-frequency papers: a proliferation, 476  
 Low Frequency Unit of ECC, 351  
 Low Frequency Workshop, 1961, 698  
 Low-Level Phase Stability project, 540n  
 LOWRIE, Patrick H. Jr., 356, 397  
 LUCAS, Donald L., 588n  
 lunar landing: first, 24  
 lunar ranging, 638  
 Lunar Ranging Experiment (LURE), 638, 639  
 lunar telescope, 639, 639n, 640n  
 LURE program, 640  
 LYONS, Harold, 20, 258, 293, 295, 296, 298, 298n, 299, 299n, 300, 300n, 309, 309n, 326, 326n, 327, 328, 330, 331, 334, 336, 338, 345, 347, 348, 361, 619, 649, 653, 684, 685, 698

## M

McCAA, William D. Jr., 388  
 McCRACKEN, Robert N., 299, 345  
 McCRACKEN, William P. (Assistant Secretary of Commerce for Aeronautics), 153  
 McDOWELL, Louise S., 62, 62n  
 McDUFFIE, Rhoda E., 425  
 McGAVIN, Raymond E., 534  
 MACHLAN, Howard, 309  
 McILWRAITH, C. G., 257, 661, 661n  
 MacMillan Arctic Expedition of 1923-1924, 183  
 McNISH, Alvin G., 411n, 441n, 450, 456, 456n, 457, 457n, 462n, 709, 723  
 MacPHERSON, Alan C., 368, 368n, 374  
 McQUATE, Paul L., 534, 535  
 magnetic characteristics of materials: an overview, 393  
 magnetic characteristics of powdered iron cores, 392  
 magnetic detector: early U.S. patent, 9  
 magnetic field, Earth, 607  
 Magnetic Measurements and Standards Project, 1950, 391  
 magnetic properties: development of a high frequency permeameter, 392  
   instrumentation for measurement of complex permeability, 392  
 magnetic storm charged particles, 607n  
 magnetometer design, 392  
 magnetometers, 609n, 610n  
 magnetosphere, 610n, 611n, 612  
 magnetron: cavity type, high-power, pulsed, 18  
   cyclotron type, 15  
   initial theory, 12  
 MAHLER, Robert J., 394, 633  
 MAIMAN, Theodore H., 22  
 MALONEY, Leo J., 534  
 MANNING, L. A. (Stanford U.), 675  
 MANSFIELD, William V., 581  
 MARCONI, Guglielmo, 1, 2, 6, 6n, 7, 8, 9, 13, 13n, 16, 29, 35, 118, 171, 172, 180, 470, 511, 550, 646, 807, 808  
 MARCONI, Guglielmo, and BRAUN, Karl Ferdinand: Nobel Prize in Physics, 1909, 10  
 MARCONI, Guglielmo: first wireless signal across Atlantic, 8, 29  
 Marconi Centennial Series (lectures), 556n  
 Marconi lecture, New York, 1912, 807  
 Marconi lecture, publication, 1912, 807  
 Marconi Wireless Telegraph Co. of America: organized, 8  
 Marine Game Fish Program, 737n  
 Marine Minerals Technology Center, 737n  
 market news: dissemination via radio, 649  
 Mark 4 fire-control radar, 323, 324  
 MAROVICH, Edward, 469  
 MARTIN, A. D., 266n  
 MARTON, L. L., 597n  
 maser: development of, 21  
   origin of word, 21n  
   solid state, 21  
 Massachusetts Institute of Technology, 18, 486  
 MATARRESE, Lawrence M., 394, 634  
 MATSUSHITA, Sadami, 425, 425n  
 MAXIM, Hiram Percy, 11  
 maximum usable frequencies: a much-quoted 1939 paper by N. Smith, 239  
   determined by critical frequencies, 452  
 maximum usable frequency (muf): defined, 238n  
   improvement of prediction method, 409  
   term introduced, 1937 publication, 238n  
 Max Planck Institute for Radio Astronomy, 24  
 MAXWELL, James Clerk, 1, 4, 4n, 5, 29, 99, 292  
 Maxwell bridge for low-loss magnetic measurements, 393  
 Maxwell's equations, 4, 29  
 May 1, 1946: formation of the CRPL, 703, 704  
 Meadows field station, 190n, 200, 201, 215, 217, 220, 224, 227, 229  
 Meadows field station, vacated, 340  
 measurement agreement, 396  
 measurement front: broad, progress on, 347  
 "measurement gap", 349  
 measurement of variation in phase difference, 542  
 Measurement Research Conferences: NBS-AIA, 349  
 measurements: the doldrums period, 110  
 Measurements and Standards in Plasma Physics and Astrophysics program, 622, 623, 627  
 measurements at 418 MHz, well beyond the radio horizon, 538  
 measurements at RF: improved method, balanced transformer circuit, 110  
 measurement techniques: new, development of, 353  
*Measures for Progress*, 316, 319  
 Mediterranean radio observations, 511  
 MEGILL, Lawrence R., 469, 469n  
 Memorandum of Understanding: financing of ECC, 355  
 MENZELL, Donald H., 605n, 706, 706n, 708, 708n, 712n, 727n  
 MENZELL, Donald H. (Harvard College Observatory), 428n  
 Mercury Control Center, Cape Canaveral, 617n  
 Mercury Faith 7, 615  
 Mercury network, 616  
 Mercury orbital flights, 616  
 Mercury program, 616  
 MERRILL, Ralph Gregg, 500n, 501, 501n



- Meteor-burst communication: an extended study, 465  
 a successful system, 464  
 early CRPL experiments, 464
- Meteor-Burst Propagation Research Project, 465
- meteorological sounding equipment: development of, 138n
- meteorology, 735
- meteor trails: radar echo dependence on frequency, 462
- methane-stabilized helium-neon laser, 634, 636
- methane-stabilized laser, 636
- Methods of Measurement and Standards Committee, URSI, 668
- Metrology Guides*, 360
- mica: a strategic material, 339  
 measurement of power factor, 339
- MICKEY, L., 266n
- micropotentiometer: described, 379n
- micropotentiometers, 378
- microwave baseline tracking systems, 545
- Microwave Calibration Services Section, 354n, 389
- Microwave Calibration Workshop, 1968, 698
- Microwave Circuit Standards Section, 366, 367, 389, 725
- microwave Fabry-Perot interferometer, 622
- microwave frequency dividers: controlled by spectral lines, 298
- microwave frequency standard, 619
- microwave frequency standard: developed, 1945, 258  
 development of, 345, 346  
 improvements, 1954, 259  
 new features added, 259
- microwave interferometry, 621, 622
- microwave interferometry: diffraction theory in, 622
- microwave Michelson interferometer, 622
- microwave microcalorimeter, 374
- microwave microcalorimeter: improved design by Engen, 374
- microwave power standards: international comparisons, 377
- microwave radio propagation, 512
- microwave refractometers, 518
- microwave spectra, 620
- microwave spectral lines, 619
- microwave spectral tables, 620
- microwave spectral tables: *NBS Monograph*, 298
- microwave spectroscopy, 2, 518
- microwave spectroscopy: first experimental work, 17  
 for measurement standards, 619
- microwave spectroscopy program, 620
- microwave standards: studies initiated by Radio Section, 334-335
- microwave standards program: funding, 347  
 initiated, 347
- Microwave Standards Section, 293, 336, 338, 345, 347, 348, 348n, 349, 367, 368, 373, 381, 389, 518, 619, 695, 698n
- microwave transmission: at 18 cm, 16
- Microwave Unit of ECC, 351
- Microwave Workshop, 1961, 698
- migration to Boulder, 724, 725
- migration to Boulder: committees, 724  
 Resettlement Committee, 724  
 Steering Committee, 724
- MIKLOFSKY, Harren A., 412
- Milky Way, 595, 595n, 597
- MILLER, Charles K. S., 356n, 382, 383
- MILLER, John M., 48, 53, 53n, 57, 60, 61, 73n, 652, 680, 680n
- MILLER, Lawrence W., 259
- Miller effect, 60, 60n
- MILLIKIN, Eugene D. (Senator), 705
- millimeter-wave interferometry, 621
- millimeter-wave research: objectives, 621
- Mills cross antenna, 21, 606n
- Mills cross antenna array, 606
- MILTON, John B., 292
- minimum field intensity: determination for satisfactory communication, 409
- Ministry of the Interior, Argentina: cooperative project with NBS, 200, 201
- Mirnyy Base, U.S.S.R., 608, 609
- Mirnyy Station, Antarctic, 610n
- Missile Development Division, 319n
- missile tracking: meteorological effects, 545  
 over-water measurements of phase and amplitude, 546  
 simulated earth-to-space links, 546  
 simulated tracking system, 545  
 theoretical considerations, 545
- missile-tracking systems, 545
- MISTRAM baseline missile tracking system, 545, 546, 546n
- MIT Radiation Laboratory, 345, 346, 362, 372
- MIZUSHIMA, Masataka, 633
- "mobile" field station, 190
- MOCKLER, Richard C., 301, 301n, 307
- modulation measurement, 110
- modulation meter, 571
- modulation method: early U.S. patents, 8
- modulation research: at NBS Washington, by CRPL, 571  
 for digital-coding communication, 572  
 for ionospheric forward scatter transmission, 572
- modulation research program, 571
- Modulation Research Section, 571n, 572
- modulation waveforms: frequency spectra, 571
- MOGEL, H., 222n
- "Mogel-Dellinger effect", 222n
- molecular microwave spectra lines, 620
- molecular microwave spectral tables: *NBS Circular*, 298
- MONTGOMERY, G. Franklin, 271-note(f), 464, 487n, 495n, 572, 572n
- monthly median transmission loss, 523
- Moon, 614, 615, 638, 639, 640
- "Moonshine" (Project CXFD): radar deception equipment, 328
- Moon's surface: illuminated by ruby laser, 23
- MOORE, Holmes S., 581n
- MOORE, Raymond T., 461
- MOORE, Roger C., 455n
- MORGAN, Alvin H., 253, 275n, 292, 292n, 441n
- Morrow Board, 153n
- MORSE, Samuel F. B., 3
- Mount Haleakala, Maui, measurement site, 544
- moving day: North site to South site, 725
- multiplex operation of FM transmitters, 23
- MURPHY, Anabeth C., 474n, 475n
- MURROW, Edward R., 295
- mutual inductance: study by Cohen, 33

## N

- NAA: Navy station, Arlington, Va., 11, 34
- NAHMAN, Norris S., 388, 388n
- NASON, Martin E., 616
- National Academy of Sciences, 655
- National Advisory Committee for Aeronautics (NACA), 316

- National Advisory Committee for Aeronautics:  
 Subcommittee on Communications, 91
- National Aeronautics and Space Administration  
 (NASA), 502, 503, 507, 616
- National Board of Fire Underwriters: Radio  
 Committees, National Electric Code, 92
- National Broadcasting Co.: first color TV  
 broadcasting, 19  
 first FM broadcast service, 18  
 introduces public TV, 18  
 organized, 15
- National Bureau of Standards (NBS), (*also, see* NBS),  
 315, 317, 334, 342, 343, 345, 348, 349, 351, 353, 355,  
 356, 359, 367, 374, 375, 385, 388, 396, 400, 403, 404,  
 405, 413, 414, 415, 416, 419, 491, 492n, 555, 573, 595,  
 597, 602, 616, 627, 628, 630, 638, 643, 643n, 647, 648,  
 651, 653, 654, 655, 660, 662, 663, 666, 674, 675, 677,  
 679, 683, 684, 690, 691, 699, 704, 706, 708, 709, 710,  
 711, 712, 712n, 713, 715, 718, 722, 723, 724, 725, 726,  
 727, 728, 733, 733n, 735, 736
- National Bureau of Standards: development of printed  
 circuits, 19  
 development of radio beacon, 12  
 first atomic clock, 20  
 first blind landing by radio, 16  
 first cesium atomic beam frequency standard, 21  
 first radio work, 31  
 frequency measurement of helium-neon laser, 24  
 functions of, 1901, 99  
 initiates broadcasting (WWV) of ionosphere  
 information, 1937, 235  
 ionosphere forecasting, 18  
 name change, 38n  
 responsibility for wireless telegraphy laboratory, 41  
 sites, 29  
 speed of light measurement, 25
- National Conference of Standards Laboratories (*also,*  
*see* NCSL), 348, 690, 691
- National Data Buoy Development Project, U.S. Coast  
 Guard, 737n
- National Defense Research Committee (NDRC), 315,  
 316, 317, 318, 319, 328, 403, 406, 440, 513
- National Defense Research Committee Wave  
 Propagation Group, Columbia University, 513
- National Electric Signaling Co. (Fessenden), 34
- national frequency standard for microwave frequencies:  
 established, 334  
 requested, 334
- National Geographic Society: stratosphere balloon  
 flights, 122
- National Geographic Society-Army Air Force Eclipse  
 Expedition: Brazil, 1947, 218
- National Geographic Society - NBS eclipse expedition:  
 Brazil, 1940, 217
- National Oceanic and Atmospheric Administration  
 (*also, see* NOAA), 601n, 628, 736, 736n, 737
- National Oceanographic Data Center, 737n
- National Oceanographic Instrumentation Center, 737n
- National Physical Laboratory (England), 557
- National Primary Frequency and Time Standard: move  
 to Boulder Laboratories, explained, 275n  
 quartz crystals moved to Boulder Laboratories,  
 275, 725
- National Primary Standard of Radio Frequency, 93
- National Primary Standard of Radio Frequency:  
 described, 254n  
 1929, 254
- National Radio Astronomy Observatory, 23, 596, 596n
- National Radio Conferences, 94
- National Radio Conferences: First, Second, Third,  
 Fourth; Committee on Frequency Allocation, 91  
 First, Second, Third, Fourth; Committee on  
 Interference, 91
- National Science Foundation, 482, 596n, 608, 609, 610
- National Science Foundation Floating Antarctic  
 Research Station: noise station, 563
- National Sea Grant Program, National Science  
 Foundation, 737n
- national standard of frequency: change-over to atomic  
 frequency standards, 258  
 early improvements, 256  
 moved to Boulder, Colorado, 258  
 refinements, 257
- National Symposium of the IRE Professional Group on  
 Microwave Theory and Techniques, 1962,  
 Boulder, 699
- National Telecommunications and Information  
 Administration (NTIA), 736n, 737
- National Television System Committee (NTSC), 592
- National Weather Records Center, Ashville, N.C.,  
 520, 521
- Naval Aircraft Radio Laboratory, 93, 176
- Naval Research Laboratory, 14, 15, 16, 17, 33, 36
- Naval Research Laboratory Expedition, Attu Island,  
 1950, 219, 600
- Naval Wireless Telegraphic Laboratory, 92
- navigational aids to mail-carrying planes: radio range  
 stations, 15
- navigational aids to planes: by radio, 12
- navigation system: Loran, 573
- navigation systems: radio, study of, 573
- Navigation Systems Section, 573, 574, 575, 592
- Navy Department, 323, 324, 326, 328, 335, 338, 345,  
 347, 348
- Navy Department: request for development of radio  
 meteorographs, 124, 125
- Navy Department: request for upper-air wind  
 measurement method, 132
- NBS (*also, see* National Bureau of Standards)
- NBS atomic time scale, 308
- NBS Boulder Laboratories, 628, 630, 637
- NBS Boulder Laboratories: dedication of, 619
- NBS Circular 462: Ionospheric Radio Propagation*, 440,  
 441, 695
- NBS Circulars*, 81
- NBS Frequency Standard, Jan. 1, 1960, 308
- NBS Handbook of Physical Measurements, 695
- NBS Letter Circulars: a publication vehicle used by  
 Radio Section, 235
- NBS Museum, 300
- NBS Precision Measurement Seminars, 358
- NBS time signals: on Coordinated Universal Time  
 system, 285
- NCSL: first meeting, 1962, 691  
 1964 meeting, 694  
 1966 meeting, 694  
 1968 meeting, 694  
 1970 meeting, 694  
 1972 meeting, 694  
 1973 meeting, 694  
 1974 meeting, 694  
 1975 meeting, 694  
 1976 meeting, 694
- NCSL (National Conference of Standards Laboratories):  
 purpose, 691
- NDRC (*see* National Defense Research Committee)
- NDRC, of OSRD (Office of Scientific Research and  
 Development), 345

negative temperature coefficient of resistance, 3  
 NELSON, Robert E., 369  
 neutrodyne circuit, 13  
 NEWELL, Allen C., 357, 388  
 Newton apple tree, 719  
 NICHOLS, E. F. and TEAR, J. D., 14  
 NICHOLS, H. W. and SCHELLENG, J. C., 174  
 nighttime errors of direction finders: caused by reflections from ionosphere, 176  
 nighttime signals: increased strength, 92  
     variations in strength, 93  
 NIPKOW, Paul, 5  
 NIXON, Richard M. (President), 25  
 NOAA: establishment by Executive Order, 736  
 NOAA (National Oceanic and Atmospheric Administration), 736  
 noctilucent clouds, 457n  
 noctilucent clouds: observation of movement, 457  
 NOEL, Adeline (*see* KINCHLOE), 73  
 noise factor, EN, 597n  
 noise figure standard: for noise figure of receivers, 381  
 noise measurement: by sum-and-difference correlation radiometer, 382  
 noise measurements: importance of, 381  
     noise comparator, 381  
     theoretical studies, 381  
 noise measurement system: automated, 383  
 noise-power comparator, 381  
 noise power equation, 15n  
 noise recording stations: worldwide network, 561  
 noise research: cooperation with CCIR and URSI, 562  
 noise spectra of nuclear explosions, 562  
 noise standard: improved Dicke-type radiometer, 382  
     low-temperature, microwave, 383  
 nomograms: for round-the-earth LF radio signals, 471n  
 North American Radio Conference, 1933, 666  
 North Atlantic Radio Warning Service, 453, 453n, 455, 616, 616n, 617n  
 North Atlantic Radio Warning Service: Silver Medal award to group members, 453n  
 North Pacific Radio Warning Service, 453  
 NORTON, Kenneth A., 112, 191, 200, 200n, 202, 208, 216, 317, 317n, 318, 408n, 441n, 471n, 475, 476, 478n, 495n, 498n, 513, 515, 516, 517, 527, 549n, 550, 551, 555n, 573, 580, 580n, 581, 581n, 583, 583n, 584, 585, 585n, 589n, 597n, 647, 655, 660, 669, 683n, 709, 723  
 Norwegian Telecommunications Administration, 608, 609  
 NUCKOLS, Richard G., 298  
 nuclear explosion, 1962: observations of, 460  
 numerical mapping of ionospheric characteristics, 429  
 NUPEN, Wilhelm (Meteorological and Geostrophysical Abstracts, Washington, D.C.), 476n  
 NYQUIST, H., 15

## O

oblique incidence: determination of maximum usable frequency at, 436  
 oblique-incidence MUF, 598n  
 oblique-incidence observations, 436  
 obstacle-gain paths: advantages, 537  
 OBV equipment: development of, 330  
     operation, 331  
     operational purposes, 330

ocean environment, 736n  
 oceanography, 735  
 OCHS, Gerard R., 439, 460, 464  
 ODABASI, Halis, 630  
 ODISHAW, Hugh, 713n  
 OERSTED, Hans Christian, 2  
 Office of Scientific Research and Development (OSRD), 18, 316, 317, 318, 319  
 Office of Standard Weights and Measures, Treasury Department, 99  
 Office of Telecommunications, Department of Commerce, 736, 736n, 737  
 Office of Telecommunications Policy: IRAC assistance, 648  
 Office of U.S. Army Engineers, 340  
 OHM, Georg Simon, 3  
 Ohm's Law, 3  
 oil baths: with precision temperature control, 397  
 OLIVER, Bernard M., 686  
 Olson Construction Co., 715  
 Omega navigation system: explained, 289n  
     use for standard frequency dissemination, 287n  
 ONDREJKA, Arthur R., 388  
 operational radar installation: first, 17  
 Operation Fish Bowl, 460n  
 optical distance, 511  
 optical horizon, 511  
 optical maser, 22  
 optimum frequency selection, 240n  
 optimum frequency selection: by electronic computer, 588  
 Orbiting Geophysical Observatories (*see* Ionosphere, upper)  
 Ordnance Development Division, 319  
 Ordnance Development Division: changes of name, 319  
 oscillator: vacuum tube, 11  
 oscillatory spark discharges, 3  
 OSRD (*see* Office of Scientific Research and Development)  
 OSTROW, Sidney M., 412, 429, 436  
 OTTING, William J., 345  
 OULD, Richard S., 53, 54, 62, 88, 91  
 OWEN, William E., 412  
 oxide-coated filaments, 11n  
 oxide-coated filaments: for thermionic vacuum tubes, 11n  
 oxygen line, 620  
 oxygen spectrometer, 620  
 OZANICH, Anton M. Jr., 523

## P

PAGE, Chester H., 319, 689  
 Page Consulting Radio Engineers, 492  
 Pan American Communications Conference, 1924, 665  
 Panel on Radiating Systems, Joint Research and Development Board, 649  
 PAPPAS, Carol F., 522  
 parametric amplifier: development, 21  
 PARKINSON, Taintor, 183, 183n, 186, 188, 194, 195, 196, 683  
 patents: the many patents on radio beacons and blind landing system, 167  
     vacuum tubes, 76n  
 path-length stability of ground-to-ground links, 542  
 PATTERSON, Donald W., 613n  
 Pearl Harbor, 315, 316

Pearl Harbor: news by radio, 19  
PEAVY, Roswell C., 73, 416n, 704n, 726n  
PECKER, Charlotte, 624  
PECKER, Jean-Claude, 624  
PELANDER, Carl E., 628n  
PELLETT, Edwin A., 336  
pentode tubes: for broadcast receivers, 16  
PENZIAS, Arno A. and WILSON, Robert W., 24  
Pereira, Luckman, and Stanton (architectural firm), 713, 713n  
persistent anomalous field strengths measured far beyond the horizon, 551  
Personnel Division, ESSA, 736  
personnel problems: after WW I, 73  
PERSSON, Karl-Birger, 627, 627n  
PETERSEN, F. Russell, 301, 306, 634, 634n  
PETERSON, Robert L., 394  
phase measurements over paths of varying length, 540  
phasemeter: electronic, direct-reading, 576  
phase scintillations, 603, 605  
phase-shift measurement: by balanced modulator technique, 389  
by modulated subcarrier technique, 389  
by unmodulated twin-channel technique, 389  
Phase Shift Measurement Seminar, 1967, 699  
Phase Stability Analysis project, 539n, 540n  
phase stability in tropospheric propagation, 539  
phase stability over low-level tropospheric path, 542  
PHELPS, Francis P., 260, 260n, 339, 339n  
PHELPS, Francis P.: in charge of quartz-crystal group, 260n  
PHILLIPS, Marcella L., 412, 424, 450, 470, 471n, 584n  
Philosophical Society of Washington, 181, 680, 681  
photometer: explained, 466  
physics of upper atmosphere: Nobel Prize in Physics, 1947, 20  
PICKARD, Greenleaf W., 10, 31, 172, 183, 186, 193, 193n, 216  
picture transmission, 1  
PIERCE, George W., 25  
piezoelectric effect: explained, 248n  
piezoelectric property of quartz crystals, 5  
piezo oscillator: portable type, temperature controlled, 252  
PIGGOTT, W. R. (Radio Research Station, England), 443n  
Pikes Peak obstacle-gain experiments, 535  
Pikes Peak transmission path, 528  
PINEO, Victor C., 133, 424, 437n, 462, 462n, 464, 464n, 489, 498, 498n  
Pioneer 10 spacecraft: approach to planet Jupiter, 25  
Pioneer 11 spacecraft: near approach to planet Jupiter, 25  
piston attenuator with phase shifter, high precision, 365  
PITTS, John J., 460  
PIZZURRO, Ernest A., 412  
Plant Division, NBS Boulder, 736  
Plasma Physics Building, 718, 735  
PLUSH, Robert W., 475n  
PLYLER, Earle K., 578n  
POAST, LaVerne M., 317, 319  
point-to-point communication, 614  
point-to-point communication systems, 614  
POKEMPNER, Minadora, 412, 429, 429n  
polar blackouts (*see* absorption: polar-cap)  
polar-cap absorption (PCA), 494, 610n  
Polarimetry Section, Optics Division, 339  
polarization errors of direction finders: a study, 318  
commendations on study, 318  
polarization of reflected waves: changes of, 427  
POMERANTZ, M. A. (Bartol Research Foundation), 444, 444n, 445, 484  
POPOV, Alexandr S., 6, 6n  
portable receiver: development in 1921, 82  
Post Office, Department of, 649  
POTTASCH, Stuart R., 623, 623n, 624  
POULSON, Valdemar, 9  
POWELL, Robert C., 354, 369, 371, 371n, 391, 392, 393, 400  
"power equations": a development by Engen, 376  
power measurement: by impedance method, 373  
by microcalorimeter, 374  
calibration of coaxial power meters with waveguide standard, 376  
DC-RF substitution error of coaxial bolometer units, 376  
early bolometric techniques, 372  
peak-pulse method, 388  
power measurements: importance of, 371  
power spectrum analysis of signal sources, 259  
power standard: for lower radio frequencies, 377  
POYNTING, John Henry, 5  
Poynting theorem, 5  
PRATT, Haraden, 152n, 155, 155n, 165n, 652, 669, 682, 683n  
prediction of maximum usable frequencies, 404  
prediction(s), ionosphere: a new service explained, 236n  
commentary, Dellinger Address, 1961, 230, 241  
prediction service: improvement by analysis of traffic logs, 431  
improvements by IGY programs, 431  
prediction services: 1942-1946, 407  
prediction(s) of maximum usable frequency: published in *Proc. IRE*, 1939-1941, 237  
predictions of useful distance for amateur communication: published in *QST*, 234  
PRESTON, John L., 63, 106, 245, 248, 389, 389n, 651, 653, 680n  
PRESTON, John L., Bureau *Circulars*, 81n  
primary frequency standards (at radio frequencies): request for establishment, 343  
*Principles Underlying Radio Communication*: WW I publication, 694  
printed circuits: development of, 19, 19n  
problems imposed by radio broadcasting, 94  
problems of interference, 95  
problems of radio patents, 96  
problems of the limited frequency spectrum, 95  
*Proc. IEEE*: special issue on RF measurements and standards, June 1967, 359, 398  
Project Bittersweet: forward scatter communication, 492  
Project "Chick": a parachute-dropped radar jammer, 333  
Project CXFD: radar deception equipment, 328  
Project CXJX, "false fleet" of ships, 331  
Project Diana, Army Signal Corps, 271  
Project Firefly, 459  
Project Firefly: explained, 459n  
Project "Flapper": vortex generator, 335  
Project Mercury, 616, 616n  
Project Mercury, ground communications network, 616, 617n  
Project Mercury Radio Warning Service, 616, 616n, 617n

Project OBV: test equipment and monitor for CXFD, 330  
 Project Phantom, 460n  
 Project Phantom: vapors and aerosols as radar reflectors, 336  
 prolonged space-wave fadeouts, 538  
 propagation, ionospheric: African studies, 448  
 Propagation of Very-Low Radio Waves Symposium, 1957, 699  
 propagation phase stability, 539  
 properties of ferromagnetic materials, 392  
 Provisional Frequency Board, 659, 660, 664  
 proximity fuse, 18, 319  
 proximity fuse: for nonrotating projectiles, U.S. Army, 19  
   for rotating projectiles, U.S. Navy, 19  
   radio type, successful trials, 19  
   radio type, used in combat, 19  
 Publications Committee, URSI, 672  
 Public Buildings Service, GSA, 713, 723  
 Public Law 267, 1912, 11  
 Pulse and Time Domain Section, 388  
 pulsed cw transmitter, 15  
 pulse measurement techniques: nanosecond pulses, 388  
 pulse repeater: balloon-borne for detection of radar signals, 323  
 PUPIN, Michael I., 7  
 PURCELL, E. M. (Harvard University), 487  
 PURDY, Charles M., 469n  
 PURINGTON, Ellison S., 54, 73n

## Q

quantum electronics: maser-laser principle, Nobel Prize in Physics, 1964, 23  
 Quantum Electronics Division, 632, 633, 634  
 Quantum Electronics Section, 633  
 quantum-mechanical uncertainty principle: comment by Lyons, 309  
 Quantum Physics Division, 628  
 Quarterly Bulletin of Solar Activity, International Astronomical Union, 601  
 quartz crystal inspection and testing service: assistance by Radio Section, 339  
 quartz crystal program: a tutorial paper, 252  
 quartz crystal research: early, by Radio Section, 256  
   frequency drift, aging, 260  
 quartz-crystal resonators: improved short-time stability, 258  
 quartz crystals: continued useful role, 258  
 quartz crystals as frequency standards: early calibration by Radio Section, 248  
 quartz crystal technology: NBS meets a problem in temperature control, 257  
   NBS serves Department of Commerce, 249  
 quartz crystal technology study: reported in *TNB*, 1926, 257  
 quartz plates: electrical parameters measured, 339  
 Quebec Center, 609  
 Quebec Center station, 609n

## R

RABI, I. I. (Columbia University), 18, 299, 299n  
 Radar: first use by English, 17  
   origin of word, 19n  
   pulse-type, first, 17  
   release of information, 19  
   single antenna, with duplexer, 17  
 radar countermeasures: a defense stratagem, 327  
 Radar Countermeasures Group, Radio Section, 328, 331, 335, 336, 460n  
 Radar Countermeasures Section, Bureau of Ships, 328  
 radar development: early, 16  
 radar reflection: from Moon, 20  
   from planet Jupiter, 23  
   from planet Venus, 22  
 radiation, from Sun, 595n  
 radiation, trapped, Earth, 612  
 radiation hazard, 616  
 radiation hazards, 616n  
 Radiation Laboratory: establishment, 19  
 Radiation Laboratory, MIT, 298, 334  
 radiation of galactic hydrogen, 21  
 radiation produced from a plasma, 626  
 radiative source function, 623, 624  
 radio, 737, 737n  
 radio: acceptance of word, 42  
   a meaning, 1  
   a tool for probing Nature, 1  
   distance range, 2  
   impact on scientific world and society, 1  
   information on weather, 2  
   origin of word, 2  
   probing of space and the atom, 2  
   probing upper atmosphere, 2  
 Radio Act of 1927, 15, 95, 96  
 Radio Advisory Committee: first, 96, 97n  
 radio altimeter: dial reading, 18  
 radio amateur, 69  
 radio amateurs: reception of early broadcasting, 12  
 "Radioana", 34n  
 Radio and Electronics Colloquium, 698  
 Radio and Microwave Materials Section, 392, 394  
 Radio and Troposphere Commission, URSI, 672  
 radio astronomy, 2, 17, 595, 595n, 597, 597n, 598, 598n, 602, 603, 603n  
 Radio Astronomy and Arctic Propagation Section, 598n  
 Radio Astronomy project, 598n, 603n  
 radio beacon (*also, see* air navigation system)  
 radio beacon: aural type, 12  
   visual type, 12  
 radio beacon system, 663  
 radio blackout, 602  
 radio blackouts, 607n, 735  
 radio boom, 73, 80  
 radio broadcasting boom, 647  
 radio broadcasting from airplane, 1928: Radio Section aids, 83  
 radio broadcasting stations. total, 1922, U.S., 13  
   total, 1941, U.S., 19  
   total, AM and FM, 1978, U.S., 20  
 radio broadcast receivers: operation from 60-Hz alternating current, 15  
 Radio Broadcast Service Section, 292  
 Radio Building, Boulder, 704, 705, 706, 708, 710, 711, 713, 715, 716, 719, 722, 723, 725, 726, 727, 728, 732, 735, 735n, 737

- Radio Building, Boulder: cornerstone, 723n  
plantings, 719
- Radio Building: new quarters, 1918, 47
- Radio Central: RCA operated, 12
- radio circuits: methods of tuning, 7
- Radio Communication and Systems Division, 496n, 555n, 613n
- Radio Communications Committee, Defense Communications Board, 648
- Radio Communication Section, 71
- radio compass: development for Bureau of Lighthouses, 140  
patents, 145, 145n  
spinoffs, 145  
tests with lighthouse tender *Tulip*, 140  
widely adapted for shipboard use, 145
- radio compass, Kolster, 643
- radio component measurements: 25 to 200 MHz, WW II period, 112
- radio control between spacecraft: Gemini 10 and Agena, 24
- Radio Coordination, a division of NDRC, 317
- Radio Corporation of America (RCA), 12, 15, 16, 17, 18, 19
- Radio Corporation of America: incorporated, 12
- radio detectors: Austin's interest, 31  
study at NBS, 31
- Radio Development Section, 71
- radio direction finder: pioneer development, 10  
portable type, "universal," 146
- radio direction finders, 139n
- radio distress calls: at sea, 10
- Radio Disturbance Analysis project, 450
- Radio Disturbance Warning Service, 451n
- Radio Division, Aeronautics Branch, Department of Commerce, 644
- Radio Electrical Coordination Committee, American Standards Association, 653
- radio emission, 605, 605n, 606
- radio emission: from interstellar space, 595
- radio emission from Sun studies: site on Gunbarrel Hill, 721
- Radio File, 29n
- radio fog signalling, 643
- radio fog signalling (*see* radio compass)
- radiofrequency radiation by a plasma, 627
- Radio Geodetic Research project, 540n
- radio horizon, 514
- radio information: a reference file, 88  
"Radio Information Clearing House," 88
- radio inspectors, Bureau of Navigation, 105, 643, 644
- radio interference, 644
- radio interferometer, 577, 604n, 605n
- radio interferometer, phase sweeping, 603
- radio interferometer, Ryle-type, 603
- Radio Laboratory, 69, 70, 71, 72, 73, 85, 101, 102, 104, 107, 244
- Radio Laboratory: ac operation of amplifiers, 85  
condensers, Bureau of Standards type, 100  
formulas for inductance, 101  
growth of, 47  
reorganized, Feb. 1921, 71
- Radio Laboratory Fund Campaign, 712
- Radio Laboratory Section (*also* Radio Section):  
formation, 43
- radio landing of airplanes, 93
- Radio Measurements and Standards Commission, URSI, 678
- Radio Measurements and Standards Group, Radio Section, 1945, 345, 367
- Radio Measurements and Standards Project, Radio Section, 1945, 345, 372, 381
- radio meteorographs (*see* radiosondes)
- radio meteorology, 512, 514, 517
- Radio Meteorology Section, 517, 521, 523, 545
- radiometer, 598n, 599, 600
- "radio music box", 12
- radio navigation, 2
- radio navigation of airplanes, 93
- radio navigation system: directional coil antenna  
adapted to shipboard use, 139
- radio navigation systems, 555
- radio noise, 513, 555, 597
- radio noise, atmospheric, 598n
- radio noise, cosmic, 595
- radio noise: effect of on radio reception, 555  
from planet Jupiter, 21  
mobile recording unit, 559, 562
- radio noise measurement: at Minuteman missile sites, 562
- radio noise outbursts, 602
- Radio Noise Section, 559n, 561, 562
- Radio Physics Division, 292, 354
- radio plasmas, 624
- Radio Plasma Section, 627
- radio probing of magnetized and bounded plasma, 624
- Radio Propagation Activity Report: a monthly paper, 416
- radio propagation at VHF over irregular terrain, 534
- Radio Propagation Course, 696
- radio propagation engineering: NBS objective, 578
- Radio Propagation Engineering Division, 477, 516, 543, 545, 555n, 614
- Radio Propagation Engineering Journal Club, 698n
- Radio Propagation Executive Council (of CRPL), 414, 415, 432, 525, 703
- Radio Propagation Executive Council (of CRPL):  
Aug. 13, 1946 meeting, 704  
first meeting, 416, 704
- Radio Propagation Field Station, Anchorage, Alaska, 453
- Radio Propagation Handbook, 1943, 556, 579
- Radio Propagation Physics Division, 477, 499
- Radio Propagation Physics Journal Club, 698n
- radio propagation predictions: IRPL-D series, 408
- Radio Propagation Problems: a section within NDRC, 316
- radio proximity fuse (nonrotating type): an NBS development, 316, 319
- radio-ray refraction, 522
- radio-ray refraction angle, 522
- radio receiver: pocket type, 82n
- Radio Receivers Committee, IRE, 652
- radio receivers for airways, 155
- radio reception in Government hospitals, 83
- radio refractive index, 517, 518, 520, 525
- radio refractive index: variability of, 520
- radio-refractive-index climatology, 523
- Radio Refractive Index Data Center, 521, 545
- radio refractive index inhomogeneities, 519
- radio refractive index profiles, 521
- radio refractive index structure, 522
- radio relay: railroad signal device, 84n
- radio relay system, 20
- Radio Research and Testing Section, 71
- Radio Science*, 675

- radio science: commentary, Dellinger Address, 1961, 230n
- Radio Science Bulletin*, 89
- Radio Section, 43, 69, 71, 78, 80, 81, 88, 90, 91, 92, 173, 182, 183, 186, 188, 190, 191, 193, 194, 195, 198, 198n, 201, 202, 204, 207, 208, 211, 215, 216, 217, 220, 221, 222, 224, 225, 227, 230, 231, 232, 233, 234, 235, 236, 237, 240n, 241, 262, 263, 315, 316, 317, 318, 319, 323, 327, 328, 329, 334, 335, 339, 340, 342, 343, 345, 369, 384, 403, 407, 407n, 408, 409, 409n, 410, 410n, 411, 411n, 412, 412n, 415, 420, 421, 422, 422n, 424, 426, 428, 433, 439, 440n, 449, 450n, 451, 462n, 465, 470, 470n, 512, 563, 571, 578, 643, 644, 645, 648, 649, 650, 651, 651n, 652, 653, 654, 657, 658, 659, 661, 663, 665, 666, 668, 671, 674, 680, 680n, 681, 694, 703, 704
- Radio Section: a source of radio information on radio receiving sets, 80
- development of aids for air navigation, 153
- development of antennas and radio systems, 110
- doldrums period of measurements, 110
- employment, low in 1924, 74
- field facilities at College Park, Md., 153
- first staff meeting, 75n
- information on radio for public, 88
- initiation date, 43n
- inventions, 96
- reorganization, 1918, 65
- signal intensity measurements, 111
- sound measurements, 109
- space problems in WW II, 340
- standard inductor developments, 102
- study and measurement of modulation, 110
- technical assistance to Department of Commerce on radio problems, 95
- use of condenser antenna, 118
- visitors during the 1920's, 90
- Radio Section reorganized, Aug. 1919, 71
- Radio Service Bulletin*: Bureau of Navigation, Department of Commerce, 260
- Radio Service (division), Bureau of Navigation, 644
- Radio Ship Act of 1910, 11
- Radio Ship Act of 1911, 42
- radio signals over Atlantic, 1935-40, anomalies, 201, 807, 808
- radiosonde: "an epoch landmark in meteorological history," 132
- a serviceable product, 128
- a technical breakthrough in development, 126
- attains technical stature, 131
- cloud height and thickness observations, 128
- earliest development by NBS (1935), 122
- earliest developments, 122n
- early development by Radio Section, 122
- early method of determining wind conditions, 126
- first publication by Radio Section, 128
- flight testing, 128
- humidity observation by electric hygrometer, 126, 128
- investigations of electric hygrometers, 124, 126, 131
- observation by audiofrequency modulation, 124
- operation at UHF, with pulse modulation, 131
- origin of name, 122n
- service in Navy Department, 128
- service to Government agencies, 128
- temperature sensor, electrolytic resistor, 124
- transistor operation, 132
- ultraviolet light measurement, 124, 124n
- Radio Spectrum Conservation*: JTAC publication, 584
- Radio Spectrum Utilization*: JTAC publication, 585
- Radio Standardization Conference, Jan. 1923, 82, 92
- radio standardization programs: NBS participation, 82
- Radio Standards Division, 292, 349, 352, 353, 354, 375, 399
- Radio Standards Division Research Seminar, 698n
- Radio Standards Engineering Division: meets new financial problems, 356
- Radio Standards Engineering Division (later, Electromagnetic Division), 345, 388
- Radio Standards Laboratory, 343, 345, 349, 351, 356, 358, 369, 391, 392, 398, 400, 698
- Radio Standards Laboratory: organizational growth, 419
- planning a 5-year program, 355
- planning a new building, 356
- provides for special *Proc. IRE* issue, 358
- Radio Standards Laboratory building, 719
- Radio Standards Physics Division (later, Radio Physics Division), 292, 345
- Radio Standards Research Seminar, 698
- radio stars, 607n
- radio-star scintillations, 603n
- Radio Star Scintillations project, 499n
- Radio Technical Commission for Aeronautics (RTCA), 576, 576n, 650, 650n
- Radio Technical Commission for Marine Services, State Department, 650
- Radio Technical Committee for Aeronautics, Bureau of Air Commerce, 650
- radio telemetry, 2
- Radio Telephone Transmitter and Receiver Terminology Subcommittee, IRE, 652
- radio telephony becomes established, 88
- radio telescope, 595, 598, 599, 600, 603n, 604
- radio telescope: Effelsberg, 24
- largest equatorially mounted, 24
- largest fixed-type transit, 23
- largest movable, 23
- largest steerable, 22
- radio telescopes, 596n, 606n
- Radio Tracking Accuracy project, 540n
- Radio Transmission Handbook, 403, 695
- Radio Transmission Handbook, Frequencies 1000 to 30,000 KC, 317
- Radio Warning Services Section, 451, 455, 616
- Radio Wave Direction Committee, URSI, 668
- radio wave field intensity observations: during WW II, 409
- radio-wave probing of dense plasma, 625
- radio wave propagation: Dellinger Address, 1961, 171
- prediction, 735
- studies by Austin, 172
- Radio Wave Propagation Commission, URSI, 672
- Radio Wave Propagation Committee, IRE, 652
- Radio Wave Transmission Phenomena Committee, American Section, URSI, 668
- "radio weather", 316
- radio work at NBS: an early need, 40n
- RAMALEY, David, 395, 396
- RANDALL, Dwight L., 512, 514
- RASMUSSEN, Alvin L., 391, 392, 393, 394, 633
- ratio, electromagnetic to electrostatic unit, 99
- ray bending, 514
- Rayleigh distribution: definition, 534n
- REBER, Grote, 219, 595, 596n, 598, 598n, 599, 600, 602, 603, 603n, 607n
- receiver: 10-meter type developed, 120
- receiver noise, 613n
- Receiving Sets Subcommittee, IRE, 652
- recording microwave refractometer, 389, 518

recording microwave refractometer: an interesting application, 391

REES, Manfred H., 469

REEVE, Gerome R., 385

"References to the Current Radio Periodical Literature" (see "Radio Information Clearing House"), 89

reflection coefficient at grazing angles, over irregular terrain, 534

refraction angle, calculation of, 522

refraction in an exponential atmosphere, 522

refractive index, 512

refractive index: of ionosphere, 605

refractive index, surface, 514

refractive-index gradient, 537

refractive index of atmosphere: calculation by computers, 588

refractive-index profile characteristics, 538

refractive-index profiles, 523

refractive-index structure, 522, 523

refractive index variations, 519

refractometer, 520

refractometer, "absolute", 519

refractometers: microwave, 519

regenerative circuit: inventor recognized, 17

    U.S. patent, Armstrong, 11

    U.S. patent, deForest, 11

REGGIA, Frank, 345, 367, 367n, 374

Regular Propagation Services Section, 725

REICH, Francis W., 709n, 711, 726n

relating useful frequencies of transmission to vertical incidence measurements, 237

relay recorder (see remote control by radio)

remote control by radio, 84

RENSE, William A., 624

requests for information and services, 100

RESA: Boulder Branch, 699, 700

    National organization, 699

RESA Boulder Scientist Award, 700

research projects abandoned: late 1920, 73

resistance: standards (resistors) for radio frequencies, 102

resistance measurement: four methods at RF, 102

resonant circuits: inductively coupled, capacitive tuning, famous Marconi patent, 8

resonant frequency: equation, 243

REYMER, Stephen E., 191, 217, 227, 236, 238n, 412

RF ammeter: first calibration of, 43

    study of, 43

RF ammeters, 43n, 380

RF current: basic principle of measurement, 103

RF voltmeter calibration console, 380

RICE, Philip L., 515, 516, 522, 581, 585

RICHARDSON, John M., 297, 297n, 307, 349, 349n, 620, 620n, 621, 625, 688, 689, 699, 700

RICHARDSON, O. W., 10

RICHARDSON, R. S., 223

RIES, Francis X., 357, 380

RIGGS, Lowell P., 522

riometer, 608, 609, 609n, 610n, 611n, 616

riometer: defined, 608n

    explained, 442n

RISHBETH, H. (consultant to CRPL), 428n

RISLEY, Allan S., 309, 394

ROACH, Franklin E., 466, 468, 468n, 469, 469n, 484, 485, 674

road names: Nobel Prize winners, 719

    suggestion by Swinerton, 719n

ROBERTS, Richard W., 309n

ROBERTS, Walter Orr, 451n, 708, 708n, 712n

ROENTGEN, Wilhelm Conrad, 6

ROGERS, J. Harris, 59

"Romance of Measurement", 342

"Romance of Measurement": a viewpoint, 342

ROOSEVELT, Franklin D. (President), 17, 316

ROOSEVELT, Franklin D.: first U.S. president to be televised, 18

ROOSEVELT, Theodore (President), 646

ROPER, Nathaniel J., 501, 501n

ROSA, Edward B., 32, 40, 47, 69, 99, 100, 643, 695

ROSENHOLD, Munk Af., 3n

rotary-vane attenuators: study of, 366

rotational period, Jupiter, 606

round-the-world broadcast, first, 16

rubidium clock: portable, development of, 306

ruby laser, high-powered, 639

ruby laser, pulsed, 631

RUEGER, Lauren J., 259, 298

RUSSELL, David H., 364, 365, 366, 389

RUSSELL, S. (Airborne Instruments Laboratory), 505n

RYAN, William E., 112, 345

## S

Sacramento Peak Observatory, 623n

Safety at Sea, Interdepartmental Radio Committee, 139

Safety at Sea, International Conference on, 1913, 139

Sagittarius, 595, 595n, 597

SALAZAR, Henry F., 301, 309

SALZBERG, Calvin D., 458

SANGSTER, Raymond C., 356, 356n

San Nicolas, California Coast tropospheric propagation measurements, 537

SARNOFF, David, 12

satellite communication relays, 614n

SAVITT, Jacob, 219

SAWYER, Charles (Secretary of Commerce), 293, 309, 705, 705n, 706, 709, 710, 711n, 723

scanning disk: mechanical, 5

scatter F: an IGY study, 425

scattering, incoherent, 437

scattering by a turbulent atmosphere, 551

scattering of electromagnetic energy in a randomly inhomogeneous atmosphere, 551

scatter measurements near the radio horizon, 552

SCHAFER, George E., 297n, 354n, 366, 366n, 389, 621, 654, 654n, 687, 697, 699, 700

SCHAWLOW, A. L. and TOWNES, Charles H., 22

SCHIFFMACHER, Edward R., 503n, 605, 608

SCHMID, Charles W., 503

SCHMIDT, Leonard B., 394, 634

SCHNEIBLE, Dennis E., 219

SCHOCKLEY, William, BARDEEN, John and BRATTAIN, Walter Houser, 21

SCHOCKLEY, William, PEARSON, G. L. and HAYNES, J. R., 21

SCHOTTKY, Walter, 12

SCHULKIN, Morris, 512, 513, 514, 522

Scientific Program Committee: dedication, Boulder Laboratories, 726n

Scientific Research Society of America (see RESA)

Scientific Staff Meetings, NBS, 696

scintillation of radio stars, 603, 605

SCOLNIK, Reuben, 339

SCOTT, Winston W., 380, 381

SCOVIL, H. E. D., FEHER, G. and SEIDEL, S., 21

screen-grid tubes: improved design, 15



- SCROGGIE, M. G., 3
- SEAC (NBS Eastern Automatic Computer), 586, 586n
- sea-level refractivity, 524
- sea-level refractivity: annual cycle of, 524
- second: atomic, 307
- definition by atomic transition, 24
  - definition by transition frequency of cesium, 1967, 307
  - definition by transition frequency of cesium, tentative, 1964, 307
  - ephemeris, definition, 307
  - in terms of rotation of Earth on axis, 307
- Second International Polar Year, 674
- Second International Polar Year: ionosphere
- observations by Radio Section, 1932-1934, 220
  - reported by NBS at General Assembly of URSI, 1934, 220
- Second National Radio Conference, 245
- Secretary of Commerce, 78, 94
- Secretary of Commerce and Labor, 644
- seismology, 735
- SELBY, Myron C., 339, 345, 358, 359, 377, 377n, 378, 379, 380, 654, 698
- SELLERY, Harry G., 482
- semiconductor research: Nobel Prize in Physics, 1956, 21
- semiconductors, 3
- semiconductors: properties of, 31
- SEN, Hari K., 457, 600n
- Senate Advisory Committee on Color Television, 590, 591, 591n
- Senate Committee on Interstate and Foreign Commerce, 591n
- SERA, Frederick, 282, 285, 285n
- service area of airborne TV transmitter, 582
- service area of radio transmitters: early
- measurements, 579
  - improved method of measurement, 581
  - tropospheric propagation, 580
- service to Government: *1915 Annual Report*, 44
- service to the Armed Forces: early, beginning 1917, 648
- serfics: properties of, that produce whistlers, 479
- spectrum analysis, 481
  - study of characteristics, 480
- SHAFER, John F., 701
- SHAPLEY, Alan H., 443n, 450, 450n, 451, 455, 482, 484, 484n, 485, 502n, 664, 665, 669, 674
- SHAULL, John M., 258, 258n, 269, 334, 345
- SHERWOOD, Jesse E., 299
- shielding: after 1946, 65
- WW I period, 64
- shielding of ignition noise: aircraft engines, 156
- SHOAF, John H., 258, 259, 275n, 309
- shock-wave effects in hot plasma, 627
- shock waves from exploding wires, 626
- SHORT, Pius J., 581
- short-term fading characteristics, 538
- short-wave radio: importance, 13
- short-wave transmission across Atlantic, 1921, 13
- shot effect, 12
- SHULTZ, Edna L., 412, 441n, 557
- SID (*see* sudden ionosphere disturbance)
- Signal Corps Radio Laboratory, 244
- Signal Corps Radio Laboratory: "wire wireless", 45n
- signal intensity: measurement by auditory method, 109
- measurement by instrumental methods, 109
- Signalling for Safety at Sea Committee, Science Advisory Board, 653
- SILBERSTEIN, Richard, 405n, 412, 436, 441n, 458, 499n, 576
- silicon detector, 10
- silicon detector: development by Austin, 31
- SILSBEE, Francis B., 695n
- SIMMONDS, Michael B., 367
- SIMMONS, William R., 634
- SIMPSON, Philip A., 260
- single-sideband radio telephony: demonstrated, 14
- Site Selection Board, 709, 709n, 710n, 723
- Site Selection Board: site requirements, 709
- skip-distance calculation: a service to the radio amateur, 233
- sky-wave field intensity calculation: from observed quantities, 409
- SLABY, Adolph K. H., 6
- SLUTZ, Ralph J., 465n, 498n, 586n, 587, 724
- SMITH, Dean, 546
- SMITH, Ernest K. Jr., 421n, 424, 424n, 425, 428n, 448, 483, 483n, 517, 609n, 615n, 700
- SMITH, Newbern, 201, 217, 218, 224, 227, 229, 233, 234, 236, 237, 238, 238n, 239, 240, 241, 317, 403n, 405n, 406, 406n, 409n, 412, 412n, 414, 416, 416n, 424n, 426, 426n, 436, 441n, 449, 462n, 465, 486n, 556n, 591n, 597, 648, 659, 660, 662, 668, 672, 683n, 709, 709n, 723, 724n, 727n
- SMITH, Stephen J., 630n
- SMITH, Walter L., 397
- SMITH, Walter L., Bronze award, 397n
- SMITH-ROSE, R. L. (National Physical Laboratory), 340
- Smithsonian Astrophysical Observatory: cooperative effort with NBS, 306
- Smith-Weintraub equation, 520, 524
- Smith-Weintraub equation: defined, 518n
- SNIDER, Charles S., 301
- SNIDER, JACK B., 301
- SNYDER, James J., 631
- SNYDER, Wilbert F., 326, 330, 336, 338, 351, 354, 354n, 700
- solar activity, 598, 601
- solar activity: studies by Austin, 36
- Solar Atmospheric Studies program: objectives, 622
- solar bursts, 600, 600n
- solar cosmic radiation, 616, 616n
- solar cosmic-ray fluxes, 616n
- solar cosmic rays, 615, 616n
- solar disturbances, 607n
- solar emanations, 610n
- solar event, 1959, 602
- solar flare, 602
- solar flare activity, 601n
- solar flares, 600, 602, 607n, 608n, 615
- Solar Geophysical Data, 601n
- solar-magnetic storms, 608
- solar noise, 597, 598, 598n, 599n, 601n, 607n
- solar noise bursts, 600
- solar patrol, 601
- solar patrol, CRPL, 601n
- solar physics, 735
- solar-proton events (SPE), 494
- solar radiation, 598, 598n, 600
- Solar Radio Astronomy, a paper, 603n
- solar radio noise, 597, 597n, 598, 598n, 599, 600n
- solar radio noise bursts, 600
- solar radio noise intensity, 601
- solar radio waves, 597n, 607n
- Solar-Terrestrial Physics Division, Environmental Data and Information Service, NOAA, 737

- solar wind, 607n
- SOLOW, Max, 380, 381, 384
- SOMMERFELD, A.: paper on attenuation of radio waves, 112
- sonometer: described, 247n  
use, 246
- SOPKA, John J., 587
- SORROWS, Howard E., 112, 330, 345, 368, 653
- sounding the ionosphere: automatic continuous recorder with transmitter installed at Beltsville field station, 1932, 208
- automatic continuous recording of height, by Gilliland, 1931, 208
- continuous height recorder installed at Tufts College, by Gilliland and Kenrick, 1931, 208
- cooperation of Naval Research Laboratory with NBS, 204
- cooperative program with Tufts College, 206
- cooperative work with Carnegie Institution of Washington, 1925, 202
- development of Model A ionosphere recorder (ionosonde), 214
- earliest observations by Gilliland at Kensington field station, 203
- early observations of ionosphere by Gilliland, November 1928, 203
- early observations over long distances, 206
- Gilliland observes splitting of F layer, 211
- Gilliland observes sporadic E layer, 212
- multifrequency automatic ionosphere recorder, 209
- multifrequency recorder at Beltsville field station, extensive observations, 209
- observations of various heights, 1930, 205
- Radio Section operates its own pulse transmitter, 207
- Radio Section operates on a regular sounding schedule, 1930, 204
- Radio Section reports on the ionosphere, 1934-1935, 215
- studies of critical frequencies, by Radio Section team, 215
- transmission path, Beltsville to Meadows field station, 215
- Sound Section, 110, 246
- Sources of Elementary Radio Information*, 89
- South Pole Station, 610n
- SOUTHWORTH, George C., 53, 53n, 107, 343, 343n, 366, 598, 607n, 683n, 726n
- SOUTHWORTH, George C. and BARROW, W. L., 17
- Soviet Union, 22, 23, 24
- Space Age, 349, 613
- space communication, 613, 613n, 614
- space communication: CRPL publications, 585
- space communications, 595n, 614n
- space communication system, 547, 613, 614
- space environment, 735
- space environment disturbance: forecasting, 735
- Space Environment Laboratory, NOAA, 737
- space exploration, 615
- space flight, 614
- space program, 615
- space travel, 613, 615
- space vehicle, 613n
- space vehicles, 613n, 615
- spark transmitter, 104
- Special Committee on Instrumentation Standardization for Antenna Measurement, 649
- Special World Interval (SWI), 455n
- spectrometer, laser electron paramagnetic resonance (LEPR), 633
- spectrum analyzer, 588n
- Spectrum Engineering—The Key to Progress*, CRPL contribution, 586
- speed of electromagnetic radiation: by Rosa and Dorsey, 99n
- speed of EM waves: measurement of, 576
- speed of light, 99
- speed of light: 1972 determination, 25, 25n  
by NBS and University of Colorado, 1972, 99n  
recent determination by NBS, 587n  
studies of, 632
- speed of light measurement, 634, 637
- sporadic E: a long-period study by NBS, 420  
a survey paper, 425  
compilation of papers, a monograph, 425  
early observations by Gilliland, 421  
early studies by E. K. Smith, 424  
monthly information on, 422n  
no variation with sunspot numbers, 425  
number of published papers, 420n  
observations by Kirby and Judson, 422  
observations by Radio Section (group), 424  
prediction of transmission, 423  
reflections not related to meteor trails, a study, 424, 462  
structure concepts for reflections, 421n  
study of equatorial sporadic E, 425  
study of variation, 424  
wind shear cause, 459
- sporadic-E reflection: defined by E. K. Smith, 421n  
defined by IGY, 421n
- sporadic-E regions, 605
- sporadic-F regions, 605
- SPRAGUE, Robert C. (Sprague Electric Co.), 352
- spread F: equatorial, 447  
presence on ionogram described, 503n
- Sputnik, October 4, 1957, 22, 349
- Sputnik I (*also, see* Ionosphere, upper), 604, 613, 675
- Sputnik II, 604, 604n
- Sputnik III (*also, see* Ionosphere, upper), 604, 604n
- SQUIER, George O. (Chief Signal Officer of Army), 683
- STAIR, Ralph, 124
- Standard Frequency Broadcast at Very Low Frequency: a proposal by W. D. George, 1957, 475n
- standardization: radio, various subjects, 82n, 651
- Standardization Committee, IRE, 652
- standardization programs, 82
- standard musical pitch: 440 Hz, broadcast over NBS network, 269n
- standards: radio, earliest reference, 48n
- standards and measurement: a doldrums cycle, 342
- Standards Committee, Institute of Radio Engineers, 82n, 652
- standards for radio frequencies: establishment of, 347
- standards of frequency: early development by NBS, 93
- standards of frequency and wavelength, 637
- Stanford University, 263
- STANLEY, John T., 292
- STANS, Maurice H. (Secretary of Commerce), 736n
- STARAS, Harold, 551, 551n
- Starfish: 1962 nuclear explosion, 460
- Stark-cell microwave spectrograph, 298, 619
- State Department, 603, 650
- Statement of the Central Continuing Mission of NBS, 1960, 360
- static problem: partially solved by broadcasting networks, 96  
successfully solved by frequency modulation, 96

- Station KK2XEI (later WWVB), began standard frequency (60 kHz) broadcasts, 276
- Station WLW: high power, 17
- Station WWV: act of Congress provides for new station, 271
- begins operation at Beltsville, Md., 266
  - begins operation at College Park, Md., 265
  - call letters assigned to Bureau of Standards, 260
  - controlled by quartz oscillator, first time, 264
  - destroyed by fire, 271, 340
  - earliest station described, 263n
  - ends operation from Bureau grounds (Washington, D.C.), 265
  - First Day Signals from Ft. Collins, QST cards, 282n
  - format of transmitted signals, 263n
  - Ft. Collins location described, 277n
  - frequencies referenced to NBS primary frequency standard at Boulder, 277
  - golden anniversary observed, 287
  - installs 30-kW transmitter, Beltsville, Md., 266
  - location transferred from Greenbelt to Ft. Collins, 282
  - new site selected, Beltsville, Md., 271
  - operation at Ft. Collins, 292
  - operation with automatic announcing equipment, 273
  - quartz frequency standards sealed in underground vault, 272
  - radio propagation disturbance warnings initiated, 273
  - short-wave disturbance forecasts for North Atlantic, 275
  - site near Ft. Collins, 722
  - standard frequencies by single sideband transmission, 276
- Stations WWV and WWVH: coded information transmitted worldwide for IGY, 277
- Geoalerts service begun for IGY, 276
  - greatest use of standard frequencies and time signals, surveys of 1952 and 1956, 276
  - Greenwich Mean Time changed to UTC, 287
  - survey indicated time-of-day announcements most used service, 288
  - time announcements referenced to Greenwich meridian, 285
  - voice announcements of time at 1-minute intervals, 287
- Station WWV used for reflection from Moon: (f) NBS successful in Moon reflection, Cedar Rapids, Ia., to Sterling, Va., 271-note(f)
- unsuccessful, 269-271
  - (a) unsuccessful, reported by W. D. George, 270-note(a)
  - (b) unsuccessful, experiment described, 270-note(b)
  - (c) unsuccessful, pulse technique not explained, 270-note(c)
  - (d) unsuccessful, Yardley Beers comments on experiment, 270-note(d)
  - U.S. Army Signal Corps successful, 1946, 270-note(e)
- Station WWVB: round-the-clock service begun, 287
- time code broadcast by level shift of carrier, 281
  - transmission initiated from Ft. Collins, 278
  - transmission of standard frequency and time interval controlled by U.S. Frequency Standard, 281
- Stations WWVB and WWVL: dedication of Ft. Collins facilities, 280n
- transmissions indicate improvement of precision of time signals, 285
- Station WWVH: experimental station on Island of Maui, 274
- moved to Island of Kauai, 286
  - new facility, Island of Kauai, 286n
  - radio propagation conditions forecast for North Pacific, 275
  - silver anniversary observed, 287
  - voice announcements added, 281
- Station WWVL: experimenting with 20 kHz, 287n
- operation begun at Sunset site, 277
  - transmission curtailed, 287
  - transmission initiated from Ft. Collins, 280
- STEINERT, Leon A., 394
- Sterling field station, 595, 597, 599, 599n, 600
- Sterling field station: established, 340
- Sterling Radio Propagation Laboratory, 453
- Sterling, Va., field station, 557, 563, 565
- STEWART, Balfour, 171
- STICKLER, Warren C., 354n
- STONE, John S., 8
- STONEHOCKER, Garth H., 219, 460
- STRATTON, Samuel W., 31, 42, 69, 82n, 94, 99, 144, 644, 647, 695
- STRATTON, Samuel W.: women on staff, 72
- STROCK, Morris S., 265
- STROCK, Morris S.: Bureau *Circulars*, 81n
- STROMBOTNE, Richard L., 301
- STROUD, Jack C., 538
- STUART, D. M., 215, 229
- submarine antenna, 563
  - submarine antenna: NBS design, 58n
  - patent litigation, 59
- Sub-Panel on Frequency Control Devices, Joint Research and Development Board, 649
- sudden ionosphere disturbance (SID), 597, 601n
- sudden ionosphere disturbance: an early prediction, 221
- cooperative observations, 221
  - correlation with disturbances on Sun, 223
  - Dellinger's explanation, 224
  - early observations, 221
  - evidence by Mt. Wilson Observatory, 223
  - magnetic storm of October 1935, 222
  - radio transmission characteristics described, 224n
  - the "Dellinger effect" acclaimed, 222
  - the many-reported occurrences, 224
  - 12 papers by Dellinger, 223
- SUGAR, George R., 464, 465, 465n, 498, 498n, 587n
- SULZER, Michael P., 639n
- SULZER, Peter G., 271-note(f), 433n, 487n
- Sun, 607n, 608
- Sun-Earth Relationship Section, 502
- Sun-Earth relationship studies, 450
- Sunset field site, 722
- Sunset field station: a new VLF facility, 473
- sunspot activity, 598
- sunspot numbers: prediction of, 450
- superheterodyne circuit: development of, 12n
- U.S. patent granted, 12
- super-refractive layer, 537
- super-refractive layers, 537
- superregenerative circuit, 13
- surface refractivity, 524
- surface resistivity: measurement of, 107
- SWINNERTON, John L., 719n
- Symposium on Communications by Scatter Techniques, 1955, 497
- Symposium on High Latitude Particles and the Ionosphere, Alpbach, Austria, 1964, 611
- Symposium on Ultra-Low Frequency Electromagnetic Fields, 1964, 699
- synchronization of clocks: by Loran, 574
- synchronization of precision clocks: by satellite experiment, 289

synchronization of time and frequency signals: by fixed-position satellite, 289  
 synchronization of time scales and time signals: by transporting standards, 289  
 synchronization of time signals: limitations by radio transmission, 289  
   via TV transmission, 290  
 synchronization on continuous basis: by phase-lock system, 289  
 synchronous communication satellite, 615  
 synchrotron radiation, 460n  
 Syncom satellite, 23  
 Syncom 2, 615  
 systematic error in phase-type distance measuring equipment, 555  
 system loss, 515  
 system loss: defined, 515  
 Systems Analysis Section, 613n  
 system transmission loss, 515, 583

## T

Table Mesa antenna range, 565  
 Table Mountain field site, 603, 604n, 606, 606n, 722  
 Table Mountain field station, 565  
 TACAN (Tactical Air Navigation): defined, 576n  
   investigation of, 576  
 TAFF, John M., 581n  
 TAGGART, Harold E., 384, 700  
 TAIT, Andrew, 576  
 TARY, John J., 700  
 Task Group on Fundamental Constants, Committee on Data for Science and Technology (CODATA), 637  
 TAYLOR, A. Hoyt, 93, 176, 176n, 180, 679n  
 TAYLOR, A. H. and YOUNG, L. C., 13  
 TAYLOR, Archer S., 201, 212, 212n, 217, 225, 226  
 TAYLOR, WILLIAM L., 477, 478, 481, 481n  
 Technical Committee on Electromagnetic Measurements State-of-the-Art, IEEE, 654  
 Technical Committee on Fundamental Units and Measurements, IRE, 653  
*Technical News Bulletin (TNB)*: a source of radio information, 90  
   reports on standards inactivity, 343  
   origin, 65  
 Technical Subcommittee of the Telecommunications Committee, State Department, 650  
 telecommunications: field of, 646  
   first use of word, 16n  
 Telecommunications and Space Disturbance Service Center, 453n  
 telecommunication sciences, 735  
 telegraph, 1, 3  
 telegraph: Morse patent, 3  
 telephone, 1  
 telephone: Bell patent, 5  
 Telephone, Telegraphy, and Radio: Subcommittee, AIEE, 651  
 television, 1  
 television: engineering standards, 20  
   introduction at World's Fair, 1939, 18  
   predicted technology, 1908, 10  
   radio, demonstrated, 1927, 15  
   two-way wire, 16  
   wire, demonstrated, 1927, 15  
 Television Allocations Study Organization (TASO), 585  
 television demonstrated: radio transmission, scanning disc, 15  
 television system: electronic, U.S. patent, 15  
   30-lens disc, 15  
 television transmission: color pictures over coaxial cable, 20  
 television transmitter: experimental, 16  
 temperature, ionosphere, 437  
 terrain: effects of irregularities, 513  
 terrain effects, 533, 534  
 terrestrial magnetic field, 607n  
 TERRIEN, J., 689, 689n  
 TESLA, Nikola, 8  
 testing of radio receivers: publications, 651  
 testing of radio receiving sets, 81  
 thallium beam frequency standard: evaluation of performance, 305  
   frequency measured, 305  
 THAYER, Gordon D., 517, 521, 522  
 The Measurement of Lumped Parameter Impedance, a Metrology Guide: *NBS Monograph 141*, 369  
 The Measurement of Noise Performance Factors, a Metrology Guide: *NBS Monograph 742*, 382  
 "The National Bureau of Standards": an address by Astin, 1953, 342  
 Theoretical Astrophysics project: objectives, 623  
 theoretical astrophysics research projects, 623  
 theoretical work as background to standards and measurements, 398  
 THEOTOKATOS, Thomas L., 626  
*The Principles Underlying Radio Communication*: a song evolves, 54n  
   WW I publication, 53  
 "The Radio Boom," 80n  
 thermionic vacuum tube: three-element, 10  
   two-element, 10  
 thermister bridge: for lower radio frequencies, 377  
 THOMAS, Harold A., 349, 349n, 700  
 THOMAS, J. A. (Cambridge University), 425  
 THOMAS, J. A. (University of Queensland), 425n  
 THOMAS, Richard N., 622, 623, 624, 628, 628n, 699  
 THOMSON, E., 5  
 THOMSON, Joseph John, 7  
 THOMPSON, Moody C. Jr., 519, 519n, 540, 540n, 542, 545, 546, 700  
 THOMPSON, S. P., 5  
 three-electrode vacuum tube, 10n  
 tides: lunar, of D region, 457  
   lunar, of ionosphere, 457  
   upper atmosphere, theoretical treatment, 457  
 Time and Frequency Division, 292, 308, 345  
 Time and Frequency Services Section, 292, 308  
 timekeeping: by an ensemble of clocks, 308  
 time variations in phase over line-of-sight paths, 543  
 Tiros satellites: first, 22  
*Titanic* disaster, 11, 41n, 657  
 Tokamaks: data for, 630  
 Topside Sounder (*see* Ionosphere, upper)  
 topside sounding: of ionosphere, 23  
 total eclipse, of Sun, 600  
 TOWNES, Charles H., 23, 298, 299, 300, 300n, 619, 620, 683n  
 TOWNES, Charles H.: awarded Nobel Prize in Physics, 300n  
 TOWNES, Charles H., GORDON J. P. and ZEIGLER, H. J., 21  
 tracking systems: accuracy of, 545  
 transatlantic cable: first, 4  
 transatlantic radio telephone service: commercial, 15  
 transatlantic two-way wireless telegraphy transmission, 10

transatlantic wireless telegraphy transmission: first, 8  
transient electric current: analysis, 4  
transistor: discovery of, 20  
transmission and fading of radio signals: long-distance studies in New Zealand by Berkner, 196, 197  
transmission and reception of speech: by spark transmitter, 8  
transmission loss, 515, 516, 523  
transmission loss: defined, 581n  
defined by Norton, 581  
obstacle-gain experiments, 535, 537  
transmission loss characteristics: a lengthy study, 581  
transmission loss experiments, across obstacles, 536  
transmission loss predictions, 516  
transmission of music and speech, with 80-kHz alternator, 10  
transmission of photographs via radio, 14  
transmission of radio waves: abundant data from Meadows field station, 200  
a geographic anomaly, 200, 807  
a 1940 account of projects and problems, 202n  
a point of view by Dellinger, 1927, 193  
character of data from Meadows field station, 200  
correlation of field intensity with sunspot activity, observations of 1927, 193  
development of receiving equipment, 191  
distance ranges of radio waves, NBS Letter Circulars, released 1932, 1940, 1941, 197, 198, 470n  
excessive attenuation across North Atlantic, 201  
forecasting, 236, 237  
observations, separating directional components, and rotating planes of polarization, 194, 195  
Parkinson's observations in combinations, summarized, 150  
pioneer study, 1902, 9  
prediction, 452  
prediction service for radio amateurs, 198  
the Monthly Report on Status of Work on Radio Wave Phenomena, 188  
studied at six field stations, 190  
Transmission of standard frequencies: accuracy of WWV, WWVH stated, 1958, 276  
announcement of first broadcast by WWV, 261  
Atomic Time Scale offset to agree with UT2 scale, 277  
by Stanford University, to cover western U.S., 263  
by WWV, preliminary, 261  
continuance of WWV service questioned, 264  
for use by radio inspectors of Bureau of Navigation, 261  
frequencies of WWV measured with piezo oscillator, 265  
frequency-control techniques at distance established, 278  
Letter Circular explains, 262  
new quartz crystals increase frequency stability, 277  
news release of early broadcast, 261n  
synchronization of time scales by portable quartz clock, 278  
WWV accuracy stated, 1936, 269  
WWV and WWVH monitored at Gunbarrel Hill, 276  
WWV begins weekly schedule, 262  
WWV transmissions of 30 and 35 MHz discontinued, 275  
WWV transmits at 2.5 MHz, 273  
WWV transmits at 10 and 15 MHz, 266  
WWV transmits at 20, 25, 30, and 35 MHz, 273  
WWV transmits 440-Hz modulation, 269  
WWV transmits 1000-Hz modulation, 269  
transmission of standard wavelength signals: a proposal, 1922, 261  
transmission of time signals: WWV begins voice announcements of standard time, 275  
WWV initiates 1-second pulses, 269  
WWV, WWVH operation on UT2 uniform time, 276  
transmitter: 10-meter type developed, 118  
Transmitter Interference Committee, CCIR, 660  
Transmitters and Antennas Committee, IRE, 652  
travelling-wave tube, 19  
TREMBATH, Charles L., 288n, 383  
tropical ducts, 520  
troposphere, 511, 512  
Tropospheric Analysis Section, 539  
tropospheric communications, 525  
tropospheric ducts, 513  
tropospheric forward scatter, 549, 550  
tropospheric forward scatter, mathematical studies, 551  
Tropospheric Measurements Section, 539  
tropospheric propagation, 511, 512, 513, 514, 516, 517, 519, 520  
tropospheric propagation: survey of research, 1948-1956, 514  
tropospheric propagation experiments, 525  
tropospheric propagation measurements, over-water paths, 537  
Tropospheric Propagation Measurements project, 539n  
Tropospheric Propagation Phase Stability Studies project, 539  
tropospheric propagation research, 512  
tropospheric propagation research: data reduction for, 587  
Tropospheric Propagation Research Section, 512, 517, 518, 539, 540  
tropospheric radio propagation, 513  
tropospheric research, 513  
tropospheric transmission loss, 515  
tropospheric transmission loss: at VHF and UHF, 581  
Troy project, at MIT, 486  
Troy project: transmission equation for forward scatter, 487n  
Truman administration, 704  
TRUMAN, Harry S. (President), 20, 650, 704n, 705  
two-way radio relay system, 17  
Tufts College: cooperative program with NBS, 206, 208  
tunnel diodes, 22  
TVETEN, Lowell H., 458  
Type "N" connector, 399

## U

U.H.F. magnetic attenuator, 367  
ULF Symposium, 1964, 475  
ULF Symposium, 1964: cosponsors, 476n  
UNDERHILL, Anne B., 623  
underwater reception and transmission of radio signals, 58  
United States Naval Wireless Telegraphic Laboratory (*also* U.S. Naval Radio Research Laboratory), 33  
United States Weather Bureau, 733, 735  
universe, 595  
University of Colorado, 627, 628, 718, 723, 735  
University of Pennsylvania, 19  
University of Wisconsin: early broadcasting, 12  
upper atmosphere, 607, 608  
upper atmosphere: definition, 498n

- Upper Atmosphere and Plasma Physics Section, 609n, 611, 625, 626
- Upper Atmosphere and Space Physics Division, 609n, 610n, 612, 616, 625
- Upper Atmosphere Research Section, 471n, 474, 587, 598n, 605n
- URSI (*also. see* International Scientific Radio Union)
- URSI: American Section, 667, 668, 669
- IInd Assembly, 1927, 668
- XII Assembly, 1957, 668, 669, 670
- U.S. National Committee, 668, 675, 676
- URSI General Assembly, Xth, 1952, 603
- U.R.S.I. Golden Jubilee Memorial*, 676
- URSIgrams, 208, 234
- URSIgrams: development of, 234n, 235n
- URSIgrams (*also. see* American URSIgram Service)
- U.S.A.F. Electrical Standards, Dayton AF Detachment, Air Force, 353
- U.S. Air Force, 491, 492, 564, 565, 570, 573, 583, 603
- U.S. Air Force Ballistic Missile Division, 539, 542n
- U.S. Air Force Manual of Standards for Tropospheric Communication Circuits Handbook, 516
- U.S. Army Air Service: request for radio aid to air navigation, 1920, 150
- U.S. Army Signal Corps, 515
- U.S. Army Signal Research and Development Laboratories, 260
- U.S. astronauts: ARMSTRONG, ALDRIN, and COLLINS, 24
- U.S.A.-U.S.S.R. exchange program, 358
- U.S. Bureau of Mines, 391
- U.S. Coast Artillery: requests radio direction finder, 146
- U.S. Congress: televised first time, 20
- U.S. Frequency Standard: transition frequency of cesium adopted, 22
- U.S. Government, 704, 705, 713, 713n, 723, 724
- U.S. Government: installs radio range stations, 15
- U.S. Joint Chiefs of Staff, 317, 405
- U.S. Lake Survey, Army Corps of Engineers, 737n
- U.S. Naval Air Missile Test Center, Point Mugu, Calif., 537n
- U.S. Naval Observatory, 273
- U.S. Naval Radio Research Laboratory, 115
- U.S. Navy, 573
- U.S. Navy: Vanguard I satellite orbited, 22
- U.S. Signal Corps, 269
- U.S. Weather Bureau, 512, 514
- UT2 (Universal Time): determination method, 276n
- utilization of ionosphere as a communication medium:  
    an investigation for the FBI, 1935-1936, 232, 233
- UTLAUT, William F., 612
- variation of electrical lengths of radio links:  
    measurement of, 542
- Venus, planet: characteristics of, 24n
- radar observations of, 439
- vertical incidence, 598n
- vertical-incidence signals: fading characteristics, 435
- Vertical Soundings Research Section, 435, 502
- VETTER, Maurice J., 519, 519n
- VHF emissions, 607
- VHF forward scatter: near geomagnetic equator, 446
- VHF propagation: a cooperative study, 580
- Vice President JOHNSON, Lyndon B., 614
- VIESBICKE, Peter P., 281n, 292, 564
- Viking I spacecraft: landing on planet Mars, 25
- Viking II spacecraft: landing on planet Mars, 25
- VIOLETTE, Edmond J., 460
- visitors on war missions: WW II, 340
- VLF emission: nature of, 479n
- VLF emissions, 609n, 611, 611n, 612, 613n
- VLF emissions and whistlers: atlas published, 480
- VLF noise (dawn chorus): by traveling-wave amplification in exosphere, 481
- VLF propagation, 480
- VLF propagation: attenuation, 477
- calculation of complex ionospheric reflection coefficient, 481
- early study by sferics, 480
- fading, 478
- field strength vs. distance, 476
- phase characteristics study, 478
- transmission loss concept, 476
- waveguide-mode theory, 474
- VLF Propagation Studies projects, 474
- VLF Symposium, 1957, 475, 475n, 480
- VLF Symposium, 1960, 475
- VLF Symposium, 1963, 475
- VOGLER, Lewis E., 522, 614, 614n, 615
- voice communications: long distance, 12
- Voice of America, 603
- Voice of America* broadcast: Jan. 12, 1949, 295
- voltage measurement: peak-pulse methods, 388
- voltage measurements: importance of, 378
- voltage standard: by use of bolometer bridge, 378
- volt-ammeter, Duncan type, 103
- volume resistivity, 107
- VOORHEES, L. E., 93, 177, 177n, 180
- VOR (VHF Omnidirectional Range): defined, 576n
- investigation of, 576
- vortex generator: literature search, 335
- vortex generators: field experiments, 336
- small-scale experiments, 335

## V

- Vacuum Tubes Subcommittee, IRE, 652
- Vacuum Tubes, Theory and Use*: WW I publication, 56
- vacuum-tube voltmeter: RF, development by Moullin (England) 1922, 378
- vacuum tube voltmeter: use of, 110
- VALEGA, Jorge L., 309
- VAN ALLEN, James A., 22
- Van Allen Belts, 22, 675
- Van Allen radiation belts, 607, 607n
- Vanguard I, 22
- VAN ZANDT, Thomas E., 437, 502, 502n, 503, 505, 505n, 506, 506n
- VARIAN, Russell and Sigurd, 18

## W

- WACKER, Paul F., 298, 386, 388n, 620, 698
- WADDELL, John H., 623
- WAINWRIGHT, Arthur E., 301, 309
- WAIT, David F., 357
- WAIT, James R., 427n, 428, 428n, 466, 466n, 474, 474n, 475, 475n, 476, 476n, 477, 478, 478n, 479n, 481, 571, 590, 675, 683n, 699, 700
- WAKEFIELD, John, 357, 371, 400
- WALDSCHMITT, J. A. (Page Communications Engineers, Inc.), 496n
- WALLACE, Henry A. (Secretary of Commerce), 315, 413, 413n, 414

- WALLS, Fred L., 309  
 WALLS, Hoy J., 263, 263n, 265  
 WALTERS, Lillie C., 477, 477n  
 WARD, Gray D., 625  
 War Department, 347  
 WARNER, John C., 117, 118  
 WARWICK, Constance S., 541  
 WARWICK, James W. (High Altitude Observatory), 499n, 604n  
*War Work of the Bureau of Standards: WW I*, 49n, 66, 88  
 Washington Conference on Limitation of Armaments, 1921-22: Technical Staff of American Delegation, 91  
 Washington Institute of Technology, 165n  
 Washington Provisional Frequency Board Liaison Committee, 660  
 Washington Section of IRE, 91  
 WATERS, Donald M., 519n, 546  
 water-vapor laser, 634  
 WATSON-WATT, Robert A., 172n  
 WATT, Arthur D., 475, 475n, 478, 571, 572  
 WATTERSON, Jane, 603n  
 WATTS, James M., 218, 426, 426n, 427, 427n, 433n, 458n, 471n, 473, 480, 481, 482, 489, 502, 502n, 612, 615  
 waveguide attenuator: inline-type standard, 367  
 waveguide attenuators: international comparisons, 366  
 waveguide below-cutoff attenuator: a useful reference standard, 363  
 waveguide below-cutoff attenuators: NBS development of, 362  
 wavemeter, 679, 680  
 wavemeter: designed by Kolster, 244  
   first calibration, 1911, 243  
   Kolster, 41  
   LC circuit, improved, Type R70B, 245  
   standardization of, 38  
   Type L, 244  
 wavemeters: early calibrations, 1914, 244  
   early commercial types noted, 244n  
   LC circuit, 100  
 Wave Propagation Committee, Combined  
   Communications Board, Joint Chiefs of Staff, 648  
 Wave Propagation Committee, of the U.S. Joint  
   Communications Board, 317, 340, 405  
 Wave Propagation Laboratory, NOAA, 737  
 wave suppressors, 514n  
 W.D. George Memorial Award, 280n  
 WEAVER, Frank D., 351, 354n, 355n, 395, 396, 396n  
 WEBER, Ernst, 685  
 WEBSTER, Arthur G., 41  
 WEEKS, Sinclair (Secretary of Commerce), 728  
 WEINSCHL, Bruno O., 359  
 WEINTRAUB, Stanley, 517, 518, 588  
 WEISS, Max T., 21  
 WELCH, Samuel W. J., 73, 416n, 704, 704n, 709, 713, 719, 723, 724, 724n, 726n  
 WELDEN, James M., 455n  
 WELLS, Joseph S., 382, 633, 634, 634n  
 WELLS, Paul I., 552  
 WENDT, Karl W., 354n  
 Western Union: radio relay system, 20  
 WEST, Estal D., 633  
 WGY (General Electric): transmitter used for fading tests, 183, 186  
 WHEELER, L. P., 695n  
 whistlers, 607, 611, 611n, 612, 613n, 625  
 whistlers: IGY program, preparations for, 481  
   nature of, 479n  
 WHITE, Charles E., 694n  
 WHITE, Marvin L., 457  
 "White Alice" project, 21  
 WHITTEMORE, Laurens E., 49n, 53, 65, 71, 71n, 82, 91, 150n, 180, 180n, 181, 647n, 651, 652, 681, 681n, 682  
 WIEDER, Bernard, 623, 625n  
 WIESNER, Jerome B., 549n, 550  
 WIEWARA, Edward J., 453, 455n  
 WILDHACK, William A., 691n  
 WILHELM, Kaiser: proposal of international radio conference, 9  
 WILKINS, John Walker, 3  
 WILLIAMS, Walter (Undersecretary of Commerce), 352  
 WILLIAMSON, Dorothy A., 515  
 WILLOUGHBY, John A., 48, 58, 58n, 59, 96, 122, 149, 563, 680n  
 WILSON, Albert E., 259  
 WILSON, Alvin C., 566, 567  
 WILSON, Lloyd B., 691n  
 wind shear in sporadic-E layer, 425  
 wind velocity by radar technique, 133  
 wind velocity by radio determination: early  
   phase-variation method by NBS, 1938, 132  
   improved NBS design, 133  
   phase-variation method in 1943, 133  
 wind velocity measurement, by radar method: pulse  
   repeater, development by Radio Section, 323  
   reflector technique development, 326  
 WINKLEMAN, James R., 461  
 wired sonde, for low-level meteorological sounding, 138  
 wireless, 1, 737n  
 wireless signals over Atlantic, 1910, anomalies, 807, 808  
 wireless system: first U.S. patent, 4  
 wireless telegraphy, 643  
 wireless telegraphy: a Government report of 1904, 646, 646n  
   prediction, 3  
   problems, 643  
 wireless telegraphy system: Braun, inductive circuits, 6  
   first U.S. patent, 6  
 "wireless" telephone: early U.S. patents, 5  
 wireless telephone system: patents, 8  
 within-the-hour fading, 539  
 WITTING, Edward G. (Deputy Director of Research and Development, Department of the Army), 352  
 WOLFF, Frank A., 39, 57  
 WOLZIEN, Eldred C., 368, 368n, 724  
 WOOD, Marion B., 451  
 WOODWARD, Milton W., 445  
 workshops: provided by ECC, 358  
 World Maps, 432  
 World Maps, of January 1, 1942, 439  
 World Maps, 1943, 440  
 World Maps, 1948, 440  
 World Maps, 1962, 441  
 world's first scheduled broadcast: by commercial organization, 12  
 World Warning Agency, of International URSIgram and World Day Service (IUWDS), 455n  
 World Wide Soundings Subcommittee, of IGY, 674  
 World War I (*also* WWI)  
 World War I, 49, 104, 106, 107, 110, 315, 318, 652  
 World War I: impact on Radio Section, 49  
   importance of radio telegraphy and telephony, 12  
   new demands for measurements, 104  
   projects, phasing out period, 71  
   radio communications, 11  
   relation of Radio Laboratory to military services, 52  
   return of commercial stations to owners, 12  
 World War II (*also*, WW II)

World War II, 315, 316, 319, 327, 330, 334, 343, 348, 377,  
398, 399, 648, 653  
World War II: broadcast announcements of invasion of  
Poland, 18  
    termination announcement by President Truman, 20  
WRIGHT, John W., 425, 435, 458, 460, 502, 502n  
WRIGHT, R. B., 257  
Würzburg radar, 599n 603n  
Würzburg (Giant) radar antenna, 599n  
WWV: listing in *Radio Service Bulletin*, 76n  
WWV: standard frequency broadcasts, 93  
    time-of-day announcements, available by  
        direct-dialing telephone, Boulder, 287  
    time-of-day announcements, available by telephone,  
        Hawaiian Islands, 287, 290  
    time signals by telephone, in continental United  
        States, 290  
WWV broadcasts market reports, 78  
WWV broadcasts music: spring of 1920, 76  
WWV Day, July 29, 1967, 285

## X

X1 (iron pentacarbonyl): field experiments with  
    radar, 338  
    laboratory experiments, 337  
    literature survey, 337  
X rays: discovered, 6

## Y

YAGI, Hidetsugu, 15  
YAGI, Hidetsugu, and SHINTARO, Uda, 15  
Yagi antenna: comment by Dellinger, 161n  
Yagi-Uda directional antenna, 15  
YATES, Bill C., 369  
YEAGER, James J., 712, 728n  
YOUNG, L. C. and HYLAND, L. A., 13n

## Z

ZAHN, Charles T., 110, 110n, 156  
ZAMBOORIE, Mohammed H., 259  
ZANDONINI, Elizabeth M., 73, 89, 233  
ZAPF, Thomas L., 395, 396, 397  
ZETA, British thermonuclear machine, 624, 625  
zonal screens, 514  
ZWORYKIN, Vladimir K., 14, 16









