

# A Historical Review of Atomic Frequency Standards

R. E. BEEHLER

**Abstract**—An attempt is made to trace the historical development of the leading contenders in the atomic frequency standards field—cesium and thallium atomic beam devices, rubidium gas cell standard, and the hydrogen maser. Many of the important experiments leading to the development of techniques basic to the various types of standards, such as the magnetic resonance method, optical pumping, buffer gases and wall coatings, and maser techniques are briefly described. Finally, the application of these basic techniques to the development of the specific types of atomic standards is discussed.

## INTRODUCTION

ALTHOUGH the exploitation of atomic frequency standards on a large scale dates back to less than 10 years ago when they came into general use as basic reference standards in many laboratories, some of the basic techniques involved had been developed almost fifty years ago. It is the purpose of this paper to review some of the early experiments and outline the subsequent development of basic techniques which have led to the present atomic frequency standards. The discussion will be confined to those standards which are presently available commercially to the general user or are at least under active development by several commercial or national standards laboratories—namely, cesium and thallium atomic beam devices, rubidium gas cell devices, and hydrogen masers. Because of the scope of the subject, it will often be impossible to include many details of the principles of operation of equipment, measurement procedures, and general performance results. However, an attempt will be made to give adequate references in all cases. The historical development of the most important *basic* techniques will first be described without regard to specific frequency standards, followed by a discussion of the later application of these basic techniques to the development of specific types of atomic standards. For an analysis of the relative merits of the different types of atomic standards discussed here and for an up-to-date status report of their performance achievements reference is made to the article by A. McCoubrey in this issue [1].

## DEVELOPMENT OF BASIC TECHNIQUES

### *Atomic Beam and Magnetic Resonance Techniques*

The first experiments using atomic or molecular beams were those of the French physicist A. L. Dunoyer in 1911 [2]. Dunoyer's apparatus, shown schematically in Fig. 1, consisted simply of a 20-cm-long glass tube with three sepa-

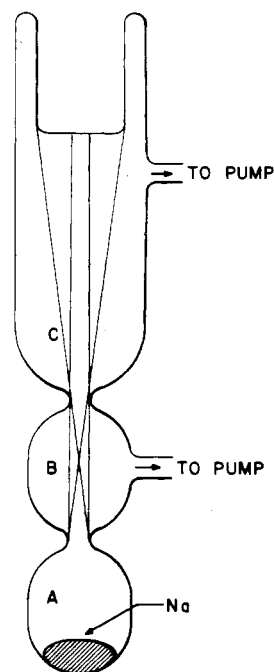

Fig. 1. Schematic diagram of Dunoyer's original atomic beam apparatus [2].

rately evacuated chambers which served as source, collimation, and observation chambers. He observed that when sodium was heated sufficiently in *A*, a deposit was formed in *C* whose distribution could be explained by the assumption that the sodium atoms traveled in straight lines.

Nine years later at the University of Frankfurt in Germany, Otto Stern became the first to use a molecular beam technique for making physical measurements. In these experiments to measure directly the speed of gas molecules, a source of silver atoms at the center of an evacuated jar produced a beam of atoms which was collimated by a narrow slit and detected by deposition on a glass plate near the jar's surface. The principal parts were mounted such that they could be rotated about a vertical axis inside the bell jar at speeds of 1500 rpm. Stern observed, in agreement with the results of Dunoyer's experiments, a narrow sharp deposit explainable by straight line atomic trajectories as long as the apparatus was stationary. However, for rotational speeds of 1500 rpm the deposited pattern was shifted slightly and also appeared fuzzy. From the amount of the shift Stern could calculate the average velocity of the atoms, which turned out to agree with the predictions of kinetic theory to within a few percent. The fuzziness of the deposit showed that a distribution of speeds existed in the beam.

Less than two more years elapsed before Stern and a colleague, Walther Gerlach, performed their celebrated "Stern-Gerlach experiment" [3] which was to have a most profound effect on the development not only of molecular beam techniques but also of quantum mechanics in general. The results of this experiment supported the concept of spatial quantization—i.e., the seemingly unlikely idea that the magnetic moment of an atom in an external magnetic field can have only a few possible discrete orientation angles with respect to the external field lines. If the atom is considered to behave as a small bar magnet of magnetic moment  $\mu$  in an external field,  $H$ , its change in energy, when placed in the field, would be given by  $\Delta E = \mu H \cos \theta$ , where  $\theta$  is the angle between the magnet and the field lines. Until the performance of the Stern-Gerlach experiment, it was generally believed that a large number of such atoms in a field would show a random distribution of the angle  $\theta$ , and hence would have energy values anywhere between  $+\mu H$  and  $-\mu H$ . An opposing view, however, was suggested by observations made as early as 1896 by the Dutch physicist Pieter Zeeman that certain spectral lines split into two or more sharp lines when the radiating atom is placed in an external magnetic field. This effect could be explained by postulating that the energy of atoms in a magnetic field is quantized, resulting in the observed spectral emission lines produced by transitions between these discrete energy levels being limited to a few sharply defined frequencies through the relation  $E_1 - E_2 = h\nu$ , where  $E_1$  and  $E_2$  are the energies of the two levels involved in the transition,  $h$  is Planck's constant, and  $\nu$  is the frequency of the emitted spectral line. If the atoms could have random orientations, and hence energies, in the field, one would expect to observe a blurred spectral line corresponding to a spread in energy of the levels of  $2\mu H$ , contrary to the experimental evidence.

In 1921 Stern conceived an experiment for testing for space quantization using a beam of silver atoms. He realized that the force exerted on a silver atom with magnetic moment  $\mu$  by a magnet designed to produce a field with a large gradient  $\partial H/\partial z$  across the gap would be given by  $-\mu(\partial H/\partial z) \cos \theta$  and would thus vary continuously from  $+\mu(\partial H/\partial z)$  to  $-\mu(\partial H/\partial z)$  if atoms were oriented randomly. On the other hand, if space quantization existed, the force on silver atoms would be either  $-\mu(\partial H/\partial z)$  or  $+\mu(\partial H/\partial z)$ . By shooting a beam of silver atoms between the poles of such a magnet and observing the deflection pattern produced, one should observe either a single broad fuzzy line (if random orientations are possible) or two discrete sharp lines (if space quantization exists). Performing the experiment with Gerlach, who had a magnet of the proper design, Stern did indeed observe two separated lines in the deflection pattern.<sup>1</sup> As we shall see shortly, magnets similar to that used in the Stern-Gerlach experiment are a basic component of today's atomic beam fre-

quency standards, being useful for obtaining a beam of atoms in a specific energy state.

In 1923 Stern became head of the Department of Physical Chemistry at the University of Hamburg. During the next 10-year period he and his students published a series of some 30 papers which served to establish many of the basic principles and techniques used in today's atomic beam devices. Particular emphasis was placed upon the development of atomic beam methods for greatly improved measurements of magnetic moments.

In 1932 O. Frisch and E. Segrè used an atomic beam technique with potassium to detect transitions produced by subjecting the atoms to a sudden variation in the direction of a static magnetic field located between two Stern-Gerlach magnets [4]. The first magnet acted as a polarizer, separating the atomic beam into two beams differing in magnetic state. One of these beams was then blocked by the obstruction of part of the magnet gap, producing a beam with atoms only in the desired state. These remaining atoms were then passed through a second Stern-Gerlach magnet which acted as an analyzer to detect whether the magnetic state had been changed in the region between the magnets. When the static field with its rapid reversal in direction was applied in the center region, a change was noted in the number of atoms reaching the atomic beam detector located after the second magnet. This indicated that some of the atoms had made transitions to different energy states (and thus had their magnetic moment reversed in direction), producing a change in their deflection by the second magnet. This apparatus, used some 35 years ago, differed primarily from present atomic beam tubes only in the method of producing the transitions between the atomic energy levels.

Six years later in 1938 at Columbia University, I. I. Rabi, one of Otto Stern's former students, made the next major advance in atomic beam techniques by developing his magnetic resonance method, which permitted the detection of transitions between the closely spaced energy levels resulting from the interaction of an external magnetic field with an atom or molecule [5]. Rabi's apparatus, shown schematically in Fig. 2, was similar to that used by Frisch and Segrè, except that transitions between the magnetic states of an atom or molecule were produced by applying an oscillating RF field of proper magnitude and direction and whose frequency satisfied the resonance condition,  $W_1 - W_2 = h\nu$ , for the two energy levels of interest.

Although the field directions in the *A* and *B* Stern-Gerlach magnets were the same, the field gradients were arranged to be in opposite directions, so that, in the absence of transitions in the *C* region, molecules from the source *O* would undergo equal and opposite deflections by the two magnets and therefore strike the detector *D*. Application of the proper frequency RF field in the region *R*, however, produced a change from one energy state to another, such that the resultant change in magnetic moment produced a sufficiently different deflection in the *B* magnet to cause the molecule to miss the detector. The surface-ionization type detector used by Rabi ionized nearly all of the molecules striking the 0.001-inch wide surface and thus produced an

<sup>1</sup> Because the existence of electron spin with its effect on effective magnetic moments was not yet known in 1921, Stern actually expected to observe three discrete lines instead of two. Thus, while this experiment supported the concept of space quantization an additional mystery was introduced which was not resolved until 1925.

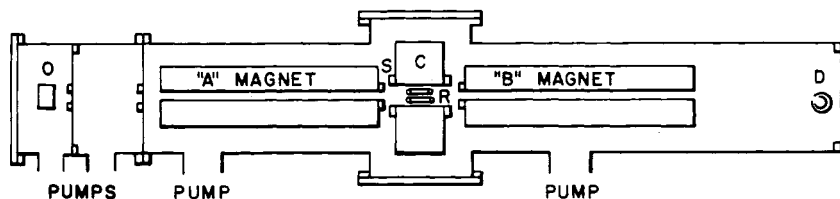

Fig. 2. Schematic diagram of Rabi's magnetic resonance apparatus [5].

electrical signal proportional to the number of molecules striking the wire per second. As the excitation frequency was varied through the resonance value for a particular transition between two energy states, Rabi observed a sharp decrease in the detector output signal.<sup>2</sup> The first resonance curve ever observed by this magnetic resonance technique is shown in Fig. 3. It was published by Rabi and his colleagues in February, 1938, and represents a resonance between two spatial quantization states of the lithium nucleus obtained with a beam of LiCl molecules in a strong enough  $C$  field to decouple completely the nuclear magnetic moments from one another and from the molecular rotation [5]. From the measured values of the frequency at resonance and the static  $C$  field in which the transition occurred, Rabi was able to calculate much improved values for several nuclear magnetic moments.

Soon thereafter another member of the Columbia group, P. Kusch, extended the new atomic beam magnetic resonance technique to measurements of separations of the closely spaced hyperfine structure levels in the ground state of atoms [6]. Hyperfine-structure level separations in several isotopes of lithium and potassium were measured to a precision of 0.005 percent. Relative to earlier hyperfine-structure measurements by optical means, the atomic beam magnetic resonance results were simpler to interpret, much more accurate, and of much higher resolution.

A further refinement in the atomic beam magnetic resonance technique, which proved to be of extreme importance in the application of the technique to frequency standards, was introduced by N. F. Ramsey at Harvard University in 1950 [7]. In the conventional atomic beam apparatus at that time the oscillating RF field for producing transitions in the beam was applied over a relatively short region, being limited by the requirements of maintaining uniform phase and uniform static magnetic field ( $C$  field) over the entire region of interaction between the atoms and the RF field. A lengthened interaction region is desirable for many experiments, however, because the longer the interaction time, the more sharply defined are the atomic energy levels and thus also the resonance frequencies associated with transitions among them. Ramsey developed a method which increased the effective interaction time without adversely affecting the phase and field uniformity requirements. He

<sup>2</sup> In the early experiments described here the transition frequencies of interest depended linearly on the magnitude of the static magnetic field provided in the  $C$  region. For reasons of experimental convenience resonance curves were actually obtained by keeping the frequency fixed and sweeping the field through the corresponding resonance value.

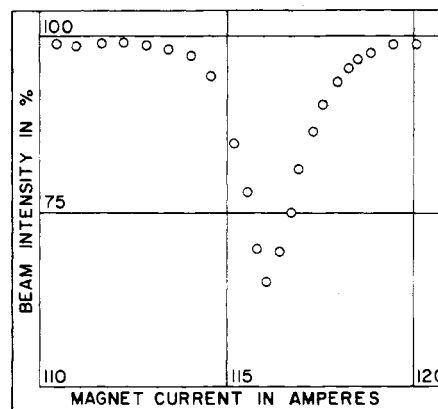

Fig. 3. First published resonance curve using Rabi's magnetic resonance technique [5].

replaced the usual single oscillating field region with two such regions separated by a relatively large distance and showed that the effective interaction time was now the entire length separating the two RF regions. Moreover, the observed resonance width under these conditions is 40 percent less than that for a single Rabi-type excitation of length equal to the separation of the two Ramsey fields and the  $C$  field uniformity requirements are actually less severe for the Ramsey case. Application of this technique to atomic beam frequency standards has resulted in resonance linewidths of less than 50 Hz at 9192 MHz.

Before discussing the specific development of cesium and thallium atomic beam frequency standards based upon the basic techniques described up to this point, let us first consider the historical evolution of some other methods and techniques which led to other types of atomic standards, such as the optically pumped gas cell devices and the hydrogen maser.

#### Optical Pumping Techniques

Optically pumped gas cell frequency standards, such as the  $\text{Rb}^{87}$  gas cell devices currently available commercially, represent a completely different approach to the problem of detecting a condition of resonance in the hyperfine structure levels of the ground state of an atom. In the atomic beam devices, as we have seen, the occurrence of transitions excited by RF resonance radiation is detected by observing resultant changes in the trajectories of the atoms comprising the beam. In gas cell devices, on the other hand, a double resonance technique is used in which the RF resonance condition is detected by the resultant changes in the intensity of transmitted optical radiation at the proper fre-

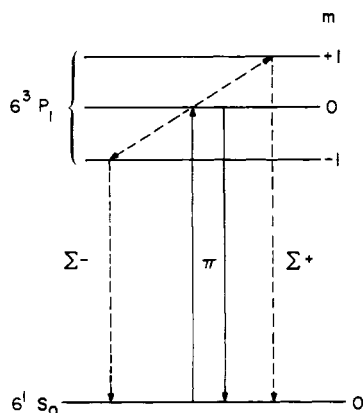

Fig. 4. Simplified energy level diagram for mercury showing states used in early double resonance experiments [12].

quency to produce transitions between the ground and first excited states of the atom.

The development of the optical pumping and double resonance techniques, which are basic to the operation of gas cell standards, can be traced back to 1949 when Prof. F. Bitter at the Massachusetts Institute of Technology showed that the frequency, intensity, and polarization of optical radiation emitted by an atom in a  $^2P \rightarrow ^2S$  (ground state) transition are all altered if the atom is simultaneously subjected to a weak oscillating RF field whose frequency is near resonance for the hyperfine levels of one of the energy states involved in the optical radiation process [8]. About this same time A. Kastler and J. Brossel of the Ecole Normale Supérieure in Paris suggested a double resonance technique as a sensitive means of gaining information about the structure of energy levels [9]. The first application of this technique was to one of the excited states of the mercury atom by Brossel and Bitter in 1950 [10].

As an aid to understanding the way in which the double resonance technique was first used, consider the simplified energy level diagram for mercury shown in Fig. 4. The levels indicated are the  $6^1 S_0$  ground state and the three Zeeman levels of the  $6^3 P_1$  excited state. If mercury vapor is illuminated by optical resonance radiation at  $2537 \text{ \AA}$ , transitions will occur from the ground state to one of the excited-state levels, the particular one depending on the polarization of the radiation. In the experiment of Brossel and Bitter a polarization (labeled  $\pi$  in Fig. 4) was used which selectively populated the  $m=0$  level of the triplet. Under these circumstances the emitted light from spontaneous transitions back to the ground state also contains only  $\pi$  radiation. If now an RF field is applied perpendicular to the static magnetic field producing the Zeeman splitting and its frequency is adjusted to the proper value for resonance between the  $m=0$  and the  $m=\pm 1$  levels, transitions will be induced to the  $m=\pm 1$  states. Decay from these levels back to the ground state will now cause  $\Sigma$  components to appear in the emitted light. Since the intensity and polarization of the emitted light are thus altered in the process, a means is available for optically detecting the occurrence of the RF resonance. A set of RF resonance curves for mercury ob-

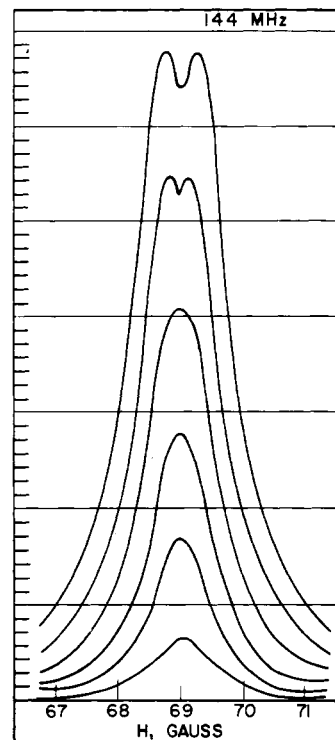

Fig. 5. Set of RF resonance curves obtained with double resonance technique for mercury [10].

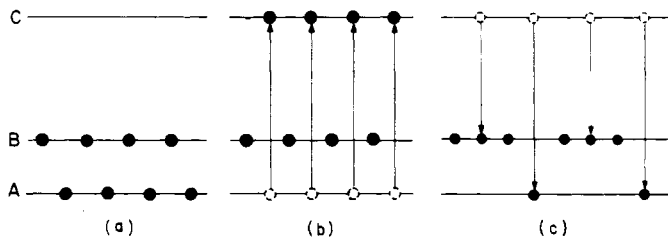

Fig. 6. Simplified optical pumping method.

tained in this manner by Brossel and Bitter is shown in Fig. 5. Each curve corresponds to a different amplitude of the RF field.

The development of the method of optical pumping as applied to the building up of the population of one certain level at the expense of others in the *ground* state of atoms is due primarily to Kastler [11], [12]. Consider the much simplified energy level diagram shown in Fig. 6, where *A* and *B* represent two closely-spaced energy states in the hyperfine structure of the ground state of an atom and *C* represents one of the levels of the first excited state. Transitions  $A \rightarrow C$  and  $B \rightarrow C$  occur at optical excitation frequencies, while transitions  $A \leftrightarrow B$  are in the RF range. Before application of any excitation radiation to the system, atoms are equally distributed between levels *A* and *B* of the ground state as in Fig. 6(a). If optical resonance radiation from which the  $B \rightarrow C$  component has been removed by some means such as filtering is now used to illuminate the system, atoms in level *A* absorb an optical photon and make transitions to *C*, as indicated in Fig. 6(b). Since lifetimes in the excited state are very short, however, the atoms in *C* sponta-

neously re-emit a photon and fall either to level *A* or *B* with approximately equal probabilities. As shown in Fig. 6(c), the net effect at this point has been to increase the population of *B* at the expense of *A*. Now, since there are still atoms in *A* which can be excited to *C* by the optical resonance radiation, the cycle is repeated until (ideally) all the atoms end up in level *B*. This is then the process of optical pumping for changing the population distribution among the ground state levels.

If an RF excitation is now applied which is adjusted in frequency to the resonance value corresponding to the frequency separation of *A* and *B*, the pumped atoms in *B* will be stimulated to make transitions back to *A*, at which point the optical pumping process resumes. In 1956 H. G. Dehmelt at the University of Washington developed the technique of monitoring the intensity of the light transmitted through the sample as a means of detecting the occurrence of the RF transitions [13]. Using a photocell detector, one observes an output current which increases to a constant maximum value (maximum transparency of the sample) for the condition in Fig. 6(c), since at that point no atoms are available to be pumped *A*→*C* by absorbing part of the incident light. As the RF signal is swept through resonance, however, atoms transfer to *A* where optical absorption again takes place, producing a sharp drop in the transmitted light. The detection of RF resonances by this means is extremely sensitive. For example, a sample of vapor at a pressure of only  $10^{-7}$  torr can reduce the intensity of the transmitted light by 20 percent when the correct RF is applied. A very large effective energy gain occurs with the optical detection technique, since the optical photon detected has an energy approximately  $10^4$  to  $10^5$  times greater than the energy of the RF photon involved in the microwave transition. As we shall see in more detail later, the use of optical pumping and optical detection with atomic systems of  $\text{Na}^{23}$ ,  $\text{Cs}^{133}$ , and  $\text{Rb}^{87}$  has made possible the development of extremely compact atomic frequency standards relative to the atomic beam devices.

### *Buffer Gas Techniques*

While the optical pumping technique as briefly described in the preceding section will, in principle, produce a large population buildup in level *B* of Fig. 6, collisions of atoms in the sample with each other and with the walls of the containing vessel actually provide a relaxation mechanism whereby atoms can "leak" back to level *A* without the application of RF. Even in very dilute samples atoms make about 10 000 collisions per second with the walls. Since this is usually greater than the number of optical photons which the atom can absorb per second for repumping to level *B*, the pump effectively becomes very leaky and at best only weak RF resonances can be observed.

In 1955 in the laboratory of A. Kastler a fortunate accident occurred during some experiments with sodium vapor in highly-evacuated glass bulbs which was to provide the key for significantly improving the efficiency of the optical pumping process. When a vacuum system failure allowed

hydrogen gas to be introduced into one of his sodium bulbs, Kastler and his colleagues were amazed to find that the optical pumping was greatly increased! The foreign gas introduced was found to act as a buffer between the sodium atoms and the walls where disorienting collisions take place. It was found in later experiments that, because of collisions between atoms of the sample and those of the buffer gas, the average diffusion time to the walls could be increased from  $10^{-4}$  second (without buffer gas) to nearly a second. It is, of course, necessary to use a buffer gas which does not itself disorient the sample atom's magnetic state during collisions. In general, use of sample atoms in a  $^2S_{1/2}$  ground state with its spherical symmetry appears to be the best way to insure minimum interaction during buffer gas collisions.

In addition to producing an enhancement of the optical pumping process by increasing the effective time during which RF transitions can be excited, the use of buffer gases also causes a reduction in the observed resonance linewidth as compared to the normally observed Doppler broadened value. This "collision-narrowing" effect in a buffer gas was first predicted by R. H. Dicke in 1953 [14] and was observed experimentally by J. Wittke and Dicke at Princeton University in 1954 [15]. Measuring the hyperfine splitting in the ground state of atomic hydrogen by a microwave absorption technique, they found that atomic hydrogen at a pressure of  $5 \times 10^{-4}$  torr in a buffer gas of clean molecular hydrogen at 0.2 torr produced a resonance width of only 3 kHz or one-sixth of the normal Doppler width.

In 1956 H. G. Dehmelt performed optical pumping experiments with sodium in argon buffer gas and observed relaxation times of up to 0.21 second which corresponds to an amazing  $10^8$  sodium-argon collisions occurring before disorientation of the sodium atom [13]. Dehmelt pointed out at that time that such long relaxation times (0.21 second) used in future RF resonance experiments with optical pumping would provide extremely narrow linewidths. Even longer relaxation times (up to 2 seconds) were obtained by Dehmelt's group by replacing the buffer gas with a solid buffer wall coating chosen to have minimum magnetic interaction with colliding rubidium atoms [16]. Using eicosane ( $\text{C}_{20}\text{H}_{42}$ ), they obtained strong resonances in rubidium and found that at least 600 collisions occurred before appreciable disorientation. W. Hawkins, working at Yale University, also obtained favorable results with wall surfaces of absorbed air molecules on Apiezon L grease and on copper [17]. Several years later, however, during the early development phase of commercial gas cell standards, R. M. Whitehorn at Varian Associates concluded that use of solid buffer coatings for commercial applications presented too many technical problems [18]. To date, all commercial gas cell standards have used buffer gases.

### *Storage Techniques for Increasing Interaction Times*

The advantages to be gained in terms of narrower resonance lines by increasing the interaction time between an atomic beam and the applied RF resonance radiation have already been mentioned briefly in connection with the de-

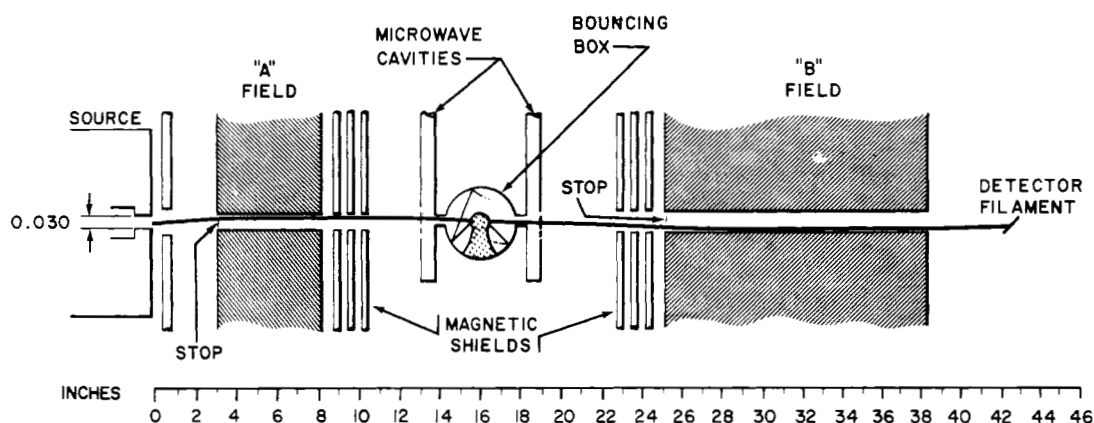

Fig. 7. Schematic diagram of "broken-beam" apparatus [21].

velopment of Ramsey's separated oscillating fields technique. In 1957 Ramsey pointed out that it should be possible to further increase the interaction time in such an experiment by "storing" the atoms in a bounce box having a suitable non-disorienting wall coating and located between the two RF field regions of an atomic beam apparatus [19]. If the collisions with the walls of the bounce box do not appreciably affect the magnetic state of the atom, an effective increase in the separation of the two fields is realized without physically lengthening the apparatus.

Kleppner, Ramsey, and Fjeldstad reported in 1958 the first successful results using this "broken-beam" technique [20]. The bounce box was designed so that an atom had to make at least two collisions in order to pass through and contribute to an observed resonance. Employing a beam of atomic cesium, they were able to observe resonances between the hyperfine states for wall coatings of teflon heated to 100°C, eicosane, and polyethylene. The authors at this time stated their intention to test other substances for wall coatings for application in a "high-precision atomic clock incorporating both the storage box and maser principles."

Further experiments with a cesium beam and a variety of wall coatings, using the apparatus shown schematically in Fig. 7, were reported in 1961 by Goldenberg, Kleppner, and Ramsey [21]. For storage bulbs coated with "Parafint" (a mixture of long chain paraffins), resonance widths of only 150 Hz were obtained as compared with 2 kHz without the storage bulb. This result implied that at least 200 collisions could occur before relaxation of the hyperfine states became a problem. One unfavorable feature of the experimental observations was a rather large shift of several hundred Hz in the resonance frequency resulting from slight displacements of the energy levels during each collision process. This type of shift was minimized later in the hydrogen maser applications because of the much lower polarizability of the hydrogen atom compared to cesium.

### Maser Techniques

The development of maser techniques in 1953, initially using ammonia, represented still another approach to the problem of using microwave resonances in atoms or mole-

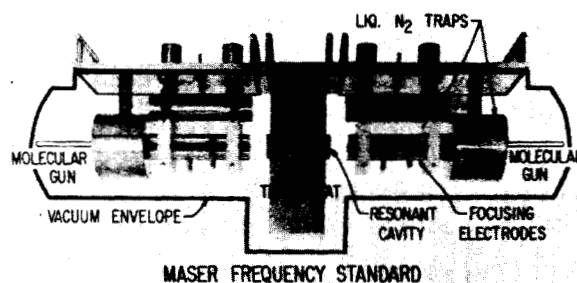

Fig. 8. Diagram of an early ammonia beam maser showing arrangement of components (courtesy of National Bureau of Standards, Boulder, Colo.).

cules as frequency standards. The maser was invented by C. H. Townes of Columbia University [22] but was also proposed independently by N. G. Basov and A. M. Prokhorov of the U.S.S.R. [23]. In this device, a collimated beam of ammonia molecules effuses from a source and then passes through an inhomogeneous electrostatic field designed to spatially separate the two energy states of the inversion spectrum, just as a Stern-Gerlach magnet separates magnetic states of atoms in the magnetic resonance method. The electrostatic state separator applies a radially outward force to molecules in the lower inversion state, but a radially inward force on the upper energy state molecules. The upper-state molecules are thus focused into a high- $Q$  cylindrical microwave cavity tuned to the resonance frequency for the ammonia inversion transition ( $J=3, K=3$ ) at 23 870 MHz. The resulting large excess population of upper energy state molecules in the cavity is then favorable for stimulated transitions from upper to lower inversion states with an accompanying emission of an RF photon.

Townes was able to get a sufficient flux of molecules into the cavity so that the emitted microwave energy exceeded the losses involved, and a small amount of excess energy could be coupled out of the cavity for external use. Operation of the maser in this manner as an oscillator was found to require a flux of at least  $5 \times 10^{12}$  molecules per second per square centimeter. Figure 8 shows the physical arrangement of the components in an ammonia maser, modified for operation with two beams to reduce Doppler effects.

Following the first successful operation of a maser in

1953, J. P. Gordon, H. J. Zeiger, and Townes studied in detail the characteristics of the maser oscillation frequency and found rather strong dependencies of the output frequency upon the ammonia source pressure and the voltage applied to the electrostatic focuser [24]. The strong coupling between the ammonia beam and the resonant cavity also causes the output frequency to depend significantly on the tuning of the cavity.

In spite of intensive research efforts in the United States, the U.S.S.R., Japan, Switzerland, and several other countries during the next few years to develop adequate techniques for controlling the critical maser parameters and for achieving a reproducible frequency from one maser to another, it has now become apparent that, except possibly for its high short-term frequency stability, the ammonia maser cannot compete with other types of atomic devices for use as a primary or secondary frequency standard. Its importance is mainly that it led to the development of one of the present-day leading contenders for the best atomic frequency standard—the hydrogen maser.

#### APPLICATION OF BASIC TECHNIQUES TO THE DEVELOPMENT OF SPECIFIC TYPES OF ATOMIC FREQUENCY STANDARDS

##### *Development of the World's First "Atomic Clock"*

The first operational complete "atomic clock" system was developed at the National Bureau of Standards (NBS), Washington, D. C., in 1948–1949 by H. Lyons and his associates [25]. This system consisted basically of a quartz crystal oscillator, electronically stabilized by the  $J=3, K=3$  absorption line in ammonia at 23 870 MHz, together with suitable frequency dividers for driving a 50-Hz clock from the stabilized oscillator. This historic accomplishment was the culmination of many years of experimental interest in the absorption spectrum of ammonia, extending back to 1933 and the remarkable experiments of C. E. Cleeton and N. H. Williams in which they were able to observe absorption lines in ammonia more than 10 years before the development of most microwave equipment and techniques [26]. Aided by the rapid development of microwave techniques for radar applications during World War II, B. Bleaney and R. P. Penrose succeeded in observing the rotational fine structure of ammonia in 1946 [27]. About this time R. V. Pound proposed stabilizing a klystron with one of the ammonia spectral lines [28]. This was accomplished by W. V. Smith et al. in 1947 [29] and shortly thereafter by W. D. Hershberger and L. E. Norton at RCA [30].

The NBS system, developed specifically for use as a frequency standard, was first operated on August 12, 1948. A photograph of this first "atomic clock" is shown in Fig. 9. The heart of the system, a 25-foot long waveguide absorption cell filled with ammonia at a pressure of 10–15 microns, is shown wrapped around the clock mounted on top of the equipment cabinets. The  $J=3, K=3$  absorption line obtained by sweeping the excitation frequency through the molecular resonance can be seen displayed on the oscilloscope in the photograph. A block diagram of the complete atomic clock system (in a somewhat modified form from

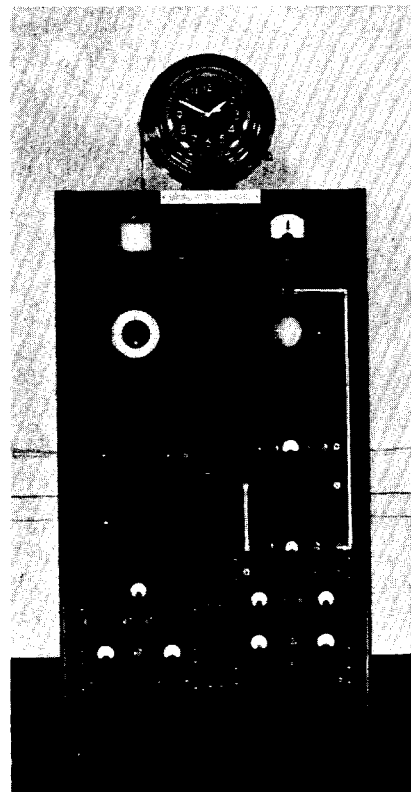

Fig. 9. Original NBS ammonia clock (courtesy of National Bureau of Standards, Boulder, Colo.).

that shown in Fig. 9) is presented in Fig. 10. Two versions of the NBS ammonia clock were built with demonstrated long-term stabilities of  $1 \times 10^{-7}$  and  $2 \times 10^{-8}$ . Work on a third version was eventually halted when it became apparent that atomic beam techniques offered more promise for frequency standard development.

##### *Development of Atomic Beam Standards Utilizing Cesium or Thallium*

According to Hershberger and Norton [30], I. I. Rabi made the specific suggestion of using atomic or molecular transitions in an atomic clock in his January, 1945 Richtmyer lecture before the American Physical Society. Four and one-half years later a program was initiated at the National Bureau of Standards to develop an atomic beam frequency standard utilizing cesium, which would hopefully avoid the problems of collision and Doppler broadening encountered in the ammonia absorption cell work.

The NBS group, led by H. Lyons and J. Sherwood, was able to obtain the services of Prof. P. Kusch of Columbia University as a consultant and set out to construct a machine using Rabi's magnetic resonance technique, with the excitation radiation at 9192 MHz being applied to the cesium beam over a 1-cm path by means of a single short-circuited section of X-band waveguide. At the 1952 New York meeting of the American Physical Society, J. Sherwood reported the first successful observation of the ( $F=4, m_F=0$ )  $\leftrightarrow$  ( $F=3, m_F=0$ ) microwave transition [31]. A photograph of the original apparatus involved is shown in Fig. 11. Shortly thereafter, this apparatus was modified for opera-

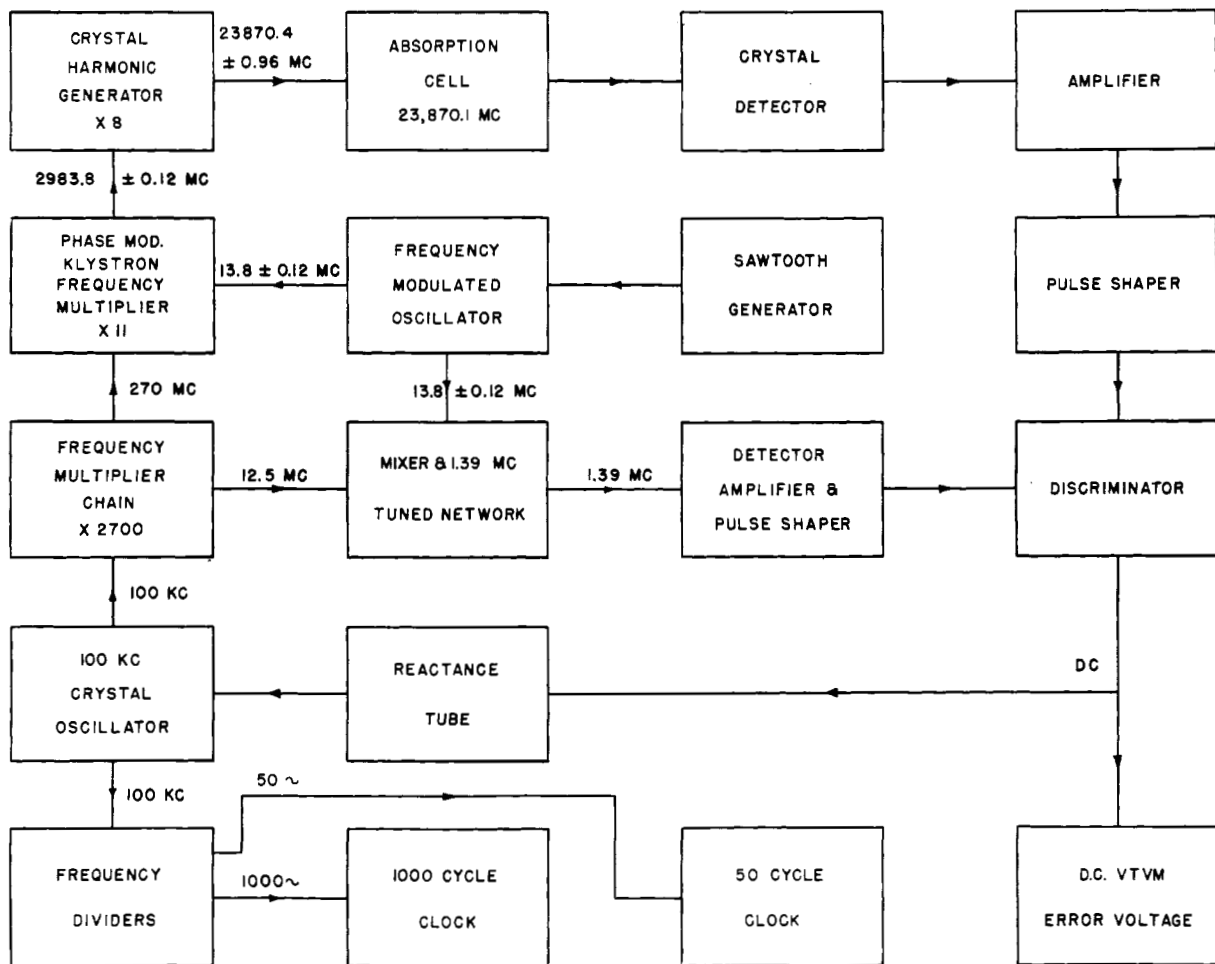

Fig. 10. Block diagram of NBS ammonia clock (courtesy of National Bureau of Standards, Boulder, Colo.).

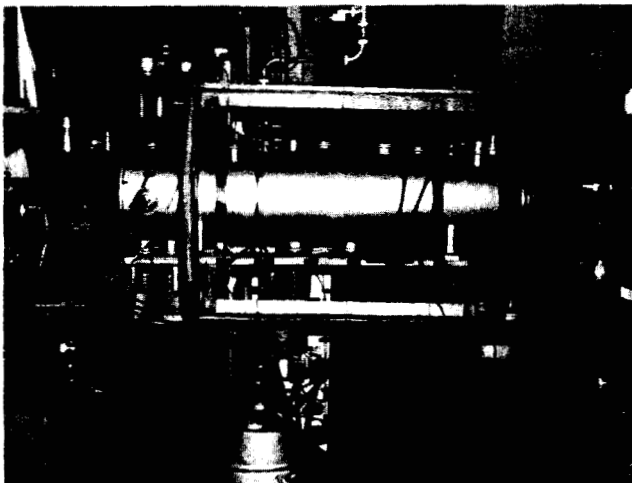

Fig. 11. First operating cesium beam frequency standard—NBS I (courtesy of National Bureau of Standards, Boulder, Colo.).

tion with the Ramsey technique of separated oscillating fields. Using a separation of 50 cm, a Ramsey resonance was observed with a line  $Q$  of 30 million, which corresponds to a linewidth of the central peak of the Ramsey resonance pattern of only 300 Hz at 9192 MHz [32]. Based on these results, Lyons predicted an eventual accuracy capability of  $1 \times 10^{-10}$ . The apparatus was soon thereafter disassembled

completely and moved to the new NBS site at Boulder, Colo., where, under the direction of R. Mockler, it was eventually reassembled with many new components and improved electronics and used to thoroughly evaluate the precision and accuracy capabilities of cesium beam frequency standards [33]. It was not until the 1958–1959 period that this first cesium beam standard was used to more or less routinely calibrate the frequencies of the NBS working standards.

Meanwhile, L. Essen and his associates at the National Physical Laboratory (NPL) in Teddington, England, had placed a similar cesium beam apparatus with a Ramsey linewidth of 340 Hz and an accuracy of  $1 \times 10^{-9}$  into operation in June, 1955 [34]. This standard, a photograph of which is shown in Fig. 12, was the first to be used on a regular basis for the calibration of secondary working frequency standards. Frequency measurements made with this standard, averaged over the 1955–1958 period, were combined with data from the U. S. Naval Observatory to obtain a determination of the cesium transition frequency (reduced to zero magnetic field conditions) in terms of the astronomical units of time interval [35]. From these measurements resulted the now familiar cesium frequency of 9192.631770 MHz in terms of the Ephemeris second. More recently, in 1964, this value was used to *define* an atomic unit of time interval.



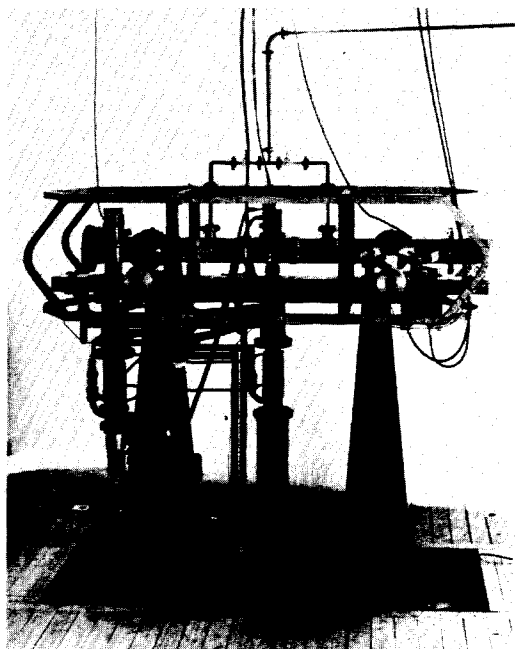

Fig. 12. Original NPL cesium beam frequency standard—NPL I (courtesy of National Physical Laboratory, Teddington, England—crown copyright reserved).

Successful operation of another laboratory-type cesium standard was reported in 1958 by S. Kalra, R. Bailey, and H. Daams at the National Research Council (NRC) in Ottawa, Canada [36]. They achieved a Ramsey linewidth of 290 Hz, a measurement accuracy of better than  $1 \times 10^{-9}$ , and a measurement precision of  $1 \times 10^{-10}$ . During the next year the first cesium standard at the Laboratoire Suisse de Recherches Horlogeres (LSRH) in Neuchatel, Switzerland was operated by J. Bonanomi, J. de Prins, and P. Kartaschoff [37].

In the case of all these early cesium beam standards developed by the various national standards laboratories, the frequency of the oscillator providing the cesium transition excitation was first adjusted manually to the peak of the resonance curve and then compared with the unknown frequency to be measured. Several years earlier, however, in 1954, J. Zacharias, J. Yates, and R. Haun at the Massachusetts Institute of Technology had been able to electronically stabilize the frequency of a quartz oscillator with the  $(4, 0) \leftrightarrow (3, 0)$  transition in cesium [38]. By choosing the time constants of the servo-loop properly, it was possible to combine the superior short-term stability of the oscillator with the excellent long-term stability of the atomic resonance itself in order to achieve optimum overall performance. The authors suggested that this technique together with a sealed-off cesium beam tube should make a commercial cesium standard feasible.

Building upon these results, R. Daly and others at the National Company, Malden, Mass., developed the first commercial cesium beam frequency standard, termed the "Atomichron," in 1956 [39]. Utilizing a cesium beam tube about 6 feet in overall length, this instrument had a specified stability after one-hour warmup of  $5 \times 10^{-10}$  for measuring

periods of greater than 5 seconds for the life of the instrument and an accuracy of  $1 \times 10^{-9}$ . These specifications were later significantly improved as more experience was accumulated. A photograph of one of the early Atomichrons is shown in Fig. 13.

The relative portability of the Atomichron made it possible in March, 1958 to transport two of these instruments to England for direct comparisons with the National Physical Laboratory cesium standard of L. Essen [40]. The results showed that the two Atomichrons agreed to within  $1 \times 10^{-10}$  but differed from the NPL standard by  $2.2 \times 10^{-10}$ . The measurement uncertainties were considered to be  $\pm 5 \times 10^{-11}$ . The relatively close agreement observed, considering the state-of-the-art at that time, was even more remarkable in view of the wide differences existing in terms of the electronics used, the beam optics employed, and the general construction techniques followed for the commercial and NPL instruments.

As new, improved versions of cesium standards evolved in the various laboratories based on the experiences with the early instruments, a trend developed in the various national standards laboratories toward very long machines with the resulting narrow linewidths, while commercial emphasis was directed more toward very short tubes with higher-efficiency beam optics, high reliability, and reduced size, weight, and electrical power consumption.

Long-beam instruments, employing separations between the two oscillating field regions ranging from 2.1 to 4.1 meters, were constructed at NPL in 1959 [41], at LSRH in 1960 [37], at NBS in 1963 [42], and at NRC in 1965 [43]. As a result of the long interaction times between the beam and the RF field, extremely narrow resonance linewidths have been achieved—as low as 20 Hz in the LSRH instrument. In all cases, except for NPL, servo systems have been incorporated in order to stabilize the frequency of a quartz oscillator with the cesium resonance. Comparisons among these four long-beam standards by means of the most recent Hewlett-Packard Company "flying clock" experiment [44] (using cesium standards) indicate agreement to within  $4 \times 10^{-12}$ . The best precision and accuracy figures achieved to date with cesium standards are believed to be  $\pm 2 \times 10^{-13}$  (one sigma estimate for one-hour averaging time) and  $\pm 1.1 \times 10^{-12}$  (one sigma estimate), respectively, reported by Beehler et al., for the NBS standard [45]. Detailed characteristics and performance results for the various individual standards discussed are given elsewhere, in the literature.

Commercial development of cesium beam standards has proceeded rapidly since 1956 with primary contributions from National Company, Varian Associates, Pickard and Burns Electronics, and Hewlett-Packard Company. Recently, the first non-U. S. commercial cesium standard has been introduced by Ebauches, S.A., in Switzerland. These instruments typically weigh about 60 pounds, require  $\approx 50$  watts of electrical power, use solid-state electronics extensively, and fit into about 9 inches of standard rack space [46], [47]. Quoted performance characteristics include

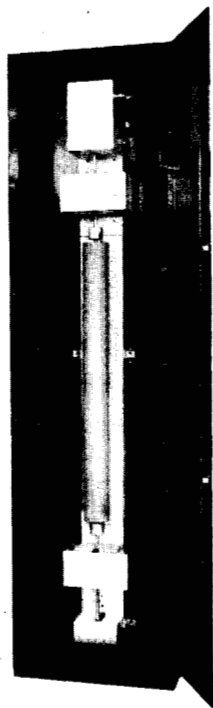

Fig. 13. Early model of National Company Atomichron (courtesy of National Company, Malden, Mass.).

$\pm 1 \times 10^{-11}$  accuracy [46],  $\pm 1 \times 10^{-11}$  long-term stability<sup>3</sup> [46], and 11 000-hour mean time between failures [48]. Considerable progress [49] has been made in the development of a highly refined 27-inch cesium beam tube and associated electronics for the U. S. Air Force with a long-term stability specification of  $\pm 5 \times 10^{-14}$ .

In parallel with the development of cesium beam devices, several laboratories have also constructed atomic beam standards utilizing thallium. Prof. P. Kusch first pointed out in 1957 that thallium should have significant advantages over cesium in an atomic beam frequency standard in terms of its higher transition frequency, its much-reduced sensitivity to external magnetic fields, its much simpler atomic spectrum resulting in the ability to utilize a higher fraction of the atoms comprising the beam with reduced overlap effects from neighboring transitions, and its lower vapor pressure [50]. Disadvantages pointed out were the greater difficulty in detecting the atomic beam and the requirement for larger deflecting magnets.

In 1962 J. Bonanomi was successful in building a thallium atomic beam standard at Neuchatel Observatory in Switzerland [51]. A resonance linewidth of 135 Hz, corresponding to a line  $Q$  of  $1.6 \times 10^8$ , was obtained. The difficult problem of detecting thallium atoms was resolved by using the surface ionization technique, as with cesium, but with an oxygenated tungsten detector wire to increase its work function. In assessing the accuracy of the instrument, Bonanomi concluded that all contributions to inaccuracy from the beam tube itself were too small to be detected.

A few months later another thallium standard was placed into operation by R. Beehler and D. Glaze at the National

Bureau of Standards [52]. Experiments there also confirmed the high accuracy potential of thallium standards, indicating that for similar-length devices, thallium provides at least as good an accuracy figure as cesium.

Much more recently, R. Lacey at Varian Associates has developed a small (28-inch length), portable thallium beam tube similar to the sealed-off commercial cesium beam tubes [53]. This tube makes use of a heated silver tube as a controllable oxygen leak for continuous oxidation of the tungsten detector ribbon. A novel double-resonance technique, first developed for thallium by J. Bonanomi, was also used by Lacey in order to reduce the size of deflecting magnets needed by making use of atoms which are in states having larger magnetic moments while in the  $A$  and  $B$  deflection magnet regions of the apparatus. A resonance linewidth of only 178 Hz was achieved and the observed signal-to-noise ratio implies a frequency stability of less than  $1 \times 10^{-11}$  for one-second averaging times, provided that shot noise of the beam is the limiting factor.

#### *Development of Practical Gas Cell Frequency Standards*

The successful incorporation of the double-resonance, optical pumping, and optical detection techniques into operating frequency standards using alkali metals, such as sodium, cesium, and rubidium, was achieved by a number of independent laboratories starting in 1958. In that year M. Arditi and T. Carver at the International Telephone and Telegraph Laboratories [54] and W. Bell and A. Bloom at Varian Associates [55] first used the optical detection technique mentioned earlier to observe the field-independent hyperfine resonance in  $\text{Na}^{23}$ . The former, using argon and neon buffer gases, obtained a linewidth of 400 Hz and were able to measure shifts of the resonance frequency as a function of the buffer gas pressure.

About the same time, P. Bender (NBS), E. Beaty (NBS), and A. Chi (Naval Research Laboratory) developed a practical cesium gas cell standard operating on the same  $(4, 0) \rightarrow (3, 0)$  hyperfine transition used in the cesium atomic beam standards [56]. The optical pumping radiation—the  $A \rightarrow C$  component in the simplified scheme of Fig. 6—was obtained from an argon discharge light source operated in a magnetic field of 5000 gauss so that one of the argon emission lines was Zeeman-shifted to a frequency near that of the desired  $A \rightarrow C$  component. Resonance linewidths of as low as 40 Hz, corresponding to a  $Q$  value of  $2 \times 10^8$ , were achieved with neon and helium buffer gases. Extensive data on pressure shifts of various buffer gases with cesium were obtained both in these NBS experiments and in similar ones conducted by Arditi at ITT Labs [57]. In 1959 Arditi reported some performance results of his cesium gas cell standard [58], including a short-term stability (several seconds) of  $\pm 2 \times 10^{-10}$ , a long-term stability (minutes or hours) of  $\pm 1 \times 10^{-10}$ , and an accuracy of  $\pm 3-4 \times 10^{-10}$ .

The  $\text{Rb}^{87}$  hyperfine resonance had been used in gas cell work as early as 1957 by T. Carver of Princeton University [59]. Utilizing optical pumping to increase the population difference within the hyperfine structure of the rubidium

<sup>3</sup> Total drift for the life of the beam tube.

ground state but detecting the microwave transition by observing the microwave absorption, rather than the optical transmission, Carver obtained linewidths of approximately 200 Hz with an argon buffer gas. Shortly thereafter, P. Bender et al. at the National Bureau of Standards developed a new technique [60] for the optical pumping of  $\text{Rb}^{87}$ . A diagram of their experimental apparatus is shown in Fig. 14. The innovation here was the method used to obtain selective pumping from only one of the hyperfine levels of the ground state up to the excited state. Light from a rubidium spectral lamp was filtered by a mixture of  $\text{Rb}^{85}$  and 5 cm Hg of argon. The broadening of the  $\text{Rb}^{85}$  absorption lines produced by the argon in the filter cell caused one of the absorption lines to overlap the lower frequency component ( $B \rightarrow C$  in Fig. 6) of the  $\text{Rb}^{87}$  lamp emitted light. Therefore, the light reaching the sample cell contained mainly the higher-frequency component ( $A \rightarrow C$ ) and the optical pumping process proceeded efficiently. This filtering scheme proved so effective that all present commercial Rb gas cell standards use it. With the apparatus shown, Bender et al. were able to achieve linewidths of only 20 Hz for  $\text{Rb}^{87}$  ( $Q = 3 \times 10^8$ ). They also reported a precision of  $5 \times 10^{-11}$  in setting the microwave signal frequency on the center of the resonance line.

With the accumulation of extensive data on cesium and rubidium gas cell standards from ITT Laboratories, NBS, Varian Associates, Space Technology Laboratories, and NPL (England), among others, three main factors which limited gas cell performance emerged. The first is the nature and density of the particular buffer gas used in the cell. Frequency shifts were found to be directly proportional to buffer gas pressure and were positive for light gases and negative for heavy gases. By using mixtures of positive and negative coefficient buffer gases it was found possible to nearly cancel out the effect. The second factor is the linear dependence of the frequency on the temperature of the gas cell. This effect can also be minimized by proper mixtures and pressures of buffer gases in the cell, but a single choice of such conditions does not minimize both the pressure and temperature shifts. R. Carpenter et al. at NBS obtained temperature coefficients of less than  $1 \times 10^{-11}/^\circ\text{C}$  with rubidium as early as 1960 [61]. Both the NBS and ITT Laboratories groups have published measured temperature and pressure shift coefficients for a variety of buffer gases with cesium and rubidium systems [61], [62].

The third limitation on performance is an observed dependence of the frequency on the intensity of the optical pumping light. This is also a linear shift (at least for low buffer gas densities) and is reduced by operating at relatively high buffer gas pressures and gas cell temperatures. A number of other methods have been proposed to reduce this "light shift" and at present manufacturers of commercial gas cell frequency standards are still devoting much effort to this problem. Data from several laboratories show that if frequency is plotted versus cell temperature for different light intensities, a series of lines result which converge to a single frequency that agrees within experimental uncertainties with the values determined by atomic beam methods

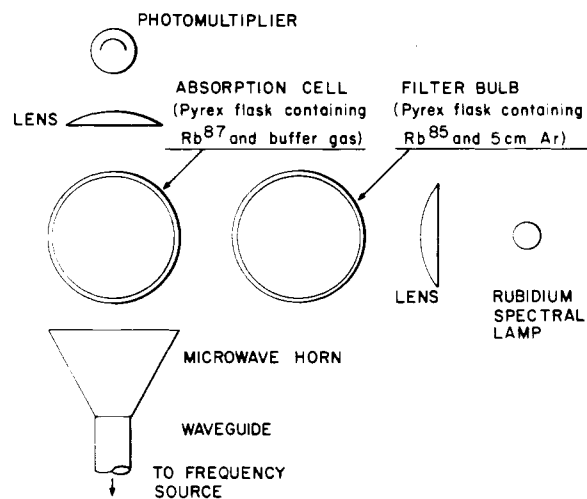

Fig. 14. Schematic diagram of NBS  $\text{Rb}^{87}$  gas cell frequency standard [60].

(after extrapolation of the gas cell data to zero magnetic field and zero buffer gas pressure).

Manufacturers of rubidium gas cell standards, such as Varian Associates and General Technology Corporation, have been able to select and control the important parameters well enough to achieve long- and short-term stabilities of  $1 \times 10^{-11}$  per month and  $1 \times 10^{-11}$  for one second, respectively, in extremely compact packages employing solid-state electronics [63]. Because of the frequency dependence on buffer gas the device must be calibrated initially with respect to a primary standard. From then on, however, the gas cell performs admirably as a secondary standard with typical stabilities as quoted above.

#### *Development of the Atomic Hydrogen Maser*

The atomic hydrogen maser, first developed at Harvard University in 1960 by N. Ramsey, M. Goldenberg, and D. Kleppner [64], was an outgrowth of several of the basic techniques discussed earlier, including those involving buffer gases, atomic beam experiments with stored atoms, and ammonia maser principles. Maser action had not been achieved previously with gaseous atoms in the ground state, primarily because of the much smaller values of the relevant magnetic dipole matrix elements as compared to the electric dipole matrix elements characterizing molecular transitions such as the  $J = 3, K = 3$  resonance used in ammonia masers. This difficulty was overcome in the atomic hydrogen maser by using a "storage bulb" with a non-disorienting wall coating in order to achieve very long effective interaction times of the order of one second.

The hydrogen maser developed at Harvard combined in a single device several outstanding advantages previously offered in part by a number of different types of atomic frequency standards. For example, an extremely narrow linewidth of about 1 Hz results from the long interaction time. The spectral line is of very high purity in contrast to the complex structure of the ammonia line. Shifts due to first-order Doppler effect are essentially eliminated by virtue of the averaging process as the typical atom makes about  $10^4$

random bounces off the storage bulb walls before undergoing magnetic relaxation from the desired energy state or escapes from the bulb. Finally, the high signal-to-noise ratio characteristic of the maser technique helps to produce the best short-term frequency stability yet observed with any atomic frequency standard.

A schematic diagram of Ramsey's original apparatus is shown in Fig. 15. Atomic hydrogen from a Wood's discharge source first passes through a state separator, just as in the ammonia maser. However, because the transition of interest in hydrogen is a *magnetic* dipole transition, the state separator consists of a hexapole deflecting magnet rather than an electrostatic version. Atoms in the higher energy state of interest ( $F=1, m_F=0$ ) are focused into the quartz storage bulb as indicated by the dashed lines, while the lower-state atoms ( $F=0, m_F=0$ ) are defocused. The storage bulb is centered within a cylindrical resonant cavity tuned to the frequency of the  $(1, 0) \leftrightarrow (0, 0)$  hyperfine transition at 1420 MHz. While bouncing around within the bulb the atoms radiate to the lower energy state and eventually leave the bulb through the entrance aperture after about a second. With the paraffin wall coating first used, at least  $10^4$  collisions with the walls could occur without seriously perturbing the energy states. Teflon coatings have been found to perform even better. With sufficient beam flux ( $\approx 4 \times 10^{12}$  atoms per second) and high enough cavity  $Q$ , maser oscillation was achieved. Not shown in Fig. 15 is a system of Helmholtz coils for applying a small dc magnetic field to the cavity region, corresponding to the  $C$  field in atomic beam magnetic resonance devices. A photograph of this first Harvard hydrogen maser is shown in Fig. 16.

As in the case of the earlier experiments with buffer gases and wall coatings mentioned previously, the maser oscillation frequency was shown both experimentally and theoretically [65] to depend on the wall coating used. Since the collision rate is an important factor, the "wall shift" depends on the bulb size. For bulb diameters normally used the shift amounts to a few parts in  $10^{11}$  but appears to be stable with time. Wall shifts have been measured both at Harvard [66] and by R. Vessot et al. of Varian Associates [67] by measuring maser frequency for different sizes of storage bulbs.

Work on hydrogen masers was undertaken at Varian Associates and at LSRH in Switzerland in 1961. C. Menoud and J. Racine at LSRH [68] and Vessot and Peters at Varian [69] reported successfully operating masers in 1962. The Varian maser has been commercially available for several years and employs many refinements developed for commercial applications, such as elaborate temperature control of the resonant cavity to reduce cavity-pulling frequency shifts due to mistuning, provision for effective degaussing of the three-layer magnetic shielding, use of oil-free ion pumps to reduce the possibility of contaminating the wall coating and changing the wall shift, and control of the hydrogen flux by a temperature-controlled palladium leak. More recently, H. Andresen at the U. S. Army Electronics Command (Ft. Monmouth, N. J.) has developed a servo system for automatically keeping the resonant cavity

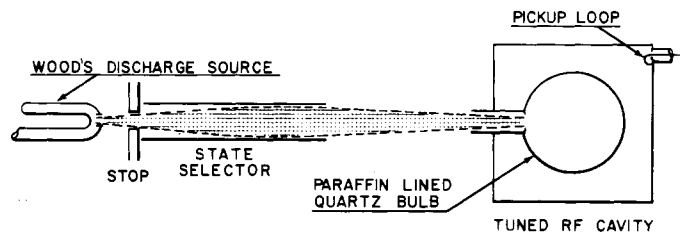

Fig. 15. Schematic diagram of Ramsey's original hydrogen maser [64].

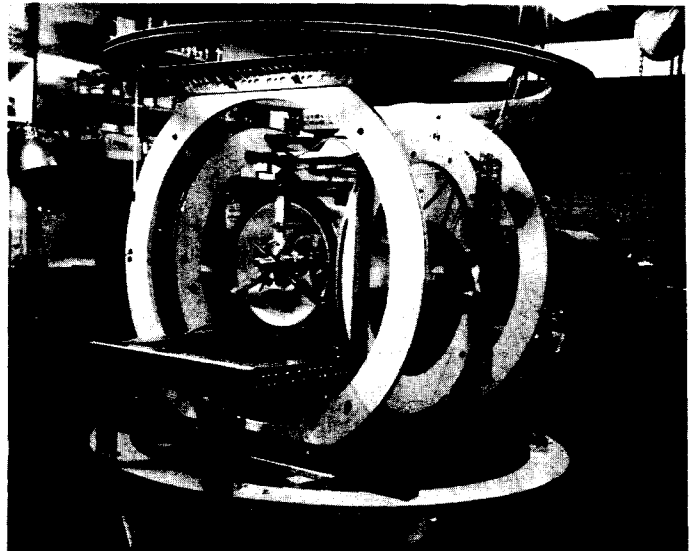

Fig. 16. Ramsey's first hydrogen maser (courtesy of N. Ramsey, Harvard University, Cambridge, Mass.).

tuned to the frequency of the atomic resonance [70]. Further work on hydrogen masers is currently in progress at many laboratories throughout the world.

For a summary of the present status of hydrogen maser performance results the reader is referred to the article by A. McCoubrey in this issue. It is worth noting, however, that maser stabilities of  $1 \times 10^{-14}$  for averaging periods in the vicinity of 30 minutes and absolute inaccuracies of less than  $1 \times 10^{-12}$  have already been achieved [71]. Since 1963, a number of intercomparisons have been made between hydrogen masers and cesium beam standards involving equipment and personnel from five different laboratories in the U. S. and one in Switzerland. The results [45], [71], with one exception in 1963, show that all measured values of the hydrogen frequency in terms of cesium (after application of appropriate corrections to both the hydrogen and cesium raw data) agree to within the quoted measurement uncertainties, which ranged from  $2 \times 10^{-11}$  to  $1.2 \times 10^{-12}$ .

#### CONCLUSION

An attempt has been made to at least touch upon the highlights of the historical development of the better known types of present atomic frequency standards. A number of other types, or modifications of existing types, of atomic standards are being investigated in various laboratories and may eventually prove superior to all those discussed here. In this class would be included the large-bulb (60-inch diameter) hydrogen maser now under construction at

Harvard University for reduction of wall shifts and cavity-pulling shifts, the rubidium maser with its extremely high short-term stability, masers using other atoms with optical pumping, electric resonance molecular beam devices operating at several hundred GHz, and possibly even lasers if the large frequency gap between RF and the optical region can be successfully bridged. In view of the large amount of effort and resources being put into the development of improved atomic frequency standards at present in many countries of the world it seems likely that the performance of atomic frequency standards will continue to improve rapidly in the foreseeable future.

#### REFERENCES

- [1] A. O. McCoubrey, "Relative merits of atomic frequency standards," this issue.
- [2] L. Dunoyer, *Comptes Rend.*, vol. 152, p. 594, 1911.
- [3] W. Gerlach and O. Stern, "On the quantization of direction in a magnetic field," *Ann. Physik*, vol. 74, pp. 673-699, 1924.
- [4] R. Frisch and E. Segrè, "On the adjustment of the direction of quantization," *Z. Physik*, vol. 80, p. 610-616, 1933.
- [5] I. I. Rabi, J. R. Zacharias, S. Millman, and P. Kusch, "A new method of measuring nuclear magnetic moment," *Phys. Rev.*, vol. 53, p. 318, February 1938.
- [6] P. Kusch, S. Millman, and I. I. Rabi, "The radiofrequency spectra of atoms," *Phys. Rev.*, vol. 57, pp. 765-780, May 1940.
- [7] N. F. Ramsey, "A molecular beam resonance method with separated oscillating fields," *Phys. Rev.*, vol. 78, pp. 695-699, June 1950.
- [8] F. Bitter, "The optical detection of radiofrequency resonance," *Phys. Rev.*, vol. 76, pp. 833-835, September 1949.
- [9] J. Brosnel and A. Kastler, *Compt. Rend.*, vol. 229, pp. 1213-1215, 1949.
- [10] J. Brosnel and F. Bitter, "A new double resonance method for investigating atomic energy levels. Application to  $Hg^3P_1$ ," *Phys. Rev.*, vol. 86, pp. 308-316, May 1952.
- [11] A. Kastler, *J. Phys. et Rad.*, vol. 11, p. 255, 1950.
- [12] —, "Optical methods of atomic orientation and of magnetic resonance," *J. Opt. Soc. Am.*, vol. 47, pp. 460-465, June 1957.
- [13] H. G. Dehmelt, "Slow spin relaxation of optically polarized sodium atoms," *Phys. Rev.*, vol. 105, pp. 1487-1489, March 1957.
- [14] R. H. Dicke, "The effect of collisions upon the Doppler width of spectral lines," *Phys. Rev.*, vol. 89, pp. 472-473, January 1953.
- [15] J. P. Wittke and R. H. Dicke, "Redetermination of the hyperfine splitting in the ground state of atomic hydrogen," *Phys. Rev.*, vol. 96, pp. 530-531, October 1954.
- [16] H. G. Robinson, E. S. Ensborg, and H. G. Dehmelt, "Preservation of spin state in free atom-inert surface collisions," *Bull. Am. Phys. Soc.*, vol. 3, p. 9, January 1958.
- [17] W. B. Hawkins, "Optical pumping, buffer gases, and walls," *Proc. 11th Annual Frequency Control Symp.*, pp. 318-323, May 1957.
- [18] R. M. Whitehorn, "Gas cell frequency standards using buffer gases and buffer walls," *Proc. 13th Annual Frequency Control Symp.*, pp. 648-654, May 1959.
- [19] N. F. Ramsey, "Resonance experiments in successive oscillatory fields," *Rev. Sci. Instr.*, vol. 28, pp. 57-58, January 1957.
- [20] D. Kleppner, N. F. Ramsey, and P. Fjelstadt, "Broken atomic beam resonance experiment," *Phys. Rev. Lett.*, vol. 1, pp. 232-233, October 1958.
- [21] H. Goldenberg, D. Kleppner, and N. F. Ramsey, "Atomic beam resonance experiments with stored beams," *Phys. Rev.*, vol. 123, pp. 530-537, July 1961.
- [22] J. Gordon, H. Zeiger, and C. Townes, "Molecular microwave oscillator and new hyperfine structure in the microwave spectrum of  $NH_3$ ," *Phys. Rev.*, vol. 95, pp. 282-284, July 1954.
- [23] N. Basov and A. Prokhorov, "The use of molecular beams in the study of the spectra of molecules by radio spectroscopy," *J. Exp. Theoret. Phys. (U.S.S.R.)*, vol. 27, pp. 431-438, 1954.
- [24] J. Gordon, H. Zeiger, and C. Townes, "The maser—new type of microwave amplifier, frequency standard, and spectrometer," *Phys. Rev.*, vol. 99, p. 1264-1274, August 1955.
- [25] H. Lyons, "Microwave spectroscopic frequency and time standards," *Electronic Engrg.*, vol. 68, p. 251, March 1949.
- [26] C. Cleeton and N. Williams, "Electromagnetic waves of 1.1 cm wavelength and the absorption spectrum of ammonia," *Phys. Rev.*, vol. 45, pp. 234-237, February 1934.
- [27] B. Bleaney and R. Penrose, "Ammonia spectrum in the 1 cm wavelength region," *Nature*, vol. 157, pp. 339-340, March 1946.
- [28] R. Pound, "Electronic frequency stabilization of microwave oscillators," *Rev. Sci. Instr.*, vol. 17, pp. 490-505, November 1946.
- [29] W. Smith, J. de Quevedo, R. Carter, and W. Bennett, "Frequency stabilization of microwave oscillators with spectral lines," *J. Appl. Phys.*, vol. 18, pp. 1112-1115, December 1947.
- [30] W. Hershberger and L. Norton, "Frequency stabilization with microwave spectral lines," *RCA Review*, vol. 9, pp. 38-49, March 1948.
- [31] J. Sherwood, H. Lyons, R. McCracken, and P. Kusch, "High frequency lines in the hfs spectrum of cesium," *Bull. Am. Phys. Soc.*, vol. 27, p. 43, 1952.
- [32] H. Lyons, "Spectral lines as frequency standards," *Ann. N. Y. Acad. Sci.*, vol. 55, pp. 831-871, November 1952.
- [33] R. Mockler, R. Beehler, and J. Barnes, "An evaluation of a cesium beam frequency standard," in *Quantum Electronics, A Symposium*, C. H. Townes, Ed. New York: Columbia University Press, 1960, pp. 127-145.
- [34] L. Essen and J. Parry, "Atomic standard of frequency and time interval," *Nature*, vol. 176, pp. 280-282, August 1955.
- [35] W. Markowitz, R. Hall, L. Essen, and J. Parry, "Frequency of cesium in terms of ephemeris time," *Phys. Rev. Lett.*, vol. 1, pp. 105-107, August 1958.
- [36] S. Kalra, R. Bailey, and H. Daams, "Cesium beam standard of frequency," *Can. J. Phys.*, vol. 36, pp. 1442-1443, 1958.
- [37] P. Kartaschoff, J. Bonanomi, and J. de Prins, "Cesium frequency standards: Description and results," *Helv. Phys. Acta*, vol. 33, pp. 969-973, 1960.
- [38] J. R. Zacharias, J. G. Yates, and R. D. Haun, Jr., "An atomic frequency standard," *Proc. IRE (Abstract)*, vol. 43, p. 364, March 1955.
- [39] W. Mainberger, "Primary frequency standard using resonant cesium," *Electronics*, vol. 31, pp. 80-85, November 1958.
- [40] A. McCoubrey, "Results of comparison: Atomichron-British cesium beam standard," *Proc. 12th Annual Frequency Control Symp.*, pp. 648-664, 1958.
- [41] L. Essen and J. Parry, "An improved cesium frequency and time standard," *Nature*, vol. 184, p. 1791, December 1959.
- [42] R. E. Beehler and D. J. Glaze, "The performance and capability of cesium beam frequency standards at the National Bureau of Standards," *IEEE Trans. on Instrumentation and Measurement*, vol. IM-15, pp. 48-55, March-June, 1966.
- [43] A. Mungall, H. Daams, and R. Bailey, "The Canadian cesium beam frequency standard," *Proc. 20th Annual Frequency Control Symp.*, pp. 436-447, 1966.
- [44] L. Bodily, D. Hartke, and R. Hyatt, "World-wide time synchronization, 1966," *Hewlett-Packard J.*, vol. 17, no. 12, pp. 13-20, August 1966.
- [45] R. Beehler, D. Halford, R. Harrach, D. Allan, D. Glaze, C. Snider, J. Barnes, R. Vessot, H. Peters, J. Vanier, L. Cutler, and L. Bodily, "An intercomparison of atomic standards," *Proc. IEEE (Letters)*, vol. 54, pp. 301-302, February 1966.
- [46] Model 5060 Data Sheet, Hewlett-Packard Company, Palo Alto, Calif., October 1, 1966.
- [47] NC 3501 Data Sheet, National Company, Melrose, Mass.
- [48] L. Bodily, "Performance characteristics of a portable cesium beam standard," *Proc. 20th Annual Frequency Control Symp.*, pp. 448-463, 1966.
- [49] J. Holloway and R. Sanborn, "Characteristics of a high performance cesium beam frequency standard," *Proc. 19th Annual Frequency Control Symp.*, pp. 344-368, 1965.
- [50] P. Kusch, "Precision atomic beam techniques," *Proc. 11th Annual Frequency Control Symp.*, pp. 373-384, 1957.
- [51] J. Bonanomi, "A thallium beam frequency standard," *IRE Trans. on Instrumentation*, vol. I-11, pp. 212-215, December 1962.
- [52] R. Beehler and D. Glaze, "Experimental evaluation of a thallium beam frequency standard," *Proc. 17th Annual Frequency Control Symp.*, pp. 392-407, 1963.
- [53] R. Lacey, "A thallium atomic beam tube for frequency control," *Proc. 20th Annual Frequency Control Symp.*, pp. 416-423, 1966.
- [54] M. Arditi and T. Carver, "Optical detection of zero-field hyperfine splitting of  $Na^{23}$ ," *Phys. Rev.*, vol. 109, pp. 1012-1013, February 1958.
- [55] W. Bell and A. Bloom, "Optically detected field-independent transition in sodium vapor," *Phys. Rev.*, vol. 109, pp. 219-220, January 1958.
- [56] E. Beaty, P. Bender, and A. Chi, "Narrow hyperfine absorption lines

- of Cs<sup>133</sup> in various buffer gases," *Phys. Rev.*, vol. 112, pp. 450-451, October 1958.
- [57] M. Arditi and T. Carver, "Frequency shift of the zero-field hyperfine splitting of Cs<sup>133</sup> produced by various buffer gases," *Phys. Rev.*, vol. 112, p. 449, October 1958.
- [58] M. Arditi, "Evaluation of a breadboard gas cell frequency standard," *Proc. 13th Annual Frequency Control Symp.*, pp. 655-667, 1959.
- [59] T. Carver, "Rubidium oscillator experiments," *Proc. 11th Annual Frequency Control Symp.*, pp. 307-317, 1957.
- [60] P. Bender, E. Beaty, and A. Chi, "Optical detection of narrow Rb<sup>87</sup> hyperfine absorption lines," *Phys. Rev. Lett.*, vol. 1, p. 311-313, November 1958.
- [61] R. J. Carpenter, E. C. Beaty, P. L. Bender, S. Saito, and R. O. Stone, "A prototype rubidium vapor frequency standard," *IRE Trans. on Instrumentation*, vol. 1-9, pp. 132-135, September 1960.
- [62] M. Arditi and T. Carver, "Pressure, light, and temperature shifts in optical detection of 0-0 hyperfine resonance of alkali metals," *Phys. Rev.*, vol. 124, pp. 800-809, November 1961.
- [63] Manufacturer's specification sheets.
- [64] H. Goldenberg, D. Kleppner, and N. Ramsey, "Atomic hydrogen maser," *Phys. Rev. Lett.*, vol. 5, pp. 361-362, October 1960.
- [65] D. Kleppner, H. Goldenberg, and N. Ramsey, "Theory of the hydrogen maser," *Phys. Rev.*, vol. 126, pp. 603-615, April 1962.
- [66] S. Crampton, D. Kleppner, and N. Ramsey, "Hyperfine separation of ground-state atomic hydrogen," *Phys. Rev. Lett.*, vol. 11, pp. 338-340, October 1963.
- [67] J. Vanier, H. E. Peters, and R. F. C. Vessot, "Exchange collisions, wall interactions, and resettability of the hydrogen maser," *IEEE Trans. on Instrumentation and Measurement*, vol. IM-13, pp. 185-188, December 1964.
- [68] C. Menoud and J. Racine, "Atomic hydrogen maser, description and preliminary results," *Helv. Phys. Acta*, vol. 35, pp. 562-567, September-October 1962.
- [69] R. F. C. Vessot and H. E. Peters, "Design and performance of an atomic hydrogen maser," *IRE Trans. on Instrumentation*, vol. I-11, pp. 183-187, December 1962.
- [70] H. Andresen and E. Pannaci, "Servo-controlled hydrogen maser cavity tuning," *Proc. 20th Annual Frequency Control Symp.*, pp. 402-415, April 1966.
- [71] R. Vessot, H. Peters, J. Vanier, R. Beehler, D. Halford, R. Harrach, D. Allan, D. Glaze, C. Snider, J. Barnes, L. Cutler, and L. Bodily, "An intercomparison of hydrogen and cesium frequency standards," *IEEE Trans. on Instrumentation and Measurements*, vol. IM-15, pp. 165-176, December 1966.

# The Relative Merits of Atomic Frequency Standards

A. O. McCoubrey, Senior Member, IEEE

**Abstract**—The relative merits of atomic frequency standards based upon resonances in hydrogen, rubidium, or cesium depend upon the particular application and the specific requirement for each of several performance factors combined with physical characteristics. While the properties of an ideal atomic frequency standard may be established, practical instruments depart from the ideal as the result of compromises in the apparatus design and construction. The resonance line sharpness is an important factor which is dependent upon the apparatus; however, others may have a greater influence upon the essential characteristics. These include instrumental offsets due to atomic collisions with neighboring atoms or walls and magnetic fields. The intensity of the resonance signal is also essential in the determination of merit. These factors are discussed in relationship to hydrogen maser rubidium gas cell and cesium beam atomic frequency standards and the merits of each are compared. The possible merits of frequency standards based upon thallium beams are also discussed; however, a lack of extensive operating experience limits the knowledge in this case.

## INTRODUCTION

DURING the past fifteen years, frequency standards based upon very stable atomic resonances have been under development and practical applications of such standards have been in progress during most of this period. Different methods for the realization of atomic resonance, first discovered in academic research laboratories, have been refined to form the basis of instrument

designs. As a result there are now in use a rapidly growing number of atomic frequency standards based upon cesium atomic-beam resonance, atomic hydrogen masers, rubidium gas-cell resonance, and there is an increasing interest in the use of thallium atomic-beam resonance. It appears to be quite clear that the further development of the different kinds of atomic frequency standards will and should advance. In each case different reasons exist for refinement and applications. It is the purpose of this paper to discuss the relative merits of the various atomic frequency standards with the goal of bringing into focus the factors which are important to those concerned with their use.

The historical aspects of the development of atomic frequency standards have been treated comprehensively by R. E. Beehler [1] in a paper also included in this issue of the PROCEEDINGS. Basic principles involved in their operation were reviewed in an article [2] recently published in a special issue of the PROCEEDINGS on Frequency Stability. The latter article also surveyed the performance levels which had been achieved up to that time and, while certain advances have been made since, an extensive treatment of these improvements is not justified in this report. It will be sufficient to point out such improvements in appropriate places.

In the discussion which follows, the relationships between the different merits of atomic frequency standards and their applications will be briefly established, and the limitations

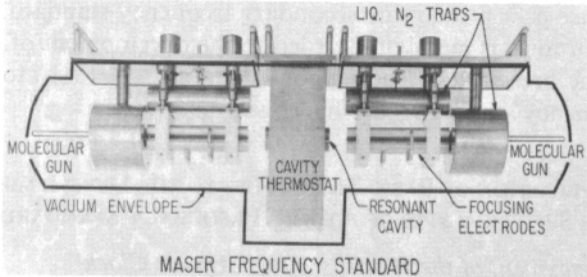

Fig. 8. Diagram of an early ammonia beam maser showing arrangement of components (courtesy of National Bureau of Standards, Boulder, Colo.).

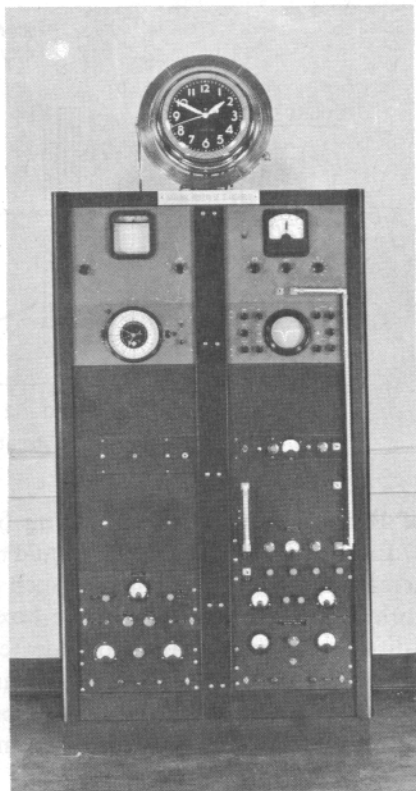

Fig. 9. Original NBS ammonia clock (courtesy of National Bureau of Standards, Boulder, Colo.).



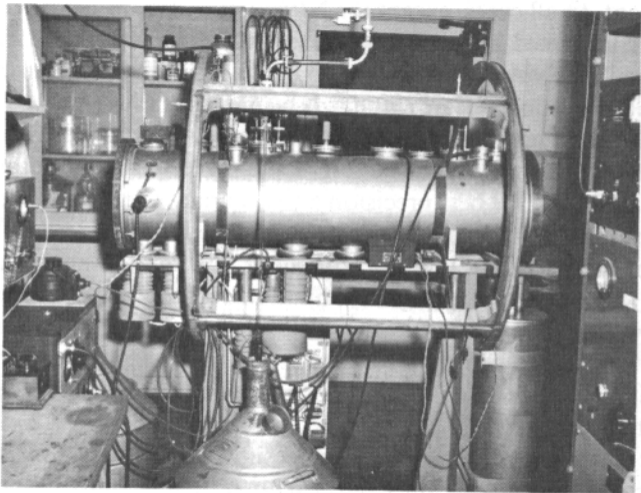

Fig. 11. First operating cesium beam frequency standard—NBS I (courtesy of National Bureau of Standards, Boulder, Colo.).

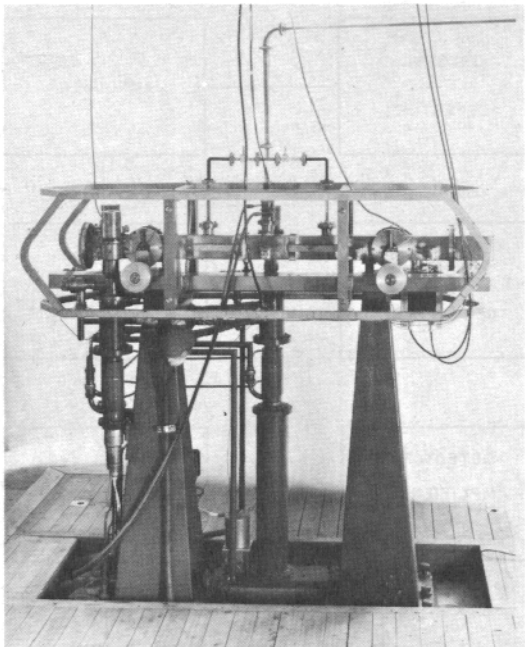

Fig. 12. Original NPL cesium beam frequency standard—NPL I (courtesy of National Physical Laboratory, Teddington, England—crown copyright reserved).

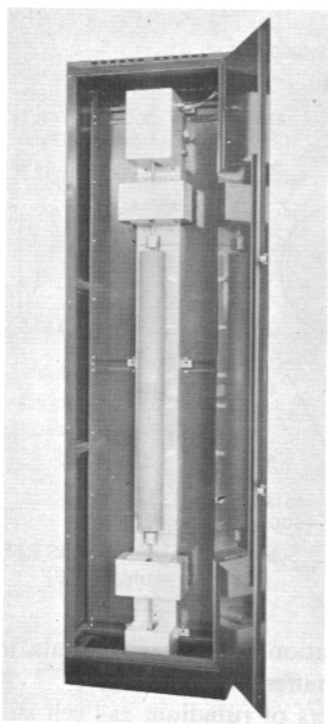

Fig. 13. Early model of National Company Atomicron  
(courtesy of National Company, Malden, Mass.).

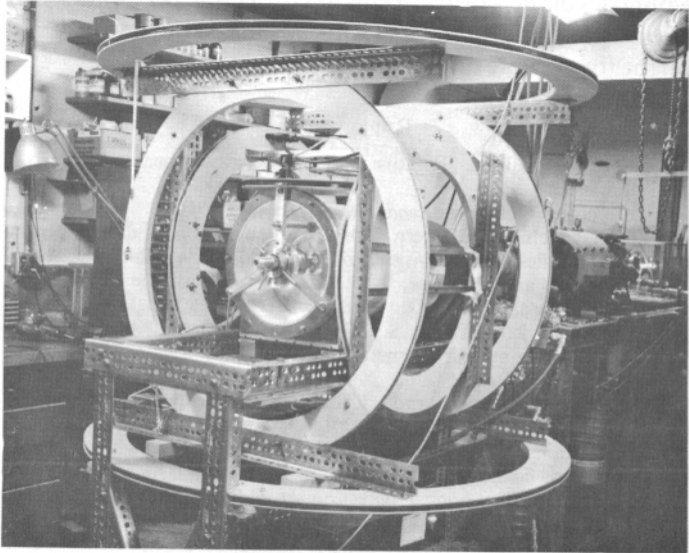

Fig. 16. Ramsey's first hydrogen maser (courtesy of N. Ramsey, Harvard University, Cambridge, Mass.).