

ORDINANCE NO. C35577

An ordinance relating to sign standards amending SMC 17C.240.010, 17C.240.060, 17C.240.070, 17C.240.090, 17C.240.120, 17C.240.130, 17C.240.140, 17C.240.150, 17C.240.180, 17C.240.220, 17C.240.230, 17C.240.240, 17C.240.250, 17C.240.260, 17C.240.270, 17C.240.280; adopting new sections 17C.240.015, 17C.240.025, 17C.240.241, 17C.240.242, 17C.240.243, 17C.240.244, 17C.240.245, 17C.240.246, 17C.240.247, 17C.240.310 to chapter 17C.240; repealing SMC 17C.240.020, 17C.240.080, 17C.240.100, 17C.240.160, 17C.240.190, 17C.240.200, 17C.240.290, and 17C.240.300 to title 17C of the Spokane Municipal Code and setting and effective date.

WHEREAS, on April 10, 2017 the City Council adopted Ordinance No. C35490, imposing an immediate, six-month moratorium on the relocation of off-premises signs into areas of Spokane having a center and corridor zoning designation; setting a public hearing; and declaring an emergency; and

WHEREAS, on May 22, 2017 the City Council held a public hearing on Ordinance No. C35490, received a staff report, presentation by the proponents and opponents of the moratorium, heard public testimony, adopted findings of fact, extended the moratorium for an additional six months and set an expiration date of November 22; and

WHEREAS, on October 9, 2017 the City Council adopted Ordinance No. C35555, heard public testimony, and extended the moratorium for an additional six months and set an expiration date of April 10, 2018; and

WHEREAS, during the moratorium, Planning Department staff conducted workshops with the Plan Commission and City Council to discuss amendments to the City's sign regulations to (i) address the concerns that prompted the Council's adoption of the moratorium and (ii) to meet the guidelines set forth in the U.S. Supreme Court's opinion in *Reed v. Gilbert*, 135 S. Ct. 2218, 192 L.Ed.2d 236 (2015) and other applicable law (the "Sign Code Update"); and

WHEREAS, during the moratorium, Planning Department staff also worked with a group of stakeholders to obtain technical and professional feedback on the proposed Sign Code Update. The group included representatives from the Community Assembly, the City Plan Commission, the Spokane Association of Realtors, and the sign industry. The group prepared a recommendation and has had the opportunity to review and comment on the proposed Sign Code Update; and

WHEREAS, the Plan Commission held workshops on proposed Sign Code Update on June 14, 2017, September 13, 2017, and September 27, 2017, and a public hearing on October 11, 2017; and

WHEREAS, based on written and verbal testimony that is a part of the record and is summarized in the City Plan Commission Recommendation, Findings and Conclusions adopted on October 25, 2017, the Plan Commission unanimously recommended that the City Council adopt the proposed Sign Code Update; and

WHEREAS, on September 26, 2017, the responsible official issued a determination of non-significance (DNS) under SEPA (Chapter 43.21C RCW) relating to the Sign Code Update and notice of said DNS was published in the Spokesman Review on September 27, and October 4, 2017.

WHEREAS, the City complied with RCW 36.70A.370 in processing the Sign Code Update.

WHEREAS, in adopting the Sign Code Update, it is the intent of the City Council to make the City's sign regulations easier to understand and for the City to enforce; and

WHEREAS, the Sign Code Update will promote and accomplish the goals, policies and objectives of the City's Comprehensive Plan and Zoning Code; and

WHEREAS, the Sign Code Update provides minimum standards in order to safeguard life, health, property and public welfare, and promote traffic safety by following the established design standards, including quality of materials, construction, illumination, size, location and maintenance of sign and sign structures; and

WHEREAS, by adopting the Sign Code Update, the City Council intends to insure that the City's sign regulations recognize free speech rights by regulating signs in a content-neutral manner; and

WHEREAS, the standards in the Sign Code Update will promote the free flow of traffic and protect pedestrians and motorists from injury and property damage caused by, or which may be fully or partially attributable to, cluttered, distracting and/or illegible signage; and

WHEREAS, these standards protect the beauty of the City's built environment by encouraging signs that are compatible with the architectural style, characteristics and scale of the building to which it may be attached, and to encourage signs that are compatible with adjacent buildings and businesses; and

WHEREAS, these standards protect property values, the local economy, and the quality of life by preserving and enhancing the appearance of the streetscape; and

WHEREAS, these standards provide consistent sign design standards; and

WHEREAS, these standards encourage creative and innovative approaches to signage, and signs that are of a quality design, pleasing in appearance and are appropriate in size, materials and illumination to the surrounding neighborhood; and

WHEREAS, these standards provide an improved visual environment for the citizens of and visitors to the City; and

WHEREAS, these standards adopt clear, understandable regulations which enable the fair and consistent enforcement of this Chapter;

NOW, THEREFORE,

The City of Spokane does ordain:

Section 1. That SMC Section 17C.240.010 is amended to read as follows:

17C.240.010 ((Purpose)) Intent and Purpose

~~((These regulations balance the need to protect the public safety and welfare; the need for a well-maintained and attractive community; and the need for adequate identification, communication, and advertising. The regulations for signs have the following specific objectives:~~

- ~~A. To ensure that signs and awnings are designed, constructed, installed, and maintained according to minimum standards to safeguard life, health, property, and public welfare.~~
- ~~B. To allow and promote positive conditions for sign communication while at the same time avoiding nuisances to nearby properties.~~
- ~~C. To reflect and support the desired character and development patterns of the various zones, overlay zones, and promote an attractive environment.~~
- ~~D. To allow for adequate and effective signs in residential, commercial, and industrial zones while preventing signs from dominating the appearance of the area.~~
- ~~E. To ensure that the constitutionally guaranteed right of free speech is protected; and~~
- ~~F. To avoid the visual clutter that is potentially harmful to traffic and pedestrian safety, property values, business opportunities, and the community's appearance.~~

~~The regulations allow for a variety of sign types and sizes for a site. The provisions do not ensure or provide for every property or business owner's desired level of visibility for the signs. The sign standards are intended to allow signs to have adequate visibility from streets and rights-of-way that abut a site, but not necessarily to streets and rights-of-way farther away.))~~

- A. Signs have a strong visual impact on the character and quality of the community. As a prominent part of the scenery, they attract or repel the viewing public, affect the safety of vehicular traffic, and their suitability or appropriateness helps to set the tone for the neighborhood. The City relies upon its scenery and physical beauty to attract commerce, aesthetic considerations assume economic value. It is the intent of the City, through this Chapter, to protect and enhance the City's historic and residential character and its economic base through the provision of appropriate and aesthetic signage. In addition, it is the intent of the City to limit the size, type and location of signs in order to minimize their distracting effect on drivers and thereby improve traffic safety. The City seeks to balance the need for the protection of public health, safety, welfare and community aesthetics, with the desire to protect the freedom of speech, and prevent discrimination in the application of free speech principles and tenets through the use of content-neutral regulations.
- B. The purpose of this Chapter is to promote the public health, safety and welfare through a comprehensive system of reasonable, effective, consistent, content-neutral and nondiscriminatory sign standards and requirements. This Chapter has also been adopted to:
 - 1. Promote and accomplish the goals, policies and objectives of the City's Comprehensive Plan and Zoning Code;
 - 2. To provide minimum standards in order to safeguard life, health, property and public welfare, and promote traffic safety by following the established design standards, including quality of materials, construction, illumination, size, location and maintenance of sign and sign structures;
 - 3. Recognize free speech rights by regulating signs in a content-neutral manner;
 - 4. Promote the free flow of traffic and protect pedestrians and motorists from injury and property damage caused by, or which may be fully or partially attributable to, cluttered, distracting and/or illegible signage;
 - 5. Protect the beauty of the City's built environment by encouraging signs that are compatible with the architectural style, characteristics and scale of the building to which it may be attached, and to encourage signs that are compatible with adjacent buildings and businesses;

6. Protect property values, the local economy, and the quality of life by preserving and enhancing the appearance of the streetscape;
7. Provide consistent sign design standards;
8. Encourage creative and innovative approaches to signage, and signs that are of a quality design, pleasing in appearance and are appropriate in size, materials and illumination to the surrounding neighborhood;
9. Provide an improved visual environment for the citizens of and visitors to the City; and
10. Adopt clear, understandable regulations which enable the fair and consistent enforcement of this Chapter.

Section 2. That there is adopted a new section 17C.240.015 to chapter 17C.240 of the Spokane Municipal Code to read as follows:

Section 17C.240.015 Definitions

“A” Definitions

Abandoned Temporary Sign.

A temporary sign that, because of the passage of time, has faded, peeled, cracked or otherwise become deteriorated or dilapidated, or is no longer affixed to the ground, or is missing the sign face, or otherwise meets the definition of litter set forth in SMC 10.08.010.

Abandoned Sign Structure.

A sign structure where no sign has been in place for a continuous period of at least six months.

Alter

To change the copy, color, size, shape, illumination, position, location, construction or supporting structure of a sign, not including ordinary maintenance.

Animated Sign.

A sign that uses movement, by either natural or mechanical means, to depict action to create a special effect or scene.

“B” Definitions

Backed Sign.

A sign where the faces of the sign are parallel or within twenty degrees of parallel to each other.

Balloon Sign.

A sign that is blown up with air or gas.

Banner.

A sign made of fabric or other similar non-rigid material with no enclosing framework or electrical components that is supported or anchored on two or more edges or at all four corners. Banners also include non-rigid signs anchored along one edge, or two corners, with weights installed that reduce the reaction of the sign to wind.

“C” Definitions

Clear View Triangle.

See SMC 17A.020.030

Community Banner.

A temporary banner made of sturdy cloth or vinyl that is not commercial advertising that has the purpose of the promotion of a civic event, public service announcement, holiday decorations, or similar community and cultural interests and is placed on a structure located in the public right-of-way, subject to procedures authorized by city administrator.

Copy.

Letters, characters, illustrations, logos, graphics, symbols, writing, or any combination thereof designed to communicate information of any kind, or to advertise, announce or identify a person, entity, business, business product, or to advertise the sale, rental, or lease of premises.

“D” Definitions

Directional Sign.

A sign exclusively limited to guiding the circulation of motorists or pedestrians on the site.

Director

See SMC 17A.020.040

“E” Definitions

Electric Sign.

Any sign containing electrical wiring, lighting, or other electrical components, but not including signs illuminated by a detached exterior light source.

Electronic Message Center Sign.

An on-premises sign capable of displaying words, symbols, figures, or images that can be electronically or mechanically changed by remote or automatic means including signs using a video display method.

“F” Definitions

Facade.

See SMC 17A.020.060(A).

Fascia Sign.

A single-faced sign attached flush to a building or other structure or a sign consisting of light projected onto a building or other structure. Fascia signs do not include signs that are attached to or projected onto structures defined as sign structures by this chapter.

Flag.

A sign made of fabric or other similar non-rigid material supported or anchored along only one edge or supported or anchored at only two corners. If any dimension of the flag is more than three times as long as any other dimension, it is classified and regulated as a banner regardless of how it is anchored or supported.

Flashing Sign.

- a. A pattern of changing light illumination where the sign illumination alternates suddenly between fully illuminated and fully non-illuminated in a strobe-like fashion for the purpose of drawing attention to the sign.
- b. Time and temperature signs are excluded from this definition.
- c. For the purpose of this title, electronic message centers consistent with the standards of SMC 17C.240.240 shall not be considered flashing signs

Freestanding Sign.

A sign on a frame, pole, or other support structure that is not attached to any building.

“I” Definitions

Illuminated Wall Highlights

See SMC 17A.020.090

Interpretive Signs.

A sign that identifies historic buildings or sites where important events occurred or which serve educational, cultural, historical, or scientific purposes.

“M” Definitions

Marquee Sign.

A sign incorporated into or attached to a marquee or permanent canopy.

Monument Sign.

A freestanding sign where the base of the sign structure is on the ground or a maximum of twelve inches above the lowest point of the ground adjacent to the sign. The width of the top of the sign structure can be no more than one hundred twenty percent of the width of the base.

MUTCD.

See SMC 17A.020.130

“N” Definitions

Nonconforming Sign.

A sign that was created and issued a permit in conformance with development regulations, but which subsequently, due to a change in the zone or land use regulations, is no longer in conformance with the current applicable development standards.

“O” Definitions

Off-premises Sign.

A sign relating, through its message and content, to a business activity, use, product, or service not available on the premises upon which the sign is erected.

“P” Definitions

Painted Wall Highlights.

Painted areas that highlight a building's architectural or structural features and that do not convey a message or image.

Painted Wall Sign.

A sign applied to a building wall with paint or a thin layer of vinyl, paper, or similar material adhered directly to the building surface and that has no sign structure.

Pedestrian-Scaled Signs

Permanent, first-floor, exterior signs designed and placed to address pedestrian traffic; may be mounted flush with or projecting from a column, building wall, awning or transom.

Permanent Sign.

Any sign not classified as a temporary sign.

Projecting Sign.

A sign attached to and projecting out from a building face or wall, generally at right angles to the building. Projecting signs include signs that are totally in the right-of-way, partially in the right-of-way, or fully on private property.

“R” Definitions

Right-of-way

See SMC 17A.020.180

Roadway

See SMC 17A.020.180

Roof Line.

The top edge of a roof or building parapet, whichever is higher, excluding any cupolas, chimneys, or other projections.

Roof mounted sign.

A sign which has a point of attachment to the roof or mansard of a building. Architectural projections, including mechanical equipment screens, above any parapet or roof line whose sole function is a background for signs shall be considered a sign structure. A sign on such an architectural projection shall be considered a roof sign.

“S” Definitions

Sandwich Board Sign.

A self-supporting A-shaped freestanding temporary sign with only two visible sides that are situated adjacent to a business, typically on a sidewalk.

Sign.

- d. Materials placed or constructed or light projected, but not including any lawful display of merchandise, that:
 - i. Conveys a message or image, and
 - ii. Is used to inform or attract the attention of the public
- e. Some examples of signs are materials or lights meeting the definition of the preceding sentence and which are commonly referred to as signs, placards, A-boards, posters, murals, diagrams, banners, flags, or projected slides, images, or holograms.
- f. The scope of the term sign does not depend on the content of the message or image conveyed.

Sign Face.

The portion of a sign which contains lettering, logo, trademark, or other graphic representations. (See SMC 17C.240.110, Sign Face Area.)

Sign Maintenance.

Normal care needed to keep a sign functional, such as cleaning, painting, oiling, and changing of light bulbs.

Sign Repair.

Fixing or replacement of broken or worn parts. Replacement includes comparable materials only. Repairs may be made with the sign in position or with the sign removed.

Sign Structure.

A structure specifically intended for supporting or containing a sign.

Special Event Sign.

A temporary sign used to announce a circus, a carnival, festivals, or other similar events.

Structural Alteration.

1. Modification of a sign, sign structure, or awning that affects size, shape, height, or sign location.
2. Changes in structural materials; or
3. Replacement of electrical components with other than comparable materials.
4. The replacement of wood parts with metal parts, the replacement of incandescent bulbs with light emitting diodes (LED), or the addition of electronic elements to a non-electrified sign would all be structural alterations.
5. Structural alteration does not include ordinary maintenance or repair, repainting an existing sign surface, including changes of message or image, exchanging painted and pasted or glued materials on painted wall signs, or exchanging display panels of a sign through release and closing of clips or other brackets.

“T” Definitions

Temporary sign (which may include special event sign)

Any sign that is used temporarily and is not permanently mounted, painted or otherwise affixed, including any poster, banner, pennants, placard, stake sign or sign not placed in the ground with concrete or other means to provide permanent support, stability and rot prevention. Temporary signs do not include off-premise signs, as defined in this chapter. Temporary signs may only be made of non-durable materials including, but not limited to, paper, corrugated board, flexible, bendable or foldable plastics, foamcore board, vinyl canvas or vinyl mesh products of less than 20 oz. fabric, vinyl canvas and vinyl mesh products without polymeric plasticizers and signs painted or drawn with water soluble paints or chalks. Signs made of any other materials shall be considered permanent and are subject to the permanent sign regulations of this Chapter.

Section 3. That SMC Section 17C.240.020 entitled “Where These Regulations Apply” is repealed.

Section 4. That there is adopted a new section 17C.240.025 to chapter 17C.240 of the Spokane Municipal Code to read as follows:

Section 17C.240.025 Applicability and Interpretations

- A. This Chapter applies to all signs as defined in Section 17C.240.015 (Definitions), within the City which are visible or audible from any street, sidewalk or public place, regardless of the type or nature.
- B. This Chapter is not intended to, and shall not be interpreted to, restrict speech on the basis of its content, viewpoint, or message. Any classification of sign authorized in this chapter for commercial purposes shall be interpreted to also be permitted for non-commercial purposes. No part of this Chapter shall be construed to favor commercial speech over non-commercial speech. To the extent that any provision of this Chapter is ambiguous, the term shall be interpreted not to regulate speech on the basis of the content of the message.
- C. Substitution Clause.

Notwithstanding anything herein to the contrary, noncommercial copy may be substituted for commercial copy on any lawful sign structure.

D. Severability

If a section, subsection, paragraph, sentence, clause, or phrase of this chapter is declared unconstitutional or invalid for any reason, the decision shall not affect the validity of the remaining portions of this chapter.

Section 5. That SMC Section 17C.240.060 is amended to read as follows:

Section 17C.240.060 Exemptions

The following signs ~~((do not require))~~ are exempt from a sign permit (unless otherwise noted)~~((;)),~~ ~~((nor shall the area and number of such signs be included in the area and number of signs permitted for any site or use))~~ The area and number of such signs shall not be included in the area and number of signs permitted for any site or use, however, all other relevant requirements of this chapter shall apply. This shall not be construed as relieving the owner of the sign from the responsibility of its erection and maintenance and its compliance with the provisions of this chapter or any other law or ordinance.

- A. ~~((The flag, emblem, or insignia of a nation or other governmental unit or nonprofit organization subject to the guidelines concerning their use set forth by the government or organization which they represent.))~~ Flags. Any flags, provided that they conform to all provisions of this chapter for signs, ~~Freestanding ((Flagpoles))~~ flagpoles require a ~~sign~~ building permit for structural review.
- B. Memorial signs or tablets, names of buildings, stained glass windows, and dates of erection when cut into the surface or the facade of the building or when projecting not more than two inches.
- C. ~~((Traffic or other municipal signs, signs required by law or emergency, railroad crossing signs, legal notices, and any temporary signs as are authorized under policy approved by the city council.))~~ Governmental signs. Signs installed by the City, County, or a federal or State governmental agency for the protection of the public health, safety and general welfare, including, but not limited to, the following:
 - 1. Emergency and warning signs necessary for public safety or civil defense;
 - 2. Traffic and/or wayfinding signs erected and maintained by an authorized public agency;
 - 3. Signs required to be displayed by law;
 - 4. Signs showing the location of public facilities including public and private hospitals and emergency medical services; and
 - 5. Any sign, posting, notice, or similar sign placed by or required by a governmental agency in carrying out its responsibility to protect the public health, safety and general welfare.
- D. Signs of public utility companies indicating danger or which serve as an aid to public safety or which show the location of underground facilities ~~((or of public telephones)).~~
- E. Flush-mounted wall signs, used to identify the name and address of the occupant for each dwelling provided the sign does not exceed two square feet in sign area.

F. ~~((Signs located in the interior of any building or within an enclosed lobby or court of any building or group of buildings, which signs are designed and located to be viewed exclusively by patrons of such use or uses.))~~ Non-visible signs. Signs not visible beyond the boundaries of the lot or parcel upon which they are located, or from any public right-of-way. Such freestanding signs require a building permit for structural review.

~~((G. Decorations, such signs in the nature of a decoration, clearly incidental and customary and commonly associated with any national, local or religious holiday.))~~

G. Changes to the face or copy of changeable copy signs, digital signs, electronic messaging signs, provided such changes do not change the material or appearance of the sign as originally permitted by the City.

~~((H. Painting, repainting, or cleaning of an advertising structure or the changing of the advertising copy of message thereon shall not be considered an erection or alteration which requires a sign permit unless a structural change is made.))~~

H. The normal repair and maintenance, (painting, repainting, cleaning) of conforming or legal nonconforming signs that does not involve structural alteration of the sign or supporting structure.

I. Sculptures, fountains, mosaics, murals, public art and design features which do not ~~((incorporate advertising or identification))~~ otherwise constitute a sign.

J. "No trespassing," "no dumping," "no parking," "private" signs identifying essential public needs (i.e., restrooms, entrance, exit, telephone, etc.) and other informational warning signs, which shall not exceed three square feet in surface area.

~~((K. Directional signs erected by the City on arterial streets directing the public to public, civic, or nonprofit facilities. Such signs shall be erected at the discretion of the director of public works and shall be subject to City design guidelines. In addition, with the approval of the design review board, the director of public works may allow the erection of directional signs as are necessary to designate commercial areas or significant tourist sites within the City.))~~

~~((L.))~~K. Publicly approved non-illuminated interpretive signs, or historical signs, or tablets displayed by a public, educational non-profit agency, or private development pursuant to ((SMC 17E.060.830 and SMC 17E.060.840)) SMC 17E.060.820 through SMC 17E.060.840, strictly for the purpose of informing or educating the public.

~~((M.))~~L. Illuminated wall highlights that do not contain words, logos, or corporate images.

M. Interior signs. Signs or displays located entirely inside of a building and located at least three (3) feet away from transparent doors and windows.

N. Temporary signs (provided they comply with 17C.240.244, Temporary Signs).

Section 6. That SMC Section 17C.240.070 is amended to read as follows:

Section 17C.240.070 Prohibitions

The following are prohibited and existing ones must be removed:

- A. ~~((Signs containing strobe lights.))~~ Flashing signs or lights. A sign that contains an intermittent or flashing light source, or a sign that includes the illusion of intermittent or flashing light by means of animation, or an externally mounted intermittent light source, except as consistent with the standards contained in Table 17C.240-4.
- B. Abandoned signs and abandoned sign structures.
- C. Signs placed on or painted on a motor vehicle or trailer parked with the primary purpose of providing signs not otherwise allowed by the code.
- D. Permanent balloon signs.

~~((E. Temporary signs (except as provided for in SMC 17C.240.240(G), Temporary Signs.))~~

E. Hazardous signs. Any sign that is dangerous or confusing to motorists on the public right-of-way, including any sign which by its color, wording, design, location or illumination resembles, conflicts, imitates or interferes with the effectiveness of any official traffic control device or which otherwise impedes the safe and efficient flow of traffic.

~~F. Signs that imitate or resemble official traffic lights, signs or signals or signs that interfere with the effectiveness of any official traffic light, sign, or signal.))~~

~~((G.))~~F. Signs which are located upon or projecting over public streets, sidewalks, or rights of way except as provided for awnings and marquees in SMC 17F.040.140, ((and)) sandwich board signs in ((SMC 17C.240.240(G)(9) and)) SMC17C.240.220, signs extending into the right-of-way allowed in ((SMC 17C.240.240(G)) SMC17C.240.180(B), and temporary signs in SMC 17C.240.244 (E).

~~((H.))~~G. Off premises signs (except as ((provided for in SMC 17C.240.240(G), Temporary Signs, such as real estate signs and community banners; SMC 12.02.0755, Signs Permitted in Conjunction With Bus Bench Signs, and SMC 17C.240.250, Off premises Signs)) expressly allowed in other sections of this chapter). No off-premises sign shall be located on a vacant lot, parcel or easement. No off-premises sign shall be located on a lot, parcel or easement as the principal use of that lot, parcel or easement. Signs may only be established as an accessory use to a principally permitted use.

~~((I. Strings of banners, pennants, and other graffiti like material with advertising copy except grand opening displays and special event signs as allowed in SMC 17C.240.240(G.))~~

~~((J.))~~H. Signs erected, constructed or structurally altered that are required to have a permit that were erected, constructed, or altered without a permit.

~~((K.))~~I. Except as otherwise allowed under this chapter or other ordinances, laws, or regulations of the City of Spokane, ((#)) it shall be unlawful for any person, except a public officer or employee in the performance of his public duty, to affix, post, paint, nail, fasten, place, or locate any sign, card, banner, handbill, poster, ((or advertising)) advertisement or notice of any kind, or cause the same to be done, ((upon public streets, highways, public right of way or any publicly owned or maintained property within the City of Spokane, or)) upon any City owned or maintained structure located in the public right of way, including but not limited to, any building, curbstone, traffic control device, street sign, utility pole, hydrant, fence, lamp post, guardrail, tree or shrubbery or any other structure situated within any such areas or to affix the same to a wire or appurtenance thereof((, except as may be authorized by the ordinances, laws, or regulations of the City of Spokane, the State of Washington or the

~~United States)). City-owned or maintained structures include, but are not limited to, bridges, overpasses, street medians, retaining walls, fences, street furniture, and shelters, among other structures located upon public streets, highways, public right-of-way or other public property. ((The prohibition contained herein shall not apply to political campaign signs which are permitted pursuant to the regulations set forth in SMC 17C.240.240(G)(6).))~~

~~((L. Flashing signs.))~~

J. No sign may impede free ingress and egress from any door, window or exit way required by building and/or fire code regulations.

Section 7. That SMC Section 17C.240.080 entitled “General Rules for Reading and Applying the Code Language” is repealed.

Section 8. That SMC Section 17C.240.090 is amended to read as follows:

Section 17C.240.090 Sign Permit Required

A. Permit Requirements.

No sign governed by the provisions of this code shall be erected, structurally altered, or relocated by any person, firm, or corporation ~~((after the date of adoption of this code))~~ without a permit issued by the City ~~((with the exceptions as noted))~~ unless an exemption applies under this chapter. No new permit is required for signs which have permits and which conform with the requirements of this code on the date of its adoption unless and until the sign is structurally altered or relocated.

B. Permit Applications.

Permit applications shall include a site plan that provides the following information:

1. The location of the affected lot, building(s), and sign(s).
2. The scale of the site plan.
3. A scaled-drawing of the proposed sign or sign revision, including size, height, copy, structural footing details, method of attachment, and illumination.
4. The location of all existing signs on the site including size and height.
5. For signs subject to spacing regulations, the location of neighboring signs on adjacent properties.
6. Tax parcel number or correct address where proposed sign will be located.

C. Fee Schedule.

Fees for sign permits are as provided by SMC 8.02.031(G).

Section 9. That SMC Section 17C.240.100 entitled “Applying the Code to Specific Situation” is repealed.

Section 10. That SMC Section 17C.240.120 is amended to read as follows:

Section 17C.240.120 Measurements

The standards contained in SMC 17C.240.130 through SMC 17C.240.180 address how the signs allowed in the various zoning categories are measured including sign area, height, and other parameters. These standards work in combination with the standards of SMC 17C.240.~~((190))~~210 through SMC 17C.240.~~((300))~~310 regarding allowed sign size, number, type, and other provisions.

Section 11. That SMC Section 17C.240.130 is amended to read as follows:

Section 17C.240.130 Primary Building Walls

The length of a primary building wall is derived for each tenant space's ground floor exterior wall (See Figure 1). When walls are not parallel to a street, they are assigned to the street frontage to which they are most oriented ((See Figure ((8a))). When the primary entrance is located in a building wall that is adjacent to, at an angle from, and shorter than the street-facing wall, the primary building wall will be measured as a combination of the street wall and the wall containing the entrance. Where the angled wall is on the corner of the building between two street-facing walls, the applicant may choose which street facing wall to combine with the wall containing the entrance to be considered the primary building wall. The length of the primary building wall will be measured in a straight line parallel to the street-facing wall ((See Figure (8b))).

**FIGURE 1:
Primary and Secondary Building Walls**

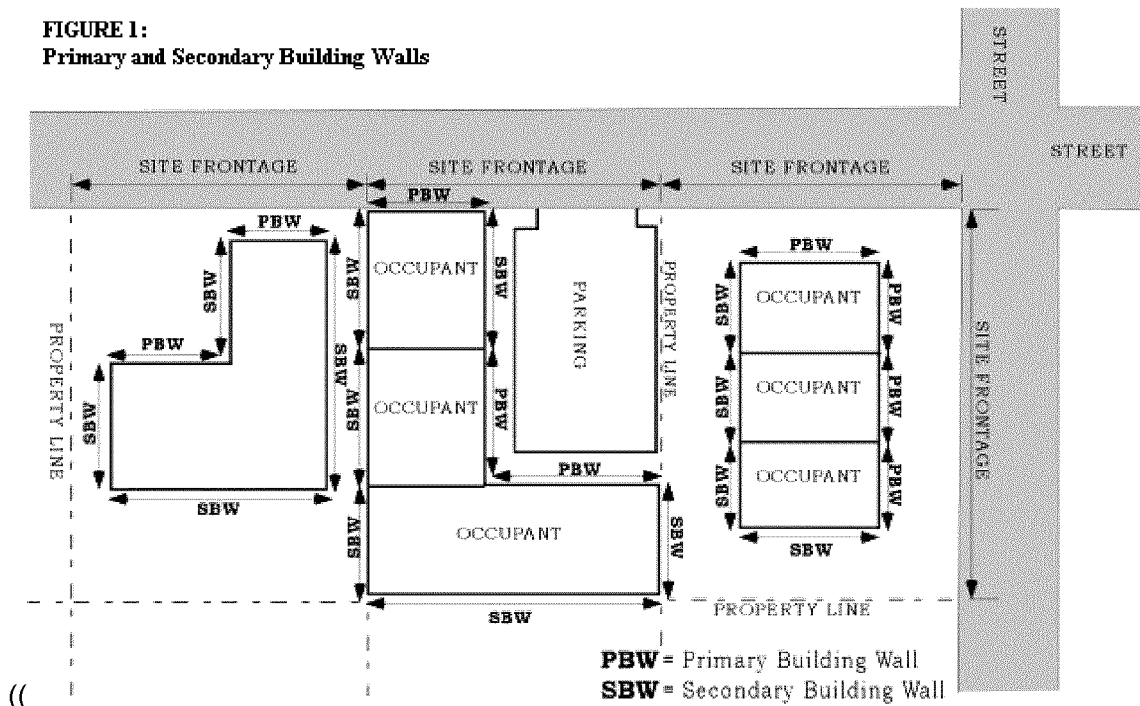
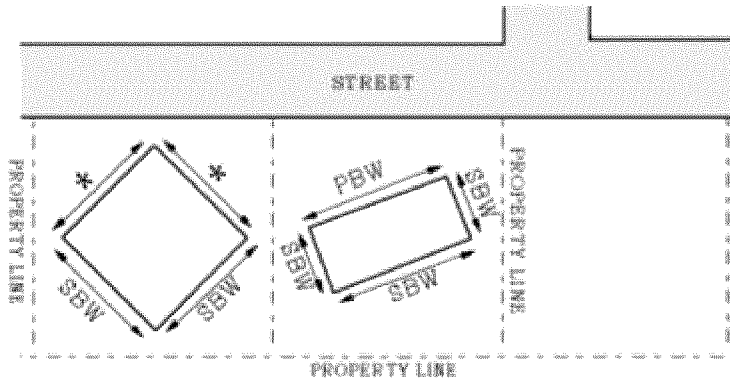

FIGURE 8a
Building Wall Orientation



PBW = Primary Building Wall
SBW = Secondary Building Wall

* Equal orientation - applicant chooses one for primary wall and one for the secondary wall

FIGURE 8b
Primary Building Wall - Angled Entrance

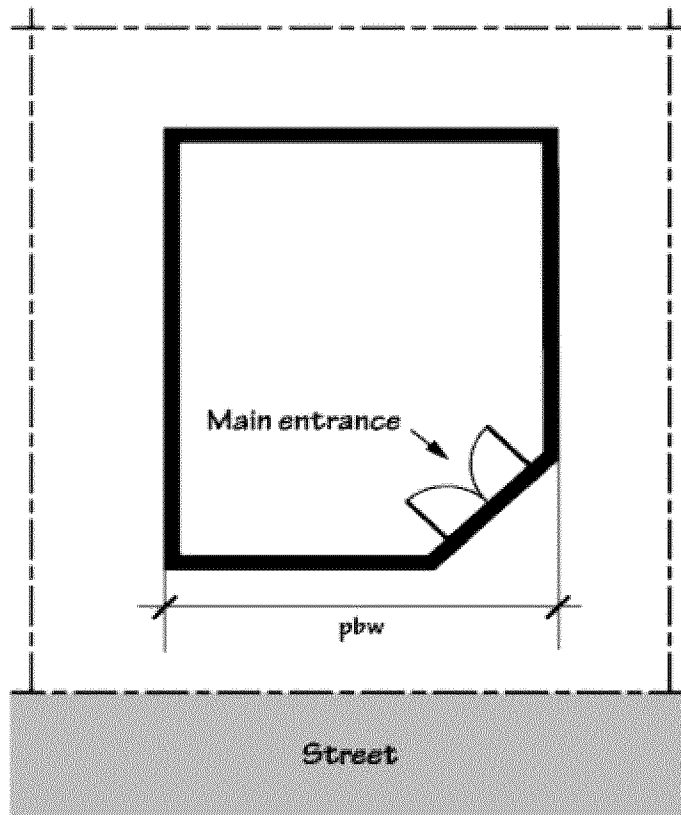
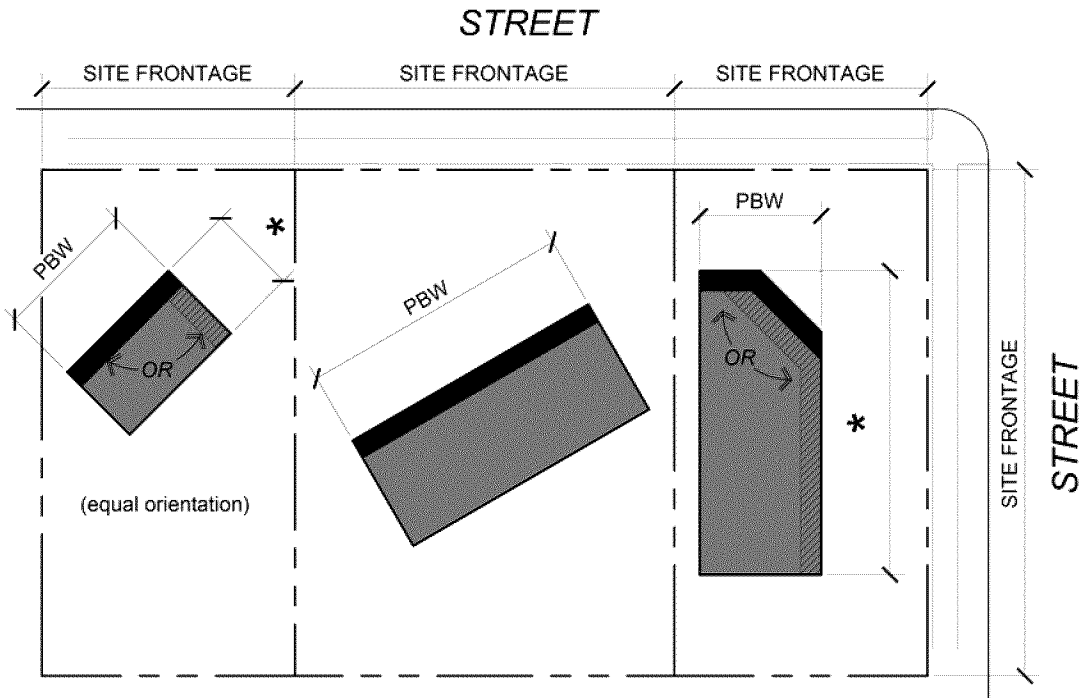
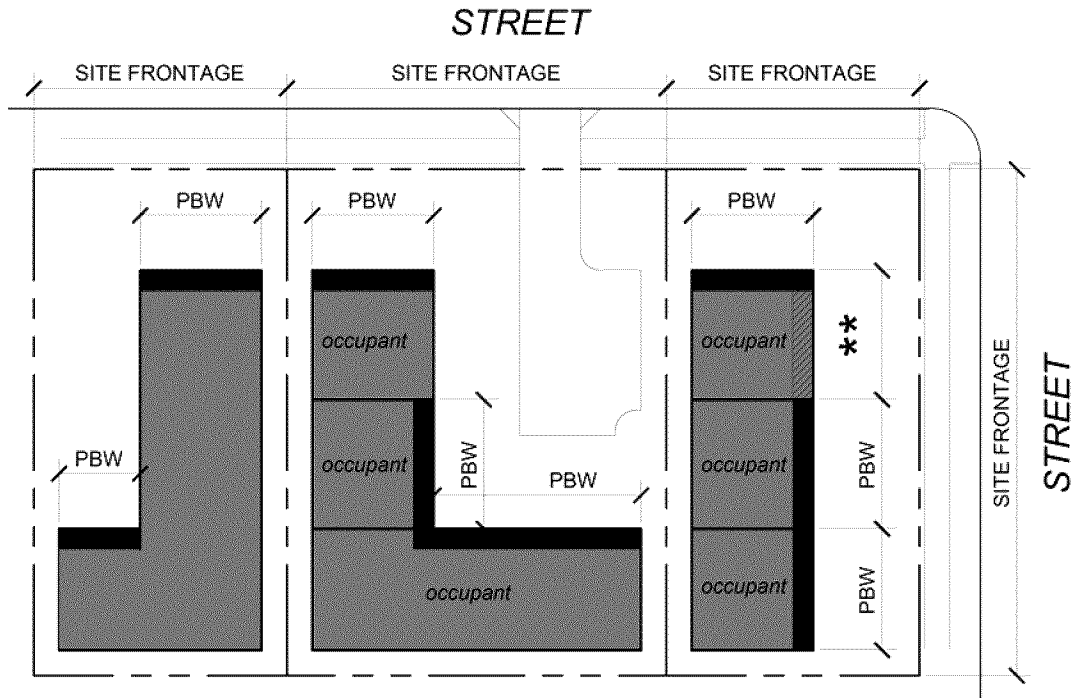

Figure 1
Primary and Secondary Building Wall

))



PBW = Primary Building Wall
 * = Applicant chooses one wall as Primary Building Wall.
 ** = PBW is whichever wall has the occupant's primary entrance.

Section 11. That SMC Section 17C.240.140 is amended to read as follows:

Section 17C.240.140 Sign Face Area

A. Sign Cabinets.

The area of sign faces enclosed in frames or cabinets is determined based on the outer dimensions of the frame or cabinet surrounding the sign face (See Figure 2).

FIGURE 2
Sign Face Measurement

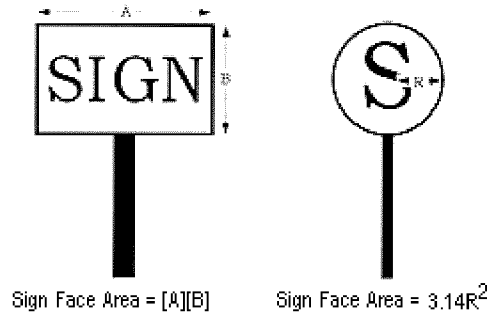

B. Backed Signs.

Only one side of a backed sign is counted in determining the area of sign faces. Where the two sides are not of equal size, the larger of the two sides is used for the determination of sign area (See Figure 3).

FIGURE 3
Sign Face Measurement

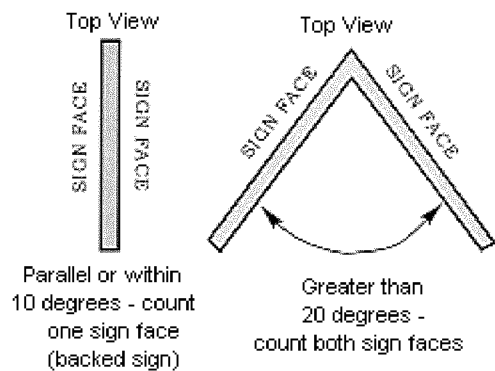

C. Multiple Cabinets.

For freestanding and projecting signs that contain multiple cabinets on one structure and oriented in the same direction, the modules together are counted as one sign face (See Figure 4).

FIGURE 4
Sign Face Measurements

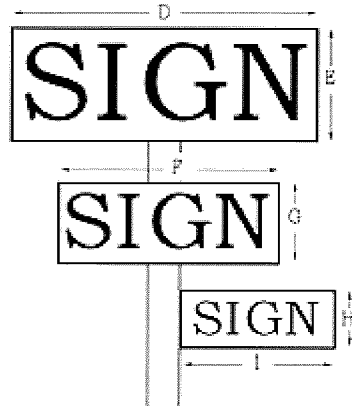

((Sign Face Area = [D][E] + [F][G] + [H][I]))

Figure 4
Multiple Cabinets

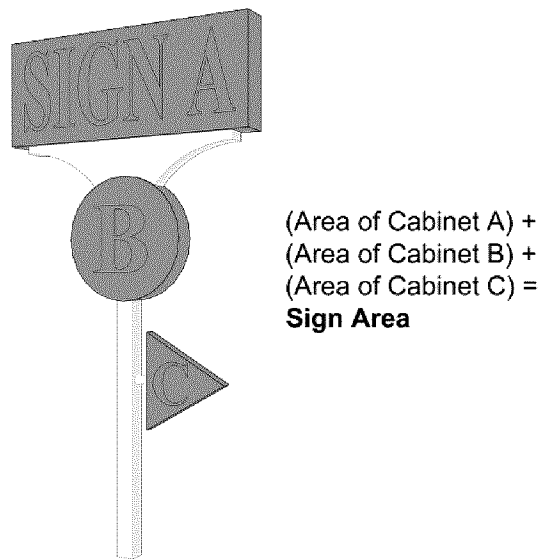

- D. Round Signs.
The maximum surface area visible at one time of a round, three dimensional, or three or more sided sign is counted to determine sign area.
- E. ~~((Signs On a Base Material.~~
~~When a sign is on a background panel and attached without a cabinet, such as a wood board or Plexiglas background panel, the dimensions of the background panel are to be used.))~~
Background panel or surface.
Sign copy mounted, affixed or painted on a background panel or surface distinctively painted, textured or constructed as a background for the sign copy, is measured as that

area contained within the smallest rectangle, parallelogram, triangle, or circle that will enclose the sign copy and the background, as shown in Figure 5.

Figure 5

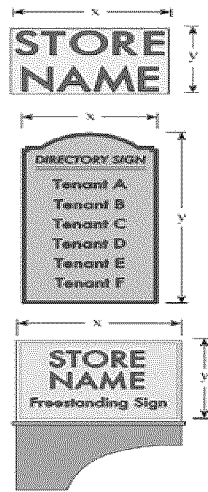

F. ((Individual Elements-

~~When signs are constructed of individual elements attached to a building wall, the sign area is determined by calculating the area of an imaginary rectangle drawn around the sign elements (See Figure 5). Sign elements will be measured as one unit when the distance between the elements is less than the dimension of the smallest element (See Figure 6).))~~

Individual letters or graphics.

Sign copy mounted as individual letters or graphics against a wall of a building or surface of another structure, that has not been painted, textured or otherwise altered to provide a distinctive background for the sign copy, is measured as the sum of the smallest square, rectangle, parallelogram, triangle or circle that will enclose each word, sentence and complete message, and each graphic in the sign.

((

FIGURE 5

Sign Face Measurements

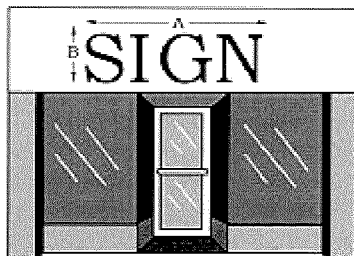

Sign Face Area = [A][B]

))

Figure 6

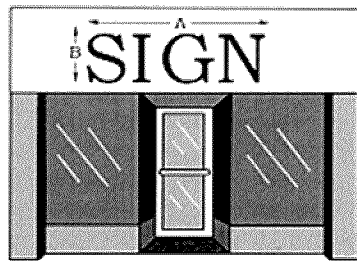

Sign Face Area = (A)(B)

G. Painted Wall Signs.

Painted wall signs are measured ~~((by drawing an imaginary rectangle around the edge of each of the sign elements. Sign elements will be measured as one unit when the distance between the elements is less than two times the length of each element (See Figure 6). Visible wall area includes windows and doors, but not openings such as loading entrances.))~~ as the sum of the smallest square, rectangle, parallelogram, triangle or circle that will enclose each word, sentence and complete message, and each graphic in the sign.

H. Awnings and Marquees.

When signs are incorporated into awnings, the sign area is determined by computing the area of an imaginary rectangle drawn around the sign face. When the ends of awnings or marquees are parallel and contain sign faces, only one side is counted in addition to the sign face area on the front.

((

FIGURE 6
Multiple Elements in a Painted Wall Sign or Fascia Sign

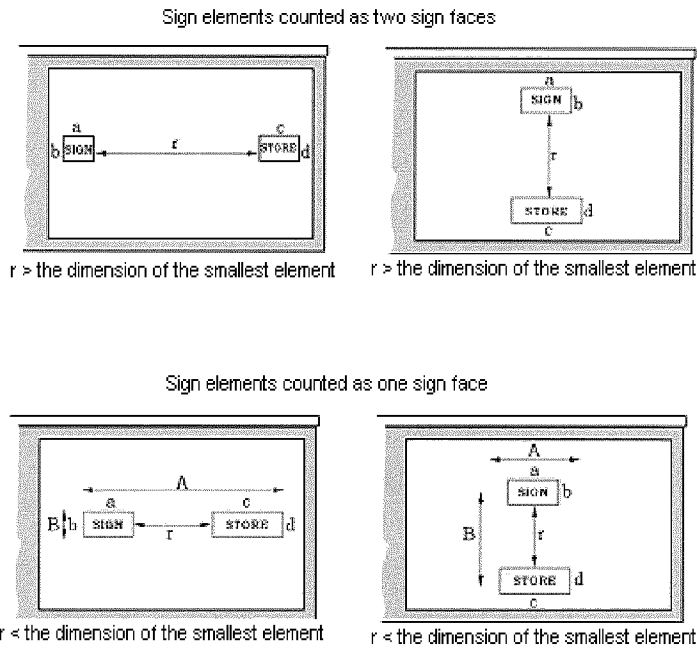

))

Section 11. That SMC Section 17C.240.150 is amended to read as follows:

Section 17C.240.150 ((Height of Signs)) Sign Heights and Clearances

A. Height

The overall height of a sign or sign structure is measured from the finish grade to the highest point of the sign or sign structure (See Figure 7).

B. Clearance

Clearances are measured from the highest point of the ground directly below the sign to the bottom of the sign structure enclosing the sign face (See Figure 7).

Figure 7
Sign Heights and Clearances

((

FIGURE 7
Sign Heights and Clearances

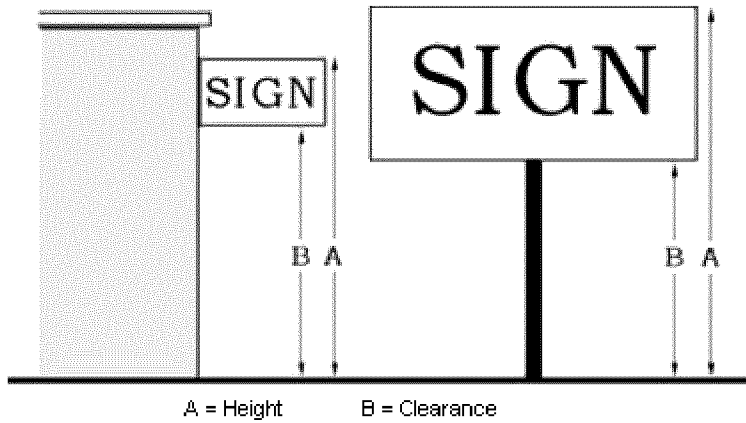

))

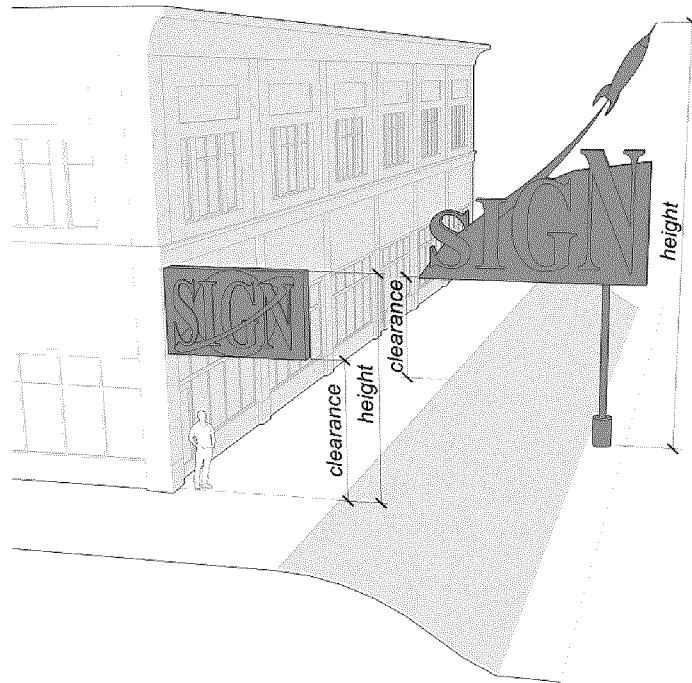

Section 12. That SMC Section 17C.240.160 entitled "Clearances" is repealed.

Section 13. That SMC Section 17C.240.180 is amended to read as follows:

Section 17C.240.180 Diagonal Corner Signs

Diagonal corner signs that face more than one street must be assigned to a street and building frontage by the applicant. The sign must meet all standards for the street and building frontage to which it is assigned ((See Figure (8))).

((

FIGURE 3a
Building Wall Orientation

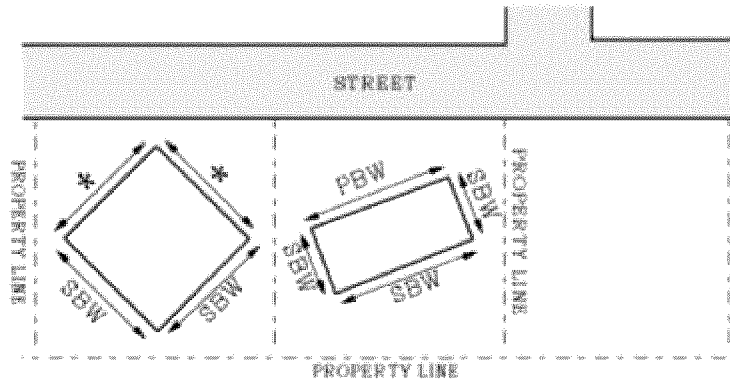

PBW = Primary Building Wall
SBW = Secondary Building Wall

* Equal orientation - applicant chooses one for primary wall and one for the secondary wall

FIGURE 8b
Primary Building Wall - Angled Entrance

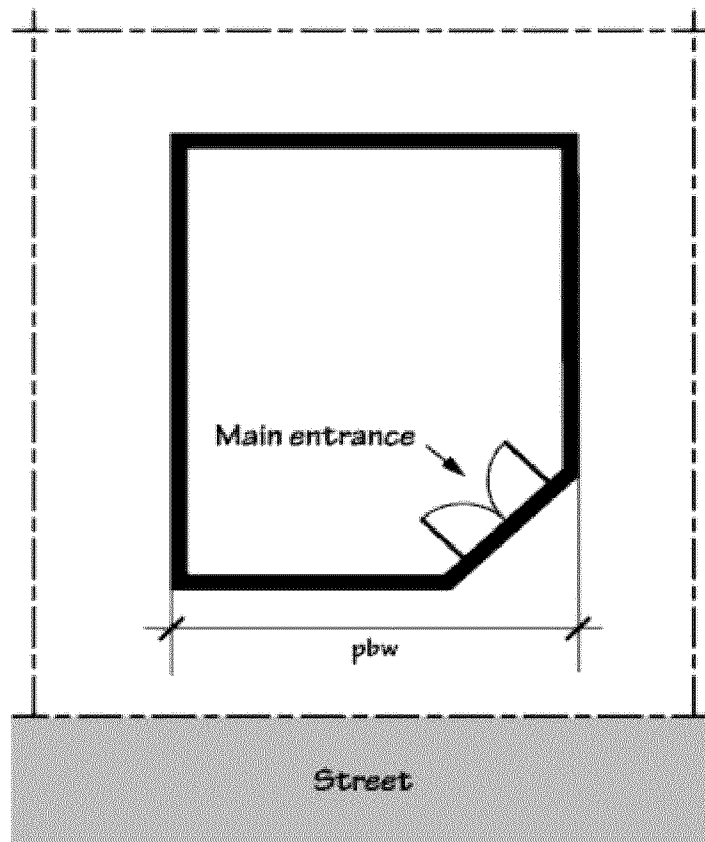

))

Section 14. That SMC Section 17C.240.190 entitled “Sign Standards Purpose” is repealed.

Section 15. That SMC Section 17C.240.200 entitled “Official Zoning Maps” is repealed.

Section 16. That SMC Section 17C.240.220 is amended to read as follows:

Section 17C.240.220 Standards in the Residential Zones

A. General Standards.

~~((The standards for))~~ All permanent signs in ((the RA through RHD)) Residential zones ((are stated in)) must comply with the standards detailed in Table 17C.240-1. ((All signs must conform to the regulations of SMC 17C.240.240.))

~~((Table 17C.240-1 (See Linked Document)))~~

<p>Table 17C.240-1. Standards for Permanent Signs in ((RA, RSF, RTF, RMF, and RHD)) Residential and CA4 Zones [1]</p>

Use Category/Structure Type [2]	Number of Signs	Max. Sign Face Area	Types of Signs Allowed	Maximum Sign Height	Additional Signs Allowed [3]
Residential Household Living/Houses, Duplexes, Attached Houses	1 per site	3 sq. ft.	Fascia, Painted Wall	Top of wall, or 10 ft. whichever is less	Directional Signs
			Freestanding	6 ft.	
Residential Household Living/Multi-family Residential Building, Group Living, Day Care, Nonresidential Category Uses Not Listed Below	1 per building	15 sq. ft.	Fascia, Painted Wall	Top of wall	Directional Signs
			Freestanding	10 ft.	
Subdivisions, PUDs, (Mobile Home Parks) Agricultural Uses [4]	1 per entrance	32 sq. ft.	Monument	10 ft.	Directional Signs
<u>Mobile Home Parks</u>	<u>The sign standards for mobile home parks are contained in 17C.345.120</u>				
Parks and Open Areas [5]	1 per street frontage	10 sq. ft.	Monument	10 ft.	Directional Signs
Colleges, Community Services, Medical Centers, Religious Institutions, Schools, Commercial Outdoor Recreation, Major Event Entertainments, Nonconforming Uses in Commercial and Industrial Use Categories, Uses in the Office Use Category Allowed as a Conditional Use in the RMF and RHD Zones	The sign standards of the NR zone apply. See SMC 17C.240.160.				

Notes:

[1] Temporary signs are regulated by SMC 17C.240.210, Temporary Signs.

[2] See Title 17C SMC, Uses, Use Categories, and Structure Types.

[3] These signs are allowed in addition to other signs when they meet the standards of SMC 17C.240.200(D).

[4] These signs are allowed in addition to those for individual buildings.

[5] Signs in, or adjacent to and facing, a sports field associated with Parks and Open Areas are subject to the standards of the NR zone. See SMC 17C.240.160.

B. Sign Features.

Signs in ~~((the RA, RSF, RMF, and RHD))~~ all residential zones, except for those subject to the NR zone sign standards, are subject to the standards of this subsection. Illuminated signs placed in windows are subject to these sign regulations. Extensions into the right-of-way are prohibited.

Section 17. That SMC Section 17C.240.230 is amended to read as follows:

Section 17C.240.230 Standards in the Commercial and Industrial Zones

General Standards and Sign Features.

~~((The standards for permanent signs and sign features in the Commercial and Industrial zones are stated in Tables 17C.240-2 and 17C.240-3. All signs must conform to the regulations of SMC 17C.240.240.))~~ All permanent signs in Commercial and Industrial zones must comply with the standards detailed in Tables 17C.240-2 and 17C.240-3.

Table 17C.240-2 Standards for Permanent Signs in Commercial, Center and Corridor, and Industrial Zones [1]					
	DTC, DTG, DTU, DTS, GC, LI & HI [8]	CC2 ((&)), CB, & CA3 [2][8]	O, OR, NR, NMU	CC1, CA1 & CA2 [2]	CC4 [2]
SIGNS ATTACHED TO BUILDINGS					
Size Allocation	1-1/2 sq. ft. per 1 ft. of primary building wall or 15 percent of the primary building wall, whichever is greater	1 sq. ft. per 1 ft. of primary building wall if a freestanding sign is also on the same street frontage, 1-1/2 sq. ft. per 1 ft. of primary building wall if there is no freestanding sign on the same street frontage	Same	Same	15 sq. ft.
Maximum	No limit within	Same	Same	Same	1

Number	size allocation				
Maximum Area Per Sign	250 sq. ft. In the DT Zones, the maximum area per sign attached to a building is not limited	100 sq. ft.	50 sq. ft.	50 sq. ft.	15 sq. ft.
Minimum Guaranteed Sign Area for a Ground Floor Tenant Space	32 sq. ft.	Same	Same	Same	15 sq. ft.
TYPES ALLOWED					
Fascia, Awning, Marquee, ((Pitched Roof))<u>Roof Mounted</u>, Painted Wall	Yes	Yes	Yes	Yes	Yes
Projecting	Yes, but no projecting signs if a freestanding sign is also on the same street frontage	Same	Same	Same	Same
((Rooftop))	((Yes))	((No))	((No))	((No))	((No))
FREESTANDING SIGNS					
Maximum Number	1 per site or 1 per 300 ft. of arterial street frontage and 1 for each additional 300 ft. or fraction thereof [3]	1 per arterial street frontage	1 per arterial street frontage	1 monument sign per arterial street frontage	1 monument sign per building
When Not Allowed	Not Limited	Not allowed if there is already a projecting sign on the same site frontage, or if existing signs attached to buildings exceed the limit of 1 sq. ft. to 1 ft. of primary building wall	Same	Same	Not allowed if there is already a wall or projecting sign
Size Allocation for All Freestanding Signs	1 sq. ft. per 1 ft. of arterial street frontage Local street	Same	Same	Same	15 sq. ft.

	frontage can be used if there are not arterial site frontages				
Size Limit	250 sq. ft.	75 sq. ft. [5]	50 sq. ft. [5]	50 sq. ft.	15 sq. ft.
Maximum Height [6]	35 ft. ((H)) In the DTS zone, the maximum height is 60 ft.	20 ft.	20 ft.	5 ft.	5 ft.

ADDITIONAL SIGNS ALLOWED

Directional Signs, Temporary Signs [7]	See SMC 17C.240.((240(H)))243(D) and SMC 17C.240.((240(G)))244
---	--

Yes = Allowed No = Prohibited

Notes:

[1] Temporary signs are regulated under SMC 17C.240.((240))244(H), Temporary Signs.

[2] Signs in CC and CA zones are subject to the standards and guidelines contained in the Initial Design Standards and Guidelines for Centers and Corridors.

[3] On sites with frontages longer than 300 feet, sign area earned from the first 300 feet may not be used on the second sign. For example, a 350-foot street frontage may have a 200 sq. ft. and a 50 sq. ft. freestanding sign. Interstate freeways, United States highways, state routes that are not also City of Spokane Arterials are not considered arterial streets for purposes of this Title. Sites with frontage on more than one arterial are allowed a freestanding sign on each arterial. The size allocation for each freestanding sign shall be calculated independently using only the length of the arterial frontage adjacent to the freestanding sign. The square footage allowance for freestanding signs for one arterial shall not be transferred to other arterials.

[4] Where a site has no arterial street frontage, one freestanding sign is allowed.

[5] The maximum sign area may be an additional twenty-five square feet for each additional business on a site having more than one business, up to a maximum area of one hundred fifty square feet.

[6] This height limit is for the total height of the combined sign face and sign structure.

[7] These signs may be allowed in addition to signs attached to buildings and freestanding signs when they meet the standards of SMC 17C.240.((240(H)))243 (D) and SMC 17C.240.((240(G)))244.

[8] Signage standards for mini-storage facilities are listed in 17C.350. Mini-storage facilities are not permitted in the DTC or CA3 zone.

((

Table 17C.240-3		
Sign Features for All Signs in Tables 17C.240-1 and 17C.240-2		
-	GC, CC2, Downtown, CB, LI & HI	O, OR, NR, NMU, CC1 & CC4
Electronic Message Center Sign Features	Yes [1]	Yes [1] Not Permitted in CC4 Zone
Lighting	Direct, Indirect, or Internal	Same

Maximum Distance Extending into ROW	See SMC 17C.240.240(C)	Same
Maximum Area Extending into ROW	See SMC 17C.240.240(C)	Same
Bonus Allowance for Outstanding Design	See SMC 17C.240.290	Same
Yes = Allowed — No = Prohibited		
Notes: [1] Electronic Message Center sign features are allowed in the GC, CC2, Downtown, CB, LI, HI O, OR, NR, NMU, & CC1 zones if they meet the standards of SMC 17C.240.240(J), Electronic Message Center Signs.)		

))

Table 17C.240-3	
Sign Features for All Signs in Table 17C.240-2	
-	<u>GC, CC2, Downtown, CB, LI, HI, O, OR, NR, NMU, CC1 & CC4</u>
<u>Electronic Message Center Sign Features</u>	<u>Allowed [1][2]</u>
<u>Lighting</u>	<u>Direct, Indirect, or Internal</u>
<u>Maximum Distance Extending into ROW</u>	<u>See SMC 17C.240.220(E)</u>
<u>Maximum Area Extending into ROW</u>	<u>See SMC 17C.240.220(E)</u>
<u>Bonus Allowance for Outstanding Design</u>	<u>See SMC 17C.240.290</u>
<u>Notes:</u>	
<u>[1] Electronic Message Center sign features are allowed in the GC, CC2, Downtown, CB, LI, HI O, OR, NR, NMU, & CC1 zones if they meet the standards of SMC 17C.240.240, Electronic Message Center Signs.</u>	
<u>[2] Electronic Message Center sign features are not allowed in the CC4 Zone</u>	

Section 18. That SMC Section 17C.240.240 is amended to read as follows:

Section 17C.240.240 ((Additional Standards in All Zones)) Sign Placement and Location Restrictions

~~((A. Where These Regulations Apply.~~

~~These regulations apply to all signs regulated by this chapter.))~~

A. Sign Placement.

All signs and sign structures must be erected and attached totally within the site except when allowed to extend into the right-of-way by this chapter.

B. Signs Extending Into the Right-of-way.

The standards of this subsection apply to permanent signs that are erected on private property and that extend into the right-of-way ~~((and temporary signs that are in the right-of-way)).~~

1. Projecting Signs.

Projecting signs that extend into the right-of-way must meet the following standards:

 - a. Distance Into the Right-of-way.
 - i. Where allowed, signs may extend into the right-of-way not more than ten feet or within two feet of the curbline, whichever is the smaller projection.
 - ii. Diagonal corner signs may extend into the right-of-way to a point that is determined by extending a line from the maximum points allowed for projecting signs on each street frontage (See Figure 8).

**FIGURE 9
Diagonal Corner Signs**

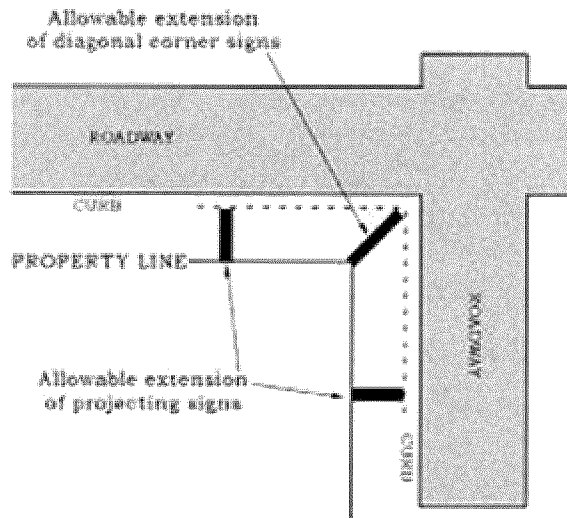
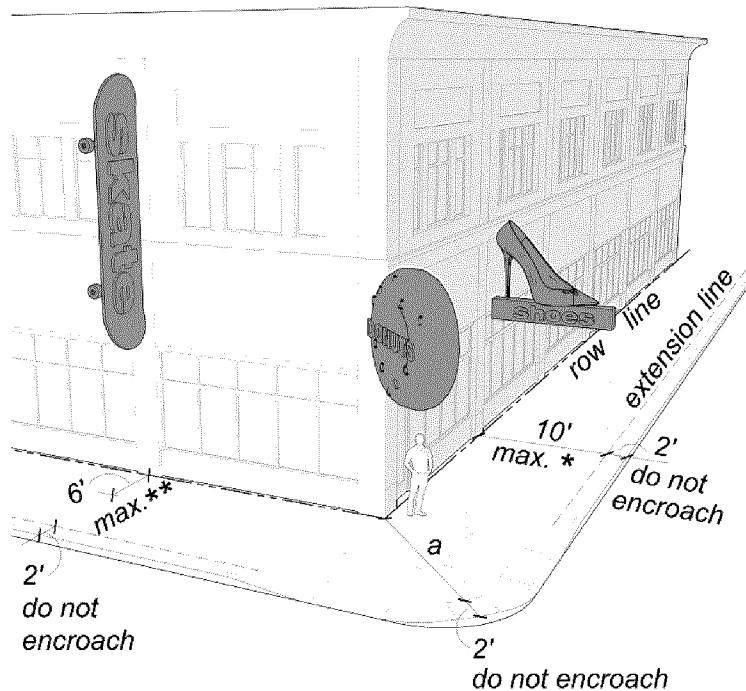

Figure 8
Signs Projecting into the Right of Way



a = Allowable extension into right-of-way for diagonal signs

* = Maximum extension into right-of-way for signs 60 sqft in area

** = Maximum extension into right-of-way for signs 100 sqft in area

b. Maximum Sign Face Area In the Right-of-way.

The area of a sign is limited by the amount the sign extends into the right-of-way, as follows:

- i. A sign extending more than six feet cannot have a total area of projection in excess of sixty square feet; and
- ii. A sign extending less than six feet may not exceed one hundred square feet in area.

c. Blanketing.

A projecting sign that extends into the right-of-way more than three feet may not be within twenty feet of another projecting or freestanding sign that extends more than three feet into the right-of-way if the new sign is within horizontal lines drawn from the top and bottom of the prior sign.

2. Awnings and Marquees.

Awnings and marquees that contain signs may extend into the right-of-way the same distance as awnings and marquees that do not contain signs (See SMC 17F.040.140, Awnings).

~~(3. Temporary Signs.~~

~~Temporary signs allowed to be placed in the right-of-way in SMC 17C.240.240(G) shall meet the following standards:~~

- ~~a. The sign is entirely outside the roadway.~~
- ~~b. The sign is no larger than nine square feet in size. The sign face is no wider than three feet and no taller than thirty six inches.~~
- ~~c. The sign is entirely outside of the area of a right-of-way corner that is between the curb and the lines created by extending the property line to the curb face (See Figure 10a).~~

FIGURE 10a
Placement of Portable Signs in the R-O-W

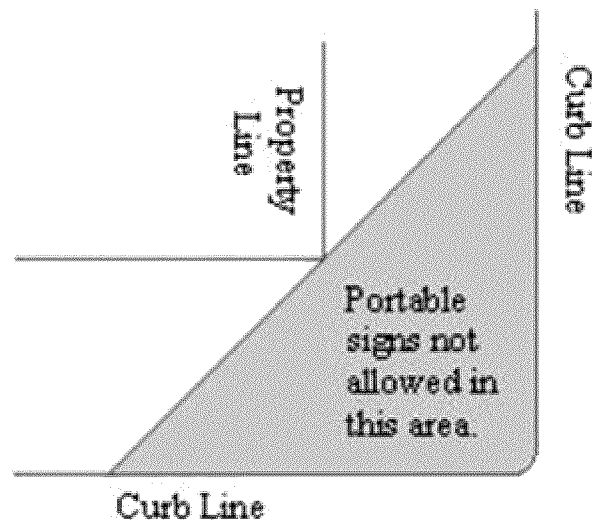

- d. The sign is entirely outside the area of a sidewalk that is between the lines created by extending the edges of any curb ramp across the sidewalk to the property line.
- e. The sign is within six inches of the curb (See Figure 10b)

FIGURE 10b
Placement of Portable Signs in the R-O-W

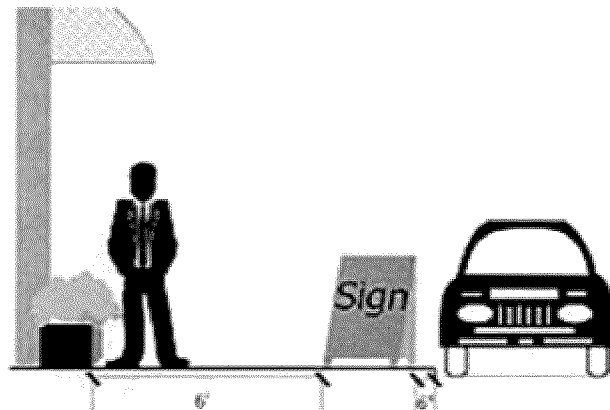

- f. The sign does not obstruct a continuous through pedestrian zone of at least six feet in width except in center and corridor zones, sandwich board signs which are located on the sidewalk shall be located in such a manner as to leave a pathway at least four feet wide that is free of obstructions.
- g. The sign does not obstruct pedestrian and wheelchair access from the sidewalk to any of the following:
 - i. Transit stop areas.

- ~~ii. Designated disabled parking spaces.~~
- ~~iii. Disabled access ramps; or~~
- ~~iv. Building exits including fire escapes.~~

~~h. Physical Attachment to Public Property.~~

~~Except as allowed for community banners, temporary signs placed in the right of way must remain portable and may not be attached or anchored in any way to trees or to public property including utility or light poles, parking meters, the ground, or pavement.~~

~~i. Additional Placement Standards for Temporary Signs.~~

~~Temporary signs placed in the right of way must meet the following additional standards:~~

~~i. Where no curb exists, the sign must be placed outside the roadway at least five feet from the edge of the roadway. Temporary signs may not be placed in medians, traffic islands, or other areas within the roadway.~~

~~ii. Temporary signs must not be placed in parking spaces, pedestrian pathways, or bicycle paths.~~

~~3. Removal of Signs.~~

~~The city engineer may require signs extending into the right of way to be modified or moved if streets are widened, or other improvements made in the right of way, which result in the creation of unsafe conditions. The modification or moving will be at the owner's expense. If a nonconforming sign is moved under this requirement, it may be re-erected on the site without being brought into conformance.~~

~~B. Signs Attached to Buildings or Structures.~~

~~1. Placement.~~

~~Signs attached to buildings or structures that are based on the sign rights of a primary building wall may be placed on that primary building wall, on a secondary building wall, or on another structure. They may not be placed on another primary building wall.~~

~~2. Awnings and Marquees.~~

~~Signs attached to an awning or marquee that extends into the right of way must comply with the pedestrian clearance and right of way extension standards of SMC 17F.040.140, Awnings.~~

~~3. Fascia Signs.~~

~~a. Vertical Extensions.~~

~~Fascia signs may not extend more than six inches above the top of the building wall. Fascia signs attached to other structures may not extend above the top of the structure.~~

~~b. Horizontal Extensions.~~

~~A fascia sign may not extend more than eighteen inches out from the wall or structure to which it is attached. Fascia signs may not extend beyond the corner of buildings or other structures.~~

~~4. Pitched Roof Signs.~~

~~a. Vertical Extensions.~~

~~The face of pitched roof signs may not extend more than six inches above the roofline.~~

~~b. Placement and Angle.~~

~~Pitched roof signs must be parallel to the building face. They may not extend beyond the building wall (See Figure 11).~~

**FIGURE 11
Pitched Roof Sign Placement**

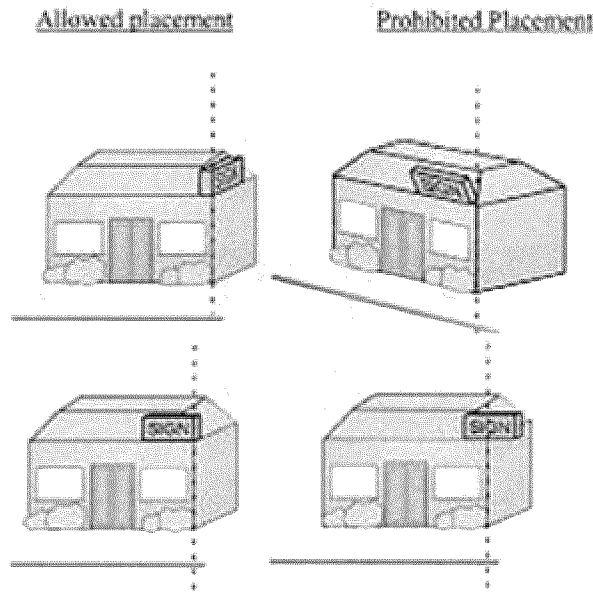

5. ~~Projecting Signs.~~

a. ~~Vertical extensions.~~

~~The face of a projecting sign may not extend more than six inches above the roof line.~~

b. ~~Placement.~~

~~Projecting signs that extend over the right of way must meet the placement standards of SMC 17C.240.240(C), Signs Extending Into the Right-of-way.~~

C. ~~Freestanding signs and monument signs.~~

1. ~~Setbacks.~~

~~Freestanding signs are regulated as follows:~~

a. ~~Residential Zones.~~

~~i. In residential zones, freestanding signs are allowed in required setbacks; however, in required front setbacks, monument signs exceeding three and one-half feet tall shall be setback ten feet from the front property line, provided that the requirements of SMC 17C.240.240(F) are met.~~

~~ii. Freestanding signs with structural supports less than two feet in width, with copy area placed at a height of seven feet or more above grade, may be located at the front property line, provided that the requirements of SMC 17C.240.240(F) are met.~~

~~iii. Freestanding signs with structural supports of more than two feet shall be set back not less than ten feet from the front property line, provided that the requirements of SMC 17C.240.240(F) are met.~~

b. ~~Commercial and Industrial Zones.~~

~~In O, OR, NR, NMU, CB, CC-2, GC, LI, and HI zones, freestanding signs are allowed in required setbacks for buildings and parking areas. However, freestanding signs are prohibited in the setback between a~~

~~property line abutting a residentially zoned site and the building line or parking area setback line.~~

~~2. Frontages.~~

~~Freestanding signs must be placed on arterial street frontages unless there are none. Freestanding signs that are allowed based on the length of one arterial street frontage may not be placed on another arterial street frontage. Frontage on a freeway is not considered arterial street frontage.~~

~~3. Extensions Into the Right of way.~~

~~Freestanding signs may project into the public right of way as follows:~~

- ~~a. No more than ten feet beyond the property line; or~~
- ~~b. Within two feet of the curblin, whichever is the smaller projection.~~
- ~~c. The area of a sign is limited by the amount of projection beyond the property line, as follows:
 - ~~i. A sign projecting more than six feet cannot have a total area of projection in excess of sixty square feet; and~~
 - ~~ii. A sign projecting less than six feet may not exceed one hundred square feet in area.~~~~
- ~~d. All supports of a freestanding sign must be on private property.))~~

C. Clearances.

1. ((Vision Clearance Areas-))Clear View Triangle

a. ((Vision Clearance Areas-

Vision clearance areas are triangular-shaped areas located at the intersection of any combination of rights of way, alleys, or driveways. The sides of the triangle extend fifteen feet from the intersection of the vehicle travel areas (See Figures 12a and b). The height of the vision clearance area is from thirty six inches above the ground to ten feet above the ground immediately below the sign or awning (See Figure 12c-)) Subject to the authority of the traffic engineer to make adjustments and special requirements in particular cases, all signs and sign features within the Clear View Triangle defined in SMC 17A.020.030 shall be maintained to keep a vertical clear view zone between three and ten feet from ground immediately below the sign or awning (see Figure 9).

FIGURE 12a
Vision Clearance Area

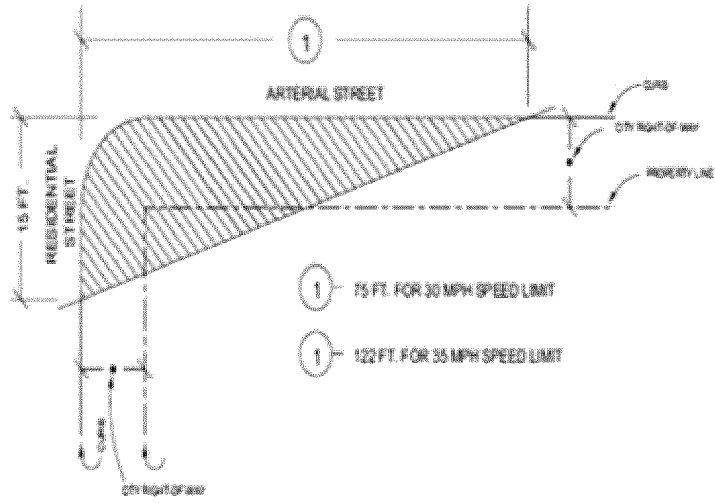

((

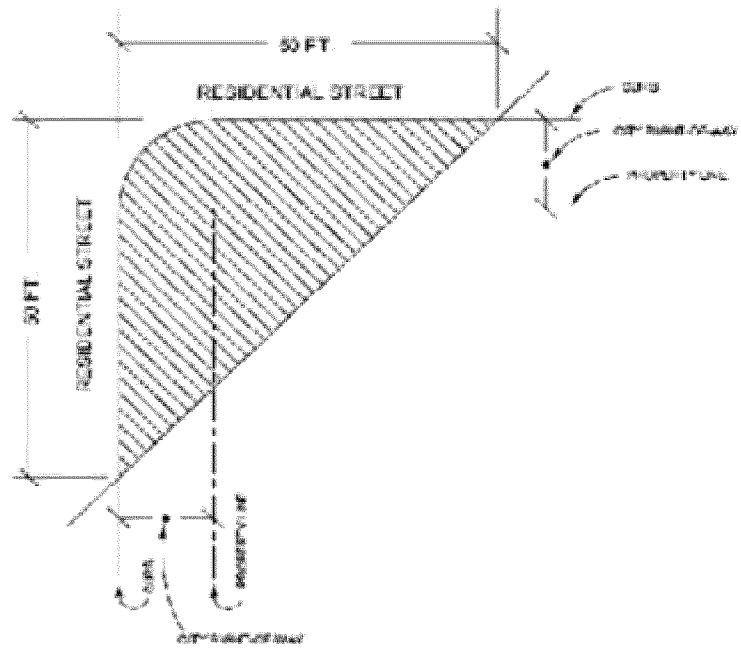

FIGURE 12b
Vision Clearance for Driveways

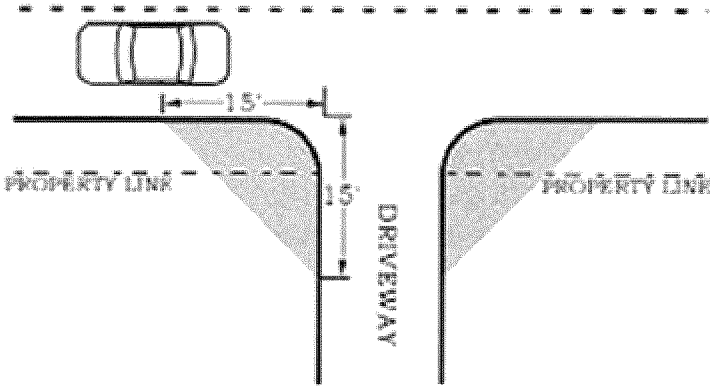
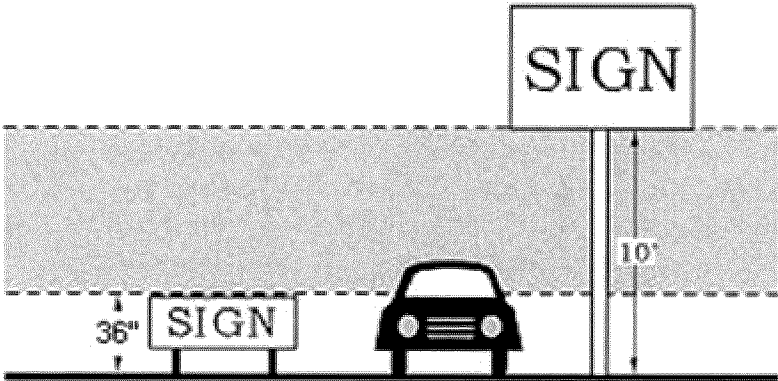

FIGURE 12c
Vision Clearance Area Height



))

Figure 9

Vertical Clear View Zone

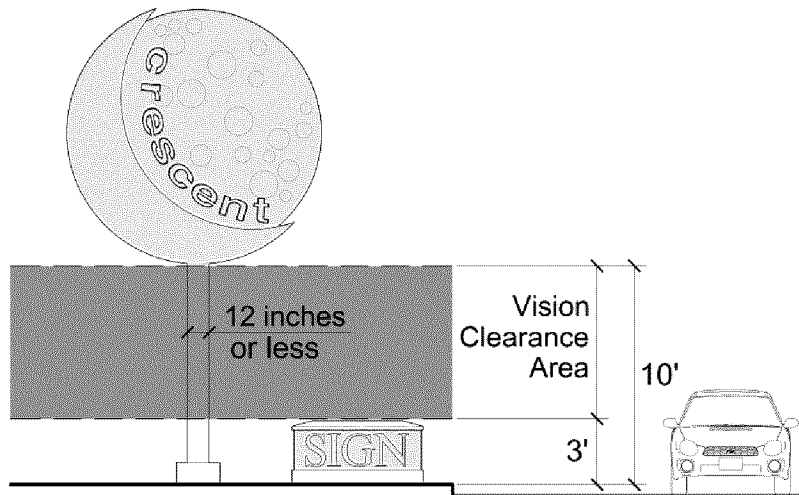

~~b. ((Signs in Vision Clearance Areas.))~~ Signs may not be located within a ~~((vision clearance area))~~ clear view triangle as defined in this paragraph. Support structures for a sign may only be located in a ~~((vision clearance area))~~ clear view triangle if the combined total width is twelve inches or less and the combined total depth is twelve inches or less.

2. Vehicle Area Clearances.

In areas outside of rights-of-way, when a sign or awning extends over where vehicles travel or are parked, the bottom of the structure must be at least fourteen feet above the ground. Vehicle areas include driveways, alleys, parking areas, and loading and maneuvering areas.

3. Pedestrian Area Clearances.

When a sign or awning extends over a sidewalk, walkway, or other space used by pedestrians, the bottom of the structure must be at least eight feet above the ground. Free-hanging valances made of fabric or other non-rigid material hung on signs, awnings, and marquees must be at least seven feet above of a sidewalk, walkway, or other space used by pedestrians.

~~((4. Clearances from Fire Escapes, Means of Egress, or Standpipes.~~

~~Signs, sign structures, and awnings are prohibited from being erected in any manner that interferes in any way with the free use of any fire escape, means of egress, or standpipe. Attaching signs, sign structures, or awnings to a fire escape is prohibited.~~

~~5. Obstruction of Windows and Ventilation.~~

~~Signs, sign structures and awnings are prohibited from being installed in any way that obstructs any building openings to such an extent that light, ventilation, or exhaust are reduced to a level below that required by the building code.))~~

4. Access to Signs.

Access clear of all obstructions must be provided to all signs.

~~((D. Temporary Signs.~~

~~The following signs are classified as temporary (non permanent). Temporary signs are permitted subject to the applicable limitations.~~

~~4. Construction Signs.~~

~~No sign permit is required. Such signs may be placed on the property on which construction is occurring upon private property only and may be displayed only after a building permit is obtained and during the period of construction on the construction site. The applicable limits are as follows:~~

- ~~a. In all zones other than single family residential zones, no construction sign shall exceed thirty two square feet in sign area or ten feet in height.~~
- ~~b. In single family residential zones, no construction sign shall exceed fifteen square feet in sign area.~~

~~5. Grand Opening Displays.~~

~~No sign permit is required. Such signs may be placed upon the premises of the business only. Such temporary signs, posters, banners, strings of lights, clusters of flags, balloons, or other air or gas filled figures, and searchlights are permitted for a period of thirty days only to announce the opening of a completely new business. All such materials shall be removed immediately upon the expiration of seven days after the event's conclusion. Such displays are permitted only in districts where the business so advertised is allowed under district zoning regulations. Searchlights may be permitted by any business provided the beam of light does not flash against any building or does not sweep an arc of forty five percent from vertical. All banners must be legible, made of durable materials, and must be well maintained.~~

~~6. Special Event Signs.~~

~~No sign permit is required. Such temporary signs may be placed upon the premises of the business only and shall not be larger than twenty square feet. Said signs shall not be posted or attached to telephone poles, power poles, or other public utility facilities. Such signs may be displayed thirty days prior to an event and must be removed within seven days after the event's conclusion. The event committee for which the sign is displayed shall be responsible for its removal and subject to the penalties as provided in this code. Searchlights may be permitted by any business provided the beam of light does not flash against any building or does not sweep an arc of forty five percent from vertical. All banners must be legible, made of durable materials, and must be well maintained.~~

~~7. Balloon Signs.~~

~~No sign permit is required. Such signs may be placed upon the premises of the business only. One balloon sign is allowed per site for a maximum of one month at a showing twice per calendar year in the commercial and industrial zones. Temporary balloon signs may be located on a building rooftop. The vertical dimension of the balloon may not exceed twenty five feet.~~

~~8. Real Estate Signs.~~

~~No sign permit is required. Such signs may be placed upon private property only. All exterior real estate signs must be of wood or plastic or other durable material. The permitted signs, with applicable limits, are as follows:~~

~~a. Residential "For Sale," "For Rent," and "Sold" Signs.~~

~~Such signs shall be limited to one sign per street frontage not to exceed five square feet in sign area, placed wholly on the property for sale or rent, and not to exceed a height of seven feet.~~

~~b. Residential "Open House" Signs.~~

~~Such signs shall be limited to one sign per street frontage on the premises for sale and up to ten off premises signs spaced not closer than two~~

~~hundred feet. Such signs are permitted only during daylight hours and when the real estate professional or seller or an agent is in attendance at the property for sale. No such sign shall exceed five square feet in sign area.~~

~~c. Undeveloped Commercial and Industrial Property "For Sale or Rent" Signs.~~

~~One sign per street frontage advertising undeveloped commercial and industrial property for sale or rent. The sign shall not exceed thirty-two square feet in sign area and ten feet in height.~~

~~d. Developed Commercial and Industrial Property "For Sale or Rent" Signs.~~

~~One sign per street frontage advertising a commercial or industrial building for rent or sale is permitted while the building is actually for rent or sale. If one face of the building is less than ten feet from the building line, the sign shall be placed on the building or in a window. The sign shall not exceed ten feet in height and, if free-standing, shall be located more than fifteen feet from any abutting property line or a public right of way line. Said sign shall not exceed thirty-two square feet in sign area.~~

~~e. Undeveloped Residential Property "For Sale" Signs.~~

~~One sign per street frontage advertising undeveloped residential property for sale is permitted not exceeding thirty-two square feet in sign area. The sign must be placed more than thirty feet from the abutting owner's property line and may not exceed a height of ten feet.~~

~~f. Subdivisions approved after the effective date of this chapter are permitted one cluster of flagpoles (not to exceed five flagpoles) in front of sales offices to advertise the new development.~~

~~9. Political Campaign Signs.~~

~~All signs which are relating to promoting or publicizing the nomination or election of any individual for a public political office to be voted on in any primary, general or special election or advocating any ballot measure to be voted on in any primary, general or special election, hereinafter referred to as political campaign signs, are permitted subject to the following regulations:~~

~~a. Size of Signs.~~

~~Political campaign signs located on private property in a residential zone shall be limited to a maximum surface area of sixteen square feet. Political campaign signs located on private property in zones other than residential zones shall be limited to a maximum surface area of thirty-two square feet. Political campaign signs located in the public right of way as set forth in subsection c shall be limited to a maximum surface area of five square feet with a maximum height of five feet. The maximum square footage shall be based upon one side of the sign. Signs may be two-sided.~~

~~b. Signs on Private Property.~~

~~Political campaign signs may be erected upon any private property with the permission of the property owner, resident, or respective agent. In cases of vacant property, or where there is no occupied structure on the property, political signs may be placed thereon with the written consent of the property owner or his agent.~~

~~c. Political Campaign Signs on the Public Right of way.~~

~~Placement of political campaign signs on the public right of way must have the permission for such placement of the abutting property owner, resident or respective agent. For purposes of this section, the public right of way shall mean that portion of the public right of way located next to a street between the roadway and the adjacent private property open to the public for general pedestrian passage, including the buffer/planting strip.~~

~~Political campaign signs may be posted preceding a primary, general or special election within the public right of way only if the signs do not create a traffic obstruction or hazard or impair or impede pedestrian thoroughfares and comply with all requirements of this section. Political campaign signs located in the public right of way shall only be attached to a self-supporting wood stick(s), metal post, or other such devices, shall not be attached to any other structures and shall not be erected in any manner which would damage the surface infrastructure in which the sign is located.~~

~~d. Method of Display.~~

~~Political campaign signs authorized under this section shall not be displayed using digital, flashing, electronic, or solar technology unless specifically authorized by other provisions of the Spokane Municipal Code. Political campaign signs authorized under this section, either on private property or within the public right of way, are subject to all other regulations regarding temporary signs.~~

~~e. Unauthorized Signs on City Property.~~

~~Unauthorized signs of any nature located on City owned or maintained property or on any portion of park property under the jurisdiction of the park board are prohibited and shall be immediately removed unless specifically authorized by law. City owned or maintained property shall include all property held in the City's name or controlled by easement or other legal devices, including all portions of the public right of way. This prohibition shall not apply to political campaign signs located in the public right of way adjacent to vacant city owned property.~~

~~f. Removal of Signs.~~

~~i. Political campaign signs on the public right of way as defined in this section or private property shall not be displayed after the date the election results have been certified for the election for which it was intended. In cases where a general election follows a primary election, those signs for candidates whose names will appear on the ballot in the general election may be displayed during the interim period and up to the date the general election results are certified. In all instances herein in which political campaign signs are required to be removed, or if the signs have become detached from their support device or damaged, it shall be the responsibility of the property owner or occupant, if the sign is located on private property, or the respective candidate, if the sign is located on the public right of way, to have the signs removed.~~

~~ii. Failure to remove political campaign signs located on the public right of way shall result in a one time sign removal fee of twenty five dollars per sign under fifteen square feet and fifty dollars for signs over fifteen square feet being assessed against the respective responsible campaign official. For the purpose of recovering the costs of removal there is a rebuttable presumption that the candidate seeking office or the sponsor of a ballot measure is the responsible campaign official who is responsible for the placement of a political campaign sign in the public right of way. Removal of signs located in the public right of way shall be under the direction of the director of public works and utilities or his or her designee.~~

~~iii. Failure to remove political campaign signs located on private property shall result in a civil infraction assessed pursuant to SMC 1.05.160 against the property owner or occupant for each sign. Each day~~

~~shall be a separate violation. A notice to remove the sign shall be issued by the code enforcement department to the property owner and/or occupant prior to the issuance of a civil infraction pursuant to SMC 1.05.040.~~

~~iv. The sign removal fee may be appealed to the hearing examiner within ten days of a letter assessing the fee. A civil infraction may be contested in the municipal court.~~

~~g. Signs Related to Constitutionally Protected Free Speech.~~

~~Signs expressing constitutionally protected free speech located on private property, including the public right of way adjacent to the private property, as defined in this section, unrelated to promoting or publicizing the nomination or election of any individual for a public political office or advocating any ballot measure to be voted on in any primary, general or special election shall not be subject to the time period for the removal of political campaign signs, but shall otherwise be subject to all other provisions of this section.~~

~~h. Public Notice.~~

~~Nothing in this chapter shall be construed to prohibit or modify the requirements for placement of public notices required by law.~~

~~i. Exemption.~~

~~Nothing in this chapter shall limit the promotion or publication of a political message by other means lawfully permitted under the City's sign code, chapter 17C.240 SMC.~~

~~j. Permit or Permit Fees.~~

~~There shall be no permit or fee requirement for political campaign signs erected under this section unless the sign is attached to a sign structure permitted under other provisions of the sign code that requires a permit and fee.~~

~~10. Community Banners.~~

~~Such signs may be permitted and extend into the public right of way by permission of the city administrator or appointed representative. Such signs may only be placed at City designated locations provided that the banner:~~

- ~~a. is not commercial advertising but, rather, has as its principal purpose the promotion of a civic event, public service announcement, holiday decoration, or similar community interests;~~
- ~~b. has been approved by the arts commission;~~
- ~~c. complies with all applicable codes; and~~
- ~~d. does not, in the judgment of the street director, present a traffic hazard.~~

~~11. Banners.~~

~~See SMC 17C.240.240(G)(2) for grand opening displays and SMC 17C.240.240(G)(3) for special event signs.~~

~~12. Sandwich Board Signs.~~

~~Businesses will only be allowed a maximum of one sandwich board sign. These signs are subject to the following conditions:~~

~~a. Notification.~~

~~Notification to the City is required prior to displaying a sandwich board sign. This notification shall include acknowledgement of the sandwich board sign requirements, list of materials used, and rendering of the sign, including the dimensions.~~

~~b. Size.~~

~~The area of the sign shall not exceed nine square feet per side in size and shall not exceed three feet in any dimension.~~

~~c. Maintenance Standards.~~

~~Signs shall be constructed out of materials able to withstand typical northwest weather. Such materials may be metal, finished wood, chalkboard, whiteboard, or plastic; signs and copy shall be of professional quality. Owners of sandwich board signs shall be required to keep their signs in a legible, intact, and well-maintained manner.~~

~~d. Display Time.~~

~~Signs may only be displayed during business hours. If business hours continue past daylight hours, precautions should be taken to place the sign in a location where it is readily visible after dark. This shall not be construed to allow the wiring of a sign for lighting.~~

~~e. Location.~~

~~Signs may be located no further than twelve feet from the entrance to the business. Such signs shall not be placed in a location which is within the vision triangle or any location which will impede vehicular traffic. Further, such signs shall not be placed in a manner which will block or otherwise obstruct the safe use of sidewalks, building entrances or stairs by pedestrians, including pedestrians who are visually impaired or otherwise handicapped.~~

~~13. Garage Sale (Yard Sales, Moving Sales, Patio Sales).~~

~~No sign permit is required. Such sign shall be limited to one sign on the premises and ten off premises signs. No such sign shall exceed four square feet in sign area. Signs shall not be posted or attached to telephone poles, power poles or other public utility facilities. The sign or signs may be displayed only during the sale and must be removed the day the sale ends. The person or persons for which the sign or signs are displayed shall be responsible for its removal and subject to the penalties as provided in this code.~~

~~14. Seasonal Sales.~~

~~No sign permit is required. Such temporary signs may be placed upon private property only. Vendors who receive a license as defined in chapter 8.01 SMC for seasonal or temporary sales activities (e.g. Christmas trees) are permitted one sign not to exceed twenty square feet in sign area. This sign shall be mounted to the booth or trailer used for temporary sales.~~

~~D. Directional Signs.~~

~~1. General Standards.~~

~~Directional signs that meet the standards of this subsection are allowed in all zones and are not counted in the total square footage of permanent signage allowed on the site. Adjustments or modifications to the standards of this subsection are prohibited.~~

~~2. Size.~~

~~Freestanding directional signs may be up to six square feet in area and forty two inches in height. Fascia directional signs may be up to six square feet in area and eight feet in height.~~

~~3. Sign Features.~~

~~Direct, internal or indirect lighting is allowed. Extensions into the right of way are prohibited.~~

~~4. Directional Signs that Do Not Meet the Standards of this Subsection.~~

~~Directional signs that do not meet the standards of this subsection must meet either the standards for signs attached to buildings or the standards for freestanding signs.~~

~~E. Permanent Banners.~~

~~1. General.~~

~~Banners used as permanent signs are allowed in all zones and will be included in the total square footage of permanent signage allowed on the site. Temporary banners are regulated under subsection (G) above.~~

~~2. Standards.~~

~~Permanent banners are subject to the standards for either fascia signs or projecting signs depending on how the banner is supported or anchored.~~

~~F. Electronic Message Center Signs.~~

~~Electronic message center signs are permitted subject to the limitations in Table 17C.240.4.)~~

D. Removal of Signs.

1. The director of public works and utilities may require any legally permitted or legal non-conforming signs extending into the right-of-way to be modified or moved if streets are widened, or other improvements made in the right-of-way, which result in the creation of unsafe conditions. The modification or moving will be at the owner's expense. If a legal nonconforming sign is moved under this requirement, it may be re-erected on the site without being brought into conformance.
2. Abandoned signs and signs not explicitly allowed within the right-of-way shall be subject to immediate removal, under the authority of the director of public works or his/her designee.

Section 19. That there is adopted a new section 17C.240.241 to chapter 17C.240 of the Spokane Municipal Code to read as follows:

Section 17C.240.241 Building Mounted Wall Signs.

A. Placement.

Signs attached to buildings or structures that are based on the sign rights of a primary building wall may be placed on that primary building wall, on a secondary building wall, or on another structure. They may not be placed on another primary building wall.

B. Awnings and Marquees.

Signs attached to an awning or marquee that extends into the right-of-way must comply with the pedestrian clearance and right-of-way extension standards of SMC 17F.040.140, Awnings

C. Fascia Signs.

1. Vertical Extensions.

Fascia signs may not extend more than six inches above the top of the building wall. Fascia signs attached to other structures may not extend above the top of the structure.

2. Horizontal Extensions.

A fascia sign may not extend more than eighteen inches out from the wall or structure to which it is attached. Fascia signs may not extend beyond the corner of buildings or other structures.

D. Projecting Signs.

1. Vertical extensions.

The face of a projecting sign may not extend more than six inches above the roof line.

2. Placement.

Projecting signs that extend over the right-of-way must meet the placement standards of SMC 17C.240.170(B), Signs Extending Into the Right-of-way.

Section 20. That there is adopted a new section 17C.240.242 to chapter 17C.240 of the Spokane Municipal Code to read as follows:

Section 17C.240.242 Roof-Mounted Signs

- A. No permit shall issue for a roof-mounted sign which does not comply with the following standards:
1. Number. No more than one (1) roof-mounted sign shall be allowed for each building.
 2. Area. The area of the roof-mounted sign shall not exceed the total amount of wall sign area that would be allowed for the building or site on which the roof mounted sign is located.
 3. Location. Allowed on the slope of peaked/sloped roof buildings only, and only on the lowest one-third (1/3) of the slope of the peaked roof. Roof-mounted signs shall be installed so that the structural supports of the sign are minimized. Angle irons, guy wires, braces or other secondary supports shall appear to be an integral part of the roof or roof-mounted sign.
 4. Zone. Roof-mounted signs are permitted in nonresidential zones only.
 5. Design. Roof-mounted signs may be non-illuminated, internally illuminated or indirectly illuminated, provided that the light is limited to the sign face only.

Figure 10
Roof Mounted Signs

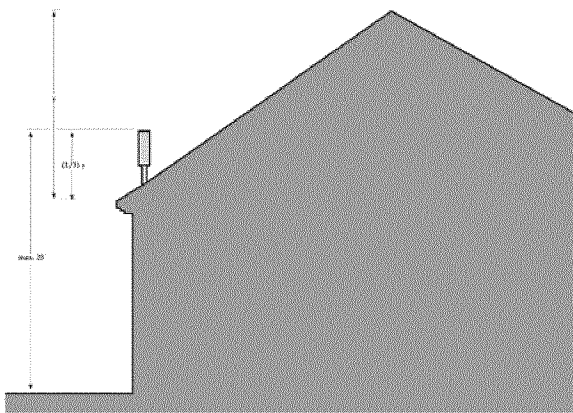

Section 21. That there is adopted a new section 17C.240.243 to chapter 17C.240 of the Spokane Municipal Code to read as follows:

Section 17C.240.243 Freestanding Signs

- A. Setbacks.
Freestanding signs are regulated as follows:
1. Residential Zones.
 - a. In residential zones, freestanding signs are allowed in required setbacks; however, in required front setbacks, monument signs exceeding three and one-half feet tall shall be setback ten feet from the front property line, provided that the requirements of SMC 17C.240.170(C) are met.
 - b. Freestanding signs with structural supports less than two feet in width, with copy area placed at a height of seven feet or more above grade, may be

located at the front property line, provided that the requirements of SMC 17C.240.170(C) are met.

- c. Freestanding signs with structural supports of more than two feet shall be set back not less than ten feet from the front property line, provided that the requirements of SMC 17C.240.170(C) are met.

2. Commercial and Industrial Zones.

In O, OR, NR, NMU, CB, CC-2, GC, LI, and HI zones, freestanding signs are allowed in required setbacks for buildings and parking areas. However, freestanding signs are prohibited in the setback between a property line abutting a residentially zoned site and the building line or parking area setback line.

- B. Frontages.

Freestanding signs must be placed on arterial street frontages unless there are none. Freestanding signs that are allowed based on the length of one arterial street frontage may not be placed on another arterial street frontage. Frontage on a freeway is not considered arterial street frontage.

- C. Extensions Into the Right-of-way.

Freestanding signs may project into the public right-of-way as follows, provided they also meet the requirements of 17C.240.170(B):

1. No more than ten feet beyond the property line; or
2. Within two feet of the curblin, whichever is the smaller projection.
3. The area of a sign is limited by the amount of projection beyond the property line, as follows:
 - a. A sign projecting more than six feet cannot have a total area of projection in excess of sixty square feet; and
 - b. A sign projecting less than six feet may not exceed one hundred square feet in area.
4. All supports of a freestanding sign must be on private property.

- D. Directional Signs.

1. General Standards.

Directional signs that meet the standards of this subsection are allowed in all zones and are not counted in the total square footage of permanent signage allowed on the site. Adjustments or modifications to the standards of this subsection are prohibited.

2. Size.

Freestanding directional signs may be up to six square feet in area and forty two inches in height. Fascia directional signs may be up to six square feet in area and eight feet in height.

3. Sign Features.

Direct, internal or indirect lighting is allowed. Extensions into the right-of-way are prohibited. Up to 25 percent of the area of the sign may contain a logo, image, or other copy.

4. Directional Signs that Do Not Meet the Standards of this Subsection.

Directional signs that do not meet the standards of this subsection must meet either the standards for signs attached to buildings or the standards for freestanding signs.

Section 22. That there is adopted a new section 17C.240.244 to chapter 17C.240 of the Spokane Municipal Code to read as follows:

Section 17C 240.244 Temporary Signs

- A. No Permit required. No sign permit is required for temporary signs.

- B. Removal. Any abandoned temporary sign, or other temporary signs that are not explicitly allowed within the right-of-way shall be removed. Failure to remove such signs shall constitute a violation of this chapter.
 - 1. The director of public works and utilities shall have the authority to require the immediate removal of any abandoned temporary sign or other temporary signs not explicitly allowed in the public right-of-way.
 - 2. Authority over abandoned temporary signs in other locations is described in SMC 17C.240.050. The removal shall be at the cost of the sign and/or property owner.
- C. Materials. See the definition of “temporary sign” in Section 17C.240.015.
- D. City property (excluding City right-of-way). Temporary signs on City-owned property (excluding City right-of-way) are allowed only in conjunction with an approved Special Event permit.
- E. City Right-of-Way outside of the Roadway. Temporary signs allowed to be placed in the right-of-way shall meet the following standards:
 - 1. The sign is entirely outside the roadway.
 - 2. The sign is no larger than the maximum allowed for a freestanding temporary sign in the zoning district.
 - 3. The sign is entirely outside of the area of a right-of-way corner that is between the curb and the lines created by extending the property line to the curb face (See Figure 11a).

Figure 11a
Exclusion Area

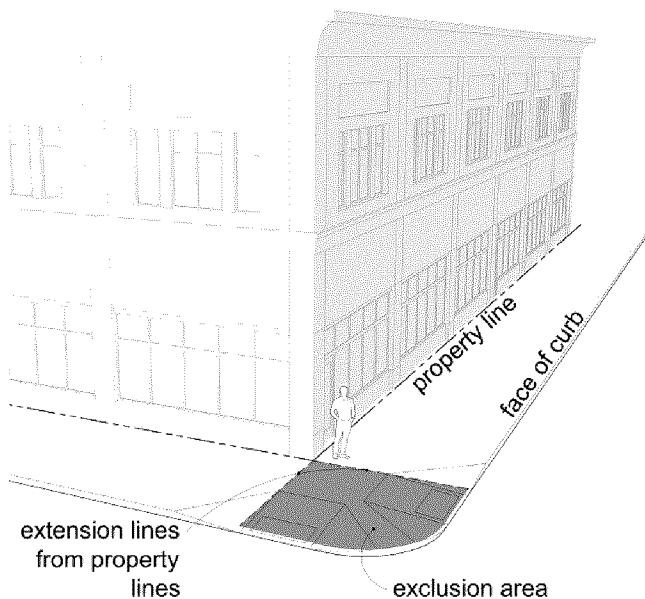

- 4. The sign is entirely outside the area of a sidewalk that is between the lines created by extending the edges of any curb ramp across the sidewalk to the property line.
- 5. The edge of the sign is within six inches of the curb (See Figure 11b).

Figure 11b
Temporary Signs in the Right of Way

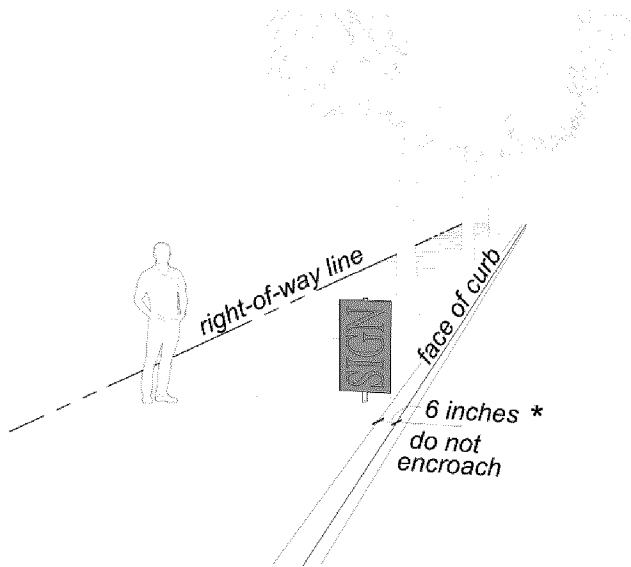

* = Where no curb is present, distance must be 5' from edge of roadway

6. The sign does not obstruct a continuous through pedestrian zone of at least six feet in width.
 7. The sign does not obstruct pedestrian and wheelchair access from the sidewalk to any of the following:
 - a. Transit stop areas.
 - b. Designated disabled parking spaces.
 - c. Disabled access ramps; or
 - d. Building exits including fire escapes.
 8. Physical Attachment to Public Property.
See SMC 17C.240.070(l).
 9. Additional Placement Standards for Temporary Signs.
Temporary signs placed in the right-of-way must meet the following additional standards:
 - a. Where no curb exists, the sign must be placed outside the roadway at least five feet from the edge of the roadway. Temporary signs may not be placed in medians, traffic islands, or other areas within the roadway.
 - b. Temporary signs must not be placed in parking spaces, pedestrian pathways, or bicycle paths. Residential zones.
 - c. Temporary signs placed in the right-of-way must have the permission for such placement of the abutting property owner, resident, or respective agent. For purposes of this section, the public right-of-way shall mean that portion of the public right-of-way located next to a street between the roadway and the adjacent private property open to the public for general pedestrian passage, including the buffer/planting strip.
- F. Temporary signs may be placed on property residentially zoned in accordance with the requirements of this Section and the following:
1. Freestanding signs (includes post-mounted, stake and portable signs).
 - a. Single-family zones: Temporary free-standing signs shall not exceed four (4) square feet in size and five (5) feet in height, if the sign is post mounted on the ground, and not to exceed three (3) feet in height if the sign is stake-mounted or portable.

- b. Multi-family zones: Temporary free-standing signs shall not exceed six (6) square feet in size and five (5) feet in height if the sign is post mounted on the ground, and not to exceed three (3) feet in height if the sign is stake-mounted or portable.
 - 2. Surface-mounted signs. Limited to sites two (2) acres or larger:
 - a. Size. No larger than thirty-two (32) square feet.
 - b. Location. Must be flatly affixed to walls below the fascia or parapet line, or flatly affixed to on-site fences either facing or abutting the street, or facing inward to the subject site. Signs shall not be attached or tethered to other site improvements.
- G. Non-residential zones. Temporary signs are allowed on non-residentially zoned property in accordance with the requirements of this Section and the following:
 - 1. Freestanding signs (including post-mounted, stake and portable signs): Size/height. Limited to four (4) square feet and five (5) feet in height if the temporary sign is mounted in the ground, and not to exceed three (3) feet in height if the temporary sign is portable.
 - 2. Surface-mounted signs:
 - a. Size. Limited to thirty-two (32) square feet.
 - b. Location. Must be flatly affixed to walls below the fascia or parapet line, or flatly affixed to on-site fences either facing the abutting street, or facing inward to the subject site. Signs shall not be attached or tethered to other site improvements.

Section 23. That there is adopted a new section 17C.240.245 to chapter 17C.240 of the Spokane Municipal Code to read as follows:

Section 17C.240.245 Sandwich Board Signs

- A. Sandwich board signs shall be limited to one sign per address. These signs are subject to the following conditions:
 - 1. Size.

The area of the sign shall not exceed nine square feet per side in size and shall not exceed three feet in any dimension.
 - 2. Maintenance Standards.

Signs shall be constructed out of materials able to withstand typical northwest weather. Such materials may be metal, finished wood, chalkboard, whiteboard, or plastic; signs and copy shall be of professional quality. Owners of sandwich board signs shall be required to keep their signs in a legible, intact, and well-maintained manner.
 - 3. Display Time.

Signs may only be displayed during business or event hours. If business or event hours continue past daylight hours, precautions should be taken to place the sign in a location where it is readily visible after dark. This shall not be construed to allow the wiring of a sign for lighting.
 - 4. Location.

Signs may be located no further than twelve feet from the business, sponsoring establishment, or event location. Such signs shall not be placed in a location which is within the vision triangle or any location which will impede vehicular traffic. Further, such signs shall not be placed in a manner which will block or otherwise obstruct the safe use of sidewalks, building entrances or stairs by pedestrians, including pedestrians who are visually impaired or otherwise handicapped.

Section 24. That there is adopted a new section 17C.240.246 to chapter 17C.240 of the Spokane Municipal Code to read as follows:

Section 17C.240.246 Community Banners

A. Community Banners.

Such signs may be permitted and extend into the public right-of-way by permission of the city administrator or appointed representative. Such signs may only be placed at City-designated locations provided that the banner:

1. is not commercial advertising but, rather, has as its principal purpose the promotion of a civic event, public service announcement, holiday decoration, or similar community interests;
2. complies with all applicable codes and officially adopted city policies; and
3. does not, in the judgment of the street director, present a traffic hazard.

Section 25. That there is adopted a new section 17C.240.247 to chapter 17C.240 of the Spokane Municipal Code to read as follows:

Section 17C.240.247 Electronic Message Center Signs

A. Electronic Message Center Signs.

Electronic message center signs are permitted subject to the limitations in Table 17C.240-4.

Table 17C240-4 Electronic Message Center Sign Features							
Zoning Category	Maximum Allowed Sign Size by Zoning Designation: Freestanding/Wall	Electronic Message Center Sign Size	Hours of Operation	Brightness	Timing	Content	Signs Using Video Display Methods Permitted?
<u>CC4</u>	<u>Wall: 15 sq. ft.</u> <u>Freestanding: 15 sq. ft.</u>	<u>Not Allowed</u>					
<u>All Residential & CA4</u>	<u>Residential Use: 15 sq. ft.</u> <u>Institutional Use: Wall: 50 sq. ft.</u> <u>Freestanding: 50 sq. ft.</u>	<u>Not allowed for residential use.</u> <u>Not greater than 50% of the allowed sign size for institutional uses.</u>	<u>Shall be turned off between the hours of 10 pm and 6 am</u>	<u>[1]</u>	<u>[2][3]</u>	<u>On premises advertising only</u>	<u>No</u>
<u>CC1, CA1 & CA2</u>	<u>Wall: 50 sq. ft.</u> <u>Freestanding: 50 sq. ft.</u>	<u>No greater than 50% maximum total allowable sign area</u>	<u>Not Limited</u>	<u>[1]</u>	<u>[2][3]</u>	<u>On premises advertising only</u>	<u>No</u>
<u>O, OR, NR [4], NMU</u>	<u>Wall: 50 sq. ft.</u> <u>Freestanding: 50 sq. ft.</u>	<u>No greater than 50% maximum total allowable sign area</u>	<u>Not Limited</u>	<u>[1]</u>	<u>[2][3]</u>	<u>On premises advertising only</u>	<u>No</u>
<u>CC2, CB, CA3</u>	<u>Wall: 100 sq. ft.</u> <u>Freestanding: 75 sq. ft.</u>	<u>No greater than 50% maximum total allowable sign area or 48 sq. feet. (the lesser of the two)</u>	<u>Not Limited</u>	<u>[1]</u>	<u>[2][3]</u>	<u>On premises advertising only</u>	<u>No</u>
<u>GC, LI, HI</u>	<u>Wall: 250 sq. ft.</u> <u>Freestanding: 250 sq. ft.</u>	<u>No greater than 50% maximum total allowable sign area or 48 sq. feet. (the lesser of the two)</u>	<u>Not Limited</u>	<u>[1]</u>	<u>[2][3]</u>	<u>On premises advertising only</u>	<u>Yes</u>
<u>DTC, DTG, DTU, DTS [5]</u>	<u>Wall: 250 sq. ft.</u> <u>Freestanding: 250 sq. ft.</u>	<u>Not Allowed</u>					

Notes:

[1] Brightness:

- Electronic message centers in all zones shall come equipped with an automatic dimming photocell, which automatically adjusts the display's brightness based on ambient light conditions.
- The brightness level in all zones shall not increase by more than 0.3 foot candles (or 3.23 lumens per square meter or lux) as measured using a foot candle meter at a pre-set distance.
- Brightness measurement process for electronic message centers shall be as follows:
 - a. At least 30 minutes past sunset, use a foot candle meter to record the ambient light reading for the area. This is done while the electronic message center is off or displaying all black copy.
 - b. The reading should be taken with the meter aimed directly at the electronic message center and measured from a distance of 100 feet.
 - c. Turn on the electronic message center to full white copy and take another reading.
 - d. If the difference between the readings is 0.3 foot candles or less, the brightness is properly adjusted.

-The owners of such signs shall include a signed letter accompanying their permit application, certifying that they will comply with the prescribed brightness limitations set by this ordinance.

[2] Timing: Electronic message centers shall display static images for not less than two seconds before transitioning to another static image. Transitions may utilize frame effects but flashing signs are prohibited.

[3] Duration: An animated sign or any portion of a sign that uses a video display method shall have a minimum duration of two seconds and a maximum duration of five seconds.

[4] NR Zone Limitation: In the NR Zone, electronic message centers are allowed only on sites that have frontage on a Minor or a Principal Arterial as designated on the Official Arterial Street Map, SMC 12.08.040.

[5] Downtown Zone Prohibition: Electronic message centers are prohibited in all downtown zones. Existing electronic message center signs are nonconforming signs and are subject to the provisions of SMC 17C.240.280

Section 26. That SMC Section 17C.240.250 is amended to read as follows:

Section 17C.240.250 Off-premises Signs

- A. No new off-premises signs may be constructed, on any site.
- B. Off-premises signs now in existence in any zone, meeting the requirements of 17C.240.280, are ~~((declared))~~ considered nonconforming uses and may remain, subject to the following restrictions:
1. A nonconforming off-premises sign may not be increased in size or elevation, relocated to another site or to a new location on the same site or expanded, enlarged, or extended in any way, including, but not limited to, the addition of advertising faces or the addition of rotating faces with movable panels designed to create additional advertising, except as provided for in the public works exception below.
 2. Public Works Exception.
~~((An existing))~~ A legal, non-conforming off-premises sign that is allowed to remain in conformance with ~~((SMC 17C.240.250(B)))~~ this section shall be allowed to be relocated if necessitated for the accomplishment of a governmental public works project. This relocation of these off-premises signs for public works projects shall be subject to the limitations in subsections (a) through ~~((e))~~f below:
 - a. No increase in square footage of ~~((outdoor advertising display))~~ off-premises sign copy shall be permitted. These signs shall be replaced at the same size they existed at immediately prior to relocation.
 - b. No additional ~~((outdoor advertising))~~ sign faces shall be added.
 - c. No increase in height of the existing ~~((outdoor advertising display))~~ off-premises sign shall be permitted except where needed to provide for minimum height clearance (from the ground to the bottom of the off-premises signs) to comply with roadway safety.
 - d. The ~~((outdoor advertising display))~~ off-premises sign shall be relocated along the same roadway it was removed from in the geographical vicinity and shall comply with the Scenic Vistas Act of 1971 (chapter 47.42 RCW and chapter 468-66 WAC) if located along a state highway. For purposes of this provision, the term "roadway" shall apply to both directions of a couplet.
 - e. The off-premise sign shall not be relocated to a site with a Residential, Neighborhood Retail, or Center and Corridor zoning designation including CA zones, or located within an historic district, regardless of the zoning or district of the original sign location.
 - ~~((e-))~~f. The relocation of the ~~((outdoor advertising))~~ off-premises sign shall be subject to all current City of Spokane rules, regulations, and procedures relating to the regulation and control of ~~((off-premises))~~ signs~~((-))~~, excepting size, height, and off premise advertising limitations.

3. A nonconforming off-premises sign may not be structurally altered. Structural alterations mean alterations to, including replacement of, either the off-premises sign face, or the supporting structure. Normal maintenance and repair including painting, cleaning, or replacing damaged parts of the off-premises sign, shall not be considered a structural alteration.
4. Any nonconforming off-premises sign which deteriorates, is damaged or destroyed by fire, explosion, wind, act of nature, failure to maintain or other accidental means may be restored if the cost thereof does not exceed fifty percent of its replacement cost. Off-premises signs damaged in an amount in excess of fifty percent of replacement cost shall be removed.
5. All nonconforming off-premises signs shall be kept in good repair and maintained in a neat, clean, attractive and safe condition. Any work required to repair or maintain an off-premises sign shall be completed promptly so long as the off-premises sign is not structurally altered, and so long as the cost of such repair and/or maintenance does not exceed fifty percent of the cost of replacing the off-premise sign.

Section 27. That SMC Section 17C.240.260 is amended to read as follows:

Section 17C.240.260 Additional Standards for Specific Uses

A. Bed and Breakfast Facilities.

Sites with bed and breakfast facilities must meet the sign regulations for household living.

~~(B. Temporary Activities.~~

~~Permanent signs associated with temporary activities are prohibited. All signs associated with a temporary activity must be removed when the activity ends.))~~

B. Home Occupations.

Sites with home occupations must meet the sign regulations for household living.

Section 28. That SMC Section 17C.240.270 is amended to read as follows:

Section 17C.240.270 Additional Standards in ~~((Overlay Zones))~~ Shoreline Districts

A. General Shoreline Regulations.

1. In addition to any restrictions and conditions in this chapter, signs in the shoreline jurisdiction are subject to special regulations as set forth in SMC 17C.240.270(A) through SMC 17C.240.270(D). These special regulations address general shoreline sign requirements and those that are specific to shoreline districts as generally represented on the shoreline districts map.
2. The following regulations apply in all shoreline districts:
 - a. No sign may front directly on the watercourse.
 - b. No sign may be located on the water side of a street parallel and adjacent to the watercourse or any place where it would impair a vista or visual access to the water.
 - c. Off-premises signs, permanent banners and roof signs are not allowed.

d. In the shoreline natural environment or those areas identified under ~~((SMC 17E.060.630))~~ SMC 17E.060.020, Natural Land Forms, all signs may be prohibited at the discretion of the director, with exceptions made for wayfinding or interpretative signs giving directions to viewpoints or trails and signs describing special flora, fauna, or historical or cultural features.

e. Directional and interpretive signs accessory to park uses shall be allowed within the shoreline buffer and may not exceed an area of twelve square feet or a height of nine feet.

~~((f. Directional signs may not exceed an area of twelve square feet or a height of nine feet.))~~

f. Pursuant to ~~((SMC 17E.060.290(R)))~~ SMC 17E.060.280(R), required access signs that indicate the public's right of access and hours of access shall be installed and maintained by the property owner and shall not exceed an area of twelve square feet or a height of nine feet.

g. Pre-existing signs are governed by the nonconforming use provisions of SMC 17C.240.280.

B. Upriver District.

1. Signs must be flat against the building or a variation of a flat sign, such as a "V" sign, and may not project more than eighteen inches into a required yard or public right-of-way.
2. No sign may exceed thirty-five feet in height above average grade along the front of the building.
3. Signs are subject to maximum area limitations based on lineal frontage and building size as follows:
 - a. One square foot of sign area is allowed for every lineal foot of street frontage, to a maximum sign area of twenty square feet.
 - b. On corner lots, additional signs up to one-half square foot in area are permitted for each lineal foot of frontage on the side street, to a maximum of twenty square feet of sign area.
 - c. The maximum sign area for a building over two stories is ten percent of the building facade on the principal street, to a maximum of sixty square feet.
4. Signs may be directly, internally, or indirectly illuminated but not animated, flashing, or rotating.
5. The illumination of a sign may not exceed the equivalent of:

- a. eight hundred MA fluorescent lamps spaced on twelve-inch centers penetrating a three-sixteenths inch white Plexiglas facing, or
- b. sixty MA neon tubing in an individual letter with no more than three tubes per letter.

C. Downtown and Campus Districts.

- 1. Signs must be flat against the building, or a variation of a flat sign such as a "V" sign, and may not project more than eighteen inches into a required yard or public right-of-way.
- 2. No sign may exceed thirty-five feet in height above average grade along the front of the building.
- 3. Signs are subject to maximum area limitations based on lineal frontage and building size as follows:
 - a. One square foot of sign area is allowed for every lineal foot of street frontage, to a maximum sign area of fifty square feet.
 - b. Additional signs may be allowed up to one-half square foot in area for each lineal foot of frontage measured along the side street, to a maximum of fifty square feet of sign area.
 - c. The maximum sign area for a building over two stories is ten percent of the area of the building facade on the principal street, up to a maximum sign area of one hundred fifty square feet.
- 4. Signs may be directly, internally, or indirectly illuminated but not animated, flashing, or rotating.
- 5. The illumination of a sign may not exceed the equivalent of:
 - a. eight hundred MA fluorescent lamps spaced on eight-inch centers penetrating a three-sixteenth inch Plexiglas facing material, or
 - b. sixty MA neon tubing in an individual letter with no more than four tubes per letter.

D. Great Gorge Park, Downriver, and Latah Creek Districts.

- 1. No sign may be illuminated, animated, flashing, or rotating.
- 2. Up to two signs of an area of six square feet or less each may be used to advertise the sale of products raised or grown on the premises.
- 3. Any Peaceful Valley commercial area is governed by regulations of the Upriver District.

Section 29. That SMC Section 17C.240.280 is amended to read as follows:

Section 17C.240.280 Nonconforming Signs

- A. Any sign legally existing prior to August 5, 2009 that does not conform in use, location, height, or size with the regulations of the zone in which such sign is located shall be considered nonconforming and may continue in such status until such time as it is removed by its owner.
- B. Regulations that Apply to All Nonconforming Signs.
1. Sign maintenance, sign repair, and changing of permanent sign faces is allowed so long as structural alterations are not made and the sign is not increased in size. In the DTS zone, for existing signs that are sixty feet or more in height, the replacement of the sign cabinet with a sign cabinet of equal or smaller sign area is permitted if the sign height is not more than the existing sign.
 2. Permanent signs and sign structures that are moved, replaced, or structurally altered must be brought into conformance with the sign regulations. However, nonconforming signs required to be moved because of public right-of-way improvements may be re-established (See SMC 17C.240.240(((C)(4)))D, Removal of Signs, and SMC 17C.240.250(B)(2), Public Works Exception.)
 3. Nonconforming temporary signs must be removed.
 4. Ownership.
The status of a nonconforming sign is not affected by changes in ownership.
 5. Change to a Conforming Sign.
A nonconforming sign may be altered to become conforming or be replaced with a conforming sign by right. Once a sign is altered to conform or is replaced with a conforming sign, the nonconforming rights for that sign are lost and a nonconforming sign may not be re-established. Unless prohibited, proposed changes that are not in conformance are subject to the adjustment process.
 6. Loss of Nonconforming Sign Status.
 - a. Discontinuance.
If there is no sign face in place on a sign structure or building wall for six continuous months, the nonconforming rights are lost and a nonconforming sign may not be re-established.
 - b. Destruction.
When a sign or sign structure is removed or intentionally destroyed, replacement signs and sign structures must comply with the current standards. However:
 - i. Repair and Maintenance.
A nonconforming sign or sign structure may be removed temporarily to perform sign maintenance or sign repair. In order to preserve the nonconforming sign status, the person removing the sign must inform the director, in writing, before the sign is removed. If the responsible party fails to inform the director, any re-erected sign will be considered a new sign.
 - ii. Unintentional Destruction.
When a sign or sign structure that has nonconforming elements is damaged or destroyed by fire, explosion, wind, act of nature, or

other accidental means, it may be rebuilt to the same size and height using the same or similar materials, so long as the cost of such repair and/or maintenance does not exceed fifty percent of the cost of replacing the non-conforming sign.

C. Documenting a Nonconforming Sign.

To document legal nonconforming status, the applicant must provide evidence to show that the sign was established prior to the effective date of this chapter or allowed when established, and that the sign has been maintained over time. If the applicant provides standard evidence from the lists below, the director will determine if the evidence is satisfactory.

1. Sign Established Before effective Date of this Chapter.

If the sign was established before the effective date of this chapter, the applicant must provide evidence to show that the sign was established before the effective date of this chapter. Standard evidence that the sign was established before the effective date of this chapter is a:

- a. building, zoning, sign, or development permit;
- b. date-stamped photograph of the sign at its current location.

2. Sign Maintained Over Time.

The applicant must provide evidence to show that the sign has been maintained over time. Standard evidence that the sign has been maintained over time is:

- a. utility bills;
- b. sign-specific property or income tax records;
- c. business licenses;
- d. listings in telephone, business, or Polk directories;
- e. advertisements in dated publications;
- f. building, sign, land use, or development permits; or
- g. records of sign lease agreements;
- h. tax returns or schedules.

Section 30. That SMC Section 17C.240.290 entitled "Bonus Allowance for Outstanding Design" is repealed.

Section 31. That SMC Section 17C.240.300 entitled "Construction Provisions and Traffic Engineer Review" is repealed.

Section 32. That there is adopted a new section 17C.240.310 to chapter 17C.240 of the Spokane Municipal Code to read as follows:

Section 17C.240.310 Exceptions

- A. Approval Required. An exception may be granted from the strict application of the regulations in this Chapter which apply to: (a) sign placement on a parcel or building frontage; (b) sign area; or (3) sign height, as regulated in this Chapter. An exception may not be granted to allow any prohibited signs or prohibited sign features, as described in Section 17C.240.070, or for any other purpose not listed in this subsection. The exception procedure in this Section does not apply to any street Right-of-Way Use permit or Building permit.
- B. Need for Sign Permit, Consolidation of Processing. An application for an exception may be submitted before or concurrent with the associated sign permit application. No sign permit application requiring an exception for issuance will be processed without a sign exception application unless the applicant specifically requests that the application be processed without an exception.
- C. Review Procedures. The following steps shall be followed in the processing of sign exception applications:
 - 1. Determination of Complete Application (Section 17G.060.090)
 - 2. Notice of Decision (Section 17G.060.190)
 - 3. Appeals (Section 17G.060.210)
- D. Application Requirements. A complete sign exception application shall consist of the following:
 - 1. Application form. A completed sign exception application, including the applicant's name, address, phone number and e-mail address. If the applicant is not the property owner, then the property owner must be identified and the application must include an affidavit from the property owner, verifying that the property owner has given permission to the applicant for the submission of the sign exception application and for the installation/posting of the sign on the property owner's property.
 - 2. Sign Permit Application (all of the materials required by Section 17C.240.080 Sign Permit required). However, the applicant may submit an exception application without a sign permit application as provided in subsection B above.
 - 3. A narrative report which describes the requested exception in detail. The report shall identify all of the sections of this Chapter from which the applicant is requesting the exception, as well as the nature and extent of the exception (in size, area, location on the property, height).
 - 4. The narrative report shall also include the applicant's description of the manner in which the sign exception satisfies all of the exception criteria in subsection E below.
 - 5. Fees. Payment of the appropriate sign exception application fee.
- E. Exception Criteria for Approval. Sign exception applications shall be reviewed by the planning director to determine whether all of the following criteria are satisfied. In order to approve any sign exception, the director must make written findings to show that all of the following criteria have been met:
 - 1. The request for an exception is due to unusual conditions pertaining to sign visibility needs for a specific building or lot; and
 - 2. The sign will not create a hazard; and

3. The sign will not violate any state statute or any City Code provision (other than the ones identified in this Chapter relating to signs); and
 4. The sign will not negatively affect adjacent property; and
 5. The sign will be in keeping with the general character of the surrounding area and the granting of the exception would not result in an alteration of the essential character of the surrounding area; and
 6. The proposed exception is consistent with the purposes and intent of the Zoning Code and the purposes of this Chapter; and
 7. The exception is consistent with the City's Comprehensive Plan; and
 8. The applicant has established that there are practical difficulties in complying with the provision(s) of this Chapter and that the proposed sign is a reasonable use of the property. (Economic considerations alone do not constitute practical difficulties.); and
 9. The plight of the applicant is due to circumstances unique to the property, which were not created by the applicant or landowner; and
 10. The exception will not permit any sign type or use that is not allowed in the zoning district where the affected land is located, nor will it allow any sign or sign feature prohibited under Section 17C.240.070.
- F. **First Amendment Exception.** Where an applicant can demonstrate that the strict application of the regulations in this Chapter would violate his/her First Amendment rights, the City may grant an exception that does not conform to all of the exception criteria in subsection E above. However, the applicant shall submit an application which provides his/her response to each of the exception criteria in subsection E. The City need not make findings that all of the exception criteria have been satisfied, but if not all criteria have not been satisfied, the exception may only be granted to the extent reasonably necessary to protect the applicant's First Amendment rights. If a First Amendment exception is granted, it shall be treated as an approval of an exception for purposes of this Chapter.
- G. **Notice of Final Decision.** A Notice of Decision incorporating the decision on the exception application shall issue not more than 120 days after issuance of the Determination of Complete Application.
- H. **Expiration of Exception.** If the exception is approved, the sign identified in the exception must be installed within 180 days or the exception will expire. No sign may be erected if there is no sign permit for the sign, or if the exception or the sign permit has expired, even if the applicant has received associated building permits or street Right-of-Way Use permits, and the latter have not expired.

Section 32. Severability Clause. If a section, subsection, paragraph, sentence, clause, or phrase of this Ordinance is declared unconstitutional or invalid for any reason, the decision shall not affect the validity of the remaining portions of this Ordinance.

ADOPTED BY THE CITY COUNCIL ON January 29, 2018

(Delivered to the Mayor on the 5th day of February 2018

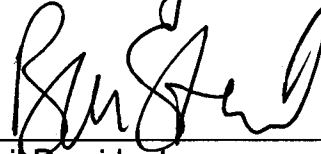

Council President

Attest:



City Clerk

Approved as to form:



Assistant City Attorney

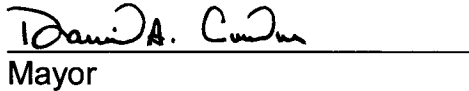

Mayor

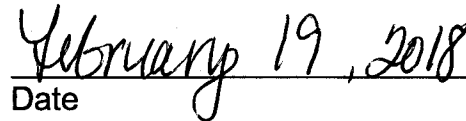

Date



Effective Date

Returned after Mayoral Signature Deadline
Returned: 02-19-2018

