



**City of Tacoma**

**Tacoma**

Environmental Services Department

# **Side Sewer and Sanitary Sewer Availability Manual**

**January 2016**

City of Tacoma  
Environmental Services Department  
326 East D Street  
Tacoma, WA 98421-1801  
(253) 591-5588

## PREFACE

This manual describes the City's policies and procedures for new and existing side sewer connections to the City wastewater sewer system. It provides a reference source for design engineers, developers, property owners and City staff.

The Side Sewer and Sanitary Sewer Availability Manual is organized in the following manner:

- **Chapter 1** – Fee and permit requirements, available financial programs, and frequently asked questions
- **Chapter 2** – How to determine sewer availability and sewer extension requirements for applicants inside and outside of the City limits
- **Chapter 3** – Criteria for the construction and inspection of gravity side sewer connections, including trenchless technologies for side sewer rehabilitation or replacement
- **Chapter 4** – Design requirements for low-pressure pump systems
- **Chapter 5** – Design requirements for pretreatment devices
- **Chapter 6** – Maintenance responsibilities and easement agreements
- **Appendix A** – Sewer availability examples for parcels inside City limits
- **Appendix B** – Troubleshooting common sewer problems

A glossary of terms and acronyms is provided at the back of the manual. The purpose of this manual is to provide a set of standards that:

- Describe the conditions that make the City's public sanitary sewer system available to parcels.
- Reduce the potential for inflow and infiltration into the City's public sewers.
- Ensure that property owners receive a well-functioning, long-lasting side sewer.

City staff will use this manual to make uniform decisions in accordance with the City's policies and procedures for all things related to side sewers and connecting to the public sewer.

This manual is intended to cover the majority of situations that may be encountered with side sewers and public sanitary sewer service. Inevitably, there will be issues that the manual does not address, or that may require exceptions to the standards provided in this manual.

The information provided in this manual may be subject to updates and revisions, with the Environmental Services Director's approval, as new technologies and products emerge and/or policies and procedures are changed. The most current manual can be found on the City of Tacoma website at: [www.cityoftacoma.org/sidesewer](http://www.cityoftacoma.org/sidesewer).

© Copyright 2016 City of Tacoma

All rights reserved. This manual is intended for the sole use of City of Tacoma employees and their designees. Any unauthorized use or distribution of this manual or dispersal of its content is prohibited. This manual may not be reproduced in whole or in part without written permission from the City of Tacoma, Environmental Services Department.

# TABLE OF CONTENTS

PREFACE .....	P-1
Chapter 1 General Information .....	1-1
1.1 Manual Overview .....	1-1
1.2 Assessment and Connection Charges .....	1-2
1.2.1 Local Improvement District Charge (LID) .....	1-2
1.2.2 Connection Charge-in-lieu-of Assessment .....	1-2
1.2.3 Right-of-Way Construction Permit .....	1-2
1.3 Side Sewer Permits .....	1-2
1.4 Financial Programs.....	1-3
A. Septic System Amnesty Program.....	1-3
B. Environmental Services Sewer Conservation Loan Program .....	1-3
1.5 Frequently Asked Questions.....	1-3
Chapter 2 Sanitary Sewer Availability .....	2-1
2.1 Introduction.....	2-1
2.2 Sewer Availability for Parcels Inside City Limits .....	2-1
A. General .....	2-1
B. Flowchart Notes .....	2-3
2.3 Sewer Availability for Parcels Outside City Limits.....	2-5
A. General .....	2-5
B. Flowchart Notes .....	2-7
2.4 Extending the Public Sanitary Sewer .....	2-8
A. Local Improvement District.....	2-8
B. Right-of-Way Construction Permit.....	2-9
C. Capital Improvement Program (CIP).....	2-9
2.5 Sewer Capacity Calculations for Large Developments.....	2-10
2.6 On-Site Septic Systems.....	2-10
A. Commercial Developments and Multi-Family Housing.....	2-11
B. Single-Family Residences and Duplexes.....	2-11
2.7 On-Site Sewage Holding Tanks .....	2-12
Chapter 3 Side Sewer Construction Requirements .....	3-1
3.1 Introduction.....	3-1
3.2 General Construction Requirements .....	3-1
A. Pipe Size .....	3-1
B. Pipe Slope .....	3-1
C. Pipe Materials .....	3-2
D. Pipe Cover .....	3-2
E. Cleanouts .....	3-3
F. Manufactured Bends.....	3-3
G. Bedding.....	3-3
H. Minimum Horizontal and Vertical Separation .....	3-3
I. Joining Dissimilar Pipe Materials .....	3-5
J. Connection to Public System.....	3-5

	K. Backflow Prevention .....	3-6
	L. Testing .....	3-6
	M. Abandonment of Side Sewers and Septic Tanks .....	3-6
3.3	Alternate Replacement & Rehabilitation Methods .....	3-7
	A. Television Inspection Requirements .....	3-7
	B. Pipe Bursting .....	3-8
	C. Cured-In-Place Pipe .....	3-8
3.4	Side Sewer Shoestring Services .....	3-8
3.5	Reuse of Existing Side Sewer for New Buildings .....	3-9
3.6	Shared Side Sewer Connections .....	3-10
	A. Separating Existing Shared Side Sewers .....	3-10
	B. Exceptions .....	3-10
3.7	Recreational Vehicle Waste Dump Site Connections .....	3-10
<b>Chapter 4 Private Sewage Pump Systems .....</b>		<b>4-1</b>
4.1	Introduction .....	4-1
	A. For Buildings Where Only Upper Levels Can Be Served by Gravity .....	4-1
	B. For Buildings Where No Levels Can Be Served by Gravity .....	4-1
4.2	Design Requirements .....	4-1
4.3	Design Checklist and Standard Details .....	4-1
<b>Chapter 5 Pretreatment .....</b>		<b>5-1</b>
5.1	Introduction .....	5-1
5.2	Grease Interceptor Sizing and Installation .....	5-1
	A. General .....	5-1
	B. Types of Grease Interceptors .....	5-1
	C. Interceptor Selection .....	5-2
	D. Grease Interceptor Sizing .....	5-4
	E. Exception Process for Grease Interceptors .....	5-7
5.3	Oil Water Separators .....	5-9
	A. Introduction .....	5-9
	B. Applicability .....	5-9
	C. General Requirements .....	5-9
	D. Sizing Criteria .....	5-10
	E. Installation Guidelines .....	5-12
	F. Maintenance Requirements .....	5-12
	G. Operation .....	5-13
	H. Additional Requirements for Fuel Islands .....	5-13
	I. Additional Requirements for Covered Parking .....	5-14
<b>Chapter 6 Side Sewer Maintenance Responsibility and Private Side Sewer Easement Agreements .....</b>		<b>6-1</b>
6.1	Introduction .....	6-1
6.2	Maintenance Responsibility of the City and the Property Owner .....	6-1
	A. Problem in Private Ownership .....	6-4
	B. Problem in Public Ownership .....	6-4
6.3	Private Side Sewer Easement Agreements .....	6-5

Appendix A Sewer Availability Examples for Parcels Inside City Limits .... A-1  
Appendix B Troubleshooting Common Sewer Problems ..... B-1  
Glossary ..... G-1

# CHAPTER 1 GENERAL INFORMATION

## 1.1 MANUAL OVERVIEW

This manual discusses the requirements for connecting to the City of Tacoma's public sanitary sewer system.

This manual reflects information from the Tacoma Municipal Code (TMC), International Building Code (IBC), Uniform Plumbing Code (UPC), Department of Ecology Criteria for Sewage Works Design (Orange Book), City of Tacoma Right-of-Way Design Manual, City of Tacoma Stormwater Management Manual (SWMM), and existing Interlocal and Franchise Agreements for municipal sanitary sewer service. Use of this manual will help ensure consistency in policies and procedures relating to private side sewers.

Exceptions to this manual may be requested in writing to the Environmental Services Department (Environmental Services) to allow a waiver or modification of a requirement prior to permit approval and construction. The Environmental Services Director, or approved authority, may grant an exception following a documented finding that:

- The exception is likely to be equally protective of public health, safety and welfare, the environment, and public and private property as the requirement from which an exception is sought.

OR

- There are physical circumstances or conditions affecting the parcel such that substantial reasons exist for approving the requested exception, provided the exception will not cause significant harm.

Substantial reasons include, but are not limited to, the following:

- The requirement is not technically feasible such as infeasibility due to utility conflicts, structure conflicts, and grade issues, etc.;
- An emergency situation necessitates approval of an exception;
- The requirement would cause significant harm or threat of harm to public health, safety, or welfare, to the environment, or to public and private property; and
- The strict application of these provisions would deprive the applicant of all reasonable use of the parcel of land in question.

The decision to grant an exception is at the sole discretion of the City. The Environmental Services Director, or approved authority, shall only approve an exception to the extent it is necessary. The applicant may be required to submit a report or analysis prepared by a Washington State licensed professional engineer along with the written request for an exception. Exceptions are intended to maintain a necessary flexible working relationship between the City and applicants.

The approval of an exception shall not be construed to be an approval of any violation of the City's Municipal Code or of other valid law of a governmental entity which has jurisdiction.

## **1.2 ASSESSMENT AND CONNECTION CHARGES**

Property owners are responsible for the installation costs of the adjacent public sanitary sewer serving a property prior to connection to that sewer. Side sewer permits will not be issued and parcels may not be connected to the public sewer until any outstanding connection charges have been paid. This obligation may be satisfied in one of the following ways.

### **1.2.1 Local Improvement District Charge (LID)**

If a public sanitary sewer is constructed via a local improvement district, properties are assessed for the design and construction cost of the public sewer. More information regarding LIDs is found in Section 2.4A.

### **1.2.2 Connection Charge-in-lieu-of Assessment**

If a property was not assessed through an LID and public sewer service is already available, the property owner may be required to pay a connection charge-in-lieu-of-assessment prior to connecting to the public sewer. Connection charge-in-lieu-of-assessment costs are established in Chapter 12.08.350 of the Tacoma Municipal Code (TMC). Contact the LID Office at 253-591-5522 to determine if a connection charge-in-lieu-of-assessment is due.

### **1.2.3 Right-of-Way Construction Permit**

If public sewer service is not available, property owners may pay for the design and construction costs to have the public sewer main extended. Since the design and construction costs are the full responsibility of the property owner, there is no assessment or connection charge-in-lieu-of-assessment due at the time of connection. More information regarding Right-of-Way Construction Permits is found in Section 2.4B.

## **1.3 SIDE SEWER PERMITS**

A side sewer permit is required prior to any repair or rehabilitation of existing side sewers or installation of new side sewers and private sewage pump systems. A side sewer permit fee is charged to cover the cost of inspection of the side sewer work in accordance with TMC 2.09 and TMC 10.22.

A side sewer permit shall be obtained at the Permit Intake Center located at 747 Market Street, 3rd Floor. Work within the City right-of-way shall be performed by a contractor licensed and bonded by the State of Washington to work in the City of Tacoma. The licensed and bonded contractor performing the work shall obtain the permit. If all work is to occur within private property, the property owner or contractor may obtain the permit and perform the work.

If a private sewage pump system is necessary and will be installed outside the footprint of the building it serves, a pump design and site plan shall be prepared in accordance with Chapter 4 of this manual and approved by Environmental Services prior to receiving a side sewer permit. Private sewage pump systems installed within the footprint of a building will be reviewed and permitted as part of a building permit, which is a process separate from the side sewer permitting process.

If the side sewer will be constructed or repaired on multiple parcels, an easement or other agreement must be obtained in accordance with Chapter 6 of this manual in order to construct

improvements on non-applicant owned property. City-issued permits do not give authority to work on another's property.

All work on new or existing side sewers will be inspected by a City Inspector to ensure the side sewer is constructed in accordance with all applicable City of Tacoma construction requirements. The City Inspector will create a record drawing of the side sewer work. For more information about the requirements and costs of side sewer permits, contact the Planning and Development Services permit counter at (253) 591-5030 or [tacomapermits.org/contact-us](http://tacomapermits.org/contact-us).

## **1.4 FINANCIAL PROGRAMS**

The City of Tacoma offers the following financial programs for qualified property owners to aid with the costs of connecting to the public sewer.

### **A. Septic System Amnesty Program**

As an incentive to property owners to decommission existing on-site septic systems and connect properties to the public sanitary sewer, the Septic System Amnesty Program offers a reduction in sewer LID assessment fees or charges-in-lieu-of assessment fees when decommissioning existing on-site septic systems and connecting to public sanitary sewer. Details regarding this program, including eligibility requirements, are in the Septic System Amnesty Program Policy and Procedures available by contacting the Environmental Services Billing Customer Service line at (253) 591-2100.

### **B. Environmental Services Sewer Conservation Loan Program**

The City of Tacoma offers low-interest loans to qualified homeowners and business owners for side sewer conservation projects. Project locations must be within the limits of the City of Tacoma and are for rehabilitation or reconstruction of existing side sewers only. New side sewer connections are not eligible for this program. Applicants must have good credit history with Tacoma Public Utilities. For more information on the Conservation Loan Program, contact the Community and Economic Development Department at (253) 591-5236.

## **1.5 FREQUENTLY ASKED QUESTIONS**

### **1. How do I find out if a parcel is already connected to the City public sanitary sewer system? Where is the side sewer located on the parcel?**

The City may have a side sewer permit card on record showing a sketch of the approximate side sewer alignment and location of the connection to the City sewer system. Cards are not available for every address. Permit cards are available on-line at the City's govME (Government Made Easy) website at: <http://govME.cityoftacoma.org>. For instructions on how to view and print side sewer inspection cards go to [www.cityoftacoma.org/sidesewer](http://www.cityoftacoma.org/sidesewer) and on the right side click the link to "View and Print Side Sewer Inspection Cards." In some cases, there may also be side sewer cleanouts outside of a building or in a yard area that can be used to locate the side sewer.

If there isn't a side sewer permit card on the website, you may contact the City to help you determine whether a parcel is connected to public sanitary sewer. If the City has no record of a side sewer connection, you may be eligible for a City-conducted smoke test or dye test to verify if the house is connected to the City sewer. Contact the Environmental



Services Billing Customer Service line at (253) 502-2100 to find out if you are eligible to request a smoke or dye test.

**2. If I have an on-site septic system, how can I find out where it is located on my parcel?**

The Tacoma-Pierce County Health Department (TPCHD) regulates on-site septic systems in the City of Tacoma and may have a record drawing of your on-site septic system. A copy of the record drawing is available on-line at [www.tpchd.org/environment/septic-systems](http://www.tpchd.org/environment/septic-systems), or you may request a copy at TPCHD's phone request line: (253) 798-6470.

In addition, the City may have a septic permit card on record showing a sketch of the on-site septic system; however, cards are not available for every address. To find a permit card on the City's website, follow the on-line instructions in Frequently Asked Question #1.

**3. Can I use an on-site septic system or holding tank instead of connecting to the public sanitary sewer?**

In general, all commercial developments that require a building permit and have plumbing fixtures are required to connect to the public sewer.

Single family and duplex residences may use on-site septic systems only if the sanitary sewer is not available and there are no land use actions requiring an extension of the public sanitary sewer to serve the parcel. On-site septic systems must meet all TPCHD regulations or a connection to public sanitary sewer will be required.

See Chapter 2 for more information regarding the use of on-site septic systems and holding tanks.

**4. Do I have to extend the public sanitary sewer if it isn't already adjacent to or abutting my parcel?**

If your parcel is considered to be available to the public sanitary sewer, then you may connect with a shoestring side sewer without having to extend the public sanitary sewer. If your parcel is not considered to be available to the public sanitary sewer, you may have to extend the public sanitary sewer by either a Right-of-Way Construction Permit or an LID. See Chapter 2 to determine if sewer is available to your parcel and whether a public sanitary sewer extension will be required.

**5. If I am permitted to install a shoestring side sewer, where should it go?**

The shoestring side sewer should be located within private property boundaries as much as possible including private sanitary sewer easements, if available. If it must be placed within the right-of-way, it may be constructed in any area that results in the least impact to the existing surface features and other utilities. Any impacted sidewalks, curbs, gutters, paving, etc., shall be restored in accordance with the City of Tacoma Right-of-Way Restoration Policy, once the side sewer is constructed. A property owner is required to submit a Shoestring Side Sewer Plan for review and approval prior to installing a shoestring side sewer in accordance with Section 3.4.

**6. If my parcel is located right next to the City's sanitary sewer, but I'm outside of the City of Tacoma limits, can I still connect to the City sanitary sewer?**

It depends on a number of factors. In some circumstances, parcels outside the City limits may be permitted to connect to the City's sewer system through existing Interlocal or Franchise Agreements between the City of Tacoma and the jurisdiction in which the parcel is located.

If there isn't an existing Interlocal or Franchise Agreement, you may be required to annex into the City to obtain service, or you may be required to connect to your jurisdiction's sewer system.

See Chapter 2 for more detailed information about sewer availability outside City limits.

**7. If my side sewer needs repair in the portion of pipe located in the street, who is responsible for repairing the pipe?**

The property owner is responsible for the repair of the side sewer from the building to the top of the vertical riser pipe or tee or wye at the public main as shown in Figure 6-1, even if a portion of it is located within the street or alley. The property owner is responsible for repairing any curb, gutter, sidewalk, street, and any other surface improvements damaged during repair of the side sewer in accordance with the City of Tacoma Right-of-Way Restoration Policy. See Section 6.2 for the division of maintenance responsibility between the City and the property owner.

**8. If I am remodeling or adding on to my building, can I re-use my existing side sewer?**

If you are performing a substantial remodel or addition valued at 60 percent of the building value or greater, your side sewer is required to meet new construction standards. You can perform a television inspection and pressure test of the side sewer to see if it meets current requirements. See Chapter 3 for more details regarding side sewer testing.

**9. Does the City have a list of qualified side sewer contractors?**

No, the City does not keep a list of contractors who are qualified to install or repair side sewers, but the City can verify if a contractor is licensed and bonded to perform work within the City of Tacoma right-of-way. For license verification, contact Planning and Development Services at (253) 591-5030. The City strongly recommends contacting at least three side sewer contractors for bids and references prior to selecting a contractor.

**10. Can I tie into my neighbor's side sewer instead of connecting directly to the public sewer?**

No. Shared side sewer connections are only permitted between two or more buildings that are under one ownership and located on the same parcel. See Section 3.6 for more information on shared side sewers.

**11. Can I repair a side sewer that my neighbor and I share?**

If a repair is required in the shared portion of the line, you must disconnect from the shared side sewer and construct a new separate connection to the public sewer. Repairs are permitted on the non-shared portion of the line. On a case by case basis, the City may

allow a property owner to repair the shared side sewer per the exception process detailed in Section 1.1. See Section 3.6 for more information on shared side sewers.

**12. Can I use a private sewage pump system instead of a gravity connection to the public sewer?**

Private sewage pump systems may be used instead of gravity flow when minimum side sewer slope requirements cannot be achieved, or if there are physical constraints that make a gravity connection impractical. See Section 3.2B for more information on minimum gravity side sewer slope requirements. Pump system designs shall be completed in accordance with Chapter 4.

**13. Can my side sewer cross other parcels to get to the public sewer?**

Side sewers crossing separate parcels from the one they serve should be avoided, if possible; however, sometimes they are necessary due to depth or location of the public sewer.

Whenever a side sewer crosses more than one parcel under separate ownership, a private side sewer easement agreement must be obtained. Whenever a side sewer crosses more than one parcel under the same ownership, the property owner may not assume an easement across multiple parcels. Instead, the property owner must enter into a recorded agreement with the City requiring a future private side sewer easement in the event the parcels are sold. See Chapter 6 for more information regarding these easement agreements.

**14. How much does it cost to connect to an existing public sewer?**

If a property has not been released of the sewer connection charge via an LID, a connection charge-in-lieu-of-assessment may be due. In addition, a fee must be paid to obtain a side sewer connection permit. See Sections 1.3 and 1.4 for additional information concerning these fees.

The property owner is also responsible for the cost of constructing the side sewer from the house to the public sewer.

**15. Does the City offer any funding or financing options for public sanitary sewer main extensions or side sewers?**

Financing options may be available for public sewer extensions depending on the method used to extend the public sewer. See Section 2.4 for more information regarding extending the public sewer.

The City has the following programs available to assist in funding side sewer construction or repairs:

- The Septic Amnesty Program
- The Environmental Services Sewer Conservation Loan Program

Refer to Section 1.4 for information regarding these programs.

# CHAPTER 2 SANITARY SEWER AVAILABILITY

## 2.1 INTRODUCTION

This chapter provides information on whether the public sanitary sewer is available for parcels located both inside and outside city limits.

## 2.2 SEWER AVAILABILITY FOR PARCELS INSIDE CITY LIMITS

### A. General

Public sanitary sewer service is considered available to all parcels located within City of Tacoma limits that are directly adjacent to a public sanitary sewer located in a public right-of-way or public easement. Connection to available public sewers may occur once all sewer charges are paid and permits are obtained.

All parcels not directly adjacent to the sewer shall be reviewed by Environmental Services for determination of whether a connection to public sewer will be permitted, or whether a public sanitary sewer main extension or other alternative is required in order to serve the parcel. Please contact Environmental Services at (253) 591-5588 for a sewer availability request.

The City is committed to providing public sanitary sewer service to areas within the City of Tacoma limits that are not currently served by public sanitary sewer. City staff will use a regional planning approach to ensure that the City's sanitary sewer system is expanded in a manner that provides the most efficient, cost-effective regional sewer system for all parcels in need of sewer service.

The Sewer Availability Flowchart for Inside City Limits, Figure 2-1, and the corresponding flowchart notes in Section 2.020B will be used to determine the best way to serve individual parcels, while taking into account the sanitary sewer needs of the entire region. Use of this flowchart will help ensure consistency in making sewer availability determinations.

This manual is intended to cover the majority of the situations in which sewer service is needed, and will be followed as consistently as possible. There will be circumstances in which the best way to provide sewer service to the region may not coincide with the Figure 2-1 flowchart. In this case, City staff will determine the best method for providing the region with sewer service.

This flowchart is intended for use with existing parcels that do not have prior land use actions requiring extensions of the public sanitary sewer. A connection to the public sewer will be required for all lots within a new subdivision (for both short and long plats). If public sewer is not available to the proposed plat, a public sewer extension will be required to serve the new lots.

Several examples of how sewer availability determinations will be made using this flowchart and notes are located in Appendix B.

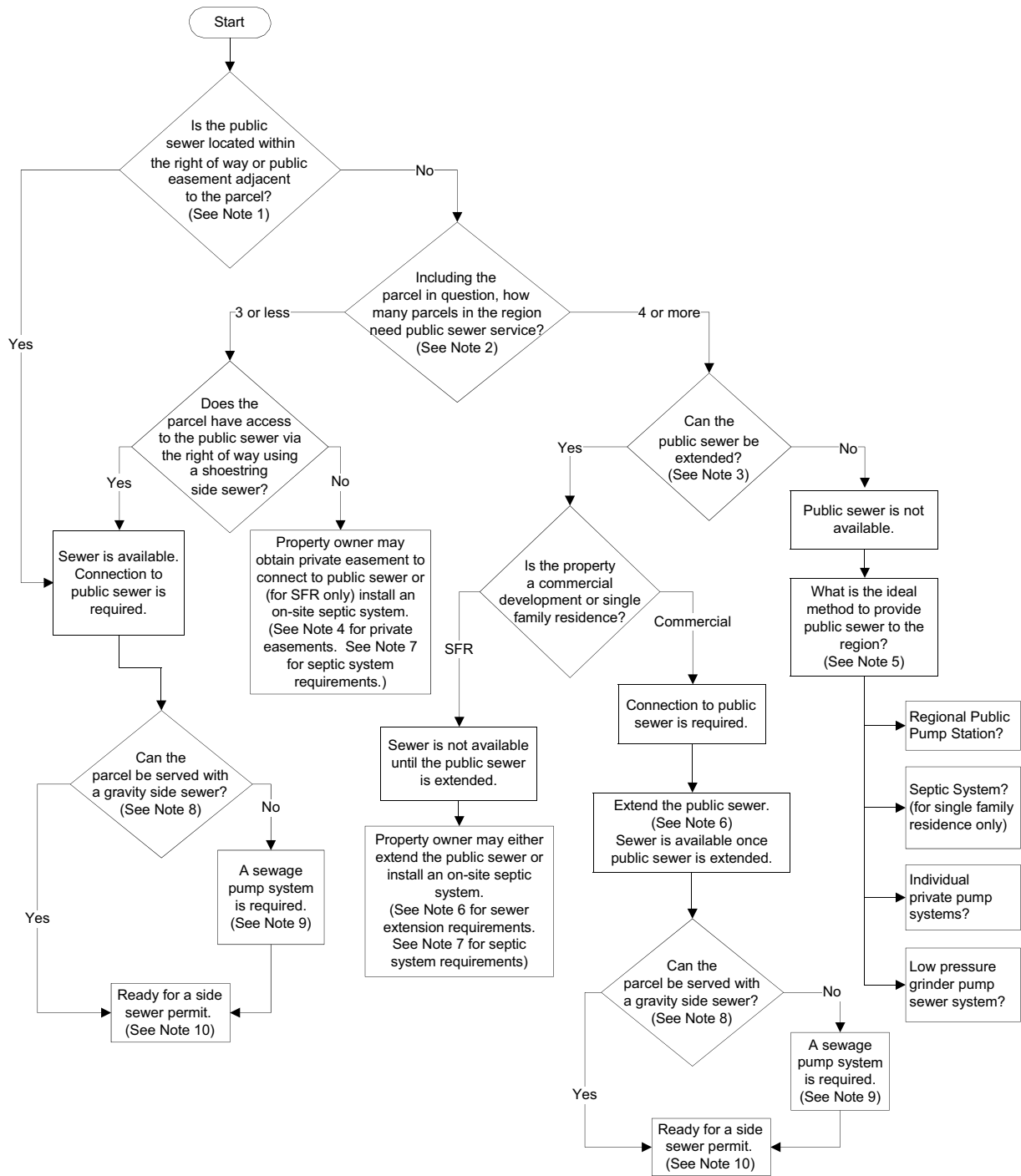

**Figure 2-1: Sewer Availability for Single Parcels Inside City Limits**

## **B. Flowchart Notes**

### ***Note #1 – Is the public sanitary sewer located within right-of-way or a public easement directly adjacent to the parcel in question?***

Public sewer service is considered available to all parcels located within City of Tacoma limits that are directly adjacent to a public sanitary sewer located in a public right-of-way or public easement. Side sewer connection permits are issued through Planning and Development Services, upon review from Environmental Services. Environmental Services review and approval is required for private side sewer pump system. See Chapter 4 for private pump system requirements. For all other parcels not adjacent to a public sewer, even those where the sewer is within 200 feet of the parcel, Environmental Services will make a determination of whether sewer is considered available in accordance with this flowchart.

### ***Note #2 – Including the property in question, how many parcels in the region need sewer service?***

Parcels that are undeveloped or have on-site septic systems will be considered in need of sewer service. Parcels large enough to be subdivided, based on current zoning requirements, will be counted as the number of potential parcels the property may be divided into if platted. For example, one 20,000 square foot parcel could possibly be subdivided into four 5,000 square foot parcels. Therefore, this one large parcel would count as four potential parcels that will need sewer service upon development.

Some publicly owned parcels and parcels considered undevelopable will not be included in the amount of parcels considered in need of sewer service. Some examples of these parcels are schools, public parks, City-owned parcels with gulches or streams, railroad right-of-way, etc.

### ***Note #3 – Can the public sanitary sewer be extended?***

Environmental Services will determine whether it is possible for the public sanitary sewer to be extended to serve the area. Available resources such as record drawings, maps, existing contours, and City of Tacoma design criteria for required depth and grades will be used to determine if the sanitary sewer can be extended. Design criteria are found in Chapter 5 of the City of Tacoma Right-of-Way Design Manual.

Sewer extensions are typically required to be constructed a minimum of 10 feet past the nearest property line of the parcel to be served. If the City determines there is a benefit to having the sewer extended, an extension may be required even if it is only extendable part of the way to the subject parcel. Longer extensions may also be required across the full length of a parcel based on the need for future extension to serve upstream areas.

### ***Note #4 – Side sewer connection through a private easement***

If a parcel is surrounded by other private parcels and has no direct access to right-of-way, the property owner may enter into a private side sewer easement agreement to install a side sewer connection through a private property to the public sanitary sewer main. Property owners are encouraged to seek legal advice when entering into private side sewer agreements.

**Note #5 – What is the ideal method to provide sewer to the region?**

Since the public sewer cannot be extended to serve the site and there is a significant need for sewer service for the region, alternative solutions will need to be examined on a case-by-case basis. Some alternative solutions might be:

- Regional public pump station – Constructed via a Right-of-Way Construction Permit, local improvement district, or city capital improvement project
- On-site septic system – For single-family residences (SFR) only
- Individual private pump systems and force mains – Designed and constructed under the Right-of-Way Construction Permit process
- Low pressure grinder pump sewer system (individual private pumps with a public force main serving many parcels) – Designed and constructed under the Right-of-Way Construction Permit process

**Note #6 – Extend the sewer**

The property owner shall extend the public sanitary sewer main prior to connecting to the sewer. There are several programs available for extending the public sewer. These are the Right-of-Way Construction Permit Process, Local Improvement District (LID) Program, and Capital Improvement Project (CIP) Program. These programs are described in more detail in Section 2.4.

**Note #7 – On-Site Septic System Requirements for SFRs only**

When a public sanitary sewer main extension is required, a property owner may elect to either extend the public sewer using one of the methods listed in Note #6, or may choose to install an on-site septic system until the sewer main is extended in the future. On-site septic systems are regulated through the Tacoma-Pierce County Health Department and shall meet all health department requirements. Refer to Section 2.6 for On-Site Septic System Requirements.

On-site septic systems are not permitted for commercial developments, including apartment complexes.

On-site septic systems are not allowed for new development within Flood Hazard Areas and Coastal High Hazard Areas per TMC 2.12.040 C.3. Maps of the Flood Hazard Areas and Coastal High Hazard Areas can be found on the govME web site or by contacting Community and Economic Development Department at (253) 591-5364.

**Note #8 – Can the parcel be served with a gravity side sewer?**

It is the property owner's responsibility to determine if the minimum gravity side sewer slope requirement specified in Section 3.2B can be achieved. The property owner shall take into account site grades, finished floor elevations, depth of the sewer main, potential utility conflicts, etc.

**Note #9 – A sewage pump system is required**

The property owner is required to install a private sewage pump system. See Chapter 4 for information on design and construction requirements for private sewage pump systems.

**Note #10 – Ready for a side sewer permit**

Once it is determined the public sewer is available to a parcel, the property owner may proceed with paying any connection charges that may be due and obtain a side sewer permit in accordance with Section 1.2 to connect to the sewer.

**2.3 SEWER AVAILABILITY FOR PARCELS OUTSIDE CITY LIMITS**

**A. General**

All parcels not located within the City of Tacoma limits shall be reviewed by Environmental Services for determination of whether public sewer service can be provided by the City. Before the adoption of the Growth Management Act (GMA) in 1990, areas outside the City limits were provided with sewer service through Interlocal and Franchise Agreements with neighboring jurisdictions. In accordance with the GMA, and to encourage annexation of areas identified as being within the City's Urban Growth Area, the City will no longer enter into new Interlocal or Franchise Agreements to provide unincorporated areas outside the City with sewer service.

Existing Interlocal and Franchise Agreements are still in effect. Parcels within existing Interlocal or Franchise Agreement areas may receive service in accordance with those agreements. Each existing agreement has an expiration date, with optional renewals by mutual agreement with both parties. Renewals will be considered on a case-by-case basis when their expiration date is imminent.

For details about existing Interlocal and Franchise Agreements and to request sewer availability determinations for parcels located outside City of Tacoma limits, contact Environmental Services at (253) 591-5588.

The Sewer Availability Flowchart for Outside City Limits, Figure 2-2, and the corresponding flowchart notes in Section 2.3B will be used to determine if sewer service can be made available to a parcel located outside the City of Tacoma limits.



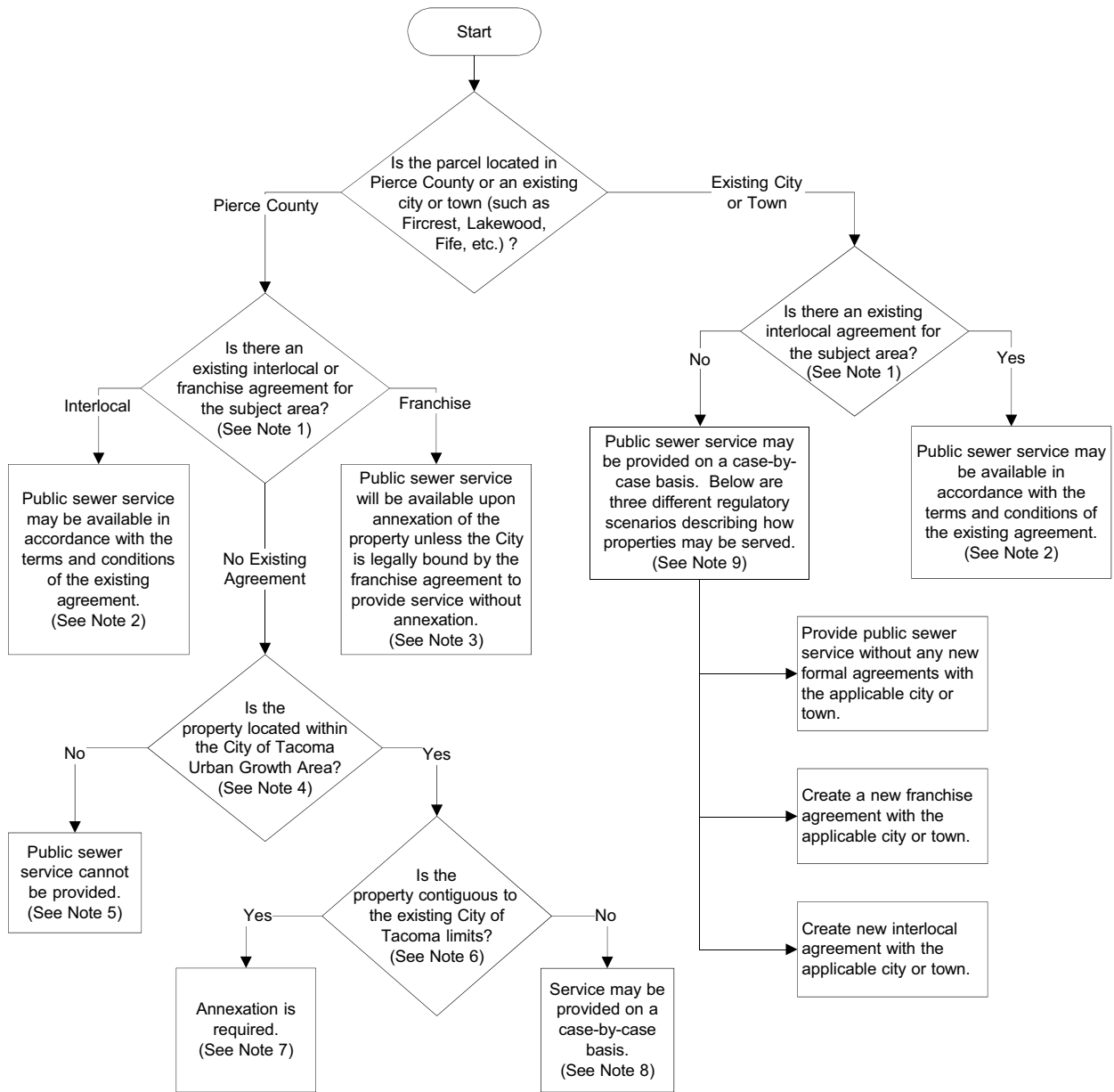

**Figure 2-2: Sewer Availability Flowchart for Outside City Limits**

## **B. Flowchart Notes**

### ***Note #1 – Is there an existing Interlocal Agreement or Franchise Agreement for the subject area?***

Environmental Services will contact the Wastewater Billing Customer Service Section to determine if there is an existing agreement for the subject area.

### ***Note #2 – Within Interlocal Agreement Area***

Sewer service may be available in accordance with the terms and conditions of the existing agreement. All new sewer connections shall meet the City of Tacoma standards in effect at the time of connection.

### ***Note #3 – Within Franchise Agreement Area***

If the City is legally bound by the Franchise Agreement to provide sewer service, the parcel may be connected to the public sewer in accordance with the terms and conditions of the existing agreement. If the City is not legally bound to serve the parcel and the parcel is contiguous to the City of Tacoma limits, service will be available upon annexation of the parcel. Public sanitary sewers constructed under Franchise Agreements are owned and maintained by the City of Tacoma but are located outside of City limits within easements granted to the City of Tacoma.

### ***Note #4 – Is the parcel located within the City of Tacoma Urban Growth Area?***

Environmental Services will contact the Community and Economic Development Department to determine if the parcel is located within the Urban Growth Area.

### ***Note #5 – Sewer service cannot be provided***

In accordance with the Growth Management Act, the City cannot provide sanitary sewer service to parcels located outside the Urban Growth Area.

### ***Note #6 – Is the parcel contiguous to the existing City of Tacoma limits?***

Environmental Services will determine if the parcel shares a common boundary with the City of Tacoma.

### ***Note #7 – Annexation is required***

The parcel shall be annexed into the City of Tacoma in order to receive City of Tacoma sewer service. Upon annexation, sewer service will be available in accordance with Section 2.2.

### ***Note #8 – Service may be provided on a case-by-case basis***

Parcels may not be annexed into the City of Tacoma unless they are contiguous to the City of Tacoma limits. Service may be provided to large areas distant from the City limits within the Urban Growth Area and upon agreement with Pierce County. These areas will be evaluated on a case-by-case basis by Environmental Services. This is only applicable to large areas and is not intended for individual residences, small developments, or sparsely populated areas.

**Note #9 – Service may be provided on a case-by-case basis**

Service may be provided to nearby incorporated areas (such as Federal Way, University Place, Lakewood, etc.) on a case-by-case basis. In some cities, Pierce County has jurisdiction to receive and treat sewage generated from those cities. In these circumstances, approval from Pierce County is required before the City of Tacoma can provide sewer service to parcels within the other city. Environmental Services will determine whether sewer service can be provided. Some examples of how the City of Tacoma may provide sewer service to other incorporated areas are as follows:

- *Provide service without any new formal agreements with the other city or town:* Sewers would be constructed by the project proponent in privately owned streets within easements granted to the City of Tacoma by the neighborhood association. The City of Tacoma would accept ownership and maintenance responsibilities of the sewer system and the parcels served would be direct customers to the City of Tacoma. No Interlocal or Franchise Agreement would be required. This is the preferred option by the City of Tacoma.
- *Create a new Franchise Agreement with the applicable city or town:* Sewers would be constructed by the project proponent in the public streets of the applicable city or town. The City of Tacoma would accept ownership and maintenance responsibilities of the sewer system and the parcels served would be direct customers to the City of Tacoma. The City of Tacoma would enter into a Franchise Agreement with the applicable city or town to allow the sewers to be located within their rights-of-way.
- *Create a new Interlocal Agreement with the applicable city or town:* The City of Tacoma would enter into an Interlocal Agreement with the other city or town. Sewers would be constructed by the project proponent and/or the applicable city or town located within their right-of-way and would be owned and maintained by the other city or town. Their system would connect to the City of Tacoma sewer system. The parcels served would be sewer customers of that city or town unless negotiated otherwise. The other city or town would then pay service fees to the City of Tacoma in accordance with the new agreement to pay for transmission and sewage treatment costs.

**2.4 EXTENDING THE PUBLIC SANITARY SEWER**

If a property owner is required to extend the public sanitary sewer prior to being permitted to connect to the sewer, the following methods are available for extending the sewer.

**A. Local Improvement District**

Forming a Local Improvement District to construct a public sanitary sewer allows all the property owners who will benefit from the public sewer to work together to have the sewer constructed and share in the costs of the sewer construction. To form an LID, a property owner must circulate an advisory survey prepared by City staff amongst the area to obtain neighborhood support. An LID may, by City policy, be formed when the majority of the property owners involved are in favor of forming the LID.

Once an LID is formed, the City will design the new public sewer, solicit a contractor through the public bidding process, and administer the construction of the new sewer. Property owners

will be responsible for paying the City their proportionate share of the costs of the sewer design and construction. This is called an LID assessment. Property owners may pay their assessment as one lump sum payment or may finance the assessment through the City with a low-interest loan over a set period of time. The City also offers an LID Assistance Program intended to provide assistance to property owners on a low or fixed income. A sewer extension through this process may take up to two years from the time the advisory petition is returned to the City to the time sewer construction begins. For more information regarding the LID process, contact the Site Development Group at 253-591-5760.

## **B. Right-of-Way Construction Permit**

This process allows a property owner to hire a Washington State licensed professional engineer to design the public sewer in accordance with all City of Tacoma design requirements, and to hire a contractor to construct the sewer. The property owner is required to obtain a Right-of-Way Construction Permit in accordance with Section 1.2C. This process may be used by a single property owner or by multiple property owners who will benefit from the use of this sewer who can then share in the costs of designing and constructing the sewer.

Public sanitary sewer extensions constructed through the Right-of-Way Construction Permit process will be required to pay the City for time and materials associated with design plan review and inspections in accordance with TMC 10.22. Engineering design and construction are performed by private consultants and contractors arranged by the applicant under private contracts. Prior to the issuance of a Right-of-Way Construction Permit, the permit applicant shall deliver to the City a performance bond whose sum is equal to the value of the work to be performed but, in any event, not less than \$15,000. For more information regarding the Right-of-Way Construction Permit process, contact the Site Development Group at (253) 591-5760.

To receive credit for extending the public wastewater sewer system, thereby not having the parcel subject to a charge-in-lieu-of assessment fee, the applicant will be required to complete and return an application provided by the LID office and provide a copy of the record drawing of the public wastewater sewer main constructed.

Prior to submitting for a work order, the applicant may want to investigate the potential for participating in the City's "Latecomer" agreement process per TMC 12.08.700.

## **C. Capital Improvement Program (CIP)**

The City prefers that all new sewers are constructed through an LID or Right-of-Way Construction Permit. However, there may be circumstances where sewer extensions are necessary for existing developments due to public health concerns, but the neighborhood will not support an LID or property owners are not able to fund the cost of the sewer design and construction through a Right of Way Construction Permit.

In these circumstances, the City may be able to design and construct the public sanitary sewer as a capital improvement project by hired contractors or by city work crews. In this situation, the City will fund the design and construction of the new public sewer. Actual costs for designing and constructing the new public sewer will be recuperated from the benefiting property owners through a connection charge-in-lieu-of assessment fee at the time they connect to the public sewer. This charge must be paid in full prior to the issuance of a side sewer connection permit and is not eligible for the City's low-interest loan program.

The CIP is intended to serve previously developed areas which are currently using on-site septic systems. This program is not intended to provide new sewer service for undeveloped areas of the City. This method of constructing new sewers may take up to a year or more, depending on yearly budgeting and other project priorities. For more information regarding public sewer extensions through the City's Capital Improvement Program, contact Environmental Services at (253) 591-5588.

## **2.5 SEWER CAPACITY CALCULATIONS FOR LARGE DEVELOPMENTS**

A new development or redevelopment will be classified as large if the proposed wastewater flow will be equal to or greater than 10 percent of the capacity of the public sanitary sewer system serving the development or if the wastewater flow generated from the development is equivalent to that generated by a 100 unit residential development. Environmental Services will determine the capacity of the public sewer system based upon the size, material, service area, slope of the pipe and proximity to existing pump stations and trunk lines. If a project is classified as large, the developer shall submit peak daily wastewater flow calculations prepared by a Washington State licensed professional engineer. Peak daily flows shall be calculated based on full site build-out in accordance with the Washington State Department of Ecology Criteria for Sewage Works Design (Orange Book). All associated calculations and references used in determining the estimated wastewater flow shall be submitted to Environmental Services for review and approval.

The City may also require that peak daily flow calculations are submitted for projects that ultimately discharge to a City-owned pump station to ensure the pump station has capacity for the proposed discharges.

Environmental Services will determine if the public sanitary sewer collection system, including pipes and pump stations, has enough capacity to accommodate the new peak flows in addition to upstream peak flows for fully developed conditions. If the public collection system does not have enough capacity to accommodate the proposed large development or redevelopment, the developer will be required to upsize the public collection system prior to sewer connection. Upsizing the public collection system shall be accomplished through the Right-of-Way Construction Permit process described in Section 2.4B.

## **2.6 ON-SITE SEPTIC SYSTEMS**

On-site septic systems (septic systems) are reviewed, permitted, and inspected by the Tacoma-Pierce County Health Department (TPCHD). The TPCHD will not permit new septic systems or allow repairs to existing septic systems in City of Tacoma limits without written approval from the City. The City will provide approval per the requirements listed below. All new septic systems and repairs to existing septic systems must be able to comply with all current TPCHD design requirements.

Septic systems are not allowed for new construction with Flood Hazard Areas and Coastal High Hazard Areas per TMC 2.12.040 C.3.

For more information regarding septic system permits, contact the Tacoma-Pierce County Health Department at (253) 798-6470.

## **A. Commercial Developments and Multi-Family Housing**

### **1. Existing On-Site Septic Systems**

If an existing commercial development has a prior approved on-site septic system that fails or is in need of repair and public sewer service is available, a connection to the public sewer is required.

If the wastewater generated from the site includes anything other than domestic wastewater, a connection to the public sewer is required, regardless of whether public sewer is available to the site. This may require an extension of the public sewer.

If commercial developments on existing on-site septic systems are not available to public sewer and all waste generated is from domestic use, repairs to the on-site septic system may be permitted upon approval from the TPCHD.

### **2. New On-Site Septic Systems**

All new commercial developments, including multi-family housing, shall be directly connected to the public sewer. On-site septic systems will not be permitted for new commercial developments.

## **B. Single-Family Residences and Duplexes**

Property owners are encouraged to connect all single-family residences and duplexes to the public sanitary sewer system. This may require an extension of the public sanitary sewer main to serve the parcel.

### **1. Existing On-Site Septic Systems**

If an existing single family residence or duplex has a prior approved on-site septic system that fails or is in need of repair that requires a permit from the TPCHD, a connection to the public sewer is required if public sewer is available. If sewer is not available, the property owner may consider extending the public sewer main to serve the site or may repair the septic system upon approval from TPCHD.

### **2. New On-Site Septic Systems**

An on-site septic system may be constructed for a new single-family residence or duplex if all the following conditions are met:

- Sewer service is not available to the parcel per Section 2.2;
- There is no existing or proposed land use action requiring an extension of the public sanitary sewer;
- The parcel is not located within a Flood Hazard Area or Coastal High Hazard Area per TMC 2.12.040 C.3; and
- The TPCHD has granted approval for construction of the on-site septic system.

If the parcel is part of a plat, short plat, or any other land use action requiring an extension of the public sanitary sewer, the parcel may not be developed until the public sanitary sewer is constructed and available to the new parcels.

## **2.7 ON-SITE SEWAGE HOLDING TANKS**

All permanent structures that have indoor plumbing facilities, including showers and sinks, and all food trucks or food stands that are located at one site for more than 24-hours shall be connected to the public sanitary sewer. On-site sewage holding tanks not connected to the public sanitary sewer are not permitted, unless otherwise permitted by the TPCHD.

Sewage holding tanks may be used for mobile espresso carts and food stands provided the carts and stands are stored within a building when not in use. The storage building shall be connected to the public sanitary sewer and have adequate facilities for discharging the holding tanks into the building's waste plumbing. Discharge of wastewater to any outside ground surfaces, including stormwater catch basins, is prohibited.

## CHAPTER 3 SIDE SEWER CONSTRUCTION REQUIREMENTS

### 3.1 INTRODUCTION

All new, rehabilitated, and repaired side sewers shall conform to the requirements stated in this chapter. A City of Tacoma permit is required for all repairs, rehabilitation, or construction of new side sewers.

For construction requirements for public sanitary sewer pipes, refer to the most recent version of the City of Tacoma Right-of-Way Design Manual. This manual is available on-line at the City's website at: [www.govme.org](http://www.govme.org) under *City Information*.

### 3.2 GENERAL CONSTRUCTION REQUIREMENTS

Per Tacoma Municipal Code Chapter 12.08.030, no stormwater, groundwater, subsurface drainage, yard drainage, roof drainage, or unpolluted water shall be connected to or discharged into the public sanitary sewer system.

#### A. Pipe Size

Side sewers shall be a minimum of 6 inches in diameter for commercial properties and 4 inches in diameter for residential properties or designed in accordance with the Uniform Plumbing Code Section 717.0 based on the number and type of plumbing fixtures within the building. The side sewer pipe size shall be equal to or greater than the size of the building drain. Downsizing of pipe materials in the direction of flow is not permitted.

Exception: Incremental decreases in internal diameter of pipe due to a change in pipe materials or Cured-In-Place Pipe lining are acceptable.

#### B. Pipe Slope

The minimum standard slope for a side sewer is 2%, with the following exceptions:

- When it is not possible to meet the 2% slope requirement due to the depth of the public sewer or other structural features, a minimum of a 1% slope may be permitted with approval from Environmental Services. When the 2% slope cannot be achieved, effort shall be made to achieve the greatest slope possible greater than 1%. Private sewage pump systems will be required when a 1% slope cannot be achieved. Additional information regarding pump systems is located in Chapter 4.
- For commercial sites that cannot meet the 2% slope requirement due to the depth of the public sewer or other structural features, a Washington State licensed professional engineer may prepare flow and velocity calculations to determine the minimum slope required to achieve a minimum scouring velocity of 2 feet per second. The calculations shall be performed in accordance with the Uniform Plumbing Code Section 708.0 or the Washington State Department of Ecology Criteria for Sewage Works Design (Orange Book) and shall be reviewed by the City.



Side sewers not meeting the minimum 2% slope requirement shall be bedded in accordance with City of Tacoma Standard Plan SU-16 per Section G. The maximum slope for side sewers is two feet vertical per one foot horizontal (200%). Vertical risers are not permitted.

**C. Pipe Materials**

Table 3.1 lists approved pipe materials for both gravity and pressure applications and specifies applicable standards for the material. Other pipe materials of equal or better standard ratings will be considered if proper material certification documents are submitted.

**Table 3.1: Acceptable Pipe Materials**

Gravity		Pressure	
Material	Standard	Material	Standard
PVC, SDR 35	ASTM D3034	PVC Schedule 40	ASTM D 1785 ASTM D 2466
ABS Composite	AASHTO M 264 ASTM D 2751	ABS Composite	AASHTO M 264 ASTM D 1527
Cured-In-Place Pipe (CIPP)	ASTM F 1216 ASTM F 1743 ANSI-NSF 14	HDPE, SDR 17	ASTM D 3350
PVC C900	AWWA C900	PVC C900	AWWA C900
HDPE, SDR 17	ASTM D 3350		
Vitrified Clay	ASTM C700, Extra Strength, WSDOT 9-05.8		

**D. Pipe Cover**

The minimum pipe cover shall be in accordance with the pipe manufacturer’s recommendations or not less than 18 inches for gravity and pressure side sewers, whichever is greater. Side sewers located in driving areas shall have a minimum cover of 3 feet. Pipe cover may be reduced to 18 inches if the pipe is designed to meet H20 traffic loading and engineering justification is submitted to the City. Ductile iron pipe and C-900 PVC pipe meet the H20 traffic loading requirements for cover depths between 18 inches and 3 feet.

Side sewers shall have a minimum of 5 feet of cover at the right-of-way line unless the depth of the public sewer main limits the depth of the side sewer. Side sewers may need to be constructed with a cover greater than 5 feet at the right-of-way line to allow for gravity sewer service depending on topography or to accommodate basements.

When side sewers are constructed at the same time as the public sewer which serves the side sewers, side sewer stub-outs shall be constructed 5 feet into the private property beyond the right-of-way limits, the easement, or the common utility trench, where applicable. During construction, the location of the stub shall be marked with a white 2x4 stake with the depth to the stub indicated on the stake. A locating wire shall be provided to extend from the stub to the stake at ground level. The locating wire shall not be attached to the stake.

## **E. Cleanouts**

Cleanouts are required at the following locations:

- Approximately two feet from the building at the change from building drain to side sewer;
- Every 135 degrees of total bend including horizontal and vertical;
- Every 100 feet of pipe run;
- Every change of pipe size;
- At the transition from a pressure line to a gravity line;
- At the property line; and
- As needed for testing requirements per Section 3.2L.

All cleanouts shall be extended to grade unless an approved cover is provided over the cleanout. Cleanouts in the right-of-way shall be constructed in accordance with City of Tacoma Standard Plan SU-24 and shall have an approved casting installed above the cleanout for protection.

## **F. Manufactured Bends**

Ninety degree bends are not permitted. Change in direction of more than 45 degrees shall be installed with multiple lesser bends. The side sewer shall be constructed using the least practical number of bends necessary to serve the building. Bends shall be manufactured fittings. A bend shall not be created by bending the straight pipe beyond the manufacturer's stated allowable deflection. It is recommended that adjacent fittings be spanned by a minimum two foot length of straight pipe.

## **G. Bedding**

All side sewer pipes in the right-of-way shall be bedded in accordance with City of Tacoma Standard Plan SU-16.

Portions of side sewers constructed on private property shall be laid on a firm bed throughout the entire length, and any such piping to be laid in fill material shall be bedded in approved materials and adequately compacted to support the pipe. All side sewers on private property that are constructed at less than 2% slope shall be bedded in accordance with City of Tacoma Standard Plan SU-16.

## **H. Minimum Horizontal and Vertical Separation**

All side sewers shall be constructed with the minimum separation between the side sewer and the structures/objects as listed in Table 3.2.

A minimum of 18 inches vertical separation should be maintained between all gravity sanitary sewers and potable water lines and storm sewer main lines (see Figure 3-1). Casings or pressure-rated pipe materials may be required when side sewers cross over water mains.

**Table 3.2 Minimum Horizontal Separation**

Buildings or Structures <sup>1</sup>	2 feet
Property Lines Adjacent to Other Private Property	2 feet
Water Supply Wells	50 feet
Streams <sup>3</sup>	50 feet
On-site Domestic Water Service Line <sup>2</sup>	10 feet
Public Water Main <sup>2</sup>	10 feet
Public Storm Main and Catch Basin Leads	5 feet

- 1 If the side sewer is within 2 feet of or underneath a building or structure, it is considered a building drain and must meet the UPC code requirements as such.
- 2 A minimum of 10 feet horizontal separation and 18 inches vertical separation should be maintained between all gravity sanitary sewers and potable water lines (see Figure 3-1). Gravity sanitary sewer lines not meeting the minimum separation requirements and all pressurized sanitary sewer lines shall be designed in accordance with the Department of Ecology's Criteria for Sewage Works Design, Section C1-9. The distance between utilities shall be measured from edge of pipe to edge of pipe. Any variances to this require the approval of Tacoma Water and Environmental Services.
- 3 Additional requirements may apply in critical areas. Refer to Tacoma Municipal Code 13.11.

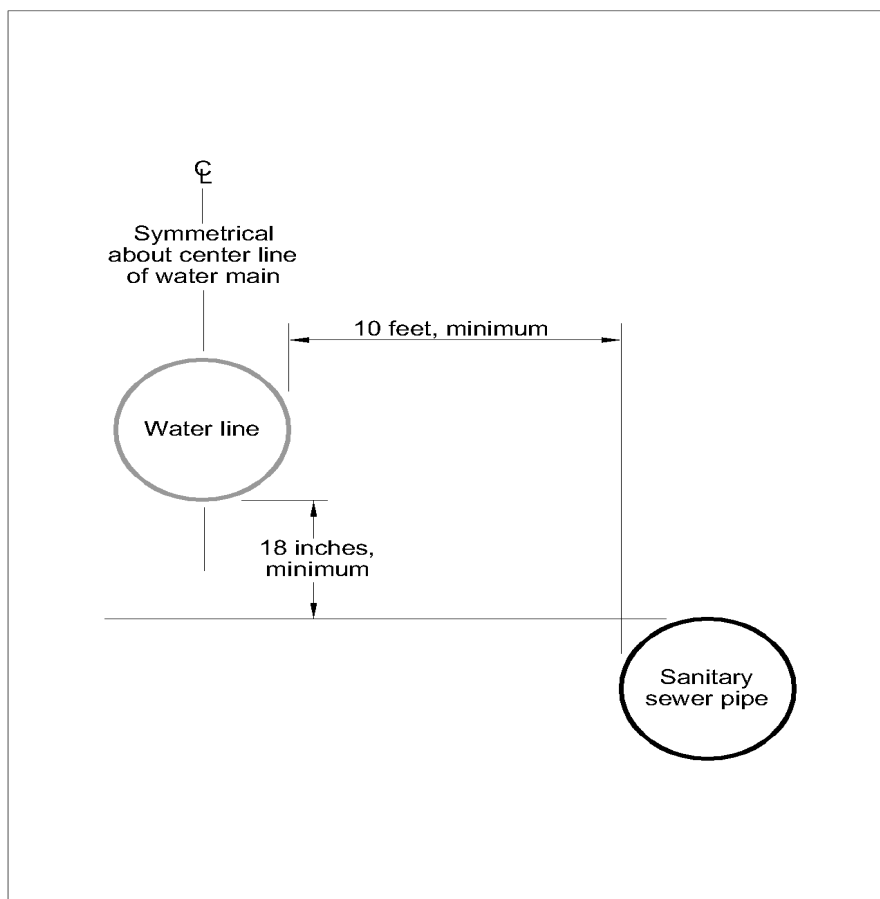

**Figure 3-1: Minimum Separation**

## **I. Joining Dissimilar Pipe Materials**

When a repair is made to a portion of the existing side sewer and the old and new pipe materials differ, the connection between the dissimilar materials shall be made with a Fernco™ watertight coupling, Romac™ watertight coupling, or approved equal. Bell donuts are not acceptable.

Connections between ABS and PVC gravity pipes may also be made using solvent cement meeting ASTM D 3138 specifically intended for non-pressure transitions between PVC and ABS.

## **J. Connection to Public System**

All connections to a public sewer shall be made at a tee, wye, or vertical riser where they exist. If there are no tees, wyes, or vertical risers, the connection shall be made by machine-made tap and mechanical saddle in accordance with City of Tacoma Standard Plan SU-23. A minimum of 3 feet of separation shall be provided between adjacent side sewer connections and a minimum of 10 feet separation shall be provided between side sewers and manholes. A minimum of 5 feet separation will be allowed between side sewers and dead-end manholes.

If the public wastewater sewer pipe has been lined with a cured-in-place pipe liner or sliplined with a new liner pipe, the exterior host pipe shall be removed from the full circumference of the liner pipe and the connection shall be made directly to the liner in accordance with City of Tacoma Standard Plan SU-23. The contractor shall repair the bedding for the public sewer in accordance with City of Tacoma Standard Plan SU-16.

If the side sewer is 8-inch diameter or greater, a manhole shall be constructed at the point of connection. Manholes constructed on pipes 12-inch diameter or greater shall be a saddle manhole base (cast-in-place) constructed per Standard Plan SU-20.

All new connections shall cross the right-of-way as close to perpendicular as possible to the public sanitary sewer main.

Side sewer connections shall be made to the public sanitary sewer main that is located within the right-of-way or easement area within the frontage limits of the premises being served, unless prior written approval is received from Environmental Services. In rare circumstances, it may be necessary to construct outside the frontage limits in order to receive gravity service.

Connections to manholes are not permitted without prior approval from Environmental Services. In the event a public sanitary sewer main will not be extended in the future, no more than 2 side sewers may be connected to a dead-end manhole.

Where connecting side sewers that are equal to or less than 6-inch diameter to a manhole, the connection shall be provided at the shelf of the manhole. Where connecting side sewers that are 8-inch diameter or larger to a manhole, the connection shall be made such that the crown of all pipes are at the same elevation or the 0.8 depth point of all sewers are at the same elevation. Drop connections into manhole are not allowed unless otherwise approved in writing by Environmental Services.

## **K. Backflow Prevention**

Where a plumbing fixture is installed at a lower elevation than the next upstream manhole cover of the public or private sewer serving such plumbing fixture, all plumbing fixtures on the building floor shall be protected from backflow of sewage by installation of a backwater valve. Plumbing fixtures on higher floor levels above the elevation of the next upstream manhole cover should not discharge through the backwater valve. The backflow preventer shall be located in an area that is easily accessible for inspection and maintenance.

## **L. Testing**

Testing of side sewers shall be performed in all new side sewer installations, all repaired portions of existing side sewers, and as otherwise specified throughout this manual. Side sewers shall be tested to ensure the side sewer is watertight. The test may consist of either a static water test with not less than 10 feet of head pressure or an air pressure test able to hold 3.5 pounds per square inch (psi). All tests shall be performed in the presence of a City inspector.

For new and repaired side sewers, the test shall be performed prior to backfilling. A cleanout shall be provided at the farthest downstream end of the new side sewer construction to allow an access point for plugging to accomplish the air or water test.

For testing existing side sewers for re-use, it may be necessary to install a cleanout if one does not exist to allow an access point for plugging to accomplish the test. Following testing, the cleanout shall be brought to the surface with a watertight removable cap and a cleanout casting to protect the pipe and cap in accordance with City of Tacoma Standard Plan SU-24. Cleanouts within the roadway and alleys shall be capped and left below grade.

## **M. Abandonment of Side Sewers and Septic Tanks**

Every abandoned side sewer, or part thereof, that will not be reused shall be plugged or capped at the public sanitary sewer main to eliminate the potential for infiltration of groundwater and dirt into the public sanitary sewer system via the abandoned side sewer. The side sewer shall be abandoned in the presence of City inspector.

All septic tanks that are no longer in use shall be decommissioned in accordance with WAC 246-272A by:

- Having the septage removed by a certified pumping company;
- Removing or destroying the lid;
- Filling the void with dirt, sand, gravel, or other approved material; and
- Certifying the abandonment of the septic tank to the Tacoma-Pierce County Health Department via a septic tank decommissioning certificate.

Contact the Tacoma-Pierce County Health Department at (253) 798-6470 for more information on abandoning septic tanks.

### **3.3 ALTERNATE REPLACEMENT & REHABILITATION METHODS**

In addition to traditional open-cut trenching to replace side sewers, alternative methods for replacing or rehabilitating existing side sewers may be used. These methods must be approved by the City prior to use and all documentation submitted per the requirements listed below.

Pipe bursting or Cured-in-Place Pipe (CIPP) lining technologies are approved for use in the City of Tacoma if the existing side sewers meet the criteria listed below. Each of these technologies has limitations preventing its use in some situations. This list is not intended to prevent the use of any alternate construction method. Approval for alternative construction methods other than pipe bursting or CIPP lining shall be submitted in writing to the Site Development Group for review and approval prior to use.

#### **A. Television Inspection Requirements**

Television inspections are required prior to the approval of pipe bursting and CIPP lining.

The inspection may be conducted in the field in the presence of the City inspector for on-site approval. To schedule an on-site video inspection, contact the City inspector at 253-591-5760 with a minimum 24-hour notice. The inspection shall be recorded to CD, DVD, or USB flash drive and provided to the City inspector immediately following the inspection.

Alternately, video inspections may be recorded without the City Inspector present and submitted to the Permit Intake Center for review. The video shall meet the following requirements:

- The video is of a quality that adequately shows the condition of the pipe and any bends, tees, obstructions, etc. Poor quality or incomplete videos will be returned to the contractor for resubmittal.
- Color video is required.
- A view of the building, or the building address written onto a piece of paper, shall be recorded at the beginning of the video. The video shall then continuously progress into the side sewer with no stoppage of footage or splicing multiple videos together.
- If City staff determines that further review is needed, review and issuance of permit may not be completed over the counter, and up to two days may be required for review.

If the video meets all trenchless technology prerequisites, and the repair meets all other City requirements, the permit will be issued.

Pipe rehabilitation will not be approved for side sewers that do not meet the prerequisites as outlined in Section 3.3B and 3.3C for Pipe Bursting and CIPP lining, respectively.

A post-rehabilitation video inspection shall be performed in the presence of the City Inspector to determine if the rehabilitation was successful.

## **B. Pipe Bursting**

Pipe bursting of side sewers will be permitted if there are no significant grade issues (sags of more than 25% of pipe diameter in a single location) and there are no conflicts with adjacent utilities.

Prior to receiving a side sewer permit, the contractor shall locate and mark all connection points, bends, and excavations on the ground surface and shall contact Utility Locate to mark all utilities in close proximity to the side sewer.

Pipe bursting construction requirements:

- The pipe shall be SDR 17 High Density Polyethylene Pipe (HDPE).
- All joints shall be welded butt-fused joints.
- The contractor shall allow the polyethylene pipe to return to its original length and shape in the unstressed state, based on the pipe manufacturer's recommendations, prior to trimming any excess liner and making connections at each end.
- The contractor shall construct cleanouts in accordance with Section 3.2E.
- The contractor shall perform a static water or air pressure test on the newly installed pipe in accordance with Section 3.2L.

## **C. Cured-In-Place Pipe**

Lining of existing side sewers using CIPP will be permitted if there are no significant grade issues (sags of more than 25% of the pipe diameter in a single location), no bends greater than 45 degrees, no offset joints greater than 10% of the pipe diameter, and the host pipe is not out-of-round more than 25% as determined by the ratio of height to width.

Prior to receiving a side sewer permit, the contractor shall locate and mark all connection points and bends on the ground surface. The contractor shall also submit the proposed felt and resin material with the name of the manufacturer for each, the design thickness of the liner, and the manufacturer's recommended cure time. No resins shall be used that are past the manufacturer's expiration date and the materials used in the liner assembly shall be verified on-site in the presence of a City Inspector.

CIPP lining construction requirements:

- The contractor shall manufacture the CIPP (wetout procedure) in the presence of the City Inspector in accordance with manufacturer's recommendations.
- If the liner protrudes into the main, the contractor is responsible for removing the protrusion.
- After lining is complete, the contractor shall submit a field sample of the cured liner to the City Inspector.

### **3.4 SIDE SEWER SHOESTRING SERVICES**

Prior to any new installation or repair of an existing, unpermitted shoestring service, a parcel shall be reviewed for sewer availability by Environmental Services in accordance with Chapter 2.

If the sewer is considered available to the parcel via a shoestring side sewer, the side sewer contractor shall submit a shoestring side sewer plan for review to the Site Development Group prior to receiving a side sewer permit for construction of the side sewer. The plan shall include the following information:

- Address and Parcel Number;
- Contractor contact information, including fax number and email address;
- Lot boundaries drawn to scale and labeled with lot dimensions;
- North directional arrow;
- Location of all streets or alleys abutting the parcel;
- Location of proposed shoestring side sewer;
- Label length, size, slope, and pipe material of shoestring side sewer;
- Public sanitary sewer and location of connection point;
- Easement locations, if on private property;
- All surface features including trees, landscaping, mailboxes, sidewalks, driveways, light poles, curb and gutter, ditches, structures, and any other surface features located within 10 feet of each side of the proposed shoestring side sewer;
- All underground utilities including sewers, power, cable, phone, water, and any other underground utilities located within 10 feet of each side of the proposed shoestring side sewer; and
- Finished floor elevation of structure to be served.

Shoestring side sewer plans shall be submitted to the Permit Intake Center at, 747 Market Street, 3rd Floor. The Site Development Group will review and approve the exhibit for general conformance to existing and/or future permanent alignment and grade within ten business days of submittal.

Repairs to existing prior permitted shoestring services will be permitted without review for sewer availability by Environmental Services and without a requirement for a shoestring side sewer plan. A side sewer permit is required for all repairs to side sewers.

### **3.5 REUSE OF EXISTING SIDE SEWER FOR NEW BUILDINGS**

In order to reuse any portion of existing side sewers for new buildings, the side sewer shall be television inspected and pressure tested in accordance with Section 3.2L to ensure it meets the requirements of this manual. This includes any existing side sewer stubs between the main and the property line, whether previously used or not. If the side sewer is found through television inspection to have any illicit connections per TMC Section 12.08.030, the illicit connection shall be disconnected. If it cannot pass the pressure test, it shall be repaired, replaced, or rehabilitated and retested until the side sewer passes the pressure test to ensure it is water tight. Television inspections shall be reviewed by a City Inspector, and all pressure tests shall be done in the presence of a City Inspector.



### **3.6 SHARED SIDE SEWER CONNECTIONS**

New shared side sewer connections are only permitted between two or more buildings that are under common ownership and are located on the same parcel. A property owner may combine tax parcels into one parcel in order to share side sewers. In the event the parcel is divided and buildings will be separated onto individual parcels, the shared side sewer shall be reconstructed such that each new parcel has a separate side sewer connection to the public sewer.

#### **A. Separating Existing Shared Side Sewers**

If a property owner utilizing a shared side sewer system is required to perform a repair, that property owner shall disconnect from the shared side sewer and construct a new separate connection to the public sewer.

The City may permit repairs on existing shared side sewers on a case by case basis if an exception is requested per Section 1.1. Additional information may be required from property owners to determine possible options.

A side sewer easement agreement or other proof of consent to access and maintain the side sewer is required for any existing shared side sewers that remain in service. This agreement or proof of consent shall be recorded to title at the Pierce County Assessor's Office. Confirmation of the recorded document shall be submitted to the City before any permits to allow repair on a shared side sewer will be permitted. City-issued permits do not give authority to work on another's property.

#### **B. Exceptions**

Condominiums which have individual parcels for each unit, or have the potential to be platted into individual parcels for each unit, shall have separate side sewer connections for each unit to the public sewer. If the condominiums are restricted by building codes and other shared utilities from ever platting into individual parcels per each unit, a shared side sewer connection to the public sewer may be permitted for all the units within one building.

### **3.7 RECREATIONAL VEHICLE WASTE DUMP SITE CONNECTIONS**

Recreational Vehicle waste dump sites are permitted for personal, intermittent use only. Commercial waste dump sites are prohibited. Dump sites shall be constructed per Figure 3-2. The concrete slab shall be fully located on private property within 25 feet of a hose bib and the cleanout shall be connected to the side sewer serving that parcel. A reduced pressure backflow assembly shall be installed in the water supply line to the hose bib designated for use at the dump site.

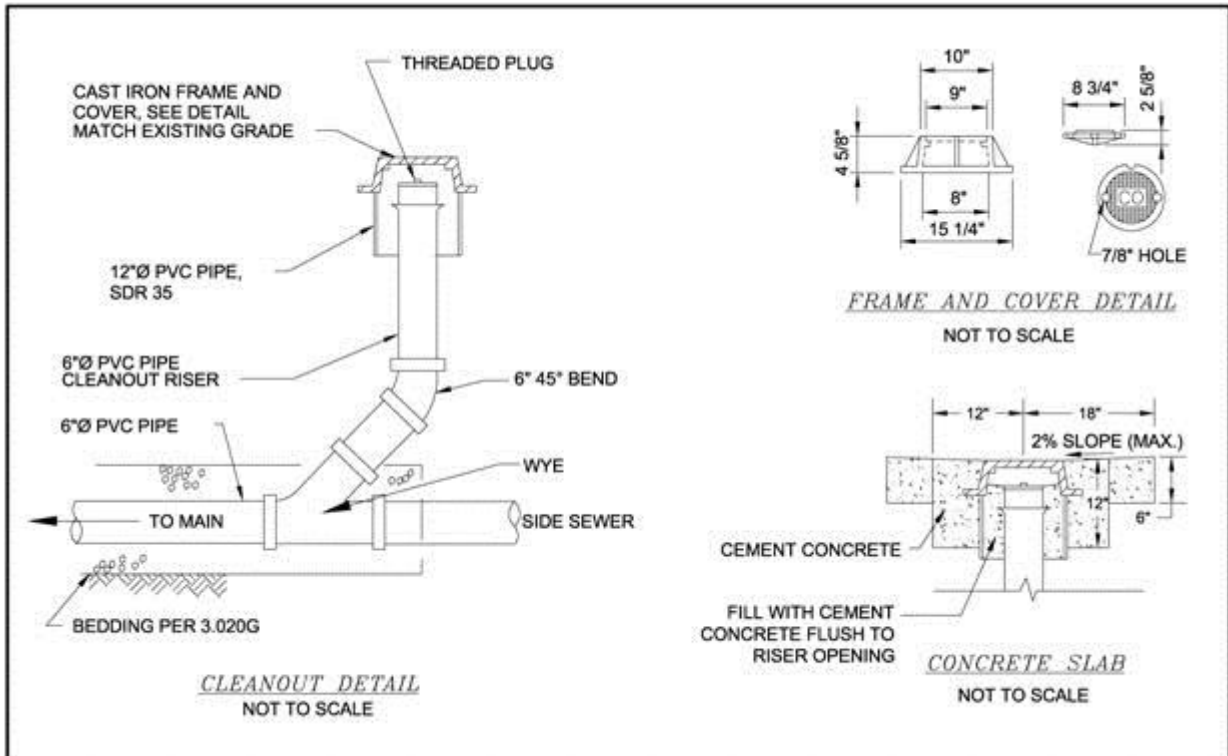

Figure 3-2: Recreational Vehicle Waste Dump Site Connection Detail

## **CHAPTER 4 PRIVATE SEWAGE PUMP SYSTEMS**

### **4.1 INTRODUCTION**

All buildings shall have a gravity connection to public sewer, meeting the minimum slope requirements of Section 3.2B, unless it is not possible due to the depth of the public sanitary sewer main or significant conflicts with existing structures or utilities.

#### **A. For Buildings Where Only Upper Levels Can Be Served by Gravity**

In some circumstances, gravity side sewer service may be possible for ground floor and upper level floors, but not basement or lower level floors within a building. If this is the case, an internal sewage pump located within the building footprint may be used to pump sewage from the lower levels to the upper level which can then be connected to the public sewer with a gravity side sewer. This option is typically less expensive for homeowners and is encouraged over external sewage pump systems located outside the building footprint. Internal sewage pumps are reviewed and permitted by Planning and Development Services. For interior pump system requirements, contact the Planning and Development Services Division at (253) 591-5030.

#### **B. For Buildings Where No Levels Can Be Served by Gravity**

If gravity sewer service is not possible from any level of a building, an exterior sewage pump system shall be used. Exterior pump systems are located below grade outside of the building and are reviewed and approved by Environmental Services. The use of private exterior sewage pump systems requires prior approval from Environmental Services. For more information regarding pump system designs or to obtain approval for use, contact Environmental Services at (253) 591-5588.

### **4.2 DESIGN REQUIREMENTS**

Exterior sewage pump systems consist of a holding tank located outside of the building that receives sewage from the building by gravity and then pumps the sewage through a small pressure side sewer. The pressurized side sewer shall transition to gravity at a cleanout located on private property.

Once approved for use, the property owner shall submit a private sewage pump system design and site plan prepared in accordance with this Chapter to the Planning and Development Services Permit Intake Center. Initial review of the design for new construction sites may take up to two weeks upon complete application. Once a design is reviewed and approved, the applicant may obtain the approved design documents and side sewer permit from the Permit Intake Center.

### **4.3 DESIGN CHECKLIST AND STANDARD DETAILS**

The following are sample standard details and a design checklist for sewage pump system design. These are intended to assist the homeowner or the homeowner's representative with preparing the design. Any designs received that do not include all of the information listed in the checklist will be returned to the applicant for completion prior to review.

# CITY OF TACOMA

## PRIVATE SEWAGE PUMP SYSTEM DESIGN CHECKLIST

*The information specified in this checklist and the sample site plan and details must be provided with the pump design submittal. Depending upon the complexity of the design, additional information not included on this checklist may be required. All questions concerning these submittal requirements should be directed to Environmental Services at (253) 591-5588.*

### **Design Requirements:**

#### Gravity and Pressure Side Sewer:

- Design and construct all portions of gravity and pressure side sewers in accordance with Chapter 3 – Side Sewer Construction Requirements.
- Provide separation between side sewers and other utilities and structures as specified in Chapter 3.

#### Pump and Holding Tank:

- Use grinder pump when head is 30 feet or greater or sewage ejector pump when head is less than 30 feet. Exception: Environment One (E-One) grinder pump or approved equivalent may be used in both conditions.
- Use waterproof seal between lid and tank.
- Provide 12" minimum between bottom of the holding tank and the pump off elevation.
- Attach 1/2-inch diameter polyethylene rope or stainless steel cable to the pump and secured to the holding tank for pump removal.
- Design the tank for H2O loading if it will be in an area subject to traffic loading.
- Provide quick disconnect of pump and power supply for removal of pump.
- Install check valve (automatic backflow prevention) upstream of disconnect coupling.
- Install gate or ball valve (manual shut off) upstream of check valve.
- Chamfer the tank bottom (1:1 fillet).
- Use waterproof non-shrinking grout around inlet and outlet pipes to seal the tank.
- Provide 12" between quick disconnect coupling and the top of the holding tank.
- Provide approximately 6" between pump on and alarm elevations.
- Design the pump system for buoyancy in accordance with tank manufacturer's recommendations.
- Provide audio visual alarm for pump failure or high volume events in the tank.

#### For Commercial Sites Only:

- Provide 24-hour flow volume backup storage capacity.
- Provide duplex pump system.
- Provide explosion proof pump system.

### **Submittal Requirements:**

#### Provide a Site Plan Showing the Following: (See Figure 4-1)

- Address and Parcel Number (from the Pierce County Assessor)
- Contact information, including fax number and e-mail address
- Lot boundaries drawn to scale and labeled with lot dimensions
- North directional arrow
- Contours or spot elevations
- Location of all streets or alleys abutting the parcel, edge of pavement, sidewalk, curb and gutter, ditches and structures

- Existing grade elevations of the lowest floor to be served
- Distances from all property lines to dwelling (the sidewalk is not the property line, but you may use it to show the distance to your dwelling)
- City sanitary sewer main location, with invert elevations of both upstream and downstream manholes
- Water service line and meter
- Easements
- Location, size, slope, and pipe material for gravity and pressure side sewers
- Location of transition from pressure line to gravity line (on private property)
- Location of all cleanouts
- Location of holding tank (minimum of 2' from structures and property lines)
- Location of control panel and audio visual alarm
- Location of vent (the building sewer vent will suffice if 24-hour storage is provided below the invert of the inlet pipe and the alarm elevation; see below "Holding Tank Detail" section).
- Include the following standard notes:
  - Contact Underground Locate ("One-Call") Service at (800) 424-5555 prior to any construction.
  - Obtain electrical permit from [www.ci.tacoma.wa.us/power/Electrical\\_Permits.htm](http://www.ci.tacoma.wa.us/power/Electrical_Permits.htm) or contact Tacoma Power at (253) 502-8277.

Provide a holding tank detail showing the following information: (See Figure 4-2)

- Depth and dimensions of tank
- Location of vent for holding tank
- Elevations of top of tank, bottom of tank, pump on, pump off, alarm elevation

Provide a side sewer connection detail with the following information: (See Figure 4-3)

- Method of transition from pressure line to gravity

Provide Manufacturers Catalog Cut Sheets and Specifications for the following:

- Pump (including pump performance curve)
- Holding Tank
- Control Panel
- Audio visual alarm

Engineering Calculations:

- System head loss calculation
- Appropriate flow rate and head characteristics plotted on pump performance curve
- Velocity calculation for the proposed diameter and type of pipe (minimum 2 ft/sec)
- Frequency and duration of pumping cycles (minimum of 2 cycles per day)
- For commercial sites only: 24 hour flow volume

Private Easement or other Agreements:

- A private easement or other agreement in accordance with Chapter 5, Pretreatment.

Provide an Operation and Maintenance Manual from the Manufacturer

- Frequency of Maintenance
- Maintenance Requirements

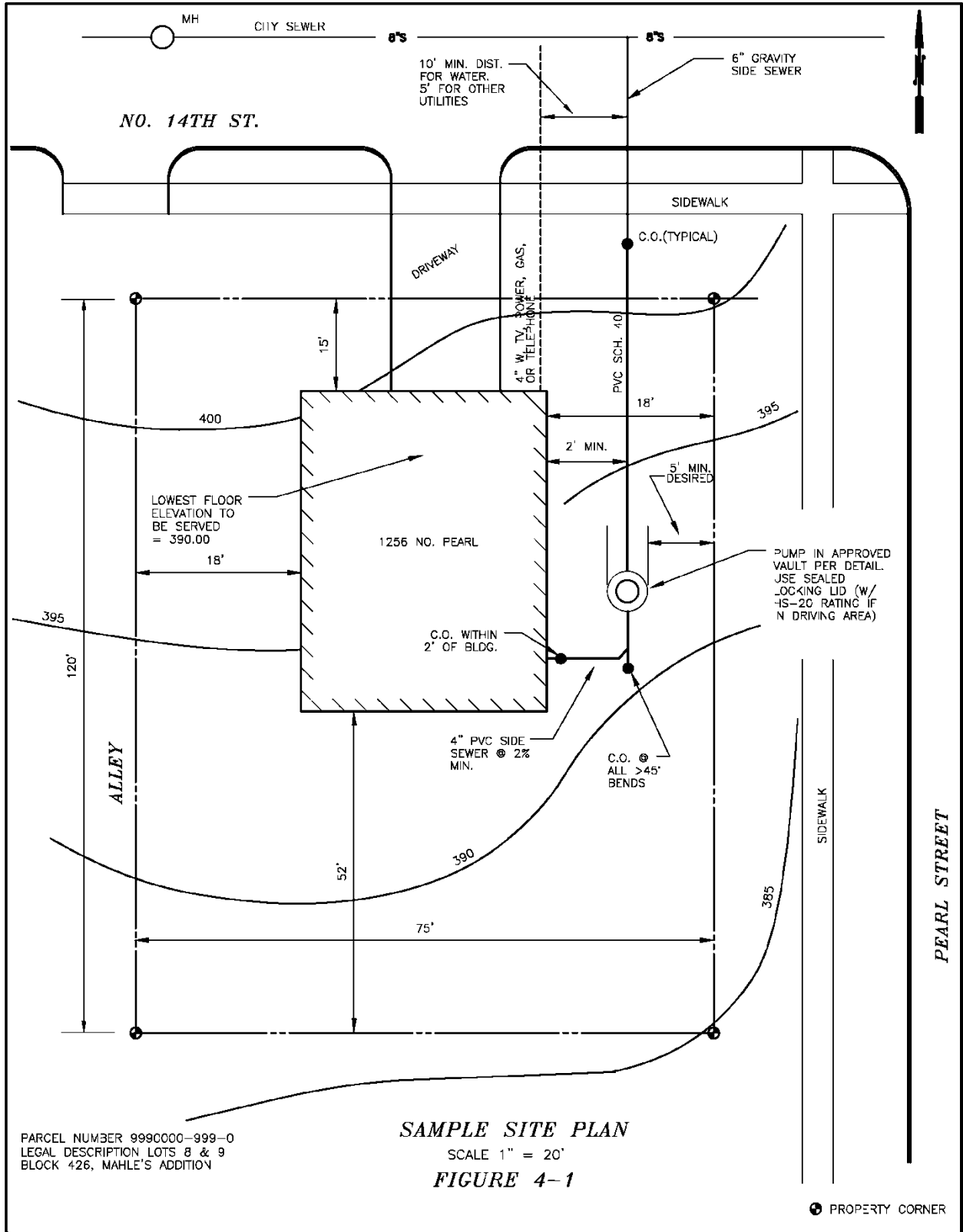
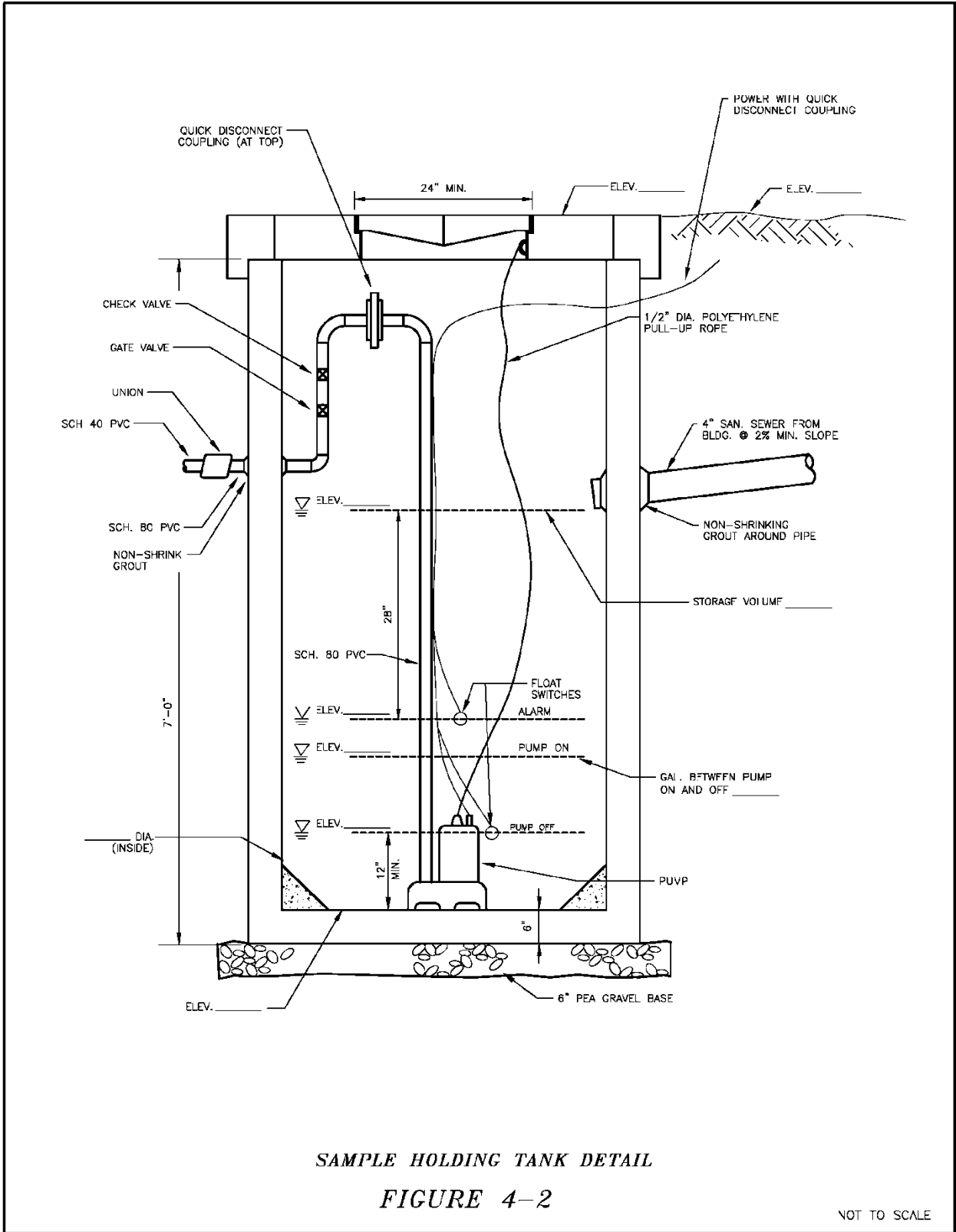
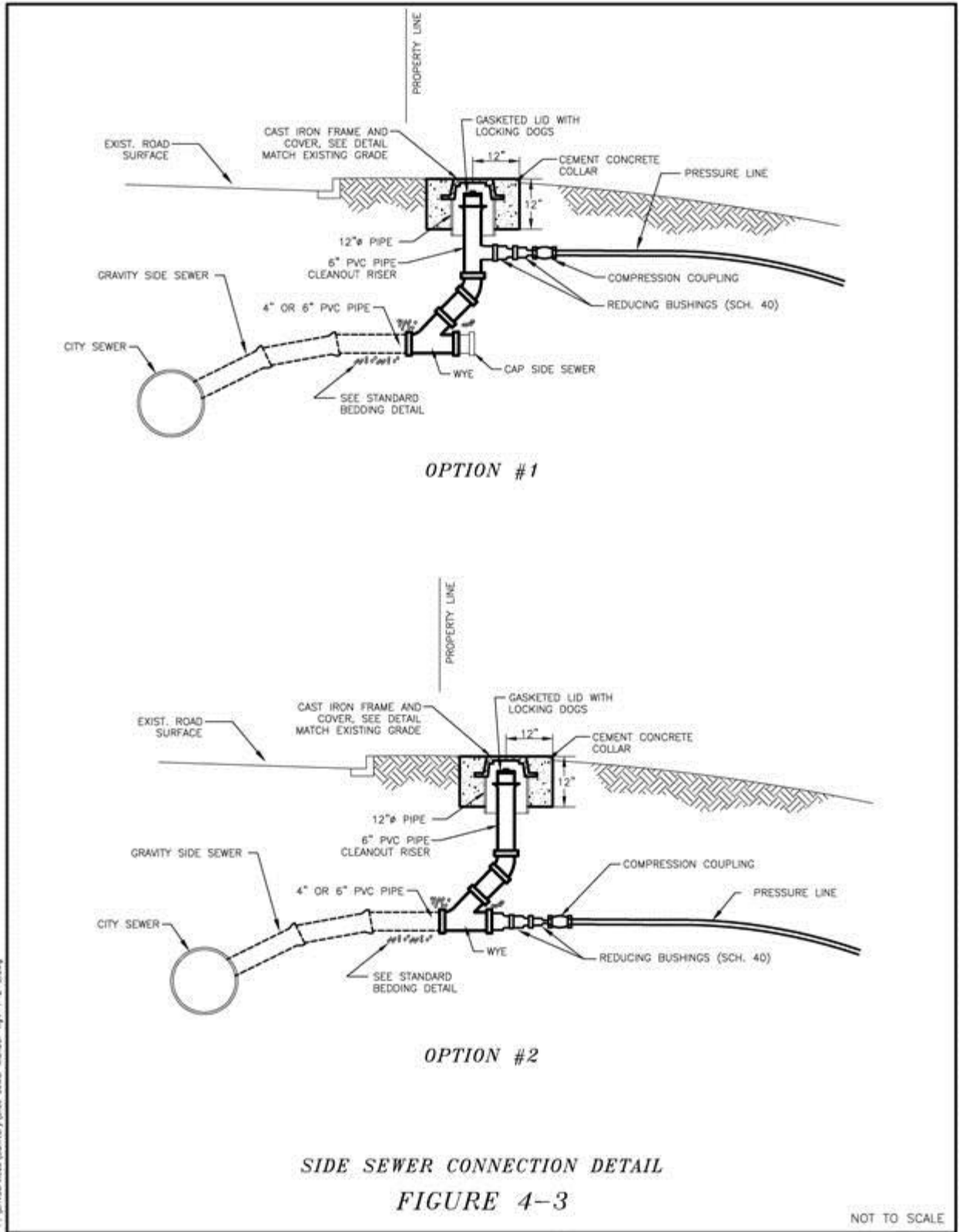

Figure 4-1: Sample Site Plan



**Figure 4-2: Sample Holding Tank Detail**



**Figure 4-3: Side Sewer Connection Detail**



# CHAPTER 5 PRETREATMENT

## 5.1 INTRODUCTION

Per TMC 12.08.020 pretreatment of wastewater is required to reduce the amount of pollutants, eliminate pollutants, or alter the nature of pollutant properties before a connection to the public sanitary sewer is allowed. This may include pretreatment to remove fats, oil, and grease, petroleum hydrocarbons and certain metals and organics. TMC 12.08 describes the pollutant discharge limitations. The following sections describe sizing and installation requirements for grease protection and oil water separators.

## 5.2 GREASE INTERCEPTOR SIZING AND INSTALLATION

### A. General

Section 5.2 provides information on the selection and installation of proper grease interceptor devices for those facilities that have the potential to discharge wastewater containing fats, oil, and grease (FOG) in quantities that may cause obstruction to the flow of wastewater or interfere with the operation of the public sanitary sewer system in violation of TMC 12.08.020 B.4. These facilities include restaurants, cafes, catering facilities, commissaries, hotels, cafeterias, convenience stores, full service grocery stores, schools, hospitals, and food manufacturing plants.

Additional equipment may be needed at certain locations to ensure proper conveyance of wastewater through the sanitary sewer system. The City of Tacoma reserves the right to modify or reduce sizing requirements on interceptors that may cause septic conditions at certain facilities. The City of Tacoma reserves the right to consider alternatives to the standards found in this chapter on a case by case basis.

Grease interceptors are installed on “gray” water drain lines and are designed to remove FOG from wastewater. FOG wastes must be regularly removed or pumped out of the interceptor. The maintenance frequency will vary for each facility; see the City of Tacoma’s Fats, Oils, and Grease Program Management Policy for minimum cleaning requirement, available at [https://www.cityoftacoma.org/government/city\\_departments/environmentalservices/wastewater/wastewater\\_services/grease\\_goes\\_in\\_the\\_garbage](https://www.cityoftacoma.org/government/city_departments/environmentalservices/wastewater/wastewater_services/grease_goes_in_the_garbage).

Plans to install a grease interceptor must be submitted to the City of Tacoma for permitting and approval. The plans shall include the location of the grease interceptor, its capacity (in gpm or gallons), the connecting pipes, the capacities of the fixtures draining to the interceptor, and any other information deemed necessary.

Grease interceptors must be watertight, constructed of materials not subject to excessive corrosion or decay, and must be accessible for inspection and cleaning.

### B. Types of Grease Interceptors

Hydromechanical Grease Interceptors (HGIs) can be located inside or outside the facility, may contain weirs or diffusers, and are required to have flow restrictors. Flow restrictors slow the flow of water entering the interceptor. Each fixture discharging to an HGI must have an approved type of vented flow restrictor. Alternatively, if approved, a single flow restrictor may be installed ahead of the HGI, as long as FOG producing plumbing fixtures and appliances

discharge through it. At no time shall the total flow through any flow restrictor(s) going to an HGI be greater than the rated flow of the interceptor. Also, the total capacity of the fixtures discharging into an HGI, in gallons, shall not exceed 2½ times the certified gallons-per-minute flow rate of the interceptor.

Gravity Grease Interceptors (GGIs) are generally installed in the ground outside the facility, upstream from the “black” water (sanitary waste) drain line, and are at least 500 gallons in capacity. See Figure 5-2 for a sample diagram of a gravity grease interceptor.

Both HGIs and GGIs must be trapped and vented in accordance with the Uniform Plumbing Code (UPC) 1013.0 which the City of Tacoma adopted in TMC 2.06. Alternatively, engineered HGI and GGI systems will be considered as provided in Section 301.2 of the UPC.

### **C. Interceptor Selection**

For facilities that have more than 40 seats or serve more than 40 meals per peak hour, a GGI sized for the number of drainage fixture units (DFUs) flowing to it is required. Dishwashers and food preparation sinks at these facilities are required to discharge to the interceptor. Food waste disposal units (garbage grinders) may discharge to a GGI; however, this will require an increase to one size larger than would otherwise be required by Table 5.5.

For facilities that have 40 seats or less and serve 40 or fewer meals per peak hour, a GGI sized for the number of DFUs flowing to it is preferred, although an HGI sized for the number of DFUs flowing to it is allowed. A dishwasher, if approved by the Director, may discharge to an HGI. A food waste disposal unit may not discharge to an HGI.

For facilities that have more than 40 seats or serve more than 40 meals per peak hour, but do not have the space or have other physical constraints that prohibit the installation of a GGI, an exception can be requested. Exceptions may be requested in accordance with Section 5.4.

A food waste disposal unit that has no potential of receiving FOG bearing wastes, such as produce preparation areas in grocery stores, may be installed to discharge directly to the building’s sewer system. These disposal units must still meet the requirements of Tacoma Municipal Code Chapter 12.08.060.

Grease protection for industrial food manufacturing facilities shall be based upon the DFU count of fixtures installed, flow rates from the manufacturing equipment, drainage pipe size, or shall be an engineered system.

Refer to the Pre-treatment Device Decision Tree (Figure 5-1) for assistance in selecting grease interceptors.

The number of meals per peak hour is determined by multiplying the number of seats by 60, and dividing by the estimated time in minutes it takes for a patron to eat. Cash register receipts may also be used to establish this number. The number of peak meals may be estimated as being equal to 100 percent of the seating capacity of the dining area and 20 percent of the seating capacity in the lounge. For facilities with drive-through service, the estimated drive-through service rate at the peak hour should be included. For rest homes, camp kitchens, and other similar facilities, the peak meals are equal to the occupant load.

## Pre-treatment Device Decision Tree Fats, Oils, and Grease (FOG)

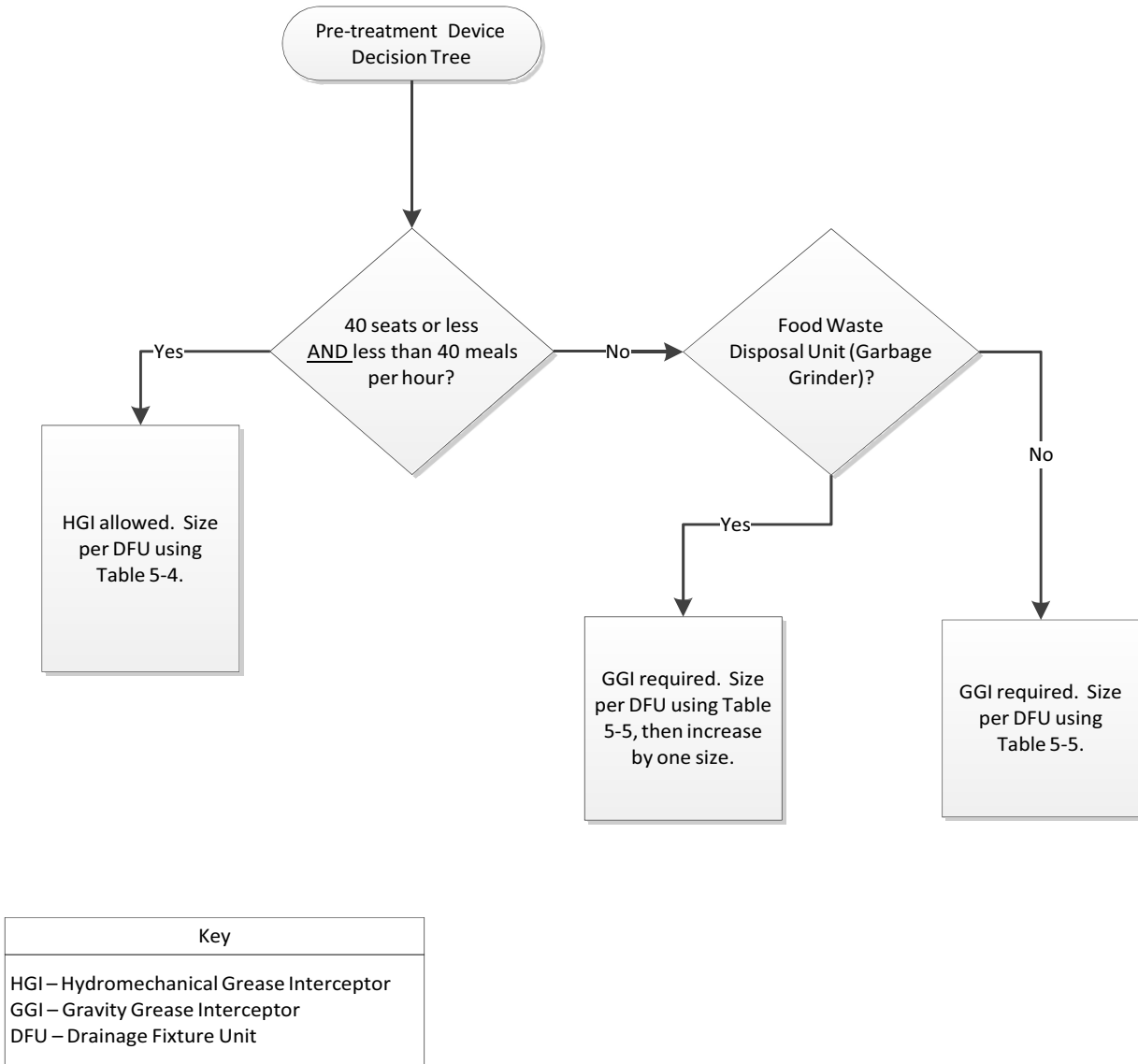

**Figure 5-1: Pre-treatment Device Decision Tree**

## D. Grease Interceptor Sizing

A Drainage Fixture Unit (DFU) is a unit of measure for the load-producing effects on a plumbing system from different kinds of plumbing fixtures. The number of DFUs assigned to a particular fixture is based upon Chapter 7 of the UPC. A list of examples for sizing interceptors is included below.

First, evaluate which fixtures in the facility have the potential to discharge FOG-bearing waste. Typically, these fixtures will include three-compartment sinks, dishwasher pre-rinse sinks, floor drains in cooking and food preparation areas, mop sinks, trench drains for soup kettles and braziers, and sinks that serve wok stations and similar fixtures and appliances. Fixtures that have the potential to discharge FOG-bearing waste must be fitted to a grease interceptor device(s).

Once the FOG bearing fixtures have been identified, determine how many DFUs each fixture should be assigned. Please refer to Tables 5.1 and 5.2 to determine the DFUs for the most common kitchen fixtures. If the DFUs cannot be determined because a kitchen plan is not available, the size of an interceptor shall be determined based upon the maximum DFUs allowed for the pipe size connected to the inlet of the interceptor. See Table 5.3 to use this method.

### **Sizing Examples:**

***A service station deli that cooks teriyaki style meals:*** The deli serves up to 10 meals per peak hour; all of it “take-out.” The deli has a 3-compartment sink, a 2-compartment vegetable and meat prep sink, a mop sink, a wok sink, and a handwash sink. FOG bearing fixtures include the 3-compartment sink (9 DFUs), the wok sink (3 DFUs), the 2-compartment food prep sink (6 DFUs) and the mop sink (3 DFUs). Because the deli has less than 40 seats and serves less than 40 meals per peak hour, an HGI can be installed. In this example, the deli has 21 (9+3+6+3) FOG bearing DFUs. Table 5.4 requires installation of a 75 gallon per minute (gpm) HGI to protect all of the deli’s fixtures.

***A neighborhood café has 40 seats, is expected to serve 40 meals per hour or less, and will serve a wide variety of foods on plates:*** The café has a 3-compartment sink, a 2-compartment food prep sink, a mop sink, a handwash sink, a pre-rinse sink, and a dishwasher. Because the café has 40 seats and serves less than 40 meals per hour, an HGI can be installed. The dishwasher may bypass the HGI, but the dishwasher pre-rinse sink must be connected to grease protection. This facility has 21 (9+3+3+6) FOG bearing DFUs, which would require installation of a 75 gpm HGI to protect all of its fixtures.

***A fast food restaurant has 40 seats but serves up to 120 meals per peak hour:*** The restaurant has a 3-compartment sink, a 2-compartment food prep sink, a mop sink, 3 handwash sinks, 2 floor drains, and a dishwasher for cleaning the serving trays. The dishwasher discharges to a floor sink with a 2 inch drain. Because the restaurant serves over 40 meals per peak hour a GGI must be installed, and all of the fixtures in the kitchen must drain to the interceptor. The fixtures include the 3-compartment sink (9 DFUs), the 2-compartment prep sink (6 DFUs), the mop sink (3 DFUs), 3 handwash sinks (3 DFUs), 2 floor drains (4 DFUs), and the dishwasher floor sink (2” drain line for 4 DFUs). Therefore, this facility has 29 (9+6+3+3+4+4) DFUs. Table 5.5 indicates a 1,000 gallon GGI unit would be required.

**Table 5.1**

Type of Fixture	# of DFUs	Comments
3-compartment sink	9	
2-compartment sink	Use floor sink criteria based upon drain size or number of sinks, whichever is larger	Each compartment is 3 DFUs.
Floor sinks	DFUs based upon sink drain size*	See Table 2 below or Section 702.1 in the UPC. *Floor sinks that receive only ice machine and cooler condensate are not counted.
Mop sink	3	If cooking meat, then new mop sinks must be connected to grease protection.
Wok sink	3	
Floor drains	2	
Trench drains	2 DFUs per lineal foot of drain	
Soup Kettle	2 DFUs per lineal foot of trench drain	
Braziers	2 DFUs per lineal foot of trench drain	
Steam tables	Use floor sink or trench drain criteria, whichever is appropriate.	
Dishwasher pre-rinse sink	3	
Dishwashers	Use floor sink criteria	
Food waste disposers, including pulpers	Use next larger size of GGI than would otherwise be required	FOG bearing food waste disposers can only discharge to properly sized GGIs

For fixtures not listed above please refer to Table 7-3 and section 702.1 of the 2009 UPC. A copy of section 702.1 is listed in Table 5.2 below.

**Table 5.2**

Fixture Unit Equivalents from section 702.1 of the UPC	
Drain Size in Inches	DFUs
1-1/4	1
1-1/2	3
2	4
3	6
4	8

**Table 5.3**

<b>Pipe Size, GPM, Maximum DFU Count</b>		
<b>Pipe Size</b>	<b>Max. Full Pipe Flow (gpm)</b>	<b>Max. DFU Count</b>
2	20	8
2-1/2	38.2	14
3	60	35
4	125	216
5	230	428
6	375	720

**Table 5.4**

<b>Hydromechanical Grease Interceptor (HGI) Sizing Chart</b>	
<b>DFUs<sup>(1)</sup></b>	<b>HGI Flow (gpm)</b>
8	20
10	25
13	35
20	50
35	75
172	100
216	150
342	200
428	250
576	350
720	500

**Table 5.5**

<b>Gravity Grease Interceptor (GGI) Sizing Chart</b>	
<b>DFUs<sup>(1)</sup></b>	<b>GGI Volume</b>
8	500 gallons
21	750 gallons
35	1,000 gallons
90	1,250 gallons
172	1,500 gallons
216	2,000 gallons
307	2,500 gallons
342	3,000 gallons
428	4,000 gallons
576	5,000 gallons
720	7,500 gallons
2112	10,000 gallons
2640	15,000 gallons

(1) The maximum allowable number of DFUs that can be connected to the grease interceptor. The information in the above tables is from section 702.0 and tables 7-5, 10-2 and 10-3 of the Uniform Plumbing Code.

## **E. Exception Process for Grease Interceptors**

Exceptions to this chapter may be requested in writing to the Environmental Services Department to allow a waiver or modification of a requirement prior to approval and construction. Exception requests shall be sent to:

City of Tacoma Environmental Services  
2201 Portland Avenue  
Tacoma, WA 98421

The applicant shall be required to submit a report by a Washington State licensed professional engineer or architect experienced in the design of private and/or public sewage disposal systems with the request for an exception.

The exception request must include:

- A description of the non-conforming circumstances;
- Proposed assessment of risk(s) associated with the non-conforming circumstances;
- Proposed plan for managing the risk(s) associated with the non-conforming circumstances; and
- Endorsement of the request by the Authorized Representative of the User. The Director of the Environmental Services Department may grant an exception following a documented finding that:

The exception is likely to be equally protective to the environment, and both the public and private infrastructure as the requirement from which an exception is sought.

OR

There are site-specific physical circumstances or conditions that provide a substantial reason to approve the exception request. An example would be where the requirement is not technically feasible to implement.

The decision to grant an exception to the Policies is at the sole discretion of the Director of the Environmental Services Department. The Director shall only approve an exception to the extent it is necessary.

The approval of an exception shall not be construed to be an approval of any violation of any of the other provisions of the Tacoma Municipal Code.

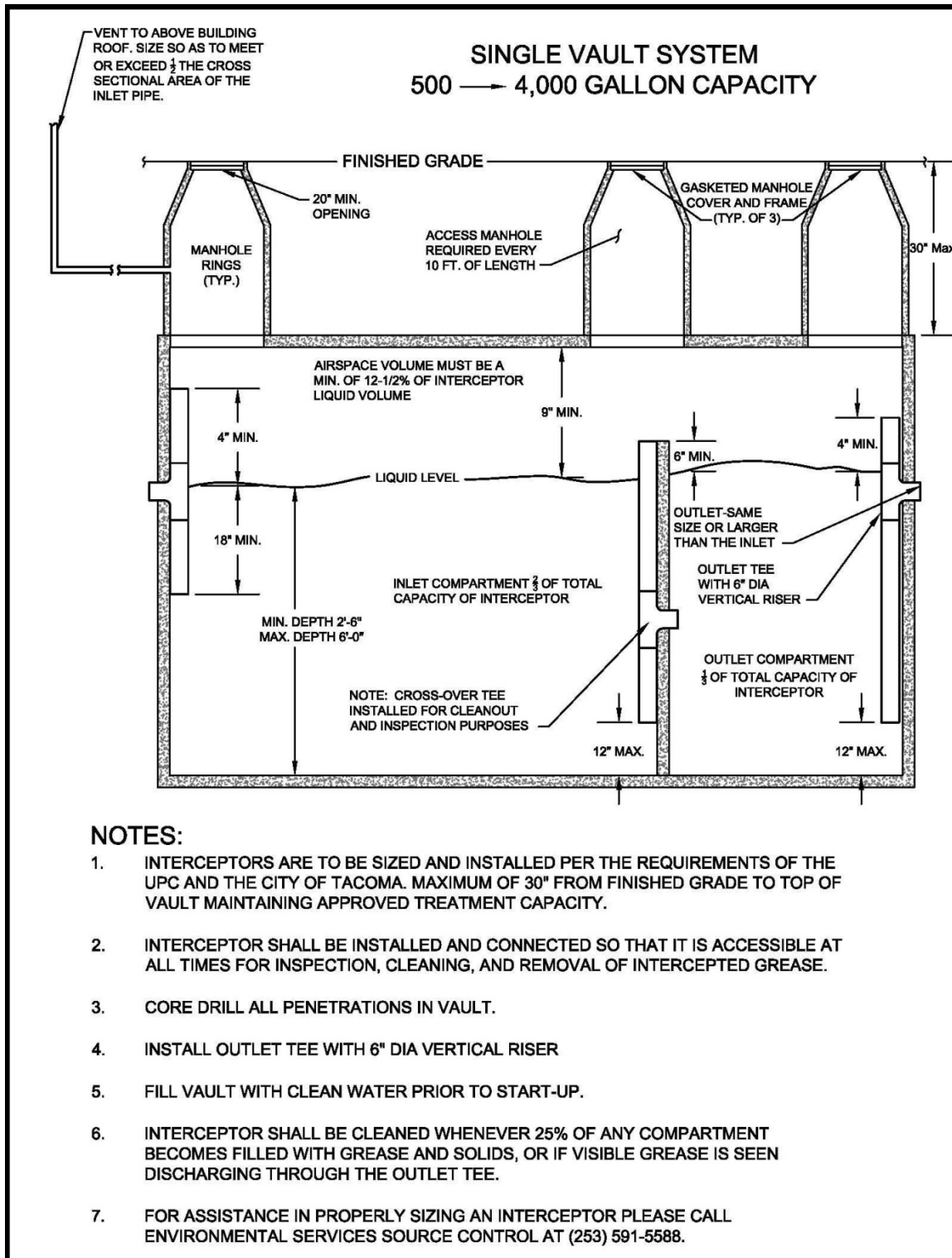

**Figure 5-2: Single Vault Gravity Grease Interceptor**



## **5.3 OIL WATER SEPARATORS**

### **A. Introduction**

Oil water separators are installed to remove oils from discharges that enter the municipal wastewater sewer system. The following section provides guidance for when oil water separators are required for discharges to the public sanitary sewer.

### **B. Applicability**

This policy applies to discharges to the City of Tacoma wastewater sewer system. Guidance on oil water separators that discharge to the City of Tacoma stormwater system can be found in the City of Tacoma Stormwater Management Manual (SWMM). Additional guidance on source control measures to reduce the potential for oil contamination of stormwater can be found in Volume 4 of the Stormwater Management Manual.

This policy shall apply to:

- All new construction in which the parcel owner is proposing or required to be connected to the City of Tacoma's wastewater sewer system;
- All parcels that undergo substantial renovation or construction that requires a Side Sewer Connection Permit. Substantial renovation or construction includes remodeling, alteration or reconstruction of and/or addition to, an existing building within a two-year period, the cost of which exceeds 50% of the value of the building as calculated using the latest Building Valuation Date published by the International Code Council (TMC 2.02.770).
- Replacing fuel island canopies or relocating or adding one or more fuel dispensers.
- Any parcel that undergoes an operational change that would require additional oil protection.

### **C. General Requirements**

An oil water separator is typically required for wastewater discharges to the wastewater sewer system from the following activities:

- Industrial manufacturing;
- Fueling stations;
- Vehicle washing facilities;
- Equipment washing facilities;
- Vehicle and equipment repair and maintenance facilities;
- Covered parking facilities;
- As required by Environmental Services

Note: Specific requirements for fueling stations and covered parking areas can be found in Section 5.3H and 5.3I.

Discharges from the above activities shall not be directed to the City of Tacoma's storm drainage system.

Areas that require oil treatment shall be paved with concrete. For purposes of this guidance document, these areas are referred to as the pad. The pad must be of sufficient size to encompass the proposed activity. If hose bibs are needed for the activity, the pad must be of sufficient size to encompass the hose length.

Areas that require oil treatment shall be graded and sized to minimize the area which drains to the wastewater sewer.

Areas outside the pad shall be sloped to prevent stormwater run-on. The pad shall be sloped to direct all water needing treatment to the oil water separator.

A 6-inch sampling and inspection tee must be installed on the discharge piping of the separator. Existing oil water separators shall be required to be retrofitted regardless of the age of the separator.

Pretreatment devices to remove solids may be required before discharge to the oil water separator.

Contact City of Tacoma Source Control at (253) 591-5588 for any questions.

#### **D. Sizing Criteria**

Design of oil water separators shall be based upon the guidance in this section and varies based upon if the area requiring oil treatment is covered or uncovered. A Professional Engineer licensed in the state of Washington shall complete all engineering calculations as outlined in Chapter 12.08.130(C) of the Tacoma Municipal Code. If the oil water separator is sized using Tables 5.6 and 5.7, a Professional Engineer is not required. For areas larger than those provided in Table 5.6, a Professional Engineer shall design the facility.

Table 5.6 provides typical flowrates that can be used when determining the appropriate oil water separator to be used at the project site.

##### **1. Covered Oil Water Separator Sizing Criteria**

Oil water separators that serve covered areas shall be designed to properly treat the flow and volume of wastewater produced from the process. The applicant shall submit sufficient information to determine the volume of wastewater produced. This may include:

- Number of hose bibs;
- Frequency of washing (if covered area is used for washing);
- Volume of wastewater produced during activity; and/or
- Spill Volume.

See Sections 5.3H and 5.3I for specific sizing information for covered parking areas and fuel islands.

## 2. Uncovered Oil Water Separator Sizing Criteria

Uncovered facilities shall be designed to properly treat the flow and volume of wastewater produced from the process plus the additional stormwater runoff. The volume and flowrate for stormwater contributions shall be based upon the 25 year, 24 hour storm event, and shall be determined using a single event model. The 25 year, 24 hour storm precipitation in the City of Tacoma shall be as noted in Appendix A of Volume 3 of the SWMM, 3.50 inches. Alternatively, the guidance in Volume 5 of the SWMM may be used to determine the size of facility needed for the stormwater contribution. This size shall be added to the flow and volume of wastewater produced from the process, hose bibs, wash water and spill volume to determine the size of the overall facility. See Table 5.6 for 25-year, 24 hour flowrates based upon impervious surface.

**Table 5.6**

Item	Flowrate (gallons per minute)
100 Square Feet of Impervious Surface	1
500 Square Feet of Impervious Surface	5
1000 Square Feet of Impervious Surface	10
1500 Square Feet of Impervious Surface	15
2000 Square Feet of Impervious Surface	20
2500 Square Feet of Impervious Surface	25
3000 Square Feet of Impervious Surface	25
3500 Square Feet of Impervious Surface	30
4000 Square Feet of Impervious Surface	35
4500 Square Feet of Impervious Surface	40
Typical ¾" Garden Hose	10

## 3. Sizing Table

The following table provides the appropriately sized API oil water separator based upon flowrate. For coalescing plate (CP) separators refer to manufacturer's recommendations in order to achieve the required discharge requirements of TMC 12.08 or size the CP separator per the SWMM, Volume 5.

**Table  
5.7**

Calculated Flow, gpm	Separator Size Requirement (gallon capacity)
18	530
30	900
72	2160
108	3230
126	3770
182	5450
215	6460

## **E. Installation Guidelines**

Prior to the installation of any oil water separator that discharges to the City of Tacoma's wastewater sewer system or the modification of any current oil water separator that discharges to the municipal wastewater sewer system, plans must be approved by the City of Tacoma. To determine permitting requirements contact Building and Land Use Services at (253) 591-5030.

The submittal must include the following items:

1. The name, address and type of business where the separator will be installed;
2. The design calculations for the separator sizing;
3. Detailed drawings of the oil water separator. These drawings shall include such items as pad sizing, plumbing details, catch basins and separator location, grading and elevations;
4. All technical data concerning the specific type of separator to be used;
5. A signed, detailed statement describing the process or type of activity that the separator will be used for; and
6. Other information as deemed necessary by Environmental Services Science and Engineering.

Oil water separators shall be installed in an accessible location for maintenance and for inspection by the City of Tacoma Source Control personnel. Access covers shall be readily removable and in good working condition. The individual businesses shall be responsible to maintain and provide on-site any equipment necessary to access the separator for maintenance and inspection. Oil water separators should be installed outside of traffic lanes whenever possible to accommodate maintenance and inspection.

## **F. Maintenance Requirements**

An Operation and Maintenance (O&M) Manual shall be provided. Oil water separators shall be maintained in accordance with the manufacturer's recommendations and industry standards for a particular application. Maintenance requirements may vary depending on the type of separator being used and the process for which it is used. At a minimum, the following maintenance practices shall be performed on all oil water separators that discharge to the City of Tacoma's wastewater sewer system:

- All separators shall be inspected by the operator/parcel owner on a monthly basis at minimum. The inspection shall include checking sludge and oil accumulations in the separator as well as for any abnormal conditions. The business shall maintain a log sheet indicating the date and findings of the monthly inspection.
- The operator/parcel owner shall be required to clean the separator on a regular basis as needed and maintain documentation of the cleaning and waste disposal for the separator. The separator shall be cleaned if any of the following conditions are present.
  - Sludge accumulations in excess of 20% of the vertical hydraulic capacity in any compartment of the separator.

- Oil accumulations in excess of two inches in any compartment of the separator. This requirement may not apply to large industrial type oil water separators such as refineries and fuel depots.
- The coalescing media is plugged with sludge and/or oils.
- Sheen is visible on the discharge of the separator.
- The effluent of the separator is sampled and analyzed to be in excess of limits set forth in Tacoma Municipal Code 12.08.040.
- The business shall repair, replace or install any necessary or missing components such as access covers, piping, pumps, valves, baffles, weirs and coalescing media.
- Access to the separator shall be maintained at all times. Covers shall be in operational order and no obstacles shall be stored on or around the separator. The operator/parcel owner shall be responsible to have and maintain all necessary equipment on site for accessing a separator for maintenance and inspection.

The Operation and Maintenance manual shall include the name and contact information for the party responsible for maintaining the oil water separator. The O&M manual shall be kept on-site and made available to City of Tacoma staff.

A parcel requiring an oil water separator may be leased to a tenant. However, the ultimate responsibility for complying with the requirements of this policy shall remain with the parcel owner.

### **G. Operation**

All oil water separators that discharge to the City of Tacoma's wastewater sewer system are to be operated within the intended and designed usage of the individual separator. Separators are not to be used as waste oil storage. Separators are not intended to remove chemical solvents or other cleaners. At no time shall any hazardous waste be allowed to discharge to the separator. Businesses should implement Best Management Practices such as dry floor cleaning or mechanical floor cleaning to ensure that separator does not accept materials not intended for the separator. The operator/parcel owner shall follow manufacturer recommended operation practices.

### **H. Additional Requirements for Fuel Islands**

The following requirements apply to fuel islands in addition to those requirements in 5.3A to 5.3G.

- Uncovered fuel islands shall be sized in accordance with Section 1.4.2 above.
- Covered fuel islands may provide a blind sump for spill containment or they may drain into the wastewater sewer through an oil water separator.
- For covered fuel islands, the blind sump shall be sized for: 15-minute retention at the greater flowrate of the highest fuel dispenser nozzle or the 6-month storm over the containment pad, whichever is greater, with a minimum of 50 gallons.
- Oil water separators for covered fuel islands with incidental run-on and no more than 4 hose bibs shall be rated at a minimum of 18 gallons per minute and have a

minimum 530 gallon capacity when proposing API separators. For coalescing plate separators refer to manufacturer's recommendations in order to achieve the required discharge requirements of TMC 12.08 or size the CP separator per the SWMM, Volume 5.

- The fuel island pad must encompass the reach of the longest fueling hose.
- The fuel island roof or canopy shall, at a minimum, cover the spill pad (within the grade break or fill dispensing area) and preferably extend several additional feet to reduce the introduction of windblown rain. All roof drains shall be conveyed away from the fueling area.
- The fuel island pad shall be designed to meet any applicable International Fire Code requirements.
- Employees shall be trained on the proper use of fuel dispensers.
- Post signs in accordance with the International Fire Code (IFC).
- Post "No Topping Off" signs.
- Ensure that the automatic shutoff on the fuel nozzle is functioning properly.
- Separators shall have an emergency shut-off valve installed on the discharge line. Valve key shall be provided and be prominently displayed near the shut-off valve.
- An Accidental Spill Prevention Plan developed by the parcel owner and approved by Environmental Services Science and Engineering shall be available for inspection. SWMM, Volume 4, BMP A714 Spills of Oil and Hazardous Materials provides guidance for the elements of a spill plan. Have designated trained person(s) available either on-site or on call at all times to promptly and properly implement the plan and immediately cleanup all spills.
- A person shall be present at the pump during fueling.
- Suitable containers for waste materials such as oil filters, oil cans, and garbage shall be provided.

#### **I. Additional Requirements for Covered Parking**

Covered parking areas with drains or hose bibs shall discharge to the wastewater sewer system through an oil water separator. The oil water separator shall be minimum 18 gpm rated and have 530 gallon capacity when proposing an API separator. For coalescing plate separators refer to manufacturer's recommendations in order to achieve the required discharge requirements of TMC 12.08 or size the CP separator per the SWMM, Volume 5.

For areas without hose bibs or drains, incidental runoff may drain to a blind sump sized to handle accidental spills.

# CHAPTER 6 SIDE SEWER MAINTENANCE RESPONSIBILITY AND PRIVATE SIDE SEWER EASEMENT AGREEMENTS

## 6.1 INTRODUCTION

This chapter discusses the responsibilities between the City of Tacoma and property owners for maintenance of the sewer collection system within the City of Tacoma. This chapter also discusses the private side sewer easement agreements for instances where side sewers cross more than one parcel.

## 6.2 MAINTENANCE RESPONSIBILITY OF THE CITY AND THE PROPERTY OWNER

The transmission of wastewater from buildings to the City's treatment facilities is accomplished through a collection system. Collection systems typically consist of private side sewers and public sanitary sewer mains. Private side sewers are the segments of pipe that connect a building to the riser, wye, or tee at the City's public sanitary sewer main.

Property owners are responsible for constructing and maintaining the side sewer, investigating service problems, and replacing the private side sewer, if necessary (see Figure 6-1). Connections to public sanitary sewer made with the use of break-in taps or mechanical connectors are the responsibility of the property owner. All construction work performed in the public rights-of-way shall be performed by a licensed and bonded contractor holding a City of Tacoma business license.

The City of Tacoma is responsible for operating and maintaining the public sanitary sewer mains, risers, wyes, and tees. The City also permits and inspects work on the area of private responsibility.

Figure 5-1 shows the area of City responsibility for the sewer collection system. Connections other than the typical drawings shown below will be evaluated by the City for jurisdictional responsibilities on a case-by-case basis. See Figure 6-2 for a flow chart of the process described here.

In the event that a property experiences a service problem, the property owner or designated representative must perform a due diligence investigation to determine if the cause of the problem lies with the private ownership or with the public ownership. Methods that may be used to determine the likely source of the problem include, but are not limited to, the following:

- Investigate within the building being served to see if the problem affects all fixtures or just a subset;
- Perform an investigation of the side sewer through a cleanout with a device such as a sewer roter, jetter or a camera to determine if the source of the problem is within the private ownership; or
- Determine if adjoining property owners are having problems.

An informational sheet is provided in Appendix C to aid property owners in troubleshooting and fixing problems in private side sewers.

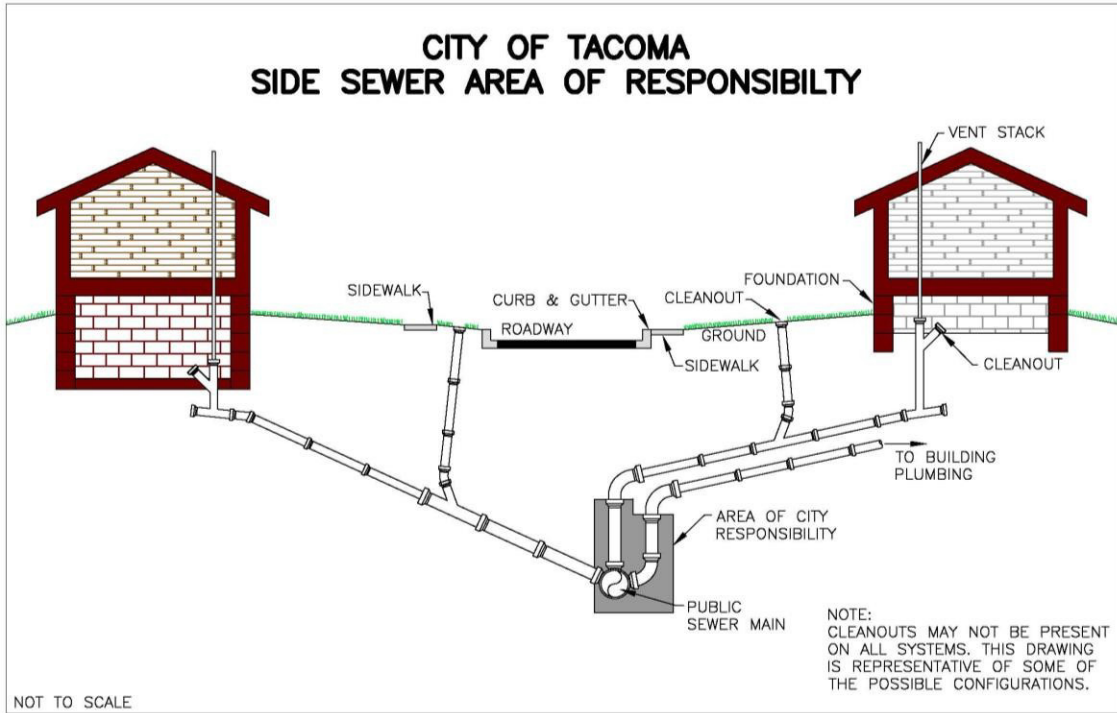

**Figure 6-1: Side Sewer Area of Responsibility**



# Private Side Sewer Repair Flowchart

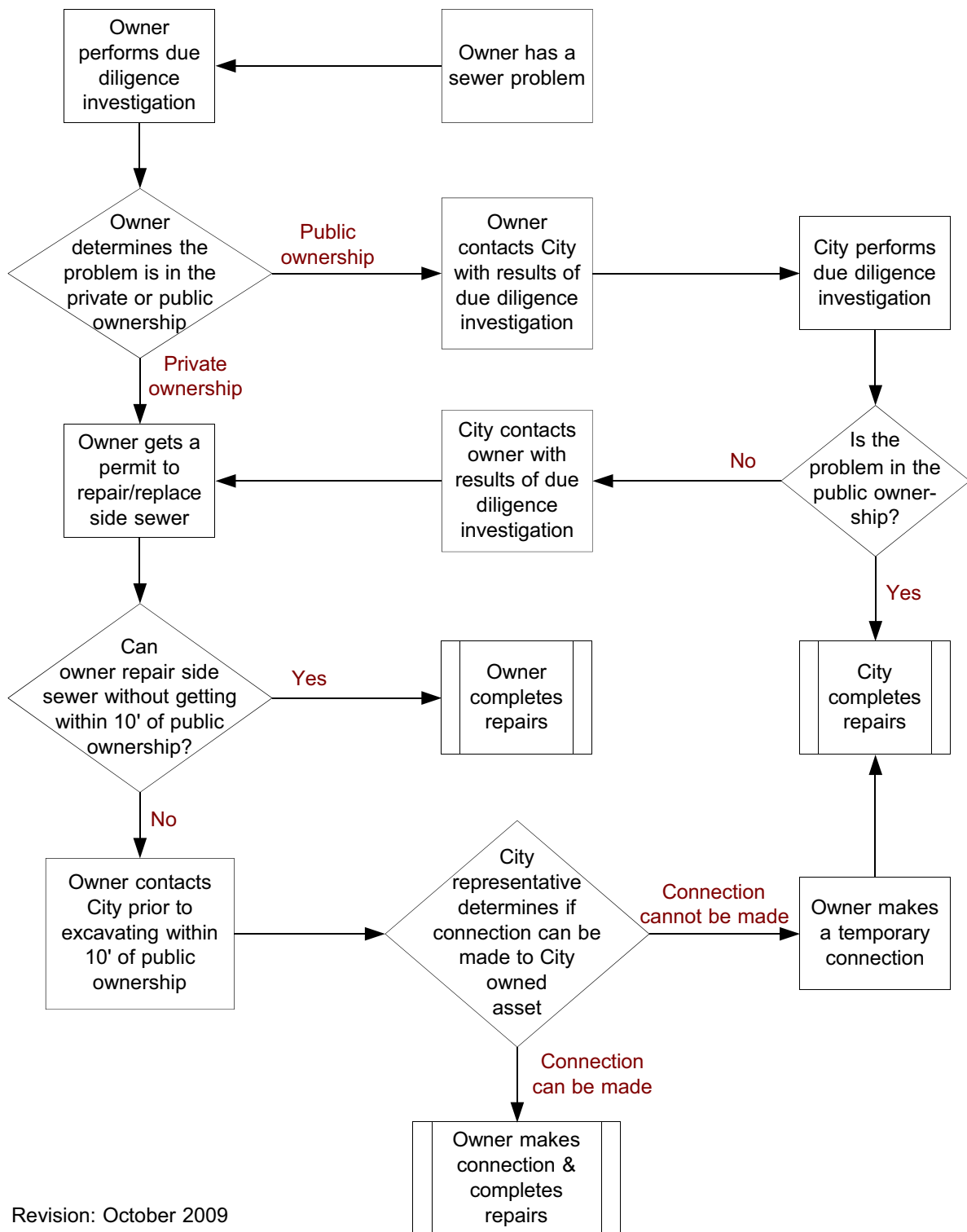

Revision: October 2009

Figure 6-2: Private Side Sewer Repair Flowchart

## **A. Problem in Private Ownership**

If the results of the property owner's due diligence indicate the problem is in the private ownership, then the property owner must implement the solution. If the solution requires repair or replacement of any part of the private side sewer, then a permit must be obtained from the City's Planning and Development Services in accordance with Section 1.2. They may be contacted at (253) 591-5030 or on the web at: [tacomapermits.org](http://tacomapermits.org). If work on the side sewer requires excavation, then a call must be made to locate underground utilities. Any work within the right-of-way must be performed by a licensed and bonded contractor who must have a City of Tacoma side sewer contractor license. The property owner or designated representative shall schedule an inspection of the side sewer repair 24 hours in advance of excavation by contacting the Site Development Group at (253) 591-5760. If any excavation by the property owner or designated representative occurs within 10 feet (horizontally in the plan view) of the sewer main and the City's representative is not on site, then the excavation must stop and the property owner (or their representative) shall contact the City Inspector at (253) 591-5760 and request an inspection.

Upon receipt of this call, the City's representative will respond within 2 to 4 hours during the normal business day. The response by the City may include one of the following actions:

- Verbal communication with the excavation contractor;
- A site visit; or
- Other action, as deemed appropriate by the City.

This will ensure that the property owners need not pay for repairs to City-owned structures, and that City-owned structures are protected from damage. In the event a connection cannot be made per the plumbing code due to condition of the City-owned structures, the City's representative will authorize the use of a temporary connection by the best means available with the intent that the City will make a repair to the public portion of the system after the property owner has finished their work. The property owner (or their representative) may make a temporary patch directly over the public portion but shall be responsible for the permanent restoration of any other area affected by their excavation. The City will be responsible for the permanent site restoration over the City owned asset.

If the property owner or designated representative) chooses to continue the excavation to within 10 feet (horizontally in the plan view) of the sewer main without the prior notification to the City, the property owner will then assume responsibility for costs and completion of the work, including replacement or repair of risers, wyes and sections of sewer main as necessary to provide an approved connection to serve the premises.

## **B. Problem in Public Ownership**

If the results of the due diligence investigation by the property owner indicates the problem is in the public ownership, then the property owner must contact Environmental Services at (253) 591-5585. The City will then perform a due diligence investigation to verify the property owner's determination of the source of the problem.

Based upon the information from the property owner's investigation and the City's investigation, the City will make a determination of whether the likely source of the problem lies within the public or the private ownership.

If the source of the problem lies within the public ownership, the City will implement the corrective measures. If the source lies within the private ownership, the City will inform the property owner (or their representative) of the results of the City's investigation. If jurisdiction cannot be fully ascertained during the investigation, the City may elect to perform an excavation to determine jurisdictional responsibility. Any excavation or repair of the public portion the system under those circumstances shall in no way be considered an assumption of responsibility for the service problem.

### **6.3 PRIVATE SIDE SEWER EASEMENT AGREEMENTS**

A side sewer crossing separate parcels from the one it serves should be avoided, if possible. The City recognizes that in some circumstances, a crossing cannot be avoided. A private side sewer easement agreement must be obtained for a side sewer that crosses a separate parcel that is not owned by the same owner as the parcel being served. This agreement shall identify the responsible parties for maintenance of the side sewer and provide an access easement to construct and maintain the side sewer. Property owners are encouraged to seek legal advice when entering into private side sewer easement agreements.

If a side sewer for a parcel must cross a second parcel and the two parcels are owned by the same person or company, the property owner cannot assume an easement across the second parcel. Instead, the property owner must enter into a recorded agreement with the City that states it will provide a future side sewer easement in the event that the parcels are sold to separate owners. The Site Development Group will coordinate preparation of this document. The property owner shall record the document with the Pierce County Assessor's Office and provide a copy to the Planning and Development permit counter prior to obtaining a side sewer connection permit. For more information regarding agreements between the City and the property owner, contact the Site Development Group at (253) 591-5760.

**APPENDIX A**

**SEWER AVAILABILITY EXAMPLES FOR PARCELS  
INSIDE CITY LIMITS**

## EXAMPLE #1

**Address:** 4543 NE 41<sup>st</sup> St

**Situation:** A property owner is considering building a house on an undeveloped parcel and would like to know if sewer service is available.

**Question #1:** *Is the parcel adjacent to the public sanitary sewer within the right-of-way or public sewer easement?* Yes, the parcel is adjacent to the public sanitary sewer.

**Determination:** Since public sanitary sewer is adjacent to this parcel in two locations, service is already available to this parcel. The property owner must determine whether a gravity side sewer is possible or whether a private pump system is necessary. If a private pump system is required, the property owner must submit a design for review prior to receiving a side sewer permit.



## EXAMPLE #2

**Address:** 1018 N Cheyenne St

**Situation:** A property owner has an on-site septic system and would like to connect to the public sewer.

**Question #1:** *Is the parcel adjacent to the public sanitary sewer within the right-of-way or public sewer easement?* No, sewer is not adjacent to the parcel. Environmental Services must determine if sewer is available.

**Question #2:** *Including the parcel in question, how many parcels in the region need sewer service?* Since all other parcels are adjacent to the sewer, this is the only parcel that still needs sewer service. Therefore, the answer to this question is one.

**Question #3:** *Does the parcel have access to the public sewer via the right-of-way using a shoestring side sewer?* Yes, the property has access via the public right-of-way.

**Determination:** Because there is only one parcel in need of sewer, an extension would not be required and the parcel would be permitted to shoestring. The property owner must determine whether a gravity shoestring side sewer is possible or whether a private pump system is necessary. The property owner must submit a shoestring side sewer plan for review prior to receiving a side sewer permit in accordance with Section 3.040.

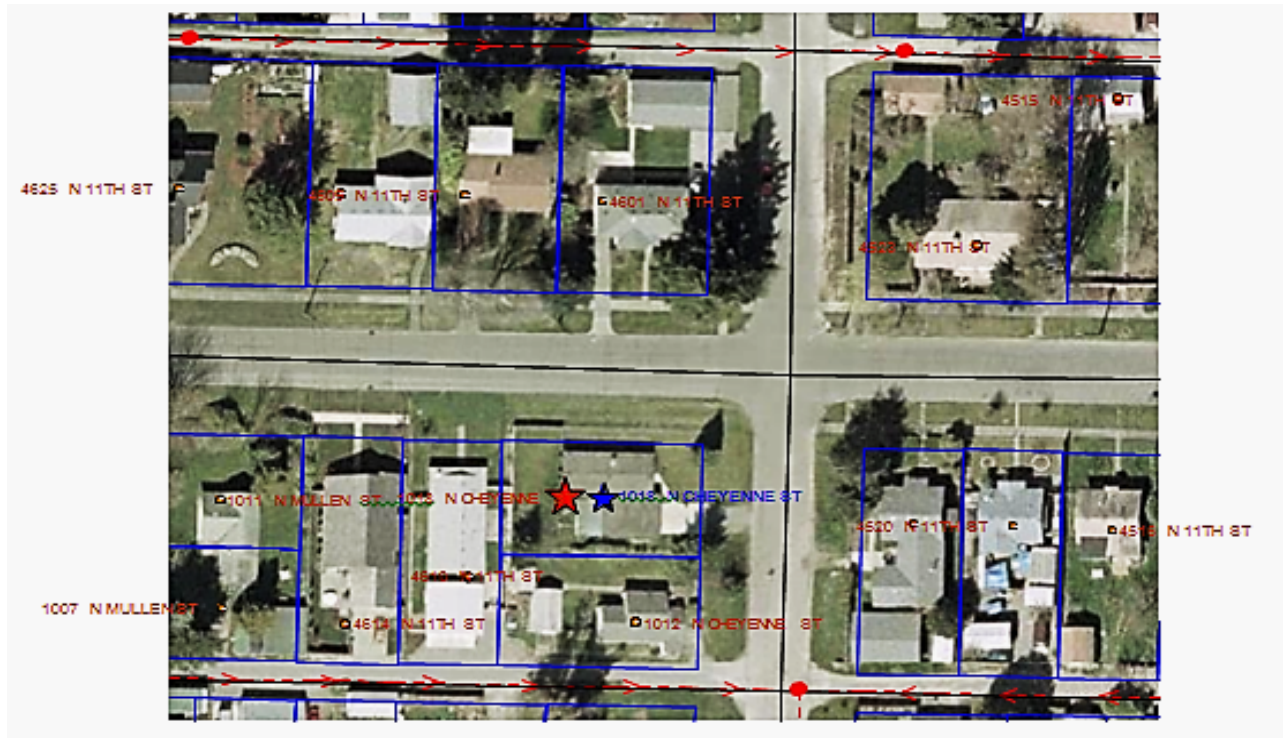

## EXAMPLE #3

**Address:** 4632 N Lexington St

**Situation:** A property owner has an on-site septic system that requires ongoing maintenance and would like to hook up to sewer soon.

**Question #1:** *Is the parcel directly adjacent to the public sewer within the right-of-way or public sewer easement?* No, public sanitary sewer is not adjacent to the parcel. Environmental Services must determine if sewer is available.

**Question #2:** *Including the parcel in question, how many parcels in the region need sewer service?* Since there is no sewer in Lexington Street, which is fully developed, there are more than four parcels that are in need of sewer service.

**Question #3:** *Can the public sanitary sewer main be extended?* Using the govME website to find ground elevations and the most current record drawing of the nearest sanitary sewer, evaluate whether the public sanitary sewer can be extended and meet the current standards. Assume in this example extending a gravity sanitary sewer pipe to this parcel is possible.

**Determination:** The public sewer must be extended to provide sewer service. A sewer extension is encouraged; however, repair to the on-site septic system would be allowed since sewer service is not currently available. Any repairs to the on-site septic system would need to be permitted through the Tacoma-Pierce County Health Department.

Once the public sanitary sewer has been extended and is available for connection, the property owner must determine whether a gravity side sewer is possible or whether a private pump system is necessary. If a private pump system is required, the property owner must submit a design for review prior to receiving a side sewer permit.



## EXAMPLE #4

**Address:** 5902 NE Nahane East

**Situation:** A property owner has a failed on-site septic system and either needs to connect to the public sanitary sewer or rebuild the drain field. Rebuilding the drain field will be very expensive so the property owner would like to know how to receive public sanitary sewer service.

**Question #1:** *Is the parcel adjacent to the public sanitary sewer within a right-of-way or public sewer easement?* No, public sanitary sewer is not adjacent to the parcel. Environmental Services must determine if sewer is available.

**Question #2:** *Including the parcel in question, how many parcels in the region need sewer service?* Since there is no public sanitary sewer in the Nahane Development, there are significantly more than four parcels that are in need of sewer service.

**Question #3:** *Can the public sanitary sewer pipe be extended?* Using the govME website to find ground elevations and the most current record drawing of the nearest sanitary sewer, evaluate whether a sewer can be extended and meet the current standards. In this example, the public sanitary sewer cannot be extended to serve this development, since they are at a significantly lower elevation than the sewer in Norpoint Way.

**Question #4:** *What is the ideal method to provide sewer to the region?* Since gravity sewers cannot serve this site, alternative solutions must be explored to determine how to serve all these parcels with sewer.

**Determination:** Meet with Environmental Services to discuss options for obtaining public sanitary sewer service for this region. In this particular situation, methods for providing sewer service to the region may consist of constructing a regional public pump station or other alternative sewer system. Until the region is served with a sewer system, the property owner may repair the drain field. Any repairs to the on-site septic system would need to be permitted through the Tacoma-Pierce County Health Department.





**APPENDIX B**

**TROUBLESHOOTING COMMON SEWER PROBLEMS**

# Trouble-Shooting your Sewer Problem

## Helpful Hints from City of Tacoma Wastewater Management

The City of Tacoma maintains more than 700 miles of sewer lines. Wastewater crews are available 24 hours a day to respond to problems with City lines and service.

However, most of the problems homeowners face are found in the sewer line that connects their house to the City's main line.

This private line — commonly called a "side sewer" or a "lateral sewer" — is the homeowner's area of responsibility.

This fact sheet is intended to help you discover where the problem with your sewer service is and how to get it fixed as soon as possible. It is the City's mission to provide customers with an efficient, cost-effective, and professionally maintained wastewater and surface-water collection system.

### Call the CITY if...

Call the City *immediately* if sewage is coming up inside your home when you are not using water. Wastewater crews will check the City sewer system serving your area and will send a maintenance crew if needed. The crew will notify you of the results as soon as possible. Wastewater maintenance crews are responsible for maintaining the City's main sewer lines and the connection to customers' side sewers, but not the side sewers themselves.

### Call a PRIVATE service provider if...

Call a private service provider if you have slow drainage or you suspect a blockage. The problem is likely in your side sewer line. However, if the worker is unable to unblock the line and you are still having problems with your sewer system, call the City *before* you incur any more expense.



Tree roots are a common cause of clogged side-sewer lines. Roots can easily penetrate pipes made of porous concrete such as this one, which is more than 25 years old. Modern side-sewer lines are made of heavy duty, water-tight plastic and therefore last much longer.

### Which private service provider should I call?

Companies offer a full range of services including unblocking, repairing and replacing lines or pipe, but some specialize only in certain areas. Make sure to ask which services they provide. You can check with the Better Business Bureau (206-431-2222, or [betterbusinessbureau.org](http://betterbusinessbureau.org)) to find reputable companies, and you might also want to ask friends and relatives for recommendations. Since companies offer a wide range of prices, it's a good idea to get at least three written estimates before choosing a company.

- **Rooter Services:** Drain cleaners or "rooters" unplug plumbing and private side sewers using water pressure or mechanical "snakes." Make sure the roofer service's snake cable is long enough to reach from your side sewer to the City's main sewer line (typically located underneath the street or alley). Rooter companies may also repair and/or replace side sewers.
- **Side Sewer Contractors:** Side sewer contractors repair and/or replace structural problems such as breaks or holes in side sewers. Some contractors may also unplug lines.
- **Plumbers:** Plumbers repair leaky or broken fixtures and they install systems in new construction and remodeling. If only some of your fixtures are not draining, or if your pipes are leaking, a plumber may be able to remedy the problem.

### What questions should I ask the service provider?

We recommend having all questions answered in *legible* writing at the time of service with the provider's signature and date.

- **Where is the blockage?** If you have your line rootered, have the service provider write down the specific footage where the blockage was found, or where he or she thinks it is. Also have the provider mark the

*continued on back*



*Side-sewer contractors are licensed and bonded to work in the City right-of-way as well as on your side-sewer line. Replacing your damaged concrete side sewer with a modern plastic version is easy with the City of Tacoma Sewer Conservation Loan Program for qualified applicants. Call 253-591-5588 for more information.*

system, but the City requires you to get a permit so wastewater maintenance crews can keep track of work that may affect the City's main line. Permits start at \$125 and are available at the City of Tacoma Building and Land Use Department, 747 Market St., Room 345, during business hours, M-F, 8 am to 5 pm. Call 253-591-5030 for more information.

**How do I know where my side sewer is and where it hooks into the City's main line?**

Check your house plans for side sewer locations or call the previous owner. You may also try accessing the permit records kept by the City of Tacoma Building and Land Use Department, 253-591-5030. Unfortunately, the City has very little information on homes built before 1950. Also, if previous work on your side sewer was done without a permit, the City will not have record of it.

spot on the ground. This information is helpful to determine if the problem is within the City's area of responsibility (see drawing). It can also be helpful if the pipe must be dug up to be repaired.

- **What is causing the problem?** Have the service provider write down what the probable cause of the blockage is. Identifying the type of blockage is helpful in determining what method should be used to open it, and in determining if regular maintenance of your side sewer is needed to prevent further back ups.

- **Should I have a service provider use a TV camera to see blockages in my line?**

Generally, this is *not* an effective method of determining what is blocking a line. TV cameras usually cannot see under water, so if a line is blocked and not draining, it won't be able to see inside your pipes. Camera inspections are most useful *after* the blockage has been cleared to determine the current

condition of your pipes and where future problems might turn up.

**Can I do it myself?**

**Unclogging a line:** A variety of tools and products can be found at your local home improvement store. Portable roter machines are available at many rental companies. You'll need to measure the distance between your side sewer and the City's main line in order to determine what size machine to rent.

**Repairing or replacing a broken or leaky side sewer line:** You may work on your own private sewer

**What if the problem lies in my private side sewer line within the City right-of-way?**

All activity in the City right-of-way *must* be done by a contractor who is licensed and bonded to work in the City of Tacoma. Check in the phone book under "Sewer Contractors."

**Low-interest loans available**

The City offers low-interest loans to *qualified* businesses and homeowners for side sewer repair and replacement. Call 253-591-5588 for more information.



**Contact information:**

City of Tacoma  
Public Works Department  
Environmental Services/Wastewater Management

Business Hours: 7:30 am to 4 pm  
253-591-5585 (Phone service available 24 hours)

FWK 5242 5/06 101401d

## GLOSSARY

The glossary provides definitions for the terms and acronyms found in this manual.

<b>Annexation</b>	The formal process of incorporating areas of Pierce County into the City of Tacoma by expanding the City boundaries. Parcels must be contiguous to the existing City of Tacoma boundaries to be annexed into the City of Tacoma.
<b>Availability</b>	See Sewer Availability.
<b>Right-of-Way Construction Permit</b>	The process used by the City to review and inspect privately designed plans for the construction of changes or additions to City-owned infrastructure, such as sewers, streets, etc. These changes or additions to infrastructure are designed and constructed by the project proponent in accordance with City standards, then dedicated to the City for ownership and maintenance upon completion of construction. The Right-Of-Way Construction Permit process is managed by the Site Development Group, (253) 591-5760.
<b>Building Drain</b>	The lower horizontal pipe inside the building to a point 2 feet outside the foundation of the building.
<b>Building Sewer</b>	The portion of pipe between the building drain and the public sanitary sewer main. Building Sewer, which is used in the Uniform Plumbing Code, has the same meaning and is another term used for "Side Sewer."
<b>CEDD</b>	Community and Economic Development Department
<b>Capital Improvement Program (CIP)</b>	This program allows the City to design and contract for the construction of sanitary sewer mains. These projects are paid for with Sewer Utility funds. As property owners connect their buildings to the new mains, they must pay a sewer assessment or a connection charge-in-lieu-of-assessment if it has not already been paid, to replenish the funds used to pay for construction of the sewer (see TMC12.08.350.B).
<b>CIPP</b>	See Cured-In-Place Pipe.

**Cleanout (Side Sewer Cleanout)**

A side sewer cleanout is a vertical portion of side sewer pipe that tees or wyes off from the side sewer and stops at the surface with a cleanout lid. It provides an access point for maintenance and inspection of the side sewer. The location and number of cleanouts required for a side sewer are specified in Section 3.2E.

**Commercial Developments**

All developments other than single family residences and duplexes are considered commercial developments for the purposes of this manual. Commercial developments include triplexes, townhomes, apartments, industrial and commercial businesses, offices, restaurants, public buildings, etc.

**Connection charge-in-lieu-of-assessment**

Parcels not participating in the cost of extending the sanitary sewer system through either an LID or Right-of-Way Construction Permit are required to pay to the City a connection charge-in-lieu-of-assessment prior to a permit being issued.

**Cured-In-Place Pipe (CIPP)**

A trenchless technology method for rehabilitating sewers. This method consists of installing a felt liner impregnated with resin into an existing pipe, called the host pipe. The liner is then pressurized to expand it to form a new pipe within the existing host pipe. Heat or Ultra Violet light is applied to the inside of the liner which cures the resin and felt or fiberglass liner into a strong, solid pipe within the existing host pipe.

**Direct Customer**

A customer whose parcel is located outside City of Tacoma limits in another jurisdiction, connected to City of Tacoma public sewer, and is billed directly from the City of Tacoma for sanitary sewer service.

**Dye Test**

A test performed by City crews to confirm connections to public sewers. The test consists of placing a small amount of non-toxic dye into a plumbing fixture or side sewer cleanout upstream and tracing the dye downstream by looking into side sewer cleanouts and manholes to determine where connections exist.

**Easement (Sanitary)**

A dedicated tract of land to allow for the construction, operation, and maintenance of a sewer line within private property. Easements are recorded against the title of a parcel with the Pierce County Assessor's Office. Typically, no permanent structures are permitted within an easement area to provide access for operations and maintenance. Public easements allow for a public sewer to be located within a parcel, whereas private easements allow for a private side sewer to be located within a parcel.

<b>Franchise Agreement</b>	An agreement between the City of Tacoma and another jurisdiction that allows the City of Tacoma to extend its sewers into the other jurisdiction. The sewers are usually within easements granted to the City of Tacoma by the other jurisdiction and are owned, operated, and maintained by the City of Tacoma. Parcels served under a Franchise Agreement are usually direct customers of the City of Tacoma.
<b>govME</b>	Government Made Easy – a City website found at <a href="http://govME.cityoftacoma.org">http://govME.cityoftacoma.org</a> .
<b>Growth Management Act (GMA)</b>	An act of legislature passed in 1990, the GMA requires state and local governments to manage Washington’s growth by identifying and protecting critical areas and natural resource lands, designating urban growth areas, preparing comprehensive plans, and implementing them through capital investments and development regulations.
<b>HDPE</b>	High-density polyethylene pipe.
<b>Holding Tank</b>	See On-Site Sewage Holding Tank.
<b>Incorporated Property</b>	A parcel located within the boundaries of a city or town.
<b>Interlocal Agreement</b>	An agreement between the City of Tacoma and another jurisdiction that allows one jurisdiction to discharge wastewater into the other jurisdiction’s sewer system. Parcels served under an Interlocal Agreement are usually billed by the jurisdiction they are located within and, in turn, that jurisdiction pays the other a user fee based upon rates established per the agreement. In addition, Interlocal Agreements may include purchase of capacity rights for one jurisdiction to treat the other jurisdictions wastewater at wastewater treatment plants.
<b>Latecomers Agreement</b>	Applicants may apply for Utility Reimbursement Agreements for the construction of wastewater and surface water improvements from parcels not participating in the cost of extension of the infrastructure. If approved by the Environmental Services Director, parcels connecting to the new infrastructure within 15-years would reimburse the owners who originally bore the expense.

**Local Improvement District (LID)**

Special purpose financing tool providing a means for property owners to make capital improvements benefiting their neighborhood and distribute the cost equitably among all owners and allow financing the costs over a number of years. Tacoma's LID programs consist primarily of paving streets and alleys, new sidewalks, new sewer mains, construction and replacement of water mains, new street lighting, new primary electrical service, and the conversion of overhead utilities to underground. An LID may also include other types of improvements.

**On-Site Septic System**

An on-site septic system is a small-scale wastewater treatment system owned and maintained by the property owner. On-site septic systems typically consist of a septic tank and a drain field, but may have more complex components depending on the soil characteristics where the system is located. On-site septic systems located within the City of Tacoma are regulated by the Tacoma-Pierce County Health Department.

**On-Site Sewage Holding Tank**

A holding tank is an on-site sanitary storage tank connected to the plumbing system of a building not connected to a public sewer or a septic drain field. Holding tanks must be regularly pumped out and wastewater disposed of in an appropriate manner.

**Pipe Bursting**

A semi-trenchless technology method for replacing sewers. In this process, a pipe bursting tool is dragged through an existing pipe which crushes and expands the existing pipe into the surrounding soil. A High Density Polyethylene Pipe is attached to the rear of the bursting tool and is dragged into the void created by the bursting tool. This process requires a small amount of excavation at each end of the pipe replacement to create an insertion pit and a retrieval pit for the bursting tool.

**Private Side Sewer Easement Agreement**

An agreement between two property owners allowing for a side sewer serving one parcel to cross another parcel to reach the public sewer. The agreement describes the easement area where the side sewer is located and identifies who is responsible for construction and maintenance of the side sewer. This document shall be recorded with the Pierce County Assessor's Office.

**Private Sewage Pump System**

A private sewage pump system serves an individual customer that cannot be served with a gravity side sewer due to grade issues or other obstructions. Private pump systems are owned and operated by the property owner and are located on private property.

<b>Public Pump Station</b>	Regional public pump stations are City-owned and operated pump stations that serve multiple customers within a region that cannot be served by gravity sewer mains alone. Public pump stations are generally located within City rights-of-way or easements near the lowest elevation of the region.
<b>Public Sewer (Main)</b>	The portion of the wastewater collection system owned and maintained by the City of Tacoma and to which private side sewers are connected. Tees and wyes are considered part of the public system. Some mains were originally constructed with bends at the tee or wye and a vertical riser pipe was used to bring the connection point up to a reasonable depth. These bends and vertical riser pipes are also considered part of the public sanitary sewer main. See Figure 5-1.
<b>Rehabilitation (of side sewers)</b>	Repairing a portion or the entire length of side sewer line using trenchless technology rather than excavating and replacing the side sewer.
<b>Residential Developments</b>	For the purposes of this manual, only single family residences and duplexes are considered residential developments.
<b>Septic System</b>	See On-Site Septic System.
<b>Sewer Availability</b>	Sewer availability is the term used to define whether a parcel may or may not connect to the public sewer in accordance with the flowcharts in Chapter 2.
<b>SFR</b>	Single-family residence.
<b>Shared Side Sewer</b>	A common private side sewer pipe serving multiple property owners or parcels.
<b>Shoestring Side Sewer</b>	A side sewer connecting to a public sanitary sewer main that is not directly adjacent to the parcel it serves. Shoestring side sewers typically travel through a private easement or along the right-of-way to reach the public sanitary sewer main.
<b>Side Sewer</b>	The portion of pipe between the building drain and the public sanitary sewer main. Side sewers are considered private systems. Property owners are responsible for construction, maintenance and rehabilitation of side sewers. Side sewer has the same meaning and is another term used for "Building Sewer," which is used in the Uniform Plumbing Code.



<b>Smoke Test</b>	A test performed by City crews to confirm connections to public sewers. A smoke test consists of forcing a non-toxic smoke produced from heated mineral oil into an open manhole using a smoke blower. The smoke will travel through the public sewers into side sewers and exit through building plumbing vents.
<b>Television Video Inspection</b>	This inspection method consists of inserting a small closed circuit television camera into a sewer pipe to view and record the visual condition of the sewer pipe. This inspection is sometimes used prior to construction to determine potential rehabilitation methods or verify side sewer connections and is sometimes used after construction is complete to ensure the pipe construction or rehabilitation was successfully completed.
<b>TPCHD</b>	Tacoma-Pierce County Health Department
<b>Trenchless Technology</b>	Methods for rehabilitating or replacing existing side sewers that do not require excavating to the existing pipe. Cured-In-Place Pipe (CIPP) is one common example of a trenchless technology and pipe bursting is one common example of a semi-trenchless technology.
<b>Unincorporated Property</b>	A parcel located outside the boundaries of a city or town (i.e., in the county).
<b>Urban Growth Area (UGA)</b>	An area in which a city expects to grow. The Growth Management Act requires cities to prepare maps showing their expected UGA and provide a comprehensive plan on how that area will be developed.