



From the edge of space to the bottom of the ocean...



Discover Your World with NOAA
 NATIONAL OCEANIC AND ATMOSPHERIC ADMINISTRATION
An Activity Book



The Discover Your World with NOAA Activity Book was compiled and developed for NOAA's Celebration of 200 years of Science, Service, and Stewardship under the direction of the

NOAA Celebration Education Working Group

Nadia Sbeih – NOAA Ocean Service (Co-chair)

Molly Harrison – NOAA Fisheries (Co-chair)

Karrie Carnes – NOAA Ocean Service

Kim Cohen - NOAA Ocean Service

Margaret Fowke – NOAA Weather

Ron Gird – NOAA Weather

Sami Grimes – NOAA Research

Jennifer Hammond – NOAA Marine and Aviation Operations

Jorgeann Hiebert – NOAA Research

Nina Jackson – NOAA Satellites

Jamie Krauk – NOAA Research

Elizabeth McMahon - NOAA Marine and Aviation Operations

Amy Painter – NOAA Research

Krista Trono – NOAA Ocean Service

Written and Edited by Mel Goodwin, PhD and science writer, Charleston, SC

Design and Layout by Sandy Goodwin, Coastal Images Graphic Design, Mount Pleasant, SC

Cover Painting by Tate Nation, Mount Pleasant, SC, ©2007

Illustrations by Paul Rossmann, Charleston, SC

The assistance and expertise of the following reviewers for the revised version is acknowledged with thanks:
Ron Gird, Susan Haynes, Molly Harrison, Tracy Hajduk, Nina Jackson, Deborah Jones, Bruce Moravchik, Peg Steffen, Krista Stegemann, Marlies Tumolo
Revised and updated August 2017

For more information on NOAA's history and time line, check out the celebration Web site,
celebrating200years.noaa.gov/

For more information on NOAA's educational offerings, please visit our Web site,
www.noaa.gov/education



Discover Your World with NOAA
NATIONAL OCEANIC AND ATMOSPHERIC ADMINISTRATION

An Activity Book

Table of Contents

INTRODUCTION

Discover Your World with NOAA 1
 NOAA's Building Blocks 2

EXPLORE THE EARTH

Introduction 8
 Boat Building Challenge 9
 Make Your Own Astrolabe 12
 Make Your Own Compass 16
 Tied Up in Knots 18
 Who's Blue Peter? 22
 The Water Writers 25
 Nautical Chart Challenge 28
 Build an Underwater Robot 34
 Earth Origami 37
 Make Your Own Volcano! 40
 Do You Have Twisted Vision? 43
 Be A Shipwreck Detective 47
 Weird, Red and Slightly Gross! 51

SCIENCE

UNDERSTAND THE EARTH

Introduction 55
 Follow That Hurricane! 56
 Build Your Own Weather Station 61
 Build an Anemometer 62
 Build a Weather Vane 64
 Build a Barometer 66
 Build a Screened Thermometer 67
 Build a Hygrometer 67
 Build a Rain Gauge 69
 Be a Citizen Weather Reporter 70
 Tornado in a Bottle 73
 Rip Currents 76
 Be a Tree Ring Detective 78
 Your Own El Niño 81
 Please Pass the Salt 83
 Satellite Communications 86
 Woolly Magma 89
 Survey Mark Hunting 93

SERVICE

PROTECT THE EARTH

Introduction 97
 Fish Fetch 98
 The Ocean Drugstore 100
 Who Trashed the Ocean? 103
 It All Runs Downhill 106
 Toxic! Or Is It? 108
 Invasive Species Super Sleuth 110
 Your Alien Dodecahedron 111
 Endangered Species Origami 118
 What Are the Impacts of Shrinking
 Polar Ice Caps? 123
 Following the Ocean Unicorn 128
 Make an Edible Coral Reef 133
 Now THAT's Complex! 139
 Fixing Our Earth 142

STEWARDSHIP



Courtesy NESDIS



Courtesy OMAO

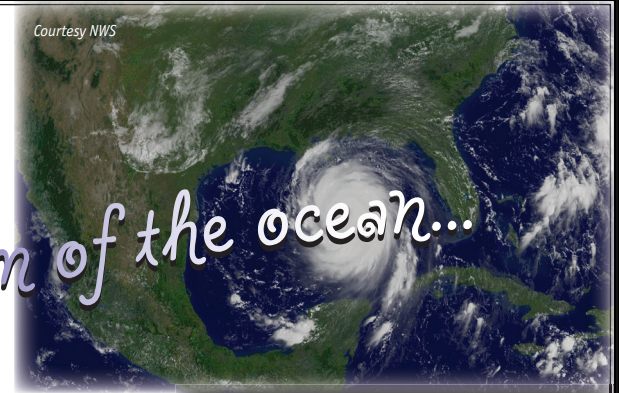

Courtesy NWS

From the edge of space to the bottom of the ocean...



Discover Your World with NOAA

NATIONAL OCEANIC AND ATMOSPHERIC ADMINISTRATION

Flying into the eye of a hurricane

Protecting whales, sea turtles, and sea lions

Watching the Earth from 22,000 miles above the ground

Diving into submarine canyons that could swallow Mt. Everest

Restoring marshes, wetlands, reefs, and other marine habitats

Saving lives threatened by tsunamis, tornadoes, and killer storms

Managing ocean resources and their habitat

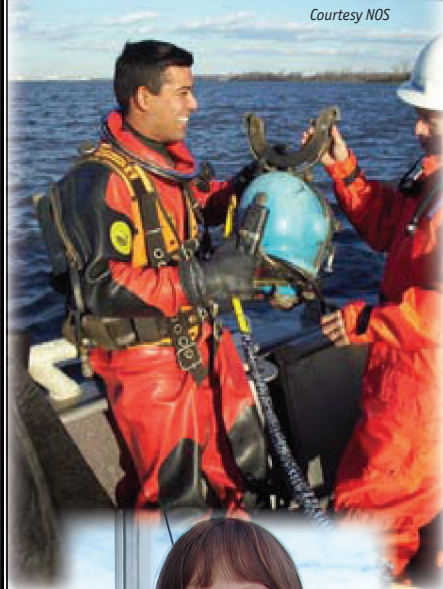

Courtesy NOS

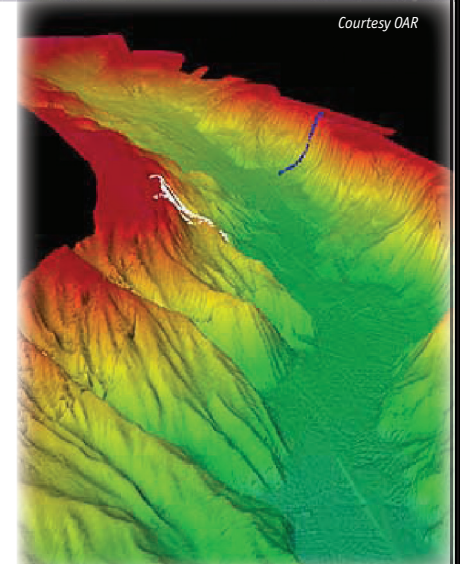

Courtesy OAR



Courtesy Todd Hasee, Michigan Sea Grant

All in a day's work for the people of NOAA as they put science, technology, and engineering to work for you. Every day, NOAA helps people with local weather forecasts, tornado warnings, oil spill cleanup, high quality seafood, navigation tools, and many other services. NOAA is also a leader in ocean exploration and environmental sciences, finding out more about the Earth and how to use and protect our planet's resources.

NOAA's motto is "Science, Service, Stewardship." Putting that motto into action leads the people of NOAA from the edge of space to the bottom of the ocean. These activities are designed to help you learn more about our world, and how NOAA helps you to explore, understand, and protect our Earth.

HAVE FUN!



Courtesy Robert Schwemmer, Channel Is. National Marine Sanctuary

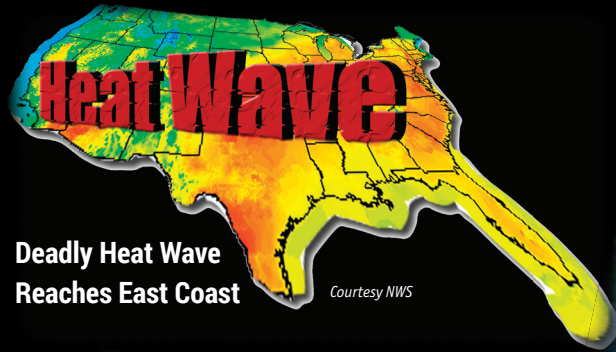

Deadly Heat Wave Reaches East Coast

Courtesy NWS

Lionfish Invade U.S. Waters



Courtesy Paula Whitfield, NOAA

New Hurricane Hunter Aircraft



Courtesy NWS

Entangled Whale Rescued



Courtesy NMFS

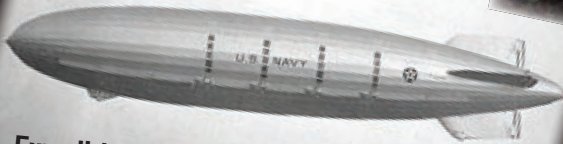

Courtesy NOAA

Expedition Explores Underwater Wreck of Historic Naval Airship

NOAA's Building Blocks

Do you know what NOAA does? Play this game and find out!

Astronauts Test Moon Exploration Concepts on Seafloor



Courtesy NOAA

Satellites Relay Distress Calls



Courtesy NESDIS

El Nino Makes a Comeback

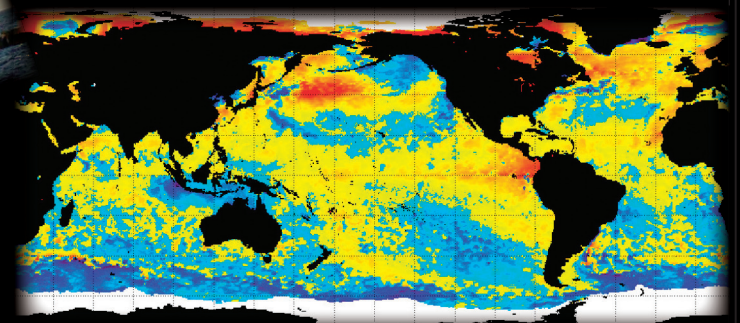

Courtesy NWS

NOAA's Building Blocks

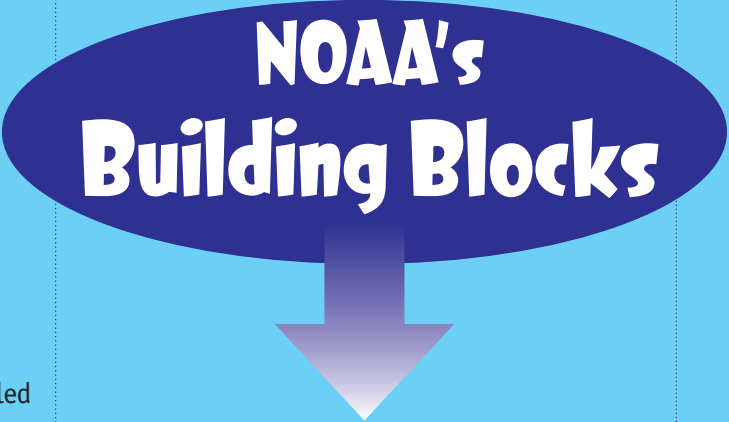

What You Will Need

- ❑ Jenga® or Uno Stacko® game
- ❑ Two sets of "NOAA's Building Blocks Game Cards" – Make two copies of the "NOAA's Building Blocks Game Cards" page and cut the cards out. The cards will last longer if you photocopy them onto heavy paper called "card stock" or "cover stock." It will be easier to tell the difference between "Problems" and "Solutions" if you use one color of paper for "Problems" and another color for "Solutions."

How to Play the Game

1. Follow the instructions that come with the game. If you are playing with one or more other people, divide into two teams. Each team gets 24 blocks, and stacks these into eight layers of three blocks per layer. Each layer should be at right angles to the layer below. Shuffle the Game Cards, and place a set of the Cards in front of each team.
2. One team at a time draws a card from the top of the Game Card pile. There are "Problem" cards and "Solution" cards. For every "Problem" there is a "Solution" somewhere in the pile of Game Cards.

What You Will Do

Play a game using blocks from Jenga® or Uno Stacko®. You can play this game by yourself, or with as many as eight players

If you draw a "Solution" card, read the card aloud and then:

- (a) Keep the card until you need it to solve a "Problem;" OR
- (b) Remove one block from the top of your team's stack, and place the card in a discard pile separate from the Game Card pile.

If you draw a "Problem" card, read the card aloud and then:

- (a) Remove one block from any layer of the stack except the top layer, and stack it on top of the stack; OR
- (b) Solve the Problem by reading a "Solution" card that your team has drawn and saved previously.

When you have finished (a) or (b), place the card in a discard pile separate from the Game Card pile.

Players may use only ONE hand when removing and stacking blocks! Blocks that are stacked on top of the pile should be at right angles to the layer below. If more than one person is on each team, team members should take turns drawing cards and moving blocks. If you run out of Game Cards, shuffle the cards in the discard pile and use these as a new stack of Game Cards.

3. Continue playing until one team's stack falls, or one team has removed all of their blocks from the stack. If your team is first to remove all of the blocks from your stack—you win! If your stack is the first to fall—you lose!

*Photocopy this page
and cut out the cards
along the lines.*

? **Problem 1**
You are driving from St. Louis, MO to Boise, ID, and need to know what the weather is likely to be along the way.

? **Problem 2**
You are travelling through the midwest and want to see whether severe weather is expected during the next three days.

? **Problem 3**
You just heard on the radio that an earthquake has been reported off the coast of Peru with a magnitude of 6.6 on the Richter scale. Is this likely to cause a tsunami on the U.S. Pacific coast?

? **Problem 4**
Every day, hundreds of private and commercial aircraft are in the air over the United States. How can pilots check on weather conditions that may affect the safety of their flights?

? **Problem 5**
More than 90 percent of the goods imported into the United States arrive via the oceans. How can ship captains obtain information to help them avoid dangerous sea conditions?

? **Problem 6**
Over 77 million Americans enjoy recreational boating. How can these boaters keep track of weather that may affect them?

? **Problem 7**
You just felt the earth shake! How can you find out if this is a minor tremor or a serious emergency?

? **Problem 8**
A railroad tank car is leaking chlorine gas. What system is in place to provide emergency information to the public?

? **Problem 9**
Intense bursts of electromagnetic radiation from the sun called "solar flares" can disrupt cell phones and GPS systems. Is there any way to predict when solar flares may happen?

? **Problem 10**
Lightning is the second most frequent cause of weather-related deaths in the United States (floods are number one). How can you find out about lightning safety?

? **Problem 11**
You are planning a boat trip through the Florida Keys. Where can you find out about nautical charts and other boating information for this area?

? **Problem 12**
You are planning a SCUBA diving trip to photograph coral reefs with some friends, and want to be sure everyone knows how to plan dives and what to do in case of emergencies. Who has this information?

? **Problem 13**
You live near a marina, and are concerned about what should be done in case of an oil spill. Where can you get this information?

? **Problem 14**
You live near a salt marsh that used to be used as a local dump for construction debris. Now you and your friends would like to clean it up and restore it as a wildlife habitat. Who knows how to do this?

? **Problem 15**
A ship captain entering Chesapeake Bay needs up-to-the-minute information on currents, tides, and water levels to be sure he can navigate beneath several bridges. Where can he get this information?

*Photocopy this page
and cut out the cards
along the lines.*

? Problem 16
You are looking for a poster that shows all of Earth's mountains and valleys, including those in the ocean. Where could you look?

? Problem 17
You are doing a report on coral reefs, and need some great pictures of reef animals. Where can you find them?

? Problem 18
Our nation's coasts are being developed at a rapid rate. What can be done to protect special coastal areas that contain unusual marine life and important historical resources like shipwrecks?

? Problem 19
The deep ocean contains new species that may provide solutions to problems such as energy and human disease. Yet, most oceans are still unexplored. What organization is dedicated to ocean exploration?

? Problem 20
In the days following Hurricane Sandy, rescuers desperately needed before-and-after aerial images that covered coastal areas affected by the storm. Who has these kinds of images?

? Problem 21
Man Overboard! A sailor has fallen overboard, but no one noticed when the accident happened. The Coast Guard has been called, but how can they find him in hundreds of square miles of ocean?

? Problem 22
You have just found an injured whale that seems to be stuck in shallow water. Who can you call?

? Problem 23
More people want to eat seafood, but overfishing is a serious problem and over 70% of our seafood is imported. How can we increase our domestic seafood supply and still protect our seafood resources?

? Problem 24
Many marine turtles are threatened by accidental capture and drowning in fishing gear, boat collisions, and damage to coastal beaches where they nest. What can be done to protect sea turtles?

? Problem 25
Living marine resources provide food, employment, and recreation, but are threatened by overuse, coastal development, pollution, and natural disasters. How can we protect living marine resources and still enjoy benefits they provide?

? Problem 26
You have heard that temperature changes in the Pacific Ocean called El Nino can have serious effects on your local weather. Where can you find out whether these changes are happening right now, or are expected later this year?

? Problem 27
You have heard that Earth's climate is changing. How can you find out whether temperatures in the U.S. have been above or below normal during the last few years?

? Problem 28
How can you find out how global climate change is likely to affect marine ecosystems such as coral reefs?

? Problem 29
Hurricane Hunters fly into the middle of storms to provide information for forecasts that save thousands of lives. Who has the planes and pilots to do this dangerous work?

? Problem 30
Your science teacher is fascinated by marine biology and ocean research, and wants to get first-hand experience with scientific research at sea. How can she do that?



Solution 1

NOAA's National Weather Service provides immediate access to all forecasts for the entire United States at

www.weather.gov/



Solution 2

The National Weather Service Storm Prediction Center shows active storm systems over the 48 states, and provides detailed discussions of severe weather events at

www.spc.noaa.gov/



Solution 3

NOAA's Pacific Tsunami Warning Center and West Coast / Alaska Tsunami Warning Center provide tsunami warnings and information at

www.ptwc.weather.gov



Solution 4

NOAA's National Weather Service's Aviation Digital Data Service provides forecasts, analyses, and observations of weather conditions that may affect safe aviation.

www.aviationweather.gov



Solution 5

The National Weather Service's Marine and Coastal Weather Services Branch provides information on coastal waters, Great Lakes, and open oceans.

www.nws.noaa.gov/om/marine/home.htm



Solution 6

The National Weather Service's Marine and Coastal Weather Services Branch provides information on conditions on coastal waters, Great Lakes, and open oceans.

www.nws.noaa.gov/om/marine/home.htm



Solution 7

NOAA Weather Radio broadcasts weather forecasts, and emergency information about natural hazards, environmental hazards, and public safety (such as AMBER alerts).

www.nws.noaa.gov/nwr



Solution 8

NOAA Weather Radio broadcasts weather forecasts, as well as emergency information about natural hazards, environmental hazards, and public safety (such as AMBER alerts).

www.nws.noaa.gov/nwr/



Solution 9

The National Weather Service Space Environment Center forecasts space weather caused by activity on the sun, such as solar flares.

www.swpc.noaa.gov



Solution 10

NOAA's Lightning Safety Web page has handouts, safety tips, medical facts, survivor stories, photos, and much more at

www.lightningsafety.noaa.gov



Solution 11

NOAA's Office of Coast Survey provides nautical charts and other navigational products needed to safely operate marine vessels.

<http://charts.noaa.gov/>



Solution 12

The NOAA Dive Manual is an encyclopedia of diving which includes information about dive planning, operations, and emergencies.

www.oma.noaa.gov/learn/diving-program/diving



Solution 13

NOAA's Office of Response and Restoration provides information and solutions for environmental hazards from oil, chemicals, and marine debris.

www.response.restoration.noaa.gov



Solution 14

NOAA's Office of Response and Restoration offers case studies, planning tools, and technical assistance to projects that restore and monitor coastal and estuary habitats.

www.response.restoration.noaa.gov



Solution 15

NOAA's Tides and Currents Web site provides real-time and historical information on tides, water levels, currents, and weather in ports and major waterways throughout the U.S.

www.tidesandcurrents.noaa.gov

Photocopy this page and cut out the cards along the lines.



Solution 16

NOAA's National Geophysical Data Center provides maps, posters, data, and images of many different features on Earth's surface.

www.ngdc.noaa.gov/



Solution 17

NOAA's Photo Library has thousands of images of marine species, shorelines, weather and space; from coral reefs to the South Pole, from great whales to microscopic bacteria.

www.photolib.noaa.gov



Solution 18

NOAA's Office of National Marine Sanctuaries includes a network of underwater parks where natural and cultural resources are protected while still allowing people to use and enjoy them.

www.sanctuaries.noaa.gov



Solution 19

NOAA's Office of Ocean Exploration coordinates expeditions to explore Earth's "final frontier." Expeditions take place around the world, but are concentrated in U.S. waters.

www.oceanexplorer.noaa.gov



Solution 20

NOAA's National Geodetic Survey has provided high-resolution aerial photography of the 95,000-mile U.S. shoreline since the 1930's.

www.oceanservice.noaa.gov/geodesy/aerialphotos



Solution 21

NOAA operates the Search & Rescue Satellite Aided Tracking System to locate people in distress almost anywhere in the world at anytime and in most conditions.

www.sarsat.noaa.gov



Solution 22

NOAA's National Marine Fisheries Service coordinates volunteer marine mammal stranding networks in all coastal states that include whale rescue teams.

www.fisheries.noaa.gov/pr/health/report.htm



Solution 23

NOAA Fisheries' Aquaculture Program develops ways to farm marine animals to provide more seafood, boost commercial and recreational fishing and restore some endangered species.

www.nmfs.noaa.gov/aquaculture



Solution 24

NOAA's National Marine Fisheries Service and the U.S. Fish and Wildlife Service have developed ways to protect and restore sea turtle populations.

www.nmfs.noaa.gov/pr/species/turtles



Solution 25

NOAA Fisheries' Office of Sustainable Fisheries works to maintain healthy fishery stocks, eliminate overfishing, rebuild overfished stocks, and increase benefits from living marine resources.

www.nmfs.noaa.gov/sfa



Solution 26

NOAA's National Weather Service Climate Prediction Center forecasts short-term events such as El Nino, and provides information about possible risks of extreme weather events.

www.cpc.ncep.noaa.gov/



Solution 27

NOAA's Climate Program Office provides current and historical information on whether temperatures in the U.S. are above or below normal.

www.ncdc.noaa.gov



Solution 28

NOAA's Climate and Ecosystems Program is dedicated to understanding and predicting the effects of climate variability and change on marine ecosystems.

www.cpo.noaa.gov



Solution 29

NOAA's Office of Marine and Aviation Operations has a fleet of aircraft that operate in extreme conditions, and have the only pilots in the world qualified to fly into hurricanes at low altitudes.

www.omaoo.noaa.gov



Solution 30

NOAA's Teacher at Sea Program provides opportunities for teachers to do scientific research aboard its ships and share that experience with students and colleagues.

www.teacheratsea.noaa.gov/

Photocopy this page and cut out the cards along the lines.



Taking the pulse of the planet...

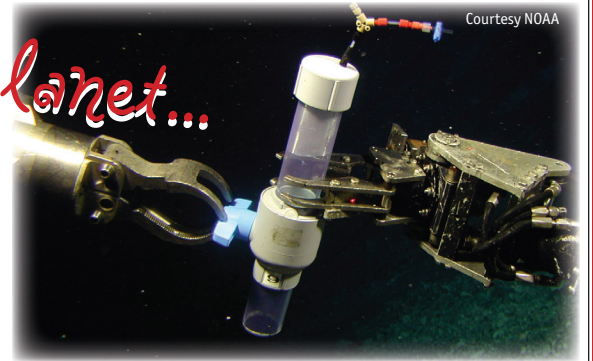
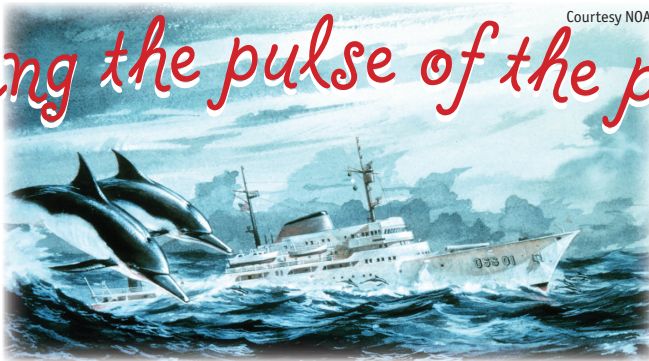

EXPLORE THE EARTH



Exploration is an important part of NOAA's focus on Earth's ecosystems. Ocean exploration in the United States began in 1807 when Thomas Jefferson authorized the Survey of the Coast. But today, after 200 years, about 95% of Earth's oceans are still unexplored—mainly because we haven't known how to handle the extreme cold and pressure of the deep ocean until very recently. Through NOAA's Office of Ocean Exploration and Research, modern pioneers are investigating parts of Earth's underwater world that have been virtually unknown and unseen. Such exploration may reveal clues to the origin of life on Earth, cures for human diseases, answers on how to achieve sustainable use of resources, links to our maritime history, and information to protect endangered marine species.

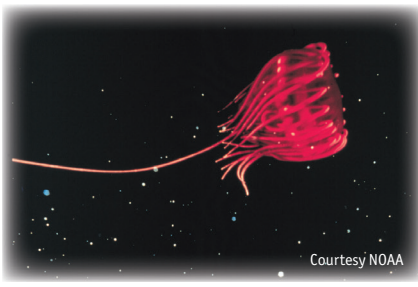

An exciting new project, the Global Earth Observation System (GOES), tells us a lot about the Earth and how it works. The basic idea is to combine information from thousands of sources that are already making observations about Earth to make people around the globe healthier, safer, and better equipped to manage basic daily needs. NOAA has partnered with more than 60 countries and the European Commission to make this idea a reality.

Learn more about NOAA's Exploration projects with these activities:

- Build an Underwater Robot
- Make Your Own Volcano
- Weird, Red, and Slightly Gross
- Do You Have Twisted Vision?
- Be A Shipwreck Detective!

and more!



Boat Building Challenge

Who were the first boat-builders?

No one really knows.

*The oldest known boats are dugout canoes constructed in China and South Korea around 6,000 B.C. But it's possible that the almost-human species Homo erectus used some type of boat **800,000 years ago!***

Since H. erectus are known to have made tools from bamboo, they may also have made rafts from the same material. But regardless of the materials and who used them, the basic principles that allowed the first boats to float are the same principles that operate on the most modern supertanker.



Egyptian tomb painting from 1450 B.C. showing officer with sounding pole. Officer is telling crew to come ahead slow. Engineers with cat-o'-nine-tails assure proper response from the "engines."
Courtesy NOAA.

What You Will Do

Design a boat hull that is able to float a specified weight.
Then, design a way to propel your vessel using wind power

What You Will Need

- Sheets of aluminum foil, 12 inches x 12 inches; one sheet for each hull
- 50 pennies for each hull
- Plastic or metal tub full of water, at least 24 inches diameter
- Foam plates
- Wooden skewers
- Poster board
- Hole punch
- Battery operated fan
- Masking tape
- Modeling clay

How to Do It

1. Fold a sheet of aluminum foil into a shape that will float in the tub of water and support the weight of ten pennies. Not sure how to do this? Read "What's Happening" for some clues.
2. Use another sheet of aluminum foil, pieces of foam plate, wooden skewers, and poster board to make a boat that will use sail power to carry ten pennies across the tub of water. The drawing below shows one way to cut and fold a piece of poster board to make a three-dimensional boat.

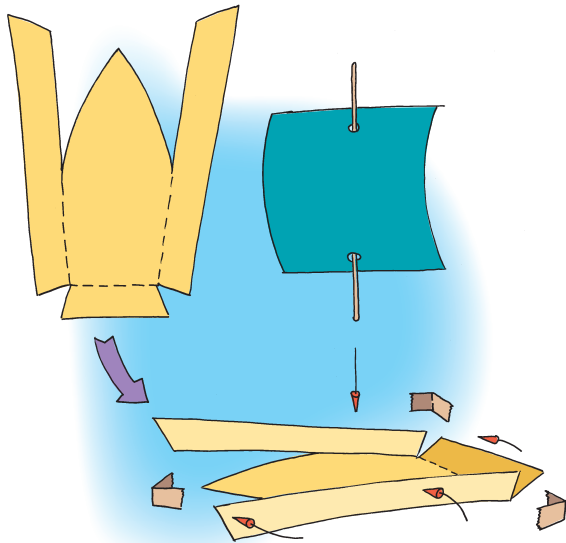

- Use masking tape at the corners of the bow (front of the boat) and stern (rear of the boat).

- Cut a sail out of heavy paper, and use the punch to make holes for the mast (wooden skewer).
- Use masking tape and/or modeling clay to help hold the mast onto the hull.
- To waterproof your boat, place it on top of a piece of aluminum foil, then fold the foil up and over the sides of the boat as shown below.

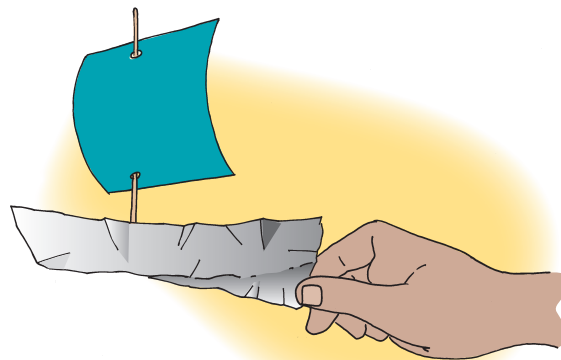
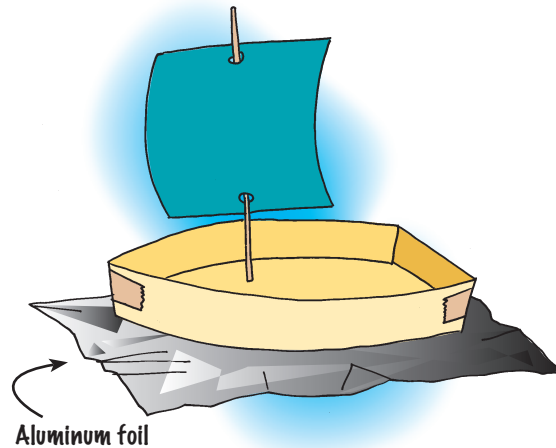

- Make a keel by pinching the aluminum foil to form a ridge that runs from front to back along the middle of the bottom of the boat. (See illustration below left.)
3. Now let's go for a sail! Place ten pennies in the boat, float the boat in a container of water, and use the fan as a source of wind to sail your vessel around the container.

Note: The pennies perform an essential function for sailing vessels: they provide weight in the hull, called "ballast," that keeps the boat from turning over when the wind presses against the sails.

Want to Do More?

Have a contest to see who can build a hull that will carry the most "cargo" (the greatest number of pennies), starting with the same materials. You can modify the contest to see whose can build the fastest sailing boat. You may want to experiment to find out whether it is better to use one large sail or several small sails to increase sailing speed, and whether triangular shaped sails or square sails give the best performance.

What's Happening?

Water tends to maintain a level surface. When you put an object into water, gravity pulls the object down and displaces some of the water, which means some of the water is pushed aside.

Now the surface of the water is no longer level. Gravity pulls the displaced water down, and causes an upward force on the object. This upward force is equal to the weight of the water that the object displaces, and is called buoyancy. Buoyancy depends upon the volume of liquid displaced as well as the density of the liquid. Density is the mass of a certain volume of liquid, usually stated as grams per milliliter. This is why it is easier to float in the ocean than in fresh water. Seawater is more dense than fresh water, so your buoyancy is greater in the ocean.

The amount of fluid that an object displaces depends upon the volume of the object: more volume means more fluid displaced, which

means more buoyancy. Increasing the volume of an object also increases its surface area, which in turn increases the effect of friction as the object moves through the fluid. Boat designers have to consider buoyancy as well as friction when deciding on the shape of a boat's hull. A boat designed for speed must have enough displacement to stay afloat, but surface area has to be minimized to decrease the effects of friction. On the other hand, an object designed to carry a heavy weight, such as a cargo ship, must be designed with greater displacement, as well as greater power to overcome the effects of increased friction.

Boat hulls are designed to displace a volume of water that weighs more than the boat and its cargo. If the force of displaced water pushing on the

hull is greater than the force of gravity pulling the boat down, then the boat floats! But if you could take a sea-worthy boat hull, break it down, and bundle the pieces together, the bundle will sink. Why? Because there is no longer sufficient water displacement to counteract the force of gravity on the pieces of the hull.

Visit www.sedl.org/scimath/compass/v02n03/boat.html and www.thirteen.org/edonline/nttidb/lessons/jx/buoyjx.html for more boat building challenge ideas.

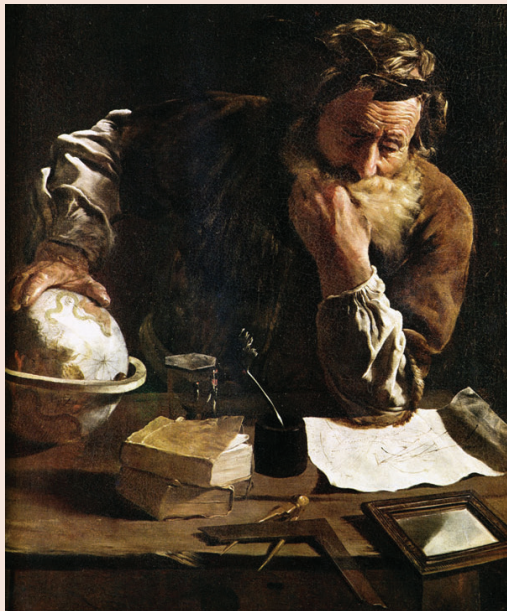

Portrait of Archimedes, by Domenico Fetti, about 1620

The Archimedes Principle

The idea of buoyancy was summed up by a Greek mathematician named Archimedes: any object, wholly or partly immersed in a fluid, is buoyed up by a force equal to the weight of the fluid displaced by the object. Today, this definition is called the Archimedes Principle.

Archimedes is considered one of the three greatest mathematicians of all time. The other two are Newton and Gauss. Archimedes was born in 287 B.C., in Syracuse, Greece. He was a master at mathematics and spent most of his time thinking about new problems to solve.

Many of these problems came from Hiero, the king of Syracuse. Archimedes came up with his famous principle while trying to solve this problem.

The king ordered a gold crown and gave the goldsmith the exact amount of metal to make it. When Hiero received it, the crown had the correct weight but the king suspected that some silver had been substituted for the gold. He did not know how to prove it, so he asked Archimedes for help.

One day while thinking this over, Archimedes went for a bath and water overflowed the tub. He recognized that there was a relationship between the amount of water that overflowed the tub and the amount of his body that was submerged. This observation gave him the means to solve the problem. He was so excited that he ran naked through the streets of Syracuse shouting "I have found it!". The goldsmith was brought to justice and Archimedes never took another bath...(just kidding!).

Make Your Own Astrolabe

The mariner's astrolabe is an ancient navigation instrument for measuring celestial altitude (celestial altitude is the "height" of a star, planet or other celestial object above the horizon). Celestial altitude is important to mariners, because it provides a way to estimate geographic latitude, which is a location's distance from the equator. Astrolabes were the most popular astronomical instrument for several centuries, but they eventually were replaced by quadrants, which today have been replaced by sextants.

What You Will Do

Make your own astrolabe, and use it to estimate the height of a tree, building, or other vertical object

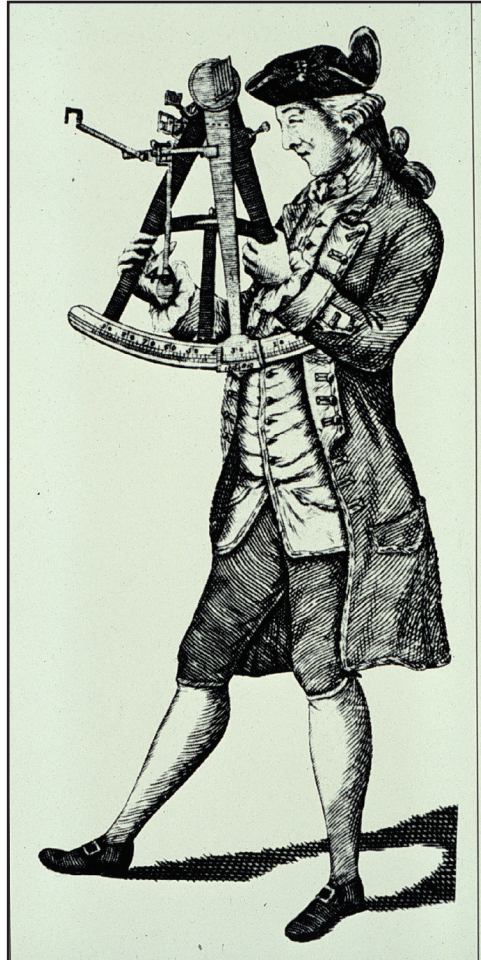

A mariner using a descendant of the astrolabe called an "octant." Courtesy NOAA

What You Will Need

- Stiff cardboard, file folder, or wood, approximately 8 inches square
- Tools for cutting the cardboard or wood
- Glue
- Drill with a 3/16 inch drill bit
- #8 Round head bolt (long enough to go through both pieces of the astrolabe), #8 nut, and three #8 washers
- Rope, string, or twine, about 12 inches long (the diameter of the rope isn't very important; about 1/8 inch is ideal)

Warnings

1. Drills and cutting tools are sharp! Get help from an adult and be careful!
2. Power saw blades and drill bits can shatter or throw scraps at high speed, possibly causing serious injury. Be sure to wear eye protection and follow other recommended safety precautions before using any power tools!

How to Do It

Optional: Before you start, you may want to search the internet for images of astrolabes (there are thousands!).

Astrolabe Template

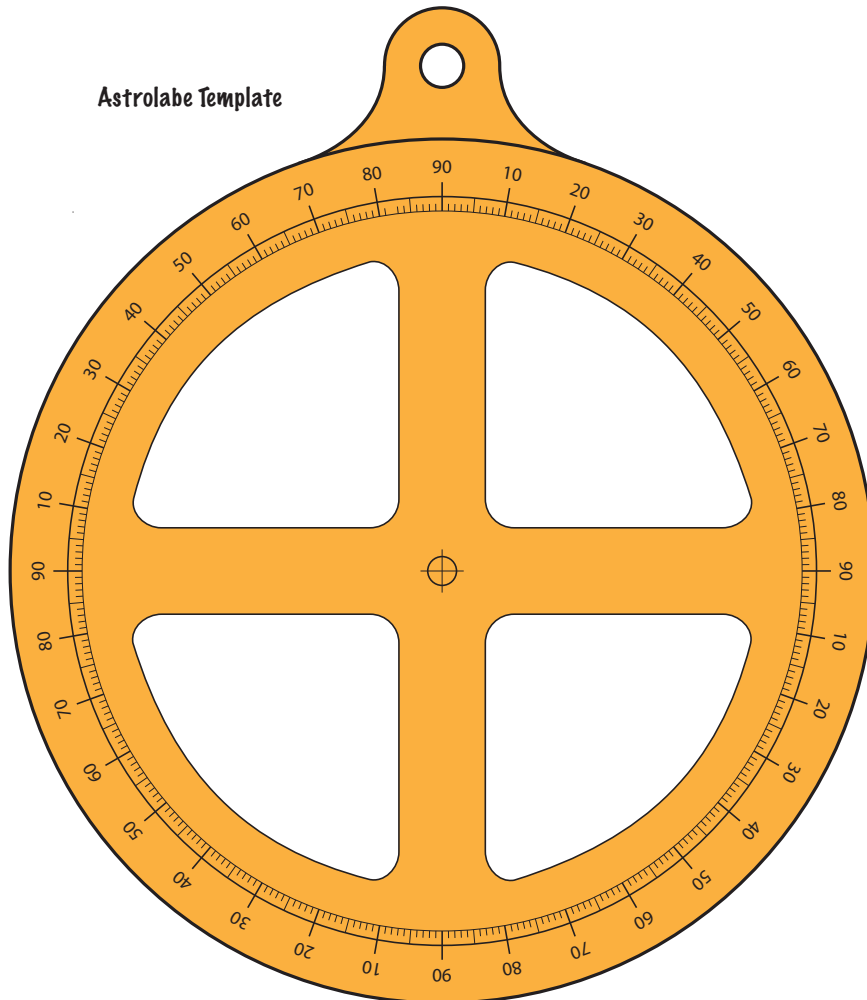

Sight Vane



1. Glue the "Astrolabe Template" onto a piece of wood or stiff cardboard. With help from an adult, cut out the two pieces of the astrolabe as closely to the lines as possible. It isn't essential to cut out the four pie-shaped pieces in the middle of the astrolabe, but it will be more authentic if you do (mariner's astrolabes had these pieces cut out to reduce wind resistance when the instrument was being used on ships).
2. Drill a $\frac{3}{16}$ inch diameter hole through the center of the astrolabe and sight vane. Assemble the two pieces with a #8 bolt, nut, and three washers (one washer under the head of the bolt, one between two astrolabe pieces, and one under the nut).

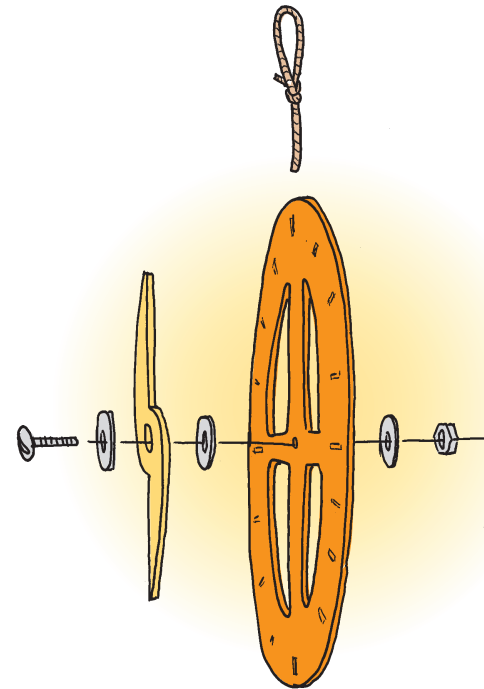

3. Tie a loop of rope, string, or twine through the hole at the top of the astrolabe.

4. To use your astrolabe, hold the instrument by the rope so that it hangs vertically. Line up the two ends of the sighting vane with the top of the object whose height you are measuring. Read the altitude of the object in degrees from the upper left or lower right scale on the astrolabe.

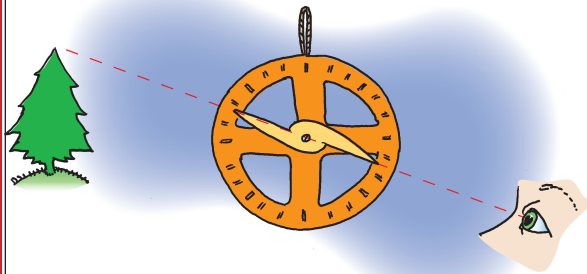

[NOTE: Notice that a horizontal object measures 90° on the upper left and lower right scales. This measurement is called “zenith distance” and is used on a mariner’s astrolabe to simplify latitude calculations.]

5. To find the height of a vertical object using your astrolabe:

a. Set the sight vane to 45° on the upper left or lower right scale.

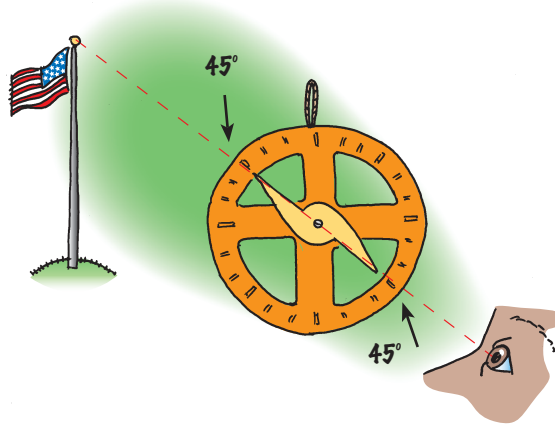

b. Hold the astrolabe so that it hangs vertically, and walk to a position at which the top of the object you want to measure is lined up with the two ends of the sight vane. Measure the height of the astrolabe above the ground.

c. Measure or pace the distance to the base of the object. Add this distance to the height of the astrolabe above the ground. The sum is equal to the height of the object.

Knowing the length of your pace can be useful for many things. Back in the day, a pace meant the distance traveled when you took TWO steps. For most people, this works out to be about 5.25 feet. So 1,000 paces is about equal to one mile. Find the length of your pace by walking 20 steps and measuring the distance covered. This distance divided by 10 is the length of your pace.

Want to Do More?

- Check out www.astrolabes.org/ for examples of astrolabes made by individuals. You may also want to watch the NOVA program, *Lost at Sea: The Search for Longitude* (available from public libraries and from www.pbs.org/wgbh/nova/novastore.html).
- Sometimes you won't be able to get far enough away from an object to line up the ends of the sight vane when it is set to 45° . You can still use the astrolabe to find height, but will have to use a little trigonometry (don't worry, it isn't really very hard). Here are the basic things you need to know:
 - A “right triangle” has two sides that meet at an angle of 90° .
 - The side of the triangle opposite the 90° angle is called the hypotenuse.

c. The tangent of one of the other angles is defined as the length of the side opposite the angle divided by the side closest to the angle (NOT the hypotenuse).

So, in the drawing below, the tangent of angle a is equal to side A divided by side B. A shorthand way to write the last sentence is:

$$\tan a = A \div B$$

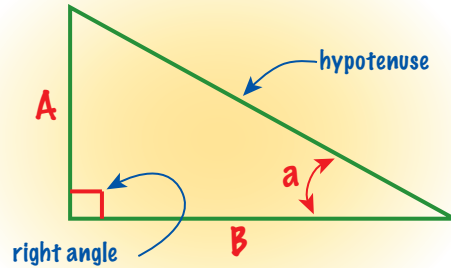

Now, we can find the height of the flagpole in the drawing to the right.

The height of the flagpole is side A plus "H" which is the height of your eyeball above the ground.

The tangent of angle a is equal to side A divided by side B. Written in the shorthand way:

$$\tan a = A \div B$$

Using Trigonometry and Your Astrolabe to Find the Height of an Object

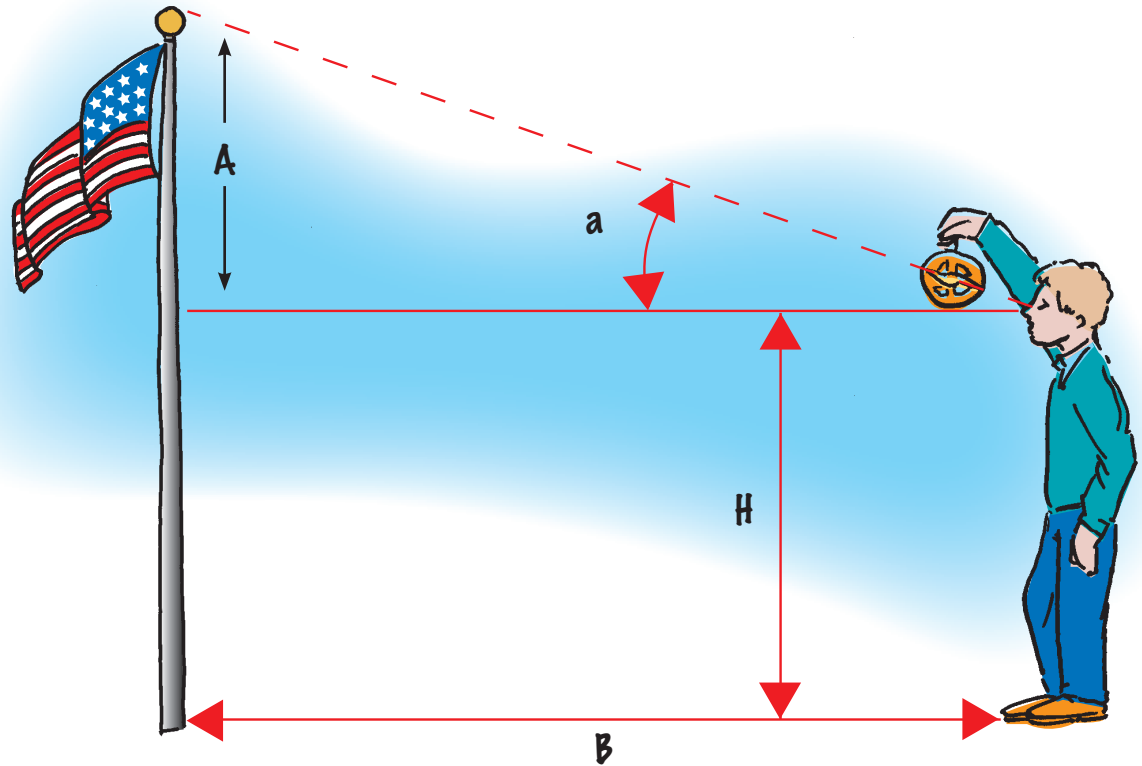

Suppose angle a is equal to 60° and side B is 50 feet. Then,

$$\tan 60^\circ = A \div 50 \text{ feet}$$

You can find tangents on many calculators, and in tables from trigonometry books and on the internet. The tangent of 60° is 1.73. So,

$$1.73 = A \div 50 \text{ feet}$$

So, A is equal to 1.73 multiplied by 50, which is 86.5 feet

The height of the flagpole is side A plus "H" which is the height of your eyeball above the ground. If H is equal to 4.5 feet, the height of the flagpole is:

$$86.5 \text{ ft} + 4.5 \text{ ft} = 91 \text{ feet}$$

Make Your Own Compass

"When neither sun nor stars appeared for many a day, they gave up hope. This was a terrible handicap to them because these ancient navigators had no compass nor any other instrument. The only way they could guide the ship was by the sun and stars. When they could not see them for many days they lost all knowledge of their whereabouts. They were drifting helplessly before a howling gale in the midst of a turbulent sea with no idea where they were headed."

~ from *God and Shipwrecks* by Ray C. Stedman

www.raystedman.org/new-testament/acts/god-and-shipwrecks

One of the most important improvements to ocean navigation was the invention of the compass. There is some disagreement about who should get credit for this invention. It's pretty clear that the Chinese knew about magnetism as early as 2637 BC, but the first written description of a compass for navigation didn't appear in Europe until 1190. Why did it take so long? After you do this activity, you may have at least one good answer!



North Pacific storm waves as seen from the M/V NOBLE STAR, Courtesy NOAA

What You Will Need

- Sewing needle about one to two inches long
- Small bar magnet or refrigerator magnet
- A small piece of cork (corks from wine bottles work well, but not the plastic stoppers)
- A small glass or cup of water to float the cork and needle
- Pair of pliers

What You Will Do

Make a simple compass to find magnetic north or south, depending on where you live

Warnings

1. Needles are sharp. Be careful!
2. Magnets can damage cards with a magnetic stripe (credit cards, library cards, school IDs, etc), floppy disks, and some electronic devices. Keep magnets away from these things.

How to Do It

1. Rub a magnet over the needle a few times, always in the same direction. This action magnetizes the needle.

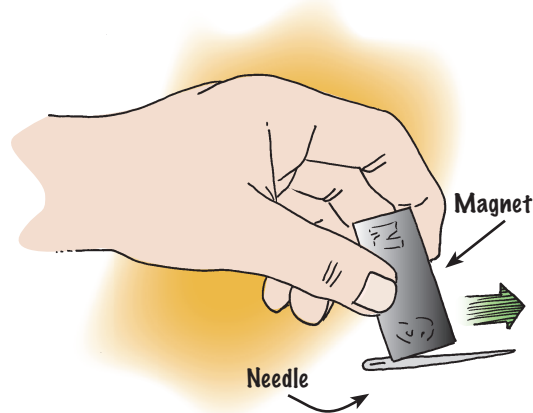

2. Cut off a small circle from one end of the cork, about 1/4-inch thick. Lay the circle on a flat surface.

3. Using a pair of pliers, carefully poke the needle into one edge of the circle and force the needle through the cork so that the end comes out the other side. Push the needle far enough through the cork so that about the same amount of needle is sticking out each side of the cork. Be careful not to stick yourself!

4. Fill the glass or cup about half full of water, and put the cork and needle assembly on the surface of the water.

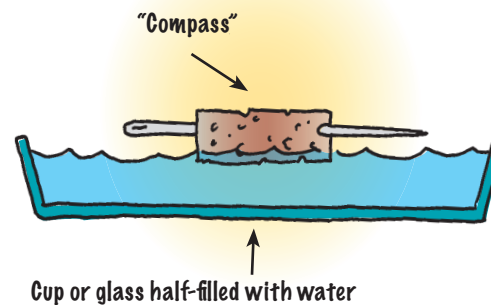

5. Place your "compass" on a flat surface and watch what happens. The needle should point towards the nearest magnetic pole — north or south, depending upon where you live.

6. Try placing a magnet near your compass and watch what happens. How close does the magnet have to be to cause any effects? Try this again with a nail or other steel object. You can see why it's important to keep metal objects away from compasses on ships!

7. Imagine you are on the deck of a ship tossing back and forth on the open ocean. How well do you think your compass would work? When the cork floats on the water it creates a sort of low-friction bearing. This kind of bearing is essential to allow the needle to rotate in response to Earth's magnetic field. But a cup of water probably wouldn't last long on the deck of a rolling ship! The need for a sturdy low-friction bearing was one of the reasons that it took a long time for mariners to use compasses at sea, even though the basic principles had been known for centuries.

What's Happening

Magnetic fields are areas that contain a force created by moving electrical charges. Earth produces a magnetic field. This field is very weak, but it is sufficient to align magnetized objects—such as your needle—that are free to rotate. By floating the needle on the cork, you allow it to rotate freely so the needle becomes lined up with Earth's magnetic field, and points toward the north or south pole of the planet.

Tied Up In Knots

“Topmen, aloft!” sang out the commodore in a piercing voice that rose above the screaming wind and roar of the sea. “Take in the topgallants and royals!”

We all raced aloft; but no sooner had these sails been furled and we returned to the deck than the commodore was at us again.

“Reef topsails!” he shouted even louder than before. “Away aloft—take in one reef!”

Mick and I scrambled up, almost out of breath, into the mizzen-top; which we hardly reached before we heard the commodore give the next order necessary to enable us to take in the reef—

“Weather topsail braces, round in! Lower the topsails!”

~ from *Young Tom Bowling* by J.C. Hutcheson, 1896.

Do you know how to tie a reef knot? A sailor's life and the safety of the entire crew and ship can depend on the quality of knots he ties. Sailors take pride in being able to match the right knot to a specific job, and even modern sailors need to master this skill.



“In the rigging”. In *The South Pole*, by Roald Amundsen, 1872-1928.
Archival Photograph by Mr. Steve Nicklas, NOS, NGS. Courtesy NOAA

What You Will Do

Learn to tie some basic knots that have been used by mariners for centuries and are often useful in everyday life

What You Will Need

- One or more pieces of rope, about 3 feet long; nylon, polypropylene, manila, or cotton ropes, 1/4-inch to 1/2-inch in diameter work well
- Pictures or video showing how to tie knots

How to do It

There are three different types of “knot.”

- A **Bend** is used to join two ropes (often of different diameters), or to fasten a rope to an eye, ring, or other structure. *Examples: sheet or becket bend; anchor bend*
- A **Hitch** is designed to stay in place under strain, but remain easily adjustable when the strain is removed. *Examples: clove hitch, half hitch, rolling hitch*
- A **Knot** is used to fasten ropes together, or to fasten a rope to an object, or to enlarge the end of a rope (as in a stopper knot.) A stopper knot is usually tied at the end of a rope to prevent the line from slipping through an eye, ring, or pulley. A good knot must be able to be easily untied. *Examples: bowline, reef (square) knot, overhand knot, figure eight knot*

Five Useful Knots

Bowline

Uses: Forms a loop at the end of a rope that will not slip (close up) when the rope is under tension. This knot is easy to untie, even after it has been under high strain.

How to Tie It: Be sure the free end of the rope lies inside the loop when the knot is completed.

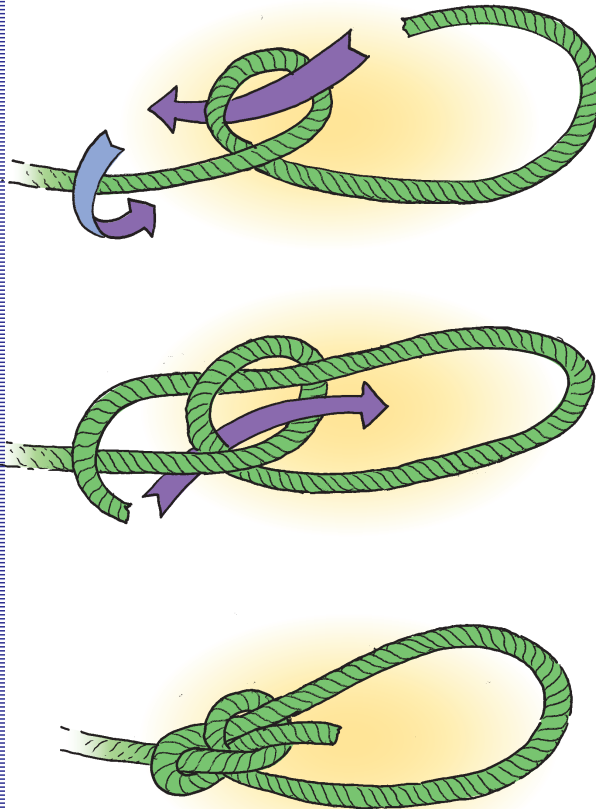
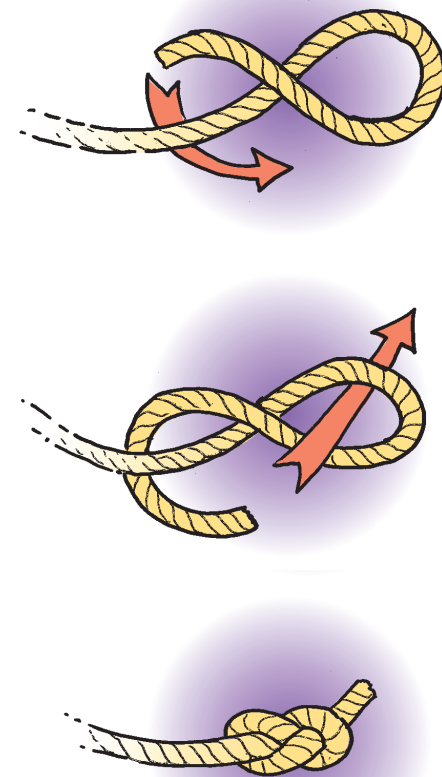

Figure Eight

Uses: A “stopper” used to prevent the end of the rope from slipping through a pulley. Also used in mountain climbing to secure a rappelling line to a climbing harness.

How to Tie It:



Clove Hitch

Uses: Used to secure a line to a round object such as a post or rail.

How to Tie It:

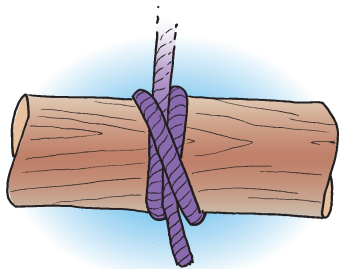
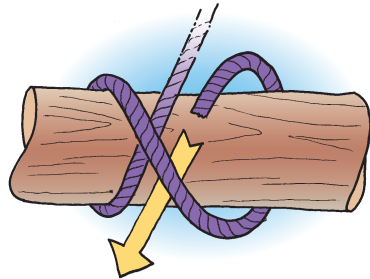
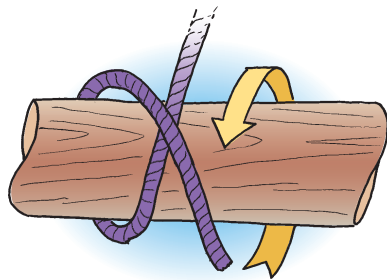

Reef Knot (Square Knot)

Uses: Used for lashings and other situations where a line must be tied around an object, but should NEVER be used as a bend to tie two ropes together. "Reefing" a sail means to make the sail smaller by partially folding or "furling" the sail. A Reef Knot is used to tie the sail in a partially folded position.

How to Tie It: If you grab one of the free ends and jerk it across the knot, the knot will "capsize" and slip apart easily.

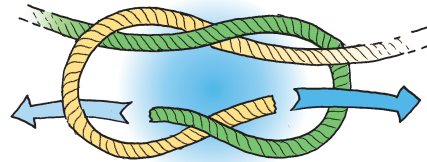
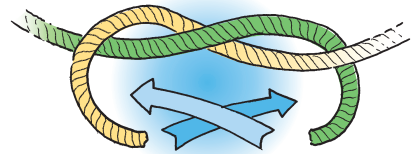

Sheet Bend

Uses: One of the best bends for joining two ropes together, especially if the ropes do not have the same diameter.

How to Tie It: The rope with the larger diameter should be used for the loop.

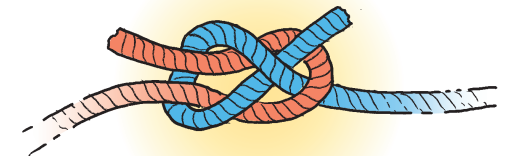
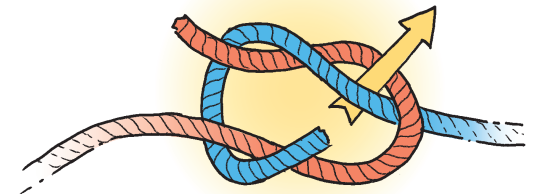
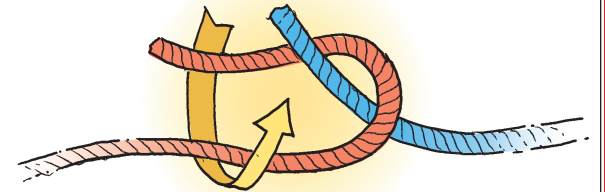

Turn Your Knot Tying Skill into a Game:

Organize a knot tying race. Give each contestant five pieces of rope, and see who will be first to correctly tie all five knots. If one knot is wrong, the contestant loses. If this seems harsh, remember that a single badly tied knot can be disaster for mariners at sea.

Want to Know More?

There are lots of books on knot tying and ropecraft. Two very good ones are: *Knotcraft: The Practical and Entertaining Art of Knot Tying* by Allan and Paullette Macfarlan; Dover Craft Books, 1983

The Arts of the Sailor – Knotting, Splicing and Ropework by Hervey Garret Smith; Dover Publications, reprint edition

You can find animated knot tying instructions at www.animatedknots.com/indexbasics.php

Another Web site with instructions for tying many different knots is: www.2020site.org/knots/

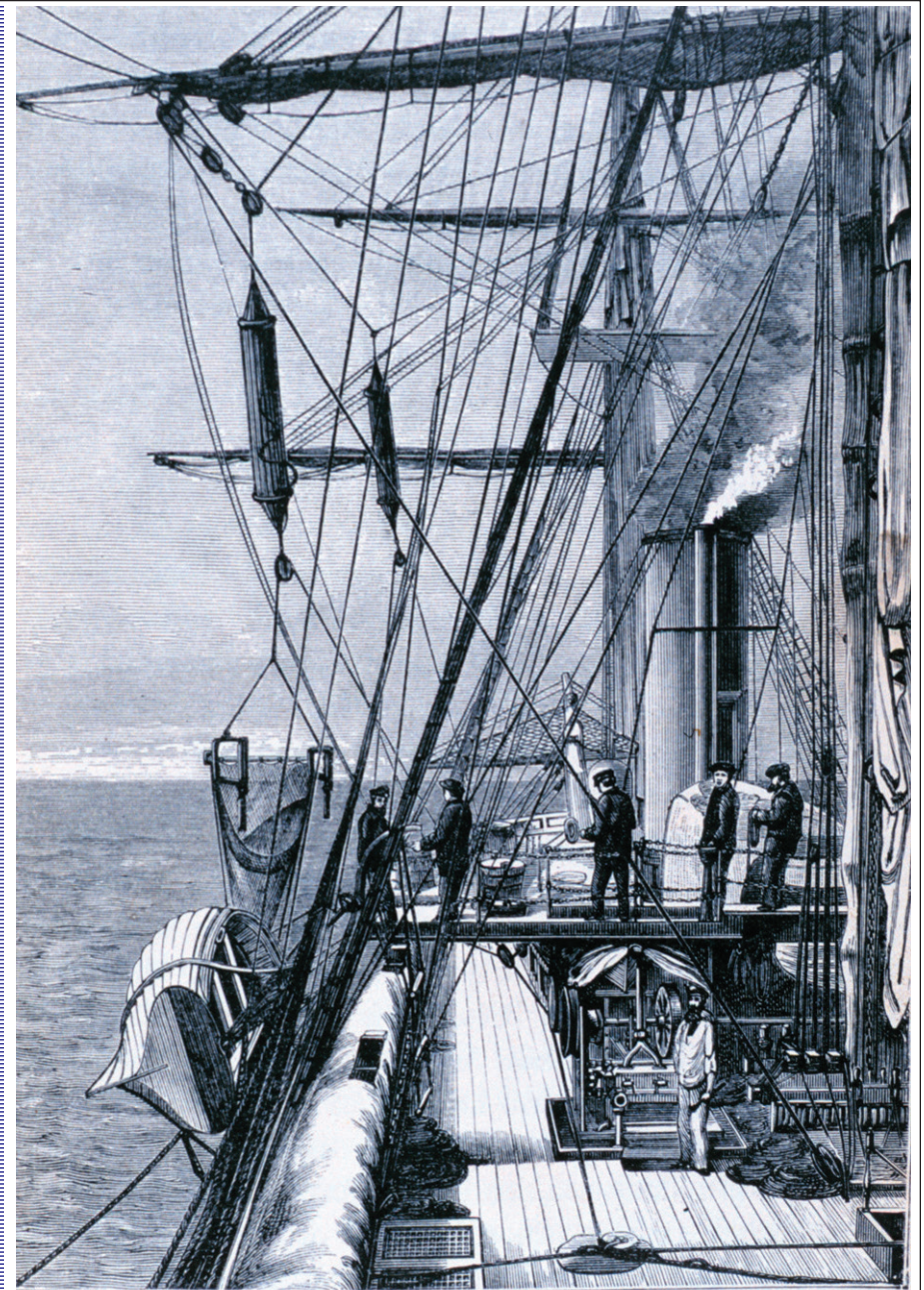

The dredging and sounding arrangements on board the CHALLENGER. In *The Voyage of the CHALLENGER - The Atlantic* Vol I, by Sir C. Wyville Thomson, 1878. Archival Photography by Steve Nicklas, NOS, NGS. Courtesy NOAA

FIG. 17.—The Dredging and Sounding Arrangements on board the 'Challenger.'

WHO'S BLUE PETER?

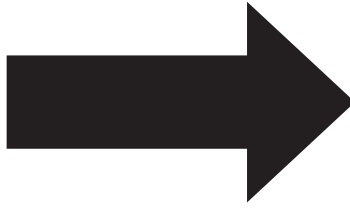

“The Gallant Frigate Amphitrite, she lay in Plymouth sound;
Blue Peter on the foremast peak for we were outward bound.
We were waiting there for orders to send us far from home;
When the orders came for Rio, and then around Cape Horn.”

~ from *The Gallant Frigate Amphitrite, a traditional sea shanty*
(This tune is available in MIDI format at
www.traditionalmusic.co.uk/song-midis/Rounding_the_Horn.htm)



The CHALLENGER at St. Paul's Rocks. In *The Voyage of the CHALLENGER - The Atlantic Vol I*, by Sir C. Wyville Thomson, 1878. Archival Photography by Steve Nicklas, NOS, NGS. Courtesy NOAA

Who—or what—do you think Blue Peter is?

Traditionally, Blue Peter is the nickname given to the nautical signal flag that represents the letter “P.” When communicating with signal flags, each letter of the alphabet has a specific meaning. The letter “P” means “All persons should report on board as the vessel is about to proceed to sea.” So when a ship is flying Blue Peter, everyone knows that its voyage is about to begin.

International code flags are still used to communicate between ships and between ship and shore. The colors used on nautical signal flags are chosen because red, blue, yellow, black, and white are colors that can be most easily distinguished at sea. Signals may use one or more flags to communicate a particular message. One-flag signals are used for very urgent or very common signals.

Two-flag signals are used to provide more specific information, particularly in emergency situations or when maneuvering a vessel. Three-, four-, five-, six-, and even seven-flag signals are used to convey other types of information. Sometimes, when a “standard” signal won’t work, flags may be used to spell out individual words.

What You Will Do

Make a set of nautical signal flags,
and use the flags to send messages

What You Will Need

- White poster board or white cloth
- Colored markers
- Two pieces of string or light rope (1/8-inch diameter or less), long enough to loop over a tree limb or other object that will allow you to hoist your flags
- One or two copies of "Table of Single Letter Signals"
- Scissors to cut poster board or cloth
- Ruler and compass (or round object such as a bowl or can)
- Note pads and pencils

How to Do It

1. Cut out 26 rectangular pieces of poster board or cloth, about 8 inches x 10 inches. Cut one triangular pennant, shaped like this:

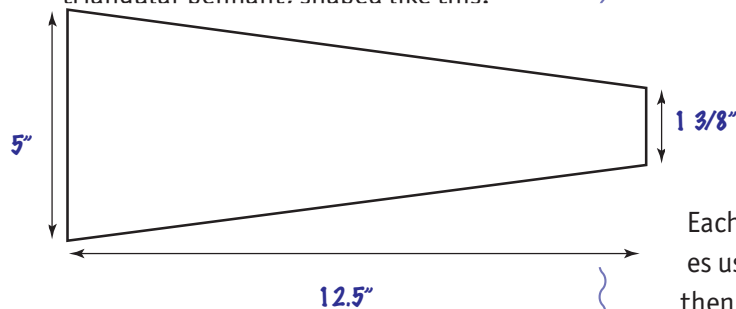

2. Use your ruler and compass (or round object) to draw the shapes needed for each flag shown in the "Nautical Signal Flags" illustration.
3. Use markers to color your flags as shown in the illustration.

4. Make holes in the left side of your flags to attach the string or rope.
5. Loop the strings or ropes over tree limbs or other objects that will allow you to raise and lower your flags.
6. If you have four or more people, you can have a competition. Each team should have a signalling crew and a receiving crew at least 20 feet away. Each crew should have a string or rope (called a "halyard") looped over a tree limb or other object that will allow the crew to hoist their signals. The signalling crew should have a complete set of alphabet flags, and the receiving crew should have an answering pennant.

Each team should make a list of ten messages using the "Table of Single Letter Signals," then give their list to the other team's signalling crew. The receiving crews are not allowed to look at the lists!

7. On the "Go" signal, each signalling crew raises the flag corresponding to the first message on their list. As soon as the receiving crew understands the message, they should write

the message on a note pad and raise their answering pennant. Then the receiving crew lowers their flag, and replaces it with the flag for the next message.

When the receiving crew understands a signal, they hoist their answering pennant as far up as the halyards will go. At this point, the pennant is said to be "close up." Then, when the signalling crew lowers their signal, the receiving crew lowers their pennant about halfway down. Now the pennant is said to be "at the dip," and is held in this position until the next signal is understood.

The first team to correctly send all ten messages wins!

Want to Do More?



























1. You can download the entire International Code of Signals from www.seasources.net/PDF/PUB102.pdf
2. See www.marine waypoints.com/learn/flag-trans/flags.shtml for a Web page that automatically translates text into flag signals.

Single Letter Signals

- A** I have a diver down; keep well clear at slow speed.
- B** I am taking in, or discharging, or carrying dangerous goods.
- C** Yes
- D** Keep clear of me; I am maneuvering with difficulty.
- E** I am altering my course to starboard.
- F** I am disabled; communicate with me.
- G** I require a pilot. When made by fishing vessels, this signal means "I am hauling nets".
- H** I have a pilot on board.

- I** I am altering my course to port.
- J** I am on fire and have dangerous cargo on board: keep well clear of me, or I am leaking dangerous cargo.
- K** I wish to communicate with you.
- L** You should stop your vessel instantly.
- M** My vessel is stopped and making no way through the water.
- N** No
- O** Man overboard.
- P** All persons should report on board as the vessel is about to proceed to sea.

- Q** My vessel is "healthy" and I request permission to proceed into port.
- S** I am operating astern propulsion.
- T** Keep clear of me; I am engaged in pair trawling.
- U** You are running into danger.
- V** I require assistance.
- W** I require medical assistance.
- X** Stop carrying out your intentions and watch for my signals.
- Y** I am dragging my anchor.
- Z** I require a tug.

A Alfa		F Foxtrot		K Kilo		P Papa		U Uniform		Z Zulu	
B Bravo		G Golf		L Lima		Q Quebec		V Victor		 Answer	
C Charlie		H Hotel		M Mike		R Romeo		W Whiskey			
D Delta		I India		N November		S Sierra		X X-ray			
E Echo		J Juliet		O Oscar		T Tango		Y Yankee			

The Water Writers

“At about 9 p.m., I felt the vessel graze the bottom... I grabbed my cap, and rushed up the steps leading to the spar deck...and immediately afterward heard the most dreadful and agonizing sounds as the ship hurled herself on the reef...The call of the boatswain: ‘All hands prepare to abandon ship,’ I heard above all of this din. I could hardly walk the decks; the pounding and jumping of the ship swaying me from side to side.”

~ from Capt. R. O. Crisp on the loss of the revenue cutter *Tahoma* after hitting an uncharted reef on the south side of the Aleutian Islands, Alaska on September 20, 1914 (www.uscg.mil/history/webcutters/Tahoma_1909.asp)

If Alaska had been a U.S. state in 1914, the reef that wrecked the *Tahoma* might have been on Captain Crisp’s navigation charts. This is because more than a hundred years earlier, in 1807, President Thomas Jefferson established the Survey of the Coast to chart the U.S. coastline to make the coasts of our nation safe for navigation. A top priority of the Coast Survey was (and is) to create charts that show the shape of the coasts, currents, and the depth of coastal waters. Gathering information needed for these charts is called “hydrography,” and people who do this work are known as “hydrographers” (“hydro” means water, and “grapher” is one who writes).

Today, hydrographers working for NOAA’s Office of Coast Survey continue the work begun by the Survey of the Coast. These scientific nomads travel around the coasts collecting information needed for up-to-date charts that guide ships in and out of U.S. ports. The most basic job of hydrographers is taking measurements of water depth (called “soundings”).

What You Will Do

Make a sounding box and discover the profile of a model seafloor



Courtesy NOAA

Sounding party off USCS Brig FAUNTLEROY. 1857-Earliest picture of Coast Survey sounding operations. Watercolor by James Madison Alden, nephew of Lieutenant Commanding James Alden.

Modern hydrographers use sidescan and multibeam sonar and satellite-based global positioning systems (GPS) to produce very detailed pictures of the sea floor. For many years though, hydrographers used lead lines to make depth measurements. A lead line is a rope or line with a 10-pound lead weight attached to the end. The hydrographer lowers the line into the water until the weight reaches the bottom. Markings on the line show how much line has been let out, which is equal to the depth of the water. Depth soundings made with lead lines are accurate, but they take a lot of time and only give information about single points of the sea bottom—so many lead line measurements are needed to accurately survey a given area.

Here’s a way to get a feel for hydrographic surveying with a lead line—and you don’t even have to get your feet wet!

What You Will Need

This activity is most challenging if you have one or more friends who also make a sounding box and set up a model seafloor inside the box. Then you can trade sounding boxes and compete to see who can discover everything on an unknown seafloor.

For each sounding box you will need:

- A shoebox or other cardboard box that is about 2 inches to 4 inches high
- A replaceable air conditioner filter large enough to cover the box
- A wooden skewer about 4 inches longer than the height of the sounding box
- A ruler
- A felt tip marker
- A copy of the “Sounding Box Plotting Sheet”
- A pencil
- Small objects such as Lego® blocks, toy vehicles, rocks, modeling clay, etc.
- Masking tape
- Rubber cement

How to Do It

1. Use masking tape or rubber cement to fasten small objects to the inside bottom of the cardboard box.
2. Mark the sides of the air conditioner filter at 1/2-inch intervals as shown in the “Air Conditioner Filter Grid” drawing.

Label the horizontal lines with numbers, and vertical lines with letters as shown.

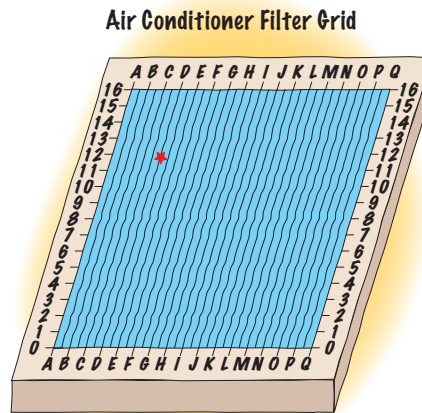

3. Mark your wooden skewer every 1/4-inch with a felt-tip marker. If you have colored markers, you can use a different color to mark one-inch and two-inch intervals as shown on the “Sounding Skewer Marking” diagram. This makes it easier to tell how deep the skewer is when you take “soundings.”

Skewer Marked in 1/4" intervals

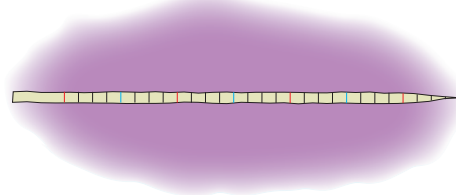

4. Fasten the air conditioner filter to the cardboard box with masking tape so no one can see inside the box.

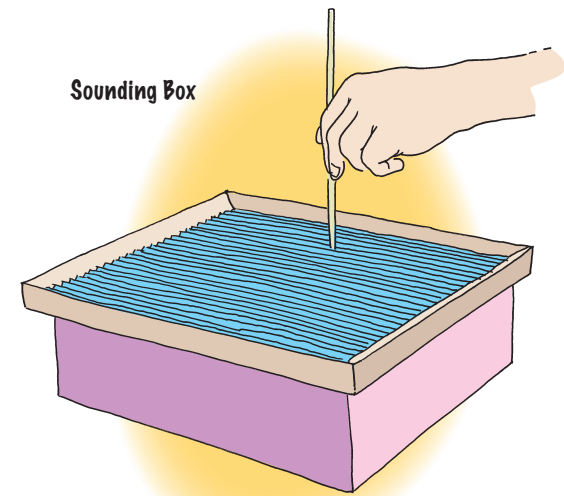

5. Now it's time to be a hydrographer! Use a ruler and the grid on the air conditioner filter to locate specific spots for “soundings.” Take “soundings” by gently pushing the skewer through the air conditioner filter until the skewer hits bottom. Read the “depth” on the skewer, and record this measurement in the place on the “Sounding Box Plotting Sheet” that matches the sampling location on the air conditioner filter grid. For example, the red star on the “Sounding Box Plotting Sheet” matches the location of the red star on the “Air Conditioner Filter Grid” drawing. If your sounding box is less than 10 inches x 10 inches, you won't use all of the grid squares. If it is larger than 10 inches x 10 inches, add more horizontal and vertical lines to the Plotting Sheet.

6. Continue making soundings until you think you have a clear picture of the model seafloor. Outline the features of the model seafloor on the Plotting Sheet, then remove the filter from the top of the box and see how well your Plotting Sheet compares with the actual "seafloor."

Want to Do More?

Check out these books at the library:

The Coast Mappers by Taylor Morrison

Mapping the Seas by Walter Oleksy

Maps and Globes by Harriet Barton

The Story of Maps and Navigation (Signs of the Times) by Anita Ganeri

Small Worlds: Maps and Map Making by Karen Romano Young

You may also want to visit these Web sites:

NOAA's Office of Coast Survey homepage:

nauticalcharts.noaa.gov

NOS's hydrographic survey page: oceanservice.noaa.gov/facts/hydrography.html

Take a look at historical maps and charts: www.nauticalcharts.noaa.gov/csdl/ctp/abstract.htm

Try a nautical chart scavenger hunt!

oceanservice.noaa.gov/education/nautical_charts/scavengerhunt.html

Sounding Box Plotting Sheet

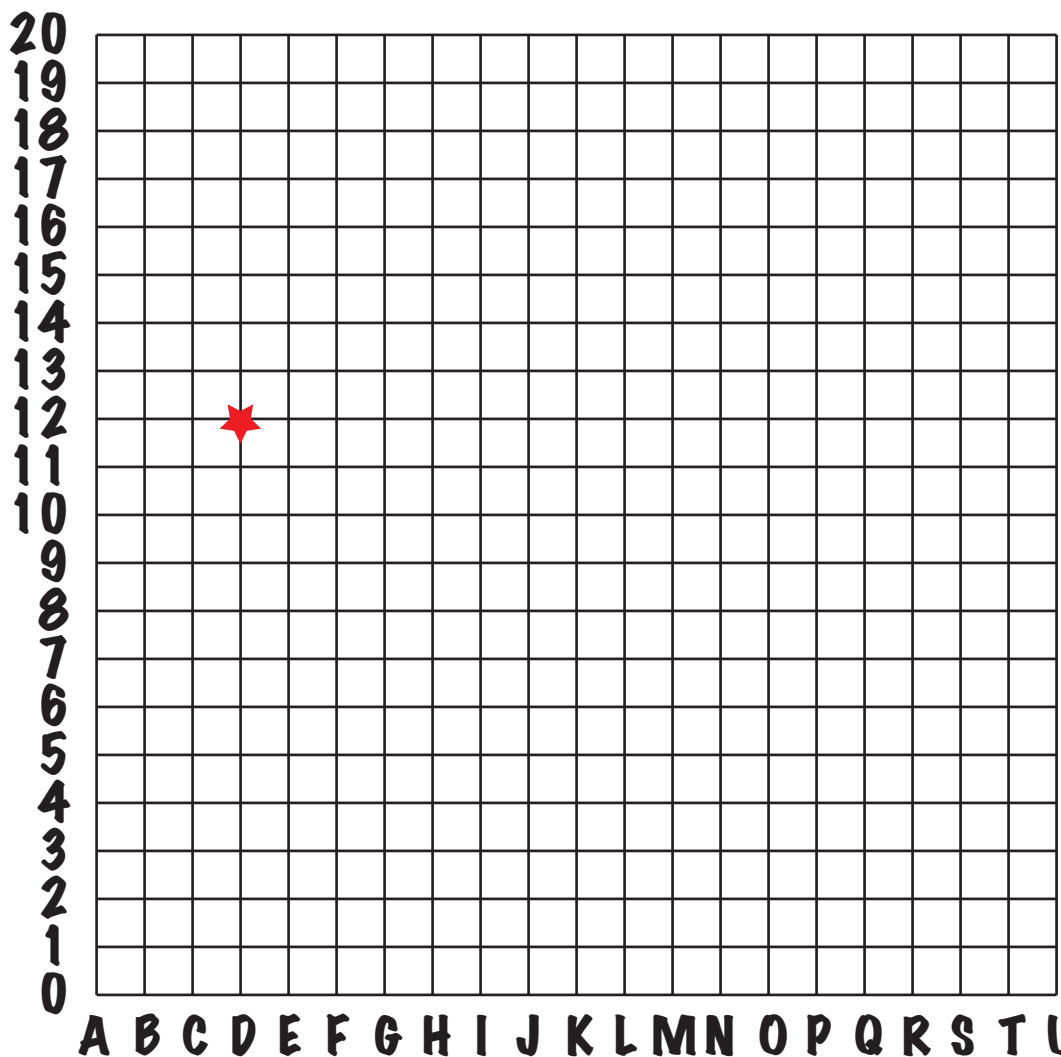

Nautical Chart Challenge

For as long as anyone in his family could remember, Francis Beaufort wanted to make scientific observations from the deck of a ship. In 1789 at the age of fourteen, he set sail as a sort of officer-in-training aboard the *Vansittart*, an East India Company tradesman bound for China and the Indies. A central goal of the *Vansittart*'s journey was to survey the Gaspar Strait, where sister ships of the East India Company had been lost on dangerous and poorly charted shoals.

The *Vansittart* found the shoals...by running hard aground, and taking on water so rapidly that the crew was forced to abandon ship on a tiny reef in the Java Sea. The waters were filled with pirates, so the crew threw thirteen treasure chests overboard, hoping to return later to reclaim them. But when they eventually made their way back aboard two British ships, Malay pirates had burned and pillaged the *Vansittart* and the crew managed to recover only three of the treasure chests.

~ based on *Defining the Wind: The Beaufort Scale, and How a 19th-Century Admiral Turned Science Into Poetry* by Scott Huler, 2004

What You Will Do

Discover some of the ways a nautical chart can help a mariner safely navigate in unfamiliar coastal waters

The sinking of the Vansittart provided dramatic evidence of the value of an accurate nautical chart, and Francis Beaufort later became one of history's premier hydrographers. Today, NOAA's Office of Coast Survey produces accurate nautical charts and many other navigational aids that help mariners navigate safely in and out of U.S. ports and along the U.S. coastline as far as 200 nautical miles from shore. How important is ocean navigation? You may be surprised to know that even in the "space age," over 98% of the nation's cargo is carried by waterborne transportation.

Here's a chance to try your hand at coastal navigation using a modern nautical chart. Watch out for shoals!

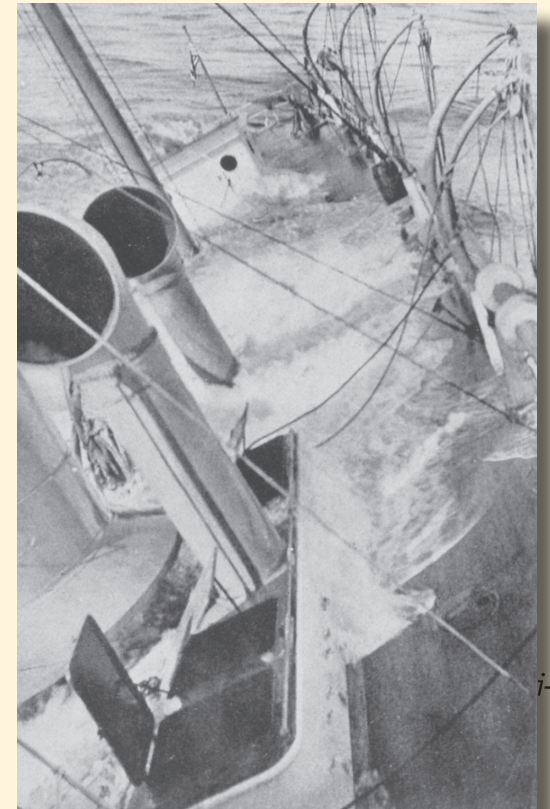

Wreck of U.S. Revenue Cutter *TAHOMA* which struck an uncharted pinnacle rock off Agattu Island, western Aleutians, September 20, 1914. Courtesy NOAA Ship Collection

What You Will Need

- ☐ "Segment of NOAA Nautical Chart 11445, Bahia Honda Key to Sugarloaf Key"

How to Do It

- Before beginning your cruise, you need to know a few things about nautical charts. Most charts contain A LOT of information, including lights, buoys, wrecks, information about the sea bottom, shoreline features, water depth, and much more. These features are often very close together, so charts use many symbols and abbreviations. A complete list of these symbols is available in a booklet known as "Chart No. 1," which can be downloaded from www.nauticalcharts.noaa.gov/mcd/chartno1.htm (the file containing the entire publication is 85 Mb, but smaller files containing specific kinds of information are also available). Here are a few basics:
 - The compass rose is a tool provided on all nautical charts to simplify the process of measuring directions. On the sample chart, the compass rose is near the upper center of the chart. The most commonly used reference point for direction on nautical charts is Earth's geographic north pole ("true north").
 - Depths on nautical charts are shown as many small numbers scattered over water areas. Depths indicated by these numbers are expressed in feet, fathoms (one fathom is equal to six feet), or meters. Contour lines (called "depth curves") connect points of equal depth, typically 6, 12, 18, 30, 60 and multiples of 60 feet. It's important to remember that depths shown on charts are average depths, so the actual depth at a given location may be less than that shown on the chart.
- The general rule for coastal navigation is "red, right, returning." This means that red markers, lights, or buoys should be on the right side of a vessel when coming into port. There are many exceptions to this general rule, though, so it is essential to have a chart that shows the arrangement of markers for a specific part of the coast.
 - In shallow water, markers are often flat "signs" fastened to wood or metal stakes. Red markers are usually triangular, and green markers are square. These markers are shown on a chart by red triangles and green squares, and usually have a number that also is shown on the chart.
 - Buoys are shown on nautical charts by diamond-shaped symbols and a small open circle that indicates the location of the buoy.
 - Red buoys are printed in magenta and often have the letter "R" nearby.
 - Green buoys are printed in green with the letter "G" nearby.
 - A number in quotation marks is the number painted on the buoy's structure.
 - Lighted buoys are indicated by a magenta disk printed over the small circle that marks the buoy's position.
 - The shape of unlighted buoys is normally shown by a letter. "C" indicates a "can" buoy whose top has a cylindrical shape
 - "N" indicates a "nun" buoy whose top is shaped like a cone with the pointed end cut off (this is called a "truncated" cone).
 - Lights on nautical charts are all shown by a magenta symbol that looks like an exclamation point and a black dot indicating the light's position. Notes alongside these symbols describe the color of the light and how it flashes. Some commonly used abbreviations are:
 - Q: A light flashing at a rate of not less than 60 flashes per minute
 - R: A red light.
 - G: A green light
 - If no color is indicated for a light, it is understood to be a white light.
 - Numbers next to the symbol for a light show the height of the light.

- If numbers are inside quotation marks, this number is painted onto the light structure.
- Numbers followed by the letter “M” show the approximate range of visibility of the light in miles.

For example:

Q R 16ft “6” 9M
 indicates a red light, 16 ft high, flashing at a rate of not less than 60 flashes per minute (“quick flashing”), with the number “6” painted on the structure, with a visibility of about 9 miles

2. Now it’s time to take the Chart Challenge!

We will use part of NOAA Nautical Chart 11445, which includes the Florida Keys from Bahia Honda Key to Sugarloaf Key. Suppose you are the captain of a 24-foot fishing boat, and are taking some friends around the Keys. As the captain of a vessel, it is very important to know how much water is under your boat (underkeel clearance). This can vary depending on how much cargo you are carrying (or in this case, how many friends are aboard). Let’s say that your boat draws 2 feet, which is another way of saying that the bottom (keel) of your boat is two feet below the surface. So, you’ll need to subtract two feet from the depths indicated on the chart to find your underkeel clearance.

- You and your friends board your boat at the dock in Doctors Arm Bay on Big Pine Key (to the right of the compass rose). What kind of markers show the location of this dock?
- After casting off from the dock, you steer southeast into Bogie Channel. What is the maximum depth shown on the chart for the Channel?
- As you pass through Spanish Harbor, you notice a low bridge ahead. The highest point on your boat is 10 feet above the water. Can you pass beneath the bridge?
- You continue heading southeast until your depth sounder shows a depth of 10 feet. What does the chart show is probably on the bottom in this area?
- Your friends are interested in snorkeling, so you decide to take them to the buoyed snorkeling area to the south of Newfound Harbor Keys, which is part of NOAA’s Florida Keys National Marine Sanctuary. Looking at the chart, you see that there are several shallow coral heads marked “Co” that are not marked with buoys. What is the water depth over these coral heads?
- Since the water over the coral heads is very shallow, you want to steer a course that

will avoid them. How could you use your depth sounder to help steer clear of these dangers?

- As you travel toward the snorkeling area, one of your friends notices the vegetation on the islands to the north. According to the chart, what kind of vegetation is this?
- According to the chart, the snorkeling area is marked by buoys labeled “A,” “B,” “C,” and “D.” What is the color and shape of these buoys?
- After snorkeling, you decide to visit Ramrod Key. One of your friends says that he can see open water between Hopkins Island and Cook Island. Would this be a good way to go to Ramrod Key?
- After looking at the chart, you decide to go to the southwest of Munson Island to enter Newfound Harbor Channel. What light could you use to be sure you avoid the shallow area to the southwest of Munson Island? How tall is this light?
- After passing Munson Island, you notice four markers that showing the location of Newfound Harbor Channel. What are the color, shape, and numbers of these markers, and how would you use them to stay in the Channel?

- l. As you enter Newfound Harbor, you notice three green markers and a red marker leading into a marina. What is the water depth near these markers?
- m. You change your mind, and decide to visit Little Torch Key instead. You want to go to a marina that is to the east of the microwave tower on Little Torch Key. Can your vessel pass beneath the bridge between Little Torch and Big Pine Key?
- n. Just before you pass beneath the bridge, one of your friends notices something sticking up out of the water. Does the chart show anything in this area?
- o. After you pass under the bridge, you notice a large marina on the west side of Big Pine Key. Are there any obstacles between your vessel and this marina?

Want to Do More?

For more about nautical charts and how to use them, see "Plot Your Course" at oceanservice.noaa.gov/education/lessons/plot_course.html.

To make your own nautical charts, go to: https://oceanservice.noaa.gov/education/nautical_charts/makechart.html

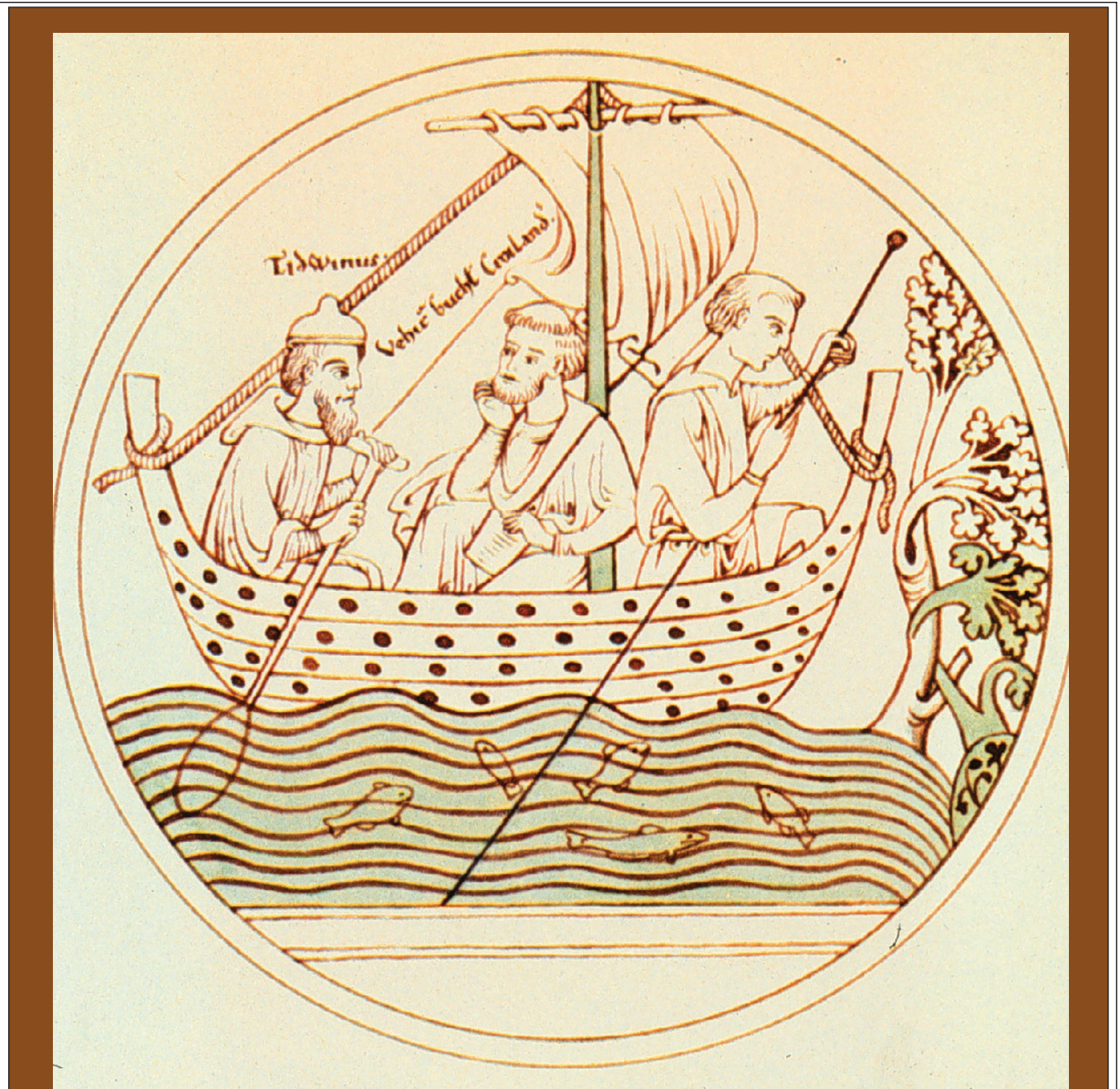

St. Brendan striking out into the Atlantic - about 6th Century A.D. St. Brendan checking depths with his sounding pole.
Courtesy NOAA.

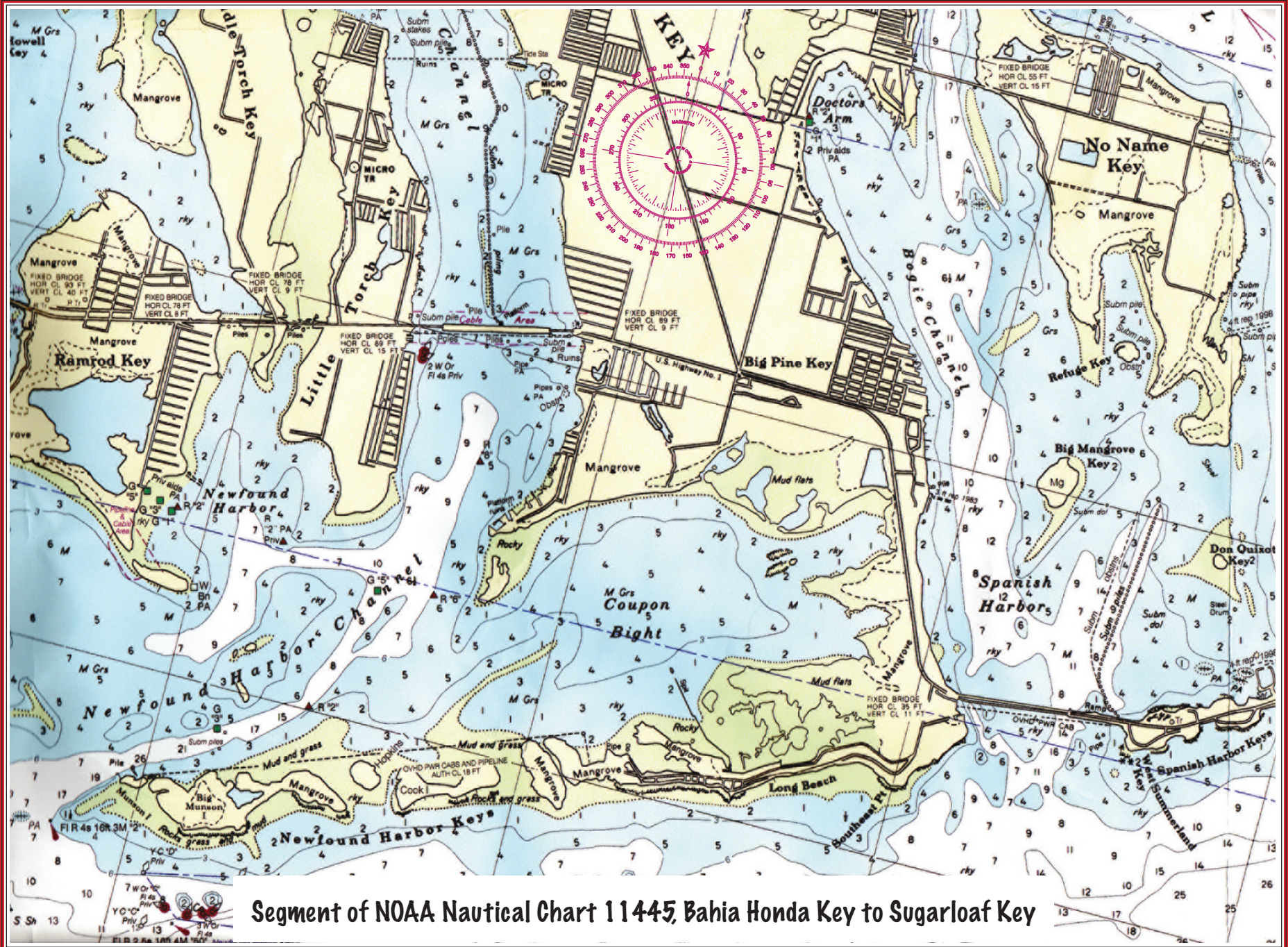

Segment of NOAA Nautical Chart 11445, Bahia Honda Key to Sugarloaf Key

Don't Peek...

Until you have answered **ALL** of the Chart Challenge questions!

Answers to the Chart Challenge

- a. A red triangle numbered "2" and a green square numbered "1"
- b. 12 feet
- c. Yes, because the vertical clearance beneath the bridge is 11 feet
- d. rocks ("rky")
- e. one to three feet
- f. You could use the depth sounder to follow the 12-foot depth contour line, which will keep you away from the coral heads.
- g. Mangroves
- h. The buoys are yellow "cans" that have a cylindrical shape.
- i. No, because the chart shows depths of less than one foot between these islands.
- j. The flashing red light which has the number "2" painted on the structure, and is 16 ft tall and visible for about three miles.
- k. There are two square green markers numbered "3" and "5" and two triangular red markers numbered "2" and "6". You would steer your vessel so that the red markers are to the right of the vessel and the green markers are to the left.
- l. one to two feet
- m. You can pass beneath the west end of the bridge because the vertical clearance is 15 feet, but the clearance is only nine feet under the east end of the bridge.
- n. The chart shows three poles on the south side of the bridge.
- o. The chart shows submerged pilings to the west of Big Pine Key.

Build an Underwater Robot

What can swim deep inside the wreck of the Titanic?

What can sit on the edge of an erupting underwater volcano?

What can dive thousands of feet below the ocean surface?

What can collect animals no one has seen before from the deep ocean?

Underwater robots can!

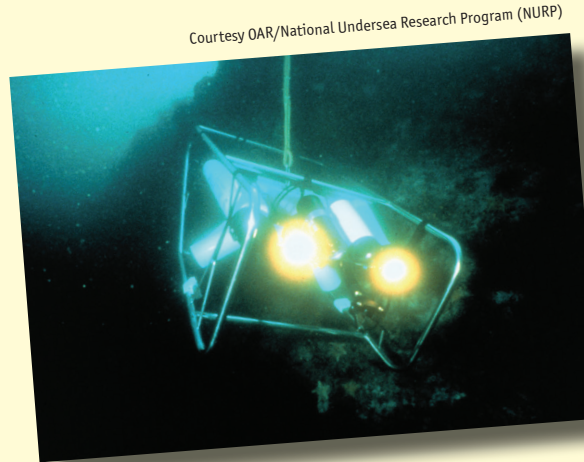

Courtesy OAR/National Undersea Research Program (NURP)

Some underwater robots are controlled by built-in computers, and can operate without any connection to the surface. These are called "Autonomous Underwater Vehicles" (AUVs). Many underwater robots are attached to a cable that allows a human operator to control the robot's movements from a ship on the ocean surface. These robots are called "Remotely Operated Vehicles" (ROVs).

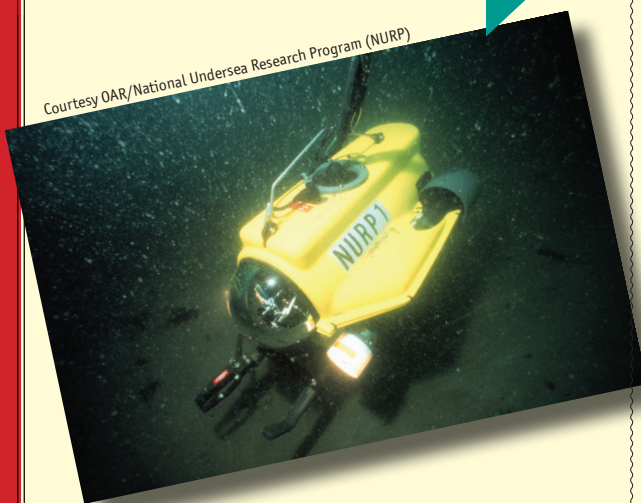

Courtesy OAR/National Undersea Research Program (NURP)

What You Will Need

- Plastic coat hanger
- 6- or 12-volt DC motor (from www.sciplus.com)
- Model boat propeller (from a hobby shop, or visit www.towerhobbies.com and search on "boat propeller")
- Epoxy glue
- Two pieces of #28 AWG stranded wire (telephone wire), each about five feet long
- Electrical tape
- 2 popsicle sticks
- Two film canisters with lids (If you cannot find film canisters, use 2.5" to 3" screw-top plastic containers available at any craft store)
- Twelve nails, about three inches long or 1/4-inch diameter bolts to use as weights
- One or two 6-volt batteries (two if you are using a 12-volt motor)
- Container of water at least 18 inches deep (bathtub, large laundry tub, etc)
- Hot glue gun
- Wire cutters or wire stripper or a sharp knife
- Optional: Hand drill and drill bit of same diameter as the motor shaft

What You Will Do

Make a simple version of an underwater remotely operated vehicle

Warnings

1. Do not connect a wire directly between the two terminals of a battery. The wire will rapidly become very hot and may start a fire or cause serious burns!
2. Do not do this activity in saltwater because everything will short out and your motor will be ruined.
3. If you use a knife to remove insulation from the wires, be careful! Put the wire onto a cutting board and roll the knife over the wire to cut the insulation, but not the wire. Keep your fingers clear of the blade!

How to Do It

1. Press the propeller onto the shaft of the motor. If the propeller is loose on the shaft, place a small drop of epoxy glue on the end of the shaft before installing the propeller. If the shaft is too large for the hole in the propeller, enlarge the hole slightly with a hand drill fitted with a small drill bit. (You may need help from an adult for this.)
2. Hold the coat hanger so that the hook is pointed down. Tape the motor onto the inside of the hook so that the propeller is facing up.
3. Tape the two film canisters (or screw-top plastic containers) with lids on, to the upper part of the coat hanger.

4. Tape enough weights to the lower parts of the coat hanger (near the hook) so that the coat hanger floats just below the surface of the water.
5. Strip about one inch of insulation off of both ends of each wire.
6. Twist one end of each wire onto a terminal of the motor. If necessary, you can keep the wires in place with a dab of hot glue.
7. Twist the wires together to make a single cable.

8. Tape the other end of each wire to a popsicle stick or chopstick so that the bare wire end is hanging over the end of the stick.
9. If you are using a 12-volt motor, connect two 6-volt batteries in series: Strip about one inch of insulation off of both ends of a piece of #28 AWG wire about 12 inches long. Twist one end of the wire around the negative terminal of one battery, and twist the other end of the wire around the positive terminal of the other battery.

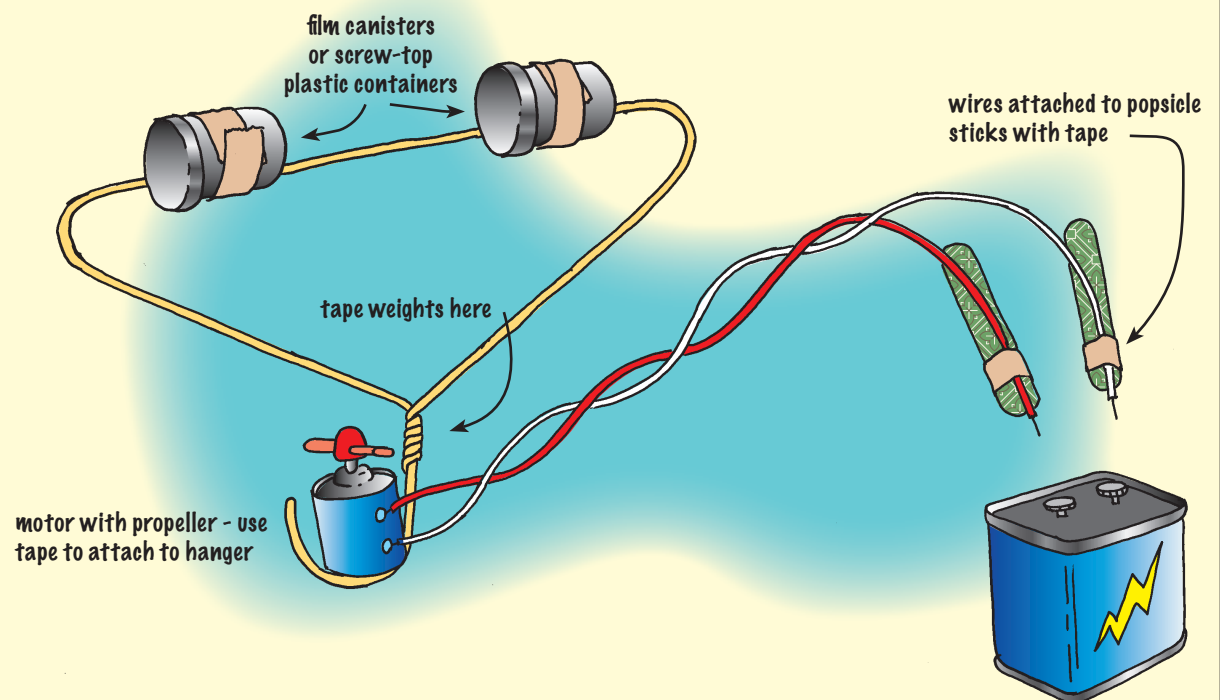

10. Test Dive Your ROV: Touch the bare end of one wire to one battery terminal, and the bare end of the other wire to the other battery terminal. If the propeller spins but does not sink, try reversing the wires on the battery terminals. If your ROV still doesn't sink, you may need to add some more weight.

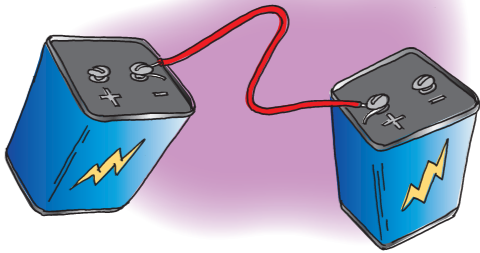

Adapted from an activity by Harry Bohm and the Marine Advanced Technology Education Center (MATE).
www.marinetech.org

A Little More about Underwater Robots

Courtesy Mountains in the Sea scientific party: NOAA, URI/IAO and IFE

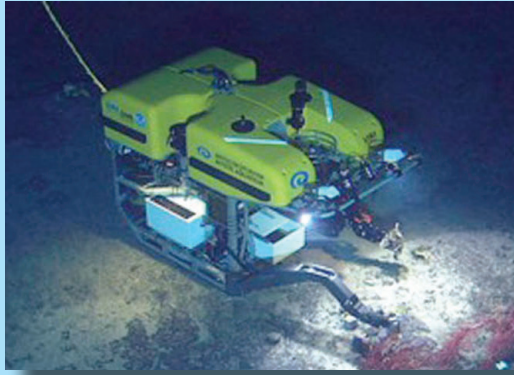

Ocean explorers use ROVs for many purposes, including monitoring underwater habitats, observing fishes and other organisms, exploring deepsea environments, investigating shipwrecks, and studying areas too dangerous for humans such as active underwater volcanoes. Underwater robots are essential tools of modern ocean explorers.

ROVs may be large or quite small, depending upon the jobs they are expected to do, but they all have some systems in common:

- Framework on which other components are mounted;

- Flotation so that the ROV is neutrally buoyant (or nearly neutral; this means it doesn't rise or sink when in the water);
- Ballast to keep the robot from rolling over;
- Power to operate motors, video cameras, and other equipment;
- Propulsion to move the robot up and down, side to side, and backward and forward;
- Control to cause the robot to perform certain tasks; and
- Navigation to keep track of the robot.

Some of these systems may not actually be on the ROV itself, but instead may be on a ship and connected to the ROV with a cable. Most ROVs carry video equipment, and many have manipulator arms that can collect samples, handle tools, etc.

For more information about underwater robots and ocean exploration, visit oceanexplorer.noaa.gov/technology/subs/subs.html. Scroll down the page for links to all kinds of submersibles!

Want to Do More?

1. Add two more motors to your ROV to make it move horizontally. You should be able to make your ROV spin or move in a straight line, depending upon how you connect the motors and the battery.

2. For more underwater robots you can build, check out these books by Harry Bohm:
Bohm, H. 1997. *Build your own underwater robot and other wet projects*. Westcoast Words. 148 pages.

Bohm, H. and V. Jensen. 1998. *Build Your Own Programmable Lego Submersible: Project: Sea Angel AUV (Autonomous Underwater Vehicle)*. Westcoast Words. 39 pages.

Earth Origami

Carl Skalak was on a solo canoe trip in the Adirondack Mountains of upstate New York when a surprise storm brought three days of high winds and heavy rain that eventually turned to snow. When the weather cleared, the river was frozen over and he was surrounded by high drifts of heavy snow.

“I knew I couldn’t get out on my own, and didn’t know if that situation would change for the positive anytime soon.”

Skalak activated a Personal Locator Beacon (PLB), which sent a distress message to NOAA’s Search and Rescue Satellite Aid Tracking System (SARSAT). According to a SARSAT operations support officer for NOAA, “Mr. Skalak was facing a life-threatening situation because of his isolated conditions and the brutally frigid weather. In a matter of a few hours, he might have become acutely hypothermic putting his life at risk.” The SARSAT distress signal was relayed to the Air Force Rescue Coordination Center at Langley Air Force Base, Va., which in turn notified the nearest rescue unit, the U.S. Army Fort Drum Air Ambulance Detachment near Watertown, N.Y. A few hours after activating his PLB, Mr. Skalak was rescued.

~from NOAA News

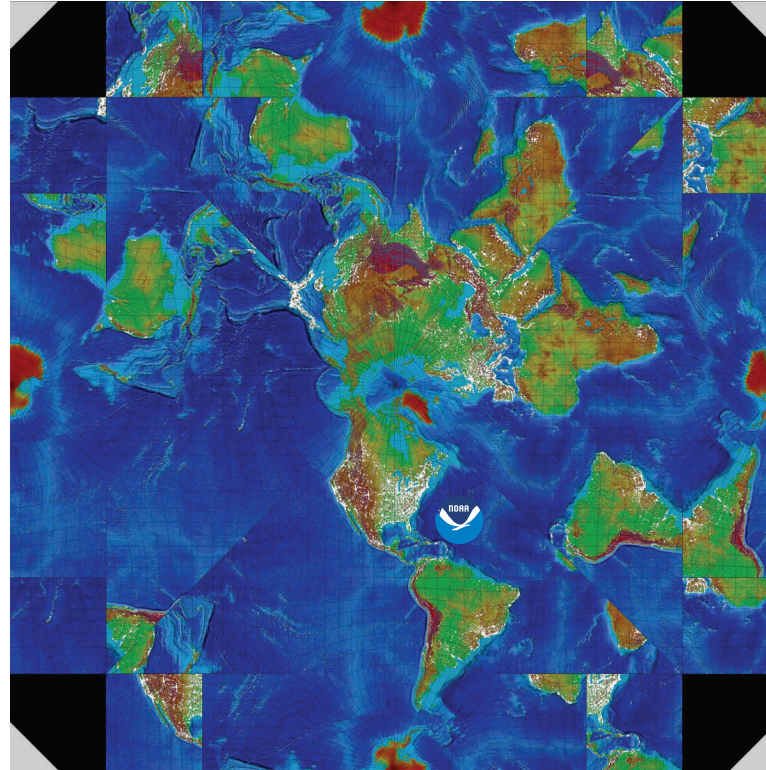

Digital Global Image by Peter W. Slos, NOAA-NGDC

What You Will Do

Make a three-dimensional model of Earth

NOAA’s National Environmental Satellite, Data, and Information Service (NESDIS) operates a search and rescue system known as COSPAS-SARSAT, in cooperation with the U.S. Coast Guard, the U.S. Air Force, and the National Aeronautics and Space Administration. This system can detect emergency signals from Personal Locator Beacons anywhere in the world. Carl Skalak’s PLB may have saved his life.

NESDIS uses satellites for many other purposes in addition to search and rescue, and gathers information about Earth’s environment that includes the location of major fishing areas, hurricanes, tsunamis, earthquakes, fires, and volcanoes, as well as information about Earth’s habitats, geology, and climate. NOAA makes this information available to many people for many different purposes. Here’s one example of a special NESDIS product: satellite images of Earth, assembled so that the combined image can be folded to produce a three-dimensional object that is almost round.

What You Will Need

- ❑ National Centers for Environmental Information (NCEI) "Origami Balloon" image, copied on a color printer as large as you can make it. You can download a pdf file of this image (2.5 MB) from www.ngdc.noaa.gov/mgg/image/origamiearth.pdf
- ❑ Scissors

How to Do It

1. Cut the Origami Balloon image into a square.
2. Put the square image face-up on a flat surface so that the NOAA logo is right-side-up. Fold the bottom edge to the top edge, and make a crease that passes through the center of the square. Now unfold and refold along the same crease so the image is facing out. This will make it easier to shape the model in later steps. Unfold the image so it is a square again.

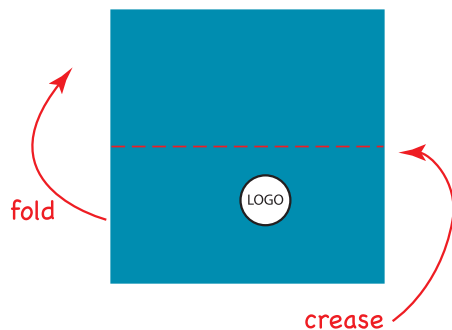

3. Bring one corner to the opposite corner and make a diagonal crease that passes through the center of the square. Unfold and refold

along the same crease in the opposite direction. Unfold the image so it is a square again.

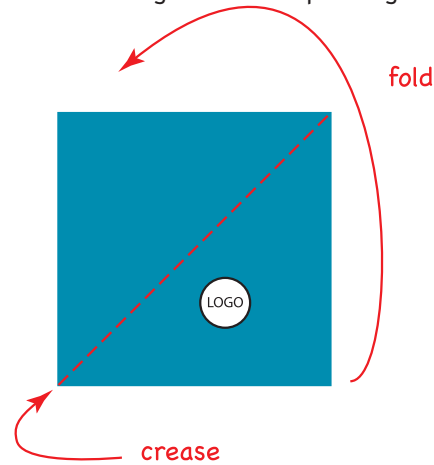

4. Fold the other corner to the opposite corner, and make another diagonal crease so that you now have three creases that cross in the center of the square. Unfold and refold along the same crease in the opposite direction. Unfold the image so it is a square again.

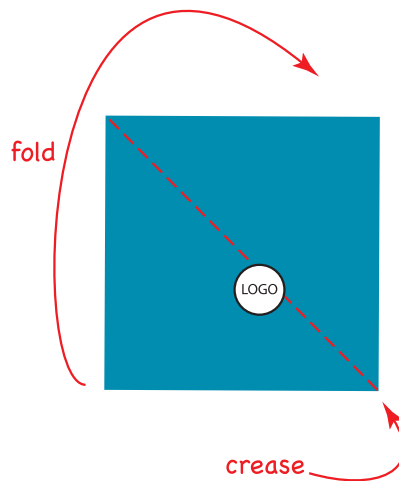

5. Put your thumbs on the ends of the horizontal crease formed in Step 2. Push the sides of the square together, and flatten into a triangle. The longest side of the triangle should be closest to you.

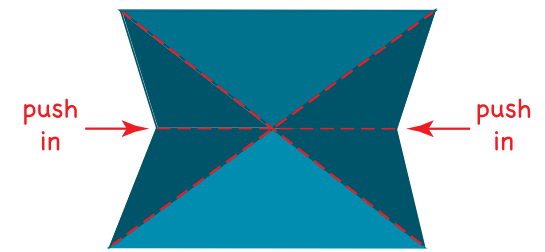

6. Notice that there are two pieces at each of the side corners of the triangle, one on top of the other. Take the upper piece at one of the side corners (a), bring it to the top of the triangle, and make a crease (b). Repeat with the upper piece of the other side corner.

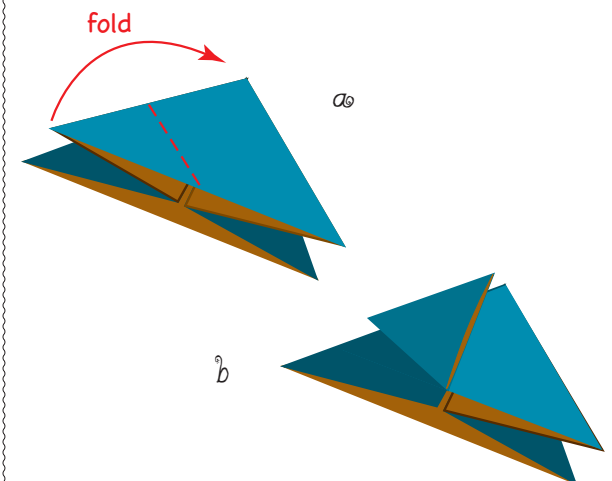

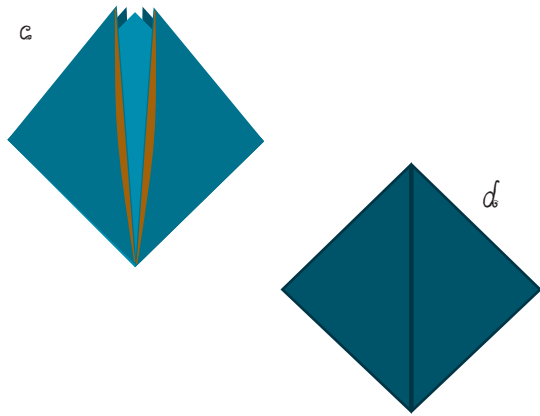

7. Turn the model over, and repeat Step 6.

8. Now there are two pieces at each of the side corners, one on top of the other. Fold the upper piece on one side to the center and make a vertical crease (a). Repeat with the upper piece of the other side (b).

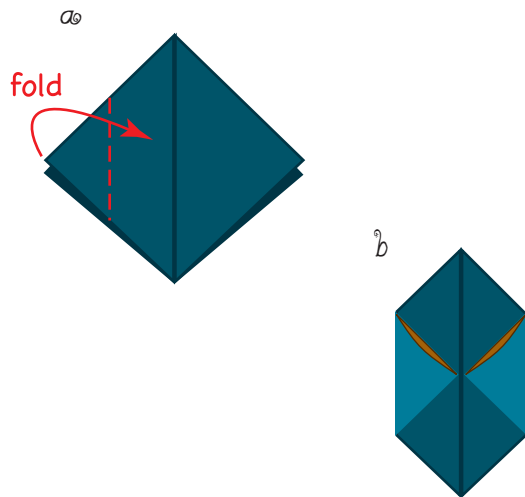

9. Turn the model over, and repeat Step 8.

10. Notice that there are two free points at the top of the model. If you turn the model over, there are two more free points at the top. Fold down the left free point at the top of the model (a). Open up the pocket on the left, and tuck the point into the pocket. Repeat with the right free point (b).

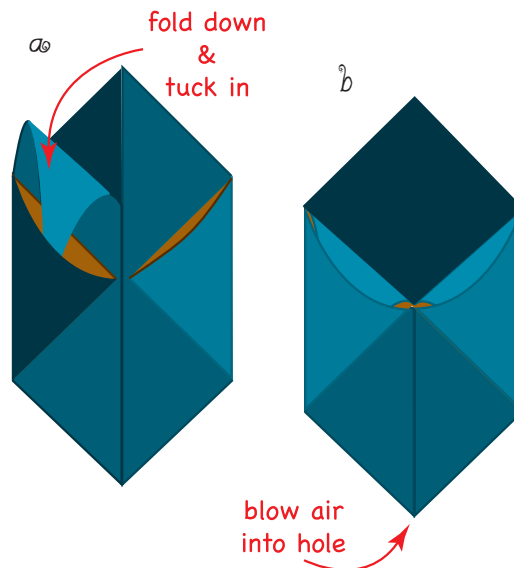

11. Turn the model over, and repeat Step 10.

12. Open up the shape and find the open end at the bottom of the model.

13. Hold the model lightly by the edges, and blow sharply into the hole. The Earth Origami Balloon will inflate!

Want to Do More?

1. See www.ngdc.noaa.gov/education/education.html for lots of other images, maps, and activities.
2. Visit www.sarsat.noaa.gov/ for more information about NOAA-Satellite and Rescue Satellite Aided Tracking (SARSAT).
3. Visit www.noaa.gov/stories/noaa-satellites-helped-save-307-lives-in-2016; www.noaa.gov/stories/noaa-satellites-helped-save-250-lives-in-2015; www.noaa.gov/media-release/noaa-satellites-help-in-rescue-of-240-people-last-year; and www.noaa.gov/noaa-satellites-helped-save-253-people-last-year to read more rescue stories.



An artist's conception of a fully integrated environmental monitoring system including satellites, balloons, ships, aircraft, buoys, and data reception and processing facilities. Courtesy NOAA.

Origami illustrations courtesy Mel Goodwin



Make Your Own Volcano!



2,000 feet below the ocean surface, we saw billowing clouds of smoke rising from the volcano's crater. Huge clouds of yellow-tinged smoke and yellow balls of molten sulfur surrounded our underwater robot...As black chunks of volcanic ash began spewing out of the pit, we decided to retreat from the site because the acidic water, sulfur, and flying rocks were endangering our robot.

— from the Ocean Explorer 2004 Ring of Fire Expedition; the first time any human actually saw an underwater volcano erupt!

What You Will Do
Make a model of a volcano, complete with eruption!

What You Will Need

- Cardboard tube from a roll of paper towels
- Sheets of newspaper
- Clear plastic tape or masking tape
- Corrugated cardboard, about 12 inches square
- Aluminum foil or homemade modeling dough (see recipe below)
- Modeling dough (store-bought or homemade)
- Baking soda (enough to fill the cardboard tube at least half full)
- Vinegar, about eight ounces
- Sharp knife to cut the cardboard tube
- Optional: spray paint; spray glue; sand; food coloring

Warnings

1. Be careful with the knife! Cut on a flat cutting board, and keep your fingers away from the blade!
2. Wear protective gloves and eye shields when handling chemicals.

Recipe for Homemade Modeling Dough

1 cup flour
1/2 cup salt
1 cup water
1 tablespoon cooking oil
2 teaspoon cream of tartar
(optional) food coloring

Mix all ingredients together and heat slowly, stirring constantly, until the mixture is thick and doughy. Let the mixture cool until it can be handled. Knead the dough ball a few times, then wrap in foil to store.

How to Do It

1. Cut the cardboard tube to a length of about eight inches. Plug the bottom of the tube with a piece of modeling dough.
2. Tape the cardboard tube to the piece of corrugated cardboard with plastic tape or masking tape.
3. Crumple sheets of newspaper into balls, and tape these onto the corrugated cardboard around the cardboard tube. Make several different size balls so the surface tapers upward from the edge of the cardboard to the top of the cardboard tube, giving your volcano its shape.
4. Cover the balls of newspaper with a sheet of aluminum foil or a rolled out sheet of homemade modeling dough. Leave a hole in the covering for the end of the cardboard tube. Fold the edges of the foil under the corrugated cardboard sheet.
5. Optional: Decorate your model. Spray with green and brown spray paint. You may also want to spray on glue and dribble sand onto the glue before it dries.
6. Fill the cardboard tube at least half full of baking soda. If desired, mix several drops of red food coloring into the vinegar to give a molten lava appearance.
7. Take your model outside before erupting! Pour the vinegar into the tube, and stand back!

Cutaway view of the volcano model

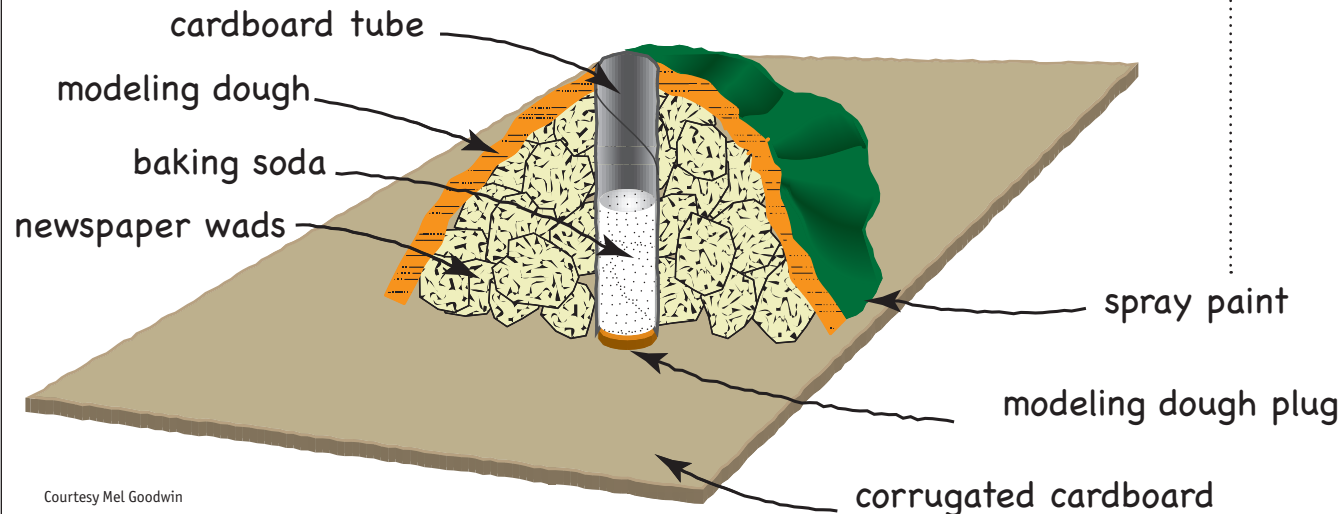

Courtesy Mel Goodwin

[Note: The volcano model made in this activity has the shape of a strato volcano. If you want to make a model of a shield volcano, cut the cardboard tube to a length of about three inches instead of eight inches (Step 1). Then follow the remaining instructions.]

What's Happening

Volcanoes erupt when rocks melt below Earth's surface. Liquid rock in the Earth's crust is called magma, and tends to rise toward the surface. Magma collects beneath the surface in magma chambers, which often contain various gases as well as magma. When the magma and gases break through the Earth's crust, an eruption happens. If pressure builds up inside the magma chamber, the eruption may be very violent. Very hot lava flows easily over the Earth's surface, and produces flattened volcanoes called shield volcanoes. If the lava is cooler, it is sticky and flows more slowly, producing the familiar cone-shaped volcanoes called strato volcanoes. If the eruption is extremely explosive and violent, the top of the volcano may be blown completely away so that only the inside of the magma chamber remains. The collapsed depression is called a caldera.

See the diagram above for a summary of the different types of submarine volcanoes.

This activity is adapted from "The Volcano Factory," a lesson from the Ocean Explorer 2004 Ring of Fire Expedition (oceanexplorer.noaa.gov/explorations/04fire/background/edu/media/RoF.volcanism.pdf); by Mel Goodwin, PhD, Marine Biologist and Science Writer, Mt. Pleasant, SC.

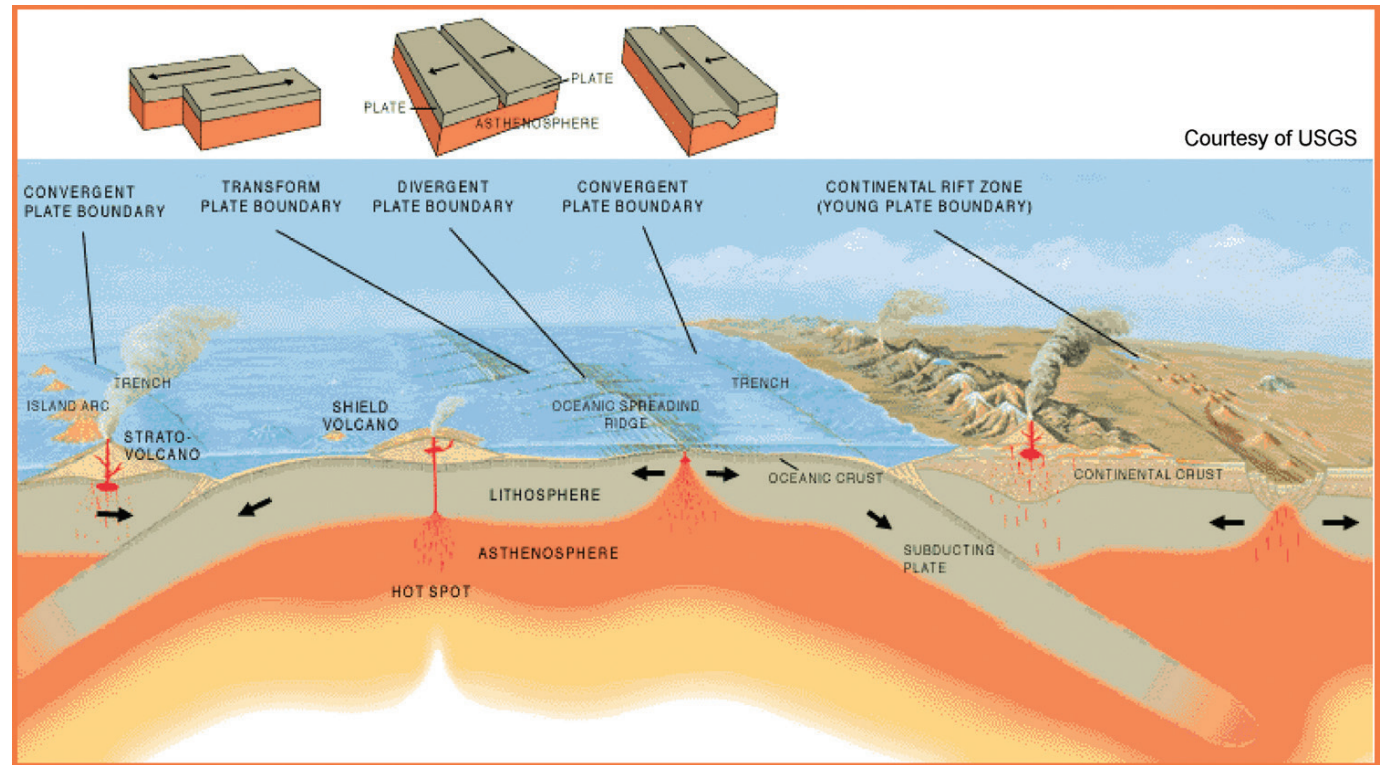

Most submarine volcanoes occur where tectonic plates are either moving apart or colliding. This image shows the many types of plate boundaries: convergent, transform, divergent, and continental rift zone. The Explorer Ridge is a divergent plate boundary at an ocean spreading ridge in the eastern Pacific, where new oceanic crust is formed. The Mariana Island Arc, on the other end of the conveyor belt in the western Pacific, was formed by the melting of the subducting Pacific Plate. (Image courtesy of USGS Web site. Cross section by Jose F. Vigil from *This Dynamic Planet*.)

Want to Do More?

1. You can see pictures from the Ocean Explorer Ring of Fire expeditions, and find out more about their discoveries at: oceanexplorer.noaa.gov/explorations/03fire/welcome.html, oceanexplorer.noaa.gov/explorations/04fire/welcome.html, oceanexplorer.noaa.gov/explorations/06fire/welcome.html, and oceanexplorer.noaa.gov/explorations/14fire/welcome.html.
2. Some volcanoes in the United States are also part of the Ring of Fire! Find out more at vulcan.wr.usgs.gov/.

Do You Have Twisted Vision?

Now you see them, now you don't!

Some marine animals are nearly invisible to the human eye, but become much easier to see if viewed through a polarizing filter. If you have ever put on a pair of polarized sunglasses to reduce glare, you have first-hand knowledge about how a polarized filter can make things easier to see.

Many animals, including fish, insects, birds, crabs, and shrimp have built-in polarized vision that helps them find food, avoid predators, navigate, and communicate with mates. Scientists know very little about how animals see in the deep ocean, and it's quite possible that many animals have been able to avoid being seen by deep ocean explorers. Maybe some animals can't be seen at all with ordinary human vision, even if they are right in front of us!

The Ocean Explorer Deep Scope Expeditions looked into the deep ocean with new eyes, including high-tech cameras that can see animals under extremely dim light, as well as instruments to observe animals that make their own light (bioluminescence) or use various types of polarization vision. Here are some simple experiments you can do to start exploring with polarized light.

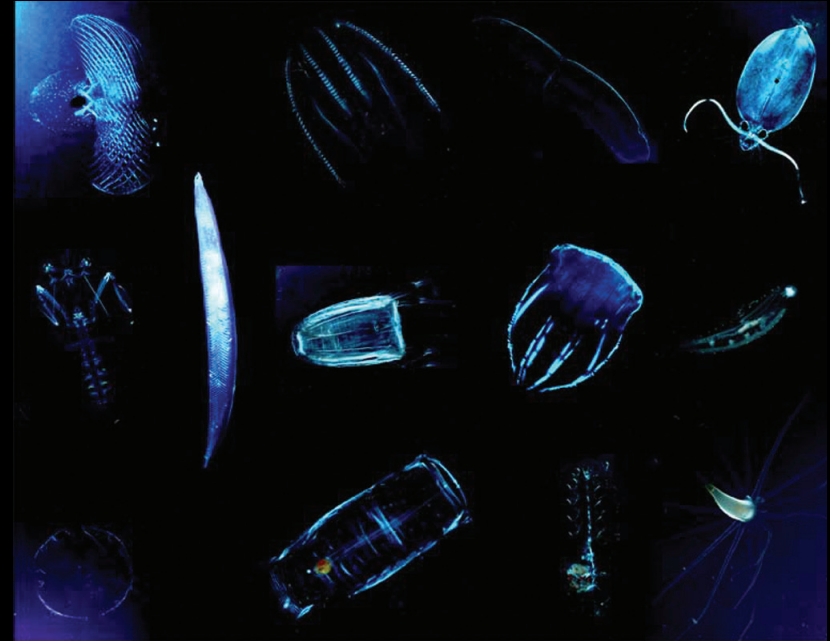

A gallery of images of plankton viewed between two polarizers. In this particular setup, a normal transparent object would still be invisible. However, if the object, or animal, contains any birefringent (doubly refractive) substance, it will appear quite bright. Tissues such as muscle and tendon can be highly birefringent and are responsible for almost all the bright areas on these images. Photo composite: S Johnsen using images from E. Widder.

What You Will Do

Experiment with polarizing filters, and find out whether you have polarization vision

What You Will Need

- ❑ Two pieces of polarizing filter material from an old pair of polarizing sunglasses, or you can buy polarizing filters from educational supply companies (<https://www.teacher-source.com>; about \$65 for a 15 inch x 17 inch sheet). The material will be marked with an arrow that shows the “polarization axis.” If you cut the filter into pieces, use a felt tip marker to draw an arrow pointing the same way on each of the pieces.
- ❑ Plastic protractor, drafting triangle, and/or clear plastic fork

Warning

NEVER look directly at the sun, even through polarized filters!

How to Do It

1. Shine a light through a single piece of polarizing filter material. Some of the light will be absorbed by the filter, but it probably won't matter very much how the filter is rotated. Take the filter outside, and look at blue sky, away from the sun. Now, if you rotate the filter the sky will appear darker and then lighter. Most light passes through when the filter is lined up with the direction of the polarized light.

2. Put a second piece of polarizing filter material on top of the first filter and shine a light through the combined filter. When one of the filters is rotated, you will see that most light comes through when the polarization axes of the filters are pointing in the same direction (parallel). Less and less light passes through as the angle between the polarization axes increases, to a point at which almost no light is transmitted when the polarization axes are perpendicular to each other.

This is an example of birefringence, which is what happens when materials bend polarized light in different directions. Birefringence occurs in many living tissues, and can make food organisms much more visible to marine animals with polarized vision.

Note: Not all plastic objects show birefringence. If some of your plastic objects don't work, try some others!

The Effect of Polarizing Filters

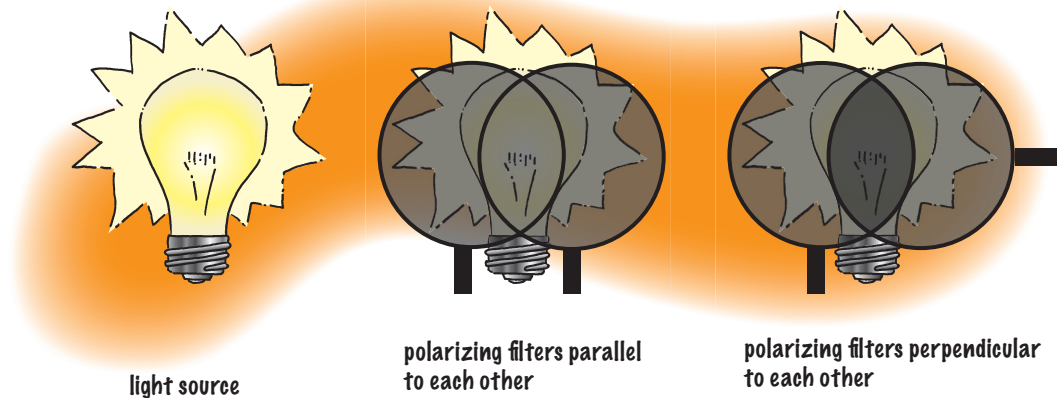

3. Place a plastic protractor, drafting triangle, or clear plastic fork between two sheets of polarizing filter material and shine a light through the stack. When one filter is rotated, bands of color will appear and move over the surface of the plastic object. Flexing the object may reveal stress lines in the material.

4. If human eyes could detect polarized light, you wouldn't need the second filter in these demonstrations. But some humans do seem to have very limited polarization vision. To find out if you are one of them, try this: Face blue sky, away from the sun, and concentrate on the center of your visual field (the area

of sky that you can see). If you see a fuzzy yellowish horizontal bar or bow-tie shape, you are seeing “Haidinger’s brush,” and you have a limited form of polarized vision! You can also try to see Haidinger’s brush by looking at a bright background (such as a well-lit white wall) through polarized sunglasses.

5. Why do you suppose so many invertebrates have polarized vision while humans do not? Part of the answer is that the human eye consists of a single lens that focuses an image onto light-sensitive cells in the retina that transmit nerve signal to the brain. Many invertebrates have compound eyes made of hundreds (or thousands) of “simpler” eyes called ommatidia. Each ommatidium has a lens, crystalline cone, and visual cells containing rhodopsin. In vertebrates, the visual pigment molecules are randomly oriented, but in many invertebrates these molecules are lined up in the same direction. This makes it possible for these animals to detect polarized light.

What’s Happening

We can imagine light as vibrating particles of energy moving in a series of waves, sort of like the particles of water that make ocean waves. In some light waves, the energy particles are vibrating in many different directions. These light waves produce unpolarized light. If the

energy particles are all vibrating in the same direction, the light is said to be polarized. Most light, including light from the sun, from ordinary light bulbs, and from candles is not polarized. Unpolarized light can be transformed into polarized light in several ways, including passing light through a filter that only transmits light waves that are vibrating in a single direction. Light waves vibrating in other directions are blocked.

It may be easier to understand this kind of polarization by imagining a picket fence with a rope passing between the pickets. If we raise and lower one end of the rope to make a wave, it’s easy to understand that the wave can only pass through the fence if the wave is parallel to the pickets, like this:

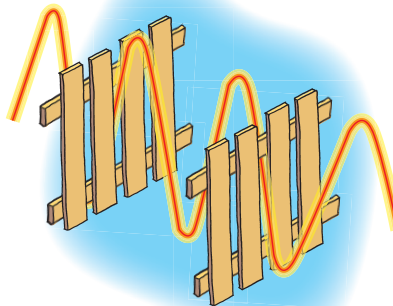

“rope” wave passing through parallel picket fences

A wave in any other direction would run into the pickets and be stopped. The same thing happens in a polarizing filter, except the molecules of the filter material are lined up instead of the pickets in the fence.

The picket fence also helps understand what happens when light is passed through two polarizing filters. If the rope passes through two picket fences, a wave in the rope will only be transmitted if the pickets in both fences are parallel. If one of the fences is rotated, the wave will be blocked, like this:

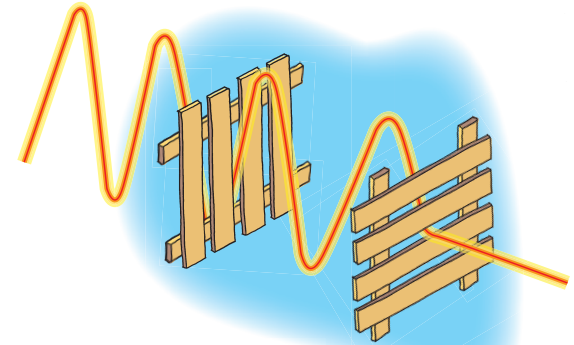

“rope” wave blocked when one fence is rotated

So, if we hold two polarizing filters in front of a light source, and then rotate one of the filters, we will see the light grow brighter as the molecular “pickets” in the two filters become parallel. Light can also be polarized by reflection from non-metallic surfaces such as roads, snow, and water. The amount of polarization depends upon the type of surface and the angle at which the light approaches the surface. Glare from these surface can be reduced or eliminated by polarizing filters (such as sunglasses) whose molecular “pickets” are not parallel to the vibration direction of the reflected light waves. Light can also be partially polarized when it is scattered off of particles in the atmosphere.

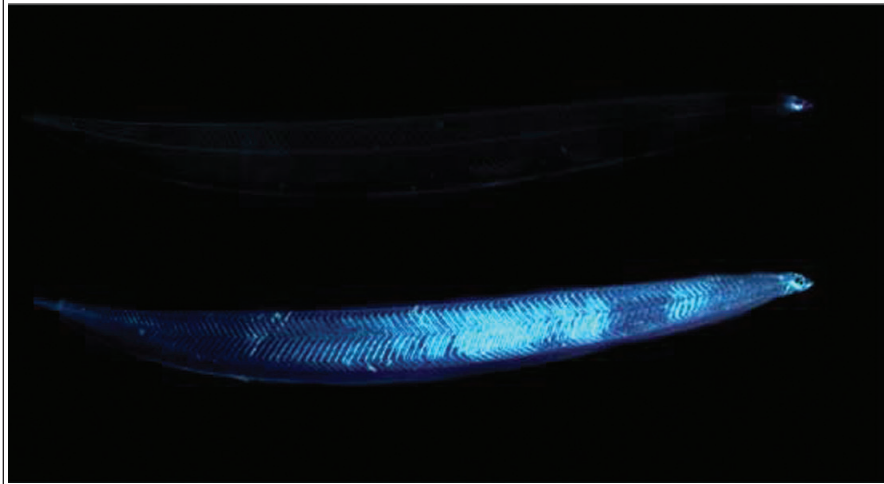

Two images of the same leptocephalus eel larva. The top image is viewed under unpolarized, transmitted light. The bottom image is viewed under polarized, transmitted light by a camera with a polarizing filter. The increased visibility of the bottom image is due to the presence of birefringent muscle and connective tissue fibers. Photo composite: S Johnsen using images from E. Widder.

Want to Do More?

One of the most famous examples of polarization vision is the discovery by Karl von Frisch that bees detect patterns of polarized light in the sky, and communicate directions to each other by dancing in a specific pattern.

- For more information about Karl von Frisch and his bees, visit polarization.com/bees/bees.html.
- For more information about Haidinger's brush and polarization vision in humans, visit polarization.com/haidinger/haidinger.html and theconversation.com/polarised-light-and-the-super-sense-you-didnt-know-you-had-44032
- For more information about the Ocean Explorer Deep Scope Expeditions, visit:
– oceanexplorer.noaa.gov/explorations/05deepscope/welcome.html

–“Secret Communication Channels in the Ocean: Polarization Vision”
oceanexplorer.noaa.gov/explorations/04deepscope/background/polarization/polarization.html

–“Hiding in Plain Sight: Birefringence”
oceanexplorer.noaa.gov/explorations/04deepscope/logs/aug15/aug15.html

–“Measuring Vision in Crustaceans”
oceanexplorer.noaa.gov/explorations/04deepscope/background/vision/vision.html

This activity is adapted from “Twisted Vision,” a lesson from the Ocean Explorer Operation Deep Scope 2005 Expedition (oceanexplorer.noaa.gov/explorations/05deepscope/background/edu/media/twisted.pdf); by Mel Goodwin, PhD, Marine Biologist and Science Writer, Mt. Pleasant, SC.



This Caranichid squid, about four-inches across, uses transparency to hide from potential predators. Open-water divers can more easily observe these creatures with polarizing filters. Compare the polarized and unpolarized images to one another. Images courtesy Edie Widder.

Be A Shipwreck Detective!

*“Great acts of courage,
senseless tragedy,
the heroism of a captain,
the greed of a stingy shipowner,
the stupidity of a watchman
all find their ways into the history of shipwrecks.”*

*~ from the Channel Islands National Marine Sanctuary
Shipwreck Database Web site*

Shipwrecks are an important part of our nautical heritage. Some of our nation’s most interesting shipwrecks are found in NOAA’s National Marine Sanctuary System, including the remains of the Civil War ironclad, U.S.S. Monitor. Some shipwrecks are hazardous to other vessels. Nautical charts produced by NOAA’s Office of Coast Survey show the location of known shipwrecks and other hazards to navigation.

In September 2003, NOAA’s Office of Ocean Exploration and Research visited a newly discovered shipwreck in the Stellwagen Bank National Marine Sanctuary on the coast of Massachusetts. Underwater archaeologists studied the wreck to learn more about what happened to cause the ship to sink. Now it’s your turn to be a Wreck Detective!



Storm, shipwreck, and sea monster. Archival Photograph by Mr. Sean Linehan, NOS, NGS



What You Will Do

Examine information about items found in and around the Stellwagen Bank shipwreck, and draw conclusions about the ship, who was aboard, and why the ship sank

What You Will Need

- "Grid Reference System for Unidentified Shipwreck Q11WRK5" and "List of Artifacts Retrieved from Unidentified Shipwreck Q11WRK5"
- Imagination

How to Do It

1. Your first task is to organize information about where the artifacts were found on the shipwreck. The "List of Artifacts" gives a grid location for each item and how deeply artifacts were buried (so "22 inches from surface" means the object was buried 22 inches into the sea bottom). Archaeologists often use a grid system to precisely record the exact location of artifacts and their relationship to each other. You have already used grids to express location if you have ever played Battleship, or even Bingo.

2. As you look at the description of each artifact, think about how deep the artifact was below the surface, and what other artifacts were found nearby. Then consider what the artifacts may suggest about

- the specific identity of the ship that sank;
- age of the vessel;
- the vessel's purpose;
- who was aboard; and
- why the vessel sank.

3. Write your conclusions on a piece of paper. Then read "The Story of the Steamship Portland" on Page 50.

This activity is adapted from "Wreck Detectives," a lesson from the Ocean Explorer Steamship Portland Expedition (oceanexplorer.noaa.gov/explorations/03portland/background/edu/media/portlandwreckdetec.pdf); by Mel Goodwin, PhD, Marine Biologist and Science Writer, Mount Pleasant SC.

Want to Do More?

1. Visit oceanexplorer.noaa.gov/explorations/03portland/welcome.html the Web site for the Steamship *Portland* expedition.
2. For another shipwreck activity see "Lost at Sea: Sunken Slave Ship" activity from Newton's Apple episode 1502. You can access this activity from www.reachoutmichigan.org/funexperiments/agesubject/lessons/newton/sunken.html.
3. Visit stellwagen.noaa.gov/maritime/portland.html for more information on the wreck of the Steamship *Portland*.
4. Visit thunderbay.noaa.gov/shipwrecks/welcome.html for information on Thunder Bay National Marine Sanctuary.
5. Visit monitor.noaa.gov for information on the Monitor National Marine Sanctuary.

Grid Reference System for Unidentified Shipwreck Q11WRK5

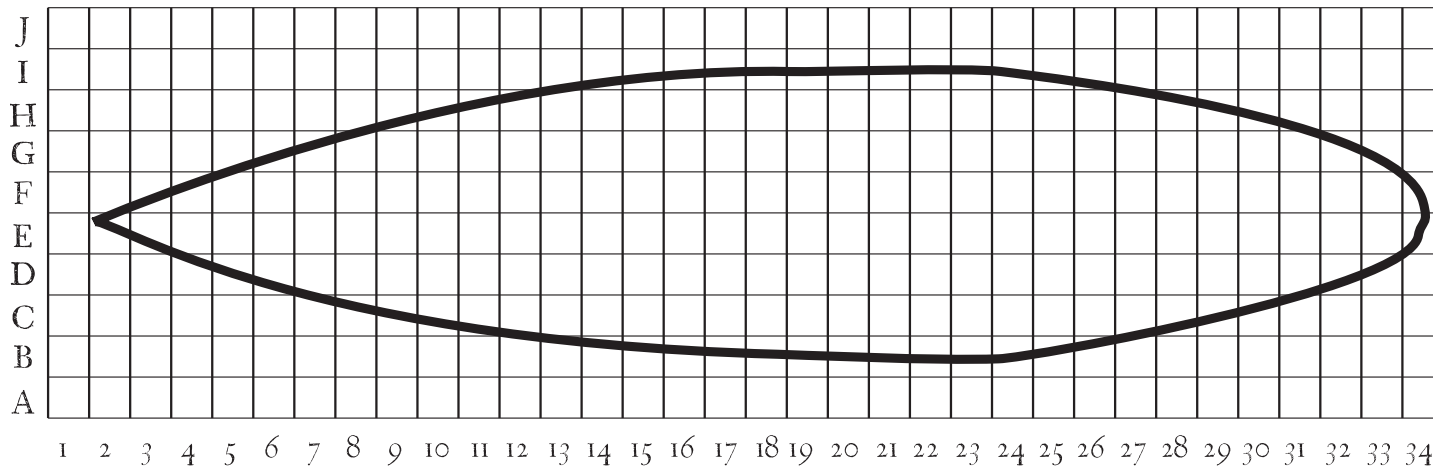

List of Artifacts Retrieved from Unidentified Shipwreck 211WRK5

Grid Reference Description

E19-E23 & F19-F23	Heavy metal structure, diamond shaped, partially buried
D10	Gentleman's gold ring, 22 inches from surface
E14	Heavy mahogany chair, velvet upholstery, 40 inches from surface
D10	China plate, 100 inches from surface
G10	China chamber pot, 20 inches from surface
D13	Silver flatware, engraved letter "P," 100 inches from surface
F14	China cup, 100 inches from surface
D10	Brandy flask, 20 inches from surface
F14	Domed skylight, 16 inches from surface
D13	Carved mahogany headboard, 28 inches from surface
F13	Ebony piano keyboard, 22 inches from surface
C19-C24	Massive paddlewheel, partially buried
G10	Child's rocking chair, mahogany, 24 inches from surface
D13	Lady's dress shoe, 26 inches from surface
G10	Shaving straight razor, 22 inches from surface
H17	Silver buckle, 28 inches from surface

Grid Reference Description

D13	China chamber pot, 24 inches from surface
E11	Carving knife, 92 inches from surface
D10	Man's leather dress shoe, 24 inches from surface
B13	Carved wooden plank, letters "RTLAND;" left side broken
E11	Silver serving platter, 92 inches from surface
E5	Rusted iron mass, possibly chain
F21	Heavily rusted iron mass, possibly tools, 100 inches from surface
E11	Ship's wheel, 12 inches from surface
D10	Small mahogany chest of drawers, 28 inches from surface
E33	Rudder, partially buried
G19-G24	Massive paddlewheel, partially buried
E17 & F17	Smokestacks

NOTE: Extensive debris around main wreck, mostly large timbers and pieces of heavy equipment; several lifeboat remnants outside main wreck. Less obvious structural debris in quadrats numbered 25 and higher; these quadrats contain mostly silt down to the apparent hull of the vessel at approximately 140 inches.

The Story of the Steamship *Portland*

On Thanksgiving Saturday, November 26, 1898, the passenger steamship *Portland* left Boston Harbor with more than 190 passengers and crew bound for Portland, Maine. The *Portland* was a state-of-the-art, luxury ship with velvet carpets, mahogany furniture, and airy staterooms. By 1898, paddlewheel steamboats had revolutionized transportation in the United States. Faster and more reliable than sailing ships, paddlewheelers could also maneuver in waters that were too shallow for sailing ships. By the 1870s, many people routinely boarded steamboats to travel between port cities. But the paddle-wheelers had a serious flaw: they were built long and narrow (the *Portland* was 281 feet long and 62 feet wide), and this shape combined with a shallow draft (the *Portland's* keel was only 11 feet below the water line) made these ships extremely unstable in high seas.

When the *Portland* steamed out of Boston Harbor, she ran straight into a monster storm moving up the Atlantic coast with northeasterly winds gusting to 90 mph, dense snow, and temperatures well below freezing. Facing a roaring northeasterly wind, the captain could not turn back; to have done so would have placed the ship broadside to wind and waves that would surely have capsized her. The only choice was to continue to head northeast into the waves, and hope to ride out the storm. Four hours after her departure, a vessel believed to have been the *Portland* was seen near Thatcher Island, about 30 miles northeast of Boston. But the *Portland* was apparently unable to make much more progress against the storm.

At 5:45 a.m. on the morning of November 27, four short blasts on a ship's steam whistle told the keeper of the Race Point Life-Saving Station on Cape Cod that a vessel was in trouble. Seventeen hours later, life jackets, debris, and human bodies washed ashore

near the the Race Point station, confirming that the *Portland* and everyone aboard had been lost in one of New England's worst maritime disasters. The loss of the *Portland* underscored the inherent instability of sidewheel paddleboats. Sidewheelers were gradually replaced by propeller-driven boats, which have a lower center of gravity.

For 90 years, the location of the *Portland* wreck was unknown, despite intense and continuing public interest. In April 1989, members of the Historical Maritime Group of New England found wreckage in water more than 300 feet deep that they were certain had been the *Portland*. Because of the depth, however, the discoverers were unable to obtain photographs or other evidence that could confirm their find. Thirteen years later, on August 29, 2002, the U.S. Commerce Department's National Oceanic and Atmospheric Administration (NOAA) confirmed that the wreck of the *Portland* had been found within NOAA's Stellwagen Bank National Marine Sanctuary. Using side-scan sonar and a remotely operated vehicle (ROV), scientists obtained high-quality video and side-scan images in a joint research mission of the Stellwagen Bank National Marine Sanctuary and the National Undersea Research Center at the University of Connecticut.

Massive storms during late October and November are not particularly unusual in the New England states. At this time of the year, large cold air masses from Canada cross the midwestern states on a regular basis. At the same time, the Atlantic Ocean retains its summer heat and these warm waters sometimes spawn hurricanes. When the east-moving cold air masses encounter the warm, humid oceanic air, the result is what New Englanders call "Nor'easters:" storms that are often severe, and are often the cause of maritime disasters. 🌪️

Clues from the "List of Artifacts Retrieved from Unidentified Shipwreck QUWRK5:"

The large paddlewheels near the middle of the ship clearly suggest a sidewheel paddleboat. This was a large vessel for a paddlewheeler; over 280 feet. The diamond shaped metal structure is probably the remains of a walking beam engine, a common design in ships of this type. The fact that this was a large paddlewheeler narrows its probable vintage to between 1890 and 1910. Artifacts in quadrats D10, D13, and G10 suggest that men, women, and children may have been aboard, and these areas may have been staterooms. The fact that artifacts in these areas were close to the surface suggests that these staterooms were on or near the deck of the vessel. Eating utensils recovered from more than 80 inches below the surface suggest a dining area, located on a lower deck. Engraved silver flatware and the carved wooden plank are valuable clues, suggesting that the name of the vessel may have begun with the letter "P" and ended with the letters "rtland." Many of the artifacts suggest wealth and luxury. This vessel almost certainly carried some wealthy passengers.

Think about the size of the debris field. Ships that sink suddenly (such as those sunk in battle) often have a rather small debris field. Ships that sink with lots of movement, on the other hand (such as ships sunk in storms) are likely to have larger debris fields. This ship has an extensive debris field, suggesting that a lot of motion, possibly due to a storm, was involved in her sinking.

Weird, Red, and Slightly Gross!

"OK, we're 8,000 feet deep now..."

Hey, there's something on the bottom that looks like twisted stone chimneys with some kind of hot fluid jetting out from the top...

Wait a minute...there's all kinds of animals down here; giant clams and huge red worms sticking out of eight-foot-long tubes...

Believe me, no one has ever seen anything like this before..."

These observations, made on February 17, 1977 aboard the deep-diving submarine Alvin, were one of the biggest scientific discoveries of the last century: a totally new ecosystem thriving at near-freezing temperatures in the total darkness of the deep Pacific Ocean, and under water pressure more than 275 times greater than the pressure at sea level.

These ecosystems, now called "hydrothermal vent communities," do not depend upon green plants and sunlight for their food. Instead, they are able to use chemicals in the hot fluids pouring out of the twisted stone "chimneys."

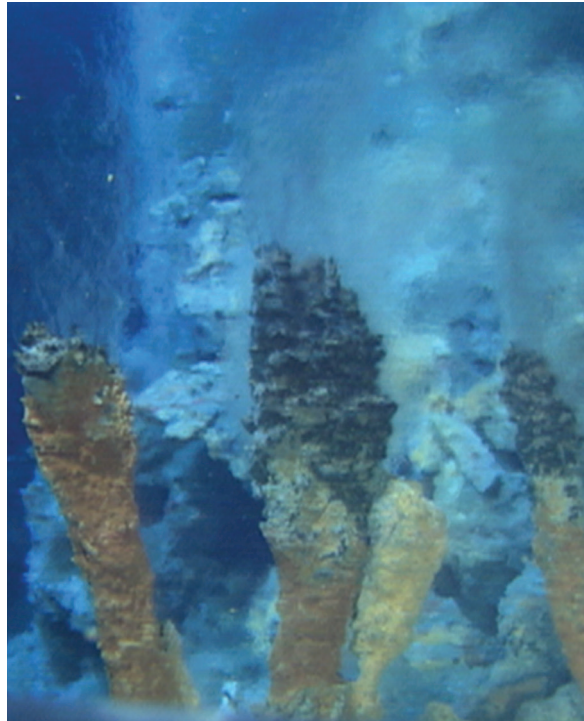

Photograph of three small (12 inches tall) actively venting spires sitting on top of one of the chimneys in the Black Forest vent field. The chimneys themselves are about 23 feet tall. The fluids here are venting at 240°C (464°F) and are expelling black (mineral-rich) smoke into the ocean.

This process is called "chemosynthesis." Most hydrothermal vent animals aren't able to use these chemicals all by themselves. Instead they have partnerships with other organisms, usually bacteria. The tubeworms, for example, have a large organ called a trophosome, that contains chemosynthetic bacteria. They do not have a mouth, stomach, or intestines. The worms have long tentacles that stick out from the end of the tube. Inside the tentacles, the worms' blood contains hemoglobin (like human blood) that can absorb chemicals from the surrounding water. The blood carries these chemicals to bacteria living in the trophosome. The bacteria produce food that provides nutrition to the tubeworm.

In 2002, 2006, and 2011, NOAA supported expeditions to the Galapagos to revisit the site where hydrothermal vents were first seen. See the links below for more on these expeditions:

oceanexplorer.noaa.gov/oceanos/explorations/ex1103/logs/photolog/photolog.html

oceanexplorer.noaa.gov/explorations/05galapagos/logs/photolog/photolog.html

oceanexplorer.noaa.gov/explorations/02galapagos/logs/photolog/photolog.html

What You Will Do

Make a three-dimensional model of a giant tubeworm

What You Will Need

- Materials that can represent parts of the tubeworm (see the drawing below). Here are some ideas, but with a little imagination you can probably find lots of other things to use:
 - Cardboard tubes (mailing tubes or paper towel rolls) for the trunk and tube
 - Pipe cleaners for tentacles
 - Modeling clay or papier mâché (news-paper and glue made from flour and water) for the vestimentum
 - Sponge for the trophosome
 - Small corks or pieces of round cereal can represent bacteria
- Other supplies: glue, scissors, poster board, colored markers, and/or spray paint
- Optional: a rotten egg in a tightly-closed jar

How to Do It

Since most of a tubeworm is hidden inside the tube, you should build your model as a “cut-away” (also called a cross section) so that the major structures can be seen. Here are the parts of a tubeworm that should be included in your model:

- **Tentacles** – All the tentacles together are called the “plume”; these should be colored red, since they contain hemoglobin.
- **Vestimentum** – This is a muscular structure that has several functions:
 - It helps to hold the worm in its tube;
 - It generates new tube material;

- It contains pores that release sperm or eggs during spawning;
- It contains the tubeworm’s version of a heart and a brain.

- **Trophosome** – This dark green-brown organ has a spongy texture, and contains bacteria that use oxygen, carbon dioxide, and hydrogen

sulfide to make food for themselves as well as the worm; be sure to include something that represents bacteria (there are billions of bacteria in the trophosome, but you don’t need to include all of them in your model!)

- **Trunk** – This is where waste is stored, since tubeworms have no mouth, stomach, intestines, or anus (nasty, maybe, but it works for the tubeworm!)

- **Tube** – This is a hard hollow cylinder, and provides protection for the worm like the shells of other animals. The tentacles can be pulled completely inside the worm to avoid predators.

- **Opisthosome** – This organ (like the vestimentum) produces new tube material and helps anchor the worm in its tube.

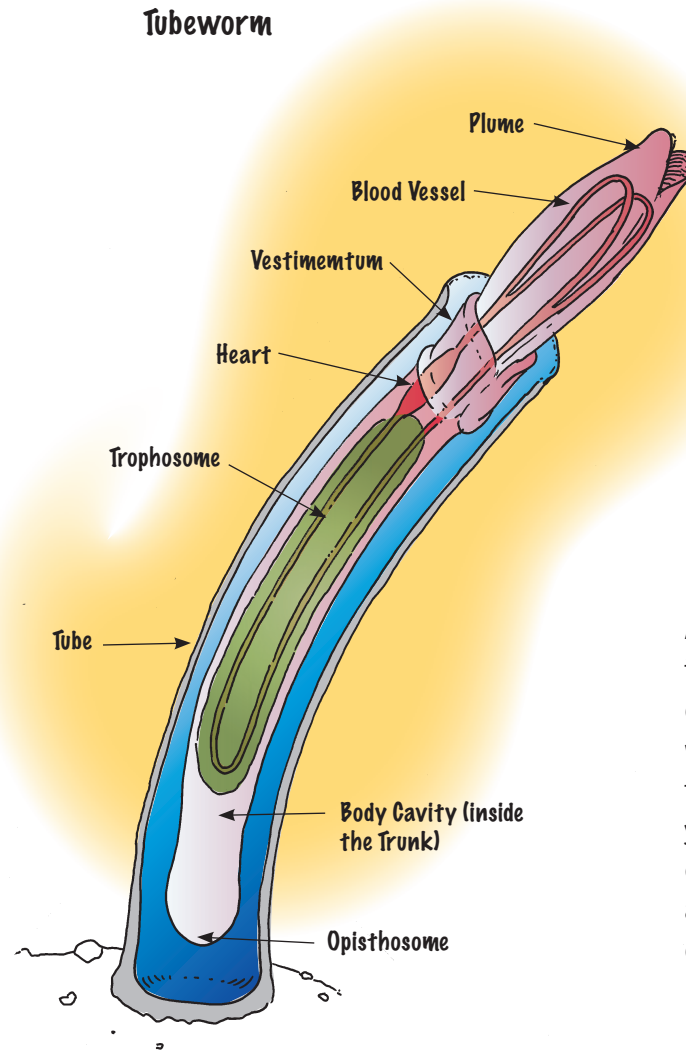

A very noticeable feature about tubeworms is their smell. One of the chemicals used by chemosynthetic bacteria is hydrogen sulfide, which is what makes rotten eggs smell the way they do. If you want to include this feature in your model, you should probably put a rotten egg (or other source of hydrogen sulfide) in a glass jar with a tight-fitting lid so you can control the smell.

Want to Do More?

1. Visit www.whoi.edu/oceanus/viewArticle.do?id=2400 to find out about black smokers (the “chimneys” around hydrothermal vents that emit hot fluids).
2. Visit oceanexplorer.noaa.gov/edu/themes/vents-and-volcanoes/welcome.html for more information and activities on hydrothermal vent communities.
3. Visit www.divediscover.whoi.edu/vents/index.html to learn more about the discovery of hydrothermal vents, including recordings of scientists aboard the submarine *Alvin*.
4. Visit oceanexplorer.noaa.gov/explorations/02fire/logs/magicmountain/welcome.html for fly-through movies of the Magic Mountain hydrothermal vent site on Explorer Ridge (in the northeastern Pacific Ocean, about 150 miles west of Vancouver Island, British Columbia, Canada).

This activity is adapted from “Let’s Make a Tubeworm!”, a lesson from the Ocean Explorer 2002 Gulf of Mexico Expedition: oceanexplorer.noaa.gov/explorations/02mexico/background/edu/media/gom_tube_gr56.pdf); by Mel Goodwin, PhD, Marine Biologist and Science Writer, Mt. Pleasant, SC.

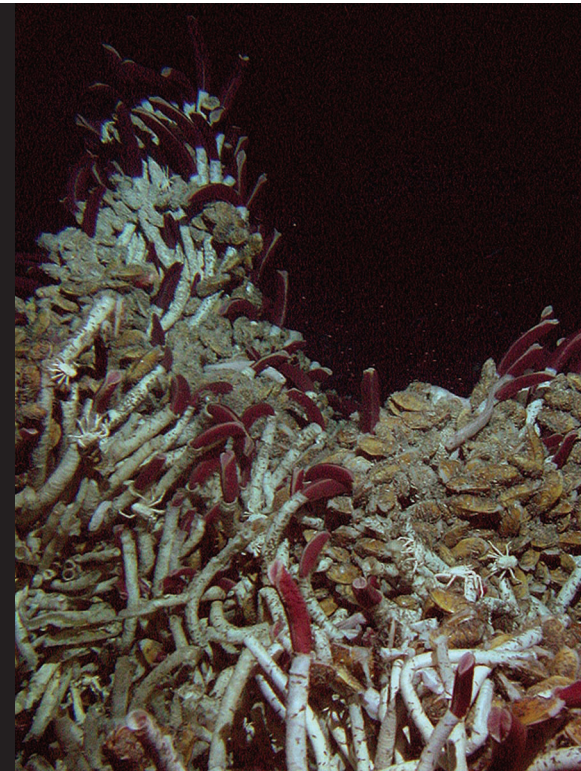

WOW!!!!
These tube worms
are about
3 feet long!



Riftia tubeworms, mussels, and scavenging crabs found at the hydrothermal vent site East Wall, located at 90 North on the East Pacific Rise. Photo courtesy of C. Van Dover, NOAA.

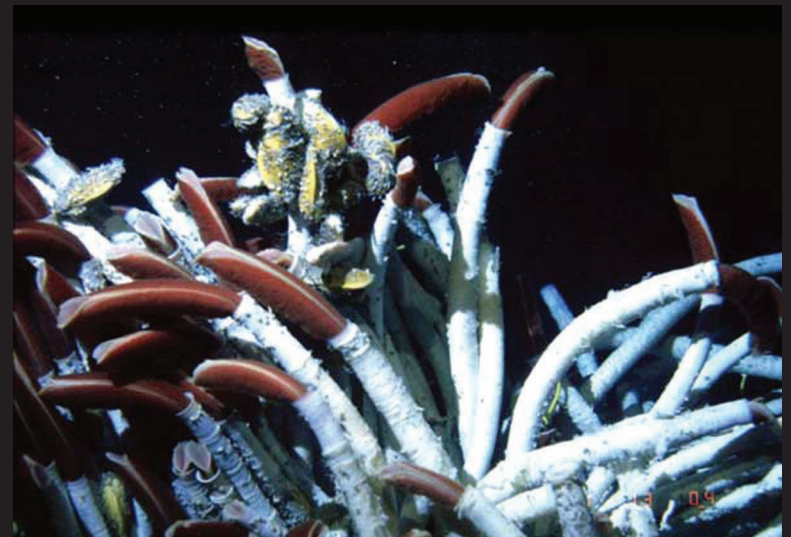

Giant tubeworm, *Riftia pachyptila*, from the hydrothermal vents at the East Pacific Rise at 2500m depth. Each individual in the photo exceeds one meter in length. Courtesy Monika Bright, University of Vienna, Austria. NOAA

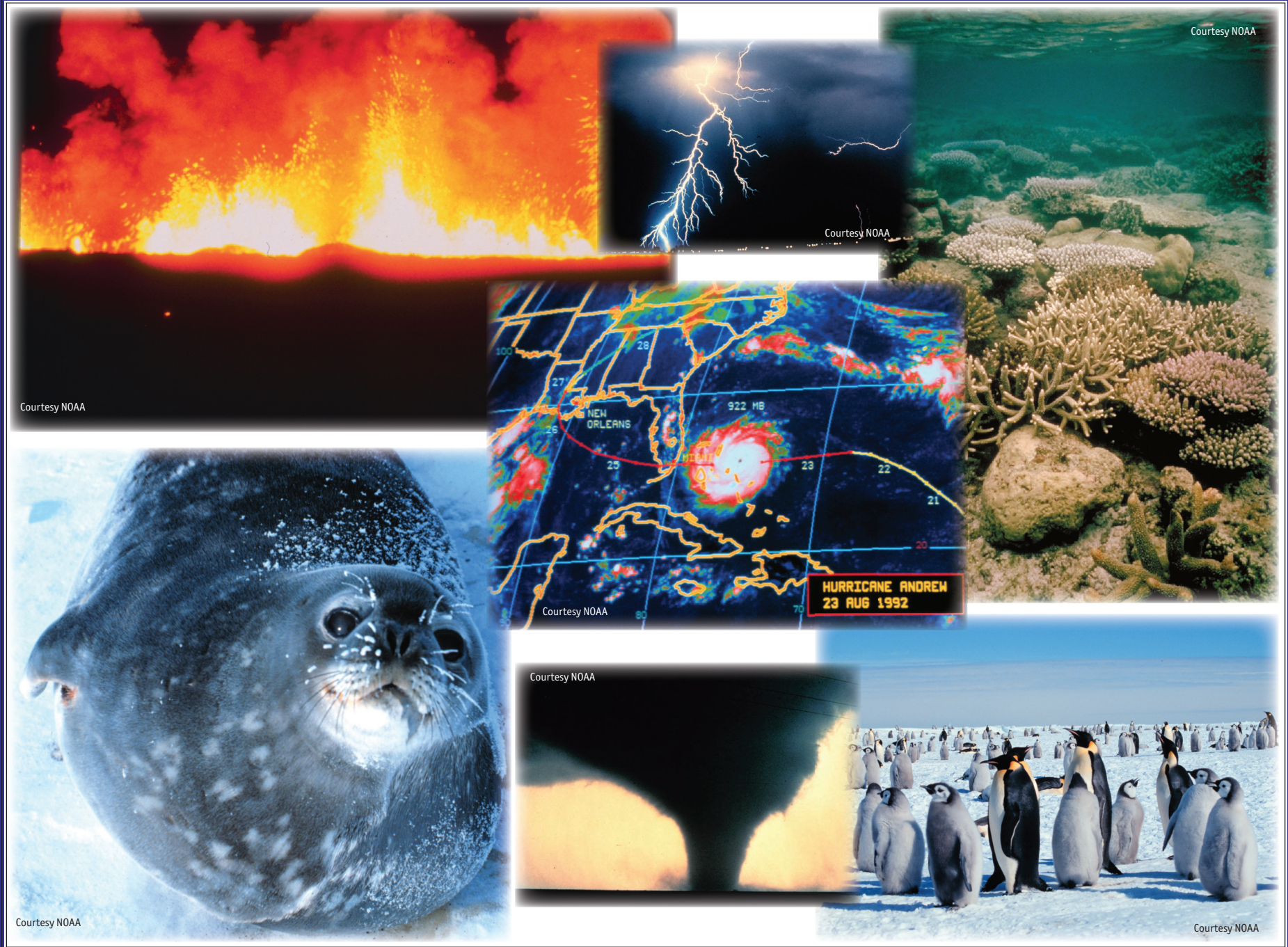

Courtesy NOAA

Courtesy NOAA

Courtesy NOAA

Courtesy NOAA

**HURRICANE ANDREW
23 AUG 1992**

Courtesy NOAA

Courtesy NOAA

Courtesy NOAA

Courtesy NOAA



Courtesy NOAA



UNDERSTAND THE EARTH

NOAA programs to understand Earth's Weather, Oceans, and Climate help make our homes and communities safer, and are important for reliable commerce and transportation. Water transportation is the backbone of the U.S. economy. Almost everyone travels in aircraft and motor vehicles. But airplanes, ships, trucks, and automobiles are all affected by bad weather. Delays due to bad weather cost U.S. airlines more than \$4 billion every year. Bad weather is also involved with over 1.5 million motor vehicle accidents each year; and these accidents caused about 800,000 injuries and 7,000 deaths. NOAA contributes to safe travel and transportation in many ways, including up-to-the-minute weather information and warnings from the National Weather Service, nautical and navigational charts, satellites that gather data on weather and ocean conditions around the world, and creating accurate maps of Earth's surface.

Besides understanding Earth's weather, NOAA also works to understand climate. Earth's climate has changed many times, and those changes can have a big impact on life in America. When some of the first people

arrived in North America between 15,000 and 30,000 years ago, two great ice sheets covered much of the continent. About 1,000 years ago, a prolonged drought forced the Anasazi people of the southwestern United States to abandon large settlements in Colorado, Utah, Arizona, and New Mexico. A shorter drought caused to the "dust bowl" in the midwestern U.S. during the 1930's. NOAA's climate programs focus on detecting signs of climate change, and on helping individuals and communities decide how to cope with the effects of changing climate.

Have fun Understanding the Earth with these activities from NOAA programs:

- Satellite Communications
- Follow That Hurricane!
- Build Your Own Weather Station
- Be a Citizen Weather Reporter
- Tornado in a Bottle
- Tree Ring Detective
- Your Own El Niño
- Woolly Magma and more!

Courtesy NOAA



Courtesy NOAA



Follow That Hurricane!

What You Will Do

Track a hurricane on the same type of chart used at the National Hurricane Center

“Devastating damage expected... A most powerful hurricane with unprecedented strength... Most of the area will be uninhabitable for weeks, perhaps longer... At least one half of well constructed homes will have roof and wall failure... all wood framed low rising apartment buildings will be destroyed... High rise office and apartment buildings will sway dangerously, a few to the point of total collapse... airborne debris will be widespread... persons, pets, and livestock exposed to the winds will face certain death if struck...”

~ from Urgent Weather Statement issued by Robert Ricks, Meteorologist, National Weather Service, New Orleans/Baton Rouge Office, August 28, 2005

This weather statement, warning of Hurricane Katrina’s approach, probably saved many lives. Providing weather forecasts and warnings is one of the ways the National Weather Service carries out its mission to protect life and property and enhance the national economy. The National Hurricane Center (part of the National Weather Service) tracks tropical storms and hurricanes, and issues hurricane watches and warnings when the storms get close to the U.S. Here’s how you can track the approach of tropical storms and hurricanes.

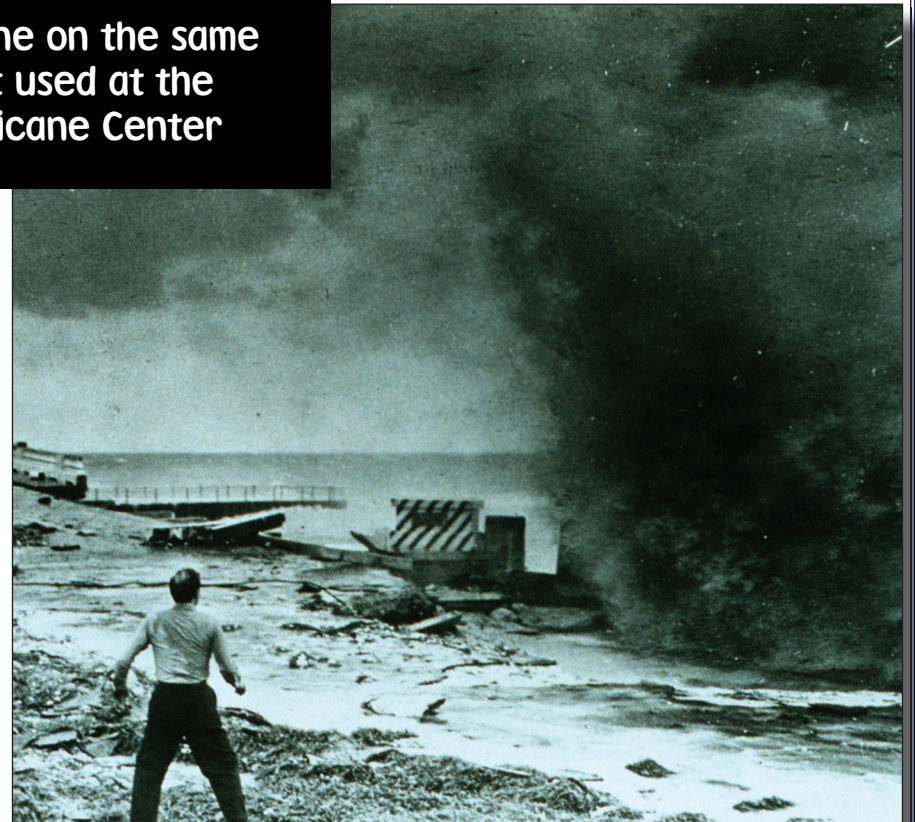

Startled man ready to run after a hurricane driven wave smashes into seawall
Historic NWS Collection. Courtesy NOAA.

What You Will Need

- Copy of the “Western Atlantic Hurricane Tracking Chart.” To download one yourself, go to www.nhc.noaa.gov/tracking_charts.shtml, scroll down the page to the blank tracking charts and click on the Western Atlantic one.
- Pencil and eraser
- A record of hurricane locations from the National Hurricane Center, or from historical hurricane records; records from four famous hurricanes are found on the following pages.

How to Do It

1. The location of a hurricane on a particular date and time is described by the latitude and longitude of the storm’s center, called the “eye.” Latitude measures how far north or south a location is from the equator, and longitude measures how far east or west a location is from a line that goes from the North Pole to the South Pole, passing through Greenwich, England. On the “Atlantic Basin Hurricane Tracking Chart,” latitude is shown by horizontal lines and longitude is shown by vertical lines. Latitude and longitude are measured in degrees. Hurricane coordinates are given in pairs, with latitude written before longitude. So, the location of Bermuda would be written as: 32.3°N, 64.7°W. The “N” means that the location is north of the equator, and the “W” means that the location is west of Greenwich, England.

2. To plot the location of a storm:
 - (a) Find the latitude of the storm (the first coordinate in the pair), and locate the horizontal line on the map that matches this latitude.
 - (b) Find the longitude (the second coordinate in the pair, usually followed by a W or E), and locate the vertical line on the map that matches this longitude.
 - (c) Find the place on the map where the two lines intersect. This is the location of the storm eye. Draw the symbol for a hurricane or a tropical storm (depending upon the kind of storm you are tracking) at this spot, and write the date and time next to the symbol. (See above right).

3. Try plotting the track of one or more famous hurricanes. You are now ready to plot real storms during the next hurricane season! You can get coordinates from NOAA WeatherRadio-All Hazards, newspapers, or from <http://www.nhc.noaa.gov>.

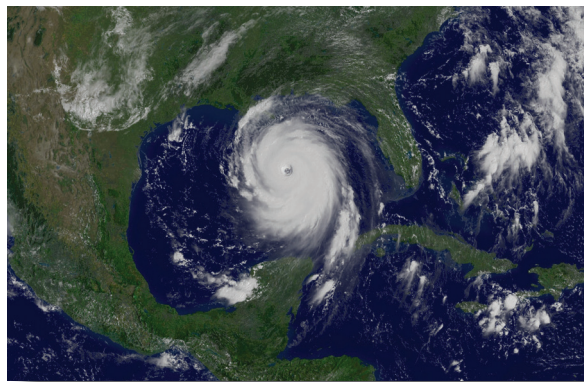

Hurricane Katrina Satellite View. Courtesy NOAA

Hurricane Symbol:



Tropical Storm Symbol:



Is It a Tropical Depression, Tropical Storm, or Hurricane?

Tropical Depressions, Tropical Storms, and Hurricanes are all cyclones, which are areas of low pressure in the atmosphere that have a spiralling inward pattern of air movement. In the Northern Hemisphere, the spiral turns counterclockwise, while cyclones in the Southern Hemisphere have spirals that turn clockwise.

A Tropical Depression is a tropical cyclone in which the maximum sustained wind speed is 38 mph or less.

A Tropical Storm is a tropical cyclone in which the maximum sustained wind speed ranges from 39 mph to 73 mph.

Hurricanes are tropical cyclones with maximum sustained wind speeds of 74 mph or greater. Hurricanes are classified into five categories:

- Category One: Winds 74-95 miles per hour
- Category Two: Winds 96-110 miles per hour
- Category Three: Winds 111-130 miles per hour
- Category Four: Winds 131-155 miles per hour
- Category Five: Winds greater than 155 miles per hour

Is Your Family Disaster-Ready?

Visit <https://www.ready.gov/kids/build-a-kit> for information about how to make a Disaster Supply Kit.



Courtesy FEMA

Want to Do More?

Check out these Web sites:

- <http://www.nhc.noaa.gov/HAW2/english/intro.shtml> – Hurricane Awareness from the National Hurricane Center
- www.nhc.noaa.gov/aboutnames.shtml – The list of World-Wide Tropical Cyclone Names
- www.nhc.noaa.gov/aboutshs.shtml – Information about the Saffir-Simpson Hurricane Scale
- <http://www.nws.noaa.gov/om/hurricane/resources/TropicalCyclones11.pdf> – “Tropical Cyclones,” a very comprehensive guide to hurricanes and how to prepare for them
- <http://www.nhc.noaa.gov/pastall.shtml> – Historical Hurricane Tracks Web site, with information about dozens of hurricanes in the Atlantic and East-Central Pacific Ocean Basins. Scroll down to **Past Track Seasonal Maps** to select information about dozens of hurricanes in the Atlantic and East-Central Pacific Ocean Basins.

Track Coordinates of Some Famous Storms

Hurricane Hugo Location and Windspeed at 0000 GMT

Date	Latitude (North)	Longitude (West)	Wind Speed (knots)
9/11/1989	13.2	23.7	30
9/12/1989	12.5	31.0	40
9/13/1989	12.6	38.2	55
9/14/1989	12.9	44.9	70
9/15/1989	13.8	50.5	100
9/16/1989	14.8	56.1	135
9/17/1989	16.1	60.4	120
9/18/1989	17.2	64.1	130
9/19/1989	19.7	66.8	100
9/20/1989	23.5	69.3	90
9/21/1989	27.2	73.4	100
9/22/1989	31.7	78.8	120
9/23/1989	42.2	80.2	35
9/24/1989	52.0	62.0	40
9/25/1989	54.0	57.0	40



Courtesy NOAA



Three views of Hurricane Andrew on 23, 24, and 25 August 1992 as the hurricane moves East to West. Time lapse satellite image courtesy NASA.

Hurricane Andrew
Location and Windspeed at 0000 GMT

Date	Latitude (North)	Longitude (West)	Wind Speed (knots)
17/8/1992	11.2	37.4	30
18/8/1992	13.6	46.2	40
19/8/1992	16.3	53.5	45
20/8/1992	19.8	59.3	40
21/8/1992	23.2	62.4	45
22/8/1992	25.3	65.9	55
23/8/1992	25.6	71.1	110
24/8/1992	25.4	77.5	125
25/8/1992	26.2	85.0	115
26/8/1992	28.5	90.5	125
27/8/1992	31.5	91.1	35
28/8/1992	34.4	86.7	20

Hurricane Floyd
Location and Windspeed at 0000 GMT

Date	Latitude (North)	Longitude (West)	Wind Speed (knots)
8/9/1999	15.0	46.9	30
9/9/1999	16.7	52.6	45
10/9/1999	18.3	57.2	60
11/9/1999	20.8	60.4	80
12/9/1999	22.7	64.1	85
13/9/1999	23.4	68.7	125
14/9/1999	24.5	74.0	115
15/9/1999	27.1	77.7	115
16/9/1999	32.1	78.7	90
17/9/1999	40.6	73.5	50
18/9/1999	44.8	67.3	40
19/9/1999	48.0	56.3	35

Hurricane Katrina
Location and Windspeed at 0000 GMT

Date	Latitude (North)	Longitude (West)	Wind Speed (knots)
24/8/2005	23.4	75.7	30
25/8/2005	26.0	77.7	45
26/8/2005	25.9	80.3	70
27/8/2005	24.6	83.3	90
28/8/2005	24.8	85.9	100
29/8/2005	27.2	89.2	140
30/8/2005	32.6	89.1	50
31/8/2005	38.6	85.3	30

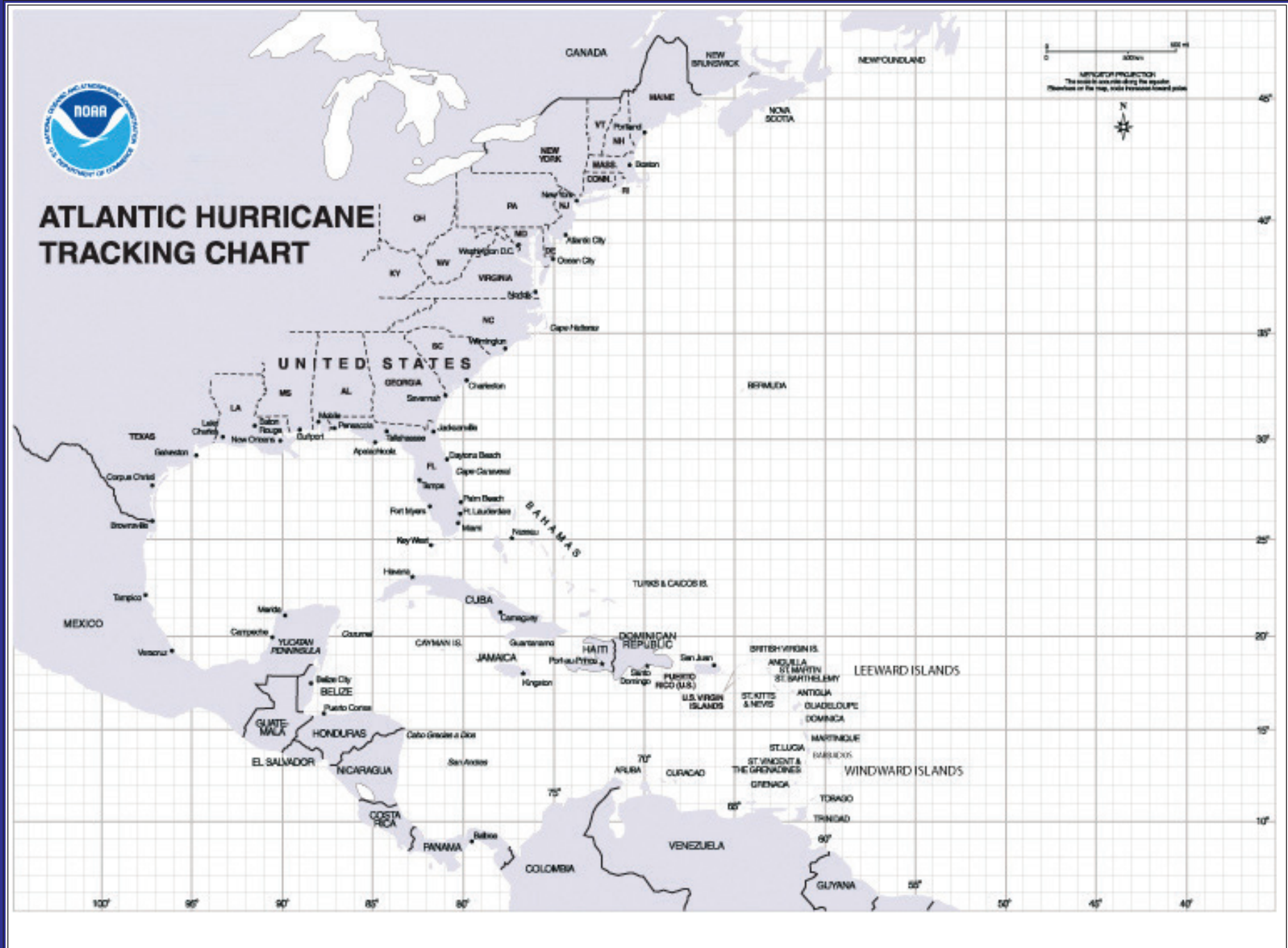

Build Your Own Weather Station



"I believe there is a train under here somewhere!"

Standing tall on North Dakota snow. A March blizzard nearly buried utility poles. Caption jokingly read "I believe there is a train under here somewhere!"
Courtesy Dr. Herbert Kroehl, NGDC

Every year, thousands of lives and millions of dollars are saved by severe weather warnings from the National Weather Service. From its earliest beginnings (on February 9th, 1870), the primary mission of the National Weather Service has been to protect life and property by providing information about dangerous weather conditions. Originally, the National Weather Service was called "The Division of Telegrams and Reports for the Benefit of Commerce" and was part of the U.S. Army. Later, its name was shortened to the Weather Bureau and it became part of the Department of Agriculture, then the Department of Commerce.

The first "weathermen" were "observing-sergeants" of the Army's Signal Service Corps. Weather forecasting in those early years was based almost entirely on the assumption that the weather observed in one location on a particular day would move to downwind locations on following days. Today, satellites, computers, and a variety of scientific instruments are added to this basic assumption to make accurate weather predictions and provide warnings about dangerous weather.

Here's how you can make your own weather observation station!

What You Will Do

Build six instruments that you can use to make scientific measurements of your local weather

Build an Anemometer to Measure Wind Speed

What You Will Need

- Five paper cups - Three ounce size
- Two straight plastic soda straws
- Straight pin
- Paper punch
- Stapler
- Sharp pencil with eraser
- Felt tip marker
- Watch or timer

Warning

Be careful with the straight pin!

How to Do It:

1. Using a paper punch, punch a hole in four paper cups about 1/2-inch below the rim of the cups.
2. Punch four equally spaced holes in a fifth paper cup about 1/4-inch below the rim, and a fifth hole in the center of the bottom of the cup (you will probably need to use the pencil to make the hole in the bottom).
3. Push a soda straw through the hole in one of the first four cups. Flatten the end of the straw and staple it to the side of the cup

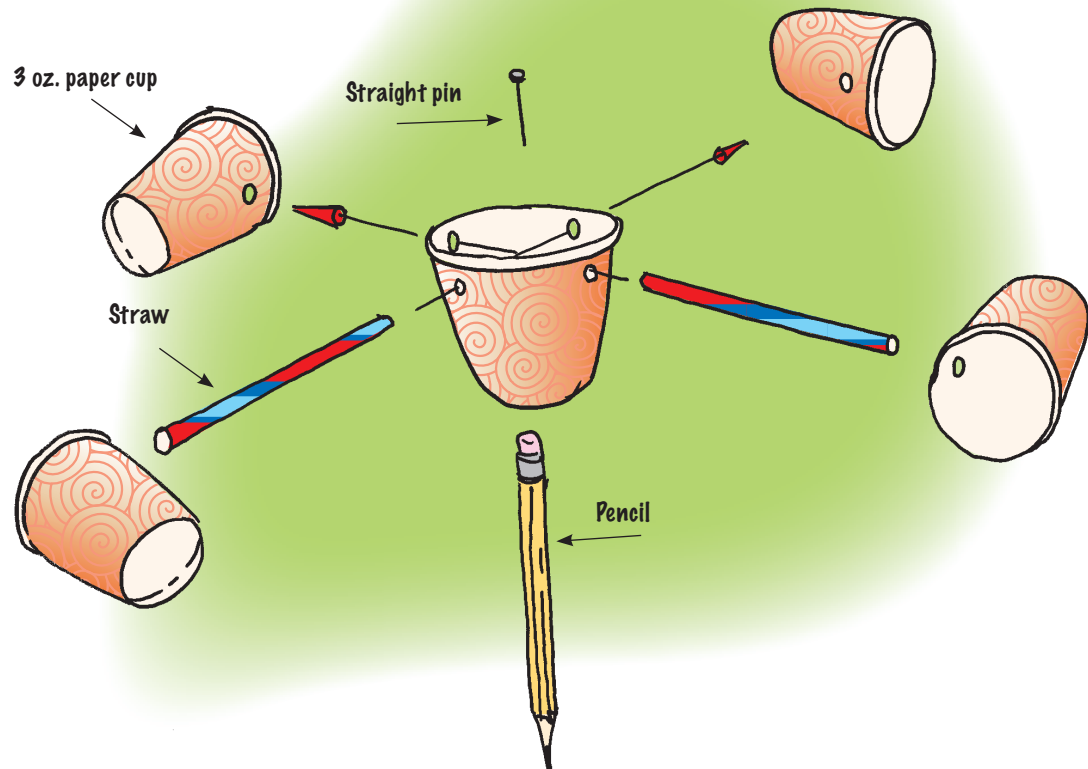

opposite the hole. Repeat this step with the other straw and another of the first four cups.

4. Slide one of the cup and straw assemblies through two opposite holes in the side of the fifth cup. Push another one-hole cup onto

the straw, and turn this cup so that the open ends of the two cups on the straw face in opposite directions. Flatten the end of the straw, and staple it to the side of the second cup. Measure the distance between the centers of the two cups. This is the diameter of your anemometer.

5. Repeat Step 4 with the remaining cup and straw assembly and the remaining one-hole cup. Before stapling the end of the straw to the last cup, turn the cups so that the open end of each cup faces the closed end of the next cup.
6. Adjust the cup and straw assemblies so that they are centered inside the fifth cup. Push the straight pin through the two straws where they intersect.
7. Push the eraser end of the pencil through the hole in the bottom of the fifth cup, and push the straight pin into the eraser as far as it will go. Your anemometer is ready to use!
8. To use the anemometer, hold the pencil vertically in a wind, and count the number of revolutions per minute (use the felt tip marker to make a mark on one cup so that you can easily see when the cup has travelled through one complete revolution). To convert revolutions per minute (rpm) into approximate wind speed:

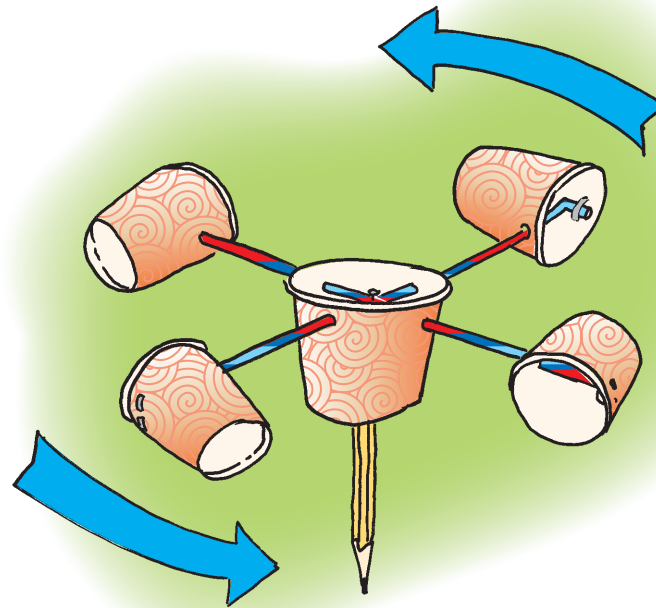

Finished Anemometer

- a. Multiply rpm by the diameter (in inches) of your anemometer (measured in Step 4)
 - b. Multiply the result by 0.003. This is the approximate wind speed in miles per hour.
- This calculation does not give exact wind speed, because drag, friction, and other forces also affect the speed at which your anemometer rotates.



Anemometer

Build a Weather Vane to Find Wind Direction

What You Will Need

- Broomstick or long wooden dowel, about one inch diameter
- Aluminum baking dish, about six inches x nine inches
- Wood stick, about 3/4 inch square and 12 inches long
- Nail, about one inch long
- Metal washer with a hole slightly larger than the nail
- Duct tape
- Small saw or serrated knife
- Scissors strong enough to cut the aluminum baking dish
- Ruler or tape measure
- Silicone or other glue that will stick to aluminum
- Leather gloves
- (Optional) Hand drill, and small drill bit slightly larger than the nail

Warning

Be careful of the sharp edges on the pieces of cut aluminum! Use gloves to protect your hands until the edges are taped.

How to Do It

1. Use the saw or serrated knife to cut a notch about 1/2-inch deep into each end of the wood stick. The notches should be parallel (see drawing on page 65).
2. Rotate the stick so that the two slots are vertical. Use the ruler or tape measure to find the exact center of the wood stick.

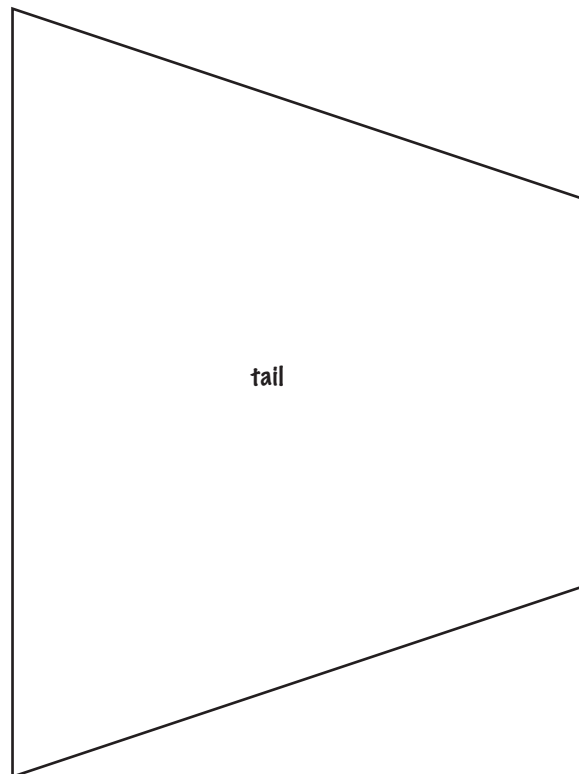

Mark this spot on the upper surface of the stick, and drive a nail through the marked spot. Be careful: if the nail is too big, the stick will probably split. To avoid this, drill a hole slightly larger than the nail through the marked spot. You may need an adult to help with the drilling.

3. Cut the head and tail pieces of the Weather Vane from the aluminum baking dish using the pattern as a guide. **Be Careful—The Edges Are Sharp!** Use duct tape to cover the sharp edges.

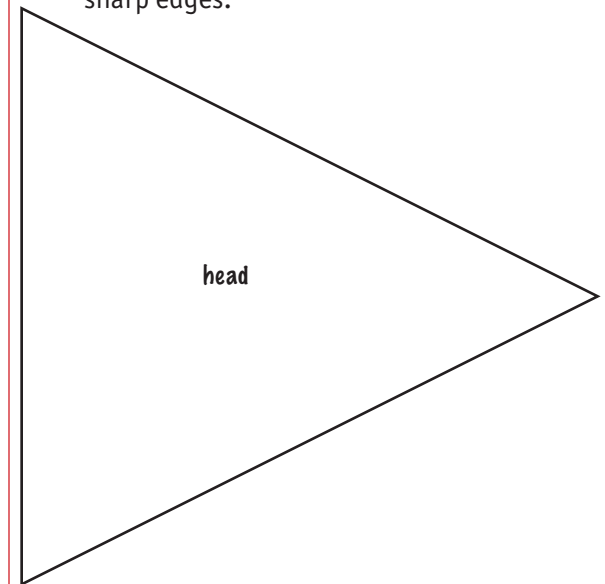

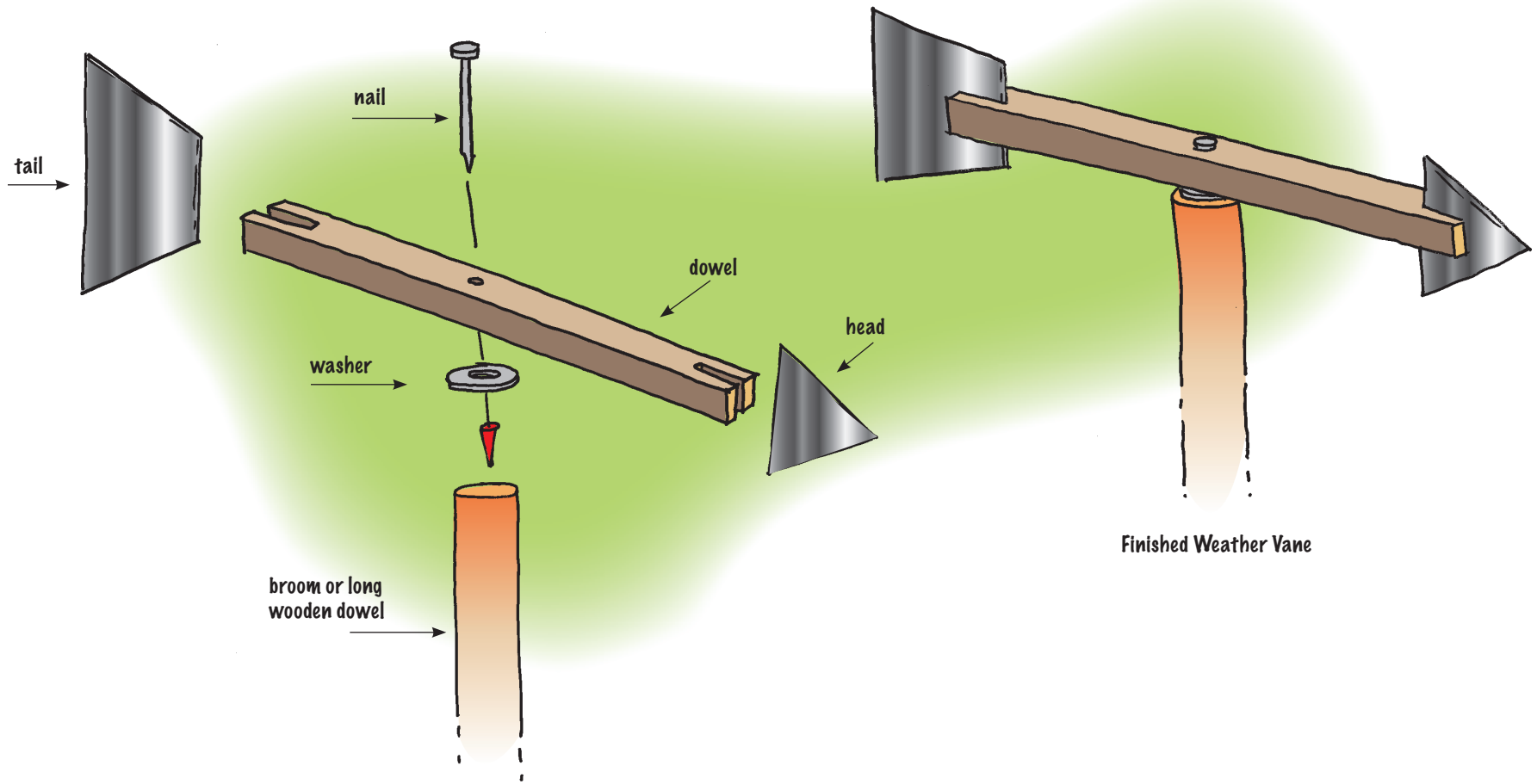

4. Fit the head piece into one of the slots in the wood stick and fit the tail piece into the other slot. Glue the head and tail pieces into place and allow the glue to dry.
5. Attach the Weather Vane to the broomstick or dowel, by placing the washer on one end of the dowel and hammering the nail through the wooden stick into the dowel.

Be sure the stick still moves freely around the nail.

6. Mount your Weather Vane outside where there are no nearby obstructions to block the wind. Try to get the dowel as high as you can while still keeping it steady and secure.

Winds are named according to the direction from which the wind is blowing, so a "north wind" is blowing from the north. The head of the Weather Vane will point to the direction from which the wind is blowing.

Build a Barometer for Measuring Atmospheric Pressure

What You Will Need

- 12-inch ruler
- Drinking glass or other container with sides tall enough to support the ruler
- Clear plastic drinking straw or piece of clear plastic tubing, about 12-inches long
- Modeling clay or chewing gum
- Clear tape
- (Optional) Food coloring

How to Do It

1. Tape the plastic straw or plastic tubing to the ruler so that one end is lined up with the "1/2-inch" mark on the ruler.
2. Stand the ruler-tubing assembly upright in the glass (or other container), and tape the assembly to the top of the container.
3. Fill the container about 3/4-full of water. If you want colored water, first mix food coloring with the water in another container.
4. Use the modeling clay or chewing gum (you'll have to chew it until it is soft enough) to plug the end of the straw or plastic tubing near the top of the ruler.

5. Carefully pour out some of the water so the container is about half full. Be sure the lower end of the straw or tubing stays beneath the water surface while you do this! When you are finished, the water in the straw or tube should be higher than the water in the container. Your barometer is now finished. Since barometers are sensitive to minor changes in weather conditions, keep your barometer indoors for greatest accuracy.

6. Keep a daily record of the height of the water in the tube, using the scale on the ruler. The water level in the tube will rise and fall as atmospheric pressure changes. When atmospheric pressure increases, air presses on the surface of the water in the container causing the height of the water

in the tube to rise. When atmospheric pressure decreases, there is less pressure on the surface of the water in the container so the height of the water in the tube falls. Decreasing atmospheric pressure usually indicates that a low pressure area is approaching, and this often brings clouds and rain. Increasing atmospheric pressure often indicates fair weather.

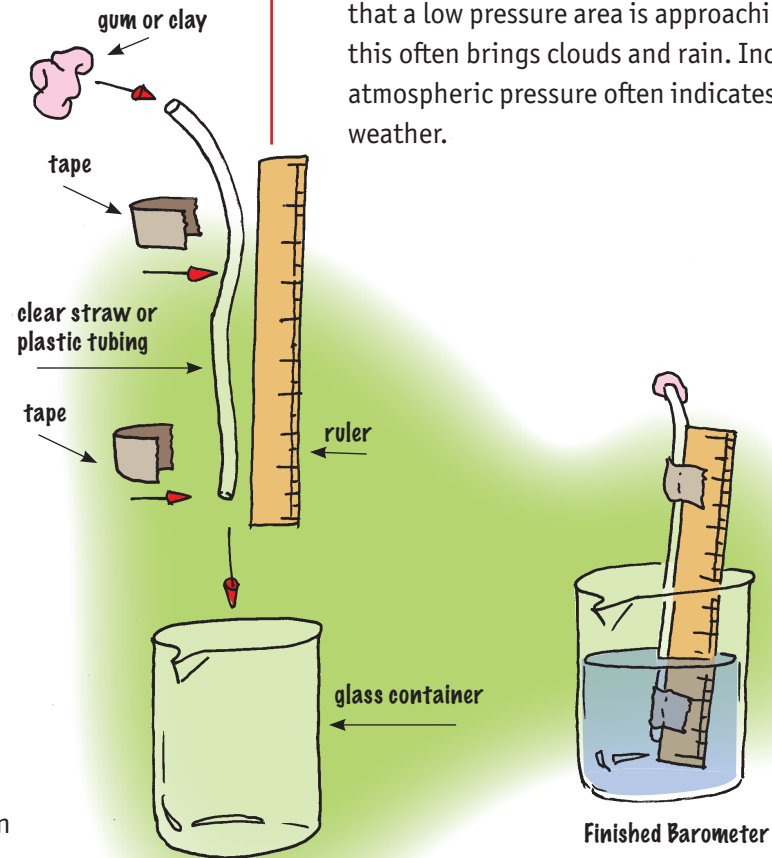

Build a Screened Thermometer to Measure Air Temperature

What You Will Need

- A wooden or plastic box, large enough to hold the thermometer and your hygrometer; see Step 1 under “How to Do It”
- Thermometer, about 0°F to 120°F
- White paint and paint brush
- Nails, screws, glue, or tape to attach the thermometer to the box

How to Do It

1. The wood or plastic box is supposed to protect your weather instruments from wind, rain, and direct sun, but still allow air to circulate so the instruments can get accurate readings. A box with a hinged lid that can be turned on its side is perfect. Turn the box on its side, and cut several slots near what is now the bottom of the box. Paint the outside of the box with white paint, and find a safe, shady outdoor location. The north side of buildings has the most shade. Try to find a location that is three to four feet above the ground.
2. Attach the thermometer to the back of the box with tape, glue, screws, or nails. The bulb of the thermometer should be about two inches above the bottom of the box.

Build a Hygrometer to Measure Humidity

What You Will Need

- Piece of wood or Styrofoam about nine inches long and four inches wide
- Flat piece of plastic, thin enough to cut with scissors; about three inches long and one inch wide (an old credit card or laminated luggage tag works well)
- Two small nails
- Three strands of human hair, about eight inches long
- Dime
- Glue
- Tape
- Hammer
- Scissors

How to Do It

1. Cut the plastic into a pointer as shown on the pattern below.

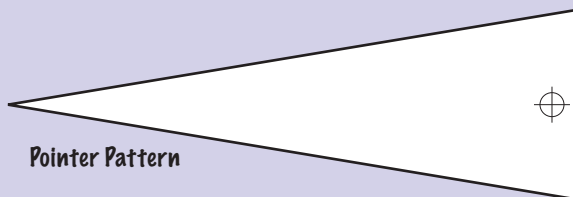

2. Poke one of the nails through the pointer near the base of the triangle. Wiggle the nail around until the pointer moves freely and loosely around the nail.
3. Tape the dime onto the pointer near the tip of the triangle.
4. Glue the hair strands onto plastic between the nail hole and the dime.
5. Use a nail to fasten the pointer to the wood or Styrofoam base about 3/4 of the way down the side. Be sure the pointer can still turn freely on the nail.
6. Attach the other nail to the base about one inch from the top of the base, in line with the spot where the hair is glued to the pointer.
7. Pull the free ends of the hair tight so that the pointer is horizontal. Wrap the hair around

the upper nail and glue to hold the hair in place.

8. Make a photocopy of the scale and cut it out. Glue the scale to the base so that the pointer is pointed to the "0" mark. Your hygrometer is finished!
9. Human hair will expand and lengthen when the air is moist, causing the pointer to move down. When the air is dry, the hair will contract and shorten, causing the pointer to move up. Use the scale to record the pointer's position. Keep your hygrometer in a sheltered location. The box used for the screened thermometer is ideal.

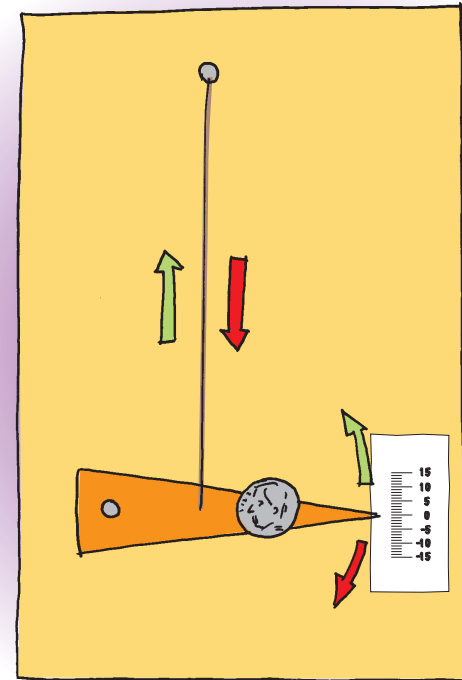
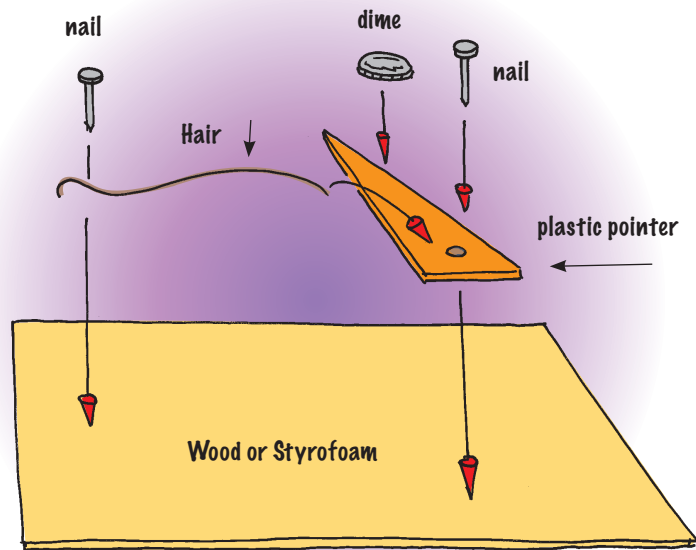

Finished Hygrometer

Build a Rain Gauge to Measure Rainfall

What You Need

- Straight-sided glass or plastic container, with a diameter of about two inches or less (such as an olive jar)
- Coat hanger or wire bent to make a holding rack (see picture)
- Measuring spoons: One teaspoon and 1/4 teaspoon
- Hammer and nails to secure the rack
- Felt tip marker

How to Do It

1. Rain gauges measure the amount of rainfall in cubic inches. So your first task is to make a scale for your container that shows how many cubic inches of water are in the container. One cubic inch of water is about 3 1/4 teaspoons, so you can draw the scale on your container by measuring 3 1/4 teaspoons of water to your container, then drawing a short line at the level of the water. If you look closely, the top of the water will seem to be slightly curved and thickened. Draw your line so that it matches the bottom of the curved surface (which is called a meniscus). This line corresponds to a rainfall of one inch.

2. Add another 3 1/4 teaspoons of water to the container and draw another line. The second line corresponds to a rainfall of two inches.
3. Repeat Step 2 until you have at least five marks on the container. This will be enough for most rain events; but you may want to add another line or two, just in case!
4. Find a location for your rain gauge where there is nothing overhead (such as trees or a building roof) that could direct water into or away from your gauge. The edge of a fence away from buildings is often a good spot. Another possibility is to attach your rain gauge to a broomstick driven into the ground in an open area. Be sure to record rainfall soon after a rain event to avoid false readings caused by evaporation.

Empty your gauge after each reading, and you are ready for the next event!

This activity is adapted from Weather Scope: An Investigative Study of Weather and Climate:
<http://www.k12science.org/curriculum/weatherproj2/en/activity1.shtml>.

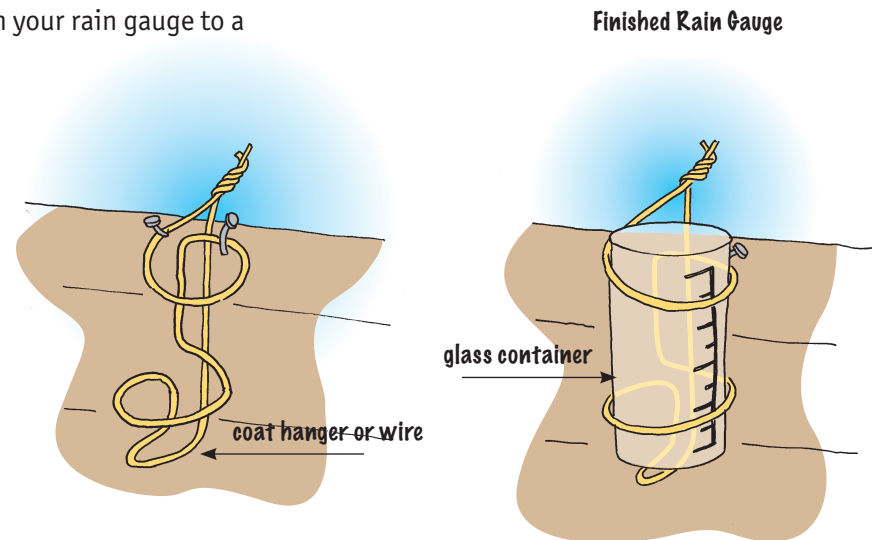

Finished Rain Gauge

Be A Citizen Weather Reporter



A young volunteer in Granger, Utah (around 1930) operates a cooperative weather station where he observes temperature, precipitation, sky conditions, etc. Courtesy NWS.

“The whole point is that person is helping out their neighbors by sharing that information”.

Chad Gimmestad - NWS Senior Meteorologist
From minute 12:18 of episode 1 of

The Crowd & The Cloud: <http://crowdandcloud.org/watch-the-episodes/episode-one>

Could you help save lives with your homemade weather instruments?

Maybe so!

The National Weather Service Cooperative Observer Program is a network of more than 11,000 volunteers who report weather observations from farms, urban and suburban areas, National Parks, seashores, and mountaintops. Data from volunteer weather observers are used to define the climate of the United States and to help measure long-term climate changes, as well as to provide real-time information to support forecasts, warnings, and other public service programs of the National Weather Service.

The Cooperative Observer Program was officially created in 1890, but the history of volunteer weather observers is even older. John Campanius Holm recorded the earliest known weather observations in the United States in 1644-45. George Washington, Thomas Jefferson, and Benjamin Franklin were also serious weather observers. Thomas Jefferson maintained an almost unbroken record of weather observations between 1776 and 1816, and George Washington took his last observation just a few days before he died.

An essential part of any weather observing station is a system for keeping accurate records of observations. Here's how to set up a Weather Journal, and some tips for making weather forecasts from your observations!

What You Will Do

Set up a Weather Journal and record regular measurements from the instruments in your Weather Station

What You Will Need

Copies of "Weather Journal Data Form"

How to Do It

At least once each day, record the measurements from each of the instruments in your weather station. Notice that there are two columns for "Barometric Pressure" and "Humidity." Record the readings from your instruments in the "Instrument" columns. The "NWS" column is where you can record measurements from your local weather office. Comparing the two columns gives you a way to convert your instruments readings to approximately the same scale used for official weather measurements.

Over time, you should begin to see patterns in your data. When the weather changes (it gets windy, starts raining, etc.), check your records for a day or two before. Was there a change in temperature, humidity, or barometric pressure? Did the wind direction shift? These kinds of changes can give clues about what kind of weather is coming. See "Tips for Amateur Forecasters" for more information about these clues.

Tips for Amateur Forecasters from the National Weather Service

Below is a general summary of wind and barometer indications in the United States. The amateur forecaster should modify the table as needed, based on his or her own observations. Barometric pressures in this table are in inches of mercury at sea level. If you use local weather reports to calibrate your instruments, you don't have to worry about this because official measurements are converted to sea level before they are reported to the public. A general rule of thumb is that atmospheric pressure decreases by one inch of mercury for every 1,000 feet of elevation.

If the Wind is Blowing from	and the Barometer is	the Probable Weather is
Southwest to Northwest	30.10 to 30.20 and steady	Fair with slight temperature change for one to two days
Southwest to Northwest	30.10 to 30.20 and rising rapidly	Fair, followed by rain within two days
Southwest to Northwest	30.20 and above and steady	Continued fair, with little temperature change
Southwest to Northwest	30.20 and above and falling slowly	Slowly rising temperature and fair for two days
South to Southeast	30.10 to 30.20 and falling slowly	Rain within 24 hours
South to Southeast	30.10 to 30.20 and falling rapidly	Wind increasing in force, rain within 12 to 24 hours
Southeast to Northeast	30.10 to 30.20 and falling slowly	Rain in 12 to 18 hours
Southeast to Northeast	30.10 to 30.20 and falling rapidly	Increasing wind, and rain within 12 hours
East to Northeast	30.10 and above and falling slowly	In summer: rain may not fall for several days In winter: rain within 24 hours
East to Northeast	30.10 and above and falling rapidly	In summer: rain likely within 12 to 24 hours In winter: rain or snow, with increasing winds
Southeast to Northeast	30.00 or below and falling slowly	Rain will continue one to two days
Southeast to Northeast	30.00 or below and falling rapidly	Rain, with high wind, followed by clearing within 36 hours, and by colder temperatures in winter
South to Southwest	30.00 or below and rising slowly	Clearing within a few hours, and fair for several days
South to East	29.80 or below and falling rapidly	Severe storm soon, followed by clearing within 24 hours, and by colder temperatures in winter
East to North	29.80 or below and falling rapidly	Severe northeast gale and heavy precipitation In winter: heavy snow, followed by a cold wave
Changing to West	29.80 or below and rising rapidly	Clearing and colder

Want to Do More?

Are you interested in becoming a volunteer weather observer? SKYWARN is a volunteer program established by NOAA's National Weather Service and partner groups to identify and describe severe local storms. Since the program started in the 1970s, information provided

by SKYWARN Spotters has helped the National Weather Service to issue more timely and accurate warnings for tornadoes, severe thunderstorms, and flash floods. In some areas, Spotters also are trained on warning signs for earthquakes, landslides, avalanches, volcanic

ashfall, and coastal hazards such as tsunamis, water spouts, and rip currents. See <https://www.weather.gov/skywarn/> for more information.

Weather Journal Data Form

Date	Time	Temperature	Barometric Pressure		Humidity		Precipitation		Wind	
			Instrument	NWS	Instrument	NWS	Type	Amount	Speed	Direction

Tornado in a Bottle



The Dimmitt Tornado,
South of Dimmitt, Texas
Courtesy NOAA.

“And then I was enveloped by the freight train roar...as I got to the stairs all of the front of the building blew in...like a bomb went off, just a huge explosion behind me...And then screaming wind...While I was crouched under the desk the building was breathing. You could feel the floor lift about a foot and then you could feel it drop...I thought any second this is going to drop and we are all going down to the first floor with the building on top of us. I was terrified when the building started moving, I thought I’m gonna die...”

Bill Morgan

*Journalist and retired Police Information Officer
recalling the tornado that struck Lubbock, Texas on May 11, 1970,
killing 26 people and injuring hundreds*

Did you know:

- The 1970 Lubbock tornado was classified as F-5, which is the highest a tornado can be rated
- In a typical year about 1,000 tornados will strike the United States
- The strongest tornadoes have rotating winds in excess of 250 mph
- Tornadoes can be up to one mile wide and may stay on the ground for more than 50 miles.
- Tornados can occur at any time of the year and have occurred in every state in the country
- More tornados strike the central United States than any other place in the world; which is why this area is nicknamed “tornado alley”

Tornadoes cause an average of 70 fatalities and 1,500 injuries each year. These numbers would be much higher without NOAA’s tornado warning and research programs. Nationwide tornado forecasts and urgent tornado warnings are issued by the National Weather Service and broadcast over NOAA’s All Hazards Weather Radio network, which is the nation’s one-stop source for weather and emergency information. NOAA’s National Severe Storms Laboratory is a leader in tornado-related research, and in developing technologies such as Doppler radar to improve forecasts and warnings of tornadoes and other severe weather.

When you hear the word “tornado” what picture pops into your mind? For most people it is the funnel-shaped black cloud, with spiralling winds called a “vortex.” Here’s how you can create your own “tornado in a bottle.”

What You Will Do

Create a vortex similar to the wind pattern of tornados

What You Will Need

- Two empty two-liter plastic soda bottles
- Tornado Tube plastic connector (available from science museums, science stores, novelty stores, scientific supply companies, etc.) - OR
- Metal washer, about one inch diameter with a 3/8-inch diameter hole, and plastic electrical or duct tape
- Dishwashing detergent
- (Optional) Food coloring

How to Do It

1. Fill one of the two-liter bottles about 2/3 full of water. Add three drops of dish soap and a couple of drops of food coloring to help make the vortex more visible.
2. Screw the plastic connector onto the bottle containing the water, then attach the empty bottle to the open end of the connector. Or, tape two bottles together with a flat washer between them. Use plastic electrical tape or duct tape.
3. Turn the two-bottle assembly over, and place the assembly on a table with the filled bottle on top. Watch the water slowly drip down into the lower bottle as air simultaneously bubbles up into the top bottle. The flow of water may come to a complete stop. Now, rapidly rotate the bottles in a horizontal circle a few times. Observe the formation of a

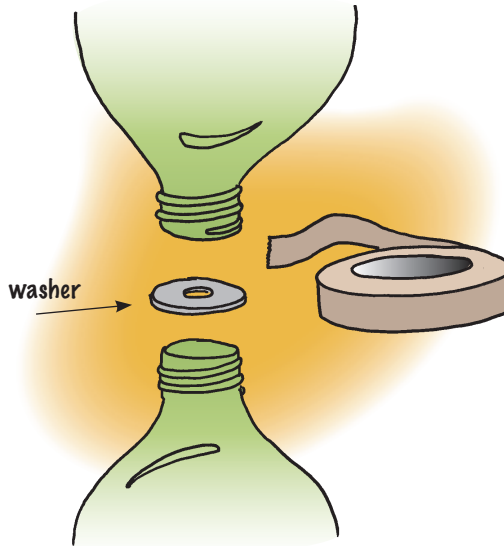

funnel shaped vortex as the top bottle drains much more quickly. You can make the vortex with a single bottle by twirling the bottle and holding it over a water basin or the ground to drain, but you lose the water and have to refill the bottle each time you use it. Now you know how to use a liquid tornado to quickly empty a large bottle!

What's Happening

When the water is not rotating, surface tension creates a skin-like layer of water across the small hole in the center of the connector or washer. If the top bottle is almost full, the weight of the water is sufficient to push out a bulge in this surface to form a large drop, which then drips into the lower bottle. As water drops into the lower bottle, the pressure in the lower bottle increases

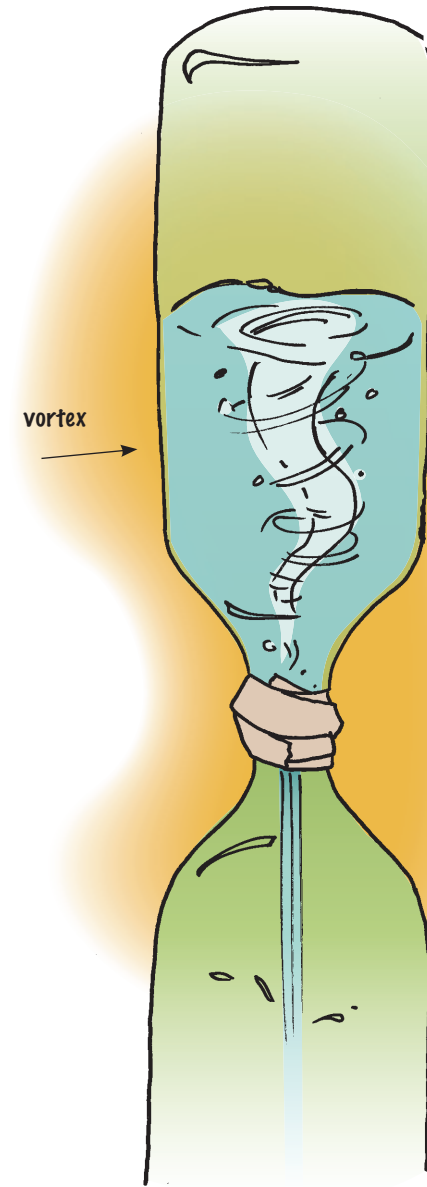

until air bubbles are forced into the upper bottle. The pressure of the water's weight at the surface of the connector or washer decreases as the water level in the upper bottle drops. When the water level and pressure decrease enough, the water surface can hold back the water and stop the flow completely.

When you rotate the bottles in a horizontal circle, the water in the upper bottle starts rotating as well. As the water rotates, forces called *centripetal forces* pull the water toward the center of the bottle. At the same time, gravity pulls the water toward the drain hole. As the water drains into the lower bottle, a vortex forms. As water particles at the outside of the bottle move toward the hole, the speed of the particles increases and the centripetal forces increase. The slope of the water shows where centripetal forces are increasing. So at the bottom of the vortex, the slope of the water is steeper because the centripetal forces are increasing as the water moves with higher speeds and in smaller circles. The water drains smoothly and rapidly because the hole in the vortex allows air from the lower bottle to flow easily into the upper bottle.

There are many examples of vortices in nature, including whirlpools, hurricanes, the Great Red Spot on Jupiter, sunspots, and spiral galaxies (such as our own galaxy, the Milky Way). Keep in mind that while the spiralling motion makes many vortices look similar, they occur for many different reasons. The vortex in your "bottle

Tune In to NOAA Weather Radio

NOAA Weather Radio (NWR) broadcasts local weather forecasts 24 hours a day from local offices of the National Weather Service. NWR is an All-Hazards program that broadcasts warnings and information about emergencies that include:

- natural events such as tornadoes, hurricanes, floods, and earthquakes;
- technological accidents such as chemical spills, oil spills, nuclear accidents; industrial emergencies, shipping accidents, or train derailments;
- AMBER alerts; and
- terrorist attacks

NWR broadcasts cannot be heard on a simple AM/FM radio receiver, but the Weather Band is built into many automobile radios, walk-

tornado" is caused by horizontal spin (provided by you) and gravity. But a real tornado in the atmosphere is caused by a combination of wind shear, changes in atmospheric pressure, and centrifugal force.

By the way, tornadoes in the atmosphere happen on a relatively small scale (compared to the size of the whole atmosphere). This means that tornadoes may rotate clockwise or counterclockwise, regardless of where they are on Earth; just like your bottle tornado can be made to rotate in either direction.

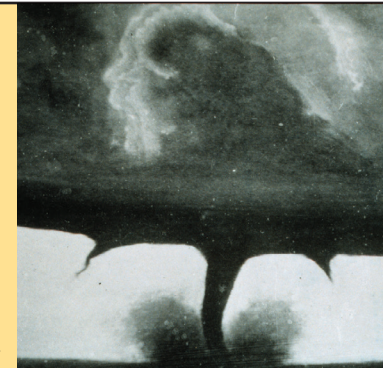

Oldest known photo of a tornado. August 28, 1884, Howard, South Dakota. Courtesy NOAA.

ie-talkies, marine radios, and other receivers. Prices for Weather Radio receivers start at about \$20. Some receivers have a built in alarm that is turned on by a special tone sent from NWR during an emergency to signal that information is being broadcast about a life-threatening situation.

For more information about NOAA Weather Radio, visit <http://www.weather.gov/nwr/>

Want to Do More?

Find out more about tornadoes at NOAA's Tornadoes Web page, <http://www.noaa.gov/tornadoes.html>. You may also want to visit the Tornado Project's Web site, <http://www.tornadoproject.com/>.

Portions of this activity are adapted from an Exploratorium Science Snack (<http://www.exploratorium.edu/snacks/>).

Rip Currents

"I grew up swimming in the ocean and am very comfortable in it. One of my favorite pastimes in the ocean is diving under breakers and floating over swells. [Once], I dove under a wave... but when I surfaced and looked back over my shoulder, I was way out from the shore. I knew immediately what had happened. I tried swimming parallel to the shore, but was still in a very strong current and began to tire quickly.

Then a wave broke over my head, and I felt the panic rising. I know that panic is one's worst enemy in the water, so I floated and treaded water for a few minutes to catch my breath and relax. ...When I looked out to sea to keep an eye on the swells,...I realized that just a little further out, there were surfers.

[So] instead of trying to make it back to shore on my own, I turned and swam out to where they were. I told them what had happened and asked if one of them would allow me to accompany him into shore using his board as a boogie board for both of us. Of course, one of them agreed.

It took both of us to get far enough away from the current so we could paddle back into shore. I feel very fortunate that I recognized what had happened, knew not to panic, and was able to find a solution."

by Kathryn T. Graham

from the National Weather Service Rip Current Safety Web page
<http://www.ripcurrents.noaa.gov/survivor.shtml>

What You Will Do

Demonstrate why swimmers caught in rip currents have to swim following the shoreline to escape

Rip currents are powerful, channeled currents of water flowing away from shore. They can occur at any beach with breaking waves, including many Great Lakes. These currents are killers. The United States Lifesaving Association estimates that every year, rip currents on our nation's beaches kill more than 100 people.

Here are some clues that a rip current may be present:

- A channel of churning, choppy water
- A difference in water color
- A line of foam, seaweed or debris moving out to sea
- A break in the incoming wave pattern

There are three basic safety rules for ocean swimming:

- Swim near a lifeguard
- Never swim alone
- If in doubt, don't go out

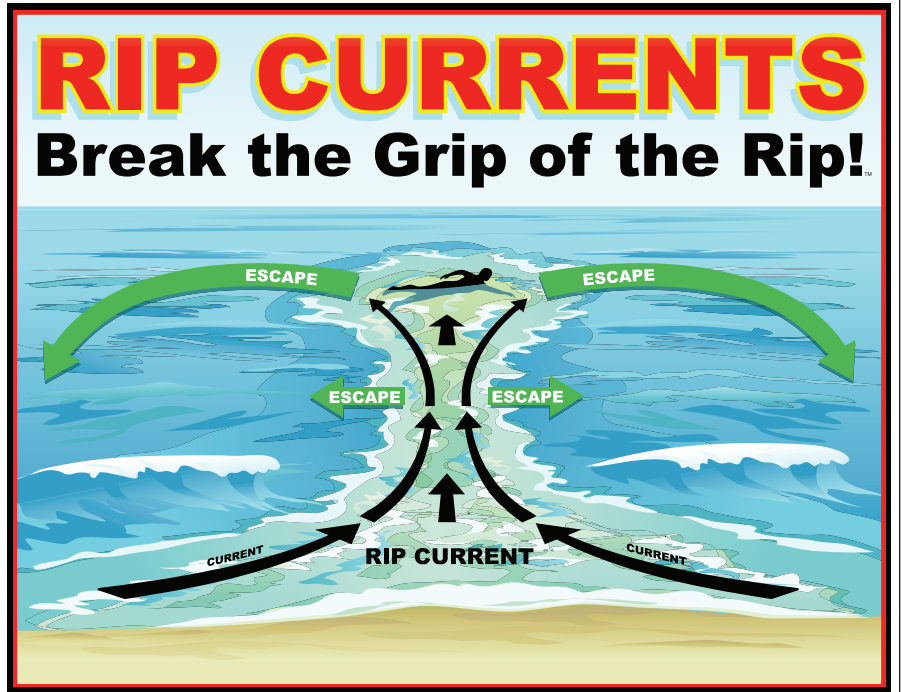

from a Rip Current Safety Poster by NOAA's National Weather Service, NOAA's National Sea Grant College Program, and the United States Lifesaving Association
http://www.ripcurrents.noaa.gov/signs/rip_signs-r.pdf

If you are ever caught in a rip current:

- Relax and float, rip currents do not pull you under
- Don't swim against the current
- Swim in a direction following the shoreline, or toward breaking waves
- If you need help, call or wave your arms for assistance

What You Will Need

- Two or more strips of ribbon, rope or string, each at least ten feet long; if you have a choice, a blue color is good for representing ocean waves
- At least five people, including yourself

How to Do It

1. Have pairs of participants hold opposite ends of the rope or ribbon. You will need at least two pairs of participants to do the demonstration.
2. Designate one side of a room or outdoor space as the “shore” and the opposite side as “deep water.”
3. Have pairs of participants stand so that the rope or ribbon is stretched out, and is perpendicular to the shore. These participants and their ropes or ribbons represent waves.
4. Place a “trapped swimmer” participant in the “current” between two of the “waves.”
5. Have the “swimmer” walk toward the “deeper water,” as if being carried out by the current. The “trapped swimmer” can only escape by swimming in a direction following the shoreline until she or he is out of the rip current. Then he or she can use the waves to return safely to the beach.



Rip Current on Grand Avenue Beach
Courtesy of Chris Brewster, USLA



Beach View of Rip Current Along Jetty
Courtesy of Dr. Tom Herrington, Stevens Institute of Technology



Want to Do More?

- Find out more about rip currents and other beach hazards on NOAA’s rip current Web site at www.ripcurrents.noaa.gov.
- In coastal areas, many of NOAA’s National Weather Service Forecast Offices issue a Rip Current Outlook as a part of their Surf Zone Forecast. NOAA identifies days with forecasts for particularly dangerous rip currents with “High Risk of rip currents.” Visit: <http://www.ripcurrents.noaa.gov/forecasts.shtml> to learn more.
- NWS National Seasonal Safety Campaign - National Weather Service:
NOAA NWS Weather Ready Nation Seasonal Safety Campaigns have replaced the awareness/preparedness weeks we had with the exception of a couple, one being Hurricane Preparedness Week.

The aim of the National Seasonal Safety Campaign is to build a Weather-Ready Nation, one that is prepared for extreme weather, water, and climate events. With the National Seasonal Safety Campaign, we seek to inform the public about seasonal weather hazards during the time they are most common.

<https://www.weather.gov/safetycampaign>

Close up of Rip Current
Courtesy of Lifeguard Captain Nick Steers,
County of Los Angeles Fire Department

Be a Tree Ring Detective



Dust storm approaching Stratford, Texas. April 18, 1935
Courtesy NOAA.

The storm took place at sundown, it lasted through the night,
When we looked out next morning, we saw a terrible sight.
We saw outside our window where wheat fields they had grown
Was now a rippling ocean of dust the wind had blown.

It covered up our fences, it covered up our barns,
It covered up our tractors in this wild and dusty storm.
We loaded our jalopies and piled our families in,
We rattled down that highway to never come back again.

~ from "The Great Dust Storm" by Woody Guthrie

Earth's climate is always changing, and these changes can have large impacts on humans. An increase in the number of droughts, floods, or hurricanes, for example, will cost U.S. citizens billions of dollars and threaten the lives of many people. Information on past climate changes can give valuable clues on how to plan and prepare for future climate change. Unfortunately, records of human weather measurements only go back about 150 years. To really understand Earth's climate change history, we need information that goes back hundreds and thousands of years.

One way to get this kind of information is to study tree rings (the analysis of tree rings is known as dendrochronology). As trees grow, their trunks increase in length and thickness. Most trees only grow during part of the year (the growing season). This starting and stopping of the growth process produces visible bands or "rings" of wood around the trunk of the tree. Each ring corresponds to one year of growth. The oldest rings are near the center of the tree, while the youngest rings are at the outside of the trunk next to the bark. The ring just inside the bark is the current year's growth. There are two kinds of wood in each ring: "earlywood" appears light in color and its cells have thin walls; "latewood" appears dark in color and its cells have thick walls. The width of the rings changes according to the environmental conditions that existed during the growing season, so ring width can tell scientists a lot about how climate changed during the years when the tree was growing. If the rings are wide, then conditions were probably favorable for tree growth. Narrow rings, on the other hand, may indicate drought, disease, or other conditions not favorable to growth.

Could you be a good Tree Ring Detective? Try solving this puzzle to find out!

What You Will Do

Cross-date tree-ring samples to find out which sample is oldest,
and then find the age of the oldest sample

What You Will Need

- Copy of “Tree Ring Sample Sheet”
- Blank piece of paper
- Scissors
- Clear tape

Warning

Be careful with scissors!

How to Do It

Most tree-ring samples are collected with a tool called an “increment borer.” This is a hollow shaft of steel, about 3/16 inch diameter, with a sharp threaded bit at the tip. A handle fits into the opposite end and is used to turn the borer into the tree. When the borer is pulled out of the tree, it removes a core of wood that shows the rings. Most trees are able to seal the small bore hole with sap, so coring does not cause any serious damage to most trees that are sampled.

You might think that you could find the age of a tree simply by counting the rings, but it isn’t that simple. The problem is that samples taken from trees growing in the same area (and even from the same tree) usually are not identical. There may be “extra” rings in some parts of the tree, or missing rings in other parts. To deal with this problem, dendrochronologists use a procedure called crossdating. This procedure involves comparing and matching the tree ring patterns from several trees that have grown in the same area, and using statistical methods to find the exact

year in which the rings were formed. This procedure also allows scientists to compare rings from trees that have grown at different times, so the age of very old wood samples can be accurately determined.

On the next page, there are two sets of tree ring samples that can be matched for crossdating. Most tree-ring studies involve many more samples and some additional analytical steps (check out the resources listed under “Want to Do More?”).

1. Cut out each of the tree ring samples.
2. Turn the blank piece of paper so that the longest side is horizontal, and tape the tree ring sample from the living tree onto the blank piece of paper near the upper right corner.
3. Find another tree ring sample that matches part of the tree ring pattern from the living tree. Line up the matching rings and tape the sample beneath the sample from the living tree.
4. Repeat Step 3 until you have matched all four samples.
5. Count how many rings are in the combined samples, starting with the left-hand ring of the oldest sample and ending with the ring next to the bark of the living tree sample. Be sure to count overlapping rings only once.

6. How old is the living tree? How old is the oldest tree? Which tree seems to have grown under the most stressful conditions? When you think you know the answers, check the answer box.

Want to Do More?

NOAA’s Paleoclimatology Web site (<https://www.ncdc.noaa.gov/data-access/paleoclimatology-data>) has information on how past climates are studied; how climate has changed, and how we can plan for future climate change.

Visit <https://www.ncdc.noaa.gov/data-access/paleoclimatology-data/datasets/tree-ring> to learn more about tree rings.

Visit <https://www.ncdc.noaa.gov/news/picture-climate-how-can-we-learn-tree-rings> to unlock the secret of how trees tell us about climate conditions.

Visit <https://www.climate.gov/teaching/resources/tree-rings-counting-years-global-warming> for a video describing the role dendrochronology plays in understanding climate change.

Visit <https://www.climate.gov/teaching/resources/signs-change-studying-tree-rings> to learn about dendrochronology (the study of tree rings to understand ecological conditions in the recent past).

<http://www.pbs.org/wgbh/nova/vikings/treer-ing.html> – Learn how dendrochronology was used to study ships of the ancient Vikings.

Tree Ring Sample Sheet

Sample Set 1

Living Tree



bark

Dead Tree A



bark

Dead Tree B



bark

Dead Tree C



bark

Sample Set 2

Living Tree



bark

Dead Tree A



bark

Dead Tree B



bark

Dead Tree C



bark

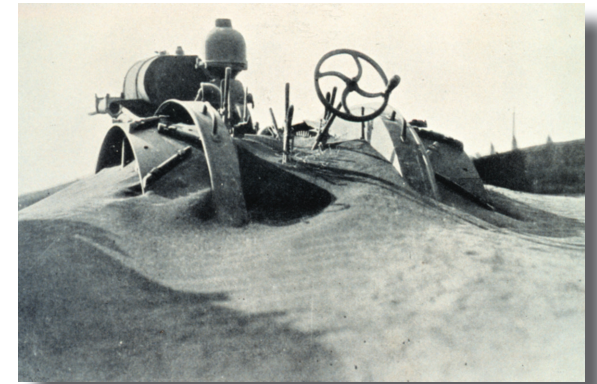

Dust buried farms and equipment, killed livestock, and caused human death and misery in the Great Plains during the height of the Dust Bowl years, 1935. Courtesy Historic NWS Collection.

Answer Box DO NOT PEEK!

until you have done
your detective work....

ANSWERS
 Sample Set 1 - The correct sequence for this set is Living Tree - Dead Tree C - Dead Tree A - Dead Tree B. The oldest tree (Dead Tree C) is 44 years old. Tree A seems to have grown under more stressful conditions than the other trees, since most of its rings are close together, indicating slow growth during those years.
 Sample Set 2 - The correct sequence for this set is Living Tree - Dead Tree B - Dead Tree A - Dead Tree C. The oldest tree (Dead Tree B) is 41 years old. The Living Tree seems to have grown under more stressful conditions than the other trees, since more of its rings are close together than in the other samples, indicating slow growth during those years.

Your Own El Niño



Virginia National Guard helicopter rescuing an individual from the James River. Note: rescued man halfway up to helicopter. Helicopter crewman standing on debris in river. Courtesy NWS Collection.

"Fifteen years ago, storms battered the West Coast of the United States...There were droughts in Australia, Indonesia, and India...Worldwide, 2,000 people died...Economic losses amounted to billions of dollars...In Indonesia and Borneo, dry conditions fed raging forest fires that consumed hundreds of thousands of acres. Smoke blanketed the area..."

~ from the PBS news program, "Bracing for El Niño"
October 7, 1997

What You Will Do

Create a working model that shows the El Niño effect, trade winds, and upwelling

What caused these disasters? Just some warm water in the Pacific Ocean!

Every two to seven years, trade-winds in the Pacific Ocean slow down or reverse their direction (no one is sure why). Normally, the Pacific trade winds blow vigorously towards the west. This causes warm surface water to pile up in the western Pacific, so that the sea surface is actually about 1/2 meter higher at Indonesia than at Ecuador. These winds also cause sea surface temperatures to be about eight degrees Celcius higher in the west, with cool temperatures off South America, due to an upwelling of cold water from deeper levels. This cold water also brings up nutrients that support the growth of marine plants, which provide food for major fisheries.

But when the trade winds slow down, everything changes. Water temperatures become warmer in the eastern Pacific and colder in the west. Nutrient upwelling slows, and fish populations become much smaller along the Pacific coast of South America. Rainfall follows the warmer water, causing flooding in Peru and drought in Indonesia and Australia. Changes in the circulation of Earth's

- *atmosphere bring unusual weather to other regions that are far away from the*
- *tropical Pacific. Fishermen in South America noticed that these changes usually*
- *happen around Christmas time, and named the event "El Niño," which means*
- *"the (Christ) Child."*
- *El Niño isn't all bad; some of the changes it causes in atmospheric circulation*
- *can reduce the chances of severe hurricanes in the North Atlantic. But many*
- *other changes are highly destructive and dangerous, so advance warning of*
- *El Niño's approach is extremely important for emergency preparation. NOAA*
- *satellites are constantly collecting information on sea surface temperatures*
- *around the globe. NOAA also operates a network of buoys that measure*
- *temperature, currents, and winds in the tropical Pacific Ocean. Every day,*
- *these buoys transmit data that are immediately available to researchers and*
- *forecasters around the world.*
- *Here's a way for you to create a miniature El Niño in your own kitchen!*

What You Will Need

- Clear plastic rectangular container, about 18 inches long, four inches high, and four inches deep (such as a food storage container)
- Water
- Mineral oil, about one cup
- Food coloring
- Hair dryer
- Funnel
- Red oil-based paint, about one ounce (two tablespoons)

Warnings

Have an adult help with the hair dryer, and be careful with any electrical appliance around water! Follow warnings on the paint container label concerning ventilation and handling.

How to Do It

1. Fill the plastic container with water to within one inch of the top.
2. Add food coloring to the water. Blue is good, since we're dealing with the ocean. Allow some of the food coloring to settle to the bottom so you can demonstrate upwelling.
3. Pour the mineral oil into a dish and mix in one to two tablespoons of the red paint.

4. Hold the funnel so that the narrow end is against the side of the container, just above the surface of the water. Gently pour mineral oil through the funnel onto the surface of the water.

5. The liquids in the plastic container represent the warm layer of surface water (the mineral oil) and the cold deep water (colored water) in the Pacific Ocean. Turn on the hair dryer and point it into one end of the container. This end represents the eastern side of the Pacific Ocean. Notice that the "warm" water piles up in the western end of the container.

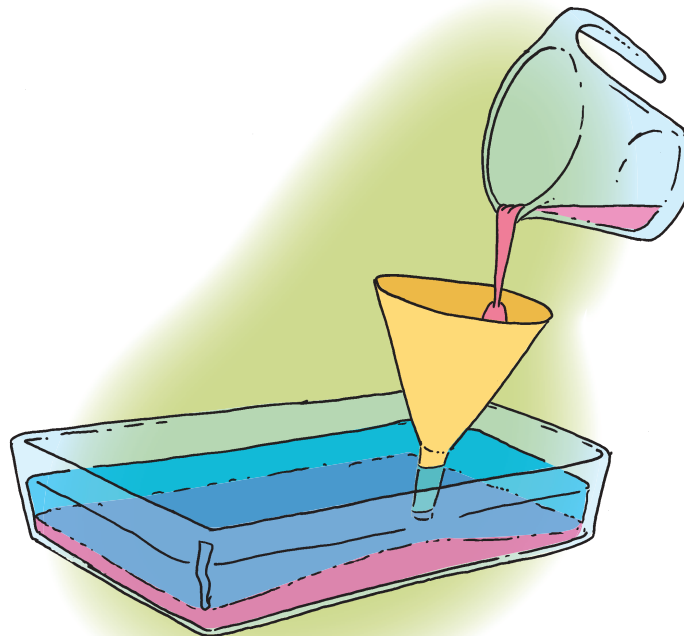

Plastic container

This is the normal condition for the Pacific Ocean near the equator. If your food coloring contained sediment particles, you may see these moving upward toward the water surface at the eastern end of the container—just like upwelling in the eastern Pacific!

6. Turn off the hair dryer, and watch what happens when the trade winds stop.

Want to Do More?

You can find out more about El Niño at:

- NOAA's Climate Prediction Center Web site www.cpc.ncep.noaa.gov/products/precip/CWlink/MJO/enso.shtml
- NOAA's El Niño Web page climate.gov/enso
- The El Niño story page www.pmel.noaa.gov/el_nino/what-is-el_nino
- NASA's Jet Propulsion Laboratory Web site www.jpl.nasa.gov/climateciences/projects/enso/index.html

This activity was adapted from "Make Your Own El Niño in the Classroom," <https://sealevel.jpl.nasa.gov/files/ostm/make-your-own-el-nino.pdf>, by Kelly Perry (Jet Propulsion Laboratory), Johan Berlin (Raytheon Corporation), James Kendall (Jet Propulsion Laboratory), and Ruby Krishnamurti (Florida State University) presented on NASA's Jet Propulsion Laboratory Education Web page (<https://www.jpl.nasa.gov/edu>).

Please Pass the Salt



A Weddell Seal at a breathing hole. Courtesy NOAA Corps Collection
Photographer: Giuseppe Zibordi. Credit: Michael Van Woert, NOAA NESDIS, OAR

“Antarctica is the coldest, driest, windiest continent on the planet. Temperatures can plummet to -58°F , which is 90°F below freezing...Antarctica is so cold that most of the ice there never melts; the continent is permanently covered in ice. Yet, Weddell seals can live there...because some water remains unfrozen, and they can dive and re-surface through these holes in the ice. How do these holes stay open?...The answer is, it’s a joint effort between the seals and the properties of the water.”

~ from the Web site of Dr. Terrie M. Williams, Professor,
Ecology and Evolutionary Biology, University of California Santa Cruz
<http://bio.research.ucsc.edu/people/williams/teachers/intro.htm>

- What is the most obvious property of seawater? It’s salty! But if you mix
- salt from your kitchen into a glass of water, it doesn’t taste exactly like
- seawater. That’s because seawater contains many other chemicals in ad-
- dition to sodium chloride (which is ordinary kitchen salt), such as mag-
- nesium sulfate, magnesium chloride, and calcium carbonate. Scientists
- call the content of all dissolved salts in seawater “salinity,” and measure
- it in parts per thousand (abbreviated ppt or ‰), which is equivalent to
- grams per kilogram. Freshwater has a salinity of 0‰ ; normal seawater
- has a salinity of about 35‰ .
-
- Salinity makes seawater very different from freshwater. Most animals
- have a specific range of salinities that they can tolerate, and cannot
- survive if the salinity is above or below their tolerance range. Changes in
- salinity can affect the circulation of the oceans, and may even affect cli-
- mate. Because salinity influences our environment in many ways, NOAA
- keeps track of salinity in many places along the U.S. coasts and around
- the world. Here are some experiments you can do to discover some of the
- most important properties of seawater.

What You Will Do

Experiment to find some of the ways that salt changes the physical properties of water

What You Will Need:

- Salt
- Water
- Freezer
- Tablespoon measure
- Cup measure
- Spoon for stirring
- Five clear plastic cups, six ounces or larger
- One fresh egg
- Food coloring

How to Do It:

1. For your first experiment, dissolve three tablespoons of salt in one cup of water. Pour the salt solution into one of the plastic cups until the cup is about 3/4 full. Pour the same amount of fresh water into another cup. Place both cups in a freezer. Check the cups every half hour for two hours. Which solution freezes first? What has happened to the salt solution after 24 hours?

2. For the second experiment, dissolve three tablespoons of salt in one cup of water, and pour the salt solution into one of the plastic cups until the cup is about half full. Fill another cup about half full of fresh water, and add a few drops of food coloring. Now, carefully pour the colored fresh water into the cup of salt water, holding the edges of the cups together so that the fresh water flows down the inside of the cup containing the salt water. Do the two solutions mix, or



An iceberg in Gerlache Strait, West Antarctica
Photographer: Rear Admiral Harley D. Nygren, NOAA Corps (ret.) Courtesy NOAA.

does one float on top of the other? Which solution has the greater density?

3. Finally, pour fresh water into a plastic cup until the cup is about 3/4 full. Carefully crack a fresh egg, and gently drop the contents of the egg into the cup. If your egg is fresh, the yolk will be a firm but flexible sphere that sinks to the bottom of the cup. If your egg is not-so-fresh, the yolk will break or ooze into the water and your experiment is over! Assuming the egg yolk is still intact, add two tablespoons of salt to the water, and gently stir with a spoon. Over the next few minutes,

the salt will slowly dissolve. What has happened to the egg after ten minutes?

Now, do you have an idea why holes the Antarctic ice stay open and don't immediately freeze over?

What's Going On Here?

Pure water freezes at 32°F (0°C), but adding salt lowers the freezing point of pure water. This is why salt is sometimes used to keep ice from forming on sidewalks. When water freezes, it forms crystal-like structures. When salt water freezes, only the water forms these structures; the salt is

left out in unfrozen water. So as salt water freezes, the water that is not frozen becomes saltier.

After 24 hours in your freezer, the cup containing fresh water should be frozen solid (if it isn't, your freezer isn't working!). The salt solution probably contains some ice, but it is not frozen solid. It may appear slushy, and you should have no trouble sticking your finger through whatever ice is in the cup.

Salt water is more dense than freshwater, so freshwater floats on top of salt water. The greater density of salt water also means that objects float more easily in salt water than in freshwater. Remember Archimedes' Principle, which says that an object in a fluid is buoyed up by a force equal to the WEIGHT of the fluid displaced by the object (see Page 11). One cup of salt water weighs more than one cup of fresh water, so its buoyant force is greater. So your egg (if it was fresh) sank in freshwater, but was buoyed up by the salt water.

Want to Do More?

1. Check out NOAA's National Ocean Service at www.oceanservice.noaa.gov/education/kits/estuaries/media/supp_estuar10c_salinity.html and www.oceanservice.noaa.gov/education/kits/estuaries/estuaries05_circulation.html to find out more about salinity and how it affects coastal ecosystems.

2. Other NOAA programs that provide information on salinity include:

- The Regional Ocean Forecast System (nsidc.org/cryosphere/seaice/characteristics/brine_salinity.html), which provides information on salinity and brine;

- The National Oceanographic Data Center (www.nodc.noaa.gov/) with records of global ocean salinity data; and
- The National Estuarine Research Reserve System (coast.noaa.gov/estuaries/science-data/) that uses automatic instruments to collect data on salinity and other physical features.



NOAA wildlife biologists Mike Goebel and Birgitte McDonald get a Southern elephant seal ready for measurement and tagging, as part of the U.S. Antarctic Marine Living Resources research program that provides scientific information needed to conserve and manage marine living resources in the oceans around Antarctica. Courtesy NOAA/Scott Seganti.

Satellite Communications

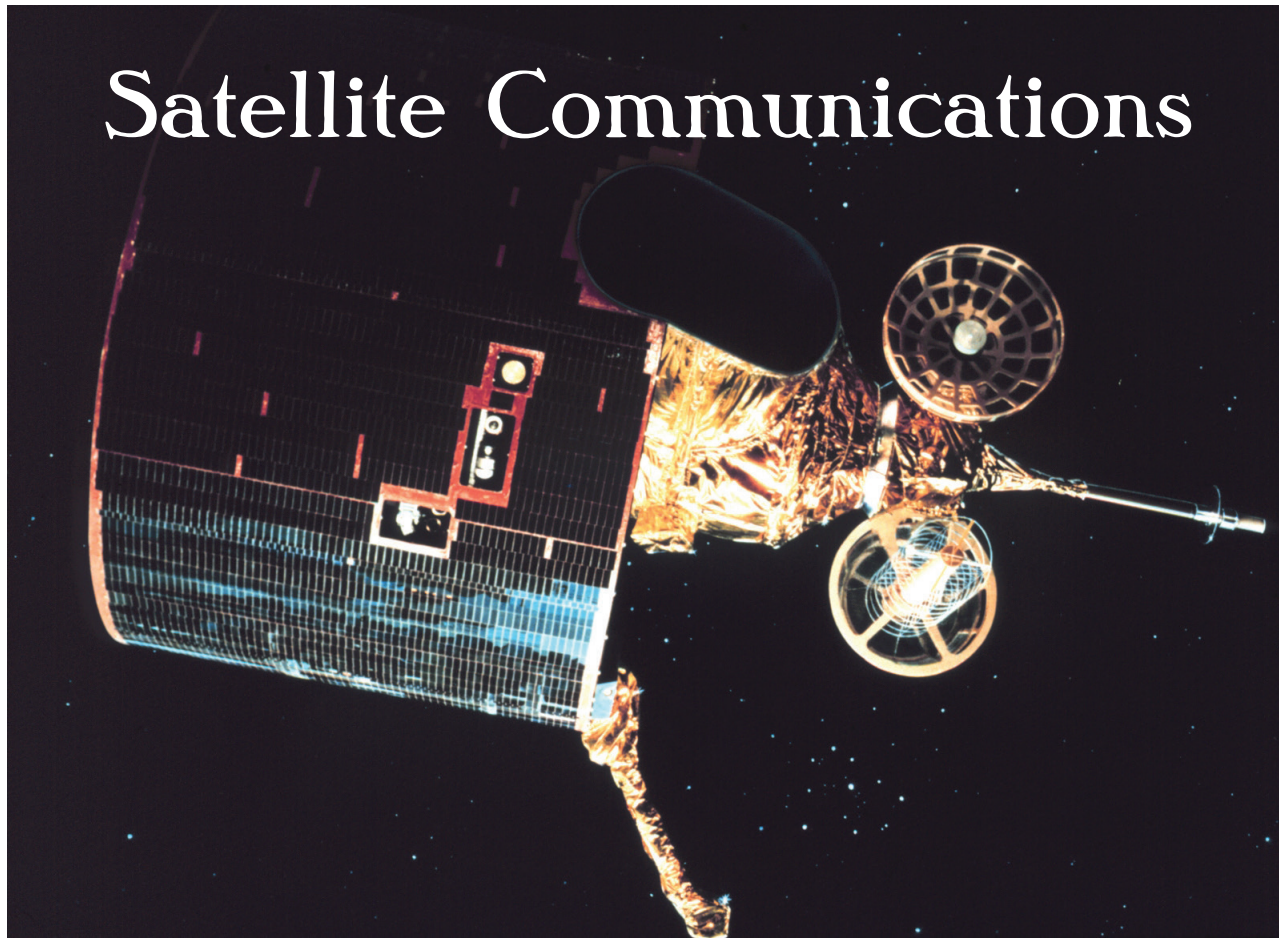

Graphic of 2nd generation GOES satellite in orbit. Courtesy NOAA.

What You Will Do

Demonstrate two of the basic principles that make satellites useful

What...

- has helped rescue more than 41,000 people since 1982;
- shows the location of fires, snow cover, thunderstorms, and erupting volcanoes everywhere on Earth;
- lets you watch the lights go on all over North America as the sun sets?

Satellites, of course! But what keeps satellites in place? And how do they help send information all over the world? Here are two simple demonstrations that answer these questions.

What You Will Need

- Empty three pound coffee can
- Poster board, at least 22-inches square
- String, about 12 inches long
- Pencil
- Scissors
- Marble
- Masking tape
- Flashlight
- Mirror
- Sheet of light-colored paper
- Two rooms connected by a doorway
- A partner

Warnings

Be careful with sharp scissors!

How to Do It

To show how satellites stay in orbit:

1. Tie one end of the string around the pencil. Hold the other end near the center of the poster board, and draw a circle about 22 inches in diameter.
2. Cut the circle out of the poster board, then cut a wedge (pie shape) that is 1/8 of the circle.
3. Overlap the two edges of the circle where the wedge was removed to form a cone, and tape the edges together so that the cone holds its shape.

4. Put the pointed end of the cone in the coffee can, and tape the cone to the sides of the can.

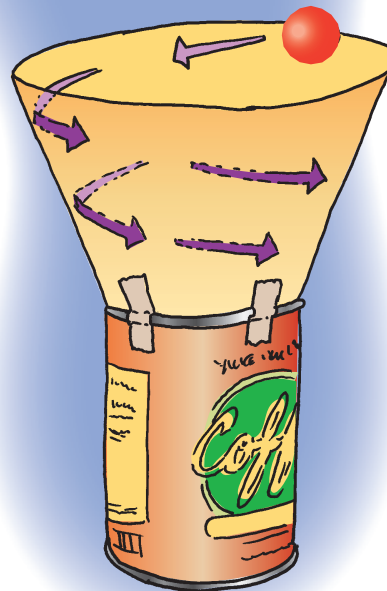
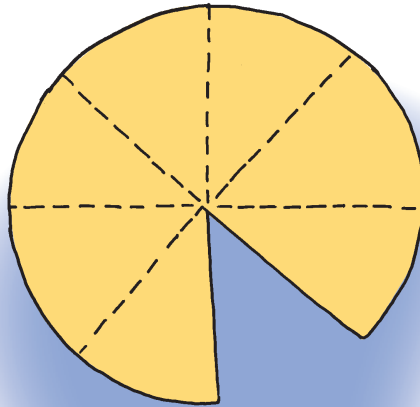

5. Roll the marble around the inside top of the cone as fast as possible, and observe the movement.

When you push the marble forward and release it, the cone applies a continuous resistance to the marble's movement and causes it to move in a circle. As the speed of the marble decreases, the gravity pulls the marble down to the bottom of the cone. If you could keep the marble moving at a constant speed, it would resist the pull from gravity and continue circling in the same place. When a satellite is launched, it moves away from Earth. Gravity causes a continuous pull on the satellite that keeps it from continuing to move out into space. Instead, the forward motion of the satellite keeps it moving in a circle around the Earth.

To show how satellites help send messages between two points on Earth:

1. Have your partner stand in one room facing the doorway and holding a piece of paper. Your demonstration will work best if your partner is about six feet away from the wall that has the doorway.
2. Set up a mirror near the doorway in the other room so that the mirror is angled toward the doorway.

3. Shine a flashlight toward the mirror. The light will reflect into the other room so that your partner can catch it on the piece of paper.

The light is like messages containing information about Earth's oceans, atmosphere, ecosystems, the location of people needing rescue, etc. These messages can be sent to satellites that relay the information to other locations on Earth that are thousands of miles away.

Before satellites were available, messages were sent by bouncing radio signals off of Earth's atmosphere. But because the atmosphere is constantly changing, radio signals don't always bounce to the place that the sender wants them to go. Satellites are above Earth's atmosphere, and are a much more reliable way to communicate.

There are two types of satellites. Geosynchronous satellites are about 22,240 miles above the equator, and travel at a speed (about 6,800 miles per hour) that matches the Earth's rotation. This allows them to hover continuously over one position on the surface. Because they stay above a fixed spot on the surface, they provide a constant lookout for the atmospheric conditions that trigger severe weather events such as tornadoes, flash floods, hail storms, and hurricanes. Polar orbiting satellites circle the Earth 14 times a day, at an altitude of about 500 miles. These satellites pass almost directly over the North and South Poles, and view all regions of the Earth in a single day.

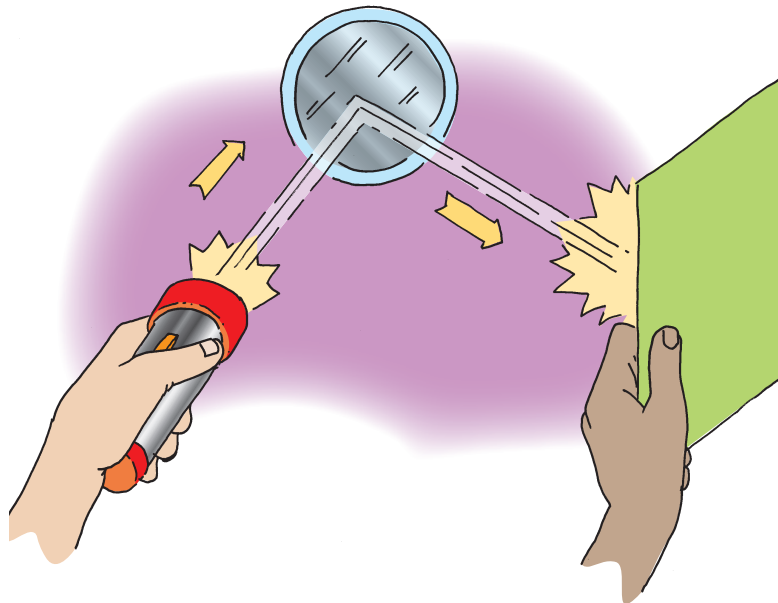

Want to Do More?

1. Visit <http://www.goes-r.gov/resources/education.html> for resources designed to educate customers about meteorology, space science, earth observing systems, and benefits satellites will provide
2. Visit www.nesdis.noaa.gov/content/our-satellites to learn about our satellites, the history, how they work, upcoming launches, and how our satellites are part of a worldwide constellation that supports forecasting around the globe.
3. See www.bu.edu/satellite/classroom/model.html for directions for making a model of an artificial satellite.
4. See www.sarsat.noaa.gov/sys-diag.html for information about how satellites are used for search and rescue.

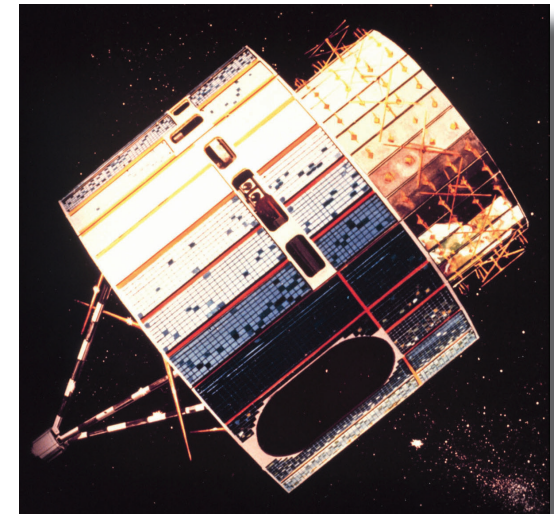

Graphic of the Synchronous Meteorological Satellite, a geosynchronous satellite that was the forerunner of the GOES (Geostationary Operational Environmental Satellite) satellites. Courtesy NOAA.

Woolly Magma

Descend into the crater of Yocul of Sneffels, which the shade of Scartaris caresses, before the kalends of July, audacious traveler, and you will reach the center of the earth. I did it.

“All scientific teaching, theoretical and practical, shows it to be impossible,” I said.

“I care nothing for theories,” retorted my uncle.

“But is it not well-known that heat increases one degree for every seventy feet you descend into the earth? Which gives a fine idea of the central heat. All the matters which compose the globe are in a state of incandescence; even gold, platinum, and the hardest rocks are in a state of fusion. What would become of us?”

“Don’t be alarmed at the heat, my boy.”

“How so?”

“Neither you nor anybody else know anything about the real state of the earth’s interior. All modern experiments tend to explode the older theories.”

~ from *A Journey to the Center Of the Earth*, by Jules Verne
jv.gilead.org.il/vt/c_earth/



Most of what Jules Verne wrote about the center of the Earth in 1864 is now considered to be wrong. While it is still true that no one has actually seen the Earth’s interior, today’s “scientific teaching, theoretical and practical” agrees more with young Harry than with his adventurous uncle. The center of the Earth is now believed to have an average temperature of 7,000°F, with maximum temperatures as high as 13,000°F. Here’s a way to show what scientists think we might find if we could really take a journey to the center of the Earth.

Overflow from Mauna Ulu Crater. View east at overflow from trench into main Mauna Ulu crater on March 19, 1972. Note partially cooled skin on lake. Photo credit: R.T. Holcomb, Hawaiian Volcano Observatory, U.S. Geological Survey.

What You Will Do

Make a colorful model of Earth’s structure

What You Will Need

- Two containers that will each hold about eight quarts (pots or bowls are fine)
- Paper towels
- Hand towel
- Dishwashing liquid
- Sharp scissors
- Serrated knife and a cutting board
- Rubber ball, about 1-1/4 inches diameter
- Wool roving in six colors; about 2/3 ounce of each color (red, gold, pink, green, white, and blue are suggested, but any colors will work)
- Hot and cold tap water
- Ice (about seven pounds)

Warnings

1. Be careful with scissors and hot water!
2. Get help from an adult to use the serrated knife!

How to Do It

To make your model, you will use a process called “felting.” You can read more about felting and how it works under “What’s Happening” at the end of this section.

1. Here is a drawing that shows the layers of Earth’s structure that will be included in your model. Since no one has actually seen Earth’s interior, we don’t know what the true colors are. So for your model, choose some colors that you like, and that are different enough so that the layers can be easily seen.

Structure of the Earth

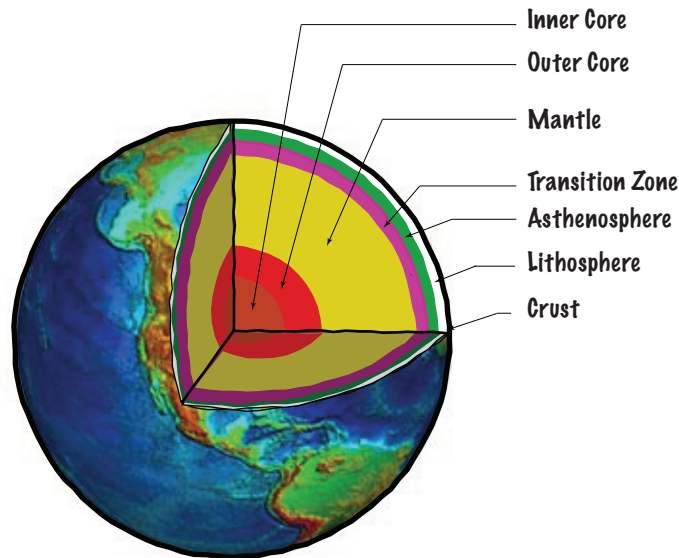

2. Begin constructing your model with the rubber ball, which represents the INNER CORE. Wrap a piece of red wool roving around the ball. The red roving represents the OUTER CORE. Be sure to wrap the wool roving tightly, and try to switch directions as often as possible. Pull the fiber as thin as you can. When you’ve reached the end, pull the fibers out to be as light and transparent as cotton candy; smooth those ends over the ball by stretching and patting them into place so they neatly stick to the ball. This will make the felting process easier because the fibers can be interlocked better that way.

3. Fill one of the containers about 2/3 full with hot tap water (the water should be as hot as your hands can stand). Fill the other container about 1/2 full with ice, then add cold tap water until the container is about 2/3 full.

4. Now for the felting! Dunk your woolen ball into either the hot or ice cold water. Hold the ball under the water and squeeze it hard to make sure water penetrates all the way to the inner core ball. Lift the woolen ball out of the water and squeeze again. Put a couple of drops of dishwashing liquid on the woolen ball, and roll the ball in your hands lightly, quickly and evenly. After the fibers have joined, begin to slightly increase pressure. The harder and faster you roll, the faster the felting process takes place.

5. After about a minute, dunk the ball into the other water container (so if you dunked it in cold water first, dunk it in hot water now.) The change of temperature shocks the wool fibers and makes them cling together.
6. Repeat the rolling process, adding more dishwashing liquid only if you need to. Too much soap will make the ball slippery and hard to press against. If the ball gets too soapy, rinse or blot off the excess dishwashing liquid with a paper towel. After about 5

minutes, you should have a hard, tight ball. Now you are ready to add the next layer.

7. Wrap the gold-colored roving around the ball to represent the lower Mantle layer. Remember to wrap the wool tightly, roll it in different directions, pull the end fibers out to be very thin, and smooth those ends over the ball.
8. Repeat Steps 4, 5, and 6.
Are you feeling tired? Felting is hard work – if you’re not feeling your muscles, you’re not working hard enough!
9. Wrap pink roving around the ball to represent the Transition Zone, remembering to wrap the wool tightly, roll it in different directions, pull the end fibers out to be very thin, and smooth the ends over the ball.
10. Repeat Steps 4, 5, and 6.
11. Next, add a layer of green roving to represent the Asthenosphere. You guessed it —Repeat Steps 4, 5, and 6.
12. Only two layers to go! Wrap the white roving around your ball to represent the Lithosphere, and repeat Steps 4, 5, and 6.
13. At last! It’s time to add the final layer to represent the Crust. This could be blue, since most of Earth’s surface is covered with

water, or multi-colored to represents both continental and oceanic crusts. Wrap the last piece of roving and repeat Steps 4, 5, and 6.

14. When you have finished your model, the felted wool ball should feel as firm as a tennis ball. Now, ask your adult partner to cut around the globe with a serrated knife to open the model up. **WARNING—Be sure to ask your partner not to cut all the way through! Leave a hinge area about 1/2 inch wide, or the whole thing will fall apart!** Carefully pull your model open and remove the ball. Trim any loose ends with scissors to make it uniform and smooth. Put the ball back in and ADMIRE your Wooly Magma—it’s yours and it’s unique! No two are alike.

What’s Happening More about Felting

What is felt? Do you know what it is made of? Have you ever seen someone throw a pair of woolen socks or a wool sweater in the washing machine and then the dryer? What happens to it? It shrinks! Almost anything made of 100% natural fiber can be felted. During felting, the tiny fibers that make up the wool interlock; tightening and closing the small holes that are also part of its make up. The felting process is basically a compacting of the material that makes the fibers very dense. Three things are needed to felt wet/moist wool: ALKALINITY, HEAT, and AGITATION. In short AHA! Any two of them together will lead to a natural

fiber or fabric felting. If you have a dog, cat, rabbit, or other pet with long fine hair, you’ve probably noticed mats or clumps behind its ears or on the body wherever the hair is exposed to AGITATION and moisture. That’s felt! If you’ve shampooed those spots on your animal, you’ll notice how hard and dense those clumps of fur become. That’s because you’ve added the ALKALINITY and intensified the felting process. To make your model, you use your muscles and a lot of “elbow grease” for the AGITATION. The HEAT part comes in when you shock your wool by dunking it into ice cold water and then in hot water. Dishwashing liquid provides the needed ALKALINITY for the process.

Why would people want to make felt on purpose? It can be beautiful and decorative, but more important, it is much warmer than a loosely woven garment. It can become nearly impenetrable; almost waterproof, and was especially important for the people who lived in the day when there were no synthetic fibers like nylon, polyester, or acrylic that our winter garments are made of now.

More About Earth’s Layers

Earth’s CORE is made out of iron and nickel and is about 1,550 miles in diameter. The temperature of the INNER CORE is on average about 7,000 degrees Fahrenheit, but it can go up to 13,000 degrees Fahrenheit. To give you an idea of how hot that is, you can bake a loaf of bread in your oven at 350 degrees and rock begins to melt at 1,600

degrees. Under the immense pressures in the INNER CORE, the metals do not flow as a liquid despite the high temperatures, but behave and vibrate like a solid.

The OUTER CORE is a sphere of iron and nickel, under less pressure than the inner core and nearly as hot. Here the metals are in a liquid state; between 4,000 and 9,000 degrees Fahrenheit. The Outer Core is 1,400 miles thick, located about 1,800 miles beneath the crust. Scientists believe that the circulation of an electric current in the Outer Core causes the Earth's magnetic field.

The MANTLE is Earth's largest layer, and is approximately two thirds of Earth's total mass. It is divided into several parts. The LOWER MANTLE (our gold layer) is very dense and hot (4,000 degrees Fahrenheit).

The TRANSITION ZONE divides the lower mantle from its upper portion. The Transition Zone starts at a depth of 250 miles and is roughly 190 miles thick. The temperatures here are much cooler than the lower mantle, around 1,600 degrees Fahrenheit.

The ASTHENOSPHERE is in the upper region of the mantle, and is the part that flows like asphalt. It both moves the plates of the Earth and permits their motion. This ability of a solid to flow is called "plasticity".



Two automobiles are all that remain after this section of Royal Gardens subdivision was overrun by lava (October 7, 1987). During October the footpath from a road into the housing area was covered, cutting residents off from the few homes that remained. Photo credit: J.D. Griggs, Hawaiian Volcano Observatory, U.S. Geological Survey

The LITHOSPHERE is a slab about 45 miles thick in which the continents are embedded. It gives us mountains and trenches (collisions), seafloor spreading and new oceans (separation), and long earthquake faults, like the San Andreas Fault (sliding side-by-side). This zone is composed of rigid, brittle rock.

The EARTH'S CRUST is the thinnest layer of the Earth at only 3-5 miles thick under the oceans and about 25 miles thick under the continents. It is composed of two basic rock types: granite and basalt. The CONTINENTAL CRUST is mostly granite while the OCEANIC CRUST consists of a volcanic lava rock called basalt. Temperatures vary from air temperature to 1,600 degrees Fahrenheit. It is here that volcanoes are started and where we find

rich soil, jewels, and rocks. We live on the Earth's Crust.

Please note that the layers we use in this project are not in scale to the Earth's real layers. They are too similar in size. Also, the colors have nothing to do with how the Earth looks underneath. No one really knows what the layers look like. We've used color just for fun and to make a contrast so we can pick out each layer more easily.

Want to Do More?

For more information about Earth and its structure, visit:

pubs.usgs.gov/gip/dynamic/inside.html

www.windows2universe.org/?page=/earth/Interior_Structure/overview.html

www.pbs.org/wnet/savageearth/hellscrust/index.html?pagewanted

This activity was created by Annie Reiser, Global Systems Division Visitor Information Specialist at NOAA's Earth System Research Laboratory

Survey Mark Hunting

National Geodetic Survey Satellite
Triangulation Program, illustrating the idea
of modeling the Earth.
Courtesy NOAA Geodesy.

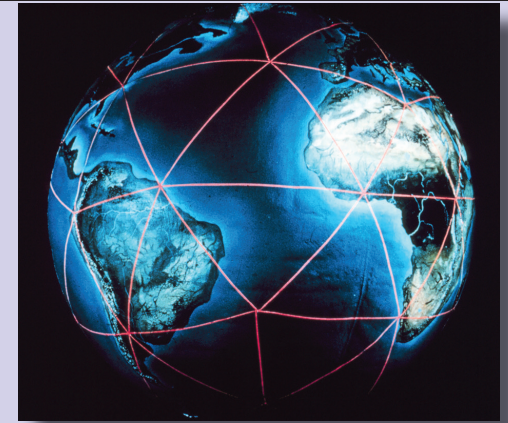

*Imagine bridges not meeting in the middle...
Airplanes landing next to runways instead of on them...
Ships frequently running aground...
This is just a glimpse of life without geodesy.*

What's geodesy? It's the science of measuring the size and shape of the Earth and accurately locating points on the Earth's surface (and is pronounced "gee-ODD - ess - ee").

READ ON, and find out how geodesy can be a lot of fun!

Another way to think about geodesy is to imagine a world globe with a lot of pins stuck in it. Geodesy is about giving each of those pins its own "address" written as latitude and longitude. Why is this important? Because each of those pins can serve as a starting point for describing the location of any other point

What You Will Do
Get information on the location and description of survey marks in your geographic area, and find out how to share your survey marking discoveries with the rest of the world!

on Earth; just like when you want to tell someone how to get to your house, you give them a starting point that they know, like a road or a building. In the United States, these reference points are developed and maintained by NOAA's National Geodetic Survey (NGS).

Hang on, we're almost to the fun stuff!

So where are all those pins stuck in the globe? They are everywhere—more than 1,200,000 in the United States!

Of course, they really aren't pins. Instead, NGS uses permanent marks called "survey marks" (you may hear survey marks called "benchmarks," but benchmarks are only one type of survey mark). Often, survey marks are marked with a metal disk like the photo below, set in concrete or bedrock:



Survey marks can also be stainless steel rods driven into the ground, drill holes in bedrock, bottles, pots, or landmarks visible from a long distance, such as a water tower, a radio mast, or a church steeple.

Courtesy NOAA Geodesy Collection

Now for the fun:

Although the majority of benchmarks are located in plain sight, they are usually ignored by the general public. Many benchmarks haven't actually been visited in a long time, and no one knows whether or not they still exist. So if you find one of these benchmarks, so you may actually be rediscovering long-neglected objects of American history!

Searching for survey marks is called "mark recovery" and is a lot like a treasure hunt (you may hear this activity called "benchmarking" but the correct term is "mark recovery"). Hunting for survey marks can lead to interesting places like high mountain peaks, deep woods, old buildings, bridges, and sometimes, ghost towns! You can enjoy the excitement of being the first to find and document a long-lost survey mark; write a log for your discoveries on the world-wide web; and if you find a survey mark that hasn't been recovered in a long time, you can submit a recovery note, with your name, to the NGS web site. Hunting for survey marks can be even more fun if you have a global positioning system (GPS) receiver. With GPS, you can go very close to the exact latitude and longitude of survey marks installed in your area. This is a kind of treasure hunt called "geocaching" (pronounced "GEE - oh - cashing").

Here's how can you find out about survey marks in your area, and try your survey mark hunting skills!

What You Will Need

- Computer with internet access
- (Optional) Digital camera (or phone) for photographing your discoveries
- (Optional) GPS receiver (this is useful for getting close to a specific survey mark, but the actual "find" is usually done by using very detailed location descriptions from the survey mark's datasheet)

Warnings

1. Mark recovery should ONLY be done with an adult partner!
2. Many survey marks are on private property, and may be in dangerous areas. Be sure to obey local laws!

How to Do It

1. The first step is to find out what survey marks are located in your area. The easiest way to do this is to use the search engine on the National Geodetic Survey website at www.ngs.noaa.gov. Click on "Survey Mark Datasheets" at the left side of the page. This will open the "Data Explorer" search engine. The "Getting Started" panel has detailed instructions for using the search engine. To find survey marks in your area:
 - a. Enter the county, city, or zip code for your area in the "Go To Location" menu, then click "Go".
 - b. The map will zoom in to the area you specified. Colored squares show the

general location of survey marks (if there are no squares, there are no marks in the specified area). You can change the radius of the area using the "Location radius" box. Click on one of the squares to zoom in further to show individual survey marks.

- c. Click on one of the survey mark icons, and a summary window will pop up. Click on "Datasheet" at the bottom of the popup window to open the complete datasheet for the survey mark you selected.
- d. Near the bottom of the Datasheet is a section titled "Station Description," which may be followed by one or more sections titled "Station Recovery." The "Station Description" section gives very precise instructions for finding the survey mark, starting from easy-to-find landmarks (such as a public building or the intersection of major roads). This description also includes information about things that may make it easier to find the survey mark, such as:

"30 FEET SOUTH OF THE CENTER LINE OF THE ROAD, 23.98 FEET WEST OF BENCHMARK 33 A (USGS), AND ABOUT 2 FEET LOWER THAN THE ROAD."

or

"8 FEET SOUTHEAST OF A GATE IN AN EAST-AND-WEST FENCE, AND IN THE TOP OF A LAVA ROCK. A UNITED STATES GEOLOGICAL SURVEY STANDARD COPPER NAIL AND WASHER, STAMPED 5240.4."

The “Station Recovery” section gives information about the condition of the survey mark at various times when the mark location was visited. This section can be very important, because sometimes it says that the mark was not found. This information can save you a lot of time spent looking for a mark that no longer exists!

2. Now see whether you can locate some benchmarks. Read the location descriptions carefully, and try to start in areas that are familiar. **BE SURE TO DO THIS ONLY WITH AN ADULT PARTNER!**

When you find a benchmark, you can take pictures, but that’s all! Never disturb or move a benchmark, even if it appears to have been damaged. Remember that benchmarks are important, they are public property, and are protected by law.

You can also log your find on the geocaching Web site. See www.geocaching.com/mark for instructions.

If the location for survey marks is described as something like a radio tower, church steeple or smokestack, the top of these structures is usually the survey point. Do not climb these structures! Just log your find, and take the structure’s picture (from the ground!) if you have a digital camera.



Members of a 1922 geodetic survey expedition. Until recent advances in satellite technology, namely the creation of the Global Positioning System (GPS), geodetic surveying was an arduous task best suited to individuals with strong constitutions, and a sense of adventure. Courtesy NOAA NOS Geodesy.

Want to Do More?

You can find out more about geodesy at NOAA’s National Ocean Service Web site: oceanservice.noaa.gov/education/tutorial_geodesy/lessons/global_pos_tutor.pdf

The official geocaching Web site www.geocaching.com/play has lots more about mark recovery and geocaching.



Courtesy Todd Marsee, Michigan Sea Grant



Courtesy Doug Helton, NOAA



Courtesy Victor Lundquist, NMFS-AFSC

Courtesy Jean Kenyon, NOAA



Courtesy Laurel Jennings, NOAA



Courtesy Laurel Jennings, NOAA



Courtesy Doug Helton, NOAA





Courtesy Caroline Rogers, USGS



Courtesy Todd Marsee, Michigan Sea Grant



Courtesy Tony Perry, NOAA

PROTECT THE EARTH

Courtesy NOAA

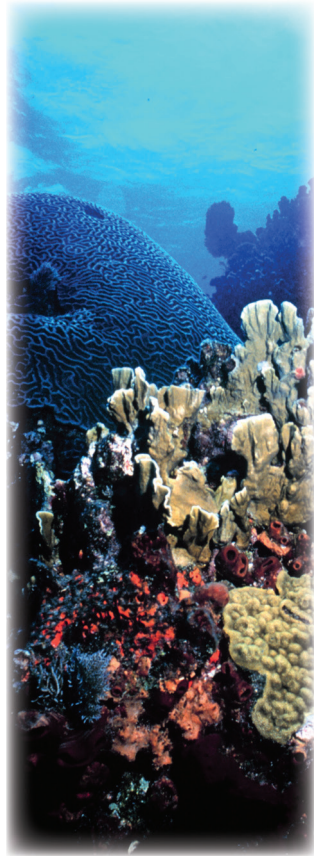

In addition to exploring and understanding the Earth, NOAA programs are also concerned with protecting Earth's ecosystems. Here's a little challenge: How many benefits can you think of that depend on oceans and coasts? Next, how many things can you think of that might damage oceans and coasts? Your list of benefits should include food, habitat for thousands of plants and animals, marine transportation, fishing, tourism and recreation, and places for communities (more than half of the U.S. population lives and works within 50 miles of the coast). Your list of threats may include pollution (many kinds), habitat destruction for development (many types), storms, and climate change.

NOAA's mission is to find ways to enjoy the benefits of oceans and coasts and at the same time protect and restore these resources for future generations. NOAA programs include protected areas, endangered species, fisheries, pollution control, and projects to restore damaged resources. Volunteers are an important part of many of these projects. In fact, the key to protecting Earth's Ecosystems is public understanding and action. **YOU CAN HELP PROTECT THE EARTH BY TEACHING OTHER PEOPLE ABOUT EARTH'S ECOSYSTEMS!**

The more you know, the more you can do! The activities in this section will give you some tools for teaching other people about what **EVERYONE** can do to help protect the ecosystems that sustain life on Earth.

Courtesy Kathy Crane, NOAA



Fish Fetch

Humans have relied on the ocean for longer than recorded history. Humans eat many species of marine fish, so we want to know the number of fish in parts of the ocean available for us to catch. This is a big reason why scientists are interested in estimating ocean populations.

The ocean covers 70% of the earth and contains many different habitats. Even in the open ocean, the difference in sunlight and temperature between the surface and 500 feet deep is enough to make different habitat for different species. Some animals like it warm and sunny at the surface, but others like it cold and dark where it is deeper.

How do scientists count ocean animals? Specific equipment and strategies have been developed to better estimate various populations. One of these is the Alaskan Walleye pollock, a close relative of the cod fish. This species is an important source of food (fish sticks, cat food, imitation crab meat among many other items) and is the center of a multi-million dollar fishery. One way scientists count pollock is by echolocation. They shoot sound waves through the water, and the waves bounce off the fishes' swim bladders (sacks filled with air inside the fish). The acoustic image the scientists see can include other fish, so the only way to be sure how many pollock are in a specific area is to bring the fish up using a sample trawl net. Once the pollock are caught in the net, they are all counted, right? Well, not really. It is very difficult to count that many fish. What



Courtesy Alaska Fisheries Science Center, NOAA

researchers do instead is get a subsample, a smaller sample of the whole. First, they weigh the net of pollock, and then the fish are split into a few subsamples. Scientists find the average age and weight of the pollock in each subsample. Then they estimate the total biomass for the entire net of fish, the sample. For example, if one fish weighs 3 pounds, then there must be 10,000 fish in a 30,000 pound sample. Based on the main sample, the net full of fish, the grand total of fish in a school of pollock seen with echolocation can then be estimated.

But how do scientists know where they counted fish and where they did not? They put an imaginary grid over the ocean floor in a certain area, and then count the fish in different squares of that grid; a method called surveying. You can do the same thing scientists do with your friends or your class with an activity called Fish Fetch.

What You Will Do

Perform a demonstration of a survey technique used by scientists to estimate fish populations.

What You Will Need

- ❑ Blue tarp with a 10 x 10 grid of 1 square foot cells laid out with yellow duct tape
- ❑ 1000 Fish-shaped craft beads, approximately 1" in length and in assorted solid colors, (to represent the total fish population)
- ❑ 5 plastic sand pails, referred to as "scientifically calibrated sample buckets"
- ❑ 5 sample selectors (e.g. soft foam boat, preferably one that bounces erratically rather than rolling)
- ❑ Whiteboard or flipchart to write on
- ❑ Whisk broom (optional) to redistribute fish after sampling

How to Do It

1. Scatter the 1000 fish around on the grid.
2. Ask, "How many fish do you think are on the grid?" (This is an initial guess – some will take a wild guess, others will try to figure it out visually in a more systematic way).
3. Players next go "out into the ocean" and throw their squishy boat onto the grid. The square that the ship lands on is the random sample.
4. Players count all the fish in the blue part of the square and put the fish into their bucket.
5. Players record the number of fish in each sample on the whiteboard or flipchart. Counts of zero are valid observations.



<https://www.aliexpress.com>

6. Ask "How can you figure out, on average, how many fish were in the squares that you counted?" (Answer: add up the number of fish in the samples, and divide by the number of samples). Players can do the math themselves on the whiteboard, or an adult can do it for them.
7. Ask, "If this is the average number of fish per square, how can you figure out how many fish there are in all?" (Answer: count the number of squares in the grid—100—and multiply the average number by 100).
8. Compare the initial guess of how many fish there were to the estimate using the samples.
9. Throw the fish back into the "sea." The whisk broom can be used to redistribute the fish around the grid. You can experiment with an even distribution of fish or a clumped distribution (where some squares have a lot of fish in them and others have none).

Want to Do More?

1. Check out NOAA Fisheries Service's education resources:
 - Alaska Fisheries Science Center: www.afsc.noaa.gov/Education/default.htm
 - Northwest Fisheries Science Center: www.nwfsc.noaa.gov/education/index.cfm
 - Pacific Islands Fisheries Science Center: www.pifsc.noaa.gov/outreach/
 - Northeast Fisheries Science Center: www.nefsc.noaa.gov/#
 - Southeast Fisheries Science Center: www.sefsc.noaa.gov/education/
 - Southwest Fisheries Science Center: www.swfsc.noaa.gov/swfsc.aspx?id=7532&Parent-MenuId=33
 - West Coast Region: www.westcoast.fisheries.noaa.gov/education/index.html
 - Pacific Islands Region: www.fpir.noaa.gov/PAO/pao_outreach_edu_index.html
 - Southeast Region: sero.nmfs.noaa.gov/outreach_education/index.html
 - Greater Atlantic Region: www.greateratlantic.fisheries.noaa.gov/educational_resources/kids/index.html
2. Play games! games.noaa.gov/

The Ocean Drugstore



Does this look like a drugstore?

Some of our most widely-used drugs come from nature:

- Aspirin was first extracted from the willow tree
- Morphine is extracted from the opium poppy
- Penicillin was discovered in common bread mold

Historically, almost all of our drugs from natural sources came from plants and animals that live on land. But recent searches for new drugs have discovered that marine invertebrates (animals without backbones) produce more antibiotic, anti-cancer, and anti-inflammatory substances than any group of organisms on land. Strangely, many of these substances come from animals that spend most of their lives just sitting around. If you looked at these animals in an aquarium, you would probably get bored pretty quickly because they don't move, and just look like blobs or skinny plants. And because they don't look very interesting, you might assume that they are not important.

But guess again! These unimpressive animals may hold the key to curing some of the most serious diseases that affect humans! Here's a way that you can help teach other people not to jump to conclusions about the importance of ocean animals.

NOAA's Office of Ocean Exploration and Research has supported several expeditions to search for new drugs from the sea. The 2003 Medicines from the Deep Sea expedition was the first scientific exploration of marine organisms from deep-water habitats in the Gulf of Mexico. Samples collected during the expedition are being studied by scientists at Harbor Branch Oceanographic Institution for chemicals that may lead to new ways to treat cancer, infectious diseases, disorders of the immune and central nervous systems, and cardiovascular disease.

What You Will Do

Make a poster to explain that we should protect animals that seem unimportant because they may provide new drugs for treating diseases such as heart disease, arthritis, and cancer

What You Will Need

- Copies of images from “Some Animals That Produce Raw Materials for New Drugs”
- Crayons, colored markers, or colored pencils
- Poster board
- Scissors (Be careful with sharp scissors!)

How to Do It

1. Use images and information from the worksheet to create a poster that explains why it is important to protect seemingly uninteresting ocean animals using the fact that these animals may be sources of important new drugs for treating human diseases.
2. Show your poster at school, to your parents, and to other groups. The more people know about the importance of ocean life, the more they will support actions to protect ocean resources.

Want to Do More?

Visit oceanexplorer.noaa.gov/explorations/03bio/welcome.html for more about the Ocean Explorer Medicines from the Deep Sea Expedition and oceanexplorer.noaa.gov/facts/medicinesfromsea.html for a fact sheet.

This activity was adapted from Chemists with no Backbones (4 pages, 356k) by Mel Goodwin, The Harmony Project, Charleston, SC; from the Ocean Explorer 2003 Medicines from the Deep Sea Expedition [oceanexplorer.noaa.gov/explorations/03bio/background/edu/media/meds_chemnobackbones.pdf]



Competition for resources is intense in habitats such as reefs. Many of the sessile invertebrates produce natural products to help them be more competitive. Photo courtesy John Reed, NOAA.

Why Do Simple Animals Produce Powerful Drugs?

Many of ocean animals that produce powerful substances are sessile, which means that they do not move. This may give a clue about why they produce these substances: Basically, these animals are “sitting ducks,” so they may use powerful chemicals to repel predators. Another possibility is that since many of these species are filter feeders, they are exposed to all sorts of parasites and disease-causing bacteria in the water; so the powerful chemicals may be a defense against parasites or antibiotics against

disease-causing organisms. Competition for space may explain why some of these animals produce anti-cancer substances: If two species are competing for the same piece of bottom space, it would be helpful to produce a substance that would attack rapidly dividing cells of the competing organism. Since cancer cells often divide more rapidly than normal cells, the same substance might have anti-cancer properties.

Some Animals That Produce Raw Materials for New Drugs

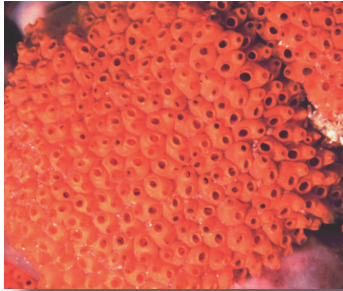

Photo courtesy NOAA.

This is a colony of tunicates. Tunicates are animals whose body is basically a sack with two openings called siphons through which water enters and exits. Small particles filtered out of the water are used for food. They are called tunicates because their body wall resembles a coat or "tunic." Some tunicates produce a chemical called Ecteinascidin, which is being tested in humans for treatment of breast and ovarian cancers and other solid tumors.

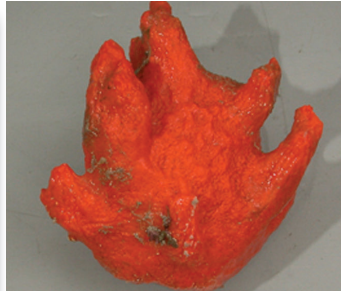

Photo courtesy NOAA.

Sponges are the most primitive invertebrate animals that are composed of more than one cell. They do not have tissues or organs, but some of their cells are specialized to perform specific functions. Sponges of the genus *Forcepia* produce substances called Lasonolides, which may provide new treatments for cancer. Other sponges belonging to the genera *Topsentia*, *Hexadella*, and *Spongisorites* produce a chemical named Topsentin, which is an anti-inflammatory that may be helpful in treating diseases like arthritis. Deep-sea sponges of the genus *Discodermia* produce a tumor-fighting substance called Discodermalide.

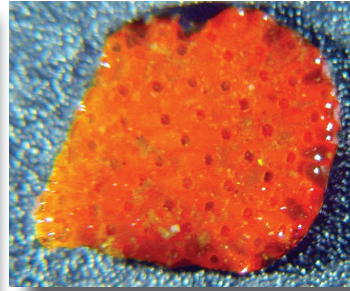
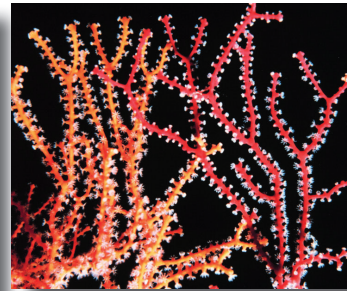

Photo courtesy NOAA.

Bryozoans are small, moss-like animals that do not move. They feed on very small floating animals called zooplankton. Some bryozoans produce a chemical called Bryostatin that may be useful in treating certain types of cancer such as leukemia and melanoma.



Courtesy Photo Collection of Dr. James P. McVey, NOAA Sea Grant Program

Gorgonians are a type of soft coral, also called "sea whips." *Pseudopterogorgia elisabethae* is a sea whip that produces substances called Pseudopterogins (soo-doh-TER-oh-sins) that reduce swelling and skin irritation and accelerate wound healing.



Photo courtesy NOAA.

Cone snails (also called cone shells) are carnivorous marine snails found in coral reefs. In this picture, the cone snail *Conus marmoreus* is eating a cowrie (another kind of snail). Cone snails produce a venom that helps capture food. The venom of some species is powerful enough to kill a human being. The cone snail *Conus magnus* also produces a chemical named ω -conotoxin MVIIA, which is a powerful pain-killer.

Who Trashed the Ocean?



When exposed to light, plastics break down into small pieces through a process known as 'photodegradation.' These small bits of plastic, known as microplastics, make up the majority of items found in the so-called 'Pacific Garbage Patch,' where they float suspended in the water column. Image courtesy NOAA.

"During our 5,000-meter dive in Sirena Canyon, along the Mariana Trench wall, we saw multiple pieces of marine debris. A soda can, a food tin, and a piece of rope all accompanied the fish, corals, and rocks that we imaged as we moved up the slope. We encountered even more trash (nine pieces!) on our dive the following day, including several plastic bags and a piece of clothing. Even in one of the deepest places on Earth, humans have left their mark."

~ from NOAA Ocean Explorer 2016 Deepwater Exploration of the Marianas
Mission Log Earth Day, April 22, 2016
Diva Amon, University of Hawaii at Manoa

Deborah Glickson, NOAA Cooperative Institute for Ocean Exploration, Research, and Technology
oceanexplorer.noaa.gov/oceanos/explorations/ex1605/logs/apr22/welcome.html

• Marine debris is man-made trash that enters the ocean or Great Lakes environment.

• The world's ocean is constantly polluted with a wide variety of trash ranging from soda cans and plastic bags to derelict fishing gear and abandoned vessels. Every day, marine debris impacts marine animals and their habitats. Wildlife can become entangled in debris or eat pieces of plastic trash, and valuable habitats can be smothered or damaged. Humans are impacted, too. Divers, ships, and boats can also become entangled in debris and garbage that litters beaches and waterfronts not only looks awful—it also costs thousands of dollars to clean up.

• The NOAA Marine Debris Program is the federal lead to investigate and prevent the negative impacts of marine debris. They do that by learning more about debris in order to best address it, reducing the amount of debris in the environment by cleaning it up, and most importantly, working to prevent marine debris in the first place. We can prevent marine debris by educating people about its consequences and why we need to stop trashing the ocean.

And that's where you come in!

What You Will Do

Make a poster to inform people about why marine debris is bad and why we need to stop it.

What You Will Need

- Crayons, colored markers, or colored pencils
- Poster board
- Scissors (Be careful with sharp scissors!)
- (Optional) Copies of images from "Some Examples of Marine Debris Posters"
- (Optional) Laptop computer, printer

How to Do It

1. Use the examples and your own ideas to create a poster that explains the consequences of marine debris, and what we can do to stop it.
2. Show your poster at school, to your parents, and to other groups. The more people know about marine debris and what it does, the more they will take personal action to prevent it.

Want to Do More?

1. Visit the NOAA Marine Debris Program Web site at marinedebris.noaa.gov/ for more about marine debris, as well as information, videos, photographs and more about cleanup and prevention projects.
2. Check out marinedebris.noaa.gov/resources for more marine debris poster ideas.

Marine debris is everyone's problem.

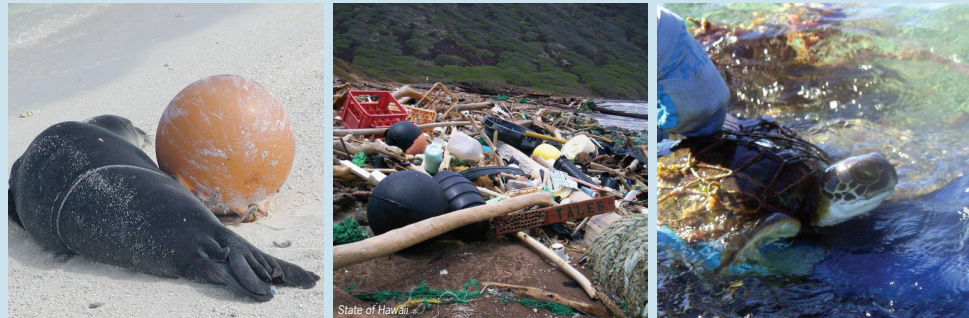

Marine debris threatens marine life and our oceans and coasts. It affects us too, whether we are boating, fishing, swimming, or simply enjoying a day at the beach. Trash can travel through storm drains, streams, and rivers and end up in your community, as well as in the ocean.

Learn ways to stop this from happening.

www.marinedebris.noaa.gov



If you have a desktop computer and printer, you can download images from the NOAA Marine Debris Program web site (marinedebris.noaa.gov/) and create your own poster with your own ideas.

Here are some more facts you can use to create your poster also from NOAA's Marine Debris web site.

IMPACTS OF MARINE DEBRIS



INGESTION
Animals mistakenly eat plastic and other debris.



ENTANGLEMENT & GHOSTFISHING
Marine life gets caught and killed in ghost nets, trapped in derelict gear, and entangled in plastic bands and other marine debris.



HAZARD TO NAVIGATION
Marine debris can be difficult to see in the ocean if it's floating below the water's surface. Encounters with large items at sea can result in costly vessel damage, either to its structure or through a tangled propeller or obstruct mechanical gears.



HABITAT DAMAGE
Heavy marine debris crushes sensitive habitat, such as coral reefs and sea grass.



NON-NATIVE SPECIES
Marine debris transports alien and invasive species from one region to another.



ECONOMIC COST
Communities lose a lot of money cleaning up trash, as well as the economic benefit of beach tourism and recreation.

HOW YOU! CAN HELP!

GET INVOLVED and participate in local cleanups in your area.

REMEMBER that our land and sea are connected.

DISPOSE OF WASTE PROPERLY no matter where you are.

REDUCE the amount of waste you produce.

REUSE items when you can. Choose reusable items over disposable ones.

RECYCLE as much as possible! Bottles, cans, cell phones, ink cartridges, and many other items can be recycled.

DEBRIS FACTS

WORLDWIDE, MORE THAN **200 SPECIES** ARE IMPACTED BY ENTANGLEMENT

AT LEAST **1/3 OF ALL SEABIRD SPECIES** EAT DEBRIS

PACKING BANDS ARE RESPONSIBLE FOR MORE THAN HALF OF THE **STELLER SEA LION** ENTANGLEMENTS IN ALASKA

ALL SEA TURTLE SPECIES EAT DEBRIS



Facebook:
www.facebook.com/NOAAMarineDebris

Instagram & Twitter
@NOAADebris

Website
<http://marinedebris.noaa.gov>



GARBAGE PATCHES

Currents and winds move marine debris throughout the ocean, sometimes far from its origin. "Garbage patches" are areas in the ocean where marine debris accumulates because of converging currents. These areas are not solid islands of trash that you can see easily with the naked eye. They are made up mostly of tiny microplastics swirling throughout the ocean's water column. Garbage patches exist in ocean gyres all over the world.



PLASTIC MARINE DEBRIS

debris in the ocean. Globally, we are consuming more and more single-use plastic items, but many countries lack the waste infrastructure to process it. In places where there is good infrastructure, intentional littering or improper disposal may add to the problem.

Plastic does not biodegrade in the ocean. It can fragment into tiny pieces called microplastics, less than 5 mm in length, from weathering and sun exposure. Plastics in the ocean can last for hundreds

This background photo, taken after a 21-day marine debris removal effort by the Pacific Island Fisheries Service Coral Reef Ecosystem Division, shows 4,781 bottle caps collected from Midway Atoll's shoreline. Most plastic bottle caps are made from polypropylene, also known as plastic #5-- a hard, durable plastic that can be difficult to recycle in some municipalities.

It All Runs Downhill



Iron contamination in the Idaho Blackbird Creek, Lemhi County, Idaho. Courtesy NOAA

What You Will Do

Make a model of a watershed, and show how rainfall carries pollution into the ocean and other water bodies.

What do you think of when you hear the word “pollution?” Black smoke belching out of factories? Horrible fluids pouring out of huge pipes?

Thirty years ago, these were classic symbols of pollution. But a lot of progress has been made in reducing pollution from sources such as industrial facilities and sewage treatment plants. Today, the big water pollution problem comes from rainwater and melting snow. Rain and snow are usually pretty clean when they fall from the sky. But as water flows over and through the ground it picks up chemicals, oil, animal wastes, and many other contaminants that change clean water into polluted runoff.

This kind of contamination comes from many sources, such as

- *fertilizers and pest control chemicals from farms and home landscapes;*
- *oil, grease, and toxic fluids from roads, parking areas, and motor vehicles;*
- *acid drainage from abandoned mines; and*
- *wastes from livestock, pets, and leaking septic tanks.*

Because the contaminants cannot be traced to a single source, this kind of pollution is called “nonpoint source pollution” or polluted runoff. More than half of the watersheds in the U.S. are affected by nonpoint source pollution. A “watershed” is an area of land that catches precipitation and channels this water into a marsh, stream, river, lake, or underground reservoir (groundwater). You can think of a watershed as a giant funnel. Water that falls on any land within the watershed will all be funneled to the same water body. Watersheds can be small, feeding to a single stream or pond. Several small watersheds may be part of a larger watershed that funnels into a larger stream or river, and eventually into the ocean.

The only way to stop nonpoint source pollution is through education about the problem and what people can do to prevent watershed contamination. Here’s a way that you can help!

What You Will Need

- Rectangular container, about ten inches x twelve inches x two inches; a metal baking pan or plastic storage container is perfect
- Two sheets newspaper
- Plastic wrap or a white garbage bag
- Spray bottle
- Water
- Blue food coloring, about four drops
- Baby powder, cocoa powder, colored drink powder, and/or cake sprinkles; about two tablespoons

How to Do It

1. Crumple two sheets of newspaper, and place them side by side in one end of the container, like this:

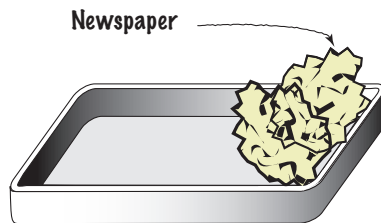

2. Stretch the plastic wrap or garbage bag over the wads of newspaper and down over the sides of the container. Press the plastic down into the container in the end without the newspaper so that it forms a shallow depression. Be sure the plastic extends all the way over both sides of the container. The wads of newspaper represent hills or high places in your model watershed, and the shallow

depression represents lakes, rivers, or the ocean.

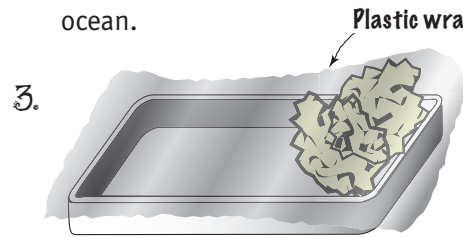

3.

Sprinkle a little baby powder, drink powder, cocoa, or cake sprinkles on the hills of your model to represent pollution. You can use different materials to represent different types of pollution. For example, baby powder could represent fertilizer; cocoa powder might represent motor oil or vehicle exhaust; colored drink powder could represent chemical runoff; and chocolate cake sprinkles could represent animal waste.

4. Predict where the pollution will flow and how many watersheds you think you have. Now, rapidly spray water onto the hills to show how rainfall carries pollution into the ocean and other water bodies. Were your predictions accurate?
5. You can use your model to teach other people about nonpoint source pollution. Be sure to talk about things that everyone can do to help solve this problem! Here are some ideas:
 - Keep trash, pet waste, chemicals, etc. out of storm drains, since these often drain directly to lakes, streams, rivers, or wetlands

- Find out about alternatives to lawn and garden chemicals such as mild detergents, planting native species, and alternating rows of herbs with rows of vegetables to attract pest predators such as damsel bugs, ladybugs, and stingless wasps
- Learn how to properly dispose of used oil and hazardous household chemicals
- Dispose of pet wastes in the garbage or toilet

You can find more ideas at www.epa.gov/hwp and www.epa.gov/hwp/basic-information-and-answers-frequent-questions

Want to Do More?

1. See NOAA's National Ocean Service Nonpoint Source Pollution Tutorial: oceanservice.noaa.gov/education/kits/pollution/04non-pointsource.html to find out more about nonpoint source pollution
2. See EarthLabs for instruction on how to make a more realistic model of a watershed: serc.carleton.edu/eslabs/drought/2a.html
3. Visit help.waterdata.usgs.gov/tutorials/site-information/ and click on "What is my watershed address and how will it help me find USGS data? (or What is a Hydrologic Unit?)" to find your watershed address.

Toxic! Or Is It?

One of the big questions about any type of pollution is, "Will it hurt plants, animals, or humans?"

How can we find out? We don't want to risk harming lots of living organisms to see whether a substance is toxic, especially if the organisms are humans!

Scientists investigating pollution often use a technique called "bioassay" to test for toxicity. A bioassay is a measurement of the effects of a substance on living organisms. Tests for toxic substances use certain species called "indicator species," which may be juvenile fishes, plant seeds, microscopic animals, or even bacteria! Several individuals of an indicator species are exposed to the substance being tested for a certain period of time, and then compared to another group of the same species that was not exposed to the substance (the second group is called the "control group"). If the organisms in the test group show effects such as slow growth, reduced movement, or death and these effects are not seen in the control group, this is considered to be an indication that the substance being tested is toxic.

Bioassays usually do not indicate which specific substances cause toxicity, or the amounts of toxic substances present. But they do provide a good indication of the total toxicity of samples that may contain more than one toxic substance, and they are a quick and inexpensive way to test for toxicity in many samples.

Here is a simple bioassay that you can use to test for toxicity in runoff water that you suspect may be contaminated.



Beach pollution at Bay St. Louis, MS after Hurricane Katrina. Courtesy NOAA.

What You Will Need

- 12 or more ziplock plastic bags
- One paper towel for each plastic bag
- Ten radish seeds for each plastic bag
- Permanent marker for labeling sample jars and plastic bags
- Household bleach, about 1/4-cup
- Distilled water, about one quart
- Ruler graduated in millimeters (mm)
- Tweezers or forceps
- Glass containers for collecting samples; baby food jars or similar size are perfect
- Clean glass jar for mixing bleach solution, about one pint
- Measuring cup that is not used for food
- Protective gloves and safety glasses, one set for each person participating in this activity

What You Will Do

Use a radish seed bioassay to test for toxicity

Warnings

- Do this activity with an adult partner!
- Always check with an adult before collecting samples that may be contaminated with harmful substances.
- Wear protective gloves and safety glasses when handling sample solutions!
- Do not use glasses, dishes, or any container that is used for food!
- Wash your hands after handling sample solutions, paper towels, and seeds!

How to Do It

1. Collect water samples to be tested. You may want to test water from puddles, streams, or ponds. Do this **ONLY** with an adult partner! Wear protective gloves and safety glasses! Collect each sample in a clean glass jar, and label the jar with a number.
2. Put on protective gloves and safety glasses, then mix one ounce of household bleach with nine ounces of distilled water in a clean glass jar.
3. Put the radish seeds in a clean glass container, and add about two ounces of the bleach solution from Step 2. The bleach solution kills fungi, which could interfere with seed germination.
4. Bioassays are carried out in zip-lock plastic bags containing a paper towel saturated with the test solution. Saturated means that the towel is damp all over, but isn't dripping. Three separate tests (called "replicates") will be done for each solution. Prepare three plastic bags for each sample to be tested, plus three more bags for the control solution (distilled water). Label each bag with the sample number, plus a letter to identify the three replicates (so for sample number 1, there would be three bags labeled "1-A," "1-B," and "1-C"). Put a folded paper towel in each bag.
5. Pour enough sample solution into each bag to saturate the filter paper. Use the same amount of sample in all tests. Saturate the paper towels in the control bags with the same amount of distilled water.
6. Using tweezers or forceps, place ten seeds on the paper, evenly spaced, in each bag. Seal the top of the bag.
7. Put the bags on a tray or shallow box where they can remain for five days. The bags should be at room temperature, but do not place them in direct sunlight! Each day, record the number of seeds that germinated (split open) in each bag, and measure (to the nearest mm) the length of the root that has emerged from each germinated seed.
8. At the end of five days, calculate the average number of seeds that germinated in the three bags for each sample and for the controls. Also, calculate the average length of the roots among the germinated seeds in the three bags. If fewer seeds germinated in bags containing test samples, or if the roots grew more slowly than in the control bags, this is an indication that the samples may contain toxic substances.

Want to Do More?

1. For more information about simple bioassays, see www.wwoa.org/resources/public-education/lettuce-seed-bioassay/
2. Visit www.epa.gov/nutrientpollution for more information about polluted runoff.
3. Visit oceanservice.noaa.gov/education/lessons/the_seeds.html for a lesson on non-point source pollution called The Seeds Tell the Story.

Invasive Species Super Sleuth

In the late 1860's, it seemed like a good idea: Let's start a silk industry in the United States! Silk is a valuable cloth, in demand all over the world. And insects do most of the work! All we need to do is import some Gypsy moths from France, then sit back and wait for the money to start rolling in!

So, the moths were imported. Unfortunately, they escaped. Today, Gypsy moths are a major threat to U.S. forests.

Gypsy moths are one example of invasive species, and there are many more. About 50,000 alien species are already in the U.S. What's the difference between "alien" and "invasive?" An alien species is not native to a particular ecosystem. If an alien species causes economic and/or environmental harm or threatens human health, then it is called invasive.

What's the big deal? Invasive species can seriously threaten native species and entire ecosystems. Plus, the costs of environmental damage, economic losses, and efforts to control invasive species average \$138 billion per year—more than the cost of all other natural disasters combined.

What can be done? NOAA's National Centers for Coastal Ocean Science are developing a group of experts that can help recognize alien species, hopefully before they become invasive. NOAA's National Sea Grant Office and state fish and wildlife agencies are partnering with the pet industry in the Habitattitude™ Campaign, which is about educating consumers about possible environmental consequences of aquarium and water garden hobbies, and how to be a responsible hobbyist. In addition, NOAA's Community-Based Restoration Program works with community groups to remove invasive plants as part of projects to repair damaged coastal habitats.

Here's how to learn a lot about aquatic invaders and have fun at the same time!

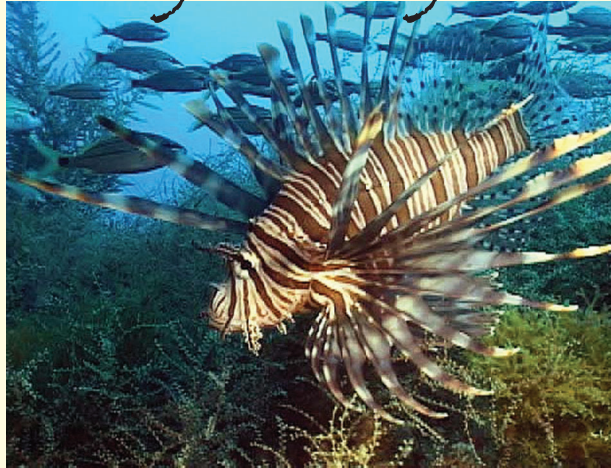

Lionfish are venomous fish from Indian and western Pacific oceans that have invaded East Coast waters Courtesy NOAA.

What You Will Need

Access to the internet.

How to Do It

Play *Nab the Aquatic Invader* and *Be a Sea Grant Super Sleuth* at www.iiseagrant.org/NabInvader/.

Want to Do More?

1. You can find a LOT more information on invasive species on the *Nab the Aquatic Invaders! Be a Sea Grant Super Sleuth* website (www.iiseagrant.org/NabInvader/). Click on "Information for Teachers" to go to all kinds of good links.
2. Visit the *GloBallast* web site archive.iwlearn.net/globallast.imo.org/globallast.imo.org/index.html and watch *Invaders from the Sea* a very informative IMO-BBC documentary about the transfer of harmful organisms in ballast water from ships. You can also find it on youtube: www.youtube.com/watch?v=u5JkRtMTedI.

3. Visit oceanservice.noaa.gov/facts/invasive.html and www.noaa.gov/topic-tags/invasive-species and http://www.habitat.noaa.gov/pdf/best_management_practices/fact_sheets/ and click on "Aquatic Invasive Species Overview.pdf" for even more information!

What You Will Do

Play a game called "Nab the Aquatic Invader!"

You will be a private investigator working with other detectives to catch suspected invaders including Louie "Sucker Mouth" Sea Lamprey, Zeke "The Prowler" Zebra Mussel, Purple "Lucky" Loosestrife, and Rocco "Ravenous" Ruffe.

Courtesy USGS

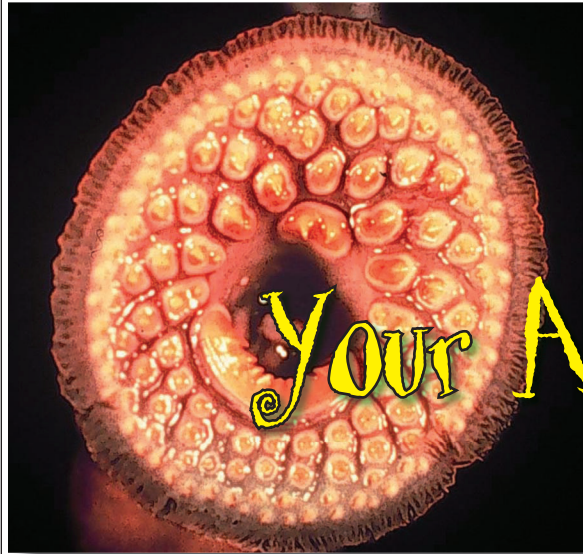

Courtesy Leo G. Nico, USGS



Courtesy Justin Secrist, Washington DFW



Your Alien Dodecahedron



Courtesy California Interagency Ecological Program

If you have played the “Invasive Species Super Sleuth” game, you already know what invasive species are and why they are a big problem (so you can skip the rest of this paragraph!). Just in case you haven’t played the game yet, invasive species are plants, animals, or other living organisms that are not native to a particular ecosystem and cause economic harm, environmental damage, or pose a threat to human health. Invasive species can seriously damage native species and entire ecosystems, and cost an about \$138 billion per year (which is more than the cost of all other natural disasters combined). NOAA’s National Centers for Coastal Ocean Science are developing a group of experts that can help recognize alien species, hopefully before they become invasive. NOAA’s National Sea Grant Office and state fish and wildlife agencies are partnering with the pet industry in the Habitattitude™ Campaign (www.habitattitude.net/), which is about educating consumers about possible environmental consequences of aquarium and water garden hobbies, and how to be a responsible hobbyist. In addition, NOAA’s Community-Based Restoration Program works with community groups to remove invasive plants as part of projects to repair damaged coastal habitats.

You can help! Here are some pictures and more information about twelve invasive alien animals. You can use these images to make a twelve-sided object that will show these examples of invasive species. This twelve-sided object is called a dodecahedron (pronounced “doe - dek - ah - HEE - dron”). You can use your “Alien Dodecahedron” to help other people understand more about the invasive species problem. Once they start looking at the dodecahedron and the images on its twelve sides, you can tell them some of the facts about invasive species. Remember: Education and understanding are key to solving most environmental problems—including invasive species!

What You Will Do

Make a dodecahedron that shows pictures of twelve invasive animals

What You Will Need

- Color copy of images on the “Alien Dodecahedron Worksheet”
- Copy of “How to Fold a Dodecahedron” worksheet
- Scissors
- Glue for paper

Warning

Be careful with scissors; they are sharp!

How to Do It

1. Carefully cut out the pattern on the “How to Fold a Dodecahedron” worksheet. Be sure NOT to cut the dashed lines!
2. Fold all of the dashed lines away from you (backward), then unfold and flatten the pattern.
3. Cut out the twelve images on the color copy of the “Alien Dodecahedron Worksheet.”
4. Glue the images onto the dodecahedron pattern.
5. Fold the dodecahedron pattern along the dashed lines so that it makes a twelve-sided shape. Glue the tabs to keep the shape from unfolding.
6. Now you have an Alien Dodecahedron!

Look over the facts about each species on the worksheet. You will see that some alien invaders were deliberately brought to the United States for various reasons. Others arrived by accident, sometimes as part of “ballast water.” Ballast water is water that is pumped into large ships when they are not carrying cargo, so that they are more stable when sailing on the ocean. This means that water from one part of the Earth can be carried thousands of miles away before it is pumped out again. If small animals or larvae happen to be in the water when it is pumped into a ship, they get a free ride to another part of the world!

You will also see that one of the biggest problems with invasive species is that they compete with native species. Native species are the organisms that are normally found in a certain ecosystem. Often, native species do not have good defenses against invaders. Species like the zebra mussel cause other problems when they attach themselves inside pipes

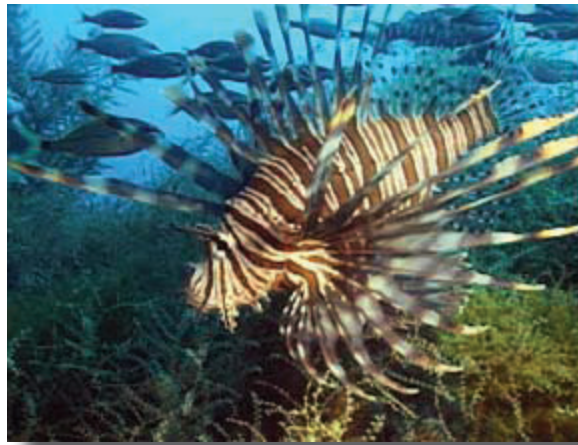

Lionfish, Courtesy Paula Whitfield, NOAA

that carry water in and out of factories or power plants. Some invaders are dangerous to humans, such as the lionfish that has spines that contain a powerful venom.

Show your Dodecahedron to other people and tell them about the invasive species problem. You can also play a game with your Dodecahedron: Players take turns, and the player who is “It” gently tosses the Dodecahedron onto a flat surface, then looks at the picture that is face down. Time the player to see how long it takes to correctly name the species and what damage it causes (or whatever other facts you want to include in the game). If the face-down image has already been named by another player, the player who is “It” tosses the Dodecahedron again until a new image is face-down.

Want to Do More?

See www.habitat.noaa.gov/restoration/programs/invasivespecies.html and coastalscience.noaa.gov/research/pollution/invasive/ to find out more about invasive species and what is being done about them.

The National Invasive Species Information Center Web site, www.invasivespeciesinfo.gov/index.shtml has a lot of information about invasive species, including links to images.

How to Fold a Dodecahedron Worksheet

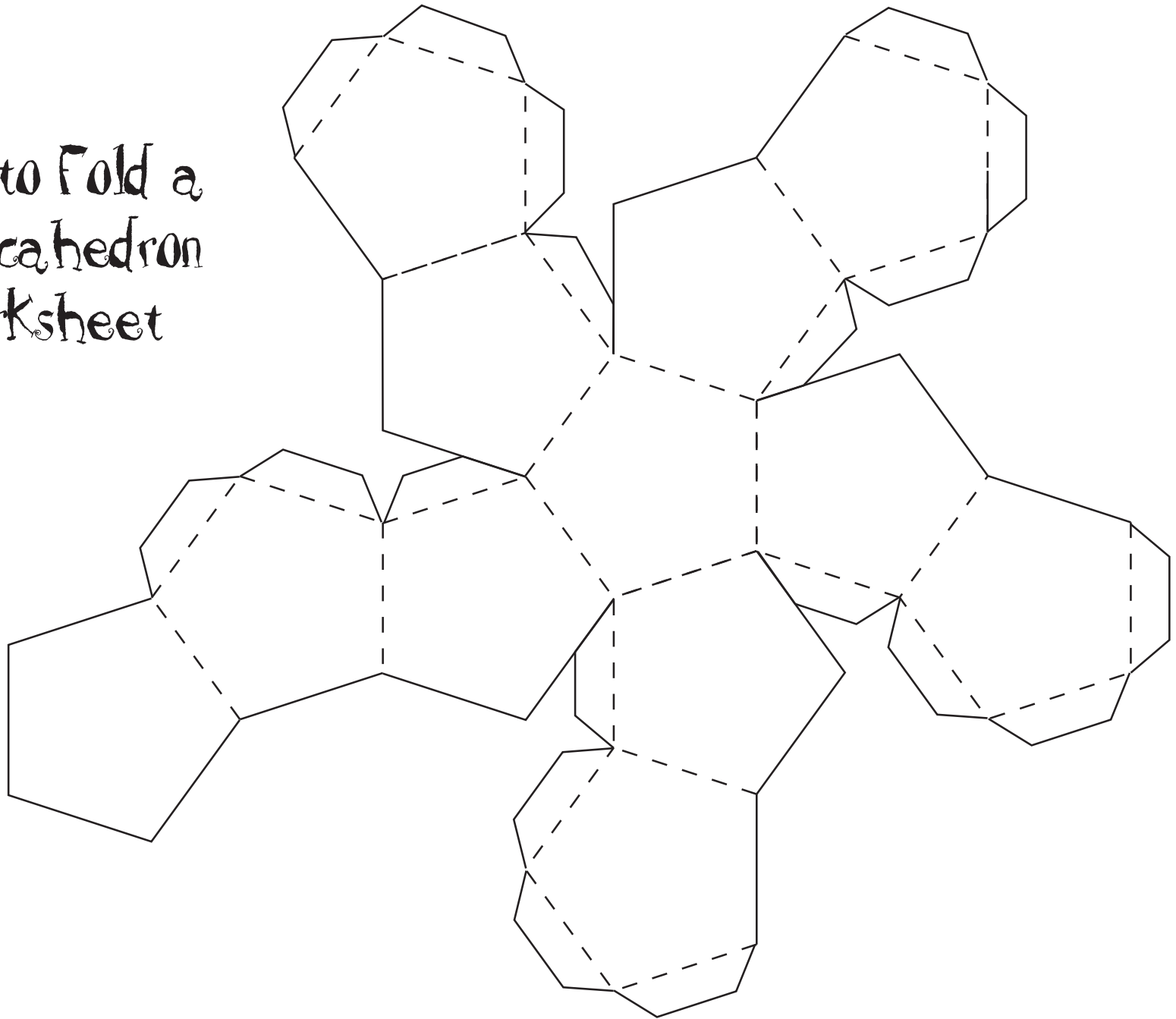

Alien Dodecahedron Worksheet

Alewife



Courtesy NOAA Restoration Center, Jim Turek

What Is It?

*A fish called an Alewife (also called mulhaden, grey herring, golden shad); its scientific name is *Alosa pseudoharengus**

Where Did It Come From?

Atlantic Ocean

How Did It Get Here?

Deliberately introduced to Lake Erie

What Does It Do?

Competes with native species

Asian Swamp Eel

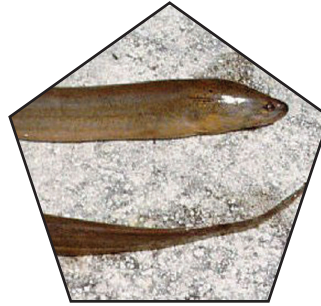

Courtesy Leo G. Nico, USGS, Gainesville, FL

What Is It?

*A fish called an Asian swamp eel or rice eel; its scientific name is *Monopterus albus**

Where Did It Come From?

Asia

How Did It Get Here?

Brought to the U.S. for aquariums and fish markets, accidentally released

What Does It Do?

Competes with native species

Chinese Mitten Crab

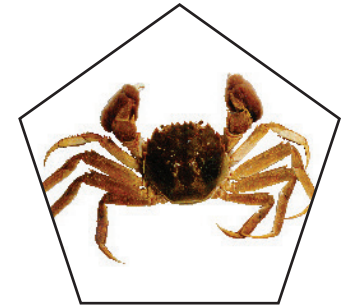

Courtesy of California Interagency Ecological Program

What Is It?

*A crab called the Chinese mitten crab; its scientific name is *Eriocheir sinensis**

Where Did It Come From?

China

How Did It Get Here?

In ballast water of ships; possibly deliberately released

What Does It Do?

Competes with native species

Lionfish

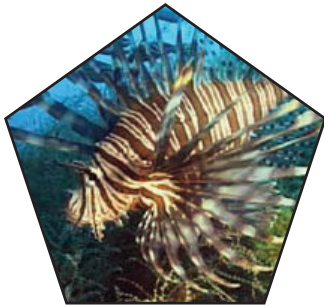

Courtesy Paula Whitfield, NOAA Center for Coastal Fisheries and Habitat Research, Beaufort, NC

What Is It?

A fish called the lionfish; its scientific name is Pterois volitans

Where Did It Come From?

Pacific Ocean

How Did It Get Here?

Brought to the U.S. for aquariums; accidentally or deliberately released

What Does It Do?

Eats native species and has venomous spines that are poisonous to humans

Northern Snakehead



Courtesy U.S. Geological Survey, Florida Integrated Science Center]

What Is It?

A fish called the Northern snakehead; its scientific name is Channa argus

Where Did It Come From?

Asia

How Did It Get Here?

Brought to the U.S. for fish markets; accidentally or deliberately released

What Does It Do?

Feeds aggressively on amphibians, fish, birds, and small mammals; can survive in waters that contain very little oxygen and can travel across land

Nutria

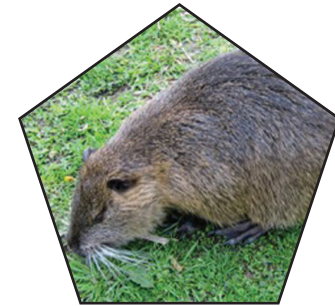

Courtesy Justin Secrist, Washington Department of Fish and Wildlife

What Is It?

A mammal called a Nutria (also called a coypu, coypu rat, nutria rat, or swamp beaver); its scientific name is Myocastor coypus

Where Did It Come From?

South America

How Did It Get Here?

Brought to the U.S. for fur production

What Does It Do?

Damages vegetation and destroys wetland habitats

Round Goby

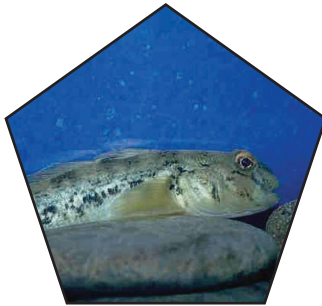

Courtesy D. Jude, University of Michigan

What Is It?

A fish called the Round Goby; its scientific name is Neogobius melanostomus

Where Did It Come From?

Eurasia

How Did It Get Here?

In ballast water of ships

What Does It Do?

Feeds on native species

Sea Lamprey

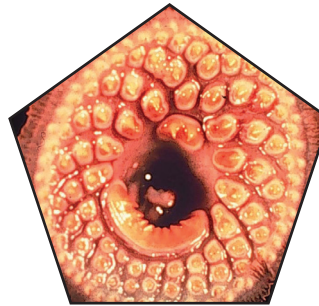

Mouth of a sea lamprey
Courtesy USGS, Great Lakes Science Center

What Is It?

A fish called a Sea Lamprey; its scientific name is Petromyzon marinus

Where Did It Come From?

Atlantic Ocean

How Did It Get Here?

Entered the Great Lakes through man-made canals

What Does It Do?

Feeds on native species

Sea Squirt



Courtesy Dann Blackwood, U.S. Geological Survey

What Is It?

An invertebrate called a Sea Squirt (also called an ascidian, colonial tunicate, or compound sea squirt); its scientific name is Didemnum lahillei

Where Did It Come From?

Europe

How Did It Get Here?

In ballast water and attached to the hulls of ships

What Does It Do?

Forms dense mats that smother native species

Zebra Mussel

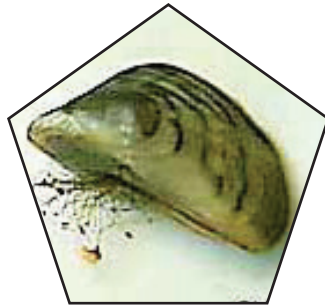

Courtesy of Ohio Sea Grant College Program

What Is It?

A mussel called the Zebra Mussel; its scientific name is Dreissena polymorpha

Where Did It Come From?

Eurasia

How Did It Get Here?

In ballast water of ships

What Does It Do?

Competes with native species, and clogs pipes of factories located on rivers and lakes

Veined Rapa Whelk

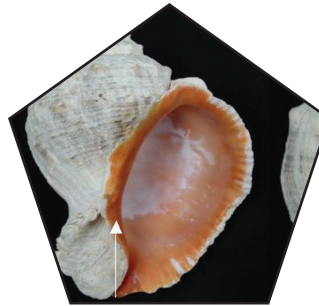

Courtesy of Julia Harding, Virginia Institute of Marine Science

What Is It?

A snail called the Veined Rapa Whelk; its scientific name is Rapana venosa

Where Did It Come From?

Pacific Ocean

How Did It Get Here?

In ballast water of ships

What Does It Do?

Eats commercially important bivalves, such as clams and oysters

European Green Crab



Courtesy of California Interagency Ecological Program

What Is It?

A crab named the European Green Crab; its scientific name is Carcinus maenas

Where Did It Come From?

Europe

How Did It Get Here?

In ballast water of ships

What Does It Do?

Eats commercially important bivalves, such as soft shell clams and scallops

Endangered Species

“For most of the wild things on Earth, the future must depend upon the conscience of mankind”

~ Dr. Archie Carr, father of modern marine turtle biology and conservation

Earth loses hundreds of species every year, and many of these losses are the result of human activity. Some of these species may have held the key to curing cancer, or feeding everyone on the planet, or improving our lives in ways we can't even imagine. But we'll never know, because they are gone.

Congress passed the Endangered Species Act (ESA) on December 28, 1973, recognizing that the natural heritage of the United States was of “esthetic, ecological, educational, recreational, and scientific value to our Nation and its people.” It was understood that, without protection, many of our nation's living resources would become extinct. Protecting endangered species needs everyone's help, and the first step is getting people to recognize the problem.



Humpback whales in the singing position. Courtesy Dr. Louis M. Herman, NOAA

Here's an activity that can help introduce the topic of endangered species, particularly whales and sea turtles.

What You Will Need

- 8 1/2 x 11 inches sheets of colored paper (one for each animal)
- Scissors

Warning

Be careful with sharp scissors.

What You Will Do

Make origami models of whales and turtles

How to Make an Origami Sea Turtle

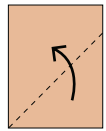
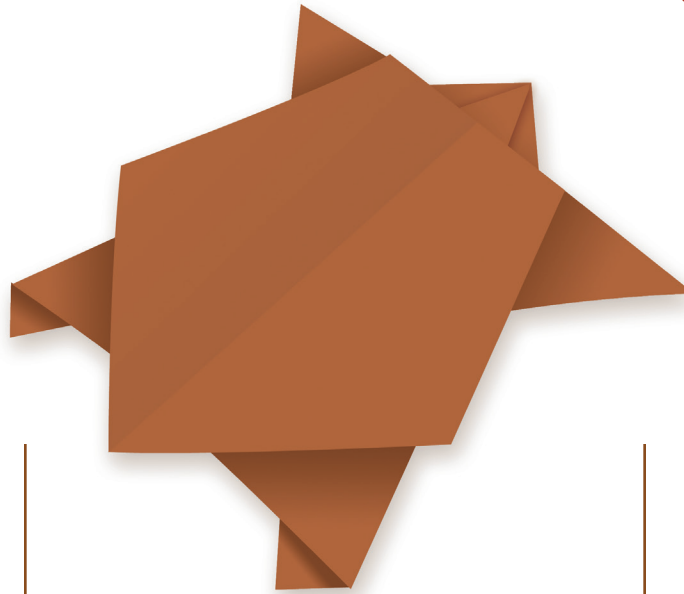

1. Begin by making a square piece of paper. Fold one corner of a piece of paper over to the adjacent side.

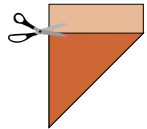

2. Like this. Finish making the square by cutting off the small rectangle.

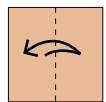

3. Fold side to side and unfold. This is the "valley fold" or "river."

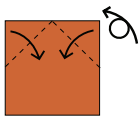

4. Turn over and fold right and left points down to form a "roof."

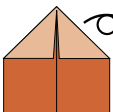

5. Like this. Then turn over.

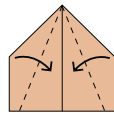

6. Bring the folded edges to meet the valley fold (the river). Crease flat.

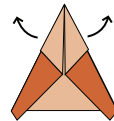

7. Unfold the top side points.

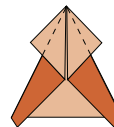

8. Like this.

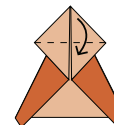

9. Fold the top point down as shown.

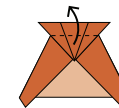

10. Fold the point upward to create a head.

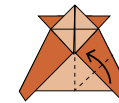

11. Lift the bottom edge to meet the vertical center line.



12. Like this. Press flat and fold outward as shown.

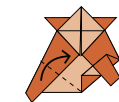

13. Repeat steps 11 and 12 with the other foot.

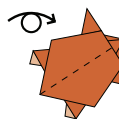

14. Turn over. You've made a turtle!

Origami illustrations courtesy Matt McIntosh, NOAA

How to Make an Origami Blue Whale

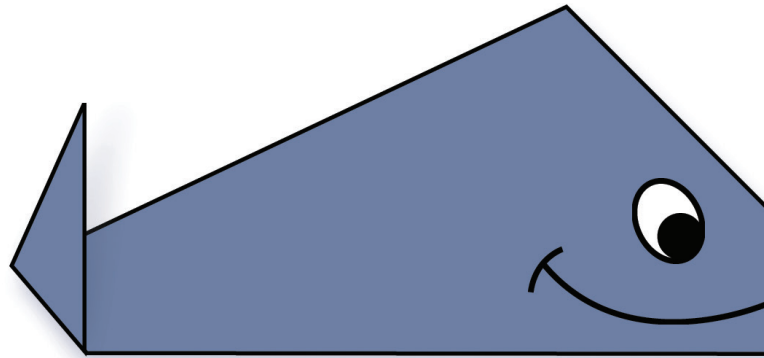

1. Begin by making a square piece of paper. Fold one corner of a piece of paper over to the adjacent side.

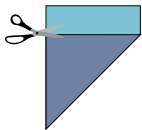

2. Like this. Finish making the square by cutting off the small rectangle.

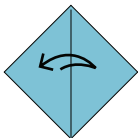

3. Put a square of paper on the table so it looks like a diamond. Fold side to side and unfold.

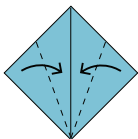

4. Fold the lower left and right sides to meet the center crease.

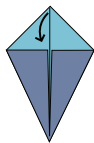

5. It looks like an ice-cream cone. Now fold the top point down, as shown.

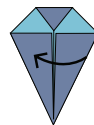

6. Fold the right side over to meet the left side.

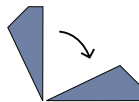

7. Put your finger on the bottom point as you turn the whale sideways.

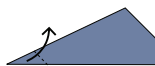

8. Fold the end point up to make a tail.

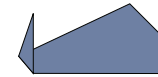

9. Like this.

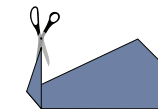

10. Make a short cut through the end of the fold in the tail. Fold the edges of the tail outwards.

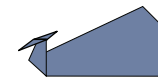

11. Like this.



12. Draw eyes, fins and any other patterns you like.

Origami illustrations courtesy Matt McIntosh, NOAA

Sea Turtle Facts

👉 Sea turtles have been on the planet since the early Mesozoic era almost 180 million years ago! They survived the great dinosaur extinction during the Cretaceous era, and flourished until recent times.

Caroline Rogers, USGS



Green Turtle

👉 There are six species of sea turtles commonly found in the United States in the Atlantic, Gulf of Mexico, and Pacific:

- * Leatherback
- * Loggerhead
- * Kemp’s Ridley
- * Hawksbill
- * Green
- * Olive Ridley

👉 Sea turtles eat a variety of organisms, including algae, seagrasses, sponges, crustaceans, jellyfish and mollusks.

👉 Adult green turtles are unique among sea turtles in that they eat only plants; they are herbivorous, feeding primarily on seagrasses and algae. This diet is thought to give them greenish-colored fat, from which they take their name.

👉 Sea turtles have a unique life history. They are highly migratory, often swim long distances, live long lives, take a long time to reach maturity, and the females crawl ashore to dig nests and lay eggs.

Caroline Rogers, USGS

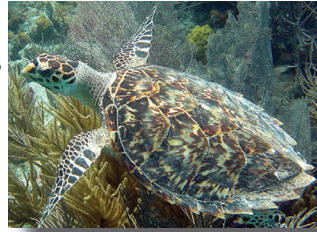

Hawksbill Turtle

👉 What’s the problem? Sea turtles are threatened by:

- * Loss of habitat and nesting areas due to coastal development
- * Incidental capture (bycatch) in commercial and recreational fisheries
- * Being caught in or eating marine debris
- * Being hit by ships

👉 NOAA and the U.S. Fish and Wildlife Service are working together to conserve and help marine turtles recover, along with other federal agencies, state partners, coastal communities, private individuals, and other nations.

👉 Some things being done to conserve sea turtles:

- * Requiring certain types of fishing vessels to use fishing gear that prevents accidental capture of sea turtles
- * Protecting and restoring prime nesting habitat along key coastal areas
- * Reduce entanglement in and ingestion of

marine debris by sea turtles

- * Ensure coastal construction activities avoid nesting and hatching periods
- * Supporting regulations to control artificial lights near turtle nesting beaches (artificial lights can disorient sea turtle hatchlings)
- * Working with other countries to conserve sea turtles throughout their range

👉 What can you do to help?

- * Avoid sea turtles when you go out in a boat.
- * Do not anchor your boat in seagrass beds where sea turtles rest and eat.
- * Properly dispose of your garbage no matter where you live. It all flows downstream to the ocean.
- * Minimize all your lights at the beach (campfires, flash lights, house lighting).
- * Celebrate events without balloon releases.

Learn as much as you can about sea turtles, the threats to the them, and their conservation. Share your knowledge with friends and family.

For more about sea turtle biology, status and the threats that face them, visit the U.S. Fish and Wildlife Service Web site: www.fws.gov/north-florida/SeaTurtles/20090700_You_Can_Help_ST.pdf.



Humpback whale breaching

Courtesy NOAA

Whale Facts



Killer whale shyopping

Courtesy NOAA

- ☞ Whales are the largest animals that ever lived on the Earth. They are even larger than the dinosaurs of prehistoric times.
- ☞ All whales belong to a group known as cetaceans (seh TAY shuhnzh). There are two types of whales—toothed (odontocete) and baleen (mysticete). Baleen is a special filter that whales use to sieve tiny food particles from the water.
- ☞ Today, there are 78 species of whales swimming in the oceans around the world; 67 species are toothed and 11 are baleen.
- ☞ Whales are large, intelligent, marine mammals. They breathe air through a blowhole into lungs, are warm-blooded, and give birth to their young as opposed to laying eggs.
- ☞ Many cetaceans, especially baleen whales, migrate over very long distances each year. They travel, sometimes in groups (pods), from coldwater feeding grounds to warm-water breeding grounds. Gray whales make the longest seasonal migration of any of the whales—about 12,500 miles each year!

- ☞ The biggest whale is the blue whale, which grows to be about 94 feet (29 m) long—the height of a 9-story building. These enormous animals eat about 4 tons of krill (microscopic floating animals) each day, obtained by filter-feeding through baleen.
- ☞ The smallest whale is the dwarf sperm whale, which as an adult is only 8.5 feet (2.6 m) long.
- ☞ Adult blue whales have no predators except man. Almost all species of baleen whales were exploited by the commercial whaling industry from the 1700s to the mid-1900s. Several species of both toothed and baleen whales were hunted close to extinction. Most populations have not yet recovered from intense hunting and still face threats to their survival from human activities.
- ☞ Many baleen whales are in danger of being hit by ships, particularly the critically endangered Northern right whale.
- ☞ Being tangled in various types of fishing gear is a serious threat to several species of cetaceans.

- ☞ NOAA works to protect and conserve whales because all whales are protected under the Marine Mammal Protection Act, and some are also protected under the Endangered Species Act.

- ☞ NOAA's efforts to protect and conserve whales include legislation, National Marine Sanctuaries and other marine protected areas. NOAA also works with the U.S. Fish and Wildlife Service on issues concerning whales and other cetaceans.

Want to Do More?

For more information, visit:

NOAA's Marine Mammals Program:

www.nmfs.noaa.gov/pr/species/mammals/

NOAA's National Marine Sanctuaries:

sanctuaries.noaa.gov/ -

NOS' What is a Marine Protected Area? oceanservice.noaa.gov/facts/mpa.html

U.S. Fish and Wildlife Service: www.fws.gov/refuges/whm/coastalandmarine.html



Courtesy Kathy Crane, NOAA Arctic Research Office

WHAT ARE THE IMPACTS OF SHRINKING POLAR ICE CAPS?

“Rarely have we seen the Arctic show a clearer, stronger or more pronounced signal of persistent warming and its cascading effects on the environment than this year.”

~ Jeremy Mathis, director of NOAA’s Arctic Research Program

During the past thirty years, the Arctic environment has changed like never before. Temperatures have increased more than twice as much as on the rest of Earth and sea ice has been getting smaller and smaller. These changes have opened the Arctic to new commercial activities such as shipping, oil and mineral exploration and tourism. These new opportunities have increased the need to understand more about Arctic change and its effects on weather and climate, as well as how it may affect human communities and industry. The information that NOAA generates about the Arctic helps to conserve and manage Arctic resources to provide healthy, productive and resilient communities and ecosystems.

The Arctic Report Card for 2016 is a report that brings together the work of 61 scientists from 11 nations who report on air, ocean, land and ecosystem changes. It is used around the world to track changes in the Arctic and how those changes may affect communities, businesses and people.

What You Will Do

Make a poster to explain how climate change is affecting polar ice mass, how it may affect humans, and what we can do about it.

Major findings in the 2016 report include:

- Warmer air temperature: Average annual air temperature over land areas was the highest in the observational record, representing a 6.3 degree Fahrenheit (3.5 degree Celsius) increase since 1900. Arctic temperatures continue to increase at double the rate of the global temperature increase.
- Record low snow cover: Spring snow cover set a record low in the North American Arctic, where the May snow cover extent fell below 1.5 million square miles (4 million square kilometers) for the first time since satellite observations began in 1967.
- Smaller Greenland ice sheet: The Greenland ice sheet continued to lose mass in 2016, as it has since 2002 when satellite-based measurement began.
- Record low sea ice: The Arctic sea ice minimum extent from mid-October 2016 to late November 2016 was the lowest since the satellite record began in 1979. Arctic ice is thinning, with multi-year ice now comprising 22 percent of the ice cover as compared to 45 percent of ice cover in 1985.

ARCTIC HAD WARMEST YEAR ON RECORD

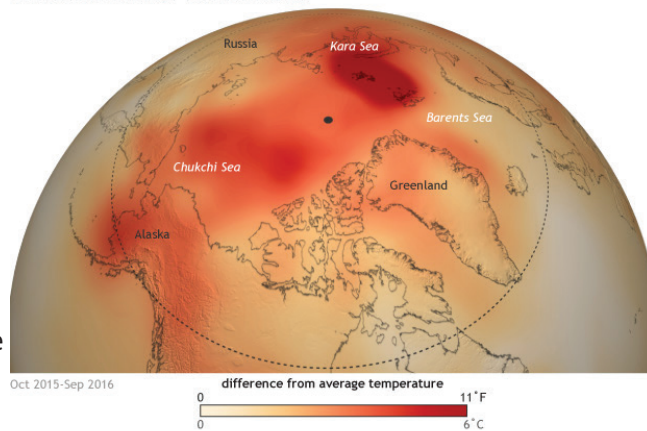

ARCTIC IS WARMING TWICE AS FAST AS THE GLOBAL AVERAGE

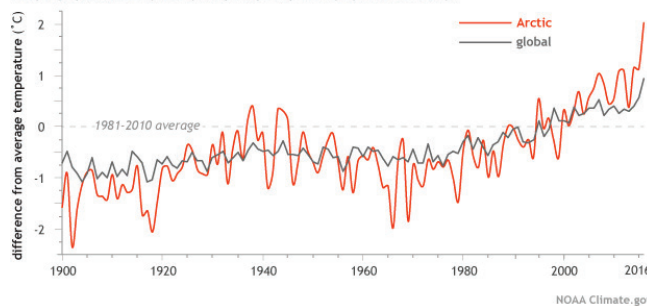

(map) Temperatures across the Arctic from October 2015-September 2016 compared to the 1981-2010 average. (graph) Yearly temperatures since 1900 compared to the 1981-2010 average for the Arctic (orange line) and the globe (gray). NOAA Climate.gov map based on National Centers for Environmental Prediction (NCEP) reanalysis data from NOAA's Earth System Research Lab. Graph adapted from Figure 1.1 in the 2016 Arctic Report Card.

- Above-average Arctic Ocean temperature: Sea surface temperature in August 2016 was 9 degrees Fahrenheit (5 degrees Celsius) above the average for 1982-2010 in the Barents and Chukchi seas and off the east and west coasts of Greenland.

- Arctic Ocean productivity: Springtime melting and retreating sea ice allowed for more sunlight to reach the upper layers of the ocean, stimulating widespread blooms of algae and other tiny marine plants which form the base of the marine food chain, another sign of the rapid changes occurring in a warming Arctic.

The 2016 report also includes scientific essays on carbon dioxide in the Arctic Ocean, on land and in the atmosphere, and changes among small mammals.

- Ocean acidification: More than other oceanic areas, the Arctic Ocean is more vulnerable to ocean acidification, a process driven by the ocean's uptake of increased carbon dioxide from Earth's atmosphere. Ocean acidification is expected to intensify in the Arctic, adding new stress to marine fisheries, particularly those that need calcium carbonate to build shells. This change affects Arctic communities that depend on fish for food security, livelihoods and culture.
- Carbon cycle changing: Overall, the warming tundra is now releasing more carbon into the

atmosphere than it is taking up. Twice as much organic carbon is locked in the northern permafrost as is currently in the Earth's atmosphere. If the permafrost melts and releases that carbon, it could have profound effects on weather and climate in the Arctic and the rest of the Earth.

- Small mammals: Recent shifts in the population of small mammals, such as shrews, may be the signs of broader consequences of environmental change.

These changes spell big trouble for animals that depend on sea ice for their survival. Polar bears, for example, live on sea ice all year. They rear their young on the ice, and hunt along the edges where seals make holes in the ice to breathe. An adult polar bear usually eats one seal every four or five days. When the sea ice melts during the summer, polar bears have to swim between floating chunks of ice (called "floes") to continue their hunt. Until recently, the floes were usually less than 15 miles apart. But as more and more of the perennial ice melts, the floes have become much farther apart, and the bears have had to swim over much longer distances.

Polar bears face other problems, too. Ocean currents can carry chemical pollution thousands of miles, and some of it reaches the Arctic. Chemicals

DECLINING ICE MASS IN GREENLAND

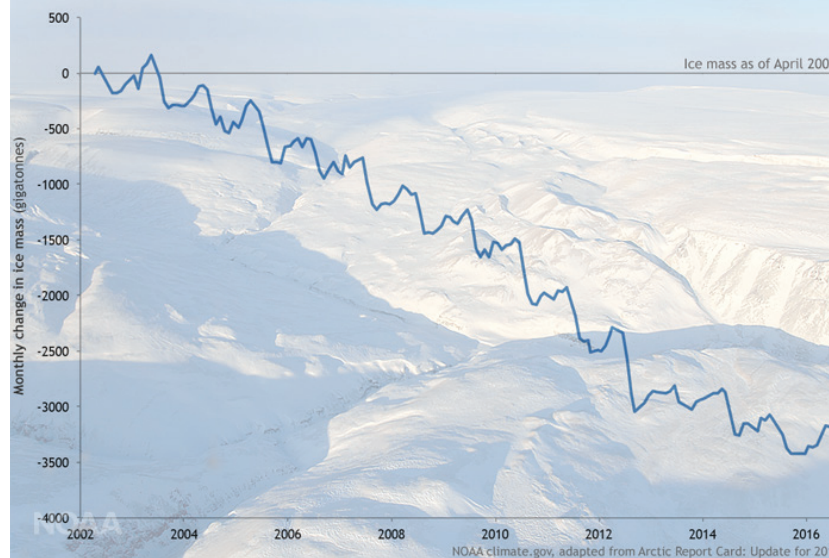

The Greenland ice sheet continued to lose mass in 2016, as it has since 2002 when satellite-based measurement began. Melting began the second earliest in the 37-year record of observations, close to the record set in 2012. Graphic shows Greenland ice sheet mass each month since April 2002. (Climate.gov; data provided by Marco Tedesco/Lamont-Doherty)

called PCBs, for example, have been found in polar bears. These chemicals cause problems with polar bears' immune systems, so the bears are more likely to get sick.

What You Will Need

- Color copies of images from "Images for Shrinking Polar Ice Caps" or other images you find in web searches
- Information from the introduction to this activity.
- Crayons, colored markers, or colored pencils
- Poster board
- Scissors

Warning

Be careful with sharp scissors!

How to Do It

1. Use the images and information to create a poster that explains what is happening to arctic sea ice, how this is related to climate change, why this is important to us, and what we can do about it.
2. Show your poster at school, to your parents, and to other groups. The more people know about climate change and how it affects life on Earth, the more they will take action to protect Earth's ecosystems.

Want to Do More?

Take a look at the short video of Arctic Report Card 2016. www.youtube.com/watch?v=G0rp6-BEur8&feature=youtu.be

For an in-depth read, go to the Arctic Report Card: Update for 2016 www.arctic.noaa.gov/Report-Card/Report-Card-2016

www.arctic.noaa.gov/ – NOAA's Arctic Theme Page with information and data about the Arctic for scientists, students, teachers and the general public.

For more information on methane, see www.climate.gov/print/827815

For more information on ocean acidification, see <http://oceanacidification.noaa.gov>

Images for Shrinking Ice Cap Posters

THE ARCTIC'S FROZEN GROUND

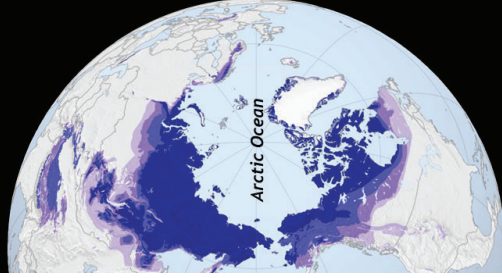

PERMAFROST
 continuous
 discontinuous
 sporadic
 isolated

Rising temperatures are **thawing** the Arctic's deep layer of frozen soil.

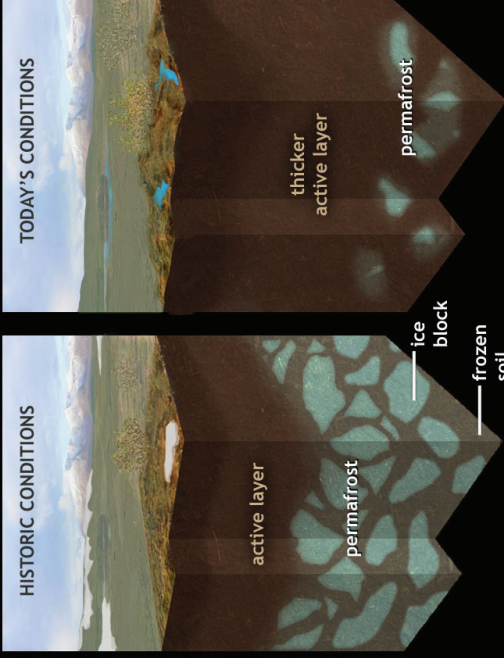

On the tundra, soil microbes are **adding carbon** to the air faster than plants can absorb it.

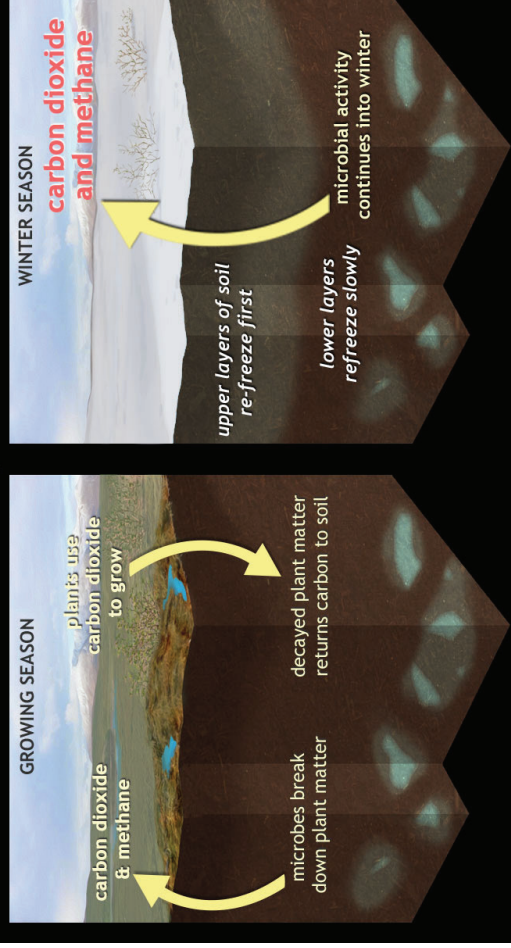

(map) Stretching from Alaska to Scandinavia to Russia, and hundreds of feet deep in places, the Arctic's frozen soils--permafrost--contain twice as much carbon as what's already in the atmosphere. As the Arctic heats up, permafrost may become a major source of greenhouse gases, which would further accelerate global warming. (top middle) Permafrost is like a giant freezer for carbon: thousands of years' worth of plant, animal, and microbe remains mixed with blocks of ice. Historically, only a shallow "active layer" thawed in the short summer. (top right) In today's warming Arctic, permafrost is thawing and the active layer is getting deeper. (bottom left) Warming in the growing season has increased plant growth and allowed plants to remove more carbon dioxide (CO₂) from the air during photosynthesis, but it is also thawing the frozen soils and stimulating decomposition of organic matter by soil microbes. Microbial activity releases the greenhouse gases CO₂ and methane (CH₄). (bottom right) When winter comes, the uppermost soil layer re-freezes quickly as air temperatures drop. But tundra that are routinely observed have become a net source of carbon-containing greenhouse gases because microbial activity is continuing well into winter after plants go dormant. NOAA Climate.gov drawing. Permafrost map from NSIDC.

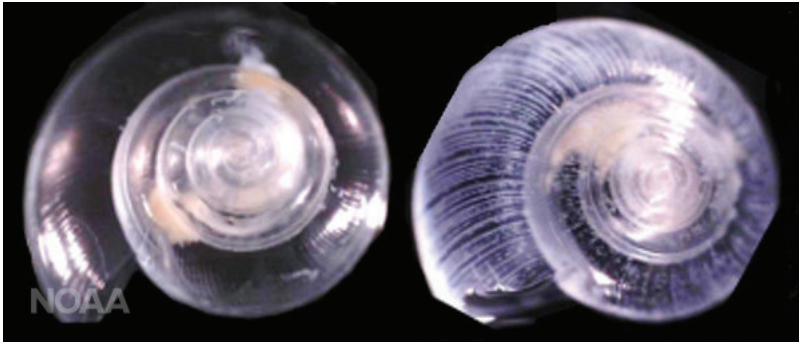

Ocean acidification impact on pteropods
 Pteropods, or sea butterflies, are a vital food source for salmon and other commercially important fish. Shown here in laboratory conditions are (left) a pteropod that has lived for six days in normal waters and (right) a pteropod showing the effects of living in acidified water for the same time period. The white lines indicate shell dissolution and explain why ocean acidification is often called “osteoporosis of the sea.” (NOAA)

Courtesy Joel Garlich-Miller, USFWS



Methane bubbles trapped in ice on Abraham Lake, in Alberta, Canada, during winter 2016-17.
 Photo by Flickr user juneaidrao, used under a Creative Commons license .



One species of shrew is now invading north into the Arctic, setting off a major reorganization of animal communities at the top of the world. Accelerating climate change in the Arctic is spurring the northward invasion of shrews, bringing an array of tapeworms and other parasites, according to authors of an essay in 2016’s report card, “Small species indicate big changes: Shrews and their parasites.” www.arctic.noaa.gov/Report-Card/Report-Card-2016/ArtMID/5022/ArticleID/268/Shrews-and-Their-Parasites-Small-Species-Indicate-Big-Changes”

Phil Myers, photographer; copyright holder/Museum of Zoology, University of Michigan-Ann Arbor

Following the Ocean Unicorn

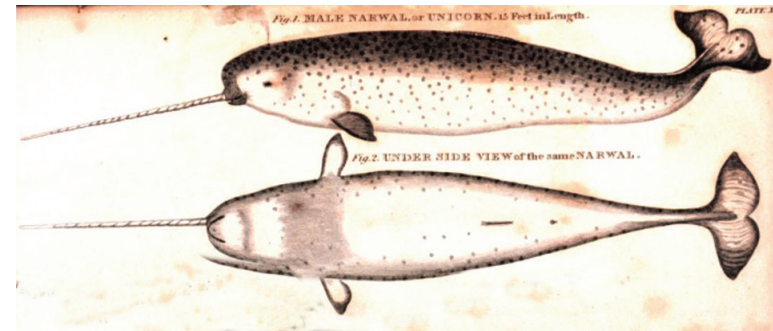

From An account of the Arctic regions with a history and description of the northern whale-fishery by W. Scoresby. 1820. Courtesy NOAA..

Is this a unicorn? Not really—it's actually a drawing of a narwhal, a whale that spends its entire life in the Arctic. Most male narwhals have a tooth in their upper jaw that forms a long tusk. For several centuries, northern traders sold narwhal tusks throughout Europe, claiming they were unicorn horns. One of the largest groups of narwhals spends most of the winter in Baffin Bay, between Canada and the western coast of Greenland. This is an unusual area, because while most of the Arctic is getting warmer, air and sea surface temperatures near western Greenland are getting cooler, and sea ice concentrations in Baffin Bay have increased significantly since 1953. But at the same time, temperatures in deep water below 1,200 feet in Baffin Bay are slowly getting warmer.

This is important, because the deep water in Baffin Bay is part of a worldwide system of deep currents that connect Earth's largest oceans. Temperature is one of the things that makes this system work, and some scientists are worried that changing temperatures in the Arctic could cause the system to slow down or even stop working entirely. Even though it's getting warmer, the Arctic is still a difficult place to do scientific work, and it has been almost impossible for scientists to gather very much information on deep ocean temperatures.

Believe it or not, narwhals may help solve this problem! Narwhals in Baffin Bay often dive more than 4,500 feet deep to find food. And they do this during the winter when it is impossible for scientists to do deep ocean research in the Arctic region. NOAA's Ocean Explorer 2006 Arctic Winter Ecosystem Exploration attached instrument packages

What You Will Do

Make a poster about narwhals, how they are being affected by climate change, how climate change may affect humans, and what we can do about it.

called “satellite tags” to narwhals to record temperature and depth during deep dives for food. A transmitter in each tag sends the information to a satellite, and the satellite sends the information back to Earth to give scientists the first-ever data on deepwater winter temperatures in Baffin Bay.

Unfortunately, narwhal populations may be declining. There are several possible reasons for this:

- Hunting by indigenous Arctic peoples (which means people who have lived in the Arctic for hundreds of years);
- Increased harvest of fish by humans, reducing the amount of food available for narwhals; and/or
- Climate change.

Baffin Bay is one of the few places in the Arctic where sea ice is increasing; and this causes problems for narwhals because it reduces the amount of open water needed by the whales, and increases the danger that they may become trapped in the ice.

Does this seem that what’s bad for the narwhals might be good for the polar bears? Not really, because not enough ice where ice should be is just as bad as too much ice where ice should not be. Remember, too,



Courtesy Kristin Laidre

that even though the average temperature in the Arctic is going up, there can still be places that are colder than the average; but these colder temperatures are balanced by temperatures in other places that are higher than the average.

Just as narwhals are helping scientists study the deep ocean, they can also help you tell other people about global climate change.

What You Will Need

- Copies of “Images for Narwhal Posters”
- Information from the introduction for this activity, the “Narwhal Fact Sheet” and “Is Our Climate Changing?” (page 137)
- Crayons, colored markers, or colored pencils
- Poster board
- Scissors

Warning

Be careful with sharp scissors!

How to Do It

1. Use the images and information to create a poster that explains about narwhals and how they are being affected by climate change. You may also want to include information about why climate change is important to us, what we can do about it, and possibly some ideas and information from the “What are the Impacts of Shrinking Polar Ice Caps?” on page 121, since it also deals with climate change and Arctic animals.
2. Show your poster at school, to your parents, and to other groups. The more people know about climate change and how it affects life on Earth, the more they will take action to protect Earth’s ecosystems.

Want to Do More?

Visit www.oceanexplorer.noaa.gov/explorations/06arctic/welcome.html for more information about narwhals and NOAA’s Ocean Explorer 2006 Arctic Winter Ecosystem Exploration.

This activity was adapted from “The Ocean Unicorn” (10 pages, 292 kb) by Mel Goodwin, PhD and science writer, Charleston, SC; from the Ocean Explorer 2006 Arctic Winter Ecosystem Exploration [www.oceanexplorer.noaa.gov/explorations/06arctic/background/edu/media/unicorn.pdf]



Several male narwhals in West Greenland. Courtesy Mads Peter Heide-Jorgensen

- Narwhals belong to the genus *Monodon* and the species *monoceros*.
- Narwhals belong to the class Mammalia and the order Cetacea.
- Male and female narwhals have two teeth, in the upper jaw. In most female narwhals, the teeth never erupt through the gum. In most males, the left tooth forms a long tusk. In rare cases, males may develop two tusks, and females may also develop one or two tusks.
- The most widely accepted explanation for the function of the narwhal's tusk is that it is possibly involved with mating behavior or as a weapon in battles over possession of females.
- Narwhals spend their entire lives in the Arctic.
- Narwhals eat fish (including polar cod, Greenland halibut, flounder, salmon, and herring), cephalopods (squids and octopuses), and shrimp.
- Narwhals can dive to depths of 4,500 feet or more.
- Narwhals need to come to the surface of the ocean periodically, because they are mammals and must surface to breathe air.
- Normally, a female narwhal produces one calf at a time.
- Narwhals seem to prefer deep water near loose pack ice. In the summer, they occupy deep bays and fjords in the Canadian High Arctic and Greenland. As winter approaches, narwhals migrate into the pack ice of Baffin Bay, the northern Davis Strait, and adjacent waters.
- Narwhals can live for 50 years or more.
- Narwhals have been traditionally hunted by indigenous Arctic peoples who value them as a staple food (the skin is rich in vitamin C), as well as for their tusks (though international efforts to control the global ivory trade may have reduced tusk sales in recent years). Narwhal sinews (tissues that attach muscles to bones) may also be used as thread.

Images for Narwhal Posters



Narwhals. Courtesy Kristin Laidre

Melville Bay is the site of many active glaciers. The area is filled with large icebergs that dwarf the *Sila*, the boat used for narwhal tagging/tracking. Courtesy Kristin Laidre.



Male narwhals. Courtesy Mads Peter Heide-Jorgensen

Narwhals. Courtesy Kristin Laidre



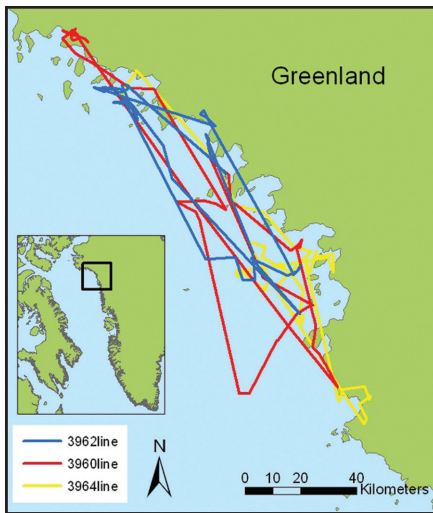

Satellite-based locations for three narwhals tagged in Melville Bay in September 2006. Whales are still in their coastal summering grounds but will migrate offshore by mid-November. Courtesy Kristin Laidre

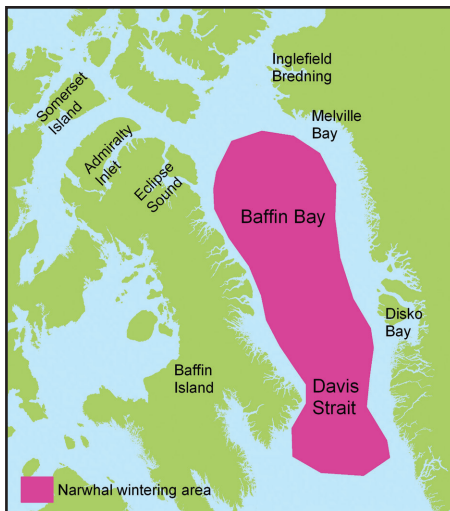

Narwhal wintering areas (pink) in Baffin Bay and Davis Strait. Courtesy Kristin Laidre



Instrument packages called “satellite tags” are attached to narwhals by plastic coated wires affixed to two nylon pins (1/4 inch diameter) inserted through the dorsal ridge on the whales’ back (the whales shed the tags after several months; 14 months is the longest time a tag has stayed on a whale). An alterna-

tive method of attaching the tags involves placing the tags into small cylinders that are implanted in the layer of blubber along the whales’ back using hand-held thrown poles similar to harpoons. Tags attached using the latter methods are only expected to provide data for four to five weeks.



Male narwhal (ID 3964) captured and satellite tagged. You can see where he went in the map to the left. Courtesy Kristin Laidre

Does Tagging Hurt Narwhals?

Researchers say “No, we have quite good evidence that tagging does not hurt them—both in the short and long term.” Satellite tags are only attached into blubber where there are few nerve endings, and the whales do not react at all when the tags are attached. As soon as the whales are released, they immediately resume normal behavior. In addition, whales that have been recaptured several years after tagging show no evidence of being harmed by the tagging process.

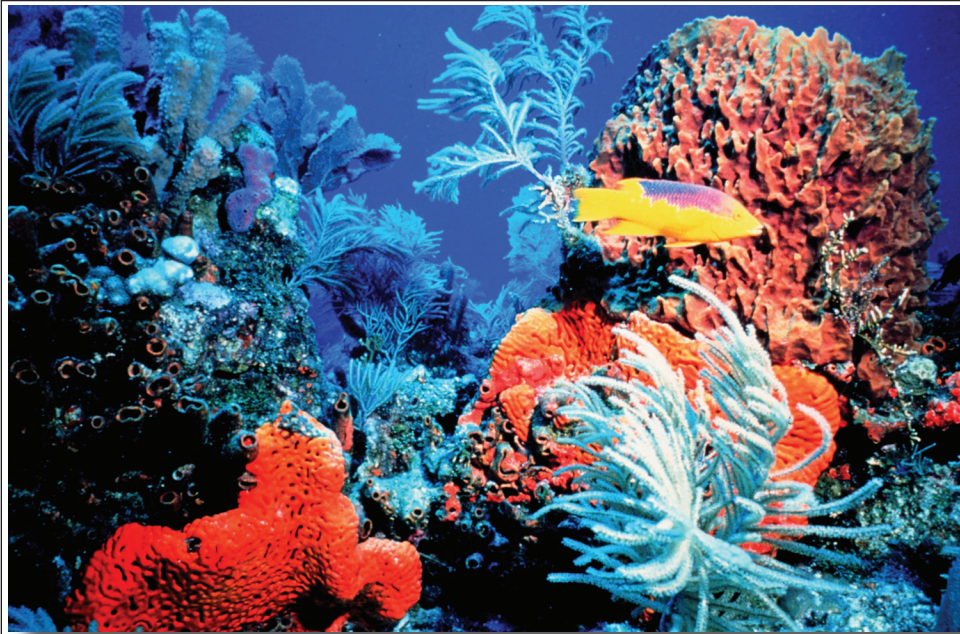

Spanish hogfish at reef.
Courtesy Florida Keys National Marine Sanctuary

Make an Edible Coral Reef

You have probably seen pictures of coral reefs before—lots of colors, fishes, and weird looking shapes! Coral reefs are not only beautiful to look at; they are also home to thousands of other species. In fact, scientists estimate that there may be another one to eight million undiscovered species living in and around reefs! Coral reefs support more species per square foot than any other marine environment. This abundance of living organisms is key to finding new medicines for the 21st century. Many drugs are now being developed from coral reef animals and plants as possible cures for cancer, arthritis, human bacterial infections, viruses, and other diseases.

Coral reefs are important for other reasons as well. Coral reefs are a breeding ground for many fish and other species, and millions of people and thousands of communities all over the world depend on coral reefs for food. In the United States, coral reef ecosystems support hundreds of commercial and recreational fisheries worth more than 200 million

dollars. Local economies receive billions of dollars from visitors to reefs through diving tours, recreational fishing trips, hotels, restaurants, and other businesses based near reef ecosystems. Coral reefs protect shorelines against waves, storms and floods, and help prevent loss of life, property damage and erosion.

Despite their importance, many of Earth's coral reefs are in trouble. Severe storms, water pollution, overfishing, disease, global climate change, and ships running aground are some of the things that have destroyed or badly damaged many reefs. Because of these threats, coral reefs and all of the creatures that call them home may be in danger of disappearing if something isn't done to protect them. NOAA is one of many organizations

What You Will Do

Make an edible model of a coral reef!

participating in the U.S. Coral Reef Task Force, which was established in 1998 to protect and conserve coral reefs. Satellites are being used to map shallow U.S. coral reefs, as well as to watch for high sea surface temperatures that can damage corals and to detect harmful algae that can smother reefs. NOAA's National Undersea Research Program does research projects to learn more about coral reefs, and restores damaged reefs in marine reserves and among deep sea coral banks.

Coral reefs need your help, too! More people need to understand why coral reefs are important and what needs to be done to protect them. Here's a tasty way to start a conversation about coral reefs.

What You Will Need:

- One half sheet cake; if you want to bake your own cake you will need a box of cake mix and other ingredients listed on the box
- Icing in various colors
- Food coloring
- Marshmallows, licorice whips, small cookies, candy sprinkles, or other edible materials for modeling coral reef animals and habitat features

Warnings:

1. Get an adult to help with baking.
2. Don't eat too much!

3. Wash your hands before handling food! If more than one person is involved with this activity, you may also want to wear disposable gloves.

How to Do It:

1. If you aren't familiar with coral reefs, read the sidebar "What is a Coral Reef?" You may also want to look at books about coral reefs or check out the Web sites listed under "Want to Do More?"



A purple soft coral. Courtesy Florida Keys National Marine Sanctuary

A healthy coral reef ecosystem contains thousands of species, so you can't really include everything in your model. Instead, plan a model that is colorful and interesting, using the images on these pages for ideas. Remember, the main idea is to create a model that will help start a conversation about coral reefs (and is also good to eat!).

Before you actually make your model, make a list of what plants or animals you want to include, and what materials will be used to show them on the model. Mounds of icing can be used for boulder-shaped corals. When icing mounds have hardened they can be sculpted to form caves and overhangs. Small cookies could represent plate-shaped corals. Coconut colored with green food coloring could be used for seagrass. Sponges could be modeled with small pieces of sponge cake (of course). Licorice whips could represent branching corals. Gummy fish or fish crackers on toothpicks can represent fish. Raisins or chocolate chips might be sea urchins. Of course, there are many more possibilities, and you probably already have a pretty good idea of things you could use in your model.

2. If you plan to bake your own cake, mix the batter according to instructions on the box, and bake the cake in an oversized flat pan like a broiler pan or turkey roasting pan. Your cake will probably take less time to bake than the time stated on the cake mix box, because your cake will be thinner than usual.
3. The flat cake is the base of your model reef. Add the features you planned in step 1 to complete the model. This is a lot of fun to do with two or three other people, but be sure you wash your hands and wear disposable gloves so you can safely eat the model later.

4. Show your model to your friends, parents, school, or other groups, and talk about why coral reefs are important, why they are in trouble, and what we can do to help save them. If you are using your model at school, your teacher may be able to arrange for you to make a presentation about coral reefs to another group of students, perhaps a younger class. When you have finished your presentation, you can say, "Now it is time for us to have a direct interaction with this model reef." Which means everyone can eat the cake!



Grey snappers at the reef.
Courtesy Florida Keys National Marine Sanctuary

Want to Do More?

www.coris.noaa.gov/ – Information about coral reefs from NOAA’s Coral Reef Information System

oceanservice.noaa.gov/facts/thingsyoucando.html – Things You Can Do to Protect Coral Reefs, a National Ocean Service fact sheet

www.coralreef.noaa.gov/ – NOAA’s Coral Reef Conservation Program

coralreefwatch.noaa.gov/satellite/education/ – Coral Reef Conservation Program, Education and Outreach

oceanservice.noaa.gov/education/tutorial_coral/welcome.html – Coral Tutorial from NOAA’s National Ocean Service

www.teachoceanscience.net/teaching_resources/education_modules/coral_reefs_and_climate_change/how_can_you_help_coral_reefs/ - Teacher resources from Teach Ocean Science

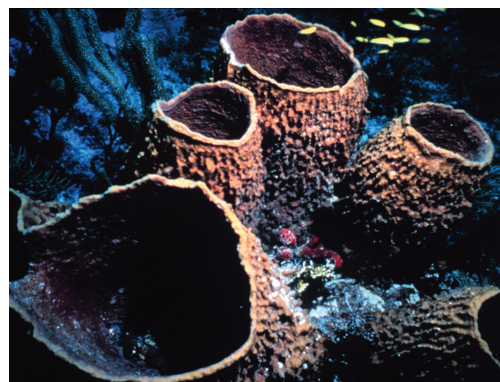

Barrel sponges.
Courtesy Florida Keys National Marine Sanctuary



Elkhorn coral and a white spotted filefish.
Courtesy Florida Keys National Marine Sanctuary



Butter hamlet fish with soft corals.
Courtesy Florida Keys National Marine Sanctuary

Corals are animals that do not have backbones, and are related to jellyfish. The large boulders that we see in pictures of coral reefs are colonies of many individual coral animals called polyps (“PAH-lips”). Polyps are made of an outer cell layer called epidermis (“ep-ih-DERM-iss”) and an inner cell layer called gastrodermis (“gas-tro-DERM-iss”), with a jelly-like substance called mesoglea (“mez-oh-GLEE-uh”) in between. Each polyp makes its own cup-shaped skeleton called a calyx (“KAY-lix”) from limestone (calcium carbonate). The base of the calyx is called the basal plate, and the outer walls of the calyx are called the theca (“THEE-kuh”). Vertical partitions called septa extend part-way into the cup from the inner surface of the theca. The outer surface of the theca is covered by the soft tissues of the coral. Polyps have a mouth surrounded by a ring of arms called tentacles. The tentacles have stinging cells called nematocysts (“nee-MAT-oh-sists”) that polyps use to capture food. Most corals are carnivorous, and feed on small floating animals or even fish. Many corals also feed by collecting very small bits of floating material on strings of mucous, which they pull into their mouths. Food is digested by digestive filaments in the stomach. Waste is expelled through the mouth.

Most reef-building corals have very small polyps, about one to three millimeters in diameter; but all of the polyps in a whole colony can make a limestone rock that weighs several tons! Individual polyps in a coral colony are connected by a thin band of living tissue called a coenosarc (“SEE-no-sark”).

What is a Coral Reef?



A colony of star coral. Courtesy Commander William Harrigan, NOAA Corps (ret.), Florida Keys National Marine Sanctuary

As the polyps grow and multiply, the coral colony may become shaped like boulders, branches or flattened plates. Some corals form tall columns, others resemble mushrooms, and some simply grow as a thin layer on top of rocks or the skeletons of dead corals.

When corals reproduce, they release free-swimming larvae that can be carried many miles away by ocean currents. A new reef begins when these larvae attach to underwater rocks or other hard surfaces along the edges of islands or continents.

As the corals grow and expand, other animals and plants join the reef system. Sponges and soft corals (sea fans and sea rods) are particularly visible on many reefs. Various types of seaweed and algae are also important. Some of algae produce limestone structures that add to the overall reef structure. Fishes and many other types of animals take advantage of shelter provided by the reef, and feed on algae and bacteria that grow on surfaces within the reef.

Most reef-building corals also contain algae that live inside the soft tissue of the polyp. These algae are called zooxanthellae (pronounced “zoh-zan-THELL-ee”), and like other algae are able to use energy from the sun to make food. So the corals and algae have a relationship that is called “mutualistic.” This means that the coral and algae both benefit from the relationship: The coral gives the algae a protected environment and chemicals the algae need to make food. In return, the algae provide the coral with food, oxygen and help remove wastes from the coral. This relationship allows corals to grow in waters that do not have much food available.

Besides providing corals with food, zooxanthellae are also responsible for the bright colors of many corals. When corals are stressed, particularly by high temperature, the polyps lose their zooxanthellae and the coral colony becomes completely white. This is often called “coral bleaching.” Coral polyps can live for a short period of time without zooxanthellae, but if bleaching lasts too long the coral may die.

Why are Coral Reefs in Trouble?

Coral reefs face numerous hazards and threats. Among these are:

Excessive Fishing – Many coral reefs have very few fishes because they have been captured for food or aquariums. In healthy reef ecosystems, fishes graze on algae. Without the fishes, algae can grow rapidly and smother coral polyps.

Destruction of Habitats – Some fishing methods destroy living reefs. Bottom trawling is extremely destructive. In some countries, fishermen use dynamite to stun fish, which also kills corals and damages the reef structure.

Invasive Species – Plants and animals that do not naturally live on reefs can damage the reef ecosystem. Some invasive seaweeds grow rapidly and smother reef-building corals.

“The Rise of Slime” – Many reefs are becoming overgrown with marine algae and films of bacteria. Part of the problem is pollution. In the Gulf of Mexico, for example, fertilizer pollution causes excessive growth of algae that is responsible for a “dead zone” the size of New Jersey. Habitat destruction, overfishing, and pollution also kill natural filters like oysters and sponges that normally help clean the water.

The 3RD Global Coral Bleaching Event 2014-2017 This is by far the longest and most widespread event in recorded history. In 1998,



The Death of a Coral Reef. This image shows the same reef in American Samoa before, during, and after a coral bleaching event. Photographed by The Ocean Agency / XL Catlin Seaview Survey / Richard Vevers.

a huge underwater heatwave killed 16% of the corals on reefs around the world. Triggered by the El Niño of that year, it was declared the first major global coral bleaching event. The second global bleaching event that struck was triggered by the El Niño of 2010. The US National Oceanic & Atmospheric Administration (NOAA) announced the third global bleaching event in October 2015 and it has already become the longest event recorded, impacting some reefs in consecutive years.

The new phenomenon of global coral bleaching events is caused by ocean warming (93% of climate change heat is absorbed by the ocean). Corals are unable

to cope with today’s prolonged peaks in temperatures – they simply haven’t been able to adapt to the higher base temperatures of the ocean. Although reefs represent less than 0.1 percent of the world’s ocean floor, they help support approximately 25 percent of all marine species. As a result, the livelihoods of 500 million people and income worth over \$30 billion are at stake.

The two previous events caught us relatively unprepared. The world simply didn’t have the technology, understanding or teams in place to reveal and record them properly. This year is different—sponsored by an insurance company interested in the risk resulting from ocean warming, the XL Catlin Seaview Survey, running off predictions issued by NOAA’s Coral Reef Watch programme (which have proven to be accurate), has been able to respond quickly. A major global bleaching event is considered one of the most visual indicators of climate change. Working together with science partners around the world, these free resources have been developed to help you research and communicate this important issue, and to ensure this event doesn’t stay out of sight and out of mind.

www.globalcoralbleaching.org/#overview

Coral Bleaching: Essential Facts

Why do corals matter?

A coral reef is like an oasis in a desert. Corals provide both food and shelter for a staggering amount of marine life. Although coral reef ecosystems represent less than 0.1% of the area of the ocean, approximately 25% of all marine species relies on them. They are especially important as a nursery for juvenile fish until they are large enough to venture into open-ocean. Losing a coral reef can have a dramatic impact on local food, fisheries and livelihoods. About 500 million people globally depend on such fisheries.

What is coral bleaching?

Coral bleaching is the process by which corals lose their colouration and turn a ghostly white. This happens when they become overly stressed especially when exposed to warmer than normal temperatures and excessive sunlight (normally over 4-6 weeks).

What happens when corals bleach?

When corals bleach they are actually expelling the brown algae that they grow within their body tissues. Corals expel algae because high temperatures cause the algae to produce toxic compounds. The expulsion of algae makes the corals appear a brilliant white—which is due to skeletons being visible through their translucent coral tissue.

How often does coral bleaching occur?

Bleaching is becoming increasingly common throughout the coral reef regions of the world as a direct result of warming oceans. Nowadays there is at least some limited coral bleaching reported each year especially during summer months, although the major, global events that span multiple oceans are usually associated with natural variability (e.g. El Niño conditions) building on top of seas that are now warmer because of climate change.



Coral bleaching in the Maldives captured by The Ocean Agency / XL Catlin Seaview Survey in May 2016

What is the connection between bleaching and climate change?

Coral bleaching is one of the most visual indicators of thermal stress due to climate change. It is a phenomenon caused by ocean warming. The oceans have absorbed 93% of the heat from climate change and are now significantly warmer than they were 50 years ago. The heat that is causing reefs to turn white represents the momentum of climate change—it will increasingly impact our weather, climate and rainfall for decades to come until a new equilibrium is reached. This hidden energy could also trigger runaway heating if the ocean's methane deposits are released. It is why coral reefs are often referred to as “the canary in the coalmine.”

What is Mass or Global Coral Bleaching?

Mass coral bleaching is where whole reef systems bleach and not just a few individual corals. This was first recorded in 1979. It is thought that a tipping point was reached around that time when the short-term temperatures that normally accompany El Niño events began to exceed the temperatures that corals could tolerate.

How damaging are mass bleaching events?

Mass bleaching events can be extremely damaging. A reef can turn from a coral dominated reef to an algae dominated reef in the space of a few months – a process that can take decades or longer to reverse. The Galapagos Islands was one of the first places where mass bleaching and mortality was first documented. The reefs there lost over 95% of their coral during the 1982 event.

Why is coral bleaching associated with El Niño?

El Niño events result in higher than normal ocean temperatures in large parts of the world. This causes higher levels of stress on coral reefs. During the warm season, the higher than normal ocean temperature, combined with additional seasonal heating and sunlight, is often enough to now cause corals to bleach.

Does bleaching only occur when there is an El Niño?

Major global events have only happened in El Niño years to date, however the baseline temperature of the ocean is now high enough that we see some mass bleaching every year. It is now only a matter of time before we have a global event that is not triggered in an El Niño year.

Can anything be done to reduce the risk of corals bleaching?

The coral's ability to recover often depends on how healthy it was before the event. Coral reefs can be 'prepared' for bleaching events by ensuring local stressors, such as overfishing and pollution, are minimised.

How does the XL Catlin Seaview Survey help?

The XL Catlin Seaview Survey team is conducting the most extensive visual and scientific survey of the world's coral reefs. The Survey's images are available for expert insight and comment on corals, bleaching and ocean change.

This Essential Guide to Coral Bleaching was prepared by Professor Ove-Hoegh-Guldberg, XL Catlin Seaview Survey's Chief Scientist and Director of the Global Change Institute at the University of Queensland, Australia. www.globalcoralbleaching.org/#essential-facts



Sponge, coral, and soft coral.
Courtesy Florida Keys National Marine Sanctuary

Now THAT's Complex!

A habitat is a place where an animal or plant lives and grows. How many habitats do you see in this picture? There are thousands! This is because the branched and wrinkled shape of the sponges and corals produce many different spaces of many sizes that can provide shelter to other organisms. The variety of habitats found on coral reefs is one of the reasons that a square foot of coral reef supports more species than any other marine environment.

Here's a way to show how coral reefs create a wide variety of habitats by repeatedly dividing a space into smaller and smaller pieces.

What You Will Need:

- Colored pencils or fine-point markers
- Ruler
- Copy of "Triangle Graph Paper"

What You Will Do

Make a Sierpinski triangle that shows how repeatedly dividing a fixed space produces an infinite series of increasingly smaller spaces.

How to Do It:

1. Begin by drawing an equilateral triangle measuring 16 cm on each side. This triangle is drawn in red on the "Triangle Graph Paper."
2. Find the midpoint of each side (8 cm), and join these midpoints as shown in Step 1.

Step 1

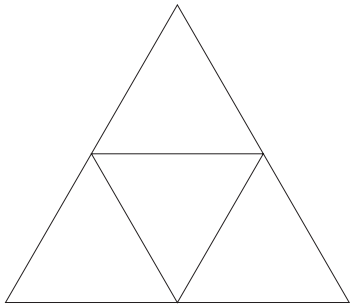

3. Shade the triangle in the middle as shown in Step 2.

Step 2

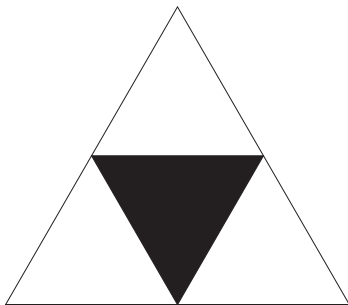

4. Find the midpoints of each side of the three outer triangles (4 cm), and join these as shown in Step 3.

Step 3

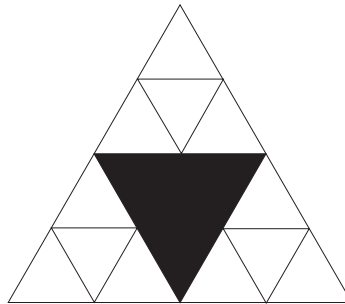

5. Shade each of the middle triangles as shown in Step 4.

Step 4

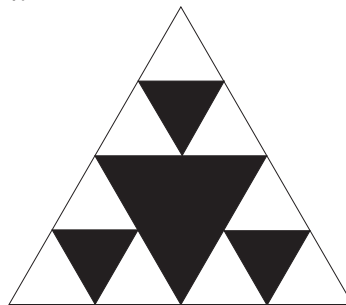

6. Continue this process three more times, until the midpoints measure 0.5 cm, shading the middle triangles each time, until the drawing appears similar to Step 5. You have made many different-size "habitats," simply by dividing the space over and over again. Theoretically, you could continue this process indefinitely to make an infinite number of habitats!

Step 5

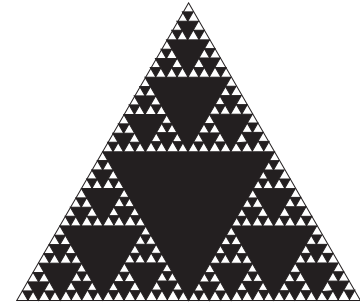

Want to Do More?

The Sierpinski Triangle is an example of fractals, which are geometric figures that have special properties and are often found in nature. For more information about fractals, visit math.rice.edu/~lanius/frac/.

This activity was adapted from "Architects of Seamount Ecosystems" by Mel Goodwin, PhD, Marine Biologist and Science Writer, Mt. Pleasant, SC.; from the Ocean Explorer 2004 Gulf of Alaska Seamount Expedition oceanexplorer.noaa.gov/explorations/04alaska/background/edu/media/goa04_form.pdf

Triangle Graph Paper

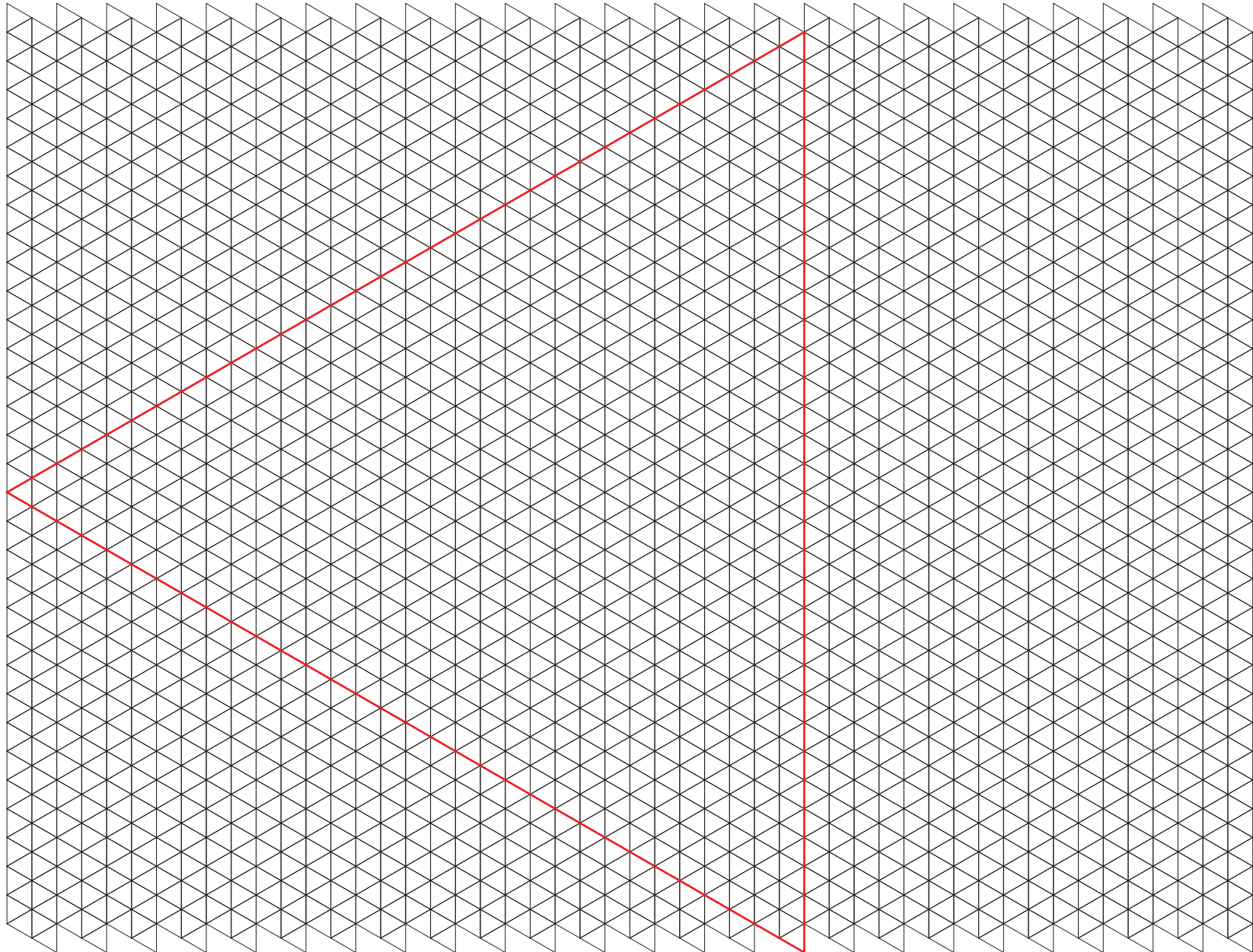

Fixing Our Earth



After four centuries as a major center of ocean commerce and naval power, the Elizabeth River is the most polluted waterway on the Chesapeake Bay for some cancer-causing chemicals. Courtesy Captain Albert E. Theberge, NOAA Corps (ret.)



Adobe Creek in Sonoma County, California was once alive with salmon and steelhead trout; but after years of pollution and neglect, state officials declared it "dead." Courtesy NOAA Restoration Center



Seagrasses provide food and habitat for different species of fish, lobster, wading birds, manatees and sea turtles. In Tampa Bay, more than 70 percent of seagrass meadows have been destroyed by pollution, coastal development, dredging, and boat propellers. Courtesy NOAA Restoration Center

What You Will Do

Get involved in a project to restore damaged natural resources

There are hundreds of stories about damage to coral reefs, rivers, fisheries and other resources caused by storms, oil spills, chemical pollution, and many other events.

So, is there anything we can do?

Yes! We can help restore habitats and save many species!

NOAA has worked with more than 2,500 groups throughout the U.S. to protect and restore marshes, wetland forests, oyster reefs, seagrass beds, beaches, and tidal streams that have been damaged by natural events and human activities. Restoration projects include:

- *Removing invasive species*
- *Repairing damaged habitats*
- *Cleaning up pollution*
- *Restoring natural ecosystem processes such as water flow*
- *Re-introducing native organisms*
- *Monitoring activities to evaluate long-term success*

Kids play a big part in many restoration projects!



Local middle and high school students grew more than 100,000 bushels of seed oysters that were used to successfully restore oyster reefs in the Elizabeth River, Portsmouth, VA. Courtesy NOAA Restoration Center



Students at Casa Grande High School built the only student run fish hatchery in the lower 48 states, removed trash from Adobe Creek, planted trees, so that Steelhead and Chinook salmon are once again spawning in the stream. Courtesy NOAA Restoration Center



Students in the Tampa Bay area grow marsh grasses and seagrasses, and assist with monitoring and planting to restore damaged habitats. Courtesy Tampa BayWatch

Here's how you can start helping to fix our Earth!

What You Will Need

- Good ideas
- Desire to make things better
- Willingness to get involved

Warning

Work on this project with an adult partner! Be sure you have permission and expert advice before starting any restoration activities.

How to Do It

1. Visit the Web sites listed on “NOAA’s Restoration Programs.” Read some of the case studies to get ideas about different kinds of restoration projects. Also, check out the “Volunteers” page at NOAA’s Restoration Portal www.habitat.noaa.gov/highlights/hlrestorehabitatsoutheast.html
2. Look over “Some Organizations Involved with Habitat Restoration Projects.” Check your local telephone directory to see if any of these organizations have an office nearby. If so, give them a call and ask about restoration projects in your area. If not, contact NOAA’s Fisheries Restoration Center (see the contact list at www.habitat.noaa.gov/restoration/connection/partnerships.html).
3. Talk to your parents, friends, teachers, and other groups about getting involved in a restoration project. Many successful restoration projects begin with one person who wants to make things better. Maybe you can be that person!

NOAA’s Restoration Programs

The Damage Assessment and Restoration Program focuses on events such as oil spills, release of toxic chemicals, or ships that run aground.

www.darrp.noaa.gov/

The Community-Based Restoration Program works with local partners to restore fishery habitats and encourage conservation of living marine resources. www.habitat.noaa.gov/restoration/programs/crp.html

The Office of Response and Restoration investigates natural resource damage, plans restoration projects, and helps local groups design monitoring plans to measure the success of restoration projects. response.restoration.noaa.gov/

Through the National Coastal Zone Management Program, NOAA partners with state coastal zone management programs to develop habitat restoration plans and carry out a variety of restoration projects. coast.noaa.gov/czm/

The National Estuarine Research Reserve System works with local and state partners as well as other NOAA offices and federal agencies carry out habitat restoration projects based on scientific observations and historical analysis of ecosystems. coast.noaa.gov/nerrs/

Some Organizations Involved with Habitat Restoration Projects

American Littoral Society
American Rivers
American Sportfishing Association
Chesapeake Bay Foundation
Coalition to Restore Coastal Louisiana
Connecticut River Watershed Council
Conservation Law Foundation
Ducks Unlimited
EarthCorps
Gulf of Maine Council on the Marine Environment
Gulf of Mexico Foundation
Institute for Fisheries Resources
Institute For Sustainable Forestry
National Fish and Wildlife Foundation
North Carolina Coastal Federation
Ocean Trust/National Fisheries Institute
Save the Bay (Narragansett Bay)
The Nature Conservancy
Tampa Bay Watch
Trout Unlimited

The Coral Reef Conservation Program provides funding and technical assistance to NOAA offices and partner groups to support restoration, monitoring, and research on the effectiveness of coral reef restoration methods. coralreef.noaa.gov/

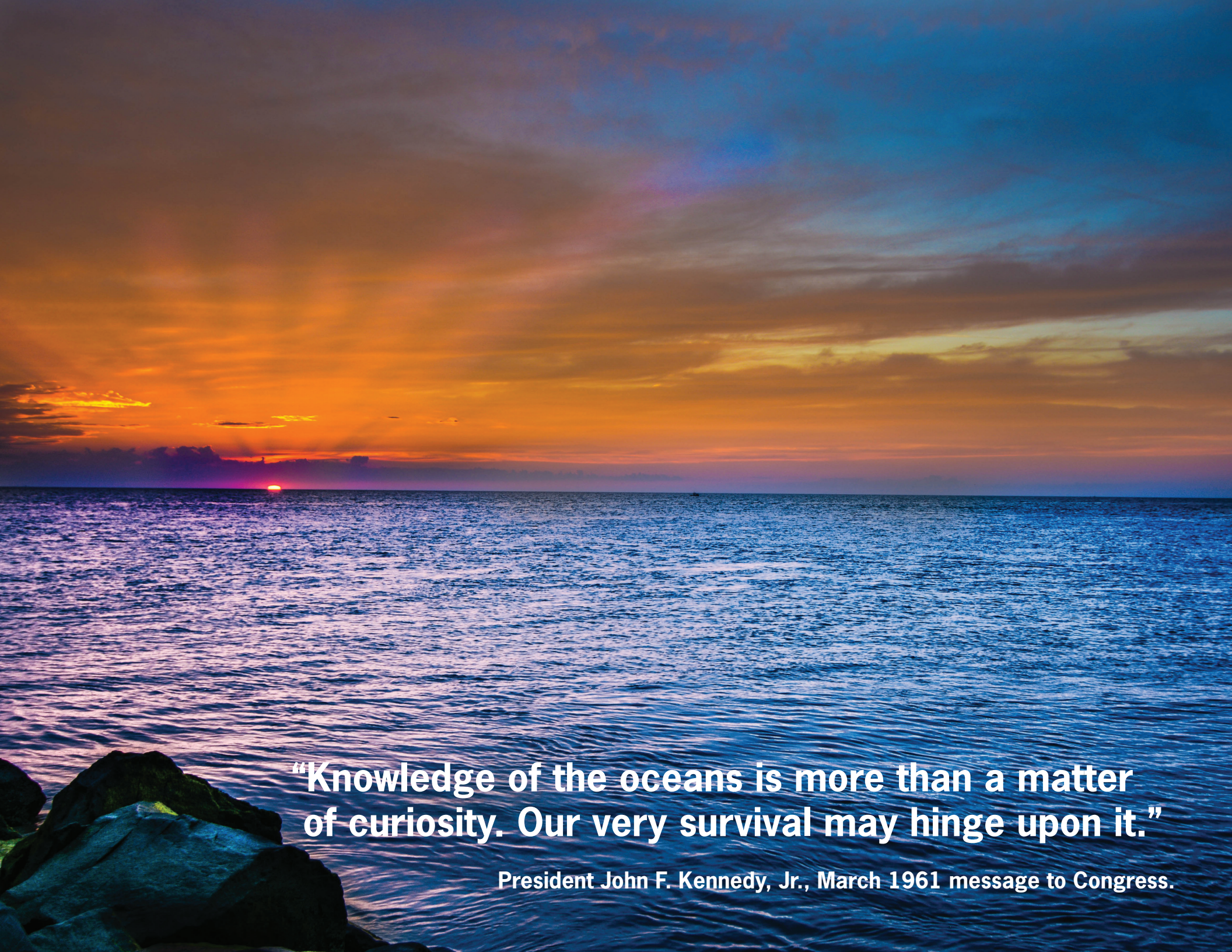
A photograph of a sunset over the ocean. The sun is a small red orb on the horizon, casting a glow of orange and yellow across the sky. The sky transitions from orange near the horizon to a deep blue at the top. The ocean is a deep blue with white-capped waves. In the bottom left corner, there are dark, jagged rocks.

“Knowledge of the oceans is more than a matter of curiosity. Our very survival may hinge upon it.”

President John F. Kennedy, Jr., March 1961 message to Congress.



United States Department of Commerce
National Oceanic and Atmospheric Administration (NOAA)
www.noaa.gov

NOAA's National Ocean Service
Communications and Education Division

Discover Your World with NOAA
<https://oceanservice.noaa.gov/education/discoveryourworld>