



ALASKA RAILROAD CORPORATION
327 W. Ship Creek Ave.
Anchorage, AK 99501

April 5, 2019

INVITATION TO BID #19-11-207154

WASILLA SHOPS HVAC UPGRADES

Cover Sheet

Response Required: This page must be completed and returned ensuring receipt of future addenda or additional information. Please e-mail this form to Goemerg@akrr.com. All addenda will be forwarded to the contact name and number listed below.

Firms that have not returned the cover sheet will not be informed of addendums and will only be alerted to addendums by checking with the ARRC procurement officer or by checking ARRC's internet site: www.alaskarailroad.com , select Corporate, Procurement and then Solicitations. Bidders must acknowledge the receipt of all issued addendums in their proposal/bid submittal.

Company _____

Address _____

Contact _____

Phone _____ Fax _____

Email _____

The Alaska Railroad Corporation web site www.alaskarailroad.com



ALASKA RAILROAD CORPORATION
327 W. Ship Creek Avenue
Anchorage, AK 99501

April 5, 2019

INVITATION TO BID NUMBER 19-11-207154

SEALED BIDS WILL BE RECEIVED AT:

**Alaska Railroad Corporation
327 W. Ship Creek Avenue
Anchorage, Alaska 99501**

UNTIL 3:00 P.M. LOCAL TIME ON May 1, 2019
AT WHICH TIME BIDS WILL BE PUBLICLY OPENED

Wasilla Shops HVAC Upgrades

Pre-Bid Conference: A pre-bid conference will be held **at 3:00 P.M.** local time on April 18th. Interested bidders will meet at the job site located @ 1400 Wasilla Shops Circle Wasilla, AK. PPE will be required at the site.

The Alaska Railroad Corporation ("ARRC") is soliciting bids from interested parties for the aforementioned project. Bids must be submitted on the bid form contained herein and must be mailed or delivered to the above address. Bids received via facsimile transmission will be considered non-responsive. The bid shall be in a sealed envelope with the bid number 19-11-207154 clearly printed on the face of the envelope. Bids must be complete and in U.S. dollars. See instructions and conditions enclosed herein.

An Alaska Business license is not a prerequisite to bid. Bidders who possess an Alaska Business license and also meet the other criteria of an Alaska Bidder shall receive a preference per the "Alaska bidder preference".

ARRC reserves the right to reject any and all bids, or any part thereof, negotiate changes in bids, accept any bids or any part thereof, waive minor informalities or defects in any bids, and not to award the proposed contract if it is in the best interest of the ARRC.

ARRC shall not be held responsible for bidder's lack of understanding of what is required by this bid. Should a bidder not understand any aspect of this bid, or require further explanation, or clarification regarding the intent or requirements of this bid, it shall be the responsibility of the bidder to seek guidance from the ARRC.

ARRC may award a contract resulting from this solicitation to the responsive offeror whose offer conforming to this solicitation will be the most advantageous to the ARRC. ARRC may reject any or all offers if such action is in the best interest of ARRC, and waives informalities and minor irregularities in offers received. Any resulting contract from this solicitation shall incorporate the

Standard Instructions, and General Terms and Conditions incorporated in this solicitation.

This solicitation is not to be construed as a commitment of any kind nor does it commit the ARRC to pay for any costs incurred in the submission of an offer or for any other incurred cost prior to the execution of a formal contract.

BIDDER/VENDOR TERMS AND CONDITIONS: PROSPECTIVE BIDDERS ARE CAUTIONED TO PAY PARTICULAR ATTENTION TO THIS CLAUSE. Bidder/contractor imposed terms and conditions which conflict with this Invitation to Bid terms and conditions are considered counter offers and, as such, will cause the Alaska Railroad Corporation to consider the bid non-responsive.

If a bidder attaches additional terms and conditions as part of the bid, such attachments must be accompanied by a disclaimer stating that in the event of conflict between the terms and conditions of this Invitation to Bid and the terms and conditions of the bidder/contractor, the terms and conditions of the Invitation to Bid will prevail.

ARRC Disadvantaged Business Enterprise (DBE) Program: ARRC is an equal opportunity corporation that encourages the participation of DBEs as prime contractors and subcontractors on its contracts funded in whole or in part by the Federal Transit Administration (FTA) or the Federal Highway Administration (FHWA). The ARRC has a race neutral DBE Program and does not set DBE goals on individual solicitations. Nonetheless, the ARRC aspires to achieve an overall DBE participation of *3.0% in federal fiscal years 2019-2021* on contracts funded by agencies within the U.S. Department of Transportation. If this contract is funded in whole or in part by funds from the FTA or the FHWA, it is imperative that you consult the Federal Terms and Conditions portion of this solicitation.



The Alaska Railroad is a member of Green Star (<http://www.greenstarinc.org/>). ARRC earned an initial Green Star Award in 1994 and a Green Star Air Quality Award in 2007. The Alaska Railroad considers Green Star membership to be a positive business attribute, and regards a Green Star award as a tangible sign of an organization's commitment to environmental stewardship and continual improvement within its operations.

Please direct all responses and/or questions concerning this invitation to bid to Greg Goemer, Alaska Railroad Corporation, 327 W. Ship Creek Avenue, Anchorage, AK 99501, telephone number 907-265-2593, email address goemerg@akrr.com. Questions must be submitted in written form prior to April 15th. Questions submitted after that date will not be accepted.

Sincerely,

Greg Goemer
Sr. Contract Administrator
Alaska Railroad Corporation

INDEX

APPENDIX A	REQUIRED DOCUMENTS
APPENDIX B	SCOPE OF WORK
APPENDIX C	BIDDERS INSTRUCTIONS
APPENDIX G	FORMS CONSTRUCTION BID FORM [FORM 395-0121] BID BOND [FORM 395-0120] BIDDERS QUESTIONNAIRE [FORM 395-0136] SUBCONTRACTORS LIST [FORM 395-0131] SAMPLE CONSTRUCTION CONTRACT [FORM 395-0122] PAYMENT BOND [FORM 395-0126] PERFORMANCE BOND [FORM 395-0127]
APPENDIX E	GENERAL CONDITIONS CONSTRUCTION (1/08/16)
APPENDIX F	CONSTRUCTION QUALITY CONTROL (CQC) PLAN
APPENDIX D	COST SCHEDULE

ATTACHMENTS:

1. Project Plan Set
2. Pamphlet 600 – Issue 37, Effective September 1, 2018

APPENDIX A

REQUIRED DOCUMENTS

REQUIRED FOR BID Bids will not be considered if the following documents are not completely filled out and submitted at the time of bidding:

1. Construction Bid Form - [Form 395-0121]
2. Bid Bond - [Form 395-0120]
3. Cost Schedule - Appendix D
4. Questionnaire - [Form 395-0136]

REQUIRED AFTER NOTICE OF APPARENT LOW BIDDER The apparent low bidder is required to complete and submit the following documents within after receipt of written notification:

1. Subcontractor List - [Form 395-0131]
2. Contractor's QA/QC Plan
3. Contractor's Site Health & Safety Plan

REQUIRED FOR AWARD In order to be awarded the contract, the successful bidder must completely fill out and submit the following documents within the time specified in the intent to award letter:

1. Certificate of Insurance - [from Insurance Carrier]
2. Payment Bond - [Form 395-0126]
3. Performance Bond - [Form 395-0127]
4. Alaska Contractors and Business Licenses
5. State of Alaska Department of Labor - Notice of Work
6. Contract - [Form 395-0122] and Notice to Proceed, ARRC Generated

POST AWARD DOCUMENTATION

1. Weekly Certified Payrolls
2. State of Alaska, DOL Notice of Completion

APPENDIX B
SCOPE OF WORK

Scope of Work: Wasilla Shops HVAC Upgrades:

Installation of heating and ventilation systems at All Seasons Clothing and ARRC Shop located 1400 Wasilla Shops Circle in Wasilla, Alaska.

Work shall be as shown on 'All Seasons Clothing Company Retail Ventilation' plans by MBA Consulting Engineers dated 1/11/19. This project includes mechanical, electrical, roofing and other trades.

This project includes work in the railroad section of the building where PPE is required. The project includes work in office areas, storage areas and in the retail store, the work will need to be scheduled to minimize the disruption of operations in the building.

All work will require two weeks' notice and the contractor will review the schedules with the occupants/users of the space being impacted.

Final Completion is required by 11/1/2019

APPENDIX C

BIDDERS INSTRUCTIONS

BIDDERS INSTRUCTIONS & SPECIAL REQUIREMENTS (CONSTRUCTION)

To be considered for award, Bids must be made in accordance with the following requirements:

Duty to Seek Clarification: ARRC shall not be held responsible for a Bidder's lack of understanding of what is required by the Invitation to Bid. Should a Bidder not understand any aspect of the Invitation to Bid, or require further explanation or clarification regarding the intent or requirements of the same, it shall be the responsibility of the Bidder to seek clarification from ARRC prior to submitting his or her Bid.

Terms and Conditions: Any resulting contract from this Invitation to Bid shall incorporate the general terms and conditions contained in this bid package.

Contract Documents: Bidders shall familiarize themselves with the requirements of all of the Contract Documents which include, but are not limited to the "Bidders Instructions & Special Requirements", the Invitation to Bid, Bid and Contract Forms, General Conditions, Special Conditions, Specifications, Drawings, any Addenda issued prior to the receipt of Bids, and any other documents referenced or incorporated therein.

Examination of Site: Bidders should visit the Project Site(s) and take such other steps as may be reasonably necessary to ascertain the nature and location of the Work, and the general and local conditions which may affect the Work and the cost thereof.

Examination and Interpretation of Documents: Each Bidder shall examine the Contract Documents carefully and shall make written requests to ARRC prior to Bid submission for interpretation or correction of any ambiguity, inconsistency, discrepancy, omission, or error therein which the bidder may discover. Any interpretation or correction will be issued in an Addendum by ARRC. Only a written interpretation or correction shall be binding. No Bidder shall rely on any interpretation or correction given by any other method.

Addenda: ARRC may modify the Invitation to Bid prior to the date fixed for opening of Bids by issuance of an Addendum to all parties who have been furnished the Bid Package for bidding purposes. Bidders must acknowledge receipt of all Addenda on the Construction Bid Form [Form 395-0121].

Qualification of Bidders: Pursuant to ARRC Procurement Rule 1600.3, before a Bid is considered for award, ARRC may request a Bidder to submit information regarding the Bidder's capability in all respects to fully perform the contract requirements or the individual integrity and reliability which will assure good faith performance. Such information shall include the Bidder's prior experience in performing comparable Work, the availability of necessary financing, equipment, facilities, expertise and personnel to perform the Work and whether he or she has ever been terminated or defaulted on construction work.

Bid Forms: Bids must be submitted on the forms provided by ARRC, completed in all respects as required by the Bid Forms and other Contract Documents and manually signed by an authorized official of the Bidder. Bidders may make copies of the Bid Forms for submission of Bids.

Submission of Bids: Bids must be sealed, marked, and addressed as directed in the Invitation to Bid and must be delivered to the office designated in the Invitation to Bid prior to the exact time set for opening bids. Late bids will not be considered.

Modification, Correction, Withdrawal of Bids: Modification, correction or withdrawal of Bids will be allowed only as provided in ARRC Procurement Rule 1200.8.

Bid Opening: Bids will be opened in public at the time set forth in the Invitation to Bid in accordance with ARRC Procurement Rule 1200.6. The contents of the Bids will be open for public inspection after the notice of intent to award a contract is given.

Evaluation of Bids: Bids will be evaluated in accordance with the provisions of ARRC Procurement Rule 1200.7. Alternative bids, if called for, are intended to provide ARRC a range of comparative costs which will allow identification of the combinations most responsive to ARRC's need. The order in which the alternatives are listed or set out in the Invitation to Bid should not be taken as any indication as to the order in which ARRC may elect to select the alternatives, if any. Bidders shall submit bid prices for all alternatives stated in the Invitation to Bid and are advised that the order in which the alternatives, if any, are chosen by ARRC, may affect which Bidder is the lowest responsive and responsible Bidder.

Bid Security: In accordance with ARRC Procurement Rule 1200.4, all Bids shall be accompanied by bid security in the form of a cashier's check or an acceptable Bid Bond, a form of which is provided herein, in the amount of five percent (5%) of the Bid price.

Rejection of Bids: ARRC reserves the right to waive minor defects or informalities in a Bid in accordance with the provisions of ARRC Procurement Rule 1200.8, or to reject any or all Bids in accordance with the provisions of ARRC Procurement Rule 1600.2.

Award of Contract: Unless the solicitation is canceled or all bids are rejected, the procurement officer shall award a contract based on the solicited bids with reasonable promptness by written notice to the lowest, responsible and responsive Bidder whose bid conforms in all material respects to the requirements and criteria set out in the Invitation to Bid.

Execution of Contract: A written contract must be signed by the Bidder to whom an award is made and returned to ARRC within ten (10) calendar days, together with all required performance and payment bonds, and certificate(s) of insurance in the amounts required by the Invitation to Bid. The Bidder to whom award is made shall not be permitted to occupy the project site until he has first obtained the required insurance and submitted to ARRC proof of such insurance together with a statement certifying that said insurance conforms to requirements set forth in the Invitation to Bid.

Failure to Execute Contract: If the Bidder to whom the Contract is awarded refuses or neglects to execute it, or fails to furnish the required bonds and insurance within the time specified, the amount of his bid security may be retained by ARRC as liquidated damages.

Government Contract Requirements: If Federal funds will be used to pay for any part of the project described in the Invitation to Bid, any contract awarded hereunder will contain provisions requiring the successful Bidder to comply with all pertinent provisions, agreements, and clauses of the subject federal grant and all pertinent laws, regulations, Presidential directives, and executive orders to the extent they apply to the subject matter of the contract.

Drug and Alcohol-Free Workplace: Safety is paramount at ARRC. For that reason, ARRC maintains an alcohol and drug-free workplace and requires that the Contractor do the same. At all times during the performance of this contract, the Contractor shall have in place a written drug and alcohol program that includes, at a minimum, the following:

- a. a requirement that all applicants present a negative pre-employment drug screen prior to being hired by the Contractor;
- b. a requirement that employees submit to a "reasonable suspicion" drug and/or alcohol test when showing signs and symptoms of drug and/or alcohol influence on duty;
- c. a requirement that employees submit to "reasonable cause/post accident" drug and alcohol tests following certain accidents or incidents (with the threshold level triggering testing to be determined by the Contractor);
- d. a provision defining a positive alcohol test as one that reveals a breath alcohol level of .02 or greater;
- e. a provision defining a positive drug test as one that reveals concentrations at the levels set forth in 49 C.F.R. § 40.87(b)(screening test) and 49 C.F.R. § 40.87(c)(confirmatory test) or greater;
- f. a provision that outlines the consequences of a positive drug or alcohol test and the consequences of an employee's refusal to submit to drug/alcohol testing; and
- g. a provision that establishes the conditions under which an employee may return to work following a positive drug and/or alcohol test, which at a minimum include an evaluation by a substance abuse professional and compliance with a recommended treatment program.

The Contractor agrees that at any time during the performance of this contract, if an ARRC employee reports to the Contractor that an employee of the Contractor or its subcontractor is showing signs and symptoms of drug/alcohol influence on duty, the Contractor shall remove the employee from ARRC property immediately and shall have the employee tested for drug/alcohol influence. If the employee tests positive, the Contractor shall ensure that the employee is not returned to work on the project until he/she has met the return to work requirements contained in the Contractor's written program.

Offer Acceptance Period: For the purpose of award, offers made in accordance with this

ITB shall be good and firm for a period of thirty (30) days from the date of bid opening.

Site-Safety Plan Requirement: Before the contractor or any subcontractor begins any construction related work under this contract including but not limited to mobilization, equipment setup, storage, etc., taking place on sites under Alaska Railroad Corporation (ARRC) control, they will submit a site Health and Safety Plan to ARRC for compatibility acceptance.

The plan must be compatible with ARRC Safety Policies, including On-Track Safety, ARRC on-site employee safety including safety for Project Managers, Construction Managers, Flaggers, Visitors, Safety personnel, Quality Assurance staff, vendors, and the public. The plan must outline procedures for first aid, emergency response, chemical exposures, spills, site sign-in requirements for site-safety briefings, coordination with ARRC dispatch, Section 6.16 (SAFETY AND PROTECTION), Section 6.17 (WORK SAFETY ON RAILROAD PROPERTY), and Section 6.18 (EMERGENCIES), other sections of the contract GENERAL CONDITIONS.

A complete, detailed Site-Safety Plan shall be submitted to the Project Manager at least 5 days prior to commencement of any Work on the Project

ALASKA BIDDER'S PREFERENCE

Preferences shall be applied to bids that qualify for an Alaska Bidder's Preference. An Alaska bidder preference is five percent (5%). "Alaska Bidder" means a person who:

1. holds a current Alaska business license;
2. submits a bid for goods, services, or construction under the name as it appears on the person's current Alaska business license;
3. has maintained a place of business within the State of Alaska staffed by bidder or an employee of the bidder for a period of six (6) months immediately preceding the date of this bid;
4. is incorporated or qualified to do business within the State of Alaska; is a sole proprietorship, and the proprietor is a resident of the State of Alaska; or is a partnership and all partners are residents of the State of Alaska;
5. is a joint venture, composed entirely of ventures that qualify under (1) through (4) of this subsection.

Contractor's Instructions for Submitting Certified Payroll

To ensure that the federal requirement for the weekly submission of certified payrolls with social security numbers is met, the following instructions will be given to the prime contractor by listing them in the contract as follows:

This contract may include work on an Alaska Railroad Corporation (ARRC) construction project, which is subject to the wage/certified payroll requirements of the Alaska Department of Labor Workforce Development (DOLWD) and/or it may include work on a federally funded construction project and be subject to U. S. Department of Labor Davis-Bacon Act wage/certified payroll requirements.

As part of the contract the following will be required:

1. All contractors on a construction project funded in whole or in part with federal funds shall pay laborers and mechanics the higher of the two wages listed in this contract from the U. S. Department of Labor (www.access.gpo.gov/davisbacon/ or <http://www.gpo.gov/davisbacon/ak.html>) or from the DOLWD (www.labor.state.ak.us/lss/home.htm). Contractors on an ARRC-funded construction project shall pay laborers and mechanics the appropriate wage established by the DOLWD under the Little Davis Bacon Act.
2. All contractors employing laborers and mechanics on the project for must submit weekly certified payrolls that contain the information listed on the DOLWD Weekly Certified Payroll Form 07-6058, pages 1 and 2. Page 2 is the "Statement of Compliance" and must bear an original signature. The prime contractor is responsible for gathering the certified payrolls from each subcontractor and for submitting them, along with their own, to ARRC.
3. These weekly certified payrolls must be sent to ARRC within seven days after the regular "payday" for that certified payroll at the following address:

The Alaska Railroad Corporation
Attn: Certified Payroll
P.O. Box 107500
Anchorage, AK 99510-7500
CertifiedPayrollProcessor@akrr.com

The contractor and its subcontractors are also responsible for filing certified payrolls with DOLWD as required.

4. The certified payroll must be completely filled out by the contractor including, but not limited to:
 - i. **Contractor's complete name**, including joint ventures, Inc., LLC., etc.
 - ii. **Contractor's license number**, also called the contractor's registration number, is required in addition to a business license to do construction work in the state

iii. **Employee's**

- a. Name
 - b. Address (domicile and mailing)
 - c. Social security number
 - d. Job classification
 - e. Hours worked
 - f. Wages/fringe benefits paid
- iv. **Contracting agency project number**, which is the ARRC contract/purchase order number and is listed on the DOLWD finalized Notice of Work. This notice also lists the **DOLWD project number, project name, and location**. The prime contractor will supply all of this information to its subcontractors.
- v. **Week ending date and payroll numbers**. The first week or part of a week of payroll will be designated as payroll number 1 for the first week, 2 for the second week, etc. until the final week worked on the project. If no work is completed during a given week, the contractor must nonetheless submit a certified payroll for that week, with the appropriate consecutive payroll number for that week, and write "No Work Performed" on payroll.
- vi. The **Statement of Compliance** must be completely filled out indicating how fringe benefits are paid and listing the payroll period. The Statement of Compliance must be signed, dated, and filed within seven days of the payment date of the payroll.
- vii. **Stamp or write "Confidential"** on the certified payroll to help insure the privacy of contractor employees.

Owner/operators working on the project as mechanics or laborers, either as prime or subcontractor, must file certified payrolls and record all information including the hourly wage, fringe benefits, hours worked, overtime, et cetera, however they can defer the weekly payment and write over the total deductions and net pay boxes "owner/operator."

Sample copies of DOLWD certified payroll forms with the "Statement of Compliance" are shown in Figures 1 and 2 below.

Failure to timely submit complete and accurately filled out weekly certified payrolls to ARRC may result in the delay of payment on the contract.

Appendix A-1: State of Alaska Certified Payroll Form, 07-6058



CERTIFIED PAYROLL

Alaska Department of Labor & Workforce Development
Labor Standards & Safety Division
Wage & Hour Administration

Contractor Name _____ X _____ Contractor SubContractor _____ Address _____

Contractor License No. 28888
907-555-1212
Name, SSN, Permanent Domicile Address (NO P.O. BOX or RURAL ROUTES ACCEPTED) and Mailing Address (if different) for each employee
Social Security numbers (SSN) MUST be included for all employees
Joe H. Worker, SSN: 555-55-5555
316 Timber Lake Road
Anchorage, AK 99515

Contracting Agency Project # 38914 Dept. Labor Project # 04/12-15/00
Week Ending 18-Dec-04
Payroll No. I
Union Membership? N/A
Apprentice (% if Applicable)
Specific Work Class Code including certificate #'s for Electronics, Plumbers, Painters, Powderman, Asbestos Workers. Truck drivers include truck license number

Contract Amount \$50,000.00 Date Work Started 12-Dec-04 Est. Completion Date October-05
Project Name and Location Gold Creek Bridge Repair

Total Hours Worked	Hourly Rate Paid	Gross Amount Earned	DEDUCTIONS				Total Deductions	Net Amount Paid	Check No. Issued
			FICA	FED WHT AXI	ESD	UNION DUES			
1.50	42.15	63.23							
32.00	28.10	899.20							
41.5	12.75	427.13	106.29	259.21		365.50	1024.06	#678 11/04/04	

"Confidential"

Appendix A-2: State of Alaska Certified Payroll Form, 07-0658, page 2

STATEMENT OF COMPLIANCE

CERTIFIED PAYROLL FORM 07-6058

Contractors & Subcontractors Please Note!!!

SSN MUST be listed for each employee on payroll

8 AAC 30.020 CERTIFIED PAYROLL. (a) All Contractors (including owner/operators) who perform work on a public construction contract for the state or political subdivision of the state shall file with the Department a certified payroll (Form 07-6058) before Friday of each week that covers the preceding week.

(b) The certified payroll shall be submitted to the Department's regional office in which the work is performed.

Region I North of N63°	Region II, South of N63°	Region IIA, Southeast Alaska, (From Yakutat south)
Labor Standards & Safety Div, DOLWD 675 7th Ave., Station J-1 Fairbanks, AK 99701-4593 (907) 451-2886 Fax: (907) 451-2885	Labor Standards & Safety Div, DOLWD 3301 Eagle Street, Suite 301 Anchorage, AK 99503-4149 (907) 269-4900 Fax: (907) 269-4915	Labor Standards & Safety, DOLWD P. O. Box 21149 1111 W. 8th Street, Rm 302 Juneau, AK 99801 (907) 465-4842 Fax: (907) 465-3584

In lieu of submitting Form 07-6058, contractors may submit his/her payroll form. THE FORM MUST CONTAIN SOCIAL SECURITY NUMBERS FOR EACH EMPLOYEE.

The contractor's payroll record must contain the same information required on this form.

Sec. 35.05.040 requires that all contractors or subcontractors who perform work on a public construction contract for the state or a political subdivision of the state shall, **BEFORE FRIDAY OF EACH WEEK**, file with the Department of Labor and Workforce Development (DOLWD), a sworn affidavit for the previous week, setting out in detail the number of workers employed, wages paid each week, job classification of each employee, hours worked each day and week, and other information which the DOLWD requires.

CONTRACTORS WHO DISREGARD THEIR OBLIGATIONS TO THEIR EMPLOYEES, INCLUDING PAYMENT OF THE APPROPRIATE PREVAILING RATES OF PAY, UNCONDITIONAL PAYMENT, AND PAYMENT NOT LESS THAN ONCE A WEEK MAY BE DEBARRED FROM PUBLIC CONSTRUCTION.

Date: 22-Dec-04

(2) That Alaska Strong Steel, Inc.

(Contractor / Subcontractor)

I, Jane Doe, President do hereby state
(Name of Signatory Party) (Title)

(1) That I pay or supervise the payment of persons employed by
Alaska Strong Steel, Inc. on the

(Contractor / Subcontractor)

Gold Creek Bridge Project; that during the payroll

(Building or Work)

period commencing on 12-Dec-04, and ending on
(date)

18-Dec-04, all persons employed on said project have
(date)

been paid full weekly wages earned, that no rebates have been or will be made either directly or indirectly to or on behalf of said

Alaska Strong Steel, Inc.

(Contractor / Subcontractor)

from the full weekly wages earned by an person, and that no deductions have been made either directly or indirectly from the full wages earned by any person, other than permissible deductions, on projects covered by Alaska Statute 36 as defined in regulations issued by the Commissioner of Labor; or on Federal Projects as defined in Regulations, Part 3 (29 CFR Subtitle A), issued by the Secretary of Labor under the Copeland Act, as amended (48 Stat. 948; 63 Stat. 108; 72 Stat. 967; 76 Stat. 357; 40 USC 276 (c), and described below:

and;

is in full compliance with the provisions set forth in AS 36.10, which requires employment preference for Alaska residents as outlined in AS 36.95.010; and

(3) That any payrolls otherwise under this contract required to be submitted for the above period are correct and complete; that the wage rates for laborers, mechanics or field surveyors contained herein are not less than the current applicable wage rates established by the DOLWD; that the classification set forth therein for each laborer, mechanic or field surveyor conforms with the work performed; and

(4) That any apprentices employed in the above period are duly registered in a bona fide apprenticeship program registered with the State apprenticeship agency recognized by the Bureau of Apprenticeship and Training, United States Department of Labor, or if no such agency exists in the State, are registered with the Bureau of Apprenticeship and Training, United States Department of Labor; or

(5) That I am a bona fide owner/operator and that my contract amount meets or exceeds the prevailing wage for each hour I have worked. My last progress payment was received on

For _____

(6) That where fringe benefits are paid to approved plans, funds or programs: (check all applicable items)

(a) In addition to the basic hourly wage rates paid to each laborer, mechanic or field surveyor listed on this payroll, payments of fringe benefits as currently published by DOLWD

have been or will be made to a union trust.

(b) In addition to the basic hourly wage rates paid to each laborer, mechanic or field surveyor listed on this payroll, payments of fringe benefits as currently published by DOLWD have been or will be made to the appropriate programs for the benefit of such workers, except as noted in Section 6(d) below. Fringe benefit payments will be made at least quarterly to an approved plan. The name of the plan is:

(c) Each laborer, mechanic or field surveyor listed on this payroll has been paid, as indicated on the payroll, an amount not less than the sum of the applicable basic hourly wage rate plus the amount of the required fringe benefits as currently published by DOLWD, except as noted in Section 6(d).

(d) Exceptions:

Exception (Craft)	Explanation

Remarks:

The willful falsification of any of the above information may subject the contractor or subcontractor to civil or criminal prosecution. See Section 1001 of Title 18 and Section 231 of the United States Code. Also see AS 36.05.060.

Jane Doe

Signature (original signature required)

Jane Doe, President

Name & Title (print or type)

APPENDIX D

FORMS

**ALASKA RAILROAD CORPORATION
CONSTRUCTION BID FORM of**

NAME _____

ADDRESS _____

To the CONTRACTING OFFICER, ALASKA RAILROAD CORPORATION:

In compliance with your Invitation for Bids No. _____, dated _____, the Undersigned proposes to furnish and deliver all the materials and do all the work and labor required in the construction of _____ Located at or near _____, according to the plans and specifications and for the amount and prices named herein as indicated on the Cost Schedule, which is made a part of this Bid.

The Undersigned declares that he/she has carefully examined the contract requirements and that he/she has made a personal examination of the site of the work; that he/she understands that the quantities, where such are specified in the Cost Schedule or on the plans for this Project, are approximate only and subject to increase or decrease, and that he/she is willing to perform increased or decreased quantities of work at unit prices bid under the conditions set forth in the Contract Documents.

The Undersigned hereby agrees to execute the said contract and bonds within **Ten (10) Calendar Days**, or such further time as may be allowed in writing by the Contracting Officer, after receiving notification of the acceptance of this Bid, and it is hereby mutually understood and agreed that in case the Undersigned does not, the accompanying bid guarantee shall be forfeited to the Alaska Railroad Corporation as liquidated damages, and said Contracting Officer may proceed to award the contract to others.

The Undersigned agrees to commence the work within **Ten (10) Calendar Days** after the effective date of the Notice to Proceed and to complete the work by _____, unless extended in writing by the Contracting Officer.

The Undersigned proposes to furnish a Payment Bond in the amount of One Hundred Percent (100%) and a Performance Bond in the amount of One Hundred Percent (100%) (of the contract), as surety conditioned for the full, complete and faithful performance of this contract.

The Undersigned acknowledges receipt of the following addenda to the drawings and/or specifications (give number and date of each).

Addenda No.	Date Issued	Addenda No.	Date Issued	Addenda No.	Date Issued
-------------	-------------	-------------	-------------	-------------	-------------

_____	_____	_____	_____	_____	_____
_____	_____	_____	_____	_____	_____
_____	_____	_____	_____	_____	_____
_____	_____	_____	_____	_____	_____

NON-COLLUSION AFFIDAVIT

The Undersigned declares, under penalty of perjury under the laws of the United States, that neither he/she nor the firm, association, or corporation of which he/she is a member, has, either directly or indirectly, entered into any agreement, participated in any collusion, or otherwise taken any action in restraint of free competitive bidding in connection with this Bid.

The Undersigned has read the foregoing proposal and hereby agrees to the conditions stated therein by affixing his/her signature below:

Signature

Name and Title of Person Signing

Telephone Number

Facsimile Number

**ALASKA RAILROAD CORPORATION
BID BOND**

		DATE BOND EXECUTED	
PRINCIPAL (Legal name and business address)		TYPE OF ORGANIZATION	
		<input type="checkbox"/> INDIVIDUAL <input type="checkbox"/> PARTNERSHIP <input type="checkbox"/> JOINT VENTURE <input type="checkbox"/> CORPORATION	
		STATE OF INCORPORATION	
SURETY(IES) (Name and business address)			
PENAL SUM OF BOND		DATE OF BID	
<p>We, the PRINCIPAL and SURETY above named, are held and firmly bound to the Alaska Railroad Corporation (ARRC), in the penal sum of the amount stated above, for the payment of which sum will be made, we bind ourselves and our legal representatives and successors, jointly and severally, by this instrument.</p> <p>THE CONDITION OF THE FOREGOING OBLIGATION is that the Principal has submitted the accompanying bid or proposal in writing, date as shown above, on the following project: , in accordance with contract documents filed in the office of the Contracting Officer, and under the Invitation for Bids therefore, and is required to furnish a bond in the amount stated above.</p> <p>If the Principal's bid is accepted and he/she is offered the proposed contract for award, and if Principal fails to enter into the contract, then the obligation to ARRC created by this bond shall be in full force and effect.</p> <p>If the Principal enters into the contract, then the foregoing obligation is null and void.</p>			

PRINCIPAL				
Signature(s)				Corporate Seal
Name(s) & Titles [Typed]				
CORPORATE SURETY(IES)				
	Name of Corporation		State of Incorporation	Liability Limit
	Signature(s)	1.	2.	Corporate Seal
	Name(s) & Titles [Typed]	1.	2.	

CORPORATE SURETY(IES)				
S U R E T Y B	Name of Corporation		State of Incorporation	Liability Limit \$
	Signature(s)	1.	2.	Corporate Seal
	Name(s) & Titles [Typed]	1.	2.	

CORPORATE SURETY(IES)				
S U R E T Y C	Name of Corporation		State of Incorporation	Liability Limit \$
	Signature(s)	1.	2.	Corporate Seal
	Name(s) & Titles [Typed]	1.	2.	

INSTRUCTIONS

1. This form shall be used whenever a bid bond is submitted.
 2. Insert the full legal name and business address of the Principal in the space designated. If the Principal is a partnership or joint venture, the names of all principal parties must be included (e.g., "Smith Construction, Inc. and Jones Contracting, Inc. dba Smith/Jones Builders, a Joint Venture"). If the Principal is a corporation, the name of the state in which incorporated shall be inserted in the space provided.
 3. Insert the full legal name and business address of the Surety in the space designated. The Surety on the bond may be any corporation or partnership authorized to do business in Alaska as an insurer under AS 21.09. Individual sureties will not be accepted.
 4. The penal amount of the bond may be shown either as an amount (in words and figures) or as a percent of the contract bid price (a not-to-exceed amount may be included).
 5. The scheduled bid opening date shall be entered in the space marked Date of Bid.
 6. The bond shall be executed by authorized representatives of the Principal and Surety. Corporations executing the bond shall also affix their corporate seal.
 7. Any person signing in a representative capacity (e.g., an attorney-in-fact) must furnish evidence of authority if that representative is not a member of the firm, partnership, or joint venture, or an officer of the corporation involved.
 8. The states of incorporation and the limits of liability of each surety shall be indicated in the spaces provided.
1. The date that bond is executed must not be later than the bid opening date.

Form 395-0120

QUESTIONNAIRE
(Revised 1-31-06)

Note: Failure to provide the information requested in this questionnaire may be cause for rejection of your bid or offer on the grounds of nonresponsiveness and/or nonresponsibility.

Project _____

Name of Your Business: _____

Street Address: _____

Mailing Address if Different: _____

City: _____ State: _____ Mailing Zip: _____

Telephone: _____ Fax: _____ E-Mail: _____

Date Firm Established: _____

1 How many years has the business been under the above name? _____

Previous business name(s)if any: _____

2 Federal Tax ID Number: _____

2.1 Business License Number: _____

Contractor License Number (For Construction: _____

Bid Acceptance Period _____ Days. (Bids providing less than thirty-day (30) calendar days for acceptance may be considered nonresponsive and may be rejected.)

Discount for prompt pay _____% _____ days.

The bidder shall list any variations from or exceptions to the Terms, Conditions or Specifications of the Solicitation

Continued on the next page

List the three most recent contracts performed by your company where the commodity or service requested in this solicitation was the primary commodity or service supplied. Include the client's name, contract amount, contract date, person to contact regarding performance, their telephone, facsimile number and e-mail.

Clients name, Contact person, Contact info. Description of Work and Contract Amount
(telephone, fax, and email)

<u>List any other business related experience:</u>	

Are you acting as a broker or the primary supplier in this transaction?

- Broker
 Primary Supplier

Business Information (Please check all that apply):

- The business is Individual
 The business is a Partnership
 The business is a Non-Profit
 The business is a Joint-Venture
 The business is a Corporation incorporated under the laws of the State of _____
 The business is full-time
 The business is part-time
 The business is not a certified Disadvantaged Business (DBE)
 Business is a certified DBE
 DBE was certified by State DOTPF
 DBE was certified by the Municipality of Anchorage
 Business is an 8(a)/WBE/MBE and is certified by SBA
 B business was certified by _____
 DBE Certification # is _____

Firms Annual Gross Receipts:

- <\$500,000
 \$500,000 - \$999,999
 \$1,000,000 - \$4,999,999
 \$5,000,000 - \$9,999,999
 \$10,000,000 - \$16,999,999
 >\$17,000,000

Completed by: _____ Title: _____

Signature: _____ Date: _____



ALASKA RAILROAD CORPORATION
SUBCONTRACTOR LIST
 [First Tier Subcontractors Only]

The apparent low bidder shall complete this form and submit it so as to be received by the Contracting Officer prior to the close of business on the **Fifth (5th) Working Day** after receipt of written notice from the Alaska Railroad Corporation.

Failure to submit this form with all required information by the due date will result in the bidder being declared non-responsive and may result in the forfeiture of the Bid Security.

Scope of work must be clearly defined. If an item of work is to be performed by more than one (1) firm, indicate the portion or percent of work to be done by each.

Check as applicable: All work on the below-referenced project will be accomplished without subcontracts greater than ½ of 1% of the contract amount.

Or

Subcontractor List is as follows:

FIRM NAME, ADDRESS, TELEPHONE NUMBER	BUSINESS LICENSE NUMBER AND CONTRACTOR'S REGISTRATION NUMBER	SCOPE OF WORK TO BE PERFORMED

[CONTINUE SUBCONTRACTOR INFORMATION ON NEXT PAGE]

I hereby certify that the above-listed licenses and registrations were valid at the time bids were received for this project. For contracts involving Federal-aid funding, Alaska Business License and Contractor Registration will be required prior to award of a subcontract.

Authorized Signature

Date

Contractor

Project Name and Number

SAMPLE CONTRACT

**ALASKA RAILROAD CORPORATION
CONSTRUCTION CONTRACT**

Contract Number: _____

This **CONTRACT**, between the ALASKA RAILROAD CORPORATION, herein called ARRC, acting by and through its Contracting Officer, and

an Individual, Partnership, Joint Venture, Sole Proprietorship, Corporation, incorporated under the laws of the State of _____, its successors and assigns, hereinafter called the Contractor, is effective the date of the signature of the Contracting Officer on this document.

Billing Information: Invoices shall be submitted to Accounts Payable, Alaska Railroad Corporation, PO Box 107500, Anchorage, AK 99510-7500. Please reference your contract number on all invoices and correspondence.

WITNESSETH: That the Contractor, for and in consideration of the payment or payments herein specified and agreed to by ARRC, hereby covenants and agrees to furnish and deliver all the materials and to do and perform all the work and labor required in the construction of the following project:

at the prices bid by the Contractor for the respective estimated quantities aggregating approximately the sum of: _____ Dollars \$_____), and such other items as are mentioned in the original Bid, which Bid and prices named, together with the Contract Documents are made a part of this Contract and accepted as such, the project being situated as follows:

It is distinctly understood and agreed that no claim for additional work or materials, done or furnished by the Contractor and not specifically herein provided for, will be allowed by ARRC, nor shall the Contractor do any work or furnish any material not covered by this Contract, unless such work is ordered in writing by ARRC. In no event shall ARRC be liable for any materials furnished or used, or for any work or labor done, unless the materials, work, or labor are required by the Contract or on written order furnished by ARRC. Any such work or materials which may be done or furnished by the Contractor without written order first being given shall be at the Contractor's own risk, cost, and expense and the Contractor hereby covenants and agrees to make no claim for compensation for work or materials done or furnished without any such written order.

The Contractor further covenants and agrees that all materials shall be furnished and delivered and all labor shall be done and performed, in every respect, to the satisfaction of ARRC, on or before:

_____, or within _____

Calendar Days.

It is expressly understood and agreed that in case of the failure on the part of the Contractor, for any reason, except with the written consent of ARRC, to complete the furnishing and delivery of materials and the doing and performance of the work before the aforesaid date, ARRC shall have the right to deduct from any money due or which may become due the Contractor, or if no money shall be due, ARRC shall have the right to recover: _____ Dollars \$_____), per day for each calendar day elapsing between the time stipulated for the completion and the actual date of completion in accordance with the terms hereof; such deduction to be made, or sum to be recovered, not as a penalty but as liquidated damages. The bonds given by the Contractor in the sum of: \$_____ Payment Bond, and \$_____ Performance Bond, to secure the proper compliance with the terms and provisions of this Contract, are submitted herewith and made a part hereof.

IN WITNESS WHEREOF, the parties hereto have executed this Contract and hereby agree to its terms and conditions.

CONTRACTOR

Name of Contractor

Signature

Date

Name and Title

(Corporate Seal)

ALASKA RAILROAD CORPORATION

Contracting Officer (Signature)

Date

Typed or Print Name
Form 395-0122

ALASKA RAILROAD CORPORATION
PAYMENT BOND

KNOW ALL PERSONS BY THESE PRESENTS:

That _____ of

as Principal, and _____ of:

as Surety, firmly bound and held unto the Alaska Railroad Corporation in the penal sum of _____ Dollars (\$ _____), good and lawful money of the United States of America for the payment whereof, well and truly to be paid to the Alaska Railroad Corporation, we bind ourselves, our heirs, successors, executors, administrators, and assigns, jointly and severally, firmly by these presents.

WHEREAS, the said Principal has entered into a written contract with said Alaska Railroad Corporation, on the _____ of _____, 20____,

For _____,
said work to be done according to the terms of said contract.

ARRC Bid Number: _____

NOW, THEREFORE, the conditions of the foregoing obligation is such that if the said Principal shall comply with all requirements of law and pay, as they become due, all just claims for labor performed and materials and supplies furnished upon or for the work under said contract, whether said labor be performed and said materials and supplies be furnished under the original contract, any subcontract, or any and all duly authorized modifications thereto, then these presents shall become null and void; otherwise they shall remain in full force and effect.

IN WITNESS WHEREOF, We have hereunto set our hands and seals this _____ day of _____, 20_____.

Principal: _____

Address: _____

Telephone number: _____

Contact Name: _____

By: _____

By: _____

Surety: _____

Address: _____

Contact Name: _____

By: _____

By: _____

The offered bond has been checked for adequacy under the applicable statutes and regulations:

Alaska Railroad Corporation Authorized Representative]

Date

3 INSTRUCTIONS

1. This form, for the protection of persons supplying labor and material, shall be used whenever a payment bond is required. There shall be no deviation from this form without approval from the Contracting Officer.
2. The full legal name, business address, telephone number, and point of contact of the Principal and Surety shall be inserted on the face of the form. Where more than a single surety is involved, a separate form shall be executed for each surety.
3. The penal amount of the bond, or in the case of more than one surety the amount of obligation, shall be entered in words and in figures.
4. The bond shall be signed by authorized persons. Where such persons are signing in a representative capacity (e.g., an attorney-in-fact), but is not a member of the firm, partnership, or joint venture, or an officer of the corporation involved, evidence of authority must be furnished.

ALASKA RAILROAD CORPORATION
PERFORMANCE BOND

KNOW ALL PERSONS BY THESE PRESENTS:

That _____ of:

as Principal, and _____ of:

as Surety, firmly bound and held unto the Alaska Railroad Corporation in the penal sum of _____ Dollars (\$ _____), good and lawful money of the United States of America for the payment whereof, well and truly to be paid to the Alaska Railroad Corporation, we bind ourselves, our heirs, successors, executors, administrators, and assigns, jointly and severally, firmly by these presents.

WHEREAS, the said Principal has entered into a written contract with said Alaska Railroad Corporation, on the _____ of _____, 20____, for _____ said work to be done according to the terms of said contract.

ARRC Bid Number: _____

NOW, THEREFORE, the conditions of the foregoing obligation is such that if the said Principal shall well and truly perform and complete all obligations and work under said contract and if the Principal shall reimburse upon demand of the Alaska Railroad Corporation any sums paid him/her which exceed the final payment determined to be due upon completion of the project, then these presents shall become null and void; otherwise they shall remain in full force and effect.

IN WITNESS WHEREOF, We have hereunto set our hands and seals this _____ day of _____, 20____.

Principal: _____

Address: _____

Telephone Number: _____

Contact Name: _____

By: _____

By: _____

Surety: _____

Address: _____

Contact Name: _____

By: _____

By: _____

The offered bond has been checked for adequacy under the applicable statutes and regulations:

Alaska Railroad Corporation [Authorized Representative]

Date

INSTRUCTIONS

1. This form shall be used whenever a performance bond is required. There shall be no deviation from this form without approval from the Contracting Officer.
2. The full legal name, business address, telephone number, and point of contact of the Principal and Surety shall be inserted on the face of the form. Where more than a single surety is involved, a separate form shall be executed for each surety.
3. The penal amount of the bond, or in the case of more than one surety the amount of obligation, shall be entered in words and in figures.
4. The bond shall be signed by authorized persons. Where such persons are signing in a representative capacity (e.g., an attorney-in-fact), but is not a member of the firm, partnership, or joint venture, or an officer of the corporation involved, evidence of authority must be furnished.

Form 395-0127

APPENDIX E

GENERAL CONDITIONS **(CONSTRUCTION)**

(Revised 01/08/16)

1. ARTICLE 1 - DEFINITIONS:

Wherever used in the Contract Documents the following terms, or pronouns in place of them, are used, the intent and meaning, unless a different intent or meaning is clearly indicated, shall be interpreted as set forth below.

The titles and headings of the Sections, Subsections and Articles herein are intended for convenience of reference and shall not be considered as having bearing on their interpretation.

Whenever used in the Specifications or other Contract Documents the following terms have the meaning indicated which are applicable to both the singular and plural thereof. Working titles which have a masculine gender are intended to refer to persons of either sex.

Terms not defined below shall have their ordinary accepted meanings within the context in which they are used. "Webster's Third New International Dictionary of the English Language, Unabridged, Copyright 1961", or subsequent revision thereof, shall provide ordinarily accepted meanings. Words which have a well-known technical or trade meaning when used to describe Work, materials or equipment shall be interpreted in accordance with such meaning.

Acceptance Tests - Quality Control tests taken by the CONTRACTOR, the results for which are used by the OWNER to determine whether the Work complies with the requirements of the Contract Documents.

Access Road - The right-of-way, the roadway, and all improvements constructed thereon connecting the Site to a public thoroughfare.

Addenda: All clarifications, corrections, or changes issued graphically or in writing by the Owner after the Invitation to Bid but prior to the opening of Bids.

Advertisement - The public announcement, as required by law, inviting bids or proposals for Work to be performed or Materials to be furnished.

Affiliate - Affiliate shall mean any subsidiary of Contractor, and any other entity in which Contractor has a financial interest or which has a financial interest in Contractor (including without limitation parent companies, related businesses under the same holding company, or any other business controlled by, under common control with, or which controls Contractor).

Allowances - Allowances shall mean the allowance amounts shown in the Schedule of Values, together with such further allowances as may be developed by the parties as the Project progresses. Any unused Allowance shall be retained by Owner.

Amendment - Amendment shall mean a written modification of the Contract (including without limitation any agreed change to the Contract Price), identified as an Amendment, and executed by the Contractor and the OWNER.

Application for Payment: The form provided by the Owner which is used by the Contractor in requesting progress or Final payments and which is to include such supporting documentation as is required by the Contract Documents.

Approved or Approval: Means written approval by the Owner or his authorized representative as defined in paragraph 2.1.

Architect/Engineer (A/E): A person, firm, or corporation, other than the CONTRACTOR or those engaged by the CONTRACTOR, retained directly by the OWNER to prepare Drawings, Specifications and other Contract Documents, perform construction administration services, or other Project related services.

ARRC: Initials which stand for Alaska Railroad Corporation.

ARRC Procurement Rules: Means the Rules governing the procurement of supplies, services, professional services and construction adopted by ARRC in accordance with A.S. 36.30.015(e). Said Rules may be downloaded from ARRC's web site, www.alaskarailroad.com, under General Information, Purchasing/Contracts.

A.S.: Initials which stand for Alaska Statute.

Award: The acceptance, by the Owner, of the successful Bid.

Bid: The offer of a Bidder, on the prescribed form to perform the Work in accordance with the Contract Documents at the prices quoted.

Bid Bond: The security furnished with a Bid to guarantee that the Bidder will enter into a Contract if his Bid is accepted by the Owner.

Bidder: Any individual, firm, corporation or any acceptable combination thereof, or joint venture submitting a Bid for the advertised Work.

Business Days: Business Days shall mean every day except Saturday, Sunday, and Holidays.

Calendar Day: Every day shown on the calendar, beginning and ending at midnight.

Change Order: A written order by the Owner directing changes to the Contract, within its general scope of the Contract Documents, issued under the provisions of Articles 9 and/or 10 in administering the Contract, including OWNER's written change Directives as well as changes reflected in a writing executed by the parties to this Contract and, if applicable, establishing a Contract Price or Contract Time adjustment for the changed Work.

Claim: A demand by CONTRACTOR pursuant to Article 15 for review of the denial of CONTRACTOR's initial request for an adjustment of Contract terms, payment of money, extension of Contract Time or other relief, submitted in accordance with the requirements and within the time limits established for review of Claims in these General Conditions.

Conditions of the Contract: Those portions of the Contract Documents which define the rights and responsibilities of the contracting parties and of others involved in the Work. The Conditions of the Contract include General Conditions, Supplementary Conditions and other Conditions specified in the Invitation to Bid.

Contract: The Contract Documents form the Contract between the Owner and the Contractor for the Work to be performed. The Contract represents the entire and integrated agreement between the parties hereto and supersedes prior negotiations, representations or agreements, either written or oral.

Contract Documents: The Contract Form, Addenda, the bidding requirements and Contractor's Bid (including all appropriate bid tender forms), the Bonds, the Conditions of the Contract and all other Contract requirements, the Specifications, and the Drawings furnished by the Owner to the Contractor, together with all Change Orders and documents approved by the Contracting Officer for inclusion, modifications and supplements issued on or after the Effective Date of the Contract.

Contracting Officer: The person authorized to enter into and administer the Contract on behalf of the Owner. He has authority to make findings, determinations and decisions with respect to the Contract and, when necessary, to modify or terminate the Contract.

Contractor: The individual, firm, corporation or any acceptable combination thereof, contracting with the Owner for performance of the Work.

Contract Amount: The total moneys payable by the Owner to the Contractor under the terms of the Contract Documents.

Contract Time: The number of Calendar Days or the date specified in the Contract and authorized time extensions which identify how much time the Contractor is allowed to achieve Final Completion.

Consultant: A person, firm, agency or corporation retained by the Owner to prepare Contract Documents, perform construction administration services, or other Project related services.

Critical Path: The sequence of activities, events, and dependencies that determine the longest overall duration and the shortest time possible, to complete the Project. Any delay of an activity on the Critical Path directly affects the planned Project completion date (i.e., there is no float on the Critical Path).

Defective: An adjective which refers to Work that is unsatisfactory, faulty or deficient, or does not conform to the Contract Documents, or does not meet the requirements of any inspection, reference standard, test or Approval referred to in the Contract Documents, or has been damaged prior to the Owner's Approval of Final payment.

Design Team: The A&E's dedicated staff working on the design of the Project with responsibility for development of the Design Development Documents.

Design Development Documents: Means the Drawings and other documents that fix and describe the size and character of the entire Project, including architectural, structural, mechanical, and electrical systems, Materials, and such other elements as may be appropriate. These documents include the draft plans, progress plans, and Final PS&E.

Direct Cost: Means, unless otherwise provided in the Contract Documents, the cost of Materials, including sales tax, cost of delivery, cost of labor, including social security, old age and unemployment insurance, and fringe benefits required by agreement or custom; worker's compensation insurance; rental cost of Equipment, and machinery required for execution of the Work; and the additional costs of field personnel directly attributable to the Work.

Directive: A written communication to the Contractor from the Owner interpreting or enforcing a Contract requirement or ordering commencement of an item of Work.

Drawings: The drawings which show the character and scope of the Work to be performed and which have been furnished by the Owner or the Owner's Consultant and are by reference made a part of the Contract Documents.

Effective Date of the Contract: The date on which the Contract is fully executed by both Contractor and the Owner.

Equipment: All machinery together with the necessary supplies for upkeep and maintenance, and also tools and apparatus necessary for the proper construction and acceptable completion of the Work.

Final Acceptance: The OWNER's written acceptance of the Work following Final Completion and the performance of all Contract requirements by the CONTRACTOR.

Final Completion: The Work (or specified part thereof) has progressed to the point that all Work is complete as determined by the Owner.

Final Payment: The last payment to be made to the CONTRACTOR following the issuance of and Final Acceptance.

Final PS&E: The final, stamped, and sealed Plans, Specifications, and estimate used to construct the Project.

General Requirements: Sections of the Contract Documents which contain administrative and procedural requirements as well as requirements for temporary facilities.

Holidays: The Owner recognizes the following Holidays:

- New Year's Day - January 1
- President's Day - Third Monday in February
- Memorial Day - Last Monday in May
- Independence Day - July 4
- Labor Day - First Monday in September
- Columbus Day-Second Monday in October
- Veteran's Day - November 11
- Thanksgiving Day - Fourth Thursday in November
- Christmas Day - December 25

If any Holiday listed above falls on a Saturday, Saturday and the preceding Friday are both legal Holidays. If the holiday should fall on a Sunday, Sunday and the following Monday are both legal Holidays.

Inspector: The OWNER's representative authorized to make determinations and inspections of Contract performance and materials.

Install: Means to build into the Work, ready to be used in complete and operable condition and in compliance with the Contract Documents.

Invitation to Bid: The public announcement, as required by law, inviting Bids for Work to be performed and/or materials to be furnished.

Laboratory: The official testing laboratories of the OWNER or such other laboratories as may be designated by the OWNER or identified in the Contract Documents.

Markup Fee: The maximum rates of cost markup as outlined in Article 10.6 to cover both the overhead and profit of CONTRACTOR, a Subcontractor or Supplier, to be used in Change Order price determination as described in Articles 10.3, 10.4 and 10.5.

Materials: Any natural or manmade substances specified for use in the construction of the Project.

Notice of Intent to Award: The written notice by the Owner to all Bidders identifying the apparent successful Bidder and establishing the Owner's intent to execute the Contract when all conditions required for execution of the Contract are met.

Notice to Proceed: A written notice to the Contractor to begin the Work and establishing the date on which the Contract Time begins.

Offer: A bid in connection with an Invitation to Bid and a proposal in connection with a Request for Proposals.

Offeror: A bidder in connection with an Invitation to Bid and a proposer in connection with a Request for Proposals.

Owner: The Alaska Railroad Corporation ("ARRC") or its authorized representative(s).

Payment Bond: The security furnished by the Contractor and his Surety to guarantee payment of the debts arising out of performance of the Work.

Performance Bond: The security furnished by the Contractor and his Surety to guarantee performance and completion of the Work in accordance with the Contract Documents.

Person: An entity doing business as a sole proprietorship, a partnership, a joint venture, a corporation, a limited liability company or partnership, or any other entity possessing the legal capacity to contract.

Plans: The Drawings and other documents which show the location, type, dimensions, and details of the Work to be performed under the Contract.

Pre-construction Meeting: A preparatory meeting between the CONTRACTOR and the OWNER, and other parties affected by the construction, to discuss the Project before the CONTRACTOR begins work.

Project: The total construction, of which the Work performed under the Contract Documents is the whole or a part.

Project Manager: The authorized representative of the Owner who is responsible for administration of the Contract.

Project Records: Means all information in any way relating to the Project or performance of the Contract, including but not limited to all:

- Financial and accounting records and information;

- Correspondence - including internal communications, E-mails, field notes, file notes, diary entries, and communications among the OWNER, CONTRACTOR, Subcontractors, and governmental authorities;
- Notices, orders, permits, and opinions;
- Survey data - including survey drawings, reports, maps, original computations, and other data;
- Materials testing records and Materials certifications;
- Work Products;
- All other documents and information whether generated by or for, or received by, the CONTRACTOR in performance of the Contract; whether any of such records are:
 - Paper-based;
 - In the form of electronic data;
 - In electronic/digital format capable of being reduced to paper-based or electronic/digital format;
 - In audio format; or
 - In a format that constitutes visual reproductions such as photos or videotape, in any way relating to the Project.

Proposal: Means the written Offer submitted by a Person in response to an Invitation to Bid or RFP, to do stated Work in the manner indicated and at the prices quoted.

Proposal Guaranty: The security furnished with a Proposal to guarantee that the Offeror will enter into a Contract if the OWNER accepts his Proposal.

Quality Assurance (QA): Tests and inspections performed by or on behalf of the OWNER to evaluate the methods, accuracy, precision, and reproducibility of Quality Control and material acceptance tests.

Quality Control (QC): Tests and inspections by the CONTRACTOR to insure that the Work conforms to the requirements of the Contract Documents and may determine its acceptability for payment.

Regulatory Requirements: All laws, rules, regulations, ordinances, codes and/or orders applicable to the Work.

Schedule of Values: The OWNER's document, submitted by the CONTRACTOR and reviewed and approved by the Project Manager, which shall serve as the basis for computing payment and for establishing the value of separate items of Work that comprise the Contract Price.

Scope Change: Scope Change shall mean only (i) changed site conditions not reasonably inferable from information available to the CONTRACTOR at the time of execution of the Fixed Price Amendment, and (ii) significant Work modifications (including additions, substitutions, and deletions), application of Allowances, and selection of alternates, all as approved by the OWNER under the Contract beyond that identified or inferable from the Fixed Price Supporting Documents (but in the case of Allowance items, the Contract Price will increase only if the cost to OWNER of the Allowance items exceeds the total amount of the Allowances).

Self-Performed Work: Work by the CONTRACTOR with its own forces in accordance with the terms and conditions of the Contract Documents and that is not performed by Subcontractors or Suppliers.

Shop Drawings: All Drawings, diagrams, illustrations, schedules and other data which are specifically prepared by or for the Contractor to illustrate some portion of the Work and all illustrations, brochures, standard schedules, performance charts, instructions, diagrams and other information prepared by a supplier and submitted by the Contractor to illustrate material, equipment, fabrication, or erection for some portion of the Work.

Site: Means the geographical dimensions of the real property on which the Work is to be performed, including designated contiguous staging areas.

Specifications: Those portions of the Contract Documents consisting of written technical descriptions of materials, equipment, construction systems, standards and workmanship as applied to the Work and certain administrative and procedural details applicable thereto. Specifications may include a description of any requirement for inspecting, testing or preparing a material, service or construction item for delivery and the quantities or qualities of materials to be furnished under the Contract. Specifications generally will state the results or products to be obtained and may, on occasion, describe the method and manner of doing the work to be performed. Specifications may be incorporated by reference and/or may be attached to the Contract.

Standards: References to standards, material specifications, test methods, or other publications of Alaska Department of Transportation and Public Facilities (DOT&PF), American Association of State Highway and Transportation Officials (AASHTO), American Society for Testing and Materials (ASTM), other governmental agencies, or other recognized national organizations that have been officially adopted by those agencies and organizations. The applicable standard, test method, material specification, or other reference shall be that which is in effect on the date the activity governed by the standard, method, etc., is performed.

Standard Specifications: Means the Alaska Department of Transportation and Public Facilities Specifications for Construction, current published edition unless another organization is otherwise specified.

Subcontractor: An individual, firm, or corporation to whom the Contractor sublets part of the Contract.

Substantial Completion: Although not fully completed, the Work (or a specified part thereof) has progressed to the point where, in the opinion of the Owner as evidenced by the Owner's written notice, it is sufficiently complete, in accordance with the Contract Documents, so that the Work (or specified part) can be utilized for the purposes for which it is intended. The terms "Substantially Complete" and "Substantially Completed" as applied to any Work refer to Substantial Completion thereof.

Supplemental Agreement: A written agreement between the Contractor and the Owner covering Work that is not within the general scope of the Contract.

Supplemental Drawings: Means detailed Drawings for Work or methods of construction furnished by the OWNER that are Project-specific, and are denoted by title in the Project title block.

Supplemental Conditions: The part of the Contract Documents that amends or supplements these General Conditions or other Contract Documents.

Supplier: A manufacturer, fabricator, distributor, material man or vendor of Materials or Equipment.

Surety: The corporation, partnership, or individual, other than the Contractor, executing a bond furnished by the Contractor.

Traffic Control Plan (TCP): A Drawing of one or more specific plans that detail the routing of pedestrian, aircraft, and/or vehicular traffic through or around a construction area.

Unit Price Work: Work to be paid for on the basis of unit prices.

Utility or Utilities: The privately, publicly or cooperatively owned lines, facilities and systems for producing, transmitting or distributing communications, power, electricity, light, heat, gas, oil, crude products, water, steam, waste, storm water not connected with highway or runway drainage, and other similar commodities, including publicly owned fire and police signal systems, street lighting systems, and railroads which directly or indirectly serve the public or any part thereof. The term "Utility" shall also mean the utility company, inclusive of any wholly owned or controlled subsidiary.

Validate: When required by the Contract Documents to validate a dimension or condition, the CONTRACTOR will be responsible for substantiating or verifying that the dimension or condition as represented in the Contract Documents meets the desired intent in sufficient time to allow correction prior to impacting the Work.

Work: Work is the act of, and the result of, performing services, furnishing labor, furnishing and incorporating materials and equipment into the Project and performing other duties and obligations, all as required by the Contract Documents. Such Work, however incremental, will culminate in the entire completed Project, or the various separately identifiable parts thereof.

Work Product: Means the Plans and Specifications, Drawings, Final PS&E and all other documents, analysis, computations, models, computer programs, and information obtained or developed for the Project or in performance of the Work, in or capable of being reduced to tangible paper-based, electronic, audio, or video format, whether or not designated as a deliverable under the Contract.

2. ARTICLE 2 - AUTHORITIES AND LIMITATIONS:

2.1 AUTHORITIES AND LIMITATIONS:

- 2.1.1 The Owner alone shall have the power to bind the Owner and to exercise the rights, responsibilities, authorities and functions vested in the Owner by the Contract Documents, except that the Owner shall have the right to designate in writing authorized representatives to act for him.
- 2.1.2 Wherever any provision of the Contract Documents specifies an individual or organization, whether Governmental or private, to perform any act on behalf of or in the interests of the Owner that individual or organization shall be deemed to be the Owner's authorized representative under this Contract but only to the extent so specified.

- 2.1.3 The Owner may, at any time during the performance of this Contract, vest in any such authorized representatives' additional power and authority to act for the Owner or designate additional representatives, specifying the extent of their authority to act for the Owner. A copy of each document vesting additional authority in or removing that authority from an authorized representative or designating an additional authorized representative shall be furnished to the Contractor.
- 2.1.4 The Owner reserves the right to appoint a new Project Manager without affecting any of the Contractor's obligations to the Owner under this Contract.
- 2.1.5 The Contractor shall perform the Work in accordance with any written order (including but not limited to instruction, direction, interpretation or determination) issued by an authorized representative in accordance with the authorized representative's authority to act for the Owner.
- 2.1.6 The Contractor assumes all the risk and consequences of performing the Work in accordance with any order (including but not limited to instruction, direction, interpretation or determination) of anyone not authorized to issue such order, and of any order not in writing.
- 2.1.7 Should the Owner or his authorized representative designate Consultant(s) to act for the Owner as provided for in Paragraph 2.1.1, the performance or nonperformance of the Consultant under such authority to act, shall not give rise to any Contractual obligation or duty of the Consultant to the Contractor, any subcontractor, any supplier, or any other organization performing any of the Work or any Surety representing them.
- 2.1.8 The term "Owner" when used in the text of these General Conditions or other Contract Documents following this section shall also mean any duly authorized representative of the Owner when authorized in accordance with Paragraph 2.1.1.

2.2 EVALUATIONS BY OWNER:

- 2.2.1 The Owner will decide all questions which may arise as to:
 - 2.2.1.1 Quality and acceptability of materials furnished;
 - 2.2.1.2 Quality and acceptability of Work performed;
 - 2.2.1.3 Compliance with the Schedule of Progress;
 - 2.2.1.4 Interpretation of Contract Documents;
 - 2.2.1.5 Acceptable fulfillment of the Contract on the part of the Contractor.
- 2.2.2 In order to avoid cumbersome terms and confusing repetition of expressions in the Contract Documents, whenever the terms "as ordered", "as directed", "as required", "as approved", or terms of like effect or import are used, or the adjectives "reasonable", "suitable", "acceptable", "proper" or "satisfactory" or adjectives of like

effect or import are used it shall be understood as if the expression were followed by the words "the Owner".

2.2.3 When such terms are used to describe a requirement, direction, review or judgment of the Owner as to the Work, it is intended that such requirement, direction, review or judgment will be solely to evaluate the Work for compliance with the Contract Documents (unless there is a specific statement indicating otherwise).

2.2.4 The use of any such term or adjective shall not be effective to assign to the Owner any duty or authority to supervise or direct the furnishing or performance of the Work or any duty or authority to undertake responsibility contrary to the provisions of paragraphs 2.3 or 2.4.

2.3 MEANS & METHODS:

2.3.1 The means, methods, techniques, necessary equipment and manpower, supervision, quality control measures, sequences or procedures of construction, or safety precautions and the program incident thereto, and the failure to perform or furnish the Work in accordance with the Contract Documents are the sole responsibility of the Contractor.

2.4 VISITS TO SITE:

2.4.1 The Owner will make visits to the site, off-site fabrication sites and approved remote storage sites at intervals appropriate to the various stages of construction to observe the progress and quality of the executed Work and to determine, in general, if the Work is proceeding in accordance with the Contract Documents.

2.4.2 Such observations or the lack of such observations shall in no way relieve the Contractor from his duty to perform the Work in accordance with the Contract Documents.

3. ARTICLE 3 - CONTRACT DOCUMENTS: INTENT, AMENDING, REUSE:

3.1 INCOMPLETE CONTRACT DOCUMENTS:

3.1.1 The execution of the Contract by the Contractor is considered a representation that the Contractor examined the Contract Documents to make certain that all sheets and pages were provided and that the Contractor is satisfied as to the conditions to be encountered in performing the Work.

3.1.2 The Owner expressly denies any responsibility or liability for a Bid submitted on the basis of an incomplete set of Contract Documents.

3.2 COPIES OF CONTRACT DOCUMENTS:

3.2.1 The OWNER shall furnish to the CONTRACTOR at least one electronic and one paper copy of the Contract Documents, and up to the number of additional copies specified in the Supplemental Conditions.

3.2.2 Additional copies will be furnished, upon request, at the cost of reproduction.

3.3 SCOPE OF WORK:

3.3.1 The Contract Documents comprise the entire Contract between the Owner and the Contractor concerning the Work.

3.3.2 The Contract Documents are complementary; what is called for by one is as binding as if called for by all. The Contract Documents will be construed in accordance with the Regulatory Requirements of the place of the Project.

3.3.3 It is specifically agreed between the parties executing this Contract that it is not intended by any of the provisions of the Contract to create in the public or any member thereof a third party benefit, or to authorize anyone not a party to this Contract to maintain a suit pursuant to the terms or provisions of the Contract.

3.4 INTENT OF CONTRACT DOCUMENTS:

3.4.1 It is the intent of the Contract Documents to describe a functionally complete Project to be constructed in accordance with the Contract Documents.

3.4.2 Any work, materials or equipment that may reasonably be inferred from the Contract Documents as being required to produce the intended result will be supplied, without any adjustment in Contract Amount or Contract Time, whether or not specifically called for.

3.4.3 Reference to standard specifications, manuals or codes of any technical society, organization or association, or to the Regulatory Requirements of any governmental authority, whether such reference be specific or by implication, shall mean the edition stated in the Contract Documents or if not stated the latest standard specification, manual, code or Regulatory Requirements in effect at the time of advertisement for the Project (or, in the Effective Date of the Contract if there was no advertisement).

3.4.4 However, no provision of any referenced standard specification, manual or code (whether or not specifically incorporated by reference in the Contract Documents) shall be effective to change the duties and responsibilities of the Owner and the Contractor, or any of their Consultants, agents or employees from those set forth in the Contract Documents, nor shall it be effective to assign to the Owner or any of the Owner's Consultants, agents or employees, any duty or authority to supervise or direct the furnishing or performance of the Work or any duty or authority to undertake responsibility contrary to the provisions of paragraphs 2.3 or 2.4.

3.4.5 Unless otherwise specified in the Contract Documents, words which have well-known technical or construction industry meanings are used in the Contract Documents in accordance with such recognized meanings.

3.5 DISCREPANCY IN CONTRACT DOCUMENTS:

- 3.5.1 Before undertaking the Work, the Contractor shall carefully study and compare the Contract Documents and check and verify pertinent figures, and dimensions shown thereon and all applicable field measurements.
- 3.5.2 Work in the area by the Contractor shall imply verification of figures, dimensions and field measurements.
- 3.5.3 If, during the above study or during the performance of the Work, the Contractor finds a conflict, error, discrepancy or omission in the Contract Document, or a discrepancy between the Contract Documents and any standard specification, manual, code, or regulatory requirement which affects the Work, the Contractor shall promptly report such discrepancy in writing to the Owner.
- 3.5.4 The Contractor shall obtain a written interpretation or clarification from the Owner before proceeding with any Work affected thereby.
- 3.5.5 Any Work or adjustment made by the Contractor without this determination shall be at his own risk and expense.
- 3.5.6 However, the Contractor shall not be liable to the Owner for failure to report any conflict, error or discrepancy in the Contract Documents unless the Contractor had actual knowledge thereof or should of reasonably have known thereof.

3.6 DISCREPANCY - ORDER OF PRECEDENCE:

- 3.6.1 When conflicts, errors, or discrepancies within the Contract Documents exist, the order of precedence from most governing to least governing will be as follows:
 - 3.6.1.1 Contract Amendments and Change Orders
 - 3.6.1.2 Supplemental Conditions
 - 3.6.1.3 General Conditions
 - 3.6.1.4 Technical Specifications
 - 3.6.1.5 Drawings
 - 3.6.1.6 AKDOT Standard Specifications
 - 3.6.1.7 AKDOT Standard Drawings

In addition, the following shall apply:

- Notes on a Drawing shall take precedence over drawing details.
- Recorded dimensions will govern over scaled dimensions.
- Large scale details will govern over small scale details.
- Schedules (e.g. equipment schedules, finish schedules, door schedules, material schedules and all similar type schedules where identified) in Specifications or Plans will govern over plans.

- 3.6.2 The Contractor shall not take advantage of any apparent error or omission in the Contract Documents. If the Contractor discovers an error or omission, the Owner shall be promptly notified. The Owner will make corrections and interpretation as

necessary to fulfill the intent of the Contract. Scaled measurements shall not be used when the dimensions on the plan are given or can be computed.

3.7 CLARIFICATIONS AND INTERPRETATIONS:

3.7.1 The Owner will issue with reasonable promptness such written clarifications or interpretations of the requirements of the Contract Documents as the Owner may determine necessary, which shall be consistent with or reasonably inferable from the overall intent of the Contract Documents.

3.8 REUSE OF DOCUMENTS:

3.8.1 Neither the Contractor nor any subcontractor, or supplier or other person or organization performing or furnishing any of the Work under a direct or indirect Contract with the Owner shall have or acquire any title to or ownership rights in any of the Contract Documents (or copies thereof) prepared by or for the Owner and they shall not reuse any of the Contract Documents on extensions of the Project or any other Project without written consent of the Owner.

3.8.2 Contract Documents prepared by the Contractor in connection with the Work shall become the property of the Owner.

3.9 DOCUMENT CONTROL:

3.9.1 The CONTRACTOR shall manage and conduct its correspondence with OWNER as follows.

3.9.2 Correspondence Requirements – All notices and other communications concerning the Contract shall be in English. All correspondence shall be identified by OWNER's Contract number and shall reference the Contract section, if any, applicable to the subject of the correspondence.

3.9.3 Document Identification and Coding – CONTRACTOR shall assign a unique sequential identifying code or serial number to each item of correspondence transmitted to OWNER. OWNER will include the identifying code or serial number in its response. In responding to correspondence from OWNER, the CONTRACTOR shall reference OWNER's identifying code or serial number on the CONTRACTOR's return correspondence.

3.9.4 Use of Electronic Mail – Electronic mail (E-mail) may be used between the CONTRACTOR and OWNER with OWNER's prior written consent (which may be withdrawn at any time). Notwithstanding any written consent, E-mail shall not, under any circumstance, constitute formal notice under the Contract, and in particular, shall not constitute notice of a Claim for time or cost.

3.9.5 Retention of Project Records – Notwithstanding any other provision to the contrary, the CONTRACTOR shall maintain all Project Records (including copies of all original documents delivered to OWNER) for a minimum of three years from date of Final Payment or resolution of all disputes relating to the Contract, whichever is later (the "Record Retention Period"). CONTRACTOR shall notify OWNER where such Project Records are kept. Further, the CONTRACTOR shall require in each of its

contracts with Subcontractors, Suppliers, and consultants that they shall keep and preserve all of their Project Records for the Record Retention Period and require that each of their lower-tier subcontractors, suppliers and consultants do likewise.

3.9.6 Maintenance of, Access to, and Audit of Project Records – For the duration of the Contract, CONTRACTOR shall maintain at its Project Manager’s local Project office a complete set of all Project Records. CONTRACTOR shall afford OWNER access to such records for inspection and copying as OWNER may request in connection with the issuance of Change Orders, the resolution of disputes, audits and inspections, and such other matters as OWNER reasonably deems necessary for purposes of verifying compliance with the Contract and applicable Regulatory Requirements. CONTRACTOR shall make these records and documents available for audit and inspection to OWNER at CONTRACTOR’s office within the Municipality of Anchorage, at all reasonable times, without charge, and shall allow such persons to make copies of such documents (at no expense to the CONTRACTOR). Further, the CONTRACTOR shall require in each of its contracts with Subcontractors, Suppliers, and consultants that they shall grant to OWNER access to such records for inspection and copying at any time during normal business hours upon reasonable notice and require that their lower-tier subcontractors, suppliers, and consultant do likewise.

3.9.6.1 Where the payment method for any Work is on a time and material basis, such examination and audit rights shall include all books, records, documents, and other evidence sufficient to identify all direct and indirect costs of whatever nature claimed to have been incurred and anticipated to be incurred for the performance of such Work. If the audit indicates the CONTRACTOR has been over-credited under a previous progress report or progress payment, that over-credit will be credited against current progress reports or payments.

3.9.6.2 For cost and pricing data submitted in connection with pricing Change Orders, unless such pricing is based on adequate price competition, established catalog or market prices of commercial items sold in substantial quantities to the public, or prices set by law, OWNER and its representatives have the right to examine all books, records, documents, and other data of the CONTRACTOR related to the negotiation of or performance of Work under such Change Orders for the purpose of evaluating the accuracy, completeness, and currency of the cost or pricing data submitted. The right of examination shall extend to all documents deemed necessary by such OWNER to permit adequate evaluation of the cost or pricing data submitted, along with the computations and projections used therein.

3.9.6.3 In every case in which the CONTRACTOR is required to retain for the benefit of OWNER or produce to OWNER information from CONTRACTOR’s Subcontractors or Suppliers, CONTRACTOR shall include in each subcontract and purchase order a requirement that the Subcontractor or Supplier retain or produce such information to OWNER.

3.9.7 Audit Rights – All Claims filed against OWNER shall be subject to audit. The audit may be performed by employees of OWNER or by an auditor under contract with OWNER. No notice is required before commencing any audit. CONTRACTOR, its Subcontractors, and their agents shall provide adequate facilities, acceptable to OWNER, for the audit during normal business hours. CONTRACTOR, its Subcontractors, and their agents shall cooperate with the auditors. Failure of the CONTRACTOR, its Subcontractors, and their agents to maintain and retain sufficient Project Records to allow the auditors to verify all or a portion of the Claim, or to permit the auditor reasonable and timely access to the Project Records, shall constitute a waiver of the Claim and shall bar any recovery thereunder.

3.9.7.1 CONTRACTOR shall make available to OWNER and its auditors all Project Records, including but not limited to:

- a. Daily time sheets and supervisor's daily reports;
- b. Union agreements;
- c. Insurance, welfare, and benefits records;
- d. Payroll registers;
- e. Earnings records;
- f. Payroll tax forms;
- g. Material invoices and requisitions;
- h. Material cost distribution work sheets;
- i. Equipment records (list of company Equipment and rates);
- j. Subcontractors' (including Suppliers) invoices;
- k. Subcontractors' and agents' payment certificates;
- l. Canceled checks (payroll and Suppliers);
- m. Job cost report;
- n. Job payroll ledger;
- o. General ledger;
- p. Cash disbursements journal;
- q. All documents that relate to each and every claim, together with all documents that support the amount of damages as to each claim; and
- r. Work sheets used to prepare the claim establishing the cost components for items of the claim, including labor, benefits and insurance, Materials, Equipment, Subcontractors, all documents that establish the time periods, individuals involved, the hours for the individuals, and the rates for the individuals.

3.9.7.2 Full compliance by the CONTRACTOR with the provisions of this Article 3.8 is a contractual condition precedent to CONTRACTOR's right to seek judicial relief.

3.9.8 Audits – OWNER, its authorized representatives, any firm of auditors appointed by OWNER and other authorized governmental authorities shall have access at all reasonable times to all Project Records maintained by the CONTRACTOR and its Subcontractors and Suppliers and their respective agents and employees for the purpose of auditing and verifying the CONTRACTOR's costs claimed to be due and payable hereunder. OWNER shall also have the right to reproduce any such records. CONTRACTOR shall make said evidence (or, to the extent accepted by OWNER, authentic reproductions thereof) available to OWNER at the CONTRACTOR's offices at all reasonable times and without charge.

3.9.8.1 The operations of the CONTRACTOR and its Subcontractors and Suppliers shall be subject at any time to audits by OWNER and other authorized governmental authorities to verify compliance with all Contract requirements relative to practices, methods, procedures, and documentation required under generally accepted accounting practices and principles.

3.9.8.2 With respect to changes in the Work, the following shall apply:

- a. If the CONTRACTOR has submitted cost or pricing data in connection with the pricing of any change to the Work, OWNER and other authorized governmental authorities shall have the right to examine, copy, and audit Project Records, including computations and projections; related to negotiating, pricing, or performing the modification in order to evaluate the accuracy, completeness, and currency of the cost or pricing data.
- b. Unless the agreed-upon method of payment for any change in the Work is to be on a time and material basis, the CONTRACTOR shall maintain and segregate relevant Project Records, including cost and pricing data, books, documents, and any other accounting evidence sufficient to properly reflect all direct and indirect costs of whatever nature claimed to have been incurred or anticipated to be incurred.
- c. At any time during the term of the Contract and for a period of three years from the date of Final Payment under the Contract, OWNER shall have the right to examine all Project Records, including but not limited to books, documents, and other data that relate to the negotiation and/or performance of any Work, for the purpose of evaluating the accuracy and completeness of the cost or pricing data submitted by the CONTRACTOR.
- d. To the extent that the examination reveals inaccurate, incomplete, or non-current data, the data shall be considered defective. If the audit indicates the CONTRACTOR has been overpaid under a previous payment application such overpayment will be credited against current progress payment applications, and the Change Order price shall be adjusted.
- e. OWNER or its authorized representatives may require that the CONTRACTOR supply appropriate documentation to support the prices proposed for changes in the Work and may refuse to complete negotiations until satisfactory documentation is submitted. CONTRACTOR's Project Records pertaining to such Change Order pricing shall be subject to audit and inspection.
- f. Also subject to audit review by OWNER, or its authorized representatives, shall be the CONTRACTOR's Project Records relating to those items on a progress payment application that relate to the following:
 - g. Work performed on a time and materials basis;
 - h. Materials not yet incorporated into the Project; and

- i. Work performed under a Change Order negotiated on a time and materials, unit price, or lump sum basis.
- j. If the audit indicates that the CONTRACTOR has been overpaid under a previous payment application, that overpayment shall be deducted from current progress payment applications.

4. ARTICLE 4 - LANDS AND PHYSICAL CONDITIONS:

4.1 AVAILABILITY OF LANDS:

- 4.1.1 The Owner shall furnish as indicated in the Contract Documents, the lands upon which the Work is to be performed, rights-of-way and easements for access thereto, and such other lands which are designated for use of the Contractor in connection with the Work.
- 4.1.2 Easements for permanent structures or permanent changes in existing facilities will be obtained and paid for by the Owner, unless otherwise provided in the Contract Documents.
- 4.1.3 The Contractor shall provide for all additional lands and access thereto that may be required for temporary construction facilities or storage of materials and equipment.

4.2 VISIT TO SITE:

- 4.2.1 The execution of the Contract by the Contractor is considered a representation that the Contractor has visited and carefully examined the site and is satisfied as to the conditions to be encountered in performing the Work and as to the requirements of the Contract Documents.

4.3 EXPLORATIONS AND REPORTS:

- 4.3.1 Reference may be made in the Contract Documents for identification of those reports of explorations and tests of subsurface conditions at the site that have been utilized by the Owner in preparation of the Contract Documents.
- 4.3.2 The Contractor may for his purposes rely upon the accuracy of the factual data contained in such reports, but not upon interpretations or opinions drawn from such factual data contained therein or for the completeness or sufficiency thereof.
- 4.3.3 Except as indicated in the immediately preceding sentence and in paragraphs 4.4 and 9.9, Contractor shall have full responsibility with respect to surface and subsurface conditions at the site.

4.4 UTILITIES:

- 4.4.1 The horizontal and vertical locations of known underground utilities as shown or indicated by the Contract Documents are approximate and are based on

information and data furnished to the Owner by the owners of such underground utilities.

4.4.2 The Contractor shall have full responsibility for:

4.4.2.1 Reviewing and checking all information and data concerning utilities.

4.4.2.2 Locating all underground utilities shown or indicated in the Contract Documents which are affected by the Work.

4.4.2.3 Coordination of the Work with the owners of all utilities during construction.

4.4.2.4 Safety and protection of all utilities as provided in paragraph 6.16.

4.4.2.5 Repair of any damage to utilities resulting from the Work in accordance with paragraphs 4.4.4 and 4.5.

4.4.3 If Work is to be performed by any utility owner, the Contractor shall cooperate with such owner to facilitate the Work.

4.4.4 In the event of interruption to any utility service as a result of accidental breakage or as a result of being exposed or unsupported, the Contractor shall promptly notify the utility owner and the Owner.

4.4.5 If service is interrupted repair Work shall be continuous until the service is restored.

4.4.6 No Work shall be undertaken around fire hydrants until provisions for continued service have been approved by the local fire authority.

4.4.7 No Work shall be undertaken within the project limits until the Contractor has provided to the Owner a locate confirmation number from Alaska Digline and identified in the field, utility locates prior to any ground disturbance activities deeper than 6 inches. The Contractor will be required to maintain a record of the utility locates and remark any locates that are lost or destroyed.

4.5 DAMAGED UTILITIES:

4.5.1 When utilities are damaged by the Contractor, the utility owner shall have the choice of repairing the utility or having the Contractor repair the utility.

4.5.2 In the following circumstances, the Contractor shall reimburse the utility Owner for repair costs or provide at no cost to the utility owner or the Owner, all materials, equipment and labor necessary to complete repair of the damage:

4.5.2.1 When the utility is shown or indicated in the Contract Documents.

4.5.2.2 When the utility has been located by the utility owner.

4.5.2.3 When no locate was requested by the Contractor for utilities shown or indicated in the Contract Documents.

4.5.2.4 All visible utilities.

4.5.2.5 When the Contractor could have, otherwise, reasonably been expected to be aware of such utility.

4.5.2.6 When the Contractor has failed to have the utilities located or maintained the locate location marks.

4.6 UTILITIES NOT SHOWN OR INDICATED:

- 4.6.1 If, while directly performing the Work, an underground utility is uncovered or revealed at the site which was not shown or indicated in the Contract Documents and which the Contractor could not reasonably have been expected to be aware of, the Contractor shall, promptly after becoming aware thereof and before performing any Work affected thereby (except in an emergency as permitted by paragraph 6.18) identify the Owner of such underground facility and give written notice thereof to that owner and to the Owner.
- 4.6.2 The Owner will promptly review the underground utility to determine the extent to which the Contract Documents and the Work should be modified to reflect the impacts of the discovered utility.
- 4.6.3. The Contract Documents will be amended or supplemented to the extent necessary through the issuance of a Change Order by the Owner.
- 4.6.4 During such time, the Contractor shall be responsible for the safety and protection of such underground utility as provided in paragraph 6.16.
- 4.6.5 The Contractor may be allowed an increase in the Contract Amount or an extension of the Contract Time, or both, to the extent that they are directly attributable to the existence of any underground utility that was not shown or indicated in the Contract Documents and which the Contractor could not reasonably have been expected to be aware of.

4.7 SURVEY CONTROL:

- 4.7.1 The Owner will identify what he or she deem sufficient horizontal and vertical control data to enable the Contractor to survey and layout the Work.
- 4.7.2 If the Contractor deems that additional control is need to complete the work it shall be the Contractor's responsibility to place the additional control. The Contractor will be required to provide copies of the survey info and data of the additional control to the Owner.
- 4.7.3 All survey control work shall be performed under the direct supervision of a registered Land Surveyor.
- 4.7.4 Upon completion of survey work, all equipment and unused materials shall be removed and the Owner's property shall be left in a neat and clean condition satisfactory to the Owner.
- 4.7.5 Should the Contractor or its subcontractor fail to comply with the preceding subparagraph, the Owner may perform the required clean-up. All Owner costs and expenses for performing this work shall be collected from the Contractor.

5. ARTICLE 5 - BONDS, INSURANCE, AND INDEMNIFICATION:

5.1 DELIVERY OF BONDS:

5.1.1 When the Contractor delivers the executed Contract to the Owner, the Contractor shall also deliver to the Owner such bonds as the Contractor may be required to furnish in accordance with paragraph 5.2.

5.2 BONDS:

5.2.1 The Contractor shall furnish Performance and Payment Bonds, each in an amount as shown on the Contract as security for the faithful performance and payment of all Contractors' obligations under the Contract Documents.

5.2.2 These bonds shall remain in effect for one year after the date of Final Completion and until all obligations under this Contract, except special guarantees as per paragraph 12.7, have been met.

5.2.3 All bonds shall be furnished on forms provided by the Owner (or copies thereof) and shall be executed by such Sureties as are authorized to do business in the State of Alaska.

5.2.4 The Owner may at his option copy the Surety with notice of any potential default or liability.

5.3 REPLACEMENT OF BOND AND SURETY:

5.3.1 If the Surety on any bond furnished in connection with this Contract is declared bankrupt or becomes insolvent or its right to do business is terminated in any state where any part of the Project is located or it ceases to meet the requirements of paragraph 5.2, or otherwise becomes unacceptable to the Owner, or if any such Surety fails to furnish reports as to his financial condition as requested by the Owner, the Contractor shall within five days thereafter substitute another bond and Surety, both of which must be acceptable to Owner.

5.4 INSURANCE REQUIREMENTS:

5.4.1 The Contractor shall carry and maintain throughout the life of this Contract, at its own expense, insurance not less than the amounts and coverage herein specified, and the Owner shall be named as an additional named insured under the insurance coverage so specified, with respect to the performance of the Work.

5.4.2 There shall be no right of subrogation against the Owner or its agents performing work in connection with the Work, and this waiver of subrogation shall be endorsed upon the policies.

5.4.3 Insurance shall be placed with the companies acceptable to the Owner, and these policies providing coverage there under shall contain provisions that no cancellation or material changes in the policy shall become effective except upon 30 days prior written notice thereof to the Owner.

5.4.4 Prior to commencement of the Work, the Contractor shall furnish certificates to the Owner, in duplicate, evidencing that the insurance policy provisions required hereunder are in force.

- 5.4.5 Acceptance by the Owner of deficient evidence of insurance does not constitute a waiver of Contract insurance requirements.
- 5.4.6 The Contractor shall furnish the Owner with certified copies of policies upon request. The minimum coverages and limits required are as follows:
- 5.4.7 Worker's Compensation insurance in accordance with the statutory coverages required by the State of Alaska and Employers Liability insurance with limits not less than \$1,000,000 and, where applicable, insurance in compliance with any other statutory obligations, whether State or Federal, pertaining to the compensation of injured employees assigned to the Work, including but not limited to Voluntary Compensation, Federal Longshoremen and Harbor Workers Act, Maritime and the Outer Continental Shelf's Land Act and the Federal Employers Liability Act.
- 5.4.8 Commercial General Liability with limits not less than \$2,000,000 per occurrence and \$2,000,000 aggregate for Bodily Injury and Property Damage, including coverage for Premises and Operations Liability, Products and Completed Operations Liability, Contractual Liability, Broad Form Property Damage Liability and Personal Injury Liability. Coverage shall not contain any exclusions of Explosion, Collapse, or Underground.
- 5.4.9 Commercial Automobile Liability on all owned, non-owned, hired and rented vehicles with limits of liability of not less than \$1,000,000 Combined Single Limit for Bodily Injury and Property Damage per each accident or loss.
- 5.4.10 If Work involves use of aircraft, Aircraft Liability insurance covering all owned and non-owned aircraft with a per occurrence limit of not less than \$5,000,000.
- 5.4.11 If Work involves use of watercraft, Protection and Indemnity insurance with limits not less than \$5,000,000 per occurrence. Hull and Machinery coverage is to be carried on the vessel for the full current market value. This coverage requirement may be waived at the discretion of the Owner if the Contractor self-insures the equipment and will waive all rights of recovery against the Owner in writing.
- 5.4.12 Where applicable, Professional Liability insurance with limits of not less than \$1,000,000 per claim and \$2,000,000 aggregate, subject to a maximum deductible \$10,000 per claim. The Owner has the right to negotiate increase of deductibles subject to acceptable financial information of the policyholder.
- 5.4.13 Where applicable, Pollution Liability insurance with a Project limit of not less than \$5,000,000 to include coverage for Asbestos, Hazardous Materials, Lead or other related environmental hazards.
- 5.4.14 Builder's Risk Insurance: Coverage shall be on an "All Risk" completed value basis and protect the interests of the Owner the Contractor and his subcontractors. Coverage shall include all materials, equipment and supplies that are intended for specific installation in the Project while such materials, supplies and equipment are located at the Project site and in transit from port of arrival to jobsite and while temporarily located away from the Project site.

5.4.15 All insurance policies as described above are required to be written on an "occurrence" basis. In the event occurrence coverage is not available, the Contractor agrees to maintain "claims made" coverage for a minimum of two years after Project Completion.

a. Other Coverages: As specified in Supplemental Conditions.

b. In addition to providing the above coverages the CONTRACTOR shall, in any contract or agreement with Subcontractors performing work, require that all indemnities and waivers of subrogation it obtains, and that any stipulation to be named as an additional insured it obtains, also be extended to waive rights of subrogation against the OWNER and to add the OWNER as an additional named indemnitee and as an additional insured.

5.4.16 CONTRACTOR shall furnish evidence of insurance to the OWNER before award of the Contract. All other coverage, including required subcontractor furnished insurance shall be evidenced prior to commencement of Work. Acceptance by the OWNER of deficient evidence does not constitute a waiver of Contract requirements as provided for by the Contract Documents.

The evidence shall be issued to the OWNER and shall be either a certificate of insurance or the policy declaration page with all required endorsements attached and must:

Denote the type, amount, and class of operations covered;

Show the effective (and retroactive) dates of the policy;

Show the expiration date of the policy;

Include all required endorsements;

Be executed by the carrier's representative; and

If a certificate of insurance, include the following statement:

"This is to certify that the policies described herein comply with all aspects of the insurance requirements of (Project Name and Number). The insurance carrier agrees that it shall notify the Contracting Officer, in writing, at least 30 days before cancellation of any coverage or reduction in any limits of liability."

5.5 INDEMNIFICATION:

5.5.1 The Contractor shall indemnify, save harmless, and defend the Owner and its agents and its employees from any and all claims or actions for injuries or damages sustained by any person or property arising directly or indirectly from the Work or the Contractor's performance of this Contract; however, this provision has no effect if, but only if, the sole proximate cause of the injury or damage is the negligence of the Owner or its agents.

6. ARTICLE 6 - CONTRACTOR'S RESPONSIBILITIES:

6.1 SUPERVISION OF WORK:

- 6.1.1 The Contractor shall supervise and direct the Work competently and efficiently, devoting such attention thereto and applying such skills and expertise as may be necessary to perform the Work in accordance with the Contract Documents.
- 6.1.2 All Work under this Contract shall be performed in a skillful and workmanlike manner. The Contractor shall be solely responsible for the means, methods, techniques, sequences and procedures of construction.
- 6.1.3 The Contractor shall keep on the Work at all times during its progress a competent resident superintendent. The Owner shall be advised in writing of the superintendent's name, local address, and telephone number. This written advice is to be kept current until Final Completion.
- 6.1.4 The superintendent will be the Contractor's representative at the site and shall have full authority to act and sign documents on behalf of the Contractor.
- 6.1.5 All communications given to the superintendent shall be as binding as if given to the Contractor.
- 6.1.6 The Contractor shall cooperate with the Owner in every way possible.
- 6.1.7 Any Contractor's supervisor's, manager's or personnel that the Owner deems uncooperative, disruptive, combative or lacking sufficient knowledge, the Owner, in writing, will demand that person be replaced. The replacement of said person will be at the sole discretion of the Owner and the Contractor will have 7 days to comply and the Contractor will do so without affecting any of the Contractor's obligations to the Owner under this Contract.

6.2 CHARACTER OF WORKERS:

- 6.2.1 The Contractor shall provide a sufficient number of competent, suitable qualified personnel to survey and lay out the Work and perform construction as required by the Contract Documents.
- 6.2.2 The Contractor shall at all times maintain good discipline and order at the site.
- 6.2.3 The Owner may, in writing, require the Contractor to remove from the Work any employee the Owner deems incompetent, careless, or otherwise detrimental to the progress of the Work, but the Owner shall have no duty to exercise this right.

6.3 CONTRACTOR TO FURNISH:

- 6.3.1 Unless otherwise specified in the Contract Documents, the Contractor shall furnish and assume full responsibility for all materials, equipment and machinery, tools, appliances, fuel, power, light, heat, telephone, water, sanitary facilities, temporary facilities and all other facilities and incidentals necessary for the furnishing, performance, testing, start-up and completion of the Work.

6.4 MATERIALS AND EQUIPMENT:

- 6.4.1 All materials and equipment shall be of specified quality and new, except as otherwise provided in the Contract Documents. If required by the Owner, the Contractor shall furnish satisfactory evidence (including reports of required tests) as to the kind and quality of materials and equipment.
- 6.4.2 All materials and equipment shall be applied, installed, connected, erected, used, cleaned, and conditioned in accordance with the instructions of the applicable Supplier except as otherwise provided in the Contract Documents; but no provision of any such instructions will be effective to assign to the Owner or any of the Owner's Consultants, agents or employees, any duty or authority to supervise or direct the furnishing or performance of the Work or any duty or authority to undertake responsibility contrary to the provisions of Paragraphs 2.3 or 2.4.

6.5 ANTICIPATED SCHEDULES:

- 6.5.1 The construction of this project shall be planned and recorded with a Critical Path Method ("CPM") schedule. The schedule shall be used for coordination and monitoring of all work under the contract including all activity of subcontractors, manufacturers, supplies, utility companies and review activity of the Owner. Within a reasonable time prior to the preconstruction conference, the Contractor shall submit for Owner's approval, a detailed initial CPM schedule. The schedule shall meet the requirements set forth below. The construction time for the entire project shall not exceed the specified Contract Time. Following the Owner's review, if revisions to the proposed CPM schedule are required, the Contractor shall do so promptly. The CPM schedule must be finalized within 30 days of the Notice to Proceed. The contractor shall submit a baseline schedule narrative and progress narratives including:
 - 6.5.1.1 Describe the construction philosophy supporting the approach to the work outlined in the baseline schedule.
 - 6.5.1.2 Describe any limited resources, potential conflicts, or other salient items that may affect the schedule and how they may be resolved.
 - 6.5.1.3 Describe the critical path and identify challenges that may arise associated with the critical path.
 - 6.5.1.4 Provide list of applicable activities and justification for usage of: Activities with durations exceeding 15 days, Constraints, Unusual calendars Assumptions and calculations for non-work weather days added to calendars, and Lags.
- 6.5.2 The CPM schedule shall be presented as a Precedence Diagram Network developed in the activity-on-node format and shall include a description of no less than 15 major project activities, the duration of each of the project activities, the resources required for each of the project activities, including:
 - 6.5.2.1 labor, showing workdays per week, holidays, shifts per day, men per shift, and hours per shift;

- 6.5.2.2 Equipment, including the number of units of each type of equipment; and Materials.
- 6.5.3 Owner reserves the right to adjust or add to the required project activities.
- 6.5.4 The activity-on-node diagram shall show the sequence and interdependence of all activities required for complete performance of all items of Work under this Contract, including shop drawings submittals and reviews and fabrication and delivery activities. No activity duration shall be longer than 15 working days without the Owner's approval. Owner reserves the right to limit the number of activities on the schedule. Clearly show the critical path using the longest path schedule option setting to define the critical activities.
- 6.5.5 Before proceeding with any Work on site, the Contractor shall prepare, submit, and receive the Owner's approval of a 60-Day Preliminary Schedule. The Preliminary Schedule shall provide a detailed breakdown of activities scheduled for the first 60 days of the project and summary of activities for Work beyond 60 days. Said schedule shall include mobilization, submittals, procurement, and construction.
- 6.5.6 No Work may be pursued at the site without an approved 60-Day Preliminary Schedule or an approved CPM schedule. A Finalized CPM Schedule with detailed breakdown of activities for the entire contract period shall be submitted prior to the first progress payment and accepted prior to application of the second progress payment. The Contractor shall create a baseline schedule of the Accepted Finalized Schedule.
- 6.5.7 Within fifteen days after the date of the Notice to Proceed, the Contractor shall submit to the Owner for review: anticipated schedule of Shop Drawing submissions, and anticipated Schedule of Values for all of the Work which will include quantities and prices of items aggregating the Contract Amount and will subdivide the Work into no less than 15 line item component parts to serve as the basis for progress payments during construction.
- 6.5.8 Such prices will include an appropriate amount of overhead and profit applicable to each item of Work which will be confirmed in writing by the Contractor at the time of submission.
- 6.5.9 The CPM schedule shall be submitted in a MS Project 2010 format. Other formats maybe use with the Owner's approval. For each submittal required hereunder, Contractor shall submit one copy in an electronic format and one hard copy.

6.6 FINALIZING SCHEDULES:

- 6.6.1 Prior to processing the first Application for Payment, the Owner and the Contractor will finalize the schedules required by paragraph 6.5.
- 6.6.2 Acceptance by the Owner of the progress schedule will neither impose on the Owner nor relieve the Contractor from full responsibility for the progress or scheduling of the Work.

- 6.6.3 If accepted, the Finalized Schedule of Shop Drawings and other required submissions will be acceptable to the Owner as providing a workable arrangement for processing the submissions. If accepted the Finalized Schedule of Values will be acceptable to the Owner as an approximation of anticipated value of Work accomplished over the anticipated Contract Time.
- 6.6.4 Receipt and acceptance of a schedule submitted by the Contractor shall not be construed to assign responsibility for performance or contingencies to the Owner or relieve the Contractor of his responsibility to adjust his forces, equipment, and work schedules as may be necessary to insure completion of the Work within prescribed Contract Time.
- 6.6.5 Should the prosecution of the Work be discontinued for any reason, the Contractor shall notify the Owner at least 24 hours in advance of resuming operations.

6.7 ADJUSTING SCHEDULES:

- 6.7.1 Progress meetings will be held bi-weekly by the Owner and the Contractor for the purpose of updating the CPM schedule. Progress will be reviewed to verify finish dates of completed activities, remaining duration of uncompleted activities, and any proposed logic and/or time estimate revisions. The Contractor shall submit a reviewed CPM schedule within seven (7) calendar days after this meeting. The revised schedule shall show finish dates of completed activities and updated times for the remaining Work, including any addition, deletion, or revision of activities required by contract modification. In submitting a revised CPM schedule, the Contractor shall state specifically the reason for the revision and the adjustments made in this schedule or methods of operation to ensure completion of all Work within the Contract Time.
- 6.7.2 The Contract Time will be adjusted only for causes specified in this Contract. As determined by CPM analysis, only delays in activities, which affect milestones dates or contract completion dates will be considered for a time extension. It is understood and agreed by the Owner and the Contractor that float is shared equally. Total project float is defined as the cumulative length of time activities can be delayed before they affect the finish date of the project or a contractual milestone. Float is a shared commodity between the contractor and the owner and not for the exclusive use or financial benefit of either party. Either party has full use of the project float until it is depleted. Project float is the time between the scheduled completion of the Work and Substantial Completion and is a resource available to both the Owner and the Contractor. Neither owns the float: the Project owns the float. Do not sequester project total float through manipulating calendars, extending activities duration, or any other such methodology. As such, liability for delay of the Substantial Completion date rests with the party whose actions, last in time, actually cause delay to the Substantial Completion date.
- 6.7.3 In addition to the CPM schedule, every week during construction, the Contractor shall submit a work plan detailing his/her proposed operations for the forthcoming two (2) weeks. The work plan presented shall be a time scaled Two Week Look Ahead bar chart based and correlated by activity number to the current schedule. In the event portions of the Work affecting critical milestone dates or contract completion dates are in danger of being delayed, or actually are delayed, the

Contractor shall develop and present a plan for remedial action. This plan shall detail the following:

- 6.7.3.1 Work activities;
- 6.7.3.2 Manpower involved by trade;
- 6.7.3.3 Work hours;
- 6.7.3.4 Equipment involved; and
- 6.7.3.5 The location of the work to be performed.

6.7.4 Preparation and updating of the CPM schedule and Two Week Work Plans will not be paid for directly. Failure to submit the CPM work schedule and Two Week Work Plans as specified will result in partial withholding of progress payments.

6.8 SUBSTITUTES OR "OR-EQUAL" ITEMS:

6.8.1 Whenever materials or equipment are specified or described in the Contract Documents by using the name of a proprietary item or the name of a particular Supplier the naming of the item is intended to establish the type, function and quality required.

6.8.2 Unless the name is followed by words indicating that no substitution is permitted, materials or equipment of other Suppliers may be accepted by the Owner only if sufficient information is submitted by the Contractor which clearly demonstrates to the Owner that the material or equipment proposed is equivalent or equal in all aspects to that named.

6.8.3 Requests for review of substitute items of material and equipment will not be accepted by the Owner from anyone other than the Contractor.

6.8.4 If the Contractor wishes to furnish or use a substitute item of material or equipment, the Contractor shall make written application to the Owner for acceptance thereof, certifying that the proposed substitute will perform adequately the functions and achieve the results called for by the general design, be similar and of equal substance to that specified and be suited to the same use as that specified.

6.8.5 The application will state that the evaluation and acceptance of the proposed substitute will not delay the Contractor's achievement of Substantial Completion on time, whether or not acceptance of the substitute for use in the Work will require a change in any of the Contract Documents (or in the provisions of any other direct Contract with the Owner for Work on the Project) to adapt the design to the proposed substitute and whether or not incorporation or use of the substitute in connection with the Work is subject to payment of any license fee or royalty.

6.8.6 All variations of the proposed substitute from that specified will be identified in the application and available maintenance, repair and replacement service will be indicated.

6.8.7 The application will also contain an itemized estimate of all costs that will result directly or indirectly from acceptance of such substitute, including costs of redesign and claims of other contractors affected by the resulting change, all of which shall be considered by the Owner in evaluating the proposed substitute.

6.8.8 The Owner may require the Contractor to furnish at the Contractor's expense additional data about the proposed substitute.

6.8.9 The Owner may reject any substitution request which the Owner determines is not in the best interest of the Owner.

6.9 SUBSTITUTE MEANS AND METHODS:

6.9.1 If a specific means, method, technique, sequence or procedure of construction is indicated in or required by the Contract Documents, the Contractor may furnish or utilize a substitute means, method, sequence, technique or procedure of construction acceptable to the Owner, if the Contractor submits sufficient information to allow the Owner to determine that the substitute proposed is equivalent to that indicated or required by the Contract Documents.

6.10 EVALUATION OF SUBSTITUTION:

6.10.1 The Owner will be allowed a reasonable time within which to evaluate each proposed substitute. . The time needed to evaluate the Contractors proposal will be dependent on the nature of the proposal; the Owner will be allowed a minimum of 21 days for review. The Owner will be the sole judge of acceptability, and no substitute will be ordered, installed or utilized without the Owner's prior written acceptance which will be evidenced by either a Change Order or a Shop Drawing approved in accordance with paragraphs 6.19 and 6.20. The Owner may require the Contractor to furnish at the Contractor's expense a special Performance Bond or other Surety with respect to any substitute.

6.11 DIVIDING THE WORK:

6.11.1 The divisions and sections of the Specifications and the identifications of any Drawings shall not control the Contractor in dividing the Work among subcontractors or suppliers or delineating the Work to be performed by any specific trade, except as required by law.

6.12 SUBCONTRACTORS:

6.12.1 The Contractor may utilize the services of licensed specialty subcontractors on those parts of the Work which, under normal contracting practices, are performed by licensed specialty subcontractors, in accordance with the following conditions:

6.12.2 The Contractor shall not award any Work to any subcontractor without prior written Approval of the Owner. This Approval will not be given until the Contractor submits to the Owner a written statement concerning the proposed award to the subcontractor which shall contain required E.E.O. Documents, evidence of insurance, and a copy of the proposed subcontract executed by the subcontractor.

- 6.12.3 No acceptance by the Owner of any such subcontractor shall constitute a waiver of any right of the Owner to reject Defective Work.
- 6.12.4 The Contractor shall be fully responsible to the Owner for all acts and omissions of the subcontractors, suppliers and other persons and organizations performing or furnishing any of the Work under a direct or indirect Contract with Contractor just as Contractor is responsible for Contractor's own acts and omissions.
- 6.12.5 All Work performed for Contractor by a subcontractor will be pursuant to an appropriate written agreement between Contractor and the subcontractor which specifically binds the subcontractor to the applicable terms and conditions of the Contract Documents for the benefit of the Owner and contains waiver provisions as required by paragraph 13.17 and termination provisions as required by Article 14.
- 6.12.6 Nothing in the Contract Documents shall create any contractual relationship between the Owner and any such subcontractor, supplier or other person or organization, nor shall it create any obligation on the part of the Owner to pay or to see to the payment of any moneys due any such subcontractor, supplier or other person or organization except as may otherwise be required by Regulatory Requirements.
- 6.12.7 The Owner will not undertake to settle any differences between or among the Contractor, subcontractors, or suppliers.
- 6.12.8 The Contractor and subcontractors shall coordinate their Work and facilitate general progress of Work.
- 6.12.9 Each trade shall afford other trades every reasonable opportunity for installation of their Work and storage of materials.
- 6.12.10 If cooperative Work of one trade must be altered due to lack of proper supervision, or failure to make proper provisions in time by another trade, such conditions shall be remedied by the Contractor with no change in Contract Amount or Contract Time.
- 6.12.11 The Contractor shall include on his own payrolls any person or persons working on the Contract who are not covered by written subcontract, and shall ensure that all subcontractors include on their payrolls all persons performing Work under the direction of the subcontractor.

6.13 USE OF PREMISES:

- 6.13.1 The Contractor shall confine construction equipment, the storage of materials and equipment and the operations of workers to the Project limits and approved remote storage sites and lands and areas identified in and permitted by Regulatory Requirements, rights-of-way, permits and easements, and shall not unreasonably encumber the premises with construction equipment or other materials or equipment.

- 6.13.2 The Contractor shall assume full responsibility for any damage to any such land or area, or to the owner or occupant thereof or of any land or areas contiguous thereto, resulting from the performance of the Work.
- 6.13.3 Should any claim be made against the Owner by any such owner or occupant because of the performance of the Work, the Contractor shall defend, indemnify and hold the Owner and its agents there from.
- 6.13.4 The Contractor shall provide the Owner with written and graphical plan of where laydown/staging areas are to be located, temporary facilities, fueling & maintenance areas and access roads whether or not they are located on the Owner's property.
- 6.13.4.1 The Owner may approve or disapprove any areas that are within the Project Limits or Owner's Property for any reason they deem prudent.
- 6.13.4.2 The Contractor will be required to provide a copy of an agreement for use of lands outside the project limits signed by the Contractor and legal Landowner. The agreement shall not bind the Owner or its Representatives in anyway and shall hold harmless the Owner and its Representatives.
- 6.13.4.3 The Owner or its Representatives shall have the right to enter any area or property the Contractor is utilizing for the prosecution of the work in order to verify that the Contractor is following all local, state and federal requirements.

6.14 STRUCTURAL LOADING:

- 6.14.1 The Contractor shall not load nor permit any part of any structure to be loaded in any manner that will endanger the structure, nor shall the Contractor subject any part of the Work or adjacent property to stresses or pressures that will endanger it.
- 6.14.2 Keep concrete culverts and bridges closed to traffic until permission to open them is received in writing from the Owner's Representative. No load is allowed on any span until the all concrete has attained a compressive strength of at least 80% of the ultimate strength ($f'c$) as shown in the Contract Documents and a minimum of 7 days of curing. The Engineer will determine the compressive strength from informational test cylinders cured on the site under temperature and moisture conditions similar to the concrete in the structure.

6.15 RECORD DOCUMENTS:

- 6.15.1 The Contractor shall maintain in a safe place at the site one record copy of all Drawings, Specifications, Addenda, Field Memos, Work Orders, Change Orders, Supplemental Agreements, and written interpretations and clarifications issued pursuant to paragraph 3.7 in good order and annotated to show all changes made during construction.

- 6.15.2 Copies of these record documents together with all approved samples and a counterpart of all approved Shop Drawings shall be provided to the Owner on site.
- 6.15.3 Upon completion of the Work, the annotated record documents, samples and Shop Drawings will be delivered to the Owner.
- 6.15.4 Record documents shall accurately record variations in the Work which vary from requirements shown or indicated in the Contract Documents.
- 6.15.5 One full-size set of plans is to be set aside in the Contractor's field office for recording all of the as-built changes made to the project during construction.
- 6.15.6 The contractor personnel associated with the change should enter all corrections, revisions, or additions to the work on the as-built drawings. New drawings or sketches should be added to the set as appropriate. The contractor personnel shall also date and initial each change or addition to the as-built. All changes or additions to the as-built drawings should be made in the color red.
- 6.15.7 Update the following information on the as-built drawings:
 - 6.15.7.1 Changes in horizontal or vertical alignment
 - 6.15.7.2 Changes in typical sections or new typical Sections
 - 6.15.7.3 New or revised utility locations
 - 6.15.7.4 Changes to electrical wiring diagrams and installations
 - 6.15.7.5 Changes to automated traffic recorders
 - 6.15.7.6 As built location and dimensions of all structures
 - 6.15.7.7 Changes in survey control or right of way/property monuments
 - 6.15.7.8 Changes in drainage features
 - 6.15.7.9 as-built data on materials sources including areas developed and waste areas (if included in the drawings)
 - 6.15.7.10 as-built location and dimensions of piles, foundation elevations and subsurface structural details
 - 6.15.7.11 revisions/substitutions of materials or equipment
 - 6.15.7.12 estimated quantities should be revised to final quantities
 - 6.15.7.13 all change document work.
 - 6.15.7.14 any change made during construction to a permanent feature of the project should be correctly shown on the final as-built drawings.
- 6.15.8 Record As-Built Changes shall be submitted for review with each pay request. The pay request will not be processed until the Record As-Built Drawings are up to date.

6.16 SAFETY AND PROTECTION:

- 6.16.1 The Contractor alone shall be responsible for initiating, maintaining and supervising all safety precautions and programs in connection with the Work.
- 6.16.2 The Contractor shall take all necessary precautions for the safety of, and shall provide the necessary protection to prevent damage, injury or loss to:

- 6.16.2.1 All employees on the Work and other persons and organizations who may be affected thereby;
- 6.16.2.2 All the Work and materials and equipment to be incorporated therein, whether in storage on or off the site; and
- 6.16.2.3 Other property at the site or adjacent thereto, including trees, shrubs, lawns, walks, pavements, roadways, structures, and utilities not designated for removal, relocation or replacement in the course of construction.
- 6.16.3 In the performance of this contract, the Contractor shall comply with all applicable Federal, State, and local laws governing safety, health, and sanitation. The contractor shall provide all safeguards, safety devices and protective equipment and take any other needed actions as it determines, or as the Owner may determine, to be reasonably necessary to protect the life and health of employees on the job and the safety of the public and to protect property in connection with the performance of the Work covered by the contract. It is a condition of this contract, and shall be made a condition of each subcontract entered into pursuant to this contract, that the Contractor and any subcontractor shall not permit any employee in performance of the contract, to work in surroundings or under conditions which are unsanitary, hazardous, or dangerous to his/her health or safety, as determined under the OSHA construction safety and health standards (29 CFR 1926) promulgated by the Secretary of Labor, in accordance with Section 107 of the Contract Work Hours and Safety Standards Act (40 U.S.C. 333). Pursuant to 29 CFR 1926.3, it is a condition of this contract that the Secretary of Labor or authorized representative thereof, shall have right of entry to any site of contract performance to inspect or investigate the matter of compliance with the construction safety and health standards and to carry out the duties of the Secretary under Section 107 of the Contract Work Hours and Safety Standards Act (40 U.S.C. 333).
- 6.16.4 The Contractor shall notify owners of adjacent property and utility owners when prosecution of the Work may affect them, and shall cooperate with them in the protection, removal, relocation and replacement of their property.
- 6.16.5 All damage, injury or loss to any property caused, directly or indirectly, in whole or in part, by the Contractor, any Subcontractor, supplier or any other person or organization directly or indirectly employed by any of them to perform or furnish any of the Work or anyone for whose acts any of them may be liable, shall be remedied by the Contractor with no change in Contract Amount or Contract Time except as stated in paragraph 4.6, except damage or loss attributable to unforeseeable causes beyond the control of and without the fault or negligence of the Contractor, including but not restricted to acts of God, or the public enemy or governmental authorities.
- 6.16.6 The Contractor's duties and responsibilities for the safety and protection of the Work shall continue until Final Completion except as otherwise expressly provided in connection with Substantial Completion.

6.16.7 The Contractor shall designate a responsible safety representative at the site. This person shall be the Contractor's superintendent unless otherwise designated in writing by the Contractor to the Owner.

6.16.8 The Contractor shall allow the Owner or the Owner's Representative to safely access the Work 24 hours of the day.

6.17 WORK SAFETY ON RAILROAD PROPERTY:

6.17.1 The safety of personnel, property, rail operations, and the public is of paramount importance in the prosecution of the Work pursuant to this contract. As reinforcement and in furtherance of overall safety measures to be observed by Contractor (and not by way of limitation), the following special safety rules shall be followed while working on Alaska Railroad Corporation ("ARRC") property. Further railroad safety information may be obtained from the ARRC Safety Office at 907-265-2265.

6.17.2 In the event Contractor or its subcontractor will be performing construction or other activities on or in close proximity to a railroad track, the Contractor shall be responsible for compliance with the Federal Railroad Administration's Roadway Worker Protection ("RWP") regulations (49 CFR 214, Subpart C). Under 49 CFR 214, Subpart C, railroad contractors are responsible for the training of their employees on these regulations. All RWP related Work shall be conducted in strict compliance with the RWP safety standards set forth in 49 CFR 214, Subpart C and the Contractor will be required to submit a Railroad Safety Plan to ARRC to demonstrate compliance with said safety standards prior to beginning any RWP related Work. Specific information on Railroad Safety Plans may be obtained from the ARRC Safety Office at 907-265-2440.

6.17.3 In the event Contractor will be performing construction or other activities on a railroad bridge, the provisions of 49 CFR 214 regarding bridge worker safety shall apply. All bridge related Work shall be conducted in strict compliance with the bridge worker safety standards set forth in 49 CFR 214 and the Contractor will be required to submit a Railroad Safety Plan to ARRC to demonstrate compliance with said safety standards prior to beginning any bridge related Work.

6.17.4 Contractor shall arrange with ARRC to keep itself informed on the time of arrival of all trains and shall stop any of Contractor's or Subcontractor's operations which might be or cause a hazard to the safe passage of the train past the Work site from 10 minutes before the expected arrival of the train until it has passed or at any other time as directed by the flagman.

6.17.5 ARRC flag protection is required before any activity can occur on or near a railroad operating facility such as a track, yard, bridge or shop building. For incidental work, such as surveying or inspection, an ARRC qualified flagman will provide a safety briefing prior to the commencement of the Work to discuss how and when protection from train traffic is to be provided. For any activity involving a disturbance or potential disturbance to the track, track embankment, or any railroad facility, ARRC may require a specific Railroad Safety Plan prior to startup. Projects which involve activities which cross the tracks or are longitudinal to the tracks will require

a specific Railroad Safety Plan and a one hour ARRC provided training course for Contractor's project supervisors prior to the initiation of Work on ARRC property.

- 6.17.6 The Contractor and/or Subcontractor shall arrange for ARRC flag protection when performing any Work within 20 feet of any track. All Work within 20 feet of the track shall cease when a train passes and all Contractor and Subcontractor employees shall maintain a distance of at least 20 feet from the track until the train has safely passed. In addition, any Work that could come within 20 feet of the track will cease when a train passes. For example, crane or pile driving activities shall stop when trains pass when the maximum boom and suspended load radius can come within 20 feet of the tracks. Pile driving shall not be done when trains are passing the Work site. Vehicles and other construction equipment shall not be operated or parked closer than 20 feet from any track without ARRC flag protection.
- 6.17.7 Track outages require ARRC's prior approval. Prior to a proposed track outage, the Contractor shall submit a closure plan to ARRC for approval. The plan will describe the Work to be accomplished, the equipment, manpower and other resources required, and the schedule. Once approved by ARRC, the Contractor shall follow the plan. ARRC reserves the right to assume control of the Work to reestablish rail service if the schedule is not met. Contractor shall bear all costs and damages which may result from failure to meet the closure schedule.
- 6.17.8 Whenever an ARRC flag person is required for performance of the Work, he or she will be provided by the ARRC at no expense to the Contractor. A minimum of 48 hours' notice is required for ARRC flag protection.

6.18 SAFETY REPRESENTATIVE

The CONTRACTOR shall designate a responsible safety representative at the Site. This person shall be the CONTRACTOR's superintendent unless otherwise designated in writing by the CONTRACTOR to the Project Manager.

6.19 EMERGENCIES:

- 6.19.1 In emergencies affecting the safety or protection of persons or the Work or property at the site or adjacent thereto, the Contractor, without special instruction or authorization from the Owner, is obligated to act to prevent threatened damage, injury or loss.
- 6.19.2 The Contractor shall give the Owner prompt written notice if the Contractor believes that any significant changes in the Work or variations from the Contract Documents is required because of the action taken in response to an emergency. A change will be authorized by one of the methods indicated in paragraph 9.2, as determined appropriate by the Owner.

6.20 SHOP DRAWINGS AND SAMPLES:

- 6.20.1 After checking and verifying all field measurements and after complying with applicable procedures specified in the Contract Documents, the Contractor shall submit to the Owner for review and Approval in accordance with the accepted

schedule of Shop Drawing submissions the required number of all Shop Drawings, which will bear a stamp or specific written indication that the Contractor has satisfied Contractor's responsibilities under the Contract Documents with respect to the review of the submission. All submissions will be identified as the Owner may require. The data shown on the Shop Drawings will be complete with respect to quantities, dimensions, specified performance and design criteria, materials and similar data to enable the Owner to review the information as required.

- 6.20.2 The Contractor shall also submit to the Owner for review and Approval with such promptness as to cause no delay in Work, all samples required by the Contract Documents. All samples will have been checked by and accompanied by a specific written indication that the Contractor has satisfied Contractor's responsibilities under the Contract Documents with respect to the review of the submission and will be identified clearly as to material, Supplier, pertinent data such as catalog numbers and the use for which intended.
- 6.20.3 Before submission of each Shop Drawing or sample the Contractor shall have determined and verified all quantities, dimensions, specified performance criteria, installation requirements, materials, catalog numbers and similar data with respect thereto and reviewed or coordinated each Shop Drawing or sample with other Shop Drawings and samples and with the requirements of the Work and the Contract Documents.
- 6.20.4 At the time of each submission the Contractor shall give the Owner specific written notice of each variation that the Shop Drawings or samples may have from the requirements of the Contract Documents, and, in addition, shall cause a specific notation to be made on each Shop Drawing submitted to the Owner for review and Approval of each such variation.
- 6.20.5 All variations of the proposed Shop drawing from that specified will be identified in the submission and available maintenance, repair and replacement service will be indicated.
- 6.20.6 The submittal will also contain an itemized estimate of all costs that will result directly or indirectly from acceptance of such variation, including costs of redesign and claims of other contractors affected by the resulting change, all of which shall be considered by the Owner in evaluating the proposed variation.
- 6.20.7 If the variation may result in a change of Contract Time or Amount, or Contract responsibility, and is not minor in nature, the Contractor must submit a written request for Change Order with the variation to notify the Owner of his intent.
- 6.20.8 The Owner may require the Contractor to furnish at the Contractor's expense additional data about the proposed variation.
- 6.20.9 The Owner may reject any variation request which the Owner determines is not in the best interest of the Owner.

6.21 SHOP DRAWING AND SAMPLE REVIEW:

- 6.21.1 The Owner will review with reasonable promptness Shop Drawings and samples, but the Owner's review will be only for conformance with the design concept of the Project and for compliance with the information given in the Contract Documents and shall not extend to means, methods, techniques, sequences or procedures of construction (except where a specific means, method, technique, sequence or procedure of construction is indicated in or required by the Contract Documents) or to safety precautions or programs incident thereto.
- 6.21.2 The time needed to evaluate the Contractors submittal will be dependent on the nature of the proposal; the Owner will be allowed a minimum of 14 days for review.
- 6.21.3 The review of a separate item as such will not indicate acceptance of the assembly in which the item functions.
- 6.21.4 The Contractor shall make corrections required by the Owner and shall return the required number of corrected copies of Shop Drawings and submit as required new samples for review.
- 6.21.5 The Contractor shall direct specific attention in writing to revisions other than the corrections called for by the Owner on previous submittals.
- 6.21.6 The Owner's review of Shop Drawings or samples shall not relieve Contractor from responsibility for any variation from the requirements of the Contract Documents unless the Contractor has in writing advised the Owner of each such variation at the time of submission as required by paragraph 6.19.4.
- 6.21.7 The Owner, if he so determines, may give written Approval of each such variation by Change Order, except that, if the variation is minor and no Change Order has been requested a specific written notation thereof incorporated in or accompanying the Shop Drawing or sample review comments shall suffice as a modification.
- 6.21.8 No Approval by the Owner will relieve the Contractor from responsibility for errors or omissions in the Shop Drawings or from responsibility for having complied with the provisions of paragraph 6.20.3.
- 6.21.9 Where a Shop Drawing or sample is required by the Specifications, any related Work performed prior to the Owner's review of the pertinent submission will be at the sole expense and responsibility of the Contractor.

6.22 MAINTENANCE DURING CONSTRUCTION:

- 6.22.1 The Contractor shall maintain the Work during construction and until Substantial Completion, at which time the responsibility for maintenance shall be established in accordance with paragraph 13.10.

6.23 CONTINUING THE WORK:

- 6.23.1 The Contractor shall carry on the Work and adhere to the progress schedule during all disputes or disagreements with the Owner.

6.23.2 No Work shall be delayed or postponed pending resolution of any disputes, disagreements, or claims except as the Contractor and the Owner may otherwise agree in writing.

6.24 CONSENT TO ASSIGNMENT:

6.24.1 The Contractor shall obtain the prior written consent of the Owner to any proposed assignment of any interest in, or part of this Contract.

6.24.2 The consent to any assignment or transfer shall not operate to relieve the Contractor or his Sureties of any of his or its obligations under this Contract or the Performance Bonds.

6.24.3 Nothing herein contained shall be construed to hinder, prevent, or affect an assignment of monies due, or to become due hereunder, made for the benefit of the Contractor's creditors pursuant to law.

6.25 USE OF EXPLOSIVES:

6.25.1 When the use of explosives is necessary for the prosecution of the Work, the Contractor shall exercise the utmost care not to endanger life or property, including new Work and shall follow all Regulatory Requirements applicable to the use of explosives.

6.25.2 The Contractor shall be responsible for all damage resulting from the use of explosives.

6.25.3 All explosives shall be stored in a secure manner in compliance with all Regulatory Requirements, and all such storage places shall be clearly marked.

6.25.4 Where no Regulatory Requirements apply, safe storage shall be provided not closer than 1,000 feet from any building, camping area, or place of human occupancy.

6.25.5 The Contractor shall notify each public utility owner having structures in proximity to the site of his intention to use explosives. Such notice shall be given sufficiently in advance to enable utility owners to take such steps as they may deem necessary to protect their property from injury.

6.25.6 However, the Contractor shall be responsible for all damage resulting from the use of the explosives, whether or not, utility owners act to protect their property.

6.26 CONTRACTOR'S RECORDS:

6.26.1 Records of the Contractor and subcontractors relating to personnel, payrolls, invoices of materials, and any and all other data relevant to the performance of the Contract, must be kept on a generally recognized accounting system.

6.26.2 Such records must be available during normal Work hours to the Owner for purposes of investigation to ascertain compliance with Regulatory Requirements and provisions of the Contract Documents.

- 6.26.3 Payroll records must contain the name and address of each employee, his correct classification, social security number, rate of pay, daily and weekly number of hours of worked, deductions made, and actual wages paid and any other information required by the U.S. and/or State Department of Labor.
- 6.26.4 The Contractor and subcontractors shall make employment records available for inspection by the Owner and representatives of the U.S. and/or State Department of Labor and will permit such representatives to interview employees during working hours on the Project.
- 6.26.5 Records of all communications between the Owner and the Contractor and other parties, where such communications affected performance of this Contract, must be kept by the Contractor and maintained for a period of three years from Final Completion.
- 6.26.6 The Owner or its assigned representative may perform an audit of these records during normal work hours after written notice to the Contractor.

6.27 CONSTRUCTION QUALITY CONTROL PLAN:

- 6.27.1 The Contractor shall establish and maintain an effective quality management system. The quality management system shall consist of plans, procedures, and the organization necessary to provide material, equipment, and workmanship to comply with the requirements of the contract documents. The system shall cover the proposed sequence of the work including both on-site and off-site operations. To meet this requirement, the Contractor shall prepare a Construction Quality Control (CQC) plan that addresses all quality control requirements specified in the contract documents. A complete, detailed CQC plan shall be submitted to the Project Manager at least 30 days prior to commencement of any Work on the Project. The CQC must be approved in writing by the Project Manager prior to proceeding with the Work. The Contractor shall not revise the CQC or the quality staffing levels or replace any of the key personnel specified therein without prior written approval from the Project Manager.

6.28 LOAD RESTRICTIONS

The CONTRACTOR shall comply with all load restrictions as set forth in the "Administrative Permit Manual", and Title 17, Chapter 25, of the Alaska Administrative Code in the hauling of Materials on public roads, beyond the limits of the Project, and on all public roads within the Project limits that are scheduled to remain in use upon completion of the Project.

Overload permits may, at the discretion of the State of Alaska, be issued for travel beyond the Project limits for purposes of mobilization and/or demobilization. Issuance of such a permit will not relieve the CONTRACTOR of liability for damage which may result from the moving of equipment.

The operation of equipment of such weight or so loaded as to cause damage to any type of construction will not be permitted. No overloads will be permitted on the base course or

surface course under construction. No loads will be permitted on a concrete pavement, base or structure before the expiration of the curing period. The CONTRACTOR shall be responsible for all damage done by his equipment.

6.29 DRUG AND ALCOHOL FREE WORKPLACE

Safety is paramount at ARRC. For that reason, OWNER maintains an alcohol and drug-free workplace and requires that the CONTRACTOR do the same. At all times during the performance of the Work, the CONTRACTOR shall have in place a written drug and alcohol program that includes, at a minimum, the following:

- a. a requirement that all applicants present a negative pre-employment drug screen prior to being hired by the CONTRACTOR;
- b. a requirement that employees submit to a "reasonable suspicion" drug and/or alcohol test when showing signs and symptoms of drug and/or alcohol influence on duty;
- c. a requirement that employees submit to "reasonable cause/post-accident" drug and alcohol tests following certain accidents or incidents (with the threshold level triggering testing to be determined by the CONTRACTOR);
- d. a provision defining a positive alcohol test as one that reveals a breath alcohol level of .02 or greater;
- e. a provision defining a positive drug test as one that reveals concentrations at the levels set forth in 49 C.F.R. § 40.87(b)(screening test) and 49 C.F.R. § 40.87(c)(confirmatory test) or greater;
- f. a provision that outlines the consequences of a positive drug or alcohol test and the consequences of an employee's refusal to submit to drug/alcohol testing; and
- g. a provision that establishes the conditions under which an employee may return to work following a positive drug and/or alcohol test, which at a minimum include an evaluation by a substance abuse professional and compliance with a recommended treatment program.

The CONTRACTOR agrees that at any time during the performance of this Contract, if an OWNER employee reports to the CONTRACTOR that an employee of the CONTRACTOR or its Subcontractor is showing signs and/or symptoms of drug/alcohol influence on duty, the CONTRACTOR shall remove the employee from OWNER'S property immediately and shall have the employee tested for drug/alcohol influence. If the employee tests positive, the CONTRACTOR shall ensure that the employee is not returned to work on the Project until he/she has met the return to work requirements contained in the CONTRACTOR'S written program.

7. ARTICLE 7 - LAWS AND REGULATIONS:

7.1 LAWS TO BE OBSERVED:

- 7.1.1 The Contractor shall keep fully informed of all Federal and State Regulatory Requirements and all Orders and decrees of bodies or tribunals having any jurisdiction or authority, which in any manner affect those engaged or employed on the Work, or which in any way affect the conduct of the Work.
- 7.1.2 The Contractor shall at all times observe and comply with all such Regulatory Requirements, orders and decrees; and shall defend and indemnify the Owner and its representatives against claim or liability arising from or based on the violation of any such Regulatory Requirement, order, or decree whether by the Contractor, subcontractor, or any employee of either.
- 7.1.3 Except where otherwise expressly required by applicable Regulatory Requirements, the Owner shall not be responsible for monitoring Contractor's compliance with any Regulatory Requirements.

7.2 PERMITS, LICENSES, AND TAXES:

- 7.2.1 The Contractor shall procure all permits and licenses, pay all charges, fees and taxes, and give all notices necessary and incidental to the due and lawful prosecution of the Work. As a condition of performance of this Contract, the Contractor shall pay all Federal, State and local taxes incurred by the Contractor, in the performance of the Contract. Proof of payment of these taxes is a condition precedent to Final payment by the Owner under this Contract.
- 7.2.2 The Contractor's certification that taxes have been paid (as contained in the Release of Contract) will be verified with the Department of Revenue and Department of Labor, prior to Final payment.
- 7.2.3 If any Federal, State or local tax is imposed, charged, or repealed after the date of Bid opening and is made applicable to and paid by the Contractor on the articles or supplies herein contracted for, then the Contract shall be increased or decreased accordingly by a Change Order.

7.3 PATENTED DEVICES, MATERIALS AND PROCESSES:

- 7.3.1 If the Contractor employs any design, device, material, or process covered by letters of patent, trademark or copyright, the Contractor shall provide for such use by suitable legal agreement with the patentee or owner.
- 7.3.2 The Contractor and the Surety shall, defend, indemnify and save harmless the Owner and its agents, any affected third party, or political subdivision from any and all claims for infringement by reason of the use of any such patented design, device, material or process, or any trademark or copyright, and shall indemnify the Owner for any costs, expenses, and damages which it may be obliged to pay by reason of any infringement, at any time during the prosecution or after the completion of the Work.

7.4 COMPLIANCE OF SPECIFICATION AND DRAWINGS:

- 7.4.1 If the Contractor observes that the Specification and Drawings supplied by the Owner are at variance with any Regulatory Requirements, Contractor shall give

the Owner prompt written notice thereof, and any necessary changes will be authorized by one of the methods indicated in paragraph 9.2. as determined appropriate by the Owner.

7.4.2 If the Contractor performs any Work knowing or having reason to know that it is contrary to such Regulatory Requirements, and without such notice to the Owner, the Contractor shall bear all costs arising there.

7.5 ACCIDENT PREVENTION:

7.5.1 The Contractor shall comply with AS 18.60.075 and all pertinent provisions of the Construction Code Occupational Safety and Health Standards issued by the Alaska Department of Labor.

7.6 SANITARY PROVISIONS:

7.6.1 The Contractor shall provide and maintain in a neat and sanitary condition such accommodations for the use of his employees and Owner representatives in strict accordance with the requirements of the State and local Boards of Health, OSHA or of other bodies or tribunals having jurisdiction.

7.7 BUSINESS REGISTRATION:

7.7.1 The Contractor shall comply with AS 08.18.011, as follows: *"it is unlawful for a person to submit a bid or Work as a Contractor until he has been issued a certificate of registration by the Department of Commerce. A partnership or joint venture shall be considered registered if one of the general partners or venturers whose name appears in the name under which the partnership or venture does business is registered."*

7.8 PROFESSIONAL REGISTRATION AND CERTIFICATION:

7.8.1 All craft trades, architects, engineers and land surveyors, electrical administrators, explosive handlers, and welders employed under the Contract shall specifically comply with applicable provisions of AS 08.18, 08.48, 08.40, 08.52, and 08.99.

7.8.2 Provide copies of individual licenses within seven days following a request from the Owner.

7.9 LOCAL BUILDING CODES:

7.9.1 The Contractor shall comply with AS 35.10.025 which requires construction in accordance with applicable local building codes including the obtaining of required permits.

7.10 AIR QUALITY CONTROL:

7.10.1 The Contractor shall comply with all applicable provision of AS 46.03.04 as pertains to Air Pollution Control.

7.11 ARCHAEOLOGICAL OR PALEONTOLOGICAL DISCOVERIES:

7.11.1 When the Contractor's operation encounters prehistoric artifacts, burials, remains of dwelling sites, or paleontological remains, such as shell heaps, land or sea mammal bones or tusks, the Contractor shall cease operations immediately and notify the Owner.

7.11.2 No artifacts or specimens shall be further disturbed or removed from the ground and no further operations shall be performed at the site until so directed.

7.11.3 Should the Owner order suspension of the Contractor's operations in order to protect an archaeological or historical finding, or order the Contractor to perform extra Work, such shall be covered by an appropriate Contract change document.

7.12 WAGES AND HOURS OF LABOR:

7.12.1 The Contractor shall submit certified payrolls bearing an original signature on a weekly or biweekly basis to the State Department of Labor as required by law, and shall comply with all other applicable labor reporting laws. The Contractor shall also submit certified payrolls bearing an original signature, along with those of its subcontractors, to the Owner on a weekly basis and shall retain copies of the payrolls for a minimum of three (3) years.

7.12.2 The Contractor shall be responsible for the submission and retention of certified payrolls of all of its subcontractors.

7.12.3 The certification shall affirm that the payrolls are current and complete, that the wage rates contained therein are not less than the applicable rates referenced in the Contract Documents, and that the classification set forth for each laborer or mechanic conforms with the work he performed.

7.12.4 The Contractor and its subcontractors shall attend all hearings and conferences and produce such books, papers, and documents all as requested by the Department of Labor.

7.13 THE FOLLOWING LABOR PROVISIONS SHALL ALSO APPLY TO THIS CONTRACT:

7.13.1 The Contractor and his subcontractors shall pay all employees unconditionally and not less than once a week. Wages may not be less than those stated in the Invitation to Bid, regardless of the contractual relationship between the Contractor or Subcontractors and laborers, mechanics, or field surveyors. The scale of wages to be paid shall be posted by the Contractor in a prominent and easily accessible place at the site of the Work. The Owner shall withhold so much of the accrued payments as is necessary to pay laborers, mechanics, or field surveyors employed by the Contractor or Subcontractors the difference between the rates of wages required by the Contract to be paid laborers, mechanics, or field surveyors on the Work, and the rates of wages in fact received by laborers, mechanics or field surveyors.

7.14 OVERTIME WORK HOURS AND COMPENSATION:

- 7.14.1 Pursuant to 40 U.S.C. 327-330 and AS 23.10.060, the Contractor shall not require nor permit any laborer or mechanic in any workweek in which he is employed on any Work under this Contract to work in excess of eight hours in any Calendar Day or in excess of forty hours in such workweek on work subject to the provisions of the Contract Work Hours and Safety Standards Act unless such laborer or mechanic receives compensation at a rate not less than one and one half times his basic rate of pay for all such hours worked in excess of eight hours in any Calendar Day or in excess of forty hours in such workweek whichever is the greater number of overtime hours.
- 7.14.2 In the event of any violation of this provision, the Contractor shall be liable to any affected employee for any amounts due and penalties and to the Owner for liquidated damages. Such liquidated damages shall be computed with respect to each individual laborer or mechanic employed in violation of this provision in the sum of \$10.00 for each Calendar Day on which such employee was required or permitted to be employed on such Work in excess of eight hours or in excess of the standard workweek of forty hours without payment of the overtime wages required by this paragraph.

7.15 COVENANTS AGAINST CONTINGENT FEES:

- 7.15.1 The Contractor warrants that no person or selling agent has been employed or retained to solicit or secure this Contract upon an agreement or understanding for a commission, percentage, brokerage, or contingent fee, excepting bona fide employees or bona fide established commercial or selling agencies maintained by the Contractor for the purpose of securing business.
- 7.15.2 For breach or violation of this warranty, the Owner shall have the right to annul this Contract without liability or, in its discretion, to deduct such improper consideration from the Contract Amount or otherwise recover the full amount of such commission, percentage, brokerage, or contingent fee.

7.16 OFFICIALS NOT TO BENEFIT:

- 7.16.1 No member of or delegate to the U.S. Congress, the State Legislature, or other State or Owner officials shall be admitted to any share or part of this Contract, nor to any benefit that may arise there from. However, this provision shall not be construed to extend to this Contract if made with a corporation for its general benefit.

7.17 PERSONAL LIABILITY OF PUBLIC OFFICIALS:

- 7.17.1 In carrying out any of the provisions thereof, or in exercising any power or authority granted to the Owner by the Contract, there will be no liability upon the Owner nor upon its agents or authorized as its representatives, either personally or as officials of the State of Alaska, it being always understood that in such matters they act as agents and representatives of the Owner.

7.19 FEDERALLY ASSISTED PROJECTS

When the United States Government pays all or any portion of the cost of a project, the Federal laws and the rules and regulations made pursuant to such laws must be observed by the CONTRACTOR, and the Work shall be subject to the inspection of the appropriate Federal agency. Such inspection shall in no sense make the Federal Government a party to this Contract and will in no way interfere with the rights of either party hereunder.

7.20 GRATUITY AND CONFLICT OF INTEREST

The CONTRACTOR agrees that he will not extend any loan, gratuity or gift of money of any form whatsoever to any employee or agent of the OWNER nor will he rent or purchase any equipment or materials from any employee of the OWNER or to the best of his knowledge from any agent of any employee of the OWNER. Before payment of the Final Payment, the CONTRACTOR shall execute and furnish the OWNER an affidavit certifying that he has complied with the above provisions of the Contract.

8. ARTICLE 8 - OTHER WORK:

8.1 RELATED WORK AT SITE:

- 8.1.1 The Owner reserves the right at any time to contract for and perform other or additional work on or near the Work covered by the Contract.
- 8.1.2 When separate contracts are let within the limits of the Project, the Contractor shall conduct his work so as not to interfere with or hinder the work being performed by other contractors. The Contractor shall join his work with that of the others in an acceptable manner and shall perform it in proper sequence to that of others.
- 8.1.3 If the fact that other such work is to be performed is identified or shown in the Contract Documents, the Contractor shall assume all liability, financial or otherwise, in connection with this Contract and indemnify and save harmless the Owner and its agents from any and all damages or claims that may arise because of inconvenience, delay, or loss experienced by the Contractor because of the presence and operations of other contractors.
- 8.1.4 If the fact that such other work is to be performed was not identified or shown in the Contract Documents, written notice thereof will be given to the Contractor prior to starting any such other work. If the Contractor believes that such performance will require an increase in Contract Amount or Contract Time, the Contractor shall notify the Owner of such required increase within fifteen (15) calendar days following receipt of the Owner's notice. Should the Owner find such increase(s) to be justified, a Change Order will be executed.

8.2 ACCESS, CUTTING, AND PATCHING:

- 8.2.1 The Contractor shall afford each utility owner and any other contractor who is a party to such a direct contract with the Owner (or the Owner, if the Owner is performing the additional work with the Owner's employees) proper and safe access to the site and a reasonable opportunity for the introduction and storage of materials and equipment and the execution of such work and shall properly connect and coordinate the Work with the work of others.
- 8.2.2 The Contractor shall do all cutting, fitting and patching of the Work that may be required to make its several parts come together properly and integrate with such other Work, the Contractor shall not endanger any Work of others by cutting, excavating or otherwise altering their Work and will only cut or alter such other Work with the written consent of the Owner.
- 8.2.3 The duties and responsibilities of the Contractor under this paragraph are for the benefit of other contractors to the extent that there are comparable provisions for the benefit of the Contractor in said direct Contracts between the Owner and other contractors.

8.3 DEFECTIVE WORK BY OTHERS:

- 8.3.1 If any part of the Contractor's Work depends for proper execution or results upon the Work of any such other Contractor, utility owner, or the Owner, the Contractor shall inspect and promptly report to the Owner in writing any delays, defects or deficiencies in such Work that render it unavailable or unsuitable for such proper execution and results. The Contractor's failure to so report will constitute an acceptance of the other Work as fit and proper for integration with Contractor's Work except for latent or non-apparent defects and deficiencies in the other Work.

8.4 COORDINATION:

- 8.4.1 If the Owner contracts with others for the performance of other Work at the site, Owner will have authority and responsibility for coordination of the activities among the various contractors.

9. ARTICLE 9 - CHANGES:

9.1 OWNER'S RIGHT TO CHANGE:

- 9.1.1 Without invalidating the Contract and without notice to any Surety, the Owner may, at any time or from time to time, order additions, deletions or revisions in the Work within the general scope of the Contract, including but not limited to changes:
- 9.1.1.1 In the Contract Documents;
 - 9.1.1.2 In the method or manner of performance of the Work;
 - 9.1.1.3 In Owner-furnished facilities, equipment, materials, services, or site;
 - 9.1.1.4 Directing acceleration in the performance of the Work.

9.2 AUTHORIZATION OF CHANGES WITHIN THE GENERAL SCOPE:

9.2.1 Additions, deletions, or revisions in the Work within the general scope of the Contract as specified in paragraph 9.1 shall be authorized by one or more of the following ways:

9.2.1.1 Directive (pursuant to paragraph 9.3)

9.2.1.2 A Change Order (pursuant to paragraph 9.4)

9.2.1.3 Owner's acceptance of Shop Drawing variations from the Contract Documents as specifically identified by the Contractor as required by paragraph 6.19.4.

9.3 DIRECTIVE:

9.3.1 The Owner shall provide written clarification or interpretation of the Contract Documents (pursuant to paragraph 3.7).

9.3.2 The Owner may authorize minor variations in the Work from the requirements of the Contract Documents which do not involve an adjustment in the Contract Amount or the Contract Time and are consistent with the overall intent of the Contract Documents.

9.3.3 The Owner may order the Contractor to correct Defective Work or methods which are not in conformance with the Contract Documents.

9.3.4 The Owner may direct the commencement or suspension of Work or emergency related Work (as provided in paragraph 6.18).

9.3.5 Upon the issuance of a directive to the Contractor by the Owner, the Contractor shall immediately proceed with the performance of the Work as prescribed by such directive.

9.3.6 If the Contractor believes that the changes noted in a directive may cause an increase in the Contract Amount or an extension of Contract Time, the Contractor shall immediately provide written notice to the Owner depicting such increases before proceeding with the directive, except in the case of an emergency.

9.3.7 If the Owner finds the increase in Contract Amount or the extension of Contract Time justified, a Change Order will be issued.

9.3.8 If however, the Owner does not find that a Change Order is justified, the Owner may direct the Contractor to proceed with the Work.

9.3.9 The Contractor shall cooperate with the Owner in keeping complete daily records of the cost of such Work.

9.3.10 If a Change Order is ultimately determined to be justified, in the absence of agreed prices and unit prices, payment for such Work will be made on a cost of the Work basis as provided in paragraph 10.4.

9.4 CHANGE ORDER:

- 9.4.1 A change in Contract Time, Contract Amount, or responsibility may be made for changes within the scope of the Work only by Change Order.
- 9.4.2 Upon receipt of an executed Change Order, the Contractor shall promptly proceed with the Work involved which will be performed under the applicable conditions of the Contract Documents except as otherwise specifically provided.
- 9.4.3 Changes in Contract Amount and Contract Time shall be made in accordance with Articles 10 and 11.

9.5 SHOP DRAWING VARIATIONS:

- 9.5.1 Variations by Shop Drawings shall only be eligible for consideration under paragraph 9.4 when the conditions affecting the price, time, or responsibility are identified by the Contractor in writing and a request for a Change Order is submitted as per paragraph 6.19.7.

9.6 CHANGES OUTSIDE THE GENERAL SCOPE; SUPPLEMENTAL AGREEMENT

- 9.6.1 Any change which is outside the general scope of the Contract, as determined by the Owner, must be authorized by the appropriate representatives of the Owner and the Contractor.

9.7 UNAUTHORIZED WORK:

- 9.7.1 The Contractor shall not be entitled to an increase in the Contract Amount or an extension of the Contract Time with respect to any Work performed that is not required by the Contract Documents as amended, modified and supplemented as provided in this Article 9, except in the case of an emergency as provided in paragraph 6.18 and except in the case of uncovering Work as provided in paragraph 12.4.4.

9.8 NOTIFICATION OF SURETY:

- 9.8.1 If notice of any change affecting the general scope of the Work or the provisions of the Contract Documents including, but not limited to, Contract Amount or Contract Time is required by the provisions of any Bond to be given to a Surety, the giving of any such notice will be the Contractor's responsibility, and the amount of each applicable Bond will be adjusted accordingly.

9.9 DIFFERING SITE CONDITIONS:

- 9.9.1 The Contractor shall promptly, and before such conditions are disturbed (except in an emergency as permitted by paragraph 6.18), notify the Owner in writing of:
 - 9.9.1.1 Subsurface or latent physical conditions at the site differing materially from those indicated in the Contract, and which could not have been discovered by a careful examination of the site, or

9.9.1.2 Unknown physical conditions at the site, or an unusual nature, differing materially from those ordinarily encountered and generally recognized as inherent in Work of the character provided for in this Contract.

9.9.1.3 Failure of the Contractor to notify the Owner in writing of conditions described in 9.9.1.1 and 9.9.1.2 before disturbing such conditions shall render any claim by the Contractor null and void.

9.9.2 The Owner shall promptly investigate the conditions, and if the Owner finds that such conditions do materially so differ and cause an increase or decrease in the Contractor's cost of, or time required for, performance of this Contract, an equitable adjustment shall be made and the Contract modified in writing accordingly.

9.9.3 Any claim for additional compensation by the Contractor under this clause shall be made in accordance with Article 15 and shall not be allowed unless the Contractor has first given the notice required by this Contract.

9.9.4 In the event that the Owner and the Contractor are unable to reach an agreement concerning an alleged differing site condition, the Contractor will be required to keep an accurate and detailed record which will indicate the actual cost of the Work done under the alleged differing site condition.

9.9.5 Failure to keep such a detailed record shall be a bar to any recovery by reason of such alleged differing site conditions. The Owner shall be given the opportunity to supervise and check the Work and keeping of such records throughout the entire duration of the Work.

9.10 INTERIM WORK AUTHORIZATION

An Interim Work Authorization may be used to establish a change within the scope of the Work; however, only a Change Order shall establish associated changes in Contract Time and Contract Price. Work authorized by Interim Work Authorization shall be converted to a Change Order. The basis of payment shall be as stated in the Interim Work Authorization, unless it states that the basis of payment has not been established and is to be negotiated, in which case the basis of payment shall be Cost of the Work pursuant to Article 10.5.

9.11 VALUE ENGINEERING PROPOSALS BY THE CONTRACTOR:

9.11.1 Proposals may be submitted to the Owner for modifying the plans, specifications, or other requirements of the Contract for the sole purpose of reducing the total costs of construction without impairing in any manner the essential functions or characteristics of the project, including service life, economy of operations, ease of maintenance, benefits to the traveling public, desired appearance or design and safety standards. After execution of the Contract, an initiative may be recommended by the Contractor or, if applicable, sponsoring governmental agency. The initiative must be identified as a Value Engineering Proposal (VEP), and may include modifications to the plans or specifications, construction phasing or procedures, or other contract requirements. Any cost savings generated to the Contract as a result of VEP offered by the Contractor and approved by Owner will

be shared equally between the Contractor and Owner as specified in paragraph 9.15. Bid prices are not to be based on the anticipated approval of a VEP. If a VEP is rejected, the Contract shall be completed in accordance with the original terms of the Contract or as otherwise modified. Any decision whether to approve or accept a VEP shall be within the sole discretion of Owner. Owner will bear no liability for any delay in considering a VEP, the refusal to accept or approve such a proposal, or any other matter connected with a VEP.

9.12 SUBMITTAL & REVIEW OF VEP CONCEPT OR IDEA:

- 9.12.1 The Contractor shall initially submit a brief letter proposal with graphics to Owner to illustrate the concept or idea. The Contractor shall indicate whether adequate time is available in its schedule for formal submittal and review prior to VEP implementation.
- 9.12.2 Owner will review the concept or idea within ten days of the Contractor's initial submittal and inform the Contractor in writing whether the concept or idea has merit and should be submitted as a formal VEP.
- 9.12.3 If Owner determines that the time for response is indicated in the Contractor's letter proposal is insufficient for review, Owner may choose to evaluate the need for a non-compensable time extension to the Contract. Its evaluation will be based on the additional time needed by the Owner for its review and the effect on the Contractor's schedule occasioned by the added time. The need for such a time extension will be evaluated in accordance with Article 11.

9.13 FORMAL SUBMITTAL OF THE VEP:

- 9.13.1 Within 30 days after Owner has determined the VEP concept or idea has merit, the Contractor shall formally submit a proposal. The proposal shall include sufficient data for Owner to make an informed decision regarding the proposal and shall include, at a minimum, the following information:
 - 9.13.1.1 A statement that the Proposal is submitted as a VEP.
 - 9.13.1.2 A description of the difference between the existing contract and the proposed change and the advantages and disadvantages of each, including effects on service life, economy of operations, ease of maintenance, benefits to the traveling public, desired appearance and safety.
 - 9.13.1.3 A complete set of plans and specifications showing the proposed revisions relative to the original contract features and requirements supported by design computations as necessary for a thorough and expeditious evaluation.
 - 9.13.1.4 A complete analysis indicating the final estimated costs and quantities to be replaced by the VEP compared to the new costs and quantities generated by the VEP.

- 9.13.1.5 A statement specifying the date by which a Change Order adopting the VEP must be executed to obtain the maximum cost reduction.
- 9.13.1.6 A statement detailing the effect the VEP will have on the time for completing the Contract.
- 9.13.1.7 A description of any previous use or testing of the VEP and the conditions and results. If the VEP was previously submitted on another Owner project, indicate the date, contract number, and the action taken by Owner.
- 9.13.1.8 A detailed statement indicating the costs for developing the changes, along with the costs for preparing the value engineering joint proposal.

9.14 VEP CONDITIONS:

- 9.14.1 Value Engineering Proposals will be considered only when all of the following conditions are met:
 - 9.14.1.1 A VEP, approved or not approved by Owner applies only to the contract on which is it submitted. A submitted VEP becomes the property of Owner. The VEP shall contain no restrictions imposed by the Contractor on its use or disclosure. Owner has the right to use, duplicate and disclose in whole or in part any data necessary for the utilization of the VEP. Owner retains the right to use any accepted VEP or part thereof on other projects without obligation to the Contractor. This provision is not intended to deny rights provided by law with respect to patented materials or processes.
 - 9.14.1.2 If Owner is already considering certain revisions to the Contract or has considered or approved changes in the Contract of a like nature on other contracts which are subsequently incorporated in a VEP, Owner may reject the VEP and may change the Contract without obligation to the Contractor.
 - 9.14.1.3 The Contractor shall have no claim for additional costs or delays resulting from the rejection of a VEP, including development costs, loss of anticipated profits, increased material or labor costs except as allowed in paragraph 9.14.
 - 9.14.1.4 Owner will determine if a VEP qualifies for consideration and evaluation. It may reject any VEP that requires excessive time or costs for review, evaluation or investigation, or that is not consistent with Owner's design policies and criteria for the project.
 - 9.14.1.5 Owner will reject all or any portion of work performed under an approved VEP if unsatisfactory results are obtained. The Owner will direct the removal of rejected work and require construction to proceed under the original contract requirements without reimbursement for rejected work performed under the VEP, or for its removal. Where modifications to the VEP are approved to adjust to field or other conditions, reimbursement will be limited to the total amount payable for the work at the contract bid

prices as if it were constructed under the original contract requirements. The rejection or limitation of reimbursement shall not constitute the basis of any claim against Owner for delay or for other costs.

9.14.1.6 The proposed work shall not contain experimental features but shall contain features that have been used under similar or acceptable conditions on other projects or locations acceptable to Owner.

9.14.1.7 VEPs will not be considered if equivalent options are already provided in the Contract.

9.14.1.8 The savings generated by the VEP must be sufficient to warrant a review and processing. A savings resulting solely from the elimination or reduction in quantity of a single bid item will not be considered as a VEP. A savings resulting from the elimination or reduction in quantity of a bid item specified as part of a VEP will be considered.

9.14.1.9 Additional information needed to evaluate VEPs shall be provided in a timely manner. Untimely submittals of additional information will result in rejection of the VEP. Where design changes are proposed, the additional information could include results of field investigations and surveys, design computations, and field change sheets.

9.14.1.10 The Contractor may submit VEPs for an approved subcontractor. Reimbursement will be made to the Contractor. Subcontractors may not submit a VEP except through the Contractor.

9.14.1.11 The Contractor shall ensure the VEP is sealed by an Alaska Registered Engineer.

9.14.1.12 All costs to for developing the changes, along with the costs for preparing the value engineering proposal shall be the Contractor's responsibility.

9.15 VEP ACCEPTANCE, REJECTION & PAYMENT:

9.15.1 Within 30 days of the Contractor's formal submission of the VEP, Owner will accept or reject the VEP.

9.15.2 The Contractor will be notified in writing by the Owner as to whether the proposal has been accepted. The decision by Owner is final and shall not be subject to the provisions of Article 15.

9.15.3 If the VEP is rejected, all costs for developing and presenting the value engineering proposal shall be the Contractor's responsibility.

9.15.4 If the VEP is accepted in whole or part, the necessary contract modifications and contract price adjustments will be made by the execution of a Change Order which will specifically state that it is executed pursuant to the provisions of this subsection. Owner will be the sole judge of the acceptability of a VEP and of the estimated net savings in construction costs from the adoption of all or any part of the VEP.

- 9.15.5 The Contractor shall continue to perform the Work in accordance with the requirements of the Contract until a Change Order incorporating the VEP has been executed, or until the Contractor has been given written acceptance or rejection by the Owner.
- 9.15.6 The executed Change Order shall incorporate the changes in the plans, specifications, or other requirements of the Contract which are necessary to permit the VEP, or such part of it which has been accepted, to be put into effect, and shall include any conditions upon which Owner's approval thereof is based. The executed Change Order shall extend or decrease the Contract Time if required by Owner.
- 9.15.7 The executed Change Order shall provide that the Contractor be paid 50% of the net savings amount as reflected by the difference between the cost of the revised work and the cost of the related construction required by the original contract computed at contract bid prices. The net savings will take into account the Contractor's cost of developing the VEP and implementing the change, and reducing this amount by Owner's cost for investigating and evaluating the VEP, including any ascertainable collateral costs to Owner. Such collateral costs may include increased costs for maintenance, operation, related work items, additional work items, or elements of related or additional work items.
- 9.15.8 The executed Change Order shall also provide for the adjustment of the Contract Amount. The Contract Amount shall be adjusted by subtracting Owner's share of the accrued net savings.
- 9.15.9 The amount specified to be paid to the Contractor in the executed Change Order shall constitute full compensation to the Contractor for the VEP and the performance of the work thereof pursuant to the said Change Order.

10. ARTICLE 10 - CONTRACT AMOUNT; COMPUTATION AND CHANGE:

10.1 CONTRACT AMOUNT:

- 10.1.1 The Contract Amount constitutes the total compensation (subject to authorized adjustments) payable to the Contractor for performing the Work. All duties, responsibilities and obligations assigned to or undertaken by the Contractor shall be at his expense without change in the Contract Amount. The Contract Amount may only be changed by a Change Order or Supplemental Agreement.

10.2 CLAIMS FOR CHANGE IN CONTRACT AMOUNT:

- 10.2.1 Any claim for an increase or decrease in the Contract Amount shall be submitted in accordance with the terms of Article 15, and shall not be allowed unless the notice requirements of this Contract have been met.

10.3 CHANGE ORDER PRICE DETERMINATION:

- 10.3.1 The value of any Work covered by a Change Order for an increase or decrease in the Contract Amount shall be determined in one of the following ways:
- 10.3.2 Where the Work involved is covered by unit prices contained in the Contract Documents, by application of unit prices to the quantities of the items involved (subject to the provisions of paragraph 10.9).
- 10.3.3 By mutual acceptance of a lump sum price which includes overhead and profit.
- 10.3.4 When 10.3.1 and 10.3.2 are inapplicable, on the basis of the Cost of the Work (determined as provided in paragraphs 10.4 and 10.5) plus a contractor's fee for overhead and profit (determined as provided in paragraph 10.6).
- 10.3.5 Before a Change Order is approved, the CONTRACTOR shall submit cost or pricing data in accordance with Articles 6.26 and 10.7 regarding the changed or extra Work. The CONTRACTOR shall certify that the data submitted is, to his best knowledge and belief, accurate, complete and current as of a mutually determined specified date and that such data will continue to be accurate and complete during the performance of the changed or extra Work.

10.4 LUMP SUM PRICE CHANGE METHOD

The CONTRACTOR shall prepare a lump sum proposal in the following format:

10.4.1 Direct Costs

a. Material (itemize)

1. The cost to the CONTRACTOR for the Material directly required for the performance of the changed Work. Such cost of Material may include the cost of transportation. Only the applicable portion of a delivery charge will be allowed if the delivery is not specifically for the changed Work,
2. Trade discounts offered by the supplier to the CONTRACTOR shall be credited to the OWNER. If the Material is obtained from a source owned wholly or in part by the CONTRACTOR, payment thereof will not exceed the current wholesale price for the material. The term "trade discount" includes the concept of cash discounting.
3. The OWNER reserves the right to furnish such Material as it deems advisable and the CONTRACTOR shall have no Claims for cost or profit on Material furnished by the OWNER.

b. Labor (man-hours, rates by crafts)

1. Payroll costs shall include, but not be limited to, salaries and wages, and fringe benefits including social security contributions, unemployment, excise and payroll taxes, workers' compensation, health and retirement

benefits, sick leave, vacation and holiday pay applicable thereto. The costs for all supervision, including general superintendents and foremen, shall be included in the markups established by this Contract. The only exception to this shall be working foremen who perform manual labor. No labor charges will be accepted for engineering or proposal preparation. These costs shall be included in the markups established by this Contract.

2. Reasonable indirect expenses and time related overhead subject to a time-impact analysis to determine the amount and reasonableness of the indirect expenses and time related overhead expenses.

c. Equipment (type, size, attachments, hours, rate)

1. The cost to the CONTRACTOR for the use of Equipment directly required in the performance of the changed Work. No mobilization or demobilization cost will be allowed for equipment already on Site.
2. For Equipment owned, furnished, or rented by the CONTRACTOR, costs allowed shall be the actual usage costs incurred as supported by the CONTRACTOR's published standard equipment rates or rental invoices. Rates charged shall not exceed the rates established by the Rental Rate Blue Book.
3. The amount to be paid to the CONTRACTOR for the use of Equipment as set forth above will constitute full compensation for the cost of fuel, power, oil, lubricants, supplies, small tools, small equipment, necessary attachments, repairs and maintenance of any kind, depreciation, storage, insurance, labor (except for equipment operators) and any and all costs incidental to the use of the Equipment.

d. Consultants

1. Cost of outside consultants and professional personnel (including but not limited to engineers, architects, testing laboratories, and surveyors) employed for services necessary for the completion of the Work as may be required by the CONTRACTOR. The CONTRACTOR shall obtain the consent of the OWNER prior to engaging such outside consultants if the consultant's services are not specifically identified in the Contract Documents and qualifications are not previously provided therefore.

e. Other direct costs as the parties may agree

f. Direct costs shall not include:

1. Payroll costs and other compensation of the CONTRACTOR's offsite officers, executives, principals of partnerships and sole proprietorships, general managers, engineers, architects, estimators, lawyers, auditors, accountants, purchasing and contracting agents, expeditors, timekeepers, clerks, superintendents and non-working foremen, and

similar administrative personnel. These costs shall be considered administrative costs covered by the CONTRACTOR's Markup Fee.

2. Expense of the CONTRACTOR's principal and branch offices other than that portion of the CONTRACTOR's office at the Site devoted to the Work.
3. Any part of the CONTRACTOR's capital expenses. Interest on the CONTRACTOR's capital employed for the Work. Charges against the CONTRACTOR for delinquent payments.
4. Costs due to the negligence of the CONTRACTOR, any Subcontractor, or anyone directly or indirectly employed by any of them or for whose acts any of them may be liable. Negligence costs include correction of defective Work, disposal of material wrongly supplied, and making good any damage to property.
5. Other overhead or general expense costs of any kind.
6. Cost of supplies not incorporated into the Work.
7. Cost of warranty work.

10.4.2 Subcontract Costs

- a. If required by OWNER, CONTRACTOR shall obtain competitive quotes from Subcontractors or Suppliers and shall select and award subcontracts in accordance with the CONTRACTOR's subcontracting solicitation plan approved by the OWNER.
- b. Direct Costs shall be as outlined in Article 10.4.1.
- c. Subcontractors' (at any tier) markups for overhead and profit shall not exceed ten percent (10%) of the Direct Costs.

10.4.3 Overhead and Profit

- a. The CONTRACTOR's Markup Fee for overhead and profit shall not exceed the amounts provided in Article 10.6.1.

10.5 COST OF THE WORK:

10.5.1 The term Cost of the Work means the sum of all costs necessarily incurred and paid by the Contractor in the proper performance of the Work.

10.5.2 Except as otherwise may be agreed to in writing by the Owner, such costs shall be in amount no higher than those prevailing in the locality of the Project, shall include only the following items and shall not include any of the costs itemized in paragraph 10.5:

- 10.5.2.1 Payroll costs for employees in the direct employ of the Contractor in the performance of the Work under schedules of job classifications agreed upon by the Owner and the Contractor.
- 10.5.2.2 Payroll costs for employees not employed full time on the Work shall be apportioned on the basis of their time spent on the Work.
- 10.5.2.3 Payroll costs shall include, but not be limited to, salaries and wages plus the cost of fringe benefits which shall include Social Security Contributions, Unemployment, Excise and Payroll Taxes, Workers' or Workmen's compensation, health and retirement benefits, bonuses, sick leave, vacation and holiday pay applicable thereto.
- 10.5.2.4 Such employees shall include superintendents and foremen at the site.
- 10.5.2.5 The expenses of performing Work after regular working hours, on Saturday, Sunday or Legal Holidays shall be included in the above to the extent authorized by the Owner.
- 10.5.2.6 Cost of all materials and equipment furnished and incorporated in the Work, including costs of transportation and storage thereof, and suppliers' field services required in connection therewith. All cash discounts shall accrue to the Contractor unless the Owner deposits funds with the Contractor with which to make payments, in which case the cash discounts shall accrue to the Owner. All trade discounts, rebates and refunds and all returns from sale of surplus materials and equipment shall accrue to the Owner, and the Contractor shall make provisions so that they may be obtained.
- 10.5.2.7 Payments made by the Contractor to subcontractors for Work performed by subcontractors. If required by the Owner, Contractor shall obtain competitive quotes from subcontractors or suppliers acceptable to the Contractor and shall deliver such quotes to the Owner who will then determine which quotes will be accepted. If a subcontract provides that the subcontractor is to be paid on the basis of Cost of the Work plus a fee, the subcontractor's Cost of the Work shall be determined in the same manner as the Contractor's Cost of Work. All subcontracts shall be subject to the other provisions of the Contract Documents insofar as applicable.
- 10.5.2.8 Costs of special Consultants (including but not limited to engineers, architects, testing laboratories, and surveyors) employed for services necessary for the completion of the Work.
- 10.5.2.9 Supplemental costs including the following:
 - 10.5.2.9.1 The proportion of necessary transportation, travel and subsistence expenses of the Contractor's employees incurred in discharge of duties connected with the Work.

- 10.5.2.9.2 Cost, including transportation and maintenance, of all materials, supplies, equipment, machinery, appliances, office and temporary facilities at the site and hand tools not owned by the workers, which are consumed in the performance of the Work, and cost less market value of such items used but not consumed which remain the property of the Contractor.
- 10.5.2.9.3 Rentals of all construction equipment and machinery and the parts thereof whether rented from the Contractor or others in accordance with rental agreements approved by the Owner and the costs of transportation, loading, unloading, Installation, dismantling and removal thereof - all in accordance with terms of said rental agreements. The rental of any such equipment, machinery or parts shall cease when the use thereof is no longer necessary for the Work.
- 10.5.2.9.4 Sales, consumer, use or similar taxes related to the Work, and for which the Contractor is liable, imposed by Regulatory Requirements.
- 10.5.2.9.5 Fees for permits and licenses.
- 10.5.2.9.6 Losses and damages (and related expenses), not compensated by insurance or otherwise, to the Work or otherwise sustained by the Contractor in connection with the performance and furnishing of the Work provided they have resulted from causes other than the negligence of the Contractor, any subcontractor, or anyone directly or indirectly employed by any of them or for whose acts any of them may be liable. Such losses shall include settlements made with the written consent and Approval of the Owner. No such losses, damages and expenses shall be included in the Cost of the Work for the purpose of determining the Contractor's Fee. If, however, any such loss or damage requires reconstruction and the Contractor is placed in charge thereof, the Contractor shall be paid for services a fee in accordance with paragraph 10.6.
- 10.5.2.9.7 The cost of utilities, fuel and sanitary facilities at the site.
- 10.5.2.9.8 Minor expenses such as telegrams, long distance telephone calls, telephone service at the site, expressage and similar petty cash items in connection with the Work.
- 10.5.2.9.9 Cost of premiums for additional bonds and insurance required because of changes in the Work and premiums for property insurance coverage within the limits of the deductible amounts established by the Owner in accordance with Article 5.

10.6 EXCLUDED COSTS:

- 10.6.1 The term Cost of the Work shall not include any of the following:

- 10.6.1.1 Payroll costs and other compensation of Contractor's officers, executives, principles (of partnership and sole proprietorships), general managers, engineers, architects, estimators, attorneys, auditors, accountants, purchasing and contracting agency, expeditors, timekeepers, clerks and other personnel employed by Contractor whether at the site or in Contractor's principal or a branch office for general administration of the Work and not specifically included in the agreed upon schedule of job classifications referred to in paragraph 10.5.2.1 - all of which are to be considered administrative costs covered by the Contractor's Fee.
- 10.6.1.2 Expenses of Contractor's principal and branch offices other than Contractor's office at the site.
- 10.6.1.3 Any part of Contractor's capital expenses including interest on Contractor's capital employed for the Work and charges against Contractor for delinquent payments.
- 10.6.1.4 Cost of premiums for all bonds and for all insurance whether or not Contractor is required by the Contract Documents to purchase and maintain the same (except for the cost of premiums covered by subparagraph 10.4.2.9.9 above).
- 10.6.1.5 Costs due to the negligence of Contractor, any subcontractor, or anyone directly or indirectly employed by any of them or for whose acts any of them may be liable, including but not limited to, the correction of Defective Work, disposal of materials or equipment wrongly supplied and making good any damage to property.
- 10.6.1.6 Costs for the use of small tools having a value of five hundred dollars (\$500) or less.
- 10.6.1.7 Other overhead or general expense costs of any kind and the costs of any item not specifically and expressly included in paragraph 10.5.

10.7 CONTRACTOR'S FEE:

- 10.7.1 The Contractor's Fee allowed to Contractor for overhead and profit shall be a mutually agreed upon fixed fee, or if none can be agreed upon, a fee based on the following percentages of the various portions of the Cost of the Work:
 - 10.7.1.1 For costs incurred under subparagraphs 10.4.2.1 through 10.4.2.6, the Contractor's Fee shall be 15%;
 - 10.7.1.2 For costs incurred under subparagraphs 10.5.2.7, 10.5.2.8 and 10.5.2.9, the Contractor's Fee shall be 10%; and if a subcontract is on the basis of Cost of the Work plus a fee, the maximum allowable to the Contractor on account of overhead and profit of all subcontractors shall be 10%;
- 10.7.2 No fee shall be payable on the basis of costs itemized under paragraph 10.5;

10.6.3 The amount of credit to be allowed by the Contractor to the Owner for any such change which results in a net decrease in cost will be the amount of the actual net decrease plus a deduction in Contractor's Fee by a mutually agreed upon amount or if none can be agreed upon, then an amount equal to 5% of the net decrease; and

10.7.4 When both additions and credits are involved in any one change, the adjustment in Contractor's Fee shall be computed on the basis of the net change in accordance with subparagraphs 10.6.1.1. and 10.6.1.2.

10.8 COST BREAKDOWN:

10.8.1 Whenever the cost of any Work is to be determined pursuant to paragraphs 10.4 and 10.5, the Contractor will submit in a form acceptable to the Owner an itemized cost breakdown together with supporting data.

10.9 CASH ALLOWANCES:

10.9.1 It is understood the Contractor has included in the Contract Amount all allowances so named in the Contract Documents and shall cause the Work so covered to be done by such subcontractors or suppliers and for such sums within the limit of the allowances as may be acceptable to the Owner. Contractor agrees that:

10.9.1.1 The allowances include the cost to Contractor (less any applicable trade discounts) of materials and equipment required by the allowances to be delivered at the site, and all applicable taxes; and

10.9.1.2 Contractor's cost for unloading and handling on the site, labor, installation costs, overhead, profit and other expenses contemplated for the allowances have been included in the Contract Amount and not in the allowances. No demand for additional payment on account of any thereof will be valid. Prior to Final payment, an appropriate Change Order will be issued to reflect actual amounts due the Contractor on account of Work covered by allowances, and the Contract Amount shall be correspondingly adjusted.

10.10 UNIT PRICE WORK:

10.10.1 Where the Contract Documents provide that all or part of the work is to be Unit Price Work, initially the Contract Amount will be deemed to include for all Unit Price Work an amount equal to the sum of the established unit prices for each separately identified item of Unit Price Work times the estimated quantity of each item as indicated in the Contract.

10.10.2 The estimated quantities of items of Unit Price Work are not guaranteed and are solely for the purpose of comparison of Bids and determining an initial Contract Amount.

- 10.10.3 Determinations of the actual quantities and classifications of Unit Price Work performed by the Contractor will be made by the Owner in accordance with paragraph 10.10.
- 10.10.4 Each unit price will be deemed to include an amount considered by the Contractor to be adequate to cover the Contractor's overhead and profit for each separately identified item.
- 10.10.5 If the "Basis of Payment" clause in the Contract Documents relating to any unit price in the bid schedule requires that the said unit price cover and be considered compensation for certain Work or material essential to the item, this same Work or material will not also be measured or paid for under any other pay item which may appear elsewhere in the Contract Documents.
- 10.10.6 Payment to the Contractor shall be made only for the actual quantities of Work performed and accepted or materials furnished, in conformance with the Contract Documents.
- 10.10.7 When the accepted quantities of Work or materials vary from the quantities stated in the bid schedule, or change documents, the Contractor shall accept as payment in full, payment at the stated unit prices for the accepted quantities of Work and materials furnished, completed and accepted, except as provided below:
- 10.10.7.1 When the quantity of Work to be done or material to be furnished under any item, for which the total cost of the item exceeds 10% of the Original Contract Amount not to include Change Order costs, is increased by more the 25% of the quantity stated in the bid schedule, or change documents, either party to the Contract, upon demand, shall be entitled to an equitable unit price adjustment on the portion of the Work above 125% of the quantity stated in the bid schedule.
- 10.10.7.2 When the quantity of Work to be done or material to be furnished under any major item, for which the total cost of the item exceeds 10% of the Original Contract Amount not to include Change Order costs, is decreased by more than 25% of the quantity stated in the bid schedule, or change documents, either party to the Contract, upon demand, shall be entitled to an equitable price adjustment for the quantity of Work performed or material furnished, limited to a total payment of not more than 75% of the amount originally bid for the item.
- 10.10.7.3 The Contractor will be required to provide detailed and accurate records showing that an equitable price adjustment is warranted.

10.11 DETERMINATIONS FOR UNIT PRICES:

- 10.11.1 The Owner will determine the actual quantities and classifications of Unit Price Work performed by the Contractor.
- 10.11.2 The Owner will review with the Contractor preliminary determinations on such matters before certifying the prices on the Bid Schedule.

10.11.3 The Owner's certification thereon will be final and binding on the Contractor, unless, within ten days after the date of any such decision, the Contractor delivers to the Owner written notice of intention to appeal from such a decision.

11. ARTICLE 11 - CONTRACT TIME; COMPUTATION & CHANGE:

11.1 COMMENCEMENT OF CONTRACT TIME; NOTICE TO PROCEED:

11.1.1 The Contract Time will commence to run on the day indicated in the Notice to Proceed.

11.2 STARTING THE WORK:

11.2.1 No Work on Contract items shall be performed before the effective date of the Notice to Proceed. The Contractor shall notify the Owner at least 72 hours in advance of the time actual construction operations will begin. The Contractor may request a limited Notice to Proceed after Award has been made, to permit him to order long lead materials which could cause delays in Project completion. However, granting is within the sole discretion of the Owner, and refusal or failure to grant a limited Notice to Proceed shall not be a basis for claiming for delay, extension of time, or alteration of price.

11.3 COMPUTATION OF CONTRACT TIME:

11.3.1 When the Contract Time is specified on a Calendar Days basis, all Work under the Contract shall be completed within the number of Calendar Days specified.

11.3.2 The count of Contract Time begins on the day following receipt of the Notice to Proceed by the Contractor, if no starting day is stipulated therein.

11.3.3 Calendar Days shall continue to be counted against Contract Time until and including the date of Final Completion of the Work.

11.3.4 When the Contract completion time is specified as a fixed calendar date, it shall be the date of Final Completion.

11.4 TIME CHANGE:

11.4.1 The Contract Time may only be changed by a Change Order or Supplemental Agreement.

11.5 EXTENSION DUE TO DELAYS:

11.5.1 The right of the Contractor to proceed shall not be terminated nor the Contractor charged with liquidated or actual damages because of any delays to the completion of the Work due to unforeseeable causes beyond the control and without the fault or negligence of the Contractor, including, but not restricted to the following: acts of God or of the public enemy, acts of the Owner in contractual

capacity, acts of another contractor in the performance of a contract with the Owner, floods, fires, epidemics, quarantine restrictions, strikes, freight embargoes, unusually severe weather and delays of subcontractors or suppliers due to such causes.

11.5.2 Any delay in receipt of materials on the site, caused by other than one of the specifically mentioned occurrences above, does not of itself justify a time extension.

11.5.3 The Owner shall ascertain the facts and the extent of the delay and extend the time for completing the Work when the findings of fact justify such an extension.

11.6 ESSENCE OF CONTRACT:

11.6.1 All time limits stated in the Contract Documents are of the essence of the Contract.

11.7 REASONABLE COMPLETION TIME:

11.7.1 It is expressly understood and agreed by and between the Contractor and the Owner that the date of beginning and the time for Final Completion of the Work described herein are reasonable times for the completion of the Work.

11.8 DELAY DAMAGES:

11.8.1 Whether or not the Contractor's right to proceed with the Work is terminated, he and his sureties shall be liable for damages resulting from his refusal or failure to complete the Work within the specified time. Liquidated damages for delay shall be paid by the Contractor or his Surety to the Owner in the amount as specified in the Supplementary Conditions for each Calendar Day the completion of the Work or any part thereof is delayed beyond the Contract Time required by the Contract, or any extension thereof. If such amount of liquidated damages is not established by the Contract Documents, then the Contractor and his Surety shall be liable to the Owner for any actual damages occasioned by such delay.

11.8.2 The Contractor acknowledges that the liquidated damages established herein are not a penalty but rather constitute an estimate of damages that the Owner will sustain by reason of delayed completion. These liquidated damages are intended as compensation for losses difficult to estimate, and include those items enumerated in the Supplementary Conditions.

11.8.3 These damages will continue to run both before and after termination in the event of default termination. These liquidated damages do not cover excess costs of completion or the Owner's costs, fees, and charges related to re-procurement.

11.8.4 If a default termination occurs, the Contractor or his Surety shall pay in addition to these damages, all excess costs and expenses related to completion as provided by Article 14.2.9. Permitting the CONTRACTOR to continue and finish the Work or any part of it after the time fixed for its completion, or after the date to which the time for completion may have been extended, will in no way operate as a waiver on the part of the OWNER of any of its rights under the Contract.

12. ARTICLE 12 - QUALITY ASSURANCE:

12.1 WARRANTY AND GUARANTY:

- 12.1.1 The Contractor warrants and guarantees to the Owner that all Work will be in accordance with the Contract Documents and will not be Defective.
- 12.1.2 Notice of all defects shall be given to the Contractor. All Defective Work, whether or not in place, may be rejected, corrected or accepted as provided for in this Article.

12.2 ACCESS TO WORK:

- 12.2.1 The Owner and the Owner's representatives, testing agencies and governmental agencies with jurisdiction interests will have access to the Work at reasonable times for their observation, inspecting and testing. The Contractor shall provide proper and safe conditions for such access.

12.3 TESTS AND INSPECTIONS:

- 12.3.1 The Contractor shall give the Owner 24 hours' notice of readiness of the Work for all required inspections, tests or Approvals.
- 12.3.2 If Regulatory Requirements of any public body having jurisdiction require any Work (or part thereof) to specifically be inspected, tested or approved, the Contractor shall assume full responsibility therefor, pay all costs in connection therewith and furnish the Owner the required certificates of inspection, testing or Approval.
- 12.3.3 The Contractor shall also be responsible for and shall pay all costs in connection with any inspection or testing required in connection with Owner's acceptance of a supplier of materials or equipment proposed to be incorporated in the Work, or of materials or equipment submitted for Approval prior to the Contractor's purchase thereof for incorporation in the Work.
- 12.3.4 The cost of all inspections, tests and Approvals in addition to the above which are required by the Contract Documents shall be paid by the Contractor.
- 12.3.5 The Owner may perform additional tests and inspections which it deems necessary to insure quality control. All such failed tests or inspections shall be at the Contractor's expense.
- 12.3.6 If any Work (including the Work of others) that is to be inspected, tested or approved is covered without written concurrence or sufficient notice to the Owner, it must, if requested by the Owner, be uncovered for observation.

12.3.7 Such uncovering shall be at the Contractor's expense unless the Contractor has given the Owner timely notice of Contractor's intention to cover the same and the Owner has not acted with reasonable promptness in response to such notice.

12.3.8 Neither observations nor inspections, test or Approvals by the Owner or others shall relieve the Contractor from the Contractor's obligations to perform the Work in accordance with the Contract Documents.

12.4 UNCOVERING WORK:

12.4.1 If any Work is covered contrary to the written request of the Owner, it must, if requested by the Owner, be uncovered for the Owner's observation and replaced at the Contractor's expense.

12.4.2 If the Owner considers it necessary or advisable that covered Work be observed, inspected or tested, the Contractor, at the Owner's request, shall uncover, expose or otherwise make available for observation, inspection or testing as the Owner may require, that portion of the Work in question, furnishing all necessary labor, material and equipment.

12.4.3 If it is found that such Work is Defective, the Contractor shall bear all direct, indirect and consequential costs of such uncovering, exposure, observation, inspection and testing and of satisfactory reconstruction, (including but not limited to fees and charges of engineers, architects, attorneys and other professional) and the Owner shall be entitled to an appropriate decrease in the Contract Amount.

12.4.4 If, however, such Work is not found to be Defective, the Contractor shall be allowed an increase in the Contract Amount or an extension of the Contract Time, or both, directly attributable to such uncovering, exposure, observation, inspection, testing and reconstruction. The Contractor will only be allowed to recover 50 percent of his actual costs.

12.5 OWNER MAY STOP THE WORK:

12.5.1 If the Work is Defective, or the Contractor fails to supply suitable materials or equipment, or fails to furnish or perform the Work in such a way that the completed Work will conform to the Contract Documents, the Owner may order the Contractor to stop the Work, or any portion thereof, until the cause for such order has been eliminated; however, this right of the Owner to stop the Work shall not give rise to any duty on the part of the Owner to exercise this right for the benefit of the Contractor or any other party.

12.6 CORRECTION OR REMOVAL OF DEFECTIVE WORK:

12.6.1 If required by the Owner, the Contractor shall promptly, as directed, either correct all Defective Work, whether or not fabricated, installed or completed, or, if the Work has been rejected by the Owner, remove it from the site and replace it with Work which conforms to the requirements of the Contract Documents. The Contractor shall bear all direct, indirect and consequential costs of such correction removal (including but not limited to fees and charges of engineers, architects, attorneys and other professionals) made necessary thereby.

12.6.2 If the Work overseen by the Contractor's supervisory personnel repeatedly doesn't meet the requirements of the Contract Documents then at the request of the Owner the Contractor shall be required to remove from the project and replace the supervisory personnel.

12.7 ONE YEAR CORRECTION PERIOD:

12.7.1 If within one year after the date of Final Completion or such longer period of time as may be prescribed by Regulatory Requirements or by the terms of any applicable special guarantee required by the Contract Documents or by any specific provision of the Contract Documents, any Work is found to be Defective, the Contractor shall promptly, without cost to the Owner and in accordance with the Owner's written instructions, either correct such Defective Work, or, if it has been rejected by the Owner, remove it from the site and replace it with conforming Work.

12.7.2 If the Contractor does not promptly comply with the terms of such instructions, or in an emergency where delay would cause serious risk of loss or damage, the Owner may have the Defective Work corrected or the rejected Work removed and replaced, and all direct, indirect and consequential costs of such removal and replacement (including but not limited to fees and charges of engineers, architects, attorneys and other professionals) will be paid by the Contractor.

12.7.3 In special circumstances where a particular item of equipment is placed in continuous service for the benefit of the Owner before Substantial Completion of all the Work, the correction period for the item may begin on an earlier date if so provided in the Specifications or by Change Order.

12.7.4 Provisions of this paragraph are not intended to shorten the Statute of Limitations for bringing an action.

12.8 ACCEPTANCE OF DEFECTIVE WORK:

12.8.1 Instead of requiring correction or removal and replacement of Defective Work, the Owner may accept Defective Work, and in this event, the Contractor shall bear all direct, indirect and consequential costs attributable to the Owner's evaluation of and determination to accept such Defective Work (costs to include but not be limited to fees and charges of engineers, architects, attorneys and other professionals).

12.8.2 If any such acceptance occurs prior to Final payment, a Change Order will be issued incorporating the necessary revisions in the Contract Documents with respect to the Work and the Owner shall be entitled to an appropriate decrease in the Contract Amount.

12.8.3 If the Owner has already made Final payment to the Contractor, an appropriate amount shall be paid by the Contractor or his Surety to the Owner.

12.9 OWNER MAY CORRECT DEFECTIVE WORK:

- 12.9.1 If the Contractor fails within a reasonable time after written notice from the Owner to proceed to correct Defective Work or to remove and replace rejected Work as required by the Owner in accordance with paragraph 12.6, or if the Contractor fails to perform the Work in accordance with the Contract Documents, or if the Contractor fails to comply with any other provision of the Contract Documents, the Owner may, after seven days' written notice to the Contractor, correct and remedy any such deficiency. In exercising the rights and remedies under this paragraph the Owner shall proceed expeditiously.
- 12.9.2 To the extent necessary to complete corrective and remedial action, the Owner may exclude the Contractor from all or part of the site, take possession of all or part of the Work, and suspend the Contractor's services related thereto, take possession of the Contractor's tool, appliances, construction equipment and machinery at the site and incorporate in the Work all materials and equipment stored at the site or approved remote storage sites or for which the Owner has paid the Contractor but which are stored elsewhere, the Contractor shall allow the Owner and his authorized representatives such access to the site as may be necessary to enable the Owner to exercise the rights and remedies under this paragraph.
- 12.9.3 All direct, indirect and consequential costs of the Owner or its agents in exercising such rights and remedies will be charged against the Contractor, and a Change Order will be issued incorporating the necessary revisions in the Contract Documents with respect to the Work and the Owner shall be entitled to an appropriate decrease in the Contract Amount.
- 12.9.4 Such direct, indirect and consequential costs will include but not be limited to fees and charges of engineers, architects, attorneys and other professionals, all court and arbitration costs and all cost of repair and replacement of Work of others destroyed or damaged by correction, removal or replacement of the Contractor's Defective Work.
- 12.9.5 The Contractor shall not be allowed an extension of the Contract Time because of any delay in performance of the Work attributable to the exercise by the Owner of the Owner's rights and remedies hereunder.

13. ARTICLE 13 - PAYMENTS TO CONTRACTOR AND COMPLETION:

13.1 SCHEDULE OF VALUES:

- 13.1.1 The Schedule of Values established as provided in paragraph 6.6 will serve as the basis for progress payments and will be incorporated into a form of Application for Payment acceptable to the Owner. Progress payments on account of Unit Price Work will be based on the number of units completed.

13.2 PRELIMINARY PAYMENTS:

13.2.1 Upon Approval of the Schedule of Values the Contractor may be paid for direct costs substantiated by paid invoices and other prerequisite documents required by the Contract Documents. Direct costs shall include the cost of Bonds, insurance, approved materials stored on the site or at approved remote storage sites, deposits required by a supplier prior to fabricating materials, and other approved direct mobilization costs substantiated as indicated above. These payments shall be included as a part of the total Contract Amount as stated in the Contract.

13.3 APPLICATION FOR PROGRESS PAYMENT:

13.3.1 The Contractor shall submit to the Owner for review an Application for Payment filled out and signed by the Contractor covering the Work completed as of the date of the Application for Payment and accompanied by such supporting documentation as required by the Contract Documents.

13.3.2 Progress payments will be made as the Work progresses on a monthly basis.

13.3.3 The Owner will not be obligated to pay the Contractor for any overruns if;

13.3.3.1 The Contractor fails to notify the Owner of an overrun prior to placement.

13.3.3.2 The Contractor doesn't have written authorization from the Owner to exceed the quantity stated in the Bid Schedule or Change Document.

13.3.3.3 The Contractor records submitted for payment are in error, to include any supporting documentation submitted.

13.4 REVIEW OF APPLICATION FOR PROGRESS PAYMENT:

13.4.1 Owner will, either indicate in writing a recommendation of payment, or return the Application for Payment to the Contractor indicating in writing the Owner's reasons for refusing to recommend payment.

13.4.2 If the latter case, the Contractor may make the necessary corrections and resubmit the Application for Payment.

13.4.3 The Owner has up to 45 days to pay the Progress Payment from the date that Owner accepts the submitted Application for Payment.

13.5 STORED MATERIALS AND EQUIPMENT:

13.5.1 If payment is requested on the basis of materials and equipment not incorporated in the Work but delivered and suitably stored at the site or at another location agreed to in writing, the Application for Payment shall also be accompanied by a bill of sale, invoice or other documentation warranting that the Owner has received the materials and equipment free and clear of all charges, security interests and encumbrances and evidence that the materials and equipment are covered by appropriate property insurance and other arrangements to protect the Owner's interest therein, all of which will be satisfactory to the Owner.

13.5.2 No payment will be made for perishable materials that could be rendered useless because of long storage periods.

13.5.3 The Owner shall have no responsibility to in the Contractors failure to properly store the materials or for the length of time the material is stored.

13.5.4 The Contractor shall replace any materials damaged during storage, by damage due to prolonged exposure and/or improper storage.

13.5.5 No progress payment will be made for living plant materials until planted.

13.5.6 The payment may be reduced by an amount equal to transportation and handling cost if the materials are stored offsite, in a remote location, or will require special handling.

13.5.7 Payment for Materials Stored will not be more than 80% of the invoiced amount paid by the Contractor.

13.6 CONTRACTOR'S WARRANTY OF TITLE:

13.6.1 The Contractor warrants and guarantees that title to all Work, materials and equipment covered by any Application for Payment, whether incorporated in the Project or not, will pass to the Owner no later than the time of payment free and clear of any claims, liens, security interests and further obligations.

13.7 WITHHOLDING OF PAYMENTS:

13.7.1 The Owner may withhold or refuse payment for any of the reasons listed below provided it gives written notice of its intent to withhold and of the basis for withholding:

13.7.2 The Work is Defective, or completed Work has been damaged requiring correction or replacement, or has been installed without Approval of Shop Drawings, or by an unapproved subcontractor.

13.7.3 The Contract Amount has been reduced by Change Order.

13.7.4 The Owner has been required to correct Defective Work or complete Work in accordance with paragraph 12.9.

13.7.5 The Owner's actual knowledge of the occurrence of any of the events enumerated in subparagraphs 14.2.1.1 through 14.2.1.11 inclusive.

13.7.6 Claims have been made against the Owner or against the funds held by the Owner on account of the Contractor's actions or inactions in performing this Contract, or there are other items entitling the Owner to a set off.

13.7.7 Subsequently discovered evidence or the results of subsequent inspections or tests, nullify any previous payments for reasons stated in subparagraphs 13.7.1 through 13.7.5.

13.7.8 The Contractor has failed to fulfill or is in violation of any of his obligations under any provision of this Contract.

13.8 RETAINAGE:

13.8.1 At any time the Owner finds that satisfactory progress is not being made it may in addition to the amounts withheld under 13.7 retain a maximum amount equal to 10% of the total amount earned on all subsequent progress payments.

13.8.2 This retainage may be released at such time as the Owner finds that satisfactory progress is being made.

13.9 REQUEST FOR RELEASE OF FUNDS:

13.9.1 If the Contractor believes the basis for withholding is invalid or no longer exists, immediate written notice of the facts and Contract provisions on which the Contractor relies, shall be given to the Owner, together with a request for release of funds and adequate documentary evidence proving that the problem has been cured.

13.9.2 In the case of withholding which has occurred at the request of the Department of Labor, the Contractor shall provide a letter from the Department of Labor stating that withholding is no longer requested.

13.9.3 Following such a submittal by the Contractor, the Owner shall have a reasonable time to investigate and verify the facts and seek additional assurances before determining whether release of withheld payments is justified.

13.10 SUBSTANTIAL COMPLETION:

13.10.1 When the Contractor considers the Work ready for its intended use the Contractor shall notify the Owner in writing that the Work of a designated portion thereof is substantially complete (except for items specifically listed by the Contractor as incomplete) and request that the Owner issue a certificate of Substantial Completion.

13.10.2 Within a reasonable time thereafter, the Owner, the Contractor and appropriate Consultant(s) shall make an inspection of the Work to determine the status of completion.

13.10.3 If the Owner does not consider the Work substantially complete, the Owner will notify the Contractor in writing giving the reasons therefore. If the Owner considers the Work substantially complete, the Owner will within fourteen days execute and deliver to the Contractor a certificate of Substantial Completion with a tentative list of items to be completed or corrected.

13.10.4 At the time of delivery of the certificate of Substantial Completion the Owner will deliver to the Contractor a written division of responsibilities pending Final

Completion with respect to security, operation, safety, maintenance, heat, utilities, insurance and warranties which shall be consistent with the terms of the Contract Documents.

13.10.5 The Owner shall be responsible for all Owner costs resulting from the initial inspection and the first re-inspection, and the Contractor shall pay all costs incurred by the Owner resulting from re-inspections, thereafter.

13.11 ACCESS FOLLOWING SUBSTANTIAL COMPLETION:

13.11.1 The Owner shall have the right to exclude the Contractor from the Work after the date of Substantial Completion, but the Owner shall allow Contractor reasonable access to complete or correct items on the tentative list.

3.12 FINAL INSPECTION:

13.12.1 Upon written notice from the Contractor that the entire Work or an agreed portion thereof is complete, the Owner will make a Final inspection with the Contractor and appropriate Consultants and will notify the Contractor in writing of all particulars in which this inspection reveals that the Work is incomplete or Defective.

13.12.2 The Contractor shall immediately take such measures as are necessary to remedy such deficiencies.

13.12.3 The Contractor shall pay for all costs incurred by the Owner resulting from re-inspections.

13.13 FINAL APPLICATION FOR PAYMENT:

13.13.1 After the Contractor has completed all such corrections to the satisfaction of the Owner and delivered all maintenance and operating instructions, schedules, guarantees, bonds, certificates of payment to all laborers, subcontractors and Suppliers, certificates of inspection, marked-up record documents and other documents all as required by the Contract Documents, and after the Owner has indicated that the Work is acceptable (subject to the provisions of paragraph 13.16), the Contractor may make application for Final payment following the procedure for progress payments.

13.13.2 The Application for Final Payment shall be accompanied by all certificates, warranties, guaranties, releases, affidavits, and other documentation required by the Contract Documents.

13.14 FINAL PAYMENT AND FINAL COMPLETION:

13.14.1 If on the basis of the Owner's observation of the Work during construction and Final inspection, and the Owner's review of the Application for Final Payment and accompanying documentation all as required by the Contract Documents, the Owner is satisfied that the Work has been completed and the Contractor's other obligations under the Contract Documents have been fulfilled, the Owner will process Application for Final Payment.

13.14.2 Otherwise, the Owner will return the Application for Final Payment to the Contractor, indicating in writing the reasons for refusing to process Final payment, in which case the Contractor shall make the necessary corrections and resubmit the Application for Final Payment.

13.14.3 If, through no fault of the Contractor, Final Completion of the Work is significantly delayed, the Owner shall, upon receipt of the Contractor's Final Application for Payment, and without terminating the Contract, make payment of the balance due for that portion of the Work fully completed and accepted. If the remaining balance to be held by the Owner for Work not fully completed or corrected is less than the retainage provided for in paragraph 13.8, and if Bonds have been furnished as required in paragraph 5.1, the written consent of the Surety to the payment of the balance due for that portion of the Work fully completed and accepted shall be submitted by the Contractor to the Owner with the application for such payment.

13.14.4 Such payment shall be made under the terms and conditions governing Final Payment, except that it shall not constitute a waiver of claims.

13.15 FINAL ACCEPTANCE:

13.15.1 Following receipt of the Contractor's Release with no exceptions, and certification that laborers, subcontractors and material men have been paid, certification of payment of payroll and revenue taxes, and Final payment to the Contractor, the Owner will issue a letter of Final Acceptance, releasing the Contractor from further obligations under the Contract, except as provided in paragraph 13.16.

13.16 CONTRACTOR'S CONTINUING OBLIGATION:

13.16.1 The Contractor's obligation to perform and complete the Work and pay all laborers, subcontractors, and material men in accordance with the Contract Documents shall be absolute.

13.16.2 Neither any progress or Final payment by the Owner, nor the issuance of a certificate of Substantial Completion, nor any use or occupancy of the Work or any part thereof by the Owner, nor any act of acceptance by the Owner nor any failure to do so, nor any review and Approval of a Shop Drawing or sample submission, nor any correction of Defective Work by the Owner will constitute an acceptance of Work not in accordance with the Contract Documents or a release of the Contractor's obligation to perform the Work in accordance with the Contract Documents.

13.17 WAIVER OF CLAIMS BY CONTRACTOR:

13.17.1 The making and acceptance of Final payment will constitute a waiver of all claims by the Contractor against the Owner other than those previously made in writing and still unsettled.

13.18 NO WAIVER OF LEGAL RIGHTS:

13.18.1 The Owner shall not be precluded or be stopped by any payment, measurement, estimate, or certificate made either before or after the completion and acceptance of the Work and payment therefor, from showing the true amount and character of the Work performed and materials furnished by the Contractor, nor from showing that any payment, measurement, estimate or certificate is untrue or is incorrectly made, or that the Work or materials are Defective.

13.18.2 The Owner shall not be precluded or estopped, notwithstanding any such measurement, estimate, or certificate and payment in accordance therewith, from recovering from the Contractor or his Sureties, or both, such damages as it may sustain by reason of Contractor's failure to comply with requirements of the Contract Documents.

13.18.3 Neither the acceptance by the Owner, or any representative of the Owner, nor any payment for or acceptance of the whole or any part of the Work, nor any extension of the Contract Time, nor any possession taken by the Owner, shall operate as a waiver of any portion of the Contract or of the power herein reserved, or of any right to damages.

13.18.4 A waiver by the Owner of any breach of the Contract shall not be held to be a waiver of any other subsequent breach.

13.19 DEDUCTIONS:

13.19.1 The Owner may deduct from the amount of any payment made to the Contractor any sums owed to the Owner by the Contractor including but not limited to:

13.19.1.1 Past due sales tax,

13.19.1.2 Port and harbor fees,

13.19.1.3 Property tax or rent.

13.19.2 Before making any such deductions, the Owner shall have provided Contractor written notice of the amount claimed by the Owner to be due and owing from the Contractor.

14. ARTICLE 14 - SUSPENSION OF WORK, DEFAULT AND TERMINATION:

14.1 OWNER MAY SUSPEND WORK:

14.1.1 The Owner may, at any time suspend the Work or any portion thereof by notice in writing to the Contractor. If the Work is suspended without cause the Contractor shall be allowed to re-coup his direct costs or an extension of the Contract Time, or both, directly attributable to any suspension if the Contractor makes an approved claim therefore as provided in Article 15.

14.1.2 However, no adjustment shall be made under this clause for any suspension, delay, or interruption to the extent that suspension is due to the fault or negligence

of the Contractor, or that suspension is necessary for Contract compliance, or that performance would have been so suspended, delayed, or interrupted by any other cause, including the fault or negligence of the Contractor.

14.1.3 In case of suspension of Work, the Contractor shall be responsible for preventing damage to or loss of any of the Work already performed and of all materials whether stored on or off the site or approved remote storage sites.

14.2 DEFAULT OF CONTRACTOR:

14.2.1 If the Contractor:

14.2.1.1 Fails to begin the Work under the Contract within the time specified in the Contract Documents, or

14.2.1.2 Fails to perform the Work in accordance with the Contract Documents (including, but not limited to, failure to supply sufficient skilled workmen or suitable materials or equipment or failure to adhere to the progress schedule established under paragraph 6.6 as revised from time to time), or

14.2.1.3 Performs the Work unsuitably or neglects or refuses to remove materials or to correct Defective Work.

14.2.1.4 Discontinues the prosecution of the Work, or

14.2.1.5 Fails to resume Work which has been discontinued within a reasonable time after notice to do so, or

14.2.1.6 Becomes insolvent or is declared bankrupt, or commits any act of bankruptcy or insolvency except as prohibited by 11 U.S.C. 363, or

14.2.1.7 Allows any final judgment to stand against him unsatisfied for period of 60 days, or

14.2.1.8 Makes an assignment for the benefit of creditors without the consent of the Owner, or

14.2.1.9 Disregards Regulatory Requirements of any public body having jurisdiction, or

14.2.1.10 Otherwise violates in any substantial way any provisions of the Contract Documents, or

14.2.1.11 For any cause whatsoever, fails to carry on the Work in an acceptable manner, the Owner may give notice in writing to the Contractor and his Surety of such delay, neglect, or default.

14.2.2 If the Contractor or Surety, within the time specified in the above Notice of Default, shall not proceed in accordance therewith, then the Owner may, upon written notification to the Contractor or Surety of the fact of such delay, neglect or default and the Contractor's failure to comply with such notice, have full power and

authority without violating the Contract, to take the prosecution of the Work out of the hands of the Contractor.

- 14.2.3 The Owner may terminate the services of the Contractor, exclude the Contractor from the site and take possession of the Work and of all the Contractor's tools, appliances, construction equipment and machinery at the site and use the same to the full extent they could be used by the Contractor (without liability to the Contractor for trespass or conversion), incorporate in the Work all materials and equipment stored at the site or for which the Owner has paid the Contractor but which are stored elsewhere, and finish the Work as the Owner may deem expedient.
- 14.2.4 The Owner may enter into an agreement for the completion of said Contract according to the terms and provisions thereof, or use such other methods that in the opinion of the Owner are required for the completion of said Contract in an acceptable manner.
- 14.2.5 The Owner may, by written notice to the Contractor and his Surety or his representative, transfer the employment of the Work from the Contractor to the Surety, or if the Contractor abandons the Work undertaken under the Contract, the Owner may, at his option with written notice to the Surety and without any written notice to the Contractor, transfer the employment for said Work directly to the Surety.
- 14.2.6 The Surety shall submit its plan for completion of the Work, including any contracts or agreements with third parties for such completion, to the Owner for Approval prior to beginning completion of the Work. Approval of such Contracts shall be in accordance with all applicable requirements and procedures for Approval of subcontracts as stated in the Contract Documents.
- 14.2.7 Upon receipt of the notice terminating the services of the Contractor, the Surety shall enter upon the premises and take possession of all materials, tools, and appliances thereon for the purpose of completing the Work included under the Contract and employ by contract or otherwise any person or persons to finish the Work and provide the materials therefore, without termination of the continuing full force and effect of this Contract.
- 14.2.8 In case of such transfer of employment to the Surety, the Surety shall be paid in its own name on estimates covering Work subsequently performed under the terms of the Contract and according to the terms thereof without any right of the Contractor to make any claim for the same or any part thereof.
- 14.2.9 If the Contract is terminated for default, the Contractor and the Surety shall be jointly and severally liable for damages for delay as provided by paragraph 11.8, and for the excess cost of completion, and all costs and expenses incurred by the Owner in completing the Work or arranging for completion of the Work, including but not limited to costs of assessing the Work to be done, costs associated with advertising, soliciting or negotiating for bids or proposals for completion, and other procurement costs.

14.2.10 Following termination the Contractor shall not be entitled to receive any further balance of the amount to be paid under the Contract until the Work is fully finished and accepted, at which time if the unpaid balance exceeds the amount due the Owner and any amounts due to persons for whose benefit the Owner has withheld funds, such excess shall be paid by the Owner to the Contractor.

14.2.11 If the damages, costs, and expenses due the Owner exceed the unpaid balance, the Contractor and his Surety shall pay the difference.

14.2.12 If, after notice of termination of the Contractor's right to proceed under the provisions of this clause, it is determined for any reason that the Contractor was not in default under the provisions of this clause, or that the delay was excusable under the provisions of this clause, or that termination was wrongful, the rights and obligations of the parties shall be determined in accordance with the clause providing for convenience termination.

14.3 RIGHTS OR REMEDIES:

14.3.1 Where the Contractor's services have been so terminated by the Owner, the termination will not affect any rights or remedies of the Owner against the Contractor then existing or which may thereafter accrue.

14.3.2 Any retention or payment of moneys due the Contractor by the Owner will not release the Contractor from liability.

14.4 CONVENIENCE TERMINATION:

14.4.1 The performance of the Work may be terminated by the Owner in accordance with this section in whole or in part, whenever, for any reason the Owner shall determine that such termination is in the best interest of the Owner.

14.4.2 Any such termination shall be effected by delivery to the Contractor of a Notice of Termination, specifying termination is for the convenience of the Owner the extent to which performance of Work is terminated, and the date upon which such termination becomes effective.

14.4.3 Immediately upon receipt of a Notice of Termination and except as otherwise directed by the Owner the Contractor shall:

14.4.3.1 Stop Work on the date and to the extent specified in the Notice of Termination;

14.4.3.2 Place no further orders or subcontracts for materials, services, or facilities except as may be necessary for completion of such portion of the Work as is not terminated;

14.4.3.3 Terminate all orders and subcontracts to the extent that they relate to the performance of Work terminated by the Notice of Termination;

14.4.3.4 With the written Approval of the Owner, to the extent he may require, settle all outstanding liabilities and all claims arising out of such

termination of orders and subcontracts, the cost of which would be reimbursable, in whole, or in part, in accordance with the provisions of the Contract;

14.4.3.5 Submit to the Owner a list, certified as to quantity and quality, of any or all items of termination inventory exclusive of items the disposition of which had been directed or authorized by the Owner;

14.4.3.6 Transfer to the Owner the completed or partially completed record Drawings, Shop Drawings, information, and other property which, if the Contract had been completed, would be required to be furnished to the Owner;

14.4.3.7 Take such action as may be necessary, or as the Owner may direct, for the protection and preservation of the property related to the Contract which is in the possession of the Contractor and in which the Owner has or may acquire any interest.

14.4.4 The Contractor shall proceed immediately with the performance of the above obligations.

14.4.5 When the Owner orders termination of the Work effective on a certain date, all Work in place as of that date will be paid for in accordance with the Basis of Payment clause of the Contract.

14.4.6 Materials required for completion and on hand but not incorporated in the Work will be paid for at cost plus 15% with materials becoming the property of the Owner or the Contractor may retain title to the materials and be paid an agreed upon lump sum.

14.4.7 Materials on order shall be canceled, and the Owner shall pay reasonable factory cancellation charges with the option of taking delivery of the materials in lieu of payment of cancellation charges.

14.4.8 The Contractor shall be paid 10% of the cost, freight not included, of materials canceled, and direct expenses only for Contractor chartered freight transport which cannot be canceled without charges, to the extent that the Contractor can establish them.

14.4.9 The extra costs due to cancellation of Bonds and insurance and that part of job start-up and phase-out costs not amortized by the amount of Work accomplished shall be paid by the Owner.

14.4.10 Charges for loss of profit, loss of potential work or consequential damages shall not be recoverable except as provided above.

14.4.11 The termination claim shall be submitted promptly, but in no event later than 90 days from the effective date of termination, unless one or more extensions in writing are granted by the Owner upon request of the Contractor made in writing within the 90 day period.

14.4.12 Upon failure of the Contractor to submit his termination claim within the time allowed, the Owner may determine, on the basis of information available to him, the amount, if any, due to the Contractor by reason of the termination and shall thereupon pay to the Contractor so determined.

14.4.13 The Contractor and the Owner may agree upon whole or any part of the amount or amounts to be paid to the Contractor by reason of the total or partial termination of the Work pursuant to paragraph 14.4.

14.4.14 The Contract shall be amended accordingly, and the Contractor shall be paid the agreed amount. In the event of the failure of the Contractor and the Owner to agree in whole or in part, as provided heretofore, as to the amounts with respect to costs to be paid to the Contractor in connection with the termination of the Work the Owner shall determine, on the basis of information available to him, the amount, if any, due to the Contractor by reason of the termination and shall pay to the Contractor the amount determined as follows:

14.4.14.1 All costs and expenses reimbursable in accordance with the Contract not previously paid to the Contractor for the performance of the Work prior to the effective date of the Notice of Termination;

14.4.14.2 So far as not included above, the cost of settling and paying claims arising out of the termination of the Work under subcontracts or orders which are properly chargeable to the terminated portions of the Contract;

14.4.14.3 The reasonable costs of settlement with respect to the terminated portion of the Contract heretofore, to the extent that these costs have not been covered under the payment provisions of the Contract.

14.4.15 The Contractor shall have the right of appeal under the Owner's claim procedures, as defined in Article 15, for any determination made by the Owner, except if the Contractor has failed to submit his claim within the time provided and has failed to request an extension of such time, Contractor shall have no such right of appeal. In arriving at the amount due the Contractor under this section, there shall be deducted:

14.4.15.1 All previous payments made to the Contractor for the performance of Work under the Contract prior to termination;

14.4.15.2 Any claim for which the Owner may have against the Contractor;

14.4.15.3 The agreed price for, or the proceeds of sale of, any materials, supplies, or other things acquired by the Contractor or sold pursuant to the provisions of this section and not otherwise recovered by or credited to the Owner; and,

14.4.15.4 All progress payments made to the Contractor under the provisions of this section.

14.4.16 Where the Work has been terminated by the Owner said termination shall not affect or terminate any of the rights of the Owner against the Contractor or his Surety then existing or which may thereafter accrue because of a default.

14.4.17 Any retention or payment of monies by the Owner due to the Contractor under the terms of the Contract shall not release the Contractor or his Surety from liability.

14.4.18 Unless otherwise provided for in the Contract Documents, or by applicable statute, the Contractor, from the effective date of termination and for a period of three years after final settlement under this Contract, shall preserve and make available to the Owner at all reasonable times at the office of the Contractor, all its books, records, documents, and other evidence bearing on the cost and expenses of the Contractor under this Contract and relating to the Work terminated hereunder.

15. ARTICLE 15 - CLAIMS AND DISPUTES:

15.1 NOTIFICATION:

15.1.1 In addition to the notice requirements set out elsewhere in this Contract, if the Contractor becomes aware of any act or occurrence which may form the basis of a claim by the Contractor for additional compensation or an extension of time for performance, or if any dispute arises regarding a question of fact or interpretation of the Contract, the Contractor shall immediately inform the Project Manager that day but no later than by noon the preceding day.

15.1.2 If the matter cannot be resolved by agreement within 7 days, the Contractor shall, within the next 14 days, submit Intent to Claim in writing to the Project Manager. The Intent to Claim shall be presented as outlined in 15.2 Presenting Claim.

15.1.3 The Claim, if not resolved, shall be presented to the Owner's Project Manager, in writing, within 60 days following receipt of the Intent to Claim.

15.1.4 Receipt of the Claim will be acknowledged in writing by the Owner's Project Manager.

15.1.5 The Contractor agrees that unless these written notices are provided, the Contractor will have no entitlement to additional time or compensation for such act, event or condition.

15.1.6 The Contractor shall in any case continue diligent performance of the Contract.

15.1.5 If the Claim or dispute is not resolved by the OWNER, then the CONTRACTOR shall submit a written Claim to the Contracting Officer within 90 days after the CONTRACTOR becomes aware of the basis of the Claim or should have known the basis of the Claim, whichever is earlier. The Contracting Officer will issue written acknowledge of the receipt of the Claim.

15.1.7 The CONTRACTOR waives any right to Claim if the OWNER was not notified properly or afforded the opportunity to inspect conditions or monitor actual costs or if the Claim is not filed on the date required.

15.2 PRESENTING CLAIM:

15.2.1 The Claim shall be submitted in accordance with ARRC Procurement Rule 1800.12 and shall specifically include the following:

15.2.1.1 The act, event or condition giving rise to the claim.

15.2.1.2 The Contract provisions which apply to the claim and under which relief is provided.

15.2.1.3 The item or items of Contract Work affected and how they are affected.

15.2.1.4 The specific relief requested, including additional Contract Time if applicable, and the basis upon which it was calculated.

15.2.1.5 All figures, computations, data, records and any other information that shows the basis of the Contractors claim and specifically how it was calculated. The information must be presented in a clear and logical presentation and only factual information will be allowed. Speculation, conjecture and assumptions will not be considered.

15.2.1.6 It is solely the Contractor's burden to clearly and accurately present the Claim. Failure to do so will null and void the Claim.

15.2.1.7 Contractor to provide a statement certifying that the Claim is made in good faith, that the supporting cost and pricing data are accurate and complete to the best of the CONTRACTOR'S knowledge and belief, and that the amount requested accurately reflects the Contract adjustment which the CONTRACTOR believes is due.

15.3 CLAIM VALIDITY, ADDITIONAL INFORMATION, & PROJECT MANAGER'S ACTIONS:

15.3.1 The Claim, in order to be valid, must not only show that the Contractor suffered damages or delay but that those conditions were actually a result of the act, event or condition complained of and that the Contract provides entitlement to relief to the Contractor for such act, event, or condition.

15.3. Also, in order for the Claim to be valid the Contractor must be able to clearly show specifically how he was damaged and all items in 15.2.1.5 must equal and clearly show the additional compensation or the extension of time for performance the Contractor is requesting.

15.3.2 The Project Manager reserves the right to make written request to the Contractor at any time for additional information which the Contractor may possess relative to the Claim.

15.3.3 The Contractor agrees to provide the Project Manager such additional information within 14 days of receipt of such a request. Failure to furnish such additional information may be regarded as a waiver of the Claim. If the Contractor requires additional time to furnish the information then a formal written request must be submitted asking for an extension in time.

15.3.4 The Claim, if not resolved by agreement within 60 days of its receipt, will automatically be forwarded to the Owner for formal written decision.

15.3.5 Failure of the Contractor to actively seek resolution with the Owner, involve, notify or provide timely information to the Owner shall render the Contractor's right to claim null and void.

15.4 OWNER'S DECISION:

15.4.1 The Contractor will be furnished the Owner's Decision within the next 90 days, unless additional information is requested by the Owner.

15.4.2 The Owner's Decision is final and conclusive unless fraudulent as to the Claim.

15.5 NOTICE OF APPEAL:

15.5.1 Within 14 days of receipt of the Owner's Decision, the Contractor may deliver a Notice of Appeal to the Owner in accordance with ARRC Procurement Rule 1800.13 and request a hearing.

15.5.2 The Notice of Appeal shall include specific exceptions to the Owner's Decision, including specific provisions of the Contract, which the Contractor intends to rely upon in the appeal.

15.5.3 General assertions that the Owner's Decision is contrary to law or to fact are not sufficient.

15.6 OWNER'S DECISION ON APPEAL:

15.6.1 The decision of the Owner on appeal will be rendered within 90 days after the conclusion of a hearing conducted under ARRC Procurement Rule 1800.15 or the date of receipt of the Notice of Appeal, whichever is later.

15.6.2 The time limits given above may be extended by mutual consent.

15.6.3 The decision of the Owner on appeal shall be final and conclusive unless the Contractor appeals to the superior court in accordance with ARRC Procurement Rule 1800.18.

15.7 FRAUD AND MISREPRESENTATION IN MAKING CLAIMS

Criminal and Civil penalties authorized under AS 36.30.687 (including, but not limited to, forfeiture of all claimed amounts) may be imposed on the CONTRACTOR if the CONTRACTOR makes or uses a misrepresentation in support of a Claim or defrauds or attempt to defraud the OWNER at any stage of prosecuting a Claim under this Contract.

16. ARTICLE 16 - MISCELLANEOUS:

16.1 GOVERNING LAW:

16.1.1 This Contract shall be governed by the laws of the State of Alaska and the provisions of ARRC's Procurement Rules.

16.2 CONTRACT CLAUSES:

16.2.1 If any contract clause is declared null and void, then all other clauses shall remain in force.

APPENDIX F

CONSTRUCTION QUALITY CONTROL (CQC) PLAN

2. SUBMITTAL AND GENERAL REQUIREMENTS

- 2.1. The Contractor shall establish and maintain an effective quality management system. The quality management system shall consist of plans, procedures, and the organization necessary to provide material, equipment, and workmanship that comply with the requirements of the contract documents. The system shall cover operations both onsite and offsite, and shall be keyed to the proposed sequence of the work.
- 2.2. The Contractor shall prepare a Construction Quality Control (CQC) plan compliant with the requirements of this appendix and all other contract documents. A complete detailed CQC plan shall be submitted to the Owner's Representative within 10 days of intent to award and shall be approved in writing by the Owner's Representative prior to proceeding with the work.
- 2.3. The CQC plan shall be capable of ensuring that the procurement, shipping, handling, fabrication, installation, cleaning, inspection, construction, testing, storage, examination, repair maintenance, and required modifications of all materials, equipment, and elements of the work comply with the requirements of the contract documents and that all materials incorporated in the work will perform satisfactorily for the purpose intended.
- 2.4. If Contractor does not provide an acceptable CQC plan, ARRC may, at its sole discretion, elect to award the contract to others.

3. AUTHORITY AND RESPONSIBILITY

- 3.1. Authority: The persons and organizations performing quality control and quality assurance functions shall have sufficient authority and organizational freedom to identify quality problems and to initiate, recommend, provide, and verify implementation of the solution.
- 3.2. Changes in Plan or Personnel: The Contractor shall not revise the CQC or the quality staffing levels or replace any of the key personnel specified herein without prior written approval from the Owner's Representative.
- 3.3. Contractor's Responsibility: The Contractor is solely responsible for achieving project quality and shall have overall responsibility for the quality of all construction work. The contractor shall conduct quality management activities, which include

inspection, materials testing, and other activities specifically developed and/or chosen by the Contractor.

3.4. Owner's Responsibility: ARRC reserves the right to, and will, conduct inspections, testing, sampling, and evaluation associated with quality assurance and independent quality assurance. ARRC's role in construction is to provide the following.

3.4.1. Quality assurance and independent assurance of construction activities, inspection, and materials testing. ARRC will do this with either its staff or a consultant acting as the owner's representative.

3.4.2. Oversight of the Contractor's quality management activities to ensure adherence to the CQC plan and compliance with the contract documents.

3.4.3. Notifying the Contractor promptly of irregularities or deficiencies observed in the work.

3.4.4. Oversight of the Contractor's construction management, including scheduling, invoicing, shop drawing review, document control, etc.

4. CONSTRUCTION QUALITY CONTROL (CQC) PLAN

4.1. Objectives: Quality in the construction phase is the program of policies, procedures, and responsibilities required to provide confidence that the desired characteristics have been obtained to help ensure the project will perform its intended function for its design life. Quality control in the construction phase shall consist of those actions necessary to assess production and construction processes so as to control the level of quality being produced in the end project. The Contractor's quality control actions shall include examining, checking, and inspecting in-process and completed work, and materials sampling and testing during production and construction, as a means of controlling and measuring the characteristics and conformity of an item, process, or feature to established requirements.

4.2. The Contractor's CQC plan shall be capable of:

4.2.1. Ensuring that the design, procurement, shipping, handling, fabrication, installation, cleaning, inspection, construction, testing, storage, examination, repair, maintenance, and required modifications of all materials, equipment, and elements of the work comply with the requirements of the contract documents.

4.2.2. Ensuring that all materials incorporated in the work, all equipment, and all elements of the work will perform satisfactorily for the purpose intended.

4.3. Contents of the CQC Plan: The CQC plan shall delineate the type and frequency of inspection, sampling, and testing deemed necessary to measure and control the various properties of material and workmanship of all construction processes within the tolerances governed by the drawings and specifications, applicable codes and regulations, permit conditions, and other contract requirements as contained herein. The CQC plan shall include the following, at a minimum.

4.3.1. Construction activity and item inspection plans.

4.3.2. Schedule of materials control including materials to be tested, test methods, and frequency of testing.

4.3.3. Sampling locations and techniques.

- 4.3.4. Control of workmanship
- 4.3.5. Identification and qualifications of key quality control personnel, including the quality control manager, inspectors, and technicians. Include an organization chart with reporting lines.
- 4.3.6. Name and location of testing laboratories.
- 4.3.7. Documentation procedures, including inspection and test records; accuracy and calibration checks; nature, number, and type of deficiencies found; nature of corrective actions; and quantities of work tested and sampled.
- 4.3.8. Mandatory inspection points.

5. CONSTRUCTION QUALITY ORGANIZATION

- 5.1. The construction CQC shall describe the Contractor's quality management organization for all of the project construction processes. At a minimum, the CQC shall identify the following positions.
 - 5.1.1. Construction Manager or Superintendent: The Construction Manager shall be the individual responsible for the overall project construction, quality management, and contract administration for this project.
 - 5.1.2. Construction Quality Manager: The Construction Quality Manager may work directly for the Contractor or may be contracted from an independent firm or organization. The Construction Quality Manager shall work under the direct supervision of the Construction Manager. It shall be the responsibility of the Construction Quality Manager to perform workmanship inspections, implement quality planning, oversee quality control testing, and coordinate with Owner's QA testing and independent assurance testing. The Construction Quality Manager shall also cooperate with the Owner's Representative in compiling a statistical correlation of materials and workmanship data. The Construction Quality Manager shall be responsible for submitting requested inspection, testing, and other data to the Owner's Representative on a daily basis or as determined by the Construction Quality Manager and ARRC's field representative.. The Construction Quality Manager shall have at least two years (within the last five years) of experience in inspection and materials testing for similar projects.
 - 5.1.3. Construction Testing Technicians: The construction testing technicians may work directly for the Contractor or may be contracted from an independent firm or organization. They shall work under the direct supervision of the Construction Quality Manager and perform inspections as indicated in the construction CQC. Each Construction Testing Technician shall have training and/or technical certification, as appropriate, for the specific type and level of work that they will be testing; e.g., asphalt certification, welding, concrete strength, etc.

- 6. **PRECONSTRUCTION MEETING:** Before the start of construction, the Contractor shall meet with ARRC or its authorized representative in a pre-construction meeting. A topic of the pre-construction meeting shall be the Contractor's proposed quality management system. During the meeting, a mutual understanding of the system details shall be

developed, including the forms for recording the Contractor's quality control operations, control activities, testing, administration of the system for both onsite and offsite work, and the Contractor's quality control program. Minutes of the meeting shall be prepared and signed by both the Construction Manager and the Owner's Representative. The minutes shall become a part of the contract file. Additional conferences may be called at any time to reconfirm mutual understandings.

7. INSPECTIONS AND TESTS

- 7.1. Except where they are specifically indicated to be the Owner's responsibility, or are provided by another identified entity, the Contractor shall provide inspections, tests, and similar quality control services in accordance with the approved CQC plan. Costs for these services shall be included in the contract price, whether performed by the Contractor's personnel or an independent firm.
- 7.2. Associated Services: The Contractor shall cooperate with organizations performing required inspections, tests, and similar services and shall provide reasonable auxiliary services as requested. Auxiliary services required include, but are not limited to:
 - 7.2.1. Providing access to the work and furnishing incidental labor and facilities necessary to facilitate inspections and tests.
 - 7.2.2. Taking adequate quantities of representative samples of materials that require testing or assisting the Owner in taking samples.
 - 7.2.3. Providing facilities for storage or curing of test samples, and delivery of samples to testing laboratories.
 - 7.2.4. Providing the Owner with a preliminary design mix proposed for use for materials mixes that require control.
 - 7.2.5. Security and protection of samples and test equipment at the project site.
- 7.3. Coordination: The Contractor, the Owner's Representative, and any independent testing agencies shall coordinate the sequence of activities to accommodate required inspection and testing services with a minimum of delay. In addition, the Contractor and ARRC shall coordinate activities so that removing and replacing construction to accommodate inspections and tests will not be required.
- 7.4. The Contractor is responsible for scheduling times for inspections, tests, taking samples, and similar activities.
- 7.5. Mandatory Inspection Documentation Points: Documentation points are mandatory verification and inspection points that shall be identified in the CQC plan and the project schedule. Documentation points should be points at which critical characteristics are to be measured and documented by the Construction Quality Manager. It will be the responsibility of the Construction Quality Manager to certify that the design and construction have met the requirements of the plans and specifications and to sign all inspection documentation. Inspection documentation shall be submitted to ARRC or its representative when requested. It shall be the responsibility of the Contractor to determine inspection documentation point criteria and required documentation. ARRC will not prescribe the inspection criteria.
- 7.6. ARRC should be notified a minimum of 24 hours prior to any mandatory inspection.

- 7.6.1. The mandatory inspection points for this project shall be established through coordination between the contractor and the Owner's Representative...
- 7.7. Completion Inspection: At the completion of all work or any increment thereof established by a completion time stated in the schedule or in the CQC plan, the Construction Quality Manager shall conduct a completion inspection of the work and develop a punch list of items that do not conform to the contract documents. Such a list of deficiencies shall be included in the QC documentation as required herein, and shall include the estimated date by which the deficiencies will be corrected. The Construction Quality Manager shall make a second completion inspection to make certain that all deficiencies noted on the punch list have been corrected and so notify ARRC. The completion inspections and any deficiency corrections required by this paragraph shall be accomplished within the time stated for completion of the entire work or any particular increment thereof if the project is divided into increments by separate completion dates.

8. DOCUMENTATION

- 8.1. The Contractor shall maintain daily records of quality control operations, activities, and tests performed, including the work of suppliers and subcontractors. These records shall be on an acceptable form and shall include factual evidence that required activities or tests have been performed, including, but not limited to, the following.
- 8.1.1. Type and number of control activities and tests involved.
 - 8.1.2. Results of control activities or tests.
 - 8.1.3. Nature of nonconformances, defects, causes for rejection, etc.
 - 8.1.4. Proposed remedial action.
 - 8.1.5. Corrective actions taken.
 - 8.1.6. Description of trades working on the project, the number of personnel working, the weather conditions encountered, any delays, and acknowledgement of any instruction given by ARRC.
- 8.2. The daily quality control report records shall cover both conforming and defective or deficient features and shall include a statement that supplies and materials incorporated in the work and workmanship comply with the contract. The Construction Quality Manager shall sign the daily quality control report and furnish legible copies to ARRC by the end of the following workday.
- 8.3. Monthly quality control reports that summarize project status, work completed related to funds expended, any nonconformance, and any necessary corrective actions shall be provided.

APPENDIX G

COST SCHEDULE

COST SCHEDULE: A Bidder's Failure to provide the information requested in this Appendix may be cause for rejection of the bid on the basis on non-responsiveness. Cost shall be bid in accordance to all specifications in Appendix B, and any Drawings or Technical Specifications incorporated herein.

AWARD CRITERIA: A contract award resulting from this solicitation shall be made to the low, responsive, responsible bidder who meets the requirements as set forth in the plans and specifications and compliance thereof. The contract may be awarded to the responsive and responsible bidder who's Lump Sum Base Bid is deemed by the Contact Administrator to be in best interest of the ARRC. The successful bidder shall hold unit prices of all additives firm for a period of thirty (30) days from the date of bid opening. Award is contingent on the availability of ARRC funds.

DESCRIPTION

LUMP SUM TOTAL

HVAC Upgrades:

\$ _____

NON-COLLUSION AFFIDAVIT: The Undersigned declares, under penalty of perjury under the laws of the United States, that neither he/she nor the firm, association, or corporation of which he/she is a member, has, either directly or indirectly, entered into any agreement, participated in any collusion, or otherwise taken any action in restraint of free competitive bidding in connection with this Bid.

The Undersigned has read the foregoing proposal and hereby agrees to the conditions stated therein by affixing his/her signature below:

BIDDERS NAME AND ADDRESS

COMPANY NAME

SIGNATURE BY AND FOR THE BIDDER

COMPANY MAILING ADDRESS

PRINTED NAME OF ABOVE BIDDER

CITY, STATE ZIP CODE

DATE OF BID

CONTACT PHONE NUMBER

CONTACT E-MAIL



ALASKA RAILROAD CORPORATION

ENGINEERING SERVICES

P.O. BOX 107500, ANCHORAGE, ALASKA 99510-7500

ALL SEASONS CLOTHING COMPANY RETAIL VENTILATION

KENAI SUPPLY BUILDING
WASILLA SHOPS CIRCLE
WASILLA, ALASKA

MBA Consulting Engineers, Inc.

3812 Spenard Road, Suite 200
ANCHORAGE, AK 99517

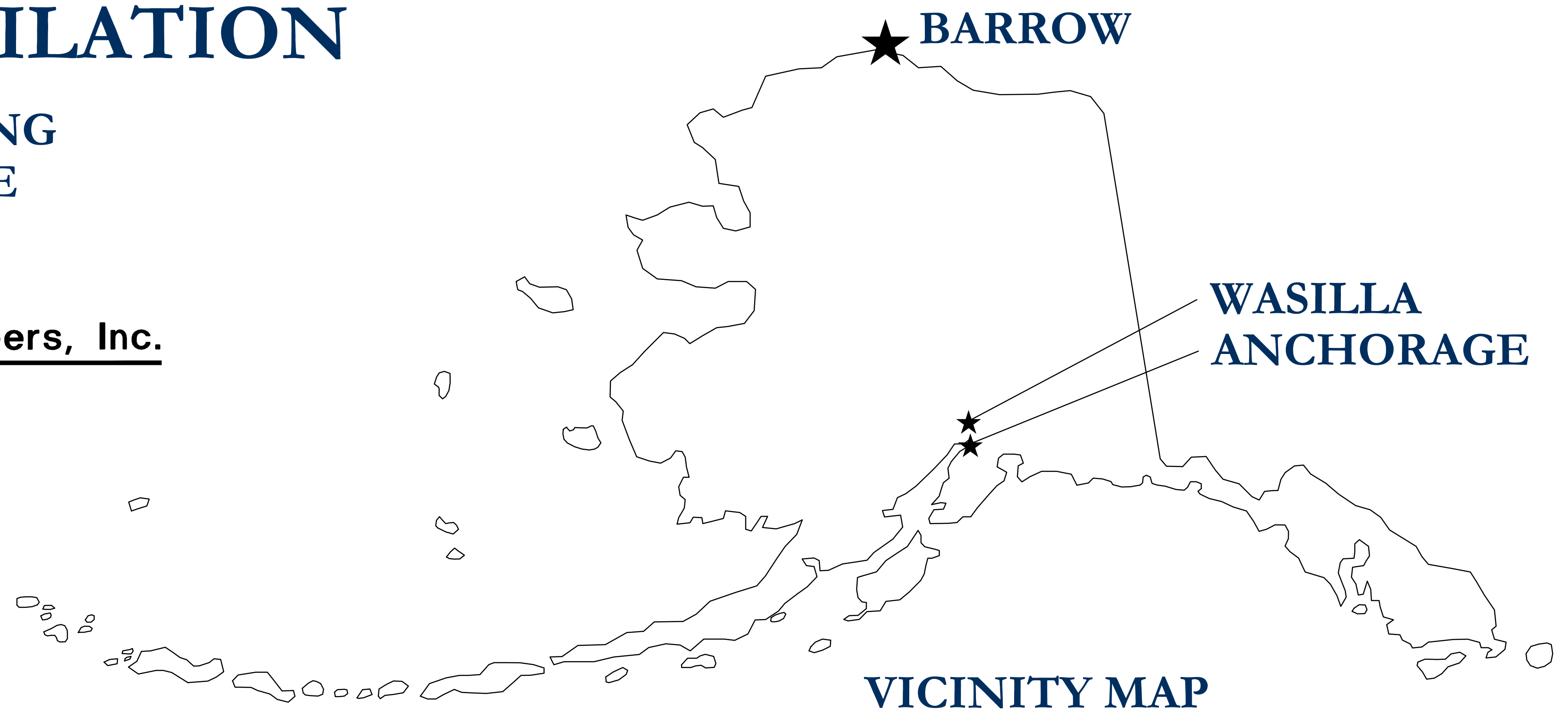

SHEET INDEX:

- 1 TITTLE SHEET
- MECHANICAL DRAWINGS
 - 2 M1 MECHANICAL LEGEND AND SCHEDULES
 - 3 M2 FIRST FLOOR HVAC PLAN
 - 4 M3 SECOND FLOOR HVAC PLAN
 - 5 M4 BOILER DEMOLITION □ REMODEL PIPING SCHEMATIC
 - 6 M5 DETAILS
 - M6 MECHANICAL SPECIFICATIONS
 - 8 M□ MECHANICAL SPECIFICATIONS
- ELECTRICAL DRAWINGS
 - 9 E1 LEGEND, SCHEDULES AND POWER ONE LINE
 - 10 E2 FIRST FLOOR ELECTRICAL PLAN
 - 11 E3 SECOND FLOOR ELECTRICAL PLAN
 - 12 E4 ELECTRICAL SPECIFICATIONS

REV.	DATE	BY	REVISION
0	1/11/19	MBA	BID SET

ALASKA RAILROAD CORPORATION ENGINEERING SERVICES P.O. BOX 107500, ANCHORAGE, ALASKA 99510-7500	
ALASKA RAILROAD CORPORATION KENAI SUPPLY BUILDING RENOVATION	
TITTLE SHEET	
DESIGNED BY: MBA DRAWN BY: MBA CHECKED BY: MBA APPROVED BY: MBA	SCALE: AS NOTED DATE: 1/11/2019
TTS	AFE NO.: ACAD FILE:17034_TTS DWG NO. 1 OF 12

HEATING COIL SCHEDULE														
SYMBOL	LOCATION	MBH	MAX CFM	VEL FPM	GPM	AIR TEMP		FLUID (%)	FLUID TEMP.		ΔP AIR	MAX. FLUID	VALVE TYPE	RELATED SYSTEM
						IN	OUT		IN	OUT				
(E)HC-1	HALL 114	7.8	--	500 MAX	0.8	--	70	WATER	190	170	0.15"	2.0'	2-WAY	HRV-1
HC-2	GARAGE 107	229	6,100	500 MAX	16.9	20	55	50% PG	180	160	0.15"	2.0'	3-WAY	AHU-1
HC-3	RETAIL 101	63.4	3,450	500 MAX	6.3	55	72	WATER	190	170	0.15"	2.0'	2-WAY	REHEAT COIL
HC-4	STORAGE 216	10.7	1,280	500 MAX	2.4	55	72	WATER	190	170	0.15"	2.0'	2-WAY	REHEAT COIL
HC-5	STORAGE 216	19.5	1,370	500 MAX	2.5	55	72	WATER	190	170	0.15"	2.0'	2-WAY	REHEAT COIL

FAN SCHEDULE											
SYMBOL	LOCATION	CFM	S.P.		RPM	O.V. FPM	TYPE		USE	MOTOR HP/VOLTS/PH	DESIGN BASIS PRODUCT
			TOT	EXT			SIZE	WHL			
AHU-1	GARAGE 107	6,100	2.9	1.0	1,706	1,307	22.25	PLEN	S/A	7.5/208/3	TRANE MODEL CSAA012UA, MIXING BOX W/ FILTER, HEATING COIL, COOLING COIL, S/A FAN SECTION, 30" H PERFORATED PLENUM, FACTORY VFD, UC600 CONTROL, LCD, ENTHALPY CONTROL, MIN O/A 3,390 CFM
RF-1	ROOF	6,100	0.5	--	515	--	--	--	E/A	1-1/2 /208/3	GREENHECK GB 300-VGD-15, VFD, 0-10VDC INPUT, ROOF FAN

ROOF HOOD SCHEDULE							
SYMBOL	SERVICE	AIR CFM	SP IN	THROAT AREA IN x IN	CURB CAP IN x IN	VELOCITY FPM	DESIGN BASIS PRODUCT

GAS FIRED HEATING UNIT SCHEDULE									
SYMBOL	TYPE	FUEL	MBH		CFM	RPM	TOTAL AMPS	MOTOR HP/VOLTS/PH	DESIGN BASIS PRODUCT
			IN	OUT					
GUH-1	HORIZONTAL UNIT HEATER	GAS	100	80.5	1,900	--	2.1	1/8 /120/1	LENOX MODEL LP24-100S, HORIZONTAL DISCHARGE, PROPELLER UNIT HEATER

COOLING COIL SCHEDULE											
SYMBOL	LOCATION RELATED SYSTEM	TOTAL SENSIBLE	CFM	VEL FPM	TYPE	EAT LAT	LIQUID SUCTION	FLUID	PRESS. DROP	DESIGN BASIS PRODUCT	
											IN
CC-1	GARAGE 107 AHU-1	153 MBH 133 MBH	6,100	500 MAX	DX	75°F 55°F	115°F 45°F	R-410A	0.02 PSI	4 ROW, 1/2" DIA, 94 PPF & ALUMINUM, INTERTWINED CIRCUITS	

CONDENSING UNIT SCHEDULE											
SYMBOL	TONS	ARI NET	EDB	LDB	UNIT CONFIG.	FLUID IEER	MCA MFS	ELECTRICAL VOLTS/PH	DESIGN BASIS PRODUCT		
										AMB.	CONF.
CU-1	12.5	150 MBH	80°F 67°F	55°F 95°F	2 SCROLL 1 FAN	R-410A 12.4	55 70	208/3	TRANE MODEL T1A15043D, MODULATING LOW AMB. KIT, COMPRESSOR ANTI-SHORT CYCLE TIMER, CRANK CASE HEATER, RAWAL APR CONTROL, STEEL SPRING ISOLATOR		

FAN SOUND POWER SCHEDULE																		
SYSTEM	FAN	OCTAVE BAND FREQUENCY								FAN	OCTAVE BAND FREQUENCY							
		1	2	3	4	5	6	7	8		1	2	3	4	5	6	7	8
		63	125	250	500	1K	2K	4K	8K		63	125	250	500	1K	2K	4K	8K
AHU-1	SF-1	74	74	70	77	70	69	66	53	RF-1	78	81	73	63	60	57	50	46

BOILER SCHEDULE									
SYMBOL	TYPE	FLUID (%)	FUEL	AGA INPUT MBH	GROSS OUTPUT MBH	MOTOR		DESIGN BASIS PRODUCT	
						HP	VOLTS/PH		
(E) B-1	CAST IRON BOILER	H2O	GAS	305	247	--	120/1	WEIL MCLAIN PFG-06	
(E) B-2	CAST IRON BOILER	H2O	GAS	305	247	--	120/1	WEIL MCLAIN PFG-06	

HEAT EXCHANGER SCHEDULES												
SYMBOL	MBH	FLUID		GPM		HOT TEMP.		COLD TEMP.		PRESS. DROP		DESIGN BASIS PRODUCT
		HOT	COLD	HOT	COLD	IN	OUT	IN	OUT	HOT	COLD	
HX-1	229	H 20	50% PG	15.6	16.9	190	160	150	180	0.53 PSI	0.76 PSI	TACO MODEL TB80x90, TYPE: BRAZE PLATE, 1-1/4"NPT

TANK SCHEDULE						
SYMBOL	FUNCTION	MEDIUM	TOTAL VOLUME GALLONS	MATERIALS	LABEL	DESIGN BASIS PRODUCT
(E)AS-2	AIR SEPARATOR	WATER	---	BRASS	---	1-1/2" SPIROVENT MODEL VJR150, COPPER COALESCING MEDIUM, BRASS BODY, AUTO AIR VENT, 4.5 LBS
AS-3	AIR & DIRT SEPARATOR	50% P.G.	---	BRASS	---	1-1/2" SPIROVENT VDR-150FT, COPPER COALESCING MEDIUM, BRASS BODY, AUTO AIR VENT, 9.0 LBS
(E)ET-1	HYDRONIC EXPANSION	WATER	6.0	STEEL/BUTYL	---	FLEXCON MODEL HXT-60, ACCEPTANCE VOLUME = 3.0
(E)ET-2	HYDRONIC EXPANSION	WATER	6.0	STEEL/BUTYL	---	FLEXCON MODEL HXT-60, ACCEPTANCE VOLUME = 3.0
ET-4	HYDRONIC EXPANSION	50% P.G.	6.0	STEEL/BUTYL	---	FLEXCON MODEL HXT-60, ACCEPTANCE VOLUME = 3.0
GT-1	GLYCOL MIX TANK	50% P.G.	6.6	---	---	AXIOM MODEL MF200, POLYETHYLENE CONTAINER, PRV, DIAPHRAGM PUMP, LOW LEVEL ALARM, 50 W, 120 V, 1ϕ

PUMP SCHEDULE									
SYMBOL	LOCATION	SERVICE	FLUID		GPM	HEAD FT.	RPM	MOTOR HP/VOLTS/PH	DESIGN BASIS PRODUCT
			TYPE	TEMP.					
(E)PMP-1	MECH ROOM	BUILDING HEAT	WATER	190	10.2	--	--	1/3 /120/1	GRUNDFOS UPS40-40/4 3 SPEED
(E)PMP-2	MECH ROOM	UH-1 TO 3, HC-1	WATER	190	4.8	--	--	1/20 /120/1	TACO HEC-2, FLOW CHECK, EC MOTOR CONSTANT POWER CONTROL
(D)PMP-3	MECH ROOM	UH-6A	WATER	190	--	--	--	1/20 /115/1	TACO HEC-2, FLOW CHECK, EC MOTOR CONSTANT POWER CONTROL
PMP-4	MECH ROOM	BUILDING VENTILATION	WATER	190	26.8	22	--	0.68 /120/1	TACO VR15, EC MOTOR, LEAD / LAG, 0-10VDC IN/OUT, PRESSURE CONTROL
PMP-5	MECH ROOM	HC-2	50% PG	180	16.9	19	1100 4400	2.5A /115/1	TACO VR3452-FC1A01, ECM, 0-10VDC INPUT, PRESSURE CONTROL, LEAD/LAG

AIR OUTLET SCHEDULE						
SYMBOL	UNIT SIZE	SCFM	FINISH	USE	DESIGN BASIS PRODUCT	
					PRICE	DUCT MOUNT
(A)	SEE PLAN	SEE PLAN	WHITE POWDER	S/A	PRICE MODEL ARCD, ALUMINUM, 4 CONES, NECK SIZE SEE DRAWING, 3 POSITION ADJUSTMENT, DUCT MOUNT	
(B)	SEE PLAN	SEE PLAN	WHITE POWDER	R/A	PRICE MODEL 630L, ALUMINUM, 3/4" BLADE SPACING, 35 DEGREE DEFLECTION, DUCT MOUNT	
(C)	SEE PLAN	SEE PLAN	WHITE POWDER	S/A	PRICE MODEL 620, DOUBLE DEFLECTION, 3/4" BLADE SPACING, FRONT BLADES PARALLEL TO LONG DIMENSION, WALL OR DUCT MOUNT AS SHOWN.	

LEGEND & ABBREVIATIONS		
ABBR.	EXPLANATION	SYMBOL
AAV	AUTOMATIC AIR VENT	□
AFF	ABOVE FINISHED FLOOR	—
BDD	BACKDRAFT DAMPER	—
BD	BALANCING DAMPER	—
	BALANCING/ISOLATION VALVE	—
	BALL VALVE	—
CFM	CUBIC FEET/MINUTE	—
CO	CLEANOUT	—
CV	CHECK VALVE	—
CW	COLD WATER	—
(D)	DEMOLISH	—
(E)	EXISTING	—
E/A	EXHAUST AIR	—
FCO	FLOOR CLEANOUT	—
FDC	FIRE DEPARTMENT CONNECTION	—
FD	FLOOR DRAIN	—
	FLEXIBLE DUCT	—
GS	GLYCOL SUPPLY	—GS—
GR	GLYCOL RETURN	—GR—
HB	HOSE BIBB	—
HC	HEATING COIL	—
HW	HOT WATER	—
HWC	HOT WATER CIRCULATION	—
HWR	HEATING WATER RETURN	—HWR—
HWS	HEATING WATER SUPPLY	—HWS—
MOD	MOTOR OPERATED DAMPER	—
MOV	2-WAY MOTOR OPERATED VALVE	—
MOV	3-WAY MOTOR OPERATED VALVE	—
NIC	NOT IN CONTRACT	—
O/A	OUTSIDE AIR	—
	PIPE ANCHOR	—
	PIPE GUIDE	—
POC	POINT OF CONNECTION	—
	PRESSURE GAGE	—
PRV	PRESSURE RELIEF VALVE	—
R/A	RETURN AIR, RELIEF AIR	—
RV	RELIEF VALVE	—
	RETURN AIR SLOT	—
	RETURN/EXHAUST AIR REG. OR GRILLE	—
S	SANITARY SOIL	—
S/A	SUPPLY AIR	—
	STRAINER WITH DRAIN VALVE	—
SL	ACOUSTICALLY LINED DUCT	—
	STATIC PRESSURE SENSOR	—
	SUPPLY AIR SLOT W/FLEX DUCT	—
	SUPPLY AIR REG. GRILLE, OR DIFFUSER	—
TW	TEMPERED WATER	—TW—
	THERMALLY INSULATED DUCT OR PIPE	—
	THERMOMETER	—
T'STAT	THERMOSTAT	—
T'STAT	RETURN AIR THERMOSTAT	—
	UNION	—
V	VENT	—
VTR	VENT THRU ROOF	—
WCO	WALL CLEANOUT	—
W	WASTE	—

THIS IS A STANDARD LEGEND, SOME SYMBOLS SHOWN ON LEGEND ARE NOT NECESSARILY ON THE DRAWING.

MBA Consulting Engineers, Inc.
3812 Spenard Road, Suite 200 • Anchorage, AK 99517
(907) 274-2822 • FAX (907) 274-0914



REV.	DATE	BY	REVISION
0	1/11/19	MBA	BID SET

 P.O. BOX 107500, ANCHORAGE, ALASKA 99510-7500 PROJECT:			
ALASKA RAILROAD CORPORATION KENAI SUPPLY BUILDING RENOVATION			
TITLE:			
MECHANICAL			
LEGEND & SCHEDULES			
DESIGNED BY: <u>MSM</u>	SCALE: AS NOTED	M-1	AFE NO.:
DRAWN BY: <u>MSM</u>	DATE: 1/11/2019		ACAD FILE: 17034-M-1
CHECKED BY: <u>SCH</u>			DWG NO.:
APPROVED BY: <u>MSM</u>			2 OF 12

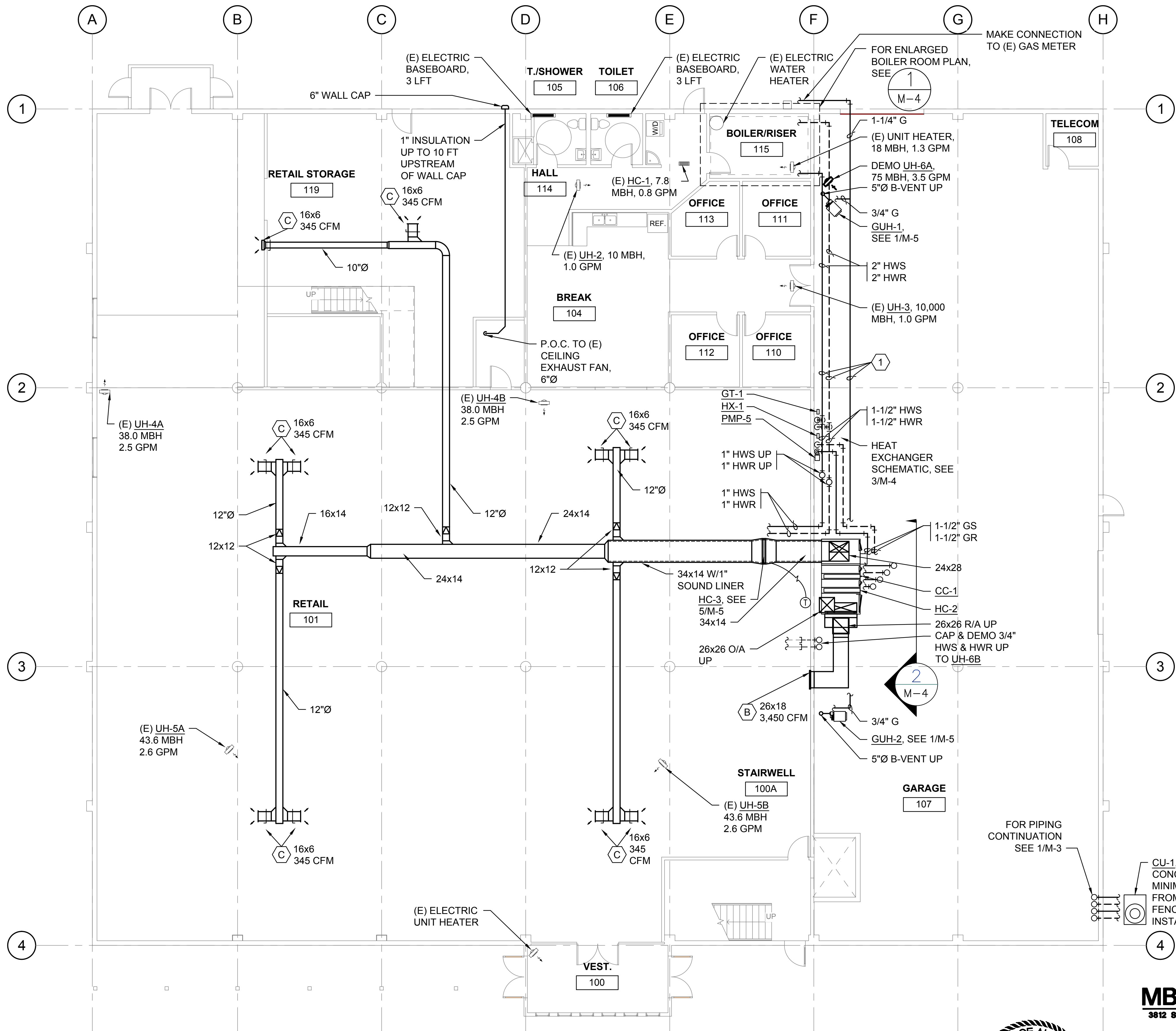

- SHEET NOTES:**
- HEATING AND GAS LINES SHOWN DIAGRAMMATICALLY FOR CLARITY. ROUTE LINES ON WALL.
 - ROUTE NEW DUCTWORK IN RETAIL EXPOSED, UNDER CEILING GRID.
 - FIELD VERIFY SPRINKLER HEAD AND SECURITY CAMERA LOCATIONS. ADJUST DUCT ROUTING TO AVOID OBSTRUCTIONS.

LEVEL 1 - HVAC PLAN
 1/8" = 1'-0"



MBA Consulting Engineers, Inc.
 3812 Spenard Road, Suite 200 • Anchorage, AK 99517
 (907) 274-2822 • FAX (907) 274-0914

REV.	DATE	BY	REVISION
0	1/11/19	MBA	BID SET

<p>ALASKA RAILROAD CORPORATION ENGINEERING SERVICES P.O. BOX 107500, ANCHORAGE, ALASKA 99510-7500</p>	
<p>PROJECT: ALASKA RAILROAD CORPORATION KENAI SUPPLY BUILDING RENOVATION</p>	
<p>TITLE: FIRST FLOOR HVAC PLAN</p>	
DESIGNED BY: MSM DRAWN BY: MSM CHECKED BY: SCH APPROVED BY: MSM	SCALE: AS NOTED DATE: 1/11/2019
AFE NO.: ACAD FILE: 17034-M1 DWG NO.: 3 OF 12	<p>M-2</p>

SHEET NOTES:

- 1 OFFSET DUCTWORK OVER LIGHTS RUNNING DOWN HALLWAY 217.
- 2 RELOCATE SPRINKLER HEADS AND BRANCHES IN STORAGE 216 AS REQUIRED TO RUN DUCT MAINS.
- 3 OFFSET UNDER BEAM, THIS LOCATION.
- 4 DUCTWORK SHALL BE ROUTED TIGHT TO BEAMS. BOTTOM OF DUCT SHALL REMAIN HIGHER THAN 7'-6" PER IBC.
- 5 RECONFIGURE SPRINKLER BRANCH LINES AND HEADS AS REQUIRED TO ACCOMMODATE HVAC SYSTEM.

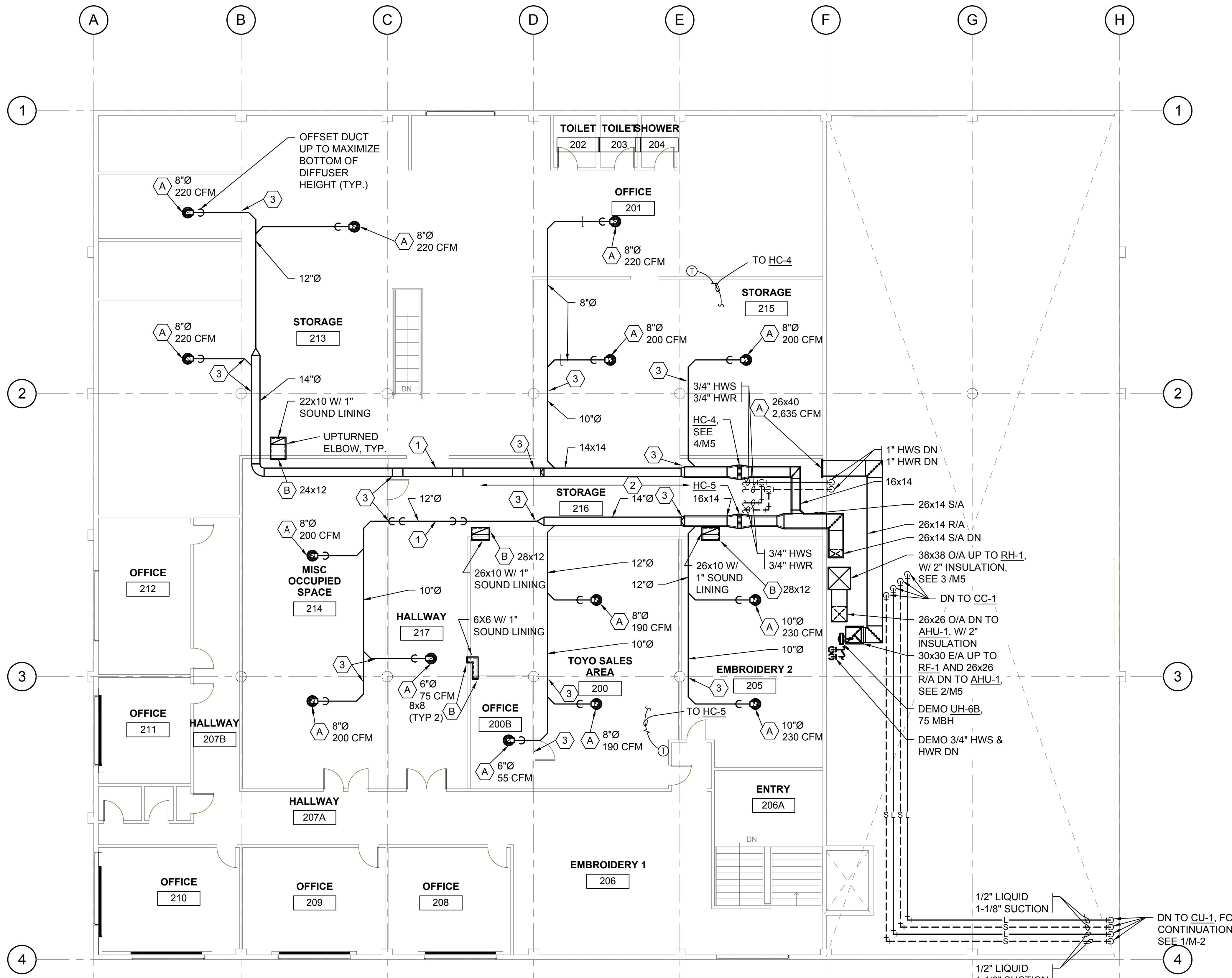

LEVEL 2 - HVAC PLAN
 M-3 1/8"=1'-0"



MBA Consulting Engineers, Inc.
 3812 Spenard Road, Suite 200 • Anchorage, AK 99517
 (907) 274-2822 • FAX (907) 274-0914

REV.	DATE	BY	REVISION
0	1/11/19	MBA	BID SET

<p>ALASKA RAILROAD CORPORATION ENGINEERING SERVICES P.O. BOX 107500, ANCHORAGE, ALASKA 99510-7500</p>	
<p>ALASKA RAILROAD CORPORATION KENAI SUPPLY BUILDING RENOVATION</p>	
<p>TITLE: SECOND FLOOR HVAC PLAN</p>	
DESIGNED BY: MSM	SCALE: AS NOTED
DRAWN BY: MSM	DATE: 1/11/2019
CHECKED BY: SCH	<div style="font-size: 2em; font-weight: bold; display: inline-block;">M-3</div>
APPROVED BY: MSM	
<p>AFE NO.: ACAD FILE: 17034-M1 DWG NO. 4 OF 12</p>	

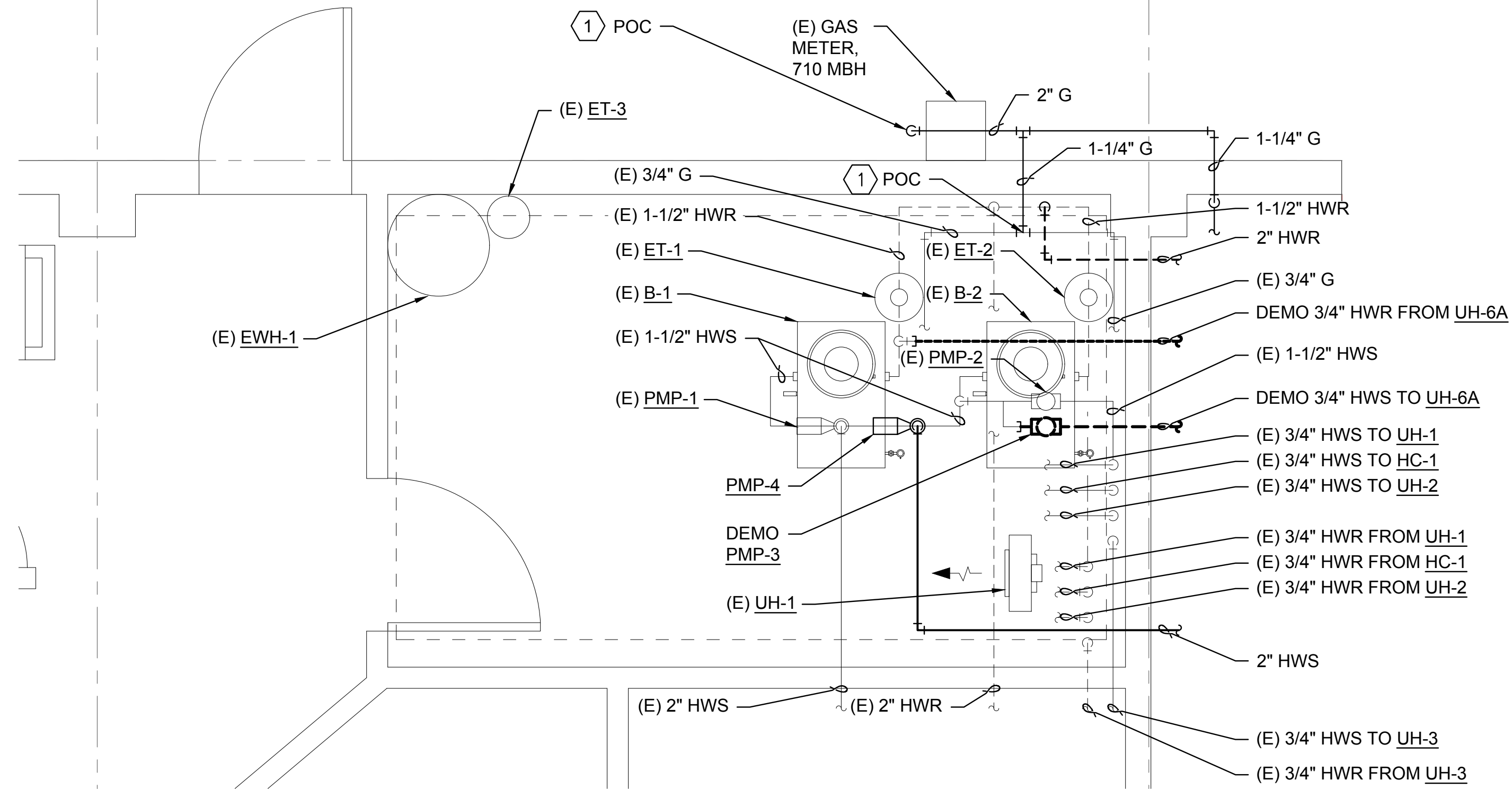

1 BOILER ROOM PLAN
M-4 1/2"=1'-0"

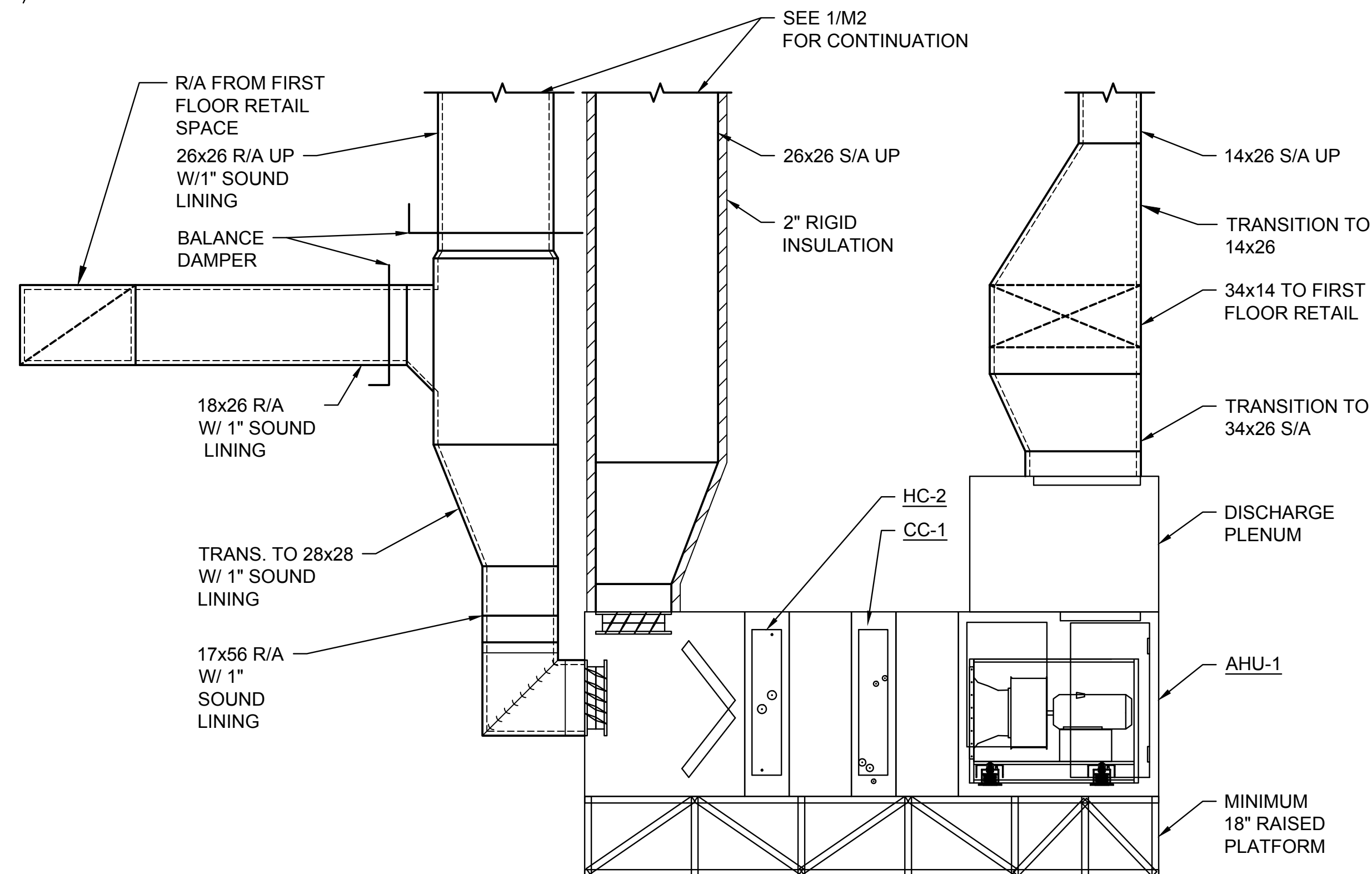

2 AHU-1 ELEVATION
M-4 1/2"=1'-0"

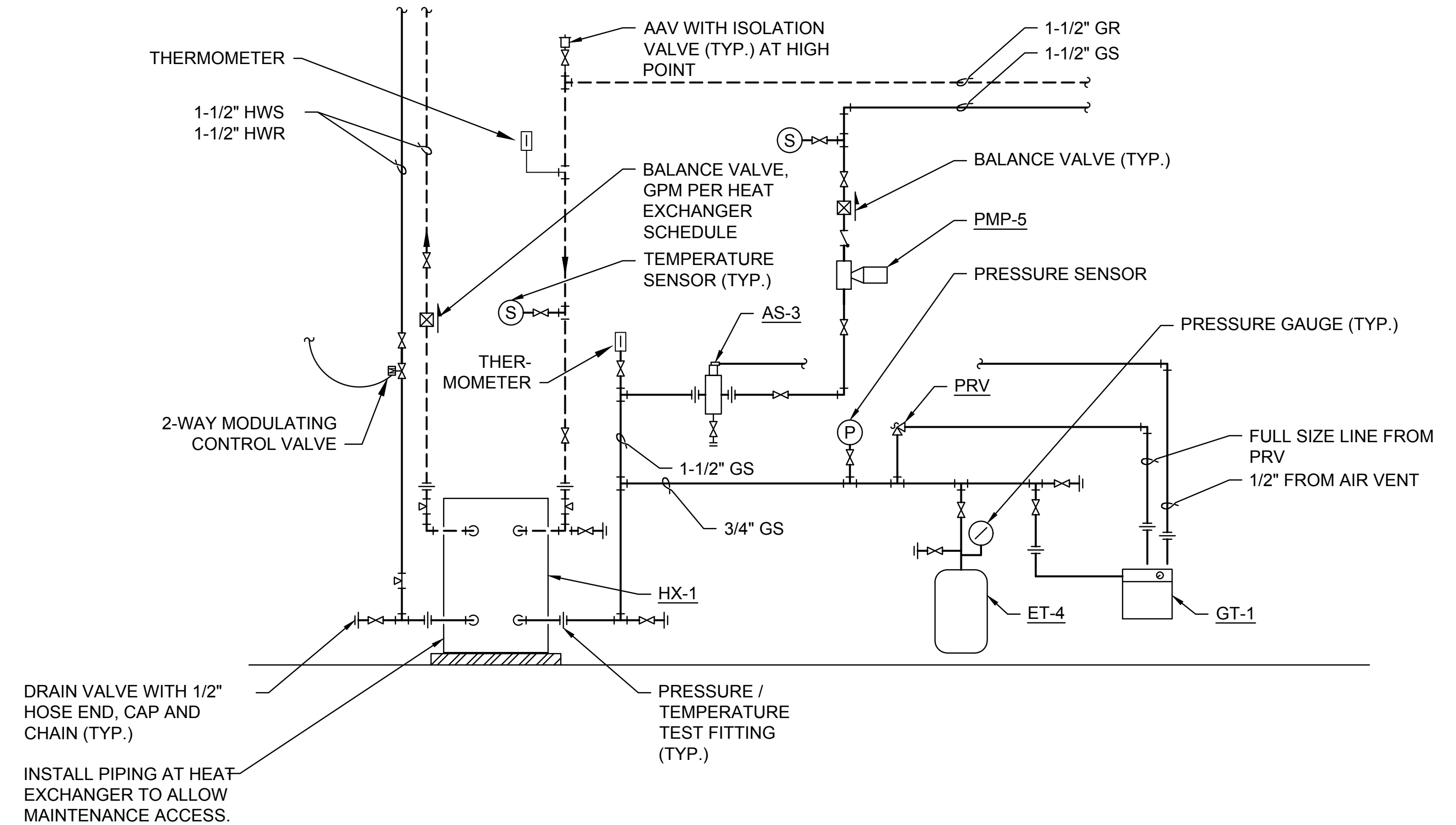

3 HEAT EXCHANGER SCHEMATIC
M-4 NTS

SHEET NOTES:

- 1 DEMOLISH EXISTING GAS LINE TO MECHANICAL ROOM, PROVIDE NEW GAS LINE TO METER.

ALASKA RAILROAD CORPORATION
ENGINEERING SERVICES
P.O. BOX 107500, ANCHORAGE, ALASKA 99510-7500

MBA Consulting Engineers, Inc.
3812 Spenard Road, Suite 200 • Anchorage, AK 99517
(907) 274-2622 • FAX (907) 274-0914

PROJECT: ALASKA RAILROAD CORPORATION KENAI SUPPLY BUILDING RENOVATION		TITLE: BOILER DEMOLITION & REMODEL PIPING SCHEMATIC	
DESIGNED BY: MSM	DRAWN BY: MSM	CHECKED BY: SCH	APPROVED BY: MSM
SCALE: AS NOTED	DATE: 1/11/2019	<div style="display: flex; align-items: center; justify-content: center;"> <div style="font-size: 2em; font-weight: bold; margin-right: 10px;">M-4</div> <div style="text-align: right;"> AFE NO.: ACAD FILE:17034-M-4 DWG NO. 5 OF 12 </div> </div>	
REV.	DATE		



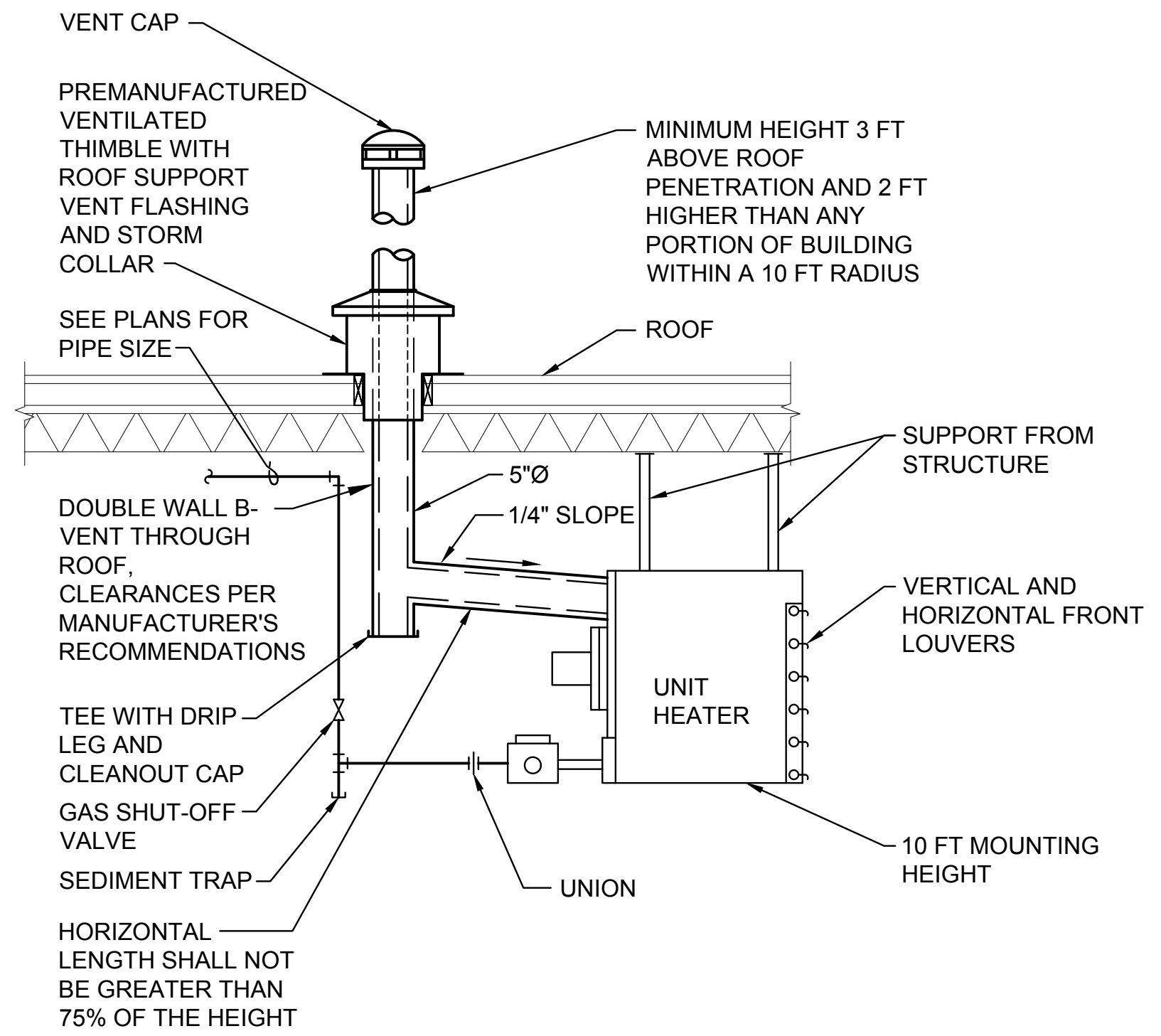

1 GAS FIRED UNIT HEATER DETAIL
M-5 NTS

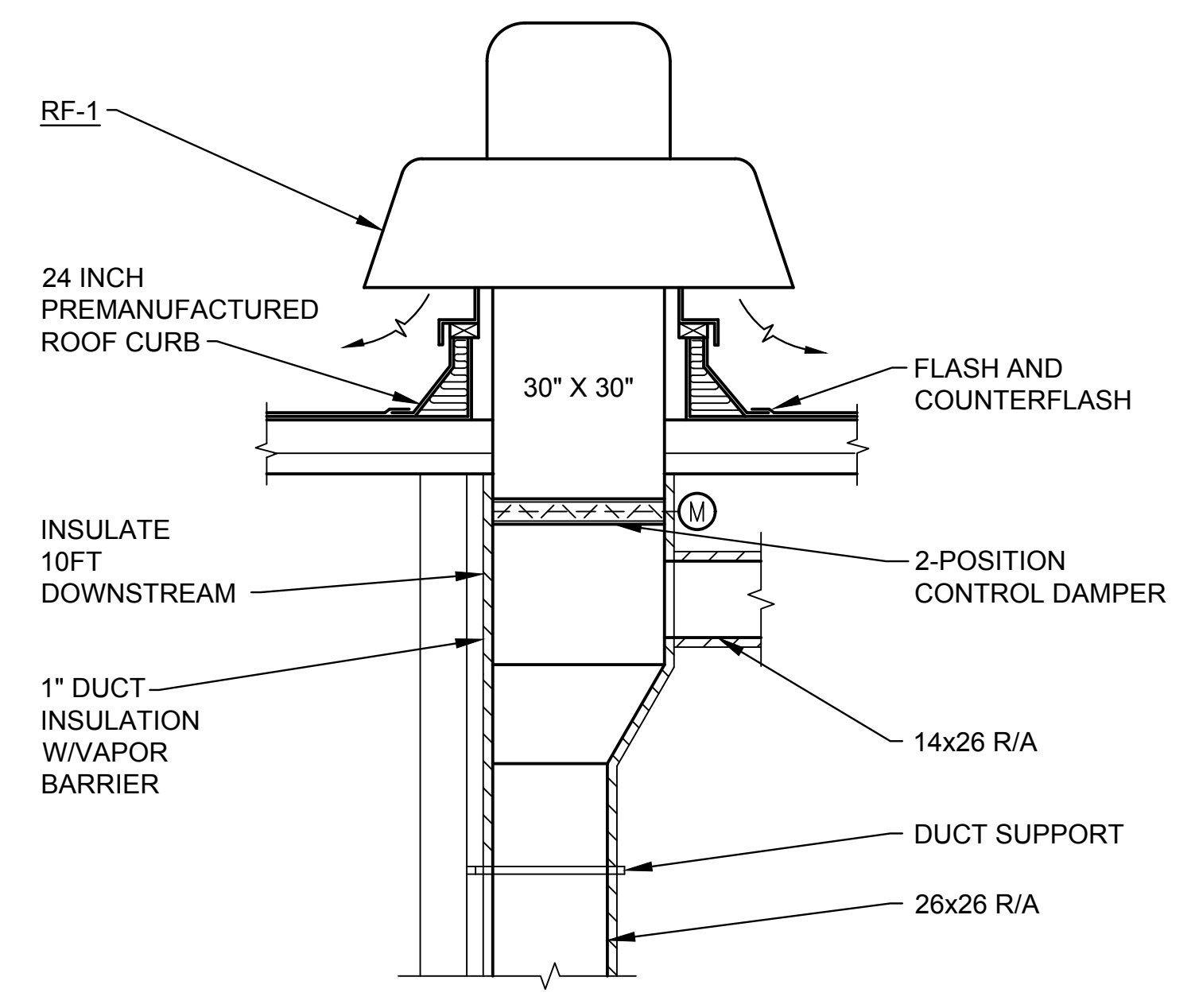

2 RELIEF FAN DETAIL
M-5 NTS

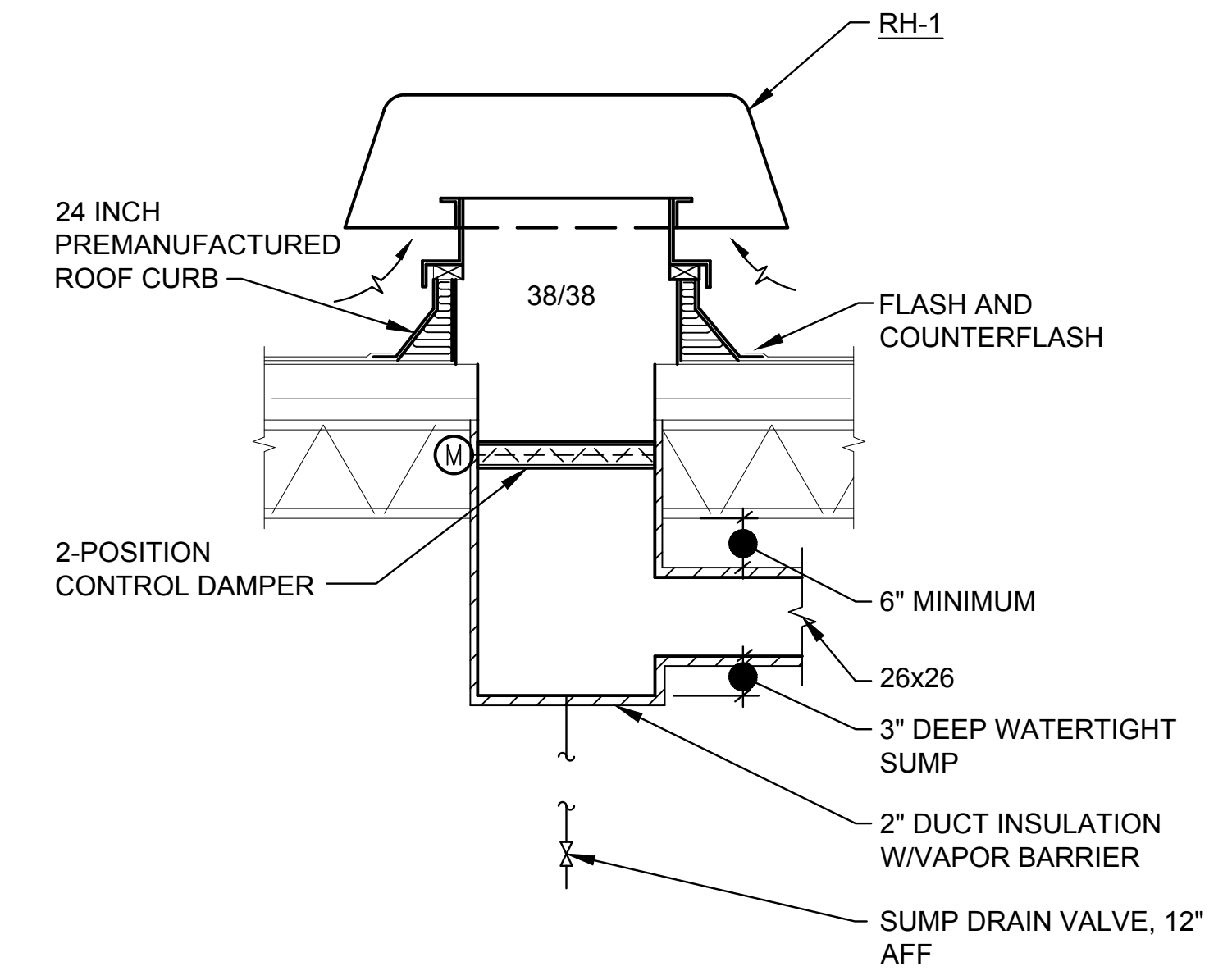

3 ROOF HOOD DETAIL
M-5 NTS

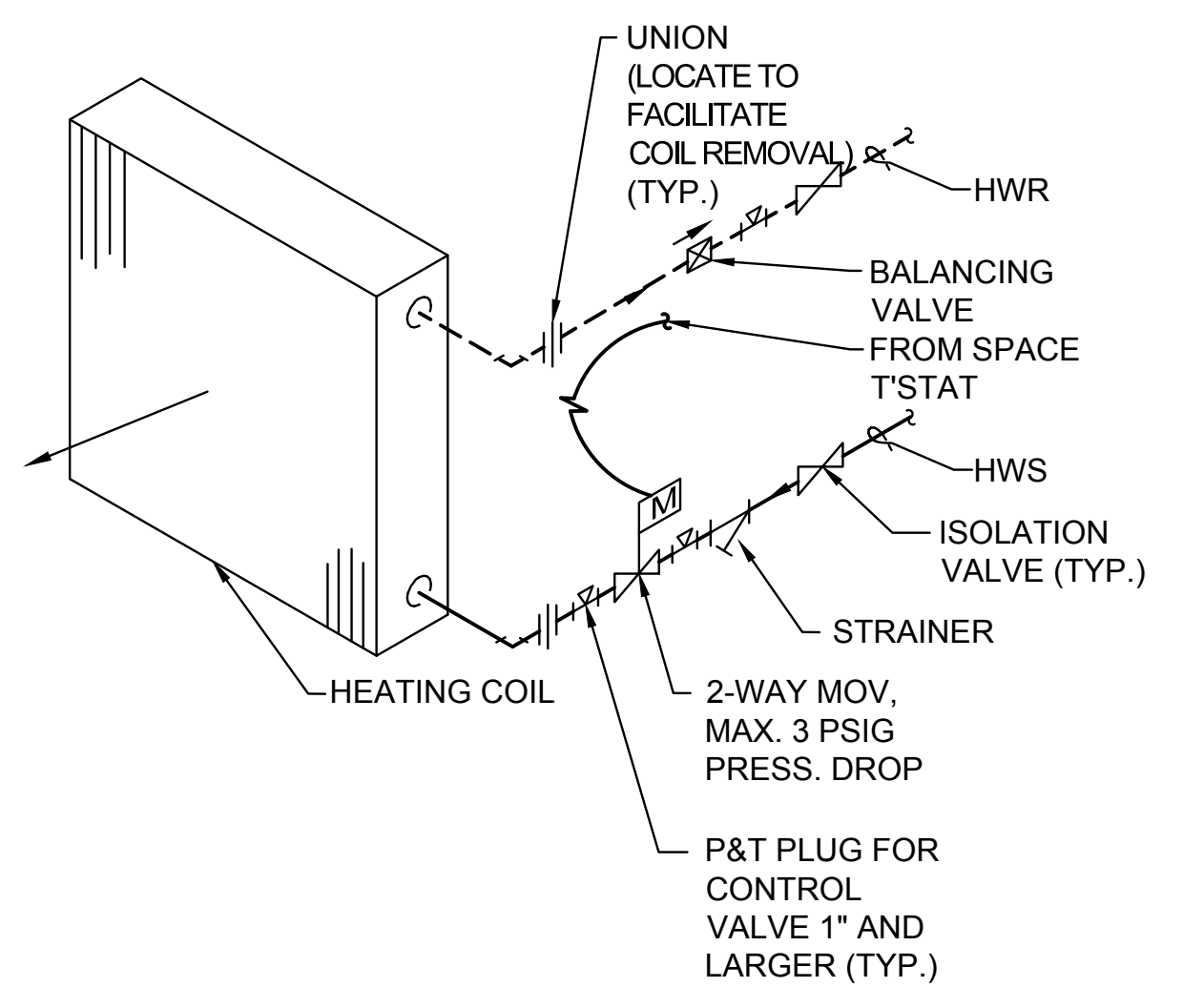

4 2-WAY HEATING COIL DETAIL
M-5 NTS

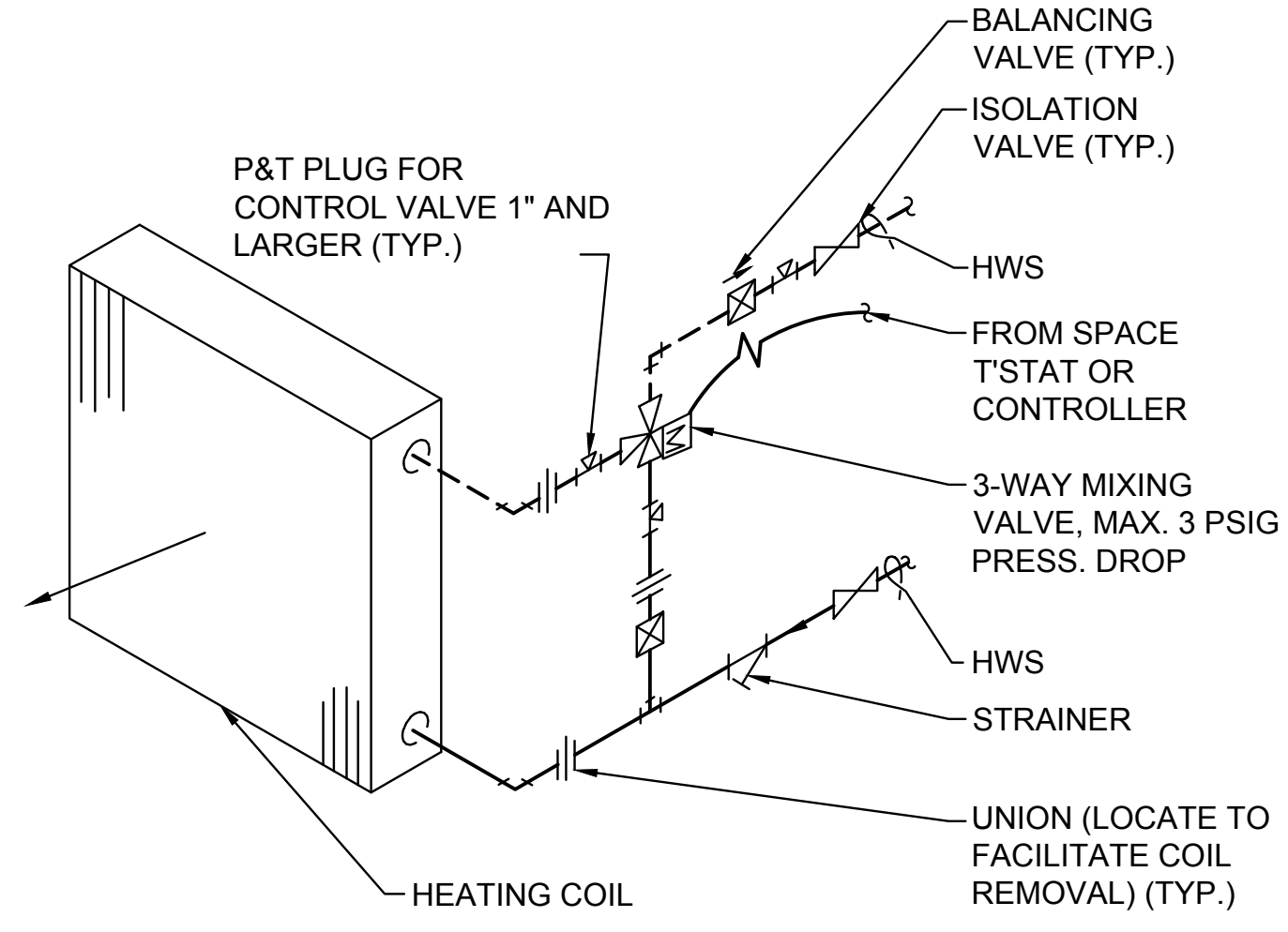

5 3-WAY HEATING COIL DETAIL
M-5 NTS



MBA Consulting Engineers, Inc.
3812 Spenard Road, Suite 200 • Anchorage, AK 99517
(907) 274-2822 • FAX (907) 274-0914

REV.	DATE	BY	REVISION
0	1/11/19	MBA	BID SET

		ALASKA RAILROAD CORPORATION ENGINEERING SERVICES P.O. BOX 107500, ANCHORAGE, ALASKA 99510-7500	
PROJECT:		ALASKA RAILROAD CORPORATION KENAI SUPPLY BUILDING RENOVATION	
DETAILS			
DESIGNED BY:	MSM	SCALE:	AS NOTED
DRAWN BY:	MSM	DATE:	1/11/2019
CHECKED BY:	SCH	M-5	AFE NO.:
APPROVED BY:	MSM		DWG NO.
			6 OF 12

DIVISION 15 - MECHANICAL

PART 1 - GENERAL

1.1 WORK INCLUDED

A. Work consists of providing labor, products, and in performing all operations required for the complete operating installation of all mechanical systems as shown and specified, in strict accordance with specifications, applicable drawings, terms, and conditions of the contract and all applicable codes and ordinances governing installation of the various mechanical systems. Correlate all work fully with the work of other crafts. Provide all systems complete and in proper operating order.

1.2 REGULATORY REQUIREMENTS

A. Comply with all applicable local, state, and national codes, ordinances and regulations in existence at bid date affecting materials and methods of installation of the mechanical systems. Follow recommended practices as set down by ASME, SMACNA, International Building Code, International Mechanical Code, Uniform Plumbing Code, International Fire Code, National Electrical Code, AGA, and OSHA as they apply to this project except in cases where statutes govern.

1.3 MANUFACTURER'S WARRANTIES

A. In the event of equipment or component failure, it is the Contractor's responsibility to repair or replace such defective equipment or components and bear all associated costs. The Contractor shall pursue Manufacturer's written implied warranties to the extent necessary to obtain replacement equipment or components prior to any other action being initiated.

1.4 ELECTRICAL WORK

A. All wiring shall be in accordance with NEC, State and Local Codes.

1.5 TESTS AND INSPECTIONS

A. Schedule, obtain, and pay all fees and/or services required by local authorities and by these specifications, to test the mechanical systems as specified.

B. Deficiencies: Immediately correct all deficiencies, which are evidenced during the tests and repeat tests until system is approved. Do not cover or conceal piping, equipment, or other portions of the mechanical installations until satisfactory tests are made and approved.

C. Completion: Upon completion of the mechanical installation, demonstrate to the contracting agency's satisfaction that the systems have been installed in a satisfactory manner in accordance with the plans, specifications, and applicable codes. Demonstrate dynamic operation of all systems. Show that all controls are operable and are properly adjusted in accordance with the requirements of the final systems balance, that all systems are properly balanced, that all equipment operates properly, that filters and strainers are clean, and that all components of all systems are installed and adjusted for proper operation.

1.6 PROJECT/SITE CONDITIONS

A. Install work in locations shown on drawings, unless prevented by project conditions.
B. Provide information showing proposed rearrangement of work to meet project conditions, including changes to work specified in other sections or interference with site conditions not in the contract. Obtain permission of Owner before proceeding.

1.7 SUBMITTALS

A. Submittal review is for general design and arrangement only and does not relieve the contractor from any requirements of contract documents. Provision of a complete and satisfactory working installation is the sole responsibility of the contractor.
B. Submittals shall be made in accordance with Division 1 requirements.

1.8 OPERATION AND MAINTENANCE MANUALS

A. Provide Operation and Maintenance (O&M) Manuals for training of and future reference by, Owner's personnel in operation and maintenance of systems and related equipment. Bind each manual in a hard-backed, loose-leaf, three-ring binder. Use 8-1/2" x 11" white paper.
B. Submittal of O&M Manuals shall be made in accordance with Division 1 requirements.

1.9 SEISMIC RESTRAINT

A. Contractor shall submit structural calculations and structurally engineered shop drawings for seismic restraint of all new mechanical components and equipment, including ductwork and piping. Calculations to be performed in accordance with the requirements of Chapter 16 of the 2012 International Building Code and are to be stamped by a registered professional structural engineer licensed in the State of Alaska.
B. Seismic Restraint design to be based on Seismic Occupancy Category II and Seismic Design Category D.

PART 2 - PRODUCTS

2.1 SUPPORTS AND ANCHORS

2.1.1 PIPE HANGERS AND SUPPORTS

A. Hangers for pipe sizes 1/2 to 1-1/2 inch: Adjustable swivel, loop hanger.
B. Hangers for pipe sizes 2 to 4 inches: Adjustable, swivel.
C. Michigan Hanger Co. Model No. 100 for steel and plastic and Model #101 for copper pipe.
D. Piping support spacing per Uniform Plumbing Code.
E. Install hangers to provide minimum 1/2 inch space between finished covering and adjacent work. Place a hanger within 12 inches of each horizontal elbow. Use hangers with 1-1/2 inch minimum vertical adjustments.

2.1.2 HANGER RODS

A. Steel hanger rods: Threaded both ends, threaded one end, or continuous threaded.

2.1.3 SLEEVES

A. Sleeves for piping and ductwork through non-fire rated floors, beams, walls, footings, and potentially wet floors: Form with steel pipe or 18 gauge galvanized steel. Extend sleeves through floors one inch above finished floor level. Caulk sleeves full depth and provide floor plate. Where piping or ductwork penetrates ceiling or wall, close off space between pipe or duct and adjacent work with fire-stopping insulation and caulk seal airtight. Provide close fitting metal collar or escutcheon covers at both sides of penetration. Fire stopping insulation: Glass fiber type, non-combustible. Caulk: Acrylic sealant.

B. Sleeves for pipes through fire rated and fire resistive floors and walls, and fireproofing: Prefabricated fire rated sleeves including seals, UL listed.

C. Size sleeves large enough to allow for movement due to expansion and contraction. Provide for continuous insulation wrapping.

D. Install chrome-plated steel escutcheons at finished surfaces.

2.1.4 DUCTWORK HANGERS AND SUPPORTS

A. Ducts 24 inches and less: Provide with one inch x 18 gauge straps fastened to ductwork and to building construction. Space not more than eight feet on center.

B. Ducts 25 inches through 42 inches: Provide mild steel rods fastened to angle iron stiffeners with nuts and to building construction with appropriate inserts, flanges, or clamps. Space not more than eight feet on center.

C. Ducts over 42 inches: Fasten hanger rods to angle stiffeners not more than four feet on center.
D. Recommended methods of fastening bracing to ductwork, include riveting, bolting, and tack welding.

2.2 MECHANICAL IDENTIFICATION

2.2.1 EQUIPMENT

A. Plastic Nameplates: Laminated three-layer plastic with engraved white letters on dark contrasting background color.

2.2.2 VALVES AND PUMPS

A. Plastic Tags: Laminated three-layer plastic with engraved white letters on dark contrasting background color. Tag size minimum of 1-1/2 inch diameter.

B. Metal Tags: Brass with stamped letters; tag size minimum 1-1/2 inch diameter with smooth edges.

2.2.3 PIPING

A. Stencils: With clean cut symbols and letters indicating flow direction arrow and fluid being conveyed.

B. Stencil Paint: Semi-gloss enamel, colors conforming to ASME A13.1.

C. Plastic Pipe Markers: Factory fabricated, flexible, semi-rigid plastic, preformed to fit around pipe or pipe covering, and indicating flow direction arrow and fluid being conveyed. Brandystrap-on, Seton or approved.

D. Plastic Tape Pipe Markers: Flexible, vinyl film tape with pressure sensitive adhesive backing and printed markings. Brandystrap-on, Craftmark, Seton or approved.

E. Underground Plastic Pipe Markers: Bright colored continuously printed plastic ribbon tape of not less than 6 inch wide by 4 mil thick, manufactured for direct burial service.

2.2.4 DUCTWORK

A. Identify ductwork with plastic nameplates or stenciled painting. Identify as to air handling unit number, and area served.

2.2.5 VALVE CHART AND SCHEDULE

A. Provide valve chart and schedule in aluminum frame with clear plastic shield. Install at location as directed.

2.3 PIPING INSULATION

2.3.1 INSULATION

A. Acceptable Manufacturers: Armstrong, Certainteed, Manville, Knauf, Pittsburgh Corning.

B. Glass fiber insulation: ASTM C547, "K" value of 0.24 at 75 degrees F, noncombustible, minimum service temperature -20, maximum service temperature 300 degrees F, maximum moisture absorption 0.20 percent by volume, vapor retarder jacket composed of white Kraft paper and aluminum foil laminate. Flame spread/smoke developed rating of 25/50 or less in accordance with UL 723.

2.3.2 HOT PIPING REQUIREMENTS

A. Insulation and Jacket.
1. On piping conveying fluids 140 degrees F or less, do not insulate flanges and unions at equipment, but bevel and seal ends of insulation at such locations. Insulate flanges and unions at equipment when fluid temperatures exceeds 140 degrees F. Insulate fittings, joints, and valves with same insulation and thickness as scheduled. Staples may be used to seal jackets.
2. Cover insulation on fittings with pre-molded PVC fittings covers.
3. Indoor, exposed applications: Size for finish paint application.

B. Insulate heating water or glycol supply and return lines thru 2 inches with 1 inch thick glass fiber insulation, and lines over 2 inches with 1-1/2 inch insulation.

C. Insulate all domestic hot water lines with 1/2 inch thick glass fiber insulation.

2.3.4 SPECIAL INSULATION REQUIREMENTS

A. Insulate refrigeration suction line with 1 inch Armaflex or equal.

2.3.5 DUCT INSULATION REQUIREMENTS

A. Insulate outside air ductwork with 2 inch of rigid glass fiber insulation, k = .24 at 75 degrees F, 450 degrees F service temperature, 0.02 perm vapor transmission, 5 percent water vapor sorption.

B. Insulate interior concealed supply air duct with 1-1/2 inches FSK faced flexible duct wrap, k = .24 at 75 degrees F, 250 degrees F service temperature, .02 perm vapor transmission, 5 percent water vapor sorption.

B. Insulate exhaust air ductwork with 1 inch rigid FSK faced glass fiber insulation, k = .24 at 75 degrees F, 450 degrees F service temperature .02 perm vapor transmission, 5 percent water vapor sorption.

C. Duct liner, Certainteed Toughgard Type 150 or equal.

2.4 SPRINKLER SYSTEM

A. Provide system design, materials, tools, equipment, supervision, labor, and transportation to complete the work and obtain specified performance.

B. Provide a complete wet type sprinkler system.

C. Coordinate and resolve details to achieve compatibility between the sprinkler system and other building elements.

D. Provide system to IBC and NFPA 13 requirements.

E. Interface system with building fire and smoke alarm system.

F. Conceal piping, except in mechanical spaces and unfinished spaces.

G. All materials shall bear UL or FM label or marking.

H. Coordinate sprinkler system piping and head locations with ceiling types, light fixtures, air diffusers, ducts, and structural members.

I. Center heads in two directions in ceiling tiles.

2.5 PLUMBING AND HYDRONIC PIPING

2.5.1 MATERIALS

A. Heating Glycol Piping, Above Grade.

1. Steel Pipe: ASTM A53, Schedule 40, black. Fittings: ASTM B16.3, malleable iron or ASTM A234, forged steel welding type fittings. Joints: AWS D1.1, welded.

2. Copper Tubing: ASTM B88, Type L, hard drawn. Fittings: ANSI/ASME B16.18 cast brass or ASME B16.22 solder wrought copper. Joints: ASTM B32, solder, Engelhard "Silvabrite 100" or other approved lead-free solder. Compatible with glycol.

3. Cross Linked Polyethylene Barrier Tubing: ASTM F876 and F877, DIN Standard 4726 oxygen diffusion barrier, rated at 100 PSI @ 180 degrees F, Uponer hePEX, Viega ViegaPEX, Zurn ZurnPEX or approved equal.

G. Natural Gas Piping, Buried Beyond 5 feet of Building.

1. Polyethylene Pipe: ASTM D2513, SDR 11.5. Fittings: ASTM D2683 or ASTM D2513 socket type. Joints: Fusion welded.

H. Natural Gas Piping, Above Ground

1. Steel Pipe: ASTM A53 Schedule 40 black. Fittings: ASME B16.3, malleable iron, or ASTM A234, forged steel welding type. Joints: NFPA 54, threaded or welded to ASME B31.1, ASME B31.2, ASME B31.9 and ASME Sec. 1. Gas pressure of 2 lbs. or more to be welded fittings and welded joints only.

2.5.2 FLANGES, UNIONS, AND COUPLINGS

A. Pipe size 2 inches and under: Piping: bronze unions for copper pipe, soldered joints.

B. Dielectric connections: Union with galvanized or plated steel threaded end, copper solder end, water impervious isolation barrier.

2.5.3 VALVES

A. Select valves of the best quality and type suited for the specific service and piping system used. Minimum working pressure rating 125 psig steam or 150 psig W.O.G. Ball valves are to be used in lieu of gate valves for shut-off and isolation service.

B. Ball valves: Up to and including 3 inches: Bronze or stainless steel body, 400 psi W.O.G. - 150 S.W.P., standard port, stainless steel or bronze ball, Teflon seats, and stuffing box ring, lever handle, solder or threaded ends. Seat material to be compatible with fluid handled.

2.6 REFRIGERATION PIPING

2.6.1 MATERIALS

A. Copper Tubing: ASTM B280, Type ACR hard drawn or annealed.

1. Fittings: ASME B16.22 wrought copper.

2. Joints: Braze AWS A5.8 Bcup silver/phosphorous/copper alloy with melting range 1190 to 1480 degrees F.

B. Copper Tubing to 7/8-inch OD: ASTM B88, Type K, annealed.

1. Fittings: ASME B16.26 cast copper.

2. Joints: Flared.

C. Pre-charged line sets.

SEE M-7 FOR CONTINUATION























MBA Consulting Engineers, Inc.
3812 Spenard Road, Suite 200 • Anchorage, AK 99517
(907) 274-2822 • FAX (907) 274-0914

Table with 4 columns: REV, DATE, BY, REVISION. Row 1: 0, 1/11/19, MBA, BID SET

ALASKA RAILROAD CORPORATION ENGINEERING SERVICES
ALASKA RAILROAD CORPORATION KENAI SUPPLY BUILDING RENOVATION
MECHANICAL SPECIFICATIONS
DESIGNED BY: MSM
DRAWN BY: MSM
CHECKED BY: SCH
APPROVED BY: MSM
SCALE: AS NOTED
DATE: 1/11/2019
M-6
AFE NO.:
ACAD FILE:17034-M-6
DWG NO. 7 OF 12

POWER LEGEND

-  ELECTRICAL POWER PANEL
-  ELECTRICAL DISTRIBUTION PANEL
-  ELECTRICAL LIGHTING PANEL
-  PANELBOARD CABINET FLUSH MOUNT
-  PANELBOARD CABINET SURFACE MOUNT
-  SWITCHBOARD NEW
-  SWITCHBOARD EXISTING
-  METER
-  CONTROLLER/DISCONNECT
-  UNFUSED DISCONNECT
-  FUSED DISCONNECT
-  VARIABLE FREQUENCY DRIVE
-  CONTROLLER
-  CONTACTOR
-  MOTOR SINGLE PHASE
-  MOTOR SINGLE PHASE : X = HORSE POWER
-  MOTOR 3PH
-  MOTOR 3PH : X = HORSE POWER
-  GENERATOR POWER
-  TRANSFORMER
-  THERMAL SWITCH

ABBREVIATIONS

[E] EXISTING TO REMAIN

PANEL: MDP [E]

PROJECT: ARRC KENAI SUPPLY BLDG
LOCATION: ROOM 107

VOLTAGE: 208Y/120 VOLT 3 PHASE 4 WIRE 800 A MCB 10k AIC

NOTE	CIRCUIT DESCRIPTION	KVA	AMP	P	CKT	CKT	AMP	P	KVA	CIRCUIT DESCRIPTION	NOTE
	PANEL SS JDA36250 250 AMP		250	3	1	2	100	3		PANEL RS1 FA36100 100 AMP	
					3	4					
					5	6					
	PANEL BR FA32100 100 AMP		100	3	7	8	100	3		PANEL RS2 FA36100 100 AMP	
					9	10					
					11	12					
1	PANEL S NORTH 2 (SN 2)	37.1	200	3	13	14	100	3		PANEL SN FA36100 100 AMP	
					15	16					
					17	18					
	SPACE				19	20				SPACE	
	SPACE				21	22				SPACE	
	SPACE				23	24				SPACE	
	SPACE				25	26				SPACE	
	SPACE				27	28				SPACE	
	SPACE				29	30				MAIN	
	SPACE				31	32				MAIN	
	SPACE				33	34				MAIN	
	SPACE				35	36				MAIN	
	SPACE				37	38				MAIN	
	SPACE				39	40				MAIN	
	SPACE				41	42				MAIN	

CONNECTED LOAD: 37.1 KVA 103.0 A NOTE:
DEMAND LOAD: 37.1 KVA 103.0 A 1. PROVIDE NEW CIRCUIT BREAKER TO FEED NEW PANEL

DATE:
REV:

PANEL: SN2 (NEW)

PROJECT: ARRC KENAI SUPPLY BLDG
LOCATION: ROOM 107

VOLTAGE: 208Y/120 VOLT 3 PHASE 4 WIRE 200 A MLO 10k AIC

NOTE	CIRCUIT DESCRIPTION	KVA	AMP	P	CKT	CKT	AMP	P	KVA	CIRCUIT DESCRIPTION	NOTE
	AHU-1 (7.5 HP)	8.8	50	3	1	2	20	1	0.5	GUH-1 (1/8 HP)	
					3	4	20	1	0.5	GUH-2 (1/8 HP)	
					5	6	20	1	0.5	GT-1 (50W)	
					7	8	20	1	0.3	PMP-5	
	CU-1 (MCA 55)	19.8	70	3	9	10	20	1		SPARE	
					11	12	20	1		SPARE	
					13	14	20	1		SPARE	
	RF-1 (1.5 HP)	2.4	15	3	15	16	20	1		SPARE	
					17	18	20	1		SPARE	
	SPACE				19	20				SPACE	
	SPACE				21	22				SPACE	
	SPACE				23	24				SPACE	
	SPACE				25	26				SPACE	
	SPACE				27	28				SPACE	
	SPACE				29	30				SPACE	
	SPACE				31	32				SPACE	
	SPACE				33	34				SPACE	
	SPACE				35	36				SPACE	
	SPACE				37	38				SPACE	
	SPACE				39	40				SPACE	
	SPACE				41	42				SPACE	

CONNECTED LOAD: 32.7 KVA 90.7 A NOTE:
DEMAND LOAD: 37.1 KVA 103.1 A

DATE:
REV:

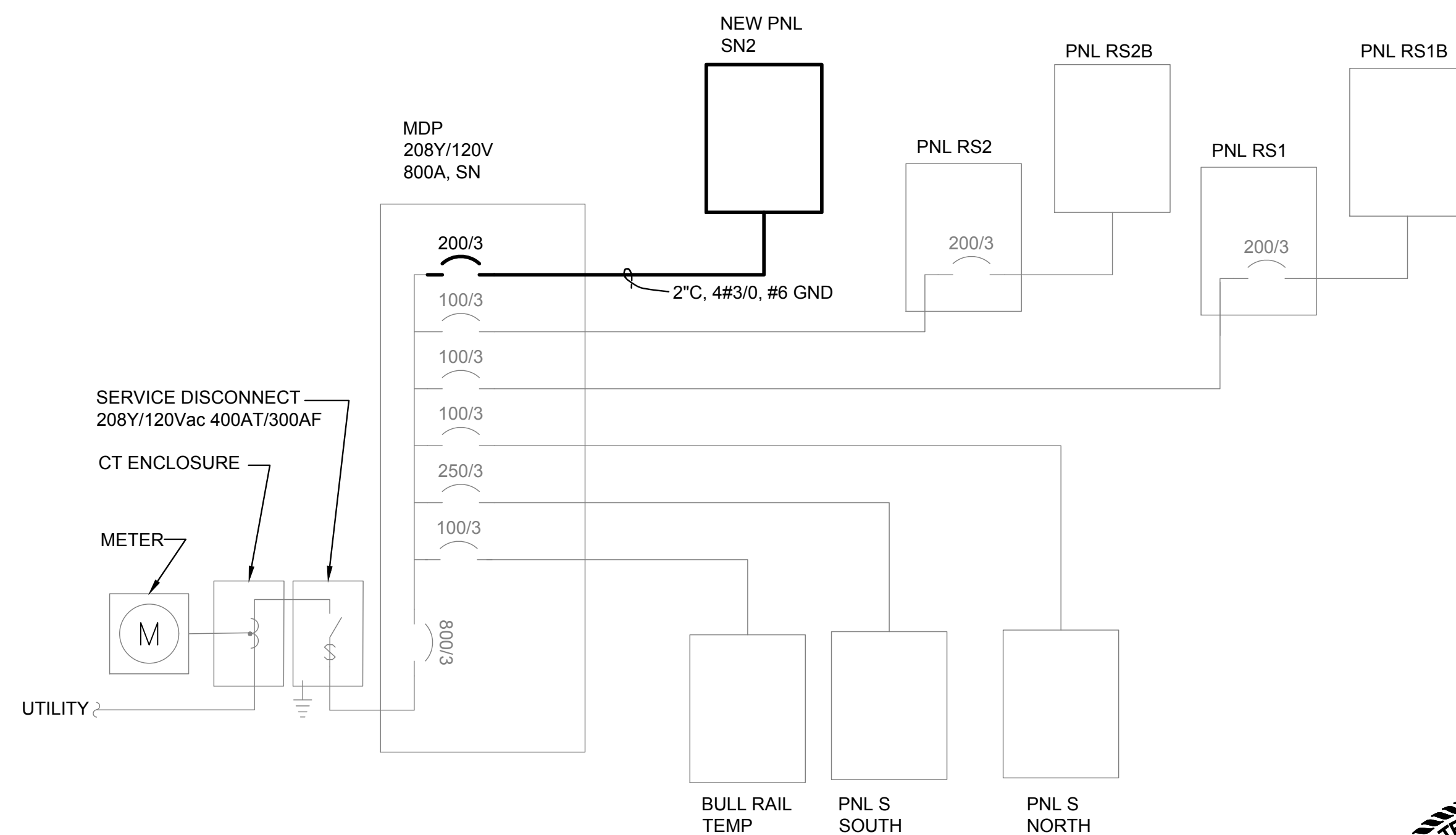

POWER ONE-LINE DIAGRAM
E-1 NTS

NEC 220.87 Service Load Calc (addition to an existing service)

KENAI SUPPLY WASILLA

Existing Load

Maximum Demand 42.00 kW (1-year history as reported by the utility)
Power Factor 0.90 Estimated
Feeder Load 46.67 kVA Connected Load

Demand Factor 125% NEC 220.87(2)
Calculated Load 58.33 kVA Demand Load 162 Amps

New Load

Voltage 208 3 Phase

PANEL Loads	kVA	NEC Factor	NEC kVA
PANEL SN2	32.20		37.10
Misc Total	32.20		37.10
New Load Total	32.20 kVA		37.10 kVA
	89.38 Amps		102.98 Amps

Total New Load Summary

	Connected Load	NEC Load
Existing Load	46.67 kVA	58.33 kVA
New Load	32.20 kVA	37.10 kVA
Total Service Load	78.87 kVA	95.43 kVA
	219 Amps	265 Amps

Existing Service Size 300 Amps 208 Volts 3 Phase
Will Provide 12% Spare Capacity

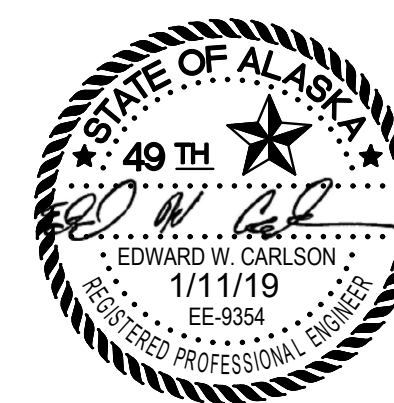

MBA Consulting Engineers, Inc.
3812 Spenard Road, Suite 200 - Anchorage, AK 99517
(907) 274-2822 • FAX (907) 274-0914

0	1/11/19	MBA	BID SET
REV.	DATE	BY	REVISION

ALASKA RAILROAD CORPORATION
ENGINEERING SERVICES
P.O. BOX 107500, ANCHORAGE, ALASKA 99510-7500

ALASKA RAILROAD CORPORATION
KENAI SUPPLY BUILDING RENOVATION

LEGEND, SCHEDULES AND POWER ONE-LINE		E-1	AFE NO.: ACAD FILE:17034-M1 DWG NO. 9 OF 12
DESIGNED BY: EWC	SCALE: AS NOTED		
DRAWN BY: SNS	DATE: 1/11/2019		
CHECKED BY: EWC			
APPROVED BY: EWC			

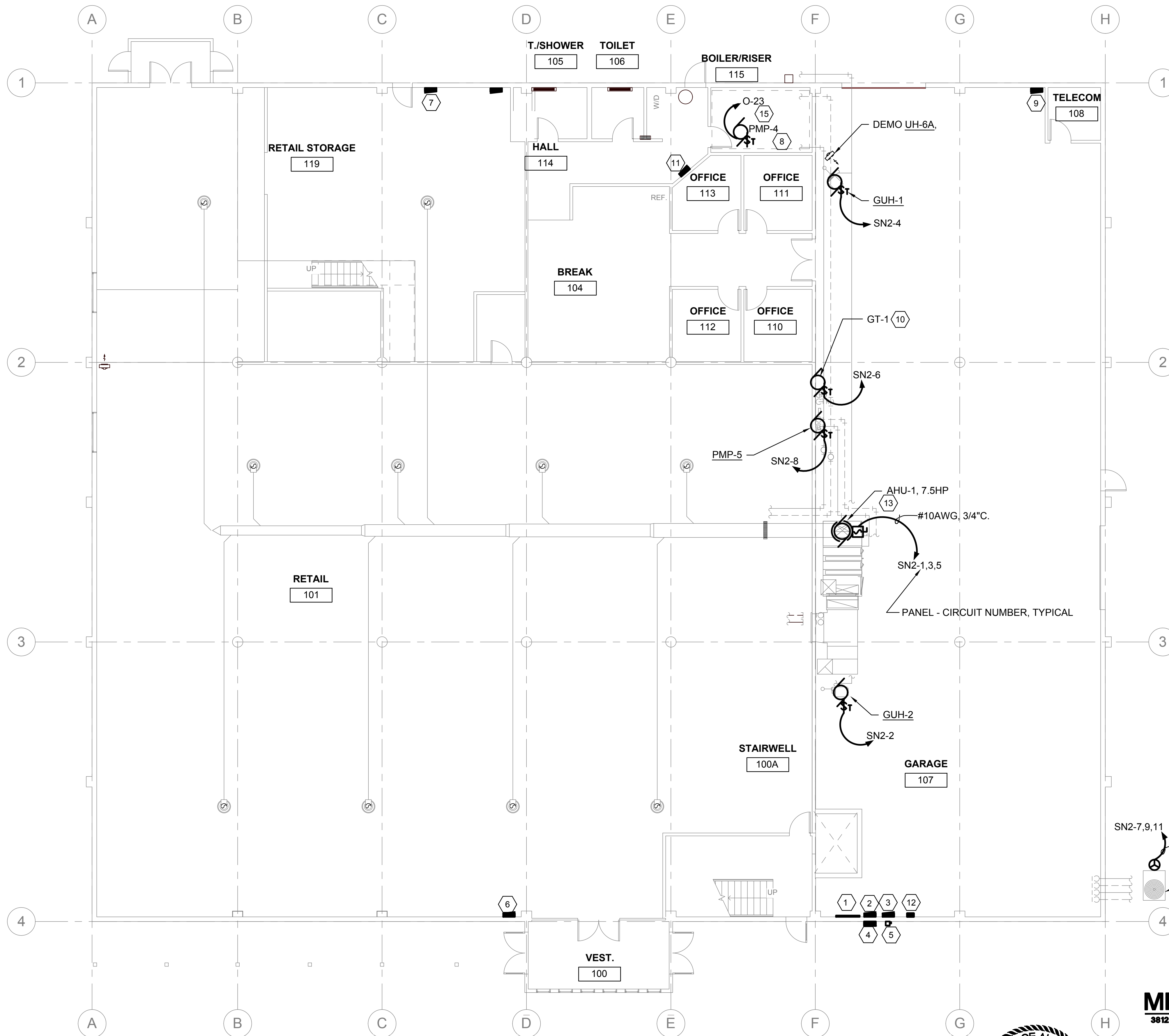

SHEET NOTES:

- 1 TELEPHONE SERVICE ENTRANCE
- 2 PANEL SHOP NORTH (SN)
- 3 MDP
- 4 CT ENCLOSURE
- 5 SERVICE DISCONNECT
- 6 PANEL RS1
- 7 PANEL RS2
- 8 DEMOLISH PMP-3 SEE SHEET M-4.
- 9 PANEL SHOP SOUTH (SS)
- 10 CONNECT GT-1 TO CIRCUIT INDICATED IN PANEL SN2.
- 11 PANEL O
- 12 NEW PANEL SN2
- 13 VFD FURNISHED WITH AHU-1
- 14 SINGLE POINT EQUIPMENT CONNECTION. PROVIDE CONDUIT FOR CONTROL WIRES (INSTALLED BY MECHANICAL) FROM CU-1 TO AHU-1.
- 15 CONNECT PMP-4 TO SPARE 20A/1P CIRCUIT BREAKER IN PANEL O.

1 LEVEL 1 - ELECTRICAL PLAN
E-2 1/8"=1'-0"



MBA Consulting Engineers, Inc.
3812 Spenard Road, Suite 200 • Anchorage, AK 99517
(907) 274-2822 • FAX (907) 274-0914

REV.	DATE	BY	REVISION
0	1/11/19	MBA	BID SET

 ALASKA RAILROAD CORPORATION ENGINEERING SERVICES P.O. BOX 107500, ANCHORAGE, ALASKA 99510-7500	
ALASKA RAILROAD CORPORATION KENAI SUPPLY BUILDING RENOVATION	
FIRST FLOOR ELECTRICAL PLAN	
DESIGNED BY: EWC	SCALE: AS NOTED
DRAWN BY: SNS	DATE: 1/11/2019
CHECKED BY: EWC	E-2 10 OF 12
APPROVED BY: EWC	
AFE NO.: ACAD FILE:17034-M1 DWG NO.	

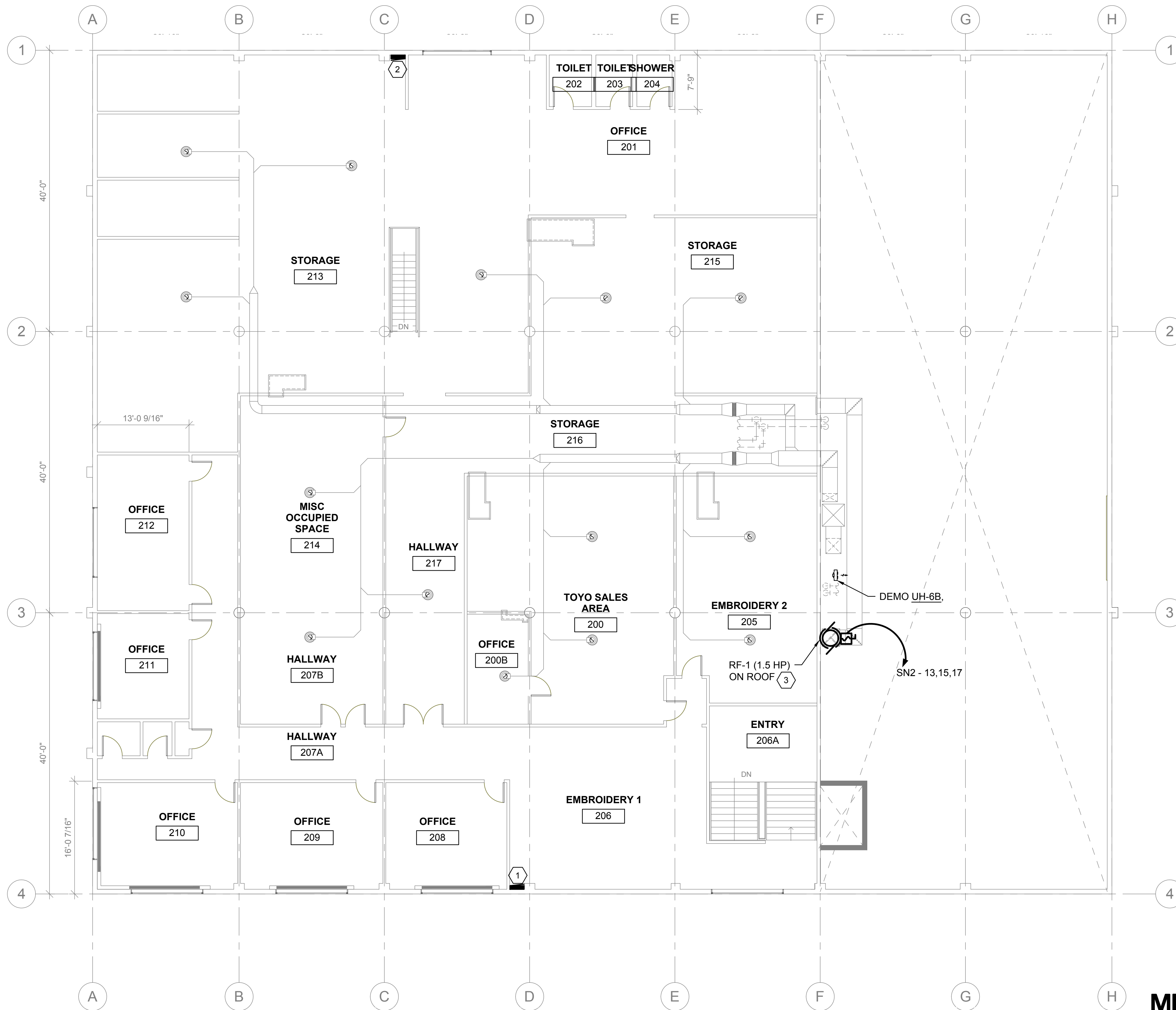

SHEET NOTES:

- ① PANEL RS1B
- ② PANEL RS2B
- ③ CONNECT TO VFD FURNISHED WITH EF-1. PROVIDE CONDUIT FOR CONTROL WIRES (INSTALLED BY MECHANICAL) FROM EF-1 TO AHU-1.

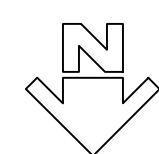

1
E-3 **LEVEL 2 - ELECTRICAL PLAN**
1/8"=1'-0"

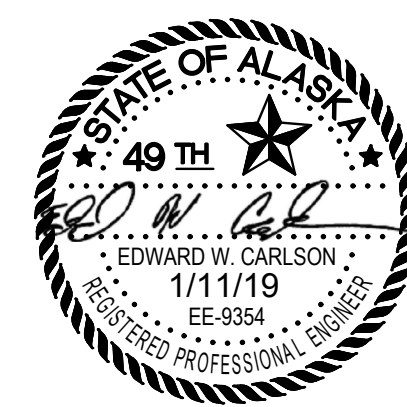
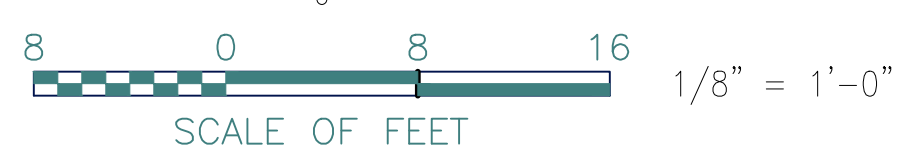

MBA Consulting Engineers, Inc.
3812 Spenard Road, Suite 200 • Anchorage, AK 99517
(907) 274-2822 • FAX (907) 274-0914

REV.	DATE	BY	REVISION
0	1/11/19	MBA	BID SET

 ALASKA RAILROAD CORPORATION ENGINEERING SERVICES P.O. BOX 107500, ANCHORAGE, ALASKA 99510-7500	
ALASKA RAILROAD CORPORATION KENAI SUPPLY BUILDING RENOVATION	
SECOND FLOOR ELECTRICAL PLAN	
DESIGNED BY: EWC DRAWN BY: SNS CHECKED BY: EWC APPROVED BY: EWC	SCALE: AS NOTED DATE: 1/11/2019
E-3	AFE NO.: ACAD FILE:17034-M1 DWG NO. 11 OF 12

PART 1 - GENERAL

1.1 SCOPE

A. PROVIDE COMPLETE ELECTRICAL SYSTEMS AS SHOWN ON DRAWINGS AND SPECIFIED. FURNISH ALL LABOR, EQUIPMENT, APPLIANCES, MATERIALS, AND PERFORM OPERATIONS REQUIRED FOR COMPLETE INSTALLATION IN ACCORDANCE WITH ALL SECTIONS OF SPECIFICATIONS, DRAWINGS, CODES, AND CONDITIONS OF CONTRACT.

1.2 CODES, STANDARDS, FEES, PERMITS

A. COMPLY WITH LATEST EDITION OF THE NATIONAL ELECTRICAL CODE, NATIONAL ELECTRICAL SAFETY CODE, LOCAL CODES, AMENDMENTS, ORDINANCES AND REQUIREMENTS OF UTILITY COMPANIES' FURNISHING SERVICES TO INSTALLATION. COMPLY WITH NEMA, UL, ANSI, ISEA AND OTHER INDUSTRY STANDARDS. COMPLY WITH REQUIREMENTS OF IBC, IMC, UPC, AND OTHER APPLICABLE CODES.

B. SECURE AND PAY FOR ALL INSPECTIONS, FEES, PERMITS, ETC., REQUIRED BY LOCAL AND STATE AGENCIES.

1.3 DRAWINGS

A. ELECTRICAL DRAWINGS ARE DIAGRAMMATIC AND DO NOT SHOW ALL FEATURES OF WORK. INSTALL ELECTRICAL ITEMS TO PROVIDE SYMMETRICAL APPEARANCE. DO NOT SCALE DRAWINGS. REVIEW OTHER DRAWINGS AND ADJUST WORK TO CONFORM TO CONDITIONS SHOWN. VERIFY FIELD CONDITIONS. IMMEDIATELY CONTACT THE OWNER'S REPRESENTATIVE FOR CLARIFICATION OF QUESTIONABLE, OBSCURE ITEMS, OR APPARENT CONFLICTS. THE OWNER'S REPRESENTATIVE'S DECISION IS FINAL FOR ALL CLARIFICATIONS REQUESTED. EXTRA COST RESULTING FROM A CONDITION WHERE CLARIFICATION WAS NOT REQUESTED: MADE AT NO INCREASE IN CONTRACT AMOUNT UNLESS EXTRA COST IS APPROVED IN WRITING.

1.4 WORKMANSHIP

A. CONSIDERED AS IMPORTANT AS ELECTRICAL AND MECHANICAL EFFICIENCY AND SUBJECT TO APPROVAL. EMPLOY WORKMEN SKILLED IN TRADE AND FAMILIAR WITH PARTICULAR TECHNIQUES APPLICABLE TO VARIOUS SECTIONS OF WORK. INSTALL IN ACCORDANCE WITH NECA "STANDARD PRACTICES FOR GOOD WORKMANSHIP IN ELECTRICAL CONTRACTING."

1.5 COORDINATION

A. COORDINATE WITH OTHER TRADES FOR PROPER INSTALLATION AND TIMELY EXECUTION. ANY CHANGES NECESSITATED BY FAILURE TO PROPERLY COORDINATE WORK: MADE AT NO INCREASE IN CONTRACT AMOUNT.

B. VERIFY INFORMATION SHOWN ON PLANS WITH EQUIPMENT ITEMS ACTUALLY FURNISHED WHERE EQUIPMENT IS FURNISHED OR INSTALLED BY OTHERS. NOTIFY OWNER'S REPRESENTATIVE OF ANY CONFLICTS.

1.6 REMODEL WORK

A. EXISTING CONDITIONS NOTED ON THE DRAWINGS WERE PREPARED FROM PREVIOUS CONSTRUCTION DRAWINGS. VISIT SITE, VERIFY EXISTING CONDITIONS AND ALLOW ADEQUATE MONIES TO COVER ADDITIONAL WORK REQUIRED AS A RESULT OF AS-BUILT CONDITIONS. ASSUME THAT THE AS-BUILT INFORMATION DOES NOT INDICATE EXACT CONDUIT ROUTING OR CIRCUITING. INCLUDE NECESSARY WORK TO PROVIDE CIRCUIT CONTINUITY TO EXISTING CIRCUITS THAT MAY BE AFFECTED BY NEW WORK. CUT BACK EXISTING WORK BEING REMOVED OR ABANDONED BEYOND FINISHED SURFACES TO ALLOW REPAIR AND REFINISHING. ASSUME CONDITION OF WIRING IS SUITABLE FOR RECONNECTING.

B. NOTIFY OWNER'S REPRESENTATIVE OF ANY FIELD CONDITIONS WHERE CONTRACTOR CANNOT REUSE EXISTING MATERIAL OR EQUIPMENT BECAUSE OF DETERIORATED CONDITIONS. ALSO NOTIFY OWNER'S REPRESENTATIVE OF ANY EXISTING CONDITIONS WHICH MAY BE CONSIDERED UNSAFE OR IN NEED OF REPAIR.

1.7 SUBMITTALS

A. SUBMITTAL REVIEW IS FOR GENERAL DESIGN AND ARRANGEMENT ONLY AND DOES NOT RELIEVE THE CONTRACTOR FROM ANY REQUIREMENTS OF CONTRACT DOCUMENTS. PROVISION OF A COMPLETE AND SATISFACTORY WORKING INSTALLATION IS THE SOLE RESPONSIBILITY OF THE CONTRACTOR.

1.8 PROJECT COMPLETION

A. THOROUGHLY CLEAN INSIDE AND OUT ALL FIXTURES AND EQUIPMENT. CLEAN PREMISES OF CONSTRUCTION DEBRIS. CALL FOR FINAL CONSTRUCTION OBSERVATION. CONDUCT OPERATING TEST FOR APPROVAL. DEMONSTRATE INSTALLATION TO OPERATE SATISFACTORILY IN ACCORDANCE WITH REQUIREMENTS OF CONTRACT DOCUMENTS. PROVIDE PERSONNEL TO ASSIST ENGINEER IN REMOVAL AND REPLACEMENT OF EQUIPMENT FOR OBSERVATION PURPOSES.

B. SHOULD ANY PORTION OF INSTALLATION FAIL, REPAIR OR REPLACE ITEMS UNTIL ITEMS CAN BE DEMONSTRATED TO COMPLY.

C. FIRE ALARM AND EMERGENCY SYSTEMS MUST BE OPERATIONAL PRIOR TO OCCUPANCY.

D. SUBMIT A LETTER CERTIFYING COMPLETION OF PROJECT IN ACCORDANCE WITH PLANS AND SPECIFICATIONS. TURN OVER RECORD DRAWINGS TO OWNER.

1.9 GUARANTEE

A. GUARANTEE ALL MATERIAL TO BE NEW, ALL WORK TO BE FREE FROM DEFECTS IN MATERIAL AND WORKMANSHIP FOR ONE YEAR FROM DATE OF FINAL ACCEPTANCE. REPAIR OR REPLACE ANY WORK OR MATERIAL DEEMED DEFECTIVE DURING THE GUARANTEE PERIOD AT NO COST TO THE OWNER.

PART 2 - PRODUCTS

2.1 RACEWAYS

A. GALVANIZED RIGID STEEL CONDUIT OR INTERMEDIATE METAL CONDUIT: USE IN DAMP OR WET LOCATIONS, UNDERGROUND, IN CONCRETE OR CMU, WHERE SUBJECT TO PHYSICAL DAMAGE, FOR SERVICE CONDUCTORS AND PANELBOARD FEEDERS.

B. ELECTRICAL METALLIC TUBING: USE IN ALL OTHER AREAS UNLESS OTHERWISE INDICATED. PROVIDE RAIN/TIGHT/CONCRETE-TIGHT COMPRESSION FITTINGS.

C. FLEXIBLE METALLIC CONDUIT: USE FOR FINAL CONNECTIONS TO FIXTURES AND EQUIPMENT TO ISOLATE VIBRATION OR ALLOW RELOCATION. PROVIDE FLEXIBLE WATERTIGHT CONDUIT IN DAMP OR WET LOCATIONS (PUMPS, KITCHEN EQUIPMENT, ETC.), WHERE USED OUTDOORS, USE LIQUIDTIGHT FLEXIBLE CONDUIT RATED FOR -60 DEGREES F AND LISTED FOR DIRECT BURY.

D. NO CONDUIT ALLOWED EMBEDDED IN SPRAY-APPLIED FIREPROOFING OR BETWEEN STRUCTURAL STEEL MEMBERS AND GYPSUM WALL BOARD.

E. UNLESS NOTED, INSTALL RACEWAYS CONCEALED EXCEPT AT SURFACE CABINETS, MOTOR AND EQUIPMENT CONNECTIONS, AND IN UTILITY ROOMS. LOCATE RACEWAYS TO NOT ENDANGER STRENGTH OF STRUCTURAL MEMBERS, AND SIX INCHES MINIMUM FROM PARALLEL RUNS OF HEAT PIPING. DO NOT INSTALL RACEWAYS IN OR THROUGH STRUCTURAL MEMBERS UNLESS SPECIFICALLY APPROVED. CROSS EXPANSION JOINTS WITH EXPANSION FITTINGS AND BONDING CONDUCTOR.

F. PROVIDE PULL WIRE IN RACEWAYS INSTALLED BUT LEFT EMPTY.

G. WATERPROOF ALL ROOF AND EXTERIOR WALL PENETRATIONS AS APPROVED.

2.2 WIRE AND CABLE

A. INSTALL ALL CONDUCTORS IN APPROVED RACEWAY SYSTEMS. TYPE MC CABLE MAY BE USED WITHIN THE LIMITS OF THE NEC UNLESS OTHERWISE NOTED ON DRAWINGS. ALL CONDUCTOR SIZES BASED ON COPPER, #12 AWG MINIMUM EXCEPT CONTROL WIRING MAY BE #14.

B. MINIMUM INSULATION RATING: 75 DEGREES C, 600 VOLT. IN LIGHTING FIXTURE CHANNELS, HIGH TEMPERATURE AREAS: 90 DEGREES C, 600 VOLT.

C. 120 VOLT BRANCH CIRCUIT LENGTHS FROM PANEL TO FIRST OUTLET EXCEEDING 75': NO. 10 AWG MINIMUM.

D. INCREASE CONDUCTOR SIZES TO #10 AWG OR USE 90 DEGREES C-RATED INSULATION TO OFFSET DERATING FACTOR, WHEN MORE THAN THREE 20 AMP CONDUCTORS ARE INSTALLED IN SINGLE RACEWAY.

E. CABLE FOR FIRE ALARM SYSTEMS AND OTHER SPECIAL INSTALLATIONS: AS DESCRIBED UNDER OTHER SECTIONS OF SPECIFICATIONS, NOTED ON DRAWINGS, OR RECOMMENDED BY MANUFACTURER.

F. COLOR CODE 120/208 VOLT SYSTEMS: BLACK, RED, BLUE AND WHITE. CODE SOUND AND SIGNAL SYSTEMS WIRING AND ANY SPECIAL EQUIPMENT IN ACCORDANCE WITH MANUFACTURER'S DIAGRAMS OR RECOMMENDATIONS.

G. INSTALL NO THERMOPLASTIC INSULATED CONDUCTORS WHEN TEMPERATURE IS BELOW 20 DEGREES F.

H. CONNECTIONS:

- #6 AND LARGER: SOLDERLESS LUGS.
- #8 AND SMALLER: INSULATED WIRE NUT CONNECTOR, IDEAL "WINGNUT" HARD SHELL.

I. LOW VOLTAGE, SPECIAL PURPOSE, COAXIAL CABLES, ETC.: INSTALL AND TERMINATE PER MANUFACTURER'S RECOMMENDATIONS.

2.3 BOXES

A. WHERE CONDUIT SYSTEMS OR MC CABLE IS USED, PROVIDE GALVANIZED OR CADMIUM PLATED, ONE PIECE PRESSED OR WELDED STEEL WITH DEVICE FINISH RING AND GANG COVER. FOUR INCH SQUARE OR OCTAGONAL, 1-1/2" DEEP MINIMUM SIZE. PROVIDE STEEL SQUARE CORNER MASONRY BOXES AND FINISH RINGS IN MASONRY, CONCRETE OR CONCRETE BLOCK WALLS.

B. THROUGH WALL BOXES NOT PERMITTED. PROVIDE SIX INCH MINIMUM NIPPLE BETWEEN OUTLETS SHOWN BACK-TO-BACK ON COMMON WALLS. MINIMUM 24" SEPARATION IN FIRE-RATED WALLS AND PENETRATIONS. SET FLUSH WITH WALL OR CEILING FINISH. PROVIDE ISOLATION BARRIER BETWEEN DISSIMILAR VOLTAGES IN SAME OUTLET AND WHERE LINE-TO-LINE VOLTAGE EXCEEDS 300 VOLTS.

C. VERIFY LOCATION OF ALL OUTLETS. UNLESS NOTED, MOUNT OUTLETS AS FOLLOWS, FINISHED FLOOR TO CENTERLINE OF OUTLET:

WALL SWITCHES, PUBLIC TELEPHONE OUTLETS	4'-0"
CONVENIENCE OUTLETS, INDIVIDUAL TELEPHONE OUTLETS	1'-6"
WEATHERPROOF OUTLETS	2'-6"

D. PROVIDE ADDITIONAL PULL BOXES AS REQUIRED TO AVOID EXCESS PULLING TENSIONS AND TO FACILITATE WORK.

2.4 PANELBOARDS AND OVERCURRENT PROTECTION

A. SQUARE D TYPE NQOD SERIES. SIMILAR EQUIPMENT BY OTHER MANUFACTURERS ACCEPTABLE. SIEMENS EQUIPMENT IS NOT ACCEPTABLE. SAME MANUFACTURER AND KEYED ALIKE THROUGHOUT PROJECT. FACTORY ASSEMBLED PANELS WITH THERMAL MAGNETIC BRANCH BREAKERS, MAIN LUGS OR CIRCUIT BREAKER, ETC., AS SHOWN. PROVIDE DEAD FRONT CONSTRUCTION, FLUSH OR SURFACE MOUNTED AS SHOWN, 20" WIDE, 5-3/4" DEEP UNLESS OTHERWISE INDICATED. PROVIDE DOORS WITH CONCEALED HINGES, FLUSH KEYED HANDLES. PROVIDE TYPED CIRCUIT DIRECTORIES ON DOOR IN FRAME WITH PROTECTIVE PLASTIC COVERING. DIRECTORY TO INCLUDE CIRCUIT NUMBER, CIRCUIT USE, ETC. SEE DRAWINGS FOR ADDITIONAL REQUIREMENTS. MOUNT TOP OF CABINET AT 6'-6" UNLESS NOTED.

B. PROVIDE CIRCUIT BREAKERS OF THERMAL MAGNETIC TYPE, QUICK-MAKE, QUICK-BREAK WITH A MINIMUM OF 10,000 AIC RATING AT 120/208 VOLT. MEET NEMA STANDARD AB1. PROVIDE HIGH INTERRUPTING CAPACITY AND NON-FUSE TYPE CURRENT LIMITING CIRCUIT BREAKERS WHERE SHOWN. PROVIDE MULTI-POLE BREAKERS WITH INTERNAL COMMON TRIP.

C. PROVIDE "SWITCHING RATED" CIRCUIT BREAKERS FOR ALL LIGHTING CIRCUITS CONTROLLED AT THE PANELBOARD. PROVIDE CIRCUIT BREAKERS DESIGNATED "GFI" EQUIPPED WITH INTEGRAL CLASS A GROUND FAULT CIRCUIT INTERRUPTER SET TO TRIP ON GROUND FAULT OF SIX MILLIAMPS OR GREATER.

2.5 WIRING DEVICES

A. DUPLEX RECEPTACLES: 20 AMP, 125 VOLT, NEMA TYPE 5-20R, MEET FEDERAL SPECIFICATION W-C-596F TESTS. COLOR TO MATCH EXISTING. PROVIDE OUTLETS DESIGNATED GFI WITH INTEGRAL CLASS A GROUND FAULT CIRCUIT INTERRUPTER UL 943-LISTED.

B. SPECIAL OUTLETS: CAPACITY, VOLTAGE AND NEMA CONFIGURATION NOTED, SAME QUALITY AS DUPLEX RECEPTACLES.

C. SWITCHES: 20 AMP, 120/277 VOLT, MEET FEDERAL SPECIFICATION W-S-896E, UL #20, SELF-GROUNDING. COLOR AS DIRECTED.

D. DEVICE PLATES: UL LISTED, ONE PIECE FLUSH PLATES STAINLESS STEEL. USE GALVANIZED PLATES FOR EXPOSED WIRING, GASKETED POLYCARBONATE SELF-CLOSING WEATHERPROOF PLATES OUTDOORS, U.L. LISTED FOR WET LOCATIONS WHILE IN USE.

2.6 MOTORS CONNECTIONS

A. UNLESS OTHERWISE INDICATED, HEATING, VENTILATING AND PLUMBING EQUIPMENT MOTORS AND CONTROLS ARE FURNISHED, SET IN PLACE, AND WIRED IN ACCORDANCE WITH THE FOLLOWING SCHEDULE: (COORDINATE ALL WORK WITH MECHANICAL.)

(MC = MECHANICAL CONTRACTOR)
(EC = ELECTRICAL CONTRACTOR)

ITEM	FURNISHED BY	SET IN PLACE BY	WIRED POWER	WIRED CONTROL
EQUIPMENT MOTORS	MC	MC	EC	MC
MAGNETIC MOTOR STARTERS:				
a)AUTOMATICALLY CONTROLLED WITH OR WITHOUT HOA SWITCHES	EC	EC	EC	MC
b)MANUALLY CONTROLLED	EC	EC	EC	EC
c)IN PACKAGED EQUIPMENT	MC	MC	EC	MC
DISCONNECT SWITCHES, MANUAL MOTOR STARTERS, THERMAL OVERLOAD SWITCHES	EC	EC	EC	--
CONTROL RELAYS, TRANSFORMERS, TIME CLOCKS, THERMOSTATS, VALVES, FLOAT CONTROLS, DAMPER MOTORS, EP AND PE SWITCHES, OTHER MISCELLANEOUS CONTROLS	MC	MC	MC	MC

B. APPLIANCE AND MISCELLANEOUS EQUIPMENT CONNECTIONS.

- PROVIDE AND MAKE ALL FINAL ELECTRICAL CONNECTIONS IN ACCORDANCE WITH MANUFACTURER'S RECOMMENDATIONS AND SHOP DRAWINGS FOR EQUIPMENT FURNISHED BY OTHERS. PROVIDE FLEXIBLE CONDUIT; TYPE SO OR ST RUBBER CORDS WITH GROUNDING CONDUCTOR; PIGTAILS, KELLEMS, CAPS, ETC., AS REQUIRED FOR AN OPERATING SYSTEM.
- PROVIDE OUTLETS AT LOCATIONS TO CONVENIENTLY SERVE EQUIPMENT. PROVIDE RECEPTACLES AS REQUIRED TO MATCH CORD CAPS ON EQUIPMENT FURNISHED. PROVIDE DIRECT WIRING OR RECEPTACLES FOR FINAL CONNECTION TO EQUIPMENT AS REQUIRED FOR PARTICULAR EQUIPMENT FURNISHED.

2.7 MOTOR STARTER AND DISCONNECTS

A. PROVIDE EACH MOTOR WITH DISCONNECTING MEANS AND WITH SUITABLE CONTROLLER OR OTHER DEVICE AS REQUIRED, COMPLETE WITH MANUAL OR AUTOMATIC CONTROL OF STANDARD NEMA SIZES.

B. PROVIDE ACROSS-THE-LINE COMBINATION STARTER-DISCONNECT MAGNETIC STARTERS WITH AMBIENT COMPENSATED THERMAL OVERLOAD PROTECTION SET AT 115% MEASURED FULL LOAD CURRENT IN EACH UNGROUNDED PHASE WITH MAINTENANCE-FREE, DOUBLE BREAK, SOLID SILVER ALLOY CONTACTS.

C. ARRANGE CONTROL CIRCUITS FOR MANUAL, AUTO AND OTHER SIGNAL INPUTS FROM MECHANICAL CONTROL PANELS, AND ARRANGE CONTROL POWER TO DE-ENERGIZE CONTROL CIRCUITS WHENEVER OPERATING POWER SUPPLY TO PARTICULAR EQUIPMENT IS DISCONNECTED.

D. PROVIDE HORSEPOWER RATED MANUAL MOTOR STARTING SWITCH WITH THERMAL OVERLOAD PROTECTION FOR EACH SINGLE PHASE MOTOR. SIZE HEATERS FOR 115% MEASURED FULL LOAD CURRENT.

E. WHERE SHOWN, PROVIDE FUSED SWITCH TYPE COMBINATION STARTERS FOR ALL THREE PHASE MOTORS RATED 7.0 FULL LOAD AMPERES AND BELOW. SIZE FUSES FOR APPROXIMATELY 115% OF MOTOR FULL LOAD CURRENT. PROVIDE NON-FUSED SWITCH TYPE FOR ALL THREE PHASE MOTORS RATED ABOVE 7.0 FULL LOAD AMPERES.

F. DISCONNECTS: HEAVY DUTY SAFETY SWITCHES, CIRCUIT BREAKERS OR MANUAL MOTOR STARTING SWITCHES.

2.8 GROUNDING

A. GROUND ALL ELECTRICAL DEVICES, MOTORS, METALLIC PIPING, DUCTWORK, METAL FRAMING, ETC., IN ACCORDANCE WITH N.E.C. ARTICLE 250.

B. PROVIDE SEPARATE GREEN GROUNDING CONDUCTOR IN ALL FEEDERS, BRANCH CIRCUITS, AND EQUIPMENT CORDS.

PART 3 - EXECUTION

3.1 GENERAL

A. INSTALL ALL MATERIAL AND EQUIPMENT IN ACCORDANCE WITH MANUFACTURER'S RECOMMENDATIONS, INSTRUCTIONS AND INSTALLATION DRAWINGS, UNLESS OTHERWISE INDICATED AND IN ACCORDANCE WITH NECA'S "STANDARD PRACTICES FOR GOOD WORKMANSHIP IN ELECTRICAL CONTRACTING".

B. SEAL PENETRATIONS WITH UL-LISTED FIREPROOFING MATERIALS TO MAINTAIN FIREPROOFING INTEGRITY AND WATERTIGHTNESS.

C. SEAL AIRTIGHT ALL PENETRATIONS THROUGH SMOKE PARTITIONING, FAN PLENUMS, DUCTWORK, AND VAPOR BARRIERS.

D. REPLACE OR REPAIR ANY SPRAY-APPLIED FIREPROOFING OR INSULATION DAMAGED BY INSTALLATION OF ELECTRICAL EQUIPMENT.

E. REPAIR ALL DAMAGE TO FINISHED SURFACES WHERE CAUSED BY INSTALLATION OF ELECTRICAL EQUIPMENT.

F. PROVIDE PROPER IDENTIFICATION FOR PANELS, SWITCHES, OR ANY ITEM OF ELECTRICAL EQUIPMENT USED AS A CONTROL DEVICE OR DISCONNECTING MEANS FOR ANY EQUIPMENT. IDENTIFY BOXES CONTAINING EMERGENCY CIRCUITS PER N.E.C. ARTICLE 700-9.

G. PROVIDE UPDATED TYPED PANEL SCHEDULES.

3.2 SUPPORTS

A. SUPPORT RACEWAYS ON APPROVED TYPES OF WALL BRACKETS, CEILING TRAPEZE HANGERS OR MALLEABLE IRON STRAPS. PLUMBERS PERFORATED STRAP NOT PERMITTED AS MEANS OF SUPPORT.

B. DO NOT SUSPEND RACEWAYS OR EQUIPMENT FROM CEILING TIE WIRE OR T-BAR, FROM STEAM, WATER OR OTHER PIPING OR DUCTWORK, BUT SUPPORT INDEPENDENTLY.

C. ANCHOR EQUIPMENT TO THE BUILDING STRUCTURE TO RESIST SEISMIC DESIGN CATEGORY D EARTHQUAKE FORCES. PROVIDE ADEQUATE BACKING AT STRUCTURAL ATTACHMENT POINTS TO ACCEPT THE FORCES INVOLVED.

D. SECURE BOXES, WALL BRACKETS, CABINETS AND HANGERS BY MEANS OF TOGGLE BOLTS IN HOLLOW MASONRY AND GYPBOARD; PRESET INSERTS OR EXPANSION BOLTS IN SOLID MASONRY AND CONCRETE; MACHINE SCREWS, BOLTS OR WELDING ON METAL SURFACES; AND WOOD SCREWS IN WOOD CONSTRUCTION.

3.3 AS-BUILT DRAWINGS

A. KEEP CLEAN SET OF PRINTS AT JOB SITE AND RECORD ALL ELECTRICAL CHANGES THAT OCCURRED DURING CONSTRUCTION. FAILURE TO DO SO MAY DELAY PAYMENT.

B. AT END OF CONSTRUCTION, PROVIDE ONE COMPLETE SET OF DRAWINGS INDICATING ALL FIELD CHANGES FOR RECORD PURPOSES TO THE OWNER'S REPRESENTATIVE.

 ALASKA RAILROAD CORPORATION ENGINEERING SERVICES P.O. BOX 107500, ANCHORAGE, ALASKA 99510-7500	
ALASKA RAILROAD CORPORATION KENAI SUPPLY BUILDING RENOVATION	
TITLE: ELECTRICAL SPECIFICATIONS	
DESIGNED BY: EWC DRAWN BY: SNS CHECKED BY: EWC APPROVED BY: EWC	SCALE: AS NOTED DATE: 1/11/2019
AFE NO.: ACAD FILE:17034-E4 DWG NO.	E-4 12 OF 12

MBA Consulting Engineers, Inc.
 3812 Spenard Road, Suite 200 • Anchorage, AK 99517
 (907) 274-2822 • FAX (907) 274-0914

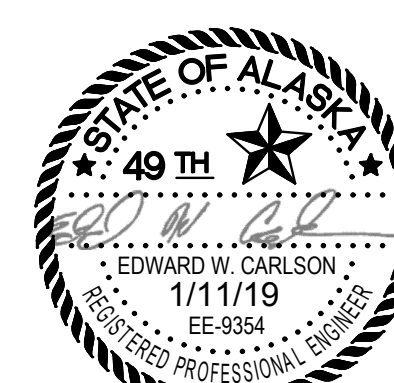

REV.	DATE	BY	REVISION
0	1/11/19	MBA	BID SET