



iMac 24-inch (M1, 2021)

Apple Recycler Guide

June 2023

Contents

- 3 [About This Guide](#)
- 4 [Identification](#)
- 5 [Directive 2012/19/EU Annex VII Components](#)
- 6 [Safety Considerations](#)
- 7 [Recommended Tools](#)
- 8 [Disassembly Instructions](#)
- 29 [Material Categorization of Output Fractions](#)

About This Guide

Apple Recycler Guides provide guidance for electronics recyclers on how to disassemble products to maximize recovery of resources. The guides provide step-by-step disassembly instructions and information on the material composition to help recyclers direct fractions to the appropriate material recycler.

To conserve important resources, we work to reduce the materials we use and aim to one day source only recycled or renewable materials in our products. A key path to reaching that goal is resource recovery from end-of-life electronics.

Disassembly procedures are intended to be performed only by trained electronics recycling professionals. The recycler is responsible for independently evaluating and ensuring compliance with all applicable environmental, health, and safety laws related to the work. These include but are not limited to laws relating to the management, handling, shipping, and disposal of the outputs of this work as waste and laws in place to ensure the health and safety of all employees who support this work.

For questions or feedback about this guide, email contactesci@apple.com.

Identification

You can find the model number of the iMac on the bottom of the stand.

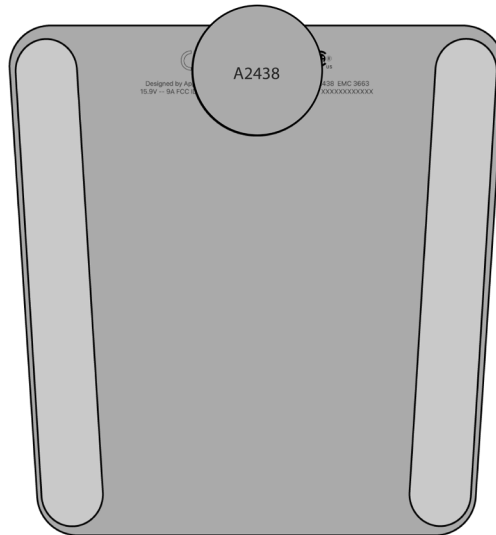

Model numbers:
A2438, A2439

Directive 2012/19/EU Annex VII Components

Directive 2012/19/EU Annex VII requirements apply to the following substances and components.

Substance/Component	Apple Part Name	Removal Instructions
Printed circuit board if the surface is greater than 10 square centimeters	Main logic board, power supply logic board, display logic board, light-emitting diode (LED) logic board	Follow steps 1–24
External electric cables	Power cord	Follow step 1
Battery	Coin cell batteries	Follow steps 1–14
Cover glass and liquid crystal display (LCD) cell if the surface is greater than 100 square centimeters	Display, bottom glass panel	Follow steps 1–15
No further substances or components as listed in Annex VII		

Safety Considerations

The recycler is responsible for independently evaluating all activities undertaken by its employees to perform or support the work and ensuring compliance with all applicable health and safety laws related to the work. These include but are not limited to laws relating to the health and safety of all employees who perform or support this work. The recycler is also responsible for evaluating the workspace and ensuring that the area in which the work is to be undertaken is designed using ergonomic best practices and meets all ergonomic requirements to ensure the protection of its employees.

Personal Protective Equipment

Personal protective equipment should be worn during the entire recycling process.



Wear hand protection



Wear protective clothing



Wear eye protection



Wear foot protection



Wear a mask

LED Safety

Broken LEDs must be handled properly to ensure the safety of your employees and mitigate any hazards. Package broken LEDs in an appropriate container to properly manage the hazards associated with the materials and store only with compatible materials. All waste must be properly classified, packaged, and labeled in accordance with all relevant laws and regulations.

Hazard Warnings



Broken glass hazard



Chemical inhalation hazard



Chemical exposure hazard

Recommended Tools

Hammer

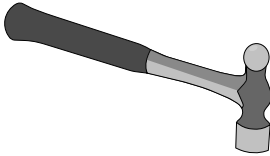

Heavy chisel

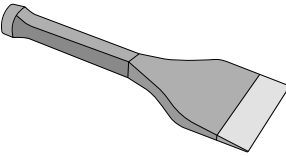

Miniature pry bar

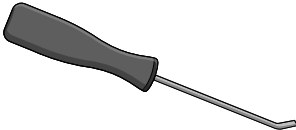

Nail-pulling screwdriver

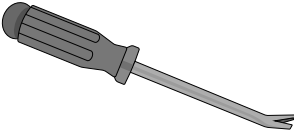

Precision pick

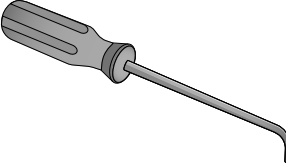

Screwdriver-handle pry bar

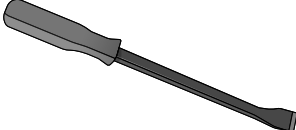

Torx T10 screwdriver

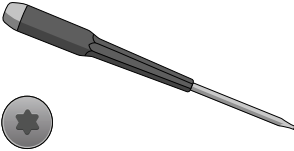

Disassembly Instructions

1. Remove the power adapter and the power cord.

» *Ensure that the iMac is turned off.*



» *Unplug the power adapter. Unplug the power cord from the back of the iMac.*

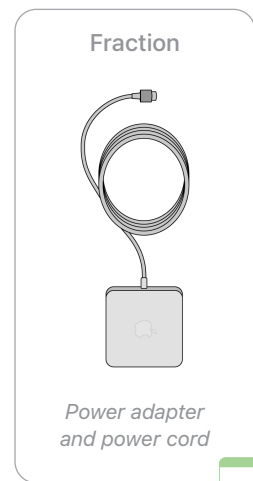
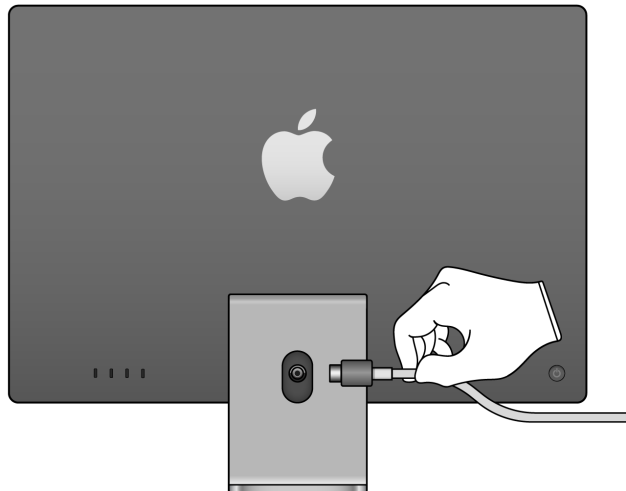

Warning: Before continuing disassembly, wait 10 minutes after unplugging the device for stored energy to discharge.

2. Pry the display away from the housing. Lay the display facedown. Set the housing aside.

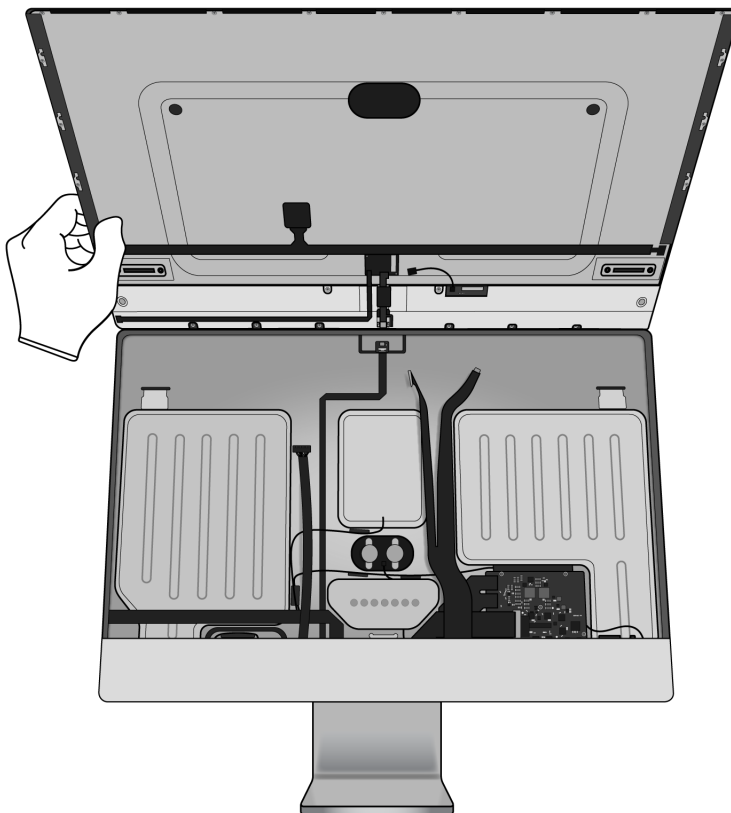
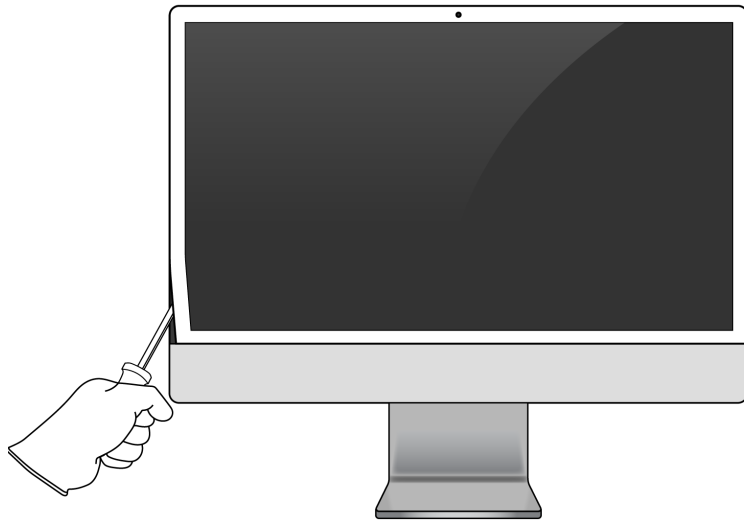
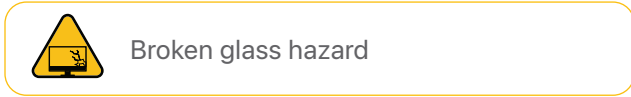

3. Remove the display logic board cover.

» *Pry the display logic board cover off the display.*

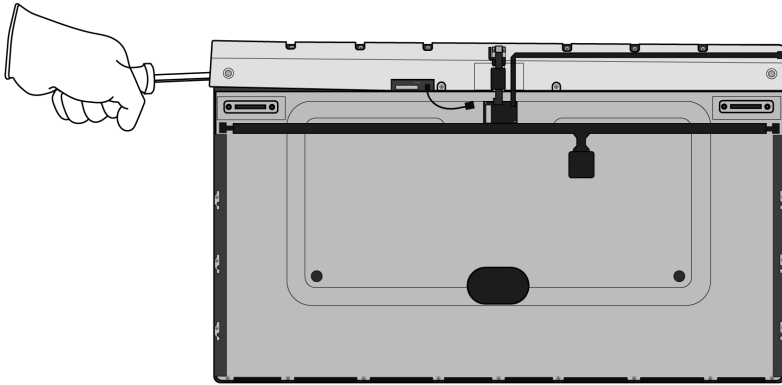

Tools Used

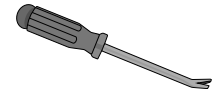

» *Pull the ribbon cable off the display logic board cover.*

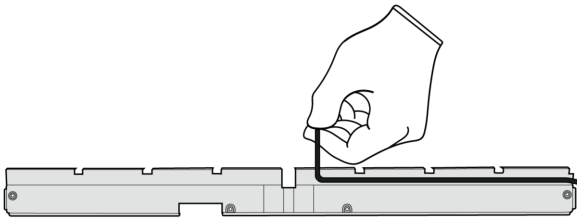

Fraction



Ribbon cable

Cu

Copper

Fraction



Display logic board cover

Fe

Ferrous

4. Pull off the display logic board.

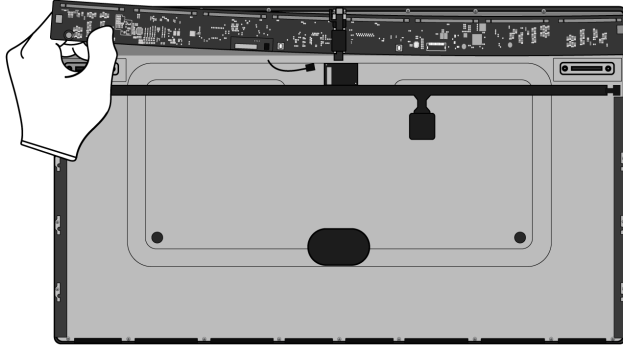

Fraction

Display logic board

PMs
Precious Metals

A diagram showing a box labeled 'Fraction' containing a small image of the display logic board. Below the box is a green label with 'PMs' and 'Precious Metals'.

5. Pry off the camera logic board.

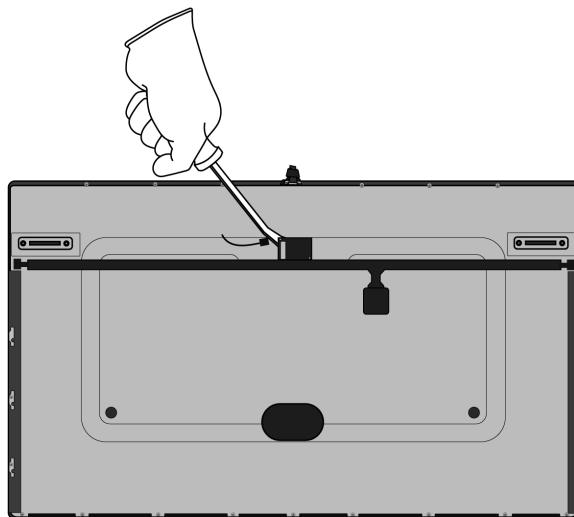

Tools Used

A diagram showing a box labeled 'Tools Used' containing an icon of a screwdriver.

Fraction

Camera logic board

PMs
Precious Metals

A diagram showing a box labeled 'Fraction' containing a small image of the camera logic board. Below the box is a green label with 'PMs' and 'Precious Metals'.

6. Remove the ribbon cables.

» *Pry off the left ribbon cable.*

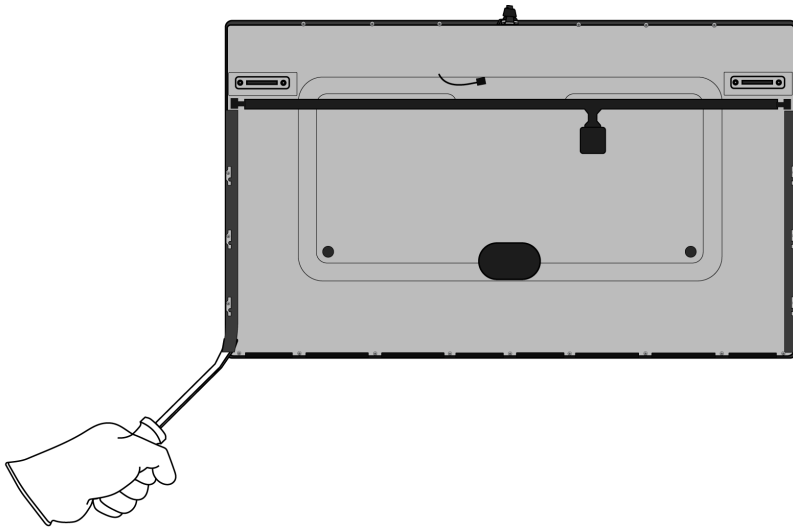

Tools Used

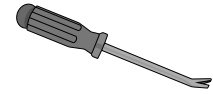

Fraction



Ribbon cable

Cu

Copper

» *Pull off the middle ribbon cable by hand.*

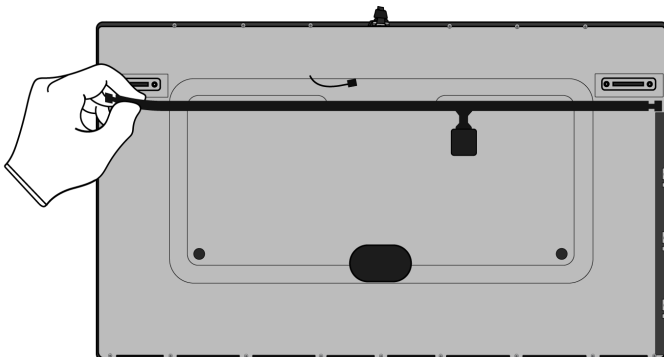

Fraction



Ribbon cable

Cu

Copper

» Pull off the right ribbon cable by hand.

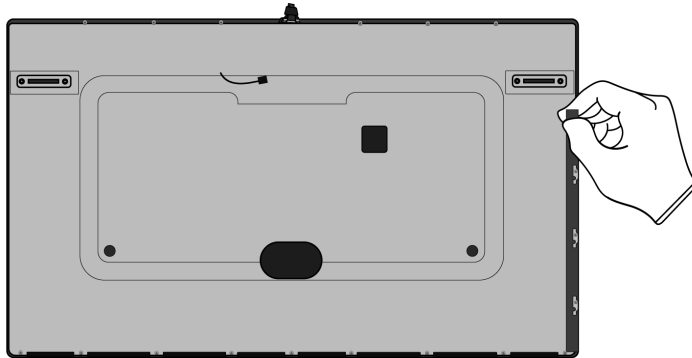

Fraction



Ribbon cable

Cu
Copper

A vertical rectangular box containing the text "Fraction" at the top, a drawing of a long, thin, black ribbon cable in the center, and the text "Ribbon cable" at the bottom. To the right of the box is a small green square with "Cu" in white and "Copper" in smaller text below it.

7. Pry off the backlight logic board.

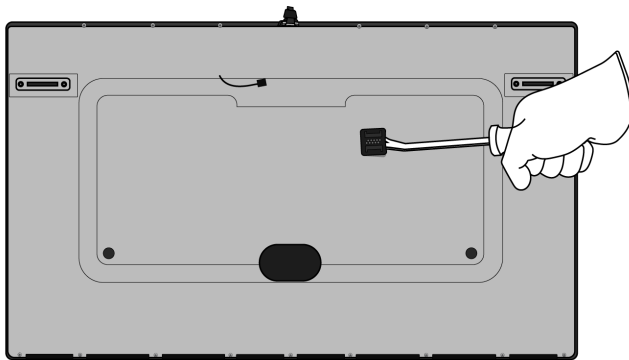

Tools Used



A drawing of a screwdriver with a grey handle and a metal shaft.

Fraction



Backlight logic board

PMs
Precious Metals

A vertical rectangular box containing the text "Fraction" at the top, a drawing of a small, rectangular backlight logic board in the center, and the text "Backlight logic board" at the bottom. To the right of the box is a small green square with "PMs" in white and "Precious Metals" in smaller text below it.

8. Pull off the flex cable.

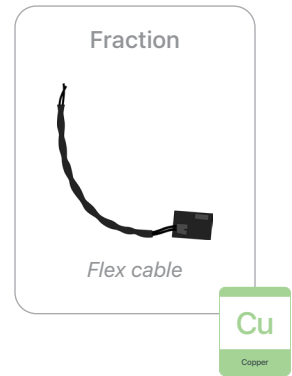
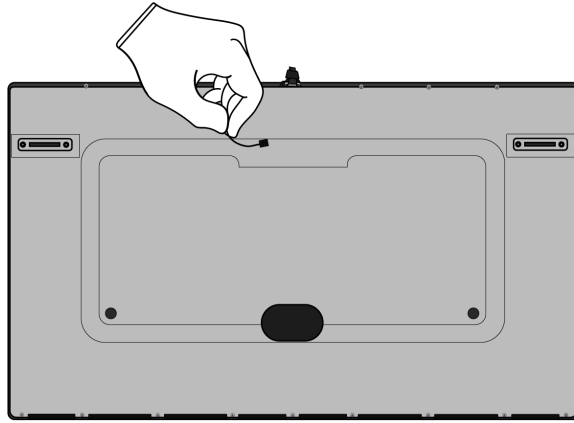

9. Pry the mid plate off the LCD cell.

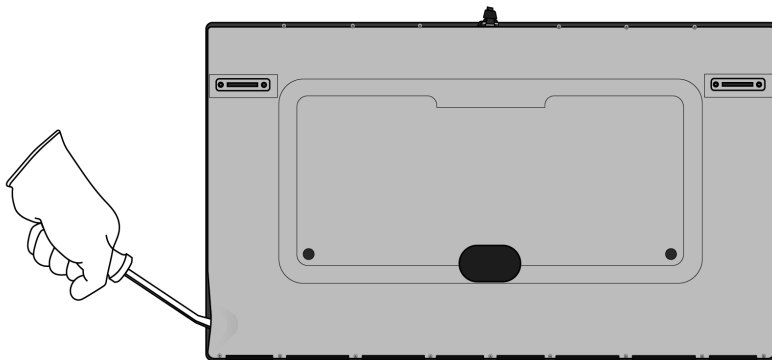
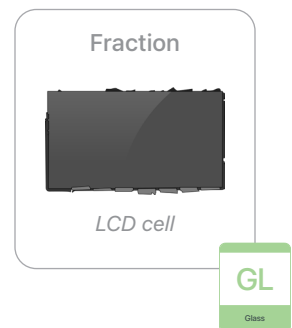
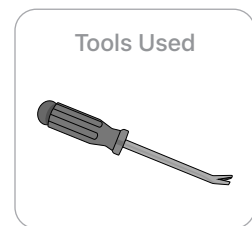
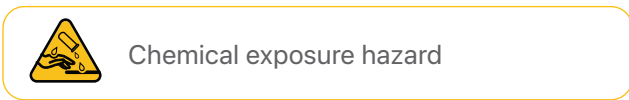
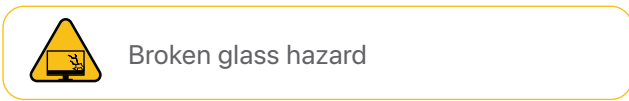

- 10.** Flip over the mid plate. Remove the display films from the mid plate.

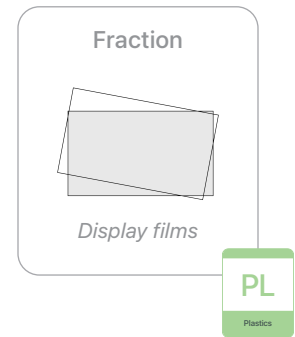
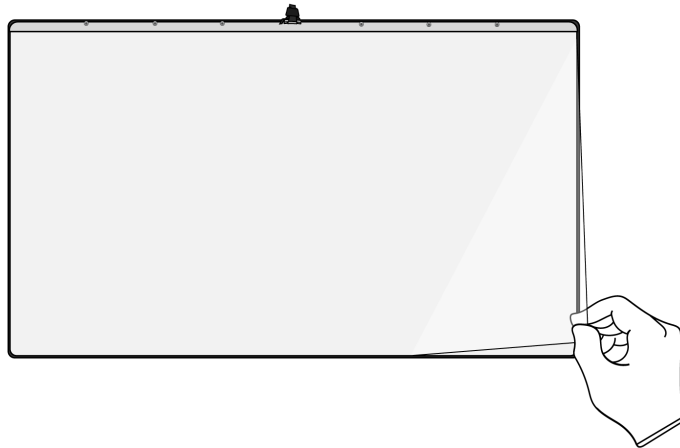

- 11.** Pull off the data board assembly.

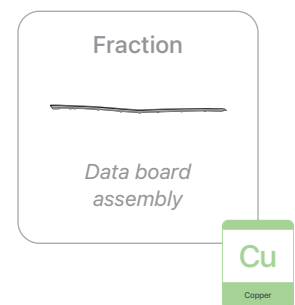
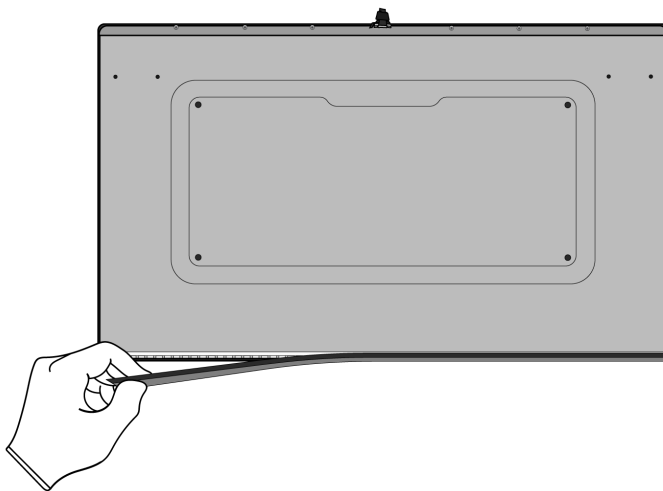

12. Pry off the LED logic board.



Chemical inhalation hazard

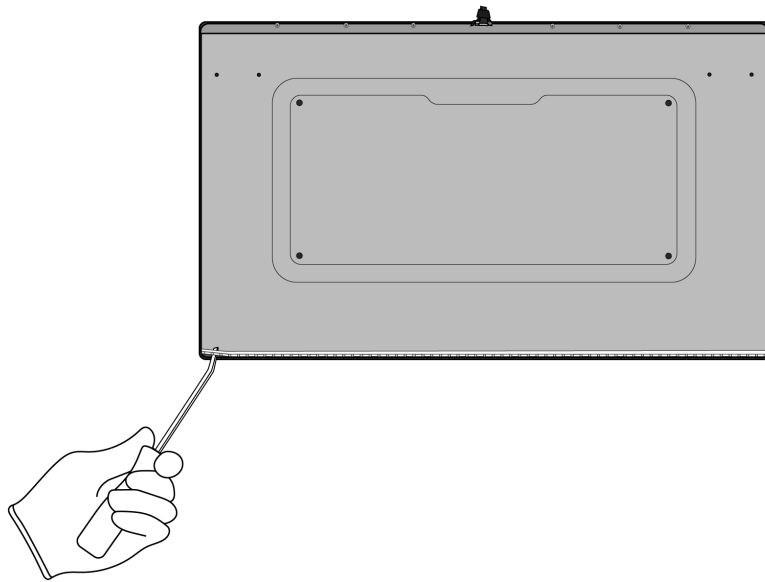

Tools Used



Fraction



LED logic board

PMs
Precious Metals

13. Pull off the camera.

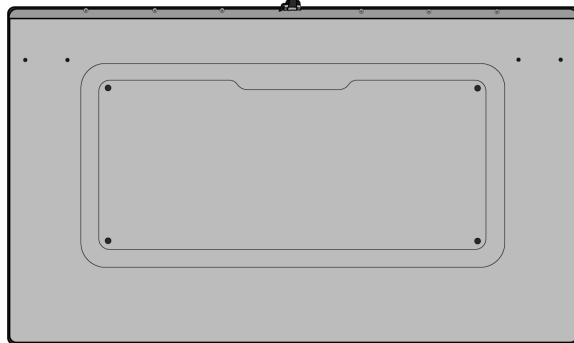

Fraction



Camera

PMs
Precious Metals

Fraction



Mid plate

Al
Aluminum

14. Pry the two coin cell battery compartments and the two coin cell batteries off the housing.

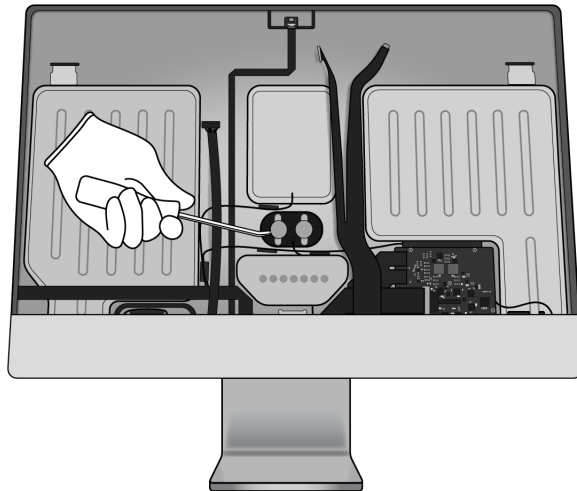

Tools Used



Fraction

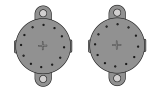

Coin cell battery compartments

Fe

Ferrous

Fraction



Coin cell batteries

BT

Battery

15. Pry off the bottom glass panel.



Broken glass hazard

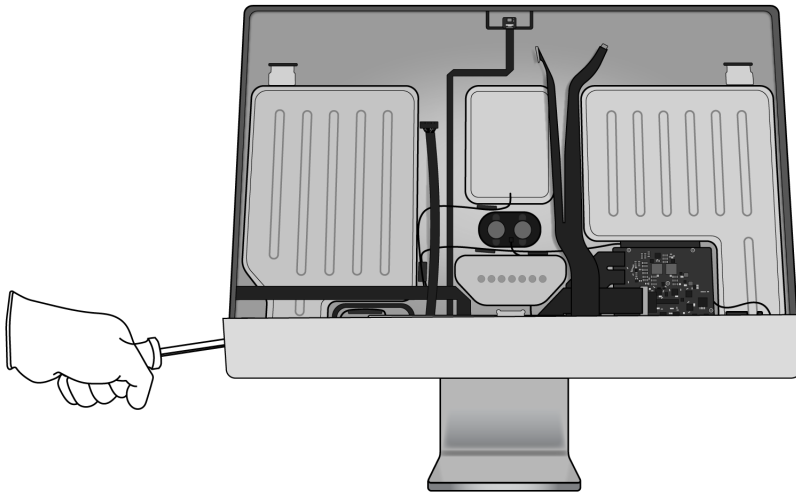

Tools Used

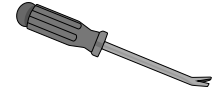

Fraction



Bottom glass panel

GL

Glass

16. Pry off the left speaker.

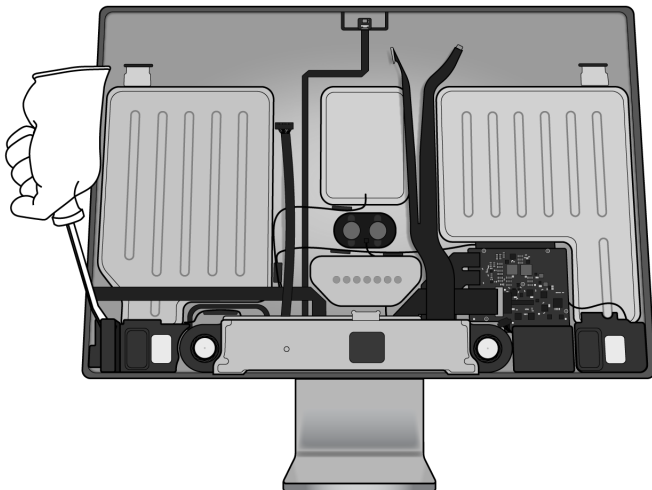

Tools Used

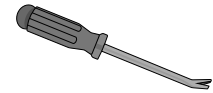

Fraction



Left speaker

REE

Rare Earth Elements

- 17.** Pry off the headphone jack and power button assembly.

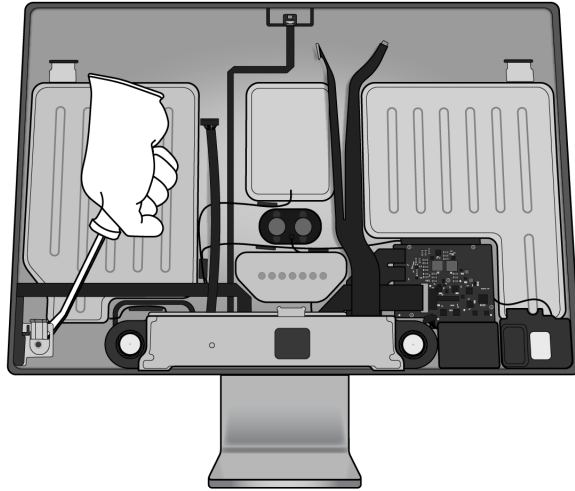

Tools Used

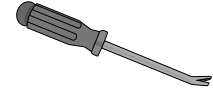

Fraction

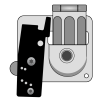

Headphone jack
and power button
assembly

Cu
Copper

- 18.** Pry off the main logic board cover.

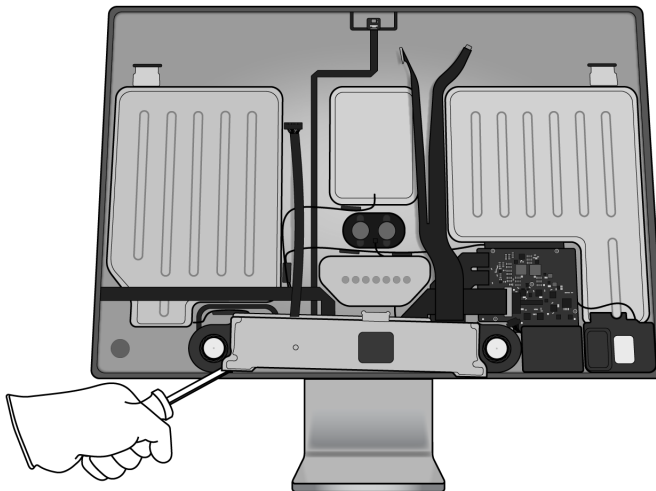

Tools Used

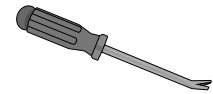

Fraction

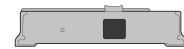

Main logic
board cover

Al
Aluminum

19. Pry off the left fan.

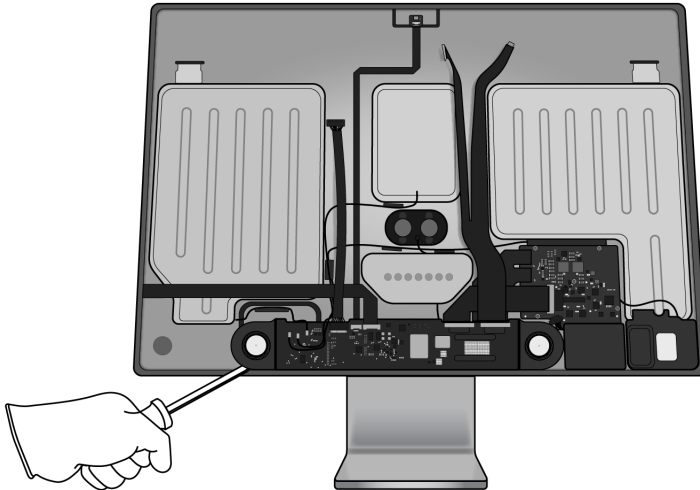

Tools Used

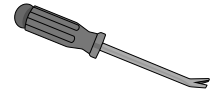

Fraction



Left fan

Cu

Copper

20. Pry off the main logic board and the attached cables.

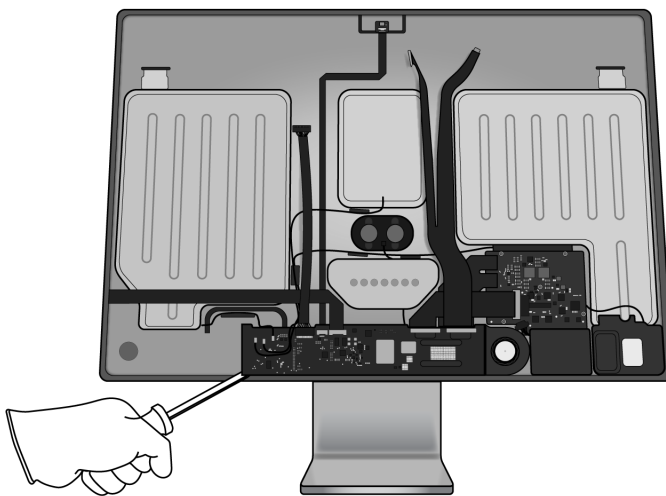

Tools Used

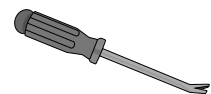

Fraction

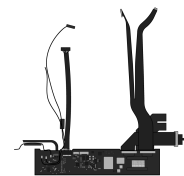

Main logic board
with cables

PMs

Precious
Metals

21. Pry off the right fan.

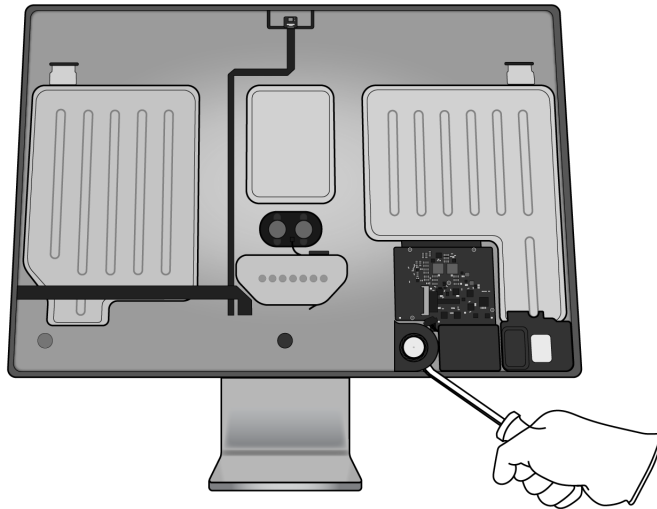

Tools Used

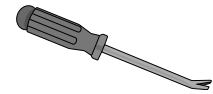

Fraction



Right fan

Cu

Copper

22. Pry off the right speaker.

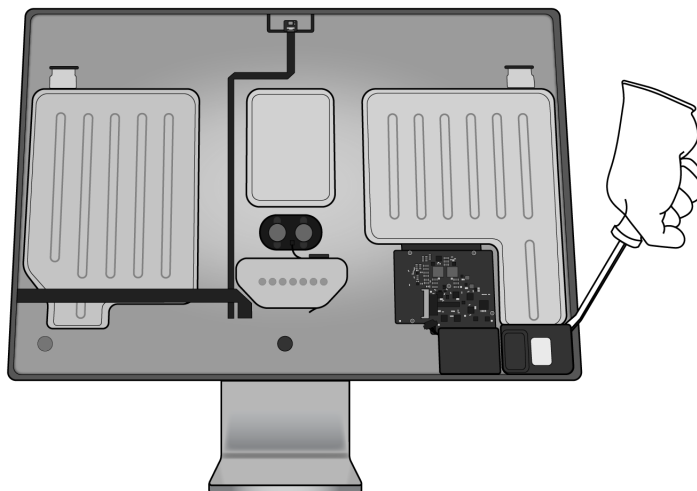

Tools Used

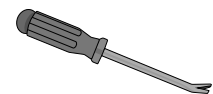

Fraction



Right speaker

REE

Rare Earth
Elements

23. Pry off the USB-C ports.

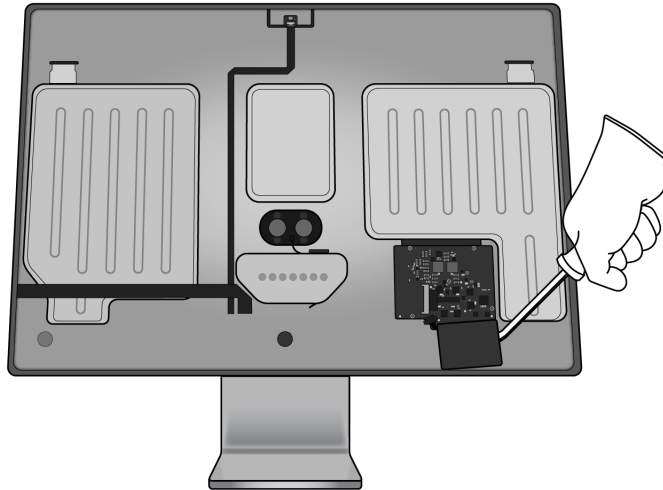

Tools Used

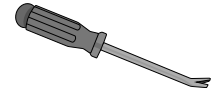

Fraction

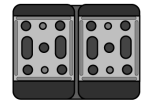

USB-C ports

Cu
Copper

24. Pry off the power supply logic board.

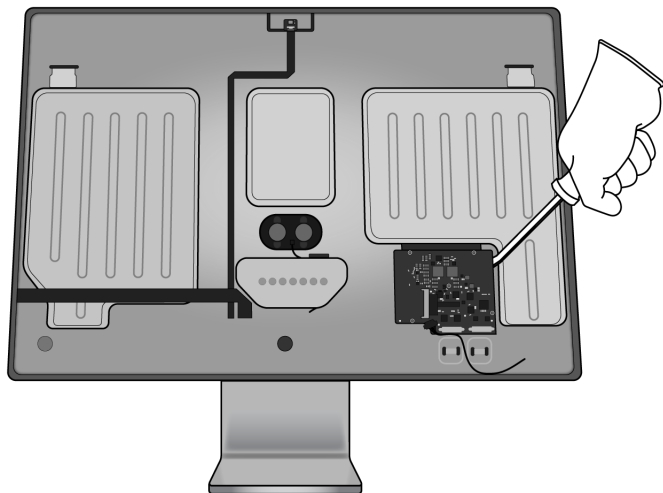

Tools Used

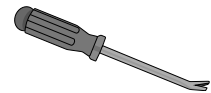

Fraction

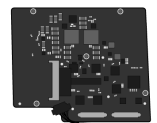

Power supply
logic board

PMs
Precious
Metals

25. Pry off the battery board.

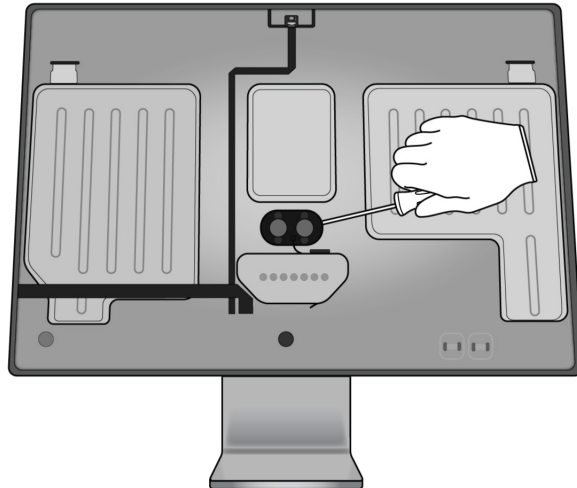

Tools Used

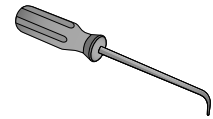

Fraction



Battery board

PMs
Precious
Metals

26. Pull off the remaining ribbon cables.

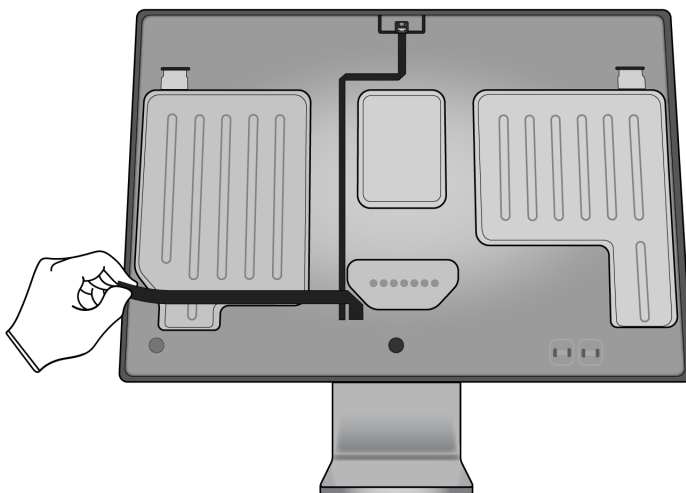

Fraction

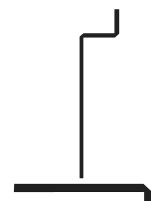

Ribbon cables

Cu
Copper

27. Pry off the microphone.

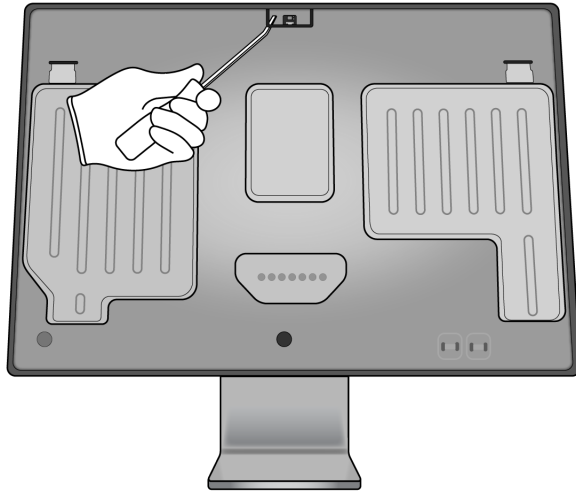

Tools Used



Fraction

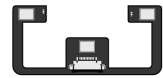

Microphone

Cu

Copper

28. Remove the antenna cover and the Wi-Fi antenna.

» *Pry off the antenna cover.*

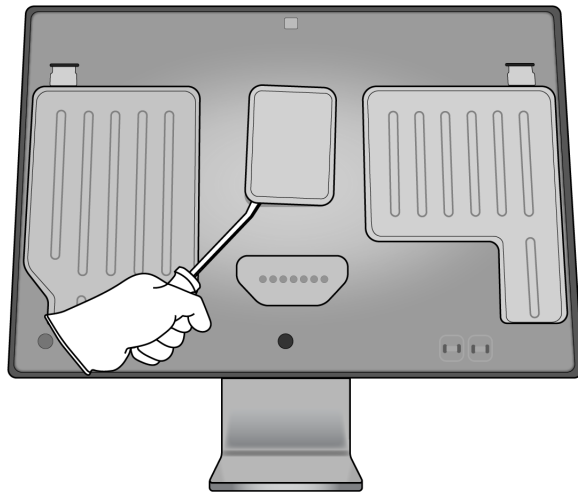

Tools Used

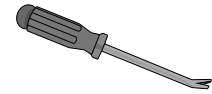

» *Pry the Wi-Fi antenna off the antenna cover.*

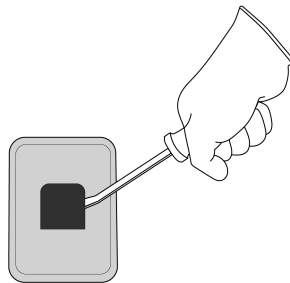

Fraction



Wi-Fi antenna

Cu

Copper

Fraction

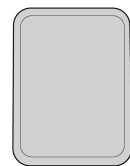

Antenna cover

Fe

Ferrous

29. Remove the stand.

» Unscrew the seven Torx T10 fasteners.

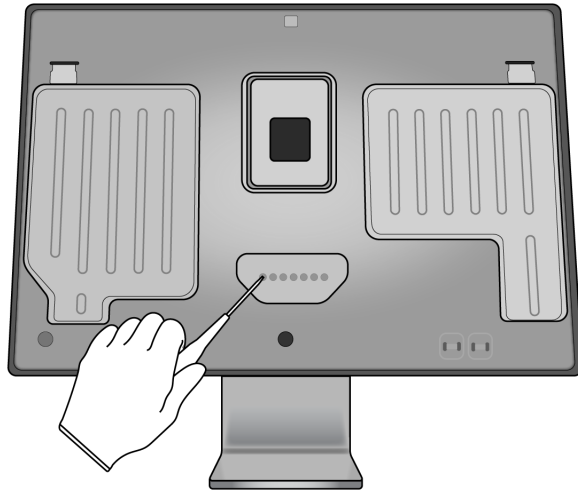

Tools Used

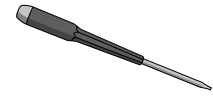

Fraction



Fasteners (x7)

Fe

Ferrous

» Pull apart the stand and the housing.

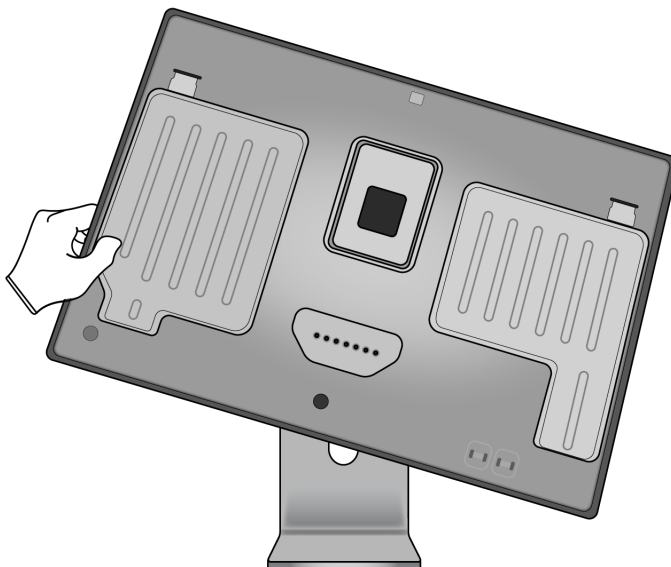

Fraction



Stand

Al

Aluminum

30. Remove the stand bracket.

» *Lift the edge of the stand bracket.*

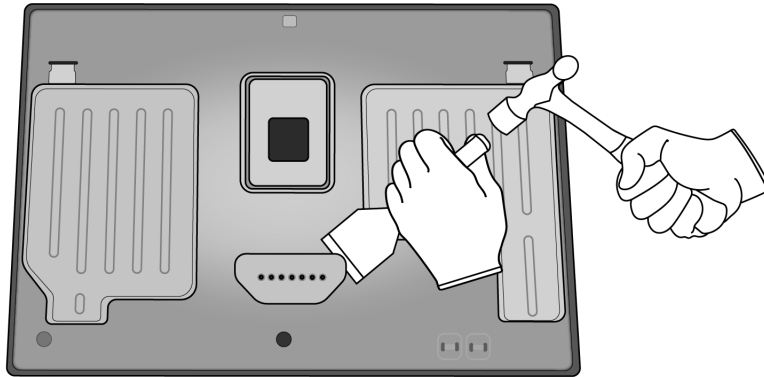

Tools Used

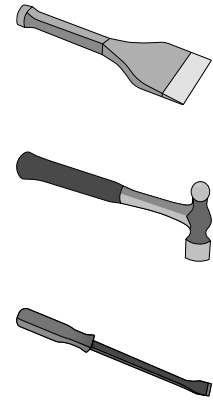

» *Pry off the stand bracket.*

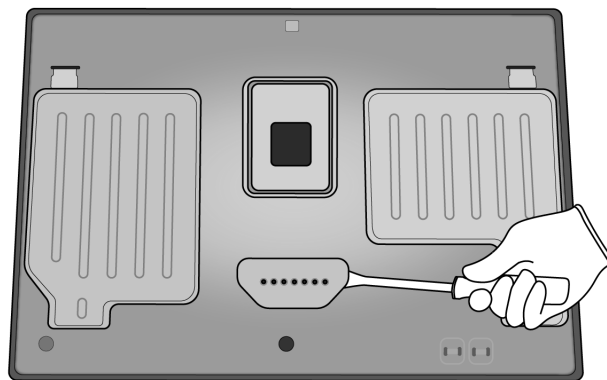

Fraction



Stand bracket

Fe

Ferrous

31. Pry off the remaining housing brackets.

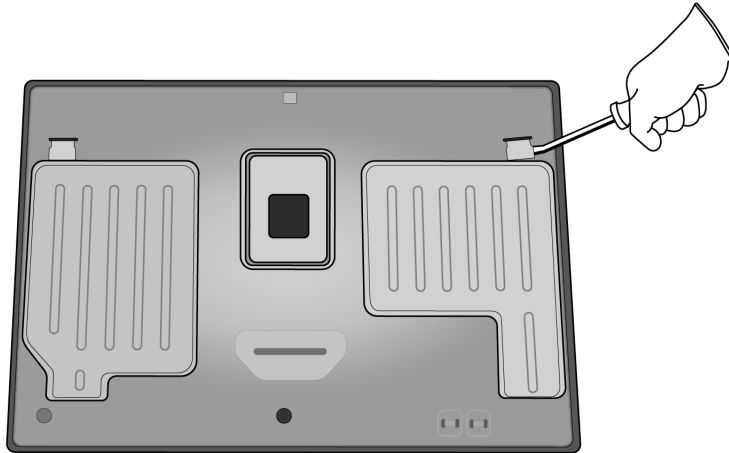

Tools Used

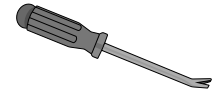

Fraction



*Housing
brackets*

Fe

Ferrous

Fraction

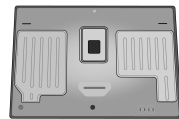







Housing

Al

Aluminum

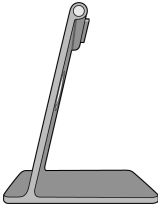
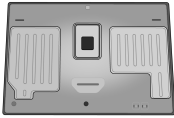
Material Categorization of Output Fractions

All outputs from this process must be managed, handled, and disposed of in accordance with applicable waste laws and regulations, including but not limited to the Waste Framework Directive and its national enactments in Europe.

Fraction	Downstream Processing
<p>Aluminum</p>  <p><i>Mid plate</i></p>  <p><i>Main logic board cover</i></p>  <p><i>Stand</i></p>  <p><i>Housing</i></p>	<p>Primary Target Material</p>  <p>Potential Additional Materials</p> 
<p>Batteries</p>  <p><i>Coin cell batteries</i></p>	<p>Primary Target Material</p> 

Fraction

Downstream Processing

Ferrous

Primary Target Material



Display logic board cover

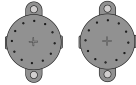

Coin cell battery compartments

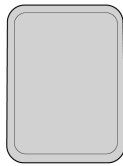

Antenna cover



Fasteners (x7)



Stand bracket



Housing brackets



Fraction

Downstream Processing

Glass



LCD cell



Bottom glass panel

Primary Target Material



Potential Additional Materials



Logic Boards



Display logic board



Camera logic board



Backlight logic board



LED logic board



Camera

Primary Target Material



Potential Additional Materials



Logic Boards (cont.)

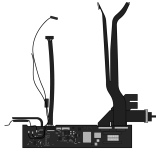

Main logic board with cables

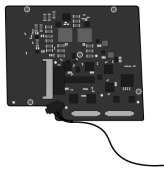

Power supply logic board



Battery board

Fraction

Downstream Processing

Mixed Electronics

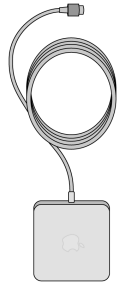

Power adapter and power cord



Ribbon cables

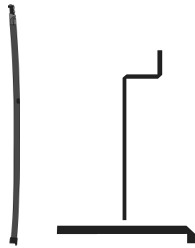

Flex cable



Data board assembly

Primary Target Material



Potential Additional Materials



Mixed Electronics (cont.)

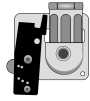

Headphone jack and power button assembly



Left fan



Right fan

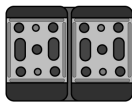

USB-C ports



Microphone



Wi-Fi antenna

Fraction

Downstream Processing

Mixed Plastics

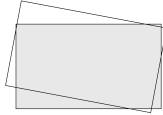

Display films

Primary Target Material



Rare Earth Magnets



Left speaker



Right speaker

Primary Target Material



Potential Additional Materials

