



iPad Pro 10.5-inch Wi-Fi

iPad Pro 10.5-inch Wi-Fi + Cellular

Apple Recycler Guide

July 2023

Contents

3	About This Guide
4	Identification
5	Directive of 2012/19/EU Annex VII Components
6	Safety Considerations
9	Recommended Tools
10	Disassembly Instructions
28	Material Categorization of Output Fractions

About This Guide

Apple Recycler Guides provide guidance for electronics recyclers on how to disassemble products to maximize recovery of resources. The guides provide step-by-step disassembly instructions and information on the material composition to help recyclers direct fractions to the appropriate material recycler.

To conserve important resources, we work to reduce the materials we use and aim to one day source only recycled or renewable materials in our products. A key path to reaching that goal is resource recovery from end-of-life electronics.

Disassembly procedures are intended to be performed only by trained electronics recycling professionals. The recycler is responsible for independently evaluating and ensuring compliance with all applicable environmental, health, and safety laws related to the work. These include but are not limited to laws relating to the management, handling, shipping, and disposal of the outputs of this work as waste and laws in place to ensure the health and safety of all employees who support this work.

For questions or feedback about this guide, email contactesci@apple.com.

Note: This guide may show images from other similar models, but the procedures are the same.

Identification

You can find the model number on the back of the iPad Pro.



Model numbers:
(Wi-Fi) A1701
(Wi-Fi + Cellular) A1709

Directive 2012/19/EU Annex VII Components

Directive 2012/19/EU Annex VII requirements apply to the following substances and components.

Substance/Component	Apple Part Name	Removal Instructions
Printed circuit board if the surface is greater than 10 square centimeters	Display logic board, light-emitting diode (LED) logic board, main logic board	Follow steps 1–18
External electric cables	Power adapter, charge cable	Follow step 1
Battery	Lithium-ion polymer batteries	Follow steps 1–8
Cover glass and liquid crystal display (LCD) cell if the surface is greater than 100 square centimeters	LCD cell	Follow steps 1–7
No further substances or components as listed in Annex VII		

Safety Considerations

The recycler is responsible for independently evaluating all activities undertaken by its employees to perform or support the work and ensuring compliance with all applicable health and safety laws related to the work. These include but are not limited to laws relating to the health and safety of all employees who perform or support this work. The recycler is also responsible for evaluating the workspace and ensuring that the area in which the work is to be undertaken is designed using ergonomic best practices and meets all ergonomic requirements to ensure the protection of its employees.

Personal Protective Equipment

Personal protective equipment should be worn during the entire recycling process.



Wear hand protection



Wear foot protection



Wear eye protection



Wear a mask



Wear protective clothing

Battery Safety

This product uses a lithium-ion polymer battery. Before beginning any disassembly work, ensure that a safe working procedure for handling lithium-ion batteries has been established, which could include discharging the batteries so that they can be more safely managed. The following considerations may also be included:

- Remove anything from your person that could conduct energy, such as jewelry and watches, to avoid electric shock to yourself or the logic board.
- To avoid the potential for thermal runaway and the release of potentially noxious fumes, don't puncture, strike, or crush lithium-ion polymer batteries or devices powered by them.
- Don't throw, drop, or bend the battery.
- Don't expose the battery to excessive heat or sunlight.
- Don't use tools that are sharp or conduct electricity.
- Keep your workspace clear of foreign objects and sharp materials.
- Dispose of batteries according to local environmental laws and guidelines.

Workspace safety guidelines

- Use heat-resistant gloves and safety glasses.
- Keep a sand dispenser within arm's reach (2 feet or 0.6 m) on one side of the workstation, not above the workstation. The dispenser should be a wide-mouthed, quick-pour metal container with a flip-top lid or tray that contains 8–10 cups (1.9–2.4 L) of clean, dry, untreated sand.
- Keep the battery at least 2 feet (0.6 m) from paper and other combustible materials.
- Work in an area with adequate ventilation.

Handling a thermal runaway

If you notice any of the following signs, a thermal runaway is likely underway, and you should act immediately:

- The lithium-ion polymer battery or a device containing one begins to smoke or emit sparks or soot.
- The battery pouch suddenly and quickly puffs out.
- You hear hissing or popping sounds.

Don't use water or an ABC/CO₂ fire extinguisher on a thermal runaway battery or a device containing one. Water and ABC/CO₂ fire extinguishers will not stop the reaction.

Do smother the battery or device immediately with plenty of clean, dry sand, dumped all at once. Timing is critical; the faster you pour all the sand, the faster the thermal runaway will stop.

Do leave the room for 30 minutes if the thermal runaway causes any irritation.

Do wait 30 minutes before touching the battery. Wear heat-resistant gloves and safety glasses to remove the battery from the sand, or use a touchless thermometer to measure the battery temperature. Only touch the battery when the event has finished.

Do dispose of the damaged battery or device (including any debris removed from the sand) according to local environmental laws and guidelines.

LED Safety

Broken light-emitting diodes (LEDs) must be handled properly to ensure the safety of your employees and mitigate any hazards. Package broken LEDs in an appropriate container to properly manage the hazards associated with the materials and store only with compatible materials. All waste must be properly classified, packaged, and labeled in accordance with all relevant laws and regulations.

Hazard Warnings



Broken glass hazard



Chemical inhalation hazard



Chemical exposure hazard



Rechargeable battery hazard

Recommended Tools

Miniature pry bar

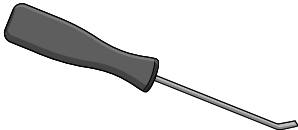

Nail-pulling screwdriver

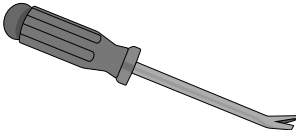

Plastic pry bar

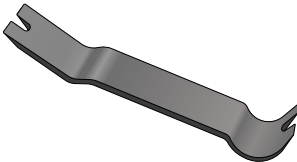

Screwdriver-handle pry bar

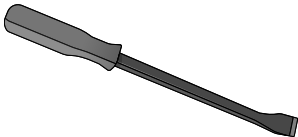

Disassembly Instructions

1. Remove the power adapter and the charge cable.

- » *Ensure that the iPad Pro is turned off.*
- » *Unplug the power adapter. Disconnect both ends of the charge cable.*

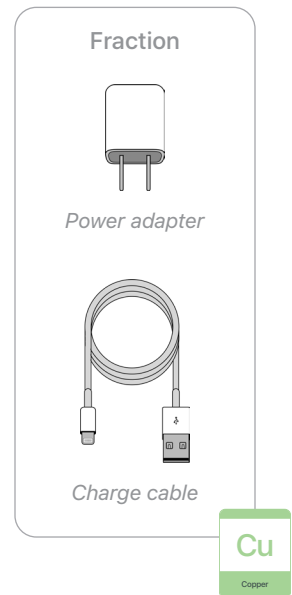

2. Remove the display.



Broken glass hazard



Chemical exposure hazard

- » *Hold the iPad Pro at the edge of a counter with the display facing up.*
- » *Insert the tool tip into the Home button/Touch ID sensor. Push the handle down to pry the display from the enclosure.*

Tools Used

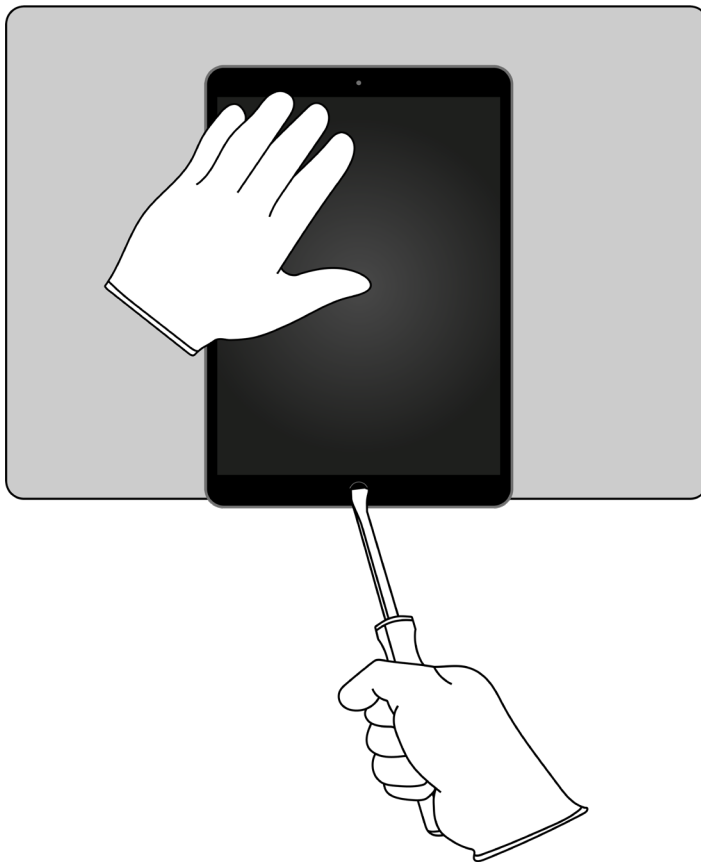

» Remove the display by hand. Set the enclosure aside.

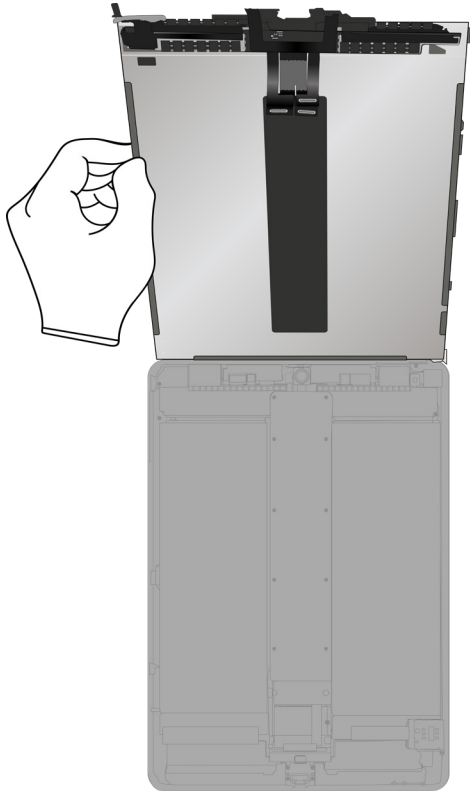

3. Remove the display logic board.

- » Lay the display face down.
- » Pry off the display logic board.

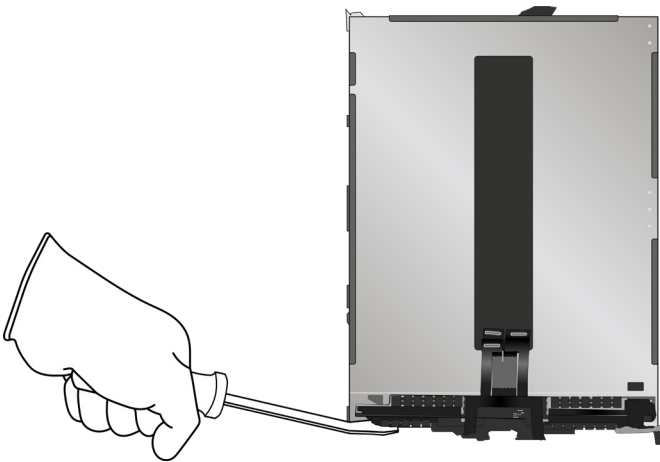

Tools Used

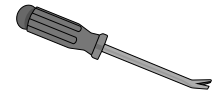

Fraction



Display logic board

PMs
Precious Metals

4. Pry off the Home button/Touch ID sensor.

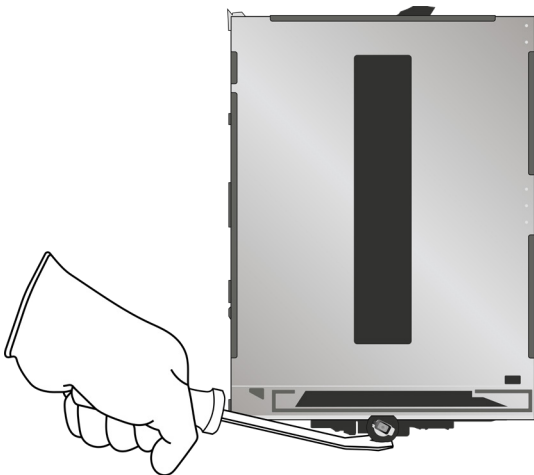

Tools Used

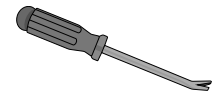

Fraction



Home button/
Touch ID sensor

Cu
Copper

5. Pry off the display cover. Set the LCD cell aside.

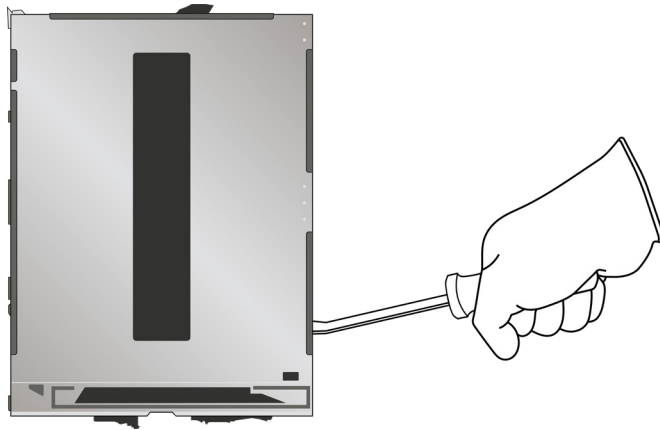

Tools Used

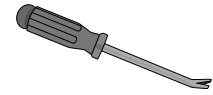

6. On the display cover, pry off the LED logic board.



Chemical inhalation hazard

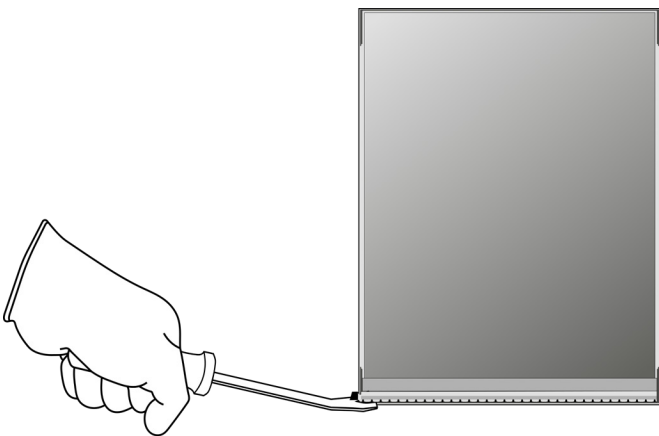

Tools Used

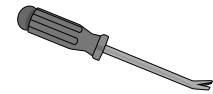

Fraction



LED logic board

PMs

Precious Metals

Fraction



Display cover

Fe

Ferrous

7. From the LCD cell, remove the display films.

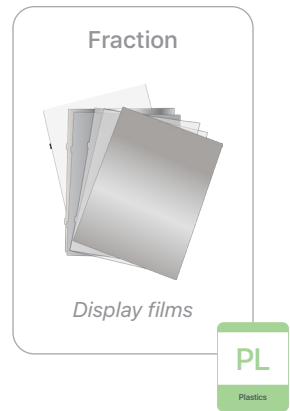
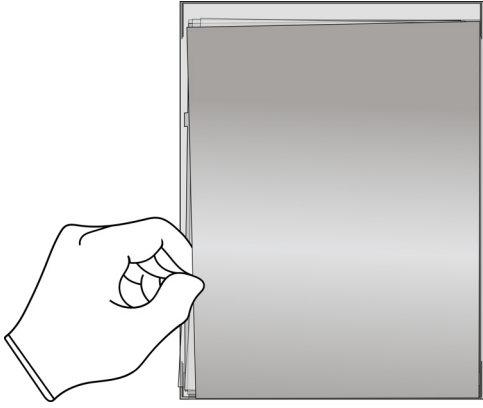

8. From the enclosure, pry off both lithium-ion polymer batteries.



Rechargeable battery hazard

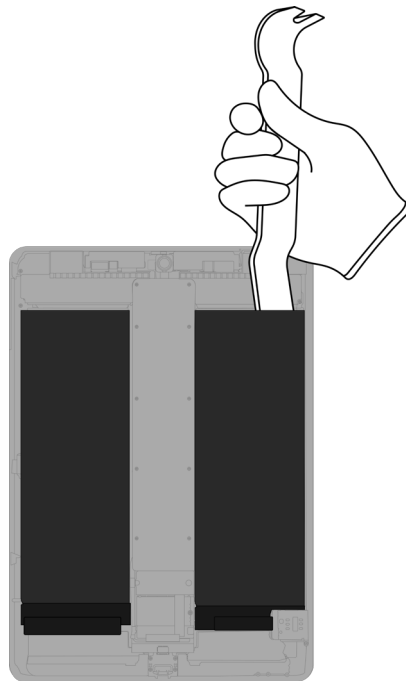

Tools Used



Fraction



Lithium-ion
polymer batteries

BT

Battery

9. Pry off the upper left speaker.

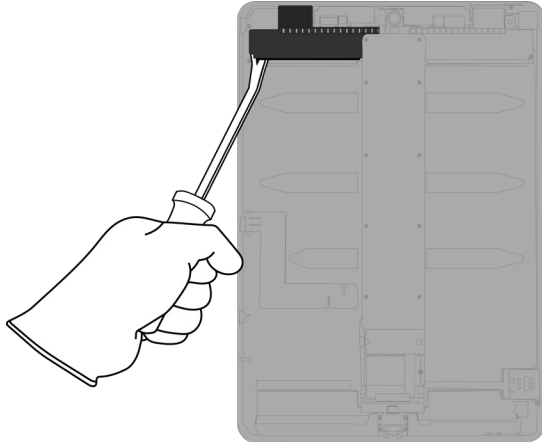

Tools Used

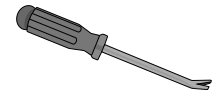

Fraction

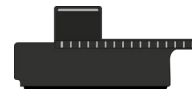

Upper left speaker

REE

Rare Earth Elements

10. Pry off the left light sensor.

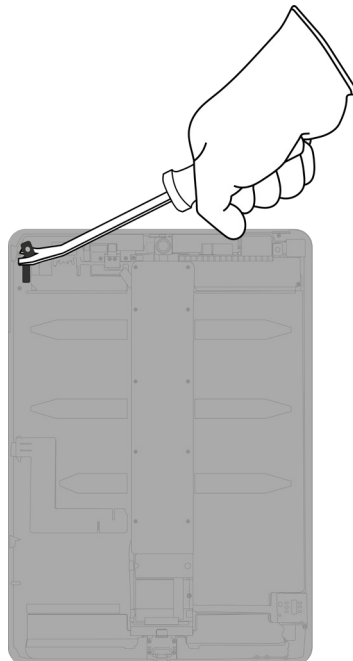

Tools Used

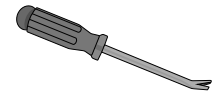

Fraction



Left light sensor

Cu

Copper

11. Pry off the headphone jack.

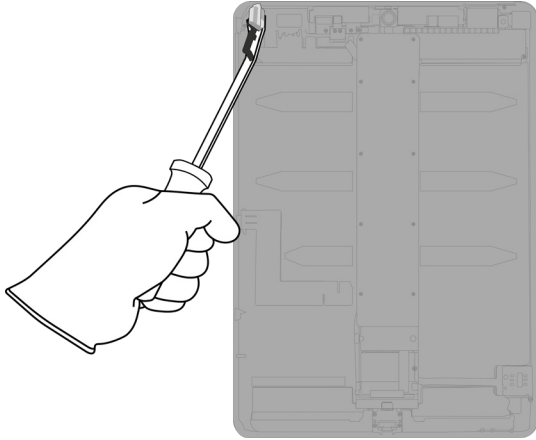

Tools Used

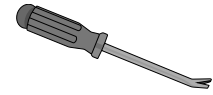

Fraction



Headphone jack

Cu
Copper

12. Pry off the ribbon cable.

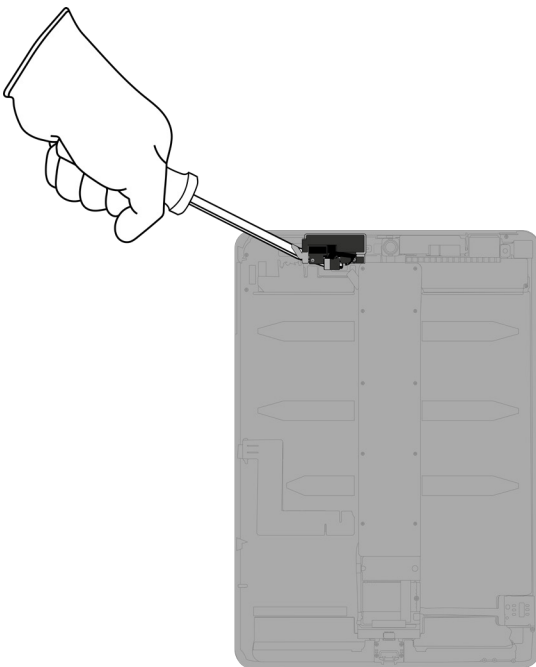

Tools Used

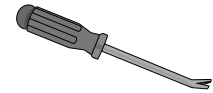

Fraction

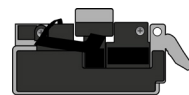

Ribbon cable

Cu
Copper

13. Pry off the front camera.

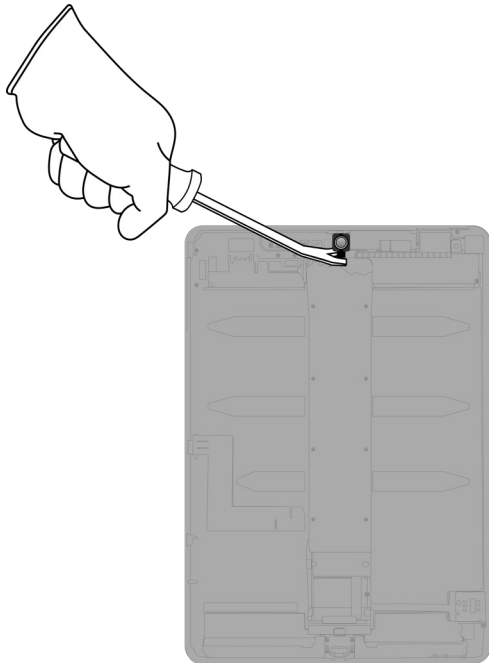

Tools Used

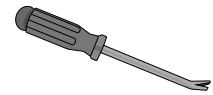

Fraction

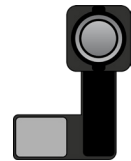

Front camera

PMs

Precious Metals

14. Pry off the upper right speaker.

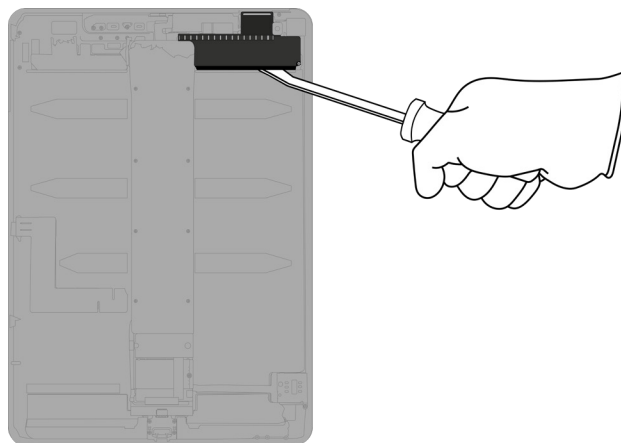

Tools Used

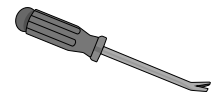

Fraction

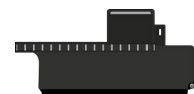

Upper right speaker

REE

Rare Earth Elements

15. Pry off the right light sensor.

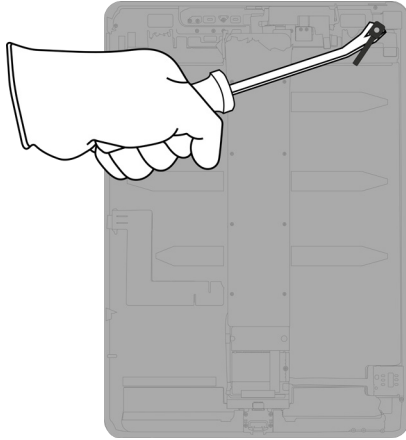

Tools Used

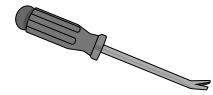

Fraction



Right light sensor

Cu

Copper

16. Pry off the rear camera.

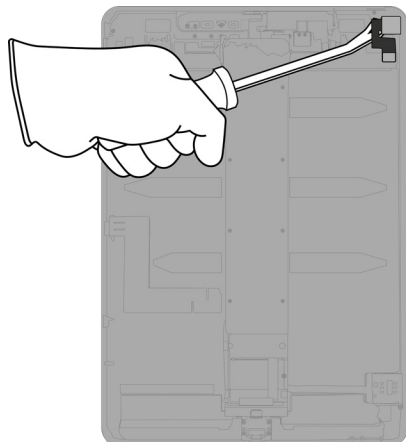

Tools Used

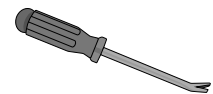

Fraction



Rear camera

PMs

Precious Metals

17. Pry off the ribbon cable.

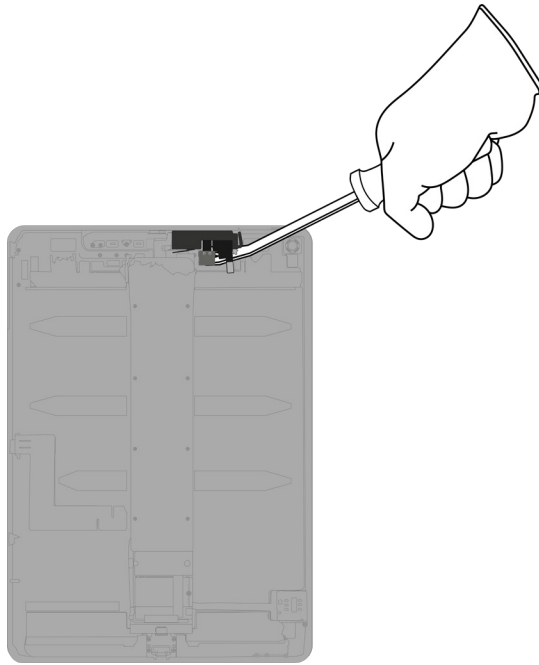

Tools Used

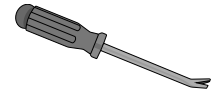

Fraction

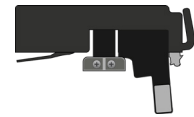

Ribbon cable

Cu
Copper

18. Pry off the main logic board.

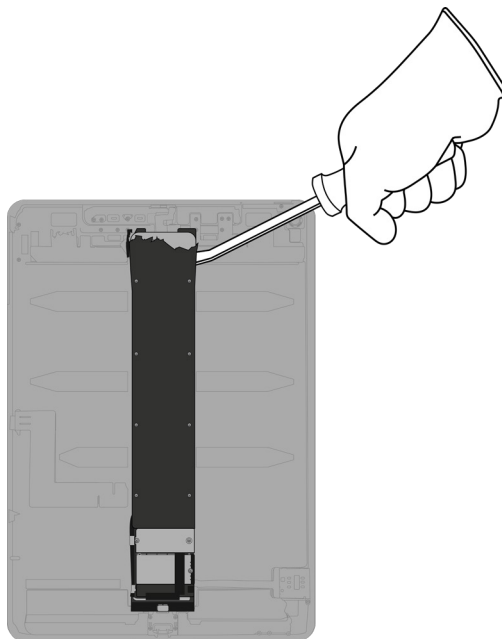

Tools Used

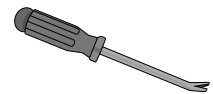

Fraction



Main logic board

PMs
Precious Metals

- 19.** (Wi-Fi + Cellular models only) Remove the SIM card and SIM tray. Separate the SIM card from the SIM tray.

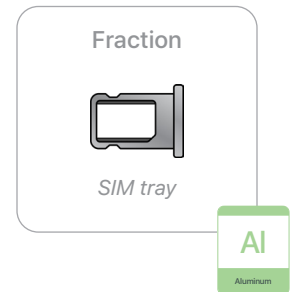
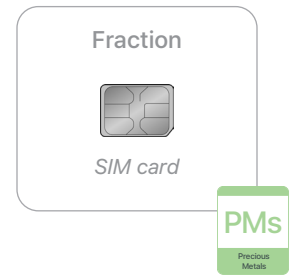
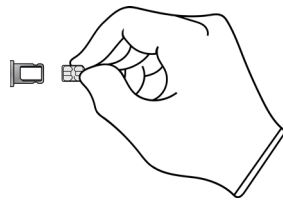
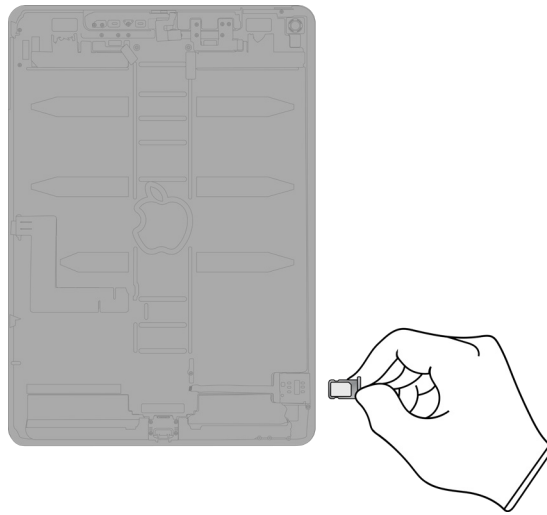

20. (Wi-Fi + Cellular models only) Pry off the SIM reader.

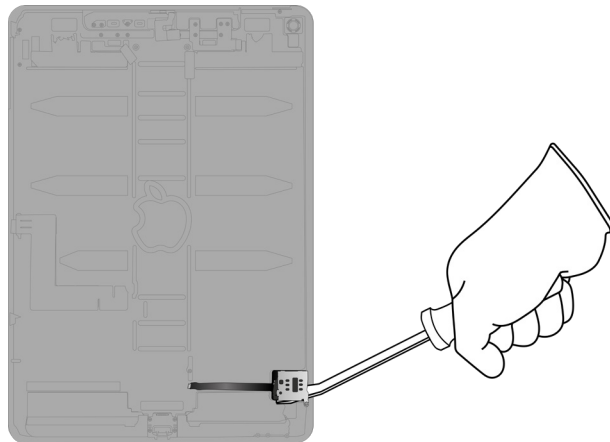

Tools Used

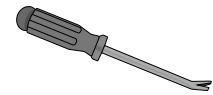

Fraction



SIM reader

Cu
Copper

21. Pry off the lower right speaker.

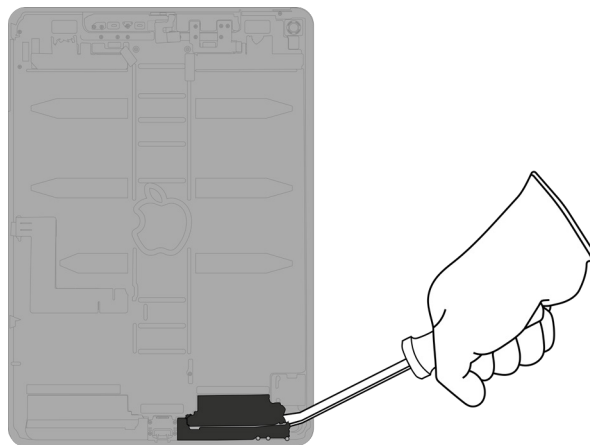

Tools Used

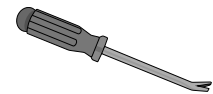

Fraction



Lower right speaker

REE
Rare Earth Elements

22. Pry off the Lightning connector.

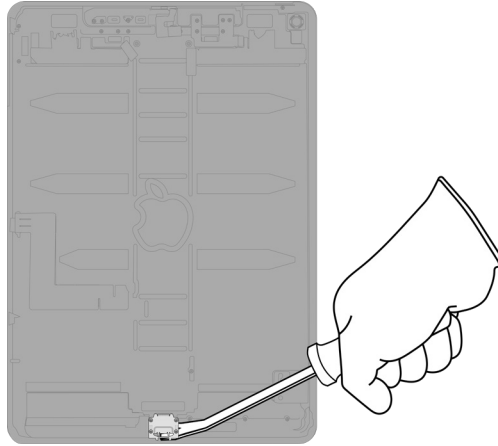

Tools Used

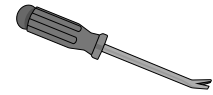

Fraction

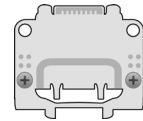

Lightning connector

Cu

Copper

23. Pry off the lower left speaker.

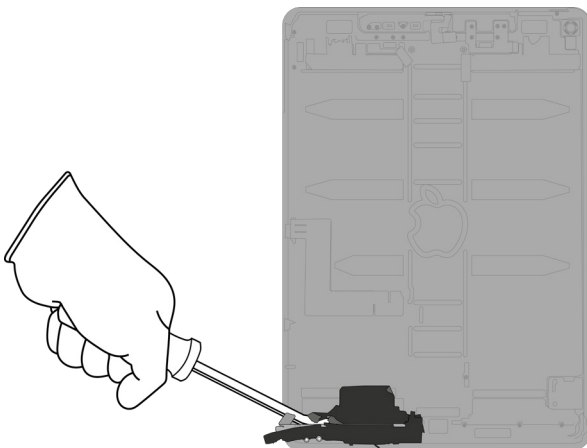

Tools Used

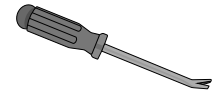

Fraction



Lower left speaker

REE

Rare Earth Elements

24. Remove the remaining ribbon cables by hand.

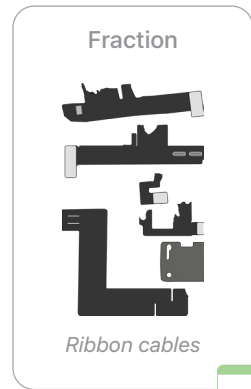
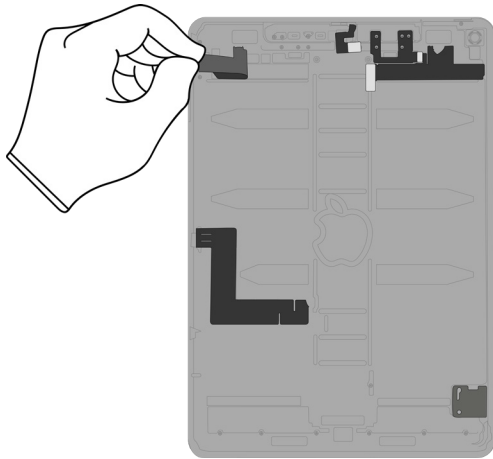

Cu
Copper

25. Pry off the strobe.

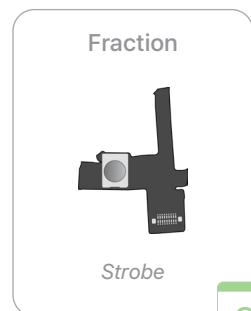
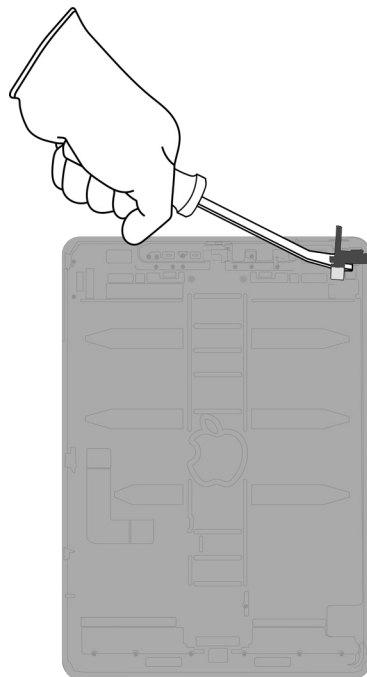

Cu
Copper

26. Pry off the battery shim.

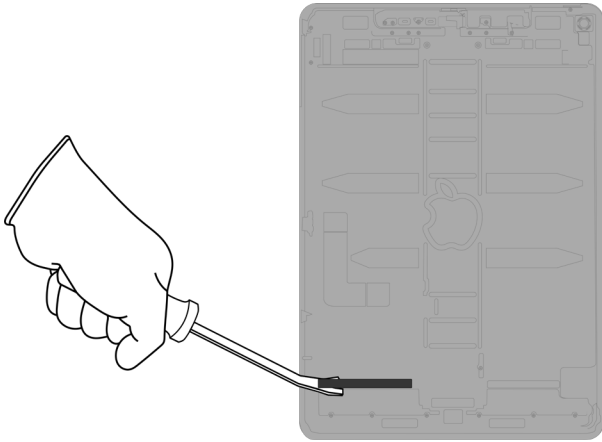

Tools Used

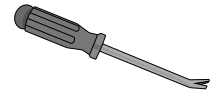

Fraction



Battery shim

PL

Plastics

27. Pry off the dual microphone array.

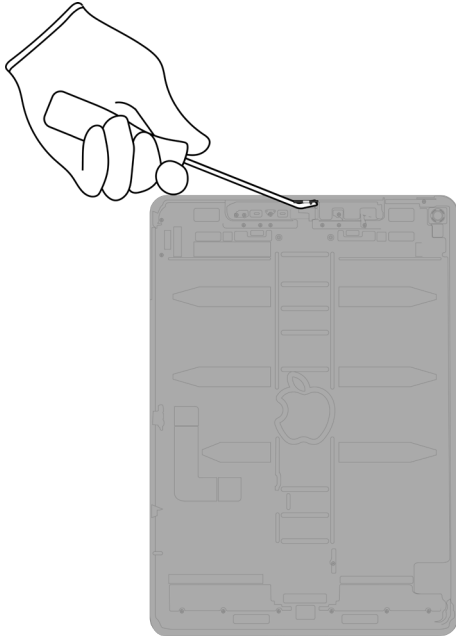

Tools Used



Fraction



Microphone array

Cu
Copper

Fraction

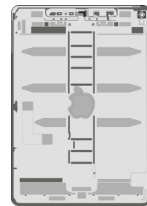

Enclosure

Al
Aluminum

Material Categorization of Output Fractions

All outputs from this process must be managed, handled, and disposed of in accordance with applicable waste laws and regulations, including but not limited to the Waste Framework Directive and its national enactments in Europe.

Fraction	Downstream Processing
----------	-----------------------

Aluminum



SIM tray

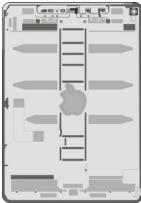

Enclosure

Primary Target Material



Batteries



Lithium-ion polymer batteries

Primary Target Material



Fraction **Downstream Processing**

Ferrous



Display cover

Primary Target Material



Glass

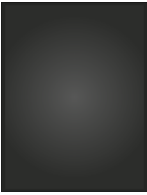

LCD cell

Primary Target Material



Potential Additional Materials



Fraction

Downstream Processing

Logic Boards



Display logic board



LED logic board

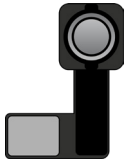

Front camera



Rear camera



Main logic board



SIM card

Primary Target Material



Potential Additional Materials



Fraction

Downstream Processing

Mixed Electronics

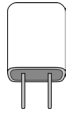

Power adapter

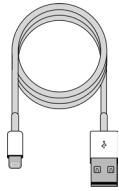

Charge cable



Home button/Touch ID sensor



Left light sensor

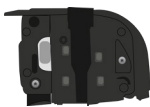

Headphone jack



Right light sensor

Primary Target Material



Potential Additional Materials



Mixed Electronics (cont.)



SIM reader

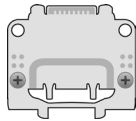

Lightning connector

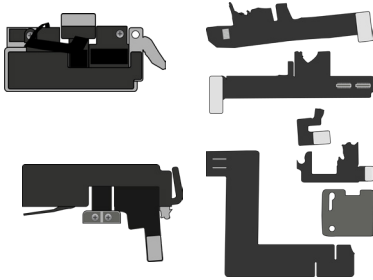

Ribbon cables

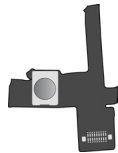

Strobe



Microphone array

Fraction

Downstream Processing

Mixed Plastics



Display films



Battery shim

Primary Target Material



Rare Earth Magnets

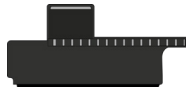

Upper left speaker

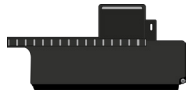

Upper right speaker



Lower right speaker



Lower left speaker

Primary Target Material



Potential Additional Materials

