



Please visit crown.com to find your local Crown dealer.

www.crown.com

CROWN

CD35S-9, CD40/45S(C)-9, CD50/D55(S)-C-9

Operation & Maintenance Manual

XSB2504E01EU



XSB2504E01EU
10. 2021

Operation & Maintenance Manual

CD35S-9, CD40S-9, CD45S-9, CD50C-9, CD55C-9

FDB41, FDB42, FDB43, FDB44, FDB45 (DM03P Tier-4)

CD40SC-9, CD45SC-9, CD50SC-9, CD55SC-9

FDB41, FDB42, FDB43, FDB44 (DM03V Stage V)



Forklifts



Operation & Maintenance Manual

Forklifts

CD35S-9, CD40S-9, CD45S-9, CD50C-9, CD55C-9

FDB41, FDB42, FDB43, FDB44, FDB45 (DM03P Tier-4)

CD40SC-9, CD45SC-9, CD50SC-9, CD55SC-9

FDB41, FDB42, FDB43, FDB44 (DM03V Stage V)



WARNING

A MOVING VEHICLE CAN BE DANGEROUS

You or others around you can be seriously injured or even killed if you are not careful or don't know how to use this truck correctly.

Do not operate this truck unless you are trained and authorized.

Read and obey all warnings and instructions in this Manual* and on the truck.

Make sure the truck is in good working order.

Head, arms, hands or legs outside the operator area can be pinned or crushed when ever the truck is moving. Stay within the operator area and stop completely before getting off.

A dockboard can move or drop while you are on it. Or you could drive off a dock. Falls from docks or dockboards can cause serious injury or even death. Make sure you are safe.

* Additional copies of this Operator Manual and all Truck Labels can be obtained from Crown Equipment Corporation New Bremen, Ohio 45869 U.S.A.

Table of Contents

Information Section

Foreword	2
----------------	---

Safety Section

Important Safety Information	4
Safety	5
Warning Signs and Labels	5
General Hazard Information	10
Operation Information	11
Before Starting the Lift Truck	12
Maintenance Information	14
If Optional Suspension Seat (weight adjusting type) Equipped	19
Avoiding Lift Truck Tipovers	22
Safety Rules	24
How to Survive in a Tipover	30

General Section

Declaration of Conformity	31
Specifications	32
Noise and Vibration	40
Capacity Chart	41
Capacity Chart (with Side Shifter)	49
Serial Number	57
Operator's Warning and Identification Plate	58

Operation Section

Operator's Station and Monitoring Systems	60
Weight Scale Option (Load Cell Type)	70
Seat Switch System	81
Lift Truck Controls	82
Fuel and DEF/Ad-Blue Replenishment	87
Before Starting the Engine	88
Starting the Engine	90
After Starting the Engine	92
Lift Truck Operation	100
Mono-Ped Control System (If Equipped)	102
Operating Techniques	107
Parking the Lift Truck	112
Lift Fork Adjustment	113
Storage Information	114
Transportation Hints	115
Towing Information	117
Parking Brake Forced Release Method	118

Maintenance Section

Jacking Information	120
Inspection, Maintenance and Repair of Lift Truck Forks	122
Tyre Inflation Information	126
Torque Specifications	127
Cooling System Specifications	129
Specifications of Fuel and DEF/Ad-Blue	131
Lubricant Specifications	133
Lubricant Viscosities and Refill Capacities	135
Maintenance Intervals	136
When Required	140
Every 10 Service Hours or Daily	152
First 50 - 100 Service Hours or a Week	156
Every 500 Service Hours or 3 Months	160
Every 1000 Service Hours or 6 Months	168
Every 2000 Service Hours or Yearly	173
Every 2500 Service Hours or 15 Months	177
Every 5000 Service Hours or 30 Months	178

Environment Protection Section

Environment Protection	179
------------------------------	-----

Index Section

Index	180
-------------	-----

Foreword

Literature Information

This manual should be stored in the operator's compartment in the literature holder or seat back literature storage area.

This manual contains safety, operation, transportation, lubrication and maintenance information.

Some photographs or illustrations in this publication show details or attachments that can be different from your lift truck. Guards and covers might have been removed for illustrative purposes.

Continuing improvement and advancement of product design might have caused changes to your lift trucks which are not included in this publication.

Read, study and keep this manual with the lift truck.

Whenever a question arises regarding your lift truck, or this publication, please consult your CROWN branch for the latest available information.

Safety

The Safety Section lists basic safety precautions. In addition, this section identifies the text and locations of warning signs and labels used on the lift truck. Read and understand the basic precautions listed in the Safety Section before operating or performing lubrication, maintenance and repair on this lift truck.

Operator Restraint System (If Equipped)

This manual contains safety, operation and maintenance information for the CROWN operator restraint system. Read, study and keep it handy.

 **WARNING**

Your CROWN truck comes equipped with an operator restraint system. Should it become necessary to replace the seat for any reason, it should only be replaced with another CROWN operator restraint system.

Photographs or illustrations guide the operator through correct procedures of checking, operation and maintenance of the CROWN operator restraint system.

SAFE and EFFICIENT OPERATION of a lift truck depends to a great extent on the skill and alertness on the part of the operator. To develop this skill the operator should read and understand the Safe Driving Practices contained in this manual.

Forklift trucks seldom tipover, but in the rare event they do, the operator may be pinned to the ground by the lift truck or the overhead guard. This could result in serious injury or death.

Operator training and safety awareness is an effective way to prevent accidents, but accidents can still happen. The CROWN operator restraint system can minimise injuries. The CROWN operator restraint system keeps the operator substantially within the confines of the operator's compartment and the overhead guard.

This manual contains information necessary for Safe Operation. Before operating a lift truck make sure that the necessary instructions are available and understood.

Operation

The Operation Section is a reference for the new operator and a refresher for the experienced one. This section includes a discussion of gauges, switches, lift truck controls, attachment controls, transportation and towing information.

Photographs and illustrations guide the operator through correct procedures of checking, starting, operating and stopping the lift truck.

Operating techniques outlined in this publication are basic. Skill and techniques develop as the operator gains knowledge of the lift truck and its capabilities.

Maintenance

The Maintenance Section is a guide to equipment care. The illustrated, step-by-step instructions are grouped by servicing intervals. Items without specific intervals are listed under "When Required" topics. Items in the "Maintenance Intervals" chart are referenced to detailed instructions that follow.

Maintenance Intervals

Use the service hour meter to determine servicing intervals. Calendar intervals shown (daily, weekly, monthly, etc.) can be used instead of service hour meter intervals if they provide more convenient servicing schedules and approximate the indicated service hour meter reading. Recommended service should always be performed at the interval that occurs first.

Under extremely severe, dusty or wet operating conditions, more frequent lubrication than is specified in the "Maintenance Intervals" chart might be necessary.

Perform service on items at multiples of the original requirement. For example, at "Every 500 Service Hours or 3 Months", also service those items listed under and "Every 10 Service Hours or Daily".

Environment Management

Note that the Crown internal combustion engine lift trucks are manufactured under ISO 14001 system which is harmonized with ISO 9001. Periodic ENVIRONMENTAL AUDITS & ENVIRONMENTAL PERFORMANCE EVALUATIONS have been made by internal and external inspection entities. LIFE-CYCLE ANALYSIS has also been made through out the total product life. ENVIRONMENT MANAGEMENT SYSTEM includes DESIGN FOR ENVIRONMENT from the initial stage of the design.

ENVIRONMENT MANAGEMENT SYSTEM considers environmental laws & regulations, reduction or elimination of resource consumption as well as environmental emission or pollution from industrial activities, energy saving, environment-friendly product design (lower noise, vibration, emission, smoke, heavy metal free, ozone depleting substance free, etc.), recycling, material cost reduction, and even environmentally oriented education for the employee.

Important Safety Information

Most accidents involving product operation, maintenance and repair are caused by failure to observe basic safety rules or precautions. An accident can often be avoided by recognizing potentially hazardous situations before an accident occurs. A person must be alert to potential hazards, and use common sense. Persons must also have the necessary training, skills and tools before attempting to perform these functions.

Improper operation, lubrication, maintenance or repair of this product can be dangerous and could result in injury or death.

Do not operate or perform any lubrication, maintenance or repair on this product, until you have read and understood the operation, lubrication, maintenance and repair information.

Safety precautions and warnings are provided in this manual and on the product. If these hazard warnings are not heeded, bodily injury or death could occur to you or other persons.

The hazards are identified by the "Safety Alert Symbol" and followed by a "Signal Word" such as "WARNING" as shown below.



The meaning of this safety alert symbol is as follows:

Attention! Become Alert! Your Safety is Involved.

The message that appears under the warning, explaining the hazard, can be either written or pictorially presented.

Operations that may cause product damage are identified by NOTICE labels on the product and in this publication.

CROWN cannot anticipate every possible circumstance that might involve a potential hazard, and common sense is always required. The warnings in this publication and on the product are therefore not all inclusive. Before any tool, procedure, work method or operating technique not specifically recommended by CROWN is used, you must be sure that it is safe for you and others. You should also ensure that the product will not be damaged or made unsafe by the operation, lubrication, maintenance or repair procedures you choose.

The information, specifications, and illustration in this publication are on the basis of information available at the time it was written. The specifications, torques, pressures, measurements, adjustments, illustrations, and other items can change at any time. These changes can affect the service given to the product. Obtain the complete and most current information before starting any job. CROWN branches have the most current information available.

Safety

The safety rules and regulations in this section are representative of some, but not all rules and regulations that apply to lift trucks. Rules and regulations are paraphrased without representation that they have been reproduced verbatim.

Please refer to 29 CFR 1910.178 in the Code of Federal Regulations, the National Fire Protection Association No. 505 (NFPA), American National Standards Institute/Industrial Truck Standards Development Foundation, ANSI/ITSDF B56.1 Safety Standard for Low lift and High Lift Trucks, UL 558 Fire Safety Standard for Internal Combustion Engine-Powered Industrial Trucks and subsequent revisions for a complete list of rules and regulations as to the safe operation of powered industrial lift trucks. Since regulations vary from country to country outside of U.S.A., operate this lift truck in accordance with local regulations.

CROWN lift trucks are manufactured in accordance with the National Fire Protection Association (NFPA) No. 505 and the American National Standards Institute, Inc. / Industrial Truck Standards Development Foundation (ANSI/ITSDF) B56.1, Safety Standard for Low and High Lift Trucks and, for European models, according to the regulations and standards laid down in EU Machinery Directive 2006/42/EC and EMC directive 2014/30/EU.

The most effective method of reducing the risk of serious injury or death to you or others is for you to know how to properly operate this lift truck, to be alert and to avoid actions or conditions that could cause accidents.

Do not operate a lift truck if it is in need of maintenance, repair or appears to be unsafe in any way. Report all unsafe conditions immediately to your supervisor, then contact your authorised lift truck branch. Do not attempt any adjustments or repairs unless trained and authorised to do so.

Warning Signs and Labels

There are several specific safety signs on your lift truck. Their exact location and description of the hazard are reviewed in this section. Please take the time to familiarise yourself with these safety signs.

Make sure that you can read all warning and instruction labels. Clean or replace these labels if you cannot read the words or see the pictures. When cleaning the labels use a cloth, water and soap. Do not use solvent, gasoline, etc.

You must replace a label if it is damaged, missing or cannot be read. If a label is on a part that is replaced, make sure a new label is installed on the replaced part. See your branch for new labels.

Training Required to Operate or Service Warning



Located on the front side of the FCU.



Improper operation or maintenance could result in injury or death. Do not operate or work on the lift truck unless you are properly trained. Read and understand the Operation and Maintenance Manual. Additional manuals are available from CROWN Lift Truck branches.

CROWN		MODEL	SERIAL NO.	TYPE
Crown Global/Starlap GmbH & Co. KG Philipp-Rohrer-Str. 10, 86632 Friedrichsdorf, Germany		TRUCK WEIGHTS:	RATED CAP.	
		W/O ATT	WITH ATT	*A*
		KG	KG	KG
ELECTRIC TRUCK ONLY		ALLOWABLE WORKING CAPACITY WITH MAST VERTICAL		
VOLT	BAT TYPE	BASIC TILT		MAST TYPE
				TIRE TYPE
NAX. AH CAP.	AT HR RATE	TIRE TREAD	MM	TIRE PRESS
BAT SIZE		ATTACH		KPA
BAT. IT. MIN	/MAX	CAPACITY		
TRUCK WT/5% W/O BAT	KG		A	B
		WITHOUT	KG	MM
		ATTACH	KG	MM
		WITH	KG	MM
		ATTACH	KG	MM
		CAPACITY C D WITHOUT MM MM ATTACH MM MM WITH MM MM ATTACH MM MM		
900209-10678 ENGL TSH		Manufactured in the REPUBLIC OF KOREA by Crown Equipment Vehicle Co., Ltd. 100 Seomun-Expomae Road		
		Manufactured by year	POWER	NV

This label also provides allowable lift truck capacity information.

General Warnings to Operator



Located on the right side of the operator's seat.

⚠ WARNING

Only trained and authorised personnel may operate this machine. For safe operation, read and follow the operation and maintenance Manual furnished with this lift truck and observe the following warnings:

1. Before starting machine. Check all controls and warning devices for proper operation.
2. Refer to machine identification plate for allowable machine capacity. Do not overload. Operate machines equipped with attachments as partially loaded machines when not handling a load.
3. Put directional control or shift lever in neutral before "ON - OFF" switch is turned on.
4. Start, turn and brake smoothly. Slow down for turns, slippery or uneven surfaces. Extremely poor surfaces should be repaired. Avoid running over loose objects or holes in the roadway surfaces. Use extreme caution when turning on inclines.
5. Travel with load as low as possible and tilted back. If load interferes with visibility, travel with load trailing.
6. When operating on a slope, place the load side on the higher part of the slope.
7. Watch out for pedestrians and obstructions. Secure enough clearance above the overhead guard so that it will not bump against anything in the truck's way.
8. Do not permit a person to ride on forks or machine at any time.
9. Do not allow anyone to stand or pass under the elevated portion of any machine.
10. Make sure operating surface can safely support machine.
11. Operate machine and attachments only from operator's position.
12. Do not handle unstable or loosely stacked loads.
13. Use minimum tilt when picking up or depositing a load.
14. Use extreme care when handling long, high or wide loads to ensure stability and durability of the truck.
15. Forks should be completely under load and spread apart as far as load permits.
16. Machine should be equipped with overhead guard or equivalent protection. Where load requires it, use load backrest extension. Use extreme caution if operating without these devices.
17. After parking, lower the forks to the floor. Put directional control or shift lever in neutral. Set parking/secondary brake. Turn "ON - OFF" switch off. Check wheels if machine is on incline. Disconnect battery when storing electric machines.
18. Observe safety rules when handling fuel for engine powered machine and when changing batteries for electric machines.
19. Avoid overuse of the inching pedal as this may cause the automatic transmission oil to overheat or the clutch to slip. Do not use as a footrest or for long periods of time.
20. If user operates continuously pushing work or both brake pedal and accelerator pedal were depressed at the same time, it may cause the automatic transmission oil to overheat or the clutch to slip.

Pressure Warning

⚠ WARNING

Contents under pressure may be hot. Allow to cool before opening.

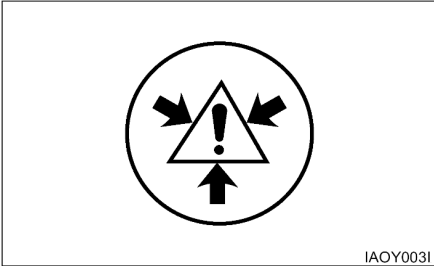

Located on the radiator top tank by the radiator cap.

Hand Placement Warning

⚠ WARNING



No hands. Do not place hands in this area. Do not touch, lean on, or reach through the mast or permit others to do so.

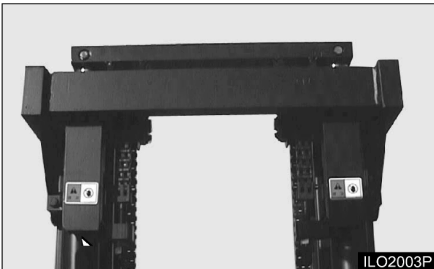

Located on the mast.

No Standing On Forks Warning, No Standing Under Forks Warning

⚠ WARNING

Do not stand or ride on the forks. Do not stand or ride on a load or pallet on the forks. Do not stand or walk under the forks.

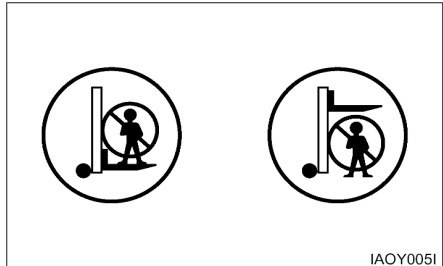

Located on the lift cylinder.

Load Backrest Must Be In Place Warning

⚠ WARNING

Operation without this device in place may be hazardous.



Located on the load backrest.

Overhead Guard Must Be In Place Warning

⚠ WARNING

Operation without this device in place may be hazardous. This guard conforms to A.N.S.I.B56.1 and F.E.M. Section IV. This design has been tested with an impact of (appropriate value).

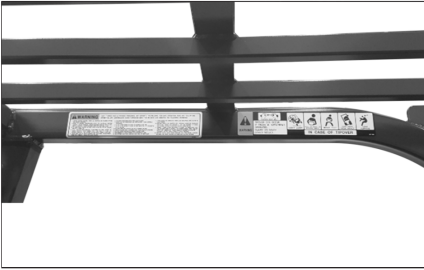

Located on the Overhead Guard.

Brake Pedal Adjustment Warning

⚠ WARNING

Improper adjustment could result in injury or death. It has to be adjusted by drawing dimension on free condition. For safe, don't unfasten clevis and nut. It has to be adjusted by trained personnel.

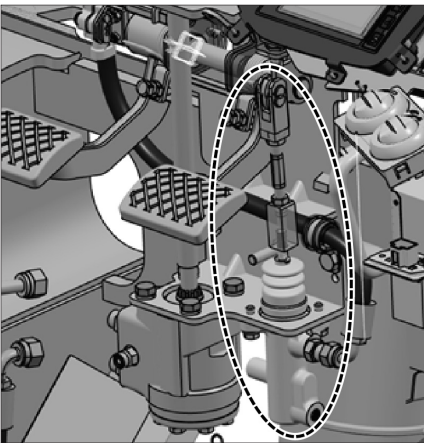

Located inside Brake pedal box.

Electrical Parking Brake



Push the front side of the parking brake switch to engage the brake.



Push the rear side of the parking brake switch to engage the brake.

Applying the parking brake puts the transmission in NEUTRAL. The parking brake must be applied when leaving the lift truck and when starting the engine. If the operator leaves the seat without applying the parking brake, an audible alarm will sound.

⚠ WARNING

When leaving machine apply parking brake!
Parking brake is not automatically applied.
Alarm will sound if parking brake is not applied.

⚠ WARNING

Correct adjustment is necessary to provide adequate braking. See the MAINTENANCE section for adjustment procedures. The lift truck may creep at engine idle and can cause damage, injury or death. Always apply the parking brake when leaving the lift truck. The parking brake is NOT automatically applied.

No Riders Warning

 **WARNING**

To avoid personal injury, allow no riders. A lift truck is designed for only one operator and no riders.



Located beside the operator's station.

Hot Muffler Warning

 **WARNING**

Be careful not to touch muffler because it's very hot when or after operating.



Moving Fan Warning

 **WARNING**

To avoid personal injury, stay clear of moving fan.

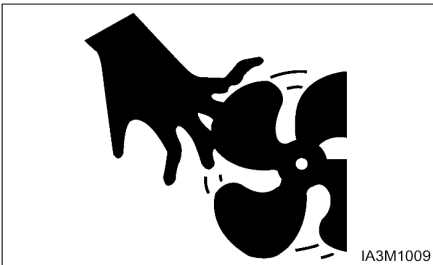

Located on the shroud and upper cover.

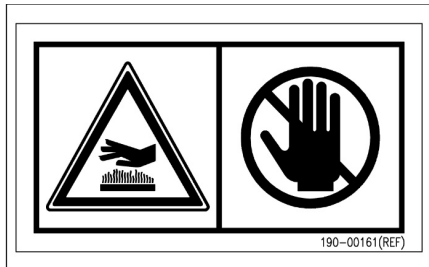

Located under muffler.

General Hazard Information

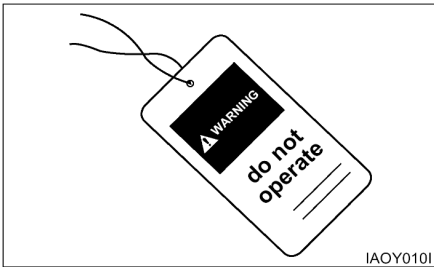

Attach a "Do Not Operate" or similar warning tag to start switch or controls before servicing or repairing the lift truck.

Do not start or service the lift truck when a "DO NOT OPERATE" or similar warning tag is attached to the start switch or controls.

Wear a hard hat, protective glasses and other protective equipment as required by job conditions.

Know the width of your attachments so proper clearance can be maintained when operating near fences, boundary obstacles, etc.

Do not wear loose clothing or jewelry that can catch on controls or other parts of the lift truck.

Keep the lift truck, especially the deck and steps, free of foreign material such as debris, oil tools and other items which are not part of the lift truck.

Secure all loose items such as lunch boxes, tools and other items which are not part of the lift truck.

Know the appropriate work-site hand signals and who gives them. Accept signals from one person only.

Always use the overhead guard. The overhead guard is intended to protect the lift truck operator from overhead obstructions and from falling objects.

A truck that is used for handling small objects or uneven loads must be fitted with a load backrest.

If the lift truck must be operated without the overhead guard in place due to low overhead clearance, use extreme care. Make sure there is no possibility of falling objects from any adjacent storage or work area. Make sure the load is stable and fully supported by the carriage and the load backrest extension (if equipped).

Do not raise loads any higher than necessary and never raise a load higher than 1830 mm (72 in) with the overhead guard removed.

Always use load backrest extension when the carriage or attachment does not fully support the load.

The load backrest extension is intended to prevent the load or any part of the load from falling backwards into the operator's station.

When operation the lift truck, do not depend only on flashing lights or back-up alarm (if equipped) to warn pedestrians.

Always be aware of pedestrians and do not proceed until the pedestrians are aware of your presence and intended actions and have moved clear of the lift truck and/or load.

Do not drive lift truck up to anyone standing in front of an object.

Obey all traffic rules and warning signs.

Keep hands, feet and head inside the operator station. Do not hold onto the overhead guard while operating the lift truck. Do not climb on any part of the mast or overhead guard or permit others to do so.

Do not allow unauthorised personnel to ride on the forks or any other part of the lift truck, at any time. When working in a building or dock, observe floor load limits and overhead clearances.

NOTICE

Inhaling Freon gas through a lit cigarette or other smoking method or inhaling fumes released from a flame contacting Freon can cause bodily harm or death. Do not smoke when servicing air conditioners or wherever Freon gas may be present.

LPG Truck contains 0.35kg of HFC-134a, of which the CO₂ equivalent value is 0.572 tons.

Diesel Truck contains 0.35kg of HFC-134a, of which the CO₂ equivalent value is 1.001 tons.

The GWP of HFC-134a is 1,430.

This is only for the trucks with air-conditioner option.

The above capacity information written on the film is attached to the truck.

Inhaling Freon gas through a lit cigarette or other smoking method or inhaling fumes released from a flame contacting Freon can cause bodily harm or death. Do not smoke when servicing air conditioners or wherever Freon gas may be present.

Never put maintenance fluids into glass containers.

Use all cleaning solutions with care.

Do not use steam, solvent, or high pressure to clean electrical components.

Report all needed repairs.

When you handle DEF/AD-Blue, wear protective equipment and observe Precautions for Handling.

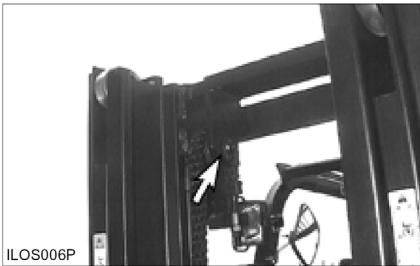

Inspect the part of the chain that is normally operated over the crosshead roller. When the chain bends over the roller, the movement of the parts against each other causes wears.

Inspect to be sure that chain link pins do not extend outside of the bore hole.

If any single link pin is extended beyond its connecting corresponding link, it should be suspected of being broken inside of its bore hole.

Inspect the chain anchor and the anchor links for wear.

Do not change any factory set adjustment values (including engine rpm setting) unless you have both authorization and training. Especially Safety equipment and switches may not be removed or adjusted incorrectly. Repairs, adjustments and maintenances that are not correct can make a dangerous operating condition.

For any checkup, repair, adjustments, maintenance and all other work concerning your forklift truck, please contact your CROWN branch. We would like to draw your attention to the fact that any secondary damages due to improper handling, insufficient maintenance, wrong repairs or the use of other than original CROWN spare parts waive any liability by CROWN.

Operation Information

Mounting and Dismounting

Mount and dismount the lift truck carefully.

Clean your shoes and wipe your hands before mounting.

Face the lift truck when mounting and dismounting.

Use both hands face the lift truck when mounting and dismounting.

Use the handgrips for mounting and dismounting.

Do not try to climb on or off the lift truck when carrying tools or supplies.

Never get on or off a moving lift truck.

Do not use any controls as handholds when entering or leaving the operator's station.

Never get on or off a moving lift truck. Never jump off the lift truck.

Keep hands and steering wheel free of slippery material.

Before Starting the Lift Truck

Perform a walk-around inspection daily and at the start of each shift. Refer to the topic “Walk-around Inspection” in “Every 10 Service Hours or Daily” section of this manual.

Adjust the seat so that full brake pedal travel can be obtained with the operator’s back against the seat back.

Make sure the lift truck is equipped with a lighting system as required by conditions.

Make sure all hydraulic controls are in the HOLD position.

Make sure the direction control lever is in the NEUTRAL position.

Make sure the parking brake is engaged.

Make sure no one is standing and/or working on, underneath or close to the lift truck before operating the lift truck.

Operate the lift truck and controls only from the operator’s station.

Make sure the lift truck horn, lights, backup alarm (if equipped) and all other devices are working properly. Check for proper operation of mast and attachments.

Pay particular attention to unusual noises or erratic movement which might indicate a problem.

Make sure service and parking brakes, steering, and directional controls are operational.

Make sure all personnel are clear of lift truck and travel path.

Refer to the topic “Lift Truck Operation” in the “Operation Section” of this manual for specific starting instructions.

Starting the Lift Truck

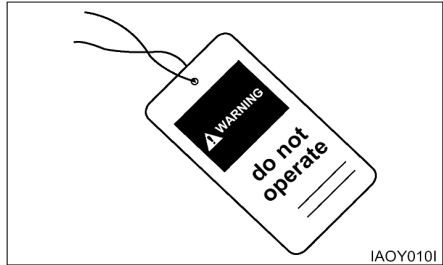

Do not start the engine or move any of the controls if there is a “DO NOT OPERATE” or similar warning tag attached to the start switch or controls.

Before Operating the Lift Truck

Test brakes, steering controls, horn and other devices for proper operation. Report faulty performance.

Do not operate lift truck until repaired.

Learn how your lift truck operates. Know its safety devices. Know how the attachments work.

Before moving the lift truck, look around. Start, turn and brake smoothly.

An operator must constantly observe his lift truck for proper operation.

Operating the Lift Truck

Always keep the lift truck under control.

Obey all traffic rules and warning signs.

Never leave the lift truck with the engine operating, or with the parking brake disengaged.

Operate the engine only in a well ventilated area.

Lower a mast, with or without load, before turning or traveling. Tip over could result. Watch out for overhead obstructions.

Always observe floor load limits and overhead clearance.

Start, turn, and brake smoothly, slow down for turns, grades, slippery or uneven surfaces.

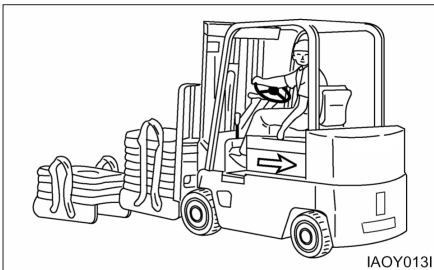

Use special care when operation on grades. Do not angle across or turn on grades. Do not use lift truck on slippery grades. Travel with forks downgrade when unloaded. Travel with load upgrade.

Do not overload, or handle offset, unstable, or loosely stacked loads. Refer to load capacity plate on the lift truck. Use extreme caution when handling suspended, long, high or wide load.

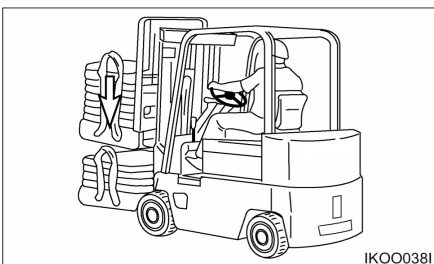

Tilt elevated load forward only when directly over unloading area and with load as low as possible.

Do not stunt ride or indulge in horseplay.

Always look and keep a clear view of the path of travel.

Travel in reverse if load or attachment obstructs visibility.

Use extreme caution if visibility is obstructed.

Stay in designated travel path, clear of dock edges, ditches, other drop-offs and surfaces which cannot safely support the lift truck.

Slow down and use extra care through doorways, intersections and other location where visibility is reduced.

Slow down for and avoid pedestrians, other vehicles, obstruction, pot holes and other hazards or objects in the path of travel.

Always use overhead guards except where operation conditions do not permit. Do not operate lift truck in high stacking areas without overhead guards.

When stacking, watch for falling objects. Use load backrest extension and overhead guard.

Refer to the topic "Operation Techniques" in the "Operation Section" of this manual.

Loading or Unloading Trucks/Trailers

Do not operate lift trucks on trucks or trailers which are not designed or intended for that purpose. Be certain truck or trailer brakes are applied and wheel chocks in place (or be certain unit is locked to the loading dock) before entering onto trucks or trailers.

If trailer is not coupled to tractor, make sure the trailer landing gear is properly secured in place. On some trailers, extra supports may be needed to prevent upending or corner dipping.

Be certain dock plates are in good condition and properly placed and secured. Do not exceed the rated capacity of dock boards or bridge plates.

Lift Truck Parking

When leaving the operator station, park the lift truck in authorised areas only. Do not block traffic.



- Park the lift truck on level ground, lowering the fork and tilting the mast forward until the fork tips touch the floor.
- Move the direction control lever to NEUTRAL.
- Engage the parking brake.
- Turn the key switch off and remove the key.
- Turn the disconnect switch to OFF and remove the key (if equipped).
- Block the drive wheels when parking on an incline.

WARNING

Do operate the disconnecting switch after 30 seconds from start key-off. (if equipped)

Otherwise Engine Control Unit (ECU) can be damaged.

Maintenance Information

Perform all maintenance unless otherwise specified as follows ;

- Park the lift truck in authorised areas only.
- Park the lift truck on level ground, lowering the fork and tilting the mast forward until the fork tips touch the floor.
- Place the transmission controls in neutral.
- Engage the parking brake.
- Stop the engine.
- Remove the start switch key and turn the disconnect switch OFF (if equipped).
- Block the drive wheels when parking on an incline.

Pressure Air

Pressure air can cause personal injury. When using pressure air for cleaning, wear a protective face shield, protective clothing and protective shoes.

The maximum air pressure must be below 205 kPa (30 psi) for cleaning purposes.

Fluid Penetration

Always use a board or cardboard when checking for a leak. Escaping fluid under pressure, even a pinhole size leak, can penetrate body tissue, causing serious injury, and possible death. If fluid is injected into your skin, it must be treated by a doctor familiar with this type of injury immediately.

Crushing or Cutting Prevention

Support equipment and attachments properly when working beneath them. Do not depend on hydraulic cylinders to hold it up. Any attachment can fall if a control is moved, or if a hydraulic line breaks.

Never attempt adjustments while the lift truck is moving or the engine is running unless otherwise specified.

Where there are attachment linkages, the clearance in the linkage area will increase or decrease with movement of the attachment.

Stay clear of all rotating and moving parts.

Keep objects away from moving fan blades.

They will throw or cut any object or tool that falls or is pushed into them.

Do not use a kinked or frayed wire rope cable. Wear gloves when handling the wire rope cable.

Retainer pins, when struck with force, can fly out and injure nearby persons. Make sure the area is clear of people when driving retainer pins.

Wear protective glasses when striking a retainer pin to avoid injury to your eyes.

Chips or other debris can fly off objects when struck. Make sure no one can be injured by flying debris before striking any object.

Falling Objects Protective Structure(FOPS)

This is an attached guard located above the operator's compartment and secured to the lift truck.

To avoid possible weakening of the Falling Objects Protective Structure (FOPS), consult a CROWN branch before altering, by adding weight to, welding on, or cutting or drilling holes into the structure.

The overhead guard is not intended to protect against every possible impact. The overhead guard may not protect against some objects penetrating into the operator's station from the sides or ends of the lift truck.

The lift truck is equipped with an overhead guard and FOPS as standard. If there is a possibility of overhead objects falling through the guard, the guard must be equipped with smaller holes or a Plexiglas cover.

Any altering done that is not specifically authorised by CROWN invalidates CROWN's FOPS certification.

The protection offered by this FOPS will be impaired if it has been subjected to structural damage.

Structural damage can be caused by an overturn accident, by falling objects, etc.

Do not mount any item such as fire extinguishers, first aid kits and lights by welding brackets to or drilling holes in any FOPS structure. See your CROWN branch for mounting guidelines.

Burn Prevention

Coolant

At operating temperature, the engine coolant is hot and under pressure. The radiator and all lines to heaters or the engine contain hot water or steam. Any contact can cause severe burns.

Steam can cause personal injury.

Check the coolant level only after engine has been stopped and the filler cap is cool enough to remove with your bare hand.

Remove the cooling system filter cap slowly to relieve pressure.

Cooling system additive contains alkali that can cause personal injury. Avoid contact with the skin and eyes and do not drink.

Allow cooling system components to cool before draining.

Oils

Hot oil and components can cause personal injury. Do not allow hot oil or components to contact the skin.

At operation temperature, the hydraulic tank is hot and can be under pressure.

Remove the hydraulic tank filter cap only after the engine has been stopped and the filter cap is cool enough to remove with your bare hand.

Remove the hydraulic tank filter cap slowly to relieve pressure.

Relieve all pressure in air, oil fuel or cooling systems before any lines, fittings or related items are disconnected or removed.

Batteries

Batteries give off flammable fumes which can explode.

Do not smoke when observing the battery electrolyte levels.

Electrolyte is an acid and can cause personal injury if it contacts skin or eyes.

Always wear protective glasses when working with batteries.

Fire or Explosion Prevention

All fuels, most lubricants and some coolant mixtures are flammable.

Fuel leaked or spilled onto hot surfaces or electrical components can cause a fire.

Do not smoke while refueling or in a refueling area.

Do not smoke in areas where batteries are charged, or where flammable materials are stored.

Batteries in series can be located in separate compartments.

When using jumper cables always connect positive(+) cable to positive(+) terminal of battery connected to starter solenoid and negative(-) cable from external source to starter negative(-) terminal.

(If not equipped with starter negative(-) terminal, connect to engine block.)

See the Operation Section of this manual for specific starting instructions.

Clean and tighten all electrical connections. Check daily for loose or frayed electrical wires. Have all loose or frayed electrical wires tightened, repaired or replaced before operation the lift truck.

Keep all fuels and lubricants stored in properly marked containers and away from all unauthorised persons.

Store all oily rags or other flammable material in a protective container, in a safe place.

Do not weld or flame cut on pipes or tubes that contain flammable fluids. Clean them thoroughly with nonflammable solvent before welding or flame cutting on them.

Remove all flammable materials such as fuel, oil and other debris before they accumulate on the lift truck.

Do not expose the lift truck to flames, burning brush, etc., if at all possible.

Shields, which protect hot exhaust components from oil or fuel spray in the event of a line, tube or seal failure, must be installed correctly.

Do not operate in areas where explosive gases exist or are suspected.

Do perform the regeneration of aftertreatment, hot exhaust gas is emitted, in a safe outdoor environment.

Fire Extinguisher

Have a fire extinguisher-type BC and 1.5KG minimum capacity-on rear overhead guard leg with latch and know how to use it. Inspect and have it serviced as recommended on its instruction plate.

LPG

LPG is poisonous and flammable.

Breathing LPG vapors or repeated contact of LPG with skin can cause personal injury.

Use LPG only in well-ventilated areas.

Do not smoke while changing LPG cylinders.

Use LPG with care to avoid fires.

Do not store replacement LPG cylinders in living areas or in the operator's compartment.

Do not store LPG cylinders in direct sunlight or at temperatures above 39°C (102°F).

Discard cylinders in a safe place. Do not puncture or burn cylinders.

Keep LPG cylinders out of the reach of unauthorised personnel.

Lines, Tubes and Hoses

Do not bend or strike high pressure lines. Do not install bent or damaged lines, tubes or hoses.

Repair any loose or damaged fuel and oil lines, tubes and hoses. Leaks can cause fires. Contact your CROWN branch for repair or replacement.

Check lines, tubes and hoses carefully. Do not use your bare hand to check for leaks. Use a board or cardboard to check for leaks. See Fluid Penetration in the Safety Section for more details. Tighten all connections to the recommended torque. Replace if any of the following conditions are found.

- End fittings damaged or leaking.
- Outer covering chafed or cut and wire reinforcing exposed.
- Outer covering ballooning locally.
- Evidence of kinking or crushing of the flexible part of hose.
- Armoring embedded in the outer cover.
- End fittings displaced.
-

Make sure that all clamps, guards and heat shields are installed correctly to prevent vibration, rubbing against other parts, and excessive heat during operation.

Tyre Information

Explosions of air-inflated tyres have resulted from heat-induced gas combustion inside the tyres. The heat, generated by welding or heating rim components, external fire, or excessive use of brakes can cause gaseous combustion.

A tyre explosion is much more violent than a blowout. The explosion can propel the tyre, rim and axle components as far as 500 m (1500 ft) or more from the lift truck. Both the force of the explosion and the flying debris can cause personal injury or death, and property damage.

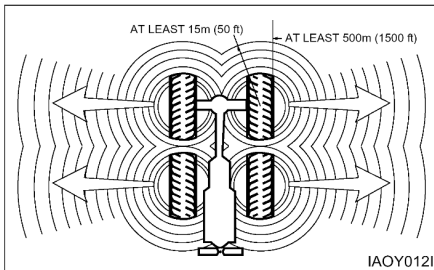

Do not approach a warm tyre closer than the outside of the area represented by the shaded area in the above drawing.

Dry nitrogen (N_2) gas is recommended for inflation of tyres. If the tyres were originally inflated with air, nitrogen is still preferred for adjusting the pressure. Nitrogen mixes properly with air.

Nitrogen inflated tyres reduce the potential of a tyre explosion, because nitrogen does not support combustion. Also, nitrogen helps prevent oxidation and the resulting deterioration of rubber and corrosion of rim components.

Proper nitrogen inflation equipment and training in its use are necessary to avoid over-inflation. A tyre blowout or rim failure can result from improper or misused equipment.

Stand behind the tread and use a self-attaching chuck when inflating a tyre.

Servicing, changing tyres and rims can be dangerous and should be done only by trained personnel using proper tools and procedures. If correct procedures are not followed while servicing tyres and rims, the assemblies could burst with explosive force and cause serious personal injury or death. Follow carefully the specific information provided by your tyre or rim servicing personnel or branch.

CROWN forklift is equipped with wheels from different manufacturers.

Please re-use the original parts of the existing wheel, if there is no deformation of the wheel after checked. Mixing up new and old parts may cause incomplete

assembly that might lead to unexpected dismantlement of parts and accident.

Operator Restraint System (If Equipped)

Warning Signs and Labels

Your CROWN lift truck has the following tipover warning decals.

Make sure that you can read all safety signs. Clean or replace these if you cannot read the words or see the pictures. When cleaning the labels use a cloth, water and soap. Do not use solvent, gasoline, etc. You must replace a label if it is damaged, missing or cannot be read. If a label is on a part that is replaced, make sure a new label is installed on the replaced part. See you CROWN Lift Truck branch for new labels.

The most effective method of preventing serious injury or death to yourself or others is to familiarise yourself with the proper operation of the lift truck, to be alert, and to avoid actions or conditions which can result in an accident.

⚠ WARNING

Tipover can occur if the truck is improperly operated. In the event of a tipover, injury or death could result.

"Survive in tipover" decal

IB900002

"Survive in tipover" decal

FOR SAFETY NOTICE FOLLOWING WARNINGS

1. Always wear your seat belt when operating the lift truck. It is the responsibility of the operator to ensure that the seat belt is properly fastened.
2. Do not drink alcohol or use drugs while operating the lift truck. Alcohol and drugs can impair your judgment and reaction time, leading to accidents.
3. Do not operate the lift truck if you are tired or fatigued. Fatigue can lead to mistakes and accidents.
4. Do not operate the lift truck if you are under the influence of medication that may impair your ability to operate the lift truck safely.

IB900003

"Fasten seat belt" decal

"Survive in tipover" decal

IB900004

The "Survive in tipover" warning is located on the overhead guard. It shows the proper use of the operator restraint system.

Seat Adjustment

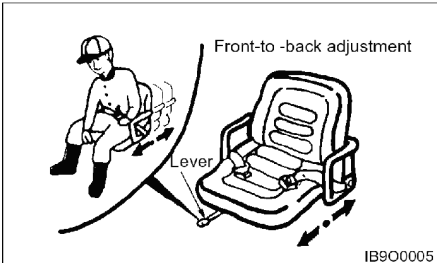

Move the lever, slide the seat to the desired position, and release the lever.

Adjust the seat before operating the lift truck. After adjusting, set the seat to make sure it is properly locked. Do not adjust the seat while the truck is in motion.

⚠ WARNING

Do not place your hand or fingers under the seat. Injury may occur as the seat moves up and down.

If Optional Suspension Seat (weight adjusting type) Equipped

Forward and Backward Adjustment

The seat can be adjusted by pushing the lever on the right side of seat.

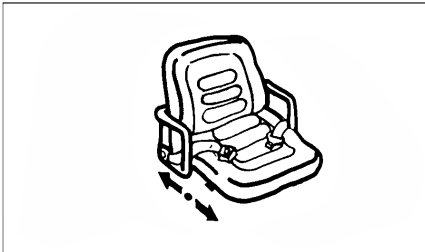
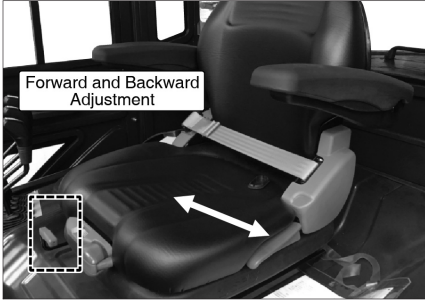

Adjust the seat before operating the lift truck. After adjusting, set the seat to make sure it is properly locked. Do not adjust the seat while the truck is in motion.

Weight adjustment

Pull the weight adjustment lever upwards and move right or left side.

Adjust to driver's weight in 7 steps (50 ~ 110 kg)



Do not place your hand or fingers under the seat. Injury may occur as the seat moves up and down.



Backrest Inclination

The backrest angle can be adjusted by using the lever on the left side of seat.

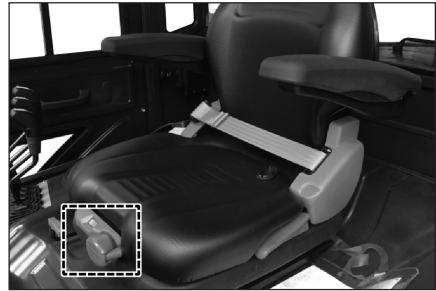

Backrest Inclination

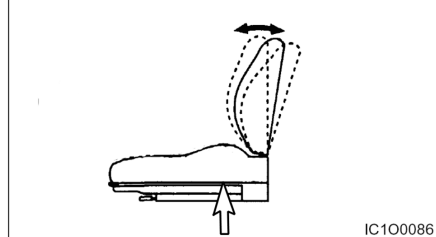

IC100086

Seat Belt

The Operator Restraint System, Prevents the operator from jumping from the operator's compartment in the event of a forward or side tipover. The system is designed to keep the operator on the seat and in the operator's compartment in the event of a tipover.

Inspection

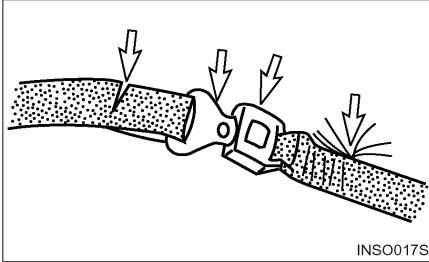

1. If the seat belt is torn, if pulling motion is interrupted during extension of the belt, or if the belt cannot be inserted into the buckle properly, replace the seat belt assembly.

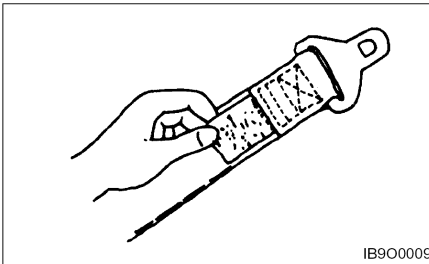

2. Belt Maintenance – Every 500 service hours. Check that the belt fastening works properly and that winding device is free from run lock when jerked. Check that the belt is suitably fastened to the seat. Check that the seat is correctly secured to the hood and the chassis. On visual inspection, fastenings must be intact, otherwise, contact the safety manager.

⚠ WARNING

Your CROWN truck comes equipped with a CROWN operator restraint system. Should it become necessary to replace the seat for any reason, it should only be replaced with another CROWN operator restraint system.



3. In the event of a tipover, the seat and restraint system should be inspected for damage and replaced, if necessary.

NOTE: Operator restraints shall be examined at the regular truck service intervals. It is recommended that they be replaced if any of the following conditions are found:

- Cut or frayed strap
- Worn or damaged hardware including anchor points
- Buckle or retractor malfunction
- Loose stitching

⚠ WARNING

The seat belt may cause the operator to bend at the waist. If you are pregnant or have suffered from some abdominal disease, consult a doctor before you use the seat belt.

Fasten the Seat Belt

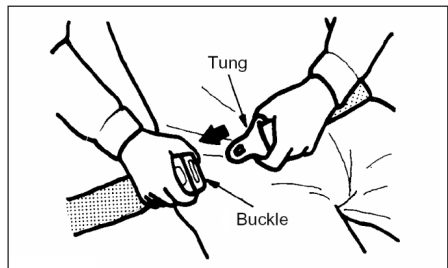

1. Grip the plate (connector) of the belt and pull the belt from the retractor. Then insert the plate into the slot of the buckle until a snap is heard. Pull on the belt to confirm it is latched.
2. Make sure the belt is not twisted.

⚠ WARNING

If you fasten the belt across your abdomen, the belt may injure your abdomen in an accident.

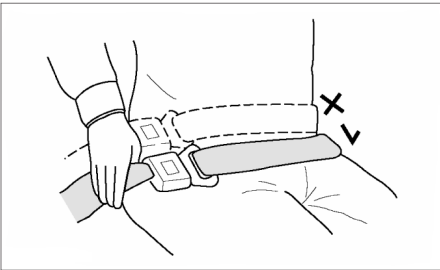

3. Be sure to fasten the belt across your hips, not across your abdomen.

NOTE: The belt is designed to automatically adjust to your size and movement. A quick pull on the belt will confirm that the automatic adjuster will hold the belt position in the event of an accident.

Release the Seat Belt

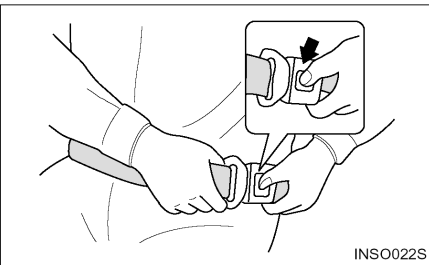

Push the button of the buckle to release the belt. The belt will automatically retract when released. Hold the plate of the belt and allow the belt to slowly retract.

Avoiding Lift Truck Tipovers

Lift Truck Stability

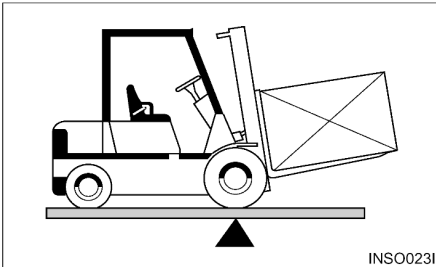

Counterbalanced lift truck design is based on the balance of two weights on opposite sides of a fulcrum (the front axle). The load on the forks must be balanced by the weight of the lift truck.

The location of the centre of gravity of both the truck and the load is also a factor. This basic principle is used for picking up a load. The ability of the lift truck to handle a load is discussed in terms of centre of gravity and both forward and sideways stability.

Centre of Gravity (CG)

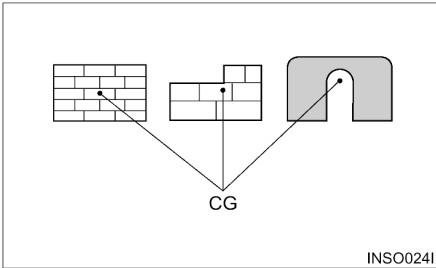

The point within an object, at which the whole weight of the object may be regarded as being concentrated, is called the centre of gravity or CG. If the object is uniform, its geometric centre will coincide with its CG. If it is not uniform, the CG could be at a point outside of the object. When the lift truck picks up a load, the truck and load have a new combined CG.

Stability and Centre of Gravity

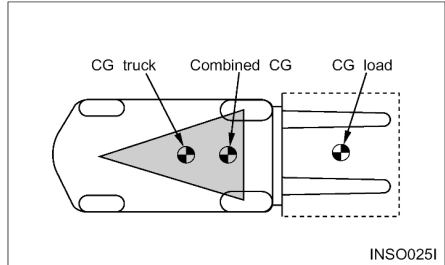

The stability of the lift truck is determined by the location of its CG; or, if the truck is loaded, the combined CG of the truck and load. The lift truck has moving parts and, therefore, has a CG that moves. The CG moves forward or backward as the mast is tilted forward or backward. The CG moves up or down as the mast moves up or down. The CG and, therefore, the stability of the loaded lift truck, is affected by a number of factors such as:

- the size, weight, shape and position of the load
- the height to which the load is lifted
- the amount of forward or backward tilt
- tyre pressure
- dynamic forces created when the lift truck is accelerated, braked or turned
- condition and grade of surfaces on which the lift truck is operated

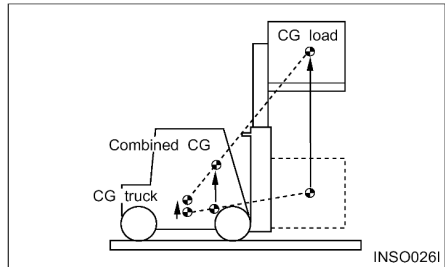

These same factors are also important for unloaded lift trucks. They tip over sideways easier than a loaded lift truck carrying its load in the lowered position.

Lift Truck Stability Base

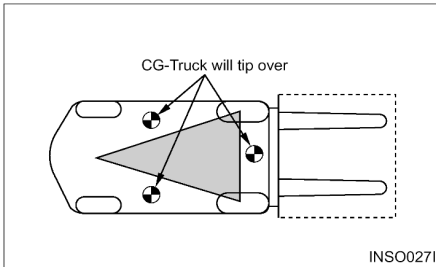

For the lift truck to be stable (not tip over forward or to the side), the CG must stay within the area of the lift truck stability base - a triangular area between the front wheels and the pivot of the steer wheels. If the CG moves forward of the front axle, the lift truck will tip forward. If the CG moves outside of the line on either side of the stability base, the lift truck will tip to the side.

WARNING

Dynamic forces (braking, acceleration, turning) also affect stability and can produce tipover even when the CG is within the stability triangle.

Capacity Load (Weight and Load Centre)

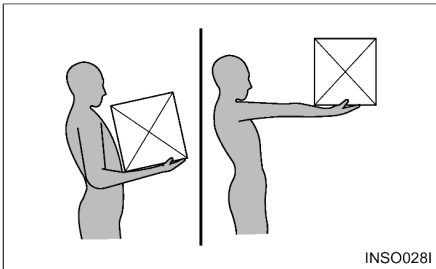

The capacity load of the lift truck is shown on the capacity/nameplate riveted to the truck. It is determined by the weight and load centre. The load centre is determined by the location of the CG of the load.

The load centre shown on the nameplate is the horizontal distance from the front face of the forks, or the load face of an attachment, to the CG of the load.

The location of the CG in the vertical direction is the same as the horizontal dimension.

Remember that, unless otherwise indicated, the capacity load shown on the nameplate is for a standard lift truck with standard backrest, forks and mast, and having no special-purpose attachment. In addition, the capacity load assumes that the load centre is no further from the top of the forks than it is from the face of the backrest. If these conditions do not exist, the operator may have to reduce the safe operating load because the truck stability may be reduced. The lift truck should not be operated if its capacity/nameplate does not indicate capacity load.

NOTE: If the load is not uniform, the heaviest portion should be placed closer to the backrest and centred on the forks.

NOTICE

1. Capacity/Nameplates originally attached to forklifts sold by CROWN shall not be removed, altered or replaced without CROWN's approval.
 2. CROWN assumes no responsibility for lift trucks placed in service without a valid CROWN Nameplate.
 3. If necessary to change your specification, contact your CROWN lift truck branch.
-

Safety Rules

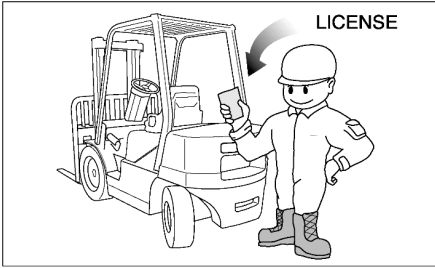

Only properly trained and authorised personnel should operate forklift trucks. Wear a hard hat and safety shoes when operating a lift truck. Do not wear loose clothing.

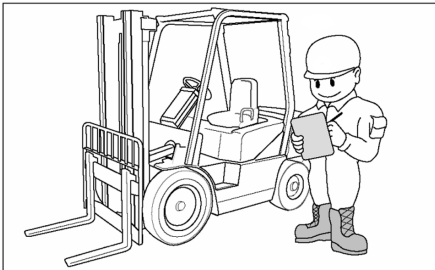

Inspect and check the condition of your forklift truck using the operator's check list before starting work. Immediately report to your supervisor any obvious defects or required repairs.

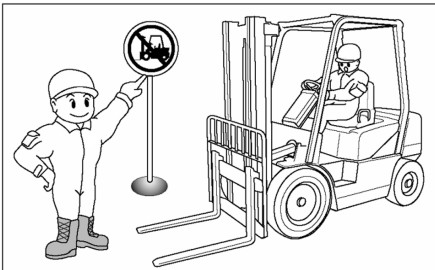

Do not operate your truck in unauthorised areas. Know your forklift truck and think safety. Do not compromise safety. Follow all safety rules and read all warning signs.

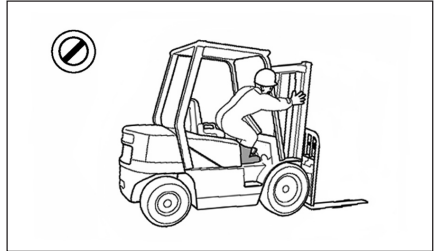

Do not operate a lift truck unless you are in the operator's seat. Keep hands and feet inside the operator's compartment. Do not put any part of the body outside of the operator's compartment. Never put any part of body into the mast structure or between the mast and the truck

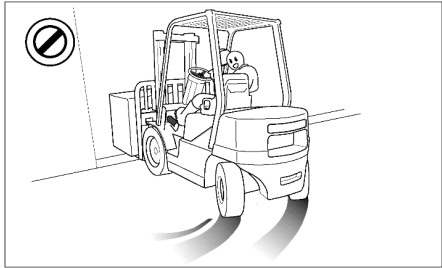

Do not start, stop, turn or change direction suddenly or at high speed. Sudden movement can cause the lift truck to tip over. Slow the speed of your truck and use the horn near corners, exits, entrances, and near people.

In case of a truck with the steering knob, Do not operate the steering knob suddenly, to prevent accident caused by quick turning.

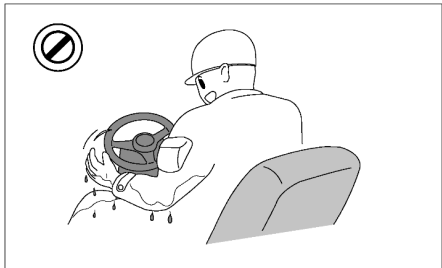

Never operate a lift truck with wet hands or shoes. Never hold any controls with grease on your hands. Your hands or feet will slide off of the controls and cause an accident.

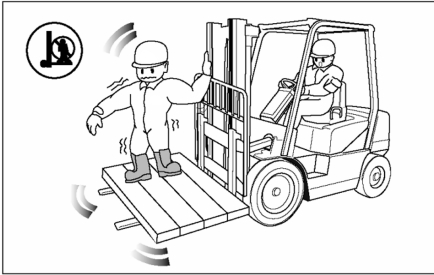

Do not raise anyone on the forks of your lift truck.
Do not let other people ride on the truck.
Lift trucks are designed to carry loads, not people.

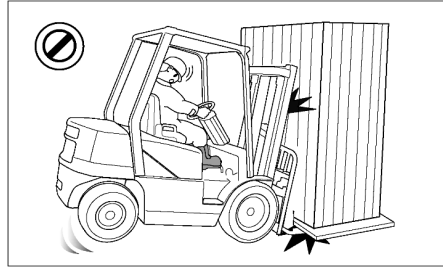

Do not overload. Always handle loads within the rated capacity shown on the capacity plate.
Do not add extra counterweight to the truck.
An overload can cause the truck to roll over and cause injury to personnel and damage to the lift truck.

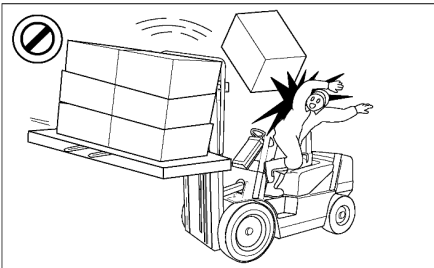

Do not operate your truck without the load backrest extension and overhead guard. Keep the load against the backrest with the mast tilted backward.

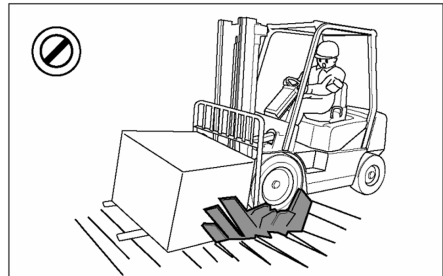

Do not drive on soft ground.
Observe all signs, especially those on maximum permitted floor loadings, elevator capacities and clearance heights.
Handle loads carefully and check them closely for stability and balance.

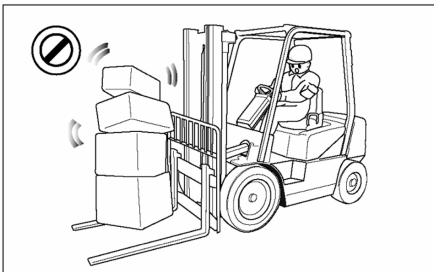

Do not lift or move loads that are not safe. Do not pick up an off centre load. Such a load increases the possibility of a tipover to the side. Make sure loads are correctly stacked and positioned across both forks. Always use the proper size pallet. Position the forks as wide as possible under the load. Position loads evenly on the forks for proper balance. Do not lift a load with one fork.

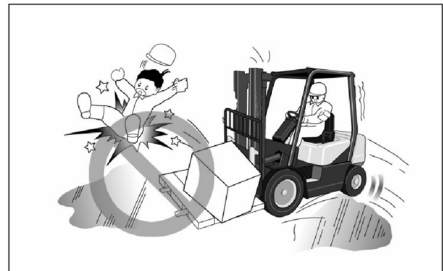

Do not drive on slippery surfaces.
Sand, gravel, ice or mud can cause a tipover. If unavoidable, slow down.

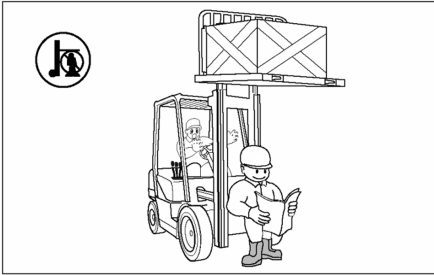

Do not permit anyone to stand or walk under the load or lifting mechanism. The load can fall and cause injury or death to anyone standing below.

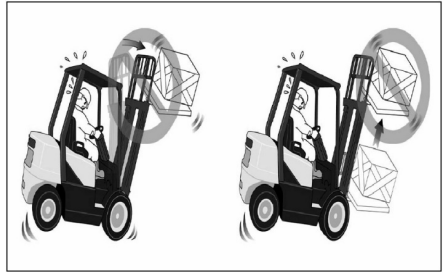

Do not elevate the load with the mast tilted forward. Do not tilt the elevated loads forwards. This will cause the lift truck to tip over forward.

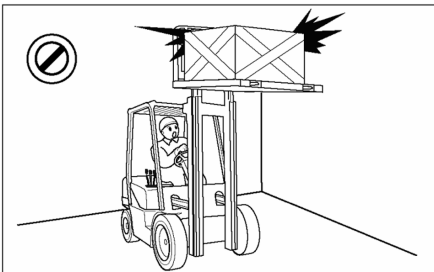

Look out for overhead obstructions when raising or stacking loads. Do not travel with a raised load. Do not travel with the mast raised. The lift truck can roll over and cause injury or death to you or other personnel.

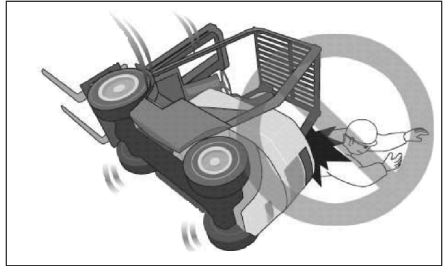

Do not jump off if your truck starts to tip over. Stay in your seat to survive.

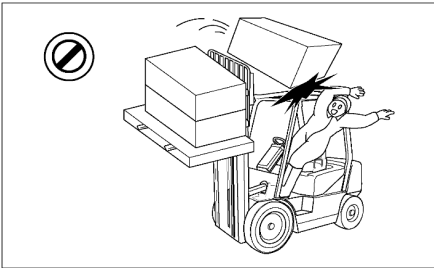

Do not move loose loads that are higher than the load backrest. Be alert for falling loads when stacking. Travel with the load tilted back and the forks as low as possible. This will increase stability to the truck and load and permit better visibility for you.

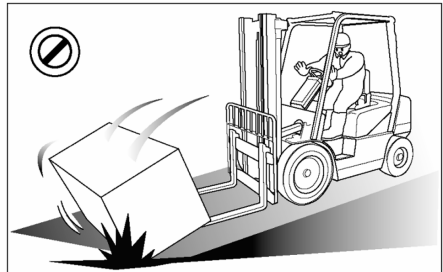

Go up ramps in forward direction and down ramps in reverse direction when moving loads. Never elevate a load with the forklift truck on an incline. Go straight off and straight down. Use an assistant when going up or down a ramp with a bulky load.

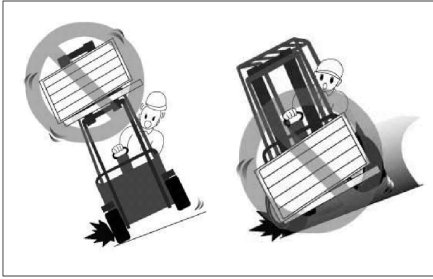

Do not stack or turn on ramps.
Do not attempt to pick-up or deposit a load unless the lift truck is level. Do not turn on or drive across an incline.

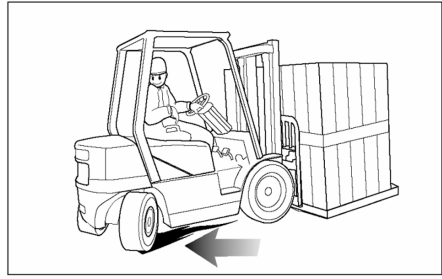

Do not drive in forward direction when loads restrict your visibility. Operate your lift truck in reverse to improve visibility except when moving up a ramp.

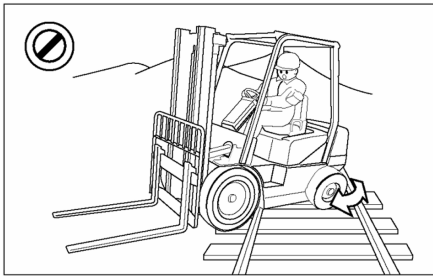

Do not go over rough terrain. If unavoidable, slow down. Cross railroad tracks slowly and diagonally whenever possible. A railroad crossing can give a loaded forklift truck a real jolt. For smoother crossing, cross the railroad diagonally so one wheel crosses at a time.

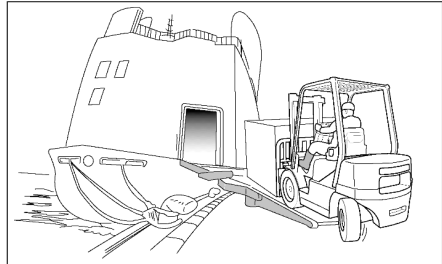

Be careful when operating a lift truck near the edge of a loading dock or ramp. Maintain a safe distance from the edge of docks, ramps and platforms. Always watch tail swing. The truck can fall over the edge and cause injury or death.

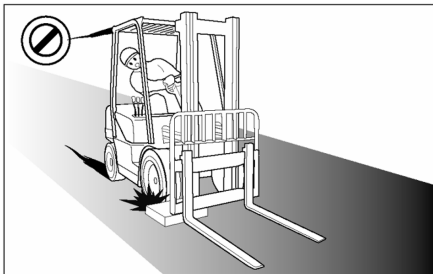

Avoid running over loose objects. Look in the direction of travel. Look out for other persons or obstructions in your path of travel. An operator must be in full control of his lift truck at all times.

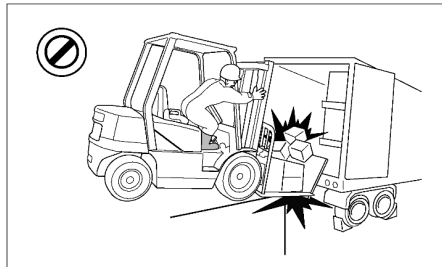

Do not operate on bridge plates unless they can support the weight of the truck and load. Make sure that they are correctly positioned. Put blocks on the vehicle you enter to keep it from moving.

Safety Section

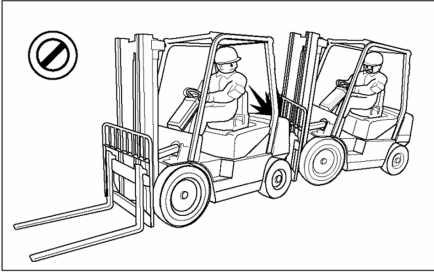

Do not operate your truck close to another truck. Always keep a safe distance from other trucks and make sure there is enough distance to stop safely. Never overtake other vehicles.



Do not use your lift truck to push or tow another truck. Do not let another push or tow your truck. If a truck will not move, call a service technician.

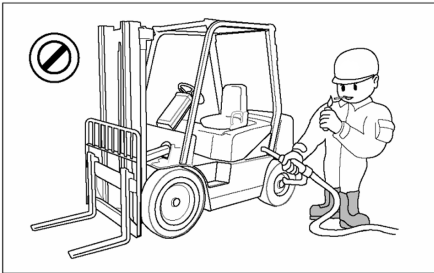

Forklift trucks may only be refueled at specially reserved locations. Switch off the engine when refueling. Smoking and handling of naked flames during refueling are strictly prohibited. This prohibition also applies during the changing of the LPG (liquefied propane gas) tank. Mop up spill fuel and do not forget to close the fuel tank before restarting the engine.

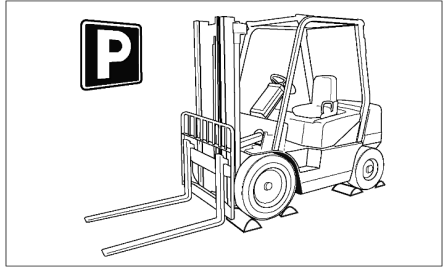

Park your lift truck in authorised areas only. Fully lower the forks to the floor, put direction lever in NEUTRAL position, engage the parking brake, and turn the key to the OFF position. Remove the key and put blocks behind the wheels to prevent the truck from rolling. Shut off your forklift truck when leaving it unattended. Check the condition of your forklift truck after the day's work.

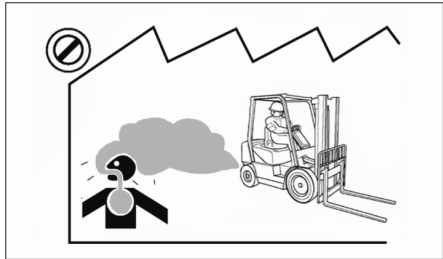

Exhaust from all internal combustion engines contains carbon monoxide, a colorless, odorless, tasteless, poisonous gas. Exposure to carbon monoxide can cause serious injury or health problems, including death, and avoid unnecessary idling of the engine. If nausea, dizziness or headaches are experienced stop the truck and seek fresh air.

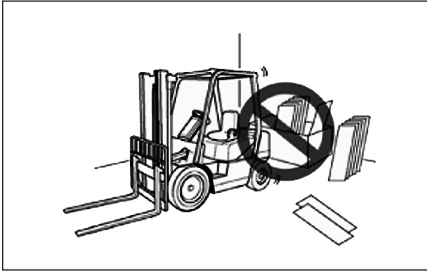

Do not operate forklifts near flammable or combustible materials.

To avoid the discoloration, deformation or combustion of materials (such as lumber, veneer board, paper products and other similar items), always park at least 30 cm (12 inches) away from them.

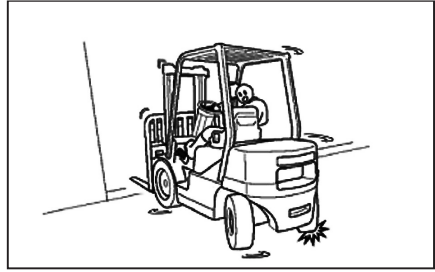

An unloaded forklift may be easier to tip over than a loaded truck.

When traveling without a load, the risk of lateral overturn is greater.

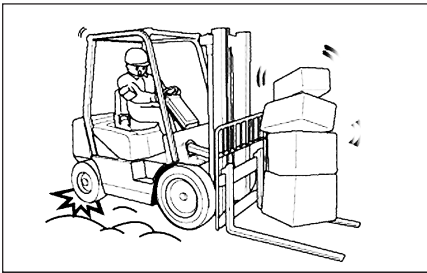

Forklift trucks are not cars. They often have small tyres, no suspension, and are very heavy.

The forklift's centre of gravity will also change when carrying loads.

Avoid uneven bumps, pot holes and other hazards whenever possible.

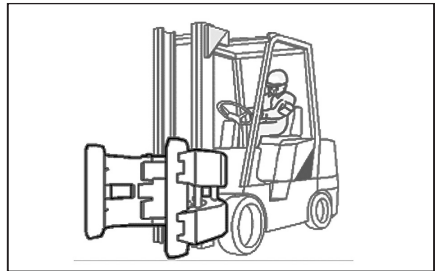

There are many special attachments available to replace the forks on a lift truck.

It is highly recommended that all the operators receive safety and special trainings.



Carrying a load suspended on a chain or a cable may unbalance a truck.

Take extra care around pedestrians with a suspended load as it may sway or even strike them.

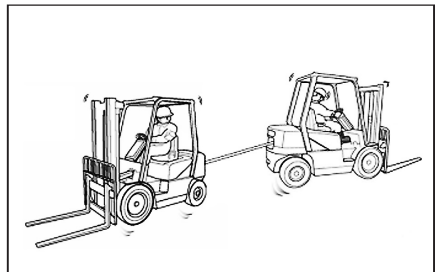

The counterweight draw bar should not be used for towing the forklift or for towing another forklift.

Towing is only advised in emergencies, by trained operators and at low speed, no faster than 2 km/h, to a convenient location for repair.

How to Survive in a Tipover

WARNING

In the event of a tipover, the risk of serious injury or death will be reduced if the operator is using the operator restraint system and follows the instructions provided.

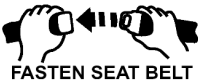

INSO046I

Always use operator restraint system.



INSO047I

DONT jump.



INSO048I

Hold on tight to the handle.



BRACE FEET

INSO049I

Spread your legs wide and secure the feet to the inner sides of the compartment.



LEAN AWAY

INSO050I

Lean away from the direction of fall.



LEAN FORWARD

INSO051I

Lean forward.

Declaration of Conformity

We,

Manufacturer

Doosan Industrial Vehicle Co., Ltd.
468, Injung-ro, Dong-gu, Incheon, Korea 22503

Authorised Representative, Compiler of Technical File According to 2006/42/EC and Keeper of Technical File According to 2000/14/EC

Doosan Industrial Vehicle Europe N.V., Mr. C. K. Chung
Europark-Noord 36 A, 9100 Sint-Niklaas, Belgium

herewith declare

that the following equipment conforms with the appropriate requirements of the Directives 2006/42/EC (Machinery Directive), Exhaust gas REGULATION (EU)2016/1628 (Stage-V), 2000/14/EC as amended by 2005/88/EC (Noise Emission in the environment by equipment for use outdoors), and 2014/30/EU (EMC Directive) based on its design and type, as brought into circulation by us

Description of the equipment:

Type : Lift Truck, Combustion-engine driven, Counterbalanced

Function : Lifting and Moving materials

Family : CD35/40/45S-9, CD50/55C-9, CD40/45/50/55SC-9 Series

Model / Commercial Name :

Serial Number :

Net installed power [kW] : 55 kW

Measured sound power level representative for this type : 99 dB(A)

Guaranteed sound power level for this equipment : 99 dB(A)

Conformity assessment procedure According to 2000/14/EC : Annex V

Applicable EC Directives : 2006/42/EC, 2014/30/EU, 2000/14/EC, (EU)2016/1628

Applicable harmonized standard : EN 16307-1;2013+A1;2015, EN ISO 3691-1;2015
EN 1175-2;1998+A1;2010, EN 1175-3;1998+A1;2010
EN 12895;2015+A1;2019

* Remark

- Tier 4 Final – Diesel : CD35S-9, CD40S-9, CD45S-9, CD50C-9, CD55C-9, CD40SC-9,
CD45SC-9, CD50SC-9, CD55SC-9 (DOOSAN DM03P engine)

Specifications

CHARACTERISTICS						
1.2	Model designation			CD35S-9	CD40S-9	
1.3	Drive: Diesel, Gasoline, LP			Diesel	Diesel	
1.4	Operator type: Hand, Pedestrian, Standing, Seated, Order-picker			Seated	Seated	
1.5	Load Capacity	Q	kg (lb)	3,500 (8,000)	4,000 (9,000)	
1.6	Load centre	C	mm (in)	600 (24)	600 (24)	
1.8	Load Distance: Centre of Driveaxle to fork	x	mm (in)	560 (22)	560 (22)	
1.9	Wheelbase	y	mm (in)	2,015 (79.5)	2,015 (79.5)	
WEIGHT						
32	Service weight			kg (lb)	5,795 (12,775)	6,100 (13,450)
33	Axle Loading, Laden Front/Rear			kg (lb)	8,390 / 905 (18,495 / 1,995)	9,115 / 985 (20,095 / 2,170)
34	Axle Loading, Unladen Front/Rear			kg (lb)	2,255 / 3,540 (4,970 / 7,805)	2,425 / 3,675 (5,345 / 8,105)
TYRES						
3.1	Tyres: pneumatic (P), superelastoc (SE), cushion (C)			P	P	
3.2	Tyre size, Front			8.25 x 15-14PR/ 7.50 x 16-12PR	300 x 15-18PR/ 7.50 x 16-12PR	
3.3	Tyre size, Rear			7.00 x 12-12PR	7.00 x 12-12PR	
3.5	Wheels, number Front/Rear (x = driven wheels)			x 2/2	x 2/2	
3.6	Tread, Front	b ₁₁	mm (in)	1,140 / 1,290 (44.9 / 50.8)	1,155 / 1,290 (45.5 / 50.8)	
3.7	Tread, Rear	b ₁₂	mm (in)	1,115 (43.9)	1,115 (43.9)	
DIMENSIONS						
4.1	Tilt of Mast/Fork carriage Forward/Backward			α/β °	8 / 10	8 / 10
4.2	Height, Mast lowered			h ₁ mm (in)	2,225 (87.6)	2,230 (87.8)
4.3	Free Lift			h ₂ mm (in)	160 (6.3)	160 (6.3)
4.4	Lift			h ₃ mm (in)	3,000 (118.1)	3,000 (118.1)
4.5	Height, Mast Extended			h ₄ mm (in)	4,265 (167.9)	4,270 (168.1)
4.7	Height of Overhead Guard (Cabin)			h ₆ mm (in)	2,225 (87.6)	2,230 (87.8)
4.8	Height of Seat			h ₇ mm (in)	1,220 (48.0)	1,225 (48.2)
4.19	Overall Length			l ₁ mm (in)	4,160 (163.8)	4,200 (165.4)
4.20	Length to Forkface			l ₂ mm (in)	2,995 (116.3)	3,000 (118.1)
4.21	Overall Width			b/b ₂ mm (in)	1,370 (53.9)	1,455 (57.3)
4.22	Fork Dimensions			s/e/l mm (in)	50 x 150 x 1,050 (2.0 x 5.9 x 41.3)	50 x 150 x 1,050 (2.0 x 5.9 x 41.3)
4.23	Fork carriage ISO 2328, class/type A,B				III	III
4.24	Fork carriage width			b ₃ mm (in)	1,250 (49.2)	1,250 (49.2)
4.31	Ground Clearance, laden, below mast			m ₁ mm (in)	150 (5.9)	160 (6.3)
4.32	Ground Clearance, centre of wheelbase			m ₂ mm (in)	205 (8.1)	205 (8.1)
4.34.1	Aisle width for pallets 1,000 x 1,200 crossways			A _{at} mm (in)	4,515 (177.8)	4,560 (179.5)
4.34.2	Aisle width for pallets 800 x 1,200 crossways			A _{at} mm (in)	4,715 (185.6)	4,760 (187.4)
4.35	Turning Radius			W _a mm (in)	2,755 (108.5)	2,800 (110.2)
4.36	Internal Turning Radius			b ₁₃ mm (in)	805 (31.7)	805 (31.7)
PERFORMANCE DATA						
5.1	Travel Speed, Laden/Unladen			km/h (mph)	24/26 (15/16)	24/26 (15 / 16)
5.2	Lift Speed, Laden/Unladen			m/s (fpm)	0.56/0.60 (109/117)	0.55/0.60 (107/117)
5.3	Lowering Speed, Laden/Unladen			m/s (fpm)	0.45/0.50 (88.5 / 98.4)	0.45/0.50 (88.5 / 98.4)
5.5	Drawbar pull, Laden/Unladen (@ 1.6 km/h)			N (lb)	34,075 (7,660)	33,540/- (7,540)
5.6	Max. Drawbar pull, Laden/Unladen			N (lb)	37,498 (8,430)	36,894/- (8,295)
5.7	Gradeability, Laden/Unladen (@ 1.6 km/h)			%	38.5	34.5
5.8	Max. Gradeability, Laden/Unladen			%	43	38.5
5.10	Service Brake				Foot/Hyd	Foot/Hyd

COMBUSTION ENGINE				
7.1	Engine Manufacturer/type		DI	DI
7.2	Engine power according to DIN ISO1585	kW (hp)	55.4 (74)	55.4 (74)
7.3	Rated Speed	min ⁻¹	2,200 ~ 2,300	2,200 ~ 2,300
7.3.1	Torque at 1/min	Nm (ft·lbs)	360 @ 1,400 (265.4)	360 @ 1,400 (265.4)
7.4	Number of Cylinders/Displacement	cc (cm ³)	4 / 3,409	4 / 3,409
7.10	Battery Voltage/normal capacity	V/Ah	12 / 100	12 / 100
ADDITION DATA				
10.1	Operating pressure for attachments	Bar (psi)	160 (2,320.5)	160 (2,320.5)
10.2	Oil volume for attachments	l/min (gpm)	110 (29.1)	110 (29.1)
10.4	Fuel Tank Capacity	l (gal)	105 (27.7)	105 (27.7)
10.7	Sound level at th driver's ear according to EN 12 053	dB (A)	79	79

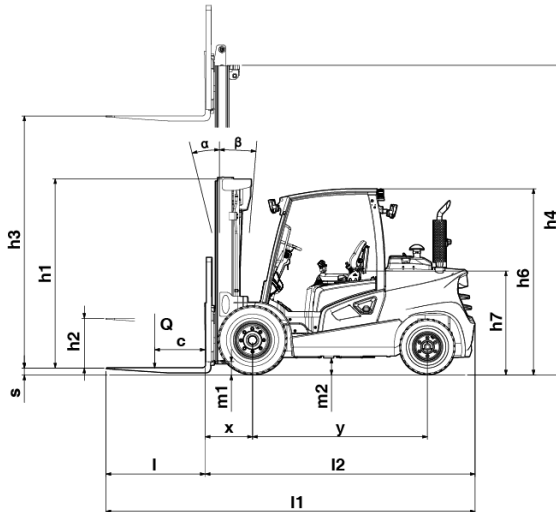
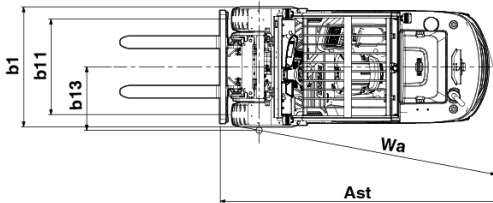

Specifications

CHARACTERISTICS						
1.2	Model designation			CD45S-9	CD50C-9	CD55C-9
1.3	Drive: Diesel, Gasoline, LP			Diesel	Diesel	Diesel
1.4	Operator type: Hand, Pedestrian, Standing, Seated, Order-picker			Seated	Seated	Seated
1.5	Load Capacity	Q	kg (lb)	4,500 (10,000)	5,000 (11,000)	5,500 (12,000)
1.6	Load centre	C	mm (in)	600 (24)	600 (24)	600 (24)
1.8	Load Distance: Centre of Driveaxle to fork	x	mm (in)	560 (22)	570(22.5)	570 (22.5)
1.9	Wheelbase	y	mm (in)	2,115 (83.3)	2,115 (83.3)	2,115 (83.3)
WEIGHT						
32	Service weight		kg (lb)	6,530 (14,395)	6,930 (15,280)	7,300 (16,095)
33	Axle Loading, Laden Front/Rear		kg (lb)	9,960 / 1,070 (21,960 / 2,360)	10,770 / 1,160 (23,745 / 2,555)	11,565 / 1,235 (25,495 / 2,720)
34	Axle Loading, Unladen Front/Rear		kg (lb)	2,630 / 3,900 (5,800 / 8,595)	2,655 / 4,275 (5,855 / 9,524)	2,705 / 4,595 (5,965 / 10,130)
TYRES						
3.1	Tyres: pneumatic (P), superelastic (SE), cushion (C)			P	P	P
3.2	Tyre size, Front			300 x 15-18PR/ 7.50 x 16-12PR	300 x 15-18PR/ 7.50 x 16-12PR	300 x 15-18PR/ 7.50 x 16-12PR
3.3	Tyre size, Rear			7.00 x 12-12PR	7.00 x 12-14PR	7.00 x 12-14PR
3.5	Wheels, number Front/Rear (x = driven wheels)			x 2/2	x 2/2	x 2/2
3.6	Tread, Front	b ₁₁	mm (in)	1,155 / 1,290 (45.5 / 50.8)	1,155 / 1,290 (45.5 / 50.8)	1,155 / 1,290 (45.5 / 50.8)
3.7	Tread, Rear	b ₁₂	mm (in)	1,115 (43.9)	1,115 (43.9)	1,115 (43.9)
DIMENSIONS						
4.1	Tilt of Mast/Fork carriage Forward/Backward	α/β	°	8 / 10	8 / 10	8 / 10
4.2	Height, Mast lowered	h ₁	mm (in)	2,230 (87.8)	2,230(87.8)	2,230 (87.8)
4.3	Free Lift	h ₂	mm (in)	160 (6.3)	170 (6.7)	170 (6.7)
4.4	Lift	h ₃	mm (in)	3,000 (118.1)	3,050 (120)	3,050 (120)
4.5	Height, Mast Extended	h ₄	mm (in)	4,420 (174.0)	4,470 (176.0)	4,470 (176.0)
4.7	Height of Overhead Guard (Cabin)	h ₆	mm (in)	2,230 (87.8)	2,230 (87.8)	2,230 (87.8)
4.8	Height of Seat	h ₇	mm (in)	1,225 (48.2)	1,225 (48.2)	1,225 (48.2)
4.19	Overall Length	l ₁	mm (in)	4,480 (176.4)	4,530 (178.4)	4,560 (179.5)
4.20	Length to Forkface	l ₂	mm (in)	3,260 (128.4)	3,300 (129.9)	3,340 (131.5)
4.21	Overall Width	b ₁ /b ₂	mm (in)	1,455 (57.3)	1,455 (57.3)	1,455 (57.3)
4.22	Fork Dimensions	s/e/l	mm (in)	50 x 150 x 1,200 (2.0 x 5.9 x 47.2)	50 x 150 x 1,200 (2.0 x 5.9 x 47.2)	50 x 150 x 1,200 (2.0 x 5.9 x 47.2)
4.23	Fork carriage ISO 2328, class/type A,B			IV	IV	IV
4.24	Fork carriage width	b ₃	mm (in)	1,330 (52.4)	1,330 (52.4)	1,330 (52.4)
4.31	Ground Clearance, laden, below mast	m ₁	mm (in)	160 (6.3)	160 (6.3)	160 (6.3)
4.32	Ground Clearance, centre of wheelbase	m ₂	mm (in)	205 (8.1)	205 (8.1)	205 (8.1)
4.34.1	Aisle width for pallets 1,000 x 1,200 crossways	A ₅₅	mm (in)	4,610 (181.5)	4,640 (182.7)	4,670 (183.9)
4.34.2	Aisle width for pallets 800 x 1,200 crossways	A ₅₅	mm (in)	4,810 (189.4)	4,840 (190.6)	4,870 (191.7)
4.35	Turning Radius	W _a	mm (in)	2,850 (112.2)	2,870 (113.0)	2,900 (114.2)
4.36	Internal Turning Radius	b ₁₃	mm (in)	820 (32.3)	820 (32.3)	820 (32.3)
PERFORMANCE DATA						
5.1	Travel Speed, Laden/Unladen		km/h (mph)	24 / 26 (15 / 16)	24 / 26 (15 / 16)	24 / 26 (15 / 16)
5.2	Lift Speed, Laden/Unladen		m/s (fpm)	0.54 / 0.60 (105 / 117)	0.53 / 0.60 (103 / 117)	0.52 / 0.60 (101 / 117)
5.3	Lowering Speed, Laden/Unladen		m/s (fpm)	0.45 / 0.50 (88.5 / 98.4)	0.45 / 0.50 (88.5 / 98.4)	0.45 / 0.50 (88.5 / 98.4)
5.5	Drawbar pull, Laden/Unladen (@ 1.6 km/h)		N (lb)	33,564 (7,545/-)	33,390 (7,505)	33,170 (7,455)
5.6	Max. Drawbar pull, Laden/Unladen		N (lb)	36,970 (8,310/-)	36,816 (8,275)	36,595 (8,225)
5.7	Gradeability, Laden/Unladen (@ 1.6 km/h)		%	31.5	28.5	26
5.8	Max. Gradeability, Laden/Unladen		%	35	31.5	29
5.10	Service Brake			Foot/Hyd	Foot/Hyd	Foot/Hyd

COMBUSTION ENGINE					
7.1	Engine Manufacturer/type		DI	DI	DI
7.2	Engine power according to DIN ISO1585	kW (hp)	55.4 (74)	55.4 (74)	55.4 (74)
7.3	Rated Speed	min ⁻¹	2,200 ~ 2,300	2,200 ~ 2,300	2,200 ~ 2,300
7.3.1	Torque at 1/min	Nm (ft·lbs)	360 @ 1,400 (265.4)	360 @ 1,400 (265.4)	360 @ 1,400 (265.4)
7.4	Number of Cylinders/Displacement	cc (cm ³)	4/3,409	4/3,409	4/3,409
7.10	Battery Voltage/normal capacity	V/Ah	12/100	12/100	12/100
ADDITION DATA					
10.1	Operating pressure for attachments	Bar (psi)	160 (2,320.5)	160 (2,320.5)	160 (2,320.5)
10.2	Oil volume for attachments	l/min (gpm)	110 (29.1)	110 (29.1)	110 (29.1)
10.4	Fuel Tank Capacity	l (gal)	105 (27.7)	119 (31.4)	119 (31.4)
10.7	Sound level at th driver's ear according to EN 12 053	dB (A)	79	79	79

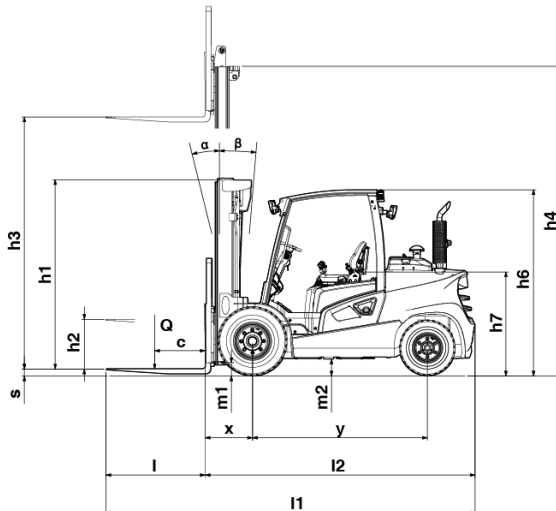
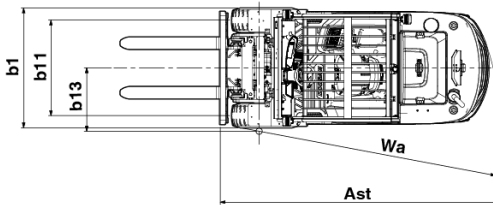

Specifications

CHARACTERISTICS					
1.2	Model designation			CD40SC-9	CD45SC-9
1.3	Drive: Diesel, Gasoline, LP			Diesel	Diesel
1.4	Operator type: Hand, Pedestrian, Standing, Seated, Order-picker			Seated	Seated
1.5	Load Capacity	Q	kg (lb)	4,500 (10,000)	5,500 (12,000)
1.6	Load centre	C	mm (in)	500 (19.7)	500 (19.7)
1.8	Load Distance: Centre of Driveaxle to fork	x	mm (in)	560 (22)	570 (22.5)
1.9	Wheelbase	y	mm (in)	2,015 (79.5)	2,115 (83.3)
WEIGHT					
2.1	Service weight		kg (lb)	5,795 (12,775)	6,100 (13,450)
2.2	Axle Loading, Laden Front / Rear		kg (lb)	8,390 / 905 (18,495 / 1,995)	9,115 / 985 (20,095 / 2,170)
2.3	Axle Loading, Unladen Front / Rear		kg (lb)	2,255 / 3,540 (4,970 / 7,805)	2,425 / 3,675 (5,345 / 8,105)
TYRES					
3.1	Tyres: pneumatic (P), superelastic (SE), cushion (C)			P	P
3.2	Tyre size, Front			8.25 x 15-14PR/ 7.50 x 16-12PR	300 x 15-18PR/ 7.50 x 16-12PR
3.3	Tyre size, Rear			7.00 x 12-12PR	7.00 x 12-12PR
3.5	Wheels, number Front / Rear (x = driven wheels)			x 2/2	x 2/2
3.6	Tread, Front	b ₁₁	mm (in)	1,140 / 1,290 (44.9 / 50.8)	1,155 / 1,290 (45.5 / 50.8)
3.7	Tread, Rear	b ₁₂	mm (in)	1,115 (43.9)	1,115 (43.9)
PERFORMANCE					
4.1	Tilt of Mast/Fork carriage Forward/Backward		α/β	°	8 / 10
4.2	Height, Mast lowered		h ₁	mm (in)	2,225 (87.6)
4.3	Free Lift		h ₂	mm (in)	160 (6.3)
4.4	Lift		h ₃	mm (in)	3,000 (118.1)
4.5	Height, Mast Extended		h ₄	mm (in)	4,265 (167.9)
4.7	Height of Overhead Guard (Cabin)		h ₆	mm (in)	2,225 (87.6)
4.8	Height of Seat		h ₇	mm (in)	1,225 (48.2)
4.19	Overall Length		l ₁	mm (in)	4,160 (163.8)
4.20	Length to Forkface		l ₂	mm (in)	2,995 (116.3)
4.21	Overall Width		b _{y/b₂}	mm (in)	1,370 (53.9)
4.22	Fork Dimensions		s/e/l	mm (in)	50 x 150 x 1,050 (2.0 x 5.9 x 41.3)
4.23	Fork carriage ISO 2328, class / type A,B			III	III
4.24	Fork carriage width		b ₃	mm (in)	1,250 (49.2)
4.31	Ground Clearance, laden, below mast		m ₁	mm (in)	150 (5.9)
4.32	Ground Clearance, centre of wheelbase		m ₂	mm (in)	205 (8.1)
4.34.1	Aisle width for pallets 1,000 x 1,200 crossways		A ₆₀	mm (in)	4,515 (177.8)
4.34.2	Aisle width for pallets 800 x 1,200 crossways		A ₆₀	mm (in)	4,715 (185.6)
4.35	Turning Radius		W _a	mm (in)	2,755 (108.5)
4.36	Internal Turning Radius		b ₁₃	mm (in)	805 (31.7)
PERFORMANCE DATA					
5.1	Travel Speed, Laden / Unladen		km/h (mph)	24 / 26 (15 / 16)	24 / 26 (15 / 16)
5.2	Lift Speed, Laden / Unladen		m/s (fpm)	0.56 / 0.60 (109/117)	0.55 / 0.60 (107 / 117)
5.3	Lowering Speed, Laden / Unladen		m/s (fpm)	0.45 / 0.50 (88.5 / 98.4)	0.45 / 0.50 (88.5 / 98.4)
5.5	Drawbar pull, Laden / Unladen (@ 1.6 km/h)		n (lb)	34,075 (7,660)	33,540 (7,540)
5.6	Max. Drawbar pull, Laden / Unladen		v (lb)	37,498 (8,430)	36,894 (8,295)
5.7	Gradeability, Laden / Unladen (@ 1.6 km/h)		%	38.5	34.5
5.8	Max. Gradeability, Laden / Unladen		%	43	38.5
5.10	Service Brake			Foot / Hyd	Foot / Hyd

COMBUSTION ENGINE				
7.1	Engine Manufacturer/type		DI	DI
7.2	Engine power according to DIN ISO1585	kW (hp)	55.4 (74)	55.4 (74)
7.3	Rated Speed	min ⁻¹	2,200 ~ 2,300	2,200 ~ 2,300
7.3.1	Torque at 1/min	Nm (ft·lbs)	360 @ 1,400 (265.4)	360 @ 1,400 (265.4)
7.4	Number of Cylinders/Displacement	cc (cm ³)	4 / 3,409	4 / 3,409
7.10	Battery Voltage/normal capacity	V/Ah	12 / 100	12 / 100
ADDITION DATA				
10.1	Operating pressure for attachments	Bar (psi)	160 (2,320.5)	160 (2,320.5)
10.2	Oil volume for attachments	l/min (gpm)	110 (29.1)	110 (29.1)
10.4	Fuel Tank Capacity	l (gal)	105 (27.7)	105 (27.7)
10.7	Sound level at th driver's ear according to EN 12 053	dB (A)	79	79

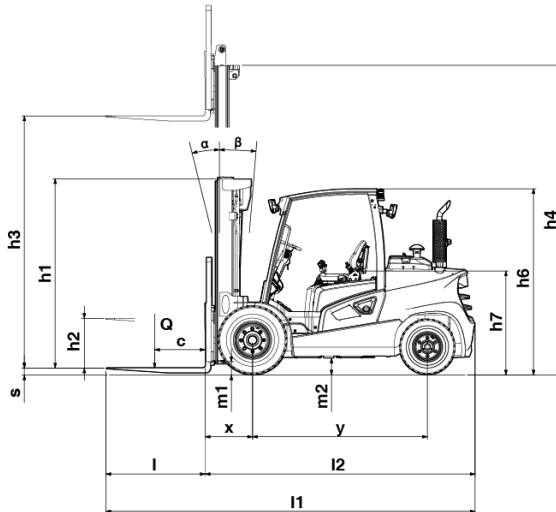
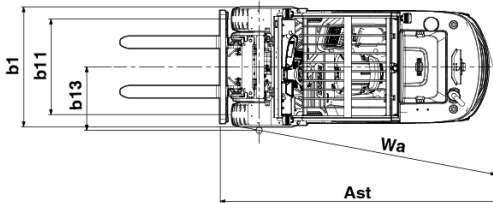

Specifications

CHARACTERISTICS					
1.2	Model designation			CD50SC-9	CD55SC-9
1.3	Drive: Diesel, Gasoline, LP			Diesel	Diesel
1.4	Operator type: Hand, Pedestrian, Standing, Seated, Order-picker			Seated	Seated
1.5	Load Capacity	Q	kg (lb)	5,000 (11,000)	5,500 (12,000)
1.6	Load centre	C	mm (in)	500 (19.7)	500 (19.7)
1.8	Load Distance: Centre of Driveaxle to fork	x	mm (in)	560 (22)	570 (22.5)
1.9	Wheelbase	y	mm (in)	2,115 (83.3)	2,115 (83.3)
WEIGHT					
2.1	Service weight		kg (lb)	6,530 (14,395)	6,930 (15,280)
2.2	Axle Loading, Laden Front / Rear		kg (lb)	9,960 / 1,070 (21,960 / 2,360)	10,770 / 1,160 (23,745 / 2,555)
2.3	Axle Loading, Unladen Front / Rear		kg (lb)	2,630 / 3,900 (5,800 / 8,595)	2,655 / 4,275 (5,855 / 9,524)
TYRES					
3.1	Tyres: pneumatic (P), superelastic (SE), cushion (C)			P	P
3.2	Tyre size, Front			300 x 15-18PR /7.50 x 16-12PR	300 x 15-18PR/ 7.50 x 16-12PR
3.3	Tyre size, Rear			7.00 x 12-12PR	7.00 x 12-14PR
3.5	Wheels, number Front / Rear (x = driven wheels)			x 2/2	x 2/2
3.6	Tread, Front	b ₁₁	mm (in)	1,155 / 1,290 (45.5 / 50.8)	1,155 / 1,290 (45.5 / 50.8)
3.7	Tread, Rear	b ₁₂	mm (in)	1,115 (43.9)	1,115 (43.9)
PERFORMANCE					
4.1	Tilt of Mast/Fork carriage Forward/Backward	α/β	°	8 / 10	8 / 10
4.2	Height, Mast lowered	h ₁	mm (in)	2,230 (87.8)	2,230 (87.8)
4.3	Free Lift	h ₂	mm (in)	160 (6.3)	170 (6.7)
4.4	Lift	h ₃	mm (in)	3,000 (118.1)	3,050 (120)
4.5	Height, Mast Extended	h ₄	mm (in)	4,420 (174.0)	4,470 (176.0)
4.7	Height of Overhead Guard (Cabin)	h ₆	mm (in)	2,230 (87.8)	2,230 (87.8)
4.8	Height of Seat	h ₇	mm (in)	1,225 (48.2)	1,225 (48.2)
4.19	Overall Length	l ₁	mm (in)	4,480 (176.4)	4,530 (178.4)
4.20	Length to Forkface	l ₂	mm (in)	3,260 (128.4)	3,300 (129.9)
4.21	Overall Width	b ₁ /b ₂	mm (in)	1,455 (57.3)	1,455 (57.3)
4.22	Fork Dimensions	s/e/l	mm (in)	50 x 150 x 1,200 (2.0 x 5.9 x 47.2)	50 x 150 x 1,200 (2.0 x 5.9 x 47.2)
4.23	Fork carriage ISO 2328, class / type A,B			IV	IV
4.24	Fork carriage width	b ₃	mm (in)	1,330 (52.4)	1,330 (52.4)
4.31	Ground Clearance, laden, below mast	m ₁	mm (in)	160 (6.3)	160 (6.3)
4.32	Ground Clearance, centre of wheelbase	m ₂	mm (in)	205 (8.1)	205 (8.1)
4.34.1	Aisle width for pallets 1,000 x 1,200 crossways	A _{st}	mm (in)	4,610 (181.5)	4,640 (182.7)
4.34.2	Aisle width for pallets 800 x 1,200 crossways	A _{st}	mm (in)	4,810 (189.4)	4,840 (190.6)
4.35	Turning Radius	W _a	mm (in)	2,850 (112.2)	2,870 (113.0)
4.36	Internal Turning Radius	b ₁₃	mm (in)	820 (32.3)	820 (32.3)
PERFORMANCE DATA					
5.1	Travel Speed, Laden / Unladen		km/h (mph)	24 / 26 (15 / 16)	24 / 26 (15 / 16)
5.2	Lift Speed, Laden / Unladen		m/s (fpm)	0.54 / 0.60 (105 / 117)	0.53 / 0.60 (103 / 117)
5.3	Lowering Speed, Laden / Unladen		m/s (fpm)	0.45 / 0.50 (88.5 / 98.4)	0.45 / 0.50 (88.5 / 98.4)
5.5	Drawbar pull, Laden / Unladen (@ 1.6 km/h)		n (lb)	33,564 (7,545)	33,390 (7,505)
5.6	Max. Drawbar pull, Laden / Unladen		v (lb)	36,970 (8,310)	36,816 (8,275)
5.7	Gradeability, Laden / Unladen (@ 1.6 km/h)		%	31.5	28.5
5.8	Max. Gradeability, Laden / Unladen		%	35	31.5
5.10	Service Brake			Foot / Hyd	Foot / Hyd

COMBUSTION ENGINE				
7.1	Engine Manufacturer/type		DI	DI
7.2	Engine power according to DIN ISO1585	kW (hp)	55.4 (74)	55.4 (74)
7.3	Rated Speed	min ⁻¹	2,200 ~ 2,300	2,200~2,300
7.3.1	Torque at 1/min	Nm (ft·lbs)	360 @ 1,400(265.4)	360 @ 1,400 (265.4)
7.4	Number of Cylinders/Displacement	cc (cm ³)	4 / 3,409	4 / 3,409
7.10	Battery Voltage/normal capacity	V/Ah	12 / 100	12 / 100
ADDITION DATA				
10.1	Operating pressure for attachments	Bar (psi)	160 (2,320.5)	160 (2,320.5)
10.2	Oil volume for attachments	l/min (gpm)	110 (29.1)	110 (29.1)
10.4	Fuel Tank Capacity	l (gal)	119 (31.4)	119 (31.4)
10.7	Sound level at th driver's ear according to EN 12 053	dB (A)	79	79

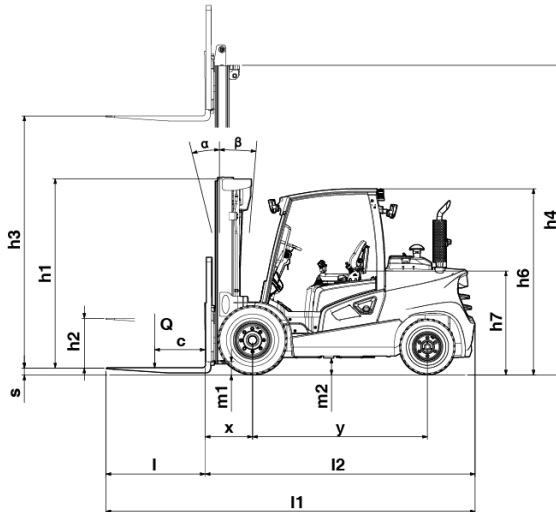
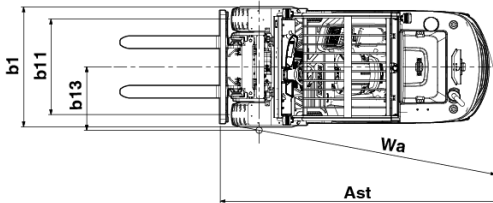

Noise and Vibration

Noise

Model	Noise Level [Unit : dB(A)]
	Sound Pressure Level at Operator's ear (Leq.)
	prEN12053
CD35/40/45S-9, CD50/55C-9 CD40/45/50/55SC-9 (Cabin)	80.6
CD35/40/45S-9, CD50/55C-9 CD40/45/50/55SC-9 (OVHG)	76.4

Vibration (weighted overall value)

Unit : m/sec²

Model	Measuring place		
	Seat	Steering Wheel	Floor Plate
CD35/40/45S-9, CD50/55C-9 CD40/45/50/55SC-9 (DM03V, DM03P)	0.08	1.19	0.1

Capacity Chart

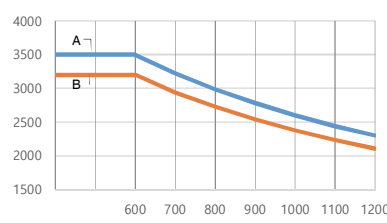
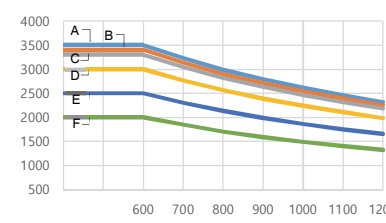
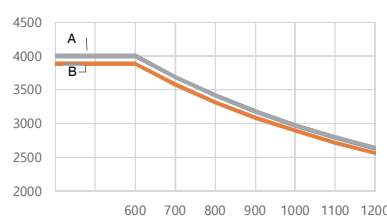
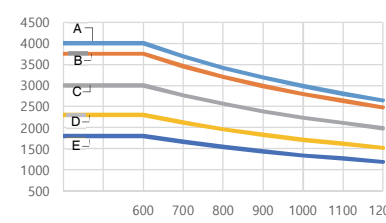
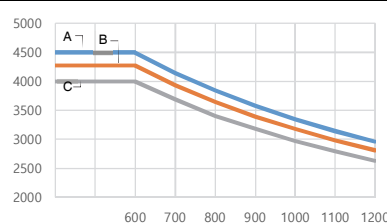
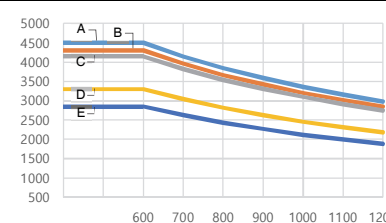
Model	SINGLE TYRE	SINGLE TYRE
	STD, FFL	FFT
CD35S-9	 <p>A. 3000/3300/3650/4000/4250/4850mm B. 5250mm</p>	 <p>A. 4000/4250/4500/4700mm B. 5150mm C. 5600mm D. 6050mm E. 6500mm F. 7000mm</p>
	 <p>A. 3000/3300/3650/4000/4250/4850mm B. 5250mm</p>	 <p>A. 4000/4250/4500/4700/5150mm B. 5600mm C. 6050mm D. 6500mm E. 7000mm</p>
CD45S-9	 <p>A. 3000/3300/3450/3650/4000/4250mm B. 4850mm C. 5500mm</p>	 <p>A. 3700/4000/4250/4500/4700mm B. 5150mm C. 5600mm D. 6050mm E. 6500mm</p>

Capacity Chart

Model	SINGLE TYRE	SINGLE TYRE
	STD, FFL	FFT
CD50C-9	<p>A. 3000/3300/3450/3650/4000mm B. 4250mm C. 4850mm D. 5500mm</p>	<p>A. 3575/3875/4125/4575mm B. 5025mm C. 5325mm D. 5475mm E. 5925mm</p>
	<p>A. 2750/3050/3400/3750/4000/4600/5000mm B. 5500mm C. 5800mm</p>	<p>A. 3575/3875/4125/4575mm B. 5025mm C. 5325mm D. 5475mm E. 5925mm</p>

Capacity Chart

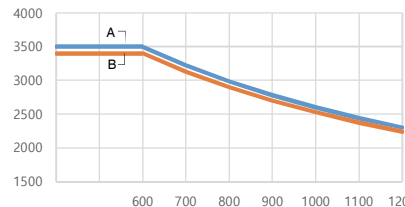
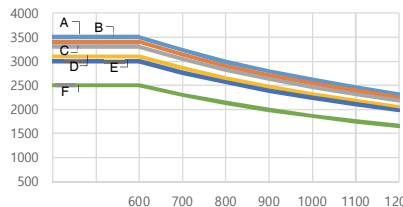
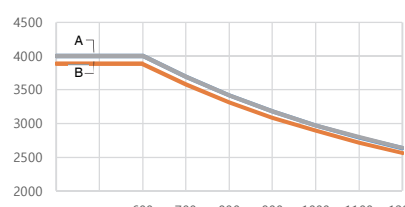
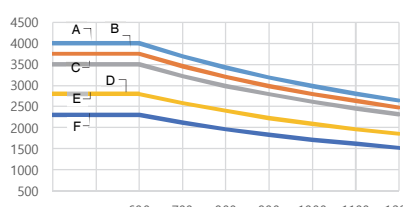
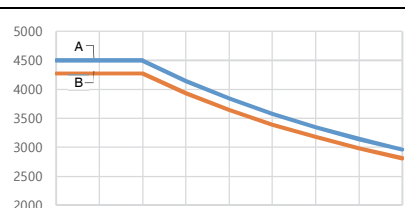
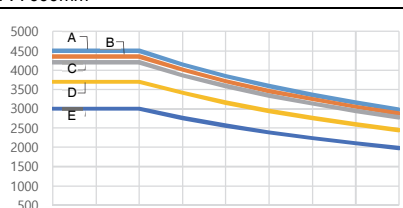
Model	DOUBLE TYRE	DOUBLE TYRE
	STD, FFL	FFT
CD35S-9	 <p>A. 3000/3300/3650/4000/4250/4850mm B. 5250mm</p>	 <p>A. 4000/4250/4500/4700mm B. 5150mm C. 5600mm D. 6050mm E. 6500mm F. 7000mm</p>
	 <p>A. 3000/3300/3650/4000/4250/4850mm B. 5250mm</p>	 <p>A. 4000/4250/4500/4700mm B. 5150mm C. 5600mm D. 6050mm E. 6500mm F. 7000mm</p>
CD45S-9	 <p>A. 3000/3300/3450/3650/4000/4250/4850mm B. 5500mm</p>	 <p>A. 3700/4000/4250/4500/4700mm B. 5150mm C. 5600mm D. 6050mm E. 6500mm</p>

Capacity Chart

Model	DOUBLE TYRE	DOUBLE TYRE
	STD, FFL	FFT
CD50C-9	<p>A. 2750/3050/3400/3750/4000mm B. 4600mm C. 5000mm D. 5500mm E. 5800mm</p>	<p>A. 3575/3875/4125/4575mm B. 5025mm C. 5325mm D. 5475mm E. 5925mm</p>
	<p>A. 2750/3050/3400/3750/4000/4600mm B. 5000mm C. 5500mm D. 5800mm</p>	<p>A. 3575/3875/4125/4575mm B. 5025mm C. 5325mm D. 5475mm E. 5925mm</p>

Capacity Chart

Model	SINGLE TYRE	
	STD, FFL	FFT
CD40SC-9	<p>A. 3000/3300/3650/4000/4250mm B. 4850mm C. 5250mm</p>	<p>A. 4000/4250mm B. 4500mm C. 4700mm D. 5150mm E. 5600mm F. 6050mm G. 6500mm H. 7000mm</p>
CD45SC-9	<p>A. 3000/3300/3650/4000/4250mm B. 4850mm C. 5250mm</p>	<p>A. 4000/4250mm B. 4500mm C. 4700mm D. 5150mm E. 5600mm F. 6050mm G. 6500mm H. 7000mm</p>
CD50SC-9	<p>A. 3000/3300/3450/3650/4000mm B. 4250mm C. 4850mm D. 5500mm</p>	<p>A. 3700/4000mm B. 4250mm C. 4500mm D. 4700mm E. 5150mm F. 5600mm G. 6050mm H. 6500mm</p>

Capacity Chart

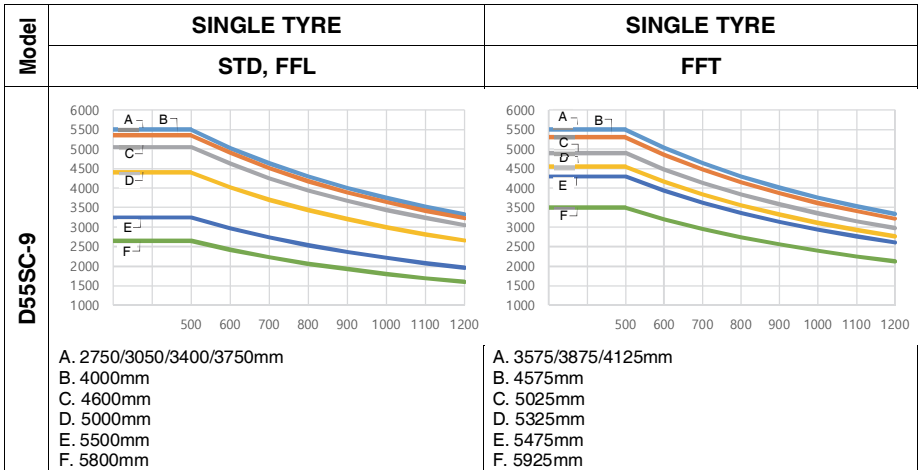

Capacity Chart

Model	DOUBLE TYRE	
	STD, FFL	FFT
CD40SC-9	<p>A. 3000/3650/4000/4250mm B. 4850mm C. 5250mm</p>	<p>A. 4000/4250/4500/4700mm B. 5150mm C. 5600mm D. 6050mm E. 6500mm F. 7000mm</p>
	<p>A. 3000/3300/3650/4000/4250mm B. 4850mm C. 5250mm</p>	<p>A. 4000/4250/4500mm B. 4700mm C. 5150mm D. 5600mm E. 6050mm F. 6500mm G. 7000mm</p>
CD50SC-9	<p>A. 3000/3300/3450/3650/4000/4250mm B. 4850mm C. 5500mm</p>	<p>A. 3700/4000/4250/4500mm B. 4700mm C. 5150mm D. 5600mm E. 6050mm F. 6500mm</p>

Capacity Chart

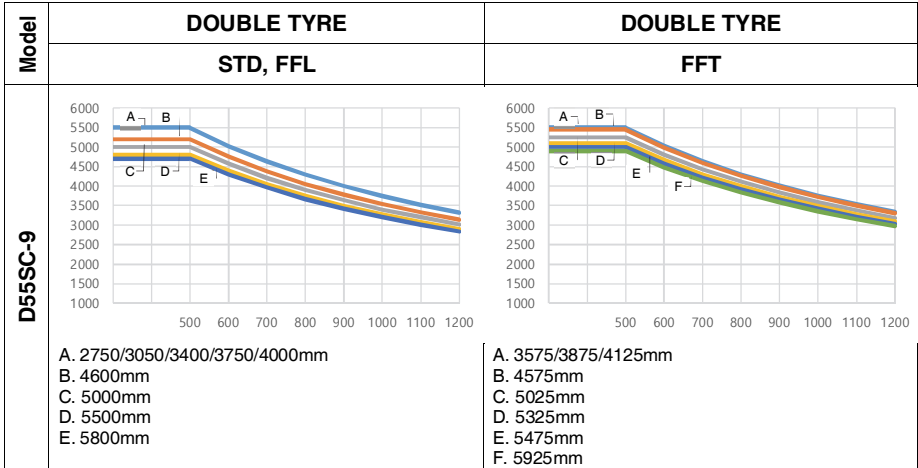

Capacity Chart (with Side Shifter)

Model	SINGLE TYRE	SINGLE TYRE
	STD, FFL	FFT
CD35S-9	<p>A. 3000/3300/3650/4000/4250mm B. 5250mm</p>	<p>A. 4000/4250mm B. 4500/4700mm C. 5150mm D. 5600mm E. 6050mm F. 6500mm G. 7000mm</p>
	<p>A. 3000/3300/3650/4000/4250mm B. 4850mm C. 5250mm</p>	<p>A. 4000/4250mm B. 4500/4700mm C. 5150mm D. 5600mm E. 6050mm F. 6500mm G. 7000mm</p>
CD45S-9	<p>A. 3000/3300/3450/3650/4000/4250mm B. 4850mm C. 5500mm</p>	<p>A. 3700/4000/4250mm B. 4500mm C. 4700mm D. 5150mm F. 5600mm G. 6050mm H. 6500mm</p>

Capacity Chart (with Side Shifter)

Model	SINGLE TYRE	SINGLE TYRE
	STD, FFL	FFT
CD50C-9	<p>A. 2750/3050/3400/3750/4000mm B. 4600mm C. 5000mm D. 5500mm E. 5800mm</p>	<p>A. 3575/3875/4125mm B. 4575mm C. 5025mm D. 5325mm E. 5475mm F. 5925mm</p>
	<p>A. 2750/3050/3400/3750/4000mm B. 4600mm C. 5000mm D. 5500mm E. 5800mm</p>	<p>A. 3575/3875/4125mm B. 4575mm C. 5025mm D. 5325mm E. 5475mm F. 5925mm</p>

Capacity Chart (with Side Shifter)

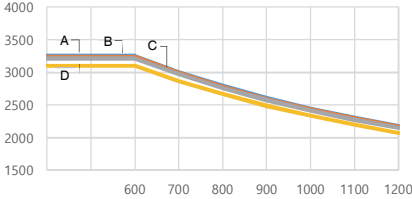
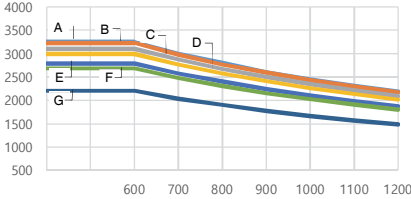
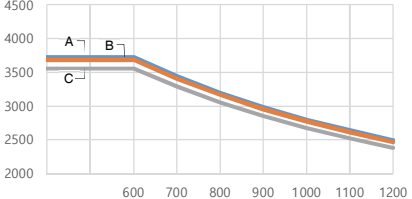
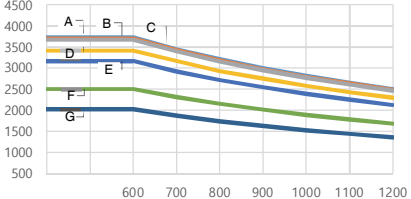
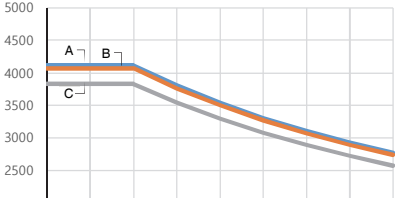
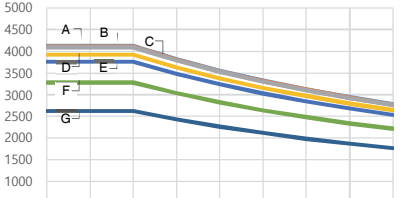
Model	DOUBLE TYRE	DOUBLE TYRE
	STD, FFL	FFT
CD35S-9	 <p>A. 3000 / 3300 / 3650 / 4000mm B. 4250mm C. 4850mm D. 5250mm</p>	 <p>A. 4000/4250mm B. 4500/4700mm C. 5150mm D. 5600mm E. 6050mm F. 6500mm G. 7000mm</p>
	 <p>A. 3000/3300/3650/4000/4250mm B. 4850mm C. 5250mm</p>	 <p>A. 4000/4250mm B. 4500/4700mm C. 5150mm D. 5600mm E. 6050mm F. 6500mm G. 7000mm</p>
CD45S-9	 <p>A. 3000/3300/3450/3650/4000/4250mm B. 4850mm C. 5500mm</p>	 <p>A. 3700/4000mm B. 4250mm C. 4500/4700mm D. 5150mm E. 5600mm F. 6050mm G. 6500mm</p>

Capacity Chart (with Side Shifter)

Model	DOUBLE TYRE	DOUBLE TYRE
	STD, FFL	FFT
CD50C-9	<p>A. 2750/3050/3400/3750/4000mm B. 4600mm C. 5000mm D. 5500mm E. 5800mm</p>	<p>A. 3575/3875/4125mm B. 4575mm C. 5025mm D. 5325mm E. 5475mm F. 5925mm</p>
	<p>A. 2750/3050/3400/3750/4000mm B. 4600mm C. 5000mm D. 5500mm E. 5800mm</p>	<p>A. 3575/3875/4125mm B. 4575mm C. 5025mm D. 5325mm E. 5475mm F. 5925mm</p>

Capacity Chart (with Side Shifter)

Model	SINGLE TYRE	SINGLE TYRE
	STD, FFL	FFT
CD40SC-9	<p>A. 3000/3300/3650/4000mm B. 4250mm C. 4850mm D. 5250mm</p>	<p>A. 4000/4250mm B. 4500mm C. 4700mm D. 5150mm E. 5600mm F. 6050mm G. 6500mm H. 7000mm</p>
	<p>A. 3000/3300/3650/4000/4250mm B. 4850mm C. 5250mm</p>	<p>A. 4000/4250mm B. 4500mm C. 4700mm D. 5150mm E. 5600mm F. 6050mm G. 6500mm H. 7000mm</p>
CD50SC-9	<p>A. 3000/3300/3450/3650/4000mm B. 4250mm C. 4850mm D. 5500mm</p>	<p>A. 3700/4000mm B. 4250mm C. 4500mm D. 4700mm E. 5150mm F. 5600mm G. 6050mm H. 6500mm</p>

Capacity Chart (with Side Shifter)

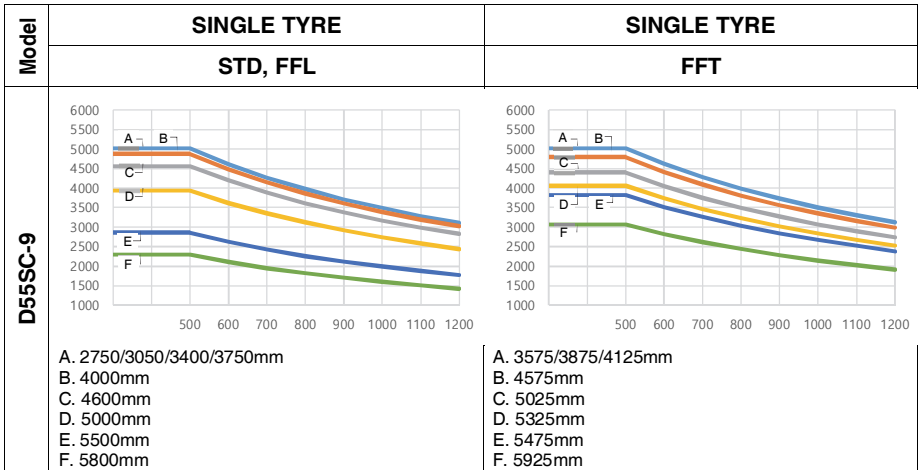

Capacity Chart (with Side Shifter)

Model	DOUBLE TYRE	
	STD, FFL	FFT
CD40SC-9	<p>A. 3000/3300/3650/4000mm B. 4250mm C. 4850mm D. 5250mm</p>	<p>A. 4000/4250mm B. 4500mm C. 4700mm D. 5150mm E. 5600mm F. 6050mm G. 6500mm H. 7000mm</p>
CD45SC-9	<p>A. 3000/3300/3650/4000/4250mm B. 4850mm C. 5250mm</p>	<p>A. 4000/4250/4500mm B. 4700mm C. 5150mm D. 5600mm E. 6050mm F. 6500mm G. 7000mm</p>
CD50SC-9	<p>A. 3000/3300/3450/3650/4000mm B. 4250mm C. 4850mm D. 5500mm</p>	<p>A. 3700/4000mm B. 4250mm C. 4500mm D. 4700mm E. 5150mm F. 5600mm G. 6050mm H. 6500mm</p>

Capacity Chart (with Side Shifter)

Model	DOUBLE TYRE	DOUBLE TYRE
	STD, FFL	FFT
D55SC-9	<p>A. 2750/3050/3400/3750/4000mm B. 4600mm C. 5000mm D. 5500mm E. 5800mm</p>	<p>A. 3575/3875/4125mm B. 4575mm C. 5025mm D. 5325mm E. 5475mm F. 5925mm</p>

Mast Abbreviations

STD - Standard Mast (single inner member, low free lift)

FF - Full Free Lift Mast (single inner member with high free lift duplex cylinder)

FFT - Triple Lift Mast (two inner members) with either low or full free lift characteristics.

QUAD - Quadruple (Quad) Mast (with three inner members)

NOTE: When only a mast-type is listed on the identification plate, a standard carriage and forks are used.

Attachment Abbreviations (Includes Special Forks)

SC - Special Carriage-increased width, height or outreach

SSS - Shaft-type Sideshift Carriage

HSS - Hook-type Sideshift Carriage (ITA)

CW - Counterweight

SF - Special Forks

SWS - Swing Shift, Sideshift

RAM - Ram or Boom

DBCBH - Double Cube Block Handler

HFP - Hydraulic Fork Positioner

CR - Crane Arm or Crane Boom

TH - Tyre Handler

CTH - Container Handler

LPP - Load Push-Pull Device

CC - Carton Clamp

RC - Roll Clamp

LS - Load Stabiliser

PWH - Pulp Wood Handler

SS-ST - Sideshift-Side Tilt Carriage

Operator's Station and Monitoring Systems

Instrument Panel

Your lift truck may not have the same indicator or warning lights as shown in the illustrations.

However, the symbols on the indicators and lights on your panel identify what those particular items are.

Also, the symbol for each of the items is identified and an explanation of their function and location is described on the following pages.



- | | |
|---|---|
| 1. Diesel Engine Water in Fuel Filter Indicator Light | 16. ECT Warning Lamp |
| 2. Alternator Indicator Light | 17. Engine Oil Pressure Warning Lamp |
| 3. Diesel Engine Start Preheat Indicator Light | 18. Fuel Warning Lamp |
| 4. Fuel Level Gauge | 19. Speedometer |
| 5. Engine Coolant Temperature Gauge | 20. Odometer |
| 6. Transmission Oil Temperature Gauge | 21. Engine rpm gauge |
| 7. Engine Malfunction Indicator Light (MIL) | 22. Vehicle mode |
| 8. Seat Belt Warning Light (If Equipment) | 23. T/M gear inform |
| 9. Service Hour Meter | 24. After treatment indicator(After treatment only) |
| 10. Parking Indicator Light | 25. Regen gauge (After treatment only) |
| 11. Front Floodlights | 26. Clock |
| 12. Transmission Neutral Position Light | 27. Weight scale indicator (Optional) |
| 13. Mast Interlock | 28. Speed limit indicator |
| 14. Directional Turning Indicator Light | |
| 15. Brake Oil Level | |



1. Diesel Engine Water in Fuel Filter Indicator Light - Indicates when the engine is running, there is water in the fuel filter exceeds 100cc.

The light will come ON when the ignition switch is turned to the ON position. The light should go off after the engine is started. If the light turns on with the engine running, park the lift truck and stop the engine. Drain some fuel (and any water) until clean fuel flows from the filter which approximately takes 5 to 6 seconds



2. Alternator Indicator Light - Indicates if the battery charging system is operational. The light will come on when the ignition switch is turned to the ON position.

The light should go off after the engine is started, indicating the alternator is producing sufficient voltage to charge the battery. If the light turns on with the engine running, check the alternator charging system for a malfunction.



3. Diesel Engine Start Preheat Indicator Light - The light will come ON when the key is turned to the ON position from the OFF position. This indicates that the glow plugs are preheating the pre-combustion chambers for easier starting.

The amount of time needed to preheat the pre-combustion chambers is approximately seven seconds, depending on the surrounding air temperature. When the light goes OFF the maximum pre-combustion chamber temperature has been reached and the key can be turned to the START position to start the engine.



4. Fuel Level Gauge - Shows current level of the fuel in the fuel tank. Replenish fuel when the Level Gauge indicates "E" during the forklift operation.

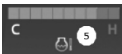

5. Engine Coolant Temperature Gauge - Indicates coolant temperature. Shows current temperature of the engine coolant. If the gauge pointer moves beyond the red band during the operation, the engine is overheated. Park the lift truck and stop the engine.

Check the cooling system for any defect. The pointer will be in the red band when the coolant temperature reaches approximately 110 °C on all engines.



6. Transmission Oil Temperature Gauge - Shows transmission oil temperature. If the gauge pointer moves beyond the red band during operation, the engine is overheated. Park the lift truck and stop the engine. Check the system for any defect. The pointer will be in the red band when the transmission oil temperature reaches approximately 125 °C.



7. Engine Malfunction Indicator Light (MIL)

- Engine control system is equipped with built-in fault diagnostics. Detected system faults can be displayed by the Malfunction Indicator Lamp (MIL) as Diagnostic Fault Codes (DFC) or flash codes, and viewed in detail with the use of service tool software. When the ignition key is turned ON the MIL will perform a self-test, illuminate once and then go OFF. If a detected fault condition exists, the fault or faults will be stored in the memory of the engine control unit (ECM). Once a fault occurs the MIL will light up and remain ON. This signals the operator that a fault has been detected by the SCEM.

To check the problem, hold the mode switch pressed for 3 seconds. When the display shows the main menu, select Check. Refer to topic "Operation Section - After Starting the Engine - Electronic Controlled Diesel Engines".



8. Seat Belt Warning Light (If Equipment)

Indicates when the seat belt dose not fastened by operator.

The light will come on when the ignition switch is turned to the on position.

The light should go off after engine is started.



9. Service hour Meter - Indicates the total

number of hours the engine and the lift truck have operated. The hour meter will operate when the ignition switch is in the ON position, whether the engine is running or not. The hour meter is used to determine lubrication and maintenance intervals.



10. Parking indicator light - The light will come ON when the parking switch is applied.



11. Front Floodlights - Push down on the switch (14), to the first step, to turn the front floodlights on.

Front and Rear Floodlights – Push down on the switch (14), to the second step, to turn both the front and rear floodlights on. The floodlights are optional.



12. Transmission Neutral Position Light -

Indicates the neutral position of transmission.



13. Mast interlock – Alarm warning lights when operator leaves the seat without applying parking brake and then, operation of mast is automatically interrupted.



14. Directional Turning Indicator Light



15. Brake oil level – Brake oil level Lamp indicates when the brake oil level is low.



16. ECT Malfunction Warning Lamp (if installed) – electronic transmission control system has a built-in diagnosis system. If a failure occurs, the electronic transmission control system reports the operator of the failure code by the number of flashes with the malfunction warning lamp.



17. Engine oil pressure warning lamp – The warning lamp will light up if the engine oil is short or the pressure is low.



18. Fuel warning lamp – The warning lamp will light up to warn the operator to refuel.



19. Speedometer – Shows vehicle speed

ODO

20. Odometer – Shows vehicle run time



21. Engine rpm gauge – Shows engine rpm speed

STANDARD

22. Vehicle mode – Shows Vehicle mode (High, Standard, ECO)

2F

23. T/M Gear inform – Shows T/M Gear state



24. After treatment indicator – Shows After treatment warning and inform.

When this warning lamp is on, refer to topic “operation section - after starting the engine - Electronic Controlled Diesel Engines.

- 1) SCR fault warning lamp: When the first lamp is on, check the SCR system.
- 2) SCR cleaning lamp: The SCR system shall be initialized on a regular basis to maintain the emission purification efficiency at an adequate level. This process is called SCR cleaning. When the second lamp is on, start the SCR cleaning process, during which the vehicle shall not be used. The lamp lights up with a message popping up 10 hours prior to the required timing of SCR

cleaning. The cleaning process takes about 30 minutes, with this lamp flickering. Press the cleaning switch for about 3 seconds to start the cleaning process.

- 3) High-temperature exhaust lamp: During SCR cleaning the temperature of exhaust emissions exceeds 600°C. When this lamp light on, the operator shall warn other people around not to approach the vehicle or touch the exhaust system, particularly at the back of the vehicle. If there is any flammable substance such as gas or particles around the vehicle, move it to a safe place.
- 4) SCR cleaning inhibition lamp: One you press the inhibition switch, this lamp lights up and the SCR process is suspended. When in a place with flammable substances or dust, you shall press the inhibition switch to prevent any fire or explosion that can be caused by high temperature emissions.



25. Regen gauge – Shows DPF Soot or DeSox Level

12:34

26. Clock – Shows Time



27. Weight scale indicator (Optional) – Shows weight and over weight warning

10

28. Speed limit indicator – Shows limit speed



29. Air cleaner indicator – If it on, need to change the air filter

Display Cluster

Display



- 1) SCR device warning display information.
- 2) Weight information on the weight scale (Option).
- 3) SCR cleaning warning display and guideline.
- 4) Urea residual quantity warning display and guideline.
- 5) Engine check warning lamp.
- 6) Speed limit setting speed (the lamp comes ON when it is set up).
- 7) Menu button.
- 8) UP button.
- 9) Down button.
- 10) Enter button.
- 11) Rear view camera operation button (manual).

Menu - Vehicle

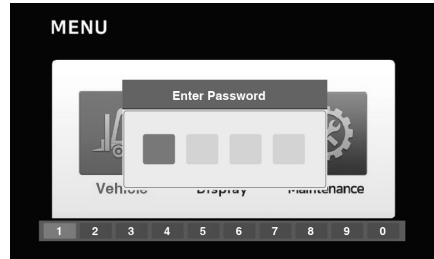

The password needs to be entered.
The initial password is 1111.

Menu - Vehicle - Model

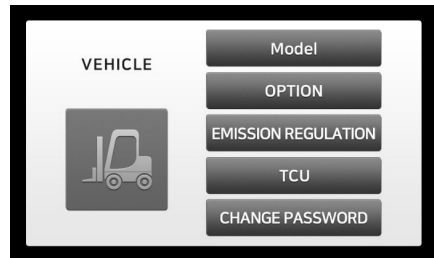

Menu

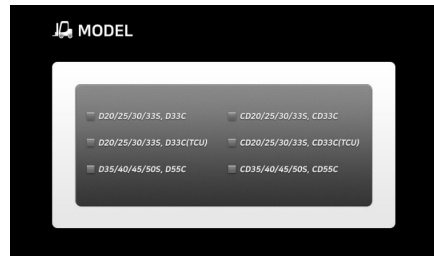

Consists of the CROWN model and the Crown model.
Upon selecting either model, the corresponding brand logo will be displayed at the time of initial starting.

Menu - Vehicle - Option



Menu - Vehicle - Option - Multi Torque



ECO: Fuel economy operation mode.
STANDARD: Ordinary operation mode.
HIGH: Heavy duty operation mode.

Menu - Vehicle - Option - T/M Option

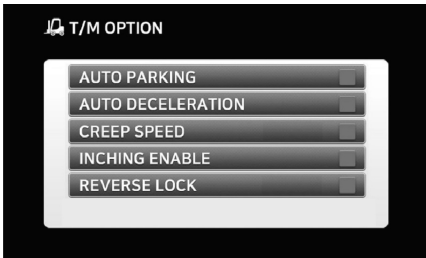

The electronic transmission option can be selected.

Auto parking: When the vehicle's speed is 0km/h, Parking turns ON.

Auto speed reduction: When the accelerator pedal is released, the speed is reduced. The vehicle can be stopped faster compared to no-load neutral operation.

Ultra low speed setup: The vehicle can be operated at a lower speed than at the engine idle speed.

Inching activation: Inching pedal ON/OFF.

Forward/backward switch control: As the transmission may be damaged in the case of forward/backward switching during a high-speed operation, a specific speed can be set so that

forward/backward switching is only possible at the selected speed.

Menu - Vehicle - Option - Pin Code Access

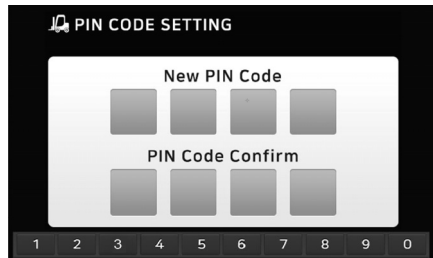
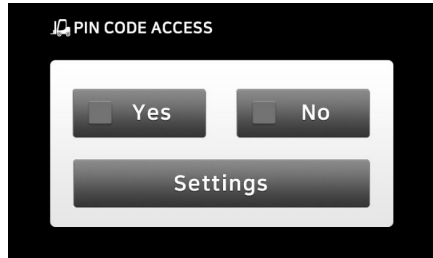

The anti-theft function allows vehicle start-up only after entering the password.

Menu - Vehicle - Option - Speed Limitation

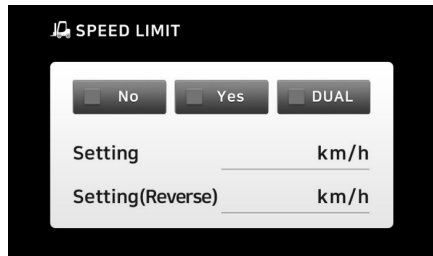

This function limits the maximum vehicle speed to the setting speed; and forward/backward speeds are identical in the case of regular setting, whereas forward/backward speeds differ in the case of dual setting.

Menu - Vehicle - Option - Weight Scale



There are three sub-menus: (No load setting, load setting, rated load setting).

Menu - Vehicle - Option - Seat Belt Interlock

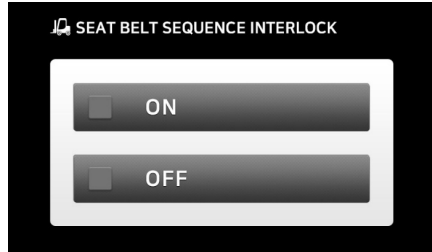

This safety function enables operation only when the seat is occupied and the safety belt is on.

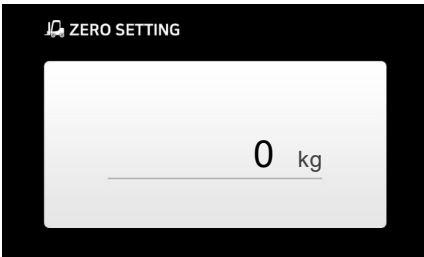

Zero setting under no-load condition.

Menu - Vehicle - Emission regulation



Tier-4, Stage-5 emission regulation setting.

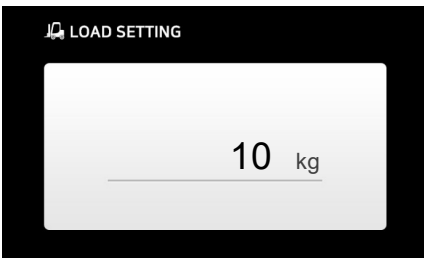

Enter the prepared load to set the corresponding load value.

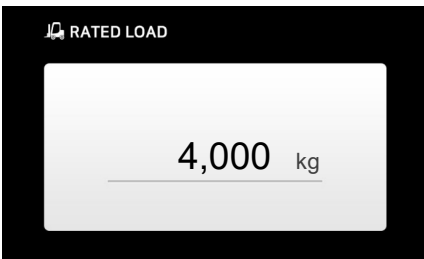

Rated load setting for warning against overload.

Menu - Vehicle - TCU

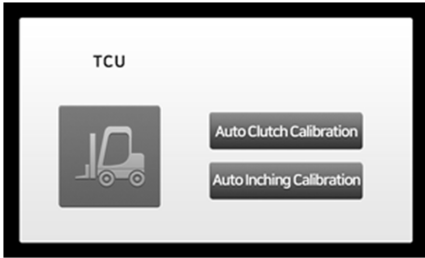

Menu - Vehicle - Change Password

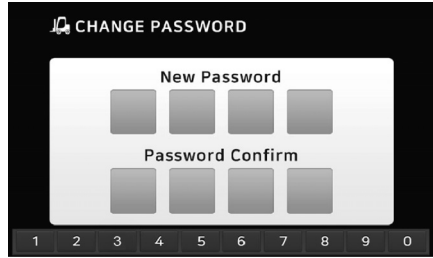

New password and setting by confirming

Menu - Vehicle - TCU - Auto Clutch Calibration

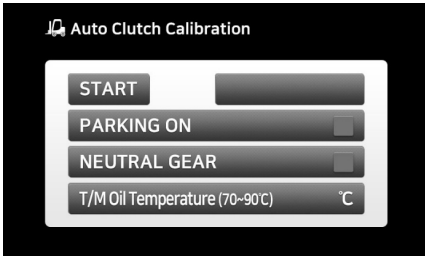

After any service below, should conduct the auto clutch calibration. See the topic, "Drive axle Oil, Transmission Oil, Oil Filter & Strainer - Clean, Change" in First 50-100 Service hours or a week.

- the oil and filter - change
- the transmission - change
- the TCU - change

Menu

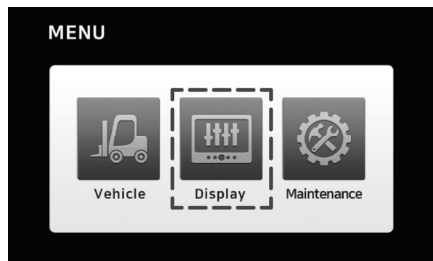

Menu - Display



Menu - Vehicle - TCU - Auto Inching Calibration

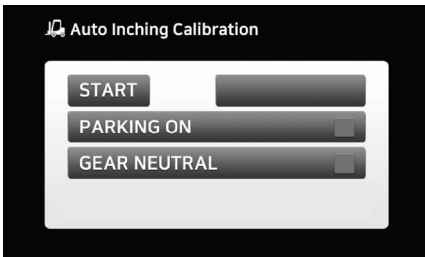

After any service below, should conduct the auto inching calibration. See the topic, "Drive axle Oil, Transmission Oil, Oil Filter & Strainer - Clean, Change" in First 50-100 Service hours or a week.

- the inching pedal - adjust
- the inching sensor - change
- the TCU - change

**Menu - Display - Rear View camera
(If the rear view camera is equipped)**

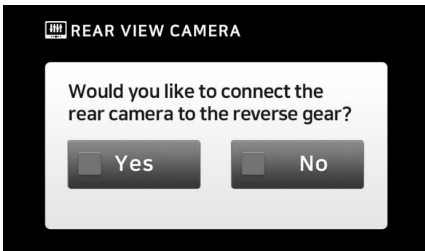

Camera connection setting while reversing

Menu - Display - Language



Setting for Korean, English, Chinese and Spanish

Menu - Display - Unit

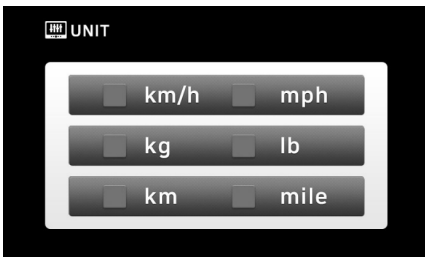

Setting for SI unit system and US unit system

Menu - Display - Time

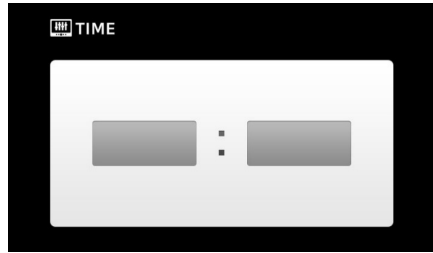

Current time setting

Menu - Display - Software Version

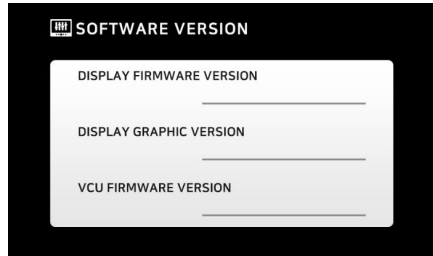

Instrument panel firmware, graphic version and VCU firmware version can be checked.

Menu - Display - Software Update

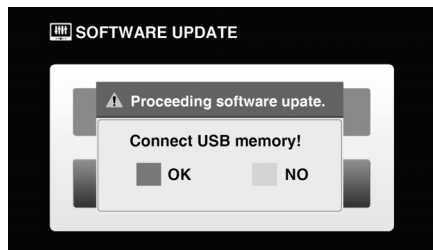
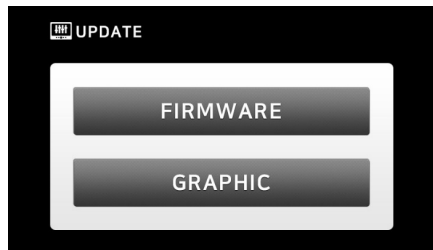

New firmware version can be updated through the USB memory.

Menu

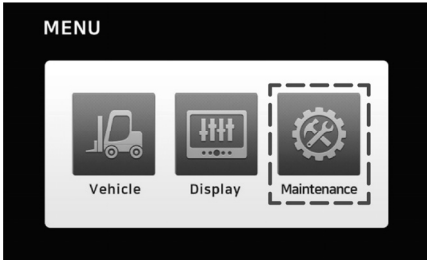

Menu - Maintenance

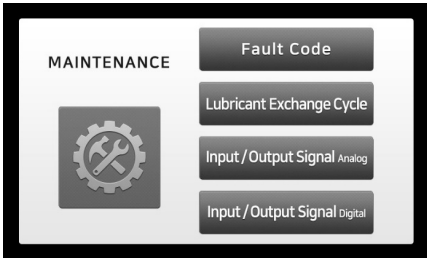

Menu - Maintenance - Fault Details

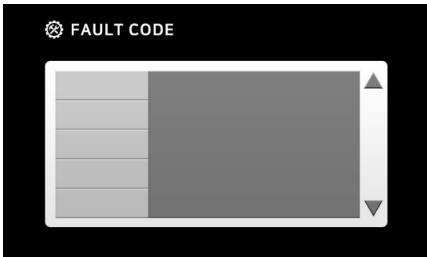

Details of faults that currently occur can be checked.

Menu - Maintenance - Consumable Item Management

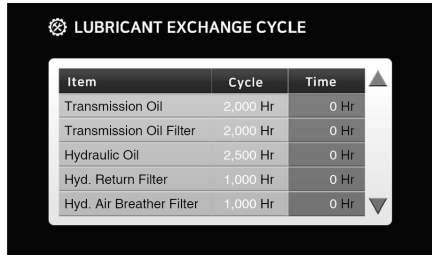

The replacement cycles and amount (in hours) of use of consumable items can be checked.

Menu - Maintenance - Input/Output Signal Analogue

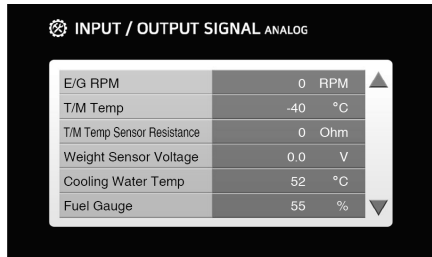

The vehicle analogue signal can be checked

Menu - Maintenance - Input/Output Signal Digital

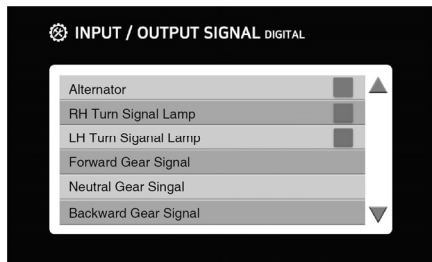

The vehicle digital signal can be checked (Alternator, RH turn signal lamp, LH turn signal lamp, forward gear signal, neutral gear signal, Backward gear signal)

Weight Scale Mode (Optional - Hydraulic)



This option enables the operator to measure and limit the weight of the load using the LCD display. Use "WEIGHT SCALE" under the "VEHICLE" menu.

Zero Setting

Raise the forks by 1 m as unloaded and press ENTER to set the weight of the mast assembly to be zero.

Load Setting

Prepare a reference load whose weight is accurately known and enter its weight into the display. Put the reference load on the forks and raise the forks. And then press ENTER to complete the setting of a reference load value.

Since the weights of any loads will be measured based on this reference load value, it must be accurately set.

Rated Load Setting

Enter the rated load capacity of the vehicle into the display and press ENTER to complete the setting of the rated load value.

An overload warning will be given if any weight exceeding the rated load entered is measured.

Weight Scale Option (Load Cell Type)

With this weight scale option, the operator can measure and limit the load's weight using a display panel. Using the key , you can start settings.

1. Entering the Calibration Mode

To perform initial settings for the load cell, enter the calibration mode as follows:

 Press this key when "ST.CAL" is displayed to start calibration mode.

 Press this key once again.



2. Specifying a Minimum Scale

You can select a minimum scale on which the load cell displays the weight from among 1 kg, 2 kg, 5 kg, 10 kg, 20 kg, and 50 kg (for example, 1235 kg is displayed with a 5 kg minimum scale and 1250 kg displayed with a 50 kg scale). The default value is "10 kg."

 Each time you press this key, the setting increases in the order of 01, 02, 05, 10, 20, and 50.

 Press this key to save the minimum scale setting and proceed the subsequent step.

 Press this key to move to the previous step.





3. Specifying a Maximum Measuring Scale

This step is to specify the rated capacity of the vehicle on which the load cell is installed.

Since the device does not weigh a load heavier than the set capacity (determines to be overloaded), it is recommended to set the capacity to be 5% higher than the actual value taking into consideration the safety factor.

 Each time you press this key, the number (0 to 9) at the cursor position increases by 1.

 Each time you press this key, the cursor is moved to the left by one point.

 Press this key to save the set value and proceed the subsequent step.

 Press this key to move to the previous step.





4. Inputting a Reference Load

This step is to input the weight of a reference load needed for weight setting.

If the weight of the reference load is 3,000 kg, input "3000" and proceed the next step (reference load lift). The initial setting value should be set to 50% to 60% of the rated capacity (for a 7 ton capacity model for example, use a 3.5 to 4 ton load).

 Each time you press this key, the number (0 to 9) at the cursor position increases by 1.

 Each time you press this key, the cursor is moved to the left by one point.

 Press this key to save the set value and proceed the subsequent step.

 Press this key to move to the previous step.



NOTE: After the initial setting, if the load weight is measured with an error, you must adjust this value.

Example: If you have inputted 3,000 kg but the actual load weighs 2,900 kg, adjust the reference load value to 2,900 kg; if the load weighs 3,100 kg, adjust the value to 3,100 kg.

5. Zero Adjustment

This step is to set the weight condition of the vehicle's unloaded front end to zero. Keeping the mast unloaded, raise it approx. 300 mm from the ground just vertically.



Press this key to save the set value and proceed the subsequent step.



Press this key to move to the previous step.



6. Reference Load Lift

Put a reference load that weighs as much as the set value on the attachment (e.g. forks).

You should align the centres of gravity of the attachment and of the reference load.

Raise the mast approx. 300 mm from the ground vertically.

Once the vehicle's vibration ends after lifting the load, press the Enter key.



Press this key.



7. Finishing Calibration

Once you have done all the steps above, a certain figure appears along with a blinking message "C_End" on the display for a while, and then the weight scale mode resumes."

Initial settings for the load cell has been finished.

Use this device after fully lowering the load for the indicator to display 0 kg.



Circuit Breaker

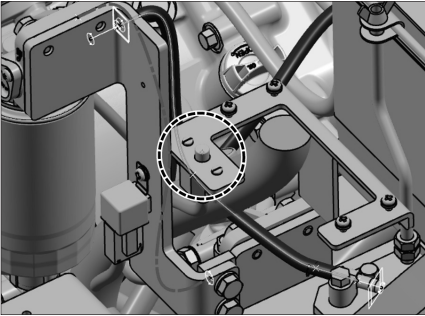

Circuit Breaker - Protects the main electrical circuits. To reset the circuit breaker, push the button in. It is located in the engine compartment.

Tilt Steering Column

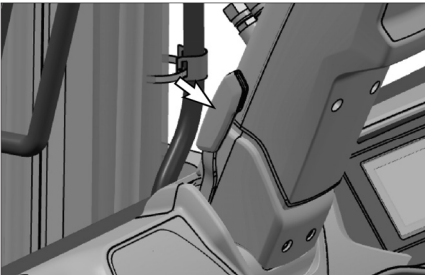

To adjust the steering column, push down the knob, and move the steering column to the desired position, then release the knob.

Electrical Disconnect Switch (If Equipped)



1. ON-Connects the battery for electrical power to all electrical circuits.



2. OFF-Disconnects the battery from all electrical circuits.

Audio System (AM/FM Tuner with USB/AUX Player, If equipped)

Location of controls



1. **AM** button: Select AM Radio mode.
2. **FM** button: Select FM Radio mode.
3. **USB** button: Select USB player.
4. **AUX** button: Select AUX mode.
5. **POWER/MUTE** [MUTE] button with **VOLUME** dial: Turn the power on or mute function on/off (press); turn the power off (press and hold); control the volume level (rotate).
6. Display window for Play/Reception/Menu state and information.
7. **PRESET** [1 II] - [6 D+] buttons
 Radio mode: Recall each stored station (press); store each station (press and hold)
 USB mode: Change the playback mode ([1 II]/[2 RPT]/[3 RDM] buttons); shows available information about the current track ([4 INFO] button); move to folder down/up ([5 D-]/[6 D+] buttons).
8. **SCN/AST** button with | ◀◀ TUNE/TRACK ▶▶ | dial
 Radio mode: Plays frequencies with superior reception for 5 seconds each (press); Saves frequencies with superior reception to Preset buttons (press and hold). select the reception frequency manually (rotate).
 USB mode: Scans the beginning parts (approx. 10 seconds per track) of tracks (press); moves to the previous/next track (rotate); rewind or fast-forward the track (rotate and hold).
9. **LOUD** button: Turn the Loudness mode on/off.
10. **MENU** button: Enter the sound setting mode (press); show/hide the clock or when power is off, enter the clock setting mode (press and hold).
11. **Input Terminal cover**: Open the cover to connect the external audio device or the USB device.
 - **AUX IN** jack: Connect the external audio device.
 - **USB port**: Connect the USB device.

Display window

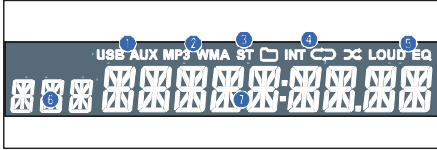

- 1. USB/AUX indicators:** When the External Device is connected, indicator is lights up.
- 2. MP3/WMA indicators:** When the Audio Stream is detected, indicator is lights up.
- 3. Stereo [ST] indicator for FM stereo station:** When a stereo Broadcast is received, indicator is lights up.
- 4. Playback mode indicators for USB mode**
 - : Folder mode
 - INT** : Intro playback
 - : Repeat playback
 - : Random playback
- 5. LOUD/EQ indicators for sound effect**
 - LOUD:** Loudness mode on
 - EQ:** EQ mode on
- 6. Multi-function display area for showing the information**

Wired remote controller

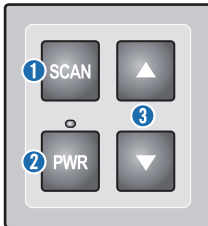

- 1. SCAN button:** In Radio mode, tune up the frequency(press); find a station (press and hold).
- 2. POWER [PWR] button:** Turn on the power or mute on/off(press); turn off the power (press and hold).
- 3. Volume [▲/▼] buttons:** Adjust the volume.

Rear view/Connectors

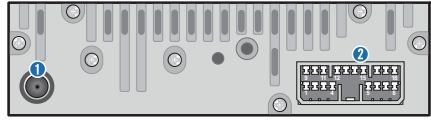

- 1. Antenna jack:** To plug the FM antenna cable.
- 2. I/O connector:** To plug the I/O cable.

<ARA-5080WF: 18 Pin>

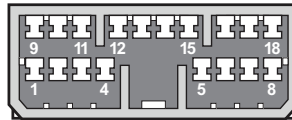

- | | |
|---------------------|--------------------------|
| 1. Front R (+) | 10. Rear R (-) |
| 2. Rear R (+) | 11. N.C/illumination (-) |
| 3. illumination (+) | 12. N.C |
| 4. ACC (+) | 13. REM GND |
| 5. Battery (B+) | 14. GND |
| 6. N.C | 15. 5V Output |
| 7. Rear L (+) | 16. REM Data |
| 8. Front L (+) | 17. Rear L (-) |
| 9. Front R (-) | 18. Front (-) |

<ARA-5081WF: 18 Pin>

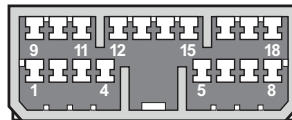

- | | |
|---------------------|----------------|
| 1. Tel Mute | 10. Rear R (-) |
| 2. Rear R (+) | 11. DMB Det |
| 3. illumination (+) | 12. DMB Mute |
| 4. ACC (+) | 13. REM GND |
| 5. Battery (B+) | 14. GND |
| 6. DMB GND | 15. 5V Output |
| 7. Rear L (+) | 16. REM Data |
| 8. DMB L-CH | 17. Rear L (-) |
| 9. H/F GND | 18. DMB R-CH |

Getting started

Turning the unit on/off



1. Turn your car's ignition key to **ACC** or **IGN (ON)** position.

Displays the current time.

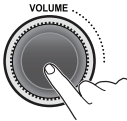

2. Press the **POWER** button to turn the power on.

If the source is ready, playback also starts.

To turn on the power directly

By connecting an USB into the USB port or pressing the AM/FM or USB button (while the USB device is connected), you can also turn on the power and the unit then plays.

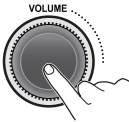

3. When power is on, press and hold the **POWER** button to turn power off.

Adjusting volume directly



1. Turn the **VOLUME** dial to control volume.

Available volume range: 1 - 41.

Setting the sound



1. Press **MENU** button repeatedly to select the Sound setting mode as below;

- **BAS** (Bass): sets the bass sound level. (-5 ~ +5)
- **MID** (Middle): sets the middle sound level. (-5 ~ +5)
- **TRE** (Treble): sets the treble sound level. (-5 ~ +5)
- **FAD** (Fader: Option): sets the sound fade between the front and rear speakers. (F15 ~ R15)
- **BAL** (Balance): sets the sound balance between the right and left speakers. (L 15 ~ R15)
- **LOUD** (Loudness): turn Loudness mode on/off
- **EQ** (Equalizer style): selects the one of the 7 EQ styles (EQ OFF, POP, ROCK, COUNTRY, VOICE, JAZZ, CLASSIC)
- **BEEP** (Beep): turn Beep sound on/off
- **SCROLL** (Scroll): turn Scroll mode on/off

- **VOL** (Volume): sets the sound volume level. (VOL 0 ~ VOL 41)



2. Turn the **VOLUME** dial left/right to adjust the value of the level, balance or style.

Setting the Loudness mode

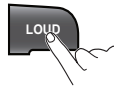

1. Press the **LOUD** button to turn loudness mode on/off.

Increases the level for low frequency.

To turn the loudness option off, press the **LOUD** button again.

Muting the sound quickly





1. Press the **MUTE** button to turn mute on. "MUTE" will flash on the display and mute the sound.

Press the **MUTE** button again or turn **VOLUME** dial to restore sound.

Radio



Setting the region of radio reception

1. When the power is turned on, press and hold the buttons more 3 seconds at the same time as below;

- U.S.A: Hold down  and press  +  more 3 seconds



FM: 87.7 - 107.9 MHz (200 kHz step)

AM: 530 - 1.7 10 kHz (10kHz step)

- South America : Hold down  and press  +  more 3 seconds



FM: 87.5 - 108.0 MHz (100 kHz step)

AM: 530 - 1.7 10 kHz (10kHz step)

- Asia : Hold down  and press  +  more 3 seconds

FM: 87.5 - 108.0 MHz (100 kHz step)

AM: 531 - 1,602 kHz (9 kHz step)

- Europe: Hold down  and press  +  seconds

FM: 87.5 - 108.0 MHz (50 kHz step)

AM: 522 - 1,629 kHz (9 kHz step)

2. Please wait for more 5 seconds with no operation, the unit will save and apply your's setting.

If the region setting is not selected correctly to your country or region, the radio reception can not be received. Retry the setting the region of radio reception correctly.

The region setting is required only for the first time

The region setting is return to the default setting when the power connector or battery is disconnected.

Tuning in a station



1. Press the **AM** or **FM** button to change the band in order of AM1. AM2. FM1 or FM2.

You can select the FM 1. FM2. AM 1 or AM2 radio band.

While the Auto Store stations are stored, you can select the AMA or FMA band by additional.

The previously chosen broadcasting station will be received.



2. Press the **SCN** button or turn the **◀◀ TUNE ▶▶** dial left/right to select the station.

Using TUNE: Briefly turn the dial, plays previous/next frequency.

Using SEEK: Turn and hold the dial, automatically search for station with superior reception.

Using SCAN: Press the button, starting from the current station, stations with superior reception are scanned for 5 seconds and the previous station is restored.

During the seeking or scanning, if press or turn the dial left/right again, the selected station will begin playing.

During the FM reception, the Stereo [ST] indicator is on.

Saving radio stations manually

You can save up to 6 preset channels each for FM 1, FM2, FMA, AM 1, AM2, and AMA.

If change the stations while driving, use preset button to prevent accidents.

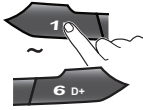

1. Press the **AM or FM** button repeatedly to select the band.
2. After selecting the frequency, press and hold the **PRESET [1 II]** - [6 D+] button.

The frequency is saved to the selected preset button.

A total of 24 frequencies with 6 preset frequencies each for FM1/FM2/AM1/AM2 modes can be saved.

Saving radio stations automatically

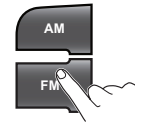

1. Press the **AM or FM** button repeatedly to select the band.

The previously chosen broadcasting station will be received.

2. Press and hold the **AST** button to automatically save receivable frequencies to Preset button.

"AST" is shown, and then stores frequencies in the order of their frequencies on the Preset buttons.

Up to 6 stations can be stored in each of the AMA and FMA band.

Listening to a preset station

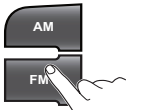

1. Press **AM or FM** button repeatedly to select the band.

You can select the FM 1, FM2, AM 1 or AM2 radio band.

While the Auto Store stations are stored, you can select the AMA or FMA band by additional.

The previously chosen broadcasting station will be received.

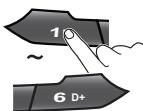

2. Press **Preset [1 II]** - [6 D+] button.

From the 6 presets, select the frequency you want to listen to.

USB player

Before MP3 [WMA] USB playback

This unit cannot play the following files;

- MP3 files encoded with MP3i and MP3 PRO format.
 - MP3 files encoded in an inappropriate format.
 - MP3 files encoded with Layer 1/2.

Folder selection order/File playback order;

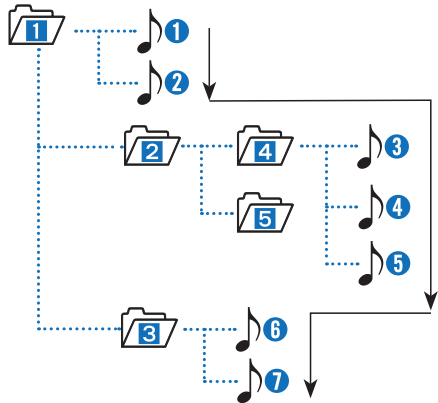

Playing a USB device



1. Open the cover, plug the USB device to the USB port.

Once a USB is connected, USB will automatically start playing from the first file within the USB.

If a previously played USB is reconnected, then the file after the most recently played file is played.

If a different USB is connected or the file information within the USB was changed, then the USB will start playing from the first song within the USB.



2. When a USB device to be played is already connected, press the USB button to play **USB** device.

The previously selected file is played.

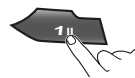

3. While playing, press the [1 II] button to pause the file.

Press the button again to play the current file.



4. Press the [4 INFO] button repeatedly to display information about the file being played.

The information displayed includes the file name, playing time, ID3 Tag or folder name information saved with the song.

If there is no information on the playing file, then the unit will display "NO INFO".

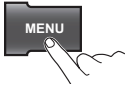

5. Press **MENU** button repeatedly to select the Scroll setting mode. Turn the **VOLUME** dial to changes the display method between Scroll On/Off.

- SCROLL ON: activate the scroll function
- SCROLL OFF: deactivate the scroll function

Controlling the playback



1. While playing, turn the ►►TRACK◄◄ dial left/right to moves to the previous or next track.

- Clockwise: move to the next file

- Counter-clockwise: move to the previous file
- You can skip files within the same folder.



2. While the ►►TRACK◄◄ dial is being turned and held, the file will rewind or fast forward at high speed. Once released, the file will begin playing at normal speed.

- Clockwise: fast forward
- Counter-clockwise: fast rewind
- The search function works but search speed is not constant.
- While fast forwarding or rewinding, you can only hear intermittent sounds.

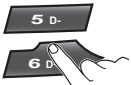

3. Press the [5 D-] or [6 D+] button to moves to the previous or next folder.

- [5 D-]: move to previous folder
[6 D+]: move to next folder
- While folder moving, the folder name will be displayed briefly.

Change the playback mode

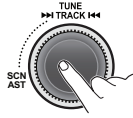

1. While playing, press the SCN button to begin the Intro scan playback.

- When pressed shortly, scans the beginning parts of device files. (approx. 10 seconds per file)

- **INT** : Successively plays the intro of the file in the USB device.
- **INT** : Successively plays the intro of the file in the current folder.
- Off : Cancels intro playback.



2. Press the [2 RPT] button to select the Repeat playback mode.

- **REPEAT** : The current file plays repeatedly.
- **REPEAT** : The current folder plays repeatedly.
- Off: Cancels repeat playback.

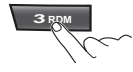

3. Press the [3 RDM] button to select the Random playback mode.

- **RANDOM** : All files of current folder play in random order
- **RANDOM** : All files of USB device play in random order
- Off: Cancels random playback.

About MP3/WMA

This unit can play MP3 (WMA) files with .mp3, .wma (lower case letters) or .MP3 and .WMA (capital letters) file name extensions.

This unit can display ID3 Tag (Version 1.0, 1.1, 2.2, 2.3 or 2.4) information for MP3 files. such as the album name and the artist.

This unit can recognize the Korean and English characters.

This unit can play MP3/WMA files meeting the conditions below;

- Bit rate: 8 kbps - 320 kbps / VBR for MP3
- Sampling frequency:
 - 48 kHz, 44.1 kHz, 32 kHz
 - (for MPEG-1 Layer 2/3)
 - 24 kHz, 22.05 kHz, 16 kHz
 - (for MPEG-2 Layer 2/3)

This unit can recognize total of 9,999 files, of 256 folders, and 7 stages of folder structure.

This product can play MP3 files using VBR. When playing an MP3 file of this VBR type, the remaining time displayed may be different from the real time.

Handling precautions for USB device

When using the external USB device, make sure to keep the device disconnected and connect only sometime after turning on the vehicle ignition. The USB device may be damaged if the USB device already connected when the ignition is turned on. (USB device is not an electronic automotive component).

Some USB devices may not operate properly because of compatibility issues. Check that the external device is supported by the device before stating use.

The device will only recognize USB devices formatted in FAT 16/32.

When formatting the external USB device, the device may not properly recognize a Byte/Sector selection other than 512 Bytes or 2,048 Bytes.

Avoid the contact of bodily parts and foreign substances with the USB connector.

Repeatedly connecting/disconnecting the USB in a short period of time may cause damage to the device.

When disconnecting the USB, an abnormal sound may occur occasionally.

Abruptly disconnecting the external USB device while the USB is operating may cause the device to be damaged or function abnormally. Make sure to disconnect the USB device only after the audio power is turned off or when the audio is operating in a different mode.

The amount of time required to recognize the external USB device may differ depending on the type, size, or file formats stored on the USB. Such differences in the required time are not indications of malfunction. Please wait the period of time required to recognize the device.

The device support only USB devices used to play music files.

Do not use the USB I/F to charge batteries or USB accessories which generate heat. Such acts may lead to deteriorated performance or damage to the device

The device may not recognize the USB device if separately purchased USB hubs and extension cables are being used.

In the case of high capacity USB devices, there are instances where the logical drives are partitioned for user convenience. In this case, it will only be possible to play the USB music in the top level drive. When using partitioned drives, save the songs you wish to play on the device only in the top-level logical drive. In addition, certain USB devices are configured with a separate drive used to install application programs and it may not be possible to play songs from such drives for the reasons as described above.

The device may not support normal operation when using formats such as HDD Type, CF, or SD Memory.

The device will not support files locked by DRM (Digital Rights Management).

AUX player

Listening to auxiliary audio equipment

By connecting an optional portable audio device to the AUX input jack (stereo mini jack) on the unit and then simply selecting the source, you can listen on your car speakers.



1. Turn the **VOLUME** dial left to decrease the volume level.

The **AUX** volume can also be controlled separately through the connected device.



2. Turn the external audio equipment off. Open the cover, connect the audio output of the external audio equipment to AUX input terminal on the unit.
3. Turn the external audio equipment on. Start playback of the external audio equipment at a moderate volume.



4. Press the **AUX** button to select the AUX function.



5. Set your usual listening volume by turn the **VOLUME** dial left/right on the unit.

Once the connector is disconnected, the previous mode will be restored.

AUX mode can be used only when an external audio player has been connected.

Listening to DMB sound (If Equipped)

1. By connecting the optional DMB receiver, you can listen the DMB source provided for the vehicle.

When the DMB receiver is turned power on, the current operation will be paused and the "AUX 1" will be displayed on the Display window.

The DMB's sound is output from the speakers in the unit.

2. While playing the DMB, press the AM, FM or USB button to change the function.
3. While playing the DMB, if turn the DMB receiver off, the unit will be returned to previous mode.

Calling via Handsfree (If Equipped)

1. By connecting the optional Handsfree equipment, you can use the Handsfree mode.

When make a call or receive. the bell will sound and the "PHONE" will be displayed on the Display window.

2. The ringtone and talker's voice are output only from the front speakers.
3. When the call is ended, the mute will be canceled and the unit will be returned to the previous mode.

Seat Switch System

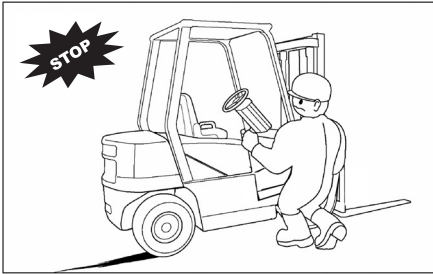

The lift truck is equipped with a SEAT SWITCH SYSTEM. In normal operation if the direction lever is placed in either forward or reverse, the lift truck will move at a speed proportional to the accelerator pedal's position. If the operator leaves the seat without setting the parking brake, within three seconds after leaving the seat, the SEAT SWITCH SYSTEM will automatically disengage the transmission. The directional lever, however, will remain in that forward or reverse location although internally the transmission will have shifted into neutral.

Before exiting the lift truck, the parking brake should always be applied.

WARNING

WHEN LEAVING MACHINE APPLY PARKING BRAKE!

PARKING BRAKE IS NOT AUTOMATICALLY APPLIED.

NOTE: Some trucks may be equipped (ask your branch if this applies to your truck) with an alarm that will sound if the parking brake is not applied when leaving the machine.



NOTICE

1. Prior to operating the lift truck, be sure to understand and check the SEAT SWITCH SYSTEM.
 2. While in normal operation and on level ground, select a direction with the directional lever and with the park brake released. You will note that the truck will move slowly in the selected direction. If you lift your hips off of the seat, within three seconds, the SEAT SWITCH SYSTEM will disengage the transmission allowing the truck to coast but not automatically stop.
 3. To restore the lift truck to normal operation, while sitting in the operator's seat depress the brake pedal to hold the lift truck, return the directional lever to the neutral position, and then reselect a direction of travel (either forward or reverse). The transmission will then re-engage.
 4. If seat or seat switch replacement becomes necessary, be sure to use genuine CROWN lift truck parts. Lift trucks should never be operated without an operational SEAT SWITCH SYSTEM.
-

Lift Truck Controls

Direction Control Lever



-  **1. Forward** - Push the lever forward for FORWARD direction travel.
-  **2. Neutral** - Move the lever to centre position for NEUTRAL.
-  **3. Reverse** - Pull the lever back for REVERSE direction travel.

Transmission Speed Range Lever



- 1. High** - Rotate the lever counterclockwise for HIGH speed range.
- 2. Low** - Rotate the lever clockwise for LOW speed range.

Auto Shift (AUTO) Selector Switch



This switch is used to select auto/manual shift on the gearshift.

1. When pressing the "AUTO" position on this switch, the blue light is illuminated on the switch, and the word "AUTO" is displayed above the gear indication on the instrument panel screen. Then, if you turn the gearshift lever to the "2nd gear" position, the auto gearshift status can be used. In the auto gearshift condition, the vehicle starts in the first gear, automatically changes to the second gear as the vehicle speeds up, and automatically changes to the first gear if the speed is reduced.

2. When pressing this switch in the opposite direction, the blue light turns OFF, and the word "AUTO" above the gear indication on the instrument panel screen disappears. In this condition, the vehicle is operated according to the gear selected on the gearshift lever.

* In the auto gearshift (AUTO) mode, if the gearshift lever is turned to and kept in "1st gear," the vehicle can only be driven in the first gear without auto gearshift.

Multi-torque



ECO: Fuel economy operation mode.
STANDARD: Ordinary operation mode.
HIGH: Heavy duty operation mode.

- The above figure shows the multi torque screen on the display. For setting, refer to the following: Operation Section - Operator Seat and Various Instruments/Devices - Menu - Vehicle - Option Setting - Multi Torque.
- “S” means “Standard Mode” in the specifications. “E” means “Economy Mode” in which maximum engine speed is reduced by 100 ~ 200 rpm together with reduced maximum torque and output power. “H” means “High Speed Mode”, in which the maximum engine speed increases by 90 ~ 100 rpm together with reduced maximum torque and output power. For changes of the maximum torque and output power values in the “E” and “H” modes, refer to the service manual.

SCR Cleaning - DeSOx Switch



This switch initiates regular regeneration process of the post-treatment device.

1. A pop-up on the SCR Display warns the operator to perform SCR Cleaning. (3 warnings: at 10 hrs remaining, 5 hrs remaining, Immediate)

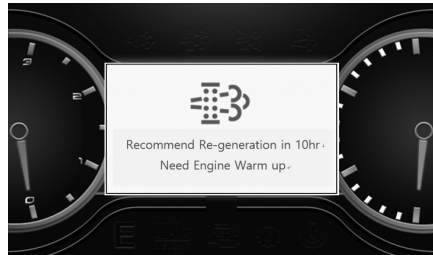

Exemplary warning – 10 hrs remaining

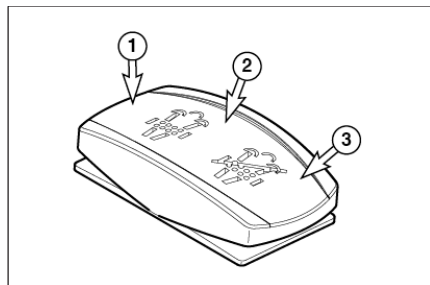

2. Press this switch and release it after 3 sec, SCR Cleaning will be started and the engine speed will be increased. Screen pop-up provides information on the warning up and cleaning process.



Warming up process

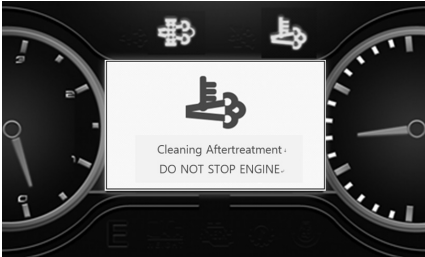

Cleaning process



Completed

3. The switch returns to the normal position of "2" after pressed by the operator to position "1". However, it does not return when pressed to position "3" and the operator shall return the switch from position "3".

4. Setting this switch to position "3" prohibits automatic SCR Cleaning in an environment subject to dust, explosion or regulated noise level. At position "3", a pop-up appears as shown below:



SCR Cleaning inhibited

Transmission Inching Control Pedal

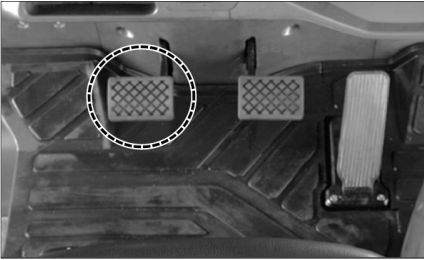

 **Inching Control Pedal** - Pushing down the inching pedal, modulates the hydraulic pressure to the clutch packs, permitting disc slippage.

Further pushing the pedal completely relieves clutch pack pressure and applies the service brakes to stop and hold the lift truck.

In order to use the inching function, "Inching Activation" must remain selected on the "T/M option function" of the instrument panel display. (Operation Section - Operator Seat and Various Instruments/Devices - Menu - Vehicle - Option Setting 1 Electronic T/M option).

NOTE: The purpose of the inching control pedal is to provide precise inching control at slow travel speed, with high engine rpm. This is used for fast hydraulic lift during load approach, pickup or positioning.

Excessive use of the inching pedal will cause the clutch to overheat and may result in damage.

If the vehicle is driven with one's foot habitually resting on the inching pedal, the vehicle will be driven in the inching condition, resulting in damage due to the clutch overheating.

If the inching pedal is used as a brake pedal, damage/overheating may occur due to frequent friction of clutch. In addition, since the engine brake does not operate at the time of braking, the regular brake may be damaged due to the increased load on the regular brake.

Service Brake Pedal

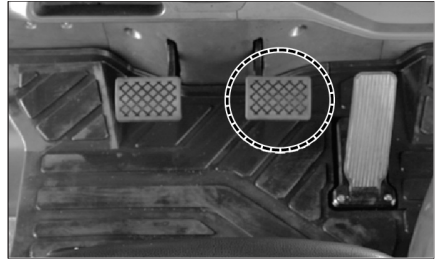



 **Push DOWN** on the brake pedal to slow or stop the lift truck.

 **RELEASE** the brake pedal to allow the lift truck to move.

Accelerator Pedal



 **Push DOWN** on the pedal to increase engine rpm (speed).

 **RELEASE** the pedal to decrease engine rpm (speed).

Parking Brake Switch



Push the front side of the parking brake switch to engage the brake.



Push the rear side of the parking brake switch to engage the brake.

Lift Control



NOTE: To prevent a sudden change of position of the load, operate all lift, tilt and attachment controls smoothly.



1. Lower Position - Push the lever FORWARD smoothly to lower the load.



2. Hold Position - When the lever is released it will return to the HOLD or centre position. Lifting or lowering action will stop.



3. Lift Position - Pull the lever BACK smoothly to lift the load.

Tilt Control



1. Mast Tilt Forward - Push the lever FORWARD smoothly to tilt the mast forward.



2. Mast Hold - When the lever is released it will return to the HOLD or centre position. Tilting action will stop.



3. Mast Tilt Back - Pull the lever BACK smoothly to tilt the mast backward.

Sideshift Attachment Control (If Equipped)



1. Sideshift Left - Push the lever FORWARD to shift the carriage to the left.



2. Sideshift Hold - When the lever is released it will return to the HOLD or centre position. Sideshifting action will stop.



3. Sideshift Right - Pull the lever BACK to shift the carriage to the right.

Fuel and DEF/Ad-Blue Replenishment

Diesel Engine Equipped

WARNING

Explosive fumes may be present during refueling.

Do not smoke in refueling areas.

Lift truck should be refueled only at designated safe locations. Safe outdoor locations are preferable to those indoors.

Stop the engine and get off the lift truck during refueling.

NOTICE

Do not allow the lift truck to become low on fuel or completely run out of fuel. Sediment or other impurities in the fuel tank could be drawn into the fuel system. This could result in difficult starting or damage to components.

Fill the fuel tank at the end of each day of operation to drive out moisture laden air and to prevent condensation. In the cold weather, the moisture condensation can cause rust in the fuel system and hard starting due to its freezing. Do not fill the tank to the top. Fuel expands when it gets warm and may overflow.



1. Park the lift truck only at a designated safe location. Place the transmission in NEUTRAL. Lower the forks to the ground. Engage the parking brake. Stop the engine.



2. Remove the filter cap.
3. Fill the fuel tank slowly. Install the filter cap. If spillage occurs, wipe off excess fuel and wash down area with water.

NOTE: Drain water and sediment from fuel tank as required by prevailing conditions. Also, drain water and sediment from the main fuel storage tank weekly and before the tank is refilled. This will help prevent water or sediment being pumped from the storage tank into the lift truck fuel tank.

Before Starting the Engine

Walk - Around Inspection

Make a thorough walk-around inspection before mounting the lift truck or starting the engine. Make sure there are no such problems as loose bolts, debris buildup, oil or coolant leaks. Check condition of tyres, mast, carriage, forks or attachments. Have repairs made as needed and all debris removed.



1. Inspect the operator's compartment for loose items and cleanliness.
2. Inspect the instrument panel for broken or damaged indicator lights or gauges.
3. Test the horn and other safety devices for proper operation.



4. Inspect the mast and lift chains for wear, broken links, pins and loose rollers.
5. Inspect the carriage, forks or attachments for wear, damage and loose or missing bolts.
6. Inspect the tyres and wheels for cuts, gouges, foreign objects, inflation pressure and loose or missing bolts.



7. Inspect the overhead guard for damage and loose or missing mounting bolts.
8. Inspect the hydraulic system for leaks, worn hoses or damaged lines.
9. Look for transmission and drive axle leaks on the lift truck and on the ground.
10. Inspect the common parts and drive axle, mast etc for damaged, loosen or missing mounting bolts.
11. Inspect the engine compartment for oil, coolant and fuel leaks.



12. Measure the engine crankcase oil level with the dip stick. Maintain the oil level between the MAX. and MIN., (or FULL and ADD) notches on the dip stick.

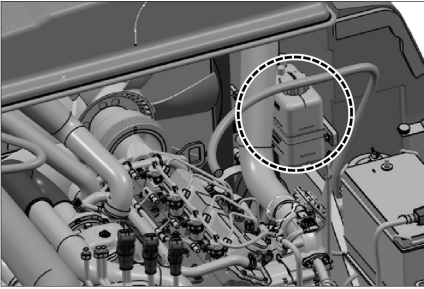

13. Observe the engine coolant level in the coolant recovery bottle. With the engine cold, maintain the level to the COLD mark. If the recovery bottle is empty, also fill the radiator at the top tank.



16. To position the seat, PUSH the lever away from the seat track and move the seat forward or backward to a comfortable position.



14. Observe the fuel level gauge after starting the truck. Add fuel if necessary.
15. In case of LPG truck, if needed, change LPG Fuel Tank as the procedure of changing LP tanks in Refueling Section.

⚠ WARNING

Personal injury may occur from accidents caused by improper seat adjustment. Always adjust the operator's seat before starting the lift truck engine.

Seat adjustment must be done at the beginning of each shift and when operators change.

Starting the Engine

Prestart Conditions

NOTE: The engine will not start unless the transmission directional control lever is in the NEUTRAL position.



1. Engage the parking brake, if not already engaged. Place the transmission directional control lever in the NEUTRAL position.



2. In case the lift truck is equipped with a electrical disconnect switch, the engine will not start unless the disconnect switch is in the ON (closed) position. Before starting, turn the disconnect switch to the OFF(open) position.

NOTICE

When you restart the engine after turning off it, wait 4 to 5 seconds and restart it to protect the starter.

Diesel Engine

Starting a Cold Diesel Engine

1. Turn the key to the ON position and the start preheat indicator light will come ON. The preheat indicator light will stay ON approximately seven seconds, depending on the surrounding air temperature.

NOTICE

Do not crank more than **10** seconds continuously.

If engine coolant is cold, engine low idle speed could be higher than normal condition. (Electronic Engine)

2. After the preheat light goes OFF, turn the ignition key to the START position.
3. Release the ignition key after engine starting and check the engine condition.
4. If the engine stalls or does not start, turn the ignition key to the OFF position, then repeat steps 1 thru 3.

Starting From a 12 Volt External Source

WARNING

Sparks occurring near the battery could cause vapors to explode.

Always connect the external power source ground cable to a point away from and below the battery, and well clear of fuel system components.

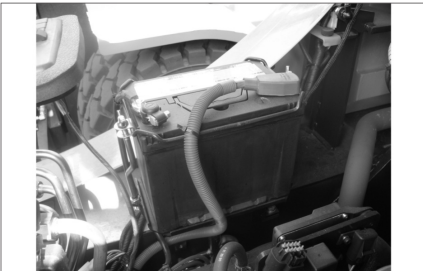

NOTICE

Do not reverse battery cables. It can cause damage to the alternator.

Always connect the external power source cables in parallel with the lift truck battery cables : POSITIVE(+) to POSITIVE(+) and NEGATIVE(-) to NEGATIVE(-).

Attach ground cable last, and remove it first. All lift trucks equipped with CROWN built internal combustion engines have NEGATIVE(-) ground connections.

After Starting the Engine

Observe all indicator lights and gauges frequently during operation, to make sure all systems are working properly. All of the indicator lights will come ON with the ignition switch in the ON position before the engine is started.

Diesel Engine

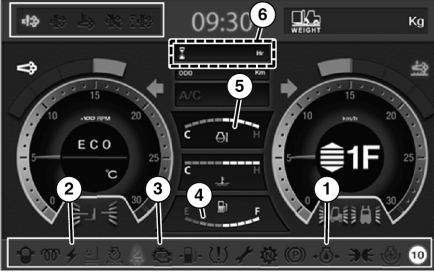

4. Observe the diesel fuel level gauge (4) for fuel level in the tank.



5. The engine coolant temperature gauge pointer (5), will be in the green band with the engine running, unless the coolant temperature is excessive.



6. Observe the hour meter (6) to make sure it is operating properly.



1. The engine oil pressure indicator light (1), will not come ON with the engine running, unless there is low or no oil pressure. Stop the engine immediately, if the light comes ON.



2. The alternator indicator light (2), should not come ON during normal operation. The alternator is not charging if the light comes ON with the engine running.



3. The engine MIL (Malfunction Indicator Light)(3) will not come ON with engine running, unless the fault or faults are stored in the memory of the engine control module (ECM). Stop the engine and check the electric engine control system if the light comes ON. Refer Engine of this section.

The engine MIL(Malfunction Indicator Light) will not come on with engine running.

If MIL does not disappear, please contact service centre.

Diesel Engine

Engine and After-treatment System

DM03P/V Diesel Engine Introduction

The DM03P/V engine which is a high-power engine in compliance with the Required Engine Emissions Standard is provided with various systems(DM03P: T4F, DM03V: Stage5). The DM03P/V engine is equipped with a turbo-charger intercooler system that compresses and cools air and feed it to the intake manifold. Here, AMF sensor and temperature/pressure sensors detect the air condition and transmit the data to the ECU which controls fuel injection rate according to the engine load, speed and air quantity. Fuel is supplied to a high pressure pump through a fuel filter. The fuel compressed in the high pressure pump is transferred to common rail and injected by injectors in controlled order. Surplus fuel after injection returns to the fuel tank via a return hose. The exhaust gas recirculation (EGR) system controls the quantity of recirculating air according to the engine speed and load in order to comply with applicable exhaust gas emission standards.

The DOC (Diesel Oxidation Catalyst) uses a chemical process to reduce hydrocarbons (HC) and carbon monoxide (CO). DPF (Diesel Particulate Filter), only for Stage5, is after-treatment to trap the PM(Particulate Matters)/Soot in exhaust gas. DPF Regeneration and Ash Cleaning is regualy required to maintain proper performance.

The figure below shows the positions of the electronic control system and sensors

NOTICE

It is normal to hear a slight operating sound after Key Switch On/Off.
This is the ECU checking the actuator before/after engine running.

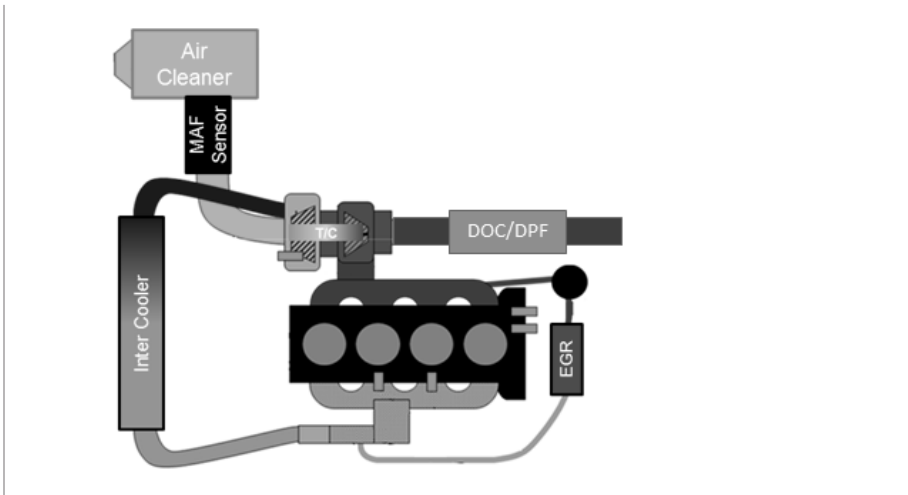

Electronic Controlled Diesel Engines (DI DM03P/M)

Check the display as follows: Menu – Maintenance – Details of Repair.

No.	SPN	Description
1	0	Timeout Error of CAN
2	27	EGR Valve
3	29	Accel pedal
4	51	Throttle valve
5	91	Accel pedal
6	97	Water in fuel
8	100	Engine Oil Pressure Sensor
9	102	Intake Manifold Pressure Sensor
10	105	Intake manifold temperature Sensor
11	108	Atmospheric Pressure Sensor
12	110	Coolant Temperature Sensor
13	132	Intake manifold pressure Sensor
14	157	Pressure relief valve(PRV)
15	171	Environment Temperature Sensor
16	172	Inlet air temperature sensor
17	173	DOC Exothermal Efficiency Fault
18	174	Fuel temperature Sensor
20	177	Transmission oil temperature high
21	190	Engine over speed detection
22	444	Battery Voltage High
23	626	Starter switch stuck
24	636	Crank Signal disturbed
25	637	Cam Signal Drift
26	639	CAN communication error
27	651	Injector High Low side Short circuit Fault
28	652	Injector Code(IQA) Program Missing Fault
29	653	Injector High Low side Short circuit Fault
30	654	Injector Code(IQA) Program Missing Fault
31	676	Glow plug Relay driver Open circuit Fault
32	729	Glowplug relay
33	970	Engine shut off request through CAN
34	975	PWM FAN Output open circuit
36	1076	Rail pressure too low for injection
38	1207	ECU temperature sensor Low fault
39	1382	Fuel filter pressure Sensor
40	1485	ECU Main relay
42	1612	Injector
43	1639	Fan speed too high fault

No.	SPN	Description
44	1761	DEF Tank Level Sensor
45	1867	ECU over temperature for SCR Monitoring
46	2789	Turbine inlet temperature
47	2791	EGR H-Bridge Driver
48	3031	DEF Tank Temperature sensor
49	3216	Upstream NOx sensor
50	3217	Upstream NOx sensor
51	3219	Upstream NOx sensor
52	3224	Upstream NOx sensor
53	3226	Downstream NOx sensor
54	3227	Downstream NOx sensor
55	3229	Downstream NOx sensor
56	3234	Downstream NOx sensor
57	3236	EGR rate slow response positive error
58	3242	DPF(SCRf) inlet temperature sensor
59	3251	DPF differential pressure sensor
60	3360	DEF pressure line heater error
61	3361	DEF dosing valve actuator
62	3363	DEF Tank heating coolant valve
63	3509	ECU Sensor supply1
64	3510	ECU Sensor supply
65	3511	ECU Sensor supply3
66	3516	DEF Quality failure (Tampering)
67	3517	DEF Tank level is empty
68	3520	DEF Quality Sensor
69	3532	DEF Level Sensor
70	3532	DEF Level Sensor
71	3695	DPF regeneration inhibit switch
72	3696	DPF regeneration switch
74	3715	DPF regeneration failure
75	3720	DPF Ash loading High
76	4082	Fuel metering unit
77	4335	DEF underpressure error
78	4344	DEF backflow Line
79	4354	DEF Pressure line heater
80	4355	DEF Backflow line heater
81	4356	DEF Suction line heater
82	4364	SCR Efficiency Too low fault
83	4365	DEF Temperature Sensor
84	4374	DEF Supply Pump Motor





Operation Section

No.	SPN	Description
85	4781	DPF Soot mass too high status (> 120%)
88	5313	Rail pressure sensor
89	5419	Throttle valve
90	5435	DEF pressure check error
91	5436	DEF Reverting valve
92	5491	DEF Pressure line heater
93	5571	Common rail pressure relief valve
94	5629	DPF differential pressure
95	5706	DEF Supply module heater
96	5965	SCR system Main relay
98	6385	Timeout Error of CAN
99	6875	DEF Supply Pump pressure sensor
102	7069	DEF Backflow line heater relay
103	7069	DEF Backflow line heater
104	7107	DEF Supply module temperature
105	7416	DEF Supply module heater
106	7538	DEF Supply module temperature
107	7540	DEF Suction line heater
108	7748	Starter relay
109	7749	Starter relay
110	8614	Injection cut off demand for shut off coordinator
111	55296	ECU EEPROM Read Error
112	55552	ECU EEPROM Write Error
113	57344	Timeout Error of CAN
114	61441	Timeout Error of CAN
115	61454	Timeout Error of CAN
116	61455	Timeout Error of CAN
117	64923	Timeout Error of CAN
118	65110	Timeout Error of CAN
119	65164	Timeout Error of CAN
120	65241	Timeout Error of CAN
121	65265	Timeout Error of CAN
122	65272	Timeout Error of CAN
123	65320	Timeout Error of CAN
124	65400	Timeout Error of CAN
125	65401	Timeout Error of CAN
126	65402	Timeout Error of CAN
127	104332	Upstream NOx sensor
128	104385	Downstream NOx sensor
129	520601	ECU

No.	SPN	Description
130	520618	ECU
131	520641	ECU
132	520642	ECU
133	520643	ECU
134	520696	ECU
135	520697	ECU
136	520698	ECU
137	520699	ECU
138	520700	ECU
139	520701	ECU
140	520702	ECU
141	520703	ECU
142	520704	ECU
143	520705	ECU
144	520706	ECU
145	520707	ECU
146	520707	ECU
147	520723	SCR Inducement Fault Level1 (EGR Block)
148	520724	SCR Inducement Fault Level2 (EGR Block)
149	520725	SCR Inducement Fault Level3 Final inducement (EGR Block)
150	520726	SCR Inducement Fault Warning (EGR Block)
151	520727	SCR Inducement Fault Level1 (Dosing Interrupt)
152	520728	SCR Inducement Fault Level2 (Dosing Interrupt)
153	520729	SCR Inducement Fault Level3 Final inducement (Dosing Interrupt)
154	520730	SCR Inducement Fault Warning (Dosing Interrupt)
155	520736	SCR Inducement Fault Level1 (Group4 – DEF Quality)
156	520737	SCR Inducement Fault Level2 (Group4 – DEF Quality)
157	520738	SCR Inducement Fault Level3 Final inducement (Group4 – DEF Quality)
158	520739	SCR Inducement Fault Warning (Group4 – DEF Quality)
159	520740	SCR Inducement Fault Level1 (Group5 – Tampering)
160	520741	SCR Inducement Fault Level2 (Group5 – Tampering)
161	520742	SCR Inducement Fault Level3 Final inducement (Group5 – Tampering)
162	520743	SCR Inducement Fault Warning (Group5 – Tampering)
163	520790	SCR inducement Repeat offense Level1
164	520791	SCR Inducement Repeat offense Level2
165	520792	SCR Inducement Repeat offense Level3 Final inducement
166	520797	MoF(Monitoring of Function) Engine speed error

Display of Detecting Control Failure





As shown in the table below, for your information, we provide correlation between Engine fault warning strategy and LCD display.



Warning Stage	Warning Strategy				LCD Display	
	Engine Check Lamp	Buzzer	Torque Reduction	RPM Limit	Method	Message on the Display
						
Normal	Off	Off	0%	NA	NA	NA
Level1	On	On	Reduced	Reduced	Continuous	ENGINE MALFUNCTION CALL CROWN SERVICE AGENT Engine Power Reduced!
Level2	Blinking	On	Limp home	Limp home	Continuous	ENGINE MALFUNCTION CALL CROWN SERVICE AGENT Engine is in Limp home Mode
Level3	Blinking	On	Engine Stop	Engine Stop	Continuous	FATAL ENGINE ERROR CALL CROWN SERVICE AGENT Engine Stop after 5min

NCD (NOx Control Diagnosis) Inducement (Diesel Stage 5 below 55 kW only)

There are several interruption level points at which the Emission System indicator and engine check lamps light up or blink and the display shows a message to warn that the NOx is not being reduced due to a fault on the engine EGR valve. The lower the point, the more the system limits the engine power and speed. As shown in the table below, for your information, we provide correlation of NCD (NOx Control Diagnosis) Inducement strategy and LCD display.

Impeded EGR and Tampering

Inducement Stage	Condition	Repeat Offence (within 40hrs)	Inducement Strategy					
			DEF Level Indicator	Emission System Indicator	Engine Check Lamp	Buzzer	Torque Reduction	RPM Limit
								
Normal	NA	≥ 95% of counter value for severe inducement (100hrs)	Green ON	Off	Off	Off	0%	NA
Level1	Impeded EGR detected		Green ON	On	Off	Off	0%	NA
Level2	36~100hrs		Green ON	On	On	At starting & Every 20min	25%	NA
Level3	over 100hrs		Green ON	Blinking	Blinking	Every 10min	50%	60% (about 1500rpm)

Inducement Stage	Condition	Repeat Offence (within 40hrs)	LCD Display	
			Method	Message on the Display
				
Normal	NA	≥ 95% of counter value for severe inducement (100hrs)	NA	NA
Level1	Impeded EGR detected		At starting & Every 20min	DPF/Aftertreatment SYSTEM MALFUNCTION CALL CROWN SERVICE AGENT Engine Power will be Reduced
Level2	36~100hrs		Every 10min	DPF/Aftertreatment SYSTEM MALFUNCTION CALL CROWN SERVICE AGENT Engine Power is Reduced By 25%
Level3	over 100hrs		Continuous	DPF/Aftertreatment SYSTEM MALFUNCTION CALL CROWN SERVICE AGENT Engine Power is Reduced By 50%

Lift Truck Operation

Power Shift Transaxle

1. Start the engine. See topic “Starting the Engine.”

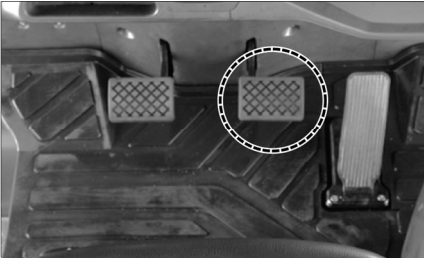

2. Push down on the service brake pedal to hold the lift truck until ready to move it.
3. Release the parking brake.

NOTE: The parking brake must be released before the directional control can be used.



4. Select the direction of travel by pushing the directional lever FORWARD for forward direction or by pulling the lever BACK for reverse direction.

WARNING

A lift truck with the engine running but without an operator can move slowly (creep) if the transmission is engaged.

This could result in personal injury.

Always place the transmission control lever in the NEUTRAL (centre) position and apply the parking brake before dismantling the lift truck.

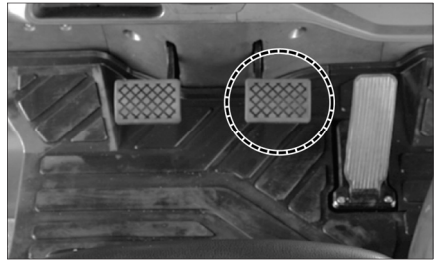

5. Release the service brake.
6. Push down on the accelerator pedal to obtain the desired travel speed. Release the pedal to decrease travel speed.

WARNING

Sudden reversal of a loaded lift truck traveling forward can cause the load to fall or the lift truck to tip.

Stop the loaded lift truck completely, before shifting to reverse.

Failure to comply could result in personal injury.

NOTE: Where conditions permit, directional changes can be made under full power at speeds up to 6 km/h (3.73mph). A speed of 6 km/h (3.73mph) is a fast walk. Directional shift changes at speeds above 6 km/h (3.73mph) are considered abusive.

Bring the lift truck to a complete stop where load stability or other factors prevent safe operation under full power shifts.

7. To change the lift truck direction of travel, release the accelerator pedal.
8. Push down on the service brake pedal to reduce the lift truck speed as necessary.



9. Move the directional lever to the desired direction of travel. Slowly push down on the accelerator pedal as the lift truck changes direction.
10. When the direction change is completed, continue to push down on the accelerator pedal to obtain the desired travel speed.

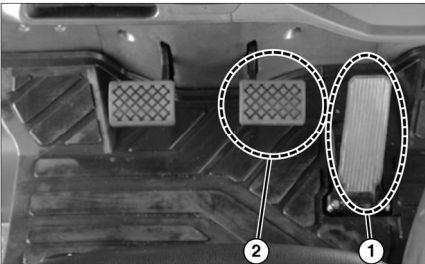

11. To stop the lift truck when traveling in either direction, release the accelerator pedal (1).
12. Push down on the service brake pedal (2) and bring the lift truck to a smooth stop.

Inching

NOTE: The purpose of the inching pedal is to provide precise lift truck inching control at very slow travel speed and high engine rpm. This is used for fast hydraulic lift, during load approach, pick up or load positioning.

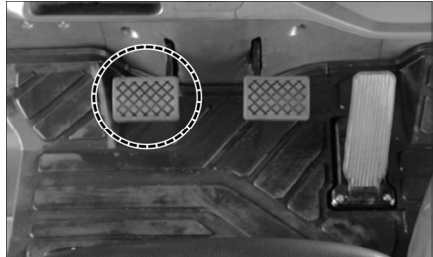

1. To inch (creep) in either direction, slowly push down on the inching pedal. This will start to apply the service brakes and allow the transmission clutch discs to slip.
2. Vary the position of the inching pedal and the accelerator pedal to control the inching speed and distance.
3. Pushing down further on the inching pedal will disengage the transmission completely and apply the service brakes fully to stop and hold the lift truck. This will provide full engine power for fast hydraulic lift.
4. Avoid overuse of the inching pedal as this may cause the automatic transmission oil to overheat or the clutch to slip. Do not use as a footrest or for long periods of time.
5. If user operates continuously pushing work or both brake pedal and accelerator pedal were depressed at the same time, it may cause the automatic transmission oil to overheat or the clutch to slip.

Steering Knob (If Equipped)

There is a steering knob available for inclusion with new truck deliveries. This option is solely intended for slow travel situations when two handed steering is not possible due to hydraulic operations.

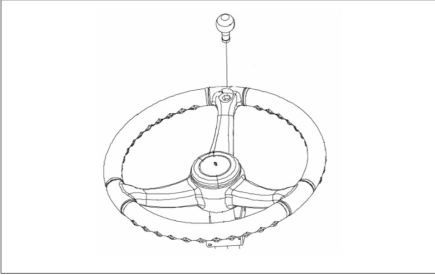

WARNING

Loss of stability can occur when a lift truck steering wheel is rotated quickly while the truck is in motion. A steering knob will assist with easy rotation of the steering wheel, but if a steering knob is improperly used (e.g., rotating the steering wheel quickly while the truck is in motion), this can contribute to truck instability and a tip over. A steering knob is intended for slow travel maneuverability **ONLY**.

Mono-Ped Control System (If Equipped)

The MONO-PED pedal controls the speed and direction of the lift truck. Pushing on the right side of the pedal causes the lift truck to move in REVERSE. The optional reverse lights and optional back-up alarm will be ON in the REVERSE position. Pushing on the left side of the pedal causes the lift truck to move in FORWARD.

The speed of the truck increases as the pedal is depressed

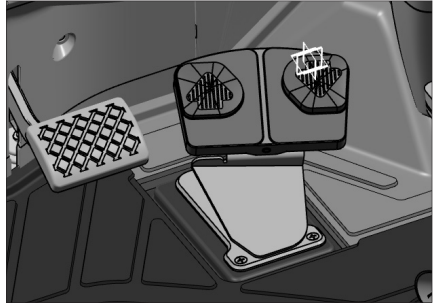

Forward-Push the left side of the pedal for FORWARD direction travel.



Neutral-The lift truck should not move when the Mono-Ped pedal is released.



Reverse-Push the right side of the pedal for REVERSE direction travel.

WARNING

Sudden reversal of a loaded lift truck traveling forward can cause the load to fall or the lift truck to tip.

Stop the loaded lift truck completely, before shifting to reverse.

Failure to comply could result in personal injury.

TMS(Lin-Q) (Option)

Safety Precautions

This information is intended to protect the safety and property of the user.

Before using the TMS (LIN-Q) terminal, make sure to read the user manual carefully and familiarise yourself with the contents.

care to ensure that it does not fall and make sure that it is secured properly.

- Do not block any vents or heat sinks. Doing so may cause a fire.

Operating Environment

- The TMS (LIN-Q) terminal has an operating voltage of DC 9 V – 34 V.
- Make sure to use it within the specified temperature range.

Precautions for Using the Product

- Avoid operating the terminal while the vehicle is running; otherwise, an accident may occur. Stop the machine in a safe place before operating the terminal.
- Do not disassemble or modify the terminal without permission. Unauthorised disassembly and modification may cause a malfunction and void the warranty for after-sales service.

Installation and Wiring

- The installation and wiring procedures require professional expertise. Consult a professional technician for assistance with installing the product. Improper installation or wiring may cause a fire and/or malfunction.
- Perform the installation and wiring in a place free of moisture. Installing the product in a place with the risk of water or rain splashing on it or with significant amounts of dust or dirt may cause malfunctions and accidents.
- Use the specified cables and parts.
- When installing the product on the ceiling of the machine or in places with severe vibrations, take

Basic TMS

Lift Control knob

The TMS (LIN-Q) terminal is mounted on the forklift to monitor the driving and operating state of the vehicle.

To register and use the product, visit the Lin-Q website or contact an administrator.

System Schematic Drawing

The terminal uses LTE, Wi-Fi communications (providing each terminal) and is an IoT terminal which can be used anywhere in the world.

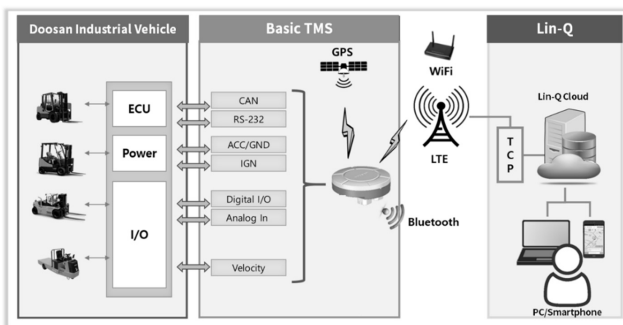

Product Configuration and Functions

The TMS (LIN-Q) terminal is configured and connected as shown in the figure below. A separate harness cable assembly is required to connect it to the vehicle.

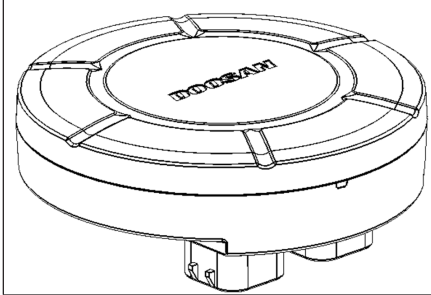

- LTE communications (Cat 4, 150M DL/ 50M UL), globally supported modem

- CAN data (J1939) collection
- Data collection from various vehicle sensors
- Periodic transmission of collected data
- Transmission of irregular event data
- Operating restriction by syncing with NFC
- Impact detection
- Remote update function
- Various I/O ports
 - 2 digital inputs
 - 3 digital in/outputs
 - 1 analog input
 - CAN
 - UART 2 ports

Product Specifications

Item	DTM-02L	
Size	ø117.7 (D) x 31 (H) [mm] [Unit: mm]	
Weight	204 grams	
Operating temp.	-30°C to +70°C (-22°F to +158°F)	
Storage temp.	-40°C to +85°C (-40°F to +185°F)	
Vibrations	Random 5 – 20 Hz 0.05 g2/Hz, 20 – 150 Hz: -3 dB/oct. (1.7g rms), 3-axis, 30 minutes for each axis.	
Thermal shock	-40°C (1H)/+85°C (1H), 1 cycle - total 24 cycles, 48H, non-operating	
Humidity	+70°C /95%/48 hours, operating	
Communication	LTE	LTE data modem (LTE Cat4, worldwide)
	BT	nRF52810, Bluetooth 5.0
GPS	Chipset	Gen8C-Lite
	TTFB	Cold start: 35 sec./Hot start: 2.5 sec.
IP class	IP66	
Operating voltage	+9 V DC to +34 V DC	
Current consumption	Sleep mode: 20 uAh or less (IGN OFF) /Standby mode: 100 mA or less	
I/O ports	2 X 8 pin waterproof connectors	
Antenna	LTE	Internal
	BT	Internal
	GPS	Internal
SIM	ESIM	
LED	4 LEDs (POWER, BT, COMM, GPS)	

Names and Functions of Parts

Terminal Body

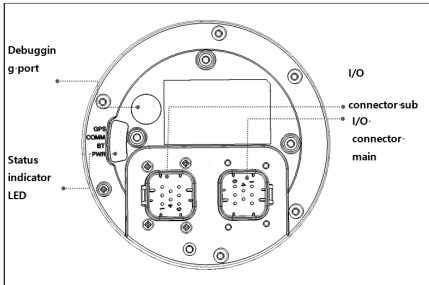

Name	Feature	Remarks
I/O connector main	A connector for connecting to the vehicle	8 pins, black
I/O connector sub	A connector for connecting to the vehicle	8 pins, natural
Status indicator LED	Four LEDs indicating the current status of the terminal	
Debugging port	Debugging port for developers	

There are two types of connectors: A (black) and B (natural). The pin map is shown in the table below.

- CONNECTOR Main (776276-1, Black)

No.	Name	Type	Description
1	FUEL_ADC	Input	Signal Input Analog (with ADC)
2	CAN Low	Input/Output	CAN Low Signal
3	IGN+	Input	IGN+ Signal Input (Logic)
4	BRK	Input	Brake Signal Input (Logic)
5	GND1	Power	Digital Ground
6	SPD	Input	Speed Signal Input (Logic)
7	CAN High	Input/Output	CAN High Signal
8	BAT+	Power	Car Battery +

- CONNECTOR Sub (776276-2, Natural)

No.	Name	Type	Description
1	ACC_TXD	Output	RS232C Level TXD Signal (Acc_Sensor)
2	GPI01	Input/Output	Digital Signal Input1/Output1 (Logic)
3	NFC_TXD	Output	RS232C Level TXD Signal (NFC Reader)
4	GPI02	Input/Output	Digital Signal Input2/Output2 (Logic)
5	GND2	Power	Digital Ground
6	ACC_RXD	Input	RS232C Level RXD Signal (Acc_Sensor)
7	GPI03	Input/Output	Digital Signal Input3/Output3 (Logic)
8	NFC_RXD	Input	RS232C Level RXD Signal (NFC Reader)

Status Indicator LED

DTM-02L indicates the status of the terminal with LEDs.

There are four LEDs which indicate the status of the terminal with colors as shown in the table below.

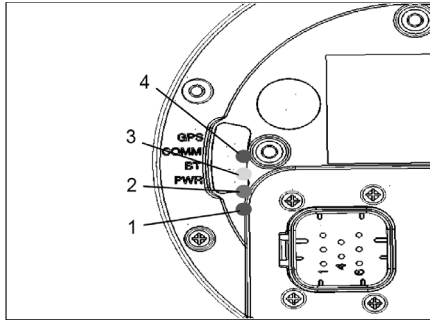

No.	Display Info	Color	Status	Detailed Status	Description
1	POWER	Red	Power status	Off	Power off
				On	Power on
2	BT	Green	BT communication status	Off	BT disconnected
				On	BT connected
				Blinking	BT data transmission in progress
3	COMM	Yellow	Communication status	Off	LTE disconnected
				On	LTE connected
				Blinking	LTE data transmission
4	GPS	Red	GPS connection status	Off	GPS disconnected
				On	GPS connected

Using the Product

A. User Registration

You must perform user registration in order to use the product.

To register a user, visit the branch from which the product was purchased or go to <https://lin-q.doosan-iv.com>.

For more details, refer to the Lin-Q user manual.

B. Activating LTE Mode

The product comes with an ESIM (chip setting SIM card) installed and activated.

Operating Techniques

Inching into Loads

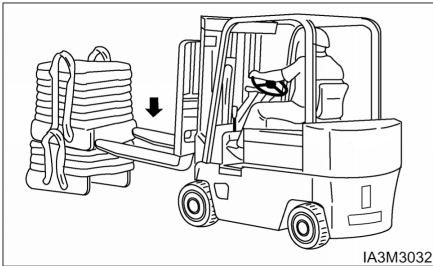

Typical Example

1. Move the lift truck slowly **FORWARD** into position and engage the load. The lift truck should be square with load, forks spaced evenly between pallet stringers and as far apart as load permits.

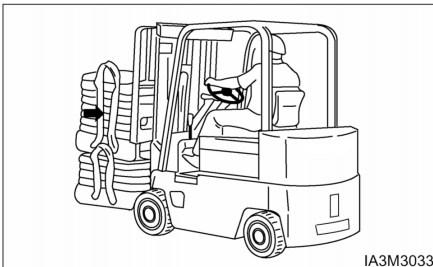

Typical Example

2. Move the lift truck **FORWARD** until the load touches the carriage.

Lifting the Load

1. Lift the load carefully and tilt the mast back a short distance.

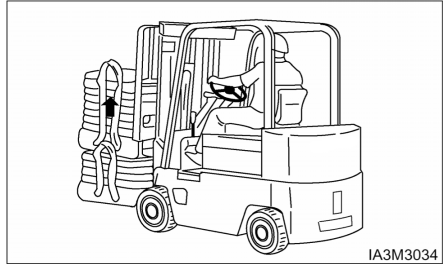

Typical Example

2. Tilt the mast further back to cradle the load.

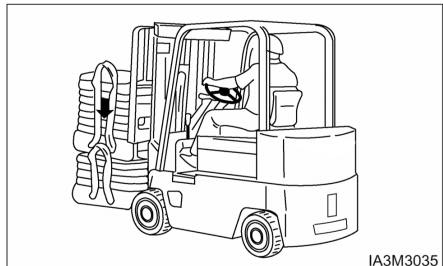

Typical Example

3. Operate the lift truck in reverse until the load is clear of the other material.
4. Lower the cradled load to the travel position.

NOTE: Lift and tilt speeds are controlled by engine rpm.

Traveling With the Load

NOTICE

Travel with the load as low as possible, while still maintaining ground clearance.

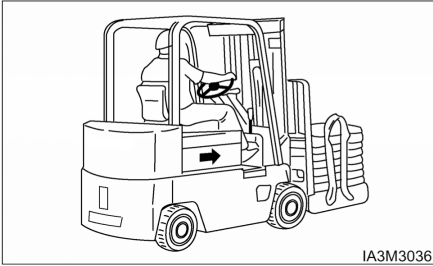

Typical Example

1. Travel with the load uphill on upgrades and downgrades.

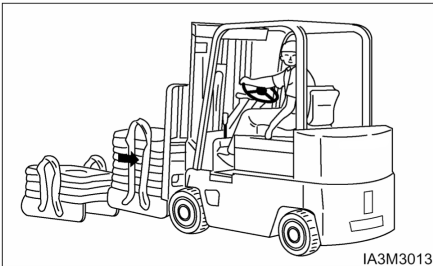

Typical Example

2. For better vision, travel in reverse with bulky loads.

Unloading

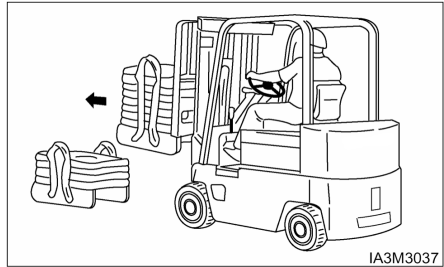

Typical Example

1. Move the lift truck into the unloading position.

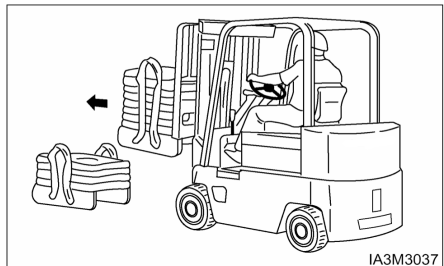

Typical Example

2. Tilt the mast FORWARD only when directly over the unloading area.

WARNING

Do not tilt the mast forward with the load unless directly over the unloading area, even if the power is off.

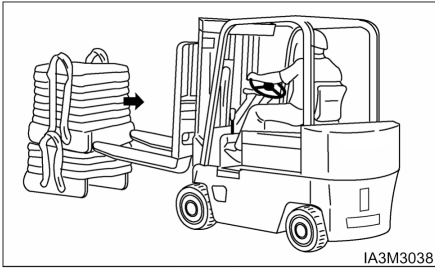

Typical Example

3. Deposit the load and **BACK** away carefully to disengage the forks.

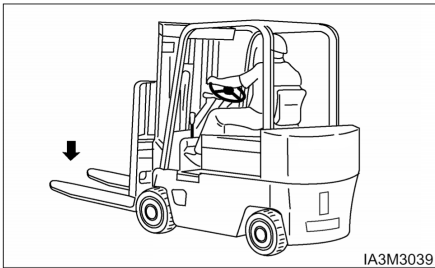

Typical Example

4. Lower the carriage and forks to the travel position or to the park position.

Turning

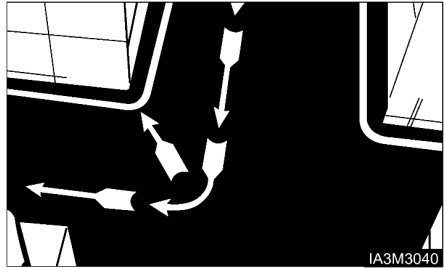

1. When turning sharp corners, keep close to the inside corner. Begin the turn when the inside drive wheel meets the corner.

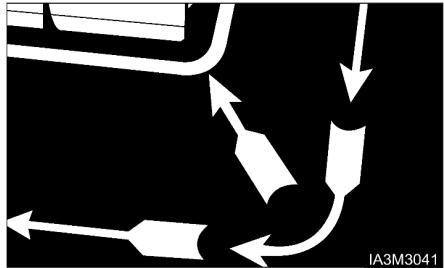

2. In narrow aisles, keep away from the stockpile when turning into the aisle. Allow for counterweight swing.

Lifting Drums or Round Objects

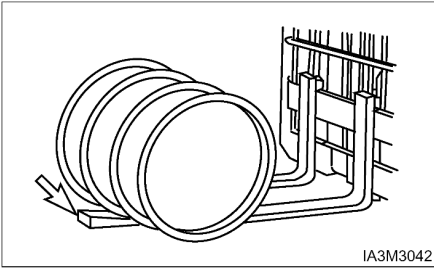

1. Block drums or round objects. Tilt the mast **FORWARD** and slide the fork tips along the floor to get under the load.

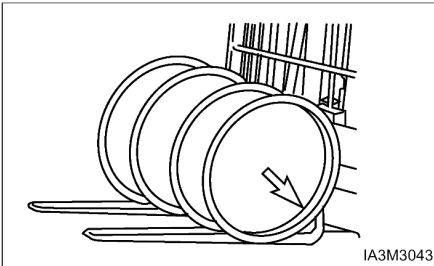

2. Before lifting, tilt the mast **BACK** slightly until the load is cradled on the forks.

Operating in hot weather

Keep the following points in mind when you operate the lift truck in hot weather.

1. Check the radiator. Clogging can cause overheating. Clean them out regularly with a blast of compressed air, also, check for leakage of water.
2. Check the fan belt tension and adjust to proper tension.
3. Even if the engine overheats and the coolant boils over, let the engine idle for a while with opening engine hood until temperature falls before shutting off the engine.

Safety instructions for attachments when transporting suspended loads

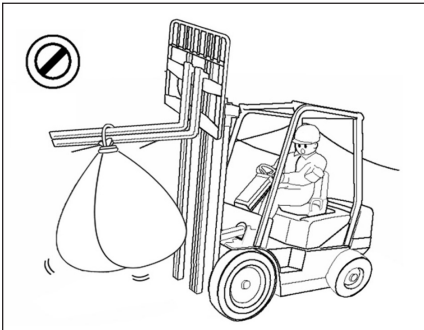

Swinging/wide loads and a reduced residual capacity can result in accidents

Adapt the travel speed to the load, less than walking pace.

Secure swinging loads for example with lifting slings.

Reduce the residual capacity and have it certified by a expert.

Failure to follow the operation precautions may cause early damage to parts.

Safety instructions for attachments when transporting wide loads

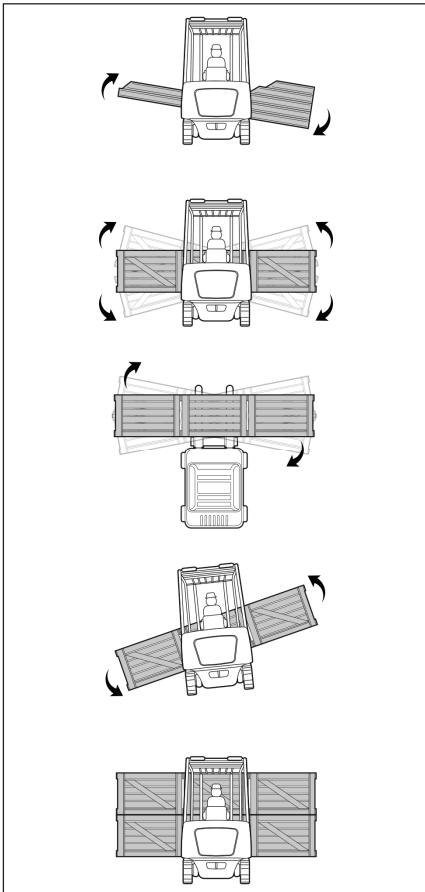

Load lateral centre of gravity

Where it is necessary to lift a wide load where the lateral load centre of gravity is unknown.

Do a test lift first to determine lateral centre of gravity and potential movement with the load during transport. Exercise extra caution when handling offcentre loads that cannot be centred.

Load Stability

Be careful when stopping or changing direction suddenly, lifting or lowering suddenly as wide loads could become unstable.

Load Swing

Be careful whilst travelling or turning, the load ends will swing wide. Make sure you have adequate clearance, and watch out for people in the area.

Load Shift

Be careful when turning, turn slowly to prevent load from shifting.

Visibility

When carrying a bulky load which blocks or restricts forward visibility the truck shall be driven with the load trailing and if necessary under the direction of a person who has visibility in the direction of travel, unless safe work practises allow otherwise.

Parking the Lift Truck

Park the lift truck on level ground, lowering the forks and tilting the mast forward until the fork tips touch the floor. Block the drive wheels when parking on an incline.



1. Park in an authorised area only. Do not block traffic



2. Place the transmission controls in NEUTRAL.
3. Engage the parking brake.
4. Lower the forks to the ground.

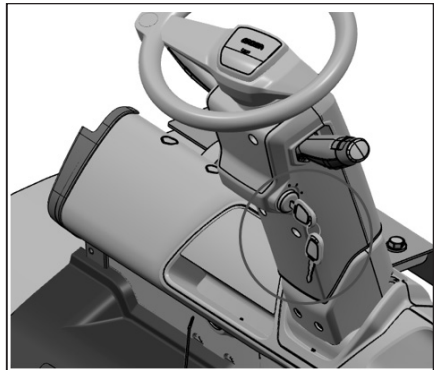

5. Turn the key in the ignition switch to the OFF position and remove the key.
6. Actuate each loading lever several times to remove the residual pressure in the respective cylinders and hoses.
7. Block the drive wheels if parking on an incline.

WARNING

Blocking the wheels will prevent unexpected lift truck movement, which could cause personal injury.

Lift Fork Adjustment

WARNING

When adjusting the fork spread, be careful not to pinch your hand between forks and the carriage slot.

Hook - on type Fork

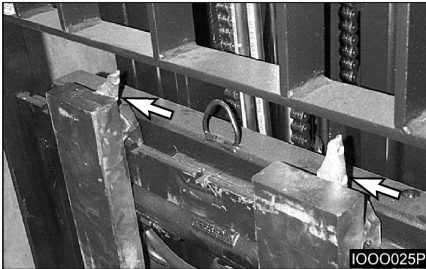

1. Move up the hook pin to the free position.
2. Raise the hook pin in each fork to side the fork on the carriage bar.
3. Adjust the forks in the position most appropriate for the load and as wide as possible for load stability.
4. When adjusting the forks, make sure that the weight of the load is centred on the truck.
5. After adjustment, set the fork locks to keep the forks in place.

WARNING

Make sure the forks are locked before carrying a load.

If the fork/locking pin is not fully engaged, the fork could become unintentionally disengaged.

Storage Information

Before Storage

Before storing your lift truck, clean and inspect as the following procedures.

- Wipe away grease, oil, etc. adhering to the body of the truck with waste cloth, and use water, if needed.
- While cleaning the truck, check general condition of the truck. Especially check the truck body for dents or damage and tyres for wear or nails or stones in the tread.
- Fill the fuel tank with fuel specified.
- Check for leakage of hydraulic oil, engine oil, fuel, or coolant, etc.
- Apply grease, where needed.
- Check for looseness of nuts and bolts, especially hub nuts.
- Check mast rollers to see that they rotate smoothly.
- Prime the oil into the lift cylinders by actuating the lift lever all the way several times.
- Drain off coolant completely in cold weather, if antifreeze is not used.
- Drain off DEF/Ad-Blue completely for long term storage. (If not the purity of DEF/Ad-Blue would be changed to lower quality.)

Long Time Storage

Perform the following service and checks in addition to the "Parking the lift truck" services.

- Taking the rainy season into consideration, park the machine at a higher and hard ground.
- Avoid parking on soft grounds such as asphalt ground in summer.
- Dismount the battery from the machine. Even though the machine is parked indoors, if the place is hot or humid, the battery should be kept in a dry, cool place. Charge the battery once a month.
- Apply antirust to the exposed parts which tend to rust.
- Cover components such as the breather and air cleaner which may be caught with humidity.
- The machine should be operated at least once a week. Fill the cooling system, if cooling water is discharged, and mount the battery. Start the engine and warm up thoroughly. Move the machine a little forwards and backwards. Operate the hydraulic controls several times.

To Operate the Lift Truck After a Long Time Storage

- Remove covers and antirust from each of the components and exposed parts.
- Drain the engine crankcase, transmission (clutch type machine), differential and final reduction gear, clean the inside of them and add new oil.
- Drain off foreign matter and water from the hydraulic oil tank and fuel tank.
- Remove the head cover from the engine cylinder. Oil valves and rocker shaft and check each valve for proper operation.
- Add cooling water to the specified level.
- Charge the battery and mount it on the machine. Connect the cables.
- Perform pre-operational checks carefully. (refer to "Before Starting the Engine")
- Warm up the machine.
- If deteriorated DEF/Ad-Blue warning lamp turns on and message appears, drain the fluid in the DEF/Ad-Blue tank thoroughly and refill with new DEF/Ad-Blue.
- Check level of DEF/Ad-Blue and if necessary refill DEF/Ad-Blue (refer page.72)

Transportation Hints

Lift Truck Shipping

Check travel route for overpass clearances. Make sure there is adequate clearance if the lift truck being transported is equipped with a high mast, overhead guard or cab.

To prevent the lift truck from slipping while loading, or shifting in transit, remove ice, snow or other slippery material from the loading dock and the truck bed before loading.

NOTICE

Obey all state and local laws governing the height, weight, width and length of a load.
Observe all regulations governing wide loads.

NOTICE

Remove ice, snow or other slippery material from the shipping vehicle and the loading dock.

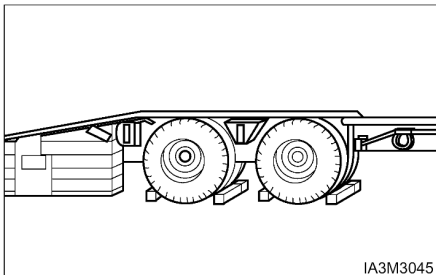

Always block the trailer or the rail car wheels before loading the lift truck.

Position the lift truck on the truck bed or the rail car.

Apply the parking brake and place the transmission control in NEUTRAL.

Turn the ignition switch to the OFF position and remove the key. If LP equipped, shut off the LP fuel tank.

Block the wheels and secure the lift truck with tiedowns.

Machine Lifting and Tiedown Information

NOTICE

Improper lifting or tiedowns can allow load to shift and cause injury and/or damage.

1. Weight and instructions given herein apply to lift trucks as manufactured by CROWN.
2. Use proper rated cables and slings for lifting. Position the crane for level lift truck lift.
3. Spreader bar widths should be sufficient to prevent contact with the lift truck.
4. Use the tiedown locations provided for lift truck tiedown.

Check the state and local laws governing weight, width and length of a load.

Contact your CROWN Lift Truck branch for shipping instructions for your lift truck.

Lifting a Forklift using a Crane

WARNING

1. If lifting rope breaks, serious injury/damage may occur.
2. The lifting wire rope and stay must be long enough to avoid contact with the forklift. Short rope/stay can damage the vehicle. If it's too long, it may cause interference.

If sling and LP tank contact happens during refloatation operation, you should get rid of tank of vehicle with LP tank first, and then proceed.

3. Rope/chain and other lifting tools must have sufficient strength, and free of any defect or wear.
4. Avoid impact load to the lifting devices/tools.

1. Check the weight, length, width and height of the vehicle before lifting.
2. Park the crane at an appropriate position.
3. Connect the rope/chain to the points A and B of the figure below.
4. If the wire rope/chain contacts the vehicle, insert a rubber plate between the rope/chain and the vehicle to protect the vehicle.

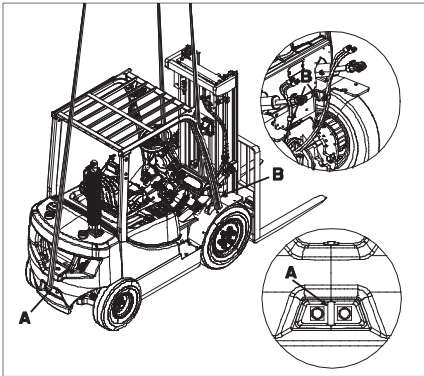

5. Lift up the vehicle slowly.

How to Fix Forklift to a Carrier

1. The rope/chain must have sufficient length for fixing.
2. Park the vehicle on a level ground.
3. Set the mast vertically. Lower the fork or attachment to the lowest position.
4. Set all the operating devices to Neutral Position. Turn OFF the start switch.
5. Apply the parking brake. Stop the tyres with blocks (C).
6. Connect towing hooks to the mast top B (if without mast, front drive axle fix frame or front fender bottom fixing hole D) and rear tow pin A, as shown in the figure below.

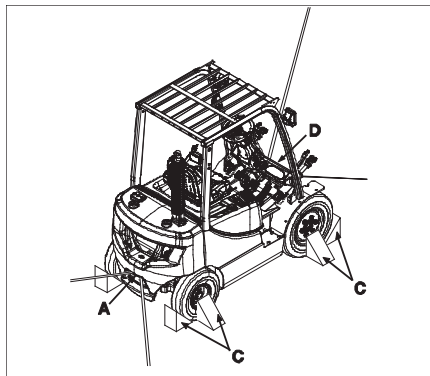
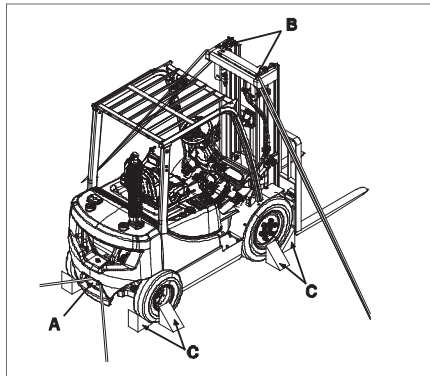

Towing Information

WARNING

Personal injury or death could result when towing a disabled lift truck incorrectly.

Block the lift truck wheels to prevent movement before releasing the brakes. The lift truck can roll free if it is not blocked.

Follow the recommendations below, to properly perform the towing procedure.

These towing instructions are for moving a disabled lift truck a short distance, at low speed, no faster than 2 km/h (1.2 mph), to a convenient location for repair. These instructions are for emergencies only. Always haul the lift truck if long distance moving is required.

Shield must be provided on the towing lift truck to protect the operator if the tow line or bar should break.

Do not allow riders on the lift truck being towed unless the operator can control the steering and/or braking.

Before towing, make sure the tow line or bar is in good condition and has enough strength for the towing situation involved. Use a towing line or bar with a strength of at least 1.5 times the gross weight of the towing lift truck for a disabled lift truck stuck in the mud or when towing on a grade.

Keep the tow line angle to a minimum. Do not exceed a 30° angle from the straight ahead position. Connect the tow line as low as possible on the lift truck that is being towed.

Quick lift truck movement could overload the tow line or bar and cause it to break. Gradual and smooth lift truck movement will work better.

Normally, the towing lift truck should be as large as the disabled lift truck. Satisfy yourself that the towing lift truck has enough brake capacity, weight and power, to control both lift trucks for the grade and the distance involved.

To provide sufficient control and braking when moving a disabled lift truck downhill, a larger towing lift truck or additional lift trucks connected to the rear could be required. This will prevent uncontrolled rolling.

The different situation requirements cannot be given as minimal towing lift truck capacity is required on smooth level surfaces to maximum on inclines or poor surface conditions.

Consult your CROWN Lift Truck branch for towing a disabled lift truck.



1. Release the parking brake.

NOTICE

Release the parking brake to prevent excessive wear and damage to the parking brake system.

2. Check that the service brake pedal is released.
3. Key switch is in the OFF position.
4. Direction control lever is in neutral.
5. Fasten the tow bar to the lift truck.
6. Remove the wheel blocks. Tow the lift truck slowly. Do not tow any faster than 2 km/h (1.2 mph).

WARNING

Be sure all necessary repairs and adjustments have been made before a lift truck that has been towed to a service area is put back into operation.

Parking Brake Forced Release Method

NOTICE

When the engine stalls, the electronic parking brake remains applied at all times regardless of the status of the parking brake switch.

If the parking brake is not released before towing the vehicle, it may cause damage to the tyres and driving system.

Parking Brake Forced Release Method 1 (In Case of Engine Start)

1. Secure the wheels with wooden blocks.
2. Start the engine and change the shift lever to "NEUTRAL" and then to the "2nd gear" position.
3. Use a spanner to fully loosen the nut on the parking brake valve in front of the transmission by turning it in the CCW direction.
4. Use a hex wrench to turn and fully tighten the inner bolt in the CW direction.
5. Install the nut (previously removed) and tighten it fully.

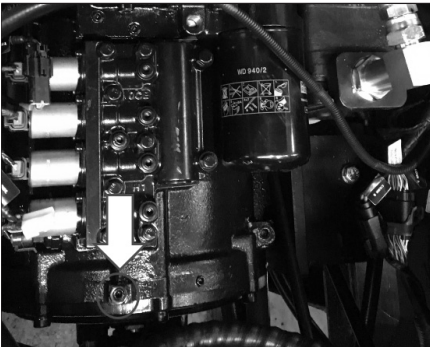

Restoration of Parking Brake Forced Release Method 1

1. Secure the wheels with blocks.
 2. Use a spanner to fully loosen the nut on the parking brake valve in front of the transmission by turning it in the CCW direction.
 3. Use a hex wrench to loosen the inner bolt by making three full turns in the CCW direction.
 4. While holding the inner bolt with a hex wrench, fully tighten the outer nut in the CW direction.
 5. Check on the housing if the bolt height "A" is 9 ~ 12 mm.
-

NOTICE

If the height is lower than that, the clutch may not operate smoothly, whereas if it is higher, it may cause an oil leak.

6. Start the engine and check that the parking brake functions normally.

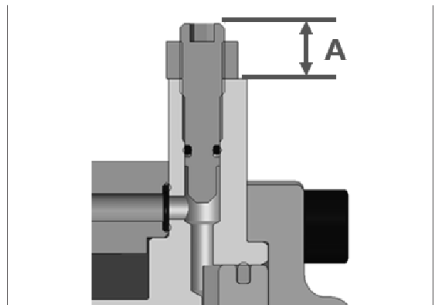

Parking Brake Forced Release Method 2 (In Case That the Engine Does Not Start)

1. Secure the tyres with wooden blocks.
2. Use a hex wrench to fully loosen the plugs in the three o'clock and nine o'clock directions on the front of the transmission.
3. Temporarily tighten the M8 x 30mm bolt by hand.
4. Use a spanner to tighten the two bolts alternately (one bolt at a time) by one turn each. (Caution: Avoid using a pneumatic impact or power tool to fully tighten the bolts as it may cause damage to the internal parts.)

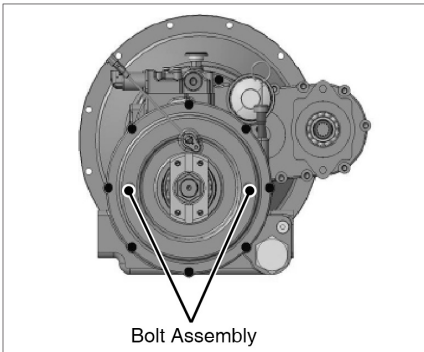

Restoration of Parking Brake Forced Release Method 2

1. Secure the tyres with wooden blocks.
2. Use a spanner to loosen alternately by one turn each the two bolts (one bolt at a time) assembled in the three o'clock and nine o'clock directions on the front of the transmission. (Caution: Avoid using a pneumatic impact or power tool to fully loosen the bolts as it may cause damage to the internal parts.)
3. Apply sealant to the plug (previously removed) and fully tighten it with a hex wrench.
4. Start the engine and check that the parking brake functions normally.

Jacking Information

⚠ WARNING

Jacking up Truck can be dangerous and should be done only by trained personnel using proper tools and procedures.

Block the lift truck wheels to prevent movement while lifting the wheels. The lift truck can roll free if it is not blocked.

Follow the recommendations below, to properly perform the jacking procedure.

NOTICE

Move Trucks to a Secure Non Traffic Maintenance Area with a Level Floor. No Load on Forks.
Remove key from ignition switch.

Hydraulic Jack & Jack Stand Capacity

Hydraulic Jack Capacity

	Model	Height Minimum*	Minimum Requirement	
1 ton class	CGC15/18S-5, CGC15/18S-5, CGC20SC-5	100 mm	2000Kg	4400lbs
	CD15/18S-5, CD20SC-5, CG15/18S-5, CG20SC-5	150 mm		
2 ton class	CD20/25/ 30/33S-5/7/9, CD35C-5/7/9, CG20/25/30E-5, CG20/25 /30/33P-5/7, CG35C-5/7	150 mm	3000Kg	6600lbs
	CGC20/25/30/ 33E-5, CGC20/25/30/ 33P-5	120 mm		
4 ton class	CD35/40/45S-5/7/9, CD50/55C-5/7/9, CD40/45/50/ 55SC-5/7/9, CG35/40/45S-5/7, CG50/55C-5/7, CG40/45/50/ 55SC-5/7 CGC35/45S-9(BCS) CGC55C-9 (BCS)	180 mm	3900Kg	8600lbs
6 ton class	CD50/60/70S-5/7, CG50/60/70S-5/7	250 mm	5800Kg	12800lbs
8 ton class	CD80/90S-5/7	250 mm	7500Kg	16500lbs
11 ton class	CD110/130 /160S-5	300 mm	10000Kg	22050lbs
18/20 ton class	CDV180/200S-7	350 mm	14000Kg	30900lbs
25 ton class	CDV250S-7	400 mm	19000Kg	42000lbs

* The height of lift truck with a flat tyre is lower than with an inflated tyre. So Height Minimum of Jack must be less than the value of the above chart.

Stand Capacity should be more than the minimum requirement of Hydraulic Jack Capacity.
Hydraulic Jack & Jack Stand are commercially available and should be especially designed for forklift trucks.

Jacking Procedure

Steering Wheel

1. Raise Forks 3 to 6 in (76 to 152 mm) from Floor.
2. Place Wheel Chocks under Both Drive Wheels.
3. Locate Hydraulic Jack under Steering Axle as Shown in Figure A.
4. Jack Up Truck with Hydraulic Jack.
5. Set Jack Stand Height as Required Not to Exceed 16 in (405mm).

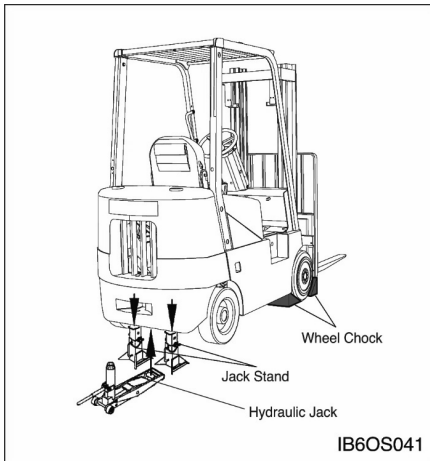

Figure A

Side

1. Lower Forks Completely.
2. Locate Hydraulic Jack under Frame as Shown in Figure B.
3. Jack Up One Side of Truck.
4. Place Hard Wood Block directly under First Stage Mast.
 - 1ton/2ton class - Use 6X6 in (150X150mm) Block
 - 3ton/5ton class - Use 8X8 in (200X200mm) Block
 - 11ton class - Use 12X12 in (300X300mm) Block
5. Jack Up Opposite Side of Truck.
6. Place Second Hard Wood Block under Other Side of First Stage Mast.
7. Do Not Tilt Mast after Blocked.

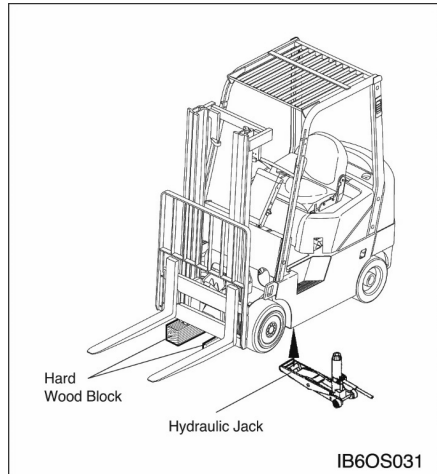

Figure B

⚠ WARNING

Locate Hydraulic Jack under Frame. Do NOT locate on side panel. Do NOT raise side of truck any more than required to insert hard wood block.

⚠ WARNING

Locate Hydraulic Jack and Jack Stands under steer axle. Do NOT locate Hydraulic Jack or Jack Stands on Counter Weight.

Inspection, Maintenance and Repair of Lift Truck Forks

The following section gives practical guidelines for inspection, maintenance and repair of lift truck forks. It also provides general information on the design and application of forks and the common cause of fork failures.

Lift truck forks can be dangerously weakened by improper repair or modification. They can also be damaged by the cumulative effects of age, abrasion, corrosion, overloading and misuse.

A fork failure during use can cause damage to the equipment and the load. A fork failure can also cause serious injury.

A good fork inspection and maintenance program along with the proper application can be very effective in preventing sudden failures on the job.

Repairs and modifications should be done only by the fork manufacturer or a qualified technician who knows the material used and the required welding and heat treatment process.

Users should evaluate the economics of returning the forks to the manufacturer for repairs or purchasing new forks. This will vary depending on many factors including the size and type of fork.

Forks should be properly sized to the weight and length of the loads, and to the size of the machine on which they are used. The general practice is to use a fork size such that the combined rated capacity of the number of forks used is equal to or greater than the "Standard(or rated) Capacity" of the lift truck.

The individual load rating, in most cases, will be stamped on the fork in a readily visible area. This is generally on the top or side of the fork shank.

- A fork rated at 1500 pounds at 24 inch load centre will be stamped 1500X24.
- A fork rated at 2000 kg at 600 mm load centre will be stamped 2000X600.

The manufacturer identification and year and date of manufacture is also usually shown.

Some countries have standards or regulations which apply specifically to the inspection and repair of forks.

Users may also refer to the International Organization For Standardization - ISO Technical Report 5057 - Inspection and Repair of Fork Arms and ISO Standard 2330 - Fork Arms-Technical Characteristics and Testing.

While there are no specific standards or regulations in the EU, users should be familiar with the requirements for inspection and maintenance of lift trucks by ISO 3691-1 as applicable to the type of machine(s) in use.

Environment Protection

When servicing this lift truck, use an authorised servicing area and an approved container to collect coolant, oil, fuel, grease, electrolyte and any other potential environmental pollutant before any lines, fittings or related items are disconnected or removed. After servicing, dispose of those materials in an authorised place and container. When cleaning the lift truck, be sure to use an authorised area.

Causes of Fork Failure

Improper Modification or Repair

Fork failure can occur as a result of a field modification involving welding, flame cutting or other similar processes which affect the heat treatment and reduces the strength of the fork.

In most cases, specific processes and techniques are also required to achieve proper welding of the particular alloy steels involved. Critical areas most likely to be affected by improper processing are the heel section, the mounting components and the fork tip.

Bent or Twisted Forks

Forks can be bent out of shape by extreme overloading, glancing blows against walls or other solid objects or using the fork tip as a pry bar.

Bent or twisted forks are much more likely to break and cause damage or injury. They should be removed from service immediately.

Fatigue

Parts which are subjected to repeated or fluctuating loads can fail after a large number of loading cycles even though the maximum stress was below the static strength of the part.

The first sign of a fatigue failure is usually a crack which starts in an area of high stress concentration. This is usually in the heel section or on the fork mounting.

As the crack progresses under repetitive load cycling, the load bearing cross section of the remaining metal is decreased in size until it becomes insufficient to support the load and complete failure occurs.

Fatigue failure is the most common mode of fork failure. It is also one which can be anticipated and prevented by recognizing the conditions which lead up to the failure and by removing the fork service prior to failing.

- **Repetitive Overloading**

Repetitive cycling of loads which exceeds the fatigue strength of the material can lead to fatigue failure. The overload could be caused by loads in excess of the rated fork capacity and by use of the forks tips as pry bars. Also, by handling loads in a manner which causes the fork tips to spread and the forks to twist laterally about their mountings.

- **Wear**

Forks are constantly subjected to abrasion as they slide on floors and loads. The thickness of the fork blade is gradually reduced to the point where it may not be capable of handling the load for which it was designed.

- **Stress Risers**

Scratches, nicks and corrosion are points of high stress concentration where cracks can develop. These cracks can progress under repetitive loading in a typical mode of fatigue failure.

Overloading

Extreme overloading can cause permanent bending or immediate failure of the forks. Using forks of less capacity than the load or lift truck when lifting loads and using forks in a manner for which they were not designed are some common causes of overloading.

Fork Inspection



Establish a daily and 12 month inspection routine by keeping a record for the forks on each lift truck.

Initial information should include the machine serial number on each the forks are used, the fork manufacturer, type, original section size, original length and capacity. Also list any special characteristics specified in the fork design.

Record the date and results of each inspection, making sure the following information is included.

- Actual wear conditions, such as percent of original blade thickness remaining.
- Any damage, failure or deformation which might impair the use of the truck.
- Note any repairs or maintenance.

An ongoing record of this information will help in identifying proper inspection intervals for each operation, in identifying and solving problem areas and in anticipating time for replacement of the forks.

First Installation

1. Inspect forks to ensure they are the correct size for the truck on which they will be used. Make sure they are the correct length and type for the loads to be handled.

If the forks have been previously used, perform the "12 Month Inspection".

If the forks are rusted, see "Maintenance and Repair".

2. Make sure fork blades are level to each other within acceptable tolerances. See "Forks, Step 4," in the "2000 Service Hours or Yearly" in "Maintenance Intervals"
3. Make sure positioning lock is in place and working. Lock forks in position before using truck. See "Forks, Step 7" in the "2000 Service Hours or Yearly" in "Maintenance Intervals".

Daily Inspection

1. Visually inspect forks for cracks, especially in the heel section, around the mounting brackets, and all weld areas. Inspect for broken or jagged fork tips, bent or twisted blades and shanks.
2. Make sure positioning lock is in place and working. Lock the forks in position before using the truck. See "2000 Service Hours or Yearly" in "Maintenance Intervals".
3. Remove all defective forks from service.

12 Months Inspection

Forks should be inspected, at a minimum, every 12 months. If the truck is being used in a multi-shift or heavy duty operation, they should be checked every six months. See "Forks" in the "2000 Service Hours or Yearly" in "Maintenance Intervals."

Consult the fork manufacturer for further information as may be applicable to the specific fork involved.

Testing is not required for repairs to the positioning lock or the markings.

Maintenance and Repair

1. Repair forks only in accordance with the manufacturer's recommendations.

Most repairs or modifications should be done only by the original manufacturer of the forks or an expert knowledgeable of the materials, design, welding and heat treatment process.

2. The following repairs or modifications **SHOULD NOT** be attempted.

- Flame cutting holes or cutouts in fork blades.
- Welding on brackets or new mounting hangers.
- Repairing cracks or other damage by welding.
- Bending or resetting.

3. The following repairs **MAY** be performed.

- Forks may be sanded or lightly ground, to remove rust, corrosion or minor defects from the surfaces.
- Heel sections may be ground with a carbon stone to remove minor surface cracks or defects. Polish the inside radius of the heel section to increase the fatigue life of the fork. Always grind or polish in the direction of the blade and shank length.
- Repair or replace the positioning locks on hook type forks.
- Repair or replace most fork retention devices used with other fork types.

4. A fork should be load tested before being returned to service on completion of repairs authorised and done in accordance with the manufacturer's recommendations.

Most manufacturers and standards require the repaired fork to be tested with a load 2.5 times the specified capacity and at the load centre marked on the fork arm.

With the fork restrained in the same manner as its mounting on the lift truck, apply the test load twice, gradually and without shock. Maintain the test for 30 seconds each time.

Check the fork arm before and after the second application of the test load. It shall not show any permanent deformation.

Tyre Inflation Information

Tyre Inflation

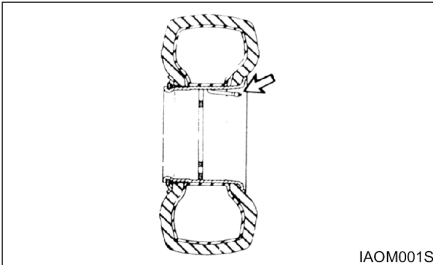

⚠ WARNING

Personal injury or death could result when tyres are inflated incorrectly.

Use a self - attaching inflation chuck and stand behind the tread when inflating a tyre.

Proper inflation equipment, and training in using the equipment, are necessary to avoid overinflation. A tyre blowout or rim failure can result from improper or misused equipment.

NOTICE

Set the tyre inflation equipment regulator at no more than 140 kPa (20 psi) over the recommended tyre pressure.

Tyre Shipping Pressure

The tyre inflation pressures shown in the following chart are cold inflation shipping pressures.

Size	Ply Rating or Strength Index	Shipping Pressure	
		kPa	psi
7.00X12 Steer	12	860	125
8.25X15 Drive	14	825	120
300X15 Drive	18	785	115
7.50X16 Drive dual	12	760	110

¹ Standard tyre, ply rating and inflation pressures.

The operating inflation pressure is based on the weight of a ready - to - work machine without attachments, at rated payload, and in average operating conditions. Pressures for each application may vary and should always be obtained from your tyre supplier.

NOTE: Fill tyres to the recommended pressures listed ± 35 kPa (5 psi). Tyres can be filled with nitrogen.

Tyre Inflation Pressures Adjustment

A tyre inflation in a warm shop area, 18° to 21°C (65° to 70°F), will be under inflated if the lift truck works in freezing temperatures. Low pressure shortens the life of a tyre.

Torque Specifications

Metric Hardware

Most of the nuts, bolts, studs, and threaded holes in your lift truck are metric. In this manual we provide specifications in both metric and U.S. customary measurement. Always replace metric hardware with metric hardware. See the parts books for proper replacement.

NOTE: For proper fit, use only metric tools on metric hardware. Non-metric tools might slip and cause injury.

Torque for Standard Hose Clamps – Worm Drive

NOTICE

The chart below gives the torques for initial installation of hose clamps on new hose and for reassembly or retightening of hose clamps on existing hose.

Clamp Width	Initial Installation Torque On New Hose	
	N·m ¹	lb·in
16 mm (.625 in)	7.5 ± 0.5	65 ± 5
13.5 mm (.531 in)	4.5 ± 0.5	40 ± 5
8 mm (.312 in)	0.9 ± 0.2	8 ± 2
Clamp Width	Reassembly Or Retightening Torque	
	N·m ¹	lb·in
16 mm (.625 in)	4.5 ± 0.5	40 ± 5
13.5 mm (.531 in)	3.0 ± 0.5	25 ± 5
8 mm (.312 in)	0.7 ± 0.2	6 ± 2

¹ 1 Newton meter (N·m) is approximately the same as 0.1 kg·m.

Torque for Standard Bolts, Nuts, and Taperlock Studs

NOTICE

The two charts below give general torques for bolts, nuts, and taperlock studs of SAE Grade 5 or better quality.

Torques for Bolts and Nuts With Standard Threads

Thread Size Inch	Standard Nut and Bolt Torque	
	N·m ¹	lb·ft
1/4	12 ± 4	9 ± 3
5/16	25 ± 7	18 ± 5
3/8	45 ± 7	33 ± 5
7/16	70 ± 15	50 ± 11
1/2	100 ± 15	75 ± 11
9/16	150 ± 20	110 ± 15
5/8	200 ± 25	150 ± 18
3/4	360 ± 50	270 ± 37
7/8	570 ± 80	420 ± 60
1	875 ± 100	640 ± 75
1 1/8	1100 ± 150	820 ± 110
1 1/4	1350 ± 175	1000 ± 130
1 3/8	1600 ± 200	1180 ± 150
1 1/2	2000 ± 275	1480 ± 200

¹ 1 Newton meter (N·m) is approximately the same as 0.1 kg·m.

Torques for Taperlock Studs

Thread Size Inch	Standard Taperlock Stud Torque	
	N·m ¹	lb·ft
1/4	8 ± 3	6 ± 2
5/16	17 ± 5	13 ± 4
3/8	35 ± 5	26 ± 4
7/16	45 ± 10	33 ± 7
1/2	65 ± 10	48 ± 7
5/8	110 ± 20	80 ± 15
3/4	170 ± 30	125 ± 22
7/8	260 ± 40	190 ± 30
1	400 ± 60	300 ± 45
1 1/8	500 ± 700	370 ± 50
1 1/4	650 ± 80	480 ± 60
1 3/8	750 ± 90	550 ± 65
1 1/2	870 ± 100	640 ± 75

¹ 1 Newton meter (N·m) is approximately the same as 0.1 kg·m.

Torque for Metric Fasteners

NOTICE

Be very careful never to mix metric with U.S. customary (standard) fasteners. Mismatched or incorrect fasteners will cause lift truck damage or malfunction and may even result in personal injury.

Original fasteners removed from the lift truck should be checked for any damages and kept for reassembly whenever possible. If new fasteners are needed, they must be of the same size and grade as the ones that are being replaced.

The material strength identification is usually shown on the bolt head by numbers (8.8, 10.9, etc.). This chart gives standard torques for bolts and nuts with Grade 8.8.

NOTE: Metric hardware must be replaced with metric hardware. Check parts book.

For mounting torques of main parts, Please refer to Service manual for detail.

Metric ISO² Tread

Thread Size Metric	Standard Torque	
	N·m ¹	lb·ft
M6	12 ± 4	9 ± 3
M8	25 ± 7	18 ± 5
M10	55 ± 10	41 ± 7
M12	95 ± 15	70 ± 11
M14	150 ± 20	110 ± 15
M16	220 ± 30	160 ± 22
M20	450 ± 70	330 ± 50
M24	775 ± 100	570 ± 75
M30	1600 ± 200	1180 ± 150
M36	2700 ± 400	2000 ± 300

¹ 1 Newton meter (N·m) is approximately the same as 0.1 kg·m.

² ISO - International Standards Organization.

Cooling System Specifications

Coolant Information

NOTE: The following information is generic and valid for lift trucks.

Engine operating temperatures have increased to improve engine efficiency. This means proper cooling system maintenance is especially important. Overheating, overcooling, pitting, cavitation erosion, cracked heads, piston seizures, and plugged radiators are classic cooling system failures. In fact, coolant is as important as the quality of fuel and lubricating oil.

Filling at over 20 liters (5 U.S. gallons) per minute can cause air pockets in the cooling system.

After draining and refilling the cooling system, operate the engine with the radiator cap removed until the coolant reaches normal operating temperature and the coolant level stabilises. Add coolant as necessary to fill the system to the proper level.

Never operate without a thermostat in the cooling system. Cooling system problems can arise without a thermostat.

NOTICE

CROWN recommends that the coolant mixture contain 50% commercially available automotive antifreeze, and 50% water.

The coolant mix with concentration of antifreeze smaller than 30% does not provide sufficient corrosion protection. Concentrations over 60% adversely affect freeze protection and heat transfer rates.

Never add coolant to an overheated engine, engine damage can result. Allow the engine to cool first.

If the machine is to be stored in, or shipped to, an area with freezing temperatures, the cooling system must be protected to the lowest expected outside (ambient) temperature.

The engine cooling system is normally protected to -28°C(-20°F) with antifreeze, when shipped from the factory unless special requirements are defined.

Check the specific gravity of the coolant solution frequently in cold weather to ensure adequate protection.

Clean the cooling system if it is contaminated, the engine overheats or foaming is observed in the radiator.

Old coolant should be drained, the system cleaned and new coolant added every 2000 service hours or yearly.

Refer to topic, "Cooling System - Clean, Change" in Every 2000 Service Hours or Yearly section.

Coolant Water

Hard water, or water with high levels of calcium and magnesium ions, encourages the formation of insoluble chemical compounds by combining with cooling system additives such as silicates and phosphates.

The tendency of silicates and phosphates to precipitate out-of-solution increases with increasing water hardness. Hard water, or water with high levels of calcium and magnesium ions encourages the formation of insoluble chemicals, especially after a number of heating and cooling cycles.

CROWN prefers the use of distilled water or deionized water to reduce the potential and severity of chemical insolubility.

Acceptable Water	
Water Content	Limits (PPM)
Chlorides (Cl)	50 maximum
Sulfates (SO ₄)	50 maximum
Total hardness	80mg/l
Total solids	250 maximum
PH	6.0 to 8.0

ppm = parts per million

Using water that meets the minimum acceptable water requirement may not prevent drop-out of these chemical compounds totally, but should minimise the rate to acceptable levels.

Antifreeze

NOTICE

CROWN recommends using automotive antifreeze suitable for gasoline engines having aluminum alloy parts. Antifreeze of poor quality will cause corrosion of the cooling system, and thus always use automotive antifreeze prepared by a reliable maker, and never use it mixed with antifreeze of different brand.

CROWN recommends that the coolant mix contain 50% commercially available automotive antifreeze, or equivalent and acceptable water to maintain and adequate water pump cavitation temperature for efficient water pump performance.

Premix coolant solution to provide protection to the lowest expected outside (ambient) temperature. Pure undiluted antifreeze will freeze at -23°C (-10°F).

Use a greater concentration (above 50%) of commercially available automotive antifreeze only as needed for anticipated outside (ambient) temperatures. Do not exceed the recommendations, provided with the commercially available automotive antifreezes, regarding the coolant mixture of antifreeze to water.

Make proper antifreeze additions.

Adding pure antifreeze as a makeup solution for cooling system top-up is an unacceptable practice. It increases the concentration of antifreeze in the cooling system which increase the concentration of dissolved solids and undissolved chemical inhibitors in the cooling system. Add antifreeze mixed with water to the same freeze protection as your cooling system.

Use the chart below to assist in determining the concentration of antifreeze to use.

Antifreeze Concentrations	
Protection Temperature	Concentration
Protection to -15°C (5°F)	30% antifreeze and 70% water
Protection to -23°C (-10°F)	40% antifreeze and 60% water
Protection to -37°C (-34°F)	50% antifreeze and 50% water
Protection to -51°C (-60°F)	60% antifreeze and 40% water

Specifications of Fuel and DEF/Ad-Blue

General Fuel Information

Use only the fuel recommended in this section.

NOTICE

Fill the fuel tank at the end of each day of operation to drive out moisture laden air and to prevent condensation. Maintain a constant level near the top of the day tank to avoid drawing moisture into the tank as the level decreases. Do not fill the tank to the top. Fuel expands as it gets warm and can overflow.

Do not fill the fuel filters with fuel before installing them. Contaminated fuel will cause accelerated wear to the fuel system parts.

Drain the water and sediment from main fuel storage tank before it is refilled. This will help prevent water and/or sediment from being pumped from the fuel storage tank into the engine fuel tank.

Diesel Specifications

These engines utilize Tier 4 standards, the use of Ultra Low Sulfur Diesel (ULSD) is mandatory for these engines.

Diesel Fuel Specification	Location
ASTM D975 No.1D/2D S15	USA
EN590:96	EU
ISO 8217 DMX	International
BS 2869-A1 or A2	United Kingdom
JIS K2204 Grade No. 2	Japan
KSM-2610	Korea
GB252	China

Additional Technical Fuel Requirements

- Cetane Rating: The minimum recommended Fuel Cetane Rating is 45. A cetane rating greater than 50 is preferred, especially for ambient temperatures below 20 °C (4 °F) or elevations above 1500 m.
- Diesel Fuel Specification Type and Sulfur Content % (ppm) used, must be compliant with all applicable emission regulations for the area in which the engine is operated.
- DO NOT USE Fuels that have sulfur content greater than 0.0015 % (15 ppm).
- Diesel fuels specified to EN 590 or ASTM D975 are recommended.
- No.2-D is a distillate fuel of lower volatility for engines in industrial and heavy mobile service. (SAE J313 JUN87)
- These engines utilize Tier 4 standards, the use of Ultra Low Sulfur Diesel is mandatory for these engines, when operated in US EPA regulated areas. Therefore, please use No.2-D S15 diesel fuel as an alternative to
 - No.2-D, and use No.1-D S15 diesel fuel as an alternative to No.1-D for ambient temperature below 10 °C (14 °F).
 - a) No.1-D or No.2-D, S15: Ultra Low Sulfur Diesel (ULSD) 15 ppm or 0.0015 wt.%

Bio-Diesel Fuels

In Europe and the United States, as well as some other countries, non-mineral oil based fuel resources such as RME (Rapeseed Methyl Ester) and SOME (Soybean Methyl Ester), collectively known as FAME (Fatty Acid Methyl Esters), are being used as extenders for mineral oil derived diesel fuels.

CROWN approves the use of bio-diesel fuels that do not exceed a blend of 5% (in volume) of FAME with 95% (by volume) of approved mineral oil derived diesel fuel. Such bio-diesel fuels are known in the marketplace as B5 diesel fuels.

These 95 diesel fuels must meet certain requirements.

1. The bio-fuels must meet the minimum specifications for the country in which they are used.
 - In Europe, bio-diesel fuels must comply with the European Standard EN14214.
 - In the United States, bio-diesel fuels must comply with the American Standard ASTM D-6751.

Bio-fuels should be purchased only from recognized and authorised diesel fuel suppliers.

Precautions and concerns regarding the use of bio-fuels:

1. Free methanol in FAME may result in corrosion of aluminum and zinc FIE components.
2. Free water in FAME may result in plugging of fuel filters and increased bacterial growth.
3. High viscosity at low temperatures may result in fuel delivery problems, injection pump seizures, and poor injection nozzle spray atomization.
4. FAME may have adverse effects on some elastomers (seal materials) and may result in fuel leakage and dilution of the engine lubricating oil.
5. Even bio-diesel fuels that comply with a suitable standard as delivered, will require additional care and attention to maintain the quality of the fuel in the equipment or other fuel tanks. It is important to maintain supplied fuels clean and fresh. Regular flushing of the fuel system, and/or fuel storage containers, is necessary.
6. The use of bio-diesel fuels that do not comply with the standards as agreed to by the diesel engine manufacturers and the diesel fuel injection equipment manufacturers, or biodiesel fuels that have degraded as per the precautions and concerns above, may affect the warranty coverage of your engine.

Lubricant Specifications

Lubricant Information

Certain abbreviations follow Society of Automotive Engineers (SAE) J754 nomenclature and some classifications follow SAE J183 abbreviations.

The MIL specifications are U.S.A. Military Specifications.

The recommended oil viscosities can be found in the Lubricant Viscosities chart in this publication.

Grease is classified by the National Lubricating Grease Institute (NLGI) based on ASTM D217-68 Worked Penetration characteristics which are given a defined consistency number.

Engine Oil (DEO and EO)

The following oil specifications provide guidelines for the selection of commercial products:

- API CJ-4 for 500 hours service interval
- API CK-4 for 1,000 hours service interval

NOTICE

Failure to follow the oil recommendations can cause shortened engine life due to carbon deposits or excessive wear.

Consult the EMA Lubricating Oils Data Book for a listing of oil brands.

NOTE: The percentage of sulphur in the fuel will affect the engine oil recommendations. For fuel sulphur effects, the Infrared Analysis or the ASTM D2896 procedure can be used to evaluate the residual neutralisation properties of an engine oil. The sulphur products formation depends on the fuel sulphur content, oil formulation, crankcase blowby, engine operating conditions and ambient temperature.

Hydraulic Oil (HYDO)

The following commercial classifications can be used in the hydraulic system.

- | | |
|---------------------|-----------|
| • ISO 6743/4 | HM |
| • AFNOR NFE 48-603 | HM |
| • DIN 51524 TEIL 2 | H-LP |
| • HAGGLUNDS DENISON | HFO-HF2 |
| • CINCINNATI | P68,69,70 |

Viscosity: ISO VG 32

Industrial premium hydraulic oils that have passed the Vickers vane pump test (35VQ25). These oils should have antiwear, antifoam, antitrust and antioxidation additives for heavy duty use as stated by the oil supplier. ISO viscosity grade of 32 would normally be selected.

NOTICE

Make-up oil added to the hydraulic tanks must mix with the oil already in the systems. Use only petroleum products unless the systems are equipped for use with special products. If the hydraulic oil becomes cloudy, water or air is entering the system. Water or air in the system will cause pump failure. Drain the fluid, retighten all hydraulic suction line clamps, purge and refill the system. Consult your CROWN Lift Truck branch for purging instructions.

Transmission Oil (TDTO)

NOTICE

This oil is formulated for transmissions and drive trains only, and should not be used in engines. Shortened engine life will result.

NOTE: Multi-grade oils are not blended by CROWN for use in transmissions. Multi-grade oils which use high molecular weight polymers as viscosity index improvers lose their viscosity effectiveness by permanent and temporary shear of the viscosity index improver and therefore, are not recommended for transmission and drive train compartments.

NOTE: Failure to follow this recommendation can cause shortened transmission life due to material incompatibility, inadequate frictional requirements for disk materials and/or excessive gear wear.

Select the oil that meets the following specification.

- GM DEXRON III
- FORD MERCON V

Drive Axle Oil

NOTE: Failure to follow the recommendation will cause shortened life due to excessive gear wear.

Brake Fluid



Use heavy duty hydraulic brake fluid certified by oil supplier to meet the latest version of following classifications.

- ISO 6743/4 HM
- AFNOR NFE 48-603 HM
- DIN 51524 TEIL 2 H-LP
- HAGGLUNDS DENISON HFO-HF2
- CINCINNATI P68,69,70

Viscosity: ISO VG32

Brake reservoir oils that have passed the Vickers vane pump test (35VQ25). These oils should have antiwear, antifoam, antirust and antioxidation additives for heavy duty use as stated by the oil supplier. ISO viscosity grade of 32 would normally be selected.

The following products are authorised for use.

Supplier	Product Name
TOTAL	AZOLLAZS
SHELL	TELLUS
MOBIL	DTE20S'
CALTEX	RANDO HD
ESS	NOTO H
CASTROL	HYSPIIN AWS

Lubricating Grease (MPGM)

Use Multipurpose Molybdenum Grease (MPGM) for all lubrication points. If MPGM grease can not be used, a multipurpose type grease which contains 3% to 5% molybdenum disulfide can be used.

NLGI No.2 grade is suitable for most temperatures. Use NLGI No.1 or No.0 grade for extremely low temperature.

Lubricant Viscosities and Refill Capacities

Lubricant Viscosities

Lubricant Viscosities for Ambient (Outside) Temperatures					
Compartment or System	Oil Viscosities	°C		°F	
		Min	Max	Min	Max
Engine Crankcase (Diesel) API CJ/CK-4	SAE 5W30	-30	+30	-22	86
	SAE10W30	-20	+30	-4	86
	SAE5W40	-30	+40	-22	104
	SAE10W40	-20	+40	-4	104
	SAE15W40	-15	+40	5	104
	SAE15W50	-15	+50	5	122
	SAE20W50	-10	+50	14	122
Hydraulic and Power Steering System ISO 6743/4 HM	ISO VG32	-20	+30	-4	+86
	ISO VG46	-10	+40	+14	+104
	ISO VG68	0	+50	+32	+122
Power Shift Transmission and Drive Axle Housing DEXRON III	DEXRON III	-20	+50	-4	+122
Brake Reservoir (Only for OCDB) ISO 6743/4HM	ISO VG32	-20	+30	-4	+86
	ISO VG46	-10	+40	+14	+104
	ISO VG68	0	+50	+32	+122

The SAE grade number indicates the viscosity of oil. A proper SAE grade number should be selected according to ambient temperature.

Capacities for Refilling

Refill Capacities-(Approximate)		
Compartment or System	Liters	U.S. Gal.
Engine Crankcase w/Filter	12.6	3.33
Cooling System /Coolant Reservoir tank	13.0	3.43
Fuel Tank – Diesel	90.0	23.78
Power Shift Transmission	20.0	5.28
Hydraulic & Power Steering System	73.0	19.3
Brake Reservoir	0.6	0.16
Transmission & Drive axle	22	5.8

Maintenance Intervals

NOTICE

Never exceed the Maintenance Intervals specified in the manual. Defects and/or damage to the important functional components may be resulted in.

NOTICE

All maintenance and repair, except Every 10 Service Hours or Daily, on the lift truck must be performed by qualified and authorised personnel only.

NOTICE

Careless disposal of waste oil can harm the environment and can be dangerous to persons. Always dispose of waste oil to authorised personnel only.

When Required

Air Intake System - Check, Clean	140
Battery Terminal - Clean, Inspect.....	142
SCR Cleaning - DeSOx.....	143
Water Separator	147
Discharge of Foreign Matter in the Fuel	147
Priming the Fuel System	148
Seat, Hood Latch & Support Cylinder - Check, Lubricate.....	148
Fuses, Bulbs & Circuit Breaker - Change, Reset.	149
Circuit Breaker	150
Tyres and Wheels - Check, Inspect.....	150
Carriage Roller Extrusion - Check, Adjust.....	151

Every 10 Service Hours or Daily

Inspect Engine for Fluid Leaks	152
Engine Oil Level - Check	152
Coolant Level - Check, Clean.....	152
Inspect Engine for Exhaust Leaks.....	153
Walk - Around Inspection - Inspect	153
Transmission Oil Level - Check.....	154
Mast Channels – Lubricate	154
Brake Oil Level – Check	154
Hydraulic Oil Level – Check.....	155
Drive Axle Oil Level – Check	155

First 50 - 100 Service Hours or a Week

Engine Oil & Filter – Change.....	156
Drive Axle Oil, Transmission Oil, Oil Filter & Strainer - Clean, Change	157
Parking Brake - Test, Adjust.....	159

Every 500 Service Hours or 3 Months

Air Intake System - Change	160
Fuel Filter - Change	160
Engine Oil & Filter - Change (with CJ-4 Grade Only)	161
Mast Hinge Pins – Lubricate	161
Tilt Cylinders - Check, Adjust, Lubricate	161
Crosshead Rollers - Inspect.....	162
Carriage Side Rollers Thrust (If Equipped) - Lubricate	163
Carriage Sideshifter (If Equipped) – Lubricate.....	163
Mast, Carriage, Lift Chains, & Attachments - Check, Lubricate	164
Carriage Side Rollers - Lubricate.....	164
Parking Brake - Test, Adjust.....	165
Horn & Lights (If Equipped) – Check	165
Overhead Guard – Inspect.....	165
Steer Suspension - Inspect	166
Steering Mechanism - Check, Lubricate	166
Wheel Bolts and Nuts – Inspect.....	167

Every 1000 Service Hours or 6 Months

Fuel Lines & Fittings - Check	168
Engine Oil & Filter - Change (with CK-4 Grade Only)	168
Fuel Filter (with Pre/Main Filter) – Change	168
Belt – Check, Adjust.....	169
Hydraulic Return Filter - Change	169
Air Breather - Change.....	170
Lift Chains - Test, Check, Adjust.....	170
Universal Joint - Inspect, Lubricate.....	172

Every 2000 Service Hours or Yearly

Drive Axle Oil, Transmission Oil, Oil Filter & Strainer - Clean, Change	173
Steer Wheel Bearings - Reassemble	173
Cooling System - Clean, Change.....	174
Forks – Inspect.....	175

Every 2500 Service Hours or 15 Months

Hydraulic Oil - Check, Clean, Change.....	177
---	-----

Inspect Battery System 177

Every 5000 Service Hours or 30 Months

DPF Maintenance (DM03V Stage 5 Engine Only) -
Ash Cleaning..... 178

Environment Protection

Environment Protection..... 179

Maintenance Section

Quick Reference to Maintenance Schedule			1st	Every						
ITEMS	SERVICES	PAGE	When Required	50-100 Service Hours or a Week	10 Service Hours or Daily	500 Service Hours or 3 Months	1000 Service Hours or 6 Months	2000 Service Hours or Yearly	2500 Service Hours or 15 Months	5000 Service Hours or 36 Months
Air Breather	Change	170					O			
Air Intake System	Check, Clean	140	O							
Air Intake System	Change	160				O				
Battery Terminal	Clean, Inspect	142	O							
Belt	Check, Adjust	169					O			
Brake Oil Level	Check	154			O					
Carriage Roller Extrusion	Check, Adjust	151	O							
Carriage Side Rollers	Lubricate	164				O				
Carriage Side Rollers Thrust (If Equipped)	Lubricate	163				O				
Carriage Sideshifter (If Equipped)	Lubricate	163				O				
Circuit Breaker		150	O							
Coolant Level	Check, Clean	152			O					
Cooling System	Clean, Change	174						O		
Crosshead Rollers	Inspect	162				O				
Discharge of Foreign Matter in the Fuel		147	O							
DPF Maintenance (DM03V Stage 5 Engine Only)	Ash Cleaning	178								O
Drive Axle Oil Level	Check	155			O					
Drive Axle Oil, Transmission Oil, Oil Filter & Strainer	Clean, Change	157, 173		O				O		
Engine Oil & Filter	Change	156		O						
Engine Oil & Filter (with CJ-4 Grade Only)	Change	161				O				
Engine Oil & Filter (with CK-4 Grade Only)	Change	168					O			
Engine Oil Level	Check	152			O					
Forks	Inspect	175						O		
Fuel Filter	Change	160				O				
Fuel Filter (with Pre/Main Filter)	Change	168					O			
Fuel Lines & Fittings	Check	168					O			
Fuses, Bulbs & Circuit Breaker	Change, Reset	149	O							
Horn & Lights (If Equipped)	Check	165				O				
Hydraulic Oil	Check, Clean, Change	177							O	
Hydraulic Oil Level	Check	155			O					
Hydraulic Return Filter	Change	169					O			
Inspect Battery System		177							O	
Inspect Engine for Exhaust Leaks		153			O					
Inspect Engine for Fluid Leaks		152			O					

Quick Reference to Maintenance Schedule			1st	Every						
ITEMS	SERVICES	PAGE	When Required	50-100 Service Hours or a Week	10 Service Hours or Daily	500 Service Hours or 3 Months	1000 Service Hours or 6 Months	2000 Service Hours or Yearly	2500 Service Hours or 15 Months	5000 Service Hours or 36 Months
Lift Chains	Test, Check, Adjust	170					O			
Mast Channels	Lubricate	154			O					
Mast Hinge Pins	Lubricate	161				O				
Mast, Carriage, Lift Chains, & Attachments	Check, Lubricate	164				O				
Overhead Guard	Inspect	165				O				
Parking Brake	Test, Adjust	159, 165		O		O				
Priming the Fuel System		148	O							
SCR Cleaning	DeSOx	143	O							
Seat, Hood Latch & Support Cylinder	Check, Lubricate	148	O							
Steer Suspension	Inspect	166				O				
Steer Wheel Bearings	Reassemble	173						O		
Steering Mechanism	Check, Lubricate	166				O				
Tilt Cylinders	Check, Adjust, Lubricate	161				O				
Transmission Oil Level	Check	154			O					
Tyres and Wheels	Check, Inspect	150	O							
Universal Joint	Inspect, Lubricate	172					O			
Walk - Around Inspection	Inspect	153			O					
Water Separator		147	O							
Wheel Bolts and Nuts	Inspect	167				O				

When Required

You must read and understand the warnings and instructions contained in the Safety section of this manual, before performing any operation or maintenance procedures.

Air Intake System - Check, Clean Precleaner (If Equipped)

NOTICE

Never service precleaner with the engine running.



Typical Example

Diesel Engine Truck

1. Check the precleaner bowl for dirt build-up. If the dirt is up to the line, remove the precleaner bowl and empty it. Periodically wash the cover and bowl in water.

Servicing Filter Element

NOTICE

Never service precleaner with the engine running.

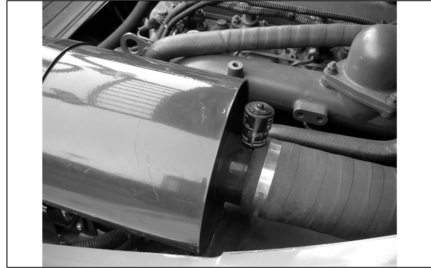

Typical Example

Diesel Engine Truck

Service the air cleaner when the red target in the service indicator stays locked in the visible position with the engine stopped.

1. To service the air cleaner, loosen the cover latches and remove the cover.

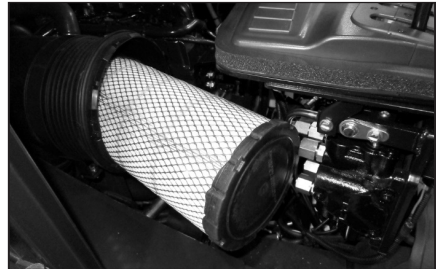

2. Rotate the element slightly to separate it from its base and remove it from the air cleaner housing.
3. Clean and inspect the element or replace with a new element. See topic, "Cleaning Primary Filter Elements".
4. Clean the inside of air cleaner housing and the cover. Inspect all connections between the air cleaner and engine. Check intake hose for cracks, damage and loose clamps. Tighten or replace parts as necessary to prevent leakage.

NOTICE

Do not allow dirty air to enter the intake hose when cleaning the inside of the air cleaner housing.

5. Check the air cleaner housing for loose latches.
6. Reset the air cleaner service indicator.
7. Install the air filter element.
8. Install the cover and tighten the cover latches.
9. Start the engine and observe the position of the indicator. If the indicator shows RED after the installation of the primary element, install another clean or a new element or, replace the secondary element. See topic, "Air Intake System - Change" in Every 500 Service Hours or 3 months section.
10. Stop the engine and close the hood and seat assembly.

Cleaning Primary Filter Elements

WARNING

Pressure air can cause personal injury.

When using pressure air for cleaning, wear a protective face shield, protective clothing and protective shoes.

The maximum air pressure must be below 205 kPa (30 psi) for cleaning purposes.

NOTICE

Do not clean the elements by bumping or tapping them.

Inspect filter elements after cleaning. Do not use a filter with damaged pleats, gaskets or seals.

When cleaning with pressure air, use 205 kPa (30 psi) maximum pressure to prevent filter element damage.

When cleaning with pressure water, use 280 kPa (40 psi) maximum pressure to prevent filter element damage.

Have spare elements on hand to use while cleaning used elements.

The primary element should be replaced after 3 months service. In case of harsh application having lots of dirt, please clean and replace the primary element more often.

Air-205 kPa (30 psi) Maximum Pressure

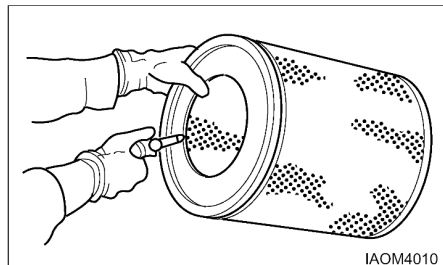

Direct air on the inside and outside of the element along the length of the pleats. Check the element for any tears, rips or damage.

Water - 280 kPa (40 psi) Maximum Pressure

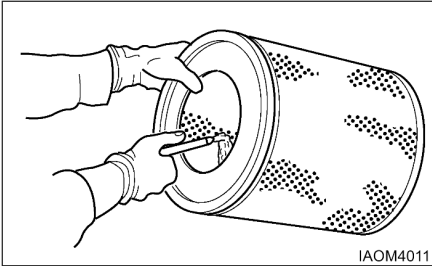

Direct water on the inside and outside of the element along the length of the pleats. Air dry it thoroughly and then examine it.

Detergent

1. Wash the element in warm water and mild household detergent.
2. Rinse the element with clean water. See instructions in preceding topic for cleaning with water.
3. Air dry it thoroughly, and then examine it.

Checking Element

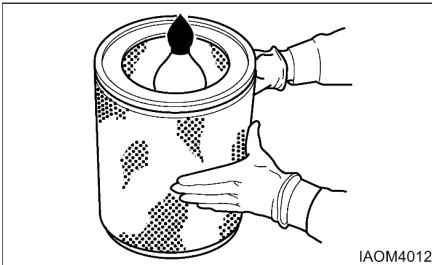

1. Insert a light inside the clean dry element and examine it. Discard the element if tears, rips or damage are found.
2. Wrap and store good elements in a clean, dry place.

Battery Terminal - Clean, Inspect

WARNING

Batteries give off flammable fumes that can explode.

Do not smoke when observing the battery electrolyte levels.

Electrolyte is an acid and can cause personal injury if it contacts skin or eyes.

Always wear protective glasses when working with batteries.

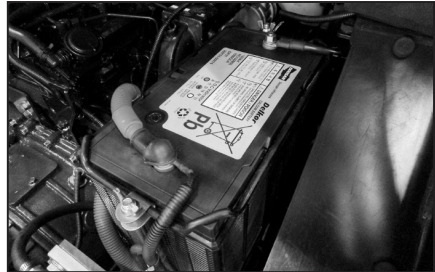

Typical Example

Diesel Engine Truck

1. Clean the top of the battery and terminals.
2. Check terminals for corrosion. Coat terminals with heavy grease.

SCR Cleaning - DeSOx

SCR Cleaning - DeSOx Display Pop-up

In order that the SCR system may maintain its exhaust cleaning efficiency at a proper level, it should be periodically initialized—"SCR cleaning."



DOC & SCR Position



SCR Cleaning switch Position

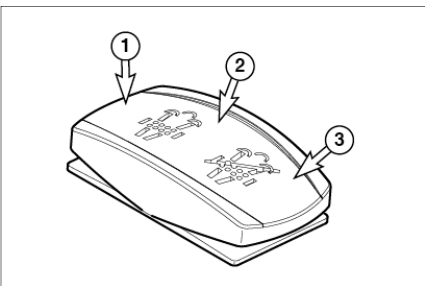

SCR Cleaning switch

NOTICE

Keep monitoring the vehicle condition via the SCREEN display.

- At a workplace which is near inflammables or, heavily populated, or an indoors space, disable the SCR cleaning function.
 - Be careful of the high temperature of the exhaust tube or other parts during SCR cleaning.
 - Do not operate the vehicle (e.g. pushing the accelerator pedal) during SCR cleaning.
 - Do not switch off the ignition during SCR cleaning. The SCR system might be damaged.
-

Automatic SCR Cleaning

The ECU attempts to start SCR cleaning during working—"automatic SCR cleaning"—at a proper moment after determining the moment. Once automatic SCR cleaning starts, the high temperature indicator lamp lights up with a popup appearing for the operator to notice it.



Display that notifies the operator of automatic SCR cleaning

If automatic SCR cleaning is failed due to a low exhaust temperature, you should perform it after the vehicle stops. Therefore, it is recommended to keep the vehicle working as far as possible in order to ensure automatic SCR cleaning is fully completed. While automatic SCR cleaning is being carried out, exhaust emissions above 500 °C may cause fires or burns.

Setting this switch to position "3" prohibits automatic SCR Cleaning in an environment subject to dust, explosion or regulated noise level. At position "3", a pop-up appears as shown below:

The switch returns to the normal position of "2" after pressed by the operator to position "1". However, it does not return when pressed to position "3" and the operator shall return the switch from position "3".



SCR Cleaning inhibited

If automatic SCR cleaning is failed, you should carry it out a while after the vehicle starts working.

A pop-up on the SCR Display warns the operator to perform SCR Cleaning. (3 warnings: at 10 hrs remaining, 5 hrs remaining, Immediate)

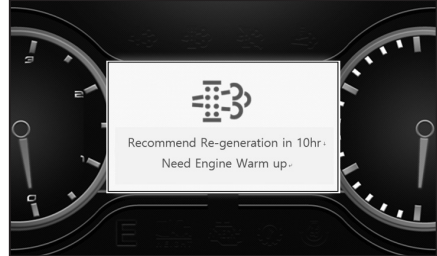

Exemplary warning – 10 hrs remaining

Limit the engine power and stop the current work when SCR cleaning is not used; you will be violating the exhaust regulations if you do not.

To carry out SCR cleaning safely, observe the following steps:

1. Park the vehicle at a safe place. White smoke can be emitted during SCR Cleaning.
2. Remove the flammable material or stained oil from exhaust system. High temperature of exhaust system and gas can cause fire.
3. Engage the parking brake, and make sure the gear is in neutral.
4. Allow engine to warm up sufficiently; the SCR cleaning is not possible in cold condition.
5. After holding down the switch at the "3" position for three seconds, check that SCR cleaning has started.
6. Once SCR cleaning finishes, the LCD display will show a notification.

Press this switch and release it after 3 sec, SCREEN Cleaning will be started and the engine speed will be increased. Screen pop-up provides information on the warming up and cleaning process.

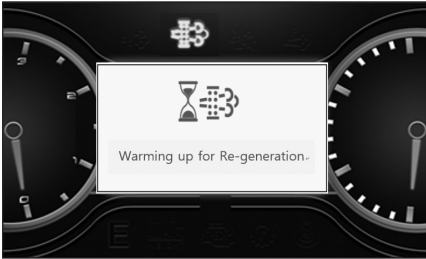

Warming up process







Proceeding



Completed

Display for SCR Cleaning

As shown in the table below, for your information, we provide Information about correlation between Symbol and message (Display).

No	State	SYMBOL	Lamp	Message on the Display
1	Request Service SCR Cleaning		-	Recommend SCR Cleaning in 10hr Need Engine Warm up
2			ON	Should Do SCR Cleaning in 5hr Need Engine Warm up
3			Blink	Must Do SCR Cleaning Immediately Need Engine Warm up
4	Progressing Passive SCR Cleaning Progressing Service SCR Cleaning		ON	Hot Exhaust Gas
5	Service SCR Cleaning Preparation Lamp		ON	Warming up for SCR Cleaning
6	Under Cleaning SCR		ON	Cleaning SCR DO NOT STOP ENGINE
7	SCR Cleaning Finish	-	ON	SCR Cleaning completed
8	SCR Cleaning inhibit switch ON		ON	SCR Cleaning is inhibited

Water Separator

1. If the engine check lamp indicates any fault related to water separator, remove the water in the separator immediately, regardless of regular maintenance schedule. (SPN 97)
2. Lower part of the fuel filter is the water separator, in which a sensor is installed to monitor water and contaminants and transmit warning signal to the indicator to notify the operator of the water accumulated in the separator.
3. Drain the water in the water separator as follows.
4. Place an approved container under the water separator for collecting the water and contaminants.
5. Open the drain cock on the bottom of the water separator of the fuel filter. Drain the water in the water separator. (Figure, 1 for Main Filter Only, 2 for Pre Filter Option)
6. Close the drain cock by hand.
7. Having completed above procedures, check that the fuel system is filled with fuel. Filling fuel system with fuel.

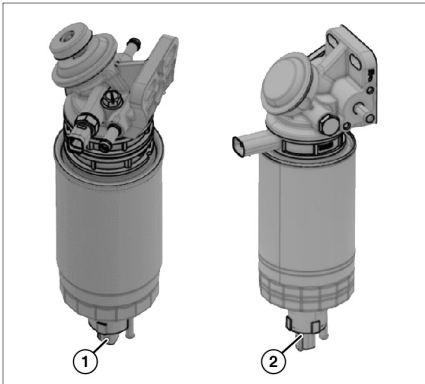

⚠ WARNING

Prior to any service or maintenance activity, Test Fuel System for Leaks.

Discharge of Foreign Matter in the Fuel

The pressure sensor warning function is activated when foreign substances are detected in the fuel. Once triggered, one or all of the following may be activated depending on the vehicle settings: warning buzzer, engine check lamp illumination, and derating of engine power. In the event that the pressure sensor warning is triggered, check the system as follows:

1. Take off the fuel tank cover and remove the filter.

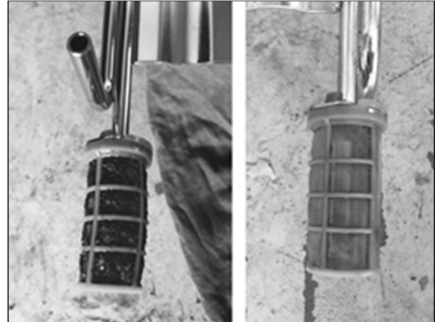

2. Wipe foreign substances off the filter with a clean cloth or blow them off using an air compressor.
3. Put the filter and cover back on the fuel tank.
4. Turn the key ON after assembly, and check that the warning function operates normally.
5. If the pressure sensor warning persists, replace the fuel filter cartridge. This is one of the items described in the sub-section: "Every 500 Service Hours or 3 Months".

NOTICE

Be careful not to damage the fuel tank's filter when cleaning it. A damaged filter may lead to contamination with foreign substances, resulting in a serious engine problem.

⚠ WARNING

Before servicing or maintenance, test the fuel system for leaks.

Priming the Fuel System

In any one of the following cases, the fuel system requires priming.

Before starting up the engine for the first (priming completed at factory), exhaust all fuel and refuel the fuel tank.

After replacing fuel filter or other part of the fuel system, drained water from oil-water separator, or after any maintenance work with the fuel system, perform priming as deAftertreatmentbed below:

Place an approved container under the air bleed port.

Loosen the plug of air bleed port (1).

Press the pump (3) with your hand until the oil comes out. In this operation, all the fuel hoses must be connected. (2)

Retighten the plug of air bleed port (1).

Wipe out spilled fuel and dispose of properly.

Never try to crank the engine with the starting motor to feed the fuel system with fuel. Otherwise, the starting motor can be overheated and the coil, pinion, and/or ring gear can be damaged.

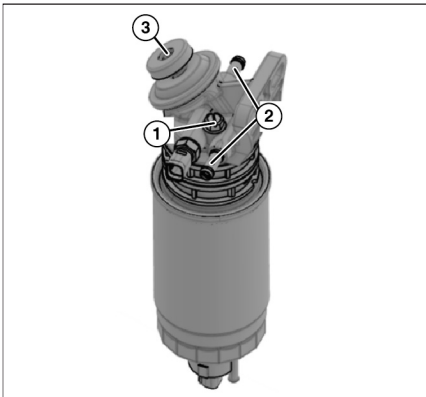

Seat, Hood Latch & Support Cylinder - Check, Lubricate



1. Check the operation of the seat adjuster rod. Make sure that the seat slides freely on its track. Lightly oil the seat slider tracks if necessary.



2. Pull the latch to raise the hood and seat assembly. Make certain the support cylinder will hold the hood open.

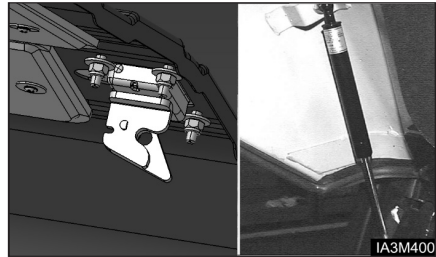

3. Lightly oil the hood latch mechanism and the rod for the hood support cylinder.

Fuses, Bulbs & Circuit Breaker - Change, Reset

Fuses

NOTE: If a fuse filament separates, use only the same type and size fuses for replacement. If the filament in a new fuse separates, have the circuits and instruments checked.

NOTICE

Always replace fuses with ones of the correct ampere rating.

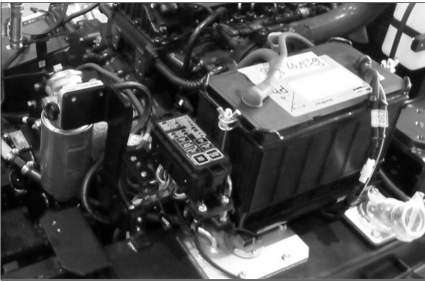

Remove the front cover from the box. The fuses are in the box.



Fuse - Protects an electrical circuit from an overload. Opens (filament separates) if an overload occurs.

Fuses are identified as follows :

1. Horn - 10 A
2. Head Lamp ,Clearance Lamp, Tail Lamp - 15 A
3. Lamp Relay Coil, Fwd/Rev. Solenoid, Rear Lamp Relay & Back-up Lamp/Alarm - 15 A
4. Instrument Panel, Hour Meter, Preheat Controller, Fuel Shut off Solenoid - 15 A
5. Stop Lamp, Turn Signal Lamp, Strobe Lamp - 15 A
6. Starter Relay - 10 A

Bulbs

Bulbs are identified as follows:

[Diesel Engine]

1. Bulb - head lamp halogen (24V - 55W)
- *2. Bulb - back up (24V - 10W)
- *3. Bulb - turn signal (24V - 25W)
- *4. Bulb - stop & tail (24V - 25/10W)

*Optional lamp or light

Circuit Breaker



1. Raise the hood and seat assembly. Make sure the support cylinder securely holds the hood open.



Typical Example Diesel Engine Truck

2. The main circuit breaker is located on the rear of the support for the controls.

NOTE: To reset circuit breakers push in the button. The button should stay in if the breaker is reset. If the button will not stay in, or comes out shortly after reset, have the circuits checked.

Tyres and Wheels - Check, Inspect

WARNING

Servicing and changing tyres and rims can be dangerous and should be done only by trained personnel using proper tools and procedures.

If correct procedures are not followed while servicing tyres and rims, the assemblies could burst with explosive force and cause serious physical injury or death.

Follow carefully the specific information provided by your tyre servicing man or branch.

Check Inflation and Damage

Inspect tyres for wear, cuts, gouges and foreign objects. Look for bent rims and correct seating of locking ring.

Check tyres for proper inflation. See "Tyre Inflation Pressures".

To inflate tyres always use a clip-on chuck with a minimum 60 cm (24 inches) length of hose to an in-line valve and gauge.

Always stand behind the tread of the tyre, NOT in front of the rim.

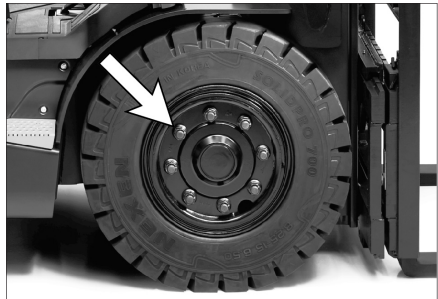

Do not reinflate a tyre that has been run while flat or underinflated, without first checking to make sure the locking ring on the rim is not damaged and is in the correct position.

When tyres are changed, be sure to clean all rim parts and, if necessary, repaint to stop detrimental effects of corrosion. Sand blasting is recommended for removal of rust.

⚠ WARNING

Deflate tyre before removing wheel nuts from the truck.

Check all components carefully and replace any cracked, badly worn, damaged and severely rusted or corroded parts with new parts of the same size and type. If there is any doubt, replace with new parts.

Do not, under any circumstances, attempt to rework, weld, heat or braze any rim components.

Carriage Roller Extrusion - Check, Adjust

1. Set the mast vertical.
2. Lower the carriage completely.
3. On full free lift and full free triple lift models, the bottom of the inner mast must be flush with the bottom of the stationary mast.

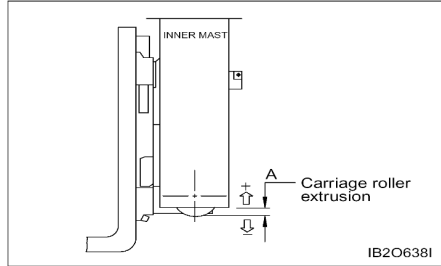

4. Measure the distance from the bottom of the inner upright to the bottom of carriage bearing.
5. The measurement (A) must be as follows in Chart below.

Height of carriage roller extrusion (A) [unit : mm]		
STD mast	FF mast	FFT mast
-7	43	43

Every 10 Service Hours or Daily

You must read and understand the warnings and instructions contained in the Safety section of this manual, before performing any operation or maintenance procedures.

Inspect Engine for Fluid Leaks

1. Start the engine and allow it to reach operating temperatures.
2. Turn the engine off.
3. Inspect the entire engine for oil and/or coolant leaks.
4. Repair as necessary before continuing.

Engine Oil Level - Check

⚠ WARNING

Hot oil and components can cause personal injury. Do not allow hot oil or components to contact skin.

Park the lift truck on level ground, with the forks lowered, the parking brake applied, the transmission in NEUTRAL, and the engine stopped.

1. Raise the hood and seat assembly. Make certain the support cylinder securely holds the hood open.

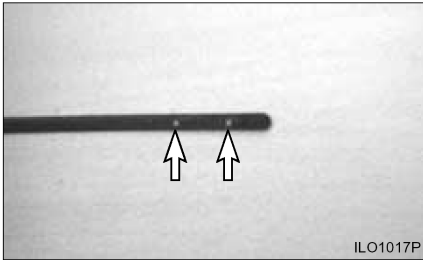

2. The oil level should be close as possible to upper point of the oil dip stick. Do not refill more than upper point.

⚠ WARNING

An excessive amount of oil may cause "Dieseling", resulting in damage to the engine.

Coolant Level - Check, Clean

Check Coolant Level

⚠ WARNING

At operating temperature, the engine coolant is hot and under pressure.

Steam can cause personal injury.

Check the coolant level only after the engine has been stopped and the filter cap is cool enough to touch with your bare hand.

Remove the filter cap slowly to relieve pressure.

Cooling system conditioner contains alkali. Avoid contact with the skin and eyes to prevent personal injury.

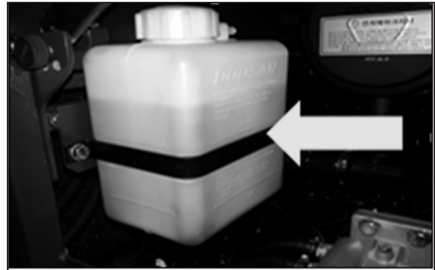

1. Observe the coolant level with engine cold. Maintain coolant level to the proper line on expansion bottle. If the expansion bottle has no coolant, it will be necessary to check coolant at the radiator filter neck.
2. Remove the radiator cap. Fill radiator to the top of the filter neck. Inspect radiator cap. Replace if damaged. Install the radiator cap.

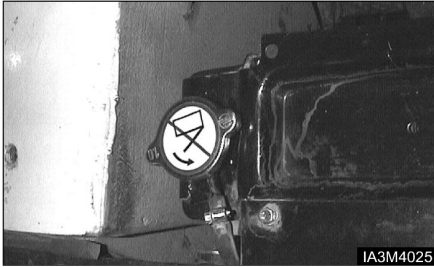

IA3M4025

3. Start and run the engine to stabilise the coolant level in the filter neck. If low add coolant until it reaches the top of the filter neck. Install the radiator cap. Observe coolant level in the expansion bottle. If necessary, add coolant to bring the coolant to the appropriate line on the expansion bottle.
4. Stop the engine.
5. Inspect the cooling system for leaks, hose cracks or loose connections.

WARNING

Pressure air can cause personal injury.

When using pressure air for cleaning, wear a protective face shield, protective clothing and protective shoes.

Maximum air pressure must be less than 205 kPa (30 psi) for cleaning purposes.

6. Blow any dust and lint from the radiator fins.

Inspect Engine for Exhaust Leaks

Start the engine and allow it to reach operating temperatures.

Perform visual inspection of exhaust system.

Repair any/all leaks found.

Walk - Around Inspection - Inspect

For maximum service life of the lift truck, make a thorough walk-around inspection. Look around and under the truck for such items as loose or missing bolts, debris or dirt buildup, fuel, oil or coolant leaks and cut or gouged tyres.

Have any repairs made and debris removed, as needed.



1. Inspect the tyres and wheels for cuts, gouges, foreign objects, inflation pressure and loose or missing bolts.
2. Inspect the mast and lift chains for wear, broken links, pins and loose rollers.
3. Inspect the hydraulic system for leaks, worn hoses or damaged lines.
4. Look for transmission and drive axle leaks on the lift truck and on the ground.
5. Inspect the operator's compartment for loose items and cleanliness.
6. Inspect the instrument panel for broken gauges and indicator lights.
7. Test the horn and other safety devices for proper operation.
8. Inspect the cooling system for leaks, worn hoses and debris buildup.
9. Inspect engine compartment for oil, coolant and fuel leaks.
10. Inspect the forks.
 - Visually inspect forks for cracks, especially in the heel section, around the mounting brackets, and all weld areas.
 - Inspect for broken or jagged fork tips, bent or twisted blades and shanks.
 - Make sure positioning lock is in place and working.
 - Lock the forks in position before using the truck. See Step 7 of "Forks" in "Every 2000 Service Hours or Yearly".
 - Remove all defective forks from service.

Transmission Oil Level - Check

WARNING

Hot oil and components can cause personal injury. Do not allow hot oil or components to contact skin.

1. Start and operate the lift truck until the engine reaches normal operating temperature.
2. Park the lift truck on level ground, with the forks lowered, the parking brake applied, and the transmission controls in NEUTRAL.
3. With the brake applied and the engine at low idle, shift the directional control lever to forward and then to reverse, to fill the clutches.
4. Shift the direction control lever to the NEUTRAL position.

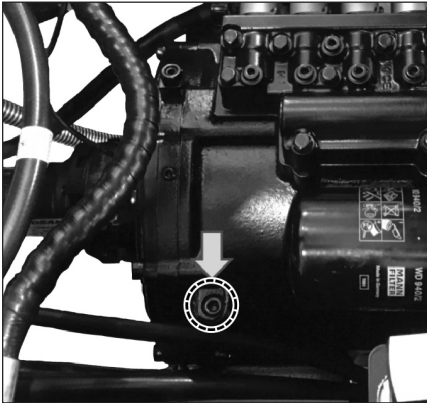

5. Open the access door in floor plate.
6. Remove the dipstick/filter cap. Observe the oil level.
7. Maintain the oil level between the Min and Max marks on the dipstick/filter cap.

When the oil temperature is 40°C approximately, the cold side mark on the dipstick is applicable. When the oil temperature is 80°C approximately, the hot side mark on the dipstick is applicable.

8. Close the access door in floor plate.
9. Stop the engine.

Mast Channels – Lubricate

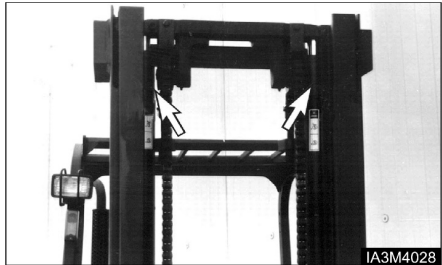

The channels on the roller-type mast require a break-in period. Apply a light film of lubricant on the channels where the rollers ride. This will prevent metal peel until the rollers set a pattern.

Brake Oil Level – Check

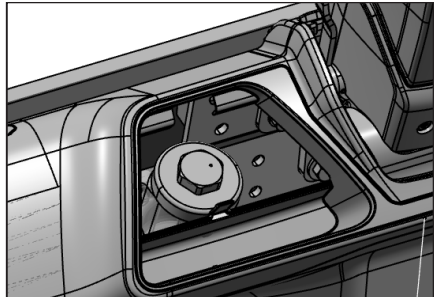

The brake reservoir is located on the left side of the steering column.

1. Remove the filler cap.
2. Maintain the brake fluid level to the fluid level mark on the brake system reservoir.
3. Clean the filter cap and install it again.

Hydraulic Oil Level – Check

⚠ WARNING

At operating temperature, the hydraulic tank is hot and under pressure.

Hot oil can cause burns.

Remove the filter cap only when the engine is stopped, and the cap is cool enough to touch with your bare hand. Remove the filter cap slowly to relieve pressure.

1. Operate the lift truck for a few minutes to warm the oil. Park the lift truck on a level surface, with the forks lowered, mast tilted back, parking brake engaged, transmission in NEUTRAL and the engine stopped.
2. Raise the hood and seat assembly. Make sure the air lift cylinder securely holds the hood open.



Remove the dipstick/ filter cap. Maintain the oil level to the FULL mark on the breather/dip stick.

Drive Axle Oil Level – Check

⚠ WARNING

Hot oil and components can cause personal injury. Do not allow hot oil or components to contact skin.

Park the lift truck on a level surface. Apply the parking brake. The engine is at the low idle. Place the directional control level in NEUTRAL.

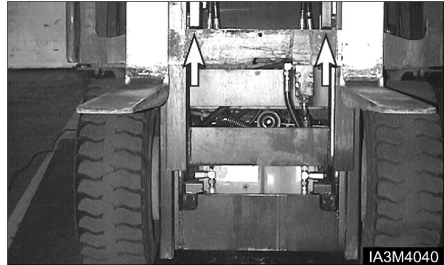

1. Lift the carriage high enough to access the drive axle housing oil level plug and fill plug.
2. Put blocks under the carriage.

Oil Cooled Disc Brake (OCDB) Type

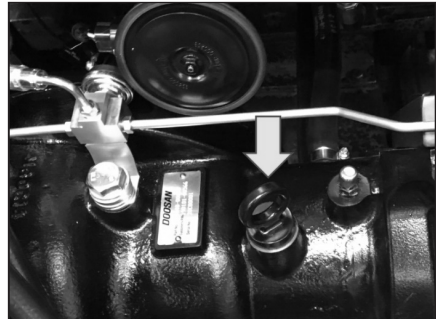

1. Remove the dip stick/filter cap. Observe the oil level.
2. Maintain the oil level between lower mark and upper mark on the dip stick/filter cap.
3. Install the dip stick/filter cap.

First 50 - 100 Service Hours or a Week

You must read and understand the warnings and instructions contained in the Safety section of this manual, before performing any operation or maintenance procedures.

Engine Oil & Filter – Change

Diesel Engine Crankcase

The percentage of sulphur in the fuel will affect the engine oil recommendations. If the fuel has over 0.5% sulphur content, the CD engine oil must have a TBN of 20 times the percentage of fuel sulphur (TBN as measured by the ASTM D-2896 method). Your oil supplier should be able to furnish the correct oils.

1. Operate lift truck a few minutes to warm oil. Park the lift truck with the forks lowered, parking brake applied, Transmission in neutral and the engine stopped.
2. Raise rear of lift truck off ground and block securely.

 **WARNING**

Hot oil and components can cause personal injury. Do not allow hot oil or components to contact skin.

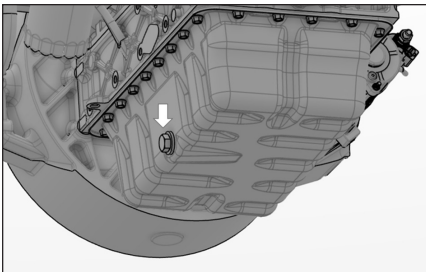

3. Remove the crankcase drain plug and allow oil to drain into a suitable container. Clean and install drain plug.
4. Remove and discard oil filter element.
5. Wipe sealing surface of oil filter element mounting base. Make sure the entire gasket is removed.
6. Before installing a new filter element, apply a small amount of clean engine oil to the filter element gasket.
7. Install the new filter element. When the gasket contacts the base, tighten it 3/4 of a turn more. Do not overtighten.
8. Raise the lift truck, remove the blocking and lower the lift truck.
9. Raise the hood and seat assembly.

10. Fill the crankcase. See “Refill Capacities”.
11. Start the engine and allow the oil to fill the filter and passages.
12. Check for oil leaks.
13. Stop the engine and measure the oil level. The oil level should be close as possible to upper point of the oil dip stick.
14. Close hood and seat assembly.

 **WARNING**

Do not refill more than upper point.

NOTICE

Servicing of the engine oil and oil filter element has large affects on the engine performance as well as the engine life.

Engine oil and filter element must be changed after the first 50 hours.

Drive Axle Oil, Transmission Oil, Oil Filter & Strainer - Clean, Change

WARNING

Hot oil and components can cause personal injury. Do not allow hot oil or components to contact skin.

Park the lift truck on level ground, with the forks lowered, the parking brake engaged, the transmission in NEUTRAL, and the engine stopped.

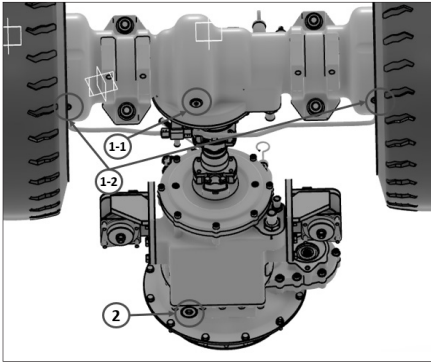

1. Remove drive axle drain plug (1-1), (1-2) and transmission drain plug (2). Allow the oil to drain into a suitable container.

NOTICE

Careless disposal of waste oil can harm the environment and can be dangerous to persons.

Always dispose of waste oil to authorised and licensed personnel only.

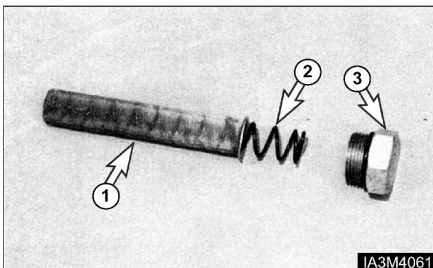

2. Wash the strainer (screen, 1), spring (2) and drain plug (3) in clean, nonflammable solvent. Dry and install the strainer, spring and drain plug.
3. Raise the hood and seat assembly.

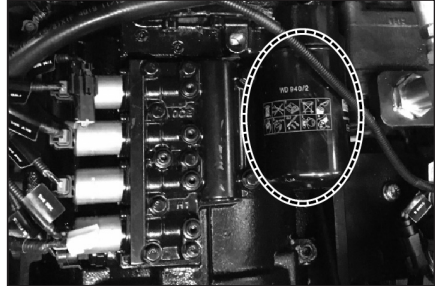

4. Remove and discard the oil filter. Wipe off the filter base. Make sure all of the old seal is removed.
5. Put a small amount of clean oil on the seal on the new filter. Install the filter by hand. When the filter contacts the base, tighten it an additional 3/4 turn.
6. Close the hood and seat assembly.
7. Open the access door in the floor plate.

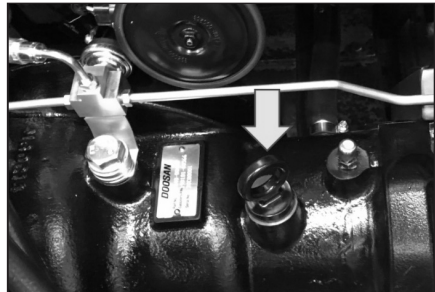

8. Remove the dipstick/filter cap. Fill the transmission with new oil. See "Refill Capacities" Install the dipstick/ filter cap.
9. Start the engine.
10. With the service brake applied and engine at low idle, shift the transmission to forward and reverse to fill the clutches.
11. Shift the transmission into NEUTRAL. Apply the parking brake.
12. Remove the dipstick/ filter cap.
13. Maintain the oil level between the Min and Max marks on the dipstick/filter cap.

When the oil temperature is 40°C approximately, the cold side mark on the dipstick is applicable. When the oil temperature is 80°C approximately, the hot side mark on the dipstick is applicable.

14. Check for oil leaks at the filter and drain plug.
15. Stop the engine.
16. Select Menu - Vehicle - TCU - "Auto clutch calibration" in the display.
17. Check that transmission oil temperature is between 40 ~ 90 degree Celsius. If the temperature is too low, warm up the transmission. In reverse, if the temperature is too high, cool down the transmission.
18. When the parking brake is ON and the gear is in neutral, the color of "start" button is changed to blue.
19. With the service brake pedal depressed, click Start button. Then, calibration will be automatically conducted. It would take about 2 minutes.

 **WARNING**

While conducting the calibration, make sure to keep engaging the service brake thoroughly until being finished. Otherwise, the vehicle may be moved and this would cause some damage or injury.

20. Select Menu - Vehicle - TCU - "Auto inching calibration" in the display.
21. Make sure if the inching pedal is not depressed.
22. When the parking brake is ON and the gear is in neutral, the color of "start" button is changed to blue.
23. Click the start button then, the calibration will be conducted automatically. It would take about (2) seconds.

NOTICE

Do not press the inching pedal during calibration.

Parking Brake - Test, Adjust

Parking Brake Testing

NOTICE

OSHA requires the parking brake to hold the lift truck, with capacity load, on a 15% grade.

Testing requires a test load equal to the capacity of the truck and a 15% grade.

If the maximum grade in the workplace is less than its capacity, use the Parking Brake inspection procedure covered in 'Inspection from Operator's Seat, Engine On' in "Every 10 Service Hours or Daily" section.

1. Pick up capacity load and drive over to a 15% grade.
2. Drive forward up the 15% grade. Halfway up the grade, stop the lift truck with its service brakes.



3. Engage the parking brake and shift the transmission to NEUTRAL. Slowly release the service brakes.
4. The parking brake adjustment is proper if it holds the lift truck on the grade.
5. If the lift truck starts to move in reverse down the grade with the parking brake engaged, stop it with the service brakes, disengage the parking brake and reverse slowly down the grade controlling your speed with the service brakes.

⚠ WARNING

If the parking brake is used for emergency braking while the vehicle is running, the parking brake must be tested.

If the forklift continues to move even when the parking brake is on, park the vehicle in a safe place and insert a block of wood underneath the wheel to prevent the vehicle from moving. Then contact the service centre and have the vehicle serviced.

⚠ WARNING

To prevent personal injury, the operator **MUST** be ready to use the service brake if the parking brake is not adjusted correctly and the lift truck starts to move.

Every 500 Service Hours or 3 Months

You must read and understand the warnings and instructions contained in the Safety section of this manual, before performing any operation or maintenance procedures.

Air Intake System - Change

Changing Primary Element

See topic, "Air Intake System - Check, Clean" in "When Required".

Changing Secondary Element

Replace the secondary element after the primary element has been cleaned three times or yearly.

1. Remove the primary air cleaner element. See topic "Servicing Filter Element". Clean the inside of the air cleaner housing and cover.
2. Remove the secondary element. Inspect the gasket between the air cleaner housing and the engine inlet. Replace the gasket if it is damaged.

NOTICE

Always replace the secondary element. Do not attempt to reuse it by cleaning.

3. Install a new secondary element. Install a new or cleaned primary element. Install the cover. Tighten the latches.
4. Start the engine and observe the air cleaner service indicator. If the indicator shows RED after installing a new secondary element and a cleaned primary (outer) element, replace the cleaned primary filter with a new element.
5. Stop the engine. Close the hood and seat assembly.

Fuel Filter - Change

The fuel filter element must be replaced on a regular basis to prevent foreign materials from entering the diesel fuel system.

Stop and cool down the engine.

Disconnect wire harness connector (1) and disconnect the fuel hose (2) connected to the fuel filter port.

When removing the fuel filter, hold it carefully to prevent fuel from flowing out. Wipe and clean spilled fuel.

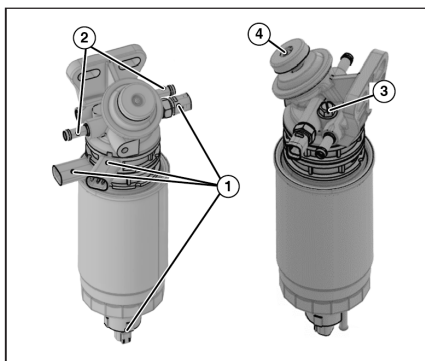

Install a new fuel filter and assemble the fuel filter cap.

Connect the wire harness connector and fuel hose connector. When connecting the fuel hose, take care to prevent foreign material from entering the hose.

After replacing the fuel filter or element, or having exhausted fuel, it is necessary to remove the air in the fuel system for safe engine start up.

Loosen the plug of air bleed port (3).

Press the pump (4) with your hand until the oil comes out. In this operation, all the fuel hose (2) must be connected.

Retighten the plug of air bleed port (3).

Check the fuel leakage

Engine Oil & Filter - Change (with CJ-4 Grade Only)

See topic, "Engine Oil & Filter - Change" in "First 50-100 Service Hours".

WARNING

Hot oil and components can cause personal injury. Do not allow hot oil or components to contact skin.

Mast Hinge Pins – Lubricate

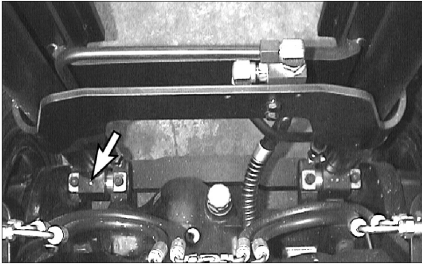

Typical Example

1. Lower the forks and tilt the mast forward.
2. Lubricate the two fittings for the mast hinge pins, one on each side of the mast.

Tilt Cylinders - Check, Adjust, Lubricate

Chassis Pivot Eyebolts

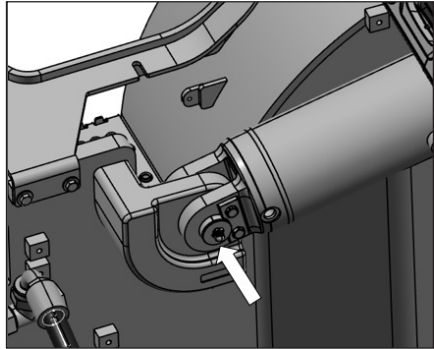

Typical Example

1. Lubricate two fittings for the pivot eyebolts, one on each tilt cylinder.
2. Check the pivot eye pins for loose retainer bolts and wear.

Mast Pivot Eyes



Typical Example

1. Lubricate two fittings for the mast pivot eyes, one on each side of the mast.
2. Check the pivot eye pins for loose retainer bolts and wear.

Cylinder Rod Extension

NOTE: The following description is for forward tilt. For cylinder rod back tilt, the collar should be stationary by the tilt eye. If it is not, the O-ring inside the collar may need to be replaced. To adjust back tilt, spacers must be added or removed.

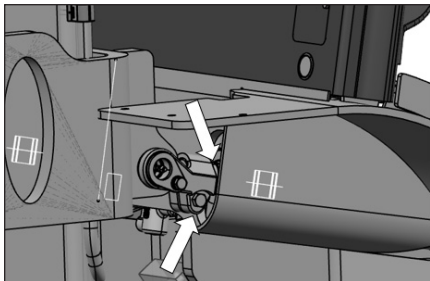

Typical Example

1. Check the tilt cylinders to make sure they extend and retract evenly.
2. If one cylinder continues to move after the other cylinder has stopped in full forward or backward tilt, an adjustment must be made to one cylinder.

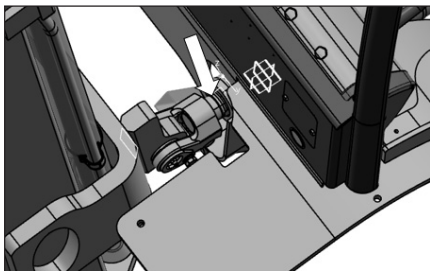

Typical Example

3. To adjust the cylinder rod extension, move the spacer to the rear and loosen the pinch bolt on the clevis.
4. Turn the cylinder rod in or out of the clevis to obtain the proper adjustment. Turning the rod into the clevis shortens the stroke. Turning the rod out of the clevis lengthens the stroke. When turning for extending rod, the overlapped length between clevis's thread and cylinder rod must be minimum 32 mm
5. Tighten the pinch bolts to a torque of 95 ± 15 N·m (70 ± 10 lb·ft). Check the cylinder rods again for even travel.

Crosshead Rollers - Inspect

1. Operate the mast through a lift cycle. Watch the chains move over the crosshead rollers. Make sure the chain is tracking over the rollers properly.

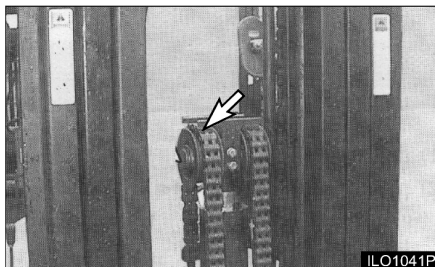

Typical Example

2. Check for damaged crosshead rollers, guards and retainers rings.

Carriage Side Rollers Thrust (If Equipped) - Lubricate

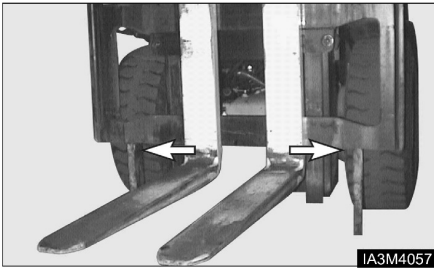

1. Raise the carriage high enough to gain access to the side thrust rollers on the back side of the carriage. Block the carriage in this position.

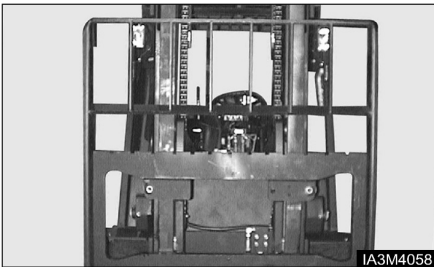

2. Lubricate 2 side thrust roller fittings, one on each side of the mast.
3. Raise the carriage, remove the blocking. Lower the carriage to the floor.

Carriage Sideshifter (If Equipped) – Lubricate

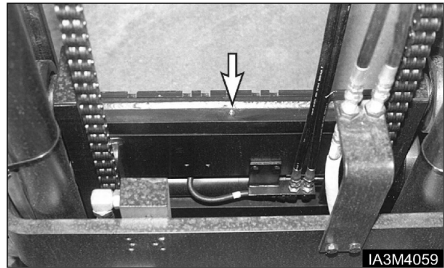

1. Lubricate 4 (6) fittings. The forks may have to be moved to gain access to all of the fittings.
2. Operate the sideshifter carriage through several complete cycles to distribute the grease the carriage to the floor.

Mast, Carriage, Lift Chains, & Attachments - Check, Lubricate

1. Operate the lift, tilt and attachment controls. Listen for unusual noises. These may indicate a need for repair.
2. Inspect for loose bolts and nuts on the carriage. Remove any debris from the carriage and mast.
3. Inspect the forks and attachments for free operation and damage. Have repairs made if necessary.

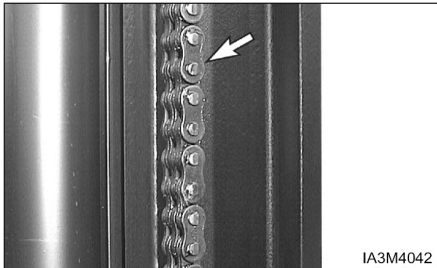

4. Brush a film of oil on all links of the chain.
5. Raise and lower the carriage a few times to work lubricant into the chain links.

NOTICE

Lubricate chains more frequently than normal in applications where the lift truck is operating in a atmosphere which could cause corrosion of components or when lift truck must work in rapid lift cycles.

6. Inspect the chain anchors and individual links for wear, loose pins or cracked leaves.

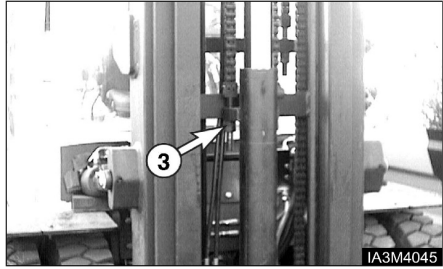
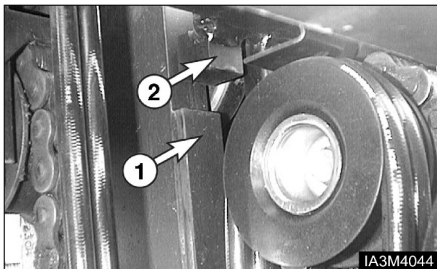

7. In case of Full Free Lift Mast, extend the primary cylinder to full length and then check the clearance and overlapped dimension between carriage stopper bolt or block (1) and Inner mast stopper block (2). Adjust the chain anchor bolt (3) so that clearance should be 14 ± 2 mm.
8. And adjust the overlapped dimension to be 10 ± 2 mm by moving or inserting washer.

Carriage Side Rollers – Lubricate



CD35/40S-9



CD45S-9, CD50/55C-9

Lubricate 2 side roller fittings, one on each side of the carriage.

Parking Brake - Test, Adjust

See topic, "Parking Brake - Test, Adjust" in "First 50-100 Service Hours."

Horn & Lights (If Equipped) – Check

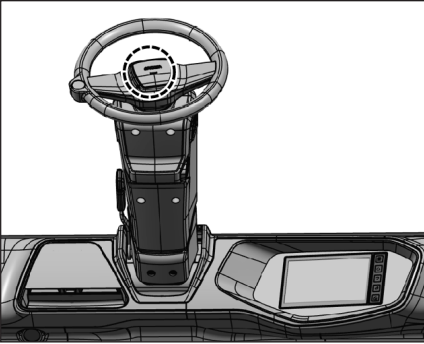

1. Press horn button, to determine if horn is operational.
2. Check all lights such as warning, directional, backup, driving and flood lights for correct operation. Replace all burned-out bulbs, and repair them if needed.

Overhead Guard – Inspect

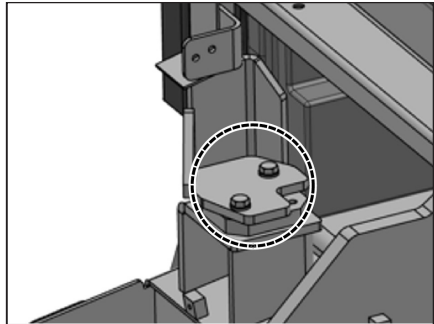

1. Check tightness of overhead guard mounting bolts at 95 N-m (70 lb-ft).
2. Check overhead guard for bent or cracked sections, and repair them if needed.

Steer Suspension - Inspect



1. Inspect the suspension mounting bolts. Tighten suspension mounting bolts, if necessary, to 240 ± 30 N·m (180 ± 20 lb·ft).



2. Look for leaks at the power steering hose connections.
3. Remove any trash buildup on the suspension or the steer axle.

Steering Mechanism - Check, Lubricate

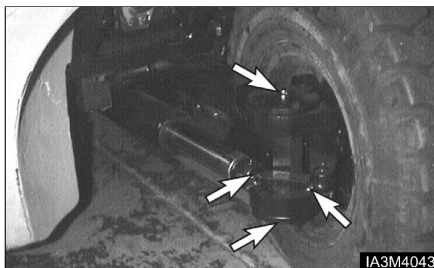

1. Lubricate the steer axle king pins, total of four fittings. Two on the right side and two on the left side.
2. Lubricate the steering link bearings, total of four fittings. Two on the right side and two on the left side.
3. Check for any worn or loose components of the steering mechanism. Remove any debris or trash as required.

Wheel Bolts and Nuts – Inspect

Inspect Tightness

NOTICE

Do not lubricate ball seas of wheels or ball faces of wheel nuts.

Be sure mounting faces of hub, wheel nuts and flat mounting surfaces are clean.

Tighten wheel nuts again after 24 hours of operation.

NOTE: Always tighten wheel lug nuts in a sequence opposite (180°) each other.

If equipped with dual wheels, follow the same nut tightening sequence for both wheels.

Steer Wheels

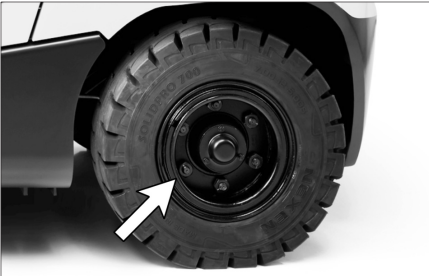

Install steer wheel. Put two nuts opposite (180°) each other. Tighten both. Install remaining nuts. Tighten all nuts in a sequence opposite (180°) each other. Tighten to 440+35 N·m (325+25 lb·ft).

Drive Wheels



Install drive wheel. Put two nuts opposite (180°) each other. Tighten both.

Install the remaining nuts. Tighten all nuts in a sequence opposite (180°) each other. Tighten to 600±90 N·m (440±60 lb·ft).

Every 1000 Service Hours or 6 Months

You must read and understand the warnings and instructions contained in the Safety section of this manual, before performing any operation or maintenance procedures.

Fuel Lines & Fittings - Check

Visually inspect fuel lines and fittings for physical damage. Replace as required.

Engine Oil & Filter - Change (with CK-4 Grade Only)

See topic, "Engine Oil & Filter - Change" in "First 50-100 Service Hours".

⚠ WARNING

Hot oil and components can cause personal injury. Do not allow hot oil or components to contact skin.

Fuel Filter (with Pre/Main Filter) – Change

The fuel filter element must be replaced on a regular basis to prevent foreign materials from entering the diesel fuel system.

Stop and cool down the engine.

Disconnect wire harness connector (1) and disconnect the fuel hose (2) connected to the fuel pre filter port.

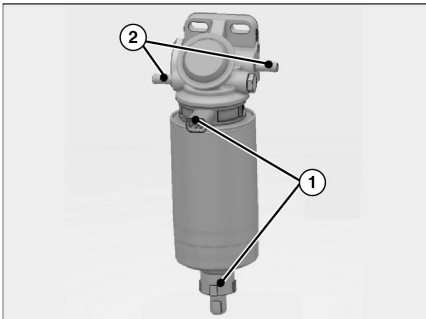

When removing the fuel filter, hold it carefully to prevent fuel from flowing out. Wipe and clean spilled fuel.

Install a new fuel filter and assemble the fuel filter ap.

Connect the wire harness connector and fuel hose connector. When connecting the fuel hose, take care to prevent foreign material from entering the hose.

Disconnect wire harness connector (3) and disconnect the fuel hose (4) connected to the fuel main filter port.

When removing the fuel filter, hold it carefully to prevent fuel from flowing out. Wipe and clean spilled fuel.

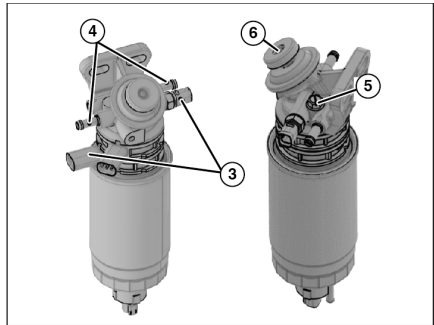

Install a new fuel filter and assemble the fuel filter cap.

Connect the wire harness connector and fuel hose connector. When connecting the fuel hose, take care to prevent foreign material from entering the hose.

After replacing the fuel filter or element, or having exhausted fuel, it is necessary to remove the air in the fuel system for safe engine start up.

Loosen the plug of air bleed port (5).

Press the pump (6) with your hand until the oil comes out. In this operation, all the fuel hose (2) and (4) must be connected.

Retighten the plug of air bleed port (5).

Check the fuel leakage.

Belt – Check, Adjust

1. The belt is equipped with an auto tensioner which automatically adjusts the belt tension so there is no need for extra adjustment of the tension.

During daily inspections, be sure to inspect whether the pointer on the auto tensioner is indicating that it is time for a replacement, as well as whether there is any damage to the belt due to external factors.

- Replacing the Micro V-Belt if necessary.
Replace the belt set in the event that the pointer on the auto tensioner indicates that it is time for a replacement, or cases where damage to the belt from external factors has been confirmed and there are concerns of severe **damage occurring**.

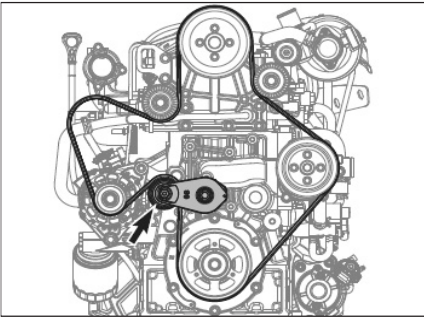

- Inspecting the condition
Inspect the Micro V-belt for cracks, oil, overheating and wear.

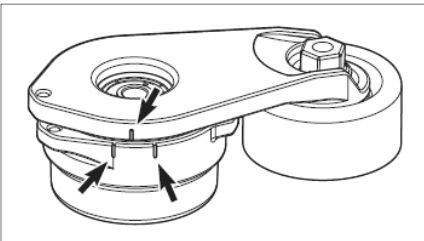

It is normal condition when the upper pointer enters the horizontal range shown by two lower pointers.

It is time for the belt to check when the upper pointer is getting out of the horizontal range, because the tension of the belt is loosened.

The belt needs to be replaced with new one for cases where damages to the belt from external factors.

NOTE: The minimum/maximum range indication is a reference value; the belt must be inspected according to its maintenance schedule.

Hydraulic Return Filter - Change

⚠ WARNING

Hot oil and components can cause personal injury. Do not allow hot oil or components to contact skin.

Park the lift truck on level ground, with the forks lowered, the parking brake engaged, the transmission in NEUTRAL, and the engine stopped.



1. Raise the hood and seat assembly. Loosen the bolts of the hydraulic tank cover, and remove the hydraulic tank cover with filter assembly.

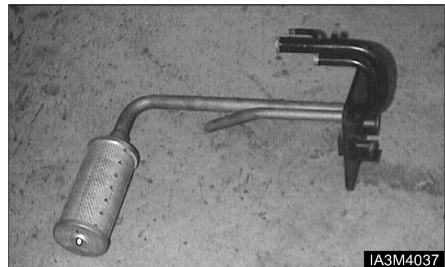

2. Remove filter assembly from the hydraulic tank cover.
3. Install new filter assembly in the hydraulic tank cover.
4. Inspect cover gasket for damage, replace it if necessary.
5. Clean and Install the cover and tighten retaining bolts.
6. Lower the hood and seat assembly.

Air Breather - Change

Park the lift truck on level ground, with the forks lowered, the parking brake engaged, the transmission in NEUTRAL, and the engine stopped.

1. Raise the hood and seat assembly.
2. Remove and discard the air breather.



3. Install a new air breather.
4. Lower the hood and seat assembly.

Lift Chains - Test, Check, Adjust

Lift Chain Wear Test

Inspect the part of the chain for its normal operation over the cross head roller. When the chain bends over the roller, the movement of the parts against each other causes wears.

Inspect to make sure that chain link pins do not extend outside of the link hole. If any single link pin is extended beyond its connecting corresponding link, it should be suspected of being broken inside of its link hole. Lift chains are required to check for wear about every 1,000 service hours or 6 months.

Chain wear test is a measurement of wear of the chain links and pins. Take the following steps to check chain wear.

1. Lift the mast and carriage enough for getting tension on lift chains.

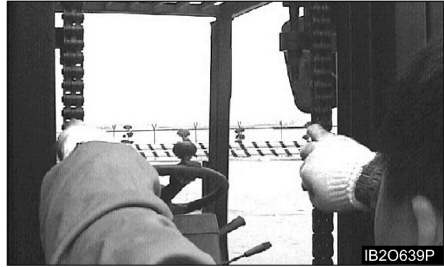

Typical example

2. Measure precisely ten links of chain distance at the centre of pins in millimeter.
3. Calculate chain wear rate*.
4. If the chain wear rate is 2% or more, replace the lift chain.

*Chain wear rate (%)

$$= \left(\frac{\text{Actual measurement} - \text{Pitch}^{**} \times 10}{\text{Pitch}^{**} \times 10} \right) \times 100$$

**Chain Pitch for CD35/40/45S-9, CD50C-9, CD40/45/50/55SC-9 = 25.40 mm (1.0 in)

Check for Equal Tension



Typical example

Lift the carriage and the mast high enough for getting tension on lift chains. Check the chains, and make sure the tension is the same. Lift chains are required to check for equal tension about every 1,000 service hours or 6 months.

WARNING

Personal injury can be caused by sudden movement of the mast and carriage.

Keep hands and feet clear of any parts that can move.

Lift Chain Adjustment



Typical example for carriage equal tension

If the tension is not the same on both chains, take the procedure as follows.

NOTE: If carriage height is not correct, make adjustments by following procedures.

Carriage Chain Adjustment

Make sure that carriage height is correct. If correct, adjust the chain for equal tension. If not, adjust the chain for correct carriage height by adjusting anchor nuts (1),(2).

NOTE: See the previous section, "Carriage Roller Extrusion" in "When Required" for proper height of carriage.

1. Fully lower the carriage and tilt mast forward or lift the carriage and put blocks under the carriage to release the tension from the lift chains.
2. Loosen nut (1) and adjust nut(2) to get proper distance from bottom of inner upright to the bottom of carriage bearing.

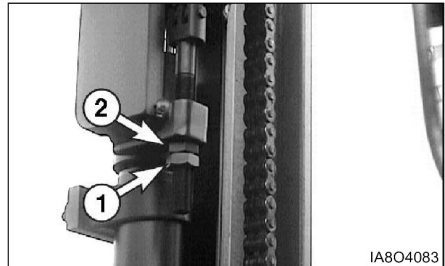

Typical example for carriage chain of STD mast

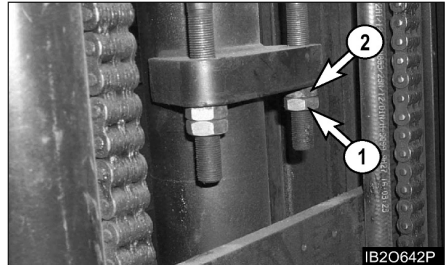

Typical example for carriage chain of FF,FFT mast

3. Make adjustment anchor nut (1),(2) for equal chain tension.
4. Set the mast vertical and raise the carriage and check equal chain tension. If not equal, repeat the same procedure as step 1 through step 3.
5. Put LOCTITE No. 242 Tread lock on the threads of the anchor nuts (1),(2) after the adjustment is completed.

Mast Chain Adjustment - FF, FFT Mast

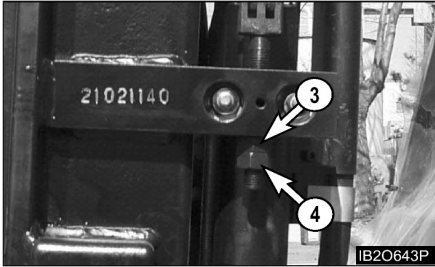

Typical example for FF mast

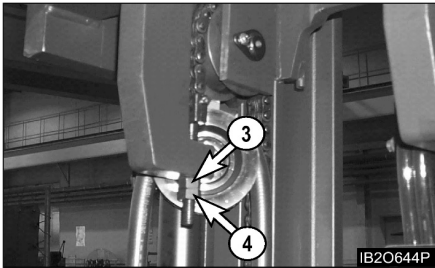

Typical example for FFT mast

Make sure that mast height is correct. If correct, adjust chain for equal tension. If not, adjust mast chain for correct mast height by adjusting anchor nuts (3), (4).

NOTE: See the previous section, "Carriage Roller Extrusion" in "When Required" for proper inner mast height.

1. Lift the inner mast and put blocks under the inner mast to release the tension from the lift chains.
2. Loosen nut (3) and adjust nut (4) to make inner mast rail flush with outer mast rail bottom.
3. Make adjustment anchor nuts (3),(4) for equal chain tension.
4. Raise the inner mast and check equal chain tension. If not equal, repeat the same procedure as step 1 through step 3.
5. Put LOCTITE No. 242 tread lock on the threads of the anchor nuts (3),(4) after the adjustment is completed.

Universal Joint - Inspect, Lubricate

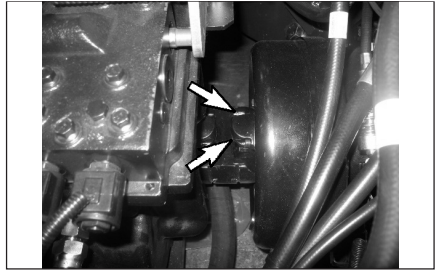

1. Inspect for loose retaining bolts. Check for worn or damaged bearings.
2. Have worn or damaged bearings replaced. Tighten the bolts if necessary.

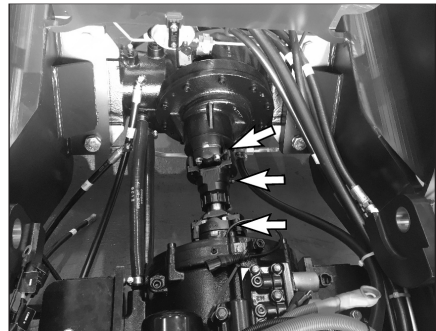

3. Lubricate the grease into the nipples of the universal joint.

Every 2000 Service Hours or Yearly

You must read and understand the warnings and instructions contained in the Safety section of this manual, before performing any operation or maintenance procedures.

Drive Axle Oil, Transmission Oil, Oil Filter & Strainer - Clean, Change

See the topic, "Drive axle Oil, Transmission Oil, Oil Filter & Strainer - Clean, Change" in First 50-100 Service hours or a week.

Steer Wheel Bearings - Reassemble

Park the lift truck on level ground, with the forks lowered, the parking brake engaged, the transmission in NEUTRAL, and the engine stopped.



Typical Example

1. Lift the steer wheels off the ground. Place stands or blocking under the frame and steer axle to support the lift truck.
2. Remove the hub cap.

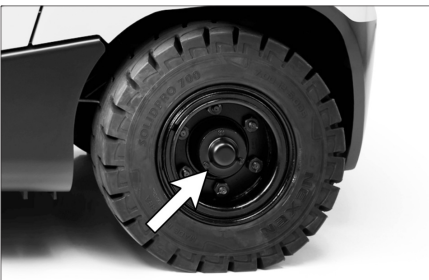

Typical Example

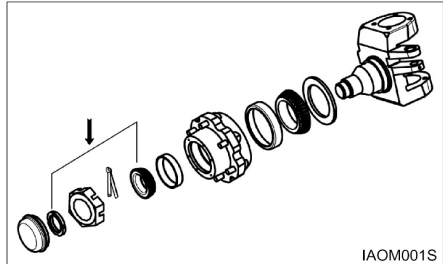

3. Remove the cutter pin.
4. Remove the castle nut and washer.
5. Remove the wheel assembly. Examine the seal for damage and wear. Replace the seal if necessary.

WARNING

Deflate tyre before removing wheel nuts at tyre change.

6. Remove the inner bearing. Clean and lubricate the steering knuckle. Reassemble both the inner and outer bearing cones.
7. Install the inner bearing. Lubricate the seal and install the wheel assembly on the knuckle.
8. Install the outer wheel bearing and the outer washer. Install a new lock washer and fit the locknut.

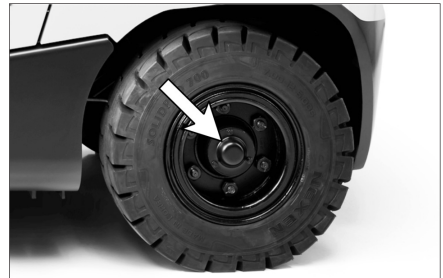

Typical Example

9. Tighten the locknut to 135 N·m (100 lb-ft), while turning wheel hub to seat the bearing.
10. Loosen the locknut. Retorque it to 50 ± 5 N·m (37 ± 4 lb-ft). Bend the lockwasher tang to secure locknut.

11. Install the hub cap.
12. Raise the lift truck and remove the blocking Lower the lift truck to the ground.

Cooling System - Clean, Change

WARNING

At operating temperature, the engine coolant is hot and under pressure.

Steam can cause personal injury.

Check the coolant level only after the engine has been stopped and the filter cap is cool enough to touch with your bare hand.

Remove the filter cap slowly to relieve pressure.

Cooling system conditioner contains alkali. Avoid contact with the skin and eyes to prevent personal injury.

Use all cleaning solutions with care.

The lift truck must be level, the forks lowered, the parking brake engaged, the transmission in NEUTRAL and the engine stopped and cool.

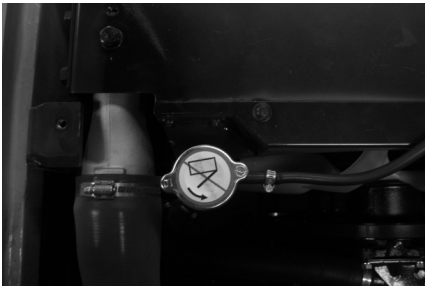

1. Turn the radiator cap slowly to relieve the pressure, then remove the cap.
2. Remove the block drain plug.
3. Open radiator drain valve. Allow the coolant to drain. Drain the recovery bottle.
4. Close radiator drain valve and install block drain plug. Fill the cooling system with 1 kg (2 lb) sodium bisulphate per 40 liters (10 gallons) of water. Most commercial cooling system cleaners can be used.
5. Start and run the engine for 30 minutes.
6. Stop the engine and drain the cleaning solution.
7. Flush the system with clean water, until draining water is clear.

8. Close the drain valve and install the block drain plug. Fill the system with neutralizing solution, 250g (1/2 lb) sodium carbonate per 40 liters (10 gallons) of water.
9. Start and run the engine for 10 minutes.
10. Stop the engine and drain the neutralizing solution.
11. Flush the system with clean water until draining water is clear.
12. Close the drain valve and install the block drain plug. Add coolant to the top of the filter neck.
13. Start and run the engine to stabilise the coolant level. See "Every 10 Service hours or Daily", "Coolant Level-Check", in this manual.

Forks – Inspect

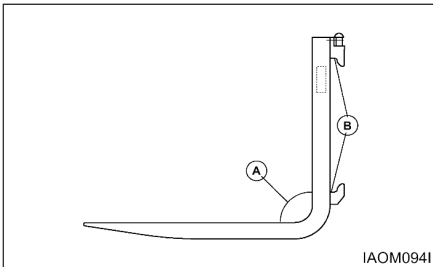

Forks should be inspected, at a minimum, every 12 months. If the truck is being used in a multi-shift or heavy duty operation, they should be checked every six months.

1. Inspect the forks carefully for cracks. Special attention should be given to the heel section (A), all weld areas and mounting brackets (B). Inspect the top and bottom hooks on forks used on hook type carriages and tubes on shaft mounted forks.

Forks with cracks should be removed from service. "Wet Test" magnetic particle inspection is generally preferred due to its sensitivity and the ease of interpreting the results. Portable equipment is usually recommended so it can be moved to the lift truck.

Inspectors should be trained and qualified in accordance with The American Society for Non Destructive Testing, Level II Qualifications.

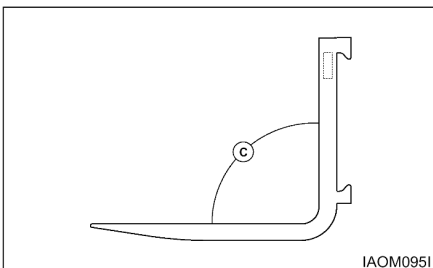

2. Check the angle between the upper face of the blade and the front face of the shank. The fork should be withdrawn from service if angle (C) exceeds 93 degrees or deviates by more than 3 degrees from an original angle other than 90 degrees, as may be found in some special application forks.

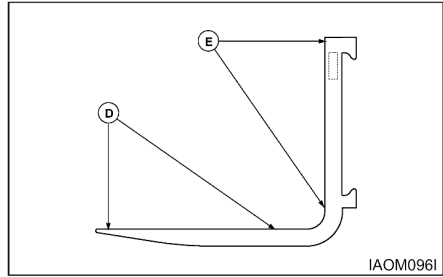

3. Check the straightness of the upper face of blade (D) and the front face of shank (E) with a straight edge.

The fork should be withdrawn from service if the deviation from straightness exceeds 0.5 percent of the length of the blade and/or the height of the shank respectively 5 mm/1000 mm (0.18"/36").

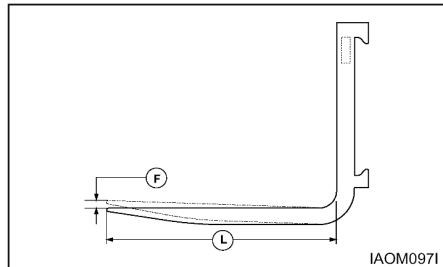

4. Check the difference in height of one fork tip to the other when mounted on the fork carrier. A difference in fork tip height can result in uneven support of the load and cause problems with entering loads.

The maximum recommended difference in fork tip elevation (F) is 6.5 mm (0.25") for pallet forks and 3 mm (0.125") for fully tapered forks. The maximum allowable difference in fork tip elevation between the two or more forks is 3 percent of blade length (L).

Replace one or both forks when the difference in fork tip height exceeds the maximum allowable difference. Contact your local CROWN Lift Truck Branch for further information.

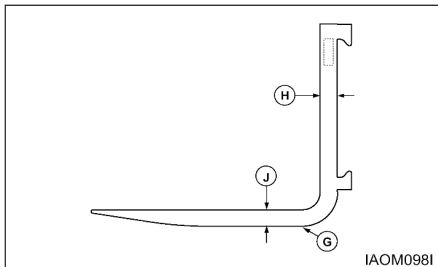

5. Check the fork blade (J) and shank (H) for wear with special attention to the heel (G). The fork should be withdrawn from service if the thickness is reduced to 90 percent or less of the original thickness.

Fork blade length may also be reduced by wear, especially on tapered forks and platens. Remove the forks from service when the blade length is no longer adequate for the intended loads.

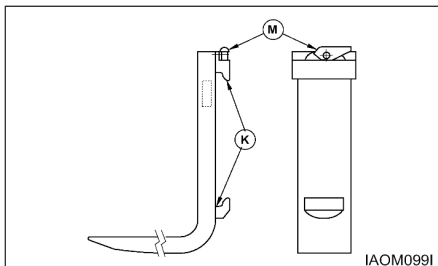

6. Check the fork mountings (K) for wear, crushing and other local deformation, which can cause excessive side to side wobble of the forks. Excessive clearance on hook type forks may allow them to fall from the carrier. Forks which show visible signs of such damage should be removed from service.
7. Check the positioning lock and other fork retention devices to make sure they are in place and working.

Hook type forks use a spring loaded pin (M), located in the top hook, to engage notches in the top carriage bar to hold the fork in place.

When adjusting the fork spacing, the forks are prevented from sliding off the end of the carriage by stop blocks. These stop blocks are at both ends of the carriage and in the path of the bottom fork hook. The load backrest extension may be used in place of the stop blocks in some cases.

Shaft mounted forks may use set collars or spacers on the shaft to either side of the fork. They may also use U bolts, pins, or similar devices which engage the fork through the top structure of the carriage.

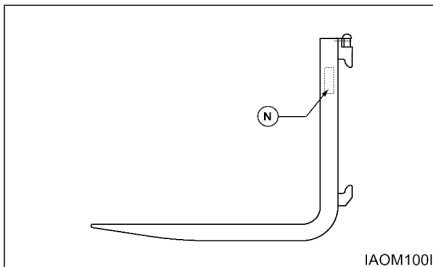

8. Check fork markings (N) for legibility. Renew markings as required to retain legibility.

- a. Lift the mast and operate the tilt control lever, until the top surface of the forks is parallel with the floor. Place two straight bars that are the same width as the carriage, across the forks as shown.

- b. Measure the distance from the bottom of each end of the two bars to the floor. The forks must be parallel within 3 mm (.12 in) for Full Tapered and Polished (FTP) forks, all other forks 6.4 mm (.25 in), for their complete length.

- c. Put one fork, one third from the tip, under a fixture that will not move. Then operate the tilt control with caution until the rear of the truck lifts just off the floor. Follow the same procedure with the second fork. Repeat Step a.

Every 2500 Service Hours or 15 Months

You must read and understand the warnings and instructions contained in the Safety section of this manual, before performing any operation or maintenance procedures.

Hydraulic Oil - Check, Clean, Change

WARNING

Hot oil and components can cause personal injury. Do not allow hot oil or components to contact skin.

Park the lift truck on level ground, with the forks lowered, the mast tilted back (all cylinders retracted), the parking brake engaged, transmission in NEUTRAL, and the engine stopped.

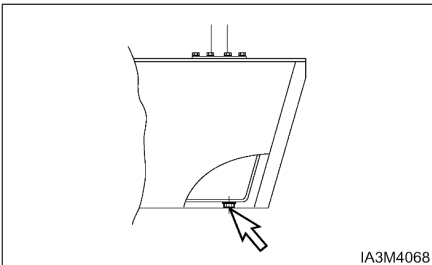

1. Remove the hydraulic tank drain plug. Allow the oil to drain. Clean and install the plug.
2. Raise the hood and seat assembly.
3. Remove dipstick/filter cap. Fill the hydraulic tank. See "Refill Capacities." Install the breather/dipstick.
4. Lower the hood and seat assembly.
5. Start the engine and operate the hydraulic controls, and the steering system, through a few cycles to fill the lines. Look for oil leaks.



6. Stop the engine and check the oil level. With all cylinders retracted, maintain the oil level to the FULL mark on the dipstick.

Inspect Battery System

1. Clean battery outer surfaces with a mixture of baking soda and water.
2. Inspect battery outer surfaces for damage and replace as necessary.
3. Remove battery cable and clean, repair and/or replace as necessary.

Every 5000 Service Hours or 30 Months

You must read and understand the warnings and instructions contained in the Safety section of this manual, before performing any operation or maintenance procedures

DPF Maintenance (DM03V Stage 5 Engine Only) - Ash Cleaning

⚠ WARNING

Ash cleaning services is recommended by the designated repair shop, if not, it can lead to damage of the product and system.

Visit designated Repair & Inspection Shop for Ash Cleaning service every 5000 Hours or 30 Months. If not the efficiency of filtering and performance of back pressure would be reduced.



DPF

Use recommended engine oil to reduce the amount of generated ash (API CJ/CK-4 Grade).

Environment Protection

When servicing this lift truck, use an authorised servicing area and an approved container to collect coolant, oil, fuel, grease, electrolyte and any other potential environmental pollutant before any lines, fittings or related items are disconnected or removed. After servicing, dispose of those materials in an authorised place and container. When cleaning the lift truck, be sure to use an authorised area.

Index

#

12 Months Inspection 125

A

Accelerator Pedal 85
 Additional Technical Fuel Requirements 131
 After Starting the Engine 92
 Air-205 kPa (30 psi) Maximum Pressure 141
 Air Breather - Change 170
 Air Intake System - Change 160
 Air Intake System - Check, Clean 140
 Antifreeze 130
 Attachment Abbreviations (Includes Special Forks) 59
 Audio System (AM/FM Tuner with USB/AUX Player, If equipped) 73
 Auto Shift (AUTO) Selector Switch 82
 Avoiding Lift Truck Tipovers 22

B

Battery Terminal - Clean, Inspect 142
 Before Operating the Lift Truck 12
 Before Starting the Engine 88
 Before Starting the Lift Truck 12
 Before Storage 114
 Belt – Check, Adjust 169
 Bent or Twisted Forks 123
 Bio-Diesel Fuels 132
 Brake Fluid 134
 Brake Oil Level – Check 154
 Brake Pedal Adjustment Warning 8
 Bulbs 149
 Burn Prevention 15

C

Capacities for Refilling 135
 Capacity Chart 41
 Capacity Chart (with Side Shifter) 49
 Carriage Chain Adjustment 171
 Carriage Roller Extrusion - Check, Adjust 151
 Carriage Side Rollers – Lubricate 164
 Carriage Side Rollers Thrust (If Equipped) - Lubricate 163
 Carriage Sideshifter (If Equipped) – Lubricate 163
 Causes of Fork Failure 123

Centre of Gravity (CG) 22
 Changing Primary Element 160
 Changing Secondary Element 160
 Chassis Pivot Eyebolts 161
 Check Coolant Level 152
 Check for Equal Tension 171
 Check Inflation and Damage 150
 Checking Element 142
 Circuit Breaker 72, 150
 Cleaning Primary Filter Elements 141
 Coolant Information 129
 Coolant Level - Check, Clean 152
 Coolant Water 130
 Cooling System - Clean, Change 174
 Cooling System Specifications 129
 Crosshead Rollers - Inspect 162
 Crushing or Cutting Prevention 14
 Cylinder Rod Extension 162

D

Daily Inspection 124
 Declaration of Conformity 31
 Detergent 142
 Diesel Engine Crankcase 156
 Diesel Engine Equipped 87
 Diesel Engine 90, 92
 Diesel Specifications 131
 Direction Control Lever 82
 Discharge of Foreign Matter in the Fuel 147
 Display Cluster 63
 Display for SCR Cleaning 146
 Display of Detecting Control Failure 98
 DPF Maintenance (DM03V Stage 5 Engine Only) - Ash Cleaning 178
 Drive Axle Oil Level – Check 155
 Drive Axle Oil 134
 Drive Axle Oil, Transmission Oil, Oil Filter & Strainer - Clean, Change 157, 173
 Drive Wheels 167

E

Electrical Disconnect Switch (If Equipped) 72
 Electrical Parking Brake 8
 Electronic Controlled Diesel Engines (DI DM03P/V) 94
 Engine and After-treatment System 93
 Engine Oil & Filter - Change (with CJ-4 Grade Only) 161
 Engine Oil & Filter - Change (with CK-4 Grade Only) 168
 Engine Oil & Filter – Change 156
 Engine Oil (DEO and EO) 133
 Engine Oil Level - Check 152

Environment Management.....	3
Environment Protection.....	122, 179
Every 10 Service Hours or Daily	152
Every 1000 Service Hours or 6 Months.....	168
Every 2000 Service Hours or Yearly	173
Every 2500 Service Hours or 15 Months.....	177
Every 500 Service Hours or 3 Months.....	160
Every 5000 Service Hours or 30 Months.....	178

F

Falling Objects Protective Structure(FOPS).....	15
Fatigue	123
Fire or Explosion Prevention.....	16
First 50 - 100 Service Hours or a Week.....	156
First Installation.....	124
Fluid Penetration	14
Foreword	2
Fork Inspection	124
Forks – Inspect	175
Forward and Backward Adjustment	19
Fuel and DEF/Ad-Blue Replenishment.....	87
Fuel Filter - Change.....	160
Fuel Filter (with Pre/Main Filter) – Change	168
Fuel Lines & Fittings - Check.....	168
Fuses.....	149
Fuses, Bulbs & Circuit Breaker - Change, Reset.....	149

G

General Fuel Information	131
General Hazard Information	10
General Warnings to Operator	6

H

Hand Placement Warning.....	7
Hook - on type Fork.....	113
Horn & Lights (If Equipped) – Check	165
Hot Muffler Warning	9
How to Fix Forklift to a Carrier.....	116
How to Survive in a Tipover.....	30
Hydraulic Oil - Check, Clean, Change	177
Hydraulic Oil (HYDO).....	133
Hydraulic Oil Level – Check.....	155
Hydraulic Return Filter - Change.....	169

I

Identification, Lift Capacity and Attachment Plate..	58
If Optional Suspension Seat (weight adjusting type) Equipped	19

Important Safety Information.....	4
Improper Modification or Repair.....	123
Inching into Loads	107
Inching.....	101
Index	180
Inspect Battery System.....	177
Inspect Engine for Exhaust Leaks	153
Inspect Engine for Fluid Leaks.....	152
Inspect Tightness.....	167
Inspection, Maintenance and Repair of Lift Truck Forks	122
Instrument Panel	60

J

Jacking Information	120
---------------------------	-----

L

Lift Chain Adjustment.....	171
Lift Chain Wear Test	170
Lift Chains - Test, Check, Adjust.....	170
Lift Control	86
Lift Fork Adjustment.....	113
Lift Truck Capacity Rating	58
Lift Truck Controls.....	82
Lift Truck Operation	100
Lift Truck Parking	14
Lift Truck Shipping	115
Lift Truck Stability Base.....	23
Lift Truck Stability.....	22
Lifting a Forklift using a Crane	116
Lifting Drums or Round Objects.....	110
Lifting the Load.....	107
Literature Information.....	2
Load Backrest Must Be In Place Warning.....	7
Loading or Unloading Trucks/Trailers.....	13
Long Time Storage.....	114
Lubricant Information	133
Lubricant Specifications.....	133
Lubricant Viscosities and Refill Capacities.....	135
Lubricant Viscosities	135
Lubricating Grease (MPGM)	134

M

Machine Lifting and Tiedown Information.....	115
Maintenance and Repair	125
Maintenance Information	14
Maintenance Intervals.....	3, 136
Maintenance	3
Make proper antifreeze additions.....	130
Mast Abbreviations.....	59
Mast Chain Adjustment - FF, FFT Mast	172

Mast Channels – Lubricate	154
Mast Hinge Pins – Lubricate.....	161
Mast Pivot Eyes.....	161
Mast, Carriage, Lift Chains, & Attachments - Check, Lubricate.....	164
Metric Hardware	127
Metric ISO2 Tread.....	128
Mono-Ped Control System (If Equipped).....	102
Mounting and Dismounting.....	11
Moving Fan Warning.....	9
Multi-torque.....	83

N

No Riders Warning.....	8
No Standing On Forks Warning, No Standing Under Forks Warning.....	7
Noise and Vibration.....	40
Noise	40

O

Oil Cooled Disc Brake (OCDB) Type.....	155
Operating in hot weather.....	110
Operating Techniques.....	107
Operating the Lift Truck.....	13
Operation Information	11
Operation	2
Operator’s Warning and Identification Plate	58
Operator Restraint System (If Equipped).....	2
Operator’s Station and Monitoring Systems.....	60
Operator’s Warning Plate.....	58
Overhead Guard – Inspect	165
Overhead Guard Must Be In Place Warning.....	8
Overloading.....	123

P

Parking Brake - Test, Adjust.....	159, 165
Parking Brake Forced Release Method 1 (In Case of Engine Start).....	118
Parking Brake Forced Release Method 2 (In Case That the Engine Does Not Start).....	119
Parking Brake Forced Release Method.....	118
Parking Brake Switch.....	86
Parking Brake Testing.....	159
Parking the Lift Truck.....	112
Power Shift Transaxle.....	100
Precleaner (If Equipped).....	140
Pressure Air	14
Pressure Warning.....	7
Prestart Conditions.....	90
Priming the Fuel System.....	148

R

Restoration of Parking Brake Forced Release Method 1.....	118
Restoration of Parking Brake Forced Release Method 2.....	119

S

Safety instructions for attachments when transporting suspended loads.....	111
Safety instructions for attachments when transporting wide loads.....	111
Safety Rules	24
Safety.....	2, 5
SCR Cleaning - DeSOx Display Pop-up.....	143
SCR Cleaning - DeSOx Switch.....	83
SCR Cleaning - DeSOx.....	143
Seat Adjustment.....	18
Seat Switch System.....	81
Seat, Hood Latch & Support Cylinder - Check, Lubricate	148
Serial Number Locations.....	57
Serial Number.....	57
Service Brake Pedal	85
Servicing Filter Element.....	140
Sideshift Attachment Control (If Equipped).....	86
Specifications of Fuel and DEF/Ad-Blue	131
Specifications	32
Stability and Centre of Gravity	22
Starting a Cold Diesel Engine	90
Starting From a 12 Volt External Source.....	91
Starting the Engine.....	90
Starting the Lift Truck.....	12
Steer Suspension - Inspect	166
Steer Wheel Bearings - Reassemble	173
Steer Wheels.....	167
Steering Mechanism - Check, Lubricate	166
Storage Information	114

T

Table of Contents.....	1
Tilt Control.....	86
Tilt Cylinders - Check, Adjust, Lubricate	161
Tilt Steering Column	72
To Operate the Lift Truck After a Long Time Storage.....	114
Torque for Metric Fasteners.....	128
Torque for Standard Bolts, Nuts, and Taperlock Studs.....	127
Torque for Standard Hose Clamps – Worm Drive.....	127
Torque Specifications	127

Torques for Bolts and Nuts With Standard Threads	127
Torques for Taperlock Studs	128
Towing Information	117
Training Required to Operate or Service Warning... 5	
Transmission Inching Control Pedal	85
Transmission Oil (TDO).....	134
Transmission Oil Level - Check.....	154
Transmission Speed Range Lever	82
Transportation Hints	115
Traveling With the Load	108
Turning	109
Tyre Inflation Information	126
Tyre Inflation Pressures Adjustment	126
Tyre Inflation	126
Tyre Shipping Pressure.....	126
Tyres and Wheels - Check, Inspect	150

U

Universal Joint - Inspect, Lubricate	172
Unloading	108

V

Vibration (weighted overall value)	40
--	----

W

Walk - Around Inspection - Inspect	153
Walk - Around Inspection	88
Warning Signs and Labels	5, 18
Water - 280 kPa (40 psi) Maximum Pressure	142
Water Separator	147
Weight adjustment	19
Weight Scale Mode (Optional - Hydraulic)	69
Weight Scale Option (Load Cell Type).....	70
Wheel Bolts and Nuts – Inspect	167
When Required	140