



Please visit [crown.com](http://crown.com) to find your local Crown dealer.

[www.crown.com](http://www.crown.com)

CROWN

CGC15/18S-9, CGC20SC-9

Operation & Maintenance Manual

XSB2474E00NA



XSB2474E00NA  
11. 2019

# Operation & Maintenance Manual

## CGC15S-9, CGC18S-9, CGC20SC-9

FGA1A, FGA1B, FGA1C (PSI Tier-3)



Forklifts



# Operation & Maintenance Manual

---

## FORKLIFTS

### **CGC15S-9, CGC18S-9, CGC20SC-9**

FGA1A, FGA1B, FGA1C (PSI Tier-3)



## **WARNING**

### **A MOVING VEHICLE CAN BE DANGEROUS**

You or others around you can be seriously injured or even killed if you are not careful or don't know how to use this truck correctly.

Do not operate this truck unless you are trained and authorized.

Read and obey all warnings and instructions in this Manual\* and on the truck.

Make sure the truck is in good working order.

Head, arms, hands or legs outside the operator area can be pinned or crushed when ever the truck is moving. Stay within the operator area and stop completely before getting off.

A dockboard can move or drop while you are on it. Or you could drive off a dock. Falls from docks or dockboards can cause serious injury or even death. Make sure you are safe.

\* Additional copies of this Operator Manual and all Truck Labels can be obtained from Crown Equipment Corporation New Bremen, Ohio 45869 U.S.A.

# Table of Contents

## Information Section

Foreword .....	2
----------------	---

## Safety Section

Important Safety Information .....	4
Safety .....	5
Warning Signs and Labels .....	5
General Hazard Information .....	10
Operation Information .....	11
Maintenance Information .....	14
Burn Prevention .....	15
Fire or Explosion Prevention .....	15
Operator Restraint System (If Equipped) .....	17
Avoiding Lift Truck Tipovers .....	22
Safety Rules .....	24
How to Survive in a Tipover .....	30

## General Section

Specifications .....	31
Noise and Vibration .....	34
Serial Number .....	35
Operator's Warning and Identification Plate .....	36

## Operation Section

Operator's Station and Monitoring Systems .....	38
Seat Switch System (If Equipped) .....	42
Lift Truck Controls .....	44
Refueling .....	47
Before Starting the Engine .....	49
Starting the Engine .....	51
After Starting the Engine .....	53
Lift Truck Operation .....	88
Operating Techniques .....	91
Parking the Lift Truck .....	96
Lift Fork Adjustment .....	97
Storage Information .....	98
Transportation Hints .....	99
Towing Information .....	101

## Maintenance Section

Inspection, Maintenance and Repair of Lift Truck Forks .....	105
Torque Specifications .....	111
Cooling System Specifications .....	113
Fuel Specifications .....	115
Lubricant Specifications .....	116
Lubricant Viscosities and Refill Capacities .....	118
Maintenance Intervals .....	119
When Required .....	121
Every 10 Service Hours or Daily .....	127
First 50-100 Service Hours or a Week .....	132
Every 250 Service Hours or Monthly .....	134
Every 500 Service Hours or 3 Months .....	135
Every 1000 Service Hours or 6 Months .....	141
Every 1500 Service Hours or 9 Months .....	146
Every 2000 Service Hours or Yearly .....	149
Every 2500 Service Hours or 15 Months .....	154
Every 8000 Service Hours or 48 Months .....	157

## Environment Protection Section

Environment Protection .....	158
------------------------------	-----

## Index Section

Index .....	159
-------------	-----

## Foreword

### Literature Information

This manual should be stored in the operator's compartment in the literature holder or seat back literature storage area.

This manual contains safety, operation, transportation, lubrication and maintenance information.

Some photographs or illustrations in this publication show details or attachments that can be different from your lift truck. Guards and covers might have been removed for illustrative purposes.

Continuing improvement and advancement of product design might have caused changes to your lift trucks which are not included in this publication. Read, study and keep this manual with the lift truck.

Whenever a question arises regarding your lift truck, or this publication, please consult your CROWN branch for the latest available information.

### Safety

The Safety Section lists basic safety precautions. In addition, this section identifies the text and locations of warning signs and labels used on the lift truck. Read and understand the basic precautions listed in the Safety Section before operating or performing lubrication, maintenance and repair on this lift truck.

### Operator Restraint System (If Equipped)

This manual contains safety, operation and maintenance information for the CROWN operator restraint system. Read, study and keep it handy.

#### **WARNING**

**Your CROWN truck comes equipped with an operator restraint system. Should it become necessary to replace the seat for any reason, it should only be replaced with another CROWN operator restraint system.**

---

Photographs or illustrations guide the operator through correct procedures of checking, operation and maintenance of the CROWN operator restraint system.

SAFE and EFFICIENT OPERATION of a lift truck depends to a great extent on the skill and alertness on the part of the operator. To develop this skill the operator should read and understand the Safe Driving Practices contained in this manual.

Forklift trucks seldom tipover, but in the rare event they do, the operator may be pinned to the ground by the lift truck or the overhead guard. This could result in serious injury or death.

Operator training and safety awareness is an effective way to prevent accidents, but accidents can still happen. The CROWN operator restraint system can minimise injuries. The CROWN operator restraint system keeps the operator substantially within the confines of the operator's compartment and the overhead guard.

This manual contains information necessary for Safe Operation. Before operating a lift truck make sure that the necessary instructions are available and understood.

### Operation

The Operation Section is a reference for the new operator and a refresher for the experienced one. This section includes a discussion of gauges, switches, lift truck controls, attachment controls, transportation and towing information.

Photographs and illustrations guide the operator through correct procedures of checking, starting, operating and stopping the lift truck.

Operating techniques outlined in this publication are basic. Skill and techniques develop as the operator gains knowledge of the lift truck and its capabilities.

## Maintenance

The Maintenance Section is a guide to equipment care. The illustrated, step-by-step instructions are grouped by servicing intervals. Items without specific intervals are listed under "When Required" topics. Items in the "Maintenance Intervals" chart are referenced to detailed instructions that follow.

### Maintenance Intervals

Use the service hour meter to determine servicing intervals. Calendar intervals shown (daily, weekly, monthly, etc.) can be used instead of service hour meter intervals if they provide more convenient servicing schedules and approximate the indicated service hour meter reading. Recommended service should always be performed at the interval that occurs first.

Under extremely severe, dusty or wet operating conditions, more frequent lubrication than is specified in the "Maintenance Intervals" chart might be necessary.

Perform service on items at multiples of the original requirement. For example, at "Every 500 Service Hours or 3 Months", also service those items listed under "Every 250 Service Hours or Monthly" and "Every 10 Service Hours or Daily".

## Environment Management

Note that the Crown internal combustion engine lift trucks are manufactured under ISO 14001 system which is harmonized with ISO 9001.

Periodic ENVIRONMENTAL AUDITS & ENVIRONMENTAL PERFORMANCE EVALUATIONS have been made by internal and external inspection entities. LIFE-CYCLE ANALYSIS has also been made through out the total product life. ENVIRONMENT MANAGEMENT SYSTEM includes DESIGN FOR ENVIRONMENT from the initial stage of the design.

ENVIRONMENT MANAGEMENT SYSTEM considers environmental laws & regulations, reduction or elimination of resource consumption as well as environmental emission or pollution from industrial activities, energy saving, environment-friendly product design (lower noise, vibration, emission, smoke, heavy metal free, ozone depleting substance free, etc.), recycling, material cost reduction, and even environmentally oriented education for the employee.

## Important Safety Information

Most accidents involving product operation, maintenance and repair are caused by failure to observe basic safety rules or precautions. An accident can often be avoided by recognizing potentially hazardous situations before an accident occurs. A person must be alert to potential hazards, and use common sense. Persons must also have the necessary training, skills and tools before attempting to perform these functions.

**Improper operation, lubrication, maintenance or repair of this product can be dangerous and could result in injury or death.**

**Do not operate or perform any lubrication, maintenance or repair on this product, until you have read and understood the operation, lubrication, maintenance and repair information.**

**Safety precautions and warnings are provided in this manual and on the product. If these hazard warnings are not heeded, bodily injury or death could occur to you or other persons.**

The hazards are identified by the "Safety Alert Symbol" and followed by a "Signal Word" such as "WARNING" as shown below.



The meaning of this safety alert symbol is as follows:

**Attention! Become Alert! Your Safety is involved.**

The message that appears under the warning, explaining the hazard, can be either written or pictorially presented.

Operations that may cause product damage are identified by NOTICE labels on the product and in this publication.

CROWN cannot anticipate every possible circumstance that might involve a potential hazard, and common sense is always required. The warnings in this publication and on the product are therefore not all inclusive. Before any tool, procedure, work method or operating technique not specifically recommended by CROWN is used, you must be sure that it is safe for you and others. You should also ensure that the product will not be damaged or made unsafe by the operation, lubrication, maintenance or repair procedures you choose.

The information, specifications, and illustration in this publication are on the basis of information available at the time it was written. The specifications, torques, pressures, measurements, adjustments, illustrations, and other items can change at any time. These changes can affect the service given to the product. Obtain the complete and most current information before starting any job. CROWN branches have the most current information available.

## Safety

The safety rules and regulations in this section are representative of some, but not all rules and regulations that apply to lift trucks. Rules and regulations are paraphrased without representation that they have been reproduced verbatim.

These fork lift trucks are built to meet Australian Standard AS2359 for Powered Industrial Trucks, American National Standard, ANSI B56.1 Safety Standard for Low Lift and High Lift Trucks. Since regulations vary from country to country, operate this lift truck in accordance with local regulations.

CROWN lift trucks are manufactured in accordance with the National Fire Protection Association (NFPA) No. 505 and the American National Standards Institute, Inc. / Industrial Truck Standards Development Foundation (ANSI/ITSDF) B56.1, Safety Standard for Low and High Lift Trucks and, for European models, according to the regulations and standards laid down in EU Machinery Directive 2006/42/EC and EMC directive 2014/30/EU.

The most effective method of reducing the risk of serious injury or death to you or others is for you to know how to properly operate this lift truck, to be alert and to avoid actions or conditions that could cause accidents.

Do not operate a lift truck if it is in need of maintenance, repair or appears to be unsafe in any way. Report all unsafe conditions immediately to your supervisor, then contact your authorised lift truck branch. Do not attempt any adjustments or repairs unless trained and authorised to do so.

## Warning Signs and Labels

There are several specific safety signs on your lift truck. Their exact location and description of the hazard are reviewed in this section. Please take the time to familiarise yourself with these safety signs. Clean or replace these if you cannot read the words or see the pictures. When cleaning the labels use a cloth, water and soap. Do not use solvent, gasoline, etc.

You must replace a label if it is damaged, missing or cannot be read. If a label is on a part that is replaced, make sure a new label is installed on the replaced part. See your branch for new labels.

## Training Required To Operate or Service Warning

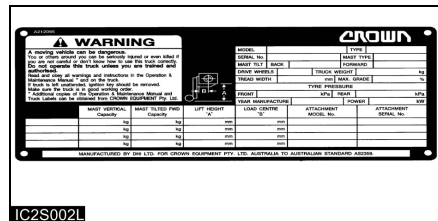

Located on the OVHG.

**⚠ WARNING**

**Improper operation or maintenance could result in injury or death. Do not operate or work on the lift truck unless you are properly trained. Read and understand the Operation and Maintenance Manual. Additional manuals are available from CROWN LIFT TRUCK branches.**

This label also provides allowable lift truck capacity information.

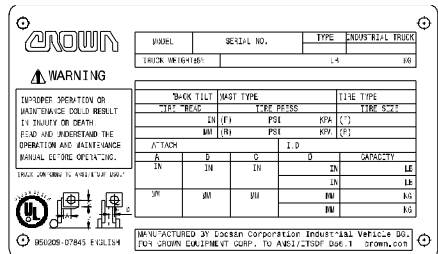

Located on the front side of the FCU.



## General Warnings to Operator



Located on the right side of the operator's seat.

### **WARNING**

**Only trained and authorised personnel may operate this machine. For safe operation, read and follow the operation and maintenance Manual furnished with this lift truck and observe the following warnings:**

1. Before starting machine. Check all controls and warning devices for proper operation.
2. Refer to machine identification plate for allowable machine capacity. Do not overload. Operate machines equipped with attachments as partially loaded machines when not handling a load.
3. Put directional control or shift lever in neutral before "ON - OFF" switch is turned on.
4. Start, turn and brake smoothly. Slow down for turns, slippery or uneven surfaces. Extremely poor surfaces should be repaired. Avoid running over loose objects or holes in the roadway surfaces. Use extreme caution when turning on inclines.
5. Travel with load as low as possible and tilted back. If load interferes with visibility, travel with load trailing.
6. On grade operations travel with load up grade.
7. Watch out for pedestrians and obstructions. Check overhead clearances.
8. Do not permit riders on forks or machine at any time.
9. Do not allow anyone to stand or pass under the elevated portion of any machine.
10. Be sure operating surface can safely support machine.
11. Operate machine and attachments only from operator's position.
12. Do not handle unstable or loosely stacked loads.
13. Use minimum tilt when picking up or depositing a load.
14. Use extreme care when handling long, high or wide loads to ensure stability and durability of the truck.
15. Forks should be completely under load and spread apart as far as load permits.
16. Machine should be equipped with overhead guard or equivalent protection. Where load requires it, use load backrest extension. Use extreme caution if operating without these devices.
17. Parking - Lower lifting mechanism to floor. Put directional control or shift lever in neutral. Set parking/secondary brake. Turn "ON - OFF" switch off. Chock wheels if machine is on incline. Disconnect battery when storing electric machines.
18. Observe safety rules when handling fuel for engine powered machine and when changing batteries for electric machines.
19. Avoid overuse of the inching pedal as this may cause the automatic transmission oil to overheat or the clutch to slip. Do not use as a footrest or for long periods of time.
20. If user operates continuously pushing work or both brake pedal and accelerator pedal were depressed at the same time, it may cause the automatic transmission oil to overheat or the clutch to slip.

### Pressure Warning

**⚠ WARNING**

Contents under pressure may be hot. Allow to cool before opening.

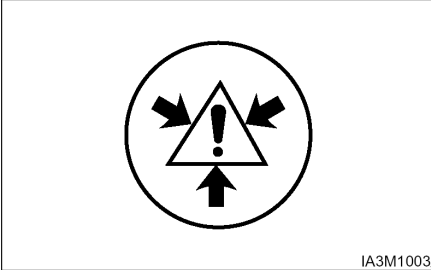

Located on the radiator top tank by the radiator cap.

### Hand Placement Warning

**⚠ WARNING**



No hands. Do not place hands in this area. Do not touch, lean on, or reach through the mast or permit others to do so.

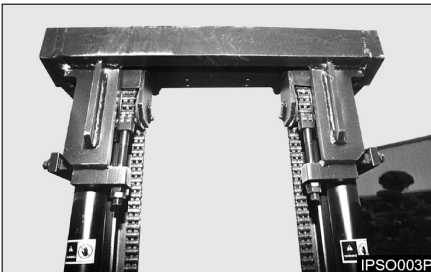

Located on the mast.

### No Standing On Forks Warning, No Standing Under Forks Warning

**⚠ WARNING**

Do not stand or ride on the forks. Do not stand or ride on a load or pallet on the forks. Do not stand or walk under the forks.

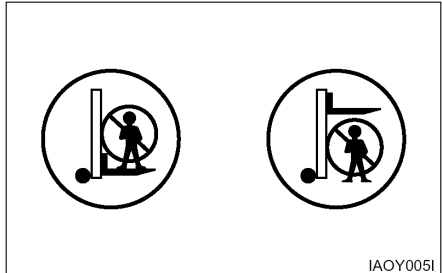

Located on the lift cylinder.

### Load Backrest Must Be In Place Warning

**⚠ WARNING**

Operation without this device in place may be hazardous.



Located on the load backrest.

### Overhead Guard Must Be In Place Warning

**⚠ WARNING**

Operation without this device in place may be hazardous. This guard conforms to A.N.S.I. B56.1 and F.E.M. Section 4.

This design has been tested with an impact of appropriate value.



Located on the Overhead Guard.

### No Riders Warning

**⚠ WARNING**

To avoid personal injury, allow no riders. A lift truck is designed for only one operator and no riders.



Located beside the operator's station.

### Moving Fan Warning

**⚠ WARNING**

To avoid personal injury, stay clear of moving fan.

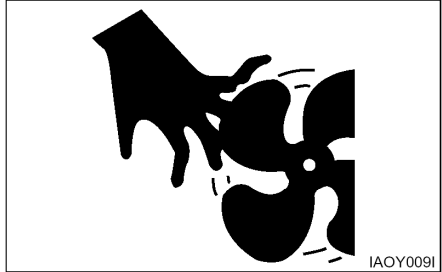

Located inside the engine compartment cover.

### Packing brake

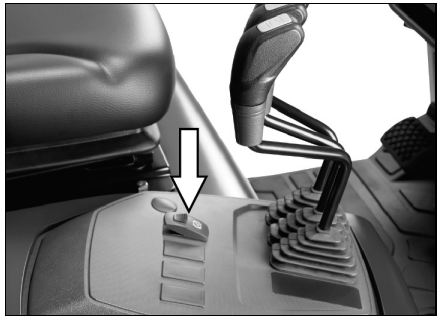

Push the front side of the parking brake switch to engage the brake.



Push the rear side of the parking brake switch to release the brake.

Applying the parking brake puts the transmission in NEUTRAL. The parking brake must be applied when leaving the lift truck and when starting the engine. If the operator leaves the seat without applying the parking brake, an audible alarm will sound.



**WARNING**

When leaving machine apply parking brake!  
Parking brake is not automatically applied.  
Alarm will sound if parking brake is not applied.

---



**WARNING**

Correct adjustment is necessary to provide adequate braking. See the MAINTENANCE section for adjustment procedures. The lift truck may creep at engine idle and can cause damage, injury or death. Always apply the parking brake when leaving the lift truck. The parking brake is NOT automatically applied.

---

## General Hazard Information

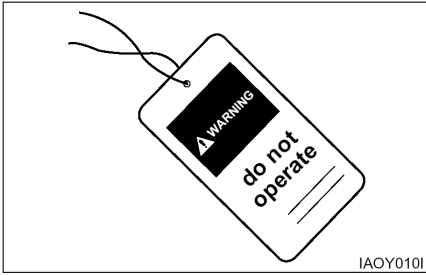

Attach a "Do Not Operate" or similar warning tag to start switch or controls before servicing or repairing the lift truck.

Do not start or service the lift truck when a "DO NOT OPERATE" or similar warning tag is attached to the start switch or controls.

Wear a hard hat, protective glasses and other protective equipment as required by job conditions.

Know the width of your attachments so proper clearance can be maintained when operating near fences, boundary obstacles, etc.

Do not wear loose clothing or jewelry that can catch on controls or other parts of the lift truck.

Keep the lift truck, especially the deck and steps, free of foreign material such as debris, oil tools and other items which are not part of the lift truck.

Secure all loose items such as lunch boxes, tools and other items which are not part of the lift truck.

Know the appropriate work-site hand signals and who gives them. Accept signals from one person only.

Always use the overhead guard. The overhead guard is intended to protect the lift truck operator from overhead obstructions and from falling objects.

A truck that is used for handling small objects or uneven loads must be fitted with a load backrest.

If the lift truck must be operated without the overhead guard in place due to low overhead clearance, use extreme care. Make sure there is no possibility of falling objects from any adjacent storage or work area. Make sure the load is stable and fully supported by the carriage and the load backrest extension (if equipped).

Do not raise loads any higher than necessary and never raise a load higher than 1830 mm (72 in) with the overhead guard removed.

Always use load backrest extension when the carriage or attachment does not fully support the load. The load backrest extension is intended to prevent the load or any part of the load from falling backwards into the operator's station.

When operation the lift truck, do not depend only on flashing lights or back-up alarm (if equipped) to warn pedestrians.

Always be aware of pedestrians and do not proceed until the pedestrians are aware of your presence and intended actions and have moved clear of the lift truck and/or load.

Do not drive lift truck up to anyone standing in front of an object.

Obey all traffic rules and warning signs.

Keep hands, feet and head inside the operator station. Do not hold onto the overhead guard while operating the lift truck. Do not climb on any part of the mast or overhead guard or permit others to do so.

Do not allow unauthorised personnel to ride on the forks or any other part of the lift truck, at any time.

When working in a building or dock, observe floor load limits and overhead clearances.

Inhaling freon gas through a lit cigarette or other smoking method or inhaling fumes released from a flame contacting freon can cause bodily harm or death. Do not smoke when servicing air conditioners or wherever freon gas may be present.

Never put maintenance fluids into glass containers.  
 Use all cleaning solutions with care.  
 Do not use steam, solvent, or high pressure to clean electrical components.  
 Report all needed repairs.

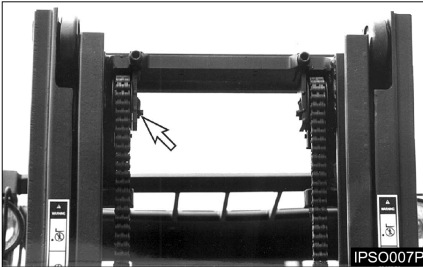

Inspect the part of the chain that is normally operated over the crosshead roller. When the chain bends over the roller, the movement of the parts against each other causes wear.

Inspect to be sure that chain link pins do not extend outside of the bore hole.

If any single link pin is extended beyond its connecting corresponding link, it should be suspected of being broken inside of its bore hole.

Inspect the chain anchor and the anchor links for wear.

Do not change any factory set adjustment values (including engine rpm setting) unless you have both authorization and training. Especially Safety equipment and switches may not be removed or adjusted incorrectly. Repairs, adjustments and maintenances that are not correct can make a dangerous operating condition.

For any checkup, repair, adjustments, maintenance and all other work concerning your forklift truck, please contact your CROWN branch. We would like to draw your attention to the fact that any secondary damages due to improper handling, insufficient maintenance, wrong repairs or the use of other than original CROWN spare parts waive any liability by CROWN.

## Operation Information

### Mounting and Dismounting

Mount and dismount the lift truck carefully.

Clean your shoes and wipe your hands before mounting.

Face the lift truck when mounting and dismounting.

Use both hands face the lift truck when mounting and dismounting.

Use the handgrips for mounting and dismounting.

Do not try to climb on or off the lift truck when carrying tools or supplies.

Never get on or off a moving lift truck.

Do not use any controls as handholds when entering or leaving the operator's station.

Never get on or off a moving lift truck. Never jump off the lift truck.

Keep hands and steering wheel free of slippery material.

### Before Starting the Lift Truck

Perform a walk-around inspection daily and at the start of each shift. Refer to the topic "Walk-around Inspection" in "Every 10 Service Hours or Daily" section of this manual.

Adjust the seat so that full brake pedal travel can be obtained with the operator's back against the seat back.

Make sure the lift truck is equipped with a lighting system as required by conditions.

Make sure all hydraulic controls are in the HOLD position.

Make sure the direction control lever is in the NEUTRAL position.

Make sure the parking brake is engaged.

Make sure no one is standing and/or working on, underneath or close to the lift truck before operating the lift truck.

Operate the lift truck and controls only from the operator's station.

Make sure the lift truck horn, lights, backup alarm (if equipped) and all other devices are working properly.

Check for proper operation of mast and attachments. Pay particular attention to unusual noises or erratic movement which might indicate a problem.

Make sure service and parking brakes, steering, and directional controls are operational. Make sure all personnel are clear of lift truck and travel path. Refer to the topic "Lift Truck Operation" in the "Operation Section" of this manual for specific starting instructions.

### Starting the Lift truck

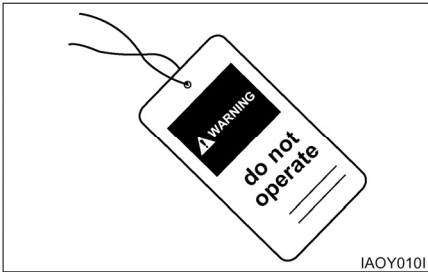

Do not start the engine or move any of the controls if there is a "DO NOT OPERATE" or similar warning tag attached to the start switch or controls.

### Before Operating the Lift Truck

Test brakes, steering controls, horn and other devices for proper operation. Report faulty performance. Do not operate lift truck until repaired.

Learn how your lift truck operates. Know its safety devices. Know how the attachments work.

Before moving the lift truck, look around. Start, turn and brake smoothly.

An operator must constantly observe his lift truck for proper operation.

### Operating the Lift Truck

Always keep the lift truck under control.

Obey all traffic rules and warning signs.

Never leave the lift truck with the engine operating, or with the parking brake disengaged.

Operate the engine only in a well ventilated area.

Lower mast, with or without load, before turning or traveling. Tip over could result. Watch out for overhead obstructions.

Always observe floor load limits and overhead clearance.

Start, turn, and brake smoothly, slow down for turns, grades, slippery or uneven surfaces.

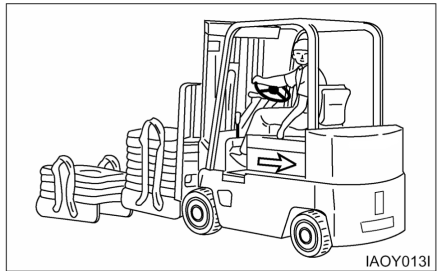

Use special care when operation on grades. Do not angle across or turn on grades. Do not use lift truck on slippery grades. Travel with forks downgrade when unloaded. Travel with load upgrade.

Do not overload, or handle offset, unstable, or loosely stacked loads. Refer to load capacity plate on the lift truck. Use extreme caution when handling suspended, long, high or wide load.

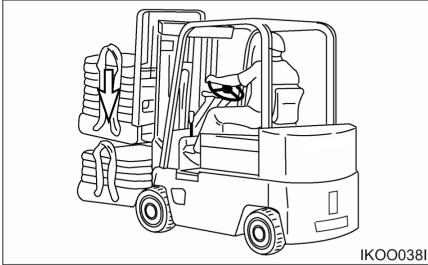

Tilt elevated load forward only when directly over unloading area and with load as low as possible.

Do not stunt ride or indulge in horseplay.

Always look and keep a clear view of the path of travel.

Travel in reverse if load or attachment obstructs visibility. Use extreme caution if visibility is obstructed.

Stay in designated travel path, clear of dock edges, ditches, other dropoffs and surfaces which cannot safely support the lift truck.

Slow down and use extra care through doorways, intersections and other location where visibility is reduced.

Slow down for and avoid pedestrians, other vehicles, obstruction, pot holes and other hazards or objects in the path of travel.

Always use overhead guards except where operation conditions do not permit. Do not operate lift truck in high stacking areas without overhead guards.

When stacking, watch for falling objects. Use load backrest extension and overhead guard.

Refer to the topic "Operation Techniques" in the "Operation Section" of this manual.

## Loading or Unloading Trucks/Trailers

Do not operate lift trucks on trucks or trailers which are not designed or intended for that purpose.

Be certain truck or trailer brakes are applied and wheel chocks in place (or be certain unit is locked to the loading dock) before entering onto trucks or trailers.

If trailer is not coupled to tractor, make sure the trailer landing gear is properly secured in place. On some trailers, extra supports may be needed to prevent unpadding or corner dipping.

Be certain dock plates are in good condition and properly placed and secured. Do not exceed the rated capacity of dock boards or bridge plates.

## Lift Truck Parking

When leaving the operator station, park the lift truck in authorised areas only. Do not block traffic.



- Park the lift truck level, with the forks lowered and the mast tilted forward until the fork tips touch the floor.
- Move the direction control lever to NEUTRAL.
- Engage the parking brake.
- Turn the key switch off and remove the key.
- Turn the disconnect switch to OFF and remove the key (if equipped).
- Block the drive wheels when parking on an incline.



## Maintenance Information

Perform all maintenance unless otherwise specified as follows:

- Park the lift truck in authorised areas only.
- Park the lift truck level, with the forks lowered and the mast tilted forward until the fork tips touch the floor.
- Place the transmission controls in neutral.
- Engage the parking brake.
- Stop the engine.
- Remove the start switch key and turn the disconnect switch OFF (if equipped).
- Block the drive wheels when parking on an incline.

## Pressure Air

Pressure air can cause personal injury. When using pressure air for cleaning, wear a protective face shield, protective clothing and protective shoes.

The maximum air pressure must be below 205 kPa (30 psi) for cleaning purposes.

## Fluid Penetration

Always use a board or cardboard when checking for a leak. Escaping fluid under pressure, even a pin-hole size leak, can penetrate body tissue, causing serious injury, and possible death. If fluid is injected into your skin, it must be treated by a doctor familiar with this type of injury immediately.

## Crushing or Cutting Prevention

Support equipment and attachments properly when working beneath them. Do not depend on hydraulic cylinders to hold it up. Any attachment can fall if a control is moved, or if a hydraulic line breaks.

Never attempt adjustments while the lift truck is moving or the engine is running unless otherwise specified.

Where there are attachment linkages, the clearance in the linkage area will increase or decrease with movement of the attachment.

Stay clear of all rotating and moving parts. Keep objects away from moving fan blades. They will throw or cut any object or tool that falls or is pushed into them.

Do not use a kinked or frayed wire rope cable. Wear gloves when handling the wire rope cable.

Retainer pins, when struck with force, can fly out and injure nearby persons. Make sure the area is clear of people when driving retainer pins.

Wear protective glasses when striking a retainer pin to avoid injury to your eyes.

Chips or other debris can fly off objects when struck. Make sure no one can be injured by flying debris before striking any object.

## Falling Objects Protective Structure(FOPS)

This is an attached guard located above the operator's compartment and secured to the lift truck.

To avoid possible weakening of the Falling Objects Protective Structure (FOPS), consult a CROWN branch before altering, by adding weight to, welding on, or cutting or drilling holes into the structure.

The overhead guard is not intended to protect against every possible impact. The overhead guard may not protect against some objects penetrating into the operator's station from the sides or ends of the lift truck.

The lift truck is equipped with an overhead guard and FOPS as standard. If there is a possibility of overhead objects falling through the guard, the guard must be equipped with smaller holes or a plexiglass cover.

Any altering done that is not specifically authorised by CROWN invalidates CROWN's FOPS certification. The protection offered by this FOPS will be impaired if it has been subjected to structural damage. Structural damage can be caused by an overturn accident, by falling objects, etc.

Do not mount any item such as fire extinguishers, first aid kits and lights by welding brackets to or drilling holes in any FOPS structure. See your CROWN branch for mounting guidelines.

## Burn Prevention

### Coolant

At operating temperature, the engine coolant is hot and under pressure. The radiator and all lines to heaters or the engine contain hot water or steam. Any contact can cause severe burns.

Steam can cause personal injury.

Check the coolant level only after engine has been stopped and the fill cap is cool enough to remove with your bare hand.  
Remove the cooling system fill cap slowly to relieve pressure.

Cooling system additive contains alkali that can cause personal injury. Avoid contact with the skin and eyes and do not drink.  
Allow cooling system components to cool before draining.

### Oils

Hot oil and components can cause personal injury. Do not allow hot oil or components to contact the skin. At operation temperature, the hydraulic tank is hot and can be under pressure.

Remove the hydraulic tank fill cap only after the engine has been stopped and the fill cap is cool enough to remove with your bare hand.

Remove the hydraulic tank fill cap slowly to relieve pressure.

Relieve all pressure in air, oil fuel or cooling systems before any lines, fittings or related items are disconnected or removed.

### Batteries

Batteries give off flammable fumes which can explode.

Do not smoke when observing the battery electrolyte levels.

Electrolyte is an acid and can cause personal injury if it contacts skin or eyes.

Always wear protective glasses when working with batteries.

## Fire or Explosion Prevention

All fuels, most lubricants and some coolant mixtures are flammable.

Fuel leaked or spilled onto hot surfaces or electrical components can cause a fire.

Do not smoke while refueling or in a refueling area.

Do not smoke in areas where batteries are charged, or where flammable materials are stored.

Batteries in series can be located in separate compartments. When using jumper cables always connect positive(+) cable to positive(+) terminal of battery connected to starter solenoid and negative(-) cable from external source to starter negative(-) terminal.

(If not equipped with starter negative(-) terminal, connect to engine block.)

See the Operation Section of this manual for specific starting instructions.

Clean and tighten all electrical connections. Check daily for loose or frayed electrical wires. Have all loose or frayed electrical wires tightened, repaired or replaced before operation the lift truck.

Keep all fuels and lubricants stored in properly marked containers and away from all unauthorised persons.

Store all oily rags or other flammable material in a protective container, in a safe place.

Do not weld or flame cut on pipes or tubes that contain flammable fluids. Clean them thoroughly with nonflammable solvent before welding or flame cutting on them.

Remove all flammable materials such as fuel, oil and other debris before they accumulate on the lift truck.

Do not expose the lift truck to flames, burning brush, etc., if at all possible.

Shields, which protect hot exhaust components from oil or fuel spray in the event of a line, tube or seal failure, must be installed correctly.

Do not operate in areas where explosive gases exist or are suspected.

## Fire Extinguisher

Have a fire extinguisher-type BC and 1.5KG minimum capacity-on rear overhead guard leg with latch and know how to use it. Inspect and have it serviced as recommended on its instruction plate.

## LPG

LPG is poisonous and flammable.

Breathing LPG vapors or repeated contact of LPG with skin can cause personal injury.

Use LPG only in well-ventilated areas.

Do not smoke while changing LPG cylinders.

Use LPG with care to avoid fires.

Do not store replacement LPG cylinders in living areas or in the operator's compartment.

Do not store LPG cylinders in direct sunlight or at temperatures above 39°C (102°F).

Discard cylinders in a safe place. Do not puncture or burn cylinders.

Keep LPG cylinders out of the reach of unauthorised personnel.

## Lines, Tubes and Hoses

Do not bend or strike high pressure lines. Do not install bent or damaged lines, tubes or hoses.

Repair any loose or damaged fuel and oil lines, tubes and hoses. Leaks can cause fires. Contact your CROWN branch for repair or replacement.

Check lines, tubes and hoses carefully. Do not use your bare hand to check for leaks. Use a board or cardboard to check for leaks. See Fluid Penetration in the Safety Section for more details. Tighten all connections to the recommended torque. Replace if any of the following conditions are found.

- End fittings damaged or leaking.
- Outer covering chafed or cut and wire reinforcing exposed.
- Outer covering ballooning locally.
- Evidence of kinking or crushing of the flexible part of hose.
- Armouring embedded in the outer cover.
- End fittings displaced.

Make sure that all clamps, guards and heat shields are installed correctly to prevent vibration, rubbing against other parts, and excessive heat during operation.

## Tyre Information

Servicing, changing tyres and rims can be dangerous and should be done only by trained personnel using proper tools and procedures. If correct procedures are not followed while servicing tyres and rims, the assemblies could burst with explosive force and cause serious personal injury or death. Follow carefully the specific information provided by your tyre or rim servicing personnel or branch.

CROWN forklift is equipped with wheels from different manufacturers.

Please re-use the original parts of the existing wheel, if there is no deformation of the wheel after checked. Mixing up new and old parts may cause incomplete assembly that might lead to unexpected dismantlement of parts and accident.

## Operator Restraint System (If Equipped)

### Warning Signs and Labels

Your CROWN lift truck has the following tipover warning decals.

Make sure that you can read all safety signs. Clean or replace these if you cannot read the words or see the pictures. When cleaning the labels use a cloth, water and soap. Do not use solvent, gasoline, etc. You must replace a label if it is damaged, missing or cannot be read. If a label is on a part that is replaced, make sure a new label is installed on the replaced part. See your CROWN Lift Truck branch for new labels.

The most effective method of preventing serious injury or death to yourself or others is to familiarise yourself with the proper operation of the lift truck, to be alert, and to avoid actions or conditions which can result in an accident.

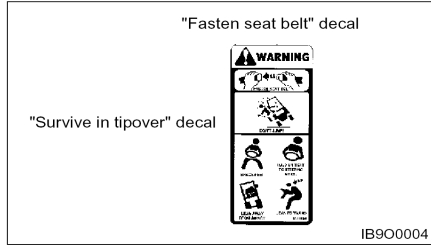

The "Survive in tipover" warning is located on the overhead guard. It shows the proper use of the operator restraint system.

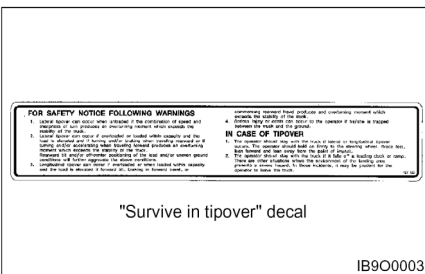
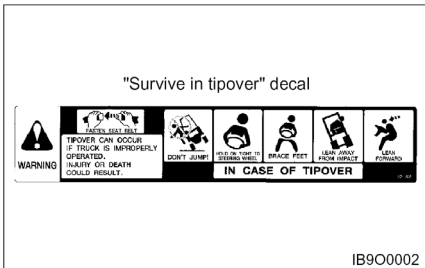
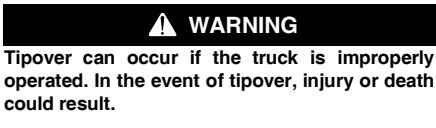

## Seat Adjustment

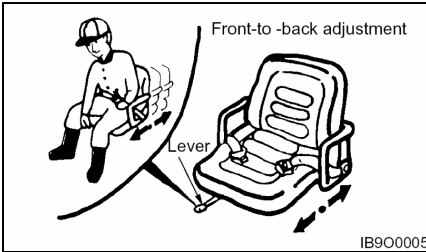

Move the lever, slide the seat to the desired position, and release the lever.

Adjust the seat before operating the lift truck. After adjusting, set the seat to make sure it is properly locked. Do not adjust the seat while the truck is in motion.

**⚠ WARNING**

**Do not place your hand or fingers under the seat. Injury may occur as the seat moves up and down.**

## If Optional Suspension Seat (Weight Adjusting Type) Equipped

### Forward and Backward Adjustment

The seat can be adjusted by pushing the lever on the left side of seat.

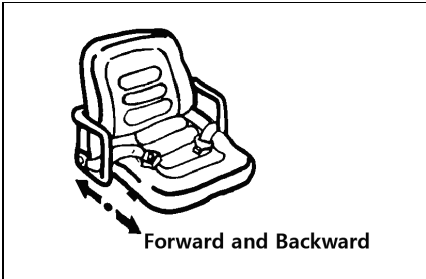
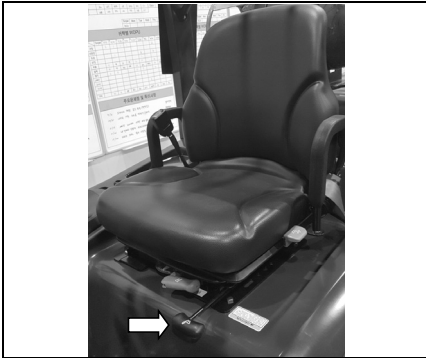

Adjust the seat before operating the lift truck. After adjusting, set the seat to make sure it is properly locked. Do not adjust the seat while the truck is in motion.

### Weight adjustment

Pull the weight adjustment lever upwards and move right or left side.

Adjust to driver's weight in 7 steps (50 ~ 110 kg)

### NOTICE

Do NOT place your hand or fingers under the seat. Injury may occur as the seat moves up and down.

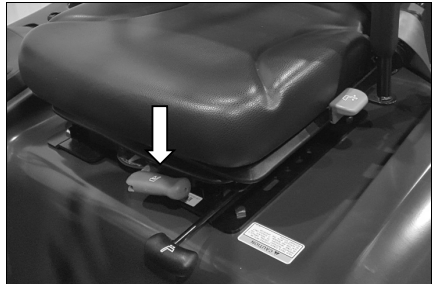

### Backrest Inclination

The backrest angle can be adjusted by using the lever on the left side of seat.

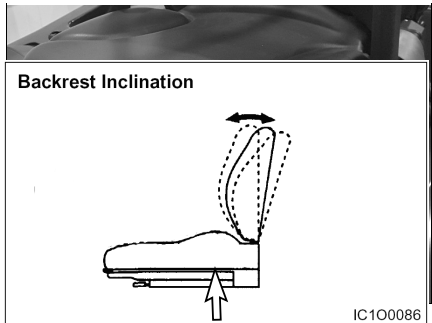

IC100086

### Seat Belt

The Operator Restraint System, Prevents the operator from jumping from the operator's compartment in the event of forward or side tipover. The system is designed to keep the operator on the seat and in the operator's compartment in the event of tipover.

### Inspection

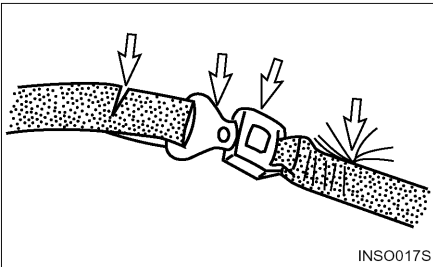

1. If the seat belt is torn, if pulling motion is interrupted during extension of the belt, or if the belt cannot be inserted into the buckle properly, replace the seat belt assembly.

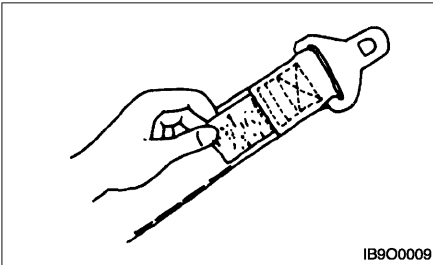

2. Belt Maintenance – Every 500 service hours. Check that the belt fastening works properly and that winding device is free from run lock when jerked. Check that the belt is suitably fastened to the seat. Check that the seat is correctly secured to the hood and the chassis. On visual inspection, fastenings must be intact, otherwise, contact the safety manager.

### ⚠ WARNING

Your CROWN truck comes equipped with a CROWN operator restraint system. Should it become necessary to replace the seat for any reason, it should only be replaced with another CROWN operator restraint system.

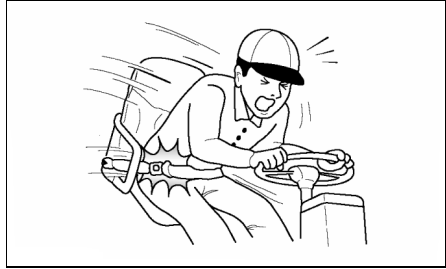

3. In the event of tipover, the seat and restraint system should be inspected for damage and replaced, if necessary.

**NOTE:** Operator restraints shall be examined at the regular truck service intervals. It is recommended that they be replaced if any of the following conditions are found:

- Cut or frayed strap
- Worn or damaged hardware including anchor points
- Buckle or retractor malfunction
- Loose stitching

### ⚠ WARNING

The seat belt may cause the operator to bend at the waist. If you are pregnant or have suffered from some abdominal disease, consult a doctor before you use the seat belt.

### Fasten the Seat Belt

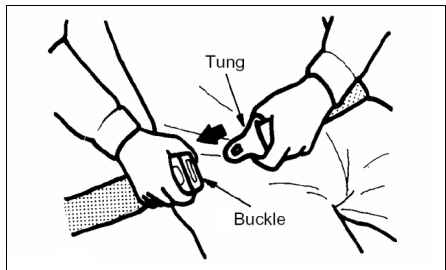

1. Grip the plate (connector) of the belt and insert the plate into the slot of the buckle until a snap is heard. Adjust the belt to fit snugly across your hips. Pull on the belt to confirm it is latched.
2. Make sure the belt is not twisted.

**⚠ WARNING**

**If you fasten the belt across your abdomen, the belt may injure your abdomen in an accident.**

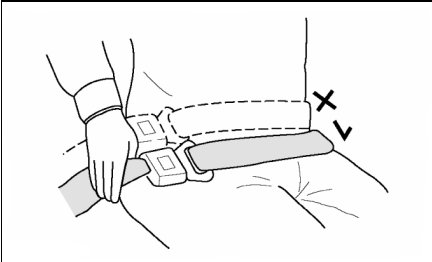

1. Be sure to fasten the belt across your hips, not across your abdomen.

**NOTE:** The belt is designed to automatically adjust to your size and movement. A quick pull on the belt will confirm that the automatic adjuster will hold the belt position in the event of an accident.

**Release the Seat Belt**

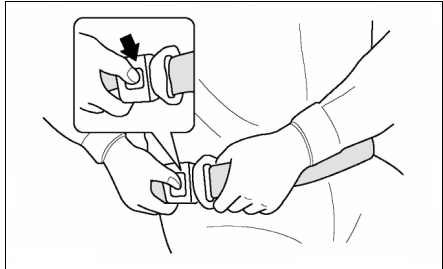

Push the button of the buckle to release the belt. The belt will automatically retract when released. Hold the plate of the belt and allow the belt to slowly retract.



## Avoiding Lift Truck Tipovers

### Lift Truck Stability

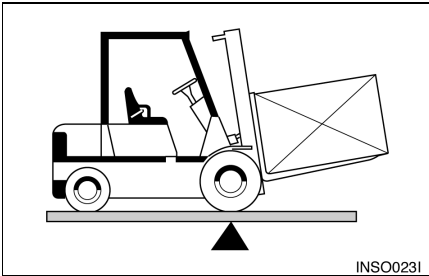

Counterbalanced lift truck design is based on the balance of two weights on opposite sides of a fulcrum (the front axle). The load on the forks must be balanced by the weight of the lift truck. The location of the centre of gravity of both the truck and the load is also a factor. This basic principle is used for picking up a load. The ability of the lift truck to handle a load is discussed in terms of centre of gravity and both forward and sideways stability.

### Centre of Gravity (CG)

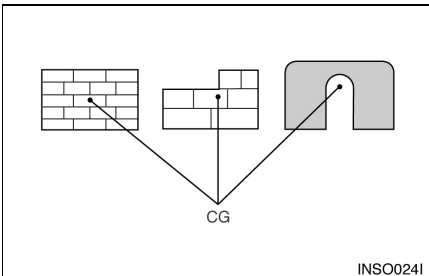

The point within an object, at which the whole weight of the object may be regarded as being concentrated, is called the centre of gravity or CG. If the object is uniform, its geometric centre will coincide with its CG. If it is not uniform, the CG could be at a point outside of the object. When the lift truck picks up a load, the truck and load have a new combined CG.

### Stability and Centre of Gravity

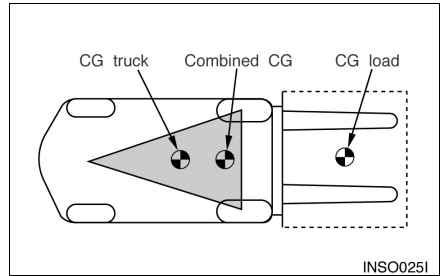

The stability of the lift truck is determined by the location of its CG; or, if the truck is loaded, the combined CG of the truck and load. The lift truck has moving parts and, therefore, has a CG that moves. The CG moves forward or backward as the mast is tilted forward or backward. The CG moves up or down as the mast moves up or down. The CG and, therefore, the stability of the loaded lift truck, is affected by a number of factors such as:

- the size, weight, shape and position of the load
- the height to which the load is lifted
- the amount of forward or backward tilt
- tyre pressure
- dynamic forces created when the lift truck is accelerated, braked or turned
- condition and grade of surfaces on which the lift truck is operated

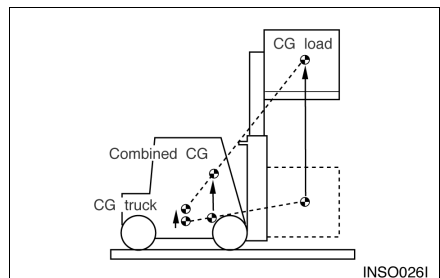

These same factors are also important for unloaded lift trucks. They tip over sideways easier than a loaded lift truck carrying its load in the lowered position.

### Lift Truck Stability Base

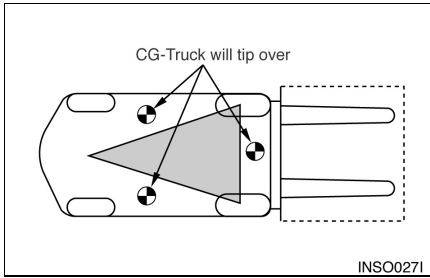

For the lift truck to be stable (not tip over forward or to the side), the CG must stay within the area of the lift truck stability base  $\Delta$  a triangular area between the front wheels and the pivot of the steer wheels. If the CG moves forward of the front axle, the lift truck will tip forward. If the CG moves outside of the line on either side of the stability base, the lift truck will tip to the side.

#### WARNING

Dynamic forces (braking, acceleration, turning) also affect stability and can produce tipover even when the CG is within the stability triangle.

### Capacity Load (Weight and Load Centre)

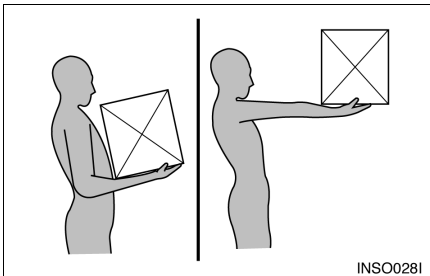

The capacity load of the lift truck is shown on the capacity/nameplate riveted to the truck. It is determined by the weight and load centre. The load centre is determined by the location of the CG of the load. The load centre shown on the nameplate is the horizontal distance from the front face of the forks, or the load face of an attachment, to the CG of the load. The location of the CG in the vertical direction is the same as the horizontal dimension.

Remember that, unless otherwise indicated, the capacity load shown on the nameplate is for a standard lift truck with standard backrest, forks and mast, and having no special-purpose attachment. In addition, the capacity load assumes that the load centre is no further from the top of the forks than it is from the face of the backrest. If these conditions do not exist, the operator may have to reduce the safe operating load because the truck stability may be reduced. The lift truck should not be operated if its capacity/nameplate does not indicate capacity load.

**NOTE :** If the load is not uniform, the heaviest portion should be placed closer to the backrest and centred on the forks.

#### WARNING

1. Capacity/Nameplates originally attached to forklifts sold by CROWN shall not be removed, altered or replaced without DOOSAN's approval.
2. CROWN assumes no responsibility for lift trucks placed in service without a valid CROWN Nameplate.
3. If necessary to change your specification, contact your CROWN lift truck branch.

## Safety Rules

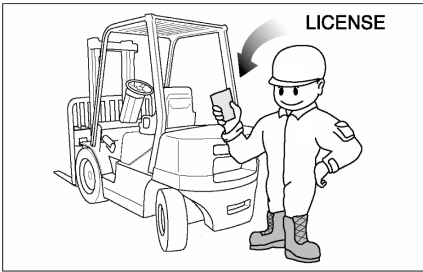

Only properly trained and authorised personnel should operate forklift trucks. Wear a hard hat and safety shoes when operating a lift truck. Do not wear loose clothing.

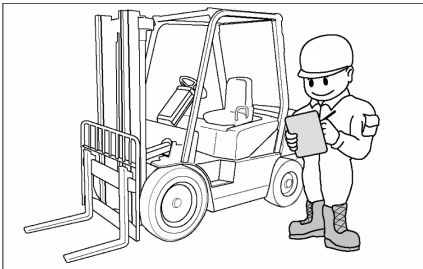

Inspect and check the condition of your forklift truck using the operator's check list before starting work. Immediately report to your supervisor any obvious defects or required repairs.

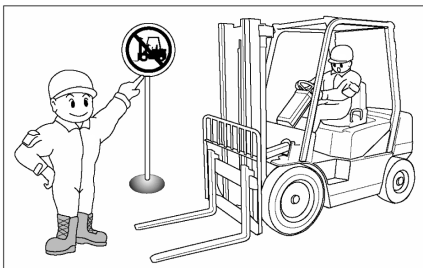

Do not operate your truck in unauthorised areas. Know your forklift truck and think safety. Do not compromise safety. Follow all safety rules and read all warning signs.

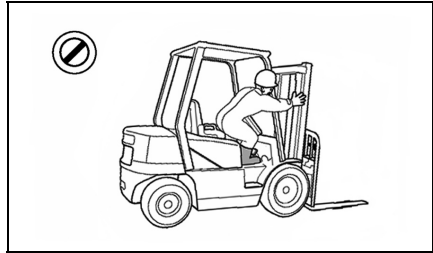

Do not operate a lift truck unless you are in the operator's seat. Keep hands and feet inside the operator's compartment. Do not put any part of the body outside of the operator's compartment. Never put any part of body into the mast structure or between the mast and the truck

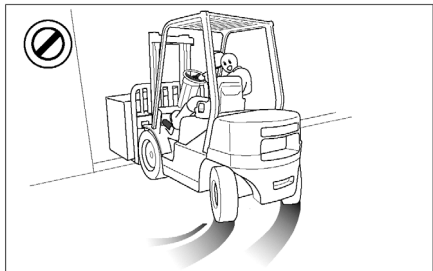

Do not start, stop, turn or change direction suddenly or at high speed. Sudden movement can cause the lift truck to tip over. Slow the speed of your truck and use the horn near corners, exits, entrances, and near people.

In case of a truck with the steering knob, Do not operate the steering knob suddenly, to prevent accident caused by quick turning.

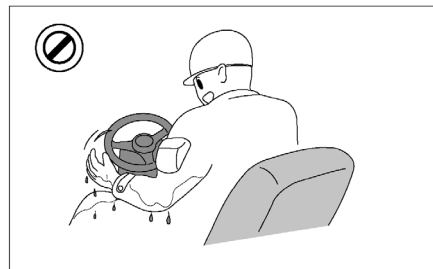

Never operate a lift truck with wet hands or shoes. Never hold any controls with grease on your hands. Your hands or feet will slide off of the controls and cause an accident.

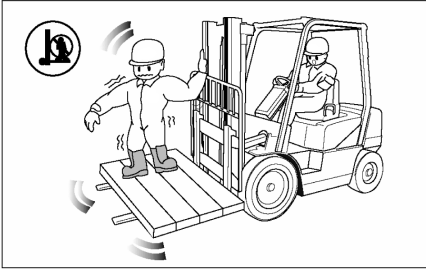

Do not raise anyone on the forks of your lift truck. Do not let other people ride on the truck. Lift trucks are designed to carry loads, not people.

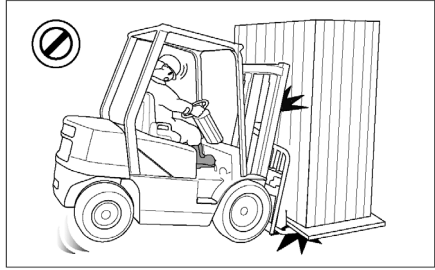

Do not overload. Always handle loads within the rated capacity shown on the capacity plate. Do not add extra counterweight to the truck. An overload can cause the truck to roll over and cause injury to personnel and damage to the lift truck.



Do not operate your truck without the load backrest extension and overhead guard. Keep the load against the backrest with the mast tilted backward

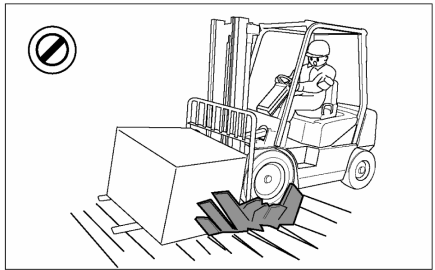

Do not drive on soft ground. Observe all signs, especially those on maximum permitted floor loadings, elevator capacities and clearance heights. Handle loads carefully and check them closely for stability and balance.

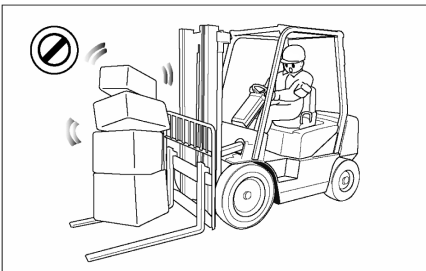

Do not lift or move loads that are not safe. Do not pick up an off centre load. Such a load increases the possibility of a tipover to the side. Make sure loads are correctly stacked and positioned across both forks. Always use the proper size pallet. Position the forks as wide as possible under the load. Position loads evenly on the forks for proper balance. Do not lift a load with one fork.



Do not drive on slippery surfaces. Sand, gravel, ice or mud can cause a tipover. If unavoidable, slow down.

Safety Section

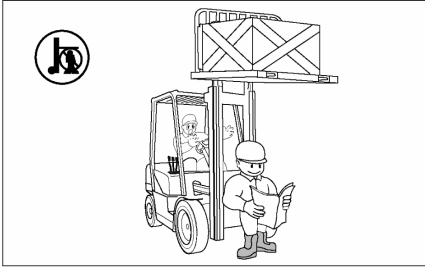

Do not permit anyone to stand or walk under the load or lifting mechanism. The load can fall and cause injury or death to anyone standing below.

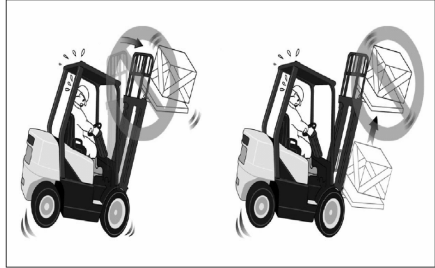

Do not elevate the load with the mast tilted forward. Do not tilt the elevated loads forwards. This will cause the lift truck to tip over forward.

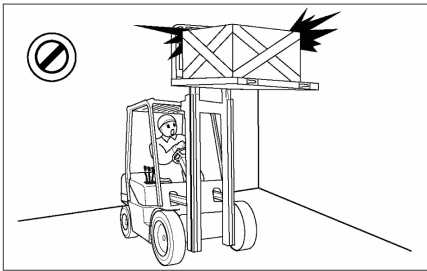

Look out for overhead obstructions when raising or stacking loads. Do not travel with a raised load. Do not travel with the mast raised. The lift truck can roll over and cause injury or death to you or other personnel.

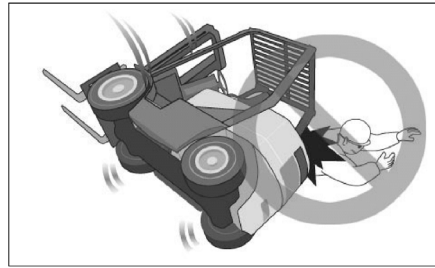

Do not jump off if your truck starts to tip over. Stay in your seat to survive.

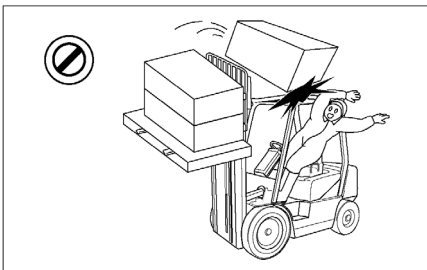

Do not move loose loads that are higher than the load backrest. Be alert for falling loads when stacking. Travel with the load tilted back and the forks as low as possible. This will increase stability to the truck and load and permit better visibility for you.

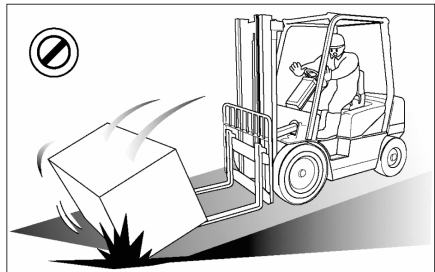

Go up ramps in forward direction and down ramps in reverse direction when moving loads. Never elevate a load with the forklift truck on an incline. Go straight off and straight down. Use an assistant when going up or down a ramp with a bulky load.

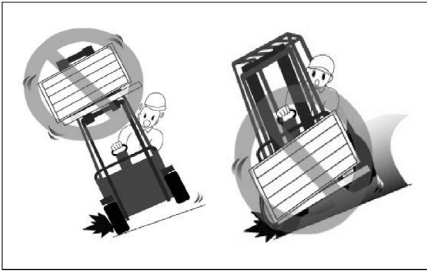

Do not stack or turn on ramps.  
Do not attempt to pick-up or deposit a load unless the lift truck is level. Do not turn on or drive across an incline.

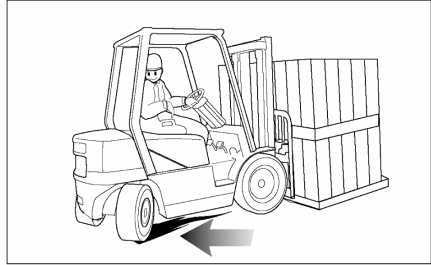

Do not drive in forward direction when loads restrict your visibility. Operate your lift truck in reverse to improve visibility except when moving up a ramp.

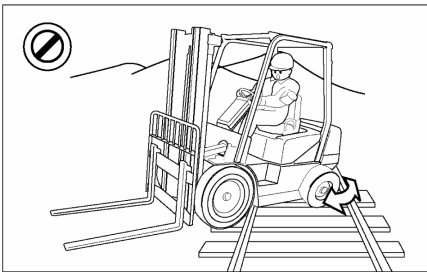

Do not go over rough terrain. If unavoidable, slow down. Cross railroad tracks slowly and diagonally whenever possible. A railroad crossing can give a loaded forklift truck a real jolt. For smoother crossing, cross the railroad diagonally so one wheel crosses at a time.

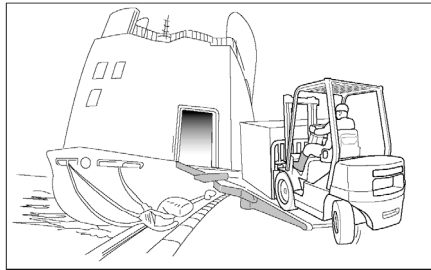

Be careful when operating a lift truck near the edge of a loading dock or ramp. Maintain a safe distance from the edge of docks, ramps and platforms. Always watch tail swing. The truck can fall over the edge and cause injury or death.

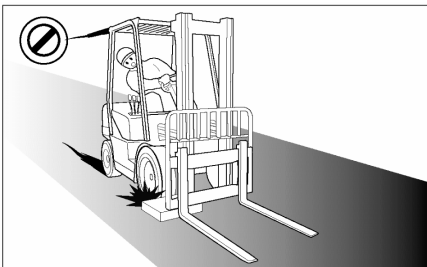

Avoid running over loose objects.  
Look in the direction of travel. Look out for other persons or obstructions in your path of travel.  
An operator must be in full control of his lift truck at all times.

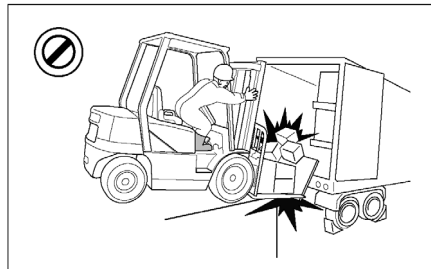

Do not operate on bridge plates unless they can support the weight of the truck and load.  
Make sure that they are correctly positioned.  
Put blocks on the vehicle you enter to keep it from moving.

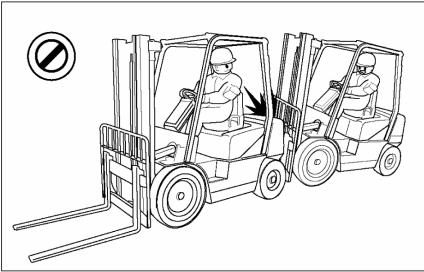

Do not operate your truck close to another truck. Always keep a safe distance from other trucks and make sure there is enough distance to stop safely. Never overtake other vehicles.

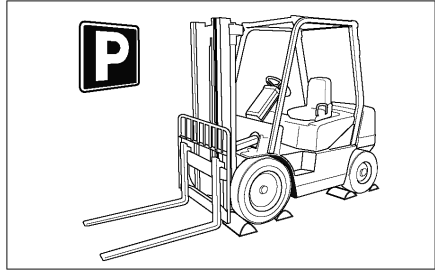

Mop up spilt fuel and do not forget to close the fuel tank before restarting the engine. Park your lift truck in authorised areas only. Fully lower the forks to the floor, put direction lever in NEUTRAL position, engage the parking brake, and turn the key to the OFF position. Remove the key and put blocks behind the wheels to prevent the truck from rolling. Shut off your forklift truck when leaving it unattended. Check the condition of your forklift truck after the day's work.

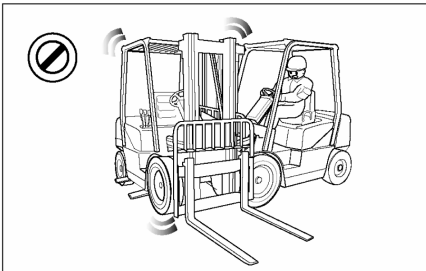

Do not use your lift truck to push or tow another truck. Do not let another push or tow your truck. If a truck will not move, call a service technician.

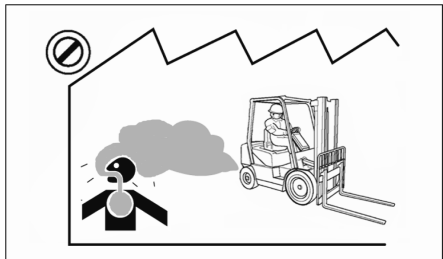

Exhaust from all internal combustion engines contains carbon monoxide, a colorless, odorless, tasteless, poisonous gas. Exposure to carbon monoxide can cause serious injury or health problems, including death. and avoid unnecessary idling of the engine. If nausea, dizziness or headaches are experienced stop the truck and seek fresh air.

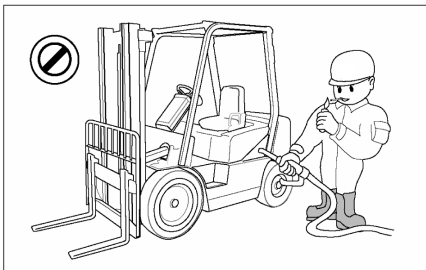

Forklift trucks may only be refueled at specially reserved locations. Switch off the engine when refueling. Smoking and handling of naked flames during refueling are strictly prohibited. This prohibition also applies during the changing of the LPG (liquefied propane gas) tank.

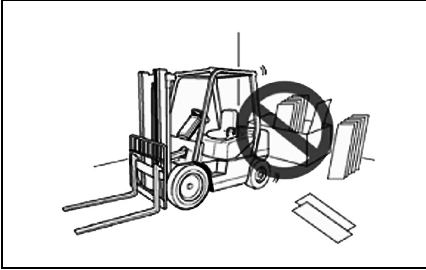

Do not operate forklifts near flammable or combustible materials.

To avoid the discoloration, deformation or combustion of materials (such as lumber, veneer board, paper products and other similar items), always park at least 30 cm (12 inches) away from them.

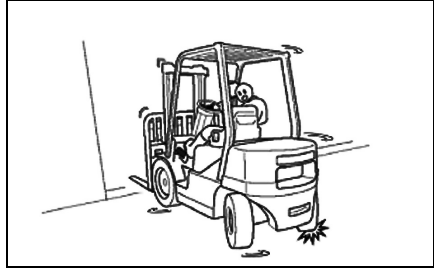

An unloaded forklift may be easier to tip over than a loaded truck.

When traveling without a load, the risk of lateral overturn is greater.

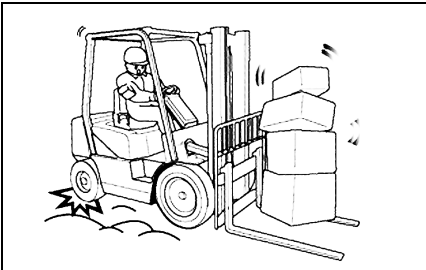

Forklift trucks are not cars. They often have small tyres, no suspension, and are very heavy. The forklift's centre of gravity will also change when carrying loads.

Avoid uneven bumps, pot holes and other hazards whenever possible.

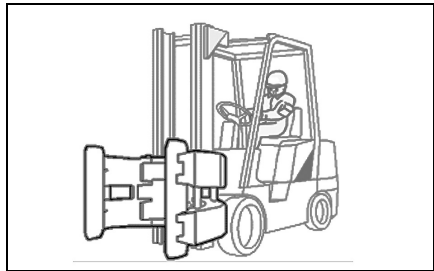

There are many special attachments available to replace the forks on a lift truck.

All carry safety implications and special training in their operation is highly recommended.



Carrying a load suspended on a chain or a cable may unbalance a truck.

Take extra care around pedestrians with a suspended load as it may sway or even strike them.

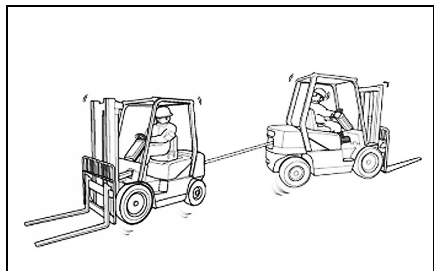

The counterweight draw bar should not be used for towing the forklift or for towing another forklift.

Towing is only advised in emergencies, by trained operators and at low speed, no faster than 2 km/h, to a convenient location for repair.



## How to Survive in a Tipover

**⚠ WARNING**

**FASTEN SEAT BELT**



TIPOVER CAN OCCUR IF TRUCK IS IMPROPERLY OPERATED. INJURY OR DEATH COULD RESULT.

DO NOT JUMP

HOLD ON TIGHT TO SEAT/CONTROLS

BRACE FEET

LEAN AWAY FROM FALL

LEAN FORWARD

LOOK DOWN

IN CASE OF TIPOVER

In the event of a tipover, the risk of serious injury or death will be reduced if the operator is using the operator restraint system and follows the instructions provided.

Always use operator restraint system.

**⚠ WARNING**

**DON'T JUMP**



TIPOVER CAN OCCUR IF TRUCK IS IMPROPERLY OPERATED. INJURY OR DEATH COULD RESULT.

DO NOT JUMP

HOLD ON TIGHT TO SEAT/CONTROLS

BRACE FEET

LEAN AWAY FROM FALL

LEAN FORWARD

LOOK DOWN

IN CASE OF TIPOVER

DON'T jump.

**⚠ WARNING**

**HOLD ON TIGHT**



TIPOVER CAN OCCUR IF TRUCK IS IMPROPERLY OPERATED. INJURY OR DEATH COULD RESULT.

DO NOT JUMP

HOLD ON TIGHT TO SEAT/CONTROLS

BRACE FEET

LEAN AWAY FROM FALL

LEAN FORWARD

LOOK DOWN

IN CASE OF TIPOVER

Hold on tight.

**⚠ WARNING**

**BRACE FEET**



TIPOVER CAN OCCUR IF TRUCK IS IMPROPERLY OPERATED. INJURY OR DEATH COULD RESULT.

DO NOT JUMP

HOLD ON TIGHT TO SEAT/CONTROLS

BRACE FEET

LEAN AWAY FROM FALL

LEAN FORWARD

LOOK DOWN

IN CASE OF TIPOVER

Brace your feet and keep them within the operator's compartment.

**⚠ WARNING**

**LEAN AWAY**



TIPOVER CAN OCCUR IF TRUCK IS IMPROPERLY OPERATED. INJURY OR DEATH COULD RESULT.

DO NOT JUMP

HOLD ON TIGHT TO SEAT/CONTROLS

BRACE FEET

LEAN AWAY FROM FALL

LEAN FORWARD

LOOK DOWN

IN CASE OF TIPOVER

Lean away from the direction of fall.

**⚠ WARNING**

**LEAN FORWARD**



TIPOVER CAN OCCUR IF TRUCK IS IMPROPERLY OPERATED. INJURY OR DEATH COULD RESULT.

DO NOT JUMP

HOLD ON TIGHT TO SEAT/CONTROLS

BRACE FEET

LEAN AWAY FROM FALL

LEAN FORWARD

LOOK DOWN

IN CASE OF TIPOVER

Lean forward.

# Specifications

Characteristics	1.1	Manufacturer			CROWN
	1.2	Model designation			CGC15S-9
	1.3	Drive: Diesel, Gasoline, LP			LP
	1.4	Operator type: Hand, Pedestrian, Standing, Seated, Order-picker			Seated
	1.5	Load Capacity	Q	lb(kg)	3000(1350)
	1.6	Load Centre	c	in(mm)	24(600)
Weight	1.8	Load Distance: Centre of Driveaxle to fork	x	in(mm)	15.5(394)
	1.9	Wheelbase	y	in(mm)	50.6(1285)
	2.1	Service weight		lb(kg)	6038(2739)
Tyres	2.2	Axle Loading, Laden Front/Rear		lb(kg)	7529/1462(3415/663)
	2.3	Axle Loading, Unladen Front/Rear		lb(kg)	2266/3770(1028/1710)
	3.1	Tyres: pneumatic (P), superelastic (SE), cushion (C)			C
	3.2	Tyre size, Front			18 x 6 x 12.12
	3.3	Tyre size, Rear			14 x 5 x 10
	3.5	Wheels, number Front/Rear (x = driven wheels)			2/2
	3.6	Tread, Front	b <sub>1</sub>	in(mm)	31(786)
Dimensions	3.7	Tread, Rear	b <sub>2</sub>	in(mm)	32(814)
	4.1	Tilt of Mast/Fork carriage Forward/Backward	$\alpha/\beta$	°	6/8
	4.2	Height, Mast lowered	h <sub>1</sub>	in(mm)	78(1980)
	4.3	Free Lift	h <sub>2</sub>	in(mm)	5.1(130)
	4.4	Lift	h <sub>3</sub>	in(mm)	118(3000)
	4.5	Height, Mast Extended	h <sub>4</sub>	in(mm)	159.3(4045)
	4.7	Height of Overhead Guard(Cabin)	h <sub>6</sub>	in(mm)	81(2060)
	4.8	Height of Seat	h <sub>7</sub>	in(mm)	41.5(1055)
	4.19	Overall Length	l <sub>1</sub>	in(mm)	124.1(3152)
	4.20	Length to Forkface	l <sub>2</sub>	in(mm)	82.8(2102)
	4.21	Overall Width	b <sub>1</sub> /b <sub>2</sub>	in(mm)	37(940)/
	4.22	Fork Dimensions	s/e/l	in(mm)	1.4/4/41(35/100/1050)
	4.23	Fork carriage ISO 2328, class/type A, B			II
	Performance data	4.24	Fork carriage width	b <sub>3</sub>	in(mm)
4.31		Ground Clearance, laden, below mast	m <sub>1</sub>	in(mm)	3(75)
4.32		Ground Clearance, centre of wheelbase	m <sub>2</sub>	in(mm)	4.1(105)
4.34.1		Aisle width for pallets L=48inch x W=40inch	A <sub>st</sub>	in(mm)	127.6(3242)
4.35		Turning Radius	W <sub>a</sub>	in(mm)	71.9(1826)
4.36		Internal Turning Radius	b <sub>13</sub>	in(mm)	23.8(605)
5.1		Travel Speed, Laden/Unladen		mph(km/h)	11.1/11.1(17.8/17.8)
5.2		Lift Speed, Laden/Unladen		fpm(m/s)	126/130(0.64/0.66)
5.3		Lowering Speed, Laden/Unladen		fpm(m/s)	100.4/98.4(0.51/0.5)
5.5		Drawbar pull, Laden/Unladen(@ 1mph)		lb(N)	3196(14225)/
Combustion Engine	5.6	Max. Drawbar pull, Laden/Unladen		lb(N)	3636(16180)/
	5.7	Gradeability, Laden/Unladen(@ 1mph)		%	38.5/69.4
	5.8	Max. Gradeability, Laden/Unladen		%	46.8/90.1
	5.10	Service Brake			Foot/Hydraulic
	7.1	Engine Manufacturer/type			PSI/4G63
	7.2	Engine power according to DIN ISO1585		hp(kW)	50.6(37.7)
	7.3	Rated Speed		min <sup>-1</sup>	2450
	7.3.1	Torque at 1/min		ft•lbs(N•m)	110@1800(148.7@1800)
	7.4	Number of Cylinders/Displacement		-/cc(-/cm <sup>3</sup> )	4/1997
	7.5	Fuel Consumption according to VDI Cycle		gal/h or lb/h (l/h or kg/h)	
Addition Data	7.10	Battery Voltage/normal capacity		V/Ah	12/45
	10.1	Operating pressure for attachments		psi(bar)	2040±35(140±2.5)
	10.2	Oil volume for attachments		gpm(l/min)	13.2(50)
	10.4	Fuel Tank Capacity		gal(l)	
10.7	Sound level at the driver's ear according to EN 12 053		dB(A)		

# Specifications

CROWN	CROWN	1.1	Characteristics
CGC18S-9	CGC20SC-9	1.2	
LP	LP	1.3	
Seated	Seated	1.4	
3500(1575)	4000(1800)	1.5	
24(600)	24(600)	1.6	
15.5(394)	15.7(399)	1.8	
50.6(1285)	50.6(1285)	1.9	
6460(2930)	6903(3131)	2.1	
8393/1504(3807/682)	9292/1545(4215/701)	2.2	
2266/4191(1028/1901)	2266/4634(1028/2102)	2.3	
C	C	3.1	Tyres
18 x 6 x 12.12	18 x 6 x 12.12	3.2	
14 x 5 x 10	14 x 5 x 10	3.3	
2/2	2/2	3.5	
31(786)	31(786)	3.6	
32(814)	32(814)	3.7	
6/8	6/8	4.1	
78(1980)	78(1980)	4.2	
5.1(130)	5.3(135)	4.3	
118(3000)	118(3000)	4.4	
159.3(4045)	159.3(4045)	4.5	
81(2060)	81(2060)	4.7	
41.5(1055)	41.5(1055)	4.8	
124.9(3173)	127.1(3228)	4.19	
83.6(2123)	85.7(2178)	4.20	
37(940)/	37(940)/	4.21	
1.4/4/41(35/100/1050)	1.6/4/41(40/100/1050)	4.22	
II	II	4.23	
36(913)	36(913)	4.24	
3(75)	3(75)	4.31	
4.1(105)	4.1(105)	4.32	
129.3(3284)	130.5(3314)	4.34.1	
73.5(1867)	74.4(1891)	4.35	
23.8(605)	23.8(605)	4.36	
11.1/11.1(17.8/17.8)	11.1/11.1(17.8/17.8)	5.1	Performance data
124/130(0.63/0.66)	122/130(0.62/0.66)	5.2	
100.4/98.4(0.51/0.5)	100.4/98.4(0.51/0.5)	5.3	
3196(14225)/	3196(14225)/	5.5	
3636(16180)/	3636(16180)/	5.6	
33.0/60.1	31.0/56.1	5.7	
39.8/76.0	36.5/70.3	5.8	
Foot/Hydraulic	Foot/Hydraulic	5.10	
PSI/4G63	PSI/4G63	7.1	
50.6(37.7)	50.6(37.7)	7.2	
2450	2450	7.3	Combustion Engine
110@1800(148.7@1800)	110@1800(148.7@1800)	7.3.1	
4/1997	4/1997	7.4	
		7.5	
12/45	12/45	7.10	
2040±35(140±2.5)	2040±35(140±2.5)	10.1	Addition Data
13.2(50)	13.2(50)	10.2	
		10.4	
		10.7	

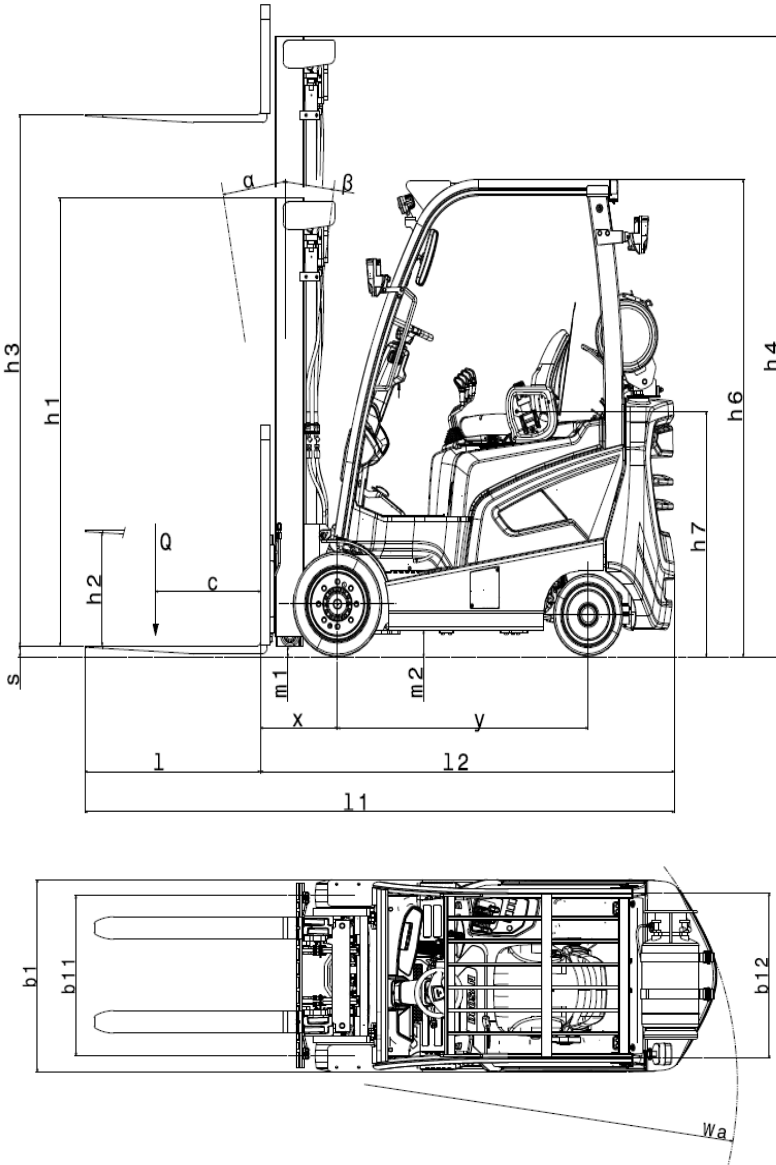



## Noise and Vibration

Model	Sound Pressure Level at Operator's ear (Leq.) according to EN12053 Guaranteed Sound	Whole-body Vibration Level according to EN13059 (m/s <sup>2</sup> )	
	dB(A)	Mean	Uncertainty
CGC15/18S-9, CGC20SC-9 4G63 Engine (W/O Cabin)	84	0.55	0.1

# Serial Number

## Serial Number Locations

For quick reference, record your lift truck's serial numbers in the spaces provided below the photographs.

	MODEL	SERIAL NO.	TYPE	INDUSTRIAL TRUCK?		
	TRUCK HEIGHT%		L3	SB		
<p><b>WARNING</b></p> <p>IMPROPER OPERATION OR MAINTENANCE COULD RESULT IN INJURY OR DEATH. READ AND UNDERSTAND THE OPERATION AND MAINTENANCE MANUAL BEFORE OPERATING.</p> <p>CLICK THROUGH TO AXLE TUBES REG.</p>   <p>850209-07345 ENGL13R</p>	BACK TILT	LAST TYPE		STRE TYPE		
	TIRE TRACD	DR PRESS	K7R	LF	TIRE SIZE	
	W1	P9	P9A	TP1		
	A TACH				I, O	
	A	B	C	D	CAPACITY	
	IN	14	14		IN	LB
	IN	MM	MM		MM	KG
					MM	KG
					MM	KG
					MM	KG
MANUFACTURED BY DOOSAN CORP/DAELI TRUCKS/TEL VEHICLE BU FOR CROWN EQUIPMENT CORP., TO ANGL/ETSDF Mod.1 crown.com						

Located on the front side of the FCU

Lift Truck Serial Number

- \_\_\_\_\_

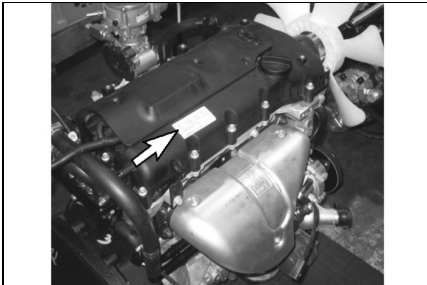

2.0 liter Spark-Ignition Engine Serial Number [4G63]

- \_\_\_\_\_

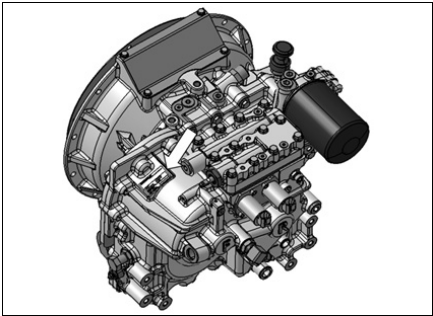

Transmission Serial Number

- \_\_\_\_\_

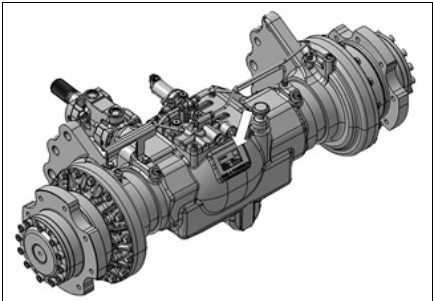

Drive axle Serial Number

- \_\_\_\_\_



Side Shift Serial Number (If Equipped)

- \_\_\_\_\_

## Operator's Warning and Identification Plate

Familiarise yourself with the OPERATOR'S WARNING Plate and, IDENTIFICATION, LIFT CAPACITY and ATTACHMENT PLATES. DO NOT exceed capacity as equipped load ratings.

### Operator's Warning Plate



Located on the right side of the operator's seat.

### Identification, Lift Capacity and Attachment Plate

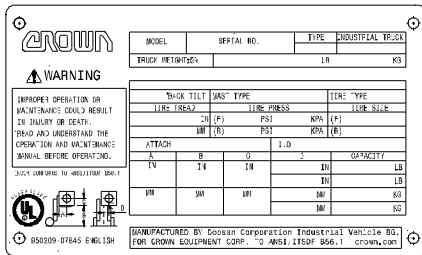

Located on the front side of the FCU.

### Lift Truck Capacity Rating

Do not exceed allowable lift truck working capacity load ratings.

The capacity of the lift truck is given by weight and distance to the load centre. For example: a capacity of 1500kg(3300 lb) at 500mm(24in) means that the lift truck can lift 1500kg(3300lb) if the load centre is 500 mm (24in) from both the vertical and horizontal faces of the forks.

Before attempting to lift any load, ensure that the weight and load centre combination is within the capacity of the lift truck as shown on the capacity rating plate. To determine the load centre measure the distance from the face of the carriage to the gravitational centre of the load.

The rated capacity on the plate refers to the capacity of the lift truck as it left the factory. Subsequent changes of any form to the equipment or battery can alter the lift truck's rating.

The rated capacity of the lift truck applies to operating conditions where the lift truck is on level ground. The capacity of the lift truck is reduced on inclines.

Below are abbreviations that may appear on the IDENTIFICATION, LIFT CAPACITY and ATTACHMENT PLATES and their meanings.

**Mast Abbreviations**

<b>STD -</b>	Standard Mast (single inner member, low free lift)
<b>FF -</b>	Full Free Lift Mast (single inner member with high free lift duplex cylinder)
<b>FFT -</b>	Triple Lift Mast (two inner members) with either low or full free lift characteristics.
<b>QUAD -</b>	Quadruple (Quad) Mast (with three inner members)

**NOTE :** When only a mast-type is listed on the Nameplate, a standard carriage and forks are used.

**Attachment Abbreviations (includes Special Forks)**

<b>SC-</b>	Special Carriage - increased width, height or outreach
<b>SSS -</b>	Shaft-type Sideshift Carriage
<b>HSS -</b>	Hook-type Sideshift Carriage (ITA)
<b>CW -</b>	Counterweight
<b>SF -</b>	Special Forks
<b>SWS -</b>	Swing Shift, Sideshift
<b>RAM -</b>	Ram or Boom
<b>DBCBH -</b>	Double Cube Block Handler
<b>HFP -</b>	Hydraulic Fork Positioner
<b>CR -</b>	Crane Arm or Crane Boom
<b>TH -</b>	Tyre Handler
<b>CTH -</b>	Container Handler
<b>LPP -</b>	Load Push-Pull Device
<b>CC -</b>	Carton Clamp
<b>RC -</b>	Roll Clamp
<b>LS -</b>	Load Stabiliser
<b>PWH -</b>	Pulp Wood Handler
<b>SS-ST -</b>	Sideshift-Side Tilt Carriage



# Operator's Station and Monitoring Systems

## Instrument Panel

Your lift truck may not have the same indicator or warning lights as shown in the illustrations. Due to the various options available, typical instrument panels are shown.

However, the symbols on the indicators and lights on your panel identify what those particular items are. Also, the symbol for each of the items is identified and an explanation of their function and location is described on the following pages

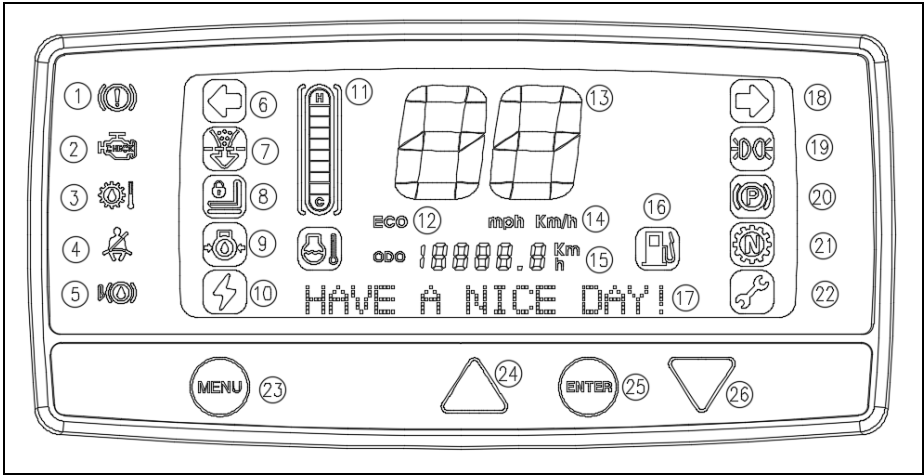

- |   |   |
|---|---|
| 1. Fault warning indicator light              | 15. Hour meter, Odometer                    |
| 2. Engine malfunction indicator light (MIL)   | 16. Empty fuel warning                      |
| 3. Transmission oil temperature warning light | 17. Letter indicator bar                    |
| 4. Seat belt warning light                    | 18. Turn signal right indicator             |
| 5. Brake oil pressure warning light           | 19. Lamp on indicator                       |
| 6. Turn signal left indicator                 | 20. Parking brake on/off indicator          |
| 7. Dust indicator warning light(Air filter)   | 21. Transmission neutral position indicator |
| 8. Mast interlock                             | 22. ECT warning indicator                   |
| 9. Engine oil pressure warning light          | 23. Menu button                             |
| 10. Alternator indicator light                | 24. Up button                               |
| 11. Engine Coolant Temperature Gauge          | 25. Enter button                            |
| 12. ECO mode indicator light                  | 26. Down button                             |
| 13. Speedometer                               |   |
| 14. Mail per hour, Kilo meter per hour unit   |   |



**1. Fault warning indicator light**



**2. Engine Malfunction Indicator Light (MIL)** - Engine control system is equipped with built-in fault diagnostics.

Detected system faults can be displayed by the Malfunction Indicator Lamp (MIL) as Diagnostic Fault Codes (DFC) or flash codes, and viewed in detail with the use of service tool software.

When the ignition key is turned ON the MIL will perform a self-test, illuminate once and then go OFF. If a detected fault condition exists, the fault or faults will be stored in the memory of the engine control unit (ECM). Once a fault occurs the MIL will light up and remain ON. This signals the operator that a fault has been detected by the SCEM.



**3. Transmission Oil Temperature warning light** - Check the system for any defect. The warning light will be on

when the transmission oil temperature reaches approximately 125 °C.



**4. Seat Belt Warning Light (If Equipment)** Indicates when the seat belt dose not fastened by operator.

The light will come on when the ignition switch is turned to the on position.

The light should go off after engine is started.



**5. Brake oil level** – Brake oil level Lamp indicates when the brake oil level is low.



**6. Directional Turning Indicator Light - Left**



**7. Air Filter Indicator** – This lamp will be on when air filter replacement is needed.

Indicates that the air filter is blocked. If the light stays on after starting the engine, stop the engine, remove the air filter element and clean it thoroughly using compressed air. Refit the filter, and check that the light goes out when the engine is started.



**8. Mast interlock** – Alarm warning lights when operator leaves the seat without applying parking brake and then, operation of mast is automatically interrupted.



**9. Engine oil pressure warning lamp** – The warning lamp will light up if the engine oil is short or the pressure is low.



**10. Alternator Indicator Light** - Indicates if the battery charging system is operational. The light will come on when the ignition switch is turned to the ON position.

position.

The light should go off after the engine is started, indicating the alternator is producing sufficient voltage to charge the battery. If the light turns on with the engine running, check the alternator charging system for a malfunction.

**11. Engine Coolant Temperature Gauge** - Indicates coolant temperature. Shows current temperature of the engine coolant. If the gauge pointer moves beyond the red band during the operation, the engine is overheated. Park the lift truck and stop the engine.

Check the cooling system for any defect. The pointer will be in the red band when the coolant temperature reaches approximately 110 °C on all engines.



**12. ECO mode indicator light**



**13. Speedometer** – Shows vehicle speed.



**15. Service hour Meter** - Indicates the total number of hours

the engine and the lift truck have operated. The hour meter will operate when the ignition switch is in the ON position, whether the engine is running or not. The hour meter is used to determine lubrication and maintenance intervals.



**16. Fuel warning lamp** – The warning lamp will light up to warn the operator to refuel.



**18. Directional Turning Indicator Light - Right**



**19. Lamp on indicator** – When turn on the lamp, lamp on indicator is on.



**20. Parking indicator light** - The light will come ON when the parking lever is applied.



**21. Transmission Neutral Position Light** - Indicates the neutral position of transmission.



**22. ECT Malfunction Warning Lamp (if installed)** – electronic transmission control system has a built-in diagnosis system.

If a failure occurs, the electronic transmission control system reports the operator of the failure code by the number of flashes with the malfunction warning lamp.

**Function description.**

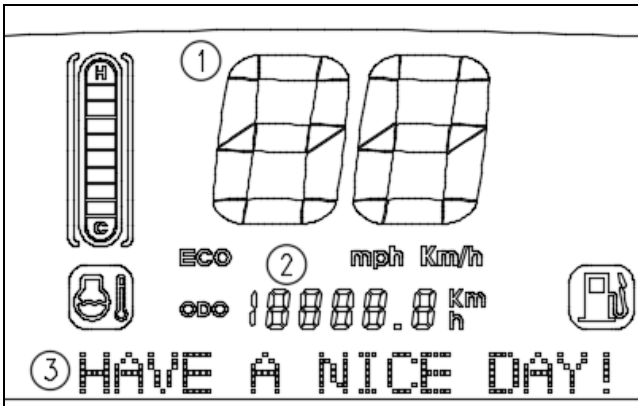

1. Set up

- 1) 1
- 2)
- 3) SET UP

1-1. Pin code menu

- 1) 1
- 2) 0 is OFF, 1 is ON
- 3) PIN CODE MENU enter to in ON/OFF

1-2. Pin code password

- 1) 2
- 2) 000(Initial password)
- 3) PIN CODE PASSWORD enter to in Number 000 is blink, enter the current password and new password and new password again

1-3. ECO mode menu

- 1) 3
- 2) 0 is OFF, 1 is ON
- 3) ECO MODE MENU enter to in ON/OFF

\*Caution: If you want ON or OFF ECO mode, set in only key on situation.(Before engine start)

1-4. ECO mode password

- 1) 4
- 2) 000(Initial password)
- 3) ECO MODE PASSWORD enter to in Number 000 is blink, enter the current password and new password and new password again

2. Maintenance

- 1) 2
- 2)
- 3) MAINTENANCE

2-1. ENGINE ERROR

(ONLY CAN COMMUNICATION ENGINE MODEL)

- 1) 1
- 2) ENGINE ERROR CODE : NUMBER
- 3) ENGINE ERROR CODE

2-2. T/M OIL TEMP

- 1) 2
- 2) T/M OIL TEMP : NUMBER
- 3) T/M OIL TEMP

2-3. UNIT

- 1) 3
- 2)
- 3) UNIT enter to in You can change SI UNIT or US UNIT

## Electrical Disconnect Switch (If Equipped)

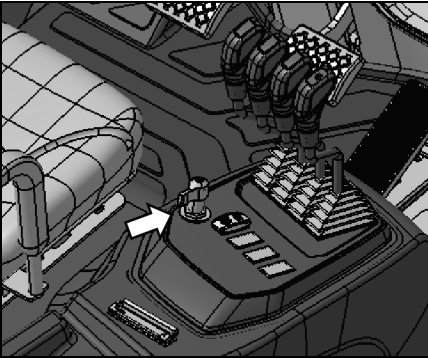

**1. ON** - Connects the battery for electrical power to all electrical circuits.



**2. OFF** - Disconnects the battery from all electrical circuits.

## Seat Switch System (If Equipped)

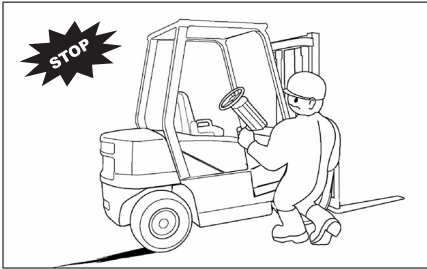

The lift truck is equipped with a SEAT SWITCH SYSTEM. In normal operation if the direction lever is placed in either forward or reverse, the lift truck will move at a speed proportional to the accelerator pedal's position. If the operator leaves the seat without setting the parking brake, within three seconds after leaving the seat, the SEAT SWITCH SYSTEM will automatically disengage the transmission. The directional lever, however, will remain in that forward or reverse location although internally the transmission will have shifted into neutral.

Before exiting the lift truck, the parking brake should always be applied.

### **WARNING**

**WHEN LEAVING MACHINE APPLY PARKING BRAKE!**

**PARKING BRAKE IS NOT AUTOMATICALLY APPLIED.**

**NOTE:** Some trucks may be equipped (ask your branch if this applies to your truck) with an alarm that will sound if the parking brake is not applied when leaving the machine.

---

### **NOTICE**

1. Prior to operating the lift truck, be sure to understand and check the SEAT SWITCH SYSTEM.
  2. While in normal operation and on level ground, select a direction with the directional lever and with the park brake released. You will note that the truck will move slowly in the selected direction. If you lift yours hips off of the seat, within three seconds, the SEAT SWITCH SYSTEM will disengage the transmission allowing the truck to coast but not automatically stop.
  3. To restore the lift truck to normal operation, while sitting in the operator's seat depress the brake pedal to hold the lift truck, return the directional lever to the neutral position, and then reselect a direction of travel (either forward or reverse). The transmission will then re-engage.
  4. If seat or seat switch replacement becomes necessary, be sure to use genuine CROWN lift truck parts. Lift trucks should never be operated without an operational SEAT SWITCH SYSTEM.
-

## Engine Compartment

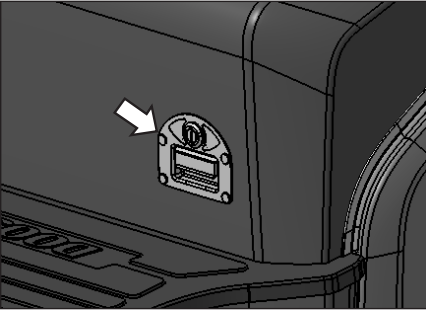

1. The engine compartment is accessible by pulling the latch and raising the hood and seat assembly.

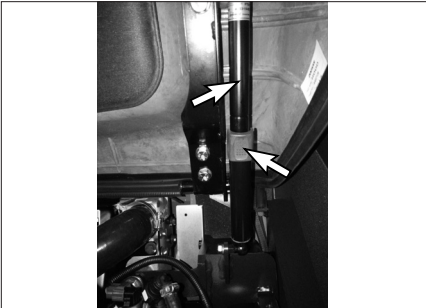

2. The hood and seat assembly is held up by a support cylinder. Make certain the air cylinder is operating properly and will hold the hood up before doing anything in the engine compartment.

## Circuit Breaker

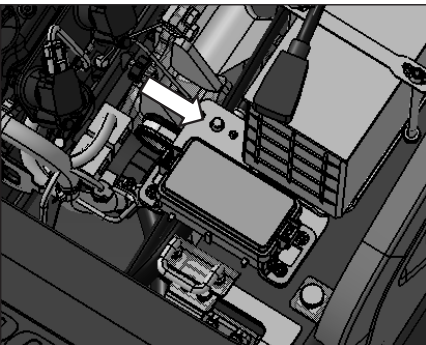

**Circuit Breaker** - Protects the main electrical circuits. To reset the circuit breaker, push the button in. It is Located in the engine compartment.

## Seat

**NOTE:** Seat arrangements may vary. Basic operation will be similar.

Seat adjustment should be checked at the beginning of each shift and when operators change. Lock the seat into position before operating, to prevent an unexpected seat change.

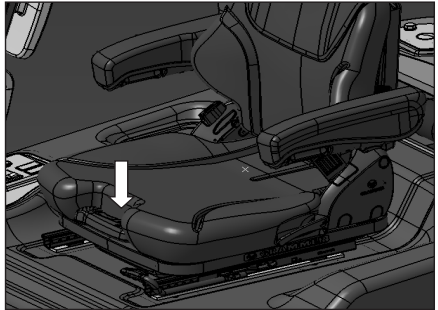

Adjust seat to allow full brake pedal travel with operator's back against seat back.

**NOTE:** The seat can only be correctly adjusted with the operator fully seated.

## Tilting Steering Column

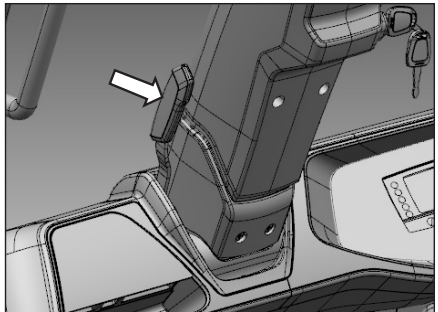



To adjust the steering column, push down the knob(1) and move the steering column to the desired position, then release the knob(1).

## Lift Truck Controls

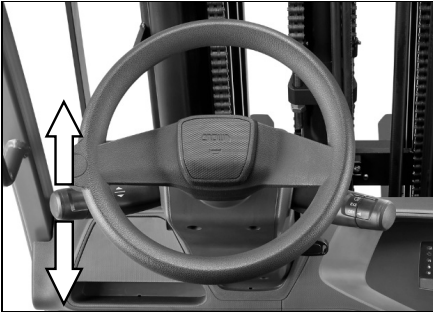
### Direction Control Lever



-  **1. Forward** - Push the lever forward for FORWARD direction travel.
-  **2. Neutral** - Move the lever to centre position for NEUTRAL.
-  **3. Reverse** - Pull the lever back for REVERSE direction travel.

### Transmission Inching Control Pedal

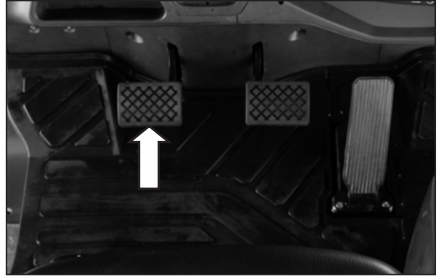



**Inching Control Pedal** - Pushing down on the inching pedal, modulates the hydraulic pressure to the clutch packs, permitting disc slippage.

Further pushing on the pedal completely relieves clutch pack pressure and applies the service brakes to stop and hold the lift truck.

**NOTE :** The purpose of the inching control pedal is to provide precise inching control at slow travel speed, with high engine rpm. This is used for fast hydraulic lift during load approach, pickup or positioning.

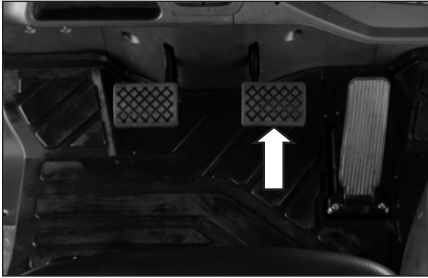

## Service Brake Pedal



-  Push **DOWN** on the brake pedal to slow or stop the lift truck.
-  **RELEASE** the brake pedal to allow the lift truck to move.



## Accelerator Pedal

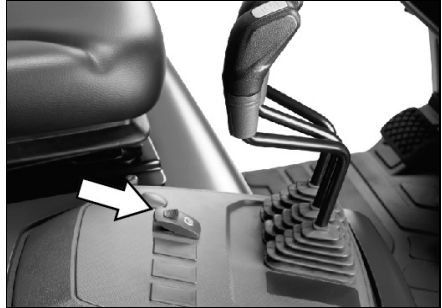

-  Push **DOWN** on the pedal to increase engine rpm (speed).
-  **RELEASE** the pedal to decrease engine rpm (speed).

## Electronic Parking Brake



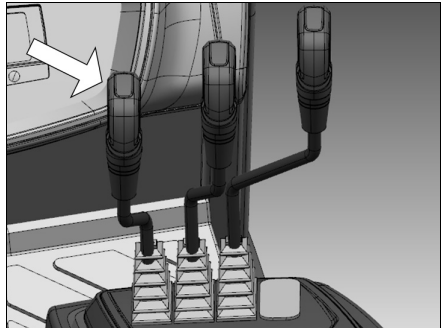

-  Push the front side of the parking brake switch to engage the brake
-  Push the rear side of the parking brake switch to release the brake.

## Lift Control



**NOTE :** To prevent a sudden change of position of the load, operate all lift, tilt and attachment controls smoothly.

-  **1. Lower Position** - Push the lever **FORWARD** smoothly to lower the load.
-  **2. Hold Position** - When the lever is released it will return to the **HOLD** or centre position. Lifting or lowering action will stop.
-  **3. Lift Position** - Pull the lever **BACK** smoothly to lift the load.



### Tilt Control

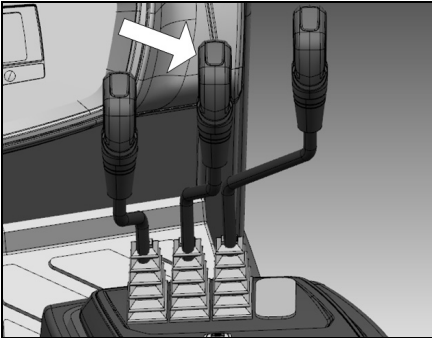

**1. Mast Tilt Back** - Pull the lever **BACK** smoothly to tilt the mast backward.



**2. Mast Hold** - When the lever is released it will return to the **HOLD** or centre position. Tilting action will stop.



**3. Mast Tilt Forward** - Push the lever **FORWARD** smoothly to tilt the mast forward.

### Sideshift Attachment Control (If Equipped)

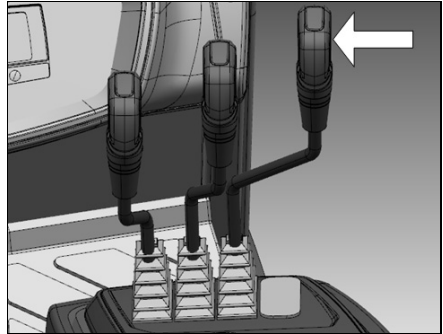

**1. Sideshift Left** - Push the lever **FORWARD** to shift the carriage to the left.



**2. Sideshift Hold** - When the lever is released it will return to the **HOLD** or centre position. Sideshifting action will stop.



**3. Sideshift Right** - Pull the lever **BACK** to shift the carriage to the right.

## Refueling

### WARNING

Only trained, authorised personnel should fill or exchange LP-Gas tanks.

Personnel engaged in filling of LP-Gas containers should wear protective clothing such as face shield, long sleeves and gauntlet gloves.

Do not refuel or store LP-Gas powered lift trucks near any underground entrance, elevator shafts or any other place where LP-Gas could collect in a pocket causing a potentially dangerous condition.

Examine all LP-Gas containers before filling and again before reuse, for damage to various valves, liquid gauge, fittings and hand valve wheels.

All defective or damaged LP-Gas containers must be removed from service.

Explosive fumes may be present during refueling.

Do not smoke in refueling areas.

Lift truck should be refueled only at designated safe locations. Safe outdoor locations are preferable to indoor locations.

Stop the engine and get off the lift truck during refueling.

The careless handling of LP-Gas containers can result in a serious accident.

Use extreme care when transporting containers to prevent damage to them.

## Changing LP-Gas Tanks

1. Park the lift truck on level ground, with the parking brake applied, the transmission in NEUTRAL, the forks lowered and the engine running at low idle.



2. Close the fuel shutoff valve at the LP-Gas tank. Run the engine until it stops, then turn off the ignition switch.
3. Disconnect the fuel supply line.



4. Loosen the retaining clamps and remove the tank.
5. Check the mounting to be sure the locating pin (dowel) is not missing or broken.

### NOTICE

If the locating pin (dowel) is missing or broken, be sure the pin is replaced.

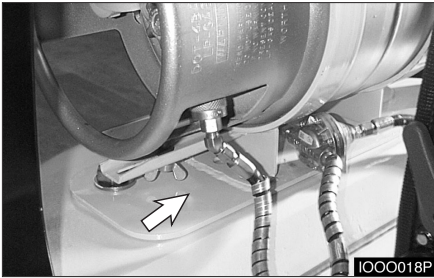

6. Check to be sure that the LP-Gas warning plate is in position on the lift truck and is legible.
7. Check to be sure the replacement tank is of the correct type.
8. Inspect the replacement tank for damage such as dents, scrapes or gouges and for indication of leakage at valves or threaded connections.

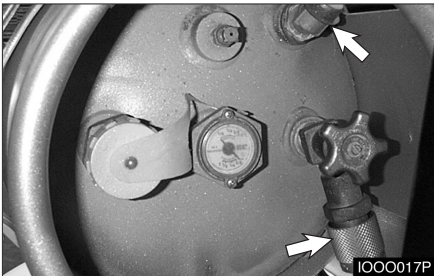

9. Check for debris in the relief valve, for damage to various valves and liquid level gauge.
10. Inspect the quick-disconnect couplings for deterioration, damage or missing flexible seals.

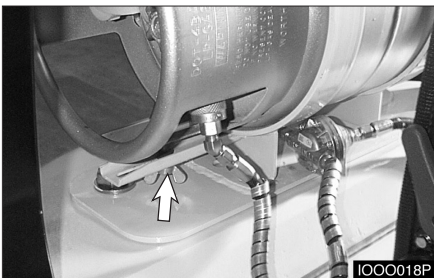

11. Position the replacement tank so that the locating pin(dowel) is in place.

**⚠ WARNING**

**The LP-Gas tank must not extend past the counterweight.**

---

12. Clamp the tank securely.
13. Connect the fuel supply line.
14. Open the fuel valve by slowly turning the valve counterclockwise. If the fuel valve is opened too quickly, a back pressure check valve will shut off the fuel supply. If this happens, close the fuel valve completely. Wait five seconds and then open the fuel valve very slowly.
15. Inspect the LP-Gas fuel lines and fittings with a soap solution after filling the tank or when looking for leaks.

## Before Starting the Engine

### Walk-Around Inspection

Make a thorough walk-around inspection before mounting the lift truck or starting the engine. Look for such items as loose bolts, debris buildup, oil or coolant leaks and cut or gouged tyres. Check condition of tyres, mast, carriage, forks or attachments. Have repairs made as needed and all debris removed.

Before starting the gas engine, push the accelerator pedal all the way down once and then slowly it to set the automatic choke.



1. Inspect the operator's compartment for loose items and cleanliness.
2. Inspect the instrument panel for broken or damaged indicator lights or gauges.
3. Test the horn and other safety devices for proper operation.

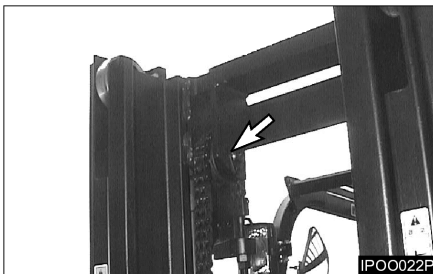

4. Inspect the mast and lift chains for wear, broken links, pins and loose rollers.

5. Inspect the carriage, forks or attachments for wear, damage and loose or missing bolts.
6. Inspect the tyres and wheels for cuts, gouges, foreign objects, inflation pressure and loose or missing bolts.



7. Inspect the overhead guard for damage and loose or missing mounting bolts.
8. Inspect the hydraulic system for leaks, worn hoses or damaged lines.
9. Look for transmission and drive axle leaks on the lift truck and on the ground.
10. Inspect common parts and drive axle, mast etc. for grounded, loosen or missing mounting bolts.



Typical Example

11. Inspect the engine compartment for oil, coolant and fuel leaks.

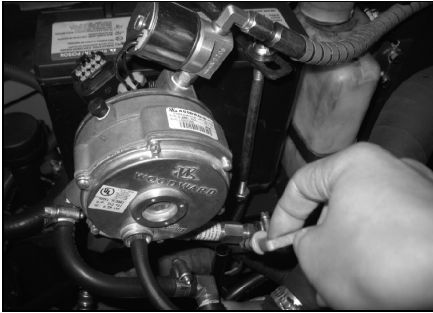

Typical Example

12. Measure the engine crankcase oil level with the dip stick. Maintain the oil level between the MAX. and MIN., (or FULL and ADD) notches on the dip stick.

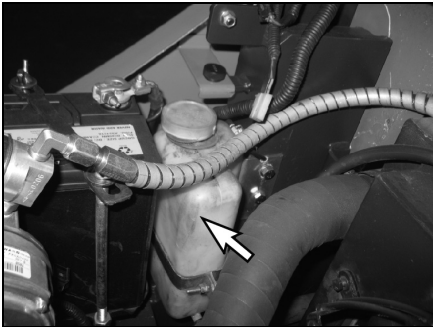

Typical Example

13. Observe the engine coolant level in the coolant recovery bottle. With the engine cold, maintain the level to the COLD mark. If the recovery bottle is empty, also fill the radiator at the top tank.

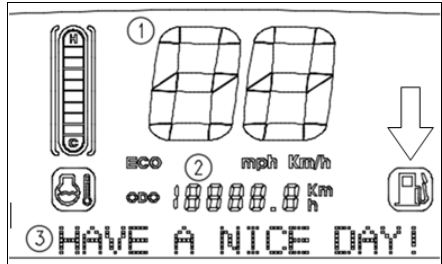

14. Observe the fuel level gauge after starting the truck. Add fuel if necessary.

**⚠ WARNING**

Personal injury may occur from accidents caused by improper seat adjustment. Always adjust the operator's seat before starting the lift truck engine.

Seat adjustment must be done at the beginning of each shift and when operators change.

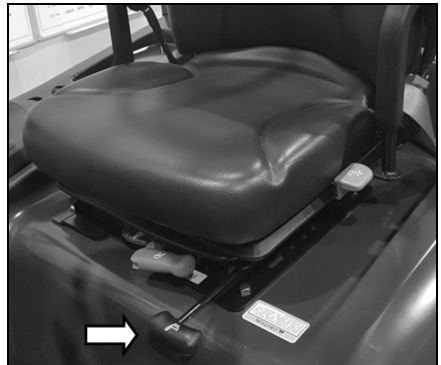

15. To position the seat, PUSH the lever away from the seat track and move the seat forward or backward to a comfortable position.

# Starting the Engine

## Prestart Conditions

**NOTE:** The engine will not start unless the transmission directional control lever is in the NEUTRAL position.

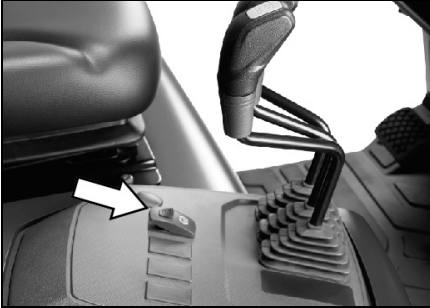

1. Engage the parking brake, if not already engaged. Place the directional control lever in the NEUTRAL position.

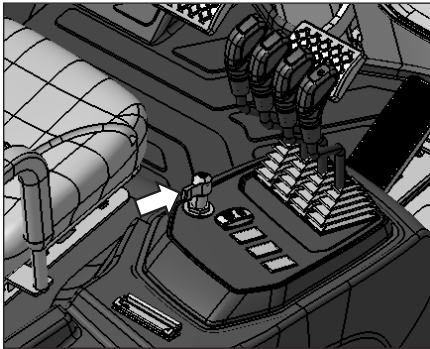

2. Lift trucks equipped with electrical disconnect switches; the engine will not start unless the disconnect switch is in the ON (closed) position. Before starting, turn the disconnect switch to the OFF (open) position.

---

### NOTICE

When you restart the engine after turning off it, wait 4 to 5 seconds and restart it to protect the starter.

---

## LP-Gas Engine

### **WARNING**

**LP - Gas fuel is flammable and can cause personal injury. Inspect LP - Gas fuel lines and fitting for leaks. Inspect tank for secure mounting.**

---

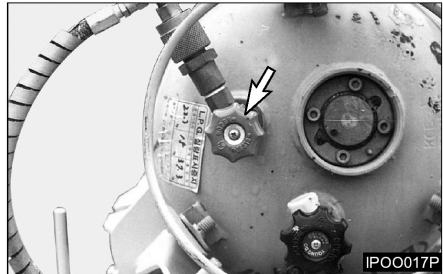

1. Turn the tank fuel valve ON by slowly turning the valve counterclockwise. Observe the LP - Gas gauge (if equipped).
2. Don't press accelerator pedal, and turn the ignition switch to the START position.
3. Once the engine starts, release the ignition switch.
4. If the engine does not start, repeat step 2.
5. If engine coolant is cold, engine speed could be higher than normal low idle speed. Don't drive forklift until engine speed becomes normal low idle speed.

## Starting From a 12 Volt External Source

### **WARNING**

Sparks occurring near the battery could cause vapors to explode.

Always connect the external power source ground cable to a point away from and below the battery, and well clear of fuel system components.

---



Typical Example

---

### **NOTICE**

Do not reverse battery cables. It can cause damage to the alternator.

Always connect the external power source cables in parallel with the lift truck battery cables: POSITIVE(+) to POSITIVE(+) and NEGATIVE(-) to NEGATIVE(-).

Attach ground cable last, remove first. All lift trucks equipped with CROWN built internal combustion engines are NEGATIVE(-) ground.

---

## After Starting the Engine

Observe all indicator lights and gauges frequently during operation, to make sure all systems are working properly. All of the indicator lights will come ON with the ignition switch in the ON position before the engine is started.

### LPG/GAS (12V)

1. The engine oil pressure indicator light (1), will not come ON with the engine running, unless there is low or no oil pressure. Stop the engine immediately, if the light comes ON.
2. The alternator indicator light (2), should not come ON during normal operation. The alternator is not producing the sufficient voltage to charge the battery if the light comes ON with the engine running.
3. The Spark-ignition 4G63 engine MIL (Malfunction Indicator Light) (3) will not come ON with the engine running, unless the fault or faults are stored in the memory of the engine control module (ECM). Stop the engine and check the electric engine control system if the light comes ON. Refer 4G63 Engine of this section.
4. The engine oil pressure indicator light (9), will not come ON with the engine running, unless there is low or no oil pressure. Stop the engine immediately, if the light comes ON.
5. The alternator indicator light (10), should not come ON during normal operation. The alternator is not charging if the light comes ON with the engine running.
6. The engine coolant temperature gauge(11) will be in the middle band with the engine running, unless the coolant temperature is excessive.
7. Observe the hour meter (15) to make sure it is operating properly.
8. The diesel engine water in fuel filter indicator light(4), will not come ON with the engine running, unless water in fuel filter exceeds 100cc. Stop the engine immediately and drain the water if the light comes ON.
9. Observe the fuel level gauge (5) for fuel level in the tank.
10. The engine coolant temperature gauge pointer (6), will be in the green band with the engine running, unless the coolant temperature is excessive.
11. The transmission oil temperature gauge pointer (7), will be in the green band with the engine running, unless the oil temperature is excessive.
12. Observe the hour meter(8) make sure it is operating properly.

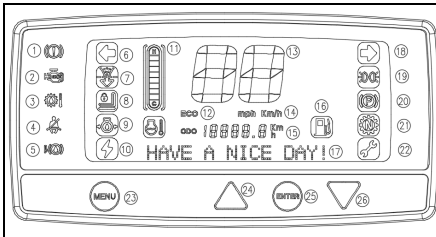

4. The engine oil pressure indicator light (9), will not come ON with the engine running, unless there is low or no oil pressure. Stop the engine immediately, if the light comes ON.
5. The alternator indicator light (10), should not come ON during normal operation. The alternator is not charging if the light comes ON with the engine running.
6. The engine coolant temperature gauge(11) will be in the middle band with the engine running, unless the coolant temperature is excessive.



## Electronic Controlled Spark-Ignition Engines

### 4G63 Engine

The primary components of the fuel system are the fuel supply, direct electronic pressure regulator (DEPR), fuel mixer, electronic throttle control (ETC) device, 2-Stage convertor, engine control module (ECM), and a catalytic converter. The system operates on a slightly positive fuel pressure. Primary fuel pressure can be measured at the LD 2-Stage convertor. Secondary fuel pressure command and actual fuel pressure is monitored by the ECM.

To obtain maximum effect from the catalyst and accurate control of the air fuel ratio, the emission certified engine is equipped with an onboard computer or Engine Control Module (ECM). The ECM is a 32 bit controller which receives input data from sensors mounted to the engine and fuel system and then outputs various signals to control engine operation.

One specific function of the controller is to maintain a closed loop fuel control which is accomplished by use of the Heated Exhaust Gas Oxygen sensor (HEGO) mounted in the exhaust system. The HEGO sensor sends a voltage signal to the controller which then outputs signals to the EPR to change the amount of fuel being delivered from the regulator or mixer to the engine.

The controller also performs diagnostic functions on the fuel system and notifies the operator of engine malfunctions by turning on a Malfunction Indicator Light (MIL) mounted in the dash. Malfunctions in the system are identified by a Diagnostic Trouble Code (DTC) number. In addition to notifying the operator of the malfunction in the system, the controller also stores the information about the malfunction in its memory. A technician can then utilize a computerized diagnostic scan tool to retrieve the stored diagnostic code and by using the diagnostic charts in this manual to determine the cause of the malfunction. In the event a technician does not have the computerized diagnostic tool, the MIL light can be used to identify the diagnostic code to activate the "blink" feature and count the number of blinks to determine the diagnostic code number to locate the fault in the system.

The primary components of the Gasoline Multi Point Fuel Injection (MPFI) fuel system are the gasoline fuel tank, electric fuel pump, fuel pressure and temperature sensor manifold, fuel filter and fuel rail.

This engine is equipped with a fuel injector rail that does not have a pressure regulator or a return circuit to the fuel tank. Fuel pressure for this engine is regulated by the engine's ECM. The ECM receives fuel pressure and temperature feedback from the gasoline fuel sensor manifold and uses this information to control the ground side of the fuel pump. Fuel pressure is regulated by the ECM pulse width modulating (PWM) the fuel pump. The fuel pressure and temperature sensor manifold has a return or "bleed" circuit that connects back to the equipment fuel tank. This circuit is used to bleed off any vapor that develops in the line and returns a small amount of fuel to the tank. The fuel comes from the fuel tank and passes through the fuel pump. Fuel exits the fuel pump, passes through the filter and then enters the fuel pressure and temperature manifold assembly. Fuel flows through the feed circuit and is delivered to the fuel injector rail. Fuel that enters the bleed circuits through the by-pass valve in the manifold is returned to the fuel tank.

**EMS schematic of 4G63 LP engine**

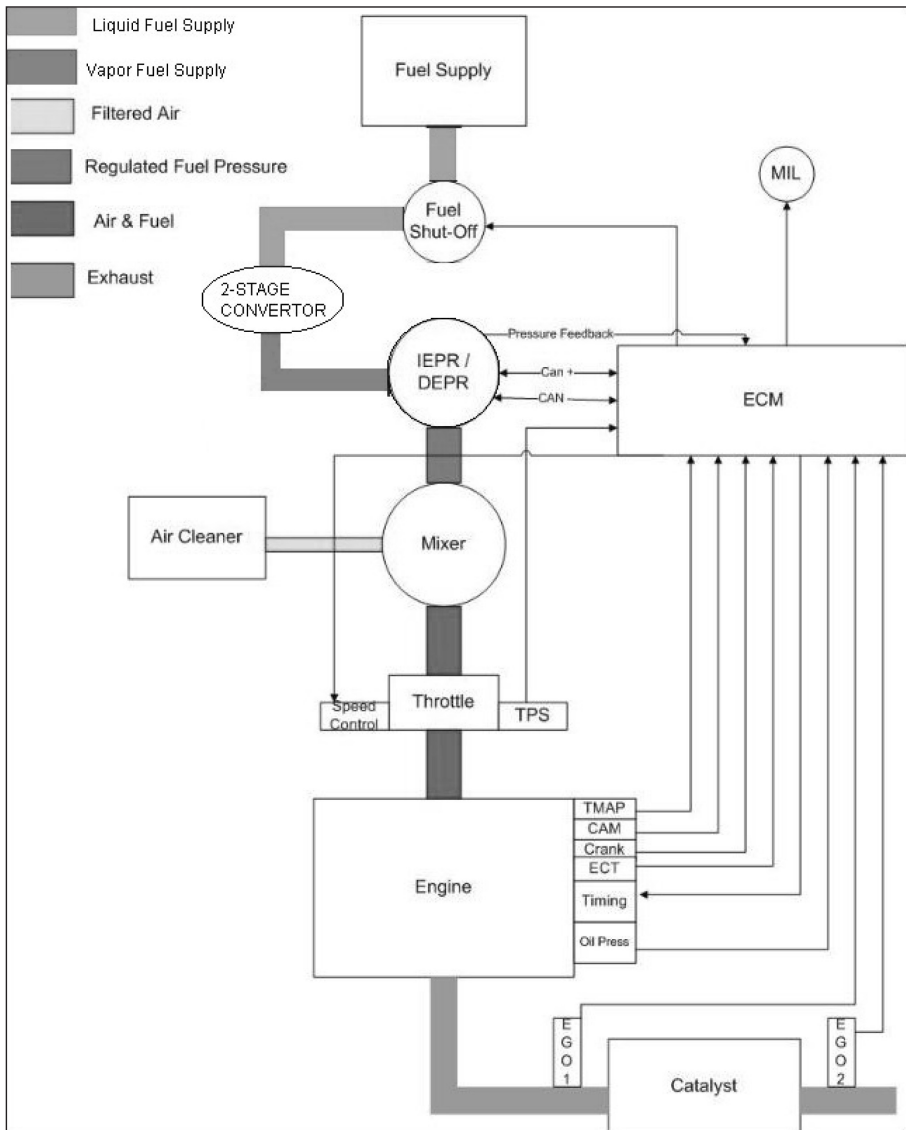

### Basic Troubleshooting

The 4G63 fuel systems are equipped with built-in fault diagnostics. Detected system faults can be displayed by the Malfunction Indicator Lamp (MIL) and are covered in the Advanced Diagnostics section. Items such as fuel level, plugged fuel lines, clogged fuel filters and malfunctioning pressure regulators may not set a fault code by the Engine Control Module (ECM).

Below are basic checks that should be made before referring to the Advanced Diagnostics section, if engine or drivability problems are encountered.

Locating a problem in a propane engine is done exactly the same way as with a gasoline engine.

Consider all parts of the ignition and mechanical systems as well as the fuel system.

### FUEL SYSTEM SYMPTOM DIAGNOSTICS

Checks	Action
<p>Before Using This Section</p>	<p>Before using this section, you should have performed On Board Diagnostic (OBD) Check and determined that:</p> <ol style="list-style-type: none"> <li>1. The ECM and MIL are operating correctly.</li> <li>2. There are no Diagnostic Trouble Codes (DTCs) stored, or a DTC exists but without a MIL.</li> </ol> <p>Several of the following symptom procedures call for a careful visual and physical check. These checks are very important as they can lead to prompt diagnosis and correction of a problem.</p>
<p>Fuel System Check</p>	<ol style="list-style-type: none"> <li>1. Verify the customer complaint.</li> <li>2. Locate the correct symptom table.</li> <li>3. Check the items indicated under that symptom.</li> <li>4. Operate the equipment under the conditions the symptom occurs. Verify HEGO switching between lean and rich. <b>IMPORTANT! Normal HEGO switching indicates the fuel system is in closed loop and operating correctly at that time.</b></li> <li>5. Take a data snapshot using the DST under the condition that the symptom occurs to review at a later time.</li> </ol>

<p>Visual and Physical Checks</p>	<ul style="list-style-type: none"> <li>• Check all ECM system fuses and circuit breakers.</li> <li>• Check the ECM ground for being clean, tight and in its proper location.</li> <li>• Check the vacuum hoses for splits, kinks and proper connections.</li> <li>• Check thoroughly for any type of leak or restriction.</li> <li>• Check for air leaks at all the mounting areas of the intake manifold sealing surfaces.</li> <li>• Check for proper installation of the mixer assembly.</li> <li>• Check for air leaks at the mixer assembly.</li> </ul> <p>Check the ignition wires for the following conditions:</p> <ul style="list-style-type: none"> <li>• Cracking</li> <li>• Hardening</li> <li>• Proper routing</li> <li>• Carbon tracking.</li> </ul> <p>Check the wiring for the following items: proper connections, pinches or cuts.  The following symptom tables contain groups of possible causes for each symptom.  The order of these procedures is not important. If the DST readings do not indicate a problem, then proceed in a logical order, easiest to check or most likely to cause the problem.</p>
-----------------------------------	---

**INTERMITTENT**

Checks	Action
<b>DEFINITION:</b> <i>The problem may or may not turn ON the (MIL) or store a Diagnostic Trouble Code (DTC).</i>	
Preliminary Checks	Do not use the DTC tables. If a fault is an intermittent, the use of the DTC tables with this condition may result in the replacement of good parts.
Faulty Electrical Connections or Wiring	<p>Faulty electrical connections or wiring can cause most intermittent problems. Check the suspected circuit for the following conditions:</p> <ul style="list-style-type: none"> <li>• Faulty fuse or circuit breaker, connectors poorly mated, terminals not fully seated in the connector (backed out). Terminals not properly formed or damaged.</li> <li>• Wire terminals poorly connected.</li> <li>• Terminal tension is insufficient.</li> <li>• Carefully remove all the connector terminals in the problem circuit in order to ensure the proper contact tension.</li> <li>• If necessary, replace all the connector terminals in the problem circuit in order to ensure the proper contact tension (except those noted as “Not Serviceable”). See section <i>Wiring Schematics</i>.</li> <li>• Checking for poor terminal to wire connections requires removing the terminal from the connector body.</li> </ul>
Operational Test	If a visual and physical check does not locate the cause of the problem, operate the vehicle with the DST connected. When the problem occurs, an abnormal voltage or scan reading indicates a problem circuit.
Intermittent MIL Illumination	<p>The following components can cause intermittent MIL and no DTC(s):</p> <ul style="list-style-type: none"> <li>• A defective relay.</li> <li>• Switch that can cause electrical system interference. Normally, the problem will occur when the faulty component is operating.</li> <li>• The improper installation of add on electrical devices, such as lights, 2-way radios, electric motors, etc.</li> <li>• The ignition secondary voltage shorted to a ground.</li> <li>• The MIL circuit or the Diagnostic Test Terminal intermittently shorted to ground.</li> <li>• The MIL wire grounds.</li> </ul>
Loss of DTC Memory	<p>To check for the loss of the DTC Memory:</p> <ol style="list-style-type: none"> <li>1. Disconnect the TMAP sensor.</li> <li>2. Idle the engine until the MIL illuminates.</li> <li>3. The ECM should store a TMAP DTC which should remain in the memory when the ignition is turned OFF. If the TMAP DTC does not store and remain, the ECM is faulty.</li> </ol>

**NO START**

Checks	Action
<b>DEFINITION:</b> <i>The engine cranks OK but does not start.</i>	
Preliminary Checks	None
ECM Checks	Use the DST to : <ul style="list-style-type: none"> <li>• Check for proper communication with both the ECM</li> <li>• Check all system fuses engine fuse holder. Refer to <i>Engine Controls Schematics</i>.</li> <li>• Check battery power, ignition power and ground circuits to the ECM. Refer to <i>Engine Control Schematics</i>. Verify voltage and/or continuity for each.</li> </ul>
Sensor Checks	<ul style="list-style-type: none"> <li>• Check the TMAP sensor.</li> <li>• Check the cam angle sensor for output (RPM).</li> </ul>
Fuel System Checks	<p><b>Important:</b> A closed LPG manual fuel shut off valve will create a no start condition.</p> <ul style="list-style-type: none"> <li>• Check for air intake system leakage between the mixer and the throttle body. Verify proper operation of the low pressure lock-off solenoids.</li> <li>• Verify proper operation of the fuel control solenoids.</li> <li>• Check the fuel system pressures.</li> <li>• Refer to the <i>LPG Fuel System Diagnosis</i>.</li> <li>• Check for proper mixer air valve operation.</li> </ul>
Ignition System Checks	<p>Note: LPG being a gaseous fuel requires higher secondary ignition system voltages for the equivalent gasoline operating conditions.</p> <ol style="list-style-type: none"> <li>1. Check for the proper ignition voltage output with <i>J 26792</i> or the equivalent.</li> <li>2. Verify that the spark plugs are correct for use with LPG.</li> </ol> <p>Check the spark plugs for the following conditions:</p> <ul style="list-style-type: none"> <li>• Wet plugs.</li> <li>• Cracks.</li> <li>• Wear.</li> <li>• Improper gap.</li> <li>• Burned electrodes.</li> <li>• Heavy deposits.</li> <li>• Check for bare or shorted ignition wires.</li> <li>• Check for loose ignition coil connections at the coil.</li> </ul>

**NO START**

Checks	Action
<p>Engine Mechanical Checks</p>	<p><b>Important:</b> The LPG Fuel system is more sensitive to intake manifold leakage than the gasoline fuel system.</p> <p>Check for the following:</p> <ul style="list-style-type: none"> <li>• Vacuum leaks.</li> <li>• Improper valve timing.</li> <li>• Low compression.</li> <li>• Improper valve clearance.</li> <li>• Worn rocker arms.</li> <li>• Broken or weak valve springs.</li> </ul> <p>Worn camshaft lobes.</p>
<p>Exhaust System Checks</p>	<p>Check the exhaust system for a possible restriction:</p> <ul style="list-style-type: none"> <li>• Inspect the exhaust system for damaged or collapsed pipes:</li> <li>• Inspect the muffler for signs of heat distress or for possible internal failure.</li> <li>• Check for possible plugged catalytic converter. Refer to <i>Restricted Exhaust System Diagnosis</i>.</li> </ul>

**HARD START**

Checks	Action
<p><b>DEFINITION:</b> The engine cranks OK, but does not start for a long time. The engine does eventually run, or may start but immediately dies.</p>	
Preliminary Checks	Make sure the vehicle's operator is using the correct starting procedure.
Sensor Checks	<ul style="list-style-type: none"> <li>• Check the Engine Coolant Temperature sensor with the DST. Compare the engine coolant temperature with the ambient air temperature on a cold engine. If the coolant temperature reading is more than 10 degrees greater or less than the ambient air temperature on a cold engine, check for high resistance in the coolant sensor circuit. Check the cam angle sensor.</li> <li>• Check the Throttle Position (TPS) and Foot Pedal Position (FPP) sensor connections.</li> </ul>
Fuel System Checks	<p><b>Important:</b> A closed LPG manual fuel shut off valve will create an extended crank OR no start condition.</p> <ul style="list-style-type: none"> <li>• Verify the excess flow valve is not tripped or that the manual shut-off valve is not closed.</li> </ul> <p>Check mixer assembly for proper installation and leakage.</p> <ul style="list-style-type: none"> <li>• Verify proper operation of the low pressure lock-off solenoid.</li> <li>• Verify proper operation of the EPR.</li> <li>• Check for air intake system leakage between the mixer and the throttle body. Check the fuel system pressures. Refer to the <i>Fuel System Diagnosis</i>.</li> </ul>
Ignition System Checks	<p>Note: LPG being a gaseous fuel requires higher secondary ignition system voltages for the equivalent gasoline operating conditions.</p> <ul style="list-style-type: none"> <li>• Check for the proper ignition voltage output with <i>J 26792</i> or the equivalent.</li> <li>• Verify that the spark plugs are the correct type and properly gapped.</li> </ul> <p>Check the spark plugs for the following conditions:</p> <ul style="list-style-type: none"> <li>• Wet plugs.</li> <li>• Cracks.</li> <li>• Wear.</li> <li>• Burned electrodes.</li> <li>• Heavy deposits</li> <li>• Check for bare or shorted ignition wires.</li> <li>• Check for moisture in the distributor cap.</li> <li>• Check for loose ignition coil connections.</li> </ul> <p><b>Important:</b></p> <ol style="list-style-type: none"> <li>1. If the engine starts but then immediately stalls, check the cam angle sensor.</li> <li>2. Check for improper gap, debris or faulty connections.</li> </ol>



**HARD START**

Checks	Action
<p>Engine Mechanical Checks</p>	<p><b>Important:</b> The LPG Fuel system is more sensitive to intake manifold leakage than the gasoline fuel supply system.</p> <p>Check for the following:</p> <ul style="list-style-type: none"> <li>• Vacuum leaks</li> <li>• Improper valve timing</li> <li>• Low compression</li> <li>• Improper valve clearance.</li> <li>• Worn rocker arms</li> <li>• Broken or weak valve springs</li> <li>• Worn camshaft lobes.</li> </ul> <p>Check the intake and exhaust manifolds for casting ash.</p>
<p>Exhaust System Checks</p>	<p>Check the exhaust system for a possible restriction:</p> <ul style="list-style-type: none"> <li>• Inspect the exhaust system for damaged or collapsed pipes.</li> <li>• Inspect the muffler for signs of heat distress or for possible internal failure.</li> </ul> <p>Check for possible plugged catalytic converter. Refer to <i>Restricted Exhaust System Diagnosis</i>.</p>

**CUTS OUT, MISSES**

Checks	Action
<b>DEFINITION:</b> A surging or jerking that follows engine speed, usually more pronounced as the engine load increases, but normally felt below 1500 RPM. The exhaust has a steady spitting sound at idle, low speed, or hard acceleration for the fuel starvation that can cause the engine to cut-out.	
Preliminary Checks	None
Ignition System Checks	<ol style="list-style-type: none"> <li>1. Start the engine.</li> <li>2. Check for proper ignition output voltage with spark tester J 26792.</li> <li>3. Check for a cylinder misfire.</li> <li>4. Verify that the spark plugs are the correct type and properly gapped.</li> </ol> <p>Remove the spark plugs and check for the following conditions:</p> <ul style="list-style-type: none"> <li>• Insulation cracks.</li> <li>• Wear.</li> <li>• Improper gap.</li> <li>• Burned electrodes.</li> <li>• Heavy deposits.</li> </ul> <p>Visually/Physically inspect the secondary ignition for the following:</p> <ul style="list-style-type: none"> <li>• Ignition wires for arcing and proper routing.</li> <li>• Cross- ring.</li> <li>• Ignition coils for cracks or carbon tracking</li> </ul>
Engine Mechanical Checks	<p>Perform a cylinder compression check. Check the engine for the following:</p> <ul style="list-style-type: none"> <li>• Improper valve timing.</li> <li>• Improper valve clearance.</li> <li>• Worn rocker arms.</li> <li>• Worn camshaft lobes.</li> <li>• Broken or weak valve springs.</li> <li>• Check the intake and exhaust manifold passages for casting ash.</li> </ul>
Fuel System Checks	<p>Check the fuel system:</p> <ul style="list-style-type: none"> <li>• Plugged fuel filter.</li> <li>• Low fuel pressure, etc. Refer to <i>LPG Fuel System Diagnosis</i>.</li> <li>• Check the condition of the wiring to the low pressure lock-off solenoid.</li> </ul>
Additional Check	<p>Check for Electromagnetic Interference (EMI), which may cause a misfire condition. Using the DST, monitor the engine RPM and note sudden increases in rpms displayed on the scan tool but with little change in the actual engine rpm. If this condition exists, EMI may be present. Check the routing of the secondary wires and the ground circuit.</p>

**HESITATION, SAG, STUMBLE**

Checks	Action
<p><b>DEFINITION:</b> <i>The engine has a momentary lack of response when putting it under load. The condition can occur at any engine speed. The condition may cause the engine to stall if it's severe enough.</i></p>	
Preliminary Checks	None
Fuel System Checks	<ul style="list-style-type: none"> <li>• Check the fuel pressure. Refer to <i>LPG Fuel System Diagnosis</i>.</li> <li>• Check for low fuel pressure during a moderate or full throttle acceleration. If the fuel pressure drops below specification, there is possibly a faulty low pressure regulator or a restriction in the fuel system.</li> <li>• Check the TMAP sensor response and accuracy.</li> <li>• Check Shut-Off electrical connection.</li> <li>• Check the mixer air valve for sticking or binding.</li> <li>• Check the mixer assembly for proper installation and leakage. Check the EPR.</li> </ul>
Ignition System Checks	<p>Note: LPG being a gaseous fuel requires higher secondary ignition system voltages for the equivalent gasoline operating conditions. If a problem is reported on LPG and not gasoline, do not discount the possibility of a LPG only ignition system failure and test the system accordingly.</p> <ul style="list-style-type: none"> <li>• Check for the proper ignition voltage output with <i>J 26792</i> or the equivalent. Verify that the spark plugs are the correct type and properly gapped.</li> <li>• Check for faulty spark plug wires.</li> <li>• Check for fouled spark plugs.</li> </ul>
Additional Check	<ul style="list-style-type: none"> <li>• Check for manifold vacuum or air induction system leaks.</li> <li>• Check the alternator output voltage.</li> </ul>

**BACKFIRE**

Checks	Action
<p><b>DEFINITION:</b> The fuel ignites in the intake manifold, or in the exhaust system, making a loud popping noise.</p>	
Preliminary Checks	None
Ignition System Checks	<p><b>Important! LPG, being a gaseous fuel, requires higher secondary ignition system voltages for the equivalent gasoline operating conditions. The ignition system must be maintained in peak condition to prevent backfire.</b></p> <ul style="list-style-type: none"> <li>• Check for the proper ignition coil output voltage using the spark tester <i>J26792</i> or the equivalent.</li> <li>• Check the spark plug wires by connecting an ohmmeter to the ends of each wire in question. If the meter reads over 30,000 ohms, replace the wires.</li> <li>• Check the connection at ignition coil.</li> <li>• Check for deteriorated spark plug wire insulation.</li> </ul> <p>Remove the plugs and inspect them for the following conditions:</p> <ul style="list-style-type: none"> <li>• Wet plugs.</li> <li>• Cracks.</li> <li>• Wear.</li> <li>• Improper gap.</li> <li>• Burned electrodes.</li> <li>• Heavy deposits.</li> </ul>
Engine Mechanical Check	<p><b>Important! The LPG Fuel system is more sensitive to intake manifold leakage than a gasoline fuel supply system.</b></p> <p>Check the engine for the following:</p> <ul style="list-style-type: none"> <li>• Improper valve timing.</li> <li>• Engine compression.</li> <li>• Manifold vacuum leaks.</li> <li>• Intake manifold gaskets.</li> <li>• Sticking or leaking valves.</li> <li>• Exhaust system leakage.</li> <li>• Check the intake and exhaust system for casting flash or other restrictions.</li> </ul>
Fuel System Checks	Perform a fuel system diagnosis. Refer to <i>LPG Fuel System Diagnosis</i> .

**LACK OF POWER, SLUGGISHNESS, OR SPONGINESS**

Checks	Action
<b>DEFINITION:</b> <i>The engine delivers less than expected power.</i>	
Preliminary Checks	<ul style="list-style-type: none"> <li>• Refer to the <i>LPG Fuel system OBD System Check</i>.</li> <li>• Compare the customer's vehicle with a similar unit to verify customer has an actual problem. <i>Do not compare the power output of the vehicle operating on LPG to a vehicle operating on gasoline as the fuels do have different drive feel characteristics.</i></li> <li>• Remove the air filter and check for dirt or restriction.</li> <li>• Check the vehicle transmission.</li> <li>• Refer to the OEM transmission diagnostics.</li> </ul>
Fuel System Checks	<ul style="list-style-type: none"> <li>• Check for a restricted fuel filter, contaminated fuel, or improper fuel pressure. Refer to <i>LPG Fuel System Diagnosis</i>.</li> <li>• Check for the proper ignition output voltage with the spark tester <i>J 26792</i> or the equivalent.</li> <li>• Check for proper installation of the mixer assembly. Check all air inlet ducts for condition and proper installation.</li> <li>• Check for fuel leaks between the EPR and the mixer.</li> <li>• Verify that the LPG tank manual shut-off valve is fully open.</li> <li>• Verify that liquid fuel (not vapor) is being delivered to the EPR.</li> </ul>
Sensor Checks	<ul style="list-style-type: none"> <li>• Check the Heated Exhaust Gas Oxygen Sensors (HEGO) for contamination and performance. Check for proper operation of the TMAP sensor.</li> <li>• Check for proper operation of the TPS and FPP sensors.</li> </ul>
Exhaust System Checks	<p>Check the exhaust system for a possible restriction:</p> <ul style="list-style-type: none"> <li>• Inspect the exhaust system for damaged or collapsed pipes.</li> <li>• Inspect the muffler for signs of heat distress or for possible internal failure.</li> <li>• Check for possible plugged catalytic converter.</li> </ul>
Engine Mechanical Check	<p>Check the engine for the following:</p> <ul style="list-style-type: none"> <li>• Engine compression.</li> <li>• Valve timing.</li> <li>• Improper or worn camshaft.</li> <li>• Refer to <i>Engine Mechanical</i> in the Service Manual.</li> </ul>
Additional Check	<ul style="list-style-type: none"> <li>• Check the ECM grounds for being clean, tight, and in their proper locations.</li> <li>• Check the alternator output voltage.</li> </ul> <p>If all procedures have been completed and no malfunction has been found, review and inspect the following items:</p> <ul style="list-style-type: none"> <li>• Visually and physically, inspect all electrical connections within the suspected circuit and/or systems.</li> <li>• Check the DST data.</li> </ul>

**ROUGH, UNSTABLE, OR INCORRECT IDLE, STALLING**

Checks	Action
<p><b>DEFINITION:</b> <i>The engine runs unevenly at idle. If severe enough, the engine may shake.</i></p>	
Preliminary Checks	None.
Sensor Checks	<p>Check the Heated Exhaust Gas Oxygen Sensors (HEGO) performance:</p> <ul style="list-style-type: none"> <li>• Check for silicone contamination from fuel or improperly used sealant. If contaminated, the sensor may have a white powdery coating result in a high but false signal voltage (rich exhaust indication). The ECM will reduce the amount of fuel delivered to the engine causing a severe driveability problem.</li> </ul> <p>Check the Temperature Manifold Absolute Pressure (TMAP) sensor response and accuracy.</p>
Fuel System Checks	<ul style="list-style-type: none"> <li>• Check for rich or lean symptom that causes the condition.</li> <li>• Drive the vehicle at the speed of the complaint.</li> <li>• Monitoring the oxygen sensors will help identify the problem.</li> <li>• Check for a sticking mixer air valve.</li> <li>• Verify proper operation of the EPR.</li> <li>• Perform a cylinder compression test. Refer to <i>Engine Mechanical</i> in the Service Manual.</li> <li>• Check the EPR fuel pressure. Refer to the <i>LPG Fuel System Diagnosis</i>.</li> <li>• Check mixer assembly for proper installation and connection.</li> </ul>
Ignition System Checks	<ul style="list-style-type: none"> <li>• Check for the proper ignition output voltage using the spark tester <i>J26792</i> or the equivalent.</li> <li>• Verify that the spark plugs are the correct type and properly gapped.</li> </ul> <p>Remove the plugs and inspect them for the following conditions:</p> <ul style="list-style-type: none"> <li>• Wet plugs.</li> <li>• Cracks.</li> <li>• Wear.</li> <li>• Improper gap.</li> <li>• Burned electrodes.</li> <li>• Blistered insulators.</li> <li>• Heavy deposits.</li> </ul> <p>Check the spark plug wires by connecting an ohmmeter to the ends of each wire in question. If the meter reads over 30,000 ohms, replace the wires.</p>
Additional Checks	<p><b>Important:</b> The LPG Fuel system is more sensitive to intake manifold leakage than the gasoline fuel supply system.</p> <ul style="list-style-type: none"> <li>• Check for vacuum leaks. Vacuum leaks can cause a higher than normal idle and low throttle angle control command.</li> <li>• Check the ECM grounds for being clean, tight, and in their proper locations. Check the battery cables and ground straps. They should be clean and secure. Erratic voltage may cause all sensor readings to be skewed resulting in poor idle quality.</li> </ul>

**ROUGH, UNSTABLE, OR INCORRECT IDLE, STALLING**

<b>Checks</b>	<b>Action</b>
Engine Mechanical Check	Check the engine for: <ul style="list-style-type: none"><li>• Broken motor mounts.</li><li>• Improper valve timing.</li><li>• Low compression.</li><li>• Improper valve clearance.</li><li>• Worn rocker arms.</li><li>• Broken or weak valve springs.</li><li>• Worn camshaft lobes.</li></ul>

## Advanced Diagnostics

The Fuel system has built-in diagnostics for system trouble shooting. The system has a dash mounted malfunction indicator lamp (MIL) that provides indications of engine or fuel system related problem. Most engine control system related problems that affect emissions or driveability of the vehicle will set a (DTC) diagnostic trouble code and illuminate the MIL.

The MIL serves as notification to the operator of a problem related to the emission control system so the driver can arrange for service as soon as possible. It will also display DTCs that have been stored due to a system malfunction.

The MIL should illuminate when the key is in the ON position and the engine is not running. This feature verifies that the lamp is in proper working order. If the MIL does not illuminate with the vehicle key ON/engine OFF, repair it as soon as possible. Once the engine is in start or run mode, the MIL should turn off. If the lamp remains on while the engine is in the start or run mode a diagnostic trouble code may be set.

The MIL will be turned OFF after three (3) consecutive run cycles or by clearing the active code with the Diagnostic Scan Tool (DST).

Diagnostic Trouble Codes are set when the GCP (Electronic Control Module) runs a diagnostic self test and the test fails. When a DTC is set, the ECM will illuminate the MIL on the instrument panel and also save the DTC in memory. The ECM will continue to run the self test. If the system continues to fail the test, the lamp will stay illuminated and the DTC is stored as an active DTC. If the self test runs and passes, the DTC will be stored as historic DTC. All DTCs are stored as historic faults until they are cleared. Most DTCs will automatically clear from memory if the DTC does not reset within 50 to 100 consecutive engine run cycles.

While a Diagnostic Trouble Code is current for a sensor, the ECM may assign a default "limp home" value and use that value in its control algorithms. All of the system diagnostic self-tests run continuously during normal vehicle operation.

The Diagnostic Trouble Codes can be read by using either the MIL lamp or a laptop computer. Diagnostic Trouble Codes can be cleared from memory with a laptop computer, or by turning the ignition key to the OFF position and removing the ECM power fuse or battery cable for at least 15 seconds.

If more than one DTC is detected, start the diagnostic repair with the lowest DTC number set. Diagnose each problem to correction unless directed to do otherwise by the diagnostic chart. The DTCs are numbered in order of importance. Both DTC 112 and DTC122 pertain to the oxygen sensor, so it is possible that a repair that corrects DTC 112 may also correct the problem causing the DTC 122.

Diagnostic test charts contained in this manual refer to the DST to be connected and in the "System Data Mode." This simply means that the DST is connected and communicating with the PC. In some instances the chart will call out a special test mode. An example of this would be instructions for the DST to be connected and in the DBW (drive by wire) mode. Always be sure to follow the special instructions to avoid a false diagnosis of fuel system components.



## Blink Code Function

Although the DST is considered a required tool to access the DTC codes, codes may be retrieved without a laptop computer using the blink code function. To enable this function follow the steps below:

- Jump pins 1 and 4 at the DLC connector (see illustration below)
- Turn the ignition key to the on position
- The system will now enter the self diagnostic blink code mode. Be ready with pen and paper to write down any codes that may be stored.
- The ECM will flash the MIL indicator with a pause between represented numbers that represent DTC codes. The sequence starts with code 1654. Code 1654 confirms the system has entered the blink code mode. The ECM will flash code 1654 (3) times before displaying the actual DTC code that may be set.

Example:

One short blink (pause) six short blinks (pause) five short blinks (pause) four short blinks.

- If no DTC codes are found, the ECM will continue to flash 1654 only. This means no stored DTC codes were found.
- If one of the numbers in the DTC code is zero (0), no flash will occur to represent the zero value—it will be represented as a short pause.

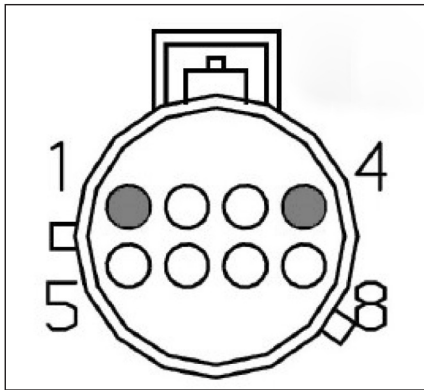

Diagnostic Connector Terminal Identification

## Malfunction Indicator Lamp (MIL) Operation

### How does my MIL work?

The emissions control system utilizes a MIL to warn the operator or technician of a possible issue with the engine or emissions control system. The system will keep the MIL illuminated for the entire key cycle in which the trouble code was set. It will keep the MIL illuminated for three additional engine run cycles under the following two circumstances: (1) The fault caused the engine to shut down or (2) the fault is related to the exhaust gas oxygen (EGO) sensors. This function is called MIL persistence.

### How does MIL persistence work?

In the event the DTC is related to either an engine shutdown fault OR an oxygen sensor fault the following statement applies: If the vehicle is not serviced by a technician and the condition causing the MIL illumination (DTC) no longer exists, the MIL will remain illuminated for the 3 additional start cycles. The MIL will go out on the 4th start cycle if the condition does not reoccur.

In the event the DTC is not related to an engine shut down or an oxygen sensor fault and the condition causing the MIL illumination (DTC) no longer exists, the MIL will go out at the next run cycle.

If the condition is serviced by a technician and the DTC is cleared using a Diagnostic Service Tool (DST), the MIL will go out immediately.

Diagnostic Trouble Codes (DTC) are permanently retained in the historic DTC section until cleared with a DST or the auto clear requirements are met. The auto clear feature will clear out historic faults after 40 run cycles.

### What are the requirements for a run cycle?

A run cycle is when the engine speed is above the "run speed" set point for 1.5 seconds or longer. The "run speed" is the transition point when the ECM recognizes the engine is going from the cranking parameters to the engine running parameters. The run speed is typically set at 450 rpm.

**DIAGNOSTIC TROUBLE CODE (DTC) CHART – SORTED BY DTC # (1 of 4)**

Description	DTC Set 2		Description	DTC Set 2	
	SPN-2	FMI-2		SPN-2	FMI-2
DTC 11: Intake cam / distributor position error	520800	7	DTC 268: Injector 3 coil shorted	653	6
DTC 16: Crank and/or cam could not synchronize during start	636	8	DTC 270: Injector 4 open or short to ground	654	5
DTC 24: Exhaust cam position error	520801	7	DTC 271: Injector 4 coil shorted	654	6
DTC 87 Fuel pressure lower than expected	94	1	DTC 273: Injector 5 open or short to ground	655	5
DTC 88 Fuel pressure higher than expected	94	0	DTC 274: Injector 5 coil shorted	655	6
DTC 91: FP low voltage	94	4	DTC 276: Injector 6 open or short to ground	656	5
DTC 92: FP high voltage	94	3	DTC 277: Injector 6 coil shorted	656	6
DTC 107: MAP voltage low	106	4	DTC 279: Injector 7 open or short to ground	657	5
DTC 108: MAP pressure high	106	16	DTC 280: Injector 7 coil shorted	657	6
DTC 111: IAT higher than expected stage 1	105	15	DTC 282: Injector 8 open or short to ground	658	5
DTC 112: IAT voltage low	105	4	DTC 283: Injector 8 coil shorted	658	6
DTC 113: IAT voltage high	105	3	DTC 285: Injector 9 open or short to ground	659	5
DTC 116: ECT higher than expected stage 1	110	15	DTC 286: Injector 9 coil shorted	659	6
DTC 117: ECT voltage low	110	4	DTC 288: Injector 10 open or short to ground	660	5
DTC 118: ECT voltage high	110	3	DTC 289: Injector 10 coil shorted	660	6
DTC 121: TPS1-2 lower than expected	51	1	DTC 1631: PWM1-Gauge1 open / ground short	697	5
DTC 122: TPS1 voltage low	51	4	DTC 299: Boost control underboost failure	1692	1
DTC 123: TPS1 voltage high	51	3	DTC 301: Cylinder 1 emissions/catalyst damaging misfire	1323	31
DTC 127: IAT higher than expected stage 2	105	0	DTC 302: Cylinder 2 emissions/catalyst damaging misfire	1324	31
DTC 129: BP pressure low	108	1	DTC 303: Cylinder 3 emissions/catalyst damaging misfire	1325	31
DTC 134: EGO1 open / lazy	724	10	DTC 304: Cylinder 4 emissions/catalyst damaging misfire	1326	31
DTC 140: EGO3 open / lazy	520209	10	DTC 305: Cylinder 5 emissions/catalyst damaging misfire	1327	31
DTC 154: EGO2 open / lazy	520208	10	DTC 306: Cylinder 6 emissions/catalyst damaging misfire	1328	31
DTC 160: EGO4 open / lazy	520210	10	DTC 307: Cylinder 7 emissions/catalyst damaging misfire	1329	31
DTC 171: Adaptive-learn gasoline bank1 high	520200	0	DTC 308: Cylinder 8 emissions/catalyst damaging misfire	1330	31

Description	DTC Set 2		Description	DTC Set 2	
	SPN-2	FMI-2		SPN-2	FMI-2
DTC 172: Adaptive-learn gasoline bank1 low	520200	1	DTC 326: Knock1 excessive or erratic signal	731	2
DTC 174: Adaptive-learn gasoline bank2 high	520201	0	DTC 327: Knock1 sensor open or not present	731	4
DTC 175: Adaptive-learn gasoline bank2 low	520201	1	DTC 331: Knock2 excessive or erratic signal	520241	2
DTC 182: FT low voltage	174	4	DTC 332: Knock2 sensor open or not present	520241	4
DTC 183: FT high voltage	174	3	DTC 336: CRANK input signal noise	636	2
DTC 187: Gaseous fuel temperature sender low voltage	520240	4	DTC 337: Crank signal loss	636	4
DTC 188: Gaseous fuel temperature sender high voltage	520240	3	DTC 341: CAM input signal noise	723	2
DTC 217: ECT higher than expected stage 2	110	0	DTC 342: Loss of CAM input signal	723	4
DTC 219: RPM higher than max allowed govern speed	515	15	DTC 359: Fuel run-out longer than expected	1239	7
DTC 221: TPS1-2 higher than expected	51	0	DTC 420: Catalyst inactive on gasoline (Bank 1)	520211	10
DTC 222: TPS2 voltage low	520251	4	DTC 430: Catalyst inactive on gasoline (Bank 2)	520212	10
DTC 223: TPS2 voltage high	520251	3	DTC 502: Roadspeed input loss of signal	84	1
DTC 234: Boost control overboost failure	1692	0	DTC 508: IAC ground short	520252	6
DTC 236: TIP active	1692	2	DTC 509: IAC coil open/short	520252	5
DTC 237: TIP low voltage	1127	4	DTC 520: Oil pressure sender low pressure stage 1	100	18
DTC 238: TIP high voltage	1127	3	DTC 521: Oil pressure sender high pressure	100	0
DTC 261: Injector 1 open or short to ground	651	5	DTC 522: Oil pressure sender low voltage	100	4
DTC 262: Injector 1 coil shorted	651	6	DTC 523: Oil pressure sender high voltage	100	3
DTC 264: Injector 2 open or short to ground	652	5	DTC 524: Oil pressure low	100	1
DTC 265: Injector 2 coil shorted	652	6	DTC 562: Vbat voltage low	168	17
DTC 267: Injector 3 open or short to ground	653	5	DTC 563: Vbat voltage high	168	15

**DIAGNOSTIC TROUBLE CODE (DTC) CHART – SORTED BY DTC # (2 of 4)**

Description	DTC Set 2		Description	DTC Set 2	
	SPN-2	FMI-2		SPN-2	FMI-2
DTC 601: Microprocessor failure - FLASH	628	13	DTC 1175: MegaJector voltage supply low	520260	4
DTC 604: Microprocessor failure - RAM	630	12	DTC 1176: MegaJector internal actuator fault detection	520260	12
DTC 606: Microprocessor failure - COP	629	31	DTC 1177: MegaJector internal circuitry fault detection	520260	12
DTC 615: Start relay coil open	1321	5	DTC 1178: MegaJector internal comm fault detection	520260	12
DTC 616: Start relay ground short	1321	4	DTC 1182: Fuel impurity level high	520401	0
DTC 617: Start relay coil short to power	1321	3	DTC 1183: MegaJector autozero / lockoff failure	520803	31
DTC 627: Fuel pump relay coil open	1348	5	DTC 1311: Cylinder 1 misfire detected	1323	11
DTC 628: Fuel-pump high-side open or short to ground	1347	5	DTC 1312: Cylinder 2 misfire detected	1324	11
DTC 628: Fuel pump relay control ground short	1348	4	DTC 1313: Cylinder 3 misfire detected	1325	11
DTC 629: Fuel-pump high-side short to power	1347	6	DTC 1314: Cylinder 4 misfire detected	1326	11
DTC 629: Fuel pump relay coil short to power	1348	3	DTC 1315: Cylinder 5 misfire detected	1327	11
DTC 642: Sensor supply voltage 1 low	1079	4	DTC 1316: Cylinder 6 misfire detected	1328	11
DTC 643: Sensor supply voltage 1 high	1079	3	DTC 1317: Cylinder 7 misfire detected	1329	11
DTC 650: MIL open	1213	5	DTC 1318: Cylinder 8 misfire detected	1330	11
DTC 652: Sensor supply voltage 2 low	1080	4	DTC 1411: EMWT1 voltage high	441	3
DTC 653: Sensor supply voltage 2 high	1080	3	DTC 1412: EMWT2 voltage high	442	3
DTC 685: Power relay coil open	1485	5	DTC 1413: EMWT1 voltage low	441	4
DTC 686: Power relay ground short	1485	4	DTC 1414: EMWT2 voltage low	442	4
DTC 687: Power relay coil short to power	1485	3	DTC 1415: EMWT1 higher than expected stage 1	441	15
DTC 916: Shift actuator feedback out-of-range	520226	3	DTC 1416: EMWT2 higher than expected stage 1	442	15
DTC 919: Shift unable to reach desired gear	520226	7	DTC 1417: EMWT1 higher than expected stage 2	441	0
DTC 920: Shift actuator or drive circuit failed	520226	31	DTC 1418: EMWT2 higher than expected stage 2	442	0
DTC 1111: RPM above fuel rev limit level	515	16	DTC 1419: ERWT1 voltage high	443	3
DTC 1112: RPM above spark rev limit level	515	0	DTC 1420: ERWT2 voltage high	444	3
DTC 1121: FPP1/2 simultaneous voltages out-of-range (redundanc	91	31	DTC 1421: ERWT1 voltage low	443	4

Description	DTC Set 2		Description	DTC Set 2	
	SPN-2	FMI-2		SPN-2	FMI-2
DTC 1122: FPP1/2 do not match each other or IVS (redundancy lo	520250	31	DTC 1422: ERWT2 voltage low	444	4
DTC 1131: WGP voltage high	1192	3	DTC 1423: ERWT1 higher than expected stage 1	443	15
DTC 1132: WGP voltage low	1192	4	DTC 1424: ERWT2 higher than expected stage 1	444	15
DTC 1151: Closed-loop LPG high	520206	0	DTC 1425: ERWT1 higher than expected stage 2	443	0
DTC 1152: Closed-loop LPG low	520206	1	DTC 1426: ERWT2 higher than expected stage 2	444	0
DTC 1153: Closed-loop NG high	520207	0	DTC 1511: AUX analog Pull-Up 1 high voltage	520216	3
DTC 1154: Closed-loop NG low	520207	1	DTC 1512: AUX analog Pull-Up 1 low voltage	520216	4
DTC 1155: Closed-loop gasoline bank1 high	520204	0	DTC 1513: AUX analog Pull-Up 2 high voltage	520217	3
DTC 1156: Closed-loop gasoline bank1 low	520204	1	DTC 1514: AUX analog Pull-Up 2 low voltage	520217	4
DTC 1157: Closed-loop gasoline bank2 high	520205	0	DTC 1515: AUX analog Pull-Down 1 high voltage	520215	3
DTC 1158: Closed-loop gasoline bank2 low	520205	1	DTC 1516: AUX analog Pull-Down 1 low voltage	520215	4
DTC 1161: Adaptive-learn LPG high	520202	0	DTC 1517: AUX analog Pull-Up 3 high voltage	520218	3
DTC 1162: Adaptive-learn LPG low	520202	1	DTC 1518: AUX analog Pull-Up 3 low voltage	520218	4
DTC 1163: Adaptive-learn NG high	520203	0	DTC 1521: CHT higher than expected stage 1	110	16
DTC 1164: Adaptive-learn NG low	520203	1	DTC 1522: CHT higher than expected stage 2	110	0
DTC 1165: Catalyst inactive on LPG	520213	10	DTC 1531: Gov1/2/3 interlock failure	520270	31
DTC 1166: Catalyst inactive on NG	520214	10	DTC 1541: AUX analog Pull-Up/Down 1 high voltage	520219	3
DTC 1171: MegaJector delivery pressure higher than expected	520260	0	DTC 1542: AUX analog Pull-Up/Down 1 low voltage	520219	4
DTC 1172: MegaJector delivery pressure lower than expected	520260	1	DTC 1543: AUX analog Pull-Up/Down 2 high voltage	520220	3
DTC 1173: MegaJector comm lost	520260	31	DTC 1544: AUX analog Pull-Up/Down 2 low voltage	520220	4
DTC 1174: MegaJector voltage supply high	520260	3	DTC 1545: AUX analog Pull-Up/Down 3 high voltage	520221	3

**DIAGNOSTIC TROUBLE CODE (DTC) CHART – SORTED BY DTC # (3 of 4)**

Description	DTC Set 2		Description	DTC Set 2	
	SPN-2	FMI-2		SPN-2	FMI-2
DTC 1546: AUX analog Pull-Up/Down 3 low voltage	520221	4	DTC 1662: PWM6 short to power	925	3
DTC 1547: AUX analog Pull-Up/Down 4 high voltage	713	3	DTC 1663: PWM7 open / ground short	926	5
DTC 1548: AUX analog Pull-Up/Down 4 low voltage	713	4	DTC 1664: PWM7 short to power	926	3
DTC 1551: AUX digital 1 high voltage	520222	3	DTC 1665: PWM8 open / ground short	2646	5
DTC 1552: AUX digital 1 low voltage	520222	4	DTC 1666: PWM8 short to power	2646	3
DTC 1553: AUX digital 2 high voltage	520223	3	DTC 1669: PWM9 open / ground short	2647	5
DTC 1554: AUX digital 2 low voltage	520223	4	DTC 1670: PWM9 short to power	2647	3
DTC 1555: AUX digital 3 high voltage	520224	3	DTC 2111: Unable to reach lower TPS	51	7
DTC 1555: Water Intrusion Detection	520224	3	DTC 2112: Unable to reach higher TPS	51	7
DTC 1556: AUX digital 3 low voltage	520224	4	DTC 2115: FPP1 higher than IVS	91	0
DTC 1561: AUX analog Pull-Down 2 high voltage	0	3	DTC 2116: FPP2 higher than IVS	29	0
DTC 1561: AUX analog Pull-Down 3 high voltage	0	3	DTC 2120: FPP1 invalid voltage and FPP2 disagrees with IVS	520250	31
DTC 1561: AUX analog Pull-Down 2 low voltage	0	4	DTC 2121: FPP1-2 lower than expected	91	18
DTC 1561: AUX analog Pull-Down 3 low voltage	0	4	DTC 2122: FPP1 voltage high	91	3
DTC 1611: Sensor supply voltage 1 and 2 out-of-range	1079	31	DTC 2123: FPP1 voltage low	91	4
DTC 1612: Microprocessor failure - RTI 1	629	31	DTC 2125: FPP2 invalid voltage and FPP1 disagrees with IVS	520250	31
DTC 1613: Microprocessor failure - RTI 2	629	31	DTC 2126: FPP1-2 higher than expected	91	16
DTC 1614: Microprocessor failure - RTI 3	629	31	DTC 2127: FPP2 voltage low	29	4
DTC 1615: Microprocessor failure - A/D	629	31	DTC 2128: FPP2 voltage high	29	3
DTC 1616: Microprocessor failure - Interrupt	629	31	DTC 2130: IVS stuck at-idle, FPP1/2 match	558	5
DTC 1621: RS-485 Rx inactive	0	31	DTC 2131: IVS stuck off-idle, FPP1/2 match	558	6
DTC 1622: RS-485 Rx noise	0	31	DTC 2135: TPS1/2 simultaneous voltages out-of-range	51	31
DTC 1623: RS-485 Rx bad packet format	0	31	DTC 2139: FPP1 lower than IVS	91	1

Description	DTC Set 2		Description	DTC Set 2	
	SPN-2	FMI-2		SPN-2	FMI-2
DTC 1624: RS-485 remote shutdown request	0	31	DTC 2140: FPP2 lower than IVS	29	1
DTC 1625: J1939 shutdown request	1384	31	DTC 2229: BP pressure high	108	0
DTC 1626: CAN-J1939 Tx fault	639	12	DTC 2300: Spark coil 1 primary open or short to ground	1268	5
DTC 1627: CAN-J1939 Rx fault	639	12	DTC 2301: Spark coil 1 primary shorted	1268	6
DTC 1628: J1939 CAN address / engine-number conflict	639	13	DTC 2303: Spark coil 2 primary open or short to ground	1269	5
DTC 1629: J1939 TSC1 message receipt loss	639	9	DTC 2304: Spark coil 2 primary shorted	1269	6
DTC 1630: J1939 ETC message receipt loss	91	2	DTC 2306: Spark coil 3 primary open or short to ground	1270	5
DTC 1632: PWM1-Gauge1 short to power	697	6	DTC 2307: Spark coil 3 primary shorted	1270	6
DTC 1633: PWM2-Gauge2 open / ground short	698	5	DTC 2309: Spark coil 4 primary open or short to ground	1271	5
DTC 1634: PWM2-Gauge2 short to power	698	6	DTC 2310: Spark coil 4 primary shorted	1271	6
DTC 1635: PWM3-Gauge3 open / ground short	699	5	DTC 2312: Spark coil 5 primary open or short to ground	1272	5
DTC 1636: PWM3-Gauge3 short to power	699	6	DTC 2313: Spark coil 5 primary shorted	1272	6
DTC 1637: PWM4 open / ground short	700	5	DTC 2315: Spark coil 6 primary open or short to ground	1273	5
DTC 1638: PWM4 short to power	700	6	DTC 2316: Spark coil 6 primary shorted	1273	6
DTC 1639: PWM5 open / ground short	520230	5	DTC 2318: Spark coil 7 primary open or short to ground	1274	5
DTC 1640: PWM5 short to power	520230	6	DTC 2319: Spark coil 7 primary shorted	1274	6
DTC 1641: Buzzer control ground short	920	4	DTC 2321: Spark coil 8 primary open or short to ground	1275	5
DTC 1642: Buzzer open	920	5	DTC 2322: Spark coil 8 primary shorted	1275	6
DTC 1643: Buzzer control short to power	920	3	DTC 2324: Spark coil 9 primary open or short to ground	1276	5
DTC 1644: MIL control ground short	1213	4	DTC 2325: Spark coil 9 primary shorted	1276	6
DTC 1645: MIL control short to power	1213	3	DTC 2327: Spark coil 10 primary open or short to ground	1277	5
DTC 1651: J1939 ETC message receipt loss while in-gear	91	9	DTC 2328: Spark coil 10 primary shorted	1277	6
DTC 1661: PWM6 open / ground short	925	5	DTC 2428: EGT temperature high	173	0



**DIAGNOSTIC TROUBLE CODE (DTC) CHART – SORTED BY DTC # (4 of 4)**

Description	DTC Set 2	
	SPN-2	FMI-2
DTC 2618: Tach output ground short	645	4
DTC 2619: Tach output short to power	645	3
DTC 8901: UEGO microprocessor internal fault	3221	31
DTC 8902: UEGO heater supply high voltage	3222	3
DTC 8903: UEGO heater supply low voltage	3222	4
DTC 8904: UEGO cal resistor voltage high	3221	3
DTC 8905: UEGO cal resistor voltage low	3221	4
DTC 8906: UEGO return voltage shorted high	3056	3
DTC 8907: UEGO return voltage shorted low	3056	4
DTC 8908: UEGO pump voltage shorted high	3218	3
DTC 8909: UEGO pump voltage shorted low	3218	4
DTC 8910: UEGO sense cell voltage high	3217	3
DTC 8911: UEGO sense cell voltage low	3217	4
DTC 8912: UEGO pump voltage at high drive limit	3225	3
DTC 8913: UEGO pump voltage at low drive limit	3225	4
DTC 8914: UEGO sense cell slow to warm up	3222	10
DTC 8915: UEGO pump cell slow to warm up	3225	10
DTC 8916: UEGO sense cell impedance high	3222	0
DTC 8917: UEGO pump cell impedance high	3225	0
DTC 8918: UEGO pump cell impedance low	3225	1

**DIAGNOSTIC TROUBLE CODE (DTC) CHART – SORTED BY SPN:FMI (1 of 4)**

Description	DTC Set 2		Description	DTC Set 2	
	SPN-2	FMI-2		SPN-2	FMI-2
DTC 1561: AUX analog Pull-Down 2 high voltage	0	3	DTC 107: MAP voltage low	106	4
DTC 1561: AUX analog Pull-Down 3 high voltage	0	3	DTC 108: MAP pressure high	106	16
DTC 1561: AUX analog Pull-Down 2 low voltage	0	4	DTC 2229: BP pressure high	108	0
DTC 1561: AUX analog Pull-Down 3 low voltage	0	4	DTC 129: BP pressure low	108	1
DTC 1621: RS-485 Rx inactive	0	31	DTC 1522: CHT higher than expected stage 2	110	0
DTC 1622: RS-485 Rx noise	0	31	DTC 217: ECT higher than expected stage 2	110	0
DTC 1623: RS-485 Rx bad packet format	0	31	DTC 118: ECT voltage high	110	3
DTC 1624: RS-485 remote shutdown request	0	31	DTC 117: ECT voltage low	110	4
Undefined DTC - Index 10297	0	31	DTC 116: ECT higher than expected stage 1	110	15
Undefined DTC - Index 10298	0	31	DTC 1521: CHT higher than expected stage 1	110	16
Undefined DTC - Index 10299	0	31	DTC 563: Vbat voltage high	168	15
DTC 2116: FPP2 higher than IVS	29	0	DTC 562: Vbat voltage low	168	17
DTC 2140: FPP2 lower than IVS	29	1	DTC 2428: EGT temperature high	173	0
DTC 2128: FPP2 voltage high	29	3	DTC 183: FT high voltage	174	3
DTC 2127: FPP2 voltage low	29	4	DTC 182: FT low voltage	174	4
DTC 221: TPS1-2 higher than expected	51	0	DTC 1417: EMWT1 higher than expected stage 2	441	0
DTC 121: TPS1-2 lower than expected	51	1	DTC 1411: EMWT1 voltage high	441	3
DTC 123: TPS1 voltage high	51	3	DTC 1413: EMWT1 voltage low	441	4
DTC 122: TPS1 voltage low	51	4	DTC 1415: EMWT1 higher than expected stage 1	441	15
DTC 2112: Unable to reach higher TPS	51	7	DTC 1418: EMWT2 higher than expected stage 2	442	0
DTC 2111: Unable to reach lower TPS	51	7	DTC 1412: EMWT2 voltage high	442	3
DTC 2135: TPS1/2 simultaneous voltages out-of-ran	51	31	DTC 1414: EMWT2 voltage low	442	4
DTC 502: Roadspeed input loss of signal	84	1	DTC 1416: EMWT2 higher than expected stage 1	442	15
DTC 2115: FPP1 higher than IVS	91	0	DTC 1425: ERWT1 higher than expected stage 2	443	0

Operation Section

Description	DTC Set 2		Description	DTC Set 2	
	SPN-2	FMI-2		SPN-2	FMI-2
DTC 2139: FPP1 lower than IVS	91	1	DTC 1419: ERWT1 voltage high	443	3
DTC 1630: J1939 ETC message receipt loss	91	2	DTC 1421: ERWT1 voltage low	443	4
DTC 2122: FPP1 voltage high	91	3	DTC 1423: ERWT1 higher than expected stage 1	443	15
DTC 2123: FPP1 voltage low	91	4	DTC 1426: ERWT2 higher than expected stage 2	444	0
DTC 1651: J1939 ETC message receipt loss while in	91	9	DTC 1420: ERWT2 voltage high	444	3
DTC 2126: FPP1-2 higher than expected	91	16	DTC 1422: ERWT2 voltage low	444	4
DTC 2121: FPP1-2 lower than expected	91	18	DTC 1424: ERWT2 higher than expected stage 1	444	15
DTC 1121: FPP1/2 simultaneous voltages out-of-ran	91	31	DTC 1112: RPM above spark rev limit level	515	0
DTC 88 Fuel pressure higher than expected	94	0	DTC 219: RPM higher than max allowed govern speed	515	15
DTC 87 Fuel pressure lower than expected	94	1	DTC 1111: RPM above fuel rev limit level	515	16
DTC 92: FP high voltage	94	3	DTC 2130: IVS stuck at-idle, FPP 1/2 match	558	5
DTC 91: FP low voltage	94	4	DTC 2131: IVS stuck off-idle, FPP 1/2 match	558	6
DTC 521: Oil pressure sender high pressure	100	0	DTC 601: Microprocessor failure - FLASH	628	13
DTC 524: Oil pressure low	100	1	DTC 606: Microprocessor failure - COP	629	31
DTC 524: Oil pressure sender low pressure	100	1	DTC 1612: Microprocessor failure - RTI 1	629	31
DTC 523: Oil pressure sender high voltage	100	3	DTC 1613: Microprocessor failure - RTI 2	629	31
DTC 522: Oil pressure sender low voltage	100	4	DTC 1614: Microprocessor failure - RTI 3	629	31
DTC 520: Oil pressure sender low pressure stage 1	100	18	DTC 1615: Microprocessor failure - A/D	629	31
DTC 127: IAT higher than expected stage 2	105	0	DTC 1616: Microprocessor failure - Interrupt	629	31
DTC 113: IAT voltage high	105	3	DTC 604: Microprocessor failure - RAM	630	12
DTC 112: IAT voltage low	105	4	DTC 336: CRANK input signal noise	636	2
DTC 111: IAT higher than expected stage 1	105	15	DTC 337: Crank signal loss	636	4

**DIAGNOSTIC TROUBLE CODE (DTC) CHART – SORTED BY SPN:FMI (2 of 4)**

Description	DTC Set 2		Description	DTC Set 2	
	SPN-2	FMI-2		SPN-2	FMI-2
DTC 16: Crank and/or cam could not synchronize du	636	8	DTC 1661: PWM6 open / ground short	925	5
DTC 1629: J1939 TSC1 message receipt loss	639	9	DTC 1664: PWM7 short to power	926	3
DTC 1626: CAN-J1939 Tx fault	639	12	DTC 1663: PWM7 open / ground short	926	5
DTC 1627: CAN-J1939 Rx fault	639	12	DTC 643: Sensor supply voltage 1 high	1079	3
DTC 1628: J1939 CAN address / engine-number con	639	13	DTC 642: Sensor supply voltage 1 low	1079	4
DTC 2619: Tach output short to power	645	3	DTC 1611: Sensor supply voltage 1 and 2 out-of-range	1079	31
DTC 2618: Tach output ground short	645	4	DTC 653: Sensor supply voltage 2 high	1080	3
DTC 261: Injector 1 open or short to ground	651	5	DTC 652: Sensor supply voltage 2 low	1080	4
DTC 262: Injector 1 coil shorted	651	6	DTC 238: TIP high voltage	1127	3
DTC 264: Injector 2 open or short to ground	652	5	DTC 237: TIP low voltage	1127	4
DTC 265: Injector 2 coil shorted	652	6	DTC 1131: WGP voltage high	1192	3
DTC 267: Injector 3 open or short to ground	653	5	DTC 1132: WGP voltage low	1192	4
DTC 268: Injector 3 coil shorted	653	6	DTC 1645: MIL control short to power	1213	3
DTC 270: Injector 4 open or short to ground	654	5	DTC 1644: MIL control ground short	1213	4
DTC 271: Injector 4 coil shorted	654	6	DTC 650: MIL open	1213	5
DTC 273: Injector 5 open or short to ground	655	5	DTC 359: Fuel run-out longer than expected	1239	7
DTC 274: Injector 5 coil shorted	655	6	DTC 2300: Spark coil 1 primary open or short to ground	1268	5
DTC 276: Injector 6 open or short to ground	656	5	DTC 2301: Spark coil 1 primary shorted	1268	6
DTC 277: Injector 6 coil shorted	656	6	DTC 2303: Spark coil 2 primary open or short to ground	1269	5
DTC 279: Injector 7 open or short to ground	657	5	DTC 2304: Spark coil 2 primary shorted	1269	6
DTC 280: Injector 7 coil shorted	657	6	DTC 2306: Spark coil 3 primary open or short to ground	1270	5
DTC 282: Injector 8 open or short to ground	658	5	DTC 2307: Spark coil 3 primary shorted	1270	6

Operation Section

Description	DTC Set 2		Description	DTC Set 2	
	SPN-2	FMI-2		SPN-2	FMI-2
DTC 283: Injector 8 coil shorted	658	6	DTC 2309: Spark coil 4 primary open or short to ground	1271	5
DTC 285: Injector 9 open or short to ground	659	5	DTC 2310: Spark coil 4 primary shorted	1271	6
DTC 286: Injector 9 coil shorted	659	6	DTC 2312: Spark coil 5 primary open or short to ground	1272	5
DTC 288: Injector 10 open or short to ground	660	5	DTC 2313: Spark coil 5 primary shorted	1272	6
DTC 289: Injector 10 coil shorted	660	6	DTC 2315: Spark coil 6 primary open or short to ground	1273	5
DTC 1631: PWM1-Gauge1 open / ground short	697	5	DTC 2316: Spark coil 6 primary shorted	1273	6
DTC 1632: PWM1-Gauge1 short to power	697	6	DTC 2318: Spark coil 7 primary open or short to ground	1274	5
DTC 1633: PWM2-Gauge2 open / ground short	698	5	DTC 2319: Spark coil 7 primary shorted	1274	6
DTC 1634: PWM2-Gauge2 short to power	698	6	DTC 2321: Spark coil 8 primary open or short to ground	1275	5
DTC 1635: PWM3-Gauge3 open / ground short	699	5	DTC 2322: Spark coil 8 primary shorted	1275	6
DTC 1636: PWM3-Gauge3 short to power	699	6	DTC 2324: Spark coil 9 primary open or short to ground	1276	5
DTC 1637: PWM4 open / ground short	700	5	DTC 2325: Spark coil 9 primary shorted	1276	6
DTC 1638: PWM4 short to power	700	6	DTC 2327: Spark coil 10 primary open or short to ground	1277	5
DTC 1547: AUX analog Pull-Up/Down 4 high voltage	713	3	DTC 2328: Spark coil 10 primary shorted	1277	6
DTC 1548: AUX analog Pull-Up/Down 4 low voltage	713	4	DTC 617: Start relay coil short to power	1321	3
DTC 341: CAM input signal noise	723	2	DTC 616: Start relay ground short	1321	4
DTC 342: Loss of CAM input signal	723	4	DTC 615: Start relay coil open	1321	5
DTC 134: EGO1 open / lazy	724	10	DTC 1311: Cylinder 1 misfire detected	1323	11
DTC 326: Knock1 excessive or erratic signal	731	2	DTC 301: Cylinder 1 emissions/catalyst damaging misfire	1323	31
DTC 327: Knock1 sensor open or not present	731	4	DTC 1312: Cylinder 2 misfire detected	1324	11
DTC 1643: Buzzer control short to power	920	3	DTC 302: Cylinder 2 emissions/catalyst damaging misfire	1324	31
DTC 1641: Buzzer control ground short	920	4	DTC 1313: Cylinder 3 misfire detected	1325	11

Description	DTC Set 2		Description	DTC Set 2	
	SPN-2	FMI-2		SPN-2	FMI-2
DTC 1642: Buzzer open	920	5	DTC 303: Cylinder 3 emissions/catalyst damaging misfire	1325	31
DTC 1662: PWM6 short to power	925	3	DTC 1314: Cylinder 4 misfire detected	1326	11

**DIAGNOSTIC TROUBLE CODE (DTC) CHART – SORTED BY SPN:FMI (3 of 4)**

Description	DTC Set 2		Description	DTC Set 2	
	SPN-2	FMI-2		SPN-2	FMI-2
DTC 304: Cylinder 4 emissions/catalyst damaging m	1326	31	DTC 175: Adaptive-learn gasoline bank2 low	520201	1
DTC 1315: Cylinder 5 misfire detected	1327	11	DTC 1161: Adaptive-learn LPG high	520202	0
DTC 305: Cylinder 5 emissions/catalyst damaging m	1327	31	DTC 1162: Adaptive-learn LPG low	520202	1
DTC 1316: Cylinder 6 misfire detected	1328	11	DTC 1163: Adaptive-learn NG high	520203	0
DTC 306: Cylinder 6 emissions/catalyst damaging m	1328	31	DTC 1164: Adaptive-learn NG low	520203	1
DTC 1317: Cylinder 7 misfire detected	1329	11	DTC 1155: Closed-loop gasoline bank1 high	520204	0
DTC 307: Cylinder 7 emissions/catalyst damaging m	1329	31	DTC 1156: Closed-loop gasoline bank1 low	520204	1
DTC 1318: Cylinder 8 misfire detected	1330	11	DTC 1157: Closed-loop gasoline bank2 high	520205	0
DTC 308: Cylinder 8 emissions/catalyst damaging m	1330	31	DTC 1158: Closed-loop gasoline bank2 low	520205	1
DTC 628: Fuel-pump high-side open or short to grou	1347	5	DTC 1151: Closed-loop LPG high	520206	0
DTC 629: Fuel-pump high-side short to power	1347	6	DTC 1152: Closed-loop LPG low	520206	1
DTC 629: Fuel pump relay coil short to power	1348	3	DTC 1153: Closed-loop NG high	520207	0
DTC 628: Fuel pump relay control ground short	1348	4	DTC 1154: Closed-loop NG low	520207	1
DTC 627: Fuel pump relay coil open	1348	5	DTC 154: EGO2 open / lazy	520208	10
DTC 1625: J1939 shutdown request	1384	31	DTC 140: EGO3 open / lazy	520209	10
DTC 687: Power relay coil short to power	1485	3	DTC 160: EGO4 open / lazy	520210	10
DTC 686: Power relay ground short	1485	4	DTC 420: Catalyst inactive on gasoline (Bank 1)	520211	10
DTC 685: Power relay coil open	1485	5	DTC 430: Catalyst inactive on gasoline (Bank 2)	520212	10
DTC 234: Boost control overboost failure	1692	0	DTC 1165: Catalyst inactive on LPG	520213	10
DTC 299: Boost control underboost failure	1692	1	DTC 1166: Catalyst inactive on NG	520214	10
DTC 236: TIP active	1692	2	DTC 1515: AUX analog Pull-Down 1 high voltage	520215	3
DTC 1666: PWM8 short to power	2646	3	DTC 1516: AUX analog Pull-Down 1 low voltage	520215	4
DTC 1665: PWM8 open / ground short	2646	5	DTC 1511: AUX analog Pull-Up 1 high voltage	520216	3

Description	DTC Set 2		Description	DTC Set 2	
	SPN-2	FMI-2		SPN-2	FMI-2
DTC 1670: PWM9 short to power	2647	3	DTC 1512: AUX analog Pull-Up 1 low voltage	520216	4
DTC 1669: PWM9 open / ground short	2647	5	DTC 1513: AUX analog Pull-Up 2 high voltage	520217	3
DTC 8906: UEGO return voltage shorted high	3056	3	DTC 1514: AUX analog Pull-Up 2 low voltage	520217	4
DTC 8907: UEGO return voltage shorted low	3056	4	DTC 1517: AUX analog Pull-Up 3 high voltage	520218	3
DTC 8910: UEGO sense cell voltage high	3217	3	DTC 1518: AUX analog Pull-Up 3 low voltage	520218	4
DTC 8911: UEGO sense cell voltage low	3217	4	DTC 1541: AUX analog Pull-Up/Down 1 high voltage	520219	3
DTC 8908: UEGO pump voltage shorted high	3218	3	DTC 1542: AUX analog Pull-Up/Down 1 low voltage	520219	4
DTC 8909: UEGO pump voltage shorted low	3218	4	DTC 1543: AUX analog Pull-Up/Down 2 high voltage	520220	3
DTC 8904: UEGO cal resistor voltage high	3221	3	DTC 1544: AUX analog Pull-Up/Down 2 low voltage	520220	4
DTC 8905: UEGO cal resistor voltage low	3221	4	DTC 1545: AUX analog Pull-Up/Down 3 high voltage	520221	3
DTC 8901: UEGO microprocessor internal fault	3221	31	DTC 1546: AUX analog Pull-Up/Down 3 low voltage	520221	4
DTC 8916: UEGO sense cell impedance high	3222	0	DTC 1551: AUX digital 1 high voltage	520222	3
DTC 8902: UEGO heater supply high voltage	3222	3	DTC 1552: AUX digital 1 low voltage	520222	4
DTC 8903: UEGO heater supply low voltage	3222	4	DTC 1553: AUX digital 2 high voltage	520223	3
DTC 8914: UEGO sense cell slow to warm up	3222	10	DTC 1554: AUX digital 2 low voltage	520223	4
DTC 8917: UEGO pump cell impedance high	3225	0	DTC 1555: AUX digital 3 high voltage	520224	3
DTC 8918: UEGO pump cell impedance low	3225	1	DTC 1555: Water Intrusion Detection	520224	3
DTC 8912: UEGO pump voltage at high drive limit	3225	3	DTC 1556: AUX digital 3 low voltage	520224	4
DTC 8913: UEGO pump voltage at low drive limit	3225	4	DTC 916: Shift actuator feedback out-of-range	520226	3
DTC 8915: UEGO pump cell slow to warm up	3225	10	DTC 919: Shift unable to reach desired gear	520226	7
DTC 171: Adaptive-learn gasoline bank1 high	520200	0	DTC 920: Shift actuator or drive circuit failed	520226	31



Operation Section

Description	DTC Set 2		Description	DTC Set 2	
	SPN-2	FMI-2		SPN-2	FMI-2
DTC 172: Adaptive-learn gasoline bank1 low	520200	1	DTC 1639: PWM5 open / ground short	520230	5
DTC 174: Adaptive-learn gasoline bank2 high	520201	0	DTC 1640: PWM5 short to power	520230	6

**DIAGNOSTIC TROUBLE CODE (DTC) CHART – SORTED BY SPN:FMI (4 of 4)**

Description	DTC Set 2	
	SPN-2	FMI-2
DTC 188: Gaseous fuel temperature sender high voltage	520240	3
DTC 187: Gaseous fuel temperature sender low voltage	520240	4
DTC 331: Knock2 excessive or erratic signal	520241	2
DTC 332: Knock2 sensor open or not present	520241	4
DTC 2120: FPP1 invalid voltage and FPP2 disagrees	520250	31
DTC 2125: FPP2 invalid voltage and FPP1 disagrees	520250	31
DTC 1122: FPP1/2 do not match each other or IVS (	520250	31
DTC 223: TPS2 voltage high	520251	3
DTC 222: TPS2 voltage low	520251	4
DTC 509: IAC coil open/short	520252	5
DTC 508: IAC ground short	520252	6
DTC 1171: MegaJector delivery pressure higher than	520260	0
DTC 1172: MegaJector delivery pressure lower than	520260	1
DTC 1174: MegaJector voltage supply high	520260	3
DTC 1175: MegaJector voltage supply low	520260	4
DTC 1176: MegaJector internal actuator fault detection	520260	12
DTC 1177: MegaJector internal circuitry fault detection	520260	12
DTC 1178: MegaJector internal comm fault detection	520260	12
DTC 1173: MegaJector comm lost	520260	31
DTC 1531: Gov1/2/3 interlock failure	520270	31
DTC 1182: Fuel impurity level high	520401	0
DTC 11: Intake cam / distributor position error	520800	7
DTC 24: Exhaust cam position error	520801	7
DTC 1183: MegaJector autozero / lockoff failure	520803	31
DTC 57: EGOH 4 Open / Ground Short	3271	4

## Lift Truck Operation

### Power Shift Transaxle

1. Start the engine. See topic "Starting the Engine."

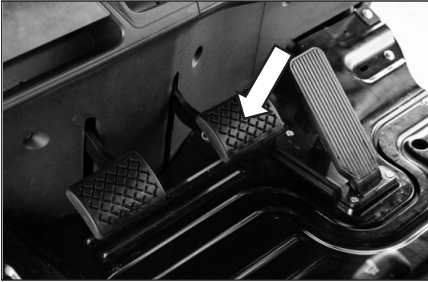

2. Push down on the service brake pedal to hold the lift truck until ready to move it.
3. Release the parking brake.

**NOTE :** The parking brake must be released before the directional control can be used.



4. Select the direction of travel by pushing the directional lever FORWARD for forward direction or by pulling the lever BACK for reverse direction.

#### **WARNING**

A lift truck with the engine running but without an operator can move slowly (creep) if the transmission is engaged.

This could result in personal injury.

Always place the transmission control lever in the NEUTRAL (centre) position and apply the parking brake before dismantling the lift truck.

5. Release the service brake.

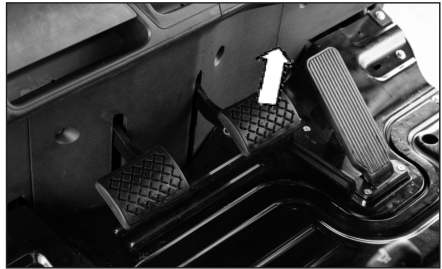

6. Push down on the accelerator pedal to obtain the desired travel speed. Release the pedal to decrease travel speed.

#### **WARNING**

Sudden reversal of a loaded lift truck traveling forward can cause the load to fall or the lift truck to tip over.

Stop the loaded lift truck completely, before shifting to reverse.

Failure to comply could result in personal injury.

**NOTE :** Where conditions permit, directional changes can be made under full power at speeds up to 8 km/h (5 mph). A speed of 8 km/h (5 mph) is a fast walk. Directional shift changes at speeds above 8 km/h (5 mph) are considered abusive. Bring the lift truck to a complete stop where load stability or other factors prevent safe operation under full power shifts safe operation under full power shifts.



7. To change the lift truck direction of travel, release the accelerator pedal.
8. Push down on the service brake pedal to reduce the lift truck speed as necessary.



9. Move the directional lever to the desired direction of travel. Slowly push down on the accelerator pedal as the lift truck changes direction.
10. When the direction change is completed, continue to push down on the accelerator pedal to obtain the desired travel speed.



11. To stop the lift truck when traveling in either direction, release the accelerator pedal.
12. Push down on the service brake pedal and bring the lift truck to a smooth stop.

## Inching

**NOTE :** The purpose of the inching pedal is to provide precise lift truck inching control at very slow travel speed and high engine rpm. This is used for fast hydraulic lift, during load approach, pick up or load positioning.



1. To inch (creep) in either direction, slowly push down on the inching pedal. This will start to apply the service brakes and allow the transmission clutch discs to slip.
2. Vary the position of the inching pedal and the accelerator pedal to control the inching speed and distance.
3. Pushing down further on the inching pedal will disengage the transmission completely and apply the service brakes fully to stop and hold the lift truck. This will provide full engine power for fast hydraulic lift.
4. Avoid overuse of the inching pedal as this may cause the automatic transmission oil to overheat or the clutch to slip. Do not use as a footrest or for long periods of time.
5. If user operates continuously pushing work or both brake pedal and accelerator pedal were depressed at the same time, it may cause the automatic transmission oil to overheat or the clutch to slip.

## Steering Knob (If Equipped)

There is a steering knob available for inclusion with new truck deliveries. This option is solely intended for slow travel situations when two handed steering is not possible due to hydraulic operations.

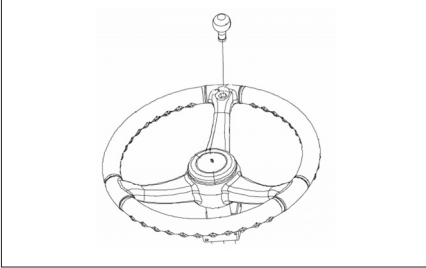

### **WARNING**

**Loss of stability can occur when a lift truck steering wheel is rotated quickly while the truck is in motion. A steering knob will assist with easy rotation of the steering wheel, but if a steering knob is improperly used (e.g., rotating the steering wheel quickly while the truck is in motion), this can contribute to truck instability and a tip over. A steering knob is intended for slow travel maneuverability ONLY.**

---

## Operating Techniques

### Inching into Loads

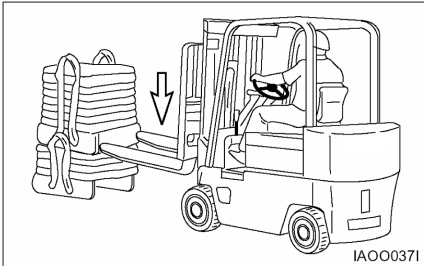

1. Move the lift truck slowly **FORWARD** into position and engage the load. The truck should be square with load, forks spaced evenly between pallet stringers and as far apart as load permits.

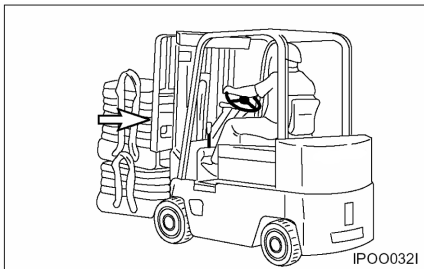

2. Move the lift truck **FORWARD** until the load touches the carriage.

### Lifting the Load

1. Lift the load carefully and tilt the mast back a short distance.

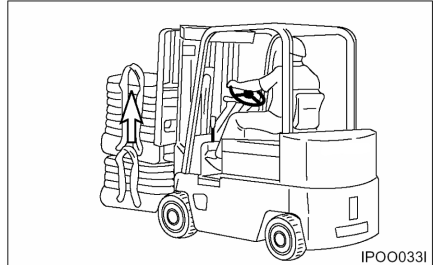

2. Tilt the mast further back to cradle the load

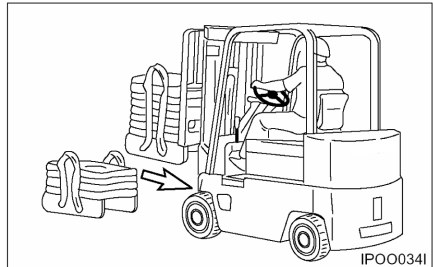

3. Operate the lift truck in reverse until the load is clear of the other material.
4. Lower the cradled load to the travel position.

**NOTE :** Lift and tilt speeds are controlled by engine rpm.

## Traveling with the Load

### NOTICE

Travel with the load as low as possible, while still maintaining ground clearance.

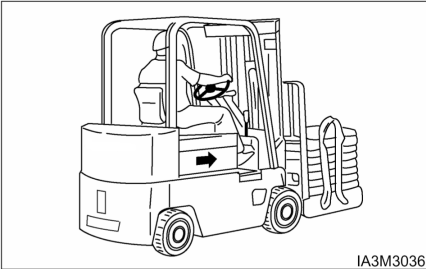

1. Travel with the load uphill on upgrades and downgrades.

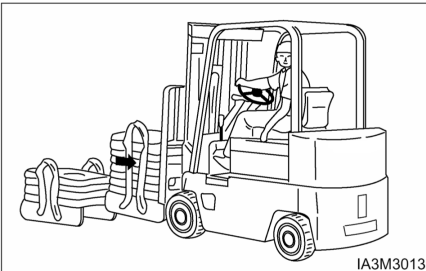

2. For better vision, travel in reverse with bulky loads.

## Unloading

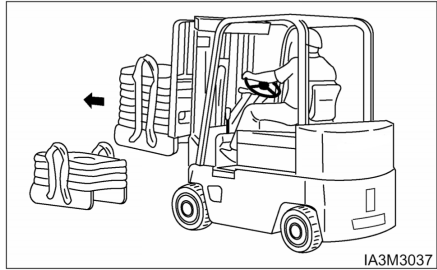

1. Move the lift truck into the unloading position.

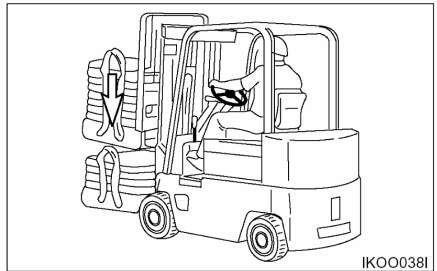

2. Tilt the mast FORWARD only when directly over the unloading area.

### **⚠ WARNING**

**Do not tilt the mast forward with the load unless directly over the unloading area, even if the power is off.**

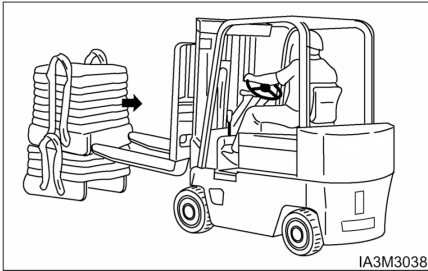

3. Deposit the load and BACK away carefully to disengage the forks.

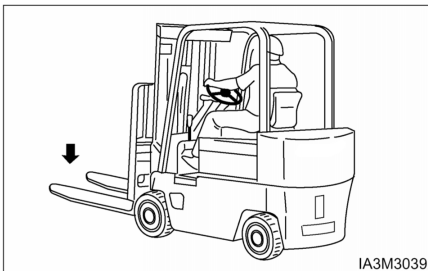

4. Lower the carriage and forks to the travel position or to the park position.

## Turning

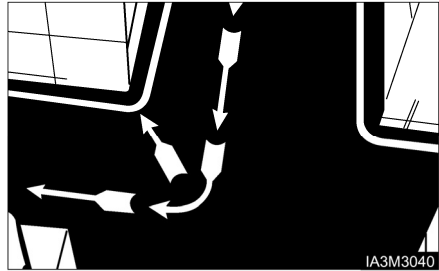

1. When turning sharp corners, keep close to the inside corner. Begin the turn when the inside drive wheel meets the corner.



2. In narrow aisles, keep away from the stockpile when turning into the aisle. Allow for counterweight swing.



## Lifting Drums or Round Objects

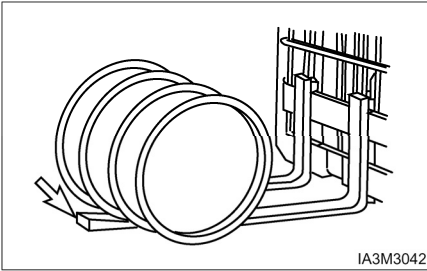

1. Block drums or round objects. Tilt the mast **FORWARD** and side the fork tips along the floor to get under the load.

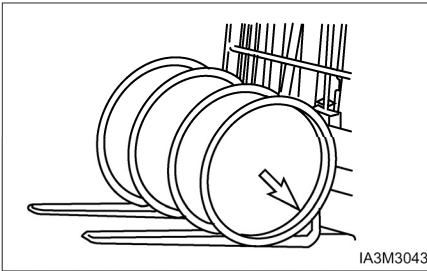

2. Before lifting, tilt the mast **BACK** slightly until the load is cradled on the forks.

## Operating in Hot Weather

Keep the following points in mind when you operate the lift truck in hot weather.

1. Check the radiator. Clogging can cause the overheating. Clean them out regularly with a blast of compressed air. Also, check the leakage of water.
2. Check the fan belt tension and adjust to proper tension
3. Even if the engine overheats and the coolant boils over, let the engine idle for a while with opening engine hood until temperature falls before shut off the engine.

## Safety instructions for attachments when transporting suspended loads

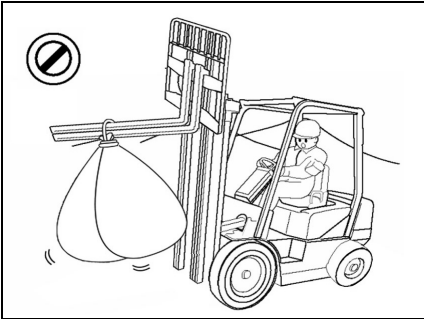

### **⚠ WARNING**

Swinging/wide loads and a reduced residual capacity can result in accidents.

Adapt the travel speed to the load, less than walking pace.

Secure swinging loads for example with lifting slings.

Reduce the residual capacity and have it certified by an expert.

Failure to follow the operation precautions may cause early damage to parts.

## Safety instructions for attachments when transporting wide loads

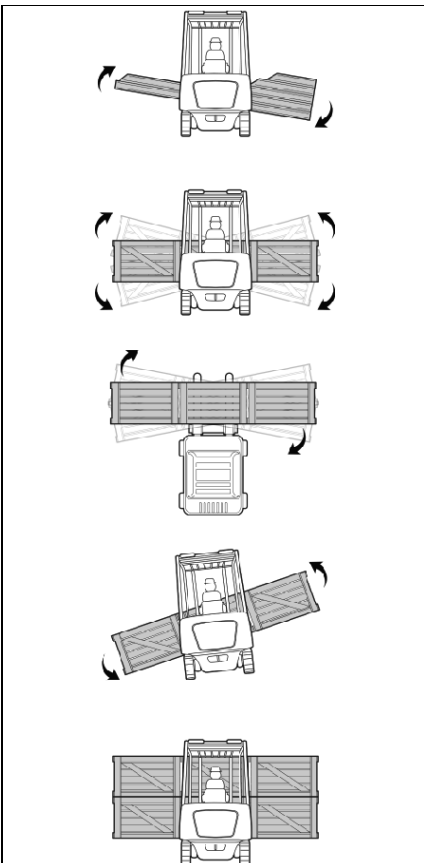

### **Load lateral centre of gravity**

Where it is necessary to lift a wide load where the lateral load centre of gravity is unknown.

Do a test lift first to determine lateral centre of gravity and potential movement with the load during transport. Exercise extra caution when handling offcentre loads that cannot be centred.

### **Load Stability**

Be careful when stopping or changing direction suddenly, lifting or lowering suddenly as wide loads could become unstable.

### **Load Swing**

Be careful whilst travelling or turning, the load ends will swing wide. Make sure you have adequate clearance, and watch out for people in the area.

### **Load Shift**

Be careful when turning, turn slowly to prevent load from shifting.

### **Visibility**

When carrying a bulky load which blocks or restricts forward visibility the truck shall be driven with the load trailing and if necessary under the direction of a person who has visibility in the direction of travel, unless safe work practices allow otherwise.

## Parking the Lift Truck

Park the lift truck level, with the forks lowered and the mast tilted forward until the fork tips touch the floor. Block the drive wheels when parking on an incline.



1. Park in an authorised area only. Do not block traffic. If LP - Gas equipped, do not park near elevator shafts or any other area where LP-Gas could collect in a pocket (low area), causing a potentially dangerous condition.

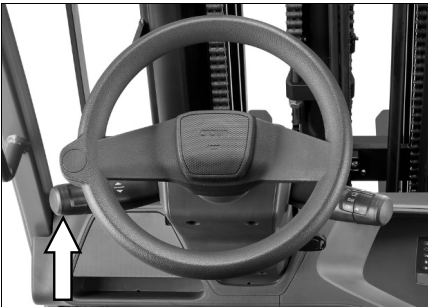

2. Place the transmission controls in NEUTRAL.
3. Engage the parking brake.
4. Lower the forks to the ground.

### WARNING

Blocking the wheels will prevent unexpected lift truck movement, which could cause personal injury.

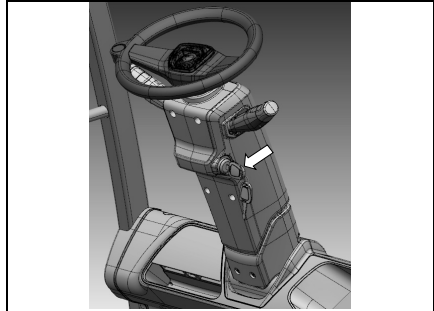

5. Turn the key in the ignition switch to the OFF position and remove the key.

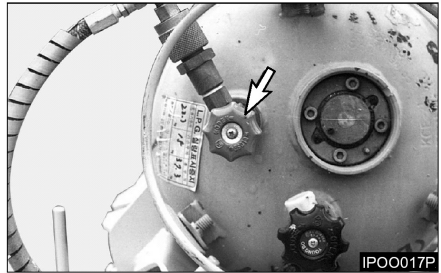

**NOTE :** If an LP- Gas equipped lift truck is stopped or parked for an indefinite or prolonged period of time, shut off the LP-Gas fuel tank valve.

6. Actuate each loading lever several times to remove the residual pressure in the respective cylinders and hoses.
7. Block the drive wheels if parking on an incline.

## Lift Fork Adjustment

### WARNING

When adjusting the fork spread, be careful not to pinch your hand between forks and the carriage slot.

---

### Hook-on type Fork

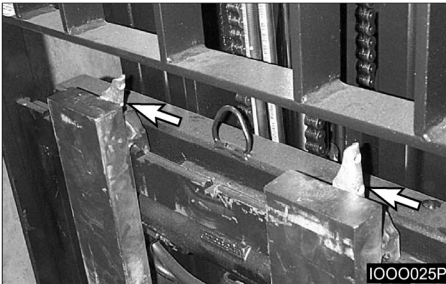

1. Move up the hook pin to the free position.
2. Raise the hook pin in each fork to side the fork on the carriage bar.
3. Adjust the forks in the position most appropriate for the load and as wide as possible for load stability.
4. When adjusting the forks, make sure that the weight of the load is centred on the truck.
5. After adjustment, set the fork locks to keep the forks in place.

### WARNING

**Make sure the forks are locked before carrying a load.**

**If the fork/locking pin is not fully engaged, the fork could become unintentionally disengaged.**

---

## Storage Information

### Before Storage

Before storing your lift truck, clean and inspect as the following procedures.

- Wipe away grease, oil, etc. adhering to the body of the truck with waste cloth, and use water, if needed.
- While cleaning the truck, check general condition of the truck. Especially check the truck body for recess or damage and tyres for wear or nails or stones in the tread.
- Fill the fuel tank with fuel specified.
- Check for leakage of hydraulic oil, engine oil, fuel, or coolant, etc.
- Apply grease, where needed.
- Check for looseness of nuts and bolts, especially hub nuts.
- Check mast rollers to see that they rotate smoothly.
- Prime the oil into the lift cylinders by actuating the lift lever all the way several times.
- Drain off coolant completely in water of cold weather, if antifreeze is not used.

### Long Time Storage

Perform the following service and checks in addition to the "Parking the lift truck" services.

- Taking the rainy season into consideration, park the machine at a higher and hard ground.
- Avoid parking on soft grounds such as an asphalt ground in summer.
- Dismount the battery from the machine. Even though the machine is parked indoors, if the place is hot or humid, the battery should be kept in a dry, cool place. Charge the battery once a month.
- Apply antirust to the exposed parts which tend to rust.
- Cover components such as the breather and air cleaner which may be caught with humidity.

- The machine should be operated at least once a week. Fill the cooling system, if cooling water is discharged, and mount the battery. Start the engine and warm up thoroughly. Move the machine a little forwards and backwards. Operate the hydraulic controls several times.

### To Operate the Lift Truck after a Long Time Storage

- Remove covers and antirust from each of the components and exposed parts.
- Drain the engine crankcase, transmission (clutch type machine), differential and final reduction gear, clean the inside of them and add new oil.
- Drain off foreign matter and water from the hydraulic oil tank and fuel tank.
- Remove the head cover from the engine cylinder. Oil valves and rocker shaft and check each valve for proper operation.
- Add cooling water to the specified level.
- Charge the battery and mount it on the machine. Connect the cables.
- Perform pre-operational checks carefully. (refer to "Before Starting the Engine")
- Warm up the machine.

## Transportation Hints

### Lift Truck Shipping

Check travel route for overpass clearances. Make sure there is adequate clearance if the lift truck being transported is equipped with a high mast, overhead guard or cab.

To prevent the lift truck from slipping while loading or shifting in transit, remove ice, snow or other slippery material from the loading dock and the truck bed before loading.

---

#### NOTICE

Obey all state and local laws governing the weight, width and length of a load.  
Observe all regulations governing wide loads.

---

#### NOTICE

Remove ice, snow or other slippery material from the shipping vehicle and the loading dock.

---

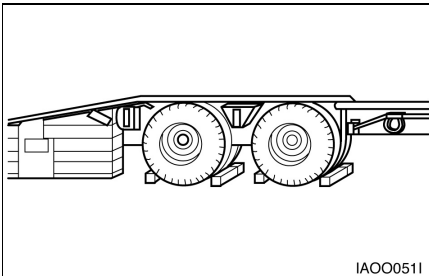

Always block the trailer or the rail car wheels before loading the lift truck. Position the lift truck on the truck bed or the rail car.

Apply the parking brake and place the directional control lever in NEUTRAL.

Turn the ignition switch to the OFF position and remove the key. If LP-Gas equipped, shut off the LP Gas fuel tank.

Block the wheels and secure the lift truck with tiedowns.

## Machine Lifting and Tiedown Information

---

#### NOTICE

Improper lifting or tiedowns can allow load to shift and cause injury and/or damage.

---

1. Weight and instructions given herein apply to lift trucks as manufactured by CROWN.
2. Use proper rated cables and slings for lifting. Position the crane for level lift truck lift.
3. Spreader bar widths should be sufficient to prevent contact with the lift truck.
4. Use the tiedown locations provided for lift truck tiedown.

Check the state and local laws governing weight, width and length of a load.

Contact your CROWN Lift Truck branch for shipping instructions for your lift truck.

## Lifting a Forklift using a Crane

### WARNING

1. If lifting rope breaks, serious injury/damage may occur.
2. The lifting wire rope and stay must be long enough to avoid contact with the forklift. Short rope/stay can damage the vehicle. If it's too long, it may cause interference.  
If sling and LP tank contact happens during refloatation operation, you should get rid of tank of vehicle with LP tank first, and then proceed.  
Cover the rope/chain with rubber or cloth to prevent damage to the vehicle, as necessary.
3. Rope/chain and other lifting tools must have sufficient strength, and free of any defect or wear.
4. Avoid impact load to the lifting devices/tools.

1. Check the weight, length, width and height of the vehicle before lifting.
2. Park the crane at an appropriate position.
3. Connect the rope/chain to the points A and B of the figure below.
4. If the wire rope/chain contacts the vehicle, insert a rubber plate between the rope/chain and the vehicle to protect the vehicle.

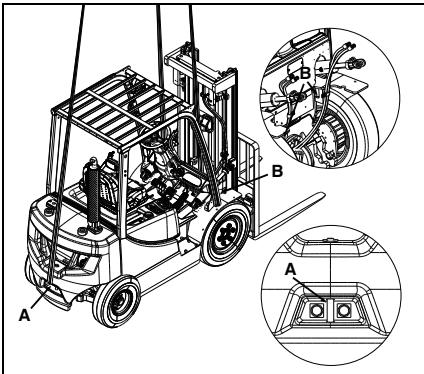

5. Lift up the vehicle slowly.

## How to Fix Forklift to a Carrier

1. The rope/chain must have sufficient length for fixing.
2. Park the vehicle on a level ground.
3. Set the mast vertically. Lower the fork or attachment to the lowest position.
4. Set all the operating devices to Neutral Position. Turn OFF the start switch.
5. Apply the parking brake. Stop the tyres with blocks (C).
6. Connect towing hooks to the mast top B (if without mast, front drive axle fix frame or front fender bottom fixing hole D) and rear tow pin A, as shown in the figure below.

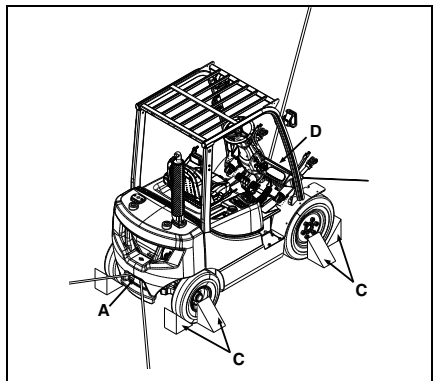
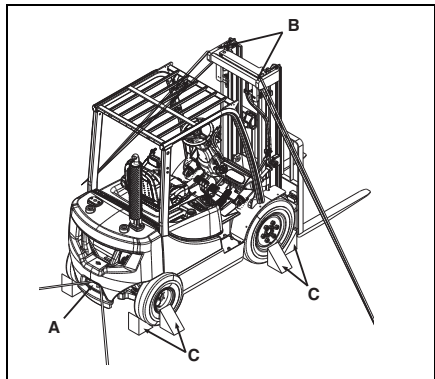

## Towing Information

### WARNING

**Personal injury or death could result when towing a disabled lift truck incorrectly.**

**Block the lift truck wheels to prevent movement before releasing the brakes. The lift truck can roll free if it is not blocked.**

**Follow the recommendations below, to properly perform the towing procedure.**

These towing instructions are for moving a disabled lift truck a short distance, at low speed, no faster than 2 km/h (1.2 mph), to a convenient location for repair. These instructions are for emergencies only. Always haul the lift truck if long distance moving is required.

Shield must be provided on the towing lift truck to protect the operator if the tow line or bar should break.

Do not allow riders on the lift truck being towed unless the operator can control the steering and/or braking.

Before towing, make sure the tow line or bar is in good condition and has enough strength for the towing situation involved. Use a towing line or bar with a strength of at least 1.5 times the gross weight of the towing lift truck for a disabled lift truck stuck in the mud or when towing on a grade.

Keep the tow line angle to a minimum. Do not exceed a 30° angle from the straight ahead position. Connect the tow line as low as possible on the lift truck that is being towed.

Quick lift truck movement could overload the tow line or bar and cause it to break. Gradual and smooth lift truck movement will better.

Normally, the towing lift truck should be as large as the disabled lift truck. Satisfy yourself that the towing lift truck has enough brake capacity, weight and power, to control both lift trucks for the grade and the distance involved.

To provide sufficient control and braking when moving a disabled lift truck downhill, a larger towing lift truck or additional lift trucks connected to the rear could be required. This will prevent uncontrolled rolling. The different situation requirements cannot be given, as minimal towing lift truck capacity is required on smooth level surfaces to maximum on inclines or poor surface conditions.

Consult your CROWN Lift Truck branch for towing a disabled lift truck.

1. Release the parking brake.

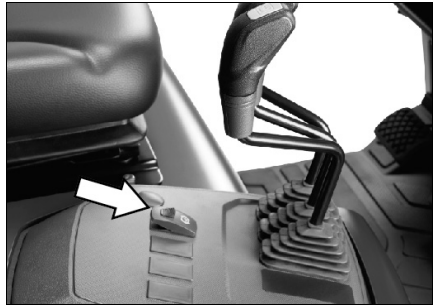

### NOTICE

Release the parking brake to prevent excessive wear and damage to the parking brake system.

2. Check that the service brake pedal is released.
3. Key switch is in the OFF position.
4. Direction control lever is in neutral.
5. Fasten the tow bar to the lift truck.
6. Remove the wheel blocks. Tow the lift truck slowly. Do not tow any faster than 2 km/h (1.2 mph).

### WARNING

**Be sure all necessary repairs and adjustments have been made before a lift truck that has been towed to a service area is put back into operation.**



## Electronic Parking Brake

---

### NOTICE

In the case of the electronic parking brake, it always stays engaged when the ignition is off, regardless of where the parking switch is positioned. Before towing the vehicle, therefore, you have to release the parking brake by force to prevent excessive wear and damage on the park brake components or tyres.

---

### How to Release by Force

1. Secure the wheels with blocks.
2. Secure the emergency-release spool (2) and remove the emergency-release nut (1).

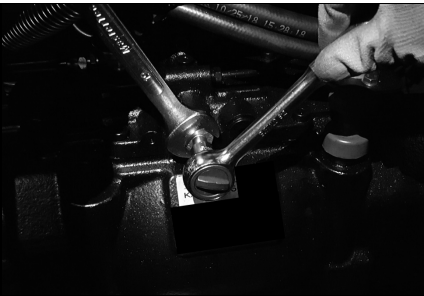
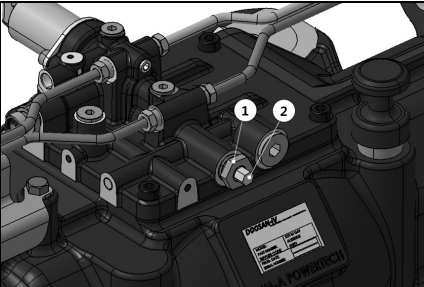

3. Fully tighten the emergency-release spool (2).

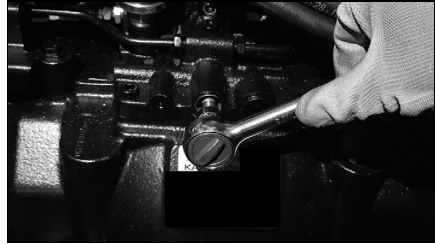

4. Tighten the emergency-release nut (1).

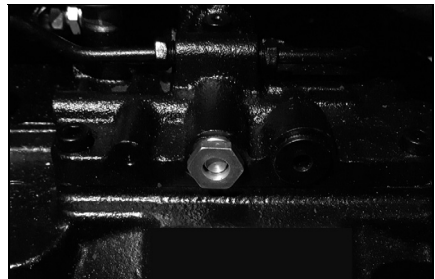

5. Press the brake pedal at least ten times until the pressure builds up high enough.

(If you depress the pedal too deeply, the pedal may get caught; press the pedal by approximately 80% of its full distance, and in case that the pedal is caught, take it out and continue pedal depression.)

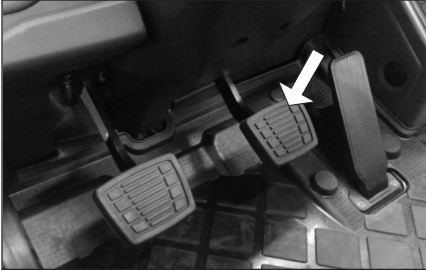

6. Connect a tow bar to the forklift.
7. Take out the supporting blocks and tow the forklift slowly. Keep the towing speed no higher than 2 km/h.

(If the wheels remain secured, repeat step 4.)

**⚠ WARNING**

**Be sure all necessary repairs and adjustments have been made before a lift truck that has been towed to a service area is put back into operation.**

**NOTE:** On the completion of towing the forklift, you must return the emergency-release spool to its original position; otherwise, both the service and parking brakes do not work.

### How to Return the Emergency-Release Spool

1. Secure the wheels with blocks.
2. Remove the emergency-release nut (1).



3. Loosen the emergency-release spool (2) until the starting point of its thread is aligned with the inlet surface indicated by the arrow.

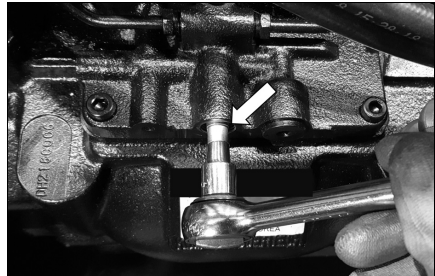

Operation Section

4. Secure the emergency-release spool (2) and tighten the emergency-release nut (1).

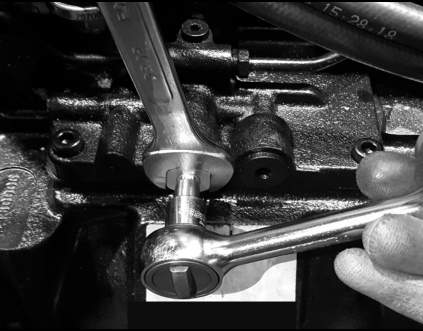

5. Press the pedal a number of times until the pressure builds up high enough.

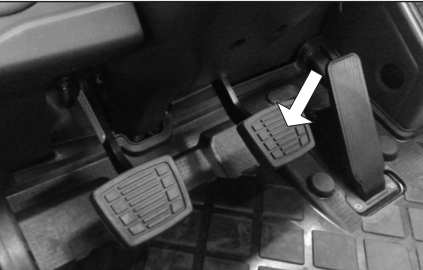

6. After starting up the forklift, take out its supporting blocks and check that the service brake works normally during travel and the parking brake secures the forklift when on a slope.
7. If you need to press the pedal too deeply, perform air removal.

## Jacking Information

### WARNING

Jacking up Truck can be dangerous and should be done only by trained personnel using proper tools and procedures.

Block the lift truck wheels to prevent movement while lifting the wheels. The lift truck can roll free if it is not blocked.

Follow the recommendations below, to properly perform the jacking procedure.

### NOTICE

Move Trucks to a Secure Non Traffic Maintenance Area with a Level Floor. No Load on Forks.  
Remove key from ignition switch.

## Hydraulic Jack & Jack Stand Capacity

### Hydraulic Jack Capacity

	Model	Height Minimum*	Minimum Requirement	
1 ton class	CGC15/18S-5/9 CGC20SC-5/9,	100mm	2000Kg	4400lbs
	CD15/18S-5, CD20SC-5, CG15/18S-5, CG20SC-5	150mm		
2 ton class	CD20/25/30/33S-5/7, CD35C-5/7, CG20/25/30E-5, CG20/25/30/33P-5/7, CG35C-5/7	150mm	3000Kg	6600lbs
	CGC20/25/30/33E-5, CGC20/25/30/33P-5 CGC20/25/30/33S-9	120mm		
4 ton class	CD35/40/45S-5/7, CD50/55C-5/7, CD40/45/50/55SC-5/7, CG35/40/45S-5/7, CG50/55C-5/7, CG40/45/50/55SC-5/7 CGC35/45S-9, CGC55C-9	180mm	3900Kg	8600lbs
6 ton class	CD50/60/70S-5/7, CG50/60/70S-5/7	250mm	5800Kg	12800lbs
8 ton class	CD80/90S-5/7	250mm	7500Kg	16500lbs
11 ton class	CD110/130/160S-5	300mm	10000 Kg	22050lbs
18/20 ton class	CDV180/200S-7	350 mm	14000 Kg	30900lbs
25 ton class	CDV250S-7	400 mm	19000 Kg	42000lbs

\* The height of lift truck with a flat tyre is lower than with an inflated tyre. So Height Minimum of Jack must be less than the value of the above chart.

Stand Capacity should be more than the minimum requirement of Hydraulic Jack Capacity.

Hydraulic Jack & Jack Stand are commercially available and should be especially designed for forklift trucks.

## Jacking Procedure

### Steering Wheel

1. Raise Forks 3 to 6 in (76 to 152 mm) from Floor.
2. Place Wheel Chocks under Both Drive Wheels.
3. Locate Hydraulic Jack under Steering Axle as Shown in Figure A.
4. Jack Up Truck with Hydraulic Jack.
5. Set Jack Stand Height as Required Not to Exceed 16 in (405mm).

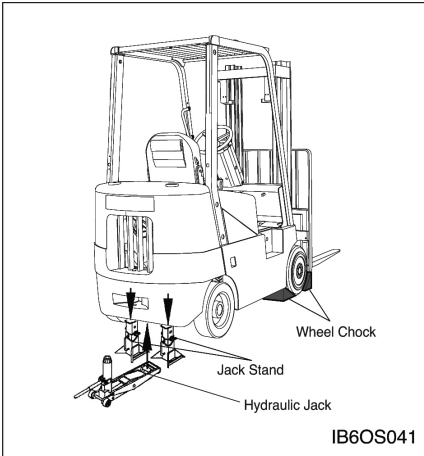

Figure A

### Side

1. Lower Forks Completely.
2. Locate Hydraulic Jack under Frame as Shown in Figure B.
3. Jack Up One Side of Truck.
4. Place Hard Wood Block directly under First Stage Mast.
  - 1ton/2ton class - Use 6X6 in (150X150mm) Block
  - 3ton/5ton class - Use 8X8 in (200X200mm) Block
  - 11ton class - Use 12X12 in (300X300mm) Block
5. Jack Up Opposite Side of Truck.
6. Place Second Hard Wood Block under Other Side of First Stage Mast.
7. Do Not Tilt Mast after Blocked.

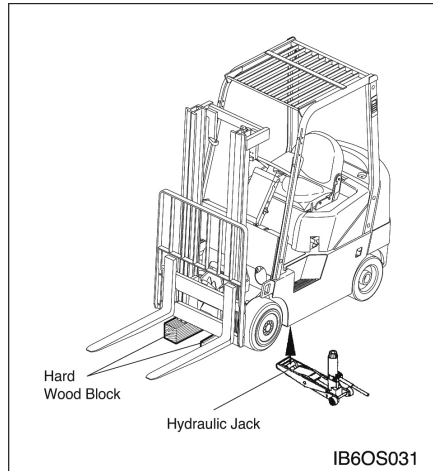

Figure B

### WARNING

Locate Hydraulic Jack under Frame. Do NOT locate on side panel. Do NOT raise side of truck any more than required to insert hard wood block.

### WARNING

Locate Hydraulic Jack and Jack Stands under steer axle. Do NOT locate Hydraulic Jack or Jack Stands on Counter Weight.

## Inspection, Maintenance and Repair of Lift Truck Forks

The following section gives practical guidelines for inspection, maintenance and repair of lift truck forks. It also provides general information on the design and application of forks and the common cause of fork failures.

Lift truck forks can be dangerously weakened by improper repair or modification. They can also be damaged by the cumulative effects of age, abrasion, corrosion, overloading and misuse.

A fork failure during use can cause damage to the equipment and the load. A fork failure can also cause serious injury.

A good fork inspection and maintenance program along with the proper application can be very effective in preventing sudden failures on the job.

Repairs and modifications should be done only by the fork manufacturer or a qualified technician who knows the material used and the required welding and heat treatment process.

Users should evaluate the economics of returning the forks to the manufacturer for repairs or purchasing new forks. This will vary depending on many factors including the size and type of fork.

Forks should be properly sized to the weight and length of the loads, and to the size of the machine on which they are used. The general practice is to use a fork size such that the combined rated capacity of the number of forks used is equal to or greater than the "Standard(or rated) Capacity" of the lift truck.

The individual load rating, in most cases, will be stamped on the fork in a readily visible area. This is generally on the top or side of the fork shank.

- A fork rated at 1500 pounds at 24 inch load centre will be stamped 1500B24.
- A fork rated at 2000 kg at 600 mm load centre will be stamped 2000B600.

The manufacturer identification and year and date of manufacture is also usually shown.

Some countries have standards or regulations which apply specifically to the inspection and repair of forks.

Users may also refer to the International Organization For Standardization - ISO Technical Report 5057 - Inspection and Repair of Fork Arms and ISO Standard 2330 - Fork Arms-Technical Characteristics and Testing.

Users should be familiar with the requirements for inspection and maintenance of lift trucks as provided by Australian Standard AS2359.

## Causes of Fork Failure

### Improper Modification or Repair

Fork failure can occur as a result of a field modification involving welding, flame cutting or other similar processes which affect the heat treatment and reduces the strength of the fork.

In most cases, specific processes and techniques are also required to achieve proper welding of the particular alloy steels involved. Critical areas most likely to be affected by improper processing are the heel section, the mounting components and the fork tip.

### Bent or Twisted Forks

Forks can be bent out of shape by extreme overloading, glancing blows against walls or other solid objects or using the fork tip as a pry bar.

Bent or twisted forks are much more likely to break and cause damage or injury. They should be removed from service immediately.

### Fatigue

Parts which are subjected to repeated or fluctuating loads can fail after a large number of loading cycles even though the maximum stress was below the static strength of the part.

The first sign of a fatigue failure is usually a crack which starts in an area of high stress concentration. This is usually in the heel section or on the fork mounting.

As the crack progresses under repetitive load cycling, the load bearing cross section of the remaining metal is decreased in size until it becomes insufficient to support the load and complete failure occurs.

Fatigue failure is the most common mode of fork failure. It is also one which can be anticipated and prevented by recognizing the conditions which lead up to the failure and by removing the fork service prior to failing.

- Repetitive Overloading

Repetitive cycling of loads which exceeds the fatigue strength of the material can lead to fatigue failure. The overload could be caused by loads in excess of the rated fork capacity and by use of the forks tips as pry bars. Also, by handling loads in a manner which causes the fork tips to spread and the forks to twist laterally about their mountings.

- Wear

Forks are constantly subjected to abrasion as they slide on floors and loads. The thickness of the fork blade is gradually reduced to the point where it may not be capable of handling the load for which it was designed.

- Stress Risers

Scratches, nicks and corrosion are points of high stress concentration where cracks can develop. These cracks can progress under repetitive loading in a typical mode of fatigue failure.

## Overloading

Extreme overloading can cause permanent bending or immediate failure of the forks. Using forks of less capacity than the load or lift truck when lifting loads and using forks in a manner for which they were not designed are some common causes of overloading.

## Fork Inspection



Establish a daily and 12 month inspection routine by keeping a record for the forks on each lift truck.

Initial information should include the machine serial number on each the forks are used, the fork manufacturer, type, original section size, original length and capacity. Also list any special characteristics specified in the fork design.

Record the date and results of each inspection, making sure the following information is included.

- Actual wear conditions, such as percent of original blade thickness remaining.
- Any damage, failure or deformation which might impair the use of the truck.
- Note any repairs or maintenance.

An ongoing record of this information will help in identifying proper inspection intervals for each operation, in identifying and solving problem areas and in anticipating time for replacement of the forks.

## First Installation

1. Inspect forks to ensure they are the correct size for the truck on which they will be used. Make sure they are the correct length and type for the loads to be handled.

If the forks have been previously used, perform the "12 Month Inspection".

If the forks are rusted, see "Maintenance and Repair".

2. Make sure fork blades are level to each other within acceptable tolerances. See "Forks, Step 4," in the "2000 Service Hours or Yearly" in "Maintenance Intervals"
3. Make sure positioning lock is in place and working. Lock forks in position before using truck. See "Forks, Step 7", in the "2000 Service Hours or Yearly" in "Maintenance Intervals"

## Daily Inspection

1. Visually inspect forks for cracks, especially in the heel section, around the mounting brackets, and all weld areas. Inspect for broken or jagged fork tips, bent or twisted blades and shanks.
2. Make sure positioning lock is in place and working. Lock the forks in position before using the truck. See "2000 Service Hours or Yearly" in "Maintenance Intervals".
3. Remove all defective forks from service.



## 12 Months Inspection

Forks should be inspected, at a minimum, every 12 months. If the truck is being used in a multi-shift or heavy duty operation, they should be checked every six months. See “Forks” in the “2000 Service Hours or Yearly” in “Maintenance Intervals.”

## Maintenance and Repair

1. Repair forks only in accordance with the manufacturer’s recommendations.

Most repairs or modifications should be done only by the original manufacturer of the forks or an expert knowledgeable of the materials, design, welding and heat treatment process.

2. The following repairs or modifications SHOULD NOT be attempted.

- Flame cutting holes or cutouts in fork blades.
- Welding on brackets or new mounting hangers.
- Repairing cracks or other damage by welding.
- Bending or resetting.

3. The following repairs MAY be performed.

- Forks may be sanded or lightly ground, to remove rust, corrosion or minor defects from the surfaces.
- Heel sections may be ground with a carbon stone to remove minor surface cracks or defects. Polish the inside radius of the heel section to increase the fatigue life of the fork. Always grind or polish in the direction of the blade and shank length.
- Repair or replace the positioning locks on hook type forks.
- Repair or replace most fork retention devices used with other fork types.

4. A fork should be load tested before being returned to service on completion of repairs authorised and done in accordance with the manufacturer’s recommendations.

Most manufacturers and standards require the repaired fork to be tested with a load 2.5 times the specified capacity and at the load centre marked on the fork arm.

With the fork restrained in the same manner as its mounting on the lift truck, apply the test load twice, gradually and without shock. Maintain the test for 30 seconds each time.

Check the fork arm before and after the second application of the test load. It shall not show any permanent deformation.

Consult the fork manufacturer for further information as may be applicable to the specific fork involved.

Testing is not required for repairs to the positioning lock or the markings.

## Torque Specifications Metric Hardware

Most of the nuts, bolts, studs, and threaded holes in your lift truck are metric. In this manual we provide specifications in both metric and U.S. customary measurement. Always replace metric hardware with metric hardware. See the parts books for proper replacement.

**NOTE :** For proper fit, use only metric tools on metric hardware. Non-metric tools might slip and cause injury.

## Torque for Standard Hose Clamps - Worm Drive

### NOTICE

The chart below gives the torques for initial installation of hose clamps on new hose and for reassembly or retightening of hose clamps on existing hose.

Clamp Width	Initial Installation Torque On New Hose	
	N·m <sup>1</sup>	lb·in
16 mm (.625 in)	7.5 + 0.5	65 + 5
13.5 mm (.531 in)	4.5 + 0.5	40 + 5
8 mm (.312 in)	0.9 + 0.2	8 + 2
Clamp Width	Reassembly Or Retightening Torque	
	N·m <sup>1</sup>	lb·in
16 mm (.625 in)	4.5 + 0.5	40 + 5
13.5 mm (.531 in)	3.0 + 0.5	25 + 5
8 mm (.312 in)	0.7 + 0.2	6 + 2

<sup>1</sup> 1 Newton meter (N·m) is approximately the same as 0.1 kg·m.

## Torque for Standard Bolts, Nuts, and Taperlock Studs

### NOTICE

The two charts below give general torques for bolts, nuts, and taperlock studs of SAE Grade 5 or better quality.

## Torques for Bolts and Nuts With Standard Threads

Thread Size Inch	Standard Nut and Bolt Torque	
	N·m <sup>1</sup>	lb·ft
1/4	12 + 4	9 + 3
5/16	25 + 7	18 + 5
3/8	45 + 7	33 + 5
7/16	70 + 15	50 + 11
1/2	100 + 15	75 + 11
9/16	150 + 20	110 + 15
5/8	200 + 25	150 + 18
3/4	360 + 50	270 + 37
7/8	570 + 80	420 + 60
1	875 + 100	640 + 75
1 1/8	1100 + 150	820 + 110
1 1/4	1350 + 175	1000 + 130
1 3/8	1600 + 200	1180 + 150
1 1/2	2000 + 275	1480 + 200

<sup>1</sup> 1 Newton meter (N·m) is approximately the same as 0.1 kg·m.

**Torques for Taperlock Studs**

Thread Size Inch	Standard Taperlock Stud Torque	
	N·m <sup>1</sup>	lb·ft
1/4	8 + 3	6 + 2
5/16	17 + 5	13 + 4
3/8	35 + 5	26 + 4
7/16	45 + 10	33 + 7
1/2	65 + 10	48 + 7
5/8	110 + 20	80 + 15
3/4	170 + 30	125 + 22
7/8	260 + 40	190 + 30
1	400 + 60	300 + 45
1 1/8	500 + 700	370 + 50
1 1/4	650 + 80	480 + 60
1 3/8	750 + 90	550 + 65
1 1/2	870 + 100	640 + 75

<sup>1</sup> 1 Newton meter (N·m) is approximately the same as 0.1 kg·m.

**Torque for Metric Fasteners**

**NOTICE**

Be very careful never to mix metric with U.S. customary (standard) fasteners. Mismatched or incorrect fasteners will cause lift truck damage or malfunction and may even result in personal injury.

Original fasteners removed from the lift truck should be checked for any damages and kept for reassembly whenever possible. If new fasteners are needed, they must be of the same size and grade as the ones that are being replaced.

The material strength identification is usually shown on the bolt head by numbers (8.8, 10.9, etc.). This chart gives standard torques for bolts and nuts with Grade 8.8.

For mounting torques of main parts, Please refer to Service manual for detail.

**NOTE :** Metric hardware must be replaced with metric hardware. Check parts book.

Thread Size Metric	Standard Torque	
	N·m <sup>1</sup>	lb·ft
M6	12 + 4	9 + 3
M8	25 + 7	18 + 5
M10	55 + 10	41 + 7
M12	95 + 15	70 + 11
M14	150 + 20	110 + 15
M16	220 + 30	160 + 22
M20	450 + 70	330 + 50
M24	775 + 100	570 + 75
M30	1600 + 200	1180 + 150
M36	2700 + 400	2000 + 300

<sup>1</sup> 1 Newton meter (N·m) is approximately the same as 0.1 kg·m.

<sup>2</sup> ISO - International Standards Organization.

## Cooling System Specifications

### Coolant Information

**NOTE :** The following information is generic and valid for lift trucks.

Engine operating temperatures have increased to improve engine efficiency. This means proper cooling system maintenance is especially important. Overheating, overcooling, pitting, cavitation erosion, cracked heads, piston seizures, and plugged radiators are classic cooling system failures. In fact, coolant is as important as the quality of fuel and lubricating oil.

---

#### NOTICE

CROWN recommends that the coolant mixture contain a minimum of 30% antifreeze or equivalent.

Never add coolant to an overheated engine, engine damage can result. Allow the engine to cool first.

All water is corrosive at engine operating temperature. The cooling system should be protected with a 3 to 6% concentration of liquid supplemental coolant additive at all times, regardless of the concentration of antifreeze.

Excessive supplemental coolant additive greater than the recommended 6%, together with concentration of antifreeze greater than 65% can cause deposits to form and can result in radiator tube blockage, overheating, and/or water pump seal damage.

If the machine is to be stored in, or shipped to, an area with freezing temperatures, the cooling system must be protected to the lowest expected outside (ambient) temperature.

The engine cooling system is normally protected to  $-28^{\circ}\text{C}$  ( $-20^{\circ}\text{F}$ ) with antifreeze, when shipped from the factory unless special requirements are defined.

---

Check the specific gravity of the coolant solution frequently in cold weather to ensure adequate protection.

Clean the cooling system if it is contaminated, if the engine overheats or if foaming is observed in the radiator.

Old coolant should be drained, the system cleaned and new coolant added every 2000 service hours or yearly.

Refer to topic, "Cooling System-Clean, Change" in every 2000 service hours or yearly section.

Filling at over 20 liters (5 U.S. gallons) per minute can cause air pockets in the cooling system.

After draining and refilling the cooling system, operate the engine with the radiator cap removed until the coolant reaches normal operating temperature and the coolant level stabilises. Add coolant as necessary to fill the system to the proper level.

Never operate without a thermostat in the cooling system. Cooling system problems can arise without a thermostat.

## Coolant Water

Hard water, or water with high levels of calcium and magnesium ions, encourages the formation of insoluble chemical compounds by combining with cooling system additives such as silicates and phosphates.

The tendency of silicates and phosphates to precipitate out-of-solution increases with increasing water hardness. Hard water, or water with high levels of calcium and magnesium ions encourages the formation of insoluble chemicals, especially after a number of heating and cooling cycles.

CROWN prefers the use of distilled water or deionized water to reduce the potential and severity of chemical insolubility.

MINIMUM ACCEPTABLE WATER	
Water Content	Limits gr/gal(ppm)
Chlorides (Cl)	2.4(40) maximum
Sulfates (SO <sub>4</sub> )	5.9(100) maximum
Total hardness	10(170) maximum
Total solids	20(340) maximum
PH	5.5 to 9.0

ppm = parts per million

Using water that meets the minimum acceptable water requirement may not prevent drop-out of these chemical compounds totally, but should minimise the rate to acceptable levels.

## Antifreeze

### Make proper antifreeze additions.

Adding pure antifreeze as a makeup solution for cooling system top-up is an unacceptable practice. It increases the concentration of antifreeze in the cooling system which increase the concentration of dissolved solids and undissolved chemical inhibitors in the cooling system. Add antifreeze mixed with water to the same freeze protection as your cooling system.

**Use the chart below to assist in determining the concentration of antifreeze to use.**

Antifreeze Concentrations	
Protection Temperature	Concentration
Protection to -15°C (5°F)	30% antifreeze and 70% water
Protection to -23°C (-10°F)	40% antifreeze and 60% water
Protection to -37°C (-34°F)	50% antifreeze and 50% water
Protection to -51°C (-60°F)	60% antifreeze and 40% water

## Fuel Specifications

### LP-Gas Specifications

LP-Gas is “Liquefied Petroleum Gas”. The exact composition of LP-Gas varies slightly between different parts of the country and different refineries. HD5 is recommended for CROWN forklift trucks. Remember LP-Gas is heavier than air and will sink to the lowest spot possible. Avoid areas near floor drains or lubrication pits where escaped fuel may collect.

Composition of HD5	
Propane (C <sub>3</sub> H <sub>8</sub> )	90.0 %
Propylene	up to 5 %
Butane (C <sub>4</sub> H <sub>10</sub> )	2.0 %
iso-Butane	1.5 %
Methane (CH <sub>4</sub> )	1.5 %
Total	100 %

#### **WARNING**

**Remember LP-Gas is heavier than air and will sink to the lowest spot possible. Avoid areas near floor drains or lubrication pits where escaped fuel may collect.**

---

# Lubricant Specifications

## Lubricant Information

Certain abbreviations follow Society of Automotive Engineers (SAE) J754 nomenclature and some classifications follow SAE J183 abbreviations.

The MIL specifications are U.S.A. Military Specifications.

The recommended oil viscosities can be found in the Lubricant Viscosities chart in this publication.

Grease is classified by the National Lubricating Grease Institute (NLGI) based on ASTM D217-68 Worked Penetration characteristics which are given a defined consistency number.

## Engine Oil (DEO and EO)

The following oil specifications provide guidelines for the selection of commercial products:

- LP-Gas Engine: API SL or higher

**NOTE** : Engine Oil Service hours can be extended to 500 hours by using CROWN supplied specific oil. Please consult CROWN branch about it.

---

### NOTICE

Failure to follow the oil recommendations can cause shortened engine life due to carbon deposits or excessive wear.

---

Consult the EMA Lubricating Oils Data Book for a listing of oil brands.

**NOTE** : The percentage of sulphur in the fuel will affect the engine oil recommendations. For fuel sulphur effects, the Infrared Analysis or the ASTM D2896 procedure can be used to evaluate the residual neutralization properties of an engine oil. The sulphur products formation depends on the fuel sulphur content, oil formulation, crankcase blowby, engine operating conditions and ambient temperature.

## Hydraulic Oil (HYDO)

The following commercial classifications can be used in the hydraulic system.

- |                     |           |
|---------------------|-----------|
| • ISO 6743/4        | HM        |
| • AFNOR NFE 48-603  | HM        |
| • DIN 51524 TEIL 2  | H-LP      |
| • HAGGLUNDS DENISON | HFO-HF2   |
| • CINCINNATI        | P68,69,70 |

Viscosity: ISO VG32

Industrial premium hydraulic oils that have passed the Vickers vane pump test (35VQ25).

These oils should have antiwear, antifoam, antirust and antioxidation additives for heavy duty use as stated by the oil supplier. ISO viscosity grade of 32 would normally be selected.

---

### NOTICE

Make-up oil added to the hydraulic tanks must mix with the oil already in the systems. Use only petroleum products unless the systems are equipped for use with special products.

If the hydraulic oil becomes cloudy, water or air is entering the system. Water or air in the system will cause pump failure. Drain the fluid, retighten all hydraulic suction line clamps, purge and refill the system. Consult your CROWN Lift Truck branch for purging instructions.

---

## Transmission & Drive axle Oil

---

### NOTICE

This oil is formulated for transmissions and drive trains only, and should not be used in engines.

Shortened engine life will result.

---

**NOTE:** Multi-grade oils are not blended by CROWN for use in transmissions. Multi-grade oils which use high molecular weight polymers as viscosity index improvers lose their viscosity effectiveness by permanent and temporary shear of the viscosity index improver and therefore, are not recommended for transmission and drive train compartments.

**NOTE:** Failure to follow this recommendation can cause shortened transmission life due to material incompatibility, inadequate frictional requirements for disk materials and/or excessive gear wear.

Select the oil that meets the following specification.

### GM DEXRON III

## Lubricating Grease (MPGM)

Use Multipurpose Molybdenum Grease (MPGM) for all lubrication points. If MPGM grease can not be used, a multipurpose type grease which contains 3% to 5% molybdenum disulfide can be used.

NLGI No.2 grade is suitable for most temperatures. Use NLGI No.1 or No.0 grade for extremely low temperature.

## Brake Fluid

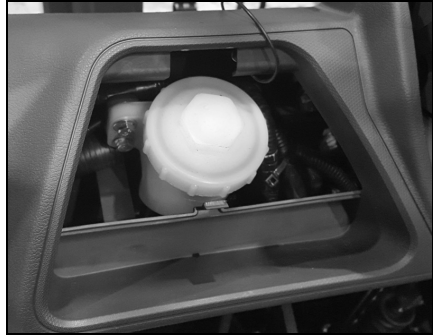

### Oil Cooled Disc Brake Only

Use heavy duty hydraulic brake fluid certified by oil supplier to meet the latest version of following classifications.

- ISO 6743/4 HM
- AFNOR NFE 48-603 HM
- DIN 51524 TEIL 2 H-LP
- HAGGLUNDS DENISON HFO-HF2
- CINCINNATI P68,69,70

Viscosity: ISO VG32

Brake reservoir oils that have passed the Vickers vane pump test (35VQ25). These oils should have antiwear, antifoam, antirust and antioxidation additives for heavy duty use as stated by the oil supplier. ISO viscosity grade of 32 would normally be selected.

The following products are authorised for use.

Supplier	Product Name
TOTAL	AZOLLAZS
SHELL	TELLUS
MOBIL	DTE20S'
CALTEX	RANDO HD
ESS	NOTO H
CASTROL	HYSPIN AWS



# Lubricant Viscosities and Refill Capacities

## Lubricant Viscosities

LUBRICANT VISCOSITIES FOR AMBIENT (OUTSIDE) TEMPERATURES						
Compartment or System	Oil Viscosities	°C		°F		
		Min	Max	Min	Max	
Engine Crankcase 4G63 API SL	SAE 5W30	-30	+30	-22	+86	
	SAE 10W30	-20	+30	-4	+86	
	SAE 5W40	-30	+40	-22	+104	
	SAE 10W40	-20	+40	-4	+104	
	SAE 15W40	-10	+40	+14	+104	
	SAE 15W50	-10	+50	+14	+122	
	SAE 20W50	-5	+50	+23	+122	
Power Shift Transmission & Drive Axle DEXRON III	DEXRON III	-20	+50	-4	+122	
Hydraulic and Power Steering System ISO 6743/4 HM	ISO VG32	-20	+30	-4	+86	
	ISO VG46	-10	+40	+14	+104	
	ISO VG68	0	+50	+32	+122	
Brake Reservoir	Disc Brake (OCDB) ISO 6743/ 4 HM	ISO VG32	-20	+30	-4	+86

The SAE grade number indicates the viscosity of oil. A proper SAE grade number should be selected according to ambient temperature.

## Refill Capacities

Refill Capacities (Approximate)		
Compartment or System	Liters	U.S. Gal.
Engine Crankcase w/Filter 4G63 LP-Gas	4.9	1.29
Cooling System w/Coolant Recovery Bottle 4G63 LP-Gas	9.0	2.38
Fuel Tank LP-Gas-G-Series	15.2Kg	33.5 lb
<b>Power Shift Transmission + Drive axle</b>	<b>15.5</b>	<b>4.09</b>
Hydraulic & Power Steering System	25	6.25
Brake System	0.6	0.16

## Maintenance Intervals

---

### NOTICE

Users should be familiar with the requirements for inspection and maintenance of lift trucks as provided by Australian Standard AS2359.

---



---

### NOTICE

Never exceed the Maintenance Intervals specified in the manual. Defects and/or damage to the important functional components may be resulted in.

---



---

### NOTICE

All maintenance and repair, except every 10 service hours or daily, on the lift truck must be performed by qualified and authorised personnel only.

---



---

### NOTICE

Careless disposal of waste oil can harm the environment and can be dangerous to persons. Always dispose of waste oil to an authorised personnel only.

---

### When Required

Operator's Seat, Hood Latch and Support Cylinder - Check, Lubricate .....	123
Fuses & Relay Change .....	123
Tyre and Wheels - Inspect, Check .....	124
Test Fuel System for Leaks .....	125
Battery Terminal - Clean, Inspect .....	125
Wheel Bolts - Inspect .....	126
Carriage Roller Extrusion – Adjust .....	126

### Every 10 Service Hours or Daily

Walk-Around Inspection – Inspect .....	127
Inspect Engine for Fluid Leaks .....	128
Engine Oil Level – Check .....	128
Coolant Level - Check .....	128
Air Intake System - Check .....	129
Inspect Foot Pedal Operation .....	130
Inspect Engine for Exhaust Leaks .....	130
Mast Channels - Lubricate .....	130

Transmission & Drive axle Oil Level – Check .....	130
Hydraulic Oil Level – Check .....	131
Brake Oil Level – Check .....	131

### First 50-100 Service Hours or a Week

Parking Brake - Test, Adjust .....	132
Transmission & Drive axle Oil, Oil Filter - Change .....	132

### Every 250 Service Hours or Monthly

Engine Oil Filter – Change .....	134
----------------------------------	-----

### Every 500 Service Hours or 3 Months

Air Intake System - Check, Clean .....	135
Belts - Check, Adjust .....	137
Tilt Cylinders - Check, Adjust, Lubricate .....	137
Cylinder Rod Extension - Adjust .....	138
Mast Hinge Pin - Lubricate .....	138
Crosshead Roller - Inspect .....	138
Parking Brake - Test, Adjust .....	139
Overhead Guard - Inspect .....	139
Steering Mechanism - Check, Lubricate .....	139
Inspect Vacuum Lines and Fittings .....	140
Inspect Electrical System .....	140
PCV Valve System - Inspect, Clean .....	140
Mast, Carriage, Lift Chains & Attachments - Inspect, Lubricate .....	140

### Every 1000 Service Hours or 6 Months

Hydraulic Return Filter, Breather & Strainer - Check, Change .....	141
Lift Chains - Test, Check, Adjust .....	142
Universal Joint – Inspect .....	144
Inspect Coolant Hoses .....	144
LP Regulator/Converter Inspection .....	144
Fuel Lines & Fittings - Check .....	145
Inspect Mixer Assembly .....	145
Inspect Throttle Assembly .....	145

### Every 1500 Service Hours or 9 Months

Inspect Ignition .....	146
Replace Spark Plugs .....	146
Replace LP Fuel Filter Element .....	147
Testing Fuel Lock-off Operation .....	148

---

**Every 2000 Service Hours or Yearly**

Steer Wheel Bearings - Repack ..... 149  
Cooling System – Clean, Change ..... 150  
Fork - Inspect..... 151  
Transmission & Drive axle Oil, Oil Filter - Change  
..... 153  
Transmission & Drive axle Strainer – Clean..... 153

**Every 2500 Service Hours or 15 Months**

Hydraulic Oil - Change, Check, Clean ..... 154  
Inspect Battery System ..... 154  
Replace Oxygen Sensor ..... 155  
Checking the TMAP Sensor ..... 155  
Inspect for Intake Leaks ..... 156  
Replace PCV Valve and breather element..... 156

**Every 8000 Service Hours or 48 Months**

Timing Belt - Change..... 157

**Environment Protection**

Environment Protection..... 158

Quick Reference to Maintenance Schedule			FIRST	EVERY								
ITEMS	SERVICES	PAGE	When Required	50-100 Service Hours or a Week	10 Service Hours or Daily	250 Service Hours or Monthly	500 Service Hours or 3 Months	1000 Service Hours or 6 Months	1500 Service Hours or 9 Months	2000 Service Hours or Yearly	2500 Service Hours or 15 Months	8000 Service Hours or 48 Months
Air Intake System	Check	129			○							
Air Intake System	Check, Clean	135				○						
Battery System	Inspect	154									○	
Battery Terminal	Clean, Inspect	125	○									
Belts	Check, Adjust	137				○						
Brake Oil Level	Check	131			○							
Carriage Roller Extrusion	Adjust	126	○									
Coolant Hoses	Inspect	144					○					
Coolant Level	Check	128			○							
Cooling System	Clean, Change	150								○		
Crosshead Roller	Inspect	138					○					
Cylinder Rod Extension	Adjust	138					○					
Electrical System	Inspect	140					○					
Engine for Exhaust Leaks	Inspect	130			○							
Engine for Fluid Leaks	Inspect	128			○							
Engine Oil Filter	Change	134				○						
Engine Oil Level	Check	128			○							
Foot Pedal Operation	Inspect	130			○							
Fork	Inspect	151								○		
Fuel Lines & Fittings	Check	145					○					
Fuel Lock-off Operation	Test	148						○				
Fuel System for Leaks	Test	125	○									
Fuses & Relay	Change	123	○									
Hydraulic Oil	Change, Check, Clean	154									○	
Hydraulic Oil Level	Check	131			○							
Hydraulic Return Filter, Breather & Strainer	Check, Change	141					○					
Ignition	Inspect	146						○				
Intake Leaks	Inspect	156									○	
Lift Chains	Test, Check, Adjust	142					○					
LP Fuel Filter Element	Replace	147						○				
LP Regulator/Converter Inspection	Inspect	144					○					
Mast Channels	Lubricate	130			○							
Mast Hinge Pin	Lubricate	138				○						



## When Required

You must read and understand the warnings and instructions contained in the Safety section of this manual, before performing any operation or maintenance procedures.

### Operator's Seat, Hood Latch and Support Cylinder - Check, Lubricate

1. Check the operation of the seat adjuster rod. Make sure that the seat slides freely on its track. Lightly oil the seat slider tracks if necessary.



2. Pull the latch to raise the hood and seat assembly. Make certain the support cylinder will hold the hood open.
3. Lightly oil the hood latch mechanism and the rod for the hood support cylinder.

### Fuses & Relay Change

#### Fuse

**NOTE :** If a fuse filament separates, use only the same type and size fuses for replacement. If the filament in a new fuse separates, have the circuits and instruments checked.

---

#### NOTICE

Always replace fuses with ones of the correct ampere rating.

---

**Fuse** - Protects an electrical circuit from an overload. Opens (filament separates) if an overload occurs.

Check the fuses. Use a flashlight, if necessary.

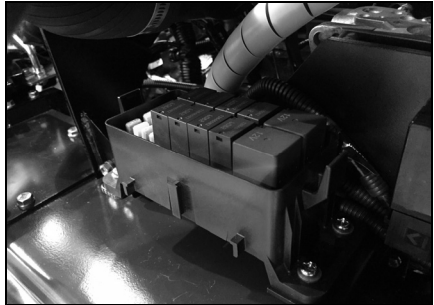

Typical Example

Fuses are identified as follows:

1. SPARE - 20A
2. SPARE - 15A
3. SPARE - 20A
4. SPARE - 10A
5. SPARE - 10A
6. EMPTY
7. IGN - 10A
8. IGN - 10A

- 9. IGN - 20A
- 10. EMPTY
- 11. ST - 10A
- 12. ACC - 20A
- 13. BAT - 10A
- 14. BAT - 10A
- 15. MPR - 10A
- 16. BAT - 15A
- 17. BAT - 15A
- 18. BAT - 15A

Relays are identified as follows:

- 1. C/SPEED
- 2. FWD
- 3. REV
- 4. REAR LAMP
- 5. FRONT LAMP
- 6. MPR

### Bulbs

Bulbs are identified as follows:

- 1. Bulb-head lamp halogen (12V-35W)
- \*2. Bulb-back up (12V-8W)
- \*3. Bulb-turn signal (12V-23W)
- \*4. Bulb-stop & tail (12V-23/8W)
- \*OPTIONALLAMP OR LIGHT

### Circuit Breaker

- 1. Raise the hood and seat assembly. Make sure the support cylinder securely holds the hood open.

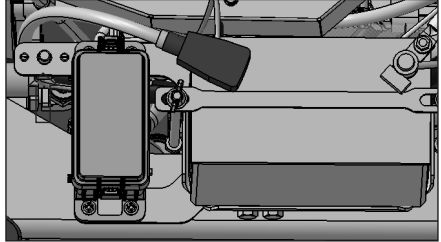

Typical Example

- 2. The main circuit breaker is located on the front of fuse & relay box.

**NOTE :** To reset circuit breakers push in on the but- ton. The button should stay in if the breaker is reset. If the button will not stay in, or comes out shortly after reset, have the circuits checked.

### Tyre and Wheels - Inspect, Check



- 1. Inspect the thickness of the tread area. It should be more than 25 mm (1 inch). If the thickness is less than 25 mm (1 inch), the tyre must be replaced.
- 2. Consult your CROWN branch. Do not try to replace the tyre yourself.
- 3. Inspect the wheels. They should have no cracks or distortion.

## Test Fuel System for Leaks

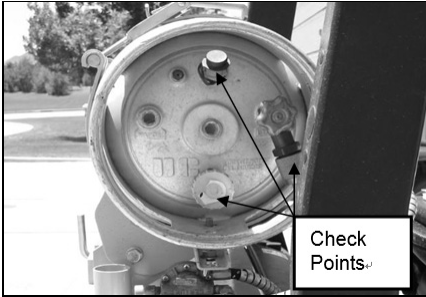

1. Obtain a leak check squirt bottle or pump spray bottle.
2. Fill the bottle with an approved leak check solution.
3. Spray a generous amount of the solution on the fuel system fuel lines and connections, starting at the storage container.
4. Wait approximately 15-60 seconds then perform a visual inspection of the fuel system. Leaks will cause the solution to bubble.
5. Repair any leaks before continuing.
6. Crank the engine through several revolutions. This will energize the fuel lock-off and allow fuel to flow to the pressure regulator/converter. Apply additional leak check solution to the regulator/converter fuel connections and housing. Repeat leak inspection as listed above.
7. Repair any fuel leaks before continuing.

### WARNING

**Prior to any service or maintenance activity, Test Fuel System for Leaks**

## Battery Terminal - Clean, Inspect

### WARNING

Batteries give off flammable fumes that can explode.

Do not smoke when observing the battery electrolyte levels.

Electrolyte is an acid and can cause personal injury if it contacts skin or eyes.

Always wear protective glasses when working with batteries.



Typical Example

1. Clean the top of the battery and terminals.
2. Check terminals for corrosion. Coat terminals with heavy grease.
3. Ensure the battery terminal is firmly tightened and rubber cap is installed.



### Wheel Bolts - Inspect

#### Inspect Tightness - Drive Wheels

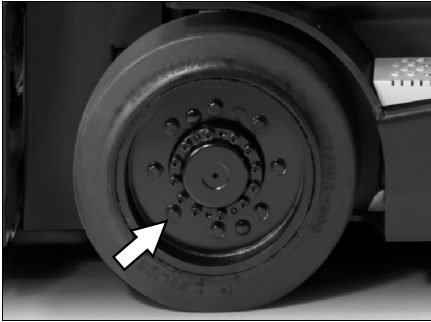

1. Inspect the tightness of the wheel bolts in a sequence opposite each other  $135 + 15 \text{ N}\cdot\text{m}$  (100lb•ft.).

### Carriage Roller Extrusion – Adjust

1. Set the mast vertical.
2. Lower the carriage completely.
3. On full free lift and full free triple lift models, the bottom of the inner mast must be flush with the bottom of the stationary mast.

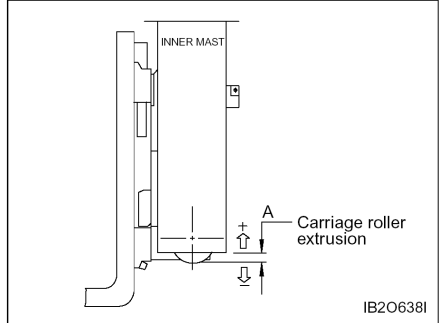

4. Measure the distance from the bottom of the inner upright to the bottom of carriage bearing.
5. The measurement (A) must be as follows in Chart below.

Height of carriage roller extrusion (A)		
STD mast	FF mast	FFT mast
-6	11	11

## Every 10 Service Hours or Daily

You must read and understand the warnings and instructions contained in the Safety section of this manual, before performing any operation or maintenance procedures.

### Walk-Around Inspection – Inspect

For maximum service lift of the lift truck, make a thorough walk-around inspection. Look around and under the truck for such items as loose or missing bolts, debris or dirt buildup, fuel, oil or coolant leaks and cut gouged tyres.

Have any repairs made and debris removed, as needed.



1. Inspect the tyres and wheels for cuts, gouges, foreign objects, inflation pressure and loose or missing bolts.
  2. Inspect the mast and lift chains for wear, broken links, pins and loose rollers.
  3. Inspect the hydraulic system for leaks, worn hoses or damaged lines.
  4. Look for transmission and differential leaks on the lift truck and on the ground.
  5. Inspect the operator's compartment for loose items and cleanliness.
  6. Inspect the instrument panel for broken gauges and indicator lights.
  7. Test the horn and other safety devices for proper operation.
  8. Inspect the cooling system for leaks, worn hoses and debris buildup.
  9. Inspect engine compartment for oil, coolant and fuel leaks.
  10. Inspect the forks.
- Visually inspect forks for cracks, especially in the heel section, around the mounting brackets, and all weld areas.
  - Inspect for broken or jagged fork tips, bent or twisted blades and shanks.
  - Make sure positioning lock is in place and working. Lock the forks in position before using the truck. See "Every 2000 Service Hours or Yearly".
  - Remove all defective forks from service.

## Inspect Engine for Fluid Leaks

1. Start the engine and allow it to reach operating temperatures.
2. Turn the engine off.
3. Inspect the entire engine for oil and/or coolant leaks.
4. Repair as necessary before continuing.

## Engine Oil Level – Check

1. Raise the hood and seat assembly.

### WARNING

Hot oil and components can cause personal injury. Do not allow hot oil or components to contact skin.

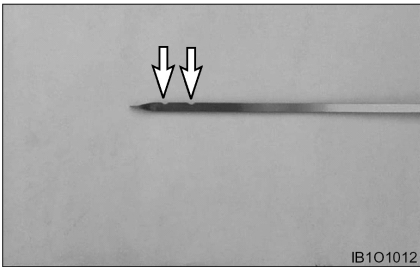
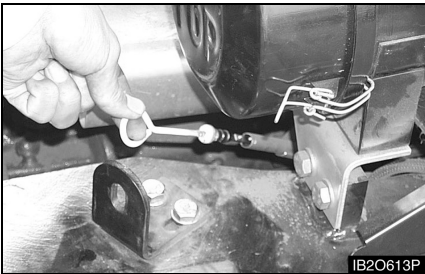

2. The oil level should be close as possible to upper point of the oil dip stick. Do not refill more than upper point.

## Coolant Level - Check

### WARNING

At operating temperature, the engine coolant is hot and under pressure.

Steam can cause personal injury.

Check the coolant level only after the engine has been stopped and the fill cap is cool enough to touch with your bare hand.

Remove the fill cap slowly to relieve pressure.

Cooling system conditioner contains alkali. Avoid contact with the skin and eyes to prevent personal injury.

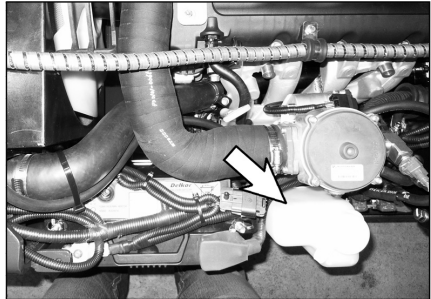

1. Observe the coolant level with engine cold. Maintain coolant level to the proper line on expansion bottle. If the expansion bottle has no coolant, it will be necessary to check coolant at the radiator filler neck.

- Remove the radiator cap. Fill radiator to the top of the filler neck. Inspect radiator cap. Replace if damaged. Install the radiator cap.

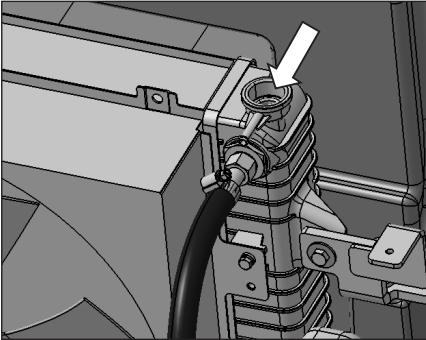

- Start and run the engine to stabilise the coolant level in the filler neck. If low add coolant until it reaches the top of the filler neck. Install the radiator cap. Observe coolant level in the expansion bottle. If necessary, add coolant to bring the coolant to the appropriate line on the expansion bottle.
- Stop the engine.
- Inspect the cooling system for leaks, hose cracks or loose connections.

**⚠ WARNING**

**Pressure air can cause personal injury.**

**When using pressure air for cleaning, wear a protective face shield, protective clothing and protective shoes.**

**Maximum air pressure must be less than 205 kPa (30 psi) for cleaning purposes.**

- Blow any dust and lint from the radiator fins.

## Air Intake System - Check

### Checking Service Indicator

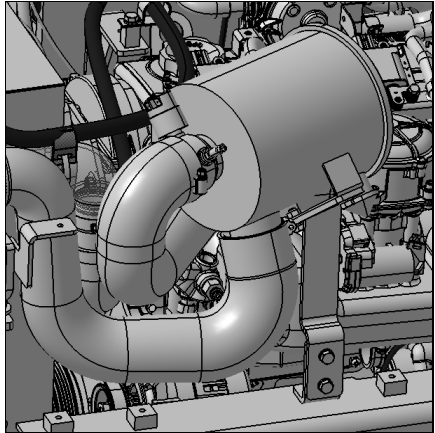

- Observe the air cleaner service indicator.
- Indicates that the air filter is blocked. If the light stays on after starting the engine, stop the engine, remove the air filter element and clean it thoroughly using compressed air. Refit the filter, and check that the light goes out when the engine is started.

**NOTE :** Service the element more frequently, as required, in severe dust or lint conditions. Also, service it more frequently where the operator is required to wear a respirator.

- Close hood and seat assembly.

## Inspect Foot Pedal Operation

- Verify foot pedal travel is smooth without sticking.

### **WARNING**

When the acceleration pedal harness is connected or disconnected, should be worked **KEY OFF** condition.

If not, occurred malfunction, can cause the personal injury.

---

## Inspect Engine for Exhaust Leaks

1. Start the engine and allow it to reach operating temperatures.
2. Perform visual inspection of exhaust system. Repair any/all leaks found.

## Mast Channels - Lubricate



The channels on the roller-type mast require a break-in period. Apply a light film of lubricant on the channels where the rollers ride. This will prevent metal peel until the rollers set a pattern.

## Transmission & Drive axle Oil Level – Check

### **WARNING**

Hot oil and components can cause personal injury. Do not allow hot oil or components to contact skin.

---

1. Start and operate the lift truck until the engine reaches normal operating temperature.
2. Park the lift truck level with the forks lowered, parking brake applied and the transmission controls in NEUTRAL.
3. With the service brake applied and the engine at low idle, shift the directional control lever to forward and then to reverse, to fill the clutches.
4. Shift the direction control lever to the NEUTRAL position.
5. Remove the dip stick/filter cap. Observe the oil level.
6. Maintain the oil level between the Min and Max marks on the dip stick/filter cap.

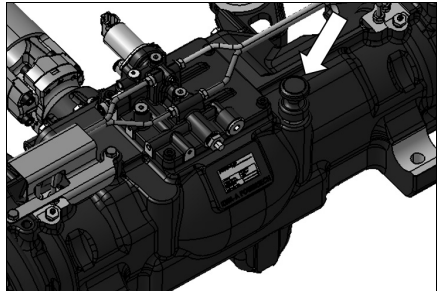

## Hydraulic Oil Level – Check

### WARNING

At operating temperature, the hydraulic tank is hot and under pressure.

Hot oil can cause burns.

Remove the fill cap only when the engine is stopped, and the cap is cool enough to touch with your bare hand. Remove the fill cap slowly to relieve pressure.

1. Operate the lift truck for a few minutes to warm the oil. Park the lift truck on a level surface, with the forks lowered, mast tilted back, parking brake engaged, transmission in NEUTRAL and the engine stopped.
2. Pull the latch and raise the hood and seat assembly. Make sure the air lift cylinder securely holds the hood open.



3. Remove the breather/dip stick. Maintain the oil level to the FULL mark on the breather/dip stick.

## Brake Oil Level – Check

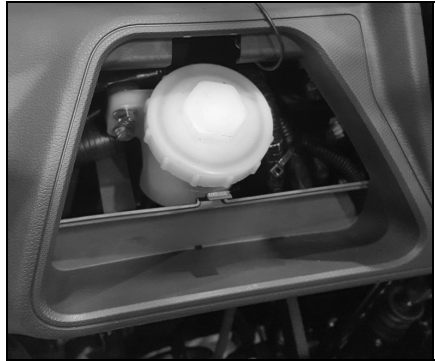

The brake reservoir is located on the left side of the steering column.

1. Remove the filler cap.
2. Maintain the brake fluid level to the fluid level mark on the brake system reservoir.
3. Clean and install the filler cap.

## First 50-100 Service Hours or a Week

You must read and understand the warnings and instructions contained in the Safety section of this manual, before performing any operation or maintenance procedures.

### Parking Brake - Test, Adjust

**NOTE :** Be sure area around the lift truck is clear of personnel and obstructions.

#### Test Operation

1. Drive the lift truck, with a capacity load, forward up a 15% incline [a slope that increases 1.5 meters in 10 meters (1.5 ft increase in 10 ft)].

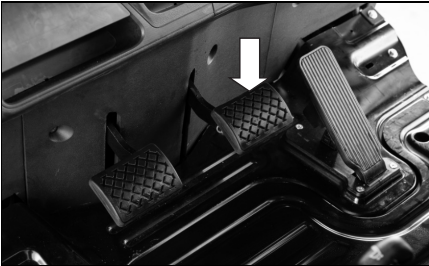

2. Halfway up the incline, stop the lift truck with the service brake.



3. Engage the parking brake. Slowly release the service brake.
4. The parking brake should hold the lift truck. If the lift truck starts to move, immediately apply the service brakes. Have the parking brake adjusted.

### Transmission & Drive axle Oil, Oil Filter - Change

#### **WARNING**

**Hot oil and components can cause personal injury. Do not allow hot oil or components to contact skin.**

#### **NOTICE**

**Transmission Oil and Drive axle Oil are identical and they are circulated.**

Park the lift truck level, with the forks lowered, parking brake engaged, direction control lever in NEUTRAL and the engine stopped.

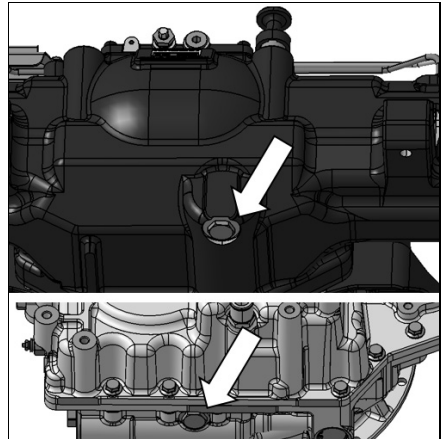

1. Remove Transmission & Drive axle drain plug. Allow the oil to drain into a suitable container. Clean the magnetic drain plug.

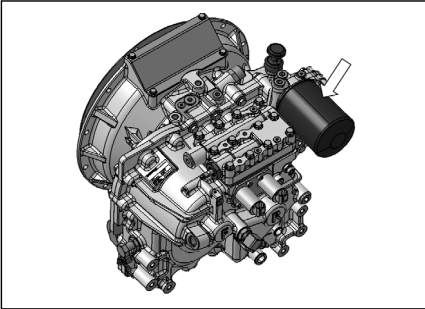

2. Remove the floor mat and the floor plate.
3. Remove and discard the oil filter.
4. Wipe off the filter base. Make certain that all of the old seal is removed.
5. Apply a small amount of clean oil on the seal of the new filter.
6. Install the filter by hand. When the filter contacts the base, tighten an additional 3/4 turn.

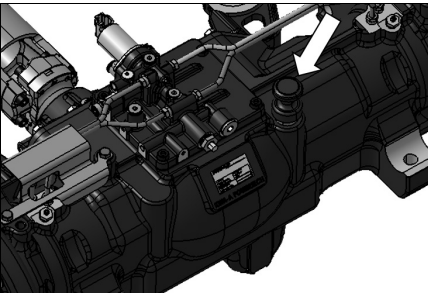

14. Check for oil leaks at the filters and drain plug.
  15. Stop the engine. Install the floor mat and floor plate.
7. Remove the dip stick/filter cap. Fill the compartment with oil. See "Refill Capacities".
  8. Install the dip stick/filter cap.
  9. Start the engine.
  10. With the service brake applied and engine at low idle, shift the direction control lever to forward and reverse to fill the clutches.
  11. Shift the direction control lever into NEUTRAL. Engage the parking brake.
  12. Remove the dip stick/filter cap. Observe the oil level.
  13. Maintain the oil level between the Min and Max marks on the dip stick/filter cap.



## Every 250 Service Hours or Monthly

You must read and understand the warnings and instructions contained in the Safety section of this manual, before performing any operation or maintenance procedures.

### Engine Oil Filter – Change

1. Operate lift truck a few minutes to warm oil. Park the lift truck with the forks lowered, parking brake applied, transmission in neutral and the engine stopped.
2. Raise rear of lift truck off ground and block securely.

**⚠ WARNING**

**Hot oil and components can cause personal injury. Do not allow hot oil or components to contact skin.**

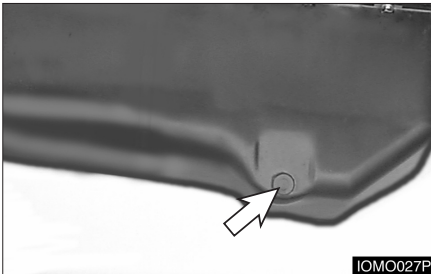

3. Remove the crankcase drain plug and allow oil to drain. Clean and install drain plug.
4. Raise the hood and seat assembly.



5. Remove and discard oil filter element.

6. Wipe sealing surface of oil filter element mounting base. Make sure all of the old gasket is removed.
7. Before installing a new filter element, apply a small amount of clean engine oil to the filter element gasket.
8. Install the new filter element. When the gasket contacts the base, tighten it 3/4 of a turn more. Do not overtighten.
9. Raise the lift truck, remove the blocking and lower the lift truck.
10. Fill the crankcase. See **Refill Capacities**.
11. Start the engine and allow the oil to fill the filter and passages.
12. Check for oil leaks.

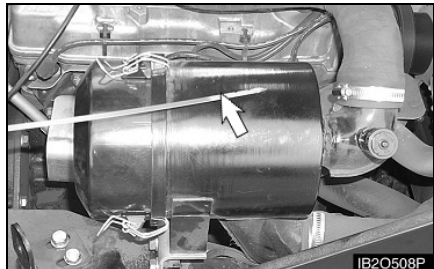

13. Stop the engine and measure the oil level. Maintain the oil level to the FULL mark on the dip stick.
14. Close hood and seat assembly.

**NOTICE**

Engine Oil Service hours can be extended to 500 hours by using CROWN supplied specific oil. Please consult CROWN branch about it.

## Every 500 Service Hours or 3 Months

You must read and understand the warnings and instructions contained in the Safety section of this manual, before performing any operation or maintenance procedures.

### Air Intake System - Check, Clean Servicing Filter Element

---

#### NOTICE

Never service filter with the engine running.

---

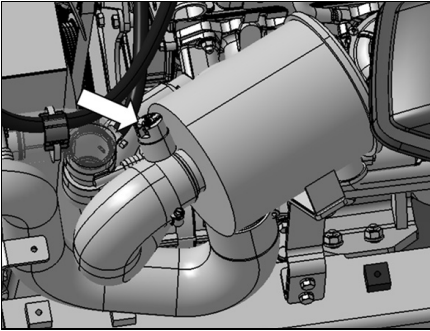

If the air cleaner indicator light stays on after starting the engine, stop the engine, remove the air filter element and clean it thoroughly using compressed air. Refit the filter, and check that the light goes out when the engine is started.

1. To service the air cleaner, raise the hood and seat assembly and remove the side panel. Make certain the support cylinder securely holds the hood open. Loosen the 2 bolts used for assemble the air cleaner bracket until the bracket is detached from frame. (Do not fully loosen the bolts).



2. Hold up and separate the air cleaner assembly (there is no need to disassemble the

bracket and molded hoses from the air cleaner ass'y) from the frame. Locate the assembly proper direction to separate an element.



3. Rotate the element slightly to separate it from its base and remove it from the air cleaner housing.
4. Clean and inspect the element or replace with a new element. See topic, "Cleaning Primary Filter Element".
5. Clean the inside of air cleaner housing and the cover. Inspect all connections between the air cleaner and carburetor. Check intake hose for cracks, damage necessary to prevent leakage.

---

#### NOTICE

Do not allow dirty air to enter the intake hose when cleaning the inside of the cleaner housing.

---

6. Check the air cleaner housing for loose retaining bolts.
7. Reset the air cleaner service indicator.
8. Install the air filter element.
9. Install the cover and tighten the cover latches.
10. Start the engine and observe the position of the indicator. If the indicator shows RED after the installation of the primary element, install another clean or a new element or, replace the secondary element. See topic, "Air Intake System - Change" in Every 1000 Service Hours or 6 months section.
11. Stop the engine and close the hood and seat assembly

## Cleaning Primary Filter Elements

**⚠ WARNING**

Pressure air can cause personal injury.

When using pressure air for cleaning, wear a protective face shield, protective clothing and protective shoes.

The maximum air pressure must be below 205 kPa (30 psi) for cleaning purposes.

**NOTICE**

Do not clean the elements by bumping or tapping them.

Inspect filter elements after cleaning. Do not use a filter with damaged pleats, gaskets or seals.

When cleaning with pressure air, use 205 kPa (30 psi) maximum pressure to prevent filter element damage.

When cleaning with pressure water, use 280 kPa (40 psi) maximum pressure to prevent filter element damage.

Have spare elements on hand to use while cleaning used elements.

The primary element should be replaced after 6 months service or after cleaning no more than 3 times.

### Air-205 kPa (30 psi) Maximum Pressure

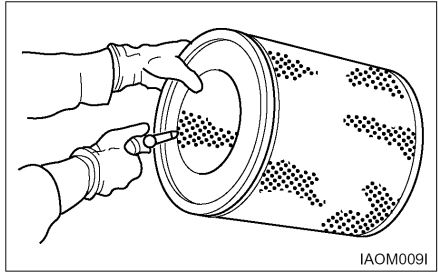

Direct air on the inside and outside of the element along the length of the pleats. Check the element for any tears, rips or damage.

### Checking Element

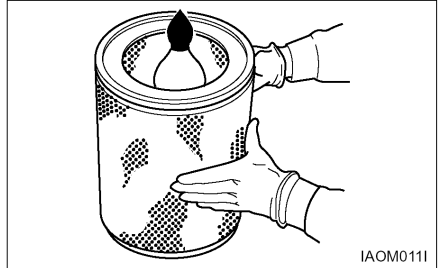

1. Insert a light inside the clean dry element and examine it. Discard the element if tears, rips or damage are found.
2. Wrap and store good elements in a clean, dry place.

## Belts - Check, Adjust

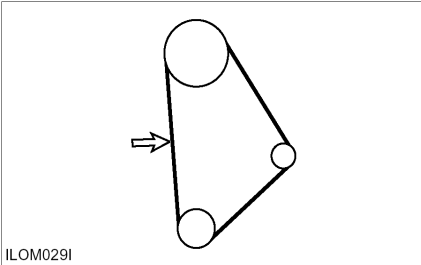

ILOM029I

Typical Example

1. Check the condition and adjustment of the belt. Correct adjustment allows 12mm (0.47 inch) deflection under 98N(22lb) of force.

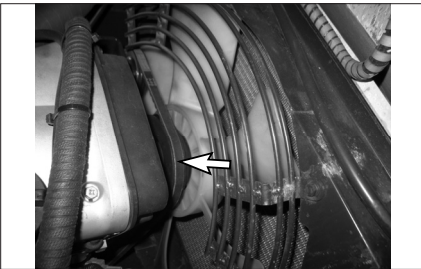

Typical Example

---

### NOTICE

Failure to loosen the alternator mounting bolt will cause excessive stress and break the alternator mounting ear.

---

2. To adjust the alternator drive belt, loosen adjusting bracket bolt and mounting bolt. Move the alternator in or out as required. Tighten bolts.

## Tilt Cylinders - Check, Adjust, Lubricate

### Chassis Pivot Eyebolts - Lubricate

1. Remove floor plates.

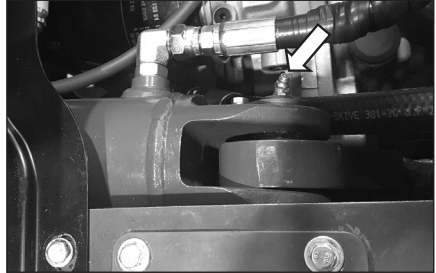

Typical Example

2. Lubricate two fittings for the pivot eyebolts, one on each tilt cylinder.
3. Check the pivot eye pins for loose retainer bolts and wear.

### Mast Pivot Eyes - Lubricate

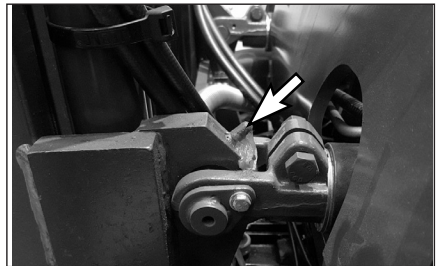

Typical Example

1. Lubricate two fittings for the mast pivot eyes, one on each side of the mast.
2. Check the pivot eye pins for loose retainer bolts and wear.

## Cylinder Rod Extension - Adjust

**NOTE :** The following description is for forward tilt. For cylinder rod back tilt, the collar should be stationary by the tilt eye. If it is not, the O-ring inside the collar may need to be replaced. To adjust back tilt, spacers must be added or removed.

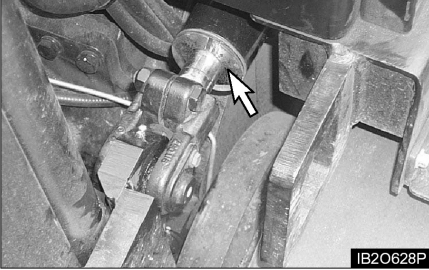

1. Check to make sure the tilt cylinders extend and retract evenly.
2. If one cylinder continues to move after the other cylinder has stopped in full forward or backward tilt, an adjustment must be made to one cylinder.
3. To adjust the cylinder rod extension, move the spacer to the rear and loosen the pinch bolt on the clevis.
4. Turn the cylinder rod in or out of the clevis to obtain the proper adjustment. Turning the rod into the clevis shortens the stroke. Turning the rod out of the clevis lengthens the stroke.
5. Tighten the pinch bolts to a torque of  $95 \pm 15$  N·m ( $70 \pm 10$  lb·ft). Check the cylinder rods again for even travel.

## Mast Hinge Pin - Lubricate

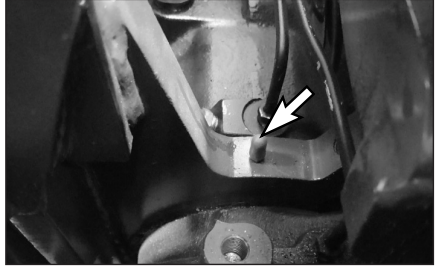

Typical Example

1. Lower the forks and tilt the mast forward.
2. Lubricate the two fittings for the mast hinge pins, one on each side of the mast.

## Crosshead Roller - Inspect

1. Operate the mast through a lift cycle. Watch the chains move over the crosshead rollers. Make sure the chain is tracking over the rollers properly.



Typical Example

2. Check for damaged crosshead rollers, guards and retainer rings.

## Parking Brake - Test, Adjust

See topic, "Parking Brake - Test, Adjust" in "First 50-100 Service Hours."

## Overhead Guard - Inspect

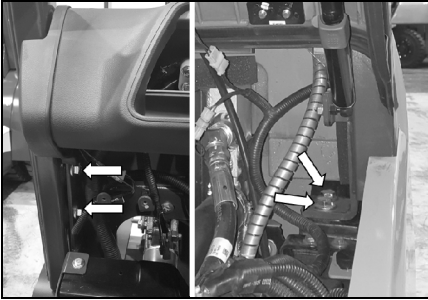

1. Check tightness of overhead guard mounting bolts at 95 N·m (70 lb-ft).
2. Check overhead guard for bent or cracked sections. Have repairs made if needed.

## Steering Mechanism - Check, Lubricate

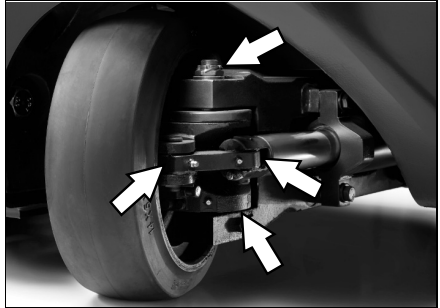

1. Lubricate the steer axle king pins, total of four fittings. Two on the right side and two on the left side.
2. Lubricate the steering link bearings, total of four fittings. Two on the right side and two on the left side.
3. Check for any worn or loose components of the steering mechanism. Remove any debris or trash as required.

## Inspect Vacuum Lines and Fittings

1. Visually inspect vacuum lines and fittings for physical damage such as brittleness, cracks and kinks. Repair/replace as required.
2. Solvent or oil damage may cause vacuum lines to become soft resulting in a collapsed line while the engine is running.
3. If abnormally soft lines are detected, replace as necessary.

## Inspect Electrical System

1. Check for loose, dirty or damaged connectors and wires on the harness including: Fuel lock-off, TMAP sensor, O2 sensor, Electronic throttle, Control Relays, Fuel Trim Valve, Foot Pedal, and crank sensor.
2. Repair and/or replace as necessary.

## PCV Valve System - Inspect, Clean



1. Loosen the hose clamps and remove the PCV valve.
2. Shake the PCV valve. If it rattles, reinstall it. If it does not rattle, replace it.
3. Tighten the hose clamps

## Mast, Carriage, Lift Chains & Attachments - Inspect, Lubricate

1. Operate the lift, tilt and attachment controls. Listen for unusual noises. These may indicate a need for repair.
2. Inspect for loose bolts and nuts on the carriage. Remove any debris from the carriage and mast.
3. Inspect the forks and attachments for free operation and damage. Have repairs made if necessary.

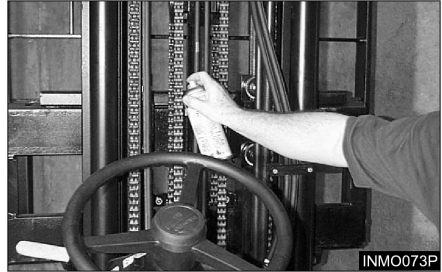

4. Brush a film of oil on all links of the chain.
5. Raise and lower the carriage a few times to work lubricant into the chain links.

---

### NOTICE

Lubricate chains more frequently than normal in applications where the lift truck is operating in an atmosphere which could cause corrosion of components or when lift truck must work in rapid lift cycles.

---

6. Inspect the chain anchors and individual links for wear, loose pins or cracked leaves.

## Every 1000 Service Hours or 6 Months

You must read and understand the warnings and instructions contained in the Safety section of this manual, before performing any operation or maintenance procedures.

### Hydraulic Return Filter, Breather & Strainer - Check, Change

#### WARNING

**Hot oil and components can cause personal injury. Do not allow hot oil or components to contact skin.**

Park the lift truck level with the forks lowered, parking brake engaged, transmission in NEUTRAL and the engine stopped.



1. Remove and discard the air breather.
2. Install a new air breather.
3. Loosen the bolts of the hydraulic tank top plate assembly.

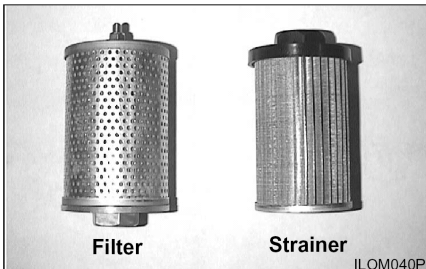

4. Remove the return filter from tank top plate assembly.
5. Change the return filter.
6. Remove the suction strainer from the tank.

7. Install a new strainer by hand.
8. Install the tank top plate assembly and fasten the bolt.
9. Start the engine and operate the hydraulic controls, and the steering system, through a few cycles to fill the lines. Look for oil leaks.
10. Stop the engine and check the oil level. With all cylinders retracted, maintain the oil level to the FULL mark on the dip stick/filler cap assembly.



## Lift Chains - Test, Check, Adjust

### Lift Chain Wear Test

Inspect the part of the chain that is normally operated over the cross head roller. When the chain bends over the roller, the movement of the parts against each other causes wear.

Inspect to be sure that chain link pins do not extend outside of the link hole. If any single link pin is extended beyond its connecting corresponding link, it should be suspected of being broken inside of its link hole. Lift chains are required to check for wear about every 1,000 service hours or 6 months.

Chain wear test is a measurement of wear of the chain links and pins. Take the following steps to check chain wear.

1. Lift the mast and carriage enough for getting tension on lift chains.



2. Measure precisely ten links of chain distance at the centre of pins in millimeter.
3. Calculate chain wear rate\*.
4. If the chain wear rate is 2% or more, replace the lift chain.

\*Chain wear rate (%)

$$= \left( \frac{\text{Actual measurement} - \text{Pitch}^{**} \times 10}{\text{Pitch}^{**} \times 100} \right) \times 100$$

\*\*Chain Pitch for GCG15/18S-9, GCG20SC-9  
= 15.88mm(0.63 in)

### Check for Equal Tension



Lift the carriage and the mast high enough for getting tension on lift chains. Check the chains, and make sure the tension is the same. Lift chains are required to check for equal tension about every 1,000 service hours or 6 months.

#### WARNING

**Personal injury can be caused by sudden movement of the mast and carriage. Keep hands and feet clear of any parts that can move.**

### Lift Chain Adjustment



Typical example for carriage equal tension

If the tension is not the same on both chains, take the procedure as follows.

**NOTE :** If carriage height is not correct, make adjustments by following procedures.

### Carriage Chain Adjustment

Make sure that carriage height is correct. If correct, adjust the chain for equal tension. If not, adjust the chain for correct carriage height by adjusting anchor nuts(1), (2).

**NOTE :** See the previous section, "Carriage Roller Extrusion" in "When Required". for proper height of carriage.

1. Fully lower the carriage and tilt mast forward or lift the carriage and put blocks under the chain to release the tension from the lift chains.
2. Loosen nut(1) and adjust nut(2) to get proper distance from bottom of inner upright to the bottom of carriage bearing.

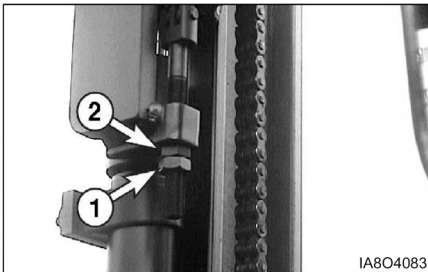

Typical example for carriage chain of STD mast

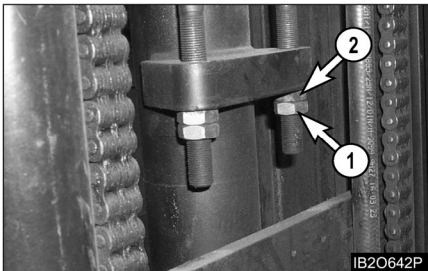

Typical example for carriage chain of FF, FFT mast

3. Make adjustment anchor nut(1), (2) for equal chain tension.

4. Set the mast vertical and raise the carriage and check equal chain tension. If not equal, repeat the same procedure as step 1 through step 3.
5. Put LOCTITE No. 242 Tread lock on the threads of the anchor nuts(1), (2) after the adjustment is completed.

### Mast Chain Adjustment - FF,FFT Mast

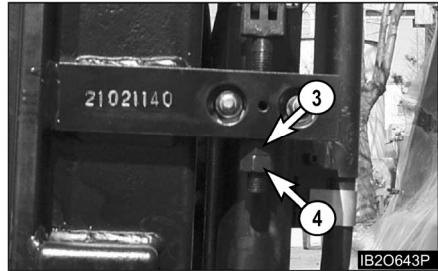

Typical example for FF mast

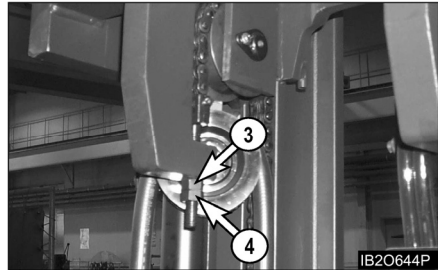

Typical example for FFT mast

Make sure that mast height is correct. If correct, adjust chain for equal tension. If not, adjust mast chain for correct mast height by adjusting anchor nuts(3), (4).

**NOTE :** See the previous section, "Carriage Roller Extrusion" in "When Required". for proper inner mast height.

1. Lift the inner mast and put blocks under the inner mast to release the tension from the lift chains.
2. Loosen nut(3) and adjust nut(4) to make inner mast rail flush with outer mast rail bottom.
3. Make adjustment anchor nuts(3), (4) for equal chain tension.

4. Raise the inner mast and check equal chain tension. If not equal, repeat the same procedure as step 1 through step 3.
5. Put LOCTITE No. 242 tread lock on the threads of the anchor nuts(3), (4) after the adjustment is completed.

### Universal Joint – Inspect

Check the bearings for wear and damage; if any are worn or damaged, replace them. Check for any loose bolts, and tighten bolts if necessary.

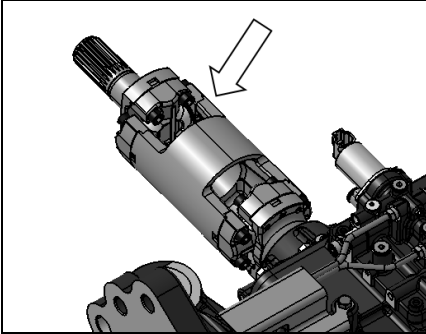

### Inspect Coolant Hoses

1. Visually inspect coolant hoses and clamps. Remember to check the two coolant lines that connect to the pressure regulator/converter.
2. Replace any hose that shows signs of swelling, cracking, abrasion or deterioration.

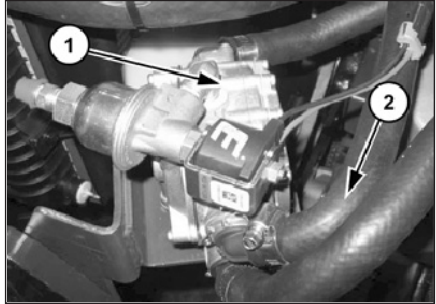

- (1) LP Regulator/Converter
- (2) Coolant hose

### LP Regulator/Converter Inspection

1. Visually inspect the pressure regulator/converter housing for coolant leaks and detect the fuel pipe joints, LP mixer and regulator/converter for LP fuel leaks.

To detect the LP fuel leaks, smear detected parts with suds, visually inspect whether there are bubbles after the engine start.

**NOTE :** For pressure testing and internal inspection of the pressure regulator/converter, contact to the CROWN service.

## Fuel Lines & Fittings - Check

Visually inspect fuel lines and fittings for physical damage. Replace as required.

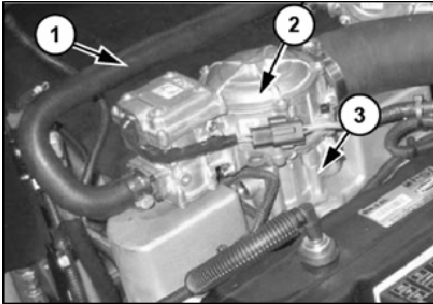

(1) Fuel line

(2) LP mixer

(3) Throttle Assembly

## Inspect Mixer Assembly

Refer to the LP mixer section of the engine service manual for procedures.

## Inspect Throttle Assembly

1. Visually inspect the throttle assembly motor housing for coking, cracks and missing cover-retaining clips. Repair and/or replace as necessary.

**NOTE :** Refer to the LP mixer and throttle section of the service manual for procedures on removing the mixer and inspecting the throttle plate.

## Every 1500 Service Hours or 9 Months

You must read and understand the warnings and instructions contained in the Safety section of this manual, before performing any operation or maintenance procedures

### Inspect Ignition

1. Disconnect Battery Cables.
2. Remove and inspect the spark plugs. Replace as required.
3. Inspect the ignition coil for cracks and heat deterioration. Visually inspect the coil heat sink fins. If any fins are broken replace as required.

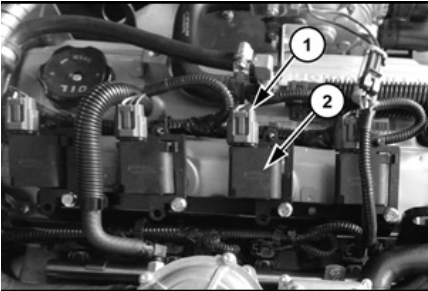

(1) Spark Plug Cables

(2) Ignition Coil

### Replace Spark Plugs

1. Disconnect Battery Cables.
2. Using a gentle twisting motion remove the high voltage cables from the spark plugs. Replace any damaged cables.
3. Remove the spark plugs.
4. Gap the new spark plugs to the proper specifications.

4G63 Engine: 0.9 mm

5. Apply anti-seize compound to the spark plug threads and install.

4G63 Engine: 30 N·m (22 lb-ft)

#### **WARNING**

**DO NOT OVERTIGHTEN THE SPARK PLUGS.**

6. Re-install the high voltage cables.

## Replace LP Fuel Filter Element

Park the lift truck in an authorised refueling area with the forks lowered, parking brake applied and the transmission in Neutral.

1. Close the fuel shutoff valve on the LP-Fuel tank. Run the engine until the fuel in the system runs out and the engine stops.
2. Turn off the ignition switch.
3. Scribe a line across the filter housing covers, which will be used for alignment purposes when re-installing the filter cover.

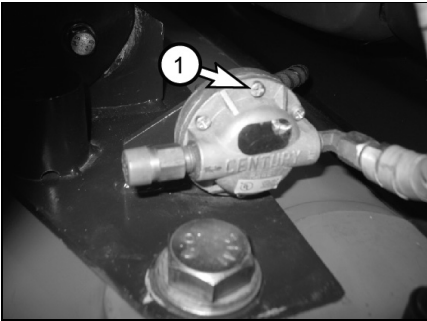

(1) screws

4. Remove the cover retaining screws (1).

## Fuel Filter

### Disassembly

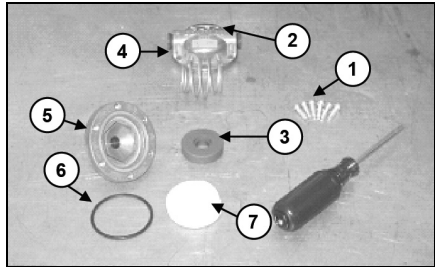

1. Check bottom cover O-ring seal (6) for damage. Replace if necessary.
2. Re-assemble the filter assembly aligning the scribe lines on the top and bottom covers.
3. Install the cover retaining screws, tightening the screws in an opposite sequence across the cover.
4. Open the fuel valve by slowly turning the valve counterclockwise.
5. Crank the engine several revolutions to open the fuel lock-off. **DO NOT START THE ENGINE.** Turn the ignition key switch to the off position.
6. Check the filter housing, fuel lines and fittings for leaks. Repair as necessary.

## Testing Fuel Lock-off Operation

1. Start engine.
2. Locate the electrical connector for the fuel lock
3. Disconnect the electrical connector.
4. The engine should run out of fuel and stop within a short period of time.
5. Turn the ignition key switch off and re-connect the fuel lock-off connector.

**NOTE:** The length of time the engine runs on trapped fuel vapor increases with any increase in distance between the fuel lock-off and the pressure regulator/converter.

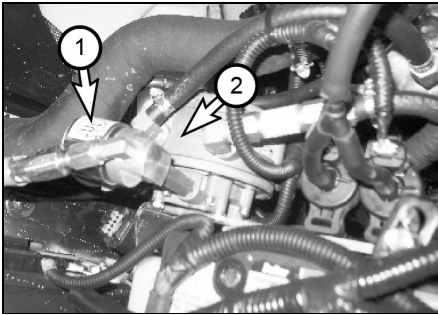

- (1) LP fuel lock-off  
(2) Regulator / converter

## Every 2000 Service Hours or Yearly

You must read and understand the warnings and instructions contained in the Safety section of this manual, before performing any operation or maintenance procedures.

### Steer Wheel Bearings - Repack



1. Raise the steer wheels off the ground. Block the lift truck up with blocking under the frame and steer axle.
2. Remove the hub cap.
3. Straighten the lockwasher tangs.
4. Remove the locknut, lockwasher and flat washer.

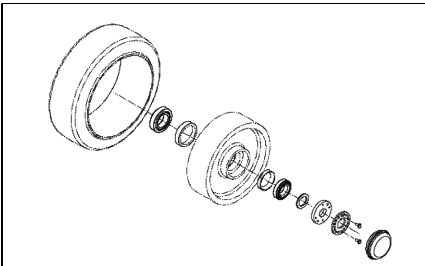

5. Remove the outer wheel bearing.
6. Remove the wheel assembly.

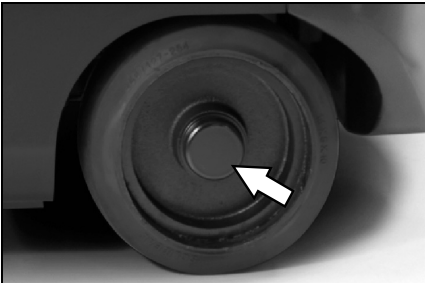

7. Examine the seal for damage and wear. Replace the seal, if necessary.
8. Remove the inner bearing.
9. Clean and lubricate the steering knuckle.
10. Repack the inner and outer bearings.
11. Install the inner bearing.
12. Install the wheel assembly on the steering knuckle.
13. Install the outer wheel bearing.
14. Install the flat washer, lockwasher and locknut.
15. Tighten the locknut to 135 N·m (100 lb-ft), while turning wheel hub to seat the bearing.
16. Loosen the locknut. Torque the locknut to 50 N·m (37 lb-ft). Tighten bolts (M6) at two points where holes are aligned between the locknut and lockwasher.
17. Install the hub cap.
18. Raise the lift truck and remove the blocking. Lower the lift truck to the ground.



## Cooling System – Clean, Change

### WARNING

At operating temperature, the engine coolant is hot and under pressure.

Steam can cause personal injury.

Check the coolant level only after the engine has been stopped and the filler cap is cool enough to touch with your bare hand.

Remove the filler cap slowly to relieve pressure.

Coolant is included antifreeze for forbidding corrosion. Avoid contact with the skin and eyes to prevent personal injury.

Use all cleaning solution with care.

The Lift truck must be level, the forks lowered, the parking brake engaged, the transmission in NEUTRAL and the engine stopped and cool.

1. Turn the radiator cap slowly to relieve the pressure, and then remove the cap.



2. Remove the drain plug or water hose on engine block.

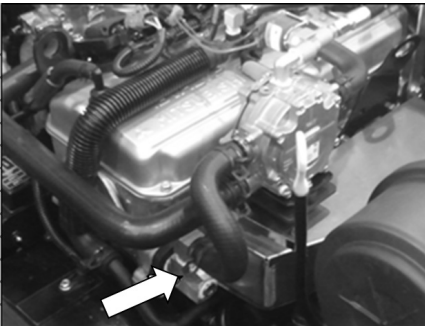

3. Open the radiator drain valve. Allow the coolant to drain into a suitable container.

Drain the recovery bottle.



### NOTICE

Hold the drain port when the radiator drain valve is turned because the tank and the drain port are separated.

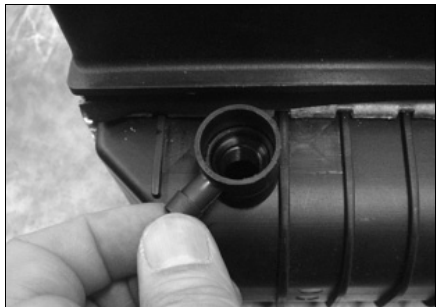

4. After draining the coolant completely, close the radiator drain valve and the block drain plug, fill the engine and the radiator full with a radiator cleaner, and clean the engine and the radiator.
5. Start and run the engine for 30 minutes.
6. Stop the engine and drain the cleaning solution into a suitable container.
7. Flush the system with clean water, until draining water is clear.
8. Close the drain valve and install the block drain plug. Fill coolant to top of the filler neck.
9. Start and run the engine to stabilise the coolant level. See topic, "Coolant Level – Check" in "Every 10 Service hours or Daily".

## Fork - Inspect

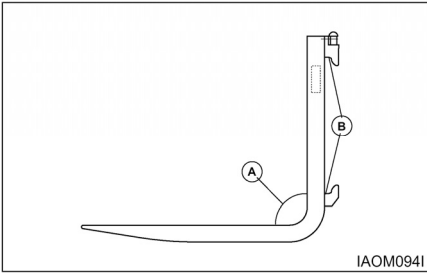

Forks should be inspected, at a minimum, every 12 months. If the truck is being used in a multi-shift or heavy duty operation, they should be checked every six months.

1. Inspect the forks carefully for cracks. Special attention should be given to the heel section (A), all weld areas and mounting brackets (B). Inspect the top and bottom hooks on forks used on hook type carriages and tubes on shaft mounted forks.

Forks with cracks should be removed from service.

"Wet Test" magnetic particle inspection is generally preferred due to its sensitivity and the ease of interpreting the results. Portable equipment is usually recommended so it can be moved to the lift truck.

Inspectors should be trained and qualified in accordance with The American Society for Non Destructive Testing, Level II Qualifications.

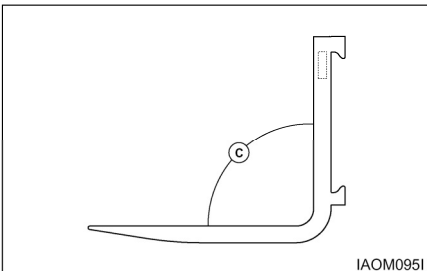

2. Check the angle between the upper face of the blade and the front face of the shank. The fork should be withdrawn from service if angle (C) exceeds 93 degrees or deviates by more than 3 degrees from an original angle other than 90

degrees, as may be found in some special application forks.

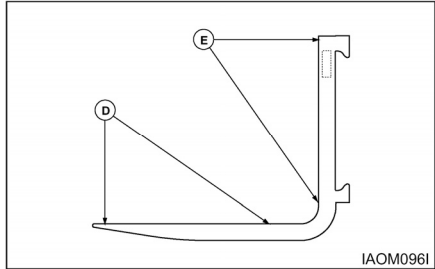

3. Check the straightness of the upper face of blade (D) and the front face of shank (E) with a straight edge.

The fork should be withdrawn from service if the deviation from straightness exceeds 0.5 percent of the length of the blade and/or the height of the shank respectively 5 mm/1000 mm (0.18"/36").

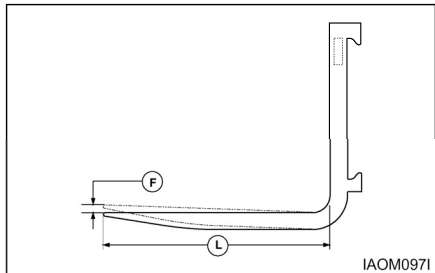

4. Check the difference in height of one fork tip to the other when mounted on the fork carrier. A difference in fork tip height can result in uneven support of the load and cause problems with entering loads.

The maximum recommended difference in fork tip elevation (F) is 6.5 mm (0.25") for pallet forks and 3 mm (0.125") for fully tapered forks. The maximum allowable difference in fork tip elevation between the two or more forks is 3 percent of blade length (L).

Replace one or both forks when the difference in fork tip height exceeds the maximum allowable difference. Contact your local CROWN Lift Truck Branch for further information.

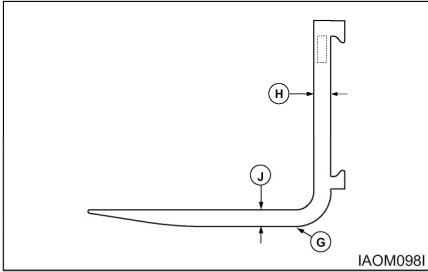

IAOM0981

5. Check the fork blade (J) and shank (H) for wear with special attention to the heel (G). The fork should be withdrawn from service if the thickness is reduced to 90 percent or less of the original thickness.

Fork blade length may also be reduced by wear, especially on tapered forks and platens. Remove the forks from service when the blade length is no longer adequate for the intended loads.

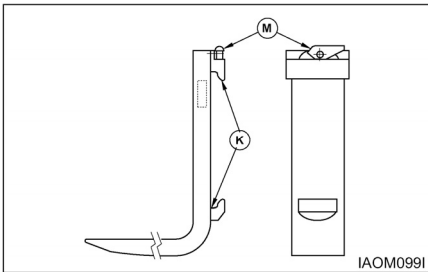

IAOM0991

6. Check the fork mountings (K) for wear, crushing and other local deformation, which can cause excessive side to side wobble of the forks. Excessive clearance on hook type forks may allow them to fall from the carrier. Forks which show visible signs of such damage should be removed from service.
7. Check the positioning lock and other fork retention devices to make sure they are in place and working.

Hook type forks use a spring loaded pin (M), located in the top hook, to engage notches in the top carriage bar to hold the fork in place.

When adjusting the fork spacing, the forks are prevented from sliding off the end of the carriage by stop blocks. These stop blocks are at both

ends of the carriage and in the path of the bottom fork hook. The load backrest extension may be used in place of the stop blocks in some cases.

Shaft mounted forks may use set collars or spacers on the shaft to either side of the fork. They may also use U bolts, pins, or similar devices which engage the fork through the top structure of the carriage.

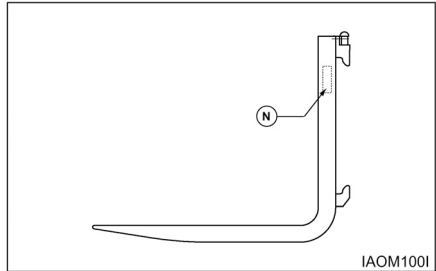

IAOM1001

8. Check fork markings (N) for legibility. Renew markings as required to retain legibility.
9.
  - a. Lift the mast and operate the tilt control lever, until the top surface of the forks is parallel with the floor. Place two straight bars that are the same width as the carriage, across the forks as shown.
  - b. Measure the distance from the bottom of each end of the two bars to the floor. The forks must be parallel within 3 mm (.12 in) for Full Tapered and Polished (FTP) forks, all other forks 6.4 mm (.25 in), for their complete length.
  - c. Put one fork, one third from the tip, under a fixture that will not move. Then operate the tilt control with caution until the rear of the truck lifts just off the floor. Follow the same procedure with the second fork. Repeat Step a.

## Transmission & Drive axle Oil, Oil Filter - Change

See topic, "Transmission & drive axle Oil, Oil Filter - Change" in "First 50 - 100 Service Hours"

## Transmission & Drive axle Strainer – Clean

Park the lift truck level, with the forks lowered, parking brake engaged, transmission in NEUTRAL and engine stopped.

1. Remove drain plug. Allow the oil to drain into a suitable container. Clean the magnetic drain plug. Check O - ring seal and replace if necessary.
2. Install the drain plug.
3. Wash the strainer assembly in clean, non flammable solvent and dry it. Install the strainer assembly and reconnect the hose.

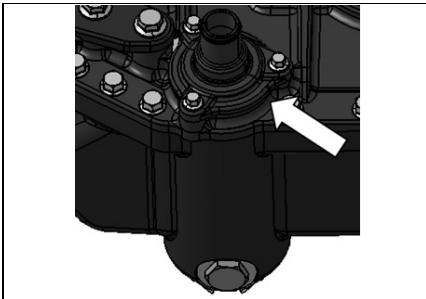
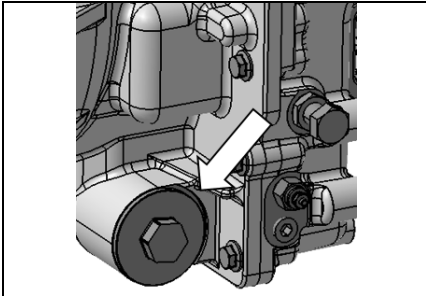

4. Remove the dip stick/filter cap. Fill the drive axle housing with oil.
5. See "Refill Capacities."
6. Start the lift truck with engine at low idle, place the directional control lever to the NEUTRAL.

7. Maintain the oil level between lower mark and upper mark on the dip stick/filter cap.
8. Install the dip stick/filter cap.

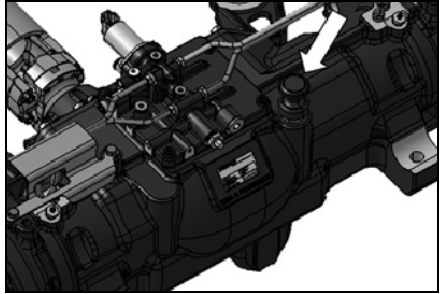

## Every 2500 Service Hours or 15 Months

You must read and understand the warnings and instructions contained in the Safety section of this manual, before performing any operation or maintenance procedures.

### Hydraulic Oil - Change, Check, Clean

**⚠ WARNING**

**Hot oil and components can cause personal injury. Do not allow hot oil or components to contact skin.**

Park the lift truck level with the forks lowered, parking brake engaged, transmission in NEUTRAL and the engine stopped.

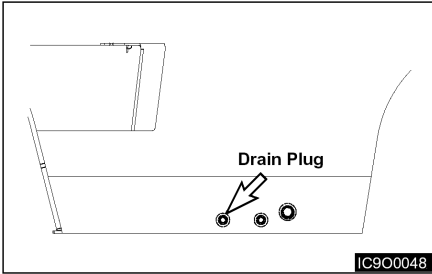

1. Remove the hydraulic tank drain plug. Allow the oil to drain. Clean and install the plug.



2. Remove the breather/dip stick.
3. Remove the strainer. Wash the breather and strainer in clean, nonflammable solvent and dry.
4. Install the strainer. Fill the hydraulic tank. See topic Refill Capacities. Install the breather/dip stick.

5. Start the engine and operate the hydraulic controls, and the steering system, through a few cycles to fill the lines. Look for oil leaks.
6. Stop the engine and check the oil level. With all cylinders retracted, maintain the oil level to the FULL mark on the breather/dip stick.

### Inspect Battery System

1. Clean battery outer surfaces with a mixture of baking soda and water.
2. Inspect battery outer surfaces for damage and replace as necessary.
3. Remove battery cable and clean, repair and/or replace as necessary.



## Replace Oxygen Sensor

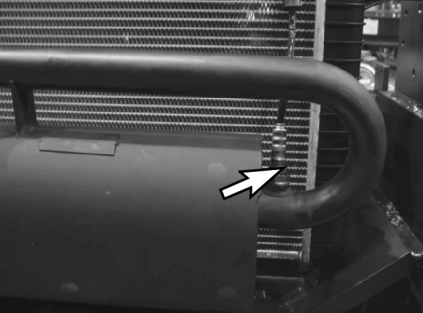
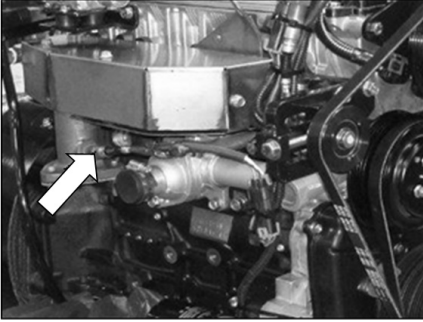

When indicated by MIL, replace oxygen sensor on the exhaust manifold and oxygen sensor on muffler assembly.

1. Stop engine and wait until the exhaust pipe and exhaust pipe is cooled.
2. Disconnect the electrical connector of oxygen sensor
3. Remove oxygen sensor
4. Assemble new oxygen sensor  
Tightening torque: 45 N·m (32.5 lb·ft)
5. Connect the electrical connector of oxygen sensor

### **WARNING**

**When assembling the filters, check the arrow mark on the filter surface.**

**The arrow mark position is same as fuel flow direction.**

## Checking the TMAP Sensor

1. Verify that the TMAP sensor (F) is mounted tightly into the manifold adapter (E), with no leakage.
2. If the TMAP is found to be loose, remove the TMAP retaining screw and the TMAP sensor from the manifold adapter.
3. Visually inspect the TMAP O-ring seal for damage. Replace as necessary.
4. Apply a thin coat of an approved silicon lubricant to the TMAP o-ring seal.
5. Re-install the TMAP sensor into the manifold adapter and securely tighten the retaining screw.

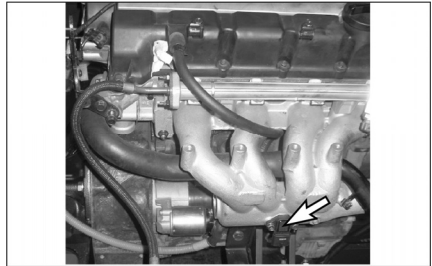

## Inspect for Intake Leaks

1. Visually inspect the intake manifold, throttle assembly (2), and manifold adapters (3), for looseness and leaks. Repair as necessary.

## Replace PCV Valve and breather element

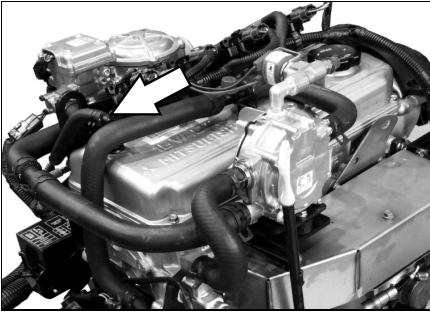

1. Loosen the hose clamps and remove the PCV valve.
2. Assemble new PCV valve and hose.
3. Tighten the hose clamps

## **Every 8000 Service Hours or 48 Months**

You must read and understand the warnings and instructions contained in the Safety section of this manual, before performing any operation or maintenance procedures.

### **Timing Belt - Change**

See the "Service manual" for the procedure and specification.



## **Environment Protection**

When servicing this lift truck, use an authorised servicing area and an approved container to collect coolant, oil, fuel, grease, electrolyte and any other potential environmental pollutant before any lines, fittings or related items are disconnected or removed.

After servicing, dispose of those materials in an authorised place and container. When cleaning the lift truck, be sure to use an authorised area.

# Index

## #

12 Months Inspection .....	110
4G63 Engine .....	54

## A

Accelerator Pedal .....	45
Advanced Diagnostics .....	69
After Starting the Engine .....	53
Air Intake System - Check .....	129
Air Intake System - Check, Clean .....	135
Antifreeze .....	114
Attachment Abbreviations (includes Special Forks) .....	37
Avoiding Lift Truck Tipovers .....	22

## B

Basic Troubleshooting .....	55
Batteries .....	15
Battery Terminal - Clean, Inspect .....	125
Before Operating the Lift Truck .....	12
Before Starting the Engine .....	49
Before Starting the Lift Truck .....	11
Before Storage .....	98
Belts - Check, Adjust .....	137
Bent or Twisted Forks .....	108
Blink Code Function .....	70
Brake Fluid .....	117
Brake Oil Level – Check .....	131
Bulbs .....	124
Burn Prevention .....	15

## C

Carriage Chain Adjustment .....	143
Carriage Roller Extrusion – Adjust .....	126
Causes of Fork Failure .....	108
Centre of Gravity (CG) .....	22
Changing LP-Gas Tanks .....	47
Chassis Pivot Eyebolts - Lubricate .....	137
Checking for Equal Tension .....	142
Checking Service Indicator .....	129
Checking the TMAP Sensor .....	155
Circuit Breaker .....	43,124
Coolant Information .....	113
Coolant Level - Check .....	128
Coolant Water .....	114
Coolant .....	15

Cooling System – Clean, Change .....	150
Cooling System Specifications .....	113
Crosshead Roller - Inspect .....	138
Crushing or Cutting Prevention .....	14
Cylinder Rod Extension - Adjust .....	138

## D

Daily Inspection .....	109
Direction Control Lever .....	44
Disassembly .....	147

## E

Electrical Disconnect Switch (If Equipped) .....	41
Electronic Controlled Spark-Ignition Engines .....	54
Electronic Parking Brake .....	45,102
EMS schematic of 4G63 LP engine .....	55
Engine Compartment .....	43
Engine Oil (DEO and EO) .....	116
Engine Oil Filter – Change .....	134
Engine Oil Level – Check .....	128
Environment Management .....	3
Environment Protection .....	158
Every 10 Service Hours or Daily .....	127
Every 1000 Service Hours or 6 Months .....	141
Every 1500 Service Hours or 9 Months .....	146
Every 2000 Service Hours or Yearly .....	149
Every 250 Service Hours or Monthly .....	134
Every 2500 Service Hours or 15 Months .....	154
Every 500 Service Hours or 3 Months .....	135
Every 8000 Service Hours or 48 Months .....	157

## F

Fatigue .....	108
Fire Extinguisher .....	16
Fire or Explosion Prevention .....	15
First 50-100 Service Hours or a Week .....	132
First Installation .....	109
Fluid Penetration .....	14
Foreword .....	2
Fork - Inspect .....	151
Fork Inspection .....	109
Fuel Filter .....	147
Fuel Lines & Fittings - Check .....	145
Fuel Specifications .....	115
Function description .....	40
Fuse .....	123
Fuses & Relay Change .....	123

**G**

General Hazard Information .....10  
 General Warnings to Operator .....6

**H**

Hand Placement Warning .....7  
 Hook-on type Fork .....97  
 How to Fix Forklift to a Carrier ..... 100  
 How to Survive in a Tipover .....30  
 Hydraulic Oil - Change, Check, Clean ..... 154  
 Hydraulic Oil (HYDO) ..... 116  
 Hydraulic Oil Level – Check .....131  
 Hydraulic Return Filter, Breather & Strainer - Check, Change .....141

**I**

Identification, Lift Capacity and Attachment Plate .....36  
 If Optional Suspension Seat (Weight Adjusting Type) Equipped .....19  
 Important Safety Information .....4  
 Improper Modification or Repair ..... 108  
 Inching into Loads ..... 91  
 Inching .....89  
 Index ..... 159  
 Inspect Battery System ..... 154  
 Inspect Coolant Hoses ..... 144  
 Inspect Electrical System ..... 140  
 Inspect Engine for Exhaust Leaks .....130  
 Inspect Engine for Fluid Leaks ..... 128  
 Inspect Foot Pedal Operation ..... 130  
 Inspect for Intake Leaks ..... 156  
 Inspect Ignition .....146  
 Inspect Mixer Assembly ..... 145  
 Inspect Throttle Assembly .....145  
 Inspect Tightness - Drive Wheels .....126  
 Inspect Vacuum Lines and Fittings ..... 140  
 Inspection, Maintenance and Repair of Lift Truck Forks .....107  
 Instrument Panel .....38

**J**

Jacking Information ..... 105

**L**

Lift Chain Adjustment ..... 142  
 Lift Chain Wear Test ..... 142

Lift Chains - Test, Check, Adjust ..... 142  
 Lift Control ..... 45  
 Lift Fork Adjustment ..... 97  
 Lift Truck Capacity Rating ..... 36  
 Lift Truck Controls ..... 44  
 Lift Truck Operation ..... 88  
 Lift Truck Parking ..... 13  
 Lift Truck Shipping ..... 99  
 Lift Truck Stability Base ..... 23  
 Lift Truck Stability ..... 22  
 Lifting a Forklift using a Crane ..... 100  
 Lifting Drums or Round Objects ..... 94  
 Lifting the Load ..... 91  
 Lines, Tubes and Hoses ..... 16  
 Literature Information ..... 2  
 Load Backrest Must Be In Place Warning ..... 7  
 Loading or Unloading Trucks/Trailers ..... 13  
 Long Time Storage ..... 98  
 LP-Gas Engine ..... 51  
 LP-Gas Specifications ..... 115  
 LP Regulator/Converter Inspection ..... 144  
 LPG ..... 16  
 Lubricant Information ..... 116  
 Lubricant Specifications ..... 116  
 Lubricant Viscosities and Refill Capacities ..... 118  
 Lubricant Viscosities ..... 118  
 Lubricating Grease (MPGM) ..... 117

**M**

Machine Lifting and Tiedown Information ..... 99  
 Maintenance and Repair ..... 110  
 Maintenance Information ..... 14  
 Maintenance Intervals ..... 3,119  
 Maintenance ..... 3  
 Make proper antifreeze additions ..... 114  
 Malfunction Indicator Lamp (MIL) Operation ..... 71  
 Mast Abbreviations ..... 37  
 Mast Chain Adjustment - FF,FFT Mast ..... 143  
 Mast Channels - Lubricate ..... 130  
 Mast Hinge Pin - Lubricate ..... 138  
 Mast Pivot Eyes - Lubricate ..... 137  
 Mast, Carriage, Lift Chains & Attachments - Inspect, Lubricate ..... 140  
 Metric Hardware ..... 111  
 Mounting and Dismounting ..... 11  
 Moving Fan Warning ..... 8

**N**

No Riders Warning ..... 8  
 No Standing On Forks Warning, No Standing Under Forks Warning ..... 7  
 Noise and Vibration ..... 34

**O**

Oil Cooled Disc Brake Only .....	117
Oils.....	15
Operating in Hot Weather .....	94
Operating Techniques.....	91
Operating the Lift Truck.....	12
Operation Information.....	11
Operation.....	2
Operator's Seat, Hood Latch and Support Cylinder - Check, Lubricate.....	123
Operator's Station and Monitoring Systems .....	38
Operator's Warning and Identification Plate .....	36
Operator's Warning Plate.....	36
Operator Restraint System (If Equipped).....	2, 17
Overhead Guard - Inspect .....	139
Overhead Guard Must Be In Place Warning .....	8
Overloading.....	108

**P**

Packing brake .....	8
Parking Brake - Test, Adjust .....	132, 139
Parking the Lift Truck .....	96
PCV Valve System - Inspect, Clean.....	140
Power Shift Transaxle .....	88
Pressure Air .....	14
Pressure Warning.....	7
Prestart Conditions .....	51

**R**

Refill Capacities.....	118
Refueling .....	47
Replace LP Fuel Filter Element.....	147
Replace Oxygen Sensor .....	155
Replace PCV Valve and breather element.....	156
Replace Spark Plugs.....	146

**S**

Safety instructions for attachments when transporting suspended loads .....	95
Safety instructions for attachments when transporting wide loads .....	95
Safety Rules.....	24
Safety .....	2, 5
Seat Adjustment .....	18
Seat Switch System (If Equipped).....	42
Seat .....	43
Serial Number Locations.....	35
Serial Number.....	35
Service Brake Pedal .....	45

Servicing Filter Element .....	135
Sideshift Attachment Control (If Equipped).....	46
Specifications .....	31, 32
Stability and Centre of Gravity .....	22
Starting From a 12 Volt External Source.....	52
Starting the Engine .....	51
Starting the Lift truck.....	12
Steer Wheel Bearings - Repack .....	149
Steering Knob (If Equipped).....	90
Steering Mechanism - Check, Lubricate .....	139
Storage Information .....	98

**T**

Table of Contents.....	1
Test Fuel System for Leaks .....	125
Test Operation .....	132
Testing Fuel Lock-off Operation .....	148
Tilt Control .....	46
Tilt Cylinders - Check, Adjust, Lubricate .....	137
Tilting Steering Column.....	43
Timing Belt - Change.....	157
To Operate the Lift Truck after a Long Time Storage .....	98
Torque for Metric Fasteners.....	112
Torque for Standard Bolts, Nuts, and Taperlock Studs.....	111
Torque for Standard Hose Clamps - Worm Drive .....	111
Torque Specifications .....	111
Torques for Bolts and Nuts With Standard Threads .....	111
Torques for Taperlock Studs.....	112
Towing Information .....	101
Training Required To Operate or Service Warning .....	5
Transmission & Drive axle Oil Level – Check.....	130
Transmission & Drive axle Oil.....	117
Transmission & Drive axle Oil, Oil Filter - Change .....	132, 153
Transmission & Drive axle Strainer – Clean .....	153
Transmission Inching Control Pedal.....	44
Transportation Hints .....	99
Traveling with the Load .....	92
Turning.....	93
Tyre and Wheels - Inspect, Check .....	124
Tyre Information .....	16

**U**

Universal Joint – Inspect .....	144
Unloading .....	92

**W**

Walk-Around Inspection – Inspect..... 127  
Walk-Around Inspection .....49  
Warning Signs and Labels ..... 5,17  
Wheel Bolts - Inspect ..... 126  
When Required..... 123