



Crown New Bremen OH 45869 USA
Please visit Crown.com to locate a Crown Dealer near you.

www.crown.com

CROWN

CGC35/45S-9, CGC55C-9, CGC35/45/55BCS-9

Operation & Maintenance Manual

XSB2475E03NA



XSB2475E03NA
12. 2021

Operation & Maintenance Manual

CGC35S-9, CGC45S-9, CGC55C-9
CGC35BCS-9, CGC45BCS-9, CGC55BCS-9

FGB1A, FGB1B, FGB1C
PSI 4.3L/KUBOTA 3.8L Tier-3



Forklifts



Operation & Maintenance Manual

Forklifts

CGC35S-9, CGC45S-9, CGC55C-9

CGC35BCS-9, CGC45BCS-9, CGC55BCS-9

FGB1A, FGB1B, FGB1C

PSI 4.3L/KUBOTA 3.8L Tier-3



WARNING

A MOVING VEHICLE CAN BE DANGEROUS

You or others around you can be seriously injured or even killed if you are not careful or don't know how to use this truck correctly.

Do not operate this truck unless you are trained and authorized.

Read and obey all warnings and instructions in this Manual* and on the truck.

Make sure the truck is in good working order.

Head, arms, hands or legs outside the operator area can be pinned or crushed when ever the truck is moving. Stay within the operator area and stop completely before getting off.

A dockboard can move or drop while you are on it. Or you could drive off a dock. Falls from docks or dockboards can cause serious injury or even death. Make sure you are safe.

* Additional copies of this Operator Manual and all Truck Labels can be obtained from Crown Equipment Corporation New Bremen, Ohio 45869 U.S.A.

Table of Contents

Information Section

Foreword	2
----------------	---

Safety Section

Important Safety Information	4
Safety	5
Warning Signs and Labels	5
Operation Information	11
Maintenance Information	14
Burn Prevention	15
Fire or Explosion Prevention	15
Operator Restraint System	17
Avoiding Lift Truck Tipovers	21
Safety Rules	23
How to Survive in a Tipover (If Operator Restraint System Equipped)	29

General Section

Specifications	30
Noise and Vibration	37
Capacity Chart (With Side Shifter)	38
Capacity Chart (Without Side Shifter)	42
Serial Number	46
Operator's Warning and Identification Plate	47

Operation Section

Operator's Station and Monitoring Systems	49
Weight Scale Option (Load Cell Type)	55
Seat Switch System (If Equipped)	57
Lift Truck Controls	58
Refueling	60
Before Starting the Engine	62
Starting the Engine	64
Lift Truck Operation	100
Mono-Ped Control System (Option)	102
Auto Shift Controller ASC - 206 (If Equipped)	103
Operating Techniques	106
Parking the Lift Truck	111
Lift Fork Adjustment	113
Storage Information	114
Transportation Hints	115
Towing Information	117

Maintenance Section

Jacking Information	121
Inspection, Maintenance and Repair of Lift Truck Forks	123
Torque Specifications	127
Cooling System Specifications	129
Fuel Specifications	131
Lubricant Specifications	133
Lubricant Viscosities and Refill Capacities	135
Maintenance Intervals	136
When Required	140
Every 10 Service Hours or Daily	148
First 50 - 100 Service Hours or a Week	153
Every 250 Service Hours or Monthly	158
Every 500 Service Hours or 3 Months	159
Every 1000 Service Hours or 6 Months	167
Every 1500 Service Hours or 9 Months	172
Every 2000 Service Hours or Yearly	176
Every 2500 Service Hours or 15 Months	182
Every 3000 Service Hours or 36 Months	185

Environment Protection Section

Environment Protection	187
------------------------------	-----

Index Section

Index	188
-------------	-----

Foreword

Literature Information

This manual should be stored in the operator's compartment in the literature holder or seat back literature storage area.

This manual contains safety, operation, transportation, lubrication and maintenance information.

Some photographs or illustrations in this publication show details or attachments that can be different from your lift truck. Guards and covers might have been removed for illustrative purposes.

Continuing improvement and advancement of product design might have caused changes to your lift trucks which are not included in this publication.

Read, study and keep this manual with the lift truck.

Whenever a question arises regarding your lift truck, or this publication, please consult your CROWN branch for the latest available information.

Safety

The Safety Section lists basic safety precautions. In addition, this section identifies the text and locations of warning signs and labels used on the lift truck. Read and understand the basic precautions listed in the Safety Section before operating or performing lubrication, maintenance and repair on this lift truck.

Operator Restraint System (If Equipped)

This manual contains safety, operation and maintenance information for the CROWN operator restraint system. Read, study and keep it handy.

WARNING

Your CROWN truck comes equipped with an operator restraint system. Should it become necessary to replace the seat for any reason, it should only be replaced with another CROWN operator restraint system.

Photographs or illustrations guide the operator through correct procedures of checking, operation and maintenance of the CROWN operator restraint system.

SAFE and EFFICIENT OPERATION of a lift truck depends to a great extent on the skill and alertness on the part of the operator. To develop this skill the operator should read and understand the Safe Driving Practices contained in this manual.

Forklift trucks seldom tipover, but in the rare event they do, the operator may be pinned to the ground by the lift truck or the overhead guard. This could result in serious injury or death.

Operator training and safety awareness is an effective way to prevent accidents, but accidents can still happen. The CROWN operator restraint system can minimize injuries. The CROWN operator restraint system keeps the operator substantially within the confines of the operator's compartment and the overhead guard.

This manual contains information necessary for Safe Operation. Before operating a lift truck make sure that the necessary instructions are available and understood.

Operation

The Operation Section is a reference for the new operator and a refresher for the experienced one. This section includes a discussion of gauges, switches, lift truck controls, attachment controls, transportation and towing information.

Photographs and illustrations guide the operator through correct procedures of checking, starting, operating and stopping the lift truck.

Operating techniques outlined in this publication are basic. Skill and techniques develop as the operator gains knowledge of the lift truck and its capabilities.

Maintenance

The Maintenance Section is a guide to equipment care. The illustrated, step-by-step instructions are grouped by servicing intervals. Items without specific intervals are listed under “When Required” topics. Items in the “Maintenance Intervals” chart are referenced to detailed instructions that follow.

Maintenance Intervals

Use the service hour meter to determine servicing intervals. Calendar intervals shown (daily, weekly, monthly, etc.) can be used instead of service hour meter intervals if they provide more convenient servicing schedules and approximate the indicated service hour meter reading. Recommended service should always be performed at the interval that occurs first.

Under extremely severe, dusty or wet operating conditions, more frequent lubrication than is specified in the “Maintenance Intervals” chart might be necessary.

Perform service on items at multiples of the original requirement. For example, at “Every 500 Service Hours or 3 Months”, also service those items listed under “Every 250 Service Hours or Monthly” and “Every 10 Service Hours or Daily”.

Environment Management

Note that the Crown internal combustion engine lift trucks are manufactured under ISO 14001 system which is harmonized with ISO 9001.

Periodic ENVIRONMENTAL AUDITS & ENVIRONMENTAL PERFORMANCE EVALUATIONS have been made by internal and external inspection entities. LIFE-CYCLE ANALYSIS has also been made through out the total product life. ENVIRONMENT MANAGEMENT SYSTEM includes DESIGN FOR ENVIRONMENT from the initial stage of the design.

ENVIRONMENT MANAGEMENT SYSTEM considers environmental laws & regulations, reduction or elimination of resource consumption as well as environmental emission or pollution from industrial activities, energy saving, environment-friendly product design (lower noise, vibration, emission, smoke, heavy metal free, ozone depleting substance free, etc.), recycling, material cost reduction, and even environmentally oriented education for the employee.

Important Safety Information

Most accidents involving product operation, maintenance and repair are caused by failure to observe basic safety rules or precautions. An accident can often be avoided by recognizing potentially hazardous situations before an accident occurs. A person must be alert to potential hazards, and use common sense. Persons must also have the necessary training, skills and tools before attempting to perform these functions.

Improper operation, lubrication, maintenance or repair of this product can be dangerous and could result in injury or death.

Do not operate or perform any lubrication, maintenance or repair on this product, until you have read and understood the operation, lubrication, maintenance and repair information.

Safety precautions and warnings are provided in this manual and on the product. If these hazard warnings are not heeded, bodily injury or death could occur to you or other persons.

The hazards are identified by the "Safety Alert Symbol" and followed by a "Signal Word" such as "WARNING" as shown below.



The meaning of this safety alert symbol is as follows:

Attention! Become Alert! Your Safety is Involved.

The message that appears under the warning, explaining the hazard, can be either written or pictorially presented.

Operations that may cause product damage are identified by NOTICE labels on the product and in this publication.

CROWN cannot anticipate every possible circumstance that might involve a potential hazard, and common sense is always required. The warnings in this publication and on the product are therefore not all inclusive. Before any tool, procedure, work method or operating technique not specifically recommended by CROWN is used, you must be sure that it is safe for you and others. You should also ensure that the product will not be damaged or made unsafe by the operation, lubrication, maintenance or repair procedures you choose.

The information, specifications, and illustration in this publication are on the basis of information available at the time it was written. The specifications, torques, pressures, measurements, adjustments, illustrations, and other items can change at any time. These changes can affect the service given to the product. Obtain the complete and most current information before starting any job. CROWN branches have the most current information available.

Safety

The safety rules and regulations in this section are representative of some, but not all rules and regulations that apply to lift trucks. Rules and regulations are paraphrased without representation that they have been reproduced verbatim.

Please refer to 29 CFR 1910.178 in the Code of Federal Regulations, the National Fire Protection Association No. 505 (NFPA), American National Standards Institute/Industrial Truck Standards Development Foundation, ANSI/ITSDF B56.1 Safety Standard for Low lift and High Lift Trucks, UL 558 Fire Safety Standard for Internal Combustion Engine-Powered Industrial Trucks and subsequent revisions for a complete list of rules and regulations as to the safe operation of powered industrial lift trucks. Since regulations vary from country to country outside of U.S.A., operate this lift truck in accordance with local regulations.

CROWN lift trucks are manufactured in accordance with the National Fire Protection Association (NFPA) No. 505 and the American National Standards Institute, Inc. / Industrial Truck Standards Development Foundation (ANSI/ITSDF) B56.1, Safety Standard for Low and High Lift Trucks and, for European models, according to the regulations and standards laid down in EU Machinery Directive 2006/42/EC and EMC directive 2014/30/EU.

The most effective method of reducing the risk of serious injury or death to you or others is for you to know how to properly operate this lift truck, to be alert and to avoid actions or conditions that could cause accidents.

Do not operate a lift truck if it is in need of maintenance, repair or appears to be unsafe in any way. Report all unsafe conditions immediately to your supervisor, then contact your authorized lift truck branch. Do not attempt any adjustments or repairs unless trained and authorized to do so.

Warning Signs and Labels

There are several specific safety signs on your lift truck. Their exact location and description of the hazard are reviewed in this section. Please take the time to familiarize yourself with these safety signs.

Make sure that you can read all warning and instruction labels. Clean or replace these labels if you cannot read the words or see the pictures. When cleaning the labels use a cloth, water and soap. Do not use solvent, gasoline, etc.

You must replace a label if it is damaged, missing or cannot be read. If a label is on a part that is replaced, make sure a new label is installed on the replaced part. See your branch for new labels.

Training Required to Operate or Service Warning

		MODEL	SERIAL NO.	TYPE	INDUSTRIAL TRUCK
TRUCK WEIGHTING		LB		KG	
ALLOWABLE WORKING CAPACITY WITH MAST VERTICAL					
BACK TILT		MAST TYPE		TIRE TYPE	
TIRE TREAD		TIRE PRESS		TIRE SIZE	
IN (F)		PSI		KPA (F)	
MM (R)		PSI		KPA (R)	
ATTACH					
A	B	C	I.D		CAPACITY
IN	IN	IN			LB
				IN	
				LB	
				MM	
				MM	
				KG	
				MM	
				MM	
				KG	
ELECTRIC TRUCK ONLY TRUCK WT50% W/O BAT					
BAT TYPE		VOLT	MAX. AM GAP.	AT	HR RATE
BAT WT.		/	LB		
MIN/MAX		/	KG	BAT SIZE	
				MM	

TRUCK COMPLIES TO ANSI/ITSDF B56.1
 IN ENJOY OR DEATH.
 READ AND UNDERSTAND THE OPERATION AND MAINTENANCE MANUAL BEFORE OPERATING.
 950209-10676 ENGLISH

Located on the right side of the steering wheel.



Improper operation or maintenance could result in injury or death. Do not operate or work on the lift truck unless you are properly trained. Read and understand the Operation and Maintenance Manual. Additional manuals are available from CROWN Lift Truck branches.

This label also provides allowable lift truck capacity information.

General Warnings to Operator



Located on the right side of the operator's seat(STD).



Located on the overhead guard. (If Convenience Package Equipped).

WARNING

Only trained and authorized personnel may operate this machine. For safe operation, read and follow the operation and maintenance Manual furnished with this lift truck and observe the following warnings:

1. Before starting machine. Check all controls and warning devices for proper operation.
2. Refer to machine identification plate for allowable machine capacity. Do not overload. Operate machines equipped with attachments as partially loaded machines when not handling a load.
3. Put directional control or shift lever in neutral before "ON - OFF" switch is turned on.
4. Start, turn and brake smoothly. Slow down for turns, slippery or uneven surfaces. Extremely poor surfaces should be repaired. Avoid running over loose objects or holes in the roadway surfaces. Use extreme caution when turning on inclines.
5. Travel with load as low as possible and tilted back. If load interferes with visibility, travel with load trailing.
6. On grade operations travel with load up grade.
7. Watch out for pedestrians and obstructions. Check

overhead clearances.

8. Do not permit riders on forks or machine at any time.
9. Do not allow anyone to stand or pass under the elevated portion of any machine.
10. Be sure operating surface can safely support machine.
11. Operate machine and attachments only from operator's position.
12. Do not handle unstable or loosely stacked loads.
13. Use minimum tilt when picking up or depositing a load.
14. Use extreme care when handling long, high or wide loads to ensure stability and durability of the truck.
15. Forks should be completely under load and spread apart as far as load permits.
16. Machine should be equipped with overhead guard or equivalent protection. Where load requires it, use load backrest extension. Use extreme caution if operating without these devices.
17. Parking - Lower lifting mechanism to floor. Put directional control or shift lever in neutral. Set parking/secondary brake. Turn "ON - OFF" switch off. Check wheels if machine is on incline. Disconnect battery when storing electric machines.
18. Observe safety rules when handling fuel for engine powered machine and when changing batteries for electric machines.
19. Avoid overuse of the inching pedal as this may cause the automatic transmission oil to overheat or the clutch to slip. Do not use as a footrest or for long periods of time.
20. If user operates continuously pushing work or both brake pedal and accelerator pedal were depressed at the same time, it may cause the automatic transmission oil to overheat or the clutch to slip.

Pressure Warning

⚠ WARNING

Contents under pressure may be hot. Allow to cool before opening.

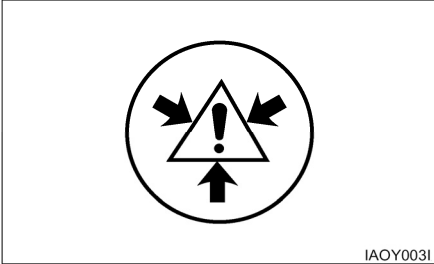

Located on the radiator top tank by the radiator cap.

Hand Placement Warning

⚠ WARNING



No hands. Do not place hands in this area. Do not touch, lean on, or reach through the mast or permit others to do so.

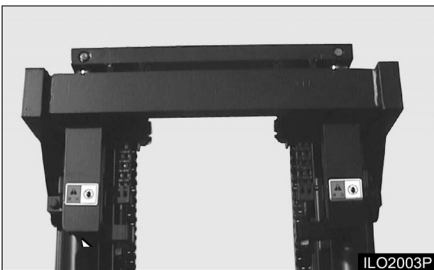

Located on the mast.

No Standing On Forks Warning, No Standing Under Forks Warning

⚠ WARNING

Do not stand or ride on the forks. Do not stand or ride on a load or pallet on the forks. Do not stand or walk under the forks.

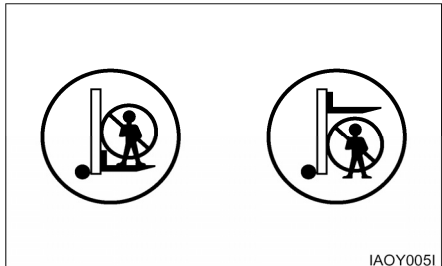

Located on the lift cylinder.

Load Backrest Must Be In Place Warning

⚠ WARNING

Operation without this device in place may be hazardous.



Located on the load backrest.

Overhead Guard Must Be In Place Warning

⚠ WARNING

Operation without this device in place may be hazardous. This guard conforms to A.N.S.I.B56.1 and F.E.M. Section IV. This design has been tested with an impact of (appropriate value).

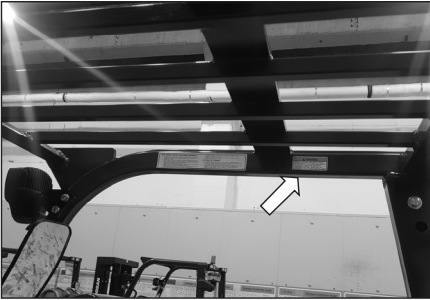

No Riders Warning

⚠ WARNING

To avoid personal injury, allow no riders. A lift truck is designed for only one operator and no riders.



Located beside the operator's station (STD) or on front of the hood (Convenience Package).

Moving Fan Warning

⚠ WARNING

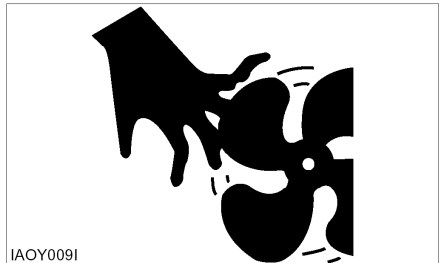

To avoid personal injury, stay clear of moving fan.

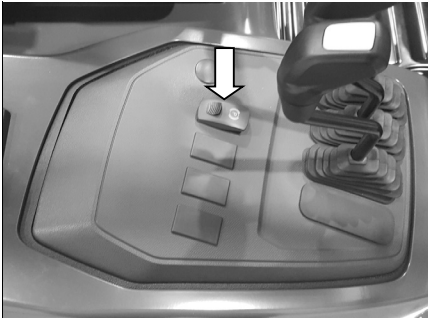

Located inside the engine compartment cover.

Parking brake



-  Push the front side of the parking brake switch to engage the brake.
-  Push the rear side of the parking brake switch to release the brake.

Applying the parking brake puts the transmission in NEUTRAL. The parking brake must be applied when leaving the lift truck and when starting the engine. If the operator leaves the seat without applying the parking brake, an audible alarm will sound.

WARNING

When leaving machine apply parking brake!
Parking brake is not automatically applied.
Alarm will sound if parking brake is not applied.

WARNING

Correct adjustment is necessary to provide adequate braking. See the MAINTENANCE section for adjustment procedures. The lift truck may creep at engine idle and can cause damage, injury or death. Always apply the parking brake when leaving the lift truck. The parking brake is NOT automatically applied.

General Hazard Information

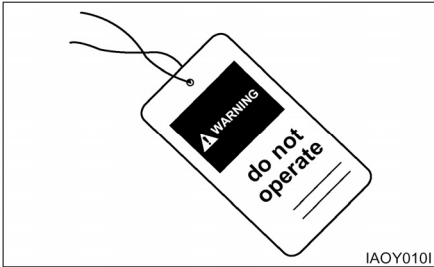

Attach a “Do Not Operate” or similar warning tag to start switch or controls before servicing or repairing the lift truck.

Do not start or service the lift truck when a “DO NOT OPERATE” or similar warning tag is attached to the start switch or controls.

Wear a hard hat, protective glasses and other protective equipment as required by job conditions.

Know the width of your attachments so proper clearance can be maintained when operating near fences, boundary obstacles, etc.

Do not wear loose clothing or jewelry that can catch on controls or other parts of the lift truck.

Keep the lift truck, especially the deck and steps, free of foreign material such as debris, oil tools and other items which are not part of the lift truck.

Secure all loose items such as lunch boxes, tools and other items which are not part of the lift truck.

Know the appropriate work-site hand signals and who gives them. Accept signals from one person only.

Always use the overhead guard. The overhead guard is intended to protect the lift truck operator from overhead obstructions and from falling objects.

A truck that is used for handling small objects or uneven loads must be fitted with a load backrest.

If the lift truck must be operated without the overhead guard in place due to low overhead clearance, use extreme care. Make sure there is no possibility of falling objects from any adjacent storage or work area. Make sure the load is stable and fully supported by the carriage and the load backrest extension (if equipped).

Do not raise loads any higher than necessary and never raise a load higher than 1830 mm (72 in) with the overhead guard removed.

Always use load backrest extension when the carriage or attachment does not fully support the load.

The load backrest extension is intended to prevent the load or any part of the load from falling backwards into the operator’s station.

When operation the lift truck, do not depend only on flashing lights or back-up alarm (if equipped) to warn pedestrians.

Always be aware of pedestrians and do not proceed until the pedestrians are aware of your presence and intended actions and have moved clear of the lift truck and/or load.

Do not drive lift truck up to anyone standing in front of an object.

Obey all traffic rules and warning signs.

Keep hands, feet and head inside the operator station. Do not hold onto the overhead guard while operating the lift truck. Do not climb on any part of the mast or overhead guard or permit others to do so.

Do not allow unauthorized personnel to ride on the forks or any other part of the lift truck, at any time. When working in a building or dock, observe floor load limits and overhead clearances.

NOTICE

Inhaling Freon gas through a lit cigarette or other smoking method or inhaling fumes released from a flame contacting Freon can cause bodily harm or death. Do not smoke when servicing air conditioners or wherever Freon gas may be present.

Do not smoke when servicing air conditioners or wherever Freon gas may be present.

The Machine contains 0.35kg of HFC-134a, of which the CO2 equivalent value is 0.501 tons.

The GWP of HFC-134a is 1,430.

This is only for the trucks with air-conditioner option.

The above capacity information written on the film is attached to the truck.

Never put maintenance fluids into glass containers.

Use all cleaning solutions with care.

Do not use steam, solvent, or high pressure to clean electrical components.

Report all needed repairs.

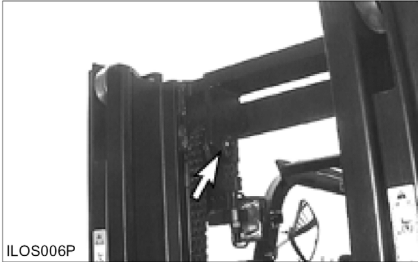

Inspect the part of the chain that is normally operated over the crosshead roller. When the chain bends over the roller, the movement of the parts against each other causes wears.

Inspect to be sure that chain link pins do not extend outside of the bore hole.

If any single link pin is extended beyond its connecting corresponding link, it should be suspected of being broken inside of its bore hole.

Inspect the chain anchor and the anchor links for wear.

Do not change any factory set adjustment values(including engine rpm setting) unless you have both authorization and training. Especially Safety equipment and switches may not be removed or adjusted incorrectly. Repairs, adjustments and maintenances that are not correct can make a dangerous operating condition.

For any checkup, repair, adjustments, maintenance and all other work concerning your forklift truck, please contact your CROWN branch. We would like to draw your attention to the fact that any secondary damages due to improper handling, insufficient maintenance, wrong repairs or the use of other than original CROWN spare parts waive any liability by CROWN.

Operation Information

Mounting and Dismounting

Mount and dismount the lift truck carefully.

Clean your shoes and wipe your hands before mounting.

Face the lift truck when mounting and dismounting.

Use both hands face the lift truck when mounting and dismounting.

Use the handgrips for mounting and dismounting.

Do not try to climb on or off the lift truck when carrying tools or supplies.

Never get on or off a moving lift truck.

Do not use any controls as handholds when entering or leaving the operator's station.

Never get on or off a moving lift truck. Never jump off the lift truck.

Keep hands and steering wheel free of slippery material.

Before Starting the Lift Truck

Perform a walk-around inspection daily and at the start of each shift. Refer to the topic "Walk-around Inspection" in "Every 10 Service Hours or Daily" section of this manual.

Adjust the seat so that full brake pedal travel can be obtained with the operator's back against the seat back.

Make sure the lift truck is equipped with a lighting system as required by conditions.

Make sure all hydraulic controls are in the HOLD position.

Make sure the direction control lever is in the NEUTRAL position.

Make sure the parking brake is engaged.

Make sure no one is standing and/or working on, underneath or close to the lift truck before operating the lift truck.

Operate the lift truck and controls only from the operator's station.

Make sure the lift truck horn, lights, backup alarm (if equipped) and all other devices are working properly. Check for proper operation of mast and attachments.

Pay particular attention to unusual noises or erratic movement which might indicate a problem.

Make sure service and parking brakes, steering, and directional controls are operational.

Make sure all personnel are clear of lift truck and travel path.

Refer to the topic "Lift Truck Operation" in the "Operation Section" of this manual for specific starting instructions.

Starting the Lift Truck

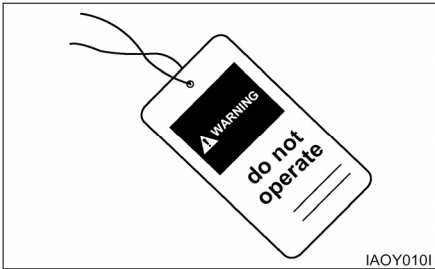

Do not start the engine or move any of the controls if there is a "DO NOT OPERATE" or similar warning tag attached to the start switch or controls.

Before Operating the Lift Truck

Test brakes, steering controls, horn and other devices for proper operation. Report faulty performance.

Do not operate lift truck until repaired.

Learn how your lift truck operates. Know its safety devices. Know how the attachments work.

Before moving the lift truck, look around. Start, turn and brake smoothly.

An operator must constantly observe his lift truck for proper operation.

Operating the Lift Truck

Always keep the lift truck under control.

Obey all traffic rules and warning signs.

Never leave the lift truck with the engine operating, or with the parking brake disengaged.

Operate the engine only in a well ventilated area.

Lower a mast, with or without load, before turning or traveling. Tip over could result. Watch out for overhead obstructions.

Always observe floor load limits and overhead clearance.

Start, turn, and brake smoothly, slow down for turns, grades, slippery or uneven surfaces.

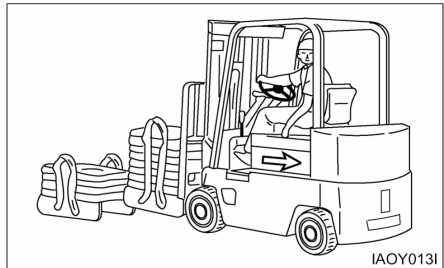

Use special care when operation on grades. Do not angle across or turn on grades. Do not use lift truck on slippery grades. Travel with forks downgrade when unloaded. Travel with load upgrade.

Do not overload, or handle offset, unstable, or loosely stacked loads. Refer to load capacity plate on the lift truck. Use extreme caution when handling suspended, long, high or wide load.

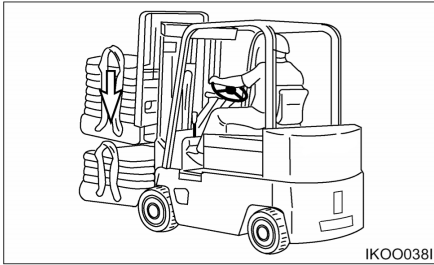

Tilt elevated load forward only when directly over unloading area and with load as low as possible.

Do not stunt ride or indulge in horseplay.

Always look and keep a clear view of the path of travel.

Travel in reverse if load or attachment obstructs visibility.

Use extreme caution if visibility is obstructed.

Stay in designated travel path, clear of dock edges, ditches, other drop-offs and surfaces which cannot safely support the lift truck.

Slow down and use extra care through doorways, intersections and other location where visibility is reduced.

Slow down for and avoid pedestrians, other vehicles, obstruction, pot holes and other hazards or objects in the path of travel.

Always use overhead guards except where operation conditions do not permit. Do not operate lift truck in high stacking areas without overhead guards.

When stacking, watch for falling objects. Use load backrest extension and overhead guard.

Refer to the topic "Operation Techniques" in the "Operation Section" of this manual.

Loading or Unloading Trucks/Trailers

Do not operate lift trucks on trucks or trailers which are not designed or intended for that purpose. Be certain truck or trailer brakes are applied and wheel chocks in place (or be certain unit is locked to the loading dock) before entering onto trucks or trailers.

If trailer is not coupled to tractor, make sure the trailer landing gear is properly secured in place. On some trailers, extra supports may be needed to prevent upending or corner dipping.

Be certain dock plates are in good condition and properly placed and secured. Do not exceed the rated capacity of dock boards or bridge plates.

Lift Truck Parking

When leaving the operator station, park the lift truck in authorized areas only. Do not block traffic.

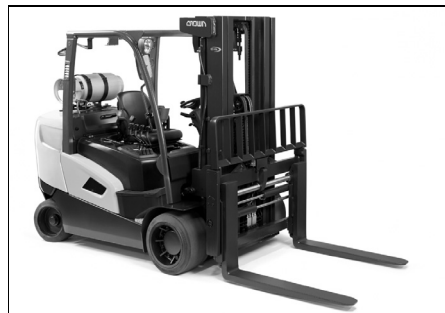

Park the lift truck level, with the forks lowered and the mast tilted forward until the fork tips touch the floor.

- Move the direction control lever to NEUTRAL.
- Engage the parking brake.
- Turn the key switch off and remove the key.
- Turn the disconnect switch to OFF and remove the key (if equipped).
- Do not operate the disconnecting switch after 30 seconds from start key-off. (if equipped)
- Otherwise, Engine Control Unit (ECU) can be damaged.
- Block the drive
- Block the drive wheels when parking on an incline.

Maintenance Information

Perform all maintenance unless otherwise specified as follows ;

- Park the lift truck in authorized areas only.
- Park the lift truck level, with the forks lowered and the mast tilted forward until the fork tips touch the floor.
- Place the transmission controls in neutral.
- Engage the parking brake.
- Stop the engine.
- Remove the start switch key and turn the disconnect switch OFF (if equipped).
- Block the drive wheels when parking on an incline.

Pressure Air

Pressure air can cause personal injury. When using pressure air for cleaning, wear a protective face shield, protective clothing and protective shoes.

The maximum air pressure must be below 205 kPa (30 psi) for cleaning purposes.

Fluid Penetration

Always use a board or cardboard when checking for a leak. Escaping fluid under pressure, even a pinhole size leak, can penetrate body tissue, causing serious injury, and possible death. If fluid is injected into your skin, it must be treated by a doctor familiar with this type of injury immediately.

Crushing or Cutting Prevention

Support equipment and attachments properly when working beneath them. Do not depend on hydraulic cylinders to hold it up. Any attachment can fall if a control is moved, or if a hydraulic line breaks.

Never attempt adjustments while the lift truck is moving or the engine is running unless otherwise specified.

Where there are attachment linkages, the clearance in the linkage area will increase or decrease with movement of the attachment.

Stay clear of all rotating and moving parts.

Keep objects away from moving fan blades.

They will throw or cut any object or tool that falls or is pushed into them.

Do not use a kinked or frayed wire rope cable. Wear gloves when handling the wire rope cable.

Retainer pins, when struck with force, can fly out and injure nearby persons. Make sure the area is clear of people when driving retainer pins.

Wear protective glasses when striking a retainer pin to avoid injury to your eyes.

Chips or other debris can fly off objects when struck. Make sure no one can be injured by flying debris before striking any object.

Falling Objects Protective Structure(FOPS)

This is an attached guard located above the operator's compartment and secured to the lift truck.

To avoid possible weakening of the Falling Objects Protective Structure (FOPS), consult a CROWN branch before altering, by adding weight to, welding on, or cutting or drilling holes into the structure.

The overhead guard is not intended to protect against every possible impact. The overhead guard may not protect against some objects penetrating into the operator's station from the sides or ends of the lift truck.

The lift truck is equipped with an overhead guard and FOPS as standard. If there is a possibility of overhead objects falling through the guard, the guard must be equipped with smaller holes or a Plexiglas cover.

Any altering done that is not specifically authorized by CROWN invalidates CROWN's FOPS certification.

The protection offered by this FOPS will be impaired if it has been subjected to structural damage.

Structural damage can be caused by an overturn accident, by falling objects, etc.

Do not mount any item such as fire extinguishers, first aid kits and lights by welding brackets to or drilling holes in any FOPS structure. See your CROWN branch for mounting guidelines.

Burn Prevention

Coolant

At operating temperature, the engine coolant is hot and under pressure. The radiator and all lines to heaters or the engine contain hot water or steam. Any contact can cause severe burns.

Steam can cause personal injury.

Check the coolant level only after engine has been stopped and the filler cap is cool enough to remove with your bare hand.

Remove the cooling system filter cap slowly to relieve pressure.

Cooling system additive contains alkali that can cause personal injury. Avoid contact with the skin and eyes and do not drink.

Allow cooling system components to cool before draining.

Oils

Hot oil and components can cause personal injury. Do not allow hot oil or components to contact the skin.

At operation temperature, the hydraulic tank is hot and can be under pressure.

Remove the hydraulic tank filter cap only after the engine has been stopped and the filter cap is cool enough to remove with your bare hand.

Remove the hydraulic tank filter cap slowly to relieve pressure.

Relieve all pressure in air, oil fuel or cooling systems before any lines, fittings or related items are disconnected or removed.

Batteries

Batteries give off flammable fumes which can explode.

Do not smoke when observing the battery electrolyte levels.

Electrolyte is an acid and can cause personal injury if it contacts skin or eyes.

Always wear protective glasses when working with batteries.

Fire or Explosion Prevention

All fuels, most lubricants and some coolant mixtures are flammable.

Fuel leaked or spilled onto hot surfaces or electrical components can cause a fire.

Do not smoke while refueling or in a refueling area.

Do not smoke in areas where batteries are charged, or where flammable materials are stored.

Batteries in series can be located in separate compartments.

When using jumper cables always connect positive(+) cable to positive(+) terminal of battery connected to starter solenoid and negative(-) cable from external source to starter negative(-) terminal.

(If not equipped with starter negative(-) terminal, connect to engine block.)

See the Operation Section of this manual for specific starting instructions.

Clean and tighten all electrical connections. Check daily for loose or frayed electrical wires. Have all loose or frayed electrical wires tightened, repaired or replaced before operation the lift truck.

Keep all fuels and lubricants stored in properly marked containers and away from all unauthorized persons.

Store all oily rags or other flammable material in a protective container, in a safe place.

Do not weld or flame cut on pipes or tubes that contain flammable fluids. Clean them thoroughly with nonflammable solvent before welding or flame cutting on them.

Remove all flammable materials such as fuel, oil and other debris before they accumulate on the lift truck.

Do not expose the lift truck to flames, burning brush, etc., if at all possible.

Shields, which protect hot exhaust components from oil or fuel spray in the event of a line, tube or seal failure, must be installed correctly.

Do not operate in areas where explosive gases exist or are suspected.

Fire Extinguisher

Have a fire extinguisher-type BC and 1.5KG minimum capacity-on rear overhead guard leg with latch and know how to use it. Inspect and have it serviced as recommended on its instruction plate.

Ether

Ether is poisonous and flammable.

Breathing ether vapors or repeated contact of ether with skin can cause personal injury.

Use ether only in well-ventilated areas.

Do not smoke while changing ether cylinders.

Use ether with care to avoid fires.

Do not store replacement ether cylinders in living areas or in the operator's compartment.

Do not store ether cylinders in direct sunlight or at temperatures above 39°C (102°F).

Discard cylinders in a safe place. Do not puncture or burn cylinders.

Keep ether cylinders out of the reach of unauthorized personnel.

Lines, Tubes and Hoses

Do not bend or strike high pressure lines. Do not install bent or damaged lines, tubes or hoses.

Repair any loose or damaged fuel and oil lines, tubes and hoses. Leaks can cause fires. Contact your CROWN branch for repair or replacement.

Check lines, tubes and hoses carefully. Do not use your bare hand to check for leaks. Use a board or cardboard to check for leaks. See Fluid Penetration in the Safety Section for more details. Tighten all connections to the recommended torque. Replace if any of the following conditions are found.

- End fittings damaged or leaking.
- Outer covering chafed or cut and wire reinforcing exposed.
- Outer covering ballooning locally.
- Evidence of kinking or crushing of the flexible part of hose.
- Armoring embedded in the outer cover.
- End fittings displaced.

Make sure that all clamps, guards and heat shields are installed correctly to prevent vibration, rubbing against other parts, and excessive heat during operation.

Tire Information

Servicing, changing tires and rims can be dangerous and should be done only by trained personnel using proper tools and procedures. If correct procedures are not followed while servicing tires and rims, the assemblies could burst with explosive force and cause serious personal injury or death. Follow carefully the specific information provided by your tire or rim servicing personnel or branch.

CROWN forklift is equipped with wheels from different manufacturers.

Please re-use the original parts of the existing wheel, if there is no deformation of the wheel after checked. Mixing up new and old parts may cause incomplete assembly that might lead to unexpected dismantlement of parts and accident.

Operator Restraint System

Warning Signs and Labels

Your CROWN lift truck has the following tipover warning decals.

Make sure that you can read all safety signs. Clean or replace these if you cannot read the words or see the pictures. When cleaning the labels use a cloth, water and soap. Do not use solvent, gasoline, etc. You must replace a label if it is damaged, missing or cannot be read. If a label is on a part that is replaced, make sure a new label is installed on the replaced part. See you CROWN Lift Truck branch for new labels.

The most effective method of preventing serious injury or death to yourself or others is to familiarize yourself with the proper operation of the lift truck, to be alert, and to avoid actions or conditions which can result in an accident.



WARNING

Tipover can occur if the truck is improperly operated. In the event of a tipover, injury or death could result.

"Survive in tipover" decal



IB900002

"Survive in tipover" decal



IB900003

"Fasten seat belt" decal



IB900004

"Survive in tipover" decal

The "Survive in tipover" warning is located on the overhead guard. It shows the proper use of the operator restraint system.

Seat Adjustment



Front-to-back adjustment

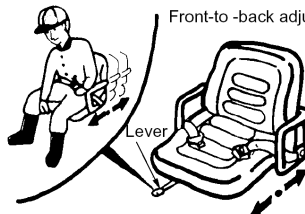

IB900005

Move the lever, slide the seat to the desired position, and release the lever.

Adjust the seat before operating the lift truck. After adjusting, set the seat to make sure it is properly locked. Do not adjust the seat while the truck is in motion.

⚠ WARNING

Do not place your hand or fingers under the seat. Injury may occur as the seat moves up and down.

Weight adjustment

Pull the weight adjustment lever upwards and move right or left side.

Adjust to driver's weight range.

- Grammer Seat : 50 ~ 170 kg
- Sears Seat : 45~136kg

NOTICE

Do not place your hand or fingers under the seat. Injury may occur as the seat moves up and down.

If Optional Suspension Seat (weight adjusting type) Equipped

Forward and Backward Adjustment

The seat can be adjusted by pushing the lever on the right side of seat.

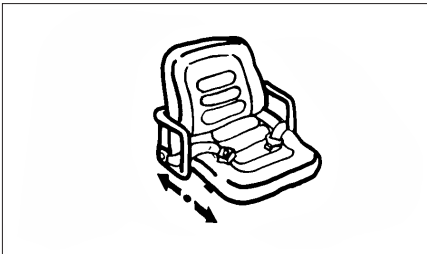

Adjust the seat before operating the lift truck. After adjusting, set the seat to make sure it is properly locked. Do not adjust the seat while the truck is in motion.

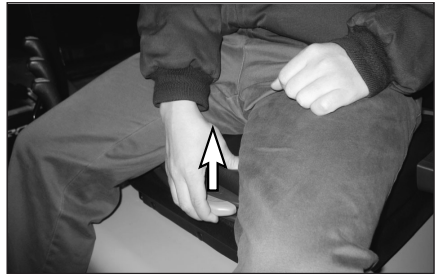

Backrest Inclination

The backrest angle can be adjusted by using the lever on the left side of seat.



Backrest Inclination

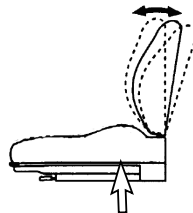

IC100086

Seat Belt

The Operator Restraint System, Prevents the operator from jumping from the operator's compartment in the event of a forward or side tipover. The system is designed to keep the operator on the seat and in the operator's compartment in the event of a tipover.

Inspection

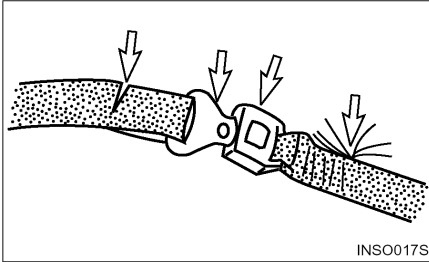

1. If the seat belt is torn, if pulling motion is interrupted during extension of the belt, or if the belt cannot be inserted into the buckle properly, replace the seat belt assembly.

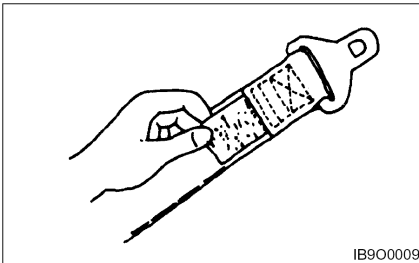

2. Belt Maintenance – Every 500 service hours. Check that the belt fastening works properly and that winding device is free from run lock when jerked. Check that the belt is suitably fastened to the seat. Check that the seat is correctly secured to the hood and the chassis. On visual inspection, fastenings must be intact, otherwise, contact the safety manager.

⚠ WARNING

Your CROWN truck comes equipped with a CROWN operator restraint system. Should it become necessary to replace the seat for any reason, it should only be replaced with another CROWN operator restraint system.

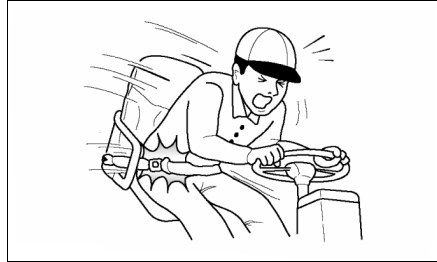

3. In the event of a tipover, the seat and restraint system should be inspected for damage and replaced, if necessary.

NOTE: Operator restraints shall be examined at the regular truck service intervals. It is recommended that they be replaced if any of the following conditions are found:

- Cut or frayed strap
- Worn or damaged hardware including anchor points
- Buckle or retractor malfunction
- Loose stitching

⚠ WARNING

The seat belt may cause the operator to bend at the waist. If you are pregnant or have suffered from some abdominal disease, consult a doctor before you use the seat belt.

Fasten the Seat Belt

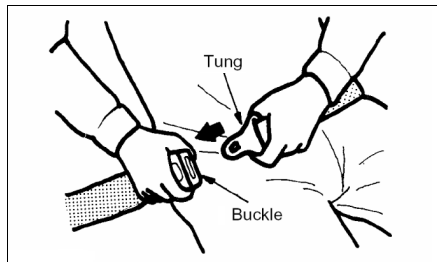

1. Grip the plate (connector) of the belt and pull the belt from the retractor. Then insert the plate into the slot of the buckle until a snap is heard. Pull on the belt to confirm it is latched.
2. Make sure the belt is not twisted.

⚠ WARNING

If you fasten the belt across your abdomen, the belt may injure your abdomen in an accident.

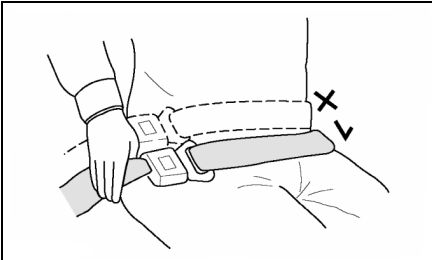

3. Be sure to fasten the belt across your hips, not across your abdomen.

NOTE: The belt is designed to automatically adjust to your size and movement. A quick pull on the belt will confirm that the automatic adjuster will hold the belt position in the event of an accident.

Release the Seat Belt

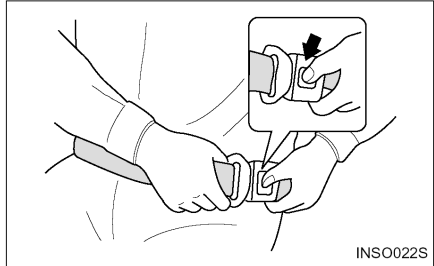

Push the button of the buckle to release the belt. The belt will automatically retract when released. Hold the plate of the belt and allow the belt to slowly retract.

Avoiding Lift Truck Tipovers

Lift Truck Stability

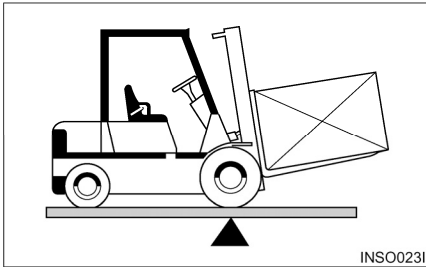

Counterbalanced lift truck design is based on the balance of two weights on opposite sides of a fulcrum (the front axle). The load on the forks must be balanced by the weight of the lift truck.

The location of the center of gravity of both the truck and the load is also a factor. This basic principle is used for picking up a load. The ability of the lift truck to handle a load is discussed in terms of center of gravity and both forward and sideways stability.

Center of Gravity (CG)

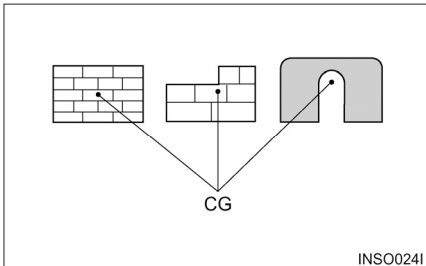

The point within an object, at which the whole weight of the object may be regarded as being concentrated, is called the center of gravity or CG. If the object is uniform, its geometric center will coincide with its CG. If it is not uniform, the CG could be at a point outside of the object. When the lift truck picks up a load, the truck and load have a new combined CG.

Stability and Center of Gravity

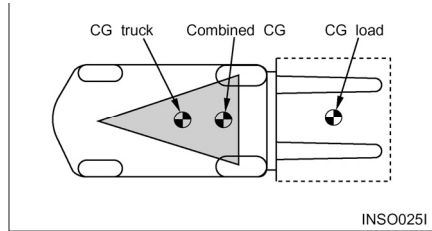

The stability of the lift truck is determined by the location of its CG; or, if the truck is loaded, the combined CG of the truck and load. The lift truck has moving parts and, therefore, has a CG that moves. The CG moves forward or backward as the mast is tilted forward or backward. The CG moves up or down as the mast moves up or down. The CG and, therefore, the stability of the loaded lift truck, is affected by a number of factors such as:

- the size, weight and CG, shape and position of the load
- the height to which the load is lifted
- the amount of forward or backward tilt
- tire pressure
- dynamic forces created when the lift truck is accelerated, braked or turned
- condition and grade of surfaces on which the lift truck is operated

WARNING

Loss of stability can cause accidents.

Changing the components can alter the stability.

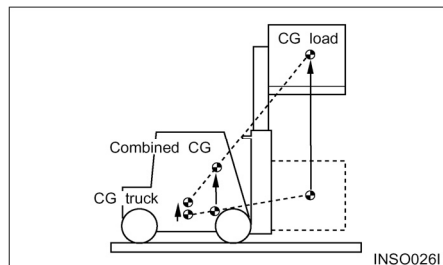

These same factors are also important for unloaded lift trucks. They tip over sideways easier than a loaded lift truck carrying its load in the lowered position.

Lift Truck Stability Base

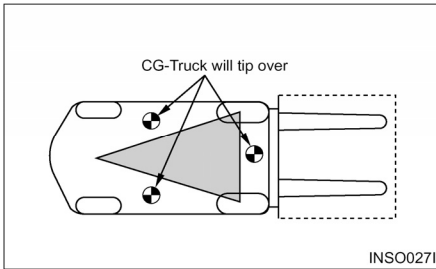

For the lift truck to be stable (not tip over forward or to the side), the CG must stay within the area of the lift truck stability base - a triangular area between the front wheels and the pivot of the steer wheels. If the CG moves forward of the front axle, the lift truck will tip forward. If the CG moves outside of the line on either side of the stability base, the lift truck will tip to the side.

WARNING

Dynamic forces (braking, acceleration, turning) also affect stability and can produce tipover even when the CG is within the stability triangle.

Capacity Load (Weight and Load Center)

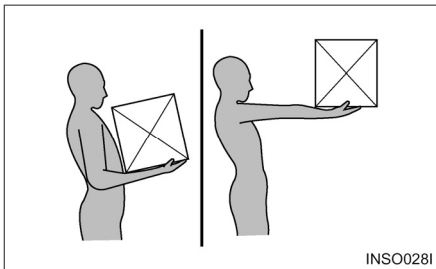

The capacity load of the lift truck is shown on the capacity/nameplate riveted to the truck. It is determined by the weight and load center. The load center is determined by the location of the CG of the load.

The load center shown on the nameplate is the horizontal distance from the front face of the forks, or the load face of an attachment, to the CG of the load.

The location of the CG in the vertical direction is the same as the horizontal dimension.

Remember that, unless otherwise indicated, the capacity load shown on the nameplate is for a standard lift truck with standard backrest, forks and mast, and having no special-purpose attachment. In addition, the capacity load assumes that the load center is no further from the top of the forks than it is from the face of the backrest. If these conditions do not exist, the operator may have to reduce the safe operating load because the truck stability may be reduced. The lift truck should not be operated if its capacity/nameplate does not indicate capacity load.

NOTE: If the load is not uniform, the heaviest portion should be placed closer to the backrest and centered on the forks.

NOTICE

1. Capacity/Nameplates originally attached to forklifts sold by CROWN shall not be removed, altered or replaced without CROWN's approval.
 2. CROWN assumes no responsibility for lift trucks placed in service without a valid CROWN Nameplate.
 3. If necessary to change your specification, contact your CROWN lift truck branch.
-

Safety Rules

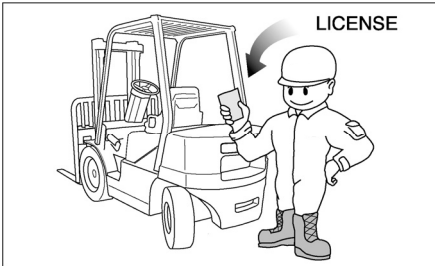

Only properly trained and authorized personnel should operate forklift trucks. Wear a hard hat and safety shoes when operating a lift truck. Do not wear loose clothing.

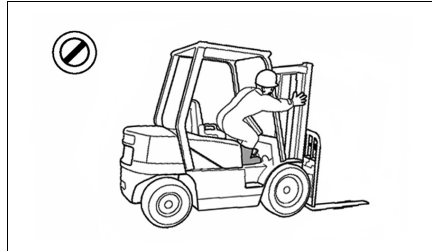

Do not operate a lift truck unless you are in the operator's seat. Keep hands and feet inside the operator's compartment. Do not put any part of the body outside of the operator's compartment. Never put any part of body into the mast structure or between the mast and the truck

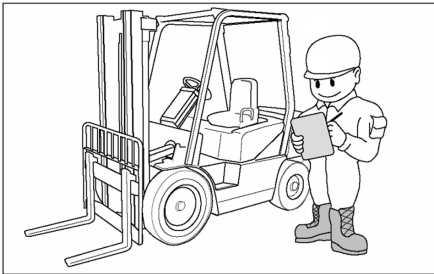

Inspect and check the condition of your forklift truck using the operator's check list before starting work. Immediately report to your supervisor any obvious defects or required repairs.



Do not start, stop, turn or change direction suddenly or at high speed. Sudden movement can cause the lift truck to tip over. Slow the speed of your truck and use the horn near corners, exits, entrances, and near people.

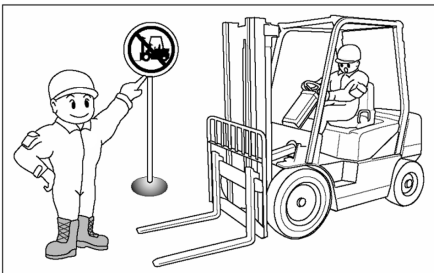

Do not operate your truck in unauthorized areas. Know your forklift truck and think safety. Do not compromise safety. Follow all safety rules and read all warning signs.

In case of a truck with the steering knob, Do not operate the steering knob suddenly, to prevent accident caused by quick turning.

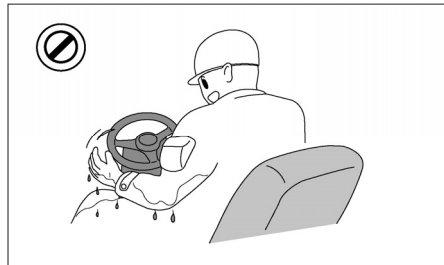

Never operate a lift truck with wet hands or shoes. Never hold any controls with grease on your hands. Your hands or feet will slide off of the controls and cause an accident.

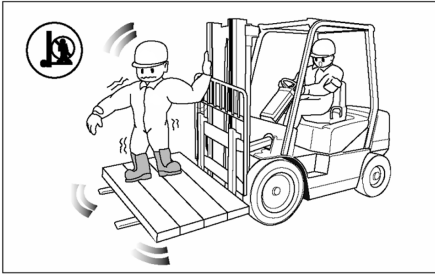

Do not raise anyone on the forks of your lift truck.
Do not let other people ride on the truck.
Lift trucks are designed to carry loads, not people.

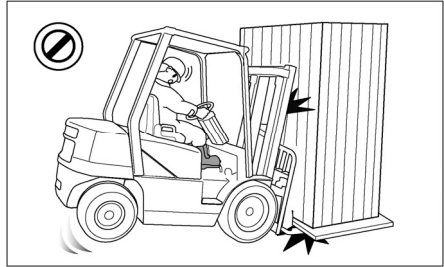

Do not overload. Always handle loads within the rated capacity shown on the capacity plate.
Do not add extra counterweight to the truck.
An overload can cause the truck to roll over and cause injury to personnel and damage to the lift truck.



Do not operate your truck without the load backrest extension and overhead guard. Keep the load against the backrest with the mast tilted backward.

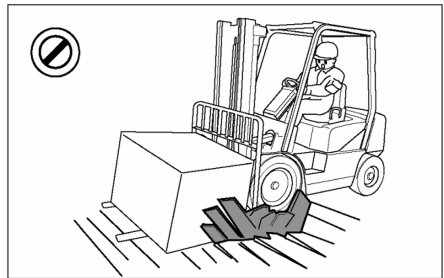

Do not drive on soft ground.
Observe all signs, especially those on maximum permitted floor loadings, elevator capacities and clearance heights.
Handle loads carefully and check them closely for stability and balance.

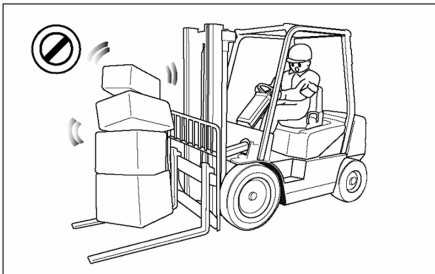

Do not lift or move loads that are not safe. Do not pick up an off center load. Such a load increases the possibility of a tipover to the side. Make sure loads are correctly stacked and positioned across both forks. Always use the proper size pallet. Position the forks as wide as possible under the load. Position loads evenly on the forks for proper balance. Do not lift a load with one fork.

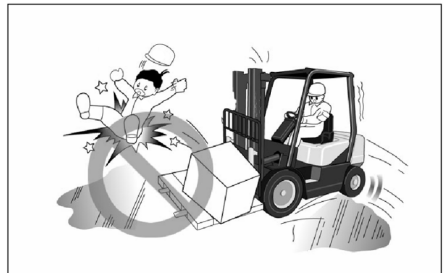

Do not drive on slippery surfaces.
Sand, gravel, ice or mud can cause a tipover. If unavoidable, slow down.

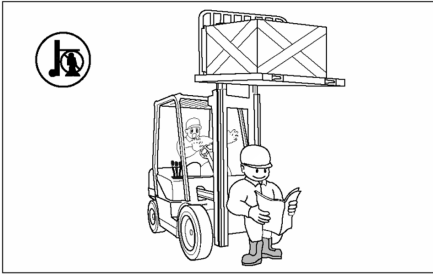

Do not permit anyone to stand or walk under the load or lifting mechanism. The load can fall and cause injury or death to anyone standing below.

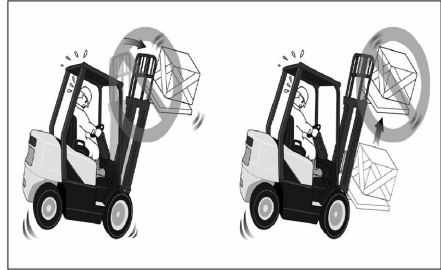

Do not elevate the load with the mast tilted forward. Do not tilt the elevated loads forwards. This will cause the lift truck to tip over forward.

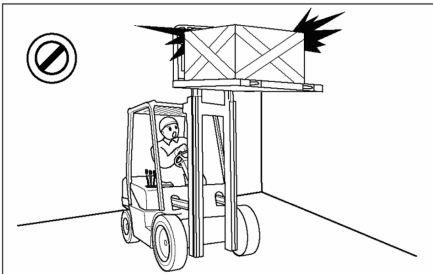

Look out for overhead obstructions when raising or stacking loads. Do not travel with a raised load. Do not travel with the mast raised. The lift truck can roll over and cause injury or death to you or other personnel.

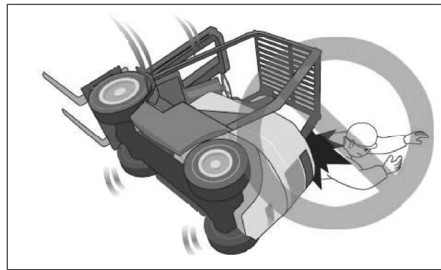

Do not jump off if your truck starts to tip over. Stay in your seat to survive.

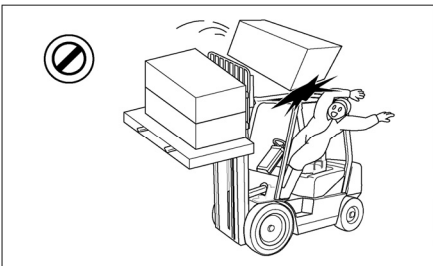

Do not move loose loads that are higher than the load backrest. Be alert for falling loads when stacking. Travel with the load tilted back and the forks as low as possible. This will increase stability to the truck and load and permit better visibility for you.

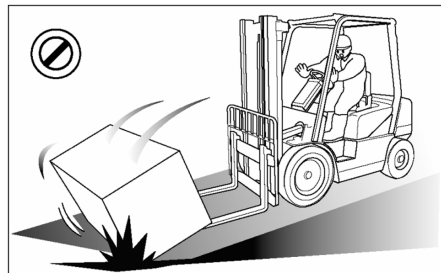

Go up ramps in forward direction and down ramps in reverse direction when moving loads. Never elevate a load with the forklift truck on an incline. Go straight off and straight down. Use an assistant when going up or down a ramp with a bulky load.

Safety Section

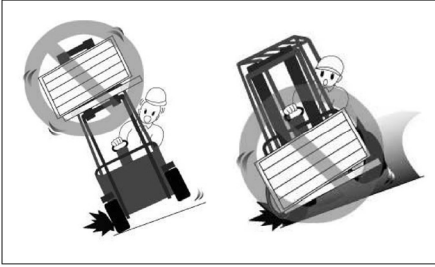

Do not stack or turn on ramps.
Do not attempt to pick-up or deposit a load unless the lift truck is level. Do not turn on or drive across an incline.



Do not drive in forward direction when loads restrict your visibility. Operate your lift truck in reverse to improve visibility except when moving up a ramp.

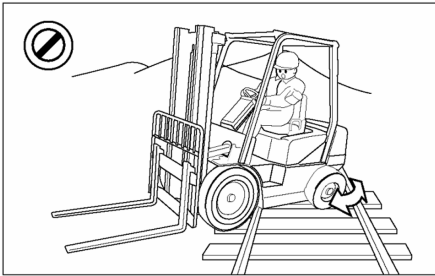

Do not go over rough terrain. If unavoidable, slow down. Cross railroad tracks slowly and diagonally whenever possible. A railroad crossing can give a loaded forklift truck a real jolt. For smoother crossing, cross the railroad diagonally so one wheel crosses at a time.

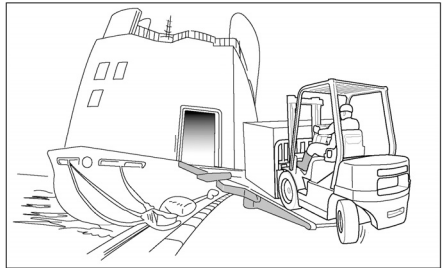

Be careful when operating a lift truck near the edge of a loading dock or ramp. Maintain a safe distance from the edge of docks, ramps and platforms. Always watch tail swing. The truck can fall over the edge and cause injury or death.

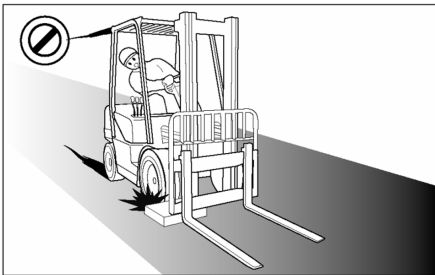

Avoid running over loose objects. Look in the direction of travel. Look out for other persons or obstructions in your path of travel. An operator must be in full control of his lift truck at all times.

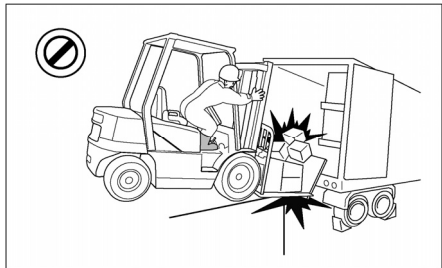

Do not operate on bridge plates unless they can support the weight of the truck and load. Make sure that they are correctly positioned. Put blocks on the vehicle you enter to keep it from moving.

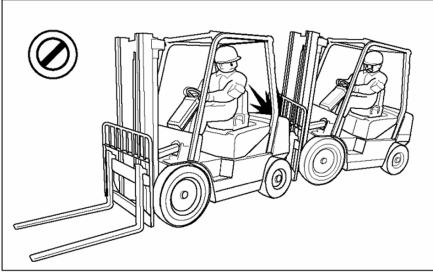

Do not operate your truck close to another truck. Always keep a safe distance from other trucks and make sure there is enough distance to stop safely. Never overtake other vehicles.



Do not use your lift truck to push or tow another truck. Do not let another push or tow your truck. If a truck will not move, call a service technician.

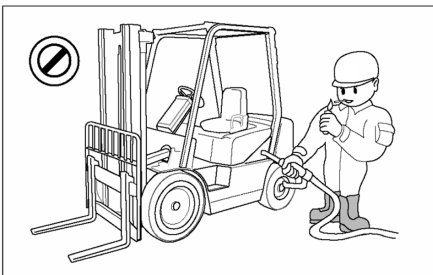

Forklift trucks may only be refueled at specially reserved locations. Switch off the engine when refueling. Smoking and handling of naked flames during refueling are strictly prohibited. This prohibition also applies during the changing of the LPG (liquefied propane gas) tank. Mop up spilled fuel and do not forget to close the fuel tank before restarting the engine.

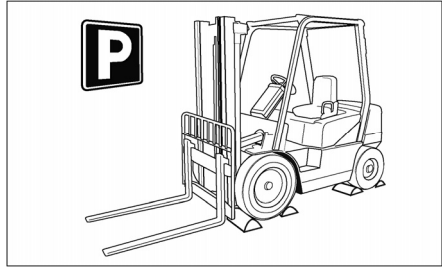

Park your lift truck in authorized areas only. Fully lower the forks to the floor, put direction lever in NEUTRAL position, engage the parking brake, and turn the key to the OFF position. Remove the key and put blocks behind the wheels to prevent the truck from rolling. Shut off your forklift truck when leaving it unattended. Check the condition of your forklift truck after the day's work.

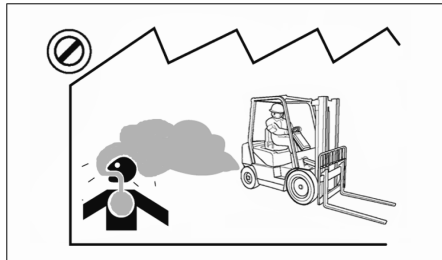

Exhaust from all internal combustion engines contains carbon monoxide, a colorless, odorless, tasteless, poisonous gas. Exposure to carbon monoxide can cause serious injury or health problems, including death. And avoid unnecessary idling of the engine. If nausea, dizziness or headaches are experienced stop the truck and seek fresh air.

Safety Section

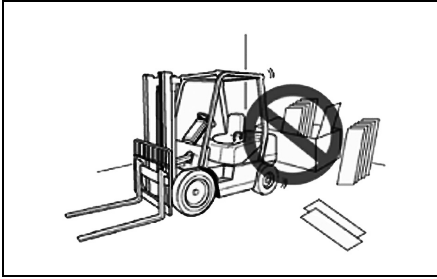

Do not operate forklifts near flammable or combustible materials.

To avoid the discoloration, deformation or combustion of materials (such as lumber, veneer board, paper products and other similar items), always park at least 30 cm (12 inches) away from them.

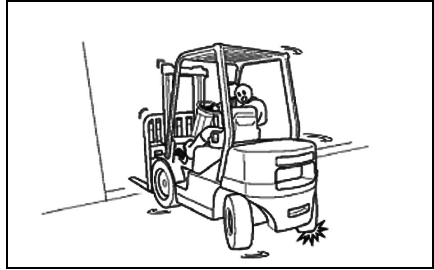

An unloaded forklift may be easier to tip over than a loaded truck.

When traveling without a load, the risk of lateral overturn is greater.

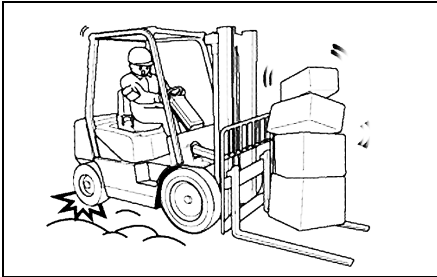

Forklift trucks are not cars. They often have small tires, no suspension, and are very heavy.

The forklift's center of gravity will also change when carrying loads.

Avoid uneven bumps, pot holes and other hazards whenever possible.

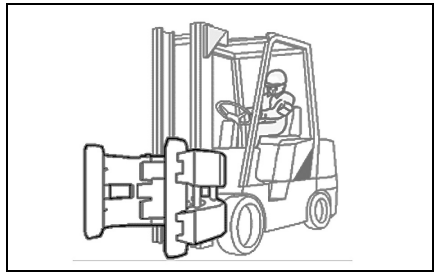

There are many special attachments available to replace the forks on a lift truck.

All carry safety implications and special training in their operation is highly recommended.

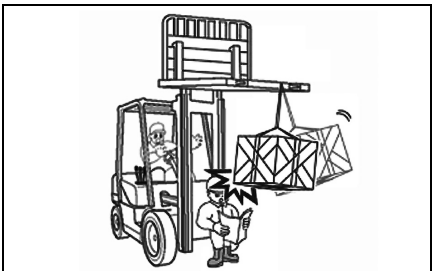

Carrying a load suspended on a chain or a cable may unbalance a truck.

Take extra care around pedestrians with a suspended load as it may sway or even strike them.

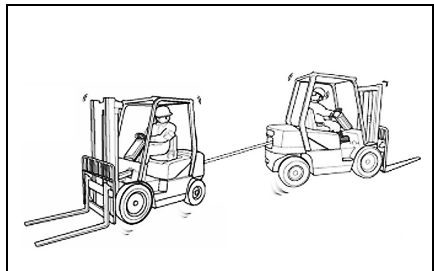

The counterweight draw bar should not be used for towing the forklift or for towing another forklift.

Towing is only advised in emergencies, by trained operators and at low speed, no faster than 2 km/h, to a convenient location for repair.

How to Survive in a Tipover (If Operator Restraint System Equipped)

WARNING

In the event of a tipover, the risk of serious injury or death will be reduced if the operator is using the operator restraint system and follows the instructions provided.



FASTEN SEAT BELT

INSO0461

Always use operator restraint system.



DON'T JUMP

INSO0471

DON'T jump.



HOLD ON TIGHT

INSO0481

Hold on tight.



BRACE FEET

INSO0491

Brace your feet and keep them within the operator's compartment.



LEAN AWAY

INSO0501

Lean away from the direction of fall.



LEAN FORWARD

INSO0511

Lean forward.

Specifications

Characteristics	1.1	Manufacturer			CROWN
	1.2	Model designation			CGC35S-9
	1.3	Drive: Diesel, Gasoline, LP			LP
	1.4	Operator type: Hand, Pedestrian, Standing, Seated, Order-picker			Seated
	1.5	Load Capacity	Q	lb(kg)	8,000 (3,620)
	1.6	Load Center	C	in(mm)	24 (600)
	1.8	Load Distance: Center of Driveaxle to fork	x	in(mm)	17.6 (447)
	1.9	Wheelbase	y	in(mm)	61.8 (1,570)
	Weight	2.1	Service weight		lb(kg)
2.2		Axle Loading, Laden Front/Rear		lb(kg)	18,043 (8,184) / 3,427 (1,554)
2.3		Axle Loading, Unladen Front/Rear		lb(kg)	4,657 (2,112) / 8,813 (3,997)
Tires	3.1	Tyres: pneumatic (P), superelastic (SE), cushion (C)			C
	3.2	Tyre size, Front			22 X 9 X 16
	3.3	Tyre size, Rear			18 X 7 X 12.2
	3.5	Wheels, number Front/Rear (x = driven wheels)			2x/ 2
	3.6	Tread, Front	b ₁₁	in(mm)	41.0 (1,042)
	3.7	Tread, Rear	b ₁₂	in(mm)	41.1 (1,044)
	Dimensions	4.1	Tilt of Mast/Fork carriage Forward/Backward	α/β	°
4.2		Height, Mast lowered	h ₁	in(mm)	86.0 (2,185)
4.3		Free Lift	h ₂	in(mm)	6.3 (160)
4.4		Lift	h ₃	in(mm)	118.1 (3,000)
4.5		Height, Mast Extended	h ₄	in(mm)	168.0 (4,265)
4.7		Height of Overhead Guard(Cabin)	h ₆	in(mm)	84.8 (2,155)
4.8		Height of Seat	h ₇	in(mm)	43.5 (1,105)
4.19		Overall Length	l ₁	in(mm)	149.2 (3,790)
4.20		Length to Forkface	l ₂	in(mm)	102.0 (2,590)
4.21		Overall Width	b ₁ /b ₂	in(mm)	50.0 (1,270)
4.22		Fork Dimensions	s/e/l	in(mm)	2.0 x 5.9 x 47.2 (50 x 150 x 1,200)
4.23		Fork carriage ISO 2328, class/type A,B			III/A
4.24		Fork carriage width	b ₃	in(mm)	44.6 (1,132)
4.31		Ground Clearance, laden, below mast	m ₁	in(mm)	4.7 (120)
4.32		Ground Clearance, center of wheelbase	m ₂	in(mm)	5.1 (130)
4.34.1	Aisle width for pallets L=48inch x W=40inch	A _{st}	in(mm)	164.0 (4,164)	
4.35	Turning Radius	W _a	in(mm)	90.5 (2,298)	
4.36	Internal Turning Radius	b ₁₃	in(mm)	29.5 (750)	
Performance data	5.1	Travel Speed, Laden/Unladen		mph(km/h)	10.2 / 10.5 (16.4 / 16.9)
	5.2	Lift Speed, Laden/Unladen		fpm(m/s)	120.1 / 126.0 (.61 / .64)
	5.3	Lowering Speed, Laden/Unladen		fpm(m/s)	100.4 / 88.6 (.51 / .45)
	5.5	Drawbar pull, Laden/Unladen(@ 1mph)		lb(N)	3,264 / 3,277 7,181 (31,987) / 7,209 (32,115)
	5.6	Max. Drawbar pull, Laden/Unladen		lb(N)	3,752 / 3,738 7,154 (31,870) / 8,224 (36,632)
	5.7	Gradeability, Laden/Unladen(@ 1mph)		%	36 / 64
	5.8	Max. Gradeability, Laden/Unladen		%	42 / 77
	5.10	Service Brake			Foot / Hydraulic
Combustion Engine	7.1	Engine Manufacturer/type			PSI / 4X 4.3L
	7.2	Engine power according to DIN ISO1585		hp(kW)	94 (70) @ 2,500
	7.3	Rated Speed		min ⁻¹	2,500
	7.3.1	Torque at 1/min		ft•lbs(N•m)	209.4 (284) @ 1,800
	7.4	Number of Cylinders/Displacement		-/cc(-/cm ³)	6 / 4,294
	7.5	Fuel Consumption according to VDI Cycle		gal/h or lb/h (l/h or kg/h)	8.56(3.88)
	7.10	Battery Voltage/normal capacity		V/Ah	12 / 75
Addition Data	10.1	Operating pressure for attachments		psi(bar)	2,330 ±50 (160 ±3.5)
	10.2	Oil volume for attachments		gpm(l/min)	31.7 (120)
	10.4	Fuel Tank Capacity		gal(l)	-
	10.7	Sound level at the driver's ear according to EN 12 053		dB(A)	84.8

Characteristics	1.1	CROWN	CROWN	CROWN
	1.2	CGC35S-9 BCS	CGC45S-9	CGC45S-9 BCS
	1.3	LP	LP	LP
	1.4	Seated	Seated	Seated
	1.5	8,000 (3,620)	10,000 (4,500)	10,000 (4,500)
	1.6	24 (600)	24 (600)	24 (600)
	1.8	17.6 (447)	18.0 (457)	17.6 (447)
	1.9	61.8 (1,570)	70.5 (1,790)	61.8 (1,570)
	2.1	12,808 (5,810)	15,754 (7,146)	14,658 (6,649)
Weight	2.2	18,378 (8,336) / 2,430 (1,102)	20,830 (9,448) / 4,924 (2,234)	21,744 (9,863) / 2,914 (1,322)
	2.3	4,992 (2,264) / 7,816 (3,545)	4,869 (2,208) / 10,885 (4,937)	4,884 (2,215) / 9,774 (4,433)
	3.1	C	C	C
Tires	3.2	22 X 9 X16	22 X 12 X16	22 X 12 X16
	3.3	18 X 7 X 12.2	18 X 8 X 12.2	18 X 8 X 12.2
	3.5	2x/ 2	2x/ 2	2x/ 2
	3.6	41.0 (1,042)	43.9 (1,116)	43.9 (1,116)
	3.7	41.1 (1,044)	41.1 (1,044)	41.1 (1,044)
	Dimensions	4.1	5 / 6	5 / 6
4.2		86.0 (2,185)	86.0 (2,185)	86.0 (2,185)
4.3		6.3 (160)	6.3 (160)	6.3 (160)
4.4		118.1 (3,000)	118.1 (3,000)	118.1 (3,000)
4.5		168.0 (4,265)	173.8 (4,415)	173.8 (4,415)
4.7		84.8 (2,155)	84.8 (2,155)	84.8 (2,155)
4.8		43.5 (1,105)	43.5 (1,105)	43.5 (1,105)
4.19		144.9 (3,680)	153.1 (3,890)	148.5 (3,773)
4.20		97.6 (2,480)	89.8 (2,690)	101.3 (2,573)
4.21		50.0 (1,270)	55.9 (1,420)	55.9 (1,420)
4.22		2.0 x 5.9 x 47.2(50 x 150 x 1,200)	2.4 x 5.9 x 47.2(60 x 150 x 1,200)	2.4 x 5.9 x 47.2(60 x 150 x 1,200)
4.23		III/A	IV/A	IV/A
4.24		44.6 (1,132)	50.8 (1,290)	50.8 (1,290)
4.31		4.7 (120)	4.7 (120)	4.7 (120)
4.32		5.1 (130)	5.1 (130)	5.1 (130)
4.34.1		148.3 (3,767)	160.6 (4,078)	153.7 (3,905)
4.35		82.8 (2,104)	95.1 (2,415)	87.9 (2,232)
4.36	29.5 (750)	29.5 (750)	29.5 (750)	
Performance data	5.1	10.2 / 10.5 (16.4 / 16.9)	10.0 / 10.5 (16.1 / 16.9)	10.2 / 10.4 (16.4 / 16.8)
	5.2	120.1 / 126.0 (.61 / .64)	116.1 / 126.0 (.59 / .64)	116.1 / 126.0 (.59 / .64)
	5.3	100.4 / 88.6 (.51 / .45)	100.4 / 88.6 (.51 / .45)	100.4 / 88.6 (.51 / .45)
	5.5	3,272 / 3,285 7,198 (32,066) / 7,227 (32,193)	3,189 / 3,247 7,016 (31,252) / 7,143 (31,821)	3,251 / 3,264 7,152 (31,860) / 7,181 (31,987)
	5.6	3,759 / 3,746 8,270 (36,838) / 8,241 (36,711)	3,668 / 3,706 8,070 (35,946) / 8,153 (36,319)	3,738 / 3,725 8,224 (36,632) / 8,195 (36,505)
	5.7	38 / 69	29 / 51	34 / 56
	5.8	44 / 84	33 / 61	35 / 68
	5.10	Foot / Hydraulic	Foot / Hydraulic	Foot / Hydraulic
	7.1	PSI / 4X 4.3L	PSI / 4X 4.3L	PSI / 4X 4.3L
	7.2	94 (70) @2,500	94 (70) @2,500	94 (70) @2,500
Combustion Engine	7.3	2,500	2,500	2,500
	7.3.1	209.4 (284) @1,800	209.4 (284) @1,800	209.4 (284) @1,800
	7.4	6 / 4,294	6 / 4,294	6 / 4,294
	7.5	8.56(3.88)	8.56(3.88)	8.56(3.88)
	7.10	12 / 75	12 / 75	12 / 75
	Addition Data	10.1	2,330 ±50 (160 ±3.5)	2,330 ±50 (160 ±3.5)
10.2		31.7 (120)	31.7 (120)	31.7 (120)
10.4		-	-	-
10.7		84.8	84.8	84.8

General Section

CROWN	CROWN	1.1	Characteristics
CGC55C-9	CGC55C-9 BCS	1.2	
LP	LP	1.3	
Seated	Seated	1.4	Weight
12,000 (5,500)	12,000 (5,500)	1.5	
24 (600)	24 (600)	1.6	
17.9 (454)	17.9 (454)	1.8	
70.5 (1,790)	70.5 (1,790)	1.9	
16,702 (7,576)	16,340 (7,412)	2.1	
23,948 (10,863) / 4,753 (2,156)	24,257 (11,003) / 4,083 (1,852)	2.2	Weight
4,795 (2,175) / 11,906 (5,401)	5,104 (2,315) / 11,236 (5,097)	2.3	
C	C	3.1	Tires
22 X 12 X16	22 X 12 X16	3.2	
18 X 8 X 12.2	18 X 8 X 12.2	3.3	
2x/ 2	2x/ 2	3.5	
43.9 (1,116)	43.9 (1,116)	3.6	
41.1 (1,044)	41.1 (1,044)	3.7	
5 / 6	5 / 6	4.1	Dimensions
86.0 (2,185)	86.0 (2,185)	4.2	
6.3 (160)	6.3 (160)	4.3	
108.3 (2,750)	108.3 (2,750)	4.4	
164.0 (4,165)	164.0 (4,165)	4.5	
84.8 (2,155)	84.8 (2,155)	4.7	
43.5 (1,105)	43.5 (1,105)	4.8	
155.5 (3,950)	151.8 (3,855)	4.19	
108.3 (2,750)	104.5 (2,655)	4.20	
55.9 (1,420)	55.9 (1,420)	4.21	
2.4 x 5.9 x 47.2 (60 x 150 x 1,200)	2.4 x 5.9 x 47.2 (60 x 150 x 1,200)	4.22	
IV/A	IV/A	4.23	
50.8 (1,290)	50.8 (1,290)	4.24	
4.7 (120)	4.7 (120)	4.31	
5.1 (130)	5.1 (130)	4.32	
162.8 (4,136)	160.4 (4,073)	4.34.1	
97 (2,463)	94.5 (2,400)	4.35	
29.5 (750)	29.5 (750)	4.36	
10.0 / 10.5 (16.0 / 16.9)	10.0 / 10.5 (16.1 / 16.9)	5.1	Performance data
110.2 / 126.0 (.56 / .64)	110.2 / 126.0 (.56 / .64)	5.2	
100.4 / 88.6 (.51 / .45)	100.4 / 88.6 (.51 / .45)	5.3	
3,154 / 3,235	3,158 / 3,240	5.5	
6,939 (30,909) / 7,117 (31,703)	6,948 (30,948) / 7,128 (31,752)		
3,633 / 3,694	3,637 / 3,698	5.6	
7,993 (35,603) / 8,127 (36,201)	8,001 (35,643) / 8,136 (36,240)		
25 / 47	25 / 49	5.7	
29 / 56	29 / 58	5.8	
Foot / Hydraulic	Foot / Hydraulic	5.10	Combustion Engine
PSI / 4X 4.3L	PSI / 4X 4.3L	7.1	
94 (70) @2,500	94 (70) @2,500	7.2	
2,500	2,500	7.3	
209.4 (284) @1,800	209.4 (284) @1,800	7.3.1	
6 / 4,294	6 / 4,294	7.4	
8.56 (3.88)	8.56 (3.88)	7.5	
12 / 75	12 / 75	7.10	
2,330 ± 50 (160 ±3.5)	2,330 ± 50 (160 ±3.5)	10.1	
31.7 (120)	31.7 (120)	10.2	
-	-	10.4	Addition Data
84.8	84.8	10.7	

Specifications

Characteristics	1.1	Manufacturer			CROWN	
	1.2	Model designation			CGC35S-9	
	1.3	Drive: Diesel, Gasoline, LP			LP	
	1.4	Operator type: Hand, Pedestrian, Standing, Seated, Order-picker			Seated	
	1.5	Load Capacity	Q	lb(kg)	8,000 (3,620)	
	1.6	Load Center	c	in(mm)	24 (600)	
	1.8	Load Distance: Center of Driveaxle to fork	x	in(mm)	17.6 (447)	
Weight	1.9	Wheelbase	y	in(mm)	61.8 (1,570)	
	2.1	Service weight		lb(kg)	13,470 (6,110)	
	2.2	Axle Loading, Laden Front/Rear		lb(kg)	18,043 (8,184) / 3,427 (1,554)	
Tires	2.3	Axle Loading, Unladen Front/Rear		lb(kg)	4,657 (2,112) / 8,813 (3,997)	
	3.1	Tyres: pneumatic (P), superelastic (SE), cushion (C)			C	
	3.2	Tyre size, Front			22 X 9 X 16	
	3.3	Tyre size, Rear			18 X 7 X 12.2	
	3.5	Wheels, number Front/Rear (x = driven wheels)			2x/ 2	
	3.6	Tread, Front	b ₁₁	in(mm)	41.0 (1,042)	
	3.7	Tread, Rear	b ₁₂	in(mm)	41.1 (1,044)	
Dimensions	4.1	Tilt of Mast/Fork carriage Forward/Backward	α/β	°	5 / 6	
	4.2	Height, Mast lowered	h ₁	in(mm)	86.0 (2,185)	
	4.3	Free Lift	h ₂	in(mm)	6.3 (160)	
	4.4	Lift	h ₃	in(mm)	118.1 (3,000)	
	4.5	Height, Mast Extended	h ₄	in(mm)	168.0 (4,265)	
	4.7	Height of Overhead Guard(Cabin)	h ₆	in(mm)	84.8 (2,155)	
	4.8	Height of Seat	h ₇	in(mm)	43.5 (1,105)	
	4.19	Overall Length	l ₁	in(mm)	149.2 (3,790)	
	4.20	Length to Forkface	l ₂	in(mm)	102.0 (2,590)	
	4.21	Overall Width	b ₁ /b ₂	in(mm)	50.0 (1,270)	
	4.22	Fork Dimensions	s/e/l	in(mm)	2.0 x 5.9 x 47.2 (50 x 150 x 1,200)	
	4.23	Fork carriage ISO 2328, class/type A,B			III/A	
	4.24	Fork carriage width	b ₃	in(mm)	44.6 (1,132)	
	4.31	Ground Clearance, laden, below mast	m ₁	in(mm)	4.7 (120)	
	Performance data	4.32	Ground Clearance, center of wheelbase	m ₂	in(mm)	5.1 (130)
		4.34.1	Aisle width for pallets L=48inch x W=40inch	A _{st}	in(mm)	164.0 (4,164)
		4.35	Turning Radius	W _a	in(mm)	90.5 (2,298)
4.36		Internal Turning Radius	b ₁₃	in(mm)	29.5 (750)	
5.1		Travel Speed, Laden/Unladen		mph(km/h)	10.2 / 10.5 (16.4 / 16.9)	
5.2		Lift Speed, Laden/Unladen		fpm(m/s)	120.1 / 126.0 (.61 / .64)	
5.3		Lowering Speed, Laden/Unladen		fpm(m/s)	100.4 / 88.6 (.51 / .45)	
5.5		Drawbar pull, Laden/Unladen(@ 1mph)		lb(N)	3,264 / 3,277 7,181 (31,987) / 7,209 (32,115)	
5.6		Max. Drawbar pull, Laden/Unladen		lb(N)	3,752 / 3,738 7,154 (31,870) / 8,224 (36,632)	
5.7		Gradeability, Laden/Unladen(@ 1mph)		%	36 / 64	
5.8	Max. Gradeability, Laden/Unladen		%	42 / 77		
5.10	Service Brake			Foot / Hydraulic		
Combustion Engine	7.1	Engine Manufacturer/type			Kubota / WG3800	
	7.2	Engine power according to DIN ISO1585		hp(kW)	92.5(69)	
	7.3	Rated Speed		min ⁻¹	2,500	
	7.3.1	Torque at 1/min		ft•lbs(N•m)	213.9 (290) @1,200	
	7.4	Number of Cylinders/Displacement		-/cc(-/cm ³)	4/3,769	
	7.5	Fuel Consumption according to VDI Cycle		gal/h or lb/h (l/h or kg/h)		
Additional Data	7.10	Battery Voltage/normal capacity		V/Ah	12 / 75	
	10.1	Operating pressure for attachments		psi(bar)	2,330 ±50 (160 ±3.5)	
	10.2	Oil volume for attachments		gpm(l/min)	31.7 (120)	
	10.4	Fuel Tank Capacity		gal(l)	-	
	10.7	Sound level at the driver's ear according to EN 12 053		dB(A)	84.8	

General Section

Characteristics	1.1	CROWN	CROWN	CROWN	
	1.2	CGC35S-9 BCS	CGC45S-9	CGC45S-9 BCS	
	1.3	LP	LP	LP	
	1.4	Seated	Seated	Seated	
	1.5	8,000 (3,620)	10,000 (4,500)	10,000 (4,500)	
	1.6	24 (600)	24 (600)	24 (600)	
	1.8	17.6 (447)	18.0 (457)	17.6 (447)	
	1.9	61.8 (1,570)	70.5 (1,790)	61.8 (1,570)	
	2.1	12,808 (5,810)	15,754 (7,146)	14,658 (6,649)	
Weight	2.2	18,378 (8,336) / 2,430 (1,102)	20,830 (9,448) / 4,924 (2,234)	21,744 (9,863) / 2,914 (1,322)	
	2.3	4,992 (2,264) / 7,816 (3,545)	4,869 (2,208) / 10,885 (4,937)	4,884 (2,215) / 9,774 (4,433)	
	3.1	C	C	C	
Tires	3.2	22 X 9 X16	22 X 12 X16	22 X 12 X16	
	3.3	18 X 7 X 12.2	18 X 8 X 12.2	18 X 8 X 12.2	
	3.5	2x/ 2	2x/ 2	2x/ 2	
	3.6	41.0 (1,042)	43.9 (1,116)	43.9 (1,116)	
	3.7	41.1 (1,044)	41.1 (1,044)	41.1 (1,044)	
	Dimensions	4.1	5 / 6	5 / 6	5 / 6
4.2		86.0 (2,185)	86.0 (2,185)	86.0 (2,185)	
4.3		6.3 (160)	6.3 (160)	6.3 (160)	
4.4		118.1 (3,000)	118.1 (3,000)	118.1 (3,000)	
4.5		168.0 (4,265)	173.8 (4,415)	173.8 (4,415)	
4.7		84.8 (2,155)	84.8 (2,155)	84.8 (2,155)	
4.8		43.5 (1,105)	43.5 (1,105)	43.5 (1,105)	
4.19		144.9 (3,680)	153.1 (3,890)	148.5 (3,773)	
4.20		97.6 (2,480)	89.8 (2,690)	101.3 (2,573)	
4.21		50.0 (1,270)	55.9 (1,420)	55.9 (1,420)	
4.22		2.0 x 5.9 x 47.2 (50 x 150 x 1,200)	2.4 x 5.9 x 47.2 (60 x 150 x 1,200)	2.4 x 5.9 x 47.2 (60 x 150 x 1,200)	
4.23		III/A	IV/A	IV/A	
4.24		44.6 (1,132)	50.8 (1,290)	50.8 (1,290)	
4.31		4.7 (120)	4.7 (120)	4.7 (120)	
4.32		5.1 (130)	5.1 (130)	5.1 (130)	
4.34.1		148.3 (3,767)	160.6 (4,078)	153.7 (3,905)	
4.35		82.8 (2,104)	95.1 (2,415)	87.9 (2,232)	
4.36		29.5 (750)	29.5 (750)	29.5 (750)	
Performance data		5.1	10.2 / 10.5 (16.4 / 16.9)	10.0 / 10.5 (16.1 / 16.9)	10.2 / 10.4 (16.4 / 16.8)
	5.2	120.1 / 126.0 (.61 / .64)	116.1 / 126.0 (.59 / .64)	116.1 / 126.0 (.59 / .64)	
	5.3	100.4 / 88.6 (.51 / .45)	100.4 / 88.6 (.51 / .45)	100.4 / 88.6 (.51 / .45)	
	5.5	3,272 / 3,285 7,198 (32,066) / 7,227 (32,193)	3,189 / 3,247 7,016 (31,252) / 7,143 (31,821)	3,251 / 3,264 7,152 (31,860) / 7,181 (31,987)	
	5.6	3,759 / 3,746 8,270 (36,838) / 8,241 (36,711)	3,668 / 3,706 8,070 (35,946) / 8,153 (36,319)	3,738 / 3,725 8,224 (36,632) / 8,195 (36,505)	
	5.7	38 / 69	29 / 51	34 / 56	
	5.8	44 / 84	33 / 61	35 / 68	
	5.10	Foot / Hydraulic	Foot / Hydraulic	Foot / Hydraulic	
	Combustion Engine	7.1	Kubota / WG3800	Kubota / WG3800	Kubota / WG3800
		7.2	92.5(69)	92.5(69)	92.5(69)
7.3		2,500	2,500	2,500	
7.3.1		213.9 (290) @1,200	213.9 (290) @1,200	213.9 (290) @1,200	
7.4		4/3,769	4/3,769	4/3,769	
7.5					
7.10		12 / 75	12 / 75	12 / 75	
Addition Data	10.1	2,330 ±50 (160 ±3.5)	2,330 ±50 (160 ±3.5)	2,330 ±50 (160 ±3.5)	
	10.2	31.7 (120)	31.7 (120)	31.7 (120)	
	10.4	-	-	-	
	10.7	84.8	84.8	84.8	

CROWN	CROWN	1.1	Characteristics
CGC55C-9	CGC55C-9 BCS	1.2	
LP	LP	1.3	
Seated	Seated	1.4	
12,000 (5,500)	12,000 (5,500)	1.5	
24 (600)	24 (600)	1.6	
17.9 (454)	17.9 (454)	1.8	
70.5 (1,790)	70.5 (1,790)	1.9	
16,702 (7,576)	16,340 (7,412)	2.1	
23,948 (10,863) / 4,753 (2,156)	24,257 (11,003) / 4,083 (1,852)	2.2	
4,795 (2,175) / 11,906 (5,401)	5,104 (2,315) / 11,236 (5,097)	2.3	
C	C	3.1	
22 X 12 X16	22 X 12 X16	3.2	
18 X 8 X 12.2	18 X 8 X 12.2	3.3	
2x/ 2	2x/ 2	3.5	
43.9 (1,116)	43.9 (1,116)	3.6	
41.1 (1,044)	41.1 (1,044)	3.7	
5 / 6	5 / 6	4.1	
86.0 (2,185)	86.0 (2,185)	4.2	
6.3 (160)	6.3 (160)	4.3	
108.3 (2,750)	108.3 (2,750)	4.4	
164.0 (4,165)	164.0 (4,165)	4.5	
84.8 (2,155)	84.8 (2,155)	4.7	
43.5 (1,105)	43.5 (1,105)	4.8	
155.5 (3,950)	151.8 (3,855)	4.19	
108.3 (2,750)	104.5 (2,655)	4.20	
55.9 (1,420)	55.9 (1,420)	4.21	
2.4 x 5.9 x 47.2 (60 x 150 x 1,200)	2.4 x 5.9 x 47.2 (60 x 150 x 1,200)	4.22	
IV/A	IV/A	4.23	
50.8 (1,290)	50.8 (1,290)	4.24	
4.7 (120)	4.7 (120)	4.31	
5.1 (130)	5.1 (130)	4.32	
162.8 (4,136)	160.4 (4,073)	4.34.1	
97 (2,463)	94.5 (2,400)	4.35	
29.5 (750)	29.5 (750)	4.36	
10.0 / 10.5 (16.0/16.9)	10.0 / 10.5 (16.1 /16.9)	5.1	
110.2 / 126.0 (.56 / .64)	110.2 / 126.0 (.56 / .64)	5.2	
100.4 / 88.6 (.51 / .45)	100.4 / 88.6 (.51 / .45)	5.3	
3,154 / 3,235	3,158 / 3,240	5.5	
6,939 (30,909) / 7,117 (31,703)	6,948 (30,948) / 7,128 (31,752)	5.6	
3,633 / 3,694	3,637 / 3,698	5.6	
7,993 (35,603) / 8,127 (36,201)	8,001 (35,643) / 8,136 (36,240)	5.6	
25 / 47	25 / 49	5.7	
29 / 56	29 / 58	5.8	
Foot / Hydraulic	Foot / Hydraulic	5.10	
Kubota / WG3800	Kubota / WG3800	7.1	
92.5(69)	92.5(69)	7.2	
2,500	2,500	7.3	
213.9 (290) @1,200	213.9 (290) @1,200	7.3.1	
4/3,769	4/3,769	7.4	
		7.5	
12 / 75	12 / 75	7.10	
2,330 ±50 (160 ±3.5)	2,330 ±50 (160 ±3.5)	10.1	
31.7 (120)	31.7 (120)	10.2	
-	-	10.4	
84.8	84.8	10.7	

General Section

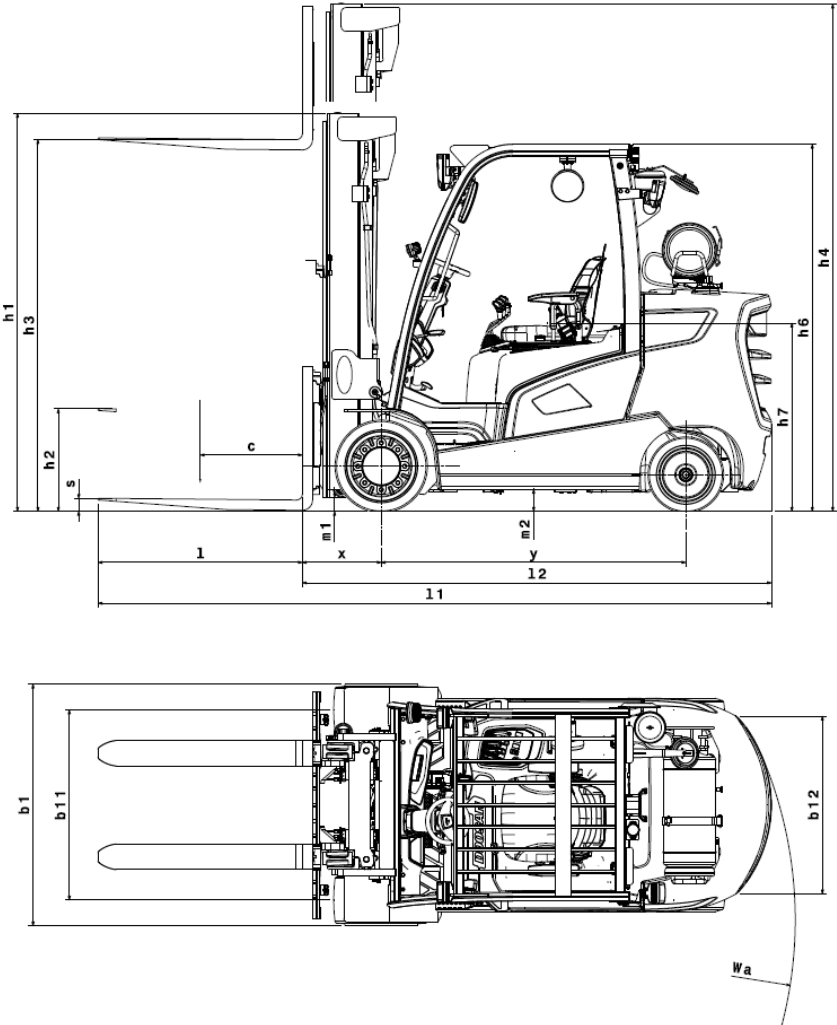

Noise and Vibration

Noise

Model	Noise Level [Unit : dB(A)]				
	Sound Pressure Level at Operator's ear(L _{eq})		Sound Pressure Level at By-stander position (AS 3713)		Guaranteed Sound Power Level(L _{wa}) by new directive 2000/14/EC
	AS3713	pEN12053	Drive-By	Lifting Mode	
CGC35/45S-9, CGC55C-9 CGC35/45/55BCS-9 (TIER III E/G)		84.8	-	-	110

Vibration(weighted overall value)

Unit : m/sec²

Model	Measuring place		
	Seat	Steering Wheel	Floor Plate
CGC35/45S-9, CGC55C-9 CGC35/45/55BCS-9 (TIER III E/G)	0.06	0.45	0.06

Capacity Chart (With Side Shifter)

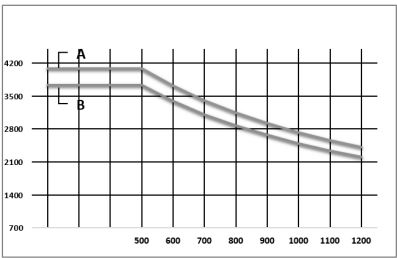
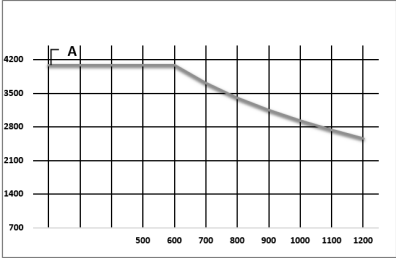
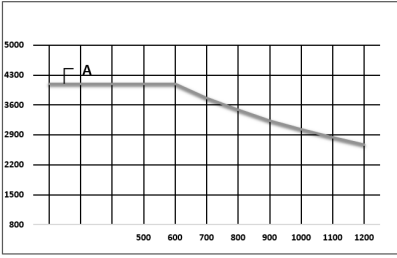
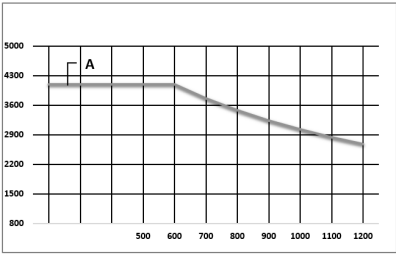
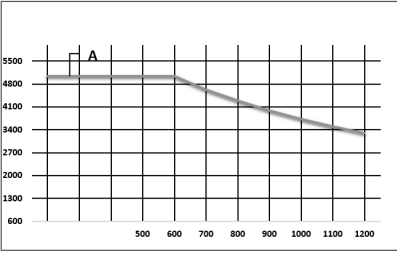
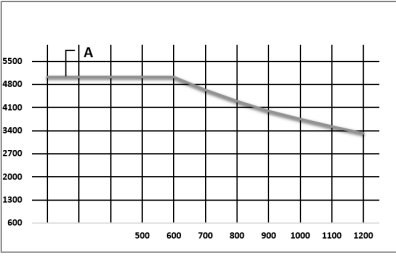
MODEL	SINGLE TIRE	SINGLE TIRE
	STD	FF
CGC35S-9	 <p>A : STD3000, 3300 B : STD4850</p>	 <p>A : FF3000</p>
	 <p>A : STD3000, 3300, 3650, 4000</p>	 <p>A : FF3000</p>
CGC55C-9	 <p>A : STD2750, 3050, 3400, 3750</p>	 <p>A : FF3300</p>

Capacity Chart (With Side Shifter)

MODEL	SINGLE TIRE
	FFT
CGC35S-9	<p> A : FFT 4000 F : FFT 5600 B : FFT 4250 G : FFT 6050 C : FFT 4700 H : FFT 6500 D : FFT 4800 I : FFT 7000 E : FFT 5150 </p>
	<p> A : FFT4000 D : FFT5150 B : FFT4250 E : FFT5600 C : FFT4700 F : FFT6500 </p>
CGC55C-9	<p> A : FFT3875 E : FFT5475 B : FFT4125 F : FFT5925 C : FFT4575 G : FFT6375 D : FFT5025 </p>

Capacity Chart (With Side Shifter)

MODEL	SINGLE TIRE	SINGLE TIRE
	STD	FF
CGC35BCS-9	<p>A : STD3000, 3300 B : STD4850</p>	<p>A : FF3000</p>
	<p>A : STD3000, 3300, 3650, 4000</p>	<p>A : FF3000</p>
CGC55BCS-9	<p>A : STD2750, 3050, 3400, 3750</p>	<p>A : FF3300</p>

Capacity Chart (With Side Shifter)

MODEL	SINGLE TIRE
	FFT
CGC35BCS-9	<p> A : FFT4000 F : FFT5600 B : FFT4250 G : FFT6050 C : FFT4700 H : FFT6500 D : FFT4800 I : FFT7000 E : FFT5150 </p>
	<p> A : FFT4000 D : FFT5150 B : FFT4250 E : FFT5600 C : FFT4700 F : FFT6500 </p>
CGC55BCS-9	<p> A : FFT3875 E : FFT5475 B : FFT4125 F : FFT5925 C : FFT4575 G : FFT6375 D : FFT5025 </p>

Capacity Chart (Without Side Shifter)

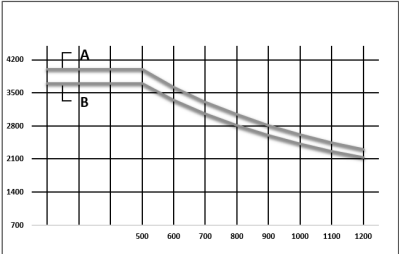
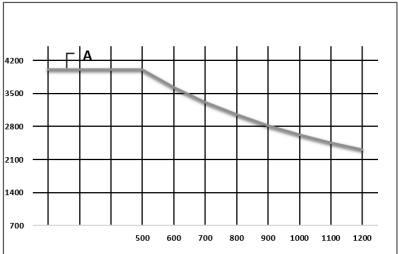
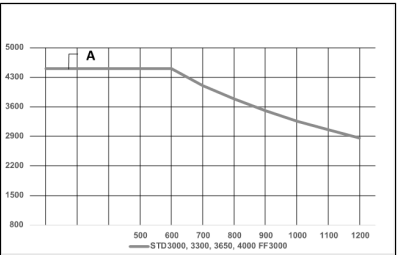
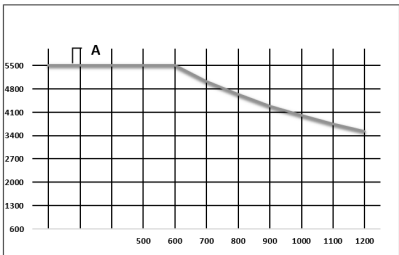
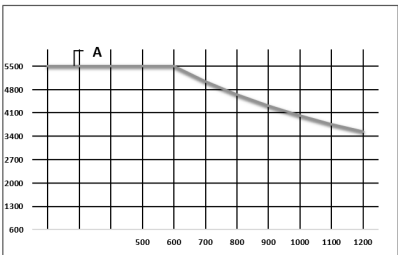
MODEL	SINGLE TIRE	SINGLE TIRE
	STD	FF
CGC35S-9	 <p>A : STD3000, 3300 B : STD4850</p>	 <p>A : FF3000</p>
	 <p>A : STD3000, 3300, 3650, 4000 / FF3000</p>	
CGC55C-9	 <p>A : STD2750, 3050, 3400, 3750</p>	 <p>A : FF3300</p>

Capacity Chart (Without Side Shifter)

MODEL	SINGLE TIRE
	FFT
CGC35S-9	<p>A line graph showing load capacity (kg) on the y-axis (700 to 4200) versus speed (km/h) on the x-axis (500 to 1200). Eight curves, labeled A through H, represent different FFT models. All curves show a decrease in load capacity as speed increases. Curve A is the highest, and curve H is the lowest.</p>
	<p>A : FFT 4000 E : FFT 5600 B : FFT 4250 F : FFT 6050 C : FFT 4700 G : FFT 6500 D : FFT 4800 H : FFT 7000</p>
CGC45S-9	<p>A line graph showing load capacity (kg) on the y-axis (800 to 5000) versus speed (km/h) on the x-axis (500 to 1200). Six curves, labeled A through F, represent different FFT models. All curves show a decrease in load capacity as speed increases. Curve A is the highest, and curve F is the lowest.</p>
	<p>A : FFT4000 D : FFT5150 B : FFT4250 E : FFT5600 C : FFT4700 F : FFT6500</p>
CGC55C-9	<p>A line graph showing load capacity (kg) on the y-axis (600 to 5500) versus speed (km/h) on the x-axis (500 to 1200). Seven curves, labeled A through G, represent different FFT models. All curves show a decrease in load capacity as speed increases. Curve A is the highest, and curve G is the lowest.</p>
	<p>A : FFT3875 E : FFT5475 B : FFT4125 F : FFT5925 C : FFT4575 G : FFT6375 D : FFT5025</p>

Capacity Chart (Without Side Shifter)

MODEL	SINGLE TIRE	SINGLE TIRE
	STD	FF
CGC35BCS-9	<p>A : STD3000, 3300 B : STD4850</p>	<p>A : FF3000</p>
	<p>A : STD3000, 3300, 3650, 4000 / FF3000</p>	
CGC55BCS-9	<p>A : STD2750, 3050, 3400, 3750</p>	<p>A : FF3300</p>

Capacity Chart (Without Side Shifter)

MODEL	SINGLE TIRE
	FFT
CGC35BCS-9	<p> A : FFT4000 F : FFT5600 B : FFT4250 G : FFT6050 C : FFT4700 H : FFT6500 D : FFT4800 I : FFT7000 E : FFT5150 </p>
	<p> A : FFT4000 D : FFT5150 B : FFT4250 E : FFT5600 C : FFT4700 F : FFT6500 </p>
CGC55BCS-9	<p> A : FFT3875 E : FFT5475 B : FFT4125 F : FFT5925 C : FFT4575 G : FFT6375 D : FFT5025 </p>

Serial Number

Serial Number Locations

For quick reference, record your lift truck's serial numbers in the spaces provided below the photographs.

<p>WARNING</p> <p>IMPROPER OPERATION OR MAINTENANCE COULD RESULT IN INJURY OR DEATH. READ AND UNDERSTAND THE OPERATION AND MAINTENANCE MANUAL BEFORE OPERATING.</p> <p>TRUCK COMPLIES TO ANSI/ITSDF B56.1</p> <p>MANUFACTURED IN THE REPUBLIC OF KOREA BY Crown Equipment Corp. 11800 Crown Equipment Corp.</p> <p>950209-106796 ENGLISH</p>	MODEL	SERIAL NO.	TYPE	INDUSTRIAL TRUCK	
	TRUCK HEIGHT		LB	KG	
	ALLOWABLE WORKING CAPACITY WITH MAST VERTICAL				
	BACK TILT	MAST TYPE	TIRE TYPE		
	TIRE TREAD	IN (F)	PSI	MPA (F)	
		MM (R)	PSI	MPA (R)	
	ATTACH		I.D.		CAPACITY
	A	B	C	D	
	IN	IN	IN	IN	LB
	MM	MM	MM	MM	KG
ELECTRIC TRUCK ONLY TRUCK WT. W/O BAT				LB	
BAT TYPE				KG	
BAT VOLT	VOLT	MAX. AH CAP.	AT	HR RATE	
BAT WT.	LB	BAT SIZE			
MM/MAX	KG	BAT SIZE			

Lift Truck Serial Number

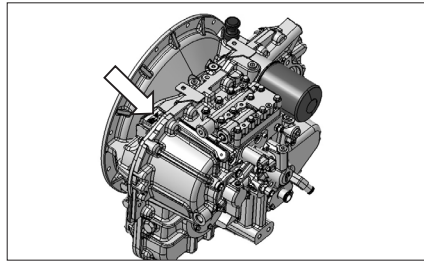

Transmission Serial Number

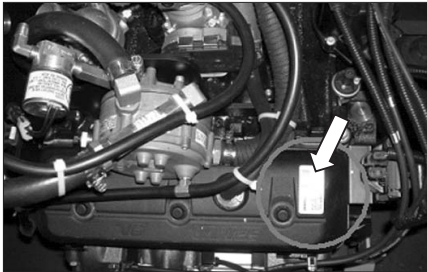

4.3 liter PSI Engine Serial Number

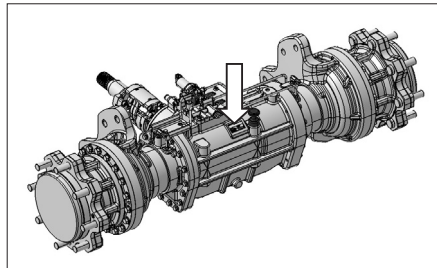

DRIVE AXLE Serial Number

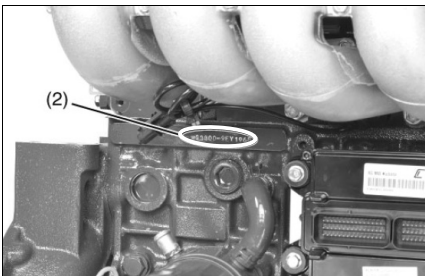

3.8 liter KUBOTA Engine Serial Number

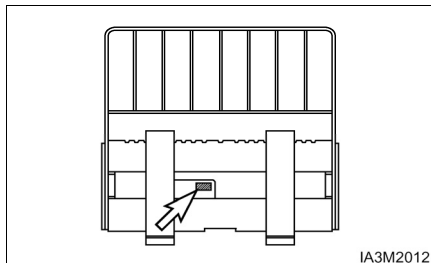

Side Shifter Serial Number (If Equipped)

Operator's Warning and Identification Plate

Familiarize yourself with the OPERATOR'S WARNING Plate, and IDENTIFICATION, LIFT CAPACITY and ATTACHMENT PLATES. Do not exceed capacity as equipped load ratings.

Operator's Warning Plate



Located on the cowl to the right side of the steering column.

Identification, Lift Capacity and Attachment Plate

CROWN		MODEL		SERIAL NO.		TYPE		INDUSTRIAL TRUCK	
TRUCK WEIGHTS*				LB		KG			
ALLOWABLE WORKING CAPACITY WITH MAST VERTICAL									
BACK TILT		MST TYPE		TIRE TYPE		TIRE TYPE			
TIRE TREAD		TIRE PRESS.		TIRE SIZE		TIRE SIZE			
IN (F)		PSI		KPA (F)		KPA (R)			
MM (R)		PSI		KPA (R)		KPA (R)			
ATTACH									
A		B		C		I, D		CAPACITY	
IN		IN		IN		IN		LB	
MM		MM		MM		MM		KG	
IN		IN		IN		IN		LB	
MM		MM		MM		MM		KG	
ELECTRIC TRUCK ONLY TRUCK WT25% W/O BAT									
BAT TYPE		VOLT		MAX. AN GAP.		AT		HR RATE	
BAT WT.		LB		BAT SIZE		BAT SIZE		MM	
MM/MAX		/		KG		BAT SIZE		MM	

TRUCK CAPACITY TO ANSI/ISO# 569.1
 MANUFACTURED IN THE REPUBLIC OF KOREA
 For Crown Equipment Corp.
 950209-10676 ENGLISH

Located on the cowl to the right side of the steering column.

If Convenience Package Equipped



Located on the overhead guard. (If Convenience Package Equipped).

Lift Truck Capacity Rating

Do not exceed allowable lift truck working capacity load ratings.

The capacity of the lift truck is given by weight and distance to the load center. For example, a capacity of 1200kg (2640lb) at 600mm (24in) means that the lift truck can lift 1200kg (2640lb) if the load center is 600 mm (24in) from both the vertical and horizontal faces of the forks.

Before attempting to lift any load, ensure that the weight and load center combination is within the capacity of the lift truck as shown on the capacity rating plate. To determine the load center, measure the distance from the face of the carriage to the gravitational center of the load.

The rated capacity on the plate refers to the capacity of the lift truck as it left the factory. Subsequent changes of any form to the equipment or battery can alter the lift truck's rating.

The rated capacity of the lift truck applies to operating conditions where the lift truck is on level ground. The capacity of the lift truck is reduced on inclines.

Below are abbreviations that may appear on the Identification, Lift Capacity and Attachment Plate and their meanings.

Mast Abbreviations

STD - Standard Mast (single inner member, low free lift)

FF - Full Free Lift Mast (single inner member with high free lift duplex cylinder)

FFT - Triple Lift Mast (two inner members) with either low or full free lift characteristics.

QUAD - Quadruple (Quad) Mast (with three inner members)

NOTE : When only a mast-type is listed on the identification plate, a standard carriage and forks are used.

Attachment Abbreviations (Includes Special Forks)

SC - Special Carriage-increased width, height or outreach

SSS - Shaft-type Sideshift Carriage

HSS - Hook-type Sideshift Carriage (ITA)

CW - Counterweight

SF - Special Forks

SWS - Swing Shift, Sideshift

RAM - Ram or Boom

DBCBH - Double Cube Block Handler

HFP - Hydraulic Fork Positioner

CR - Crane Arm or Crane Boom

TH - Tire Handler

CTH - Container Handler

LPP - Load Push-Pull Device

CC - Carton Clamp

RC - Roll Clamp

LS - Load Stabilizer

PWH - Pulp Wood Handler

SS-ST - Sideshift-Side Tilt Carriage

Operator's Station and Monitoring Systems

Instrument Panel

Your lift truck may not have the same indicator or warning lights as shown in the illustrations.

Due to the various options available, typical instrument panels are shown.

However, the symbols on the indicators and lights on your panel identify what those particular items are.

Also, the symbol for each of the items is identified and an explanation of their function and location is described on the following pages.

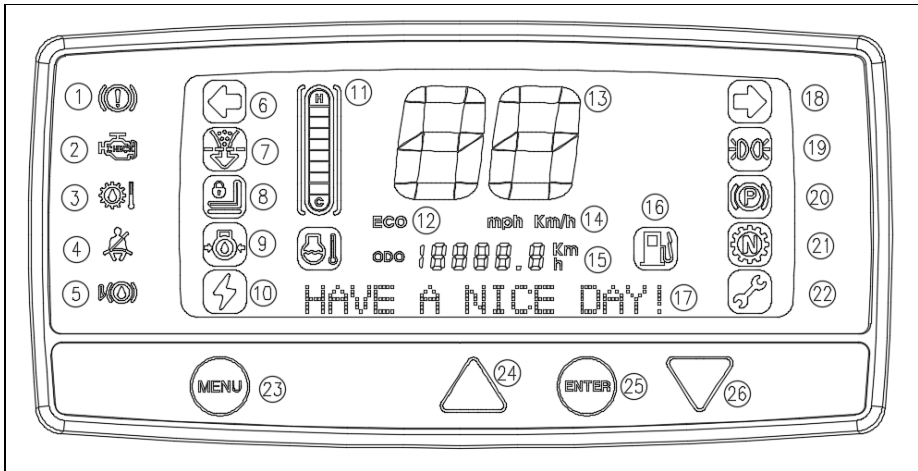

1. Fault warning indicator light
2. Engine malfunction indicator light (MIL)
3. Transmission oil temperature warning light
4. Seat belt warning light
5. Brake oil pressure warning light
6. Turn signal left indicator
7. Dust indicator warning light(Air filter)
8. Mast interlock
9. Engine oil pressure warning light
10. Alternator indicator light
11. Engine Coolant Temperature Gauge
12. ECO mode indicator light
13. Speedometer

14. Mail per hour, Kilo meter per hour unit
15. Hour meter, Odometer
16. Empty fuel warning
17. Letter indicator bar
18. Turn signal right indicator
19. Lamp on indicator
20. Parking brake on/off indicator
21. Transmission neutral position indicator
22. ECT warning indicator
23. Menu button
24. Up button
25. Enter button
26. Down button



1. Fault warning indicator light



2. Engine Malfunction Indicator Light (MIL) - Engine control system is equipped with built-in fault diagnostics.

Detected system faults can be displayed by the Malfunction Indicator Lamp (MIL) as Diagnostic Fault Codes (DFC) or flash codes, and viewed in detail with the use of service tool software.

When the ignition key is turned ON the MIL will perform a self-test, illuminate once and then go OFF. If a detected fault condition exists, the fault or faults will be stored in the memory of the engine control unit (ECM). Once a fault occurs the MIL will light up and remain ON. This signals the operator that a fault has been detected by the SCEM.



3. Transmission Oil Temperature warning light - Check the system for any defect. The warning light will be on when

the transmission oil temperature reaches approximately 125 °C.



4. Seat Belt Warning Light (If Equipment)

Indicates when the seat belt dose not fastened by operator.

The light will come on when the ignition switch is turned to the on position. The light should go off after engine is started.



5. Brake oil level - Brake oil level Lamp indicates when the brake oil level is low.



6. Directional Turning Indicator Light - Left



7. Air Filter Indicator - This lamp will be on when air filter replacement is needed.



8. Mast interlock - Alarm warning lights when operator leaves the seat without applying parking brake and then, operation of mast is automatically

interrupted.



9. Engine oil pressure warning lamp - The warning lamp will light up if the engine oil is short or the pressure is low.



10. Alternator Indicator Light - Indicates if the battery charging system is operational. The light will come on when the ignition switch is turned to the ON position.

The light should go off after the engine is started, indicating the alternator is producing sufficient

voltage to charge the battery. If the light turns on with the engine running, check the alternator charging system for a malfunction.

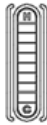

11. Engine Coolant Temperature Gauge -

Indicates coolant temperature. Shows current temperature of the engine coolant. If the gauge pointer moves beyond the red band during the operation, the engine is overheated. Park the lift truck and stop the engine.



Check the cooling system for any defect. The pointer will be in the red band when the coolant temperature reaches approximately 110 °C on all engines.



12. ECO mode indicator light



13. Speedometer - Shows vehicle speed.



15. Service hour Meter

- Indicates the total number of hours the engine and the lift truck have operated. The hour meter will operate when the ignition switch is in the ON position, whether the engine is running or not. The hour meter is used to determine lubrication and maintenance intervals.



16. Fuel warning lamp - The warning lamp will light up to warn the operator to refuel.



18. Directional Turning Indicator Light - Right



19. Lamp on indicator - When turn on the lamp, lamp on indicator is on.



20. Parking indicator light - The light will come ON when the parking lever is applied.



21. Transmission Neutral Position Light - Indicates the neutral position of transmission.



22. ECT Malfunction Warning Lamp (if installed) - electronic transmission control system has a built-in diagnosis system.

If a failure occurs, the electronic transmission control system reports the operator of the failure code by the number of flashes with the malfunction warning lamp.

Horn Switch – Push on the horn button to sound the horn.



Function description.

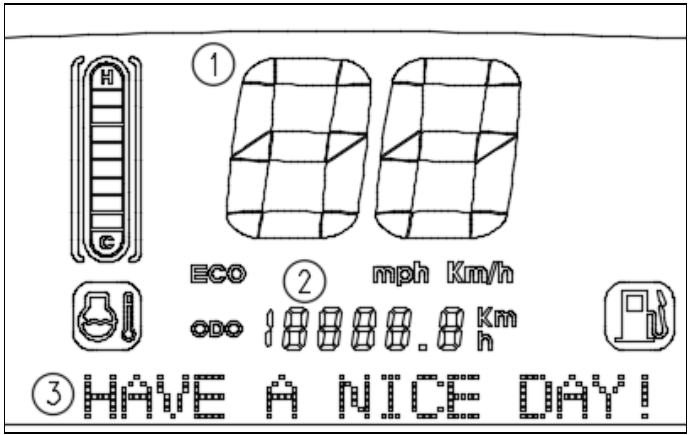

1. Set up

- 1) 1
- 2)
- 3) SET UP

1-1. Pin code menu

- 1) 1
- 2) 0 is OFF, 1 is ON
- 3) PIN CODE MENU enter to in ON/OFF

1-2. Pin code password

- 1) 2
- 2) 000(Initial password)
- 3) PIN CODE PASSWORD enter to in Number 000 is blink, enter the current password and new password and new password again

1-3. ECO mode menu

- 1) 3
- 2) 0 is OFF, 1 is ON
- 3) ECO MODE MENU enter to in ON/OFF

*Caution: If you want ON or OFF ECO mode, set in only key on situation.(Before engine start)

1-4. ECO mode password

- 1) 4
- 2) 000(Initial password)
- 3) ECO MODE PASSWORD enter to in Number 000 is blink, enter the current password and new password and new password again

2. Maintenance

- 1) 2
- 2)
- 3) MAINTENANCE

2-1.ENGINE ERROR (ONLY CAN COMMUNICATION ENGINE MODEL)

- 1) 1
- 2) ENGINE ERROR CODE : NUMBER
- 3) ENGINE ERROR CODE

2-2. T/M OIL TEMP

- 1) 2
- 2) T/M OIL TEMP : NUMBER
- 3) T/M OIL TEMP

2-3. UNIT

- 1) 3
- 2)
- 3) UNIT enter to in You can change SI UNIT or US UNIT

Electrical Disconnect Switch (If Equipped)

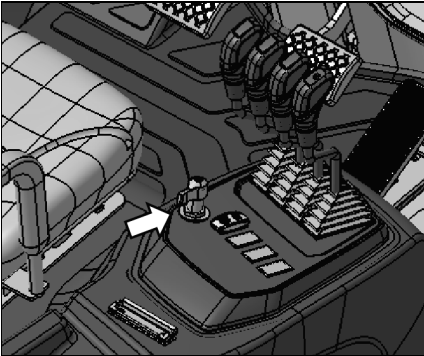

1. ON - Connects the battery for electrical power to all electrical circuits.



2. OFF - Disconnects the battery from all electrical circuits.

Engine Compartment

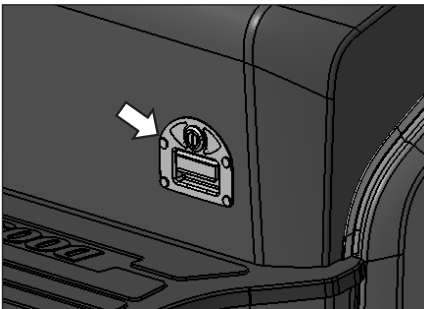

1. The engine compartment is accessible by pulling the latch.

NOTE: Unlock latch before pulling if key equipped.

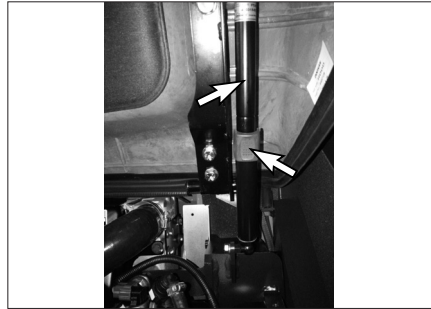

2. The hood and seat assembly is held up by a support cylinder. Make certain the air cylinder is operating properly and securely holds the hood up before doing anything in the engine compartment.

WARNING

Since the exhaust tube is very hot, make sure to fold the seat before opening the hood.

WARNING

If boxcar special(BCS) counter weight equipped, make sure to swing out down LP tank cradle before open the hood.

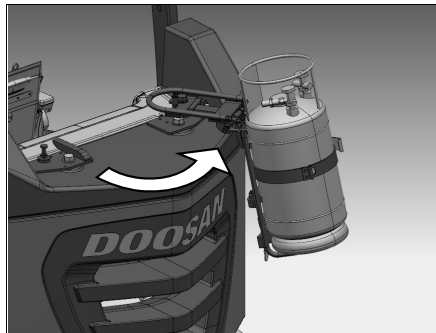

Circuit Breaker

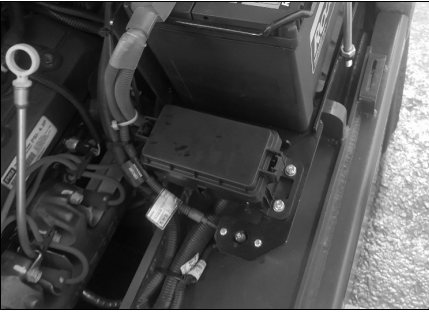

 **Circuit Breaker** - Protects the main electrical circuits. To reset the circuit breaker, push the button in. Located in the engine compartment.

Tilt & Telescopic Steering Column

To adjust the steering column, turn the lever clockwise to unlock the column, move it to your desired position, and then turn the lever counterclockwise to lock the column again.

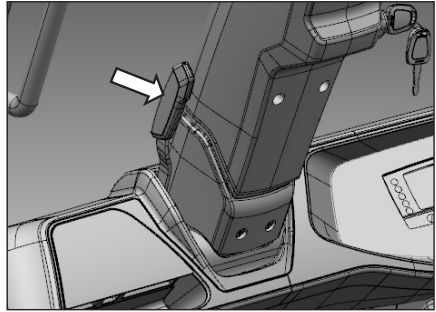

Seat

NOTE: Seat arrangements may vary.
Basic operation will be similar.

Seat adjustment should be checked at the beginning of each shift and when operators change.

Lock the seat into position before operating, to prevent an unexpected seat change.

Adjust seat to allow full brake pedal travel with operator's back against seat back.

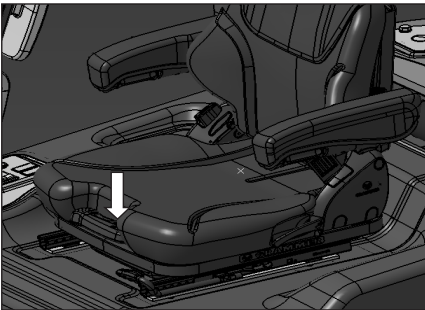

The seat can only be correctly adjusted with the operator fully seated.

Weight Scale Option (Load Cell Type)

With this weight scale option, the operator can measure and limit the load's weight using a display panel. Using the key , you can start settings.

1. Entering the Calibration Mode

To perform initial settings for the load cell, enter the calibration mode as follows:

 Press this key when "ST.CAL" is displayed to start calibration mode.

 Press this key once again.



2. Specifying a Minimum Scale

You can select a minimum scale on which the load cell displays the weight from among 1 kg, 2 kg, 5 kg, 10 kg, 20 kg, and 50 kg (for example, 1235 kg is displayed with a 5 kg minimum scale and 1250 kg displayed with a 50 kg scale). The default value is "10 kg."

 Each time you press this key, the setting increases in the order of 01, 02, 05, 10, 20, and 50.

 Press this key to save the minimum scale setting and proceed the subsequent step.

 Press this key to move to the previous step.

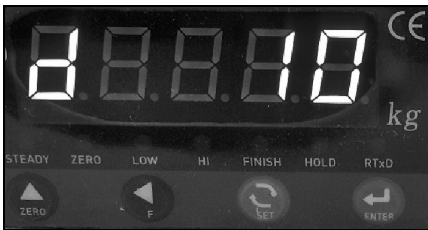



3. Specifying a Maximum Measuring Scale

This step is to specify the rated capacity of the vehicle on which the load cell is installed.

Since the device does not weigh a load heavier than the set capacity (determines to be overloaded), it is **recommended to set the capacity to be 5% higher than the actual value taking into consideration the safety factor.**

 Each time you press this key, the number (0 to 9) at the cursor position increases by 1.

 Each time you press this key, the cursor is moved to the left by one point.

 Press this key to save the set value and proceed the subsequent step.

 Press this key to move to the previous step.





4. Inputting a Reference Load

This step is to input the weight of a reference load needed for weight setting.

If the weight of the reference load is 3,000 kg, input "3000" and proceed the next step (reference load lift).

The initial setting value should be set to 50% to 60% of the rated capacity (for a 7ton capacity model for example, use a 3.5 to 4ton load).

 Each time you press this key, the number (0 to 9) at the cursor position increases by 1.

 Each time you press this key, the cursor is moved to the left by one point.

 Press this key to save the set value and proceed the subsequent step.

 Press this key to move to the previous step.

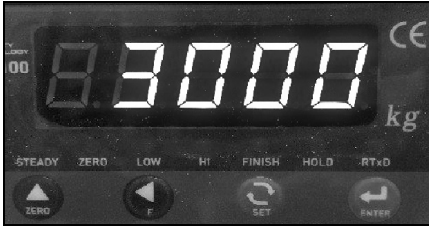

After the initial setting, if the load weight is measured with an error, you must adjust this value.

NOTE: Example: If you have inputted 3,000 kg but the actual load weighs 2,900 kg, adjust the reference load value to 2,900 kg; if the load weighs 3,100 kg, adjust the value to 3,100 kg

5. Zero Adjustment

This step is to set the weight condition of the vehicle's unloaded front end to zero. Keeping the mast unloaded, raise it approx. 300 mm from the ground just vertically.



Press this key to save the set value and proceed the subsequent step.



Press this key to move to the previous step.



6. Reference Load Lift

Put a reference load that weighs as much as the set value on the attachment (e.g. forks).

You should align the centers of gravity of the attachment and of the reference load.

Raise the mast approx. 300 mm from the ground vertically.

Once the vehicle's vibration ends after lifting the load, press the Enter key.



Press this key.



7. Finishing Calibration

Once you have done all the steps above, a certain figure appears along with a blinking message "C_End" on the display for a while, and then the weight scale mode resumes."

Initial settings for the load cell has been finished.

Use this device after fully lowering the load for the indicator to display 0 kg.



Seat Switch System (If Equipped)



The lift truck is equipped with a SEAT SWITCH SYSTEM. In normal operation if the direction lever is placed in either forward or reverse, the lift truck will move at a speed proportional to the accelerator pedal's position. If the operator leaves the seat without setting the parking brake, within three seconds after leaving the seat, the SEAT SWITCH SYSTEM will automatically disengage the transmission. The directional lever, however, will remain in that forward or reverse location although internally the transmission will have shifted into neutral.

Before exiting the lift truck, the parking brake should always be applied.

WARNING

WHEN LEAVING MACHINE APPLY PARKING BRAKE!

PARKING BRAKE IS NOT AUTOMATICALLY APPLIED.

NOTE: Some trucks may be equipped (ask your branch if this applies to your truck) with an alarm that will sound if the parking brake is not applied when leaving the machine.

NOTICE

Prior to operating the lift truck, be sure to understand and check the SEAT SWITCH SYSTEM.

While in normal operation and on level ground, select a direction with the directional lever and with the park brake released. You will note that the truck will move slowly in the selected direction. If you lift your hips off of the seat, within three seconds, the SEAT SWITCH SYSTEM will disengage the transmission allowing the truck to coast but not automatically stop.



To restore the lift truck to normal operation, while sitting in the operator's seat depress the brake pedal to hold the lift truck, return the directional lever to the neutral position, and then reselect a direction of travel (either forward or reverse). The transmission will then re-engage.

If seat or seat switch replacement becomes necessary, be sure to use genuine parts. Lift trucks should never be operated without an operational SEAT SWITCH SYSTEM.

Lift Truck Controls

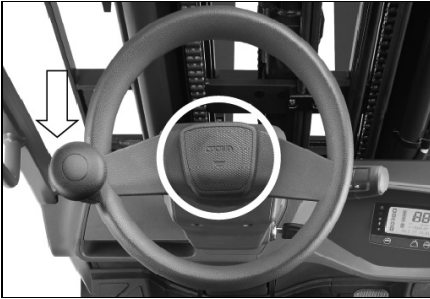
Direction Control Lever



-  1. Forward - Push the lever forward for FORWARD direction travel.
-  2. Neutral - Move the lever to center position for NEUTRAL.
-  3. Reverse - Pull the lever back for REVERSE direction travel.

Transmission Inching Control Pedal

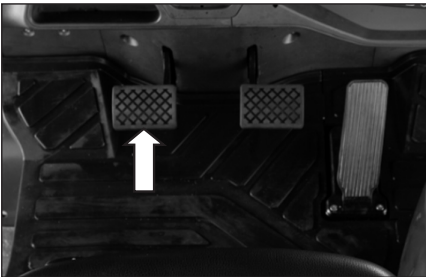



 **Inching Control Pedal** - Pushing down on the inching pedal, modulates the hydraulic pressure to the clutch packs, permitting disc slippage.

Further pushing on the pedal completely relieves clutch pack pressure and applies the service brakes to stop and hold the lift truck.

NOTE: The purpose of the inching control pedal is to provide precise inching control at slow travel speed, with high engine rpm. This is used for fast hydraulic lift during load approach, pickup or positioning.

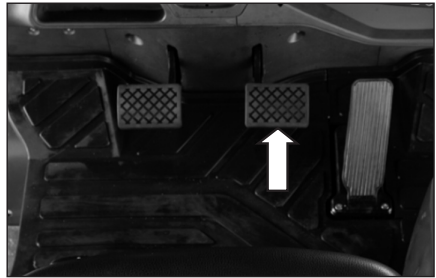

Service Brake Pedal

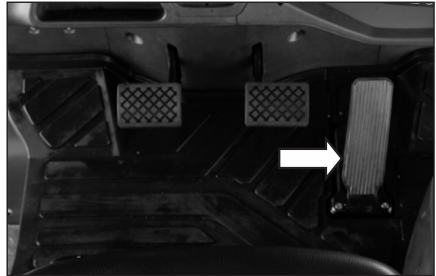

-  **Push DOWN** on the brake pedal to slow or stop the lift truck.
-  **RELEASE** the brake pedal to allow the lift truck to move.

Accelerator Pedal



-  **Push DOWN** on the pedal to increase engine rpm (speed).
-  **RELEASE** the pedal to decrease engine rpm (speed).

Electronic Parking Brake

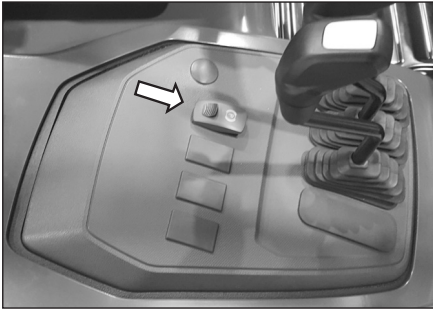

Push the front side of the parking brake switch to engage the brake.



Push the rear side of the parking brake switch to release the brake.

Lift Control

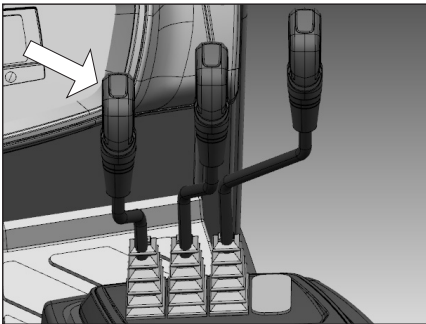

NOTE: To prevent a sudden change of position of the load, operate all lift, tilt and attachment controls smoothly.



1. Lower Position - Push the lever FORWARD smoothly to lower the load.



2. Hold Position - When the lever is released it will return to the HOLD or center position. Lifting or lowering action will stop.



3. Lift Position - Pull the lever BACK smoothly to lift the load.

Tilt Control

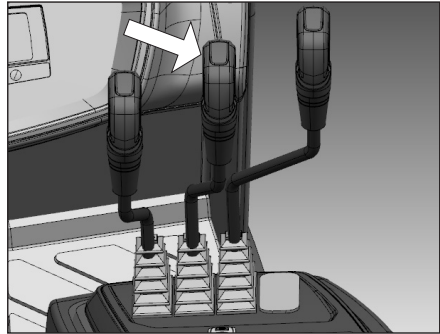

1. Mast Tilt Forward - Push the lever FORWARD smoothly to tilt the mast forward.



2. Mast Hold - When the lever is released it will return to the HOLD or center position. Tilting action will stop.



3. Mast Tilt Back - Pull the lever BACK smoothly to tilt the mast backward.

Sideshift Attachment Control (If Equipped)

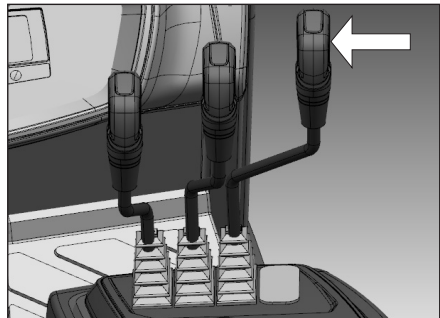

1. Sideshift Left - Push the lever FORWARD to shift the carriage to the left.



2. Sideshift Hold - When the lever is released it will return to the HOLD or center position. Sideshifting action will stop.



3. Sideshift Right - Pull the lever BACK to shift the carriage to the right.

Refueling

Changing LP Tanks

⚠ WARNING

Only trained, authorized personnel should fill or exchange LP tanks.

Personnel engaged in filling of LP containers should wear protective clothing such as face shield, long sleeves and gauntlet gloves.

Do not refuel or store LP powered lift trucks near any underground entrance, elevator shafts or any other place where LP could collect in a pocket causing a potentially dangerous condition.

Examine all LP containers before filling and again before reuse, for damage to various valves, liquid gauge, fittings and hand valve wheels.

All defective or damaged LP containers must be removed from service.

Explosive fumes may be present during refueling.

Do not smoke in refueling areas.

Lift truck should be refueled only at designated safe locations. Safe outdoor locations are preferable to indoor locations.

Stop the engine and get off the lift truck during refueling.

The careless handling of LP containers can result in a serious accident.

Use extreme care when transporting containers to prevent damage to them.

1. Park the lift truck on level ground, with the parking brake applied, the transmission in NEUTRAL, the forks lowered and the engine running at low idle.

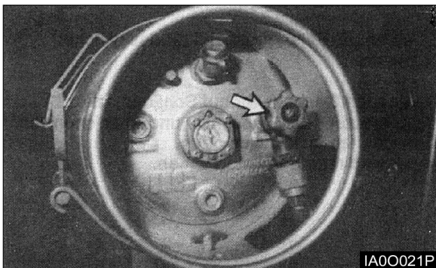

2. Close the fuel inlet valve at the LP tank. Run the engine until it stops, then turn off the ignition switch and the electrical disconnect switch (if equipped).
3. Disconnect the fuel supply line.

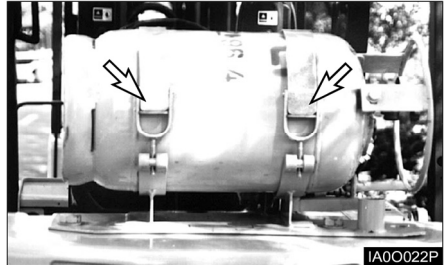

4. Loosen the retaining clamps and remove the tank.
5. Check the mounting to be sure the locating pin (dowel) is not missing or broken.

NOTICE

If the location pin (dowel) is missing or broken, be sure the pin is replaced.

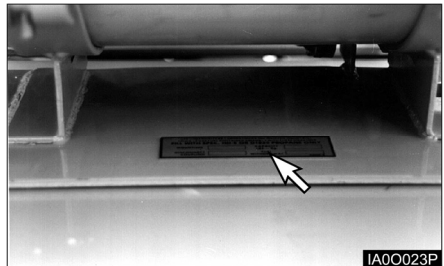

6. Check to be sure that the LP warning plate is in position on the lift truck, and is legible.
7. Check to be sure the replacement tank is of the correct type.
8. Inspect the replacement tank for damage such as dents, scrapes or gouges and for indication of leakage at valves or threaded connections.

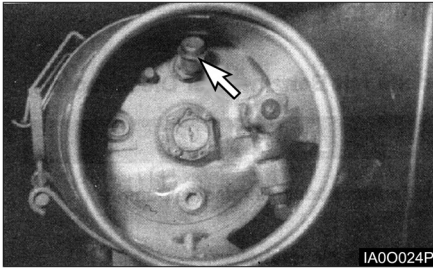

IA00024P

9. Check for debris in the relief valve, for damage to various valves and liquid level gauge.
10. Inspect the quick-disconnect couplings for deterioration, damage or missing flexible seals.

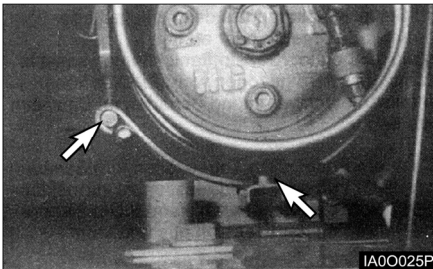

IA00025P

11. Position the replacement tank so that the locating pin (dowel) is in place.

⚠ WARNING

The LP tank must not extend past the counterweight.

12. Clamp the tank securely.
13. Connect the fuel supply line.
14. Open the fuel valve by slowly turning the valve counterclockwise. If the fuel valve is opened too quickly, a back pressure check valve will shut off the fuel supply. If this happens, close the fuel valve completely. Wait five seconds and then open the fuel valve very slowly.
15. Inspect the LP fuel lines and fittings with a soap solution after filling the tank or when looking for leaks.

Before Starting the Engine

Walk - Around Inspection

Make a thorough walk-around inspection before mounting the lift truck or starting the engine. Look for such items as loose bolts, debris buildup, oil or coolant leaks. Check condition of tires, mast, carriage, forks or attachments. Have repairs made as needed and all debris removed.

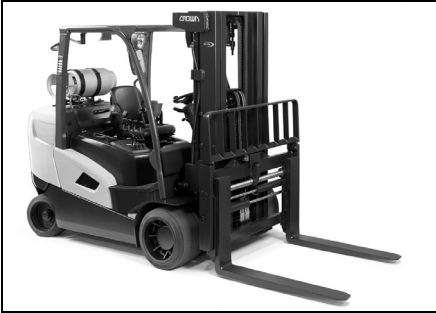

1. Inspect the operator's compartment for loose items and cleanliness.
2. Inspect the instrument panel for broken or damaged indicator lights or gauges.
3. Test the horn and other safety devices for proper operation.

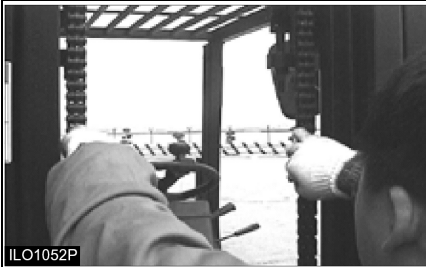

4. Inspect the mast and lift chains for wear, broken links, pins and loose rollers.
5. Inspect the carriage, forks or attachments for wear, damage and loose or missing bolts.
6. Inspect the tires and wheels for cuts, gouges, foreign objects, inflation pressure and loose or missing bolts.



7. Inspect the overhead guard for damage and loose or missing mounting bolts.
8. Inspect the hydraulic system for leaks, worn hoses or damaged lines.
9. Look for transmission and drive axle leaks on the lift truck and on the ground.



10. Inspect the engine compartment for oil, coolant and fuel leaks.
11. Inspect common parts and drive axle, mast etc. for grounded, loosen or missing mounting bolts.
12. Inspect common parts and drive axle, mast etc. for grounded, loosen or missing mounting bolts.

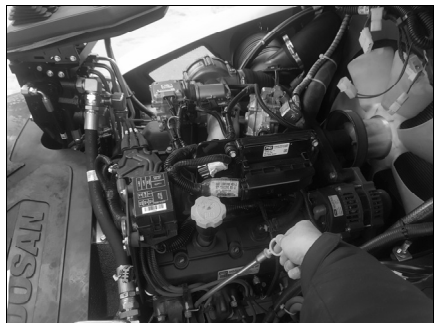

13. Measure the engine crankcase oil level with the dip stick. Maintain the oil level between the MAX. and MIN., (or FULL and ADD) notches on the dip stick.

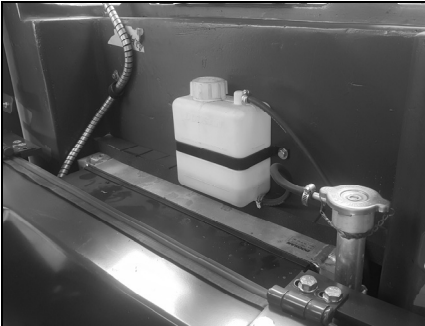

14. Observe the engine coolant level in the coolant recovery bottle. With the engine cold, maintain the level to the COLD mark. If the recovery bottle is empty, also fill the radiator at the top tank.
15. In case of LPG truck, if needed, change LPG Fuel Tank as the procedure of changing LP tanks in Refueling Section.

⚠ WARNING

Personal injury may occur from accidents caused by improper seat adjustment. Always adjust the operator's seat before starting the lift truck engine.

Seat adjustment must be done at the beginning of each shift and when operators change.

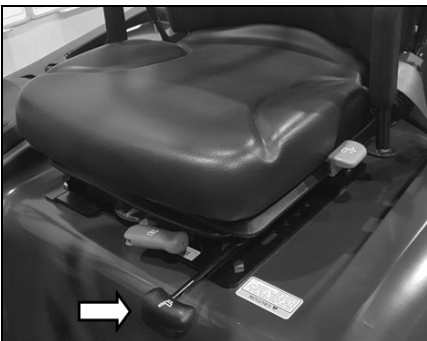

16. To position the seat, PUSH the lever away from the seat track and move the seat forward or backward to a comfortable position.

Starting the Engine

Prestart Conditions

NOTE: The engine will not start unless the transmission directional control lever is in the NEUTRAL position.

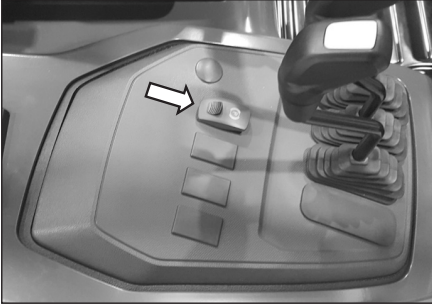

1. Engage the parking brake (EPB switch), if not already engaged. Place the transmission directional control lever in the NEUTRAL position.

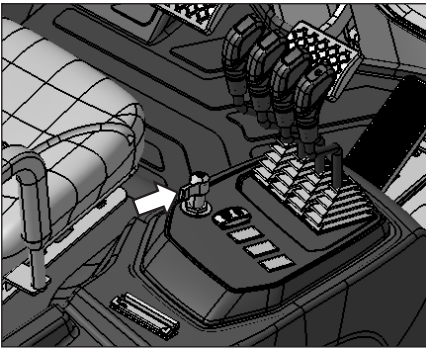

2. If Lift trucks are equipped with electrical disconnect switches, the engine will not start unless the disconnect switch is in the ON (closed) position. Before starting, turn the disconnect switch to the OFF(open) position.

NOTICE

When you restart the engine after turning off it, wait 4 to 5 seconds and restart it to protect the starter.

LP Engine

WARNING

LP fuel is flammable and can cause personal injury.

Inspect LP fuel lines and fitting for leaks.

Inspect tank for secure mounting.

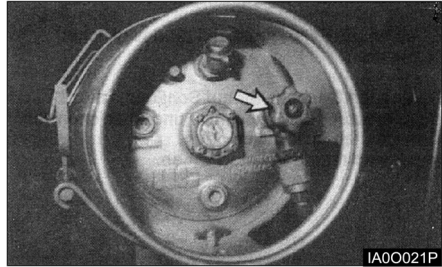

1. Open the tank fuel valve by slowly turning the valve counterclockwise. Observe the LP gauge(if equipped).
2. Turn the engine ignition switch to the START position. Release it when the engine starts.
3. If the engine does not start, do not press on the accelerator pedal. Turn the starter switch to OFF position, then repeat step 2 and depress the accelerator pedal slightly during cranking.
4. Allow the engine to warm up slowly.

Starting From a 12 Volt External Source

⚠ WARNING

Sparks occurring near the battery could cause vapors to explode.

Always connect the external power source ground cable to a point away from and below the battery, and well clear of fuel system components.



NOTICE

Do not reverse battery cables. It can cause damage to the alternator.

Always connect the external power source cables in parallel with the lift truck battery cables: POSITIVE(+) to POSITIVE(+) and NEGATIVE(-) to NEGATIVE(-).

Attach ground cable last, remove first. All lift trucks equipped with CROWN built internal combustion engines are NEGATIVE(-) ground.

After Starting the Engine

Observe all indicator lights and gauges frequently during operation, to make sure all systems are working properly. The entire indicator lights will come ON with the ignition switch in the ON position before the engine is started.

LPG (12V)

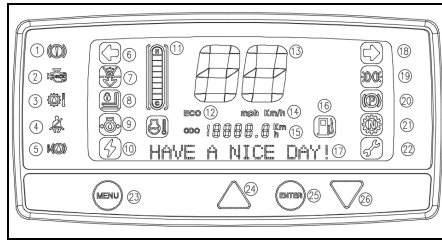

The engine oil pressure indicator light (9), will not come ON with the engine running, unless there is low or no oil pressure. Stop the engine immediately, if the light comes ON.

The alternator indicator light (10), should not come ON during normal operation. The alternator is not charging if the light comes ON with the engine running.

The engine coolant temperature gauge(11) will be in the middle band with the engine running, unless the coolant temperature is excessive.

Observe the hour meter (15) to make sure it is operating properly.

Electronic Controlled Spark-Ignition Engines

PSI 4.3L LP Engine / Kubota WG3800 LP engine

The primary components of the fuel system are the fuel supply, direct electronic pressure regulator (DEPR), fuel mixer, electronic throttle control (ETC) device, 2-Stage convertor, engine control module (ECM), and a catalytic converter. The system operates on a slightly positive fuel pressure. Primary fuel pressure can be measured at the LD 2-Stage convertor. Secondary fuel pressure command and actual fuel pressure is monitored by the ECM.

To obtain maximum effect from the catalyst and accurate control of the air fuel ratio, the emission certified engine is equipped with an onboard computer or Engine Control Module (ECM). The ECM is a 32 bit controller which receives input data from sensors mounted to the engine and fuel system and then outputs various signals to control engine operation.

One specific function of the controller is to maintain a closed loop fuel control which is accomplished by use of the Heated Exhaust Gas Oxygen sensor (HEGO) mounted in the exhaust system. The HEGO sensor sends a voltage signal to the controller which then outputs signals to the EPR to change the amount of fuel being delivered from the regulator or mixer to the engine.

The controller also performs diagnostic functions on the fuel system and notifies the operator of engine malfunctions by turning on a Malfunction Indicator Light (MIL) mounted in the dash. Malfunctions in the system are identified by a Diagnostic Trouble Code (DTC) number. In addition to notifying the operator of the malfunction in the system, the controller also stores the information about the malfunction in its memory. A technician can then utilize a computerized diagnostic scan tool to retrieve the stored diagnostic code and by using the diagnostic charts in this manual to determine the cause of the malfunction. In the event a technician does not have the computerized diagnostic tool, the MIL light can be used to identify the diagnostic code to activate the "blink" feature and count the number of blinks to determine the diagnostic code number to locate the fault in the system.

The primary components of the Gasoline Multi Point Fuel Injection (MPFI) fuel system are the gasoline fuel tank, electric fuel pump, fuel pressure and temperature sensor manifold, fuel filter and fuel rail.

This engine is equipped with a fuel injector rail that does not have a pressure regulator or a return circuit to the fuel tank. Fuel pressure for this engine is regulated by the engine's ECM. The ECM receives fuel pressure and temperature feedback from the gasoline fuel sensor manifold and uses this information to control the ground side of the fuel pump. Fuel pressure is regulated by the ECM pulse width modulating (PWM) the fuel pump. The fuel pressure and temperature sensor manifold has a return or "bleed" circuit that connects back to the equipment fuel tank. This circuit is used to bleed off any vapor that develops in the line and returns a small amount of fuel to the tank. The fuel comes from the fuel tank and passes through the fuel pump. Fuel exits the fuel pump, passes through the filter and then enters the fuel pressure and temperature manifold assembly. Fuel flows through the feed circuit and is delivered to the fuel injector rail. Fuel that enters the bleed circuits through the by-pass valve in the manifold is returned to the fuel tank.

EMS schematic of PSI 4.3L LP engine / Kubota WG3800 LP engine

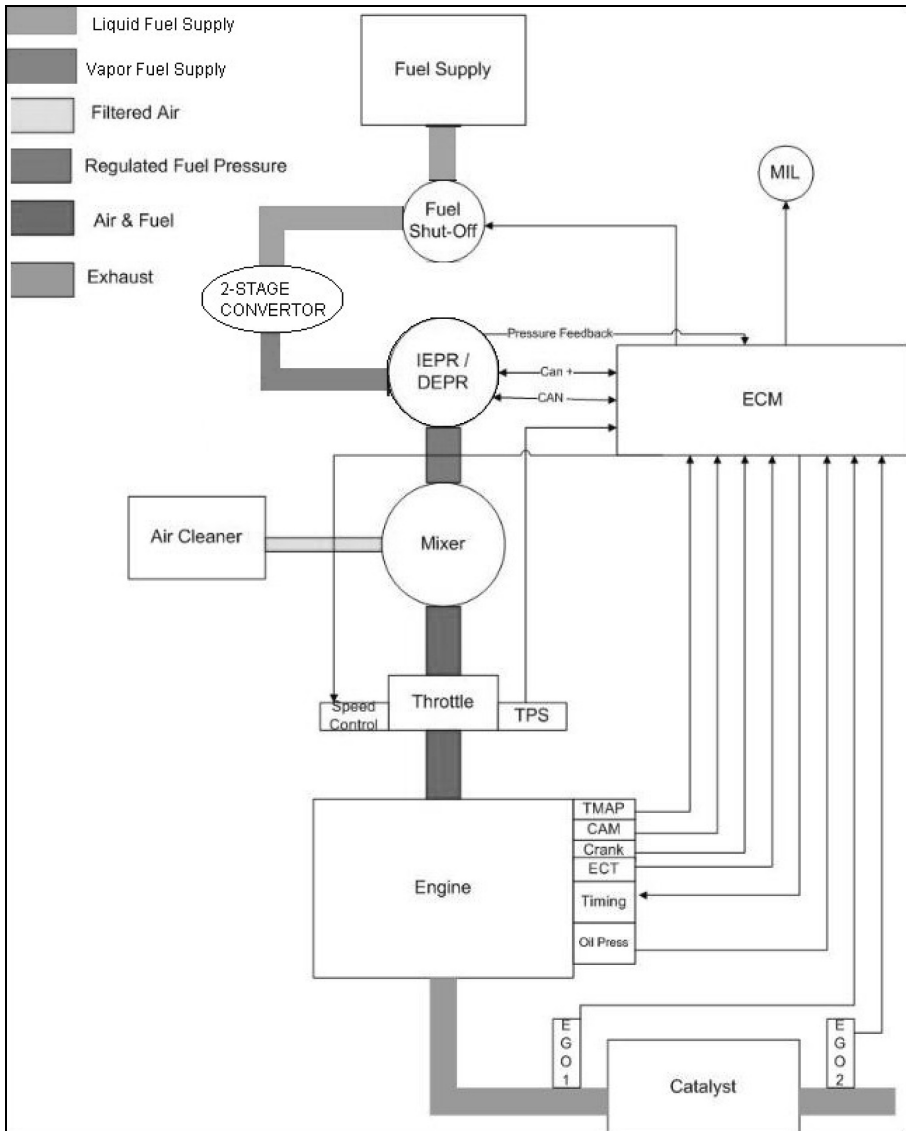

Basic Troubleshooting(LP)

The PSI 4.3L fuel systems are equipped with built-in fault diagnostics. Detected system faults can be displayed by the Malfunction Indicator Lamp (MIL) and are covered in the Advanced Diagnostics section. Items such as fuel level, plugged fuel lines, clogged fuel filters and malfunctioning pressure regulators may not set a fault code by the Engine Control Module (ECM).

Below are basic checks that should be made before referring to the Advanced Diagnostics section, if engine or drivability problems are encountered.

Locating a problem in a propane engine is done exactly the same way as with a gasoline engine.

Consider all parts of the ignition and mechanical systems as well as the fuel system.

FUEL SYSTEM SYMPTOM DIAGNOSTICS

Checks	Action
<p>Before Using This Section</p>	<p>Before using this section, you should have performed On Board Diagnostic (OBD) Check and determined that:</p> <ol style="list-style-type: none"> 1. The ECM and MIL are operating correctly. 2. There are no Diagnostic Trouble Codes (DTCs) stored, or a DTC exists but without a MIL. <p>Several of the following symptom procedures call for a careful visual and physical check. These checks are very important as they can lead to prompt diagnosis and correction of a problem.</p>
<p>Fuel System Check</p>	<ol style="list-style-type: none"> 1. Verify the customer complaint. 2. Locate the correct symptom table. 3. Check the items indicated under that symptom. 4. Operate the equipment under the conditions the symptom occurs. Verify HEGO switching between lean and rich. IMPORTANT! Normal HEGO switching indicates the fuel system is in closed loop and operating correctly at that time. 5. Take a data snapshot using the DST under the condition that the symptom occurs to review at a later time.
<p>Visual and Physical Checks</p>	<ul style="list-style-type: none"> • Check all ECM system fuses and circuit breakers. • Check the ECM ground for being clean, tight and in its proper location. • Check the vacuum hoses for splits, kinks and proper connections. • Check thoroughly for any type of leak or restriction. • Check for air leaks at all the mounting areas of the intake manifold sealing surfaces. • Check for proper installation of the mixer assembly. • Check for air leaks at the mixer assembly. <p>Check the ignition wires for the following conditions:</p> <ul style="list-style-type: none"> • Cracking • Hardening • Proper routing • Carbon tracking. <p>Check the wiring for the following items: proper connections, pinches or cuts.</p> <p>The following symptom tables contain groups of possible causes for each symptom. The order of these procedures is not important. If the DST readings do not indicate a problem, then proceed in a logical order, easiest to check or most likely to cause the problem.</p>

INTERMITTENT

Checks	Action
DEFINITION: <i>The problem may or may not turn ON the (MIL) or store a Diagnostic Trouble Code (DTC).</i>	
Preliminary Checks	Do not use the DTC tables. If a fault is an intermittent, the use of the DTC tables with this condition may result in the replacement of good parts.
Faulty Electrical Connections or Wiring	<p>Faulty electrical connections or wiring can cause most intermittent problems. Check the suspected circuit for the following conditions:</p> <ul style="list-style-type: none"> • Faulty fuse or circuit breaker, connectors poorly mated, terminals not fully seated in the connector (backed out). Terminals not properly formed or damaged. • Wire terminals poorly connected. • Terminal tension is insufficient. • Carefully remove all the connector terminals in the problem circuit in order to ensure the proper contact tension. • If necessary, replace all the connector terminals in the problem circuit in order to ensure the proper contact tension (except those noted as “Not Serviceable”). See section <i>Wiring Schematics</i>. • Checking for poor terminal to wire connections requires removing the terminal from the connector body.
Operational Test	If a visual and physical check does not locate the cause of the problem, operate the vehicle with the DST connected. When the problem occurs, an abnormal voltage or scan reading indicates a problem circuit.
Intermittent MIL Illumination	<p>The following components can cause intermittent MIL and no DTC(s):</p> <ul style="list-style-type: none"> • A defective relay. • Switch that can cause electrical system interference. Normally, the problem will occur when the faulty component is operating. • The improper installation of add on electrical devices, such as lights, 2-way radios, electric motors, etc. • The ignition secondary voltage shorted to a ground. • The MIL circuit or the Diagnostic Test Terminal intermittently shorted to ground. • The MIL wire grounds.
Loss of DTC Memory	<p>To check for the loss of the DTC Memory:</p> <ol style="list-style-type: none"> 1. Disconnect the TMAP sensor. 2. Idle the engine until the MIL illuminates. 3. The ECM should store a TMAP DTC which should remain in the memory when the ignition is turned OFF. If the TMAP DTC does not store and remain, the ECM is faulty.

NO START

Checks	Action
DEFINITION: <i>The engine cranks OK but does not start.</i>	
Preliminary Checks	None
ECM Checks	Use the DST to: <ul style="list-style-type: none"> • Check for proper communication with both the ECM • Check all system fuses engine fuse holder. Refer to <i>Engine Controls Schematics</i>. • Check battery power, ignition power and ground circuits to the ECM. Refer to <i>Engine Control Schematics</i>. Verify voltage and/or continuity for each.
Sensor Checks	<ul style="list-style-type: none"> • Check the TMAP sensor. • Check the cam angle sensor for output (RPM).
Fuel System Checks	<p>Important: A closed LPG manual fuel shut off valve will create a no start condition.</p> <ul style="list-style-type: none"> • Check for air intake system leakage between the mixer and the throttle body. Verify proper operation of the low pressure lock-off solenoids. • Verify proper operation of the fuel control solenoids. • Check the fuel system pressures. • Refer to the <i>LPG Fuel System Diagnosis</i>. • Check for proper mixer air valve operation.
Ignition System Checks	<p>Note: LPG being a gaseous fuel requires higher secondary ignition system voltages for the equivalent gasoline operating conditions.</p> <ol style="list-style-type: none"> 1. Check for the proper ignition voltage output with <i>J 26792</i> or the equivalent. 2. Verify that the spark plugs are correct for use with LPG. <p>Check the spark plugs for the following conditions:</p> <ul style="list-style-type: none"> • Wet plugs. • Cracks. • Wear. • Improper gap. • Burned electrodes. • Heavy deposits. • Check for bare or shorted ignition wires. • Check for loose ignition coil connections at the coil.

NO START

Checks	Action
<p>Engine Mechanical Checks</p>	<p>Important: The LPG Fuel system is more sensitive to intake manifold leakage than the gasoline fuel system.</p> <p>Check for the following:</p> <ul style="list-style-type: none"> • Vacuum leaks. • Improper valve timing. • Low compression. • Improper valve clearance. • Worn rocker arms. • Broken or weak valve springs. <p>Worn camshaft lobes.</p>
<p>Exhaust System Checks</p>	<p>Check the exhaust system for a possible restriction:</p> <ul style="list-style-type: none"> • Inspect the exhaust system for damaged or collapsed pipes: • Inspect the muffler for signs of heat distress or for possible internal failure. • Check for possible plugged catalytic converter. Refer to <i>Restricted Exhaust System Diagnosis</i>.

HARD START

Checks	Action
<p>DEFINITION: <i>The engine cranks OK, but does not start for a long time. The engine does eventually run, or may start but immediately dies.</i></p>	
<p>Preliminary Checks</p>	<p>Make sure the vehicle's operator is using the correct starting procedure.</p>
<p>Sensor Checks</p>	<ul style="list-style-type: none"> • Check the Engine Coolant Temperature sensor with the DST. Compare the engine coolant temperature with the ambient air temperature on a cold engine. If the coolant temperature reading is more than 10 degrees greater or less than the ambient air temperature on a cold engine, check for high resistance in the coolant sensor circuit. Check the cam angle sensor. • Check the Throttle Position (TPS) and Foot Pedal Position (FPP) sensor connections.
<p>Fuel System Checks</p>	<p>Important: A closed LPG manual fuel shut off valve will create an extended crank OR no start condition.</p> <ul style="list-style-type: none"> • Verify the excess flow valve is not tripped or that the manual shut-off valve is not closed. <p>Check mixer assembly for proper installation and leakage.</p> <ul style="list-style-type: none"> • Verify proper operation of the low pressure lock-off solenoid. • Verify proper operation of the EPR. • Check for air intake system leakage between the mixer and the throttle body. Check the fuel system pressures. Refer to the <i>Fuel System Diagnosis</i>.
<p>Ignition System Checks</p>	<p>Note: LPG being a gaseous fuel requires higher secondary ignition system voltages for the equivalent gasoline operating conditions.</p> <ul style="list-style-type: none"> • Check for the proper ignition voltage output with <i>J 26792</i> or the equivalent. • Verify that the spark plugs are the correct type and properly gapped. <p>Check the spark plugs for the following conditions:</p> <ul style="list-style-type: none"> • Wet plugs. • Cracks. • Wear. • Burned electrodes. • Heavy deposits • Check for bare or shorted ignition wires. • Check for moisture in the distributor cap. • Check for loose ignition coil connections. <p>Important:</p> <ol style="list-style-type: none"> 1. If the engine starts but then immediately stalls, check the cam angle sensor. 2. Check for improper gap, debris or faulty connections.

HARD START

Checks	Action
Engine Mechanical Checks	<p>Important: The LPG Fuel system is more sensitive to intake manifold leakage than the gasoline fuel supply system.</p> <p>Check for the following:</p> <ul style="list-style-type: none"> • Vacuum leaks • Improper valve timing • Low compression • Improper valve clearance. • Worn rocker arms • Broken or weak valve springs • Worn camshaft lobes. <p>Check the intake and exhaust manifolds for casting ash.</p>
Exhaust System Checks	<p>Check the exhaust system for a possible restriction:</p> <ul style="list-style-type: none"> • Inspect the exhaust system for damaged or collapsed pipes. • Inspect the muffler for signs of heat distress or for possible internal failure. <p>Check for possible plugged catalytic converter. Refer to <i>Restricted Exhaust System Diagnosis</i>.</p>

CUTS OUT, MISSES

Checks	Action
<p>DEFINITION: A surging or jerking that follows engine speed, usually more pronounced as the engine load increases, but normally felt below 1500 RPM. The exhaust has a steady spitting sound at idle, low speed, or hard acceleration for the fuel starvation that can cause the engine to cut-out.</p>	
Preliminary Checks	None
Ignition System Checks	<ol style="list-style-type: none"> 1. Start the engine. 2. Check for proper ignition output voltage with spark tester J 26792. 3. Check for a cylinder misfire. 4. Verify that the spark plugs are the correct type and properly gapped. <p>Remove the spark plugs and check for the following conditions:</p> <ul style="list-style-type: none"> • Insulation cracks. • Wear. • Improper gap. • Burned electrodes. • Heavy deposits. <p>Visually/Physically inspect the secondary ignition for the following:</p> <ul style="list-style-type: none"> • Ignition wires for arcing and proper routing. • Cross- ring. • Ignition coils for cracks or carbon tracking
Engine Mechanical Checks	<p>Perform a cylinder compression check. Check the engine for the following:</p> <ul style="list-style-type: none"> • Improper valve timing. • Improper valve clearance. • Worn rocker arms. • Worn camshaft lobes. • Broken or weak valve springs. • Check the intake and exhaust manifold passages for casting ash.
Fuel System Checks	<p>Check the fuel system:</p> <ul style="list-style-type: none"> • Plugged fuel filter. • Low fuel pressure, etc. Refer to <i>LPG Fuel System Diagnosis</i>. • Check the condition of the wiring to the low pressure lock-off solenoid.
Additional Check	<p>Check for Electromagnetic Interference (EMI), which may cause a misfire condition. Using the DST, monitor the engine RPM and note sudden increases in rpms displayed on the scan tool but with little change in the actual engine rpm. If this condition exists, EMI may be present. Check the routing of the secondary wires and the ground circuit.</p>

HESITATION, SAG, STUMBLE

Checks	Action
<p>DEFINITION: <i>The engine has a momentary lack of response when putting it under load. The condition can occur at any engine speed. The condition may cause the engine to stall if it's severe enough.</i></p>	
Preliminary Checks	None
Fuel System Checks	<ul style="list-style-type: none"> • Check the fuel pressure. Refer to <i>LPG Fuel System Diagnosis</i>. • Check for low fuel pressure during a moderate or full throttle acceleration. If the fuel pressure drops below specification, there is possibly a faulty low pressure regulator or a restriction in the fuel system. • Check the TMAP sensor response and accuracy. • Check Shut-Off electrical connection. • Check the mixer air valve for sticking or binding. • Check the mixer assembly for proper installation and leakage. Check the EPR.
Ignition System Checks	<p>Note: LPG being a gaseous fuel requires higher secondary ignition system voltages for the equivalent gasoline operating conditions. If a problem is reported on LPG and not gasoline, do not discount the possibility of a LPG only ignition system failure and test the system accordingly.</p> <ul style="list-style-type: none"> • Check for the proper ignition voltage output with <i>J 26792</i> or the equivalent. Verify that the spark plugs are the correct type and properly gapped. • Check for faulty spark plug wires. • Check for fouled spark plugs.
Additional Check	<ul style="list-style-type: none"> • Check for manifold vacuum or air induction system leaks. • Check the alternator output voltage.

BACKFIRE

Checks	Action
<p>DEFINITION: The fuel ignites in the intake manifold, or in the exhaust system, making a loud popping noise.</p>	
Preliminary Checks	None
Ignition System Checks	<p>Important! LPG, being a gaseous fuel, requires higher secondary ignition system voltages for the equivalent gasoline operating conditions. The ignition system must be maintained in peak condition to prevent backfire.</p> <ul style="list-style-type: none"> • Check for the proper ignition coil output voltage using the spark tester <i>J26792</i> or the equivalent. • Check the spark plug wires by connecting an ohmmeter to the ends of each wire in question. If the meter reads over 30,000 ohms, replace the wires. • Check the connection at ignition coil. • Check for deteriorated spark plug wire insulation. <p>Remove the plugs and inspect them for the following conditions:</p> <ul style="list-style-type: none"> • Wet plugs. • Cracks. • Wear. • Improper gap. • Burned electrodes. • Heavy deposits.
Engine Mechanical Check	<p>Important! The LPG Fuel system is more sensitive to intake manifold leakage than a gasoline fuel supply system.</p> <p>Check the engine for the following:</p> <ul style="list-style-type: none"> • Improper valve timing. • Engine compression. • Manifold vacuum leaks. • Intake manifold gaskets. • Sticking or leaking valves. • Exhaust system leakage. • Check the intake and exhaust system for casting flash or other restrictions.
Fuel System Checks	Perform a fuel system diagnosis. Refer to <i>LPG Fuel System Diagnosis</i> .

LACK OF POWER, SLUGGISHNESS, OR SPONGINESS

Checks	Action
DEFINITION: <i>The engine delivers less than expected power.</i>	
Preliminary Checks	<ul style="list-style-type: none"> • Refer to the <i>LPG Fuel system OBD System Check</i>. • Compare the customer's vehicle with a similar unit to verify customer has an actual problem. <i>Do not compare the power output of the vehicle operating on LPG to a vehicle operating on gasoline as the fuels do have different drive feel characteristics.</i> • Remove the air filter and check for dirt or restriction. • Check the vehicle transmission. • Refer to the OEM transmission diagnostics.
Fuel System Checks	<ul style="list-style-type: none"> • Check for a restricted fuel filter, contaminated fuel, or improper fuel pressure. Refer to <i>LPG Fuel System Diagnosis</i>. • Check for the proper ignition output voltage with the spark tester <i>J 26792</i> or the equivalent. • Check for proper installation of the mixer assembly. Check all air inlet ducts for condition and proper installation. • Check for fuel leaks between the EPR and the mixer. • Verify that the LPG tank manual shut-off valve is fully open. • Verify that liquid fuel (not vapor) is being delivered to the EPR.
Sensor Checks	<ul style="list-style-type: none"> • Check the Heated Exhaust Gas Oxygen Sensors (HEGO) for contamination and performance. Check for proper operation of the TMAP sensor. • Check for proper operation of the TPS and FPP sensors.
Exhaust System Checks	<p>Check the exhaust system for a possible restriction:</p> <ul style="list-style-type: none"> • Inspect the exhaust system for damaged or collapsed pipes. • Inspect the muffler for signs of heat distress or for possible internal failure. • Check for possible plugged catalytic converter.
Engine Mechanical Check	<p>Check the engine for the following:</p> <ul style="list-style-type: none"> • Engine compression. • Valve timing. • Improper or worn camshaft. • Refer to <i>Engine Mechanical</i> in the Service Manual.
Additional Check	<ul style="list-style-type: none"> • Check the ECM grounds for being clean, tight, and in their proper locations. • Check the alternator output voltage. <p>If all procedures have been completed and no malfunction has been found, review and inspect the following items:</p> <ul style="list-style-type: none"> • Visually and physically, inspect all electrical connections within the suspected circuit and/or systems. • Check the DST data.

ROUGH, UNSTABLE, OR INCORRECT IDLE, STALLING

Checks	Action
DEFINITION: <i>The engine runs unevenly at idle. If severe enough, the engine may shake.</i>	
Preliminary Checks	None.
Sensor Checks	<p>Check the Heated Exhaust Gas Oxygen Sensors (HEGO) performance:</p> <ul style="list-style-type: none"> • Check for silicone contamination from fuel or improperly used sealant. If contaminated, the sensor may have a white powdery coating result in a high but false signal voltage (rich exhaust indication). The ECM will reduce the amount of fuel delivered to the engine causing a severe driveability problem. <p>Check the Temperature Manifold Absolute Pressure (TMAP) sensor response and accuracy.</p>
Fuel System Checks	<ul style="list-style-type: none"> • Check for rich or lean symptom that causes the condition. • Drive the vehicle at the speed of the complaint. • Monitoring the oxygen sensors will help identify the problem. • Check for a sticking mixer air valve. • Verify proper operation of the EPR. • Perform a cylinder compression test. Refer to <i>Engine Mechanical</i> in the Service Manual. • Check the EPR fuel pressure. Refer to the <i>LPG Fuel System Diagnosis</i>. • Check mixer assembly for proper installation and connection.
Ignition System Checks	<ul style="list-style-type: none"> • Check for the proper ignition output voltage using the spark tester <i>J26792</i> or the equivalent. • Verify that the spark plugs are the correct type and properly gapped. <p>Remove the plugs and inspect them for the following conditions:</p> <ul style="list-style-type: none"> • Wet plugs. • Cracks. • Wear. • Improper gap. • Burned electrodes. • Blistered insulators. • Heavy deposits. <p>Check the spark plug wires by connecting an ohmmeter to the ends of each wire in question. If the meter reads over 30,000 ohms, replace the wires.</p>
Additional Checks	<p>Important: The LPG Fuel system is more sensitive to intake manifold leakage than the gasoline fuel supply system.</p> <ul style="list-style-type: none"> • Check for vacuum leaks. Vacuum leaks can cause a higher than normal idle and low throttle angle control command. • Check the ECM grounds for being clean, tight, and in their proper locations. Check the battery cables and ground straps. They should be clean and secure. Erratic voltage may cause all sensor readings to be skewed resulting in poor idle quality.

ROUGH, UNSTABLE, OR INCORRECT IDLE, STALLING

Checks	Action
Engine Mechanical Check	Check the engine for: <ul style="list-style-type: none">• Broken motor mounts.• Improper valve timing.• Low compression.• Improper valve clearance.• Worn rocker arms.• Broken or weak valve springs.• Worn camshaft lobes.

Advanced Diagnostics(PSI 4.3L LP Engine)

The Fuel system has built-in diagnostics for system trouble shooting. The system has a dash mounted malfunction indicator lamp (MIL) that provides indications of engine or fuel system related problem. Most engine control system related problems that affect emissions or driveability of the vehicle will set a (DTC) diagnostic trouble code and illuminate the MIL.

The MIL serves as notification to the operator of a problem related to the emission control system so the driver can arrange for service as soon as possible. It will also display DTCs that have been stored due to a system malfunction.

The MIL should illuminate when the key is in the ON position and the engine is not running. This feature verifies that the lamp is in proper working order. If the MIL does not illuminate with the vehicle key ON/engine OFF, repair it as soon as possible. Once the engine is in start or run mode, the MIL should turn off. If the lamp remains on while the engine is in the start or run mode a diagnostic trouble code may be set.

The MIL will be turned OFF after three (3) consecutive run cycles or by clearing the active code with the Diagnostic Scan Tool (DST).

Diagnostic Trouble Codes are set when the GCP (Electronic Control Module) runs a diagnostic self test and the test fails. When a DTC is set, the ECM will illuminate the MIL on the instrument panel and also save the DTC in memory. The ECM will continue to run the self test. If the system continues to fail the test, the lamp will stay illuminated and the DTC is stored as an active DTC. If the self test runs and passes, the DTC will be stored as historic DTC. All DTCs are stored as historic faults until they are cleared. Most DTCs will automatically clear from memory if the DTC does not reset within 50 to 100 consecutive engine run cycles.

While a Diagnostic Trouble Code is current for a sensor, the ECM may assign a default "limp home" value and use that value in its control algorithms. All of the system diagnostic self-tests run continuously during normal vehicle operation.

The Diagnostic Trouble Codes can be read by using either the MIL lamp or a laptop computer. Diagnostic Trouble Codes can be cleared from memory with a laptop computer, or by turning the ignition key to the OFF position and removing the ECM power fuse or battery cable for at least 15 seconds.

If more than one DTC is detected, start the diagnostic repair with the lowest DTC number set. Diagnose each problem to correction unless directed to do otherwise by the diagnostic chart. The DTCs are numbered in order of importance. Both DTC 112 and DTC122 pertain to the oxygen sensor, so it is possible that a repair that corrects DTC 112 may also correct the problem causing the DTC 122.

Diagnostic test charts contained in this manual refer to the DST to be connected and in the "System Data Mode." This simply means that the DST is connected and communicating with the PC. In some instances the chart will call out a special test mode. An example of this would be instructions for the DST to be connected and in the DBW (drive by wire) mode. Always be sure to follow the special instructions to avoid a false diagnosis of fuel system components.

Blink Code Function

Although the DST is considered a required tool to access the DTC codes, codes may be retrieved without a laptop computer using the blink code function. To enable this function follow the steps below:

- Jump pins 1 and 4 at the DLC connector (see illustration below)
- Turn the ignition key to the on position
- The system will now enter the self diagnostic blink code mode. Be ready with pen and paper to write down any codes that may be stored.
- The ECM will flash the MIL indicator with a pause between represented numbers that represent DTC codes. The sequence starts with code 1654. Code 1654 confirms the system has entered the blink code mode. The ECM will flash code 1654 (3) times before displaying the actual DTC code that may be set.

Example:

One short blink (pause) six short blinks (pause) five short blinks (pause) four short blinks.

- If no DTC codes are found, the ECM will continue to flash 1654 only. This means no stored DTC codes were found.
- If one of the numbers in the DTC code is zero (0), no flash will occur to represent the zero value—it will be represented as a short pause.

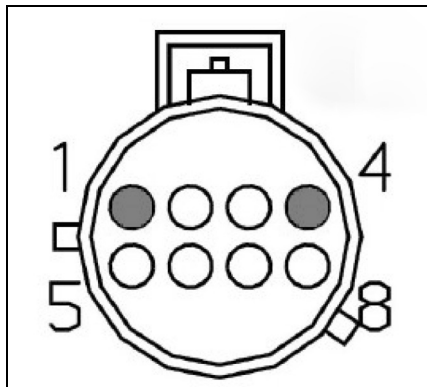

Diagnostic Connector Terminal Identification

Malfunction Indicator Lamp (MIL) Operation

How does my MIL work?

The emissions control system utilizes a MIL to warn the operator or technician of a possible issue with the engine or emissions control system. The system will keep the MIL illuminated for the entire key cycle in which the trouble code was set. It will keep the MIL illuminated for three additional engine run cycles under the following two circumstances: (1) The fault caused the engine to shut down or (2) the fault is related to the exhaust gas oxygen (EGO) sensors. This function is called MIL persistence.

How does MIL persistence work?

In the event the DTC is related to either an engine shutdown fault OR an oxygen sensor fault the following statement applies: If the vehicle is not serviced by a technician and the condition causing the MIL illumination (DTC) no longer exists, the MIL will remain illuminated for the 3 additional start cycles. The MIL will go out on the 4th start cycle if the condition does not reoccur.

In the event the DTC is not related to an engine shut down or an oxygen sensor fault and the condition causing the MIL illumination (DTC) no longer exists, the MIL will go out at the next run cycle.

If the condition is serviced by a technician and the DTC is cleared using a Diagnostic Service Tool (DST), the MIL will go out immediately.

Diagnostic Trouble Codes (DTC) are permanently retained in the historic DTC section until cleared with a DST or the auto clear requirements are met. The auto clear feature will clear out historic faults after 40 run cycles.

What are the requirements for a run cycle?

A run cycle is when the engine speed is above the “run speed” set point for 1.5 seconds or longer. The “run speed” is the transition point when the ECM recognizes the engine is going from the cranking parameters to the engine running parameters. The run speed is typically set at 450 rpm.

DIAGNOSTIC TROUBLE CODE (DTC) CHART – SORTED BY DTC # (1 of 4) (for PSI 4.3L Engine)

Description	DTC Set 2		Description	DTC Set 2	
	SPN-2	FMI-2		SPN-2	FMI-2
DTC 11: Intake cam / distributor position error	520800	7	DTC 268: Injector 3 coil shorted	653	6
DTC 16: Crank and/or cam could not synchronize during start	636	8	DTC 270: Injector 4 open or short to ground	654	5
DTC 24: Exhaust cam position error	520801	7	DTC 271: Injector 4 coil shorted	654	6
DTC 87 Fuel pressure lower than expected	94	1	DTC 273: Injector 5 open or short to ground	655	5
DTC 88 Fuel pressure higher than expected	94	0	DTC 274: Injector 5 coil shorted	655	6
DTC 91: FP low voltage	94	4	DTC 276: Injector 6 open or short to ground	656	5
DTC 92: FP high voltage	94	3	DTC 277: Injector 6 coil shorted	656	6
DTC 107: MAP voltage low	106	4	DTC 279: Injector 7 open or short to ground	657	5
DTC 108: MAP pressure high	106	16	DTC 280: Injector 7 coil shorted	657	6
DTC 111: IAT higher than expected stage 1	105	15	DTC 282: Injector 8 open or short to ground	658	5
DTC 112: IAT voltage low	105	4	DTC 283: Injector 8 coil shorted	658	6
DTC 113: IAT voltage high	105	3	DTC 285: Injector 9 open or short to ground	659	5
DTC 116: ECT higher than expected stage 1	110	15	DTC 286: Injector 9 coil shorted	659	6
DTC 117: ECT voltage low	110	4	DTC 288: Injector 10 open or short to ground	660	5
DTC 118: ECT voltage high	110	3	DTC 289: Injector 10 coil shorted	660	6
DTC 121: TPS1-2 lower than expected	51	1	DTC 1631: PWM1-Gauge1 open / ground short	697	5
DTC 122: TPS1 voltage low	51	4	DTC 299: Boost control underboost failure	1692	1
DTC 123: TPS1 voltage high	51	3	DTC 301: Cylinder 1 emissions/catalyst damaging misfire	1323	31
DTC 127: IAT higher than expected stage 2	105	0	DTC 302: Cylinder 2 emissions/catalyst damaging misfire	1324	31
DTC 129: BP pressure low	108	1	DTC 303: Cylinder 3 emissions/catalyst damaging misfire	1325	31
DTC 134: EGO1 open / lazy	724	10	DTC 304: Cylinder 4 emissions/catalyst damaging misfire	1326	31
DTC 140: EGO3 open / lazy	520209	10	DTC 305: Cylinder 5 emissions/catalyst damaging misfire	1327	31
DTC 154: EGO2 open / lazy	520208	10	DTC 306: Cylinder 6 emissions/catalyst damaging misfire	1328	31
DTC 160: EGO4 open / lazy	520210	10	DTC 307: Cylinder 7 emissions/catalyst damaging misfire	1329	31
DTC 171: Adaptive-learn gasoline bank1 high	520200	0	DTC 308: Cylinder 8 emissions/catalyst damaging misfire	1330	31

Operation Section

Description	DTC Set 2		Description	DTC Set 2	
	SPN-2	FMI-2		SPN-2	FMI-2
DTC 172: Adaptive-learn gasoline bank1 low	520200	1	DTC 326: Knock1 excessive or erratic signal	731	2
DTC 174: Adaptive-learn gasoline bank2 high	520201	0	DTC 327: Knock1 sensor open or not present	731	4
DTC 175: Adaptive-learn gasoline bank2 low	520201	1	DTC 331: Knock2 excessive or erratic signal	520241	2
DTC 182: FT low voltage	174	4	DTC 332: Knock2 sensor open or not present	520241	4
DTC 183: FT high voltage	174	3	DTC 336: CRANK input signal noise	636	2
DTC 187: Gaseous fuel temperature sender low voltage	520240	4	DTC 337: Crank signal loss	636	4
DTC 188: Gaseous fuel temperature sender high voltage	520240	3	DTC 341: CAM input signal noise	723	2
DTC 217: ECT higher than expected stage 2	110	0	DTC 342: Loss of CAM input signal	723	4
DTC 219: RPM higher than max allowed govern speed	515	15	DTC 359: Fuel run-out longer than expected	1239	7
DTC 221: TPS1-2 higher than expected	51	0	DTC 420: Catalyst inactive on gasoline (Bank 1)	520211	10
DTC 222: TPS2 voltage low	520251	4	DTC 430: Catalyst inactive on gasoline (Bank 2)	520212	10
DTC 223: TPS2 voltage high	520251	3	DTC 502: Roadspeed input loss of signal	84	1
DTC 234: Boost control overboost failure	1692	0	DTC 508: IAC ground short	520252	6
DTC 236: TIP active	1692	2	DTC 509: IAC coil open/short	520252	5
DTC 237: TIP low voltage	1127	4	DTC 520: Oil pressure sender low pressure stage 1	100	18
DTC 238: TIP high voltage	1127	3	DTC 521: Oil pressure sender high pressure	100	0
DTC 261: Injector 1 open or short to ground	651	5	DTC 522: Oil pressure sender low voltage	100	4
DTC 262: Injector 1 coil shorted	651	6	DTC 523: Oil pressure sender high voltage	100	3
DTC 264: Injector 2 open or short to ground	652	5	DTC 524: Oil pressure low	100	1
DTC 265: Injector 2 coil shorted	652	6	DTC 562: Vbat voltage low	168	17
DTC 267: Injector 3 open or short to ground	653	5	DTC 563: Vbat voltage high	168	15

DIAGNOSTIC TROUBLE CODE (DTC) CHART – SORTED BY DTC # (2 of 4) (for PSI 4.3L Engine)

Description	DTC Set 2		Description	DTC Set 2	
	SPN-2	FMI-2		SPN-2	FMI-2
DTC 601: Microprocessor failure - FLASH	628	13	DTC 1175: MegaJector voltage supply low	520260	4
DTC 604: Microprocessor failure - RAM	630	12	DTC 1176: MegaJector internal actuator fault detection	520260	12
DTC 606: Microprocessor failure - COP	629	31	DTC 1177: MegaJector internal circuitry fault detection	520260	12
DTC 615: Start relay coil open	1321	5	DTC 1178: MegaJector internal comm fault detection	520260	12
DTC 616: Start relay ground short	1321	4	DTC 1182: Fuel impurity level high	520401	0
DTC 617: Start relay coil short to power	1321	3	DTC 1183: MegaJector autozero / lockoff failure	520803	31
DTC 627: Fuel pump relay coil open	1348	5	DTC 1311: Cylinder 1 misfire detected	1323	11
DTC 628: Fuel-pump high-side open or short to ground	1347	5	DTC 1312: Cylinder 2 misfire detected	1324	11
DTC 628: Fuel pump relay control ground short	1348	4	DTC 1313: Cylinder 3 misfire detected	1325	11
DTC 629: Fuel-pump high-side short to power	1347	6	DTC 1314: Cylinder 4 misfire detected	1326	11
DTC 629: Fuel pump relay coil short to power	1348	3	DTC 1315: Cylinder 5 misfire detected	1327	11
DTC 642: Sensor supply voltage 1 low	1079	4	DTC 1316: Cylinder 6 misfire detected	1328	11
DTC 643: Sensor supply voltage 1 high	1079	3	DTC 1317: Cylinder 7 misfire detected	1329	11
DTC 650: MIL open	1213	5	DTC 1318: Cylinder 8 misfire detected	1330	11
DTC 652: Sensor supply voltage 2 low	1080	4	DTC 1411: EMWT1 voltage high	441	3
DTC 653: Sensor supply voltage 2 high	1080	3	DTC 1412: EMWT2 voltage high	442	3
DTC 685: Power relay coil open	1485	5	DTC 1413: EMWT1 voltage low	441	4
DTC 686: Power relay ground short	1485	4	DTC 1414: EMWT2 voltage low	442	4
DTC 687: Power relay coil short to power	1485	3	DTC 1415: EMWT1 higher than expected stage 1	441	15
DTC 916: Shift actuator feedback out-of-range	520226	3	DTC 1416: EMWT2 higher than expected stage 1	442	15
DTC 919: Shift unable to reach desired gear	520226	7	DTC 1417: EMWT1 higher than expected stage 2	441	0
DTC 920: Shift actuator or drive circuit failed	520226	31	DTC 1418: EMWT2 higher than expected stage 2	442	0
DTC 1111: RPM above fuel rev limit level	515	16	DTC 1419: ERWT1 voltage high	443	3
DTC 1112: RPM above spark rev limit level	515	0	DTC 1420: ERWT2 voltage high	444	3
DTC 1121: FPP1/2 simultaneous voltages out-of-range (redundanc	91	31	DTC 1421: ERWT1 voltage low	443	4

Operation Section

Description	DTC Set 2		Description	DTC Set 2	
	SPN-2	FMI-2		SPN-2	FMI-2
DTC 1122: FPP1/2 do not match each other or IVS (redundancy lo	520250	31	DTC 1422: ERWT2 voltage low	444	4
DTC 1131: WGP voltage high	1192	3	DTC 1423: ERWT1 higher than expected stage 1	443	15
DTC 1132: WGP voltage low	1192	4	DTC 1424: ERWT2 higher than expected stage 1	444	15
DTC 1151: Closed-loop LPG high	520206	0	DTC 1425: ERWT1 higher than expected stage 2	443	0
DTC 1152: Closed-loop LPG low	520206	1	DTC 1426: ERWT2 higher than expected stage 2	444	0
DTC 1153: Closed-loop NG high	520207	0	DTC 1511: AUX analog Pull-Up 1 high voltage	520216	3
DTC 1154: Closed-loop NG low	520207	1	DTC 1512: AUX analog Pull-Up 1 low voltage	520216	4
DTC 1155: Closed-loop gasoline bank1 high	520204	0	DTC 1513: AUX analog Pull-Up 2 high voltage	520217	3
DTC 1156: Closed-loop gasoline bank1 low	520204	1	DTC 1514: AUX analog Pull-Up 2 low voltage	520217	4
DTC 1157: Closed-loop gasoline bank2 high	520205	0	DTC 1515: AUX analog Pull-Down 1 high voltage	520215	3
DTC 1158: Closed-loop gasoline bank2 low	520205	1	DTC 1516: AUX analog Pull-Down 1 low voltage	520215	4
DTC 1161: Adaptive-learn LPG high	520202	0	DTC 1517: AUX analog Pull-Up 3 high voltage	520218	3
DTC 1162: Adaptive-learn LPG low	520202	1	DTC 1518: AUX analog Pull-Up 3 low voltage	520218	4
DTC 1163: Adaptive-learn NG high	520203	0	DTC 1521: CHT higher than expected stage 1	110	16
DTC 1164: Adaptive-learn NG low	520203	1	DTC 1522: CHT higher than expected stage 2	110	0
DTC 1165: Catalyst inactive on LPG	520213	10	DTC 1531: Gov1/2/3 interlock failure	520270	31
DTC 1166: Catalyst inactive on NG	520214	10	DTC 1541: AUX analog Pull-Up/Down 1 high voltage	520219	3
DTC 1171: MegaJector delivery pressure higher than expected	520260	0	DTC 1542: AUX analog Pull-Up/Down 1 low voltage	520219	4
DTC 1172: MegaJector delivery pressure lower than expected	520260	1	DTC 1543: AUX analog Pull-Up/Down 2 high voltage	520220	3
DTC 1173: MegaJector comm lost	520260	31	DTC 1544: AUX analog Pull-Up/Down 2 low voltage	520220	4
DTC 1174: MegaJector voltage supply high	520260	3	DTC 1545: AUX analog Pull-Up/Down 3 high voltage	520221	3

DIAGNOSTIC TROUBLE CODE (DTC) CHART – SORTED BY DTC # (3 of 4) (for PSI 4.3L Engine)

Description	DTC Set 2		Description	DTC Set 2	
	SPN-2	FMI-2		SPN-2	FMI-2
DTC 1546: AUX analog Pull-Up/Down 3 low voltage	520221	4	DTC 1662: PWM6 short to power	925	3
DTC 1547: AUX analog Pull-Up/Down 4 high voltage	713	3	DTC 1663: PWM7 open / ground short	926	5
DTC 1548: AUX analog Pull-Up/Down 4 low voltage	713	4	DTC 1664: PWM7 short to power	926	3
DTC 1551: AUX digital 1 high voltage	520222	3	DTC 1665: PWM8 open / ground short	2646	5
DTC 1552: AUX digital 1 low voltage	520222	4	DTC 1666: PWM8 short to power	2646	3
DTC 1553: AUX digital 2 high voltage	520223	3	DTC 1669: PWM9 open / ground short	2647	5
DTC 1554: AUX digital 2 low voltage	520223	4	DTC 1670: PWM9 short to power	2647	3
DTC 1555: AUX digital 3 high voltage	520224	3	DTC 2111: Unable to reach lower TPS	51	7
DTC 1555: Water Intrusion Detection	520224	3	DTC 2112: Unable to reach higher TPS	51	7
DTC 1556: AUX digital 3 low voltage	520224	4	DTC 2115: FPP1 higher than IVS	91	0
DTC 1561: AUX analog Pull-Down 2 high voltage	0	3	DTC 2116: FPP2 higher than IVS	29	0
DTC 1561: AUX analog Pull-Down 3 high voltage	0	3	DTC 2120: FPP1 invalid voltage and FPP2 disagrees with IVS	520250	31
DTC 1561: AUX analog Pull-Down 2 low voltage	0	4	DTC 2121: FPP1-2 lower than expected	91	18
DTC 1561: AUX analog Pull-Down 3 low voltage	0	4	DTC 2122: FPP1 voltage high	91	3
DTC 1611: Sensor supply voltage 1 and 2 out-of-range	1079	31	DTC 2123: FPP1 voltage low	91	4
DTC 1612: Microprocessor failure - RTI 1	629	31	DTC 2125: FPP2 invalid voltage and FPP1 disagrees with IVS	520250	31
DTC 1613: Microprocessor failure - RTI 2	629	31	DTC 2126: FPP1-2 higher than expected	91	16
DTC 1614: Microprocessor failure - RTI 3	629	31	DTC 2127: FPP2 voltage low	29	4
DTC 1615: Microprocessor failure - A/D	629	31	DTC 2128: FPP2 voltage high	29	3
DTC 1616: Microprocessor failure - Interrupt	629	31	DTC 2130: IVS stuck at-idle, FPP1/2 match	558	5
DTC 1621: RS-485 Rx inactive	0	31	DTC 2131: IVS stuck off-idle, FPP1/2 match	558	6
DTC 1622: RS-485 Rx noise	0	31	DTC 2135: TPS1/2 simultaneous voltages out-of-range	51	31
DTC 1623: RS-485 Rx bad packet format	0	31	DTC 2139: FPP1 lower than IVS	91	1
DTC 1624: RS-485 remote shutdown request	0	31	DTC 2140: FPP2 lower than IVS	29	1
DTC 1625: J1939 shutdown request	1384	31	DTC 2229: BP pressure high	108	0
DTC 1626: CAN-J1939 Tx fault	639	12	DTC 2300: Spark coil 1 primary open or short to ground	1268	5
DTC 1627: CAN-J1939 Rx fault	639	12	DTC 2301: Spark coil 1 primary shorted	1268	6

Operation Section

Description	DTC Set 2		Description	DTC Set 2	
	SPN-2	FMI-2		SPN-2	FMI-2
DTC 1628: J1939 CAN address / engine-number conflict	639	13	DTC 2303: Spark coil 2 primary open or short to ground	1269	5
DTC 1629: J1939 TSC1 message receipt loss	639	9	DTC 2304: Spark coil 2 primary shorted	1269	6
DTC 1630: J1939 ETC message receipt loss	91	2	DTC 2306: Spark coil 3 primary open or short to ground	1270	5
DTC 1632: PWM1-Gauge1 short to power	697	6	DTC 2307: Spark coil 3 primary shorted	1270	6
DTC 1633: PWM2-Gauge2 open / ground short	698	5	DTC 2309: Spark coil 4 primary open or short to ground	1271	5
DTC 1634: PWM2-Gauge2 short to power	698	6	DTC 2310: Spark coil 4 primary shorted	1271	6
DTC 1635: PWM3-Gauge3 open / ground short	699	5	DTC 2312: Spark coil 5 primary open or short to ground	1272	5
DTC 1636: PWM3-Gauge3 short to power	699	6	DTC 2313: Spark coil 5 primary shorted	1272	6
DTC 1637: PWM4 open / ground short	700	5	DTC 2315: Spark coil 6 primary open or short to ground	1273	5
DTC 1638: PWM4 short to power	700	6	DTC 2316: Spark coil 6 primary shorted	1273	6
DTC 1639: PWM5 open / ground short	520230	5	DTC 2318: Spark coil 7 primary open or short to ground	1274	5
DTC 1640: PWM5 short to power	520230	6	DTC 2319: Spark coil 7 primary shorted	1274	6
DTC 1641: Buzzer control ground short	920	4	DTC 2321: Spark coil 8 primary open or short to ground	1275	5
DTC 1642: Buzzer open	920	5	DTC 2322: Spark coil 8 primary shorted	1275	6
DTC 1643: Buzzer control short to power	920	3	DTC 2324: Spark coil 9 primary open or short to ground	1276	5
DTC 1644: MIL control ground short	1213	4	DTC 2325: Spark coil 9 primary shorted	1276	6
DTC 1645: MIL control short to power	1213	3	DTC 2327: Spark coil 10 primary open or short to ground	1277	5
DTC 1651: J1939 ETC message receipt loss while in-gear	91	9	DTC 2328: Spark coil 10 primary shorted	1277	6
DTC 1661: PWM6 open / ground short	925	5	DTC 2428: EGT temperature high	173	0

DIAGNOSTIC TROUBLE CODE (DTC) CHART – SORTED BY DTC # (4 of 4) (for PSI 4.3L Engine)

Description	DTC Set 2	
	SPN-2	FMI-2
DTC 2618: Tach output ground short	645	4
DTC 2619: Tach output short to power	645	3
DTC 8901: UEGO microprocessor internal fault	3221	31
DTC 8902: UEGO heater supply high voltage	3222	3
DTC 8903: UEGO heater supply low voltage	3222	4
DTC 8904: UEGO cal resistor voltage high	3221	3
DTC 8905: UEGO cal resistor voltage low	3221	4
DTC 8906: UEGO return voltage shorted high	3056	3
DTC 8907: UEGO return voltage shorted low	3056	4
DTC 8908: UEGO pump voltage shorted high	3218	3
DTC 8909: UEGO pump voltage shorted low	3218	4
DTC 8910: UEGO sense cell voltage high	3217	3
DTC 8911: UEGO sense cell voltage low	3217	4
DTC 8912: UEGO pump voltage at high drive limit	3225	3
DTC 8913: UEGO pump voltage at low drive limit	3225	4
DTC 8914: UEGO sense cell slow to warm up	3222	10
DTC 8915: UEGO pump cell slow to warm up	3225	10
DTC 8916: UEGO sense cell impedance high	3222	0
DTC 8917: UEGO pump cell impedance high	3225	0
DTC 8918: UEGO pump cell impedance low	3225	1

DIAGNOSTIC TROUBLE CODE (DTC) CHART – SORTED BY SPN:FMI (1 of 4) (for PSI 4.3L Engine)

Description	DTC Set 2		Description	DTC Set 2	
	SPN-2	FMI-2		SPN-2	FMI-2
DTC 1561: AUX analog Pull-Down 2 high voltage	0	3	DTC 107: MAP voltage low	106	4
DTC 1561: AUX analog Pull-Down 3 high voltage	0	3	DTC 108: MAP pressure high	106	16
DTC 1561: AUX analog Pull-Down 2 low voltage	0	4	DTC 2229: BP pressure high	108	0
DTC 1561: AUX analog Pull-Down 3 low voltage	0	4	DTC 129: BP pressure low	108	1
DTC 1621: RS-485 Rx inactive	0	31	DTC 1522: CHT higher than expected stage 2	110	0
DTC 1622: RS-485 Rx noise	0	31	DTC 217: ECT higher than expected stage 2	110	0
DTC 1623: RS-485 Rx bad packet format	0	31	DTC 118: ECT voltage high	110	3
DTC 1624: RS-485 remote shutdown request	0	31	DTC 117: ECT voltage low	110	4
Undefined DTC - Index 10297	0	31	DTC 116: ECT higher than expected stage 1	110	15
Undefined DTC - Index 10298	0	31	DTC 1521: CHT higher than expected stage 1	110	16
Undefined DTC - Index 10299	0	31	DTC 563: Vbat voltage high	168	15
DTC 2116: FPP2 higher than IVS	29	0	DTC 562: Vbat voltage low	168	17
DTC 2140: FPP2 lower than IVS	29	1	DTC 2428: EGT temperature high	173	0
DTC 2128: FPP2 voltage high	29	3	DTC 183: FT high voltage	174	3
DTC 2127: FPP2 voltage low	29	4	DTC 182: FT low voltage	174	4
DTC 221: TPS1-2 higher than expected	51	0	DTC 1417: EMWT1 higher than expected stage 2	441	0
DTC 121: TPS1-2 lower than expected	51	1	DTC 1411: EMWT1 voltage high	441	3
DTC 123: TPS1 voltage high	51	3	DTC 1413: EMWT1 voltage low	441	4
DTC 122: TPS1 voltage low	51	4	DTC 1415: EMWT1 higher than expected stage 1	441	15
DTC 2112: Unable to reach higher TPS	51	7	DTC 1418: EMWT2 higher than expected stage 2	442	0
DTC 2111: Unable to reach lower TPS	51	7	DTC 1412: EMWT2 voltage high	442	3
DTC 2135: TPS1/2 simultaneous voltages out-of-ran	51	31	DTC 1414: EMWT2 voltage low	442	4
DTC 502: Roadspeed input loss of signal	84	1	DTC 1416: EMWT2 higher than expected stage 1	442	15
DTC 2115: FPP1 higher than IVS	91	0	DTC 1425: ERWT1 higher than expected stage 2	443	0
DTC 2139: FPP1 lower than IVS	91	1	DTC 1419: ERWT1 voltage high	443	3
DTC 1630: J1939 ETC message receipt loss	91	2	DTC 1421: ERWT1 voltage low	443	4
DTC 2122: FPP1 voltage high	91	3	DTC 1423: ERWT1 higher than expected stage 1	443	15

Description	DTC Set 2		Description	DTC Set 2	
	SPN-2	FMI-2		SPN-2	FMI-2
DTC 2123: FPP1 voltage low	91	4	DTC 1426: ERWT2 higher than expected stage 2	444	0
DTC 1651: J1939 ETC message receipt loss while in	91	9	DTC 1420: ERWT2 voltage high	444	3
DTC 2126: FPP1-2 higher than expected	91	16	DTC 1422: ERWT2 voltage low	444	4
DTC 2121: FPP1-2 lower than expected	91	18	DTC 1424: ERWT2 higher than expected stage 1	444	15
DTC 1121: FPP1/2 simultaneous voltages out-of-ran	91	31	DTC 1112: RPM above spark rev limit level	515	0
DTC 88 Fuel pressure higher than expected	94	0	DTC 219: RPM higher than max allowed govern speed	515	15
DTC 87 Fuel pressure lower than expected	94	1	DTC 1111: RPM above fuel rev limit level	515	16
DTC 92: FP high voltage	94	3	DTC 2130: IVS stuck at-idle, FPP1/2 match	558	5
DTC 91: FP low voltage	94	4	DTC 2131: IVS stuck off-idle, FPP1/2 match	558	6
DTC 521: Oil pressure sender high pressure	100	0	DTC 601: Microprocessor failure - FLASH	628	13
DTC 524: Oil pressure low	100	1	DTC 606: Microprocessor failure - COP	629	31
DTC 524: Oil pressure sender low pressure	100	1	DTC 1612: Microprocessor failure - RTI 1	629	31
DTC 523: Oil pressure sender high voltage	100	3	DTC 1613: Microprocessor failure - RTI 2	629	31
DTC 522: Oil pressure sender low voltage	100	4	DTC 1614: Microprocessor failure - RTI 3	629	31
DTC 520: Oil pressure sender low pressure stage 1	100	18	DTC 1615: Microprocessor failure - A/D	629	31
DTC 127: IAT higher than expected stage 2	105	0	DTC 1616: Microprocessor failure - Interrupt	629	31
DTC 113: IAT voltage high	105	3	DTC 604: Microprocessor failure - RAM	630	12
DTC 112: IAT voltage low	105	4	DTC 336: CRANK input signal noise	636	2
DTC 111: IAT higher than expected stage 1	105	15	DTC 337: Crank signal loss	636	4

DIAGNOSTIC TROUBLE CODE (DTC) CHART – SORTED BY SPN:FMI (2 of 4) (for PSI 4.3L Engine)

Description	DTC Set 2		Description	DTC Set 2	
	SPN-2	FMI-2		SPN-2	FMI-2
DTC 16: Crank and/or cam could not synchronize du	636	8	DTC 1661: PWM6 open / ground short	925	5
DTC 1629: J1939 TSC1 message receipt loss	639	9	DTC 1664: PWM7 short to power	926	3
DTC 1626: CAN-J1939 Tx fault	639	12	DTC 1663: PWM7 open / ground short	926	5
DTC 1627: CAN-J1939 Rx fault	639	12	DTC 643: Sensor supply voltage 1 high	1079	3
DTC 1628: J1939 CAN address / engine-number con	639	13	DTC 642: Sensor supply voltage 1 low	1079	4
DTC 2619: Tach output short to power	645	3	DTC 1611: Sensor supply voltage 1 and 2 out-of-range	1079	31
DTC 2618: Tach output ground short	645	4	DTC 653: Sensor supply voltage 2 high	1080	3
DTC 261: Injector 1 open or short to ground	651	5	DTC 652: Sensor supply voltage 2 low	1080	4
DTC 262: Injector 1 coil shorted	651	6	DTC 238: TIP high voltage	1127	3
DTC 264: Injector 2 open or short to ground	652	5	DTC 237: TIP low voltage	1127	4
DTC 265: Injector 2 coil shorted	652	6	DTC 1131: WGP voltage high	1192	3
DTC 267: Injector 3 open or short to ground	653	5	DTC 1132: WGP voltage low	1192	4
DTC 268: Injector 3 coil shorted	653	6	DTC 1645: MIL control short to power	1213	3
DTC 270: Injector 4 open or short to ground	654	5	DTC 1644: MIL control ground short	1213	4
DTC 271: Injector 4 coil shorted	654	6	DTC 650: MIL open	1213	5
DTC 273: Injector 5 open or short to ground	655	5	DTC 359: Fuel run-out longer than expected	1239	7
DTC 274: Injector 5 coil shorted	655	6	DTC 2300: Spark coil 1 primary open or short to ground	1268	5
DTC 276: Injector 6 open or short to ground	656	5	DTC 2301: Spark coil 1 primary shorted	1268	6
DTC 277: Injector 6 coil shorted	656	6	DTC 2303: Spark coil 2 primary open or short to ground	1269	5
DTC 279: Injector 7 open or short to ground	657	5	DTC 2304: Spark coil 2 primary shorted	1269	6
DTC 280: Injector 7 coil shorted	657	6	DTC 2306: Spark coil 3 primary open or short to ground	1270	5
DTC 282: Injector 8 open or short to ground	658	5	DTC 2307: Spark coil 3 primary shorted	1270	6
DTC 283: Injector 8 coil shorted	658	6	DTC 2309: Spark coil 4 primary open or short to ground	1271	5
DTC 285: Injector 9 open or short to ground	659	5	DTC 2310: Spark coil 4 primary shorted	1271	6

Description	DTC Set 2		Description	DTC Set 2	
	SPN-2	FMI-2		SPN-2	FMI-2
DTC 286: Injector 9 coil shorted	659	6	DTC 2312: Spark coil 5 primary open or short to ground	1272	5
DTC 288: Injector 10 open or short to ground	660	5	DTC 2313: Spark coil 5 primary shorted	1272	6
DTC 289: Injector 10 coil shorted	660	6	DTC 2315: Spark coil 6 primary open or short to ground	1273	5
DTC 1631: PWM1-Gauge1 open / ground short	697	5	DTC 2316: Spark coil 6 primary shorted	1273	6
DTC 1632: PWM1-Gauge1 short to power	697	6	DTC 2318: Spark coil 7 primary open or short to ground	1274	5
DTC 1633: PWM2-Gauge2 open / ground short	698	5	DTC 2319: Spark coil 7 primary shorted	1274	6
DTC 1634: PWM2-Gauge2 short to power	698	6	DTC 2321: Spark coil 8 primary open or short to ground	1275	5
DTC 1635: PWM3-Gauge3 open / ground short	699	5	DTC 2322: Spark coil 8 primary shorted	1275	6
DTC 1636: PWM3-Gauge3 short to power	699	6	DTC 2324: Spark coil 9 primary open or short to ground	1276	5
DTC 1637: PWM4 open / ground short	700	5	DTC 2325: Spark coil 9 primary shorted	1276	6
DTC 1638: PWM4 short to power	700	6	DTC 2327: Spark coil 10 primary open or short to ground	1277	5
DTC 1547: AUX analog Pull-Up/Down 4 high voltage	713	3	DTC 2328: Spark coil 10 primary shorted	1277	6
DTC 1548: AUX analog Pull-Up/Down 4 low voltage	713	4	DTC 617: Start relay coil short to power	1321	3
DTC 341: CAM input signal noise	723	2	DTC 616: Start relay ground short	1321	4
DTC 342: Loss of CAM input signal	723	4	DTC 615: Start relay coil open	1321	5
DTC 134: EGO1 open / lazy	724	10	DTC 1311: Cylinder 1 misfire detected	1323	11
DTC 326: Knock1 excessive or erratic signal	731	2	DTC 301: Cylinder 1 emissions/catalyst damaging misfire	1323	31
DTC 327: Knock1 sensor open or not present	731	4	DTC 1312: Cylinder 2 misfire detected	1324	11
DTC 1643: Buzzer control short to power	920	3	DTC 302: Cylinder 2 emissions/catalyst damaging misfire	1324	31
DTC 1641: Buzzer control ground short	920	4	DTC 1313: Cylinder 3 misfire detected	1325	11
DTC 1642: Buzzer open	920	5	DTC 303: Cylinder 3 emissions/catalyst damaging misfire	1325	31
DTC 1662: PWM6 short to power	925	3	DTC 1314: Cylinder 4 misfire detected	1326	11

DIAGNOSTIC TROUBLE CODE (DTC) CHART – SORTED BY SPN:FMI (3 of 4) (for PSI 4.3L Engine)

Description	DTC Set 2		Description	DTC Set 2	
	SPN-2	FMI-2		SPN-2	FMI-2
DTC 304: Cylinder 4 emissions/catalyst damaging m	1326	31	DTC 175: Adaptive-learn gasoline bank2 low	520201	1
DTC 1315: Cylinder 5 misfire detected	1327	11	DTC 1161: Adaptive-learn LPG high	520202	0
DTC 305: Cylinder 5 emissions/catalyst damaging m	1327	31	DTC 1162: Adaptive-learn LPG low	520202	1
DTC 1316: Cylinder 6 misfire detected	1328	11	DTC 1163: Adaptive-learn NG high	520203	0
DTC 306: Cylinder 6 emissions/catalyst damaging m	1328	31	DTC 1164: Adaptive-learn NG low	520203	1
DTC 1317: Cylinder 7 misfire detected	1329	11	DTC 1155: Closed-loop gasoline bank1 high	520204	0
DTC 307: Cylinder 7 emissions/catalyst damaging m	1329	31	DTC 1156: Closed-loop gasoline bank1 low	520204	1
DTC 1318: Cylinder 8 misfire detected	1330	11	DTC 1157: Closed-loop gasoline bank2 high	520205	0
DTC 308: Cylinder 8 emissions/catalyst damaging m	1330	31	DTC 1158: Closed-loop gasoline bank2 low	520205	1
DTC 628: Fuel-pump high-side open or short to grou	1347	5	DTC 1151: Closed-loop LPG high	520206	0
DTC 629: Fuel-pump high-side short to power	1347	6	DTC 1152: Closed-loop LPG low	520206	1
DTC 629: Fuel pump relay coil short to power	1348	3	DTC 1153: Closed-loop NG high	520207	0
DTC 628: Fuel pump relay control ground short	1348	4	DTC 1154: Closed-loop NG low	520207	1
DTC 627: Fuel pump relay coil open	1348	5	DTC 154: EGO2 open / lazy	520208	10
DTC 1625: J1939 shutdown request	1384	31	DTC 140: EGO3 open / lazy	520209	10
DTC 687: Power relay coil short to power	1485	3	DTC 160: EGO4 open / lazy	520210	10
DTC 686: Power relay ground short	1485	4	DTC 420: Catalyst inactive on gasoline (Bank 1)	520211	10
DTC 685: Power relay coil open	1485	5	DTC 430: Catalyst inactive on gasoline (Bank 2)	520212	10
DTC 234: Boost control overboost failure	1692	0	DTC 1165: Catalyst inactive on LPG	520213	10
DTC 299: Boost control underboost failure	1692	1	DTC 1166: Catalyst inactive on NG	520214	10
DTC 236: TIP active	1692	2	DTC 1515: AUX analog Pull-Down 1 high voltage	520215	3
DTC 1666: PWM8 short to power	2646	3	DTC 1516: AUX analog Pull-Down 1 low voltage	520215	4
DTC 1665: PWM8 open / ground short	2646	5	DTC 1511: AUX analog Pull-Up 1 high voltage	520216	3
DTC 1670: PWM9 short to power	2647	3	DTC 1512: AUX analog Pull-Up 1 low voltage	520216	4
DTC 1669: PWM9 open / ground short	2647	5	DTC 1513: AUX analog Pull-Up 2 high voltage	520217	3

Description	DTC Set 2		Description	DTC Set 2	
	SPN-2	FMI-2		SPN-2	FMI-2
DTC 8906: UEGO return voltage shorted high	3056	3	DTC 1514: AUX analog Pull-Up 2 low voltage	520217	4
DTC 8907: UEGO return voltage shorted low	3056	4	DTC 1517: AUX analog Pull-Up 3 high voltage	520218	3
DTC 8910: UEGO sense cell voltage high	3217	3	DTC 1518: AUX analog Pull-Up 3 low voltage	520218	4
DTC 8911: UEGO sense cell voltage low	3217	4	DTC 1541: AUX analog Pull-Up/Down 1 high voltage	520219	3
DTC 8908: UEGO pump voltage shorted high	3218	3	DTC 1542: AUX analog Pull-Up/Down 1 low voltage	520219	4
DTC 8909: UEGO pump voltage shorted low	3218	4	DTC 1543: AUX analog Pull-Up/Down 2 high voltage	520220	3
DTC 8904: UEGO cal resistor voltage high	3221	3	DTC 1544: AUX analog Pull-Up/Down 2 low voltage	520220	4
DTC 8905: UEGO cal resistor voltage low	3221	4	DTC 1545: AUX analog Pull-Up/Down 3 high voltage	520221	3
DTC 8901: UEGO microprocessor internal fault	3221	31	DTC 1546: AUX analog Pull-Up/Down 3 low voltage	520221	4
DTC 8916: UEGO sense cell impedance high	3222	0	DTC 1551: AUX digital 1 high voltage	520222	3
DTC 8902: UEGO heater supply high voltage	3222	3	DTC 1552: AUX digital 1 low voltage	520222	4
DTC 8903: UEGO heater supply low voltage	3222	4	DTC 1553: AUX digital 2 high voltage	520223	3
DTC 8914: UEGO sense cell slow to warm up	3222	10	DTC 1554: AUX digital 2 low voltage	520223	4
DTC 8917: UEGO pump cell impedance high	3225	0	DTC 1555: AUX digital 3 high voltage	520224	3
DTC 8918: UEGO pump cell impedance low	3225	1	DTC 1555: Water Intrusion Detection	520224	3
DTC 8912: UEGO pump voltage at high drive limit	3225	3	DTC 1556: AUX digital 3 low voltage	520224	4
DTC 8913: UEGO pump voltage at low drive limit	3225	4	DTC 916: Shift actuator feedback out-of-range	520226	3
DTC 8915: UEGO pump cell slow to warm up	3225	10	DTC 919: Shift unable to reach desired gear	520226	7
DTC 171: Adaptive-learn gasoline bank1 high	520200	0	DTC 920: Shift actuator or drive circuit failed	520226	31
DTC 172: Adaptive-learn gasoline bank1 low	520200	1	DTC 1639: PWM5 open / ground short	520230	5
DTC 174: Adaptive-learn gasoline bank2 high	520201	0	DTC 1640: PWM5 short to power	520230	6

DIAGNOSTIC TROUBLE CODE (DTC) CHART – SORTED BY SPN:FMI (4 of 4) (for PSI 4.3L Engine)

Description	DTC Set 2	
	SPN-2	FMI-2
DTC 188: Gaseous fuel temperature sender high voltage	520240	3
DTC 187: Gaseous fuel temperature sender low voltage	520240	4
DTC 331: Knock2 excessive or erratic signal	520241	2
DTC 332: Knock2 sensor open or not present	520241	4
DTC 2120: FPP1 invalid voltage and FPP2 disagrees	520250	31
DTC 2125: FPP2 invalid voltage and FPP1 disagrees	520250	31
DTC 1122: FPP1/2 do not match each other or IVS (520250	31
DTC 223: TPS2 voltage high	520251	3
DTC 222: TPS2 voltage low	520251	4
DTC 509: IAC coil open/short	520252	5
DTC 508: IAC ground short	520252	6
DTC 1171: MegaJector delivery pressure higher than	520260	0
DTC 1172: MegaJector delivery pressure lower than	520260	1
DTC 1174: MegaJector voltage supply high	520260	3
DTC 1175: MegaJector voltage supply low	520260	4
DTC 1176: MegaJector internal actuator fault detection	520260	12
DTC 1177: MegaJector internal circuitry fault detection	520260	12
DTC 1178: MegaJector internal comm fault detection	520260	12
DTC 1173: MegaJector comm lost	520260	31
DTC 1531: Gov1/2/3 interlock failure	520270	31
DTC 1182: Fuel impurity level high	520401	0
DTC 11: Intake cam / distributor position error	520800	7
DTC 24: Exhaust cam position error	520801	7
DTC 1183: MegaJector autozero / lockoff failure	520803	31
DTC 57: EGOH 4 Open / Ground Short	3271	4

DIAGNOSTIC TROUBLE CODE (DTC) CHART (for WG3800 Engine)

Leader/Trailer Code(Sign of the beginning)		111		
Repeat times		3		
KUBOTA WG-LSI MIL Blink Fault Code List		KUBOTA (4G ECU)		
DTC/ Pcode	Setting & Fault	CAN SPN	CAN FMI	MIL Flash Code
(P0) 16	CRANK and/or CAM could not synchronize during start	636	8	216
(P0) 107	MAP Low Voltage	106	4	127
(P0) 108	MAP High Pressure	106	16	128
(P0) 112	IAT Low Voltage	105	4	112
(P0) 113	IAT High Voltage	105	3	113
(P0) 111	IAT Higher than Expected Stage 1	105	15	911
(P0) 127	IAT Higher than Expected Stage 2	105	0	227
(P0) 116	ECT higher than Expected Stage 1	110	15	116
(P0) 117	ECT Low Voltage	110	4	117
(P0) 118	ECT High Voltage	110	3	118
(P0) 121	TPS 1 Lower than TPS 2	51	1	121
(P0) 122	TPS1 Signal Voltage Low	51	4	122
(P0) 123	TPS1 Signal Voltage High	51	3	123
(P0) 134	EGO1 Open/Lazy	3217	5	134
(P0) 1151	Closed-loop High (LPG)	4236	0	151
(P0) 1152	Closed-loop Low (LPG)	4236	1	152
(P0) 154	EGO2 Open/Lazy	3227	5	154
(P0) 1155	Closed-loop bank High (Gasoline)	4236	0	155
(P0) 1156	Closed-loop bank Low (Gasoline)	4236	1	156
(P0) 1165	Catalyst inactive on LPG	3050	11	165
(P0) 171	Adaptive Lean Bank 1 High(Gasoline)	4237	0	171
(P0) 172	Adaptive Lean Bank 1 Low(Gasoline)	4237	1	172
(P0) 182	Gasoline Fuel Temp Low	174	4	182
(P0) 183	Gasoline Fuel Temp High	174	3	183
(P0) 187	LPG Fuel Temp extremely low	3468	1	187
(P0) 217	ECT Higher than Expected Stage 2	110	0	217
(P0) 219	RPM Higher than Max Speed	515	15	219
(P0) 221	TPS 1 Higher than TPS 2	51	0	221
(P0) 222	TPS 2 Signal Voltage Low	3673	4	222
(P0) 223	TPS 2 Signal Voltage High	3673	3	223
(P0) 261	Injector #1 Open/Short to GND	651	5	261
(P0) 262	Injector #1 Short to Power	651	6	262
(P0) 264	Injector #2 Open/Short to GND	652	5	264
(P0) 265	Injector #2 Short to Power	652	6	265
(P0) 267	Injector #3 Open/Short to GND	653	5	267
(P0) 268	Injector #3 Short to Power	653	6	268
(P0) 270	Injector #4 Open/Short to GND	654	5	269
(P0) 271	Injector #4 Short to Power	654	6	271
(P0) 87	Gasoline Fuel Pressure Low	94	1	287
(P0) 88	Gasoline Fuel Pressure High	94	0	288
(P0) 91	Gasoline Fuel Pressure Low Voltage	94	4	291
(P0) 92	Gasoline Fuel Pressure High Voltage	94	3	292
(P0) 326	Knock Signal Excessive or Erratic	731	2	326
(P0) 327	Knock Signal Open or Not Present	731	4	327

Leader/Trailer Code(Sign of the beginning)		111		
Repeat times		3		
KUBOTA WG-LSI MIL Blink Fault Code List		KUBOTA (4G ECU)		
DTC/ Pcode	Setting & Fault	CAN SPN	CAN FMI	MIL Flash Code
(P0) 336	CRANK Signal Noise	636	2	336
(P0) 337	CRANK Signal Loss	636	4	337
(P0) 341	CAM Signal Noise	723	2	341
(P0) 342	CAM Signal Loss	723	4	342
(P0) 359	Fuel run-out longer than expected (LPG or NG)	632	31	359
(P0) 420	Catalyst inactive on Gasoline	3050	11	421
(P0) 524	Oil Pressure Low	100	1	524
(P0) 562	Battery Voltage Low	168	17	562
(P0) 563	Battery Voltage High	168	15	563
(P0) 601	Microprocessor failure - FLASH	628	13	621
(P0) 604	Microprocessor failure - RAM	630	12	624
(P0) 606	Microprocessor failure - COP	629	31	626
(P0) 627	Gasoline fuel pump relay coil open	1348	5	627
(P0) 628	Gasoline fuel pump relay short to ground	1348	4	628
(P0) 629	Gasoline fuel pump relay coil short to Power	1348	3	629
(P0) 628	FPump motor loop open or high-side shorted to ground	1347	5	728
(P0) 629	FPump motor high-side short to power	1347	6	729
(P0) 642	5V External #1 VoltageLow	1079	4	642
(P0) 643	5V External #1 Voltage High	1079	3	643
(P0) 652	5V External #2 Voltage Low	1080	4	652
(P0) 653	5V External #2 Voltage High	1080	3	653
(P0) 686	Power relay short to GND	1485	4	686
(P0) 687	Power relay short to Power	1485	3	687
(P0) 1161	Adaptive-learn High (LPG)	4237	0	161
(P0) 1162	Adaptive-learn Low (LPG)	4237	1	162
(P0) 1171	EPR delivery pressure higher than expected	520260	0	371
(P0) 1172	EPR delivery pressure lower than expected	520260	1	372
(P0) 1173	EPR-ECU communications lost	520260	31	173
(P0) 1174	EPR voltage supply high	520260	3	174
(P0) 1175	EPR voltage supply low	520260	4	175
(P0) 1176	EPR internal actuator fault detected	520260	12	176
(P0) 1177	EPR internal circuitry fault detected	520260	12	177
(P0) 1554	AUX DIGITAL INPUT 2 low	708	4	554
(P0) 1611	5VE1/2 simultaneous out-of-range	1079	31	611
(P0) 1612	Microprocessor failure - RT1 1	629	31	712
(P0) 1613	Microprocessor failure - RT1 2	629	31	713
(P0) 1614	Microprocessor failure - RT1 3	629	31	714
(P0) 1615	Microprocessor failure - A/D	629	31	715
(P0) 1616	Microprocessor failure - Interrupt	629	31	716
(P0) 1674	Hardware ID Failure	1634	2	674
(P0) 2121	FPP1 lower than FPP2	91	18	321
(P0) 2123	FPP1 signal low voltage	91	4	323
(P0) 2122	FPP1 signal high voltage	91	3	322
(P0) 2126	FPP1 higher than FPP2	91	16	426
(P0) 2127	FPP2 signal low voltage	29	4	427
(P0) 2128	FPP2 signal high voltage	29	3	328

Leader/Trailer Code(Sign of the beginning)		111		
Repeat times		3		
KUBOTA WG-LSI MIL Blink Fault Code List		KUBOTA (4G ECU)		
DTC/ Pcode	Setting & Fault	CAN SPN	CAN FMI	MIL Flash Code
(P0) 2300	Ignition coil #1 Open/Short to GND	1268	5	411
(P0) 2301	Ignition coil #1 Short to Power	1268	6	412
(P0) 2303	Ignition coil #2 Open/Short to GND	1269	5	461
(P0) 2304	Ignition coil #2 Short to Power	1269	6	422
(P0) 2306	Ignition coil #3 Open/Short to GND	1270	5	431
(P0) 2307	Ignition coil #3 Short to Power	1270	6	432
(P0) 2309	Ignition coil #4 Open/Short to GND	1271	5	441
(P0) 2310	Ignition coil #4 Short to Power	1271	6	442
(P0) 2112	Unable to reach higher TPS	51	7	312
(P0) 2111	Unable to reach lower TPS	51	7	311
(P0) 2135	TPS1/2 simultaneous voltages out of range	51	31	335
(P0) 1111	Fuel rev limit	515	16	211
(P0) 1112	Spark rev limit	515	0	212
(P0) 129	BP Low Pressure	108	1	129
(P0) 1121	FPP1/2 simultaneous voltages	91	31	521

Lift Truck Operation

Power Shift Transaxle

1. Start the engine. See topic "Starting the Engine."

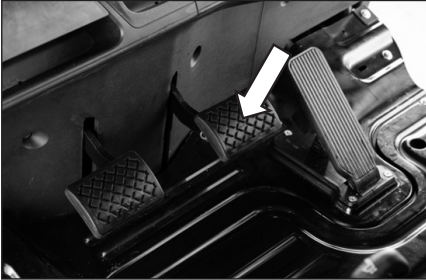

2. Push down on the service brake pedal to hold the lift truck until ready to move it.
3. Release the parking brake.

NOTE: The parking brake must be released before the directional control can be used.

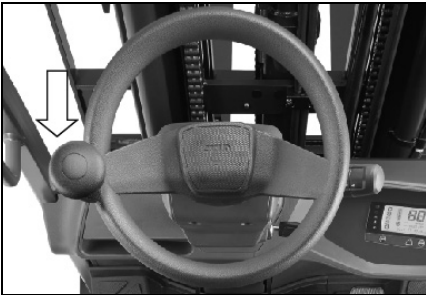

4. Select the direction of travel by pushing the directional lever FORWARD for forward direction or by pulling the lever BACK for reverse direction.

WARNING

A lift truck with the engine running but without an operator can move slowly (creep) if the transmission is engaged.

This could result in personal injury.

Always place the transmission control lever in the NEUTRAL (center) position and apply the parking brake before dismounting the lift truck.

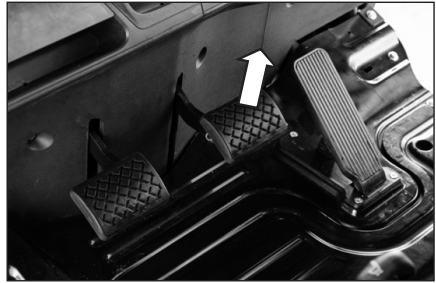

5. Release the service brake.
6. Push down on the accelerator pedal to obtain the desired travel speed. Release the pedal to decrease travel speed.

WARNING

Sudden reversal of a loaded lift truck traveling forward can cause the load to fall or the lift truck to tip.

Stop the loaded lift truck completely, before shifting to reverse.

Failure to comply could result in personal injury.

NOTE: Where conditions permit, directional changes can be made under full power at speeds up to 6 km/h (3.73mph). A speed of 6 km/h (3.73mph) is a fast walk. Directional shift changes at speeds above 6 km/h (3.73mph) are considered abusive.

Bring the lift truck to a complete stop where load stability or other factors prevent safe operation under full power shifts.



7. To change the lift truck direction of travel, release the accelerator pedal.
8. Push down on the service brake pedal to reduce the lift truck speed as necessary.

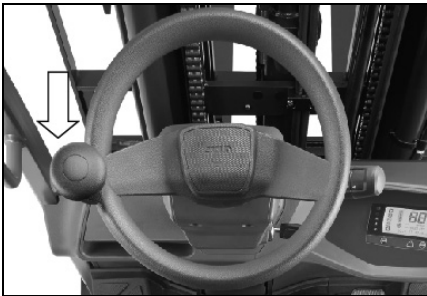

9. Move the directional lever to the desired direction of travel. Slowly push down on the accelerator pedal as the lift truck changes direction.
10. When the direction change is completed, continue to push down on the accelerator pedal to obtain the desired travel speed.



11. To stop the lift truck when traveling in either direction, release the accelerator pedal.
12. Push down on the service brake pedal and bring the lift truck to a smooth stop.

Inching

NOTE: The purpose of the inching pedal is to provide precise lift truck inching control at very slow travel speed and high engine rpm. This is used for fast hydraulic lift, during load approach, pick up or load positioning.



1. To inch (creep) in either direction, slowly push down on the inching pedal. This will start to apply the service brakes and allow the transmission clutch discs to slip.
2. Vary the position of the inching pedal and the accelerator pedal to control the inching speed and distance.
3. Pushing down further on the inching pedal will disengage the transmission completely and apply the service brakes fully to stop and hold the lift truck. This will provide full engine power for fast hydraulic lift.
4. Avoid overuse of the inching pedal as this may cause the automatic transmission oil to overheat or the clutch to slip. Do not use as a footrest or for long periods of time.
5. If user operates continuously pushing work or both brake pedal and accelerator pedal were depressed at the same time, it may cause the automatic transmission oil to overheat or the clutch to slip.

Steering Knob (If Equipped)

There is a steering knob available for inclusion with new truck deliveries. This option is solely intended for slow travel situations when two handed steering is not possible due to hydraulic operations.

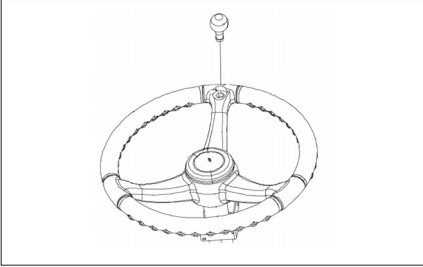

⚠ WARNING

Loss of stability can occur when a lift truck steering wheel is rotated quickly while the truck is in motion. A steering knob will assist with easy rotation of the steering wheel, but if a steering knob is improperly used (e.g., rotating the steering wheel quickly while the truck is in motion), this can contribute to truck instability and a tip over. A steering knob is intended for slow travel maneuverability ONLY.

Mono-Ped Control System (Option)

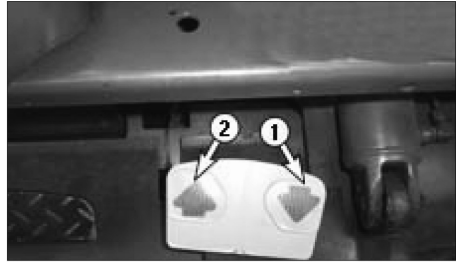

Forward-Push the left side (2) of the pedal for FORWARD direction travel.



Neutral-The lift truck should not move when the Mono-Ped pedal is released.



Reverse-Push the right side (1) of the pedal for REVERSE direction travel.

The MONO-PED pedal controls the speed and direction of the lift truck. Pushing on the right side of the pedal (1) causes the lift truck to move in REVERSE. The optional reverse lights and optional back-up alarm will be ON in the REVERSE position. Pushing on the left side of the pedal (2) causes the lift truck to move in FORWARD.

The speed of the truck increases as the pedal is depressed

Auto Shift Controller ASC - 206 (If Equipped)

Product Description

The Autoshift controller is an electrical control system, specially designed for use on forklift trucks with internal combustion engines.

Its primary purpose is to prevent the operator from operating the truck outside of the design parameters, e.g. selecting the reverse gear when traveling in excess of 6.0 km/h (3.73mph) in a forward direction, and vice versa.

The Autoshift controller is mounted on a convenient position away from excessive heat sources and retrofits into the truck's electrical system. An inductive speed sensor is mounted on the transmission case where it will pick up a pulse from a gear tooth pattern. This pulse is used to monitor the truck in motion and its travel speed. To enable the system to change gears smoothly, the shift points for offset speed are adjustable.

An operator no longer has to change gears with his hands, therefore he can be more productive.

The Autoshift controller prevents strain and abuse to the transmission by changing gears up and down automatically. It also prevents damage to the half shaft, excessive tire wear and heat to the transmission.

Features

1. 2 - speed auto shift control
2. Prevent downshifting at high speed
3. Inhibit selecting direction at high speed outside of the design parameters.



Adjustments

SW1 (Low-High Shift Point)		SW2 (Direction Inhibit Point)	
NOTCH	Vehicle Speed	NOTCH	Vehicle Speed
0	2.5 km/h (1.55 mph)	0	3.3 km/h (2.05 mph)
1	3.0 km/h (1.86 mph)	1	3.6 km/h (2.24 mph)
2	3.5 km/h (2.17 mph)	2	3.9 km/h (2.42 mph)
3	4.0 km/h (2.49 mph)	3	4.2 km/h (2.61 mph)
4	4.5 km/h (2.80 mph)	4	4.5 km/h (2.80 mph)
5	5.0 km/h (3.11 mph)	5	4.8 km/h (2.98 mph)
6	5.5 km/h (3.42 mph)	6	5.1 km/h (3.17 mph)
7	6.0 km/h (3.73 mph)	7	5.4 km/h (3.36 mph)
8	6.5 km/h (4.04 mph)	8	5.7 km/h (3.54 mph)
9	7.0 km/h (4.35 mph)	9	6.0 km/h (3.73 mph)

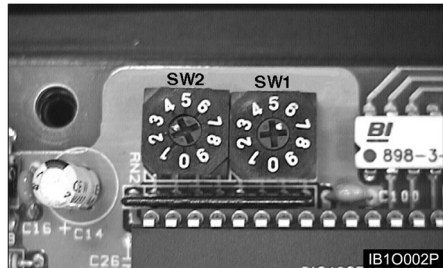

Adjustment Switch

Low-High Shift Point (SW1)

ASC-206 allows you to set the 2 speed Auto Gear Shift Point, the maximum travel speed at which the Auto Shift Controller up-shift or down-shift the transmission automatically according to the vehicle speed. For adjustment of 2 speed Auto Gear Shift speed, the SW1 switch is used on the printed circuit board.

For example if SW1 put to 5th notch, the 2 Speed Auto Gear Shift speed will be 5.0 km/h(3.11 mph), which is factory setting value as a default.

Direction Inhibit Point (SW2)

Auto Shift allows you to set the Direction Inhibit Speed, the maximum travel speed at which the transmission can be reversed. For adjustment of direction inhibit speed, the SW2 switch is used on the printed circuit board.

For example SW2 is put to 7th notch, the Direction Inhibit Speed will be 5.4 km/h (3.36 mph), which is factory setting value as a default.

Diagnostics Features

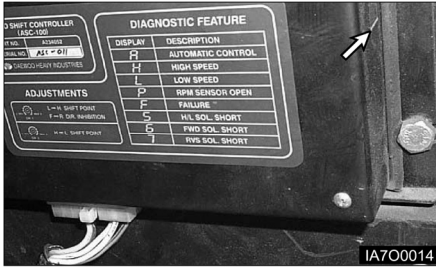

ASC-206 has internal indicator on the right side of the controller for displaying the selected gear and the abnormal condition.

⚠ WARNING

Do not diagnose or repair Auto Shift Controller Faults unless trained and authorized to do so. Improper performance of maintenance procedures is dangerous and could result in personal injury or death.

Below is a description applicable for many ASC-500 implementations.

Display for Operator

Display	Description	Remark
A	Automatic operation	
H	High speed	At 2nd shift gear
L	Low speed	At 1st shift gear
P	T/M Speed sensor open	Flashing
E	E/G Speed sensor open	Flashing
F	Controller fault	Flashing
5	FWD 2 Sol. Short or REV 2 Sol. Short	Flashing
6	FWD 1 Sol. Short	Flashing
7	REV 1 Sol. Short	Flashing

This information is given during normal operating when something special happens.

For example, on ASC-500's with the speed sensor, one of the indicators is used to indicate a sensor problem.

Display for Troubleshooting

Display	Description	Remark
A	Automatic operation	
2	High speed s/w input	Lever input test
3	Forward s/w input	Lever input test
4	Reverse s/w input	Lever input test

This information is input for signal diagnostics.

This test is used to verify operation of direction control lever.

Operation

This system can be basically operated in two preselected modes, automatic mode and manual mode. Automatic Mode is selected in factory-setting controller as a default.

Manual Mode (Fail-Safe Mode) is selected to operate the truck manually in case of emergency.

Automatic mode

Direction Inhibit

1. Start the engine with the direction control lever in NEUTRAL and the parking brake engaged.
2. Press down on the service brake pedal, disengage the parking brake and move the direction control lever to FORWARD.

NOTE: Release the parking brake before using the directional control lever.

3. Observe the LED on the Auto Shift Controller. The LED should indicate "A" while the direction control lever is in FORWARD, NEUTRAL and REVERSE. Report Auto Shift as faulty if the LED indicates anything other than "A".
4. Keep the service brake pushed down until ready to move the truck.
5. To change directions of a traveling lift truck when the Auto Shift Controller LED displays "A", shift the direction control lever to the opposite direction and wait for the lift truck to change direction.
6. If however, your travel speed is higher than the pre-selected direction change speed as direction inhibit point in the controller, Auto Shift will shift the transmission to NEUTRAL until the lift truck's travel speed slows to the pre-selected direction change speed, and then shift the transmission to the direction selected.
7. You should be prepared to help slow the lift truck to the pre-selected direction change speed by pressing down on the service brake pedal.

⚠ WARNING

When you want to change the travel direction, you must press down on the service brake pedal to reduce the travel speed. Be cautious that the lift truck's stopping distance may be longer than in manual mode because the lift truck continues to travel forward regardless of the selection of reverse with the direction control lever until the vehicle speed is sufficiently reduced.

- The direction of travel will change automatically when the vehicle speed is reduced as much as the pre-selected speed in the controller.

⚠ WARNING

Bring the loaded lift truck to a complete stop before changing travel direction. Changing travel direction while traveling may cause the lift truck to lose the load or tip over.

- When the direction change is completed, continue to push down on the accelerator pedal to obtain the desired travel speed.

NOTICE

The transmission of your lift truck may be reversed under full power up to a travel of 6.0 km/h (3.73 mph). But the Inhibit Speed of Auto Shift is set by the factory at 5.4 km/h (3.36 mph) because reversing the transmission at lower travel speeds prolongs the life of the transmission, axle shafts and tires.

Two-Speed Auto Shift Control

While traveling forward with the high speed gear, that is, 2nd gear selected, the ASC-206 can up-shift or down-shift the transmission automatically according to the vehicle speed by its own speed ratio control so that the appropriate gear may be engaged in every situation.

NOTICE

Two-Speed Auto Shift Control function can be accomplished only when the direction control lever is placed in the high speed (2nd gear) position.

Manual Mode (Fail-Safe mode)

In case that the controller is broken down or you don't want to use the functions of the Auto Shift Controller, you can select Manual Mode. In Manual Mode, you can operate your lift truck in the same manner as any lift truck without Auto Shift Controller. You can select the Manual mode or the Automatic mode by doing following procedures.

⚠ WARNING

In the manual mode, direction inhibition function can not be operated normally. The sudden reversal of a loaded lift truck traveling forward can cause the load to fall or the lift truck to tip over.

An operator can operate the truck manually by selecting the Manual mode with the Fail-Safe mode switches on the PCB (Printed Circuit Board).

With the switch (1) in "MANUAL" position, direction inhibit function is disable.

If an operator moves the switch (2) from "AUTO" position to "MANUAL" position, then 2-speed auto shift function will become disabled.

Move the switches as indicated, up of Automatic (AUTO) operation or down for Manual (MANUAL) operation.

NOTE: In the factory-setting controller, AUTO mode is selected as a default on the PCB (Printed Circuit Board) as shown below.

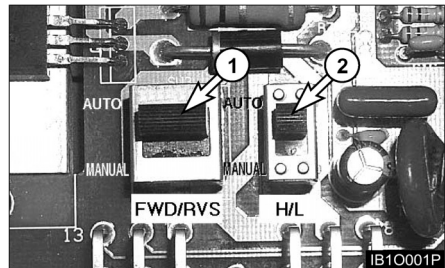

Fail-Safe mode

NOTE: After operating the truck manually by selecting the Manual Mode switch on PCB(Printed Circuit Board), the position of mode must be checked before operating the truck automatically.

Operating Techniques

Inching into Loads

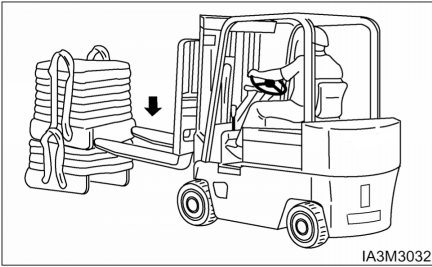

Typical Example

1. Move the lift truck slowly **FORWARD** into position and engage the load. The lift truck should be square with load, forks spaced evenly between pallet stringers and as far apart as load permits.

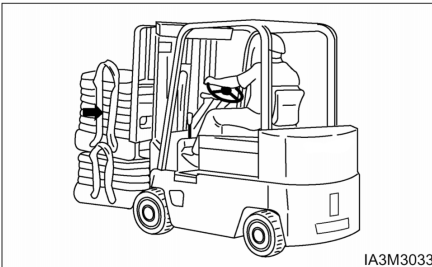

Typical Example

2. Move the lift truck **FORWARD** until the load touches the carriage.

Lifting the Load

1. Lift the load carefully and tilt the mast back a short distance.

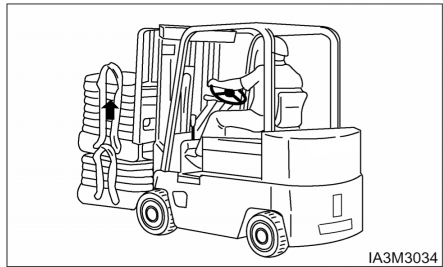

Typical Example

2. Tilt the mast further back to cradle the load.

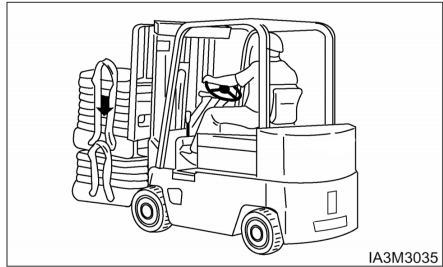

Typical Example

3. Operate the lift truck in reverse until the load is clear of the other material.
4. Lower the cradled load to the travel position.

NOTE: Lift and tilt speeds are controlled by engine rpm.

Traveling With the Load

NOTICE

Travel with the load as low as possible, while still maintaining ground clearance.

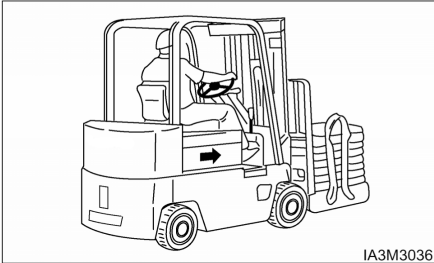

Typical Example

1. Travel with the load uphill on upgrades and downgrades.

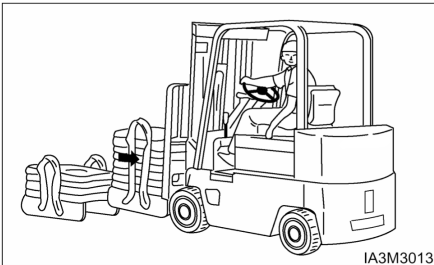

Typical Example

2. For better vision, travel in reverse with bulky loads.

Unloading

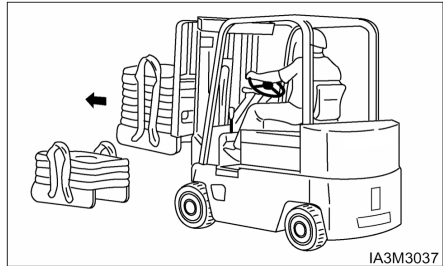

Typical Example

1. Move the lift truck into the unloading position.

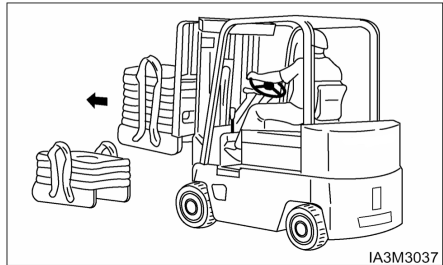

Typical Example

2. Tilt the mast FORWARD only when directly over the unloading area.

WARNING

Do not tilt the mast forward with the load unless directly over the unloading area, even if the power is off.

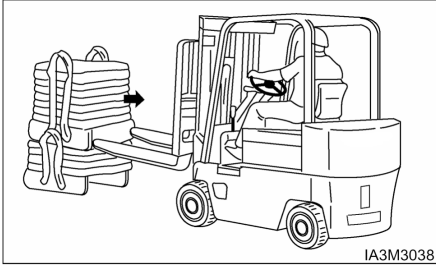

Typical Example

3. Deposit the load and BACK away carefully to disengage the forks.

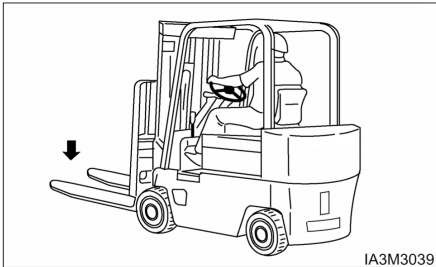

Typical Example

4. Lower the carriage and forks to the travel position or to the park position.

Turning

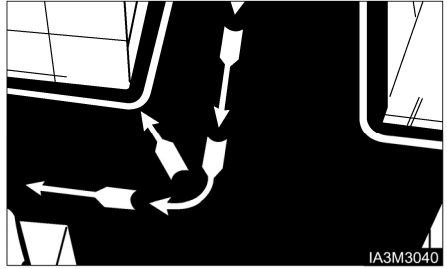

IA3M3040

1. When turning sharp corners, keep close to the inside corner. Begin the turn when the inside drive wheel meets the corner.

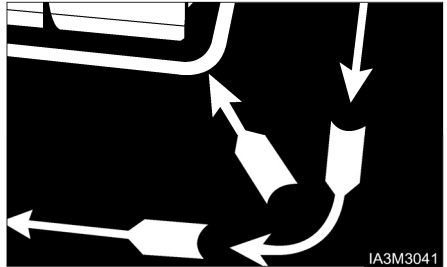

IA3M3041

2. In narrow aisles, keep away from the stockpile when turning into the aisle. Allow for counterweight swing.

Lifting Drums or Round Objects

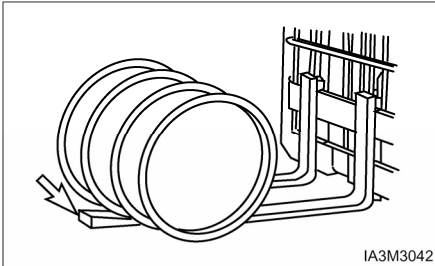

1. Block drums or round objects. Tilt the mast **FORWARD** and slide the fork tips along the floor
2. to get under the load.

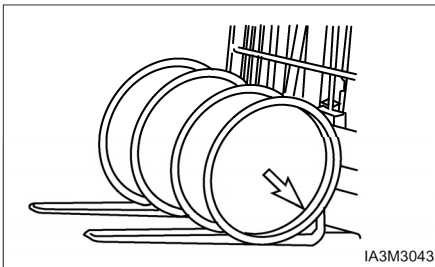

3. Before lifting, tilt the mast **BACK** slightly until the load is cradled on the forks.

Operating in hot weather

Keep the following points in mind when you operate the lift truck in hot weather.

1. Check the radiator. Clogging can cause overheating. Clean them out regularly with a blast of compressed air, also, check for leakage of water.
2. Check the fan belt tension and adjust to proper tension.
3. Even if the engine overheats and the coolant boils over, let the engine idle for a while with opening engine hood until temperature falls before shutting off the engine.

Safety instructions for attachments when transporting suspended loads

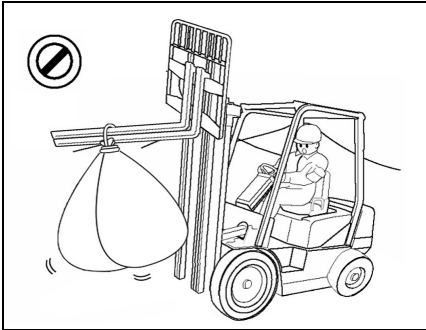

WARNING

Swinging/wide loads and a reduced residual capacity can result in accidents

Adapt the travel speed to the load, less than walking pace.

Secure swinging loads for example with lifting slings.

Reduce the residual capacity and have it certified by an expert.

Failure to follow the operation precautions may cause early damage to parts.

Safety instructions for attachments when transporting wide loads

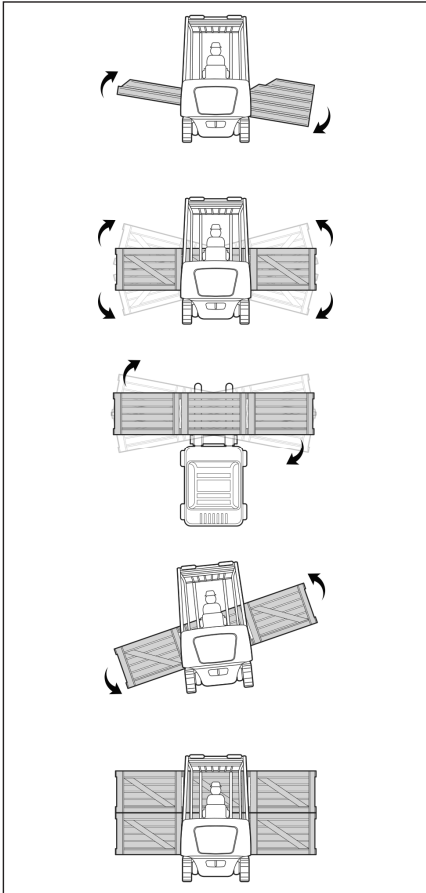

Load lateral center of gravity

Where it is necessary to lift a wide load where the lateral load center of gravity is unknown.

Do a test lift first to determine lateral center of gravity and potential movement with the load during transport. Exercise extra caution when handling offcenter loads that cannot be centered.

Load Stability

Be careful when stopping or changing direction suddenly, lifting or lowering suddenly as wide loads could become unstable.

Load Swing

Be careful whilst travelling or turning, the load ends will swing wide. Make sure you have adequate clearance, and watch out for people in the area.

Load Shift

Be careful when turning, turn slowly to prevent load from shifting.

Visibility

When carrying a bulky load which blocks or restricts forward visibility the truck shall be driven with the load trailing and if necessary under the direction of a person who has visibility in the direction of travel, unless safe work practices allow otherwise.

Parking the Lift Truck

Park the lift truck level, with the forks lowered and the mast tilted forward until the fork tips touch the floor. Block the drive wheels when parking on an incline.

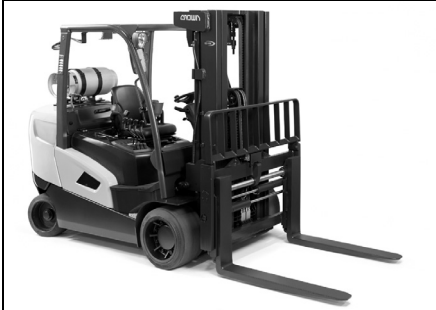

1. Park in an authorized area only. Do not block traffic. If LP equipped, do not park near elevator shafts or any other area where LP could collect in a pocket (low area), causing a potentially dangerous condition.



2. Place the transmission controls in NEUTRAL.
3. Engage the parking brake.
4. Lower the forks to the ground.

WARNING

Blocking the wheels will prevent unexpected lift truck movement, which could cause personal injury.

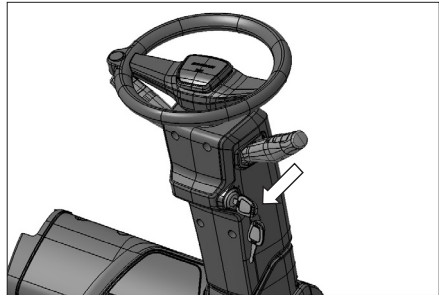

5. Turn the key in the ignition switch to the OFF position and remove the key.
6. Turn the disconnect switch to OFF (if equipped). Do operate the disconnecting switch after 30 seconds from start key-off.

Otherwise Engine Control Unit (ECU) can be damaged.
7. Actuate each loading lever several times to remove the residual pressure in the respective cylinders and hoses.

If Parking Brake Alarm Equipped

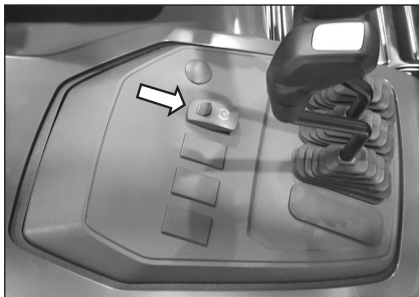

WARNING

**When leaving machine apply parking brake!
Parking brake is not automatically applied.
Alarm will sound if parking brake is not applied.**

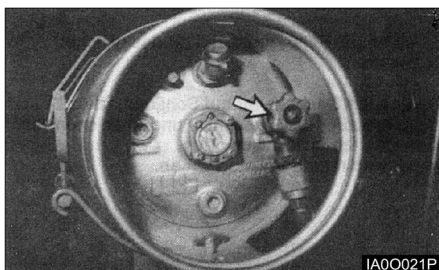

NOTE: If a LP equipped lift truck is stopped or parked for an indefinite or prolonged period of time, close the fuel shutoff valve on the LP tank. Run the engine until fuel in the line runs out and the engine stops. Turn off the ignition switch and disconnect switch (if equipped).

8. Actuate each loading lever several times to remove the residual pressure in the respective cylinders and hoses.
9. Block the drive wheels if parking on an incline.

Lift Fork Adjustment

WARNING

When adjusting the fork spread, be careful not to pinch your hand between forks and the carriage slot.

Hook - on type Fork

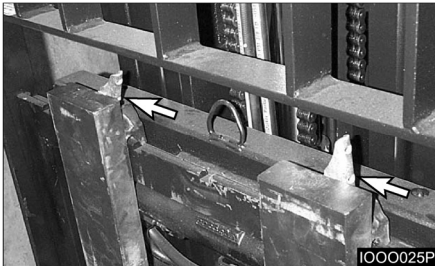

1. Move up the hook pin to the free position.
2. Raise the hook pin in each fork to side the fork on the carriage bar.
3. Adjust the forks in the position most appropriate for the load and as wide as possible for load stability.
4. When adjusting the forks, make sure that the weight of the load is centered on the truck.
5. After adjustment, set the fork locks to keep the forks in place.

WARNING

Make sure the forks are locked before carrying a load.

If the fork/locking pin is not fully engaged, the fork could become unintentionally disengaged.

Storage Information

Before Storage

Before storing your lift truck, clean and inspect as the following procedures.

- Wipe away grease, oil, etc. adhering to the body of the truck with waste cloth, and use water, if needed.
- While cleaning the truck, check general condition of the truck. Especially check the truck body for dents or damage and tires for wear or nails or stones in the tread.
- Fill the fuel tank with fuel specified.
- Check for leakage of hydraulic oil, engine oil, fuel, or coolant, etc.
- Apply grease, where needed.
- Check for looseness of nuts and bolts, especially hub nuts.
- Check mast rollers to see that they rotate smoothly.
- Prime the oil into the lift cylinders by actuating the lift lever all the way several times.
- Drain off coolant completely in cold weather, if antifreeze is not used.

Long Time Storage

Perform the following service and checks in addition to the "Parking the lift truck" services.

- Taking the rainy season into consideration, park the machine at a higher and hard ground.
- Avoid parking on soft grounds such as asphalt ground in summer.
- Dismount the battery from the machine. Even though the machine is parked indoors, if the place is hot or humid, the battery should be kept in a dry, cool place. Charge the battery once a month.
- Apply antirust to the exposed parts which tend to rust.
- Cover components such as the breather and air cleaner which may be caught with humidity.
- The machine should be operated at least once a week. Fill the cooling system, if cooling water is discharged, and mount the battery. Start the engine and warm up thoroughly. Move the machine a little forwards and backwards. Operate the hydraulic controls several times.

To Operate the Lift Truck After a Long Time Storage

- Remove covers and antirust from each of the components and exposed parts.
- Drain the engine crankcase, transmission (clutch type machine), differential and final reduction gear, clean the inside of them and add new oil.
- Drain off foreign matter and water from the hydraulic oil tank and fuel tank.
- Remove the head cover from the engine cylinder. Oil valves and rocker shaft and check each valve for proper operation.
- Add cooling water to the specified level.
- Charge the battery and mount it on the machine. Connect the cables.
- Perform pre-operational checks carefully. (refer to "Before Starting the Engine")
- Warm up the machine.

Transportation Hints

Lift Truck Shipping

Check travel route for overpass clearances. Make sure there is adequate clearance if the lift truck being transported is equipped with a high mast, overhead guard or cab.

To prevent the lift truck from slipping while loading, or shifting in transit, remove ice, snow or other slippery material from the loading dock and the truck bed before loading.

NOTICE

Obey all state and local laws governing the height, weight, width and length of a load. Observe all regulations governing wide loads.

NOTICE

Remove ice, snow or other slippery material from the shipping vehicle and the loading dock.

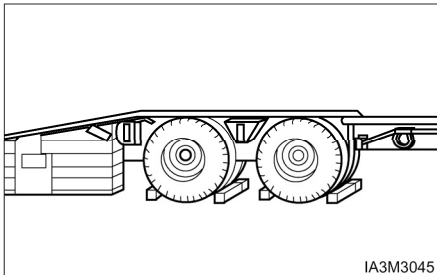

Always block the trailer or the rail car wheels before loading the lift truck.

Position the lift truck on the truck bed or the rail car.

Apply the parking brake and place the transmission control in NEUTRAL.

Turn the ignition switch to the OFF position and remove the key. If LP equipped, shut off the LP fuel tank.

Block the wheels and secure the lift truck with tiedowns.

Machine Lifting and Tiedown Information

NOTICE

Improper lifting or tiedowns can allow load to shift and cause injury and/or damage.

1. Weight and instructions given herein apply to lift trucks as manufactured by CROWN.
2. Use proper rated cables and slings for lifting. Position the crane for level lift truck lift.
3. Spreader bar widths should be sufficient to prevent contact with the lift truck.
4. Use the tiedown locations provided for lift truck tiedown.

Check the state and local laws governing weight, width and length of a load.

Contact your CROWN Lift Truck branch for shipping instructions for your lift truck.

Lifting a Forklift using a Crane

⚠ WARNING

1. If lifting rope breaks, serious injury/damage may occur.
2. The lifting wire rope and stay must be long enough to avoid contact with the forklift. Short rope/stay can damage the vehicle. If it's too long, it may cause interference.
3. If sling and LP tank contact happens during refloatation operation, you should get rid of tank of vehicle with LP tank first, and then proceed.
4. Cover the rope/chain with rubber or cloth to prevent damage to the vehicle, as necessary.
5. Rope/chain and other lifting tools must have sufficient strength, and free of any defect or wear.
6. Avoid impact load to the lifting devices/tools.

1. Check the weight, length, width and height of the vehicle before lifting.
2. Park the crane at an appropriate position.
3. Connect the rope/chain to the points A and B of the figure below.
4. If the wire rope/chain contacts the vehicle, insert a rubber plate between the rope/chain and the vehicle to protect the vehicle.

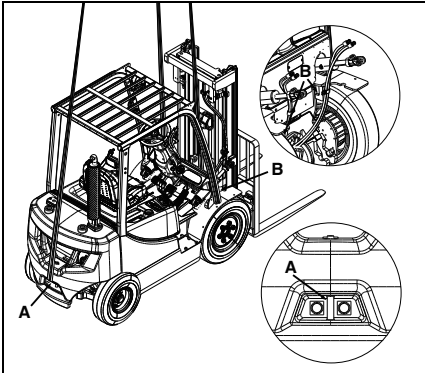

5. Lift up the vehicle slowly.

How to Fix Forklift to a Carrier

1. The rope/chain must have sufficient length for fixing.
2. Park the vehicle on a level ground.
3. Set the mast vertically. Lower the fork or attachment to the lowest position.
4. Set all the operating devices to Neutral Position. Turn OFF the start switch.
5. Apply the parking brake. Stop the tires with blocks (C).
6. Connect towing hooks to the mast top B (if without mast, front drive axle fix frame or front fender bottom fixing hole D) and rear tow pin A, as shown in the figure below.

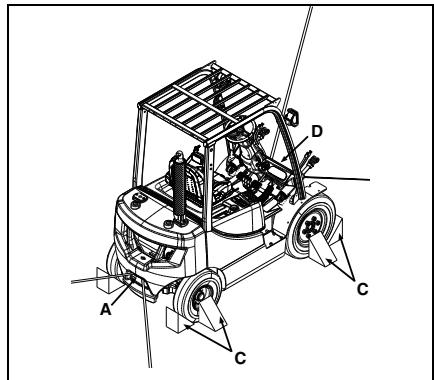
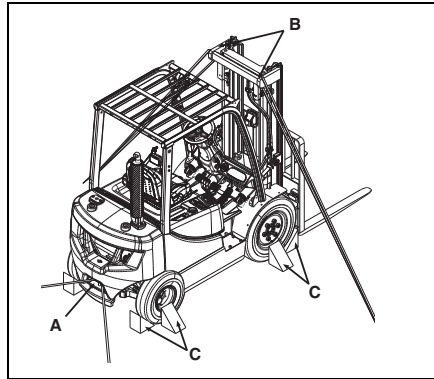

Towing Information

WARNING

Personal injury or death could result when towing a disabled lift truck incorrectly.

Block the lift truck wheels to prevent movement before releasing the brakes. The lift truck can roll free if it is not blocked.

Follow the recommendations below, to properly perform the towing procedure.

These towing instructions are for moving a disabled lift truck a short distance, at low speed, no faster than 2 km/h (1.2 mph), to a convenient location for repair. These instructions are for emergencies only. Always haul the lift truck if long distance moving is required.

Shield must be provided on the towing lift truck to protect the operator if the tow line or bar should break.

Do not allow riders on the lift truck being towed unless the operator can control the steering and/or braking.

Before towing, make sure the tow line or bar is in good condition and has enough strength for the towing situation involved. Use a towing line or bar with a strength of at least 1.5 times the gross weight of the towing lift truck for a disabled lift truck stuck in the mud or when towing on a grade.

Keep the tow line angle to a minimum. Do not exceed a 30° angle from the straight ahead position. Connect the tow line as low as possible on the lift truck that is being towed.

Quick lift truck movement could overload the tow line or bar and cause it to break. Gradual and smooth lift truck movement will work better.

Normally, the towing lift truck should be as large as the disabled lift truck. Satisfy yourself that the towing lift truck has enough brake capacity, weight and power, to control both lift trucks for the grade and the distance involved.

To provide sufficient control and braking when moving a disabled lift truck downhill, a larger towing lift truck or additional lift trucks connected to the rear could be required. This will prevent uncontrolled rolling.

The different situation requirements cannot be given as minimal towing lift truck capacity is required on smooth level surfaces to maximum on inclines or poor surface conditions.

Consult your CROWN Lift Truck branch for towing a disabled lift truck.

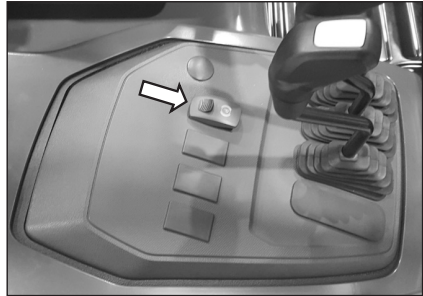

1. Release the parking brake.

NOTICE

Release the parking brake to prevent excessive wear and damage to the parking brake system.

2. Check that the service brake pedal is released.
3. Key switch is in the OFF position.
4. Direction control lever is in neutral.
5. Fasten the tow bar to the lift truck.
6. Remove the wheel blocks. Tow the lift truck slowly. Do not tow any faster than 2 km/h (1.2 mph).

WARNING

Be sure all necessary repairs and adjustments have been made before a lift truck that has been towed to a service area is put back into operation.

Electronic Parking Brake

NOTICE

In the case of the electronic parking brake, it always stays engaged when the ignition is off, regardless of where the parking switch is positioned. Before towing the vehicle, therefore, you have to release the parking brake by force to prevent excessive wear and damage on the park brake components or tires.

How to Release by Force

1. Secure the wheels with blocks.
2. Secure the emergency-release spool (2) and remove the emergency-release nut (1).

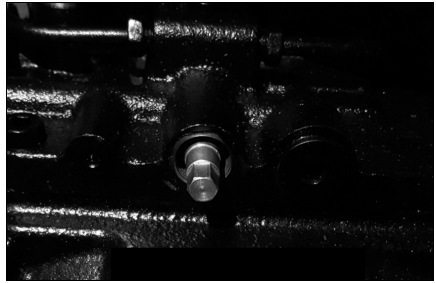
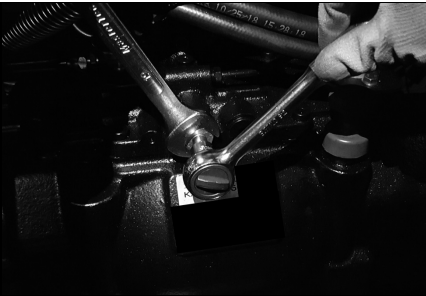
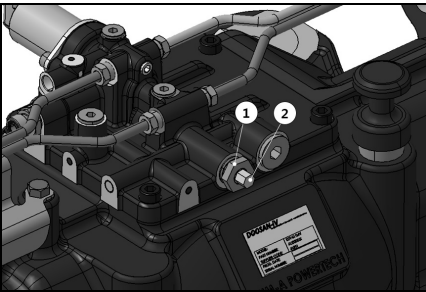

3. Fully tighten the emergency-release spool (2).

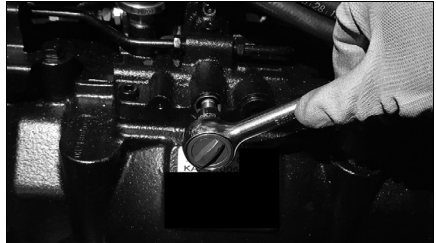

4. Tighten the emergency-release nut (1).

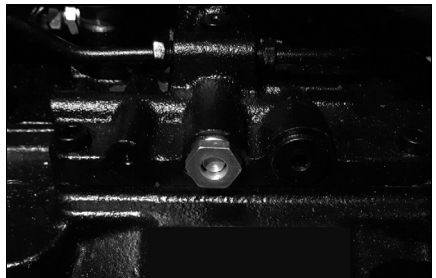

5. Press the brake pedal at least ten times until the pressure builds up high enough.

(If you depress the pedal too deeply, the pedal may get caught; press the pedal by approximately 80% of its full distance, and in case that the pedal is caught, take it out and continue pedal depression.)

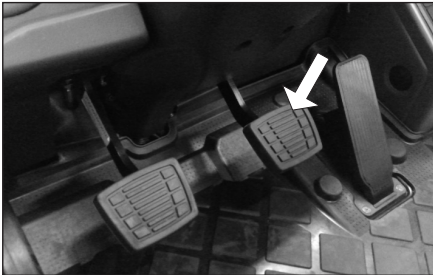

6. Connect a tow bar to the forklift.
7. Take out the supporting blocks and tow the forklift slowly. Keep the towing speed no higher than 2 km/h.
(If the wheels remain secured, repeat step 4.)

⚠ WARNING

Be sure all necessary repairs and adjustments have been made before a lift truck that has been towed to a service area is put back into operation.

NOTE: On the completion of towing the forklift, you must return the emergency-release spool to its original position; otherwise, both the service and parking brakes do not work.

How to Return the Emergency-Release Spool

1. Secure the wheels with blocks.
2. Remove the emergency-release nut (1).



3. Loosen the emergency-release spool (2) until the starting point of its thread is aligned with the inlet surface indicated by the arrow.



Operation Section

4. Secure the emergency-release spool (2) and tighten the emergency-release nut (1).

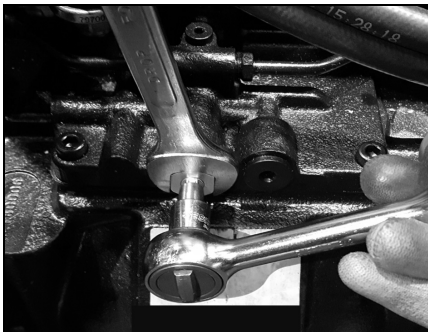

5. Press the pedal a number of times until the pressure builds up high enough.



6. After starting up the forklift, take out its supporting blocks and check that the service brake works normally during travel and the parking brake secures the forklift when on a slope.
7. If you need to press the pedal too deeply, perform air removal.

Jacking Information

WARNING

Jacking up Truck can be dangerous and should be done only by trained personnel using proper tools and procedures.

Block the lift truck wheels to prevent movement while lifting the wheels. The lift truck can roll free if it is not blocked.

Follow the recommendations below, to properly perform the jacking procedure.

NOTICE

Move Trucks to a Secure Non Traffic Maintenance Area with a Level Floor. No Load on Forks.
Remove key from ignition switch.

Hydraulic Jack & Jack Stand Capacity

Hydraulic Jack Capacity

	Model	Height Minimum*	Minimum Requirement	
1 ton class	CGC15/18S-5, CGC15/18S-5, CGC20SC-5	100mm	2000Kg	4400lbs
	CD15/18S-5, CD20SC-5, CG15/18S-5, CG20SC-5	150mm		
2 ton class	CD20/25/ 30/33S-5/7, CD35C-5/7, CG20/25/30E-5, CG20/25 /30/33P-5/7, CG35C-5/7	150mm	3000Kg	6600lbs
	CGC20/25/30/33E-5, CGC20/25/30/33P-5	120mm		
4 ton class	CD35/40/45S-5/7, CD50/55C-5/7, CD40/45/50/ 55SC-5/7, CG35/40/45S-5/7, CG50/55C-5/7, CG40/45/50/ 55SC-5/7 CGC35/45S-9(BCS) CGC55C-9 (BCS)	180mm	3900Kg	8600lbs
6 ton class	CD50/60/70S-5/7, CG50/60/70S-5/7	250mm	5800Kg	12800lbs
8 ton class	CD80/90S-5/7	250mm	7500Kg	16500lbs
11 ton class	CD110/130/160S-5	300mm	10000 Kg	22050lbs
18/20 ton class	CDV180/200S-7	350 mm	14000 Kg	30900lbs
25 ton class	CDV250S-7	400 mm	19000 Kg	42000lbs

- The height of lift truck with a flat tyre is lower than with an inflated tyre. So Height Minimum of Jack must be less than the value of the above chart.

Stand Capacity should be more than the minimum requirement of Hydraulic Jack Capacity. Hydraulic Jack & Jack Stand are commercially available and should be especially designed for forklift trucks.

Jacking Procedure

Steering Wheel

1. Raise Forks 3 to 6 in (76 to 152 mm) from Floor.
2. Place Wheel Chocks under Both Drive Wheels.
3. Locate Hydraulic Jack under Steering Axle as Shown in Figure A.
4. Jack Up Truck with Hydraulic Jack.
5. Set Jack Stand Height as Required Not to Exceed 16 in (405 mm).

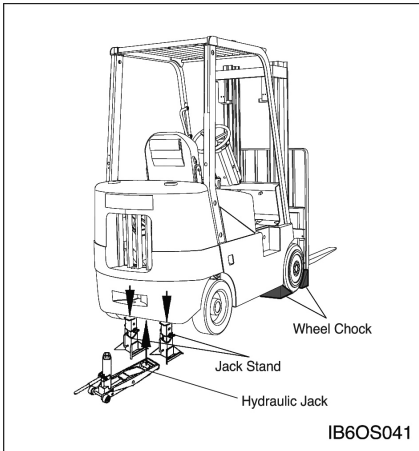

Figure A

Side

1. Lower Forks Completely.
2. Locate Hydraulic Jack under Frame as Shown in Figure B.
3. Jack Up One Side of Truck.
4. Place Hard Wood Block directly under First Stage Mast.
 - 1ton/2ton class - Use 6X6 in (150X150 mm) Block
 - 3ton/5ton class - Use 8X8 in (200X200 mm) Block
 - 11ton class - Use 12X12 in (300X300 mm) Block
5. Jack Up Opposite Side of Truck.
6. Place Second Hard Wood Block under Other Side of First Stage Mast.

7. Do Not Tilt Mast after Blocked.

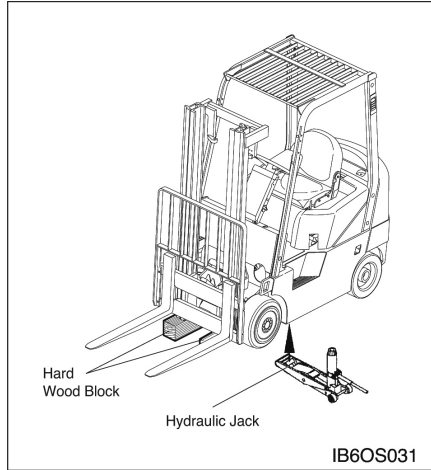

Figure B

- The height of lift truck with a flat tyre is lower than with an inflated tyre. So Height Minimum of Jack must be less than the value of the above chart.

Stand Capacity should be more than the minimum requirement of Hydraulic Jack Capacity. Hydraulic Jack & Jack Stand are commercially available and should be especially designed for forklift trucks.

WARNING

Locate Hydraulic Jack under Frame. Do NOT locate on side panel. Do NOT raise side of truck any more than required to insert hard wood block.

WARNING

Locate Hydraulic Jack and Jack Stands under steer axle. Do NOT locate Hydraulic Jack or Jack Stands on Counter Weight.

Inspection, Maintenance and Repair of Lift Truck Forks

The following section gives practical guidelines for inspection, maintenance and repair of lift truck forks. It also provides general information on the design and application of forks and the common cause of fork failures.

Lift truck forks can be dangerously weakened by improper repair or modification. They can also be damaged by the cumulative effects of age, abrasion, corrosion, overloading and misuse.

A fork failure during use can cause damage to the equipment and the load. A fork failure can also cause serious injury.

A good fork inspection and maintenance program along with the proper application can be very effective in preventing sudden failures on the job.

Repairs and modifications should be done only by the fork manufacturer or a qualified technician who knows the material used and the required welding and heat treatment process.

Users should evaluate the economics of returning the forks to the manufacturer for repairs or purchasing new forks. This will vary depending on many factors including the size and type of fork.

Forks should be properly sized to the weight and length of the loads, and to the size of the machine on which they are used. The general practice is to use a fork size such that the combined rated capacity of the number of forks used is equal to or greater than the "Standard(or rated) Capacity" of the lift truck.

The individual load rating, in most cases, will be stamped on the fork in a readily visible area. This is generally on the top or side of the fork shank.

- A fork rated at 1500 pounds at 24 inch load center will be stamped 1500X24.
- A fork rated at 2000 kg at 600 mm load center will be stamped 2000X600.

The manufacturer identification and year and date of manufacture is also usually shown.

Some countries have standards or regulations which apply specifically to the inspection and repair of forks.

Users may also refer to the International Organization For Standardization - ISO Technical Report 5057 - Inspection and Repair of Fork Arms and ISO Standard 2330 - Fork Arms-Technical Characteristics and Testing.

While there are no specific standards or regulations in the United States, users should be familiar with the requirements for inspection and maintenance of lift trucks as provided by the 29 Code Federal Register 1910.178 Powered Industrial Truck, and ANSI/ASME Safety Standard(s) B56.1 as applicable to the type of machine(s) in use.

Environment Protection

When servicing this lift truck, use an authorized servicing area and an approved container to collect coolant, oil, fuel, grease, electrolyte and any other potential environmental pollutant before any lines, fittings or related items are disconnected or removed. After servicing, dispose of those materials in an authorized place and container. When cleaning the lift truck, be sure to use an authorized area.

Causes of Fork Failure

Improper Modification or Repair

Fork failure can occur as a result of a field modification involving welding, flame cutting or other similar processes which affect the heat treatment and reduces the strength of the fork.

In most cases, specific processes and techniques are also required to achieve proper welding of the particular alloy steels involved. Critical areas most likely to be affected by improper processing are the heel section, the mounting components and the fork tip.

Bent or Twisted Forks

Forks can be bent out of shape by extreme overloading, glancing blows against walls or other solid objects or using the fork tip as a pry bar.

Bent or twisted forks are much more likely to break and cause damage or injury. They should be removed from service immediately.

Fatigue

Parts which are subjected to repeated or fluctuating loads can fail after a large number of loading cycles even though the maximum stress was below the static strength of the part.

The first sign of a fatigue failure is usually a crack which starts in an area of high stress concentration. This is usually in the heel section or on the fork mounting.

As the crack progresses under repetitive load cycling, the load bearing cross section of the remaining metal is decreased in size until it becomes insufficient to support the load and complete failure occurs.

Fatigue failure is the most common mode of fork failure. It is also one which can be anticipated and prevented by recognizing the conditions which lead up to the failure and by removing the fork service prior to failing.

- **Repetitive Overloading**

Repetitive cycling of loads which exceeds the fatigue strength of the material can lead to fatigue failure. The overload could be caused by loads in excess of the rated fork capacity and by use of the forks tips as pry bars. Also, by handling loads in a manner which causes the fork tips to spread and the forks to twist laterally about their mountings.

- **Wear**

Forks are constantly subjected to abrasion as they slide on floors and loads. The thickness of the fork blade is gradually reduced to the point where it may not be capable of handling the load for which it was designed.

- **Stress Risers**

Scratches, nicks and corrosion are points of high stress concentration where cracks can develop. These cracks can progress under repetitive loading in a typical mode of fatigue failure.

Overloading

Extreme overloading can cause permanent bending or immediate failure of the forks. Using forks of less capacity than the load or lift truck when lifting loads and using forks in a manner for which they were not designed are some common causes of overloading.

Fork Inspection



Establish a daily and 12 month inspection routine by keeping a record for the forks on each lift truck.

Initial information should include the machine serial number on each the forks are used, the fork manufacturer, type, original section size, original length and capacity. Also list any special characteristics specified in the fork design.

Record the date and results of each inspection, making sure the following information is included.

- Actual wear conditions, such as percent of original blade thickness remaining.
- Any damage, failure or deformation which might impair the use of the truck.
- Note any repairs or maintenance.

An ongoing record of this information will help in identifying proper inspection intervals for each operation, in identifying and solving problem areas and in anticipating time for replacement of the forks.

First Installation

1. Inspect forks to ensure they are the correct size for the truck on which they will be used. Make sure they are the correct length and type for the loads to be handled.

If the forks have been previously used, perform the "12 Month Inspection".

If the forks are rusted, see "Maintenance and Repair".

2. Make sure fork blades are level to each other within acceptable tolerances. See "Forks, Step 4," in the "2000 Service Hours or Yearly" in "Maintenance Intervals"
3. Make sure positioning lock is in place and working. Lock forks in position before using truck. See "Forks, Step 7" in the "2000 Service Hours or Yearly" in "Maintenance Intervals".

Daily Inspection

1. Visually inspect forks for cracks, especially in the heel section, around the mounting brackets, and all weld areas. Inspect for broken or jagged fork tips, bent or twisted blades and shanks.
2. Make sure positioning lock is in place and working. Lock the forks in position before using the truck. See "2000 Service Hours or Yearly" in "Maintenance Intervals".
3. Remove all defective forks from service.

12 Months Inspection

Forks should be inspected, at a minimum, every 12 months. If the truck is being used in a multi-shift or heavy duty operation, they should be checked every six months. See "Forks" in the "2000 Service Hours or Yearly" in "Maintenance Intervals."

Consult the fork manufacturer for further information as may be applicable to the specific fork involved.

Testing is not required for repairs to the positioning lock or the markings.

Maintenance and Repair

1. Repair forks only in accordance with the manufacturer's recommendations.

Most repairs or modifications should be done only by the original manufacturer of the forks or an expert knowledgeable of the materials, design, welding and heat treatment process.

2. The following repairs or modifications SHOULD NOT be attempted.

- Flame cutting holes or cutouts in fork blades.
- Welding on brackets or new mounting hangers.
- Repairing cracks or other damage by welding.
- Bending or resetting.

3. The following repairs MAY be performed.

- Forks may be sanded or lightly ground, to remove rust, corrosion or minor defects from the surfaces.
- Heel sections may be ground with a carbon stone to remove minor surface cracks or defects. Polish the inside radius of the heel section to increase the fatigue life of the fork. Always grind or polish in the direction of the blade and shank length.
- Repair or replace the positioning locks on hook type forks.
- Repair or replace most fork retention devices used with other fork types.

4. A fork should be load tested before being returned to service on completion of repairs authorized and done in accordance with the manufacturer's recommendations.

Most manufacturers and standards require the repaired fork to be tested with a load 2.5 times the specified capacity and at the load center marked on the fork arm.

With the fork restrained in the same manner as its mounting on the lift truck, apply the test load twice, gradually and without shock. Maintain the test for 30 seconds each time.

Check the fork arm before and after the second application of the test load. It shall not show any permanent deformation.

Torque Specifications

Metric Hardware

Most of the nuts, bolts, studs, and threaded holes in your lift truck are metric. In this manual we provide specifications in both metric and U.S. customary measurement. Always replace metric hardware with metric hardware. See the parts books for proper replacement.

NOTE: For proper fit, use only metric tools on metric hardware. Non-metric tools might slip and cause injury.

Torque for Standard Hose Clamps – Worm Drive

NOTICE

The chart below gives the torques for initial installation of hose clamps on new hose and for reassembly or retightening of hose clamps on existing hose.

Clamp Width	Initial Installation Torque On New Hose	
	N·m ¹	lb·in
16 mm (.625 in)	7.5 ± 0.5	65 ± 5
13.5 mm (.531 in)	4.5 ± 0.5	40 ± 5
8 mm (.312 in)	0.9 ± 0.2	8 ± 2
Clamp Width	Reassembly Or Retightening Torque	
	N·m ¹	lb·in
16 mm (.625 in)	4.5 ± 0.5	40 ± 5
13.5 mm (.531 in)	3.0 ± 0.5	25 ± 5
8 mm (.312 in)	0.7 ± 0.2	6 ± 2

¹ 1 Newton meter (N·m) is approximately the same as 0.1 kg·m.

Torque for Standard Bolts, Nuts, and Taperlock Studs

NOTICE

The two charts below give general torques for bolts, nuts, and taperlock studs of SAE Grade 5 or better quality.

Torques for Bolts and Nuts With Standard Threads

Thread Size Inch	Standard Nut and Bolt Torque	
	N·m ¹	lb·ft
1/4	12 ± 4	9 ± 3
5/16	25 ± 7	18 ± 5
3/8	45 ± 7	33 ± 5
7/16	70 ± 15	50 ± 11
1/2	100 ± 15	75 ± 11
9/16	150 ± 20	110 ± 15
5/8	200 ± 25	150 ± 18
3/4	360 ± 50	270 ± 37
7/8	570 ± 80	420 ± 60
1	875 ± 100	640 ± 75
1 1/8	1100 ± 150	820 ± 110
1 1/4	1350 ± 175	1000 ± 130
1 3/8	1600 ± 200	1180 ± 150
1 1/2	2000 ± 275	1480 ± 200

¹ 1 Newton meter (N·m) is approximately the same as 0.1 kg·m.

Torques for Taperlock Studs

Thread Size Inch	Standard Taperlock Stud Torque	
	N·m ¹	lb·ft
1/4	8 ± 3	6 ± 2
5/16	17 ± 5	13 ± 4
3/8	35 ± 5	26 ± 4
7/16	45 ± 10	33 ± 7
1/2	65 ± 10	48 ± 7
5/8	110 ± 20	80 ± 15
3/4	170 ± 30	125 ± 22
7/8	260 ± 40	190 ± 30
1	400 ± 60	300 ± 45
1 1/8	500 ± 700	370 ± 50
1 1/4	650 ± 80	480 ± 60
1 3/8	750 ± 90	550 ± 65
1 1/2	870 ± 100	640 ± 75

¹ 1 Newton meter (N·m) is approximately the same as 0.1 kg·m.

Torque for Metric Fasteners

NOTICE

Be very careful never to mix metric with U.S. customary (standard) fasteners. Mismatched or incorrect fasteners will cause lift truck damage or malfunction and may even result in personal injury.

Original fasteners removed from the lift truck should be checked for any damages and kept for reassembly whenever possible. If new fasteners are needed, they must be of the same size and grade as the ones that are being replaced.

The material strength identification is usually shown on the bolt head by numbers (8.8, 10.9, etc.). This chart gives standard torques for bolts and nuts with Grade 8.8.

For mounting torques of main parts, Please refer to Service manual for detail.

NOTE: Metric hardware must be replaced with metric hardware. Check parts book.

Metric ISO² Tread

Thread Size Metric	Standard Torque	
	N·m ¹	lb·ft
M6	12 ± 4	9 ± 3
M8	25 ± 7	18 ± 5
M10	55 ± 10	41 ± 7
M12	95 ± 15	70 ± 11
M14	150 ± 20	110 ± 15
M16	220 ± 30	160 ± 22
M20	450 ± 70	330 ± 50
M24	775 ± 100	570 ± 75
M30	1600 ± 200	1180 ± 150
M36	2700 ± 400	2000 ± 300

¹ 1 Newton meter (N·m) is approximately the same as 0.1 kg·m.

² ISO - International Standards Organization.

Cooling System Specifications

Coolant Information

NOTE: The following information is generic and valid for lift trucks.

Engine operating temperatures have increased to improve engine efficiency. This means proper cooling system maintenance is especially important. Overheating, overcooling, pitting, cavitation erosion, cracked heads, piston seizures, and plugged radiators are classic cooling system failures. In fact, coolant is as important as the quality of fuel and lubricating oil.

Filling at over 20 liters (5 U.S. gallons) per minute can cause air pockets in the cooling system.

After draining and refilling the cooling system, operate the engine with the radiator cap removed until the coolant reaches normal operating temperature and the coolant level stabilizes. Add coolant as necessary to fill the system to the proper level.

Never operate without a thermostat in the cooling system. Cooling system problems can arise without a thermostat.

NOTICE

CROWN recommends that the coolant mixture contain 50% commercially available automotive antifreeze, and 50% water.

The coolant mix with concentration of antifreeze smaller than 30% does not provide sufficient corrosion protection. Concentrations over 60% adversely affect freeze protection and heat transfer rates.

Never add coolant to an overheated engine, engine damage can result. Allow the engine to cool first.

If the machine is to be stored in, or shipped to, an area with freezing temperatures, the cooling system must be protected to the lowest expected outside (ambient) temperature.

The engine cooling system is normally protected to -28°C (-20°F) with antifreeze, when shipped from the factory unless special requirements are defined.

Check the specific gravity of the coolant solution frequently in cold weather to ensure adequate protection.

Clean the cooling system if it is contaminated, the engine overheats or foaming is observed in the radiator.

Old coolant should be drained, the system cleaned and new coolant added every 2000 service hours or yearly.

Refer to topic, "Cooling System - Clean, Change" in Every 2000 Service Hours or Yearly section.

Coolant Water

Hard water, or water with high levels of calcium and magnesium ions, encourages the formation of insoluble chemical compounds by combining with cooling system additives such as silicates and phosphates.

The tendency of silicates and phosphates to precipitate out-of-solution increases with increasing water hardness. Hard water, or water with high levels of calcium and magnesium ions encourages the formation of insoluble chemicals, especially after a number of heating and cooling cycles.

CROWN prefers the use of distilled water or deionized water to reduce the potential and severity of chemical insolubility.

Acceptable Water	
Water Content	Limits (PPM)
Chlorides (Cl)	50 maximum
Sulfates (SO ₄)	50 maximum
Total hardness	80mg/l
Total solids	250 maximum
PH	6.0 to 8.0

ppm = parts per million

Using water that meets the minimum acceptable water requirement may not prevent drop-out of these chemical compounds totally, but should minimize the rate to acceptable levels.

Antifreeze

NOTICE

CROWN recommends using automotive antifreeze suitable for gasoline engines having aluminum alloy parts. Antifreeze of poor quality will cause corrosion of the cooling system, and thus always use automotive antifreeze prepared by a reliable maker, and never use it mixed with antifreeze of different brand.

CROWN recommends that the coolant mix contain 50% commercially available automotive antifreeze, or equivalent and acceptable water to maintain and adequate water pump cavitation temperature for efficient water pump performance.

Premix coolant solution to provide protection to the lowest expected outside (ambient) temperature. Pure undiluted antifreeze will freeze at -23°C (-10°F).

Use a greater concentration (above 50%) of commercially available automotive antifreeze only as needed for anticipated outside (ambient) temperatures. Do not exceed the recommendations, provided with the commercially available automotive antifreezes, regarding the coolant mixture of antifreeze to water.

Make proper antifreeze additions.

Adding pure antifreeze as a makeup solution for cooling system top-up is an unacceptable practice. It increases the concentration of antifreeze in the cooling system which increase the concentration of dissolved solids and undissolved chemical inhibitors in the cooling system. Add antifreeze mixed with water to the same freeze protection as your cooling system.

Use the chart below to assist in determining the concentration of antifreeze to use.

Antifreeze Concentrations	
Protection Temperature	Concentration
Protection to -15°C (5°F)	30% antifreeze and 70% water
Protection to -23°C (-10°F)	40% antifreeze and 60% water
Protection to -37°C (-34°F)	50% antifreeze and 50% water
Protection to -51°C (-60°F)	60% antifreeze and 40% water

Fuel Specifications

General Fuel Information

Use only fuel as recommended in this section.

NOTICE

Fill the fuel tank at the end of each day of operation to drive out moisture laden air and to prevent condensation. Maintain a constant level near the top of the day tank to avoid drawing moisture into the tank as the level decreases. Do not fill the tank to the top. Fuel expands as it gets warm and can overflow.

Do not fill the fuel filters with fuel before installing them. Contaminated fuel will cause accelerated wear to the fuel system parts.

Drain the water and sediment from main fuel storage tank before it is refilled. This will help prevent water and/or sediment from being pumped from the fuel storage tank into the engine fuel tank.

LP Specifications

LP is "Liquefied Petroleum Gas". The exact composition of LP varies slightly between different parts of the country and different refineries.

HD5 is recommended for CROWN forklift trucks. Remember LP is heavier than air and will sink to the lowest spot possible. Avoid areas near floor drains or lubrication pits where escaped fuel may collect.

Composition of HD5	
Propane (C ₃ H ₈)	90.0 %
Propylene	up to 5 %
Butane (C ₄ H ₁₀)	2.0 %
iso-Butane	1.5 %
Methane (CH ₄)	1.5 %
Total	100 %

Diesel Fuel Specifications

Diesel fuel should comply with the following specifications. The table lists several worldwide specifications for diesel fuels

Diesel Fuel Specification	Location
ASTM D975 No.1D/2D	USA
EN590:96	EU
ISO 8217 DMX	International
BS 2869-A1 or A2	United Kingdom
JIS K2204 Grade No. 2	Japan
KSM-2610	Korea
GB252	China

Additional Technical Fuel Requirements

- The fuel cetane number should be equal to 45 or higher.
- The sulfur content must not exceed 0.5% by volume. Less than 0.05% is preferred.
- For electronically controlled engines, for example 4TNV98-ZSDF, it is mandatory to use fuel that does not contain 0.1 % or more sulfur content.
- In general, using a high sulfur fuel may possible result in corrosion inside the cylinder.
- Especially in U.S.A. and Canada, Low Sulfur (300-500mg/kg sulfur content) or Ultra Low Sulfur fuel should be used.
- Bio-Diesel fuels. See Bio-Diesel Fuels on next page.
- NEVER mix kerosene, used engine oil, or residual fuels with the diesel fuel.
- The water and sediment in the fuel should not exceed 0.05% by volume.
- Keep the fuel tank and fuel-handling equipment clean at all times.
- Poor quality fuel can reduce engine performance and / or cause engine damage.
- Fuel additives are not recommended. Some fuel additives may cause poor engine performance.

- Consult your CROWN representative for more information.
- The ash content must not exceed 0.01% by volume.
- The carbon residue content must not exceed 0.35% by volume. Less than 0.1 % is preferred.
- The total aromatics content should not exceed 35% by volume. Less than 30% is preferred.
- The PAH (polycyclic aromatic hydrocarbons) content should be below 10% by volume.
- The metal content of Na, Mg, Si, and Al should be equal to or lower than 1 mass ppm.
- Lubricity: The wear mark of WS1.4 should be Max. 0.01 8 in (460 pm) at HFRR test.

Bio-Diesel Fuels

In Europe and in the United States, as well as some other countries, non-mineral oil based fuel resources such as RME (Rapeseed Methyl Ester) and SOME (Soybean Methyl Ester), collectively known as FAME (Fatty Acid Methyl Esters), are being used as extenders for mineral oil derived diesel fuels.

CROWN approves the use of bio-diesel fuels that do not exceed a blend of 5% (by volume) of FAME with 95% (by volume) of approved mineral oil derived diesel fuel. Such bio-diesel fuels are known in the marketplace as B5 diesel fuels.

These 95 diesel fuels must meet certain requirements.

1. The bio-fuels must meet the minimum specifications for the country in which they are used.
 - In Europe, bio-diesel fuels must comply with the European Standard EN14214.
 - In the United States, bio-diesel fuels must comply with the American Standard ASTM D-6751.
2. Bio-fuels should be purchased only from recognized and authorized diesel fuel suppliers.

Precautions and concerns regarding the use of bio-fuels:

1. Free methanol in FAME may result in corrosion of aluminum and zinc FIE components.
2. Free water in FAME may result in plugging of fuel filters and increased bacterial growth.
3. High viscosity at low temperatures may result in fuel delivery problems, injection pump seizures, and poor injection nozzle spray atomization.
4. FAME may have adverse effects on some elastomers (seal materials) and may result in fuel leakage and dilution of the engine lubricating oil.
5. Even bio-diesel fuels that comply with a suitable standard as delivered, will require additional care and attention to maintain the quality of the fuel in the equipment or other fuel tanks. It is important to maintain a supply of clean, fresh fuel. Regular flushing of the fuel system, and / or fuel storage containers, may be necessary.
6. The use of bio-diesel fuels that do not comply with the standards as agreed to by the diesel engine manufacturers and the diesel fuel injection equipment manufacturers, or biodiesel fuels that have degraded as per the precautions and concerns above, may affect the warranty coverage of your engine.

Lubricant Specifications

Lubricant Information

Certain abbreviations follow Society of Automotive Engineers (SAE) J754 nomenclature and some classifications follow SAE J183 abbreviations.

The MIL specifications are U.S.A. Military Specifications.

The recommended oil viscosities can be found in the Lubricant Viscosities chart in this publication.

Grease is classified by the National Lubricating Grease Institute (NLGI) based on ASTM D217-68 Worked Penetration characteristics which are given a defined consistency number.

Engine Oil (DEO and EO)

The following oil specifications provide guidelines for the selection of commercial products :

- Gasoline/LP Engine : API SJ or higher

NOTE: Engine Oil Service hours can be extended to 500 hours by using CROWN supplied specific oil. Please consult CROWN branch about it.

NOTICE

Failure to follow the oil recommendations can cause shortened engine life due to carbon deposits or excessive wear.

Consult the EMA Lubricating Oils Data Book for a listing of oil brands.

NOTE: The percentage of sulfur in the fuel will affect the engine oil recommendations. For fuel sulfur effects, the Infrared Analysis or the ASTM D2896 procedure can be used to evaluate the residual neutralization properties of an engine oil. The sulfur products formation depends on the fuel sulfur content, oil formulation, crankcase blowby, engine operating conditions and ambient temperature.

Hydraulic Oil (HYDO)

The following commercial classifications can be used in the hydraulic system.

- ISO 6743/4 HM
- AFNOR NFE 48-603 HM
- DIN 51524 TEIL 2 H-LP
- HAGGLUNDS DENISON HFO-HF2
- CINCINNATI P68,69,70

Viscosity : ISO VG 32

Industrial premium hydraulic oils that have passed the Vickers vane pump test (35VQ25). These oils should have antiwear, antifoam, antirust and antioxidation additives for heavy duty use as stated by the oil supplier. ISO viscosity grade of 32 would normally be selected.

NOTICE

Make-up oil added to the hydraulic tanks must mix with the oil already in the systems. Use only petroleum products unless the systems are equipped for use with special products. If the hydraulic oil becomes cloudy, water or air is entering the system. Water or air in the system will cause pump failure. Drain the fluid, retighten all hydraulic suction line clamps, purge and refill the system. Consult your CROWN Lift Truck branch for purging instructions.

Transmission & Drive axle Oil

NOTICE

This oil is formulated for transmissions and drive trains only, and should not be used in engines. Shortened engine life will result.

NOTE: Multi-grade oils are not blended by CROWN for use in transmissions. Multi-grade oils which use high molecular weight polymers as viscosity index improvers lose their viscosity effectiveness by permanent and temporary shear of the viscosity index improver and therefore, are not recommended for transmission and drive train compartments.

NOTE: Failure to follow this recommendation can cause shortened transmission life due to material incompatibility, inadequate frictional requirements for disk materials and/or excessive gear wear.

Select the oil that meets the following specification.

- **GM DEXRON III**

Brake Fluid

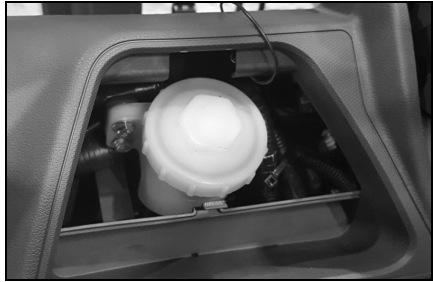

Oil Cooled Disc Brake Only

Use heavy duty hydraulic brake fluid certified by oil supplier to meet the latest version of following classifications.

- ISO 6743/4 HM
- AFNOR NFE 48-603 HM
- DIN 51524 TEIL 2 H-LP
- HAGGLUNDS DENISON HFO-HF2
- CINCINNATI P68,69,70

Viscosity : ISO VG32

Brake reservoir oils that have passed the Vickers vane pump test (35VQ25). These oils should have antiwear, antifoam, antirust and antioxidation additives for heavy duty use as stated by the oil supplier. ISO viscosity grade of 32 would normally be selected.

The following products are authorized for use.

Supplier	Product Name
TOTAL	AZOLLAZS
SHELL	TELLUS
MOBIL	DTE20S'
CALTEX	RANDO HD
ESS	NOTO H
CASTROL	HYSPIN AWS

Lubricating Grease (MPGM)

Use Multipurpose Molybdenum Grease (MPGM) for all lubrication points. If MPGM grease can not be used, a multipurpose type grease which contains 3% to 5% molybdenum disulfide can be used.

NLGI No.2 grade is suitable for most temperatures. Use NLGI No.1 or No.0 grade for extremely low temperature.

Lubricant Viscosities and Refill Capacities

Lubricant Viscosities

Lubricant Viscosities for Ambient (Outside) Temperatures					
Compartment or System	Oil Viscosities	°C		°F	
		Min	Max	Min	Max
Engine Crankcase (LP) and Lift Chains API SJ	SAE 5W30	-30	+30	-22	+86
	SAE 10W30	-20	+30	-4	+86
	SAE 5W40	-30	+40	-22	+104
	SAE 10W40	-20	+40	-4	+104
	SAE 15W40	-10	+40	+14	+104
	SAE 15W50	-10	+50	+14	+122
SAE 20W50	-5	+50	+23	+122	
Power Shift Transmission & Drive axle DEXRON III	DEXRON III	-20	+50	-4	+122
Hydraulic and Power Steering System ISO 6743/4 HM	ISO VG32	-20	+30	-4	+86
	ISO VG46	-10	+40	+14	+104
	ISO VG68	0	+50	+32	+122
Brake Reservoir (Only for OCDB) ISO 6743/4HM	ISO VG32	-20	+30	-4	+86
	ISO VG46	-10	+40	+14	+104
	ISO VG68	0	+50	+32	+122

The SAE grade number indicates the viscosity of oil. A proper SAE grade number should be selected according to ambient temperature.

Refill Capacities

Refill Capacities-(Approximate)			
Compartment or System		Liters	U.S. Gal.
Engine Crankcase w/Filter LP	PSI 4.3L	4.3	1.1
	WG3800	12.2	3.22
Cooling System w/Coolant Reservoir tank	PSI 4.3L	19.0	5.0
	WG3800	19.0	5.0
Power Shift Transmission + Drive axle		23.0	6.1
Hydraulic & Power Steering System		73.0	19.3
Drive Axle	Disc Brake (OCDB)	14.0	3.7
Brake Reservoir (Only for OCDB)		0.6	0.16

Maintenance Intervals

NOTICE

Never exceed the Maintenance Intervals specified in the manual. Defects and/or damage to the important functional components may be resulted in.

NOTICE

All maintenance and repair, except Every 10 Service Hours or Daily, on the lift truck must be performed by qualified and authorized personnel only.

NOTICE

Careless disposal of waste oil can harm the environment and can be dangerous to persons. Always dispose of waste oil to authorized personnel only.

When Required

Air Intake System - Check, Clean	140
Test Fuel System for Leaks (LP Engine Only)	142
Seat, Hood Latch & Support Cylinder - Check, Lubricate.....	143
Fuses, Bulbs & Circuit Breaker - Change, Reset.	143
Circuit Breaker	145
Tires and Wheels - Check, Inspect	146
Carriage Roller Extrusion - Check, Adjust	147
Battery Terminal - Clean, Inspect.....	147

Every 10 Service Hours or Daily

Inspect Engine for Fluid Leaks	148
Engine Oil Level - Check	148
Coolant Level - Check, Clean	148
Air Cleaner Indicator - Check	149
Inspect Acceleration Pedal Operation.....	149
Inspect Engine for Exhaust Leaks.....	149
Walk - Around Inspection - Inspect	150
Mast Channels – Lubricate	151
Brake Oil Level - Check	151
Transmission & Drive axle Oil Level - Check	151
Hydraulic Oil Level – Check.....	152

First 50 - 100 Service Hours or a Week

Engine Oil – Change (WG3800 Engine only)	153
Belts - Check, Adjust (WG3800 only)	154
Transmission & Drive axle Oil, Oil Filter - Change	155
Parking Brake - Inspect	156
Spark Plug - Cleaning (WG3800 only)	157

Every 250 Service Hours or Monthly

Engine Oil & Filter – Change.....	158
-----------------------------------	-----

Every 500 Service Hours or 3 Months

Air Intake System – Change.....	159
Engine Oil & Filter Change (WG3800 Engine).....	159
Belts - Change (WG3800 Engine)	160
Tilt Cylinders - Check, Adjust, Lubricate	161
Mast Hinge Pins – Lubricate	162
Crosshead Rollers - Inspect	162
Carriage Side Rollers Thrust (If Equipped) - Lubricate	162
Carriage Sideshifter (If Equipped) – Lubricate.....	163
Parking Brake - Test, Adjust.....	163
Mast, Carriage, Lift Chains, & Attachments - Check, Lubricate	163
Carriage Side Rollers - Lubricate.....	164
Circulation Pump Belt (OCDB & LP Engine Only. If Equipped) - Check, Adjust.....	164
Horn & Lights (If Equipped) – Check	164
Inspect Electrical System	165
Overhead Guard – Inspect	165
Steer Suspension - Inspect	165
Steering Mechanism - Check, Lubricate	166
Wheel Bolts and Nuts – Inspect.....	166

Every 1000 Service Hours or 6 Months

Inspect Coolant Hoses (LP Engines Only)	167
LP Regulator/Converter Inspection.....	167
Fuel Lines & Fittings - Check	167
Inspect Mixer Assembly.....	167
Inspect Throttle Assembly	167
Hydraulic Return Filter - Change	168
Lift Chains - Test, Check, Adjust.....	168
Universal Joint - Inspect	170
Drive axle – Inspect	171
PCV Valve - Check (WG3800 Engine).....	171

Every 1500 Service Hours or 9 Months

Inspect Ignition System (PSI 4X only).....	172
Replace Spark Plugs (PSI 4X only)	172
Replace LP Fuel Filter Element.....	173
Fuel Filter (LP Engine Only)	173
Testing Fuel Lock-off Operation	174
Replace Oil Separator (WG3800 Engine only)	174
Valve Clearance - Check (WG3800 Engine only)	175

Every 2000 Service Hours or Yearly

Steer Wheel Bearings -Reassemble	176
Cooling System - Clean, Change	177
Transmission & Drive axle Oil, Oil Filter - Change	178
Replace Spark plug (WG3800 Engine only).....	179
Fork – Inspect	180

Every 2500 Service Hours or 15 Months

Hydraulic Oil - Check, Clean, Change	182
Inspect Battery System	182
Checking the TMAP Sensor (PSI 4X only)	183
Inspect for Intake Leaks	183
Replace PCV Valve and breather element - Change (PSI 4X only)	183
Replace Oxygen Sensor (PSI 4X only).....	184

Every 3000 Service Hours or 36 Months

DEF/Ad-Blue Supply module filter replacement (D34P Engine Only)	185
Replace of LPG Fuel hose and clamp bands (WG3800 Engine).....	185
Replace of coolant hose of vaporizer (WG3800 Engine)	185
Check of LPG vaporizer (WG3800 Engine).....	186
Replace of lockoff valve filter (WG3800 Engine)..	186

Environment Protection

Environment Protection.....	187
-----------------------------	-----

Maintenance Section

Quick Reference to Maintenance Schedule			FIRST	EVERY								
ITEMS	SERVICES	PAGE	When Required	50-100 Service Hours or a Week	10 Service Hours or Daily	250 Service Hours or Monthly	500 Service Hours or 3 Months	1000 Service Hours or 6 Months	1500 Service Hours or 9 Months	2000 Service Hours or Yearly	2500 Service Hours or 15 Months	Every 3000 Service Hours or 36 Months
Air Cleaner Indicator	Check	149			O							
Air Intake System	Check, Clean	140	O									
Air Intake System	Change	159					O					
Battery Terminal	Clean, Inspect	147	O									
Belts (WG3800 only)	Check, Adjust	154		O								
Belts (WG3800 Engine)	Change	160					O					
Brake Oil Level	Check	151			O							
Carriage Roller Extrusion	Check, Adjust	147	O									
Carriage Side Rollers	Lubricate	164					O					
Carriage Side Rollers Thrust (If Equipped)	Lubricate	162					O					
Carriage Sideshifter (If Equipped)	Lubricate	163					O					
Check of LPG vaporizer (WG3800 Engine)		186										O
Checking the TMAP Sensor (PSI 4X only)		183									O	
Circuit Breaker		145	O									
Circulation Pump Belt (OCDB & LP Engine Only, If Equipped)	Check, Adjust	164					O					
Coolant Level	Check, Clean	148			O							
Cooling System	Clean, Change	177								O		
Crosshead Rollers	Inspect	162					O					
DEF/Ad-Blue Supply module filter replacement (D34P Engine Only)		185										O
Drive axle	Inspect	171						O				
Engine Oil Change (WG3800 Engine only)		153		O								
Engine Oil & Filter	Change	158				O						
Engine Oil & Filter (WG3800 Engine)	Change	159					O					
Engine Oil Level	Check	148			O							
Fork	Inspect	180								O		
Fuel Filter (LP Engine Only)		173							O			
Fuel Lines & Fittings	Check	167						O				
Fuses, Bulbs & Circuit Breaker	Change, Reset	143	O									
Horn & Lights (If Equipped)	Check	164					O					
Hydraulic Oil	Check, Clean, Change	182									O	
Hydraulic Oil Level	Check	152			O							
Hydraulic Return Filter	Change	168						O				
Inspect Acceleration Pedal Operation		149			O							
Inspect Battery System		182									O	
Inspect Coolant Hoses (LP Engines Only)		167						O				
Inspect Electrical System		165					O					
Inspect Engine for Exhaust Leaks		149			O							
Inspect Engine for Fluid Leaks		148			O							
Inspect for Intake Leaks		183									O	

Quick Reference to Maintenance Schedule			EVERY									
ITEMS	SERVICES	PAGE	When Required	50-100 Service Hours or a Week	10 Service Hours or Daily	250 Service Hours or Monthly	500 Service Hours or 3 Months	1000 Service Hours or 6 Months	1500 Service Hours or 9 Months	2000 Service Hours or Yearly	2500 Service Hours or 15 Months	Every 3000 Service Hours or 36 Months
Inspect Ignition System (PSI 4X only)		172										
Inspect Mixer Assembly		167										
Inspect Throttle Assembly		167										
Lift Chains	Test, Check, Adjust	168										
LP Regulator/Converter Inspection		167										
Mast Channels	Lubricate	151										
Mast Hinge Pins	Lubricate	162										
Mast, Carriage, Lift Chains, & Attachments	Check, Lubricate	163										
Overhead Guard	Inspect	165										
Parking Brake	Inspect	156										
Parking Brake	Test, Adjust	163										
PCV Valve (WG3800 Engine)	Check	171										
Replace LP Fuel Filter Element		173										
Replace of coolant hose of vaporizer (WG3800 Engine)		185										
Replace of lockoff valve filter (WG3800 Engine)		186										
Replace of LPG Fuel hose and clamp bands (WG3800 Engine)		185										
Replace Oil Separator (WG3800 Engine only)		174										
Replace Oxygen Sensor (PSI 4X only)		184										
Replace PCV Valve and breather element (PSI 4X only)	Change	183										
Replace Spark plug (WG3800 Engine only)		179										
Replace Spark Plugs (PSI 4X only)		172										
Seat, Hood Latch & Support Cylinder	Check, Lubricate	143										
Spark Plug (WG3800 only)	Cleaning	157										
Steer Suspension	Inspect	165										
Steer Wheel Bearings	Reassemble	176										
Steering Mechanism	Check, Lubricate	166										
Test Fuel System for Leaks (LP Engine Only)		142										
Testing Fuel Lock-off Operation		174										
Tilt Cylinders	Check, Adjust, Lubricate	161										
Tires and Wheels	Check, Inspect	146										
Transmission & Drive axle Oil Level	Check	151										
Transmission & Drive axle Oil, Oil Filter	Change	155, 178										
Universal Joint	Inspect	170										
Valve Clearance (WG3800 Engine only)	Check	175										
Walk - Around Inspection	Inspect	150										
Wheel Bolts and Nuts	Inspect	166										

When Required

You must read and understand the warnings and instructions contained in the Safety section of this manual, before performing any operation or maintenance procedures.

When required indicates no set schedule for review or replacement. This should be done based on operational conditions and operational environment. The Air filtration system should be kept as clean as possible and checked as often as the operational conditions demand. The harsher the application the more frequently the air filter should be checked. In some applications daily inspection may be required.

Air Intake System - Check, Clean

Servicing Filter Element

NOTICE

Never service precleaner with the engine running.

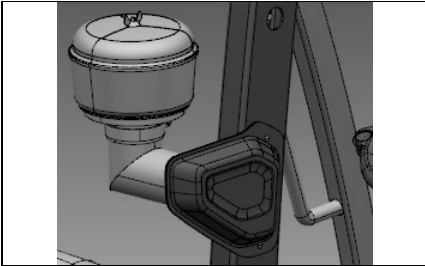

1. Check the precleaner bowl for dirt build-up.
2. If the dirt is up to the line, remove the precleaner bowl and empty it. Periodically wash the cover and bowl in water.

Servicing Filter Element

NOTICE

Never service precleaner with the engine running.

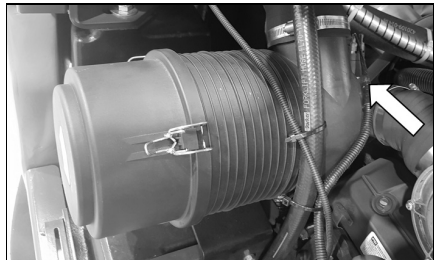

1. Service the air cleaner when the red target in the service indicator stays locked in the visible position with the engine stopped.
2. To service the air cleaner, loosen the cover latches and remove the cover.



3. Rotate the element slightly to separate it from its base and remove it from the air cleaner housing.
4. Clean and inspect the element or replace with a new element. See topic, "Cleaning Primary Filter Element".

5. Clean the inside of air cleaner housing and the cover. Inspect all connections between the air cleaner and engine. Check intake hose for cracks, damage and loose clamps. Tighten or replace parts as necessary to prevent leakage.

NOTICE

Do not allow dirty air to enter the intake hose when cleaning the inside of the air cleaner housing.

6. Check the air cleaner housing for loose latches.
7. Reset the air cleaner service indicator.
8. Install the air filter element.
9. Install the cover and tighten the cover latches.
10. Start the engine and observe the position of the indicator. If the indicator shows RED after the installation of the primary element, install another clean or a new element or, replace the secondary element. See topic, "Air Intake System - Change" in Every 500 Service Hours or 3 months section.

Stop the engine and close the hood and seat assembly.

Cleaning Primary Filter Elements

WARNING

Pressure air can cause personal injury.

When using pressure air for cleaning, wear a protective face shield, protective clothing and protective shoes.

The maximum air pressure must be below 205 kPa (30 psi) for cleaning purposes.

NOTICE

Do not clean the elements by bumping or tapping them.

Inspect filter elements after cleaning. Do not use a filter with damaged pleats, gaskets or seals.

When cleaning with pressure air, use 205 kPa (30 psi) maximum pressure to prevent filter element damage.

When cleaning with pressure water, use 280 kPa (40 psi) maximum pressure to prevent filter element damage.

Have spare elements on hand to use while cleaning used elements.

The primary element should be replaced after 3 months service. In case of harsh application having lots of dirt, please clean and replace the primary element more often.

Air-205 kPa (30 psi) Maximum Pressure

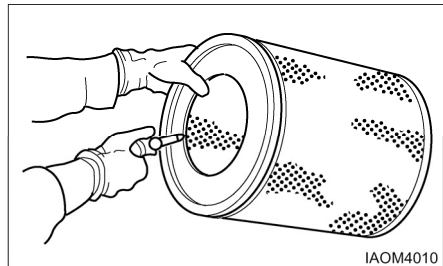

Direct air on the inside and outside of the element along the length of the pleats. Check the element for any tears, rips or damage.

Water-280 kPa (40 psi) Maximum Pressure

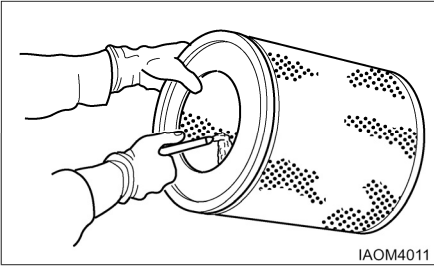

Direct water on the inside and outside of the element along the length of the pleats. Air dry it thoroughly and then examine it.

Detergent

1. Wash the element in warm water and mild household detergent.
2. Rinse the element with clean water. See instructions in preceding topic for cleaning with water.
3. Air dry it thoroughly, and then examine it.

Checking Element

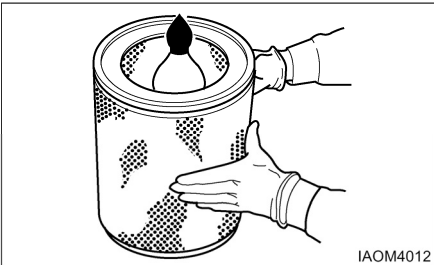

1. Insert a light inside the clean dry element and examine it. Discard the element if tears, rips or damage are found.
2. Wrap and store good elements in a clean, dry place.

Test Fuel System for Leaks (LP Engine Only)

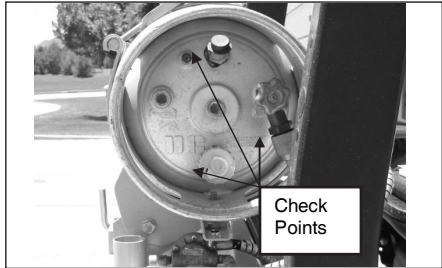

1. Obtain a leak check squirt bottle or pump spray bottle.
2. Fill the bottle with an approved leak check solution.
3. Spray a generous amount of the solution on the fuel system fuel lines and connections, starting at the storage container.
4. Wait approximately 15-60 seconds then perform a visual inspection of the fuel system. Leaks will cause the solution to bubble.
5. Repair any leaks before continuing.
6. Crank the engine through several revolutions. This will energize the fuel lock-off and allow fuel to flow to the pressure regulator/converter. Apply additional leak check solution to the regulator/converter fuel connections and housing. Repeat leak inspection as listed above.
7. Repair any fuel leaks before continuing.

WARNING

Prior to any service or maintenance activity, Test Fuel System for Leaks

Seat, Hood Latch & Support Cylinder - Check, Lubricate

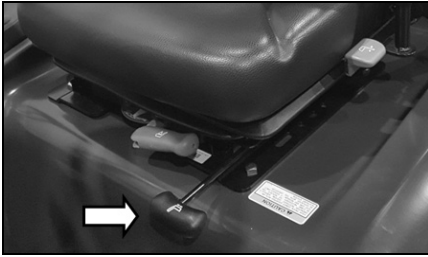

1. Check the operation of the seat adjuster rod. Make sure that the seat slides freely on its track. Lightly oil the seat slider tracks if necessary.



2. Pull up the lever latch to open the hood and seat assembly. Make certain the support cylinder will hold the hood open.



3. Lightly oil the hood latch mechanism and the rod for the hood support cylinder.

WARNING

If boxcar special(BCS) counter weight equipped, make sure to swing out down LP tank cradle before open the hood. (Pic. page 53)

Fuses, Bulbs & Circuit Breaker - Change, Reset

Fuses

NOTE: If a fuse filament separates, use only the same type and size fuses for replacement. If the filament in a new fuse separates, have the circuits and instruments checked.

NOTICE

Always replace fuses with ones of the correct ampere rating.



PSI 4X

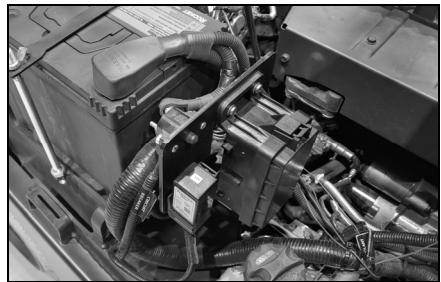

Kubota WG3800

Remove the front cover from the fuse box. The fuses are located under the air cleaner.



Fuse - Protects an electrical circuit from an overload. Opens (filament separates) if an overload occurs.

Fuse Box (Open)



PSI 4X

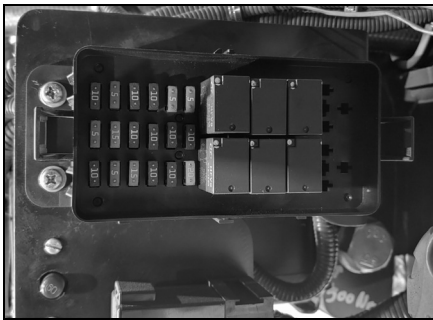

Kubota WG3800

[PSI 4X equipped truck]

Fuses are identified as follows:

1. BAT - 15A
2. BAT - 15A
3. BAT - 20A
4. BAT - 20A
5. IGN - 20A
6. IGN - 25A
7. EMPTY -
8. ACC - 20A
9. BAT - 20A
10. BAT - 10A
11. BAT - 15A
12. BAT - 15A

Relays are identified as follows:

1. REAR LAMP
2. C/SPEED
3. FWD
4. REV
5. START MOTOR
6. ETC
7. NEUTRAL
8. FRONT LAMP
9. LP CUT
10. MAIN POWER

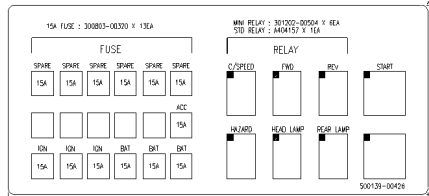

Kubota WG3800 equipped Truck

Fuses and Relays are identified as follows:

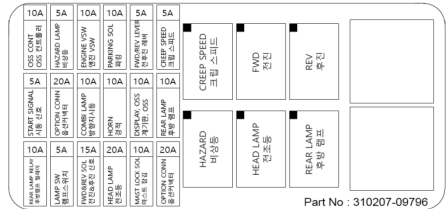

Fuse Box (Close)

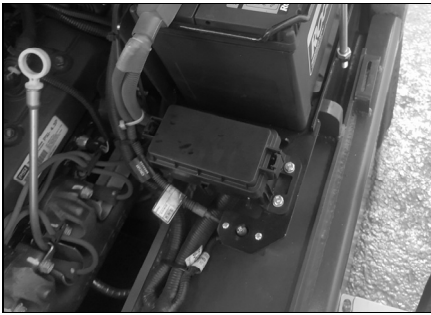

PSI 4X

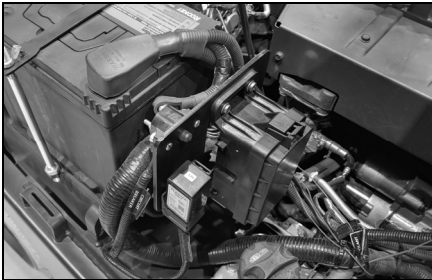

Kubota WG3800

Bulbs

Bulbs are identified as follows:

[PSI 4X equipped truck]

1. Bulb - head lamp halogen (12V - 35W)
- *2. Bulb - back up (12V - 8W)
- *3. Bulb - turn signal (12V - 23W)
- *4. Bulb - stop & tail (12V - 23/8W)

[Kubota WG3800 equipped Truck]

1. LED - head lamp-LED (12V - 18W)
- *2. LED - back up-LED (12V - 1.8W)
- *3. LED - turn signal (12V - 4W)
- *4. LED - stop & tail (12V - 2/2W)
- *Optional lamp or light

Circuit Breaker



1. Raise the hood and seat assembly. Make sure the support cylinder securely holds the hood open.

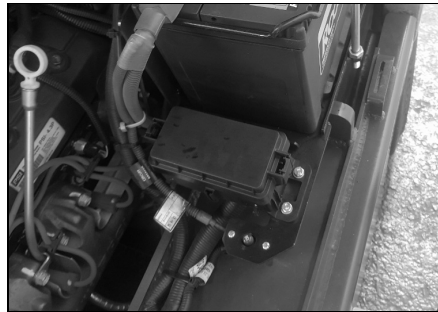

PSI 4X



Kubota WG3800

2. The main circuit breaker is located on the rear of the support for the controls.

NOTE: To reset circuit breakers push in on the button. The button should stay in if the breaker is reset. If the button will not stay in, or comes out shortly after reset, have the circuits checked.

 **WARNING**

If boxcar special(BCS) counter weight equipped, make sure to swing out down LP tank cradle before open the hood. (Pic. page 53)

Tires and Wheels - Check, Inspect

 **WARNING**

Servicing and changing tires and rims can be dangerous and should be done only by trained personnel using proper tools and procedures.

If correct procedures are not followed while servicing tires and rims, the assemblies could burst with explosive force and cause serious physical injury or death.

Follow carefully the specific information provided by your tire servicing man or branch.

Check Inflation and Damage

Inspect tires for wear, cuts, gouges and foreign objects. Look for bent rims and correct seating of locking ring.

When tires are changed, be sure to clean all rim parts and, if necessary, repaint to stop detrimental effects of corrosion. Sand blasting is recommended for removal of rust.

Check all components carefully and replace any cracked, badly worn, damaged and severely rusted or corroded parts with new parts of the same size and type. If there is any doubt, replace with new parts.

Do not, under any circumstances, attempt to rework, weld, heat or braze any rim components.

Carriage Roller Extrusion - Check, Adjust

1. Set the mast vertical.
2. Lower the carriage completely.
3. On full free lift and full free triple lift models, the bottom of the inner mast must be flush with the bottom of the stationary mast.

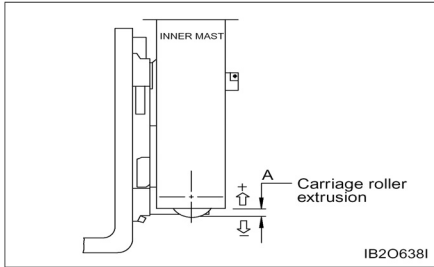

4. Measure the distance from the bottom of the inner upright to the bottom of carriage bearing.
5. The measurement (A) must be as follows in Chart below.

Height of carriage roller extrusion (A) [unit: mm]		
STD mast	FF mast	FFT mast
-7	43	43

Battery Terminal - Clean, Inspect

WARNING

Batteries give off flammable fumes that can explode.

Do not smoke when observing the battery electrolyte levels.

Electrolyte is an acid and can cause personal injury if it contacts skin or eyes.

Always wear protective glasses when working with batteries.

LP Engine - 12V X 1



1. Clean the top of the battery and terminals.
2. Check terminals for corrosion. Coat terminals with heavy grease.
3. Ensure the battery terminal is firmly tightened and rubber cap is installed.

Every 10 Service Hours or Daily

You must read and understand the warnings and instructions contained in the Safety section of this manual, before performing any operation or maintenance procedures.

Inspect Engine for Fluid Leaks

1. Start the engine and allow it to reach operating temperatures.
2. Turn the engine off.
3. Inspect the entire engine for oil and/or coolant leaks.
4. Repair as necessary before continuing.

Engine Oil Level - Check

⚠ WARNING

Hot oil and components can cause personal injury. Do not allow hot oil or components to contact skin.

Park the lift truck level, with the forks lowered, parking brake applied, transmission in NEUTRAL and the engine stopped.



1. Raise the hood and seat assembly. Make certain the support cylinder securely holds the hood open.

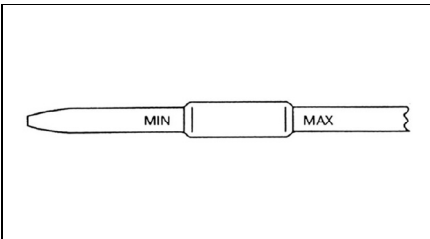

2. The oil level should be close as possible to upper point of the oil dip stick. Do not refill more than upper point.

Coolant Level - Check, Clean

Check Coolant Level

⚠ WARNING

At operating temperature, the engine coolant is hot and under pressure.

Steam can cause personal injury.

Check the coolant level only after the engine has been stopped and the filter cap is cool enough to touch with your bare hand.

Remove the filter cap slowly to relieve pressure.

Cooling system conditioner contains alkali. Avoid contact with the skin and eyes to prevent personal injury.

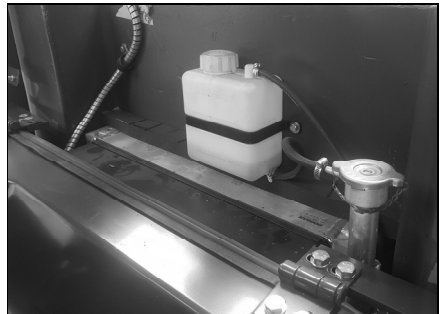

1. Observe the coolant level with engine cold. Maintain coolant level to the proper line on expansion bottle. If the expansion bottle has no coolant, it will be necessary to check coolant at the radiator filter neck.
2. Remove the radiator cap. Fill radiator to the top of the filter neck. Inspect radiator cap. Replace if damaged. Install the radiator cap.

⚠ WARNING

If boxcar special(BCS) counter weight equipped, make sure to swing out down LP tank cradle before open the hood. (Pic. page 53)



3. Start and run the engine to stabilize the coolant level in the filter neck. If low add coolant until it reaches the top of the filter neck. Install the radiator cap. Observe coolant level in the expansion bottle. If necessary, add coolant to bring the coolant to the appropriate line on the expansion bottle.
4. Stop the engine.
5. Inspect the cooling system for leaks, hose cracks or loose connections.

⚠ WARNING

Pressure air can cause personal injury.

When using pressure air for cleaning, wear a protective face shield, protective clothing and protective shoes.

Maximum air pressure must be less than 205 kPa (30 psi) for cleaning purposes.

6. Blow any dust and lint from the radiator fins.

Air Cleaner Indicator - Check

Checking Service Indicator

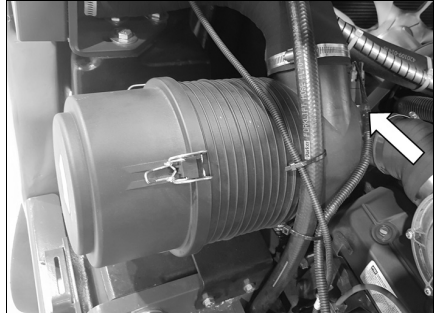

1. Observe the air cleaner service indicator.
2. Indicates that the air filter is blocked. If the light stays on after starting the engine, stop the engine, remove the air filter element and clean it thoroughly using compressed air. Refit the filter, and check that the light goes out when the engine is started.

NOTE: Service the element more frequently, as required, in severe dust or lint conditions. Also, service it more frequently where the operator is required to wear a respirator.

3. Close hood and seat assembly.

Inspect Acceleration Pedal Operation

1. Verify foot pedal travel is smooth without sticking.

⚠ WARNING

When the acceleration pedal harness is connected or disconnected, should be worked key OFF condition.

If not, occurred malfunction, can cause the personal injury.

Inspect Engine for Exhaust Leaks

1. Start the engine and allow it to reach operating temperatures.
2. Perform visual inspection of exhaust system.
3. Repair any/all leaks found.

Walk - Around Inspection - Inspect

For maximum service life of the lift truck, make a thorough walk-around inspection.

Look around and under the truck for such items as loose or missing bolts, debris or dirt buildup, fuel, oil or coolant leaks and cut gouged tires.

Have any repairs made and debris removed, as needed.

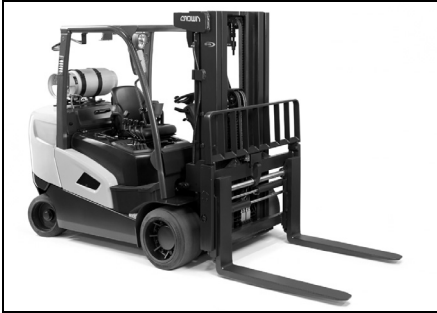

1. Inspect the tires and wheels for cuts, gouges, foreign objects, inflation pressure and loose or missing bolts.
2. Inspect the mast and lift chains for wear, broken links, pins and loose rollers.
3. Inspect the hydraulic system for leaks, worn hoses or damaged lines.
4. Look for transmission and differential leaks on the lift truck and on the ground.
5. Inspect the operator's compartment for loose items and cleanliness.
6. Inspect the instrument panel for broken gauges and indicator lights.
7. Test the horn and other safety devices for proper operation.

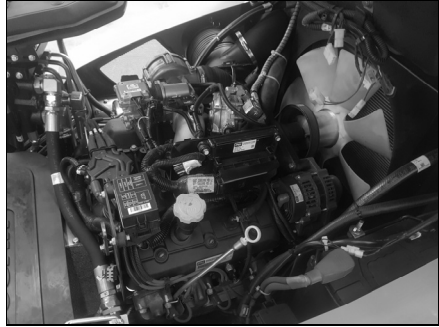

8. Inspect the cooling system for leaks, worn hoses and debris buildup.
9. Inspect engine compartment for oil, coolant and fuel leaks.
10. Inspect the forks.
 - Visually inspect forks for cracks, especially in the heel section, around the mounting brackets, and all weld areas.
 - Inspect for broken or jagged fork tips, bent or twisted blades and shanks.
 - Make sure positioning lock is in place and working. Lock the forks in position before using the truck. See Step 7 of " Forks " in " Every 2000 Service Hours or Yearly "
 - Remove all defective forks from service.

 **WARNING**

If boxcar special(BCS) counter weight equipped, make sure to swing out down LP tank cradle before open the hood. (Pic. page 53)

Mast Channels – Lubricate

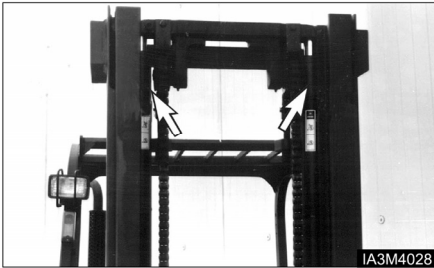

The channels on the roller-type mast require a break-in period. Apply a light film of lubricant on the channels where the rollers ride. This will prevent metal peel until the rollers set a pattern.

Brake Oil Level - Check

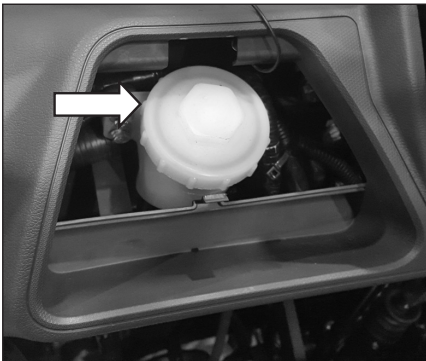

The brake reservoir is located on the left side of the steering column.

1. Remove the filler cap.
2. Maintain the brake fluid level to the fluid level mark on the brake system reservoir.
3. Clean and install the filler cap

Transmission & Drive axle Oil Level - Check

WARNING

Hot oil and components can cause personal injury. Do not allow hot oil or components to contact skin.

1. Start and operate the lift truck until the engine reaches normal operating temperature.
2. Park the lift truck level with the forks lowered, parking brake applied and the transmission controls in NEUTRAL.
3. With the brake applied and the engine at low idle, shift the directional control lever to forward and then to reverse, to fill the clutches.
4. Shift the direction control lever to the NEUTRAL position.
5. Open the access door in floor plate.
6. Remove the dipstick/filter cap. Observe the oil level.
7. Maintain the oil level between the Min and Max marks on the dipstick/filter cap.

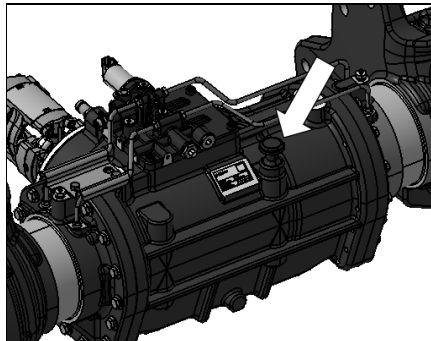

8. Close the access door in floor plate.
9. Stop the engine.

Hydraulic Oil Level – Check

⚠ WARNING

At operating temperature, the hydraulic tank is hot and under pressure.

Hot oil can cause burns.

Remove the filter cap only when the engine is stopped, and the cap is cool enough to touch with your bare hand. Remove the filter cap slowly to relieve pressure.

1. Operate the lift truck for a few minutes to warm the oil. Park the lift truck on a level surface, with the forks lowered, mast tilted back, parking brake engaged, transmission in NEUTRAL and the engine stopped.
2. Raise the hood and seat assembly. Make sure the air lift cylinder securely holds the hood open.

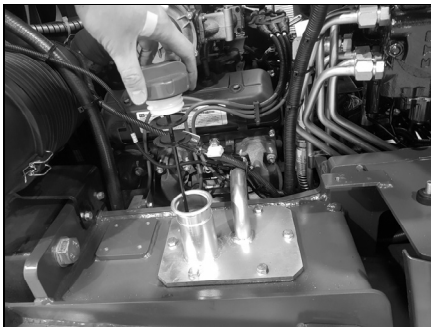

3. Remove the dipstick/ filter cap. Maintain the oil level to the FULL mark on the breather/dip stick.

⚠ WARNING

If boxcar special(BCS) counter weight equipped, make sure to swing out down LP tank cradle before open the hood. (Pic. page 53)

First 50 - 100 Service Hours or a Week

You must read and understand the warnings and instructions contained in the Safety section of this manual, before performing any operation or maintenance procedures.

Engine Oil – Change (WG3800 Engine only)

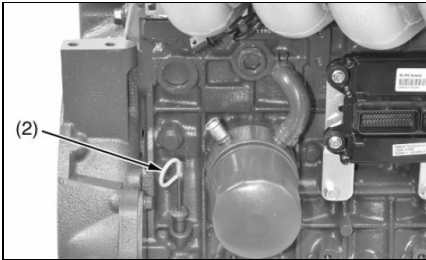
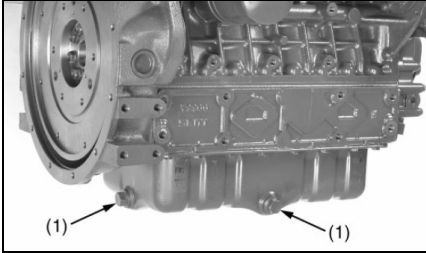

(1) Drain Plug (2) Dipstick

⚠ CAUTION

• **Make sure that you stop the engine before you change the engine oil.**

1. Start and warm-up the engine for approximately 5 minutes.
2. Put an oil pan below the engine.
3. Remove the drain plug (1) at the bottom of the engine and drain the oil fully.
4. Tighten the drain plug (1).
5. Fill new oil until the upper line on the dipstick (2).

NOTICE

- When you use an oil of different brand or viscosity from the previous, drain the remaining oil.
- Do not mix 2 different types of oil.
- Engine oil must have the properties of API classification SL or higher.
- Use the correct SAE Engine Oil by reference to the ambient temperature.

Engine oil capacity	12.2 L 3.22 U.S.gals
---------------------	-------------------------

Tightening torque	Drain plug	45 to 53 N·m 4.5 to 5.5 kgf·m 33 to 39 lbf·ft
-------------------	------------	---

Replacement of Oil Filter Cartridge

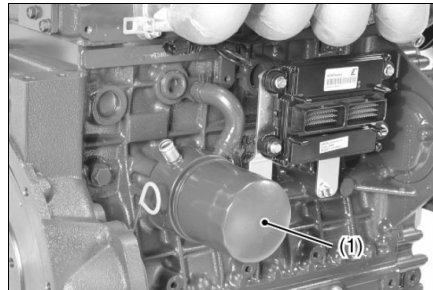

(1) Oil Filter Cartridge

⚠ CAUTION

• **Make sure that you stop the engine before you replace the oil filter cartridge.**

1. Remove the oil filter cartridge (1) with the filter wrench.
2. Apply a thin layer of oil on the new cartridge gasket.

3. Install the new cartridge by hand. Do not tighten too much because it can cause deformation of the rubber gasket. After you replace the cartridge, the engine oil usually decrease by a small level. Make sure that the engine oil does not flow through the seal and read the oil level on the dipstick.
4. Fill the engine oil until the specified level.

NOTICE

- To prevent serious damage to the engine, use only CROWN genuine filters or its equivalent.

NOTE: Engine oil and filter element must be changed after the first 50 hours.

Belts - Check, Adjust (WG3800 only)

Fan Belt Tension

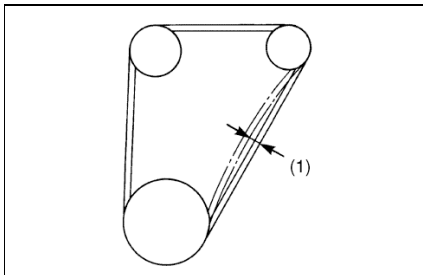

(1) Deflection

1. Examine if the fan belt is worn out and sunk in the pulley groove, and if it is, replace it.
2. Push the belt halfway between the fan drive pulley and alternator pulley at a specified force 98 N (10 kgf, 22 lbf) to measure the deflection (1).
3. If the measurement is out of the factory specifications, loosen the alternator mounting screws and adjust its position.

Transmission & Drive axle Oil, Oil Filter - Change

WARNING

Hot oil and components can cause personal injury. Do not allow hot oil or components to contact skin.

NOTICE

Transmission Oil and Drive axle Oil are identical and they are circulated.

Park the lift truck level, with the forks lowered, parking brake engaged, direction control lever in NEUTRAL and the engine stopped.

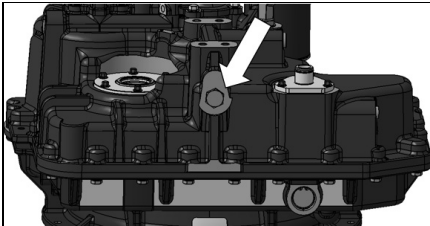
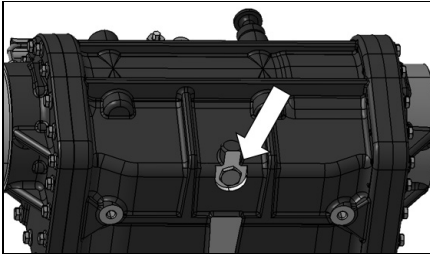

1. Remove Transmission & Drive axle drain plug. Allow the oil to drain into a suitable container. Clean the magnetic drain plug. Check O-ring seal and replace if necessary. Remove the spring and the strainer.

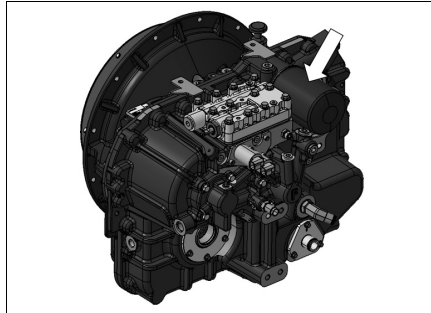

2. Remove the floor mat and the floor plate.
3. Remove and discard the oil filter.
4. Wipe off the filter base. Make certain that all of the old seal is removed.
5. Apply a small amount of clean oil on the seal of the new filter.
6. Install the filter by hand. When the filter contacts the base, tighten an additional 3/4 turn.

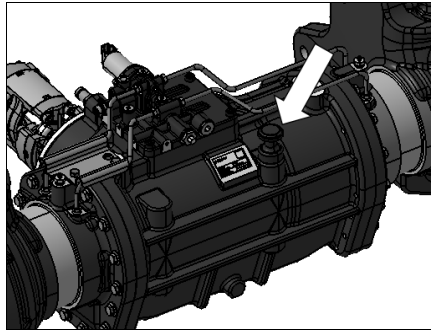

7. Remove the dip stick/filter cap. Fill the compartment with oil. See "Refill Capacities".
8. Install the dip stick/filter cap.
9. Start the engine.
10. With the service brake applied and engine at low idle, shift the direction control lever to forward and reverse to fill the clutches.
11. Shift the direction control lever into NEUTRAL. Engage the parking brake.
12. Remove the dip stick/filter cap. Observe the oil level.
13. Maintain the oil level between the Min and Max marks on the dip stick/filter cap.
14. When the oil temperature is 40°C approximately, the cold side mark on the dipstick is applicable.

15. When the oil temperature is 80°C approximately, the hot side mark on the dipstick is applicable.
16. Check for oil leaks at the filters and drain plug.
17. Stop the engine. Install the floor mat and floor plate.

Parking Brake - Inspect

Inspection from Operator's Seat, Engine OFF

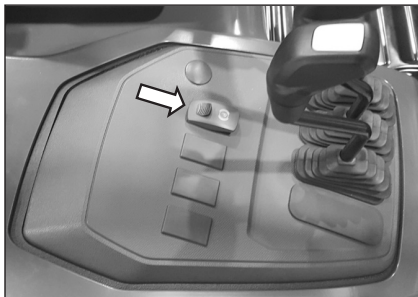

1. Push the front side of the parking brake switch to engage the brake and push the rear side to release it.

Inspection from Operator's Seat, Engine ON

Parking Brake Switch

1. With the parking brake engaged, the direction control lever in NEUTRAL and the engine running, shift the direction control lever to FORWARD.
2. The lift truck should not move forward or feel like it wants to move forward, even when the engine is accelerated briefly.
3. Repeat this procedure in REVERSE. Report truck movement or tendency to move under power with the parking brake engaged.

Parking Brake

NOTE: The parking brake is required to be adjusted to hold the lift truck with capacity load on a 15% grade.

If there is a 15% grade in your workplace, engage a capacity load and drive over to the grade. If the maximum grade in your workplace is less than 15% or if the maximum load carried by the lift truck is less than the lift truck's load capacity, pick up the maximum load and drive to the steepest grade in your workplace.

1. Raise the forks or load engaging attachment about 30 cm (12 in) from the floor.
2. Drive forward up the grade, or in reverse down the grade, and stop the lift truck with the service brakes.
3. Engage the parking brake and release the service brakes.
4. If the lift truck moves down the grade, control its speed with the service brakes, release the parking brake and return directly to the inspection area.
5. Park the lift truck, engage the parking brake, shift the direction control lever to NEUTRAL, lower the forks or load engaging attachment to the floor, shut OFF the engine, remove the key, chock the tires, terminate the inspection, tag the lift truck "Do Not Operate" and immediately report the failure of the parking brake to hold the lift truck.

Spark Plug - Cleaning (WG3800 only)

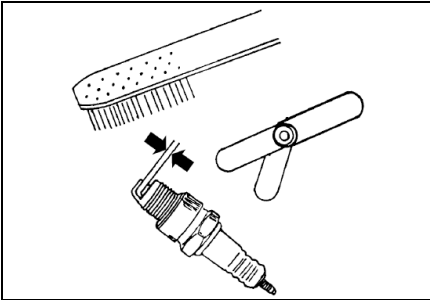

1. Remove the spark plug, and remove carbon from the electrode with a wire brush or other tools.
2. Measure the spark plug gap with a feeler gauge, and adjust or replace the spark plug if the measured gap differs from the factory specification.
3. Replace the spark plug if the electrode or the insulator is deformed or cracked.
4. Tighten the spark plug with a plug wrench.

NOTICE

When reassembling

- Put the ignition coil inside the spark plug terminal firmly.
 - Make sure that the wiring and the ignition coil are correctly connected.
 - Fix the ignition coil by screw.
-

• **Spark plug** : NGK IFR6F8DN

Spark plug gap	Factory specification	0.70 to 0.80 mm 0.028 to 0.031 in.
----------------	-----------------------	---------------------------------------

Tightening torque	Spark plug	24.5 to 29.4 N·m 2.50 to 2.99 kgf·m 18.1 to 21.6 lb·ft
	Ignition coil mounting screw / nut	9.81 to 11.3 N·m 1.00 to 1.15 kgf·m 7.24 to 8.33 lb·ft

Every 250 Service Hours or Monthly

You must read and understand the warnings and instructions contained in the Safety section of this manual, before performing any operation or maintenance procedures.

Engine Oil & Filter – Change

LP Engine Crankcase (PSI 4X Engine only)

1. Operate lift truck a few minutes to warm oil. Park the lift truck with the forks lowered, parking brake applied, transmission in neutral and the engine stopped.
2. Raise rear of lift truck off ground and block securely.

⚠ WARNING

Hot oil and components can cause personal injury. Do not allow hot oil or components to contact skin.

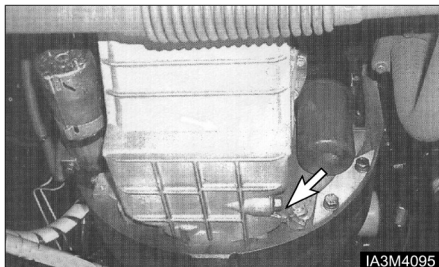

3. Remove the crankcase drain plug and allow oil to drain. Clean and install drain plug.
4. Raise the hood and seat assembly.
5. Remove and discard oil filter element.
6. Wipe sealing surface of oil filter element mounting base. Make sure the entire old gasket is removed.
7. Before installing a new filter element, apply a small amount of clean engine oil to the filter element gasket.
8. Install the new filter element. When the gasket contacts the base, tighten it 3/4 of a turn more. Do not overtighten.
9. Raise the lift truck, remove the blocking and lower the lift truck.
10. Fill the crankcase. See "Refill Capacities".
11. Start the engine and allow the oil to fill the filter and passages.

12. Check for oil leaks.

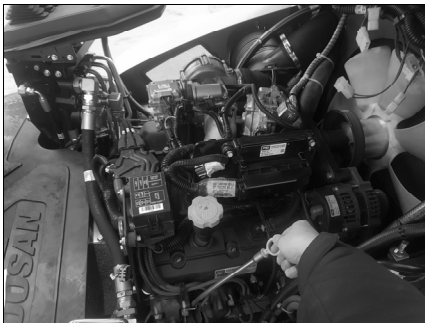

13. Stop the engine and measure the oil level. Maintain the oil level to the FULL mark on the dip stick.
14. Close hood and seat assembly.

NOTICE

Engine Oil Service hours can be extended to 500 hours by using CROWN supplied specific oil. Please consult CROWN branch about it.

⚠ WARNING

If boxcar special(BCS) counter weight equipped, make sure to swing out down LP tank cradle before open the hood. (Pic. page 53)

Every 500 Service Hours or 3 Months

You must read and understand the warnings and instructions contained in the Safety section of this manual, before performing any operation or maintenance procedures.

Air Intake System – Change

Changing Primary Element

See topic, “Air Intake System - Check, Clean” in “When Required”.

Changing Secondary Element

Replace the secondary element after the primary element has been cleaned three times or yearly.

1. Remove the primary air cleaner element. See topic “Servicing Filter Element”. Clean the inside of the air cleaner housing and cover.



2. Remove the secondary element. Inspect the gasket between the air cleaner housing and the engine inlet. Replace the gasket if it is damaged.

NOTICE

Always replace the secondary element. Do not attempt to reuse it by cleaning.

3. Install a new secondary element. Install a new or cleaned primary element. Install the cover. Tighten the latches.
4. Start the engine and observe the air cleaner service indicator. If the indicator shows RED after installing a new secondary element and a cleaned primary (outer) element, replace the cleaned primary filter with a new element.
5. Stop the engine. Close the hood and seat assembly.

Engine Oil & Filter Change (WG3800 Engine)

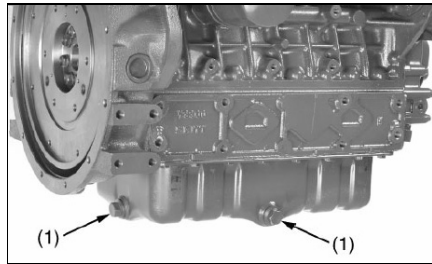
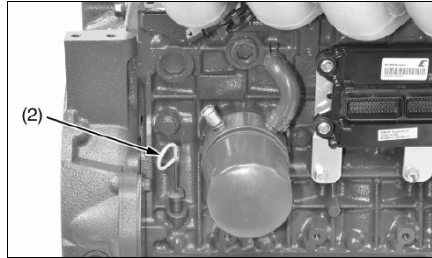

(1) Drain Plug (2) Dipstick

CAUTION

Make sure that you stop the engine before you change the engine oil.

1. Start and warm-up the engine for approximately 5 minutes.
2. Put an oil pan below the engine.
3. Remove the drain plug (1) at the bottom of the engine and drain the oil fully.
4. Tighten the drain plug (1).
5. Fill new oil until the upper line on the dipstick (2).

NOTICE

- When you use an oil of different brand or viscosity from the previous, drain the remaining oil.
- Do not mix 2 different types of oil.
- Engine oil must have the properties of API classification SL or higher.
- Use the correct SAE Engine Oil by reference to the ambient temperature.

Engine oil capacity	12.2 L 3.22 U.S.gals
----------------------------	-------------------------

Tightening torque	Drain plug	45 to 53 N·m 4.5 to 5.5 kgf·m 33 to 39 lbf·ft
--------------------------	------------	---

Replacement of Oil Filter Cartridge



(1) Oil Filter Cartridge

⚠ CAUTION

Make sure that you stop the engine before you replace the oil filter cartridge.

1. Remove the oil filter cartridge (1) with the filter wrench.
2. Apply a thin layer of oil on the new cartridge gasket.
3. Install the new cartridge by hand. Do not tighten too much because it can cause deformation of the rubber gasket.
4. After you replace the cartridge, the engine oil usually decrease by a small level. Make sure that the engine oil does not flow through the seal and read the oil level on the dipstick.

5. Fill the engine oil until the specified level.

NOTICE

- To prevent serious damage to the engine, use only CROWN genuine filters or its equivalent.

Belts - Change (WG3800 Engine)

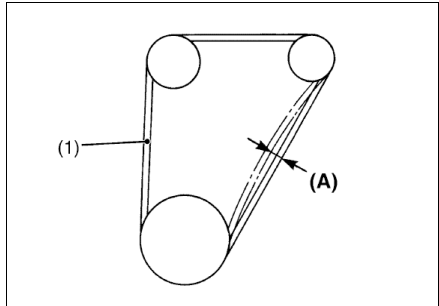

(1) Fan Belt (A) Deflection

1. Remove the alternator.
2. Remove the fan belt (1).
3. Replace the fan belt with a new one.
4. Install the alternator.
5. Check the deflection (A) of fan belt.

Deflection (A)	Factory specification	10 to 12 mm / 98 N 0.40 to 0.47 in. / 98 N (10 kgf, 22 lbf)
-----------------------	-----------------------	---

Tilt Cylinders - Check, Adjust, Lubricate

Chassis Pivot Eyebolts

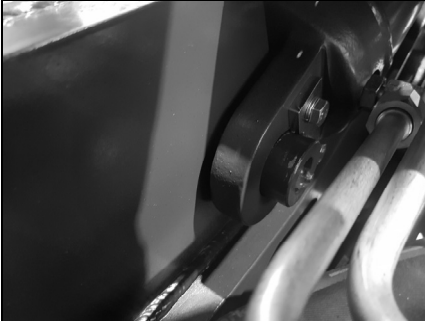

Typical Example

1. Lubricate two fittings for the pivot eyebolts, one on each tilt cylinder.
2. Check the pivot eye pins for loose retainer bolts and wear.

Mast Pivot Eyes

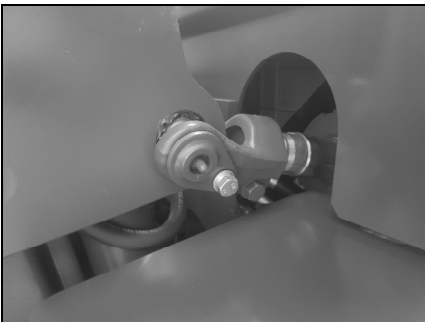

Typical Example

1. Lubricate two fittings for the mast pivot eyes, one on each side of the mast.
2. Check the pivot eye pins for loose retainer bolts and wear.

Cylinder Rod Extension

NOTE: The following description is for forward tilt. For cylinder rod back tilt, the collar should be stationary by the tilt eye. If it is not, the O-ring inside the collar may need to be replaced. To adjust back tilt, spacers must be added or removed.

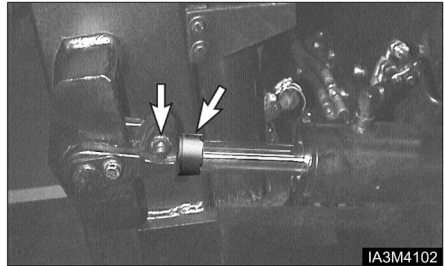

Typical Example

1. Check to make sure the tilt cylinders extend and retract evenly.
2. If one cylinder continues to move after the other cylinder has stopped in full forward or backward tilt, an adjustment must be made to one cylinder.

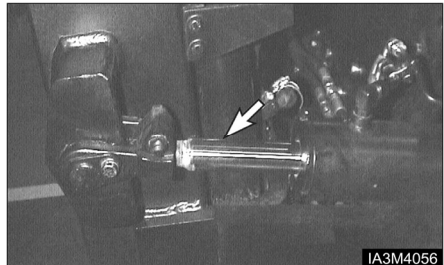

Typical Example

3. To adjust the cylinder rod extension, move the spacer to the rear and loosen the pinch bolt on the clevis.
4. Turn the cylinder rod in or out of the clevis to obtain the proper adjustment. Turning the rod into the clevis shortens the stroke. Turning the rod out of the clevis lengthens the stroke. When turning for extending rod, the overlapped length between clevis's thread and cylinder rod must be minimum 32 mm
5. Tighten the pinch bolts to a torque of 95 ± 15 N·m (70 ± 10 lb·ft). Check the cylinder rods again for even travel.

Mast Hinge Pins – Lubricate

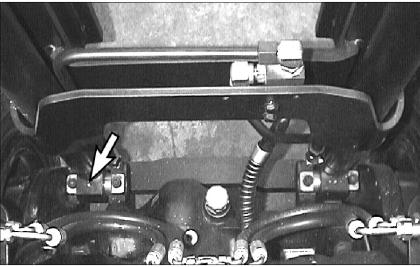

Typical Example

1. Lower the forks and tilt the mast forward.
2. Lubricate the two fittings for the mast hinge pins, one on each side of the mast.

Crosshead Rollers - Inspect

1. Operate the mast through a lift cycle. Watch the chains move over the crosshead rollers. Make sure the chain is tracking over the rollers properly.

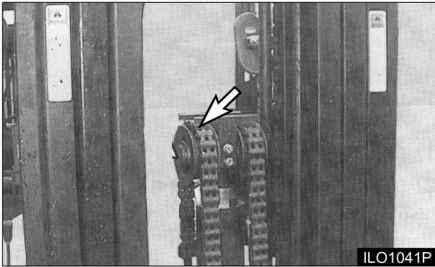

Typical Example

2. Check for damaged crosshead rollers, guards and retainer rings.

Carriage Side Rollers Thrust (If Equipped) - Lubricate

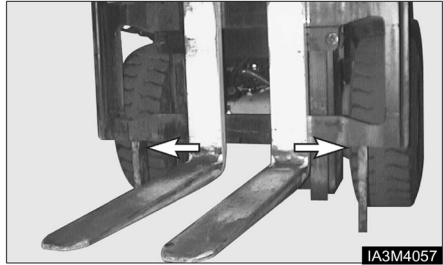

IA3M4057

1. Raise the carriage high enough to gain access to the side thrust rollers on the back side of the carriage. Block the carriage in this position.

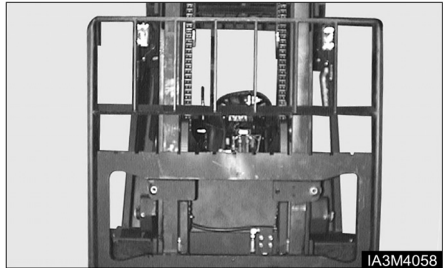

IA3M4058

2. Lubricate 2 side thrust roller fittings, one on each side of the mast.
3. Raise the carriage, remove the blocking. Lower the carriage to the floor.

Carriage Sideshifter (If Equipped) – Lubricate

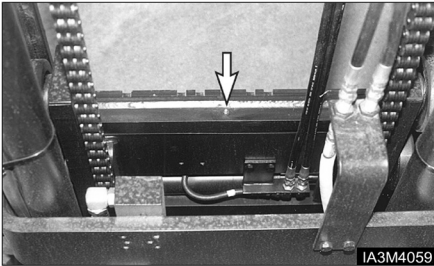

1. Lubricate 4 (6) fittings. The forks may have to be moved to gain access to all of the fittings.
2. Operate the sideshifter carriage through several complete cycles to distribute the grease the carriage to the floor.

Parking Brake - Test, Adjust

See topic, "Parking Brake - Test, Adjust" in "First 50-100 Service Hours."

Mast, Carriage, Lift Chains, & Attachments - Check, Lubricate

1. Operate the lift, tilt and attachment controls. Listen for unusual noises. These may indicate a need for repair.
2. Inspect for loose bolts and nuts on the carriage. Remove any debris from the carriage and mast.
3. Inspect the forks and attachments for free operation and damage. Have repairs made if necessary.

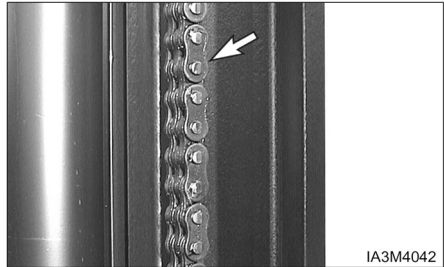

4. Brush a film of oil on all links of the chain.
5. Raise and lower the carriage a few times to work lubricant into the chain links.

NOTICE

Lubricate chains more frequently than normal in applications where the lift truck is operating in an atmosphere which could cause corrosion of components or when lift truck must work in rapid lift cycles.

6. Inspect the chain anchors and individual links for wear, loose pins or cracked leaves.

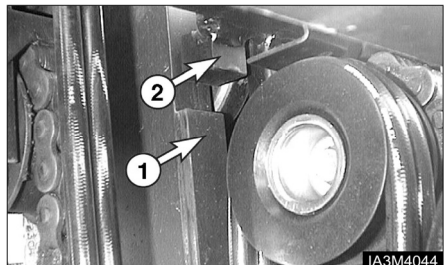

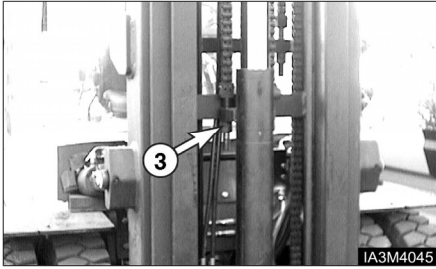

IA3M4045

7. In case of Full Free Lift Mast, Extend the primary cylinder to full length and then check the clearance and overlapped dimension between carriage stopper bolt or block (1) and Inner mast stopper block (2). Adjust the chain anchor bolt (3) so that clearance should be 14 ± 2 mm.
8. And adjust the overlapped dimension to be 10 ± 2 mm by moving or inserting washer.

Carriage Side Rollers - Lubricate



CGC35S-9, CGC35BCS-9, CGC45S-9, CGC45BCS-9



CGC55C-9, CGC55BCS-9

Lubricate 2 side roller fittings, one on each side of the carriage.

Circulation Pump Belt (OCDB & LP Engine Only. If Equipped) - Check, Adjust

1. Raise the hood and seat assembly.

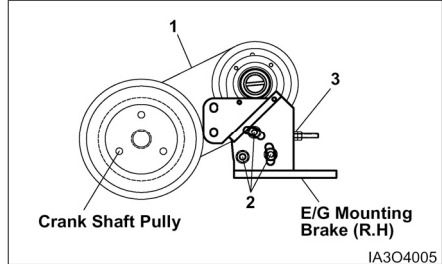

IA3O4005

2. Check the condition and adjustment of the belt (1). Correct adjustment allows 10 mm (3/8 inch) deflection under 45 N of force.
3. To adjust the circulation pump belt, loosen the mounting bolts (2) and adjust the adjusting inner nut (3). Tighten the adjusting outer nut (4).
4. Lower the hood and seat assembly.

Horn & Lights (If Equipped) – Check

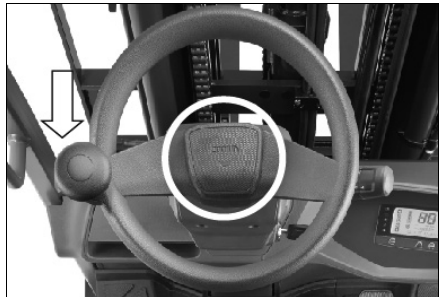

1. Press horn button, to determine if horn is operational.
2. Check and replace all defective gauges.
3. Check all lights such as warning, directional, backup, driving and flood lights for correct operation. Replace all burned out bulbs. Have repairs made if needed.

Inspect Electrical System

1. Check for loose, dirty or damaged connectors and wires on the harness including: Fuel lock-off, TMAP sensor, O2 sensor, Electronic throttle, Control Relays, Fuel Trim Valve, Foot Pedal, and Distributor sensor.
2. Repair and/or replace as necessary.

Overhead Guard – Inspect

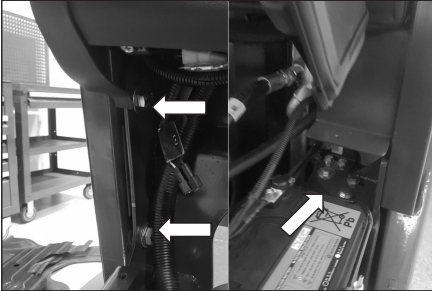

1. Check tightness of overhead guard mounting bolts at 95 N·m (70 lb-ft).
2. Check overhead guard for bent or cracked sections. Have repairs made if needed.

Steer Suspension - Inspect

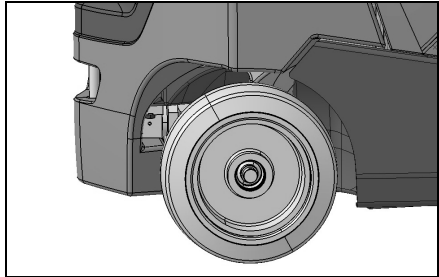

1. Inspect the suspension mounting bolts. Tighten suspension mounting bolts, if necessary, to 240 ± 30 N·m (180 ± 20 lb-ft).



2. Look for leaks at the power steering hose connections.
3. Remove any trash buildup on the suspension or the steer axle.

Steering Mechanism - Check, Lubricate

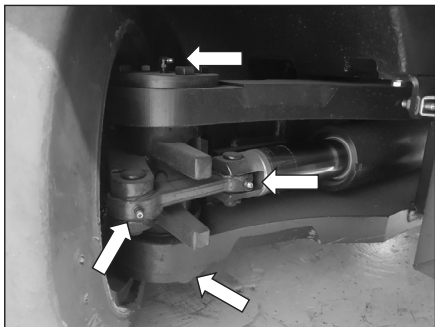

1. Lubricate the steer axle king pins, total of four fittings. Two on the right side and two on the left side.
2. Lubricate the steering link bearings, total of four fittings. Two on the right side and two on the left side.
3. Check for any worn or loose components of the steering mechanism. Remove any debris or trash as required.

Wheel Bolts and Nuts – Inspect Inspect Tightness

NOTICE

Do not lubricate ball seas of wheels or ball faces of wheel nuts.

Be sure mounting faces of hub, wheel nuts and flat mounting surfaces are clean.

Tighten wheel nuts again after 24 hours of operation.

NOTE: Always tighten wheel lug nuts in a sequence opposite (180°) each other.

If equipped with dual wheels, follow the same nut tightening sequence for both wheels.

Drive Wheels



Install drive wheel. Put two nuts opposite (180°) each other. Tighten both.

Install the remaining nuts. Tighten all nuts in a sequence opposite (180°) each other. Tighten to 600±90 N·m (440±60 lb·ft).

Every 1000 Service Hours or 6 Months

You must read and understand the warnings and instructions contained in the Safety section of this manual, before performing any operation or maintenance procedures.

Inspect Coolant Hoses (LP Engines Only)

1. Visually inspect coolant hoses and clamps. Remember to check the two coolant lines that connect to the pressure regulator/converter.
2. Replace any hose that shows signs of swelling, cracking, abrasion or deterioration.

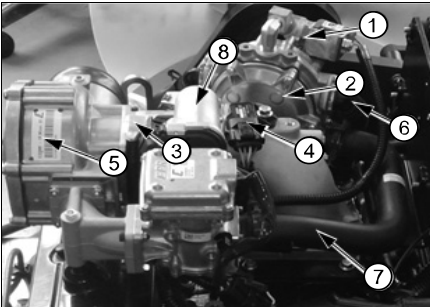

PSI 4X

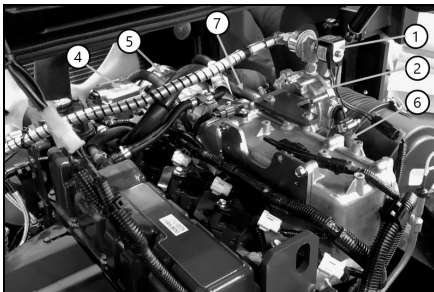

WG3800

- 1) LP fuel lock-off, (2) LP regulator/converter
- (3) Adapter, (4) Throttle Body
- (5) LP mixer, (6) Coolant lines, (7) LP fuel line

LP Regulator/Converter Inspection

1. Visually inspect the pressure regulator/converter housing(2) for coolant leaks and detect the fuel pipe joints, LP mixer and regulator/converter for LP fuel leaks.

To detect the LP fuel leaks, smear detected parts with suds, visually inspect whether there are bubbles after the engine start.

NOTE: For pressure testing and internal inspection of the pressure regulator/converter, contact to the CROWN service.

Fuel Lines & Fittings - Check

Visually inspect fuel lines and fittings for physical damage. Replace as required.

Inspect Mixer Assembly

Refer to the LP mixer section of the engine service manual for procedures.

Inspect Throttle Assembly

1. Visually inspect the throttle assembly motor housing for coking, cracks and missing cover-retaining clips. Repair and/or replace as necessary.

NOTE: Refer to the LP mixer and throttle section of the service manual for procedures on removing the mixer and inspecting the throttle plate.

Hydraulic Return Filter - Change



Hot oil and components can cause personal injury. Do not allow hot oil or components to contact skin.

Park the lift truck level with the forks lowered, parking brake engaged, transmission in NEUTRAL and the engine stopped.

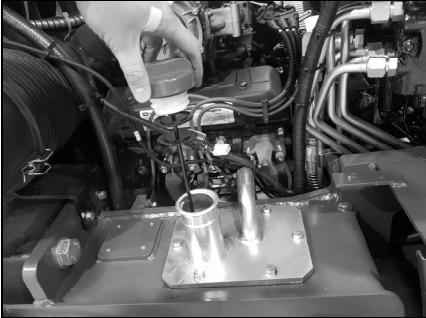

1. Raise the hood and seat assembly. Loosen the bolts of the hydraulic tank cover, and remove the hydraulic tank cover with filter assembly.



2. Remove filter assembly from the hydraulic tank cover.
3. Install new filter assembly in the hydraulic tank cover.
4. Inspect cover gasket for damage, replace it if necessary.
5. Clean and Install the cover and tighten retaining bolts.
6. Lower the hood and seat assembly.

Lift Chains - Test, Check, Adjust

Lift Chain Wear Test

Inspect the part of the chain that is normally operated over the cross head roller. When the chain bends over the roller, the movement of the parts against each other causes wears.

Inspect to be sure that chain link pins do not extend outside of the link hole. If any single link pin is extended beyond its connecting corresponding link, it should be suspected of being broken inside of its link hole. Lift chains are required to check for wear about every 1,000 service hours or 6 months.

Chain wear test is a measurement of wear of the chain links and pins. Take the following steps to check chain wear.

1. Lift the mast and carriage enough for getting tension on lift chains.

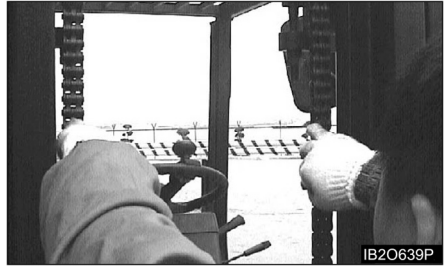

Typical example

2. Measure precisely ten links of chain distance at the center of pins in millimeter.
3. Calculate chain wear rate*.
4. If the chain wear rate is 2% or more, replace the lift chain.

*Chain wear rate (%)

$$= \left(\frac{\text{Actual measurement} - \text{Pitch}^{**} \times 10}{\text{Pitch}^{**} \times 10} \right) \times 100$$

** Chain Pitch for CGC35/45S-9, CGC55C-9, CGC35/45/55BCS-9

= 25.40 mm (1.0 in)

Check for Equal Tension



Typical example

Lift the carriage and the mast high enough for getting tension on lift chains. Check the chains, and make sure the tension is the same. Lift chains are required to check for equal tension about every 1,000 service hours or 6 months.

WARNING

Personal injury can be caused by sudden movement of the mast and carriage.

Keep hands and feet clear of any parts that can move.

Lift Chain Adjustment



Typical example for carriage equal tension

If the tension is not the same on both chains, take the procedure as follows.

NOTE: If carriage height is not correct, make adjustments by following procedures.

Carriage Chain Adjustment

Make sure that carriage height is correct. If correct, adjust the chain for equal tension. If not, adjust the chain for correct carriage height by adjusting anchor nuts(1),(2).

NOTE: See the previous section, "Carriage Roller Extrusion" in "When Required" for proper height of carriage.

1. Fully lower the carriage and tilt mast forward or lift the carriage and put blocks under the carriage to release the tension from the lift chains.
2. Loosen nut(1) and adjust nut(2) to get proper distance from bottom of inner upright to the bottom of carriage bearing.

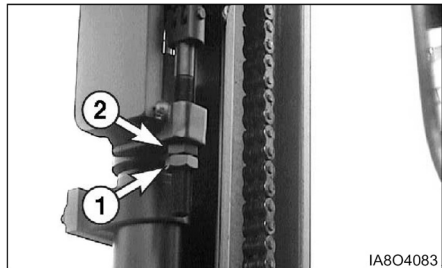

Typical example for carriage chain of STD mast

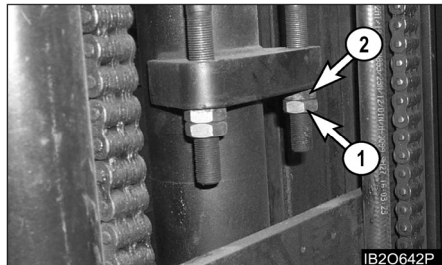

Typical example for carriage chain of FF,FFT mast

3. Make adjustment anchor nut(1), (2) for equal chain tension.
4. Set the mast vertical and raise the carriage and check equal chain tension. If not equal, repeat the same procedure as step 1 through step 3.
5. Put LOCTITE No. 242 Tread lock on the threads of the anchor nuts(1), (2) after the adjustment is completed.

Mast Chain Adjustment - FF, FFT Mast

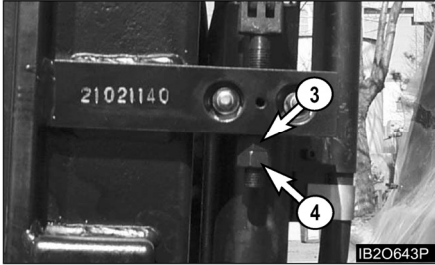

Typical example for FF mast

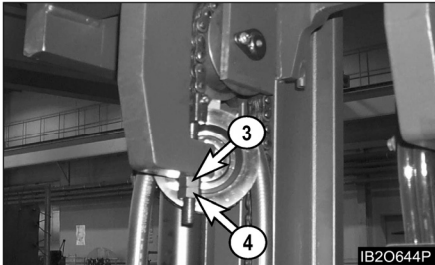

Typical example for FFT mast

Make sure that mast height is correct. If correct, adjust chain for equal tension. If not, adjust mast chain for correct mast height by adjusting anchor nuts (3), (4).

NOTE: See the previous section, "Carriage Roller Extrusion" in "When Required" for proper inner mast height.

1. Lift the inner mast and put blocks under the inner mast to release the tension from the lift chains.
2. Loosen nut(3) and adjust nut(4) to make inner mast rail flush with outer mast rail bottom.
3. Make adjustment anchor nuts(3), (4) for equal chain tension.
4. Raise the inner mast and check equal chain tension. If not equal, repeat the same procedure as step 1 through step 3.
5. Put LOCTITE No. 242 tread lock on the threads of the anchor nuts(3), (4) after the adjustment is completed.

Universal Joint - Inspect

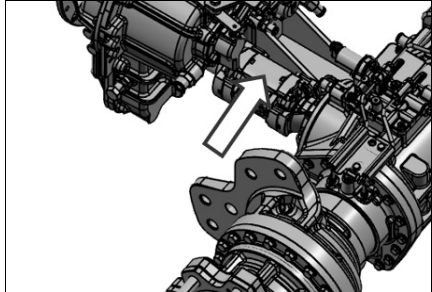
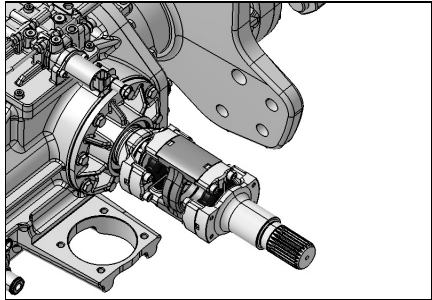

1. Inspect for loose retaining bolts. Check for worn or damaged bearings.
2. Have worn or damaged bearings replaced. Tighten the bolts if necessary.

Drive axle – Inspect Inspect Tightness

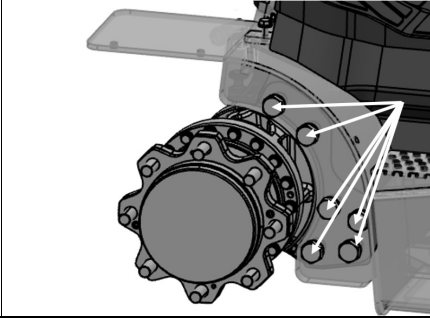

Tighten bolts and nuts if necessary (800+/-100 N.m or 600 ft lbs) remark bolts with marker. If replacing bolts apply small amount of Loctite to the threads.

PCV Valve - Check (WG3800 Engine)

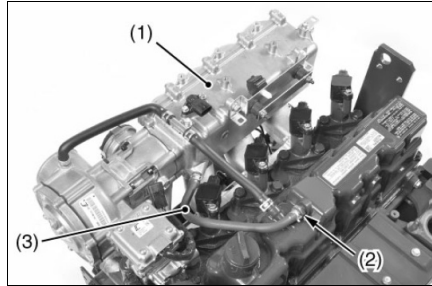

(1) Intake Manifold (2) PCV Valve (3) Breather Hose

1. Disconnect the breather hose (3) from the intake manifold (1).
2. Blow into the breather hose (3).
3. Stop to blow.
4. Make sure that a slight operation sound is heard from the PCV valve.
5. If there is no operation sound, replace the PCV valve (2).
6. Connect the breather hose (3) to the intake manifold (1).

Every 1500 Service Hours or 9 Months

You must read and understand the warnings and instructions contained in the Safety section of this manual, before performing any operation or maintenance procedures.

Inspect Ignition System (PSI 4X only)

1. Disconnect Battery Cables.
2. Remove and inspect the spark plugs. Replace as required.
3. Test secondary cables with an Ohmmeter. If maximum resistance is higher than 25 kOhms, repair and/or replace.
4. Remove distributor cap and perform visual inspection. Replace cap and rotor if corrosion is found on the contacts.
5. Inspect the ignition coil for cracks and heat deterioration. Visually inspect the coil heat sink fins. If any fins are broken replace as required.



Replace Spark Plugs (PSI 4X only)

1. Disconnect Battery Cables.
2. Using a gentle twisting motion remove the high voltage cables from the spark plugs. Replace any damaged cables.
3. Remove the spark plugs.
4. Gap the new spark plugs to the proper specifications.
PSI Engine: 0.9 mm (0.035 inch)
5. Apply anti-seize compound to the spark plug threads and install.
PSI Engine: 30 N·m (22 lb·ft)

WARNING

Do not overtighten the spark plugs.

6. Re-install the high voltage cables.

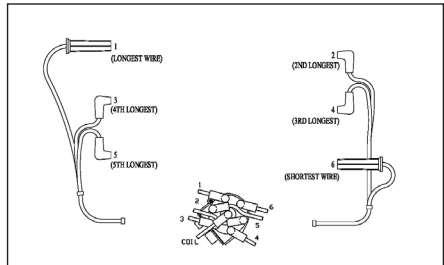
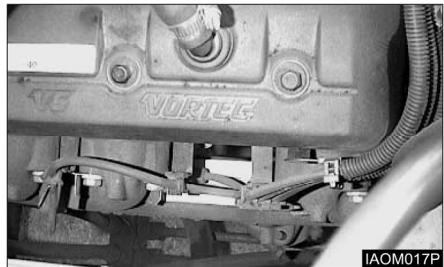

Replace LP Fuel Filter Element

Park the lift truck in an authorized refueling area with the forks lowered, parking brake applied and the transmission in Neutral.

1. Close the fuel shutoff valve on the LP-Fuel tank. Run the engine until the fuel in the system runs out and the engine stops.
2. Turn off the ignition switch.
3. Scribe a line across the filter housing covers, which will be used for alignment purposes when re-installing the filter cover.

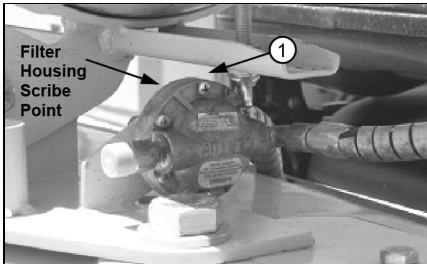

4. Remove the cover retaining screws (1)

Fuel Filter (LP Engine Only)

Disassembly

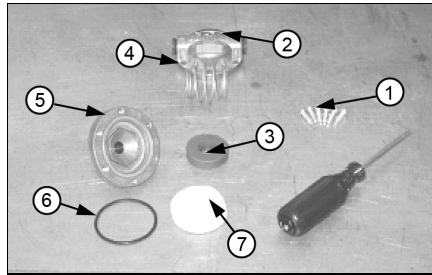

1. Remove top cover (2), magnet (3), spring (4), and filter element (7) from bottom cover (5).
2. Replace the filter element (7).
3. Check bottom cover O-ring seal (6) for damage. Replace if necessary.
4. Re-assemble the filter assembly aligning the scribe lines on the top and bottom covers.
5. Install the cover retaining screws, tightening the screws in an opposite sequence across the cover.
6. Open the fuel valve by slowly turning the valve counterclockwise.
7. Crank the engine several revolutions to open the fuel lock-off. **DO NOT START THE ENGINE.** Turn the ignition key switch to the off position.
8. Check the filter housing, fuel lines and fittings for leaks. Repair as necessary.

Testing Fuel Lock-off Operation

1. Start engine.
2. Locate the electrical connector for the fuel lock
3. Disconnect the electrical connector.
4. The engine should run out of fuel and stop within a short period of time.
5. Turn the ignition key switch off and re-connect the fuel lock-off connector.

NOTE: The length of time the engine runs on trapped fuel vapor increases with any increase in distance between the fuel lock-off and the pressure regulator/converter.

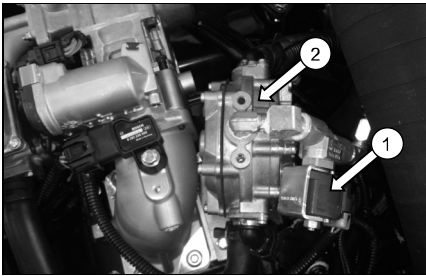

(1) LP fuel lock-off, (2) LP regulator/converter

Replace Oil Separator (WG3800 Engine only)

Replacement of Oil Separator Element

CAUTION

Be sure to stop the engine before replacement the oil separator element.

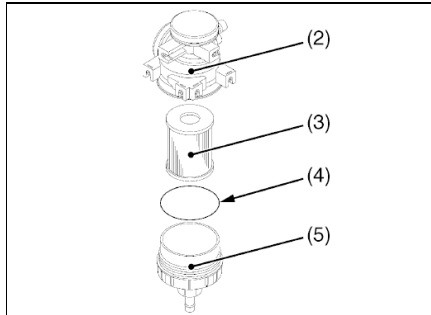
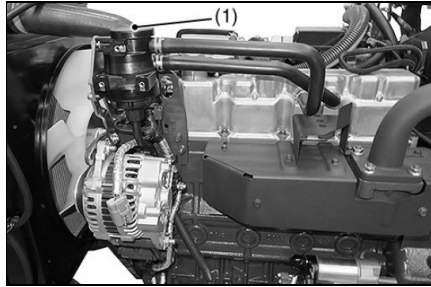

(1) Oil Separator Assembly (2) Body (3) Element (4) O-ring (5) Case

1. Remove the case (5).
2. Remove the oil separator element (3) and O-ring (4).
3. Replace the oil separator element and O-ring with a new one.

Tightening torque	Case of oil separator	9.50 to 10.5 N·m 0.969 to 1.07 kgf·m 7.01 to 7.74 lbf·ft
--------------------------	-----------------------	--

Valve Clearance - Check (WG3800 Engine only)

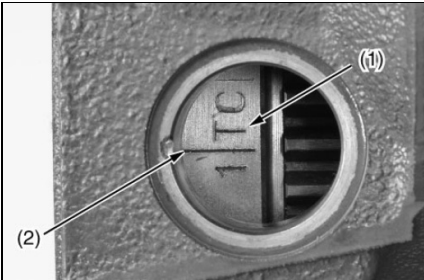
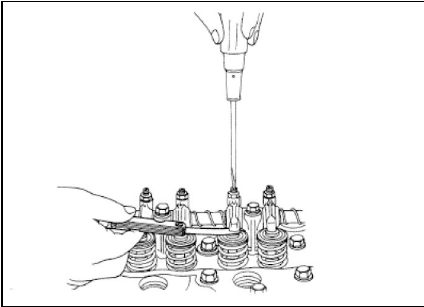

(1) "1TC" Mark (2) Alignment Mark

1. Remove the head cover.
2. Align the "1TC" mark line (1) on the flywheel and alignment mark (2) on the housing. Make sure that the No.1 piston comes to the compression or overlap top dead center.
3. Examine the subsequent valve clearance at the mark "#" with a feeler gauge.
4. If the clearance is out of the factory specifications, adjust with the adjusting screw.

Adjustable Cylinder Location of Piston	Intake valve	Exhaust valve
When No. 1 piston is at compression top dead center	1st	#
	2nd	#
	3rd	#
	4th	
When No. 1 piston is at overlap position	1st	
	2nd	#
	3rd	#
	4th	#

Intake and exhaust valve clearance (cold)	Factory specification	0.18 to 0.22 mm 0.0071 to 0.0086 in.

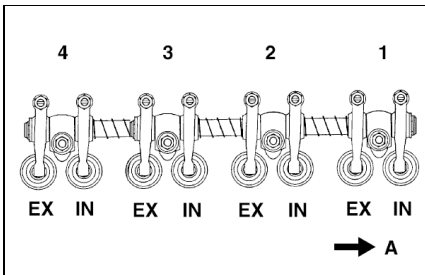

A: Gear Case Side

NOTICE

- The sequence of cylinder numbers is No.1, No.2, No.3 and No.4 and it starts from the gear case side.
- After you adjust the valve clearance, tighten the lock nut of the adjusting screw.

WARNING

You must examine and adjust the valve clearance when the engine is cold.

Every 2000 Service Hours or Yearly

You must read and understand the warnings and instructions contained in the Safety section of this manual, before performing any operation or maintenance procedures.

Steer Wheel Bearings - Reassemble

Park the lift truck level with the forks lowered, parking brake engaged, transmission in NEUTRAL and the engine stopped.



Typical Example

1. Lift the steer wheels off the ground. Place stands or blocking under the frame and steer axle to support the lift truck.
2. Remove the hub cap.

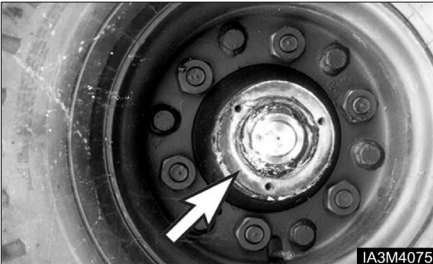

Typical Example

3. Remove the cotter pin.

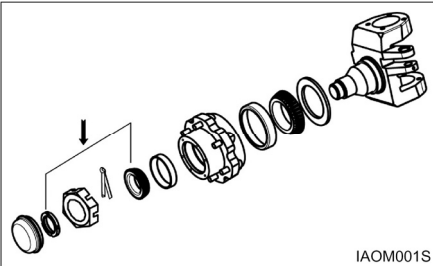

4. Remove the castle nut and washer.
5. Remove the wheel assembly. Examine the seal for damage and wear. Replace the seal if necessary.

WARNING

Deflate tire before removing wheel nuts at tire change.

6. Remove the inner bearing. Clean and lubricate the steering knuckle. Reassemble both the inner and outer bearing cones.
7. Install the inner bearing. Lubricate the seal and install the wheel assembly on the knuckle.
8. Install the outer wheel bearing and the outer washer. Install a new lock washer and fit the locknut.

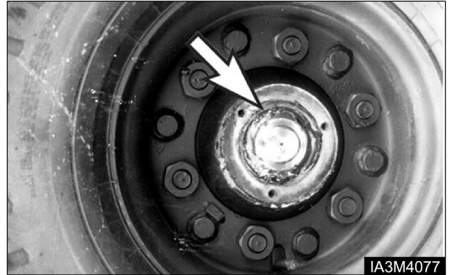

Typical Example

9. Tighten the locknut to 135 N·m (100 lb-ft), while turning wheel hub to seat the bearing.
10. Loosen the locknut. Retorque it to 50 ± 5 N·m (37 ± 4 lb-ft). Bend the lockwasher tang to secure locknut.
11. Install the hub cap.
12. Raise the lift truck and remove the blocking. Lower the lift truck to the ground.

Cooling System - Clean, Change

WARNING

At operating temperature, the engine coolant is hot and under pressure.

Steam can cause personal injury.

Check the coolant level only after the engine has been stopped and the filter cap is cool enough to touch with your bare hand.

Remove the filter cap slowly to relieve pressure.

Cooling system conditioner contains alkali. Avoid contact with the skin and eyes to prevent personal injury.

Use all cleaning solutions with care.

The lift truck must be level, the forks lowered, the parking brake engaged, the transmission in NEUTRAL and the engine stopped and cool.

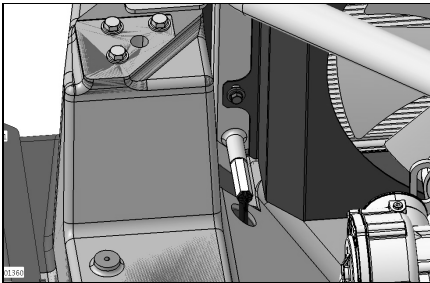

1. Turn the radiator cap slowly to relieve the pressure, then remove the cap.
2. Remove the block drain plug.

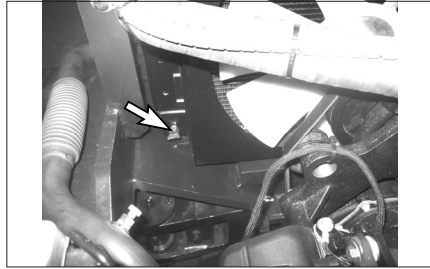

3. Open radiator drain valve. Allow the coolant to drain. Drain the recovery bottle.
4. Close radiator drain valve and install block drain plug. Fill the cooling system with 1 kg (2 lb) sodium bisulphate per 40 liters (10 gallons) of water. Most commercial cooling system cleaners can be used.
5. Start and run the engine for 30 minutes.
6. Stop the engine and drain the cleaning solution.
7. Flush the system with clean water, until draining water is clear.
8. Close the drain valve and install the block drain plug. Fill the system with neutralizing solution, 250g (1/2 lb) sodium carbonate per 40 liters (10 gallons) of water.
9. Start and run the engine for 10 minutes.
10. Stop the engine and drain the neutralizing solution.
11. Flush the system with clean water until draining water is clear.
12. Close the drain valve and install the block drain plug. Add coolant to the top of the filter neck.
13. Start and run the engine to stabilize the coolant level. See "Every 10 Service hours or Daily", "Coolant Level-Check", in this manual.

Transmission & Drive axle Oil, Oil Filter - Change

See topic, "Transmission & drive axle Oil, Oil Filter - Change" in "First 50 - 100 Service Hours".

NOTICE

Transmission Oil and Drive axle Oil are identical and they are circulated.

Transmission & Drive axle Strainer - Clean

Park the lift truck level, with the forks lowered, parking brake engaged, transmission in NEUTRAL and engine stopped.

1. Remove drain plug. Allow the oil to drain into a suitable container. Clean the magnetic drain plug. Check O - ring seal and replace if necessary.
2. Install the drain plug.
3. Wash the strainer assembly in clean, non flammable solvent and dry it. Install the strainer assembly and reconnect the hose.

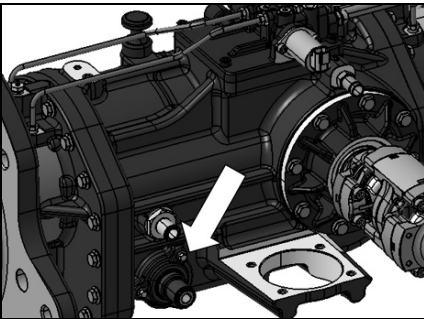
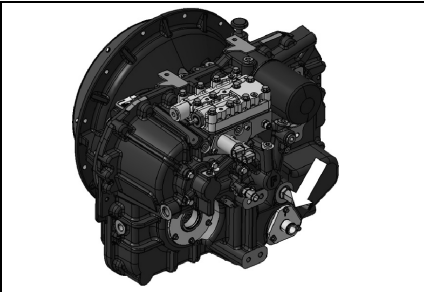

4. Remove the dip stick/filter cap. Fill the drive axle housing with oil.

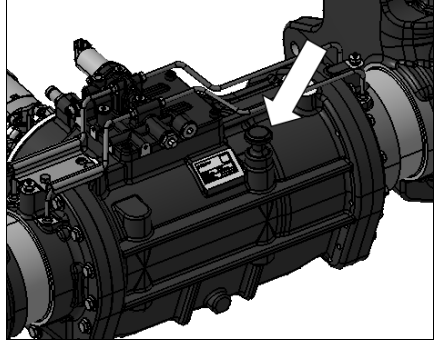

5. See "Refill Capacities."
6. Start the lift truck with engine at low idle, place the directional control lever to the NEUTRAL.
7. Maintain the oil level between lower mark and upper mark on the dip stick/filter cap.
8. Install the dip stick/filter cap.

Replace Spark plug (WG3800 Engine only)

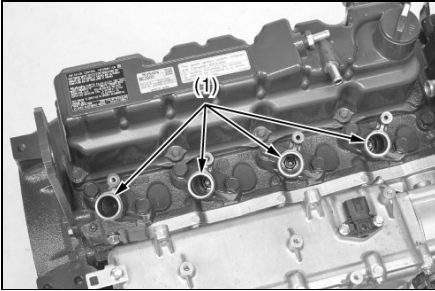

(1) Spark Plug

1. Disconnect the ignition coil.
2. Remove the spark plug.
3. Replace the new spark plug.
4. Tighten the spark plug with a plug wrench.

NOTICE

When reassembling

- Put the ignition coil inside the spark plug terminal firmly.
 - Make sure that the wiring and the ignition coil are correctly connected.
 - Fix the ignition coil by screw.
-

• Spark plug : NGK IFR6F8DN

Tightening torque	Spark plug	24.5 to 29.4 N·m 2.50 to 2.99 kgf·m 18.1 to 21.6 lbf·ft
	Ignition coil mounting screw	9.81 to 11.3 N·m 1.00 to 1.15 kgf·m 7.24 to 8.33 lbf·ft

Fork – Inspect

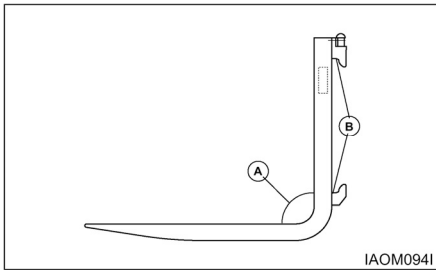

Forks should be inspected, at a minimum, every 12 months. If the truck is being used in a multi-shift or heavy duty operation, they should be checked every six months.

1. Inspect the forks carefully for cracks. Special attention should be given to the heel section (A), all weld areas and mounting brackets (B). Inspect the top and bottom hooks on forks used on hook type carriages and tubes on shaft mounted forks.

Forks with cracks should be removed from service. "Wet Test" magnetic particle inspection is generally preferred due to its sensitivity and the ease of interpreting the results. Portable equipment is usually recommended so it can be moved to the lift truck.

Inspectors should be trained and qualified in accordance with The American Society for Non Destructive Testing, Level II Qualifications.

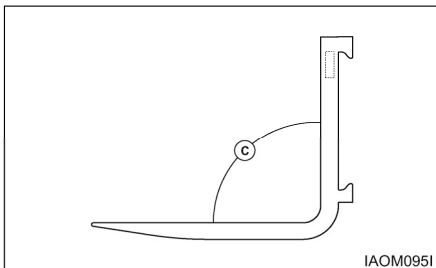

2. Check the angle between the upper face of the blade and the front face of the shank. The fork should be withdrawn from service if angle (C) exceeds 93 degrees or deviates by more than 3 degrees from an original angle other than 90 degrees, as may be found in some special application forks.

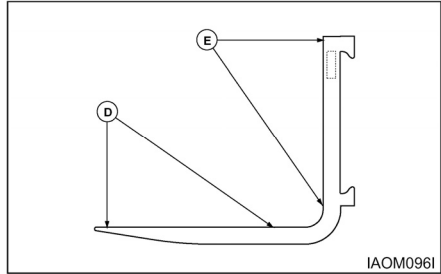

3. Check the straightness of the upper face of blade (D) and the front face of shank (E) with a straight edge.

The fork should be withdrawn from service if the deviation from straightness exceeds 0.5 percent of the length of the blade and/or the height of the shank respectively 5 mm/1000 mm (0.18"/36").

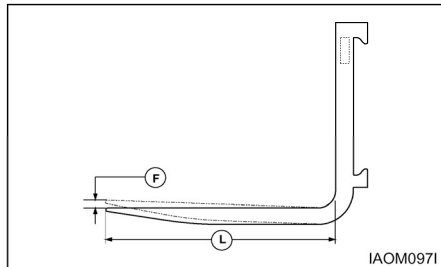

4. Check the difference in height of one fork tip to the other when mounted on the fork carrier. A difference in fork tip height can result in uneven support of the load and cause problems with entering loads.

The maximum recommended difference in fork tip elevation (F) is 6.5 mm (0.25") for pallet forks and 3 mm (0.125") for fully tapered forks. The maximum allowable difference in fork tip elevation between the two or more forks is 3 percent of blade length (L).

Replace one or both forks when the difference in fork tip height exceeds the maximum allowable difference. Contact your local CROWN Lift Truck Branch for further information.

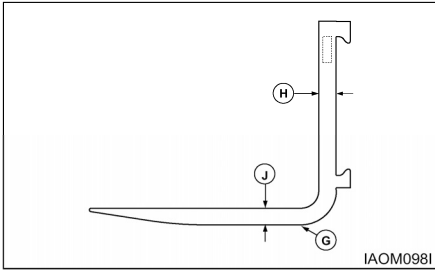

5. Check the fork blade (J) and shank (H) for wear with special attention to the heel (G). The fork should be withdrawn from service if the thickness is reduced to 90 percent or less of the original thickness.

Fork blade length may also be reduced by wear, especially on tapered forks and platens. Remove the forks from service when the blade length is no longer adequate for the intended loads.

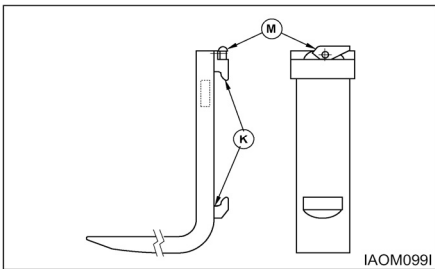

6. Check the fork mountings (K) for wear, crushing and other local deformation, which can cause excessive side to side wobble of the forks. Excessive clearance on hook type forks may allow them to fall from the carrier. Forks which show visible signs of such damage should be removed from service.
7. Check the positioning lock and other fork retention devices to make sure they are in place and working.

Hook type forks use a spring loaded pin (M), located in the top hook, to engage notches in the top carriage bar to hold the fork in place.

When adjusting the fork spacing, the forks are prevented from sliding off the end of the carriage by stop blocks. These stop blocks are at both ends of the carriage and in the path of the bottom fork hook. The load backrest extension may be used in place of the stop blocks in some cases.

Shaft mounted forks may use set collars or spacers on the shaft to either side of the fork. They may also use U bolts, pins, or similar devices which engage the fork through the top structure of the carriage.

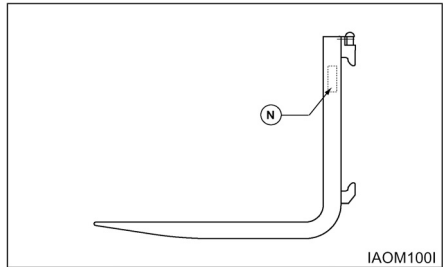

8. Check fork markings (N) for legibility. Renew markings as required to retain legibility.
9.
 - a. Lift the mast and operate the tilt control lever, until the top surface of the forks is parallel with the floor. Place two straight bars that are the same width as the carriage, across the forks as shown.
 - b. Measure the distance from the bottom of each end of the two bars to the floor. The forks must be parallel within 3 mm (.12 in) for Full Tapered and Polished (FTP) forks, all other forks 6.4 mm (.25 in), for their complete length.
 - c. Put one fork, one third from the tip, under a fixture that will not move. Then operate the tilt control with caution until the rear of the truck lifts just off the floor. Follow the same procedure with the second fork. Repeat Step a.

Every 2500 Service Hours or 15 Months

You must read and understand the warnings and instructions contained in the Safety section of this manual, before performing any operation or maintenance procedures.

Hydraulic Oil - Check, Clean, Change

⚠ WARNING

Hot oil and components can cause personal injury. Do not allow hot oil or components to contact skin.

Park the lift truck level with the forks lowered, mast tilted back (all cylinders retracted), parking brake engaged, transmission in NEUTRAL and the engine stopped.

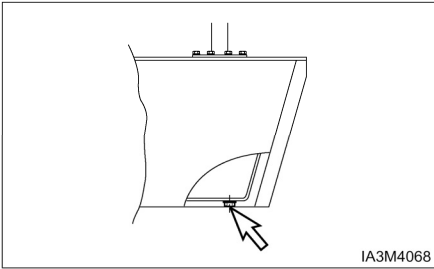

1. Remove the hydraulic tank drain plug. Allow the oil to drain. Clean and install the plug.
2. Raise the hood and seat assembly.
3. Remove dipstick/filter cap. Fill the hydraulic tank. See "Refill Capacities." Install the breather/dipstick.
4. Lower the hood and seat assembly.
5. Start the engine and operate the hydraulic controls, and the steering system, through a few cycles to fill the lines. Look for oil leaks.

⚠ WARNING

If boxcar special(BCS) counter weight equipped, make sure to swing out down LP tank cradle before open the hood. (Pic. page 53)



6. Stop the engine and check the oil level. With all cylinders retracted, maintain the oil level to the FULL mark on the dipstick.

Inspect Battery System

1. Clean battery outer surfaces with a mixture of baking soda and water.
2. Inspect battery outer surfaces for damage and replace as necessary.
3. Remove battery cable and clean, repair and/or replace as necessary.



Checking the TMAP Sensor (PSI 4X only)

1. Verify that the TMAP sensor (2) is mounted tightly into the manifold adapter (3), with no leakage.
2. If the TMAP is found to be loose, remove the TMAP retaining screw and the TMAP sensor from the manifold adapter.
3. Visually inspect the TMAP O-ring seal for damage. Replace as necessary.
4. Apply a thin coat of an approved silicon lubricant to the TMAP o-ring seal.
5. Re-install the TMAP sensor into the manifold adapter and securely tighten the retaining screw.

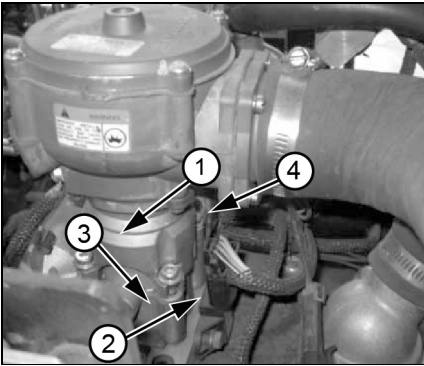

6. (1) Adapter-Throttle body, (2) TMAP sensor, (3) Adapter-Manifold, (4) Throttle body

Replace PCV Valve and breather element - Change (PSI 4X only)

1. Loosen the hose clamps and remove the PCV valve.
2. Assemble new PCV valve and hose.
3. Tighten the hose clamps



Inspect for Intake Leaks

1. Visually inspect the intake manifold, throttle assembly (4), and manifold adapters (3), for looseness and leaks. Repair as necessary.

Replace Oxygen Sensor (PSI 4X only)

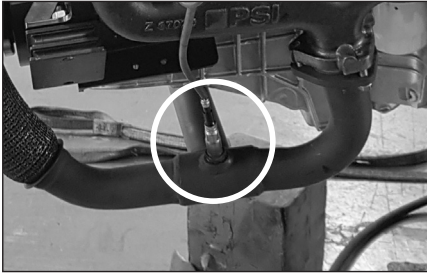

Exhaust Tube



Muffler Ass'y

When indicated by MIL, replace oxygen sensors on the exhaust tube and muffler assembly.

1. Stop engine and wait until the exhaust pipe and exhaust pipe is cooled.
2. Disconnect the electrical connector of oxygen sensor.
3. Remove oxygen sensor.
4. Assemble new oxygen sensor Tightening torque :
45 N·m (32.5 lb·ft)
5. Connect the electrical connector of oxygen sensor.

Every 3000 Service Hours or 36 Months

You must read and understand the warnings and instructions contained in the Safety section of this manual, before performing any operation or maintenance procedures

DEF/Ad-Blue Supply module filter replacement (D34P Engine Only)

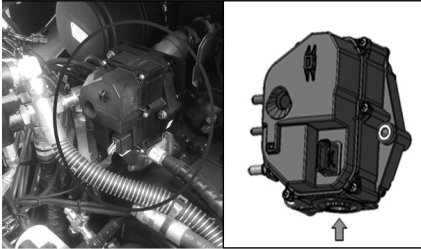

1. Loosen the supply module plug located on the inside of frame step (LH).
2. Remove the filter element from the supply module.
3. Insert a new filter element.
4. Fasten with the supply module plug.

For more details, refer to the "engine service manual"

Replace of LPG Fuel hose and clamp bands (WG3800 Engine)

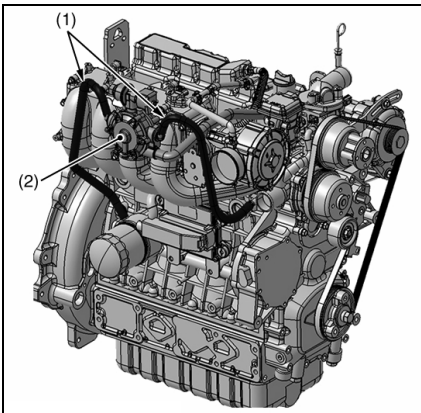

(1) Coolant Hose (2) Vaporizer

1. Replace the fuel hose and the clamps.

Replace of coolant hose of vaporizer (WG3800 Engine)

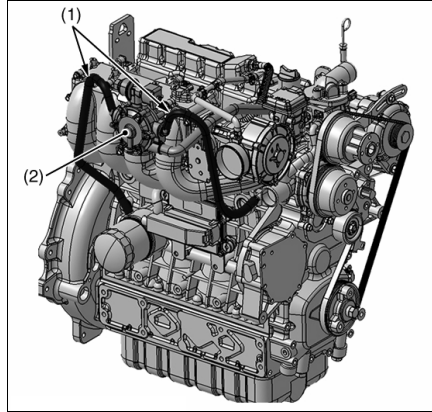

(1) Coolant Hose (2) Vaporizer

1. Connect the new coolant hose (1) to the vaporizer (2).
2. Fill the coolant to radiator, and bleed the air from the vaporizer(2).

Check of LPG vaporizer (WG3800 Engine)

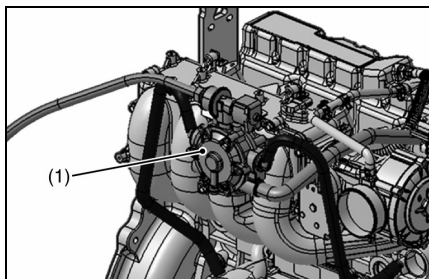

(1) Vaporizer

1. Connect the diagnostic tool (EDIS), and key on, engine off.
2. Check whether the DTC appear or not.
3. Check that the LPG / Natural gas fuel tank has a minimum 1/4 tank of fuel, and manual valve is open.
4. Connect a pressure gauge to the primary test port of vaporizer.
5. Key on and engine start.
6. Measure the pressure of test port.

If the measurement value is out of factory specification, replace the vaporizer.

Test port pressure	Factory specification	14 to 24 kPa 0.15 to 0.24 kgf/cm ² 2.1 to 3.4 psi
--------------------	-----------------------	--

NOTICE

After checking, connect the test plug and check the gas leak with bubbles or leak checker or equivalent during engine running.

Recommended pressure gauge range is 0 to 69 kPa (0 to 10 psi).

Use 3/16 hex socket head screw for test port plug.

Replace of lockoff valve filter (WG3800 Engine)

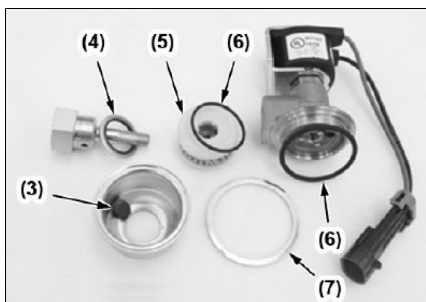
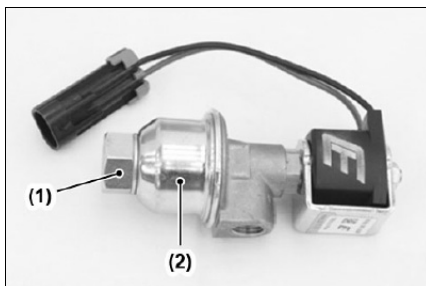

(1) Fitting Union, (2) Filter Chamber, (3) Magnet
(4) Seal, (5) Lockoff Valve Filter, (6) O-ring
(7) Spacer Ring

Replacement of Lockoff Valve Filter

1. Remove the fitting union (1) and open the filter chamber (2).
2. Replace lockoff valve filter (5), magnet (3), seal (4) and O-rings (6).
3. Reassemble lockoff valve filter (5), magnet (3), seal (4), O-rings (6) and the filter chamber (2).
4. Tighten the fitting union (1) at specific torque.

Tightening torque	Fitting union	11.2 to 12.8 N·m 1.15 to 1.30 kgf·m 8.26 to 9.44 lbf·ft
-------------------	---------------	---

NOTE: When reassemble the spacer ring, be careful of the direction.

Environment Protection

When servicing this lift truck, use an authorized servicing area and an approved container to collect coolant, oil, fuel, grease, electrolyte and any other potential environmental pollutant before any lines, fittings or related items are disconnected or removed. After servicing, dispose of those materials in an authorized place and container. When cleaning the lift truck, be sure to use an authorized area.

Index

#

12 Months Inspection 126

A

Accelerator Pedal 58
 Additional Technical Fuel Requirements 131
 Adjustments 103
 Advanced Diagnostics (PSI 4.3L LP Engine) 80
 After Starting the Engine 65
 Air-205 kPa (30 psi) Maximum Pressure 141
 Air Cleaner Indicator - Check 149
 Air Intake System - Check, Clean 140
 Air Intake System – Change 159
 Antifreeze 130
 Attachment Abbreviations (Includes Special Forks)
 48
 Auto Shift Controller ASC - 206 (If Equipped) 103
 Automatic mode 104
 Avoiding Lift Truck Tipovers 21

B

Basic Troubleshooting (LP) 68
 Batteries 15
 Battery Terminal - Clean, Inspect 147
 Before Operating the Lift Truck 12
 Before Starting the Engine 62
 Before Starting the Lift Truck 11
 Before Storage 114
 Belts - Change (WG3800 Engine) 160
 Belts - Check, Adjust (WG3800 only) 154
 Bent or Twisted Forks 124
 Bio-Diesel Fuels 132
 Brake Fluid 134
 Brake Oil Level - Check 151
 Burn Prevention 15

C

Capacity Chart (With Side Shifter) 38, 39, 40, 41
 Capacity Chart (Without Side Shifter) .. 42, 43, 44, 45
 Carriage Chain Adjustment 169
 Carriage Roller Extrusion - Check, Adjust 147
 Carriage Side Rollers - Lubricate 164
 Carriage Side Rollers Thrust (If Equipped) -
 Lubricate 162
 Carriage Sideshifter (If Equipped) – Lubricate 163

Causes of Fork Failure 124
 Center of Gravity (CG) 21
 Changing LP Tanks 60
 Changing Primary Element 159
 Changing Secondary Element 159
 Chassis Pivot Eyebolts 161
 Check Coolant Level 148
 Check for Equal Tension 169
 Check Inflation and Damage 146
 Check of LPG vaporizer (WG3800 Engine) 186
 Checking Element 142
 Checking Service Indicator 149
 Checking the TMAP Sensor (PSI 4X only) 183
 Circuit Breaker 145
 Circuit Breaker 54
 Circulation Pump Belt (OCDB & LP Engine Only. If
 Equipped) - Check, Adjust 164
 Cleaning Primary Filter Elements 141
 Coolant Information 129
 Coolant Level - Check, Clean 148
 Coolant Water 130
 Coolant 15
 Cooling System - Clean, Change 177
 Cooling System Specifications 129
 Crosshead Rollers - Inspect 162
 Crushing or Cutting Prevention 14
 Cylinder Rod Extension 161

D

Daily Inspection 125
 DEF/Ad-Blue Supply module filter replacement
 (D34P Engine Only) 185
 Detergent 142
 Diagnostics Features 104
 Diesel Fuel Specifications 131
 Direction Control Lever 58
 Direction Inhibit Point (SW2) 103
 Disassembly 173
 Display for Operator 104
 Display for Troubleshooting 104
 Drive axle – Inspect 171
 Drive Wheels 166

E

Electrical Disconnect Switch (If Equipped) 53
 Electronic Controlled Spark-Ignition Engines 66
 Electronic Parking Brake 59
 EMS schematic of PSI 4.3L LP engine / Kubota
 WG3800 LP engine 67
 Engine Compartment 53
 Engine Oil – Change (WG3800 Engine only) 153
 Engine Oil & Filter – Change 158
 Engine Oil & Filter Change (WG3800 Engine) 159

Engine Oil (DEO and EO).....	133
Engine Oil Level - Check	148
Environment Management.....	3
Environment Protection.....	123, 187
Every 10 Service Hours or Daily	148
Every 1000 Service Hours or 6 Months	167
Every 1500 Service Hours or 9 Months	172
Every 2000 Service Hours or Yearly	176
Every 250 Service Hours or Monthly	158
Every 2500 Service Hours or 15 Months	182
Every 3000 Service Hours or 36 Months.....	185
Every 500 Service Hours or 3 Months	159

F

Falling Objects Protective Structure(FOPS).....	14
Fan Belt Tension	154
Fatigue	124
Features	103
Fire or Explosion Prevention.....	15
First 50 - 100 Service Hours or a Week.....	153
First Installation.....	125
Fluid Penetration	14
Foreword	2
Fork – Inspect	180
Fork Inspection	125
Fuel Filter (LP Engine Only)	173
Fuel Lines & Fittings - Check.....	167
Fuel Specifications	131
Function description.....	52
Fuses.....	143
Fuses, Bulbs & Circuit Breaker - Change, Reset.	143

G

General Fuel Information	131
General Hazard Information	9
General Warnings to Operator	6

H

Hand Placement Warning.....	7
Hook - on type Fork.....	113
Horn & Lights (If Equipped) – Check	164
How to Fix Forklift to a Carrier.....	116
How to Survive in a Tipover (If Operator Restraint System Equipped)	29
Hydraulic Jack & Jack Stand Capacity	121
Hydraulic Jack Capacity.....	121
Hydraulic Oil - Check, Clean, Change	182
Hydraulic Oil (HYDO).....	133
Hydraulic Oil Level – Check.....	152
Hydraulic Return Filter - Change	168

I

Identification, Lift Capacity and Attachment Plate .	47
If Convenience Package Equipped.....	47
If Optional Suspension Seat (weight adjusting type) Equipped	18
If Parking Brake Alarm Equipped.....	112
Important Safety Information.....	4
Improper Modification or Repair.....	124
Inching into Loads	106
Inching.....	101
Index	188
Inspect Acceleration Pedal Operation	149
Inspect Battery System	182
Inspect Coolant Hoses (LP Engines Only)	167
Inspect Electrical System	165
Inspect Engine for Exhaust Leaks	149
Inspect Engine for Fluid Leaks.....	148
Inspect for Intake Leaks.....	183
Inspect Ignition System (PSI 4X only)	172
Inspect Mixer Assembly.....	167
Inspect Throttle Assembly	167
Inspect Tightness	166, 171
Inspection, Maintenance and Repair of Lift Truck Forks	123
Instrument Panel	49

J

Jacking Information	121
Jacking Procedure	122

L

Lift Chain Adjustment.....	169
Lift Chain Wear Test	168
Lift Chains - Test, Check, Adjust.....	168
Lift Control	59
Lift Fork Adjustment.....	113
Lift Truck Capacity Rating	48
Lift Truck Controls.....	58
Lift Truck Operation	100
Lift Truck Parking	13
Lift Truck Shipping	115
Lift Truck Stability Base	22
Lift Truck Stability	21
Lifting a Forklift using a Crane	116
Lifting Drums or Round Objects.....	109
Lifting the Load.....	106
Literature Information	2
Load Backrest Must Be In Place Warning.....	7
Loading or Unloading Trucks/Trailers.....	13
Long Time Storage.....	114

Low-High Shift Point (SW1).....	103
LP Engine Crankcase (PSI 4X Engine only)	158
LP Engine.....	64
LP Regulator/Converter Inspection	167
LP Specifications	131
LPG (12V)	65
Lubricant Information.....	133
Lubricant Specifications	133
Lubricant Viscosities and Refill Capacities	135
Lubricant Viscosities.....	135
Lubricating Grease (MPGM).....	134

M

Machine Lifting and Tiedown Information.....	115
Maintenance and Repair	126
Maintenance Information	14
Maintenance Intervals	3, 136
Maintenance	3
Make proper antifreeze additions	130
Malfunction Indicator Lamp (MIL) Operation	82
Manual Mode (Fail-Safe mode).....	105
Mast Abbreviations	48
Mast Chain Adjustment - FF, FFT Mast.....	170
Mast Channels – Lubricate	151
Mast Hinge Pins – Lubricate.....	162
Mast Pivot Eyes.....	161
Mast, Carriage, Lift Chains, & Attachments - Check, Lubricate.....	163
Metric Hardware	127
Metric ISO2 Tread	128
Mono-Ped Control System (Option).....	102
Mounting and Dismounting	11
Moving Fan Warning	8

N

No Standing On Forks Warning, No Standing Under Forks Warning	7
Noise and Vibration	37
Noise	37

O

Oil Cooled Disc Brake Only.....	134
Oils.....	15
Operating in hot weather.....	109
Operating Techniques.....	106
Operating the Lift Truck.....	12
Operation Information	11
Operation	2, 104
Operator's Warning and Identification Plate	47
Operator Restraint System (If Equipped).....	2
Operator Restraint System	17

Operator's Station and Monitoring Systems.....	49
Operator's Warning Plate	47
Overhead Guard – Inspect	165
Overhead Guard Must Be In Place Warning.....	8
Overloading	124

P

Parking Brake - Inspect	156
Parking Brake - Test, Adjust.....	163
Parking brake	9
Parking the Lift Truck	111
PCV Valve - Check (WG3800 Engine).....	171
Power Shift Transaxle.....	100
Pressure Air.....	14
Pressure Warning	7
Prestart Conditions.....	64
Product Description.....	103
PSI 4.3L LP Engine / Kubota WG3800 LP engine 66	

R

Refill Capacities.....	135
Refueling.....	60
Replace LP Fuel Filter Element	173
Replace of coolant hose of vaporizer (WG3800 Engine).....	185
Replace of lockoff valve filter (WG3800 Engine) .	186
Replace of LPG Fuel hose and clamp bands (WG3800 Engine)	185
Replace Oil Separator (WG3800 Engine only)	174
Replace Oxygen Sensor (PSI 4X only)	184
Replace PCV Valve and breather element - Change (PSI 4X only)	183
Replace Spark plug (WG3800 Engine only)	179
Replace Spark Plugs (PSI 4X only)	172
Replacement of Lockoff Valve Filter	186
Replacement of Oil Filter Cartridge	153, 160
Replacement of Oil Separator Element.....	174

S

Safety instructions for attachments when transporting suspended loads	110
Safety instructions for attachments when transporting wide loads	110
Safety Rules	23
Safety	2, 5
Seat Adjustment.....	17
Seat Switch System (If Equipped)	57
Seat, Hood Latch & Support Cylinder - Check, Lubricate	143
Serial Number Locations	46
Serial Number.....	46

Servicing Filter Element	140
Side.....	122
Sideshift Attachment Control (If Equipped)	59
Spark Plug - Cleaning (WG3800 only).....	157
Specifications.....	30, 33
Stability and Center of Gravity	21
Starting From a 12 Volt External Source	65
Starting the Engine	64
Starting the Lift Truck	12
Steer Suspension - Inspect.....	165
Steer Wheel Bearings -Reassemble	176
Steering Knob (If Equipped)	102
Steering Mechanism - Check, Lubricate	166
Steering Wheel	122
Storage Information.....	114

T

Table of Contents	1
Test Fuel System for Leaks (LP Engine Only)	142
Testing Fuel Lock-off Operation	174
Tilt Control.....	59
Tilt Cylinders - Check, Adjust, Lubricate.....	161
Tires and Wheels - Check, Inspect	146
To Operate the Lift Truck After a Long Time Storage	114
Torque for Metric Fasteners	128
Torque for Standard Bolts, Nuts, and Taperlock Studs	127
Torque for Standard Hose Clamps – Worm Drive	127
Torque Specifications.....	127
Torques for Bolts and Nuts With Standard Threads	127
Torques for Taperlock Studs	128
Towing Information	117
Training Required to Operate or Service Warning... 5	
Transmission & Drive axle Oil Level - Check	151
Transmission & Drive axle Oil	134
Transmission & Drive axle Oil, Oil Filter - Change	155, 178
Transmission Inching Control Pedal	58
Transportation Hints	115
Traveling With the Load	107
Turning	108

U

Universal Joint - Inspect.....	170
Unloading	107

V

Valve Clearance - Check (WG3800 Engine only) 175	
Vibration(weighted overall value)	37

W

Walk - Around Inspection - Inspect.....	150
Walk - Around Inspection	62
Warning Signs and Labels.....	5, 17
Water-280 kPa (40 psi) Maximum Pressure	142
Weight Scale Option (Load Cell Type)	55
Wheel Bolts and Nuts – Inspect.....	166
When Required	140