



Operation & Maintenance Manual

FORKLIFTS

CGC35S-5, CGC40S-5, CGC45S-5
CGC50C-5, CGC55C-5

FGB0A, FGB0B, FGB0C, FBGB0D, FGB0E
PSI 4.3L Tier-3



Crown New Bremen OH 45869 USA
Please visit Crown.com to locate a Crown Dealer near you.

www.crown.com



MOCGC-35S--51216

Operation & Maintenance Manual

CROWN CGC35/40/45S-5, CGC50/55C-5

Operation & Maintenance Manual

MOCGC-35S--51216

CGC35S-5, CGC40S-5, CGC45S-5, CGC50C-5, CGC55C-5
FGB0A, FGB0B, FGB0C, FBGB0D, FGB0E
PSI 4.3L Tier-3



Forklifts



WARNING

A MOVING VEHICLE CAN BE DANGEROUS

You or others around you can be seriously injured or even killed if you are not careful or don't know how to use this truck correctly.

Do not operate this truck unless you are trained and authorized.

Read and obey all warnings and instructions in this Manual* and on the truck.

Make sure the truck is in good working order.

Head, arms, hands or legs outside the operator area can be pinned or crushed when ever the truck is moving. Stay within the operator area and stop completely before getting off.

A dockboard can move or drop while you are on it. Or you could drive off a dock. Falls from docks or dockboards can cause serious injury or even death. Make sure you are safe.

* Additional copies of this Operator Manual and all Truck Labels can be obtained from Crown Equipment Corporation New Bremen, Ohio 45869 U.S.A.

Table of Contents

Information Section

Foreword	2
----------------	---

Safety Section

Important Safety Information	4
Safety	5
Warning Signs and Labels	5
General Hazard Information	10
Operation Information	11
Maintenance Information	14
Burn Prevention	15
Fire or Explosion Prevention	15
Operator Restraint System (If Equipped)	17
Avoiding Lift Truck Tipovers	21
Safety Rules	23
How to Survive in a Tipover (If Operator Restraint System Equipped)	29

General Section

Declaration of Conformity	30
Specifications	31
Noise and Vibration	33
Capacity Chart (Not used in Australia)	34
Capacity Chart (with Side Shifter) (Not used in Australia)	35
Serial Number	38
Operator's Warning and Identification Plate	39

Operation Section

Operator's Station and Monitoring Systems	41
Seat Switch System (If Equipped)	45
Lift Truck Controls	46
Refueling	49
Before Starting the Engine	51
Starting the Engine	53
Lift Truck Operation	84
Mono-Ped Control System (Option)	86
Auto Shift Controller ASC - 206 (Standard)	87
Operating Techniques	90
Parking the Lift Truck	94
Lift Fork Adjustment	95
Storage Information	96
Transportation Hints	97
Towing Information	99

Maintenance Section

Jacking Information	100
Inspection, Maintenance and Repair of Lift Truck Forks	102
Torque Specifications	106
Cooling System Specifications	108
Fuel Specifications	110
Lubricant Specifications	111
Lubricant Viscosities and Refill Capacities	113
Maintenance Intervals	114
When Required	118
Every 10 Service Hours or Daily	122
First 50 - 100 Service Hours or a Week	128
Every 250 Service Hours or Monthly	133
Every 500 Service Hours or 3 Months	134
Every 1000 Service Hours or 6 Months	143
Every 1500 Service Hours or 9 Months	148
Every 2000 Service Hours or Yearly	151
Every 2500 Service Hours or 15 Months	155

Environment Protection Section

Environment Protection	157
------------------------------	-----

Index Section

Index	158
-------------	-----

Foreword

Literature Information

This manual should be stored in the operator's compartment in the literature holder or seat back literature storage area.

This manual contains safety, operation, transportation, lubrication and maintenance information.

Some photographs or illustrations in this publication show details or attachments that can be different from your lift truck. Guards and covers might have been removed for illustrative purposes.

Continuing improvement and advancement of product design might have caused changes to your lift trucks which are not included in this publication.

Read, study and keep this manual with the lift truck.

Whenever a question arises regarding your lift truck, or this publication, please consult your CROWN dealer for the latest available information.

Safety

The Safety Section lists basic safety precautions. In addition, this section identifies the text and locations of warning signs and labels used on the lift truck. Read and understand the basic precautions listed in the Safety Section before operating or performing lubrication, maintenance and repair on this lift truck.

Operator Restraint System (If Equipped)

This manual contains safety, operation and maintenance information for the CROWN operator restraint system. Read, study and keep it handy.

 **WARNING**

Your CROWN truck comes equipped with an operator restraint system. Should it become necessary to replace the seat for any reason, it should only be replaced with another CROWN operator restraint system.

Photographs or illustrations guide the operator through correct procedures of checking, operation and maintenance of the CROWN operator restraint system.

SAFE and EFFICIENT OPERATION of a lift truck depends to a great extent on the skill and alertness on the part of the operator. To develop this skill the operator should read and understand the Safe Driving Practices contained in this manual.

Forklift trucks seldom tipover, but in the rare event they do, the operator may be pinned to the ground by the lift truck or the overhead guard. This could result in serious injury or death.

Operator training and safety awareness is an effective way to prevent accidents, but accidents can still happen. The CROWN operator restraint system can minimise injuries. The CROWN operator restraint system keeps the operator substantially within the confines of the operator's compartment and the overhead guard.

This manual contains information necessary for Safe Operation. Before operating a lift truck make sure that the necessary instructions are available and understood.

Operation

The Operation Section is a reference for the new operator and a refresher for the experienced one. This section includes a discussion of gauges, switches, lift truck controls, attachment controls, transportation and towing information.

Photographs and illustrations guide the operator through correct procedures of checking, starting, operating and stopping the lift truck.

Operating techniques outlined in this publication are basic. Skill and techniques develop as the operator gains knowledge of the lift truck and its capabilities.

Maintenance

The Maintenance Section is a guide to equipment care. The illustrated, step-by-step instructions are grouped by servicing intervals. Items without specific intervals are listed under “When Required” topics. Items in the “Maintenance Intervals” chart are referenced to detailed instructions that follow.

Maintenance Intervals

Use the service hour meter to determine servicing intervals. Calendar intervals shown (daily, weekly, monthly, etc.) can be used instead of service hour meter intervals if they provide more convenient servicing schedules and approximate the indicated service hour meter reading. Recommended service should always be performed at the interval that occurs first.

Under extremely severe, dusty or wet operating conditions, more frequent lubrication than is specified in the “Maintenance Intervals” chart might be necessary.

Perform service on items at multiples of the original requirement. For example, at “Every 500 Service Hours or 3 Months”, also service those items listed under “Every 10 Service Hours or Daily”.

Environment Management

Note that the Crown internal combustion engine lift trucks are manufactured under ISO 14001 system which is harmonized with ISO 9001. Periodic ENVIRONMENTAL AUDITS & ENVIRONMENTAL PERFORMANCE EVALUATIONS have been made by internal and external inspection entities. LIFE-CYCLE ANALYSIS has also been made throughout the total product life. ENVIRONMENT MANAGEMENT SYSTEM includes DESIGN FOR ENVIRONMENT from the initial stage of the design.

ENVIRONMENT MANAGEMENT SYSTEM considers environmental laws & regulations, reduction or elimination of resource consumption as well as environmental emission or pollution from industrial activities, energy saving, environment-friendly product design (lower noise, vibration, emission, smoke, heavy metal free, ozone depleting substance free, etc.), recycling, material cost reduction, and even environmentally oriented education for the employee.

Important Safety Information

Most accidents involving product operation, maintenance and repair are caused by failure to observe basic safety rules or precautions. An accident can often be avoided by recognizing potentially hazardous situations before an accident occurs. A person must be alert to potential hazards, and use common sense. Persons must also have the necessary training, skills and tools before attempting to perform these functions.

Improper operation, lubrication, maintenance or repair of this product can be dangerous and could result in injury or death.

Do not operate or perform any lubrication, maintenance or repair on this product, until you have read and understood the operation, lubrication, maintenance and repair information.

Safety precautions and warnings are provided in this manual and on the product. If these hazard warnings are not heeded, bodily injury or death could occur to you or other persons.

The hazards are identified by the "Safety Alert Symbol" and followed by a "Signal Word" such as "WARNING" as shown below.



The meaning of this safety alert symbol is as follows:

Attention! Become Alert! Your Safety is Involved.

The message that appears under the warning, explaining the hazard, can be either written or pictorially presented.

Operations that may cause product damage are identified by NOTICE labels on the product and in this publication.

CROWN cannot anticipate every possible circumstance that might involve a potential hazard, and common sense is always required. The warnings in this publication and on the product are therefore not all inclusive. Before any tool, procedure, work method or operating technique not specifically recommended by CROWN is used, you must be sure that it is safe for you and others. You should also ensure that the product will not be damaged or made unsafe by the operation, lubrication, maintenance or repair procedures you choose.

The information, specifications, and illustration in this publication are on the basis of information available at the time it was written. The specifications, torques, pressures, measurements, adjustments, illustrations, and other items can change at any time. These changes can affect the service given to the product. Obtain the complete and most current information before starting any job. CROWN dealers have the most current information available.

Safety

The safety rules and regulations in this section are representative of some, but not all rules and regulations that apply to lift trucks. Rules and regulations are paraphrased without representation that they have been reproduced verbatim.

These fork lift trucks are built to meet Australian Standard AS2359 for Powered Industrial Trucks, American National Standard, ANSI B56.1 Safety Standard for Low Lift and High Lift Trucks. Since regulations vary from country to country, operate this lift truck in accordance with local regulations.

CROWN lift trucks are manufactured in accordance with the National Fire Protection Association (NFPA) No. 505 and the American National Standards Institute, Inc. / Industrial Truck Standards Development Foundation (ANSI/ITSDF) B56.1, Safety Standard for Low and High Lift Trucks and, for European models, according to the regulations and standards laid down in EU Machinery Directive 2006/42/EC and EMC directive 2014/30/EU.

The most effective method of reducing the risk of serious injury or death to you or others is for you to know how to properly operate this lift truck, to be alert and to avoid actions or conditions that could cause accidents.

Do not operate a lift truck if it is in need of maintenance, repair or appears to be unsafe in any way. Report all unsafe conditions immediately to your supervisor, then contact your authorised lift truck dealer. Do not attempt any adjustments or repairs unless trained and authorised to do so.

Warning Signs and Labels

There are several specific safety signs on your lift truck. Their exact location and description of the hazard are reviewed in this section. Please take the time to familiarise yourself with these safety signs.

Make sure that you can read all warning and instruction labels. Clean or replace these labels if you cannot read the words or see the pictures. When cleaning the labels use a cloth, water and soap. Do not use solvent, gasoline, etc.

You must replace a label if it is damaged, missing or cannot be read. If a label is on a part that is replaced, make sure a new label is installed on the replaced part. See your dealer for new labels.

Training Required to Operate or Service Warning



Located on the OVHG.



Improper operation or maintenance could result in injury or death. Do not operate or work on the lift truck unless you are properly trained. Read and understand the Operation and Maintenance Manual. Additional manuals are available from CROWN Lift Truck dealers.

This label also provides allowable lift truck capacity information.

CROWN		MODEL	SERIAL NO.	TYPE	INDUSTRIAL TRUCK																														
WARNING IMPROPER OPERATION OR MAINTENANCE COULD RESULT IN INJURY OR DEATH. READ AND UNDERSTAND THE OPERATION AND MAINTENANCE MANUAL BEFORE OPERATING.		INDEX	HEAD	LIFT	NO																														
73551 CROWN 12 10 2017/10/10 11:51 		<table border="1"> <thead> <tr> <th colspan="2">BACK TILT</th> <th colspan="2">LIFT TYPE</th> <th colspan="2">TIRE TYPE</th> </tr> <tr> <th>TYPE</th> <th>TRUCK</th> <th>TYPE</th> <th>PRESS</th> <th>TYPE</th> <th>SIZE</th> </tr> </thead> <tbody> <tr> <td>IN (F)</td> <td></td> <td>PST</td> <td></td> <td>SPA (F)</td> <td></td> </tr> <tr> <td>IM (H)</td> <td></td> <td>PSI</td> <td></td> <td>SPA (H)</td> <td></td> </tr> </tbody> </table>				BACK TILT		LIFT TYPE		TIRE TYPE		TYPE	TRUCK	TYPE	PRESS	TYPE	SIZE	IN (F)		PST		SPA (F)		IM (H)		PSI		SPA (H)							
BACK TILT		LIFT TYPE		TIRE TYPE																															
TYPE	TRUCK	TYPE	PRESS	TYPE	SIZE																														
IN (F)		PST		SPA (F)																															
IM (H)		PSI		SPA (H)																															
090209-07445 ENGLISH		<table border="1"> <thead> <tr> <th colspan="2">ATTACH</th> <th colspan="2">L.D.</th> <th colspan="2">CAPACITY</th> </tr> <tr> <th>X</th> <th>Z</th> <th>C</th> <th>D</th> <th>IN</th> <th>LB</th> </tr> </thead> <tbody> <tr> <td>IN</td> <td>CN</td> <td>CN</td> <td>D</td> <td>IN</td> <td>LB</td> </tr> <tr> <td>IM</td> <td>IM</td> <td>IM</td> <td>IM</td> <td>IM</td> <td>KG</td> </tr> <tr> <td></td> <td></td> <td></td> <td></td> <td>IM</td> <td>KG</td> </tr> </tbody> </table>				ATTACH		L.D.		CAPACITY		X	Z	C	D	IN	LB	IN	CN	CN	D	IN	LB	IM	IM	IM	IM	IM	KG					IM	KG
ATTACH		L.D.		CAPACITY																															
X	Z	C	D	IN	LB																														
IN	CN	CN	D	IN	LB																														
IM	IM	IM	IM	IM	KG																														
				IM	KG																														
090209-07445 ENGLISH		MANUFACTURED BY Doosan Corporation Industrial Vehicle Div. FOR CROWN EQUIPMENT CORP. TO ANSI/ITSDF B56.1 crown.com																																	

Located on the front side of the FCU.

General Warnings to Operator



Located on the right side of the operator's seat.

⚠ WARNING

Only trained and authorised personnel may operate this machine. For safe operation, read and follow the operation and maintenance Manual furnished with this lift truck and observe the following warnings:

1. Before starting machine. Check all controls and warning devices for proper operation.
2. Refer to machine identification plate for allowable machine capacity. Do not overload. Operate machines equipped with attachments as partially loaded machines when not handling a load.
3. Put directional control or shift lever in neutral before "ON - OFF" switch is turned on.
4. Start, turn and brake smoothly. Slow down for turns, slippery or uneven surfaces. Extremely poor surfaces should be repaired. Avoid running over loose objects or holes in the roadway surfaces. Use extreme caution when turning on inclines.
5. Travel with load as low as possible and tilted back. If load interferes with visibility, travel with load trailing.
6. On grade operations travel with load up grade.
7. Watch out for pedestrians and obstructions. Check overhead clearances.
8. Do not permit riders on forks or machine at any time.
9. Do not allow anyone to stand or pass under the elevated portion of any machine.
10. Be sure operating surface can safely support machine.
11. Operate machine and attachments only from operator's position.
12. Do not handle unstable or loosely stacked loads.
13. Use minimum tilt when picking up or depositing a load.
14. Use extreme care when handling long, high or wide loads to ensure stability and durability of the truck.
15. Forks should be completely under load and spread apart as far as load permits.
16. Machine should be equipped with overhead guard or equivalent protection. Where load requires it, use load backrest extension. Use extreme caution if operating without these devices.
17. Parking - Lower lifting mechanism to floor. Put directional control or shift lever in neutral. Set parking/secondary brake. Turn "ON - OFF" switch off. Check wheels if machine is on incline. Disconnect battery when storing electric machines.
18. Observe safety rules when handling fuel for engine powered machine and when changing batteries for electric machines.
19. Avoid overuse of the inching pedal as this may cause the automatic transmission oil to overheat or the clutch to slip. Do not use as a footrest or for long periods of time.

If user operates continuously pushing work or both brake pedal and accelerator pedal were depressed at the same time, it may cause the automatic transmission oil to overheat or the clutch to slip.

Pressure Warning

⚠ WARNING

Contents under pressure may be hot. Allow to cool before opening.



Located on the radiator top tank by the radiator cap.

Hand Placement Warning

⚠ WARNING



No hands. Do not place hands in this area. Do not touch, lean on, or reach through the mast or permit others to do so.



Located on the mast.

No Standing On Forks Warning, No Standing Under Forks Warning

⚠ WARNING

Do not stand or ride on the forks. Do not stand or ride on a load or pallet on the forks. Do not stand or walk under the forks.

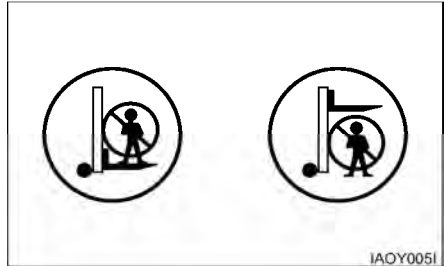

Located on the lift cylinder.

Load Backrest Must Be In Place Warning

⚠ WARNING

Operation without this device in place may be hazardous.



Located on the load backrest.

Overhead Guard Must Be In Place Warning

⚠ WARNING

Operation without this device in place may be hazardous. This guard conforms to A.N.S.I.B56.1 and F.E.M. Section IV. This design has been tested with an impact of (appropriate value).



Located on the Overhead Guard.

Brake Pedal Adjustment Warning

⚠ WARNING

Improper adjustment could result in injury or death. It has to be adjusted by drawing dimension on free condition. For safe, don't unfasten clevis and nut. It has to be adjusted by trained personnel.

(OCDB Type Only)

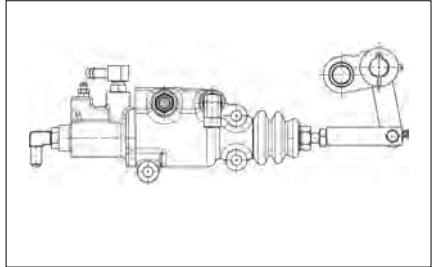

Located inside Brake pedal box.

Parking brake

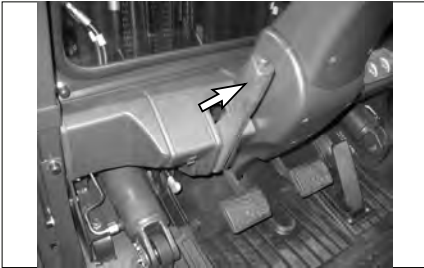

Pull the lever **BACK** to engage the parking brake.



Push the lever **FORWARD** to release the parking brake.

Applying the parking brake puts the transmission in NEUTRAL. The parking brake must be applied when leaving the lift truck and when starting the engine. If the operator leaves the seat without applying the parking brake, an audible alarm will sound.

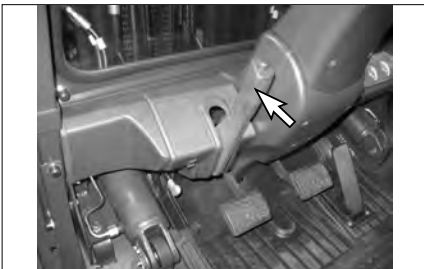

WARNING

When leaving machine apply parking brake!
Parking brake is not automatically applied.
Alarm will sound if parking brake is not applied.

WARNING

Correct adjustment is necessary to provide adequate braking. See the MAINTENANCE section for adjustment procedures. The lift truck may creep at engine idle and can cause damage, injury or death. Always apply the parking brake when leaving the lift truck. The parking brake is NOT automatically applied.

No Riders Warning

WARNING

To avoid personal injury, allow no riders. A lift truck is designed for only one operator and no riders.



Located beside the operator's station.

Moving Fan Warning

WARNING

To avoid personal injury, stay clear of moving fan.



Located on the shroud and upper cover.

General Hazard Information



Attach a "Do Not Operate" or similar warning tag to start switch or controls before servicing or repairing the lift truck.

Do not start or service the lift truck when a "DO NOT OPERATE" or similar warning tag is attached to the start switch or controls.

Wear a hard hat, protective glasses and other protective equipment as required by job conditions.

Know the width of your attachments so proper clearance can be maintained when operating near fences, boundary obstacles, etc.

Do not wear loose clothing or jewelry that can catch on controls or other parts of the lift truck.

Keep the lift truck, especially the deck and steps, free of foreign material such as debris, oil tools and other items which are not part of the lift truck.

Secure all loose items such as lunch boxes, tools and other items which are not part of the lift truck.

Know the appropriate work-site hand signals and who gives them. Accept signals from one person only.

Always use the overhead guard. The overhead guard is intended to protect the lift truck operator from overhead obstructions and from falling objects.

A truck that is used for handling small objects or uneven loads must be fitted with a load backrest.

If the lift truck must be operated without the overhead guard in place due to low overhead clearance, use extreme care. Make sure there is no possibility of falling objects from any adjacent storage or work area. Make sure the load is stable and fully supported by the carriage and the load backrest extension (if equipped).

Do not raise loads any higher than necessary and never raise a load higher than 1830 mm (72 in) with the overhead guard removed.

Always use load backrest extension when the carriage or attachment does not fully support the load.

The load backrest extension is intended to prevent the load or any part of the load from falling backwards into the operator's station.

When operation the lift truck, do not depend only on flashing lights or back-up alarm (if equipped) to warn pedestrians.

Always be aware of pedestrians and do not proceed until the pedestrians are aware of your presence and intended actions and have moved clear of the lift truck and/or load.

Do not drive lift truck up to anyone standing in front of an object.

Obey all traffic rules and warning signs.

Keep hands, feet and head inside the operator station. Do not hold onto the overhead guard while operating the lift truck. Do not climb on any part of the mast or overhead guard or permit others to do so.

Do not allow unauthorised personnel to ride on the forks or any other part of the lift truck, at any time. When working in a building or dock, observe floor load limits and overhead clearances.

Inhaling Freon gas through a lit cigarette or other smoking method or inhaling fumes released from a flame contacting Freon can cause bodily harm or death. Do not smoke when servicing air conditioners or wherever Freon gas may be present.

Never put maintenance fluids into glass containers.

Use all cleaning solutions with care.

Do not use steam, solvent, or high pressure to clean electrical components.

Report all needed repairs.



Inspect the part of the chain that is normally operated over the crosshead roller. When the chain bends over the roller, the movement of the parts against each other causes wears.

Inspect to be sure that chain link pins do not extend outside of the bore hole.

If any single link pin is extended beyond its connecting corresponding link, it should be suspected of being broken inside of its bore hole.

Inspect the chain anchor and the anchor links for wear.

Do not change any factory set adjustment values(including engine rpm setting) unless you have both authorization and training. Especially Safety equipment and switches may not be removed or adjusted incorrectly. Repairs, adjustments and maintenances that are not correct can make a dangerous operating condition.

For any checkup, repair, adjustments, maintenance and all other work concerning your forklift truck, please contact your CROWN dealer. We would like to draw your attention to the fact that any secondary damages due to improper handling, insufficient maintenance, wrong repairs or the use of other than original CROWN spare parts waive any liability by CROWN.

Operation Information

Mounting and Dismounting

Mount and dismount the lift truck carefully.

Clean your shoes and wipe your hands before mounting.

Face the lift truck when mounting and dismounting.

Use both hands face the lift truck when mounting and dismounting.

Use the handgrips for mounting and dismounting.

Do not try to climb on or off the lift truck when carrying tools or supplies.

Never get on or off a moving lift truck.

Do not use any controls as handholds when entering or leaving the operator's station.

Never get on or off a moving lift truck. Never jump off the lift truck.

Keep hands and steering wheel free of slippery material.

Before Starting the Lift Truck

Perform a walk-around inspection daily and at the start of each shift. Refer to the topic "Walk-around Inspection" in "Every 10 Service Hours or Daily" section of this manual.

Adjust the seat so that full brake pedal travel can be obtained with the operator's back against the seat back.

Make sure the lift truck is equipped with a lighting system as required by conditions.

Make sure all hydraulic controls are in the HOLD position.

Make sure the direction control lever is in the NEUTRAL position.

Make sure the parking brake is engaged.

Safety Section

Make sure no one is standing and/or working on, underneath or close to the lift truck before operating the lift truck.

Operate the lift truck and controls only from the operator's station.

Make sure the lift truck horn, lights, backup alarm (if equipped) and all other devices are working properly. Check for proper operation of mast and attachments.

Pay particular attention to unusual noises or erratic movement which might indicate a problem.

Make sure service and parking brakes, steering, and directional controls are operational.

Make sure all personnel are clear of lift truck and travel path.

Refer to the topic "Lift Truck Operation" in the "Operation Section" of this manual for specific starting instructions.



Do not start the engine or move any of the controls if there is a "DO NOT OPERATE" or similar warning tag attached to the start switch or controls.

Before Operating the Lift Truck

Test brakes, steering controls, horn and other devices for proper operation. Report faulty performance.

Do not operate lift truck until repaired.

Learn how your lift truck operates. Know its safety devices. Know how the attachments work.

Before moving the lift truck, look around. Start, turn and brake smoothly.

An operator must constantly observe his lift truck for proper operation.

Operating the Lift Truck

Always keep the lift truck under control.

Obey all traffic rules and warning signs.

Never leave the lift truck with the engine operating, or with the parking brake disengaged.

Operate the engine only in a well ventilated area.

Lower a mast, with or without load, before turning or traveling. Tip over could result. Watch out for overhead obstructions.

Always observe floor load limits and overhead clearance.

Start, turn, and brake smoothly, slow down for turns, grades, slippery or uneven surfaces.

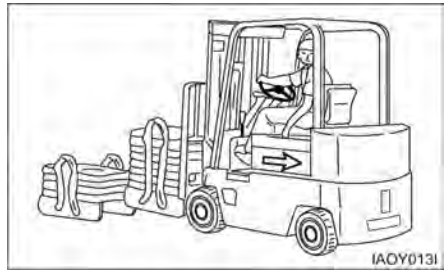

Use special care when operation on grades. Do not angle across or turn on grades. Do not use lift truck on slippery grades. Travel with forks downgrade when unloaded. Travel with load upgrade.

Do not overload, or handle offset, unstable, or loosely stacked loads. Refer to load capacity plate on the lift truck. Use extreme caution when handling suspended, long, high or wide load.



Tilt elevated load forward only when directly over unloading area and with load as low as possible.

Do not stunt ride or indulge in horseplay.

Always look and keep a clear view of the path of travel.

Travel in reverse if load or attachment obstructs visibility.

Use extreme caution if visibility is obstructed.

Stay in designated travel path, clear of dock edges, ditches, other drop-offs and surfaces which cannot safely support the lift truck.

Slow down and use extra care through doorways, intersections and other location where visibility is reduced.

Slow down for and avoid pedestrians, other vehicles, obstruction, pot holes and other hazards or objects in the path of travel.

Always use overhead guards except where operation conditions do not permit. Do not operate lift truck in high stacking areas without overhead guards.

When stacking, watch for falling objects. Use load backrest extension and overhead guard.

Refer to the topic "Operation Techniques" in the "Operation Section" of this manual.

Loading or Unloading Trucks/Trailers

Do not operate lift trucks on trucks or trailers which are not designed or intended for that purpose. Be certain truck or trailer brakes are applied and wheel chocks in place (or be certain unit is locked to the loading dock) before entering onto trucks or trailers.

If trailer is not coupled to tractor, make sure the trailer landing gear is properly secured in place. On some trailers, extra supports may be needed to prevent upending or corner dipping.

Be certain dock plates are in good condition and properly placed and secured. Do not exceed the rated capacity of dock boards or bridge plates.

Lift Truck Parking

When leaving the operator station, park the lift truck in authorised areas only. Do not block traffic.



- Park the lift truck level, with the forks lowered and the mast tilted forward until the fork tips touch the floor.
- Move the direction control lever to NEUTRAL.
- Engage the parking brake.
- Turn the key switch off and remove the key.
- Turn the disconnect switch to OFF and remove the key (if equipped).
- Block the drive wheels when parking on an incline.

Maintenance Information

Perform all maintenance unless otherwise specified as follows ;

- Park the lift truck in authorised areas only.
- Park the lift truck level, with the forks lowered and the mast tilted forward until the fork tips touch the floor.
- Place the transmission controls in neutral.
- Engage the parking brake.
- Stop the engine.
- Remove the start switch key and turn the disconnect switch OFF (if equipped).
- Block the drive wheels when parking on an incline.

Pressure Air

Pressure air can cause personal injury. When using pressure air for cleaning, wear a protective face shield, protective clothing and protective shoes.

The maximum air pressure must be below 205 kPa (30 psi) for cleaning purposes.

Fluid Penetration

Always use a board or cardboard when checking for a leak. Escaping fluid under pressure, even a pinhole size leak, can penetrate body tissue, causing serious injury, and possible death. If fluid is injected into your skin, it must be treated by a doctor familiar with this type of injury immediately.

Crushing or Cutting Prevention

Support equipment and attachments properly when working beneath them. Do not depend on hydraulic cylinders to hold it up. Any attachment can fall if a control is moved, or if a hydraulic line breaks.

Never attempt adjustments while the lift truck is moving or the engine is running unless otherwise specified.

Where there are attachment linkages, the clearance in the linkage area will increase or decrease with movement of the attachment.

Stay clear of all rotating and moving parts.

Keep objects away from moving fan blades.

They will throw or cut any object or tool that falls or is pushed into them.

Do not use a kinked or frayed wire rope cable. Wear gloves when handling the wire rope cable.

Retainer pins, when struck with force, can fly out and injure nearby persons. Make sure the area is clear of people when driving retainer pins.

Wear protective glasses when striking a retainer pin to avoid injury to your eyes.

Chips or other debris can fly off objects when struck. Make sure no one can be injured by flying debris before striking any object.

Falling Objects Protective Structure(FOPS)

This is an attached guard located above the operator's compartment and secured to the lift truck.

To avoid possible weakening of the Falling Objects Protective Structure (FOPS), consult a CROWN dealer before altering, by adding weight to, welding on, or cutting or drilling holes into the structure.

The overhead guard is not intended to protect against every possible impact. The overhead guard may not protect against some objects penetrating into the operator's station from the sides or ends of the lift truck.

The lift truck is equipped with an overhead guard and FOPS as standard. If there is a possibility of overhead objects falling through the guard, the guard must be equipped with smaller holes or a Plexiglas cover.

Any altering done that is not specifically authorised by CROWN invalidates CROWN's FOPS certification.

The protection offered by this FOPS will be impaired if it has been subjected to structural damage.

Structural damage can be caused by an overturn accident, by falling objects, etc.

Do not mount any item such as fire extinguishers, first aid kits and lights by welding brackets to or drilling holes in any FOPS structure. See your CROWN dealer for mounting guidelines.

Burn Prevention

Coolant

At operating temperature, the engine coolant is hot and under pressure. The radiator and all lines to heaters or the engine contain hot water or steam. Any contact can cause severe burns.

Steam can cause personal injury.

Check the coolant level only after engine has been stopped and the filler cap is cool enough to remove with your bare hand.

Remove the cooling system filter cap slowly to relieve pressure.

Cooling system additive contains alkali that can cause personal injury. Avoid contact with the skin and eyes and do not drink.

Allow cooling system components to cool before draining.

Oils

Hot oil and components can cause personal injury. Do not allow hot oil or components to contact the skin.

At operation temperature, the hydraulic tank is hot and can be under pressure.

Remove the hydraulic tank filter cap only after the engine has been stopped and the filter cap is cool enough to remove with your bare hand.

Remove the hydraulic tank filter cap slowly to relieve pressure.

Relieve all pressure in air, oil fuel or cooling systems before any lines, fittings or related items are disconnected or removed.

Batteries

Batteries give off flammable fumes which can explode.

Do not smoke when observing the battery electrolyte levels.

Electrolyte is an acid and can cause personal injury if it contacts skin or eyes.

Always wear protective glasses when working with batteries.

Fire or Explosion Prevention

All fuels, most lubricants and some coolant mixtures are flammable.

Fuel leaked or spilled onto hot surfaces or electrical components can cause a fire.

Do not smoke while refueling or in a refueling area.

Do not smoke in areas where batteries are charged, or where flammable materials are stored.

Batteries in series can be located in separate compartments.

When using jumper cables always connect positive(+) cable to positive(+) terminal of battery connected to starter solenoid and negative(-) cable from external source to starter negative(-) terminal.

(If not equipped with starter negative(-) terminal, connect to engine block.)

See the Operation Section of this manual for specific starting instructions.

Clean and tighten all electrical connections. Check daily for loose or frayed electrical wires. Have all loose or frayed electrical wires tightened, repaired or replaced before operation the lift truck.

Keep all fuels and lubricants stored in properly marked containers and away from all unauthorised persons.

Store all oily rags or other flammable material in a protective container, in a safe place.

Do not weld or flame cut on pipes or tubes that contain flammable fluids. Clean them thoroughly with nonflammable solvent before welding or flame cutting on them.

Remove all flammable materials such as fuel, oil and other debris before they accumulate on the lift truck.

Do not expose the lift truck to flames, burning brush, etc., if at all possible.

Shields, which protect hot exhaust components from oil or fuel spray in the event of a line, tube or seal failure, must be installed correctly.

Do not operate in areas where explosive gases exist or are suspected.

Fire Extinguisher

Have a fire extinguisher-type BC and 1.5KG minimum capacity-on rear overhead guard leg with latch and know how to use it. Inspect and have it serviced as recommended on its instruction plate.

LPG

LPG is poisonous and flammable.

Breathing LPG vapors or repeated contact of LPG with skin can cause personal injury.

Use LPG only in well-ventilated areas.

Do not smoke while changing LPG cylinders.

Use LPG with care to avoid fires.

Do not store replacement LPG cylinders in living areas or in the operator's compartment.

Do not store LPG cylinders in direct sunlight or at temperatures above 39°C (102°F).

Discard cylinders in a safe place. Do not puncture or burn cylinders.

Keep LPG cylinders out of the reach of unauthorised personnel.

Lines, Tubes and Hoses

Do not bend or strike high pressure lines. Do not install bent or damaged lines, tubes or hoses.

Repair any loose or damaged fuel and oil lines, tubes and hoses. Leaks can cause fires. Contact your CROWN dealer for repair or replacement.

Check lines, tubes and hoses carefully. Do not use your bare hand to check for leaks. Use a board or cardboard to check for leaks. See Fluid Penetration in the Safety Section for more details. Tighten all connections to the recommended torque. Replace if any of the following conditions are found.

- End fittings damaged or leaking.
- Outer covering chafed or cut and wire reinforcing exposed.
- Outer covering ballooning locally.
- Evidence of kinking or crushing of the flexible part of hose.
- Armoring embedded in the outer cover.
- End fittings displaced.

Make sure that all clamps, guards and heat shields are installed correctly to prevent vibration, rubbing against other parts, and excessive heat during operation.

Operator Restraint System (If Equipped)

Warning Signs and Labels

Your CROWN lift truck has the following tipover warning decals.

Make sure that you can read all safety signs. Clean or replace these if you cannot read the words or see the pictures. When cleaning the labels use a cloth, water and soap. Do not use solvent, gasoline, etc. You must replace a label if it is damaged, missing or cannot be read. If a label is on a part that is replaced, make sure a new label is installed on the replaced part. See your CROWN Lift Truck dealer for new labels.

The most effective method of preventing serious injury or death to yourself or others is to familiarise yourself with the proper operation of the lift truck, to be alert, and to avoid actions or conditions which can result in an accident.

WARNING

Tipover can occur if the truck is improperly operated. In the event of a tipover, injury or death could result.



The "Survive in tipover" warning is located on the overhead guard. It shows the proper use of the operator restraint system.

Seat Adjustment



Move the lever, slide the seat to the desired position, and release the lever.

Adjust the seat before operating the lift truck. After adjusting, set the seat to make sure it is properly locked. Do not adjust the seat while the truck is in motion.

WARNING

Do not place your hand or fingers under the seat. Injury may occur as the seat moves up and down.

If Optional Suspension Seat (weight adjusting type) Equipped

Forward and Backward Adjustment

The seat can be adjusted by pushing the lever on the right side of seat.



Adjust the seat before operating the lift truck. After adjusting, set the seat to make sure it is properly locked. Do not adjust the seat while the truck is in motion.

Weight adjustment

Pull the weight adjustment lever upwards and move right or left side.

Adjust to driver's weight in 7 steps (50 ~ 110 kg)

NOTICE

Do not place your hand or fingers under the seat. Injury may occur as the seat moves up and down.



Backrest Inclination

The backrest angle can be adjusted by using the lever on the left side of seat.

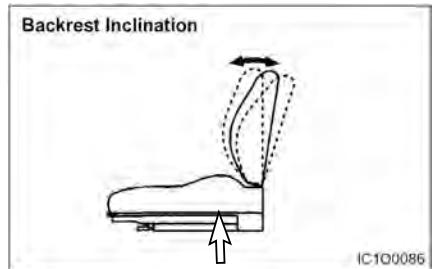

Seat Belt

The Operator Restraint System, Prevents the operator from jumping from the operator's compartment in the event of a forward or side tipover. The system is designed to keep the operator on the seat and in the operator's compartment in the event of a tipover.

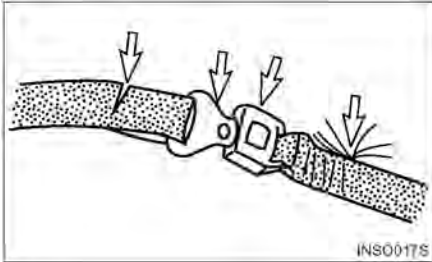

1. If the seat belt is torn, if pulling motion is interrupted during extension of the belt, or if the belt cannot be inserted into the buckle properly, replace the seat belt assembly.

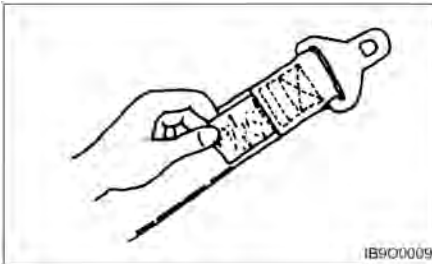

2. Belt Maintenance – Every 500 service hours. Check that the belt fastening works properly and that winding device is free from run lock when jerked. Check that the belt is suitably fastened to the seat. Check that the seat is correctly secured to the hood and the chassis. On visual inspection, fastenings must be intact, otherwise, contact the safety manager.

WARNING

Your CROWN truck comes equipped with a CROWN operator restraint system. Should it become necessary to replace the seat for any reason, it should only be replaced with another CROWN operator restraint system.



3. In the event of a tipover, the seat and restraint system should be inspected for damage and replaced, if necessary.

NOTE: Operator restraints shall be examined at the regular truck service intervals. It is recommended that they be replaced if any of the following conditions are found:

- Cut or frayed strap
- Worn or damaged hardware including anchor points
- Buckle or retractor malfunction
- Loose stitching

WARNING

The seat belt may cause the operator to bend at the waist. If you are pregnant or have suffered from some abdominal disease, consult a doctor before you use the seat belt.

Fasten the Seat Belt

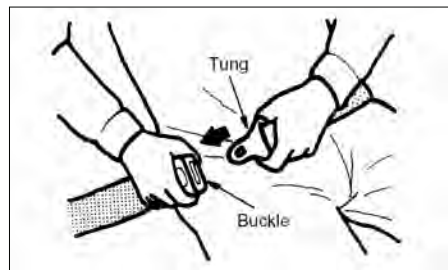

1. Grip the plate (connector) of the belt and pull the belt from the retractor. Then insert the plate into the slot of the buckle until a snap is heard. Pull on the belt to confirm it is latched.
2. Make sure the belt is not twisted.

⚠ WARNING

If you fasten the belt across your abdomen, the belt may injure your abdomen in an accident.

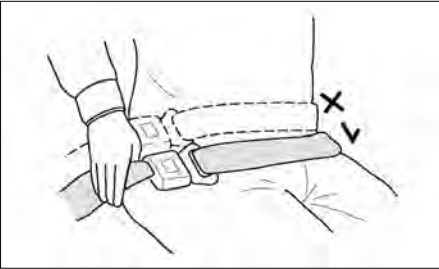

3. Be sure to fasten the belt across your hips, not across your abdomen.

NOTE: The belt is designed to automatically adjust to your size and movement. A quick pull on the belt will confirm that the automatic adjuster will hold the belt position in the event of an accident.

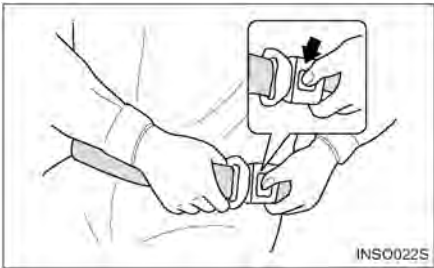

Push the button of the buckle to release the belt. The belt will automatically retract when released. Hold the plate of the belt and allow the belt to slowly retract.

Avoiding Lift Truck Tipovers

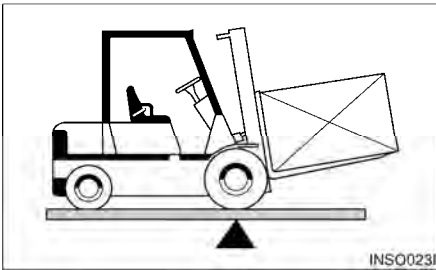

Counterbalanced lift truck design is based on the balance of two weights on opposite sides of a fulcrum (the front axle). The load on the forks must be balanced by the weight of the lift truck.

The location of the centre of gravity of both the truck and the load is also a factor. This basic principle is used for picking up a load. The ability of the lift truck to handle a load is discussed in terms of centre of gravity and both forward and sideways stability.

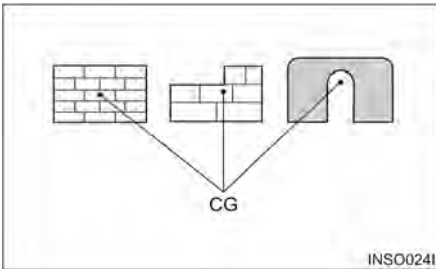

The point within an object, at which the whole weight of the object may be regarded as being concentrated, is called the centre of gravity or CG. If the object is uniform, its geometric centre will coincide with its CG. If it is not uniform, the CG could be at a point outside of the object. When the lift truck picks up a load, the truck and load have a new combined CG.

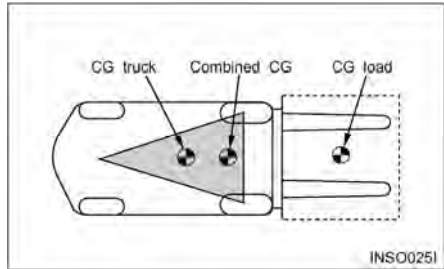

The stability of the lift truck is determined by the location of its CG; or, if the truck is loaded, the combined CG of the truck and load. The lift truck has moving parts and, therefore, has a CG that moves. The CG moves forward or backward as the mast is tilted forward or backward. The CG moves up or down as the mast moves up or down. The CG and, therefore, the stability of the loaded lift truck, is affected by a number of factors such as:

- the size, weight, shape and position of the load
- the height to which the load is lifted
- the amount of forward or backward tilt
- tyre pressure
- dynamic forces created when the lift truck is accelerated, braked or turned
- condition and grade of surfaces on which the lift truck is operated

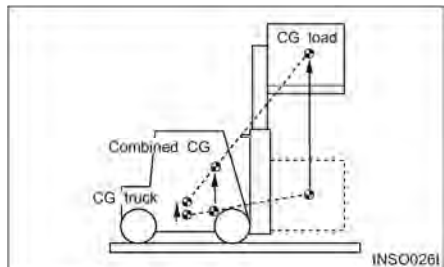

These same factors are also important for unloaded lift trucks. They tip over sideways easier than a loaded lift truck carrying its load in the lowered position.

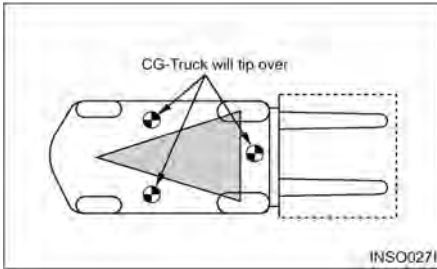

For the lift truck to be stable (not tip over forward or to the side), the CG must stay within the area of the lift truck stability base - a triangular area between the front wheels and the pivot of the steer wheels. If the CG moves forward of the front axle, the lift truck will tip forward. If the CG moves outside of the line on either side of the stability base, the lift truck will tip to the side.

⚠ WARNING

Dynamic forces (braking, acceleration, turning) also affect stability and can produce tipover even when the CG is within the stability triangle.

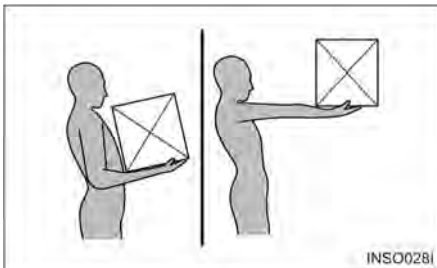

The capacity load of the lift truck is shown on the capacity/nameplate riveted to the truck. It is determined by the weight and load centre. The load centre is determined by the location of the CG of the load.

The load centre shown on the nameplate is the horizontal distance from the front face of the forks, or the load face of an attachment, to the CG of the load.

The location of the CG in the vertical direction is the same as the horizontal dimension.

Remember that, unless otherwise indicated, the capacity load shown on the nameplate is for a standard lift truck with standard backrest, forks and mast, and having no special-purpose attachment. In addition, the capacity load assumes that the load centre is no further from the top of the forks than it is from the face of the backrest. If these conditions do not exist, the operator may have to reduce the safe operating load because the truck stability may be reduced. The lift truck should not be operated if its capacity/nameplate does not indicate capacity load.

NOTE: If the load is not uniform, the heaviest portion should be placed closer to the backrest and centred on the forks.

NOTICE

1. Capacity/Nameplates originally attached to forklifts sold by CROWN shall not be removed, altered or replaced without CROWN's approval.
 2. CROWN assumes no responsibility for lift trucks placed in service without a valid CROWN Nameplate.
 3. If necessary to change your specification, contact your CROWN lift truck dealer.
-

Safety Rules



Only properly trained and authorised personnel should operate forklift trucks. Wear a hard hat and safety shoes when operating a lift truck. Do not wear loose clothing.



Inspect and check the condition of your forklift truck using the operator's check list before starting work. Immediately report to your supervisor any obvious



Do not operate your truck in unauthorised areas. Know your forklift truck and think safety. Do not compromise safety. Follow all safety rules and read all warning signs.

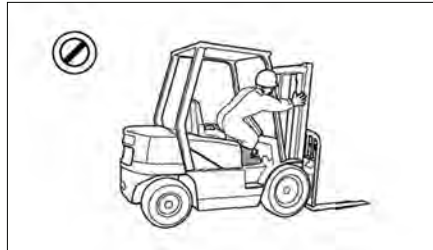

Do not operate a lift truck unless you are in the operator's seat. Keep hands and feet inside the operator's compartment. Do not put any part of the body outside of the operator's compartment. Never put any part of body into the mast structure or between the mast and the truck



Do not start, stop, turn or change direction suddenly or at high speed. Sudden movement can cause the lift truck to tip over. Slow the speed of your truck and use the horn near corners, exits, entrances, and near people.

In case of a truck with the steering knob, Do not operate the steering knob suddenly, to prevent accident caused by quick turning.



Never operate a lift truck with wet hands or shoes. Never hold any controls with grease on your hands. Your hands or feet will slide off of the controls and cause an accident.

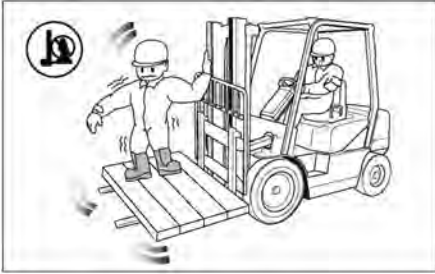

Do not raise anyone on the forks of your lift truck. Do not let other people ride on the truck. Lift trucks are designed to carry loads, not people.



Do not overload. Always handle loads within the rated capacity shown on the capacity plate. Do not add extra counterweight to the truck. An overload can cause the truck to roll over and cause injury to personnel and damage to the lift



Do not operate your truck without the load backrest extension and overhead guard. Keep the load against the backrest with the mast tilted backward.



Do not drive on soft ground. Observe all signs, especially those on maximum permitted floor loadings, elevator capacities and clearance heights. Handle loads carefully and check them closely for stability and balance.



Do not lift or move loads that are not safe. Do not pick up an off centre load. Such a load increases the possibility of a tipover to the side. Make sure loads are correctly stacked and positioned across both forks. Always use the proper size pallet. Position the forks as wide as possible under the load. Position loads evenly on the forks for proper balance. Do not lift a load with one fork.



Do not drive on slippery surfaces. Sand, gravel, ice or mud can cause a tipover. If unavoidable, slow down.



Do not permit anyone to stand or walk under the load or lifting mechanism. The load can fall and cause injury or death to anyone standing below.

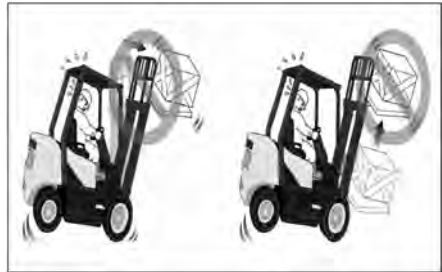

Do not elevate the load with the mast tilted forward. Do not tilt the elevated loads forwards. This will cause the lift truck to tip over forward.



Look out for overhead obstructions when raising or stacking loads. Do not travel with a raised load. Do not travel with the mast raised. The lift truck can roll over and cause injury or death to you or other personnel.

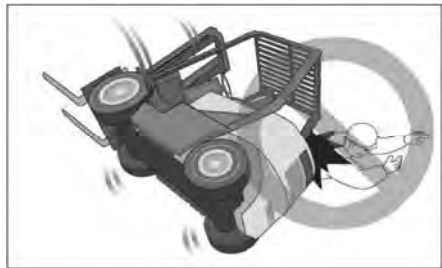

Do not jump off if your truck starts to tip over. Stay in your seat to survive.

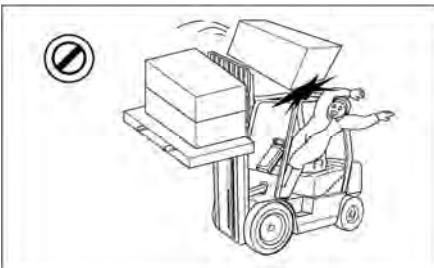

Do not move loose loads that are higher than the load backrest. Be alert for falling loads when stacking. Travel with the load tilted back and the forks as low as possible. This will increase stability to the truck and load and permit better visibility for you.



Go up ramps in forward direction and down ramps in reverse direction when moving loads. Never elevate a load with the forklift truck on an incline. Go straight off and straight down. Use an assistant when going up or down a ramp with a bulky load.

Safety Section

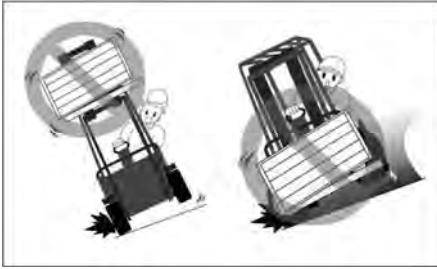

Do not stack or turn on ramps. Do not attempt to pick-up or deposit a load unless the lift truck is level. Do not turn on or drive across an incline.



Do not drive in forward direction when loads restrict your visibility. Operate your lift truck in reverse to improve visibility except when moving up a ramp.

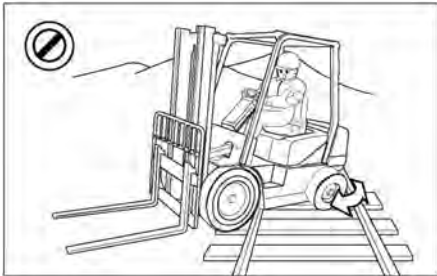

Do not go over rough terrain. If unavoidable, slow down. Cross railroad tracks slowly and diagonally whenever possible. A railroad crossing can give a loaded forklift truck a real jolt. For smoother crossing, cross the railroad diagonally so one wheel crosses at a time.

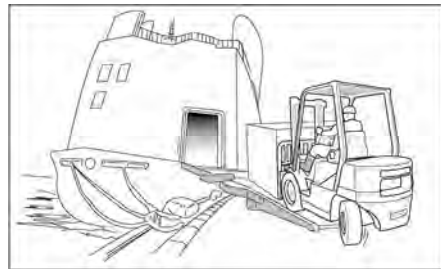

Be careful when operating a lift truck near the edge of a loading dock or ramp. Maintain a safe distance from the edge of docks, ramps and platforms. Always watch tail swing. The truck can fall over the edge and cause injury or death.



Avoid running over loose objects. Look in the direction of travel. Look out for other persons or obstructions in your path of travel. An operator must be in full control of his lift truck at all times.



Do not operate on bridge plates unless they can support the weight of the truck and load. Make sure that they are correctly positioned. Put blocks on the vehicle you enter to keep it from moving.

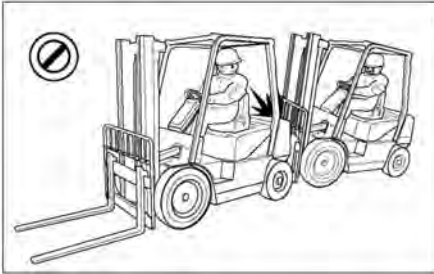

Do not operate your truck close to another truck. Always keep a safe distance from other trucks and make sure there is enough distance to stop safely. Never overtake other vehicles.



Park your lift truck in authorised areas only. Fully lower the forks to the floor, put direction lever in NEUTRAL position, engage the parking brake, and turn the key to the OFF position. Remove the key and put blocks behind the wheels to prevent the truck from rolling. Shut off your forklift truck when leaving it unattended. Check the condition of your forklift truck after the day's work.



Do not use your lift truck to push or tow another truck. Do not let another push or tow your truck. If a truck will not move, call a service technician.



Exhaust from all internal combustion engines contains carbon monoxide, a colorless, odorless, tasteless, poisonous gas. Exposure to carbon monoxide can cause serious injury or health problems, including death. And avoid unnecessary idling of the engine. If nausea, dizziness or headaches are experienced stop the truck and seek fresh air.



Forklift trucks may only be refueled at specially reserved locations. Switch off the engine when refueling. Smoking and handling of naked flames during refueling are strictly prohibited. This prohibition also applies during the changing of the LPG (liquefied propane gas) tank. Mop up spilt fuel and do not forget to close the fuel tank before restarting the engine.

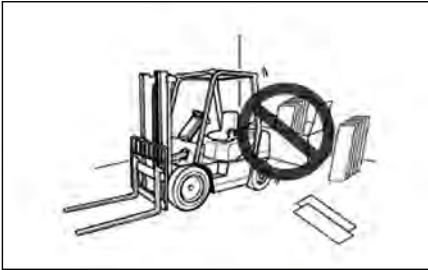

Do not operate forklifts near flammable or combustible materials.

To avoid the discoloration, deformation or combustion of materials (such as lumber, veneer board, paper products and other similar items), always park at least 30 cm (12 inches) away from them.



An unloaded forklift may be easier to tip over than a loaded truck.

When traveling without a load, the risk of lateral overturn is greater.



Forklift trucks are not cars. They often have small tyres, no suspension, and are very heavy.

The forklift's centre of gravity will also change when carrying loads.

Avoid uneven bumps, pot holes and other hazards whenever possible.

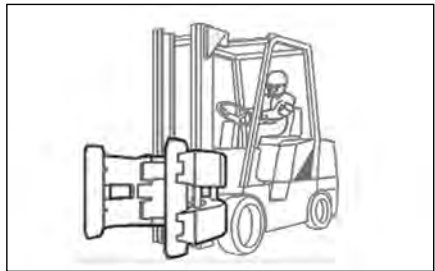

There are many special attachments available to replace the forks on a lift truck.

All carry safety implications and special training in their operation is highly recommended.



Carrying a load suspended on a chain or a cable may unbalance a truck.

Take extra care around pedestrians with a suspended load as it may sway or even strike them.

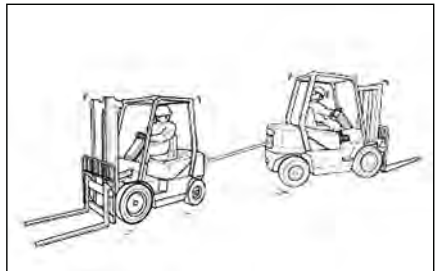

The counterweight draw bar should not be used for towing the forklift or for towing another forklift.

Towing is only advised in emergencies, by trained operators and at low speed, no faster than 2 km/h, to a convenient location for repair.

How to Survive in a Tipover (If Operator Restraint System Equipped)

⚠ WARNING

In the event of a tipover, the risk of serious injury or death will be reduced if the operator is using the operator restraint system and follows the instructions provided.

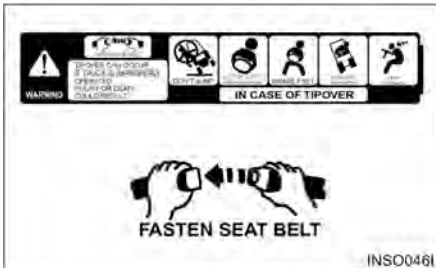

Always use operator restraint system.



DON'T jump.



Hold on tight.

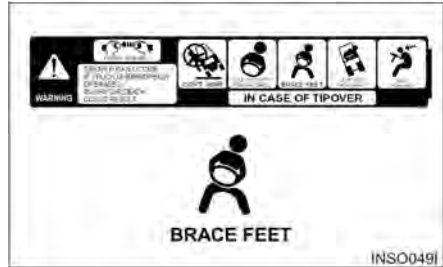

Brace your feet and keep them within the operator's compartment.



Lean away from the direction of fall.



Lean forward.

Declaration of Conformity

We,

Manufacturer

Doosan Corporation Industrial Vehicle BG.
468, Injung-ro, Dong-gu, Incheon, Korea 22503

Authorized Representative and Compiler of Technical File According to 2006/42/EC

Doosan Industrial Vehicle Europe N.V, Mr. Chankyo Chung
Europark Noord 36 A 9100 Sint-Niklaas BELGIUM

herewith declare

that the following equipment conforms with the appropriate requirements of the Directives 2006/42/EC (Machinery Directive), 2000/14/EC as amended by 2005/88/EC (Noise Emission in the environment by equipment for use outdoors), 97/68/EC amended by 2004/24/EC (Exhaust Gas Directive) and 2014/30/EU (EMC Directive) based on its design and type, as brought into circulation by us.

Description of the equipment:

Type : **Lift Truck, Combustion-engine driven, Counterbalanced**

Function : **Lifting and Moving materials**

Family : **CGC40S-5 Series**

Model Name : **CGC35S-5, CGC40S-5, CGC45S-5**
CGC50C-5, CGC55C-5

Specifications

CHARACTERISTICS			TIER-III		
1	Manufacturer		CROWN	CROWN	
2	Model		GC35S-5	GC40S-5	
3	Capacity	at rated load center	lb (kg)	7,000 (3,500)	8,000 (4,000)
4	Load center		in (mm)	24 (600)	24 (600)
5	Power type	Elec, Diesel, LPG, Gasoline		LPG	LPG
6	Operator type	Stand-on, Driver-seated		Driver-seated	Driver-seated
7	Tire type	P=Pneu, E=Solid Soft, C=Cushion		C	C
8	Wheels(x=driven)	number, front/rear		x2/2	x2/2
DIMENSIONS					
9	Max. Fork Height	with STD 2-Stage Mast	in (mm)	113.4 (2,880)	113.4 (2,880)
10	Free lift	with STD 2-Stage Mast	in (mm)	6.3 (160)	6.3 (160)
11	Fork carriage	ISO class		III	III
12	Forks	Length x Width x Thickness	in (mm)	47.2x5.9x2.0 (1,200x150x50)	47.2x5.9x2.0 (1,200x150x50)
13		Fork Spacing (min X Max)	in (mm)	12.2x44.6 (310 x 1,132)	12.2x44.6 (310 x 1,132)
14	Tilt of mast	Forward/Backward	deg	5/6	5/6
15	Overall dimensions	Length to Fork Face	in (mm)	105.6 (2,682)	105.7 (2,686)
16		Overall Width	in (mm)	50.0 (1,270)	50.0 (1,270)
17		Mast Lowered Height	in (mm)	84.1 (2,135)	84.1 (2,135)
18		Mast Extended Height	in (mm)	162.0 (4,115)	162.0 (4,115)
19		Overhead guard Height	in (mm)	84.8 (2,155)	84.8 (2,155)
20		Seat Height	in (mm)	44.3 (1,125)	44.3 (1,125)
21	Turning radius	Minimum outside	in (mm)	92.9 (2,360)	94.5 (2,400)
22	Load Moment constant		in (mm)	19.9 (505)	19.9 (505)
23	90° Stacking aisle		in (mm)	112.8 (2,865)	114.4 (2,905)
PERFORMANCE					
24	Speed	Travel, loaded/unloaded	mhp(km/h)	11.2/12.7 (18/19)	11.2/12.7 (18/19)
25		Lift, loaded/unloaded	fpm(mm/s)	98.4/108.3 (500/550)	94.5/108.3 (480/550)
26		Lowering, loaded/unloaded	fpm(mm/s)	104.3/88.6 (530/450)	98.4/88.6 (500/450)
27	Drawbar pull	at 1.0 km/h, loaded	lb (kg)	8,488 (3,850)	8,455 (3,835)
		at 1.6 km/h, loaded		8,025 (3,640)	7,981 (3,620)
28	Gradeability	at 1.0 km/h, loaded	%	48	42
		at 1.6 km/h, loaded		44	39
WEIGHT					
29	Total weight	Unloaded	lb (kg)	12,060 (5,470)	12,895 (5,850)
30	Axle load	with loaded, front/rear	lb (kg)	16,935/2,125 (7,970/1,000)	18,435/2,460 (8,690/1,160)
31		without loaded, front/rear	lb (kg)	4,915/7,145 (2,230/3,240)	4,695/8,200 (2,130/3,720)
CHASSIS					
32	Tires	Number of front/rear		2/2	2/2
33		Size, front single		22x9x16	22x9x16
34		Size, rear		18x6x12-1/8	18x7x12-1/8
35	Wheel base		in (mm)	64.2 (1,630)	64.2 (1,630)
36	Tread	Front/Rear	in (mm)	41.0/41.1 (1,042/1,044)	41.0/41.1 (1,042/1,044)
37	Ground clearance	loaded, at the lowest point	in (mm)	5.1 (130)	5.1 (130)
38		loaded, at center of wheelbase	in (mm)	5.1 (130)	5.1 (130)
39	Brake	Service		foot/hyd	foot/hyd
40		Parking		hand/mech	hand/mech
DRIVE					
41	Battery	Voltage/Ampere-hour	V/AH	12/75	12/75
42	Engine	Manufacturer/Model		PSI / 4X 4.3L	PSI / 4X 4.3L
43		Rated output (at rpm)	kW/rpm	70.0/2,500	70.0/2,500
44		Max. torque	lb_ft/rpm	209.4/1,800	209.4/1,800
45		Cycle/Cylinders/Displacement	cc	4/6/4,294	4/6/4,294
46	Transmission	type		Powershift	Powershift
47		No. of Speeds forward/reverse		2/2	2/2
48	Operating pressure	System/Attachment	psi (bar)	2,755/2,030 (190/140)	3,045/2,030 (210/140)

General Section

TIER-III			
CROWN	CROWN	CROWN	
GC45S-5	GC50C-5	GC55C-5	1
9,000 (4,500)	10,000(5,000)	12,000 (5,500)	2
24 (600)	24 (600)	24 (600)	3
LPG	LPG	LPG	4
D rider-seated	D rider-seated	D rider-seated	5
C	C	C	6
x2/2	x2/2	x2/2	7
			8
			9
113.4 (2,880)	103.5 (2,630)	103.5 (2,630)	10
6.3 (160)	6.3 (160)	6.3 (160)	11
IV	IV	IV	12
47.2x5.9x2.0 (1,200x150x50)	47.2x5.9x2.4 (1,200x150x60)	47.2x5.9x2.4 (1,200x150x60)	13
13.4x50.8 (340 x 1,290)	13.4x50.8 (340 x 1,290)	13.4x50.8 (340 x 1,290)	14
5/6	5/6	5/6	15
111.3 (2,828)	113.3 (2,878)	118.5 (3,010)	16
55.9 (1,420)	55.9 (1,420)	55.9 (1,420)	17
86.0 (2,185)	86.0 (2,185)	86.0 (2,185)	18
169.9 (4,315)	160.0 (4,065)	160.0 (4,065)	19
84.8 (2,155)	84.8 (2,155)	84.8 (2,155)	20
44.3 (1,125)	44.3 (1,125)	44.3 (1,125)	21
99.6 (2,530)	101.6 (2,580)	103.5 (2,630)	22
19.9 (505)	20.3 (515)	20.3 (515)	23
119.5 (3,035)	121.9 (3,095)	123.8 (3,145)	24
			25
11.2/12.7 (18/19)	11.2/12.7 (18/19)	11.2/12.7 (18/19)	26
94.5/98.4 (480/500)	88.6/98.4 (450/500)	88.6/98.4 (450/500)	27
98.4/86.6 (500/440)	94.5/86.6 (480/440)	94.5/86.6 (480/440)	28
8,466 (3,840)	8,411 (3,815)	8,367 (3,795)	29
8,003 (3,630)	7,937 (2,638)	7,893 (3,580)	30
37	34	31	31
34	31	29	32
			33
14,330 (6,500)	15,410 (6,990)	16,180 (7,340)	34
20,730/2,600 (9,775/1,225)	22,530/2,880 (10,630/1,360)	24,865/3,315 (11,330/1,510)	35
5,500/8,830 (2,495/4,005)	5,555/9,855 (2,520/4,470)	5,290/10,890 (2,400/4,940)	36
			37
2/2	2/2	2/2	38
22X12X16	22X12X16	22X12X16	39
18X8X12.1	18X8X12.1	18X8X12.1	40
70.5 (1,790)	70.5 (1,790)	70.5 (1,790)	41
43.9/41.1 (1,116/1,044)	43.9/41.1 (1,116/1,044)	43.9/41.1 (1,116/1,044)	42
5.1 (130)	5.1 (130)	5.1 (130)	43
5.1 (130)	5.1 (130)	5.1 (130)	44
foot/hyd	foot/hyd	foot/hyd	45
hand/mech	hand/mech	hand/mech	46
			47
12/75	12/75	12/75	48
PSI / 4X 4.3L	PSI / 4X 4.3L	PSI / 4X 4.3L	49
70.0/2,500	70.0/2,500	70.0/2,500	50
209.4/1,800	209.4/1,800	209.4/1,800	51
4/6/4,294	4/6/4,294	4/6/4,294	52
Powershift	Powershift	Powershift	53
2/2	2/2	2/2	54
3,045/2,030 (210/140)	3,045/2,030 (210/140)	3,335/2,030 (230/140)	55

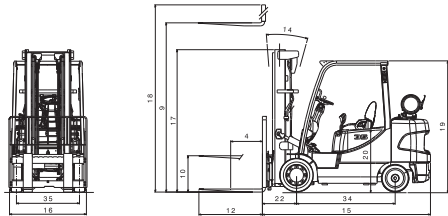
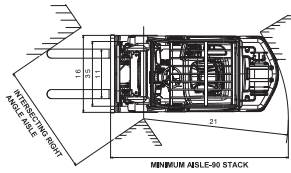

Noise and Vibration

Noise

Model		Noise Level [Unit : dB(A)]				
		Sound Pressure Level at Operator's ear (Leq)		Sound Pressure Level at By-stander position (AS 3713)		Guaranteed Sound Power Level (L_{WA}) by new directive 2000/14/EC
		AS3713	pEN12053	Drive-By	Lifting Mode	
CGC35/40/45S-5, CGC50/55C-5 (PSI TIER III E/G)			85.9	-	-	110

Vibration(weighted overall value)

Unit : m/sec²

Model	Measuring place		
	Seat	Steering Wheel	Floor Plate
CGC35/40/45S-5, CGC50/55C-5 (PSI TIER III E/G)	0.07	1.2	0.09

Capacity Chart (Not used in Australia)

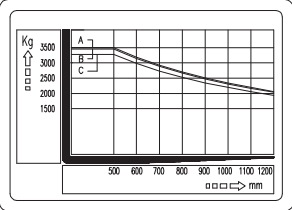
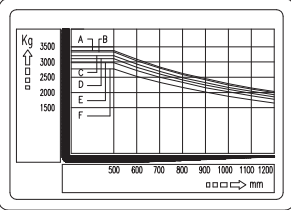
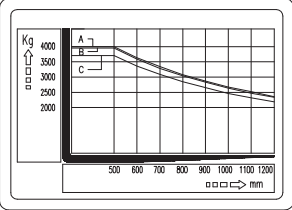
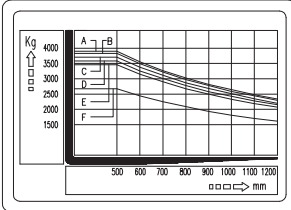
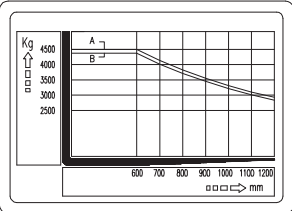
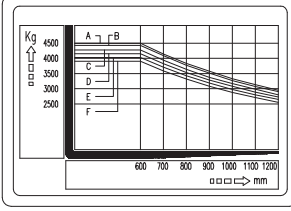
MODEL	SINGLE TYRE	SINGLE TYRE
	STD, FFL	FFT
CGC35S-5	 <p>A. 3000, 3300, 3650, 4000, 3000mm MAST B. 4250mm MAST C. 4850mm MAST</p>	 <p>A. 4000mm MAST B. 4250mm MAST C. 4700mm MAST D. 5150mm MAST E. 5600mm MAST F. 6050mm MAST</p>
	 <p>A. 3000, 3300, 3650, 4000, 3000mm MAST B. 4250mm MAST C. 4850mm MAST</p>	 <p>A. 4000mm MAST B. 4250mm MAST C. 4700mm MAST D. 5150mm MAST E. 5600mm MAST F. 6050mm MAST</p>
CGC45S-5	 <p>A. 3000, 3300, 3650, 4000, 4250, 3000mm MAST B. 4850mm MAST</p>	 <p>A. 4000mm MAST B. 4250mm MAST C. 4700mm MAST D. 5150mm MAST E. 5600mm MAST F. 6050mm MAST</p>

Capacity Chart (with Side Shifter) (Not used in Australia)

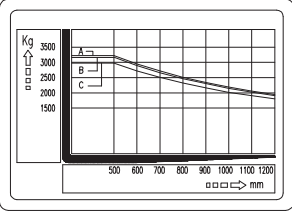
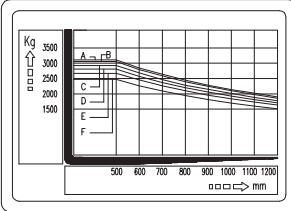
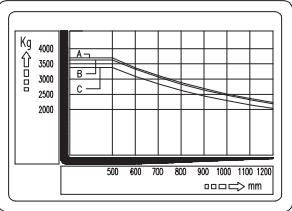
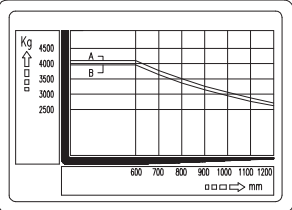
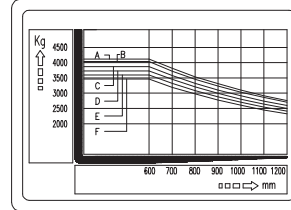
MODEL	SINGLE TYRE	SINGLE TYRE
	STD, FFL	FFT
CGC35S-5	 <p>A. 3000, 3300, 3650, 4000, 3000mm MAST B. 4250mm MAST C. 4850mm MAST</p>	 <p>A. 4000mm MAST D. 5150mm MAST B. 4250mm MAST E. 5600mm MAST C. 4700mm MAST F. 6050mm MAST</p>
	CGC40S-5	 <p>A. 3000, 3300, 3650, 4000, 3000mm MAST B. 4250mm MAST C. 4850mm MAST</p>
CGC45S-5	 <p>A. 3000, 3300, 3650, 4000, 4250, 3000mm MAST B. 4850mm MAST</p>	 <p>A. 4000mm MAST D. 5150mm MAST B. 4250mm MAST E. 5600mm MAST C. 4700mm MAST F. 6050mm MAST</p>

Capacity Chart (Not used in Australia)

MODEL	SINGLE TYRE	SINGLE TYRE
	STD, FFL	FFT
CGC50C-5	<p>A. 2750, 3050, 3400, 3750, 4000, 2875mm MAST B. 4600mm MAST</p>	<p>A. 3875mm MAST D. 5025mm MAST B. 4125mm MAST E. 5475mm MAST C. 4575mm MAST F. 5925mm MAST</p>
	<p>A. 2750, 3050, 3400, 3750, 4000, 2875mm MAST B. 4600mm MAST</p>	<p>A. 3875mm MAST D. 5025mm MAST B. 4125mm MAST E. 5475mm MAST C. 4575mm MAST F. 5925mm MAST</p>

Capacity Chart (with Side Shifter) (Not used in Australia)

MODEL	SINGLE TYRE	SINGLE TYRE
	STD, FFL	FFT
CGC50C-5	<p>A. 2750, 3050, 3400, 3750, 4000, 2875mm MAST B. 4600mm MAST</p>	<p>A. 3875mm MAST B. 4125mm MAST C. 4575mm MAST D. 5025mm MAST E. 5475mm MAST F. 5925mm MAST</p>
	<p>A. 2750, 3050, 3400, 3750, 4000, 2875mm MAST B. 4600mm MAST</p>	<p>A. 3875mm MAST B. 4125mm MAST C. 4575mm MAST D. 5025mm MAST E. 5475mm MAST F. 5925mm MAST</p>

Serial Number

Serial Number Locations

For quick reference, record your lift truck's serial numbers in the spaces provided below the photographs.

Located on the front side of the FCU.



Transmission Serial Number

	MODEL	SERIAL NO.	TYPE	INDUSTRIAL TRUCK
	TRUCK WEIGHT		LB	KG
WARNING IMPROPER OPERATION OR MAINTENANCE COULD RESULT IN INJURY OR DEATH. READ AND UNDERSTAND THE OPERATOR AND MAINTENANCE MANUAL BEFORE OPERATING.	DUMP TILT		HOIST TYPE	TIRE TYPE
	TIRE TREAD		TIRE PRESS	TIRE SIZE
	IN (F)	PSI	SPA (F)	
	MM (IN)	PSI	SPA (IN)	
ATTACH				
A	B	C	D	CAPACITY
IN	CH	CH	IN	LB
MM	MM	MM	MM	KG
MM	MM	MM	MM	KG
MANUFACTURED BY DOBBIN CORPORATION INDUSTRIAL VEHICLE DIV. FOR CROWN EQUIPMENT CORP. TO ANSI/ISO/BSI Std. 1 crown.com				

Lift Truck Serial Number



4.3 liter PSI Engine Serial Number(PSI)



DRIVE AXLE Serial Number

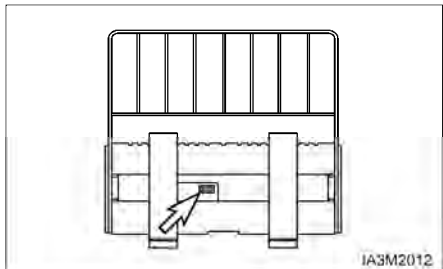

Side Shifter Serial Number(If Equipped)

Operator's Warning and Identification Plate

Familiarise yourself with the OPERATOR'S WARNING Plate, and IDENTIFICATION, LIFT CAPACITY and ATTACHMENT PLATES. Do not exceed capacity as equipped load ratings.

Operator's Warning Plate



Located on the cowl to the right side of the steering column.

Identification, Lift Capacity and Attachment Plate



Located on the front side of the FCU.

Lift Truck Capacity Rating

Do not exceed allowable lift truck working capacity load ratings.

The capacity of the lift truck is given by weight and distance to the load centre. For example, a capacity of 1200kg (2640lb) at 600mm (24in) means that the lift truck can lift 1200kg (2640lb) if the load centre is 600 mm (24in) from both the vertical and horizontal faces of the forks.

Before attempting to lift any load, ensure that the weight and load centre combination is within the capacity of the lift truck as shown on the capacity rating plate. To determine the load centre, measure the distance from the face of the carriage to the gravitational centre of the load.

The rated capacity on the plate refers to the capacity of the lift truck as it left the factory. Subsequent changes of any form to the equipment or battery can alter the lift truck's rating.

The rated capacity of the lift truck applies to operating conditions where the lift truck is on level ground. The capacity of the lift truck is reduced on inclines.

Below are abbreviations that may appear on the Identification, Lift Capacity and Attachment Plate and their meanings.

Mast Abbreviations

STD - Standard Mast (single inner member, low free lift)

FF - Full Free Lift Mast (single inner member with high free lift duplex cylinder)

FFT - Triple Lift Mast (two inner members) with either low or full free lift characteristics.

QUAD - Quadruple (Quad) Mast (with three inner members)

NOTE : When only a mast-type is listed on the identification plate, a standard carriage and forks are used.

Attachment Abbreviations (Includes Special Forks)

SC - Special Carriage-increased width, height or outreach

SSS - Shaft-type Sideshift Carriage

HSS - Hook-type Sideshift Carriage (ITA)

CW - Counterweight

SF - Special Forks

SWS - Swing Shift, Sideshift

RAM - Ram or Boom

DBCBH - Double Cube Block Handler

HFP - Hydraulic Fork Positioner

CR - Crane Arm or Crane Boom

TH - Tyre Handler

CTH - Container Handler

LPP - Load Push-Pull Device

CC - Carton Clamp

RC - Roll Clamp

LS - Load Stabiliser

PWH - Pulp Wood Handler

SS-ST - Sideshift-Side Tilt Carriage

Operator's Station and Monitoring Systems

Instrument Panel

Your lift truck may not have the same indicator or warning lights as shown in the illustrations. Due to the various options available, typical instrument panels are shown.

However, the symbols on the indicators and lights on your panel identify what those particular items are.

Also, the symbol for each of the items is identified and an explanation of their function and location is described on the following pages.

LPG (12V)

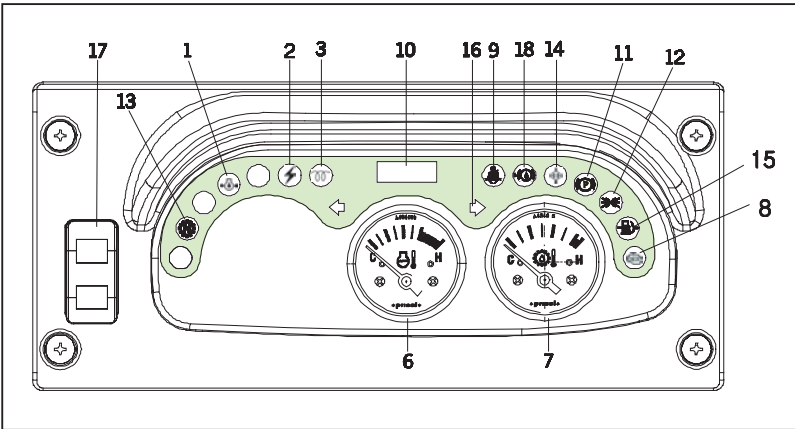



1. Engine Oil Pressure Indicator Light - Indicates insufficient engine oil pressure. The light will come on when the ignition switch is turned to the ON position. The light should go off after the engine is started. If the light turns on while operating the lift trucks, insufficient engine oil pressure is indicated. Park the lift truck and stop the engine.



2. Alternator Indicator Light - Indicates if the battery charging system is operational. The light will come on when the ignition switch is turned to the ON position.

The light should go off after the engine is started, indicating the alternator is producing sufficient voltage to charge the battery. If the light turns on with the engine running, check the alternator charging system for a malfunction.



3. Diesel Engine Start Preheat Indicator Light - The light will come ON when the key is turned to the ON position from the OFF position. This indicates that the glow plugs are preheating the pre-combustion chambers for easier starting.

The amount of time needed to preheat the pre-combustion chambers is approximately seven seconds, depending on the surrounding air temperature. When the light goes OFF the maximum pre-combustion chamber temperature has been reached and the key can be turned to the START position to start the engine.



6. Engine Coolant Temperature Gauge - Shows current temperature of the engine coolant. If the gauge pointer moves beyond the red band during the operation, the engine is overheated. Park the lift truck and stop the engine.

Check the cooling system for any defect. The pointer will be in the red band when the coolant temperature reaches approximately 110 °C on all engines.



7. Transmission Oil Temperature Gauge - Shows transmission oil temperature. If the gauge pointer moves beyond the red band during operation, the engine is overheated. Park the lift truck and stop the engine.

Check the system for any defect. The pointer will be in the red band when the transmission oil temperature reaches approximately 125 °C.



8. PSI Engine Malfunction Indicator Lamp (MIL) - PSI engine control system are equipped with built-in fault diagnostics. Detected system faults can be displayed by the Malfunction Indicator Lamp

(MIL) as Diagnostic Faults Codes (DFC) or flash codes, and viewed in detail with the use of service tool software. When the ignition key is turned ON the MIL will perform a self-test, illuminate once and then go OFF. If a detected fault condition exists, the fault or faults will be stored in the memory of the engine control module (ECM). Once a fault occurs the MIL will illuminate and remain ON. This signals the operator that a faults has been detected by the SECM.



9. Seat Belt Warning Light (If Equipment) - Indicates when the seat belt does not fastened by operator.

The light will come on when the ignition switch is turned to the ON position. The light should go off after engine is started.



10. Service Hour Meter - Indicates the total number of hours the engine and the lift truck have operated. The hour meter will operate when the ignition switch is in the ON position, whether the engine is running or not. The hour meter is used to determine lubrication and maintenance intervals.



11. Parking indicator light- The light will come ON when the parking lever is applied.



12. Front Floodlights- Push down on the switch(17), to the first step, to turn the front floodlights on.

Front and Rear Floodlights – Push down on the switch(17), to the second step, to turn both the front and rear floodlights on. The floodlights are optional.



13. Transmission Neutral Position Light - Indicates the neutral position of transmission.



14. Drive Axle Oil Indicator Light (OCDB only) - Indicates too hot drive axle oil.

The light will be ON when the ignition switch is in the ON position and must go OFF when the engine is running. Do not continue to operate the lift truck if the light is ON during operation.



15. Low Level Light of LP GAS – Indicates the low Level of LP GAS (LP only) (If Equipped)



16. Directional Turning Indicator Light



17. Front and Rear Floodlights Switch – The front floodlight is ON when push down switch to the first step. The front and rear floodlights are ON when push down switch to the second step.



18. Brake Fluid Oil Light (If Equipped) – The light is ON when the brake fluid oil of brake reservoir comes down to low level position. Refill the proper brake fluid oil if its light is ON.

⚠ WARNING

Frequent rapid starts at 2nd speed can be the cause of overheating at torque converter. With this operating condition, the pointer can sometimes exceed the green band. If this situation occurs from time to time, please avoid this operating condition to protect the transmission and increase the work efficiency. That is, start the truck at 1st speed and shift to 2nd speed to increase the travel speed.

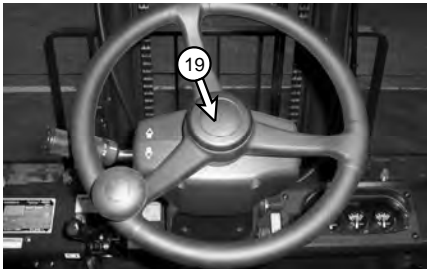

19. Horn Switch - Push on the horn button to sound the horn.

Engine Compartment

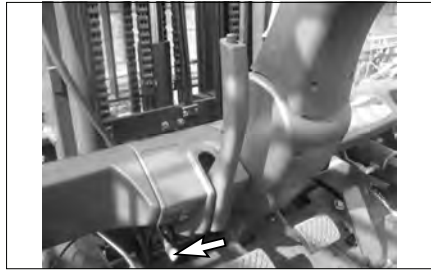

1. The engine compartment is accessible by pulling the latch and raising the hood and seat assembly.

NOTE: Unlock latch before pulling if key equipped.

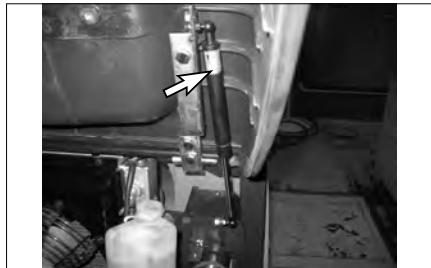

2. The hood and seat assembly is held up by a support cylinder. Make certain the air cylinder is operating properly and securely holds the hood up before doing anything in the engine compartment.

Circuit Breaker

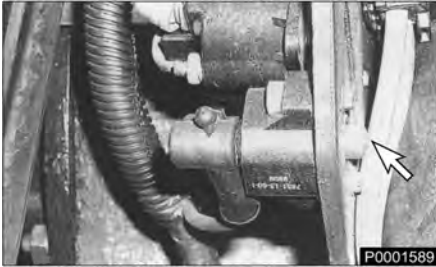

Typical Example

LP Engine Truck



Circuit Breaker - Protects the main electrical circuits. To reset the circuit breaker, push the button in. Located in the engine compartment.

Tilt Steering Column

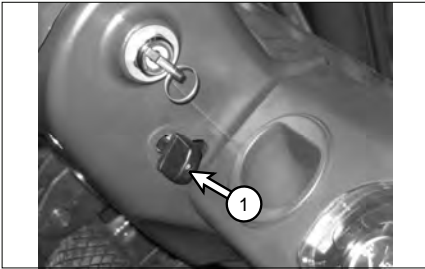

To adjust the steering column, push down the knob(1), and move the steering column to the desired position, then release the knob(1).

Electrical Disconnect Switch (If Equipped)

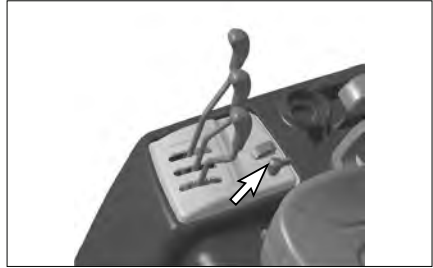

1. ON-Connects the battery for electrical power to all electrical circuits.



2. OFF-Disconnects the battery from all electrical circuits.

Seat

NOTE: Seat arrangements may vary. Basic operation will be similar.

Seat adjustment should be checked at the beginning of each shift and when operators change.

Lock the seat into position before operating, to prevent an unexpected seat change.

Adjust seat to allow full brake pedal travel with operator's back against seat back.



NOTE: The seat can only be correctly adjusted with the operator fully seated.

Seat Switch System (If Equipped)



The lift truck is equipped with a SEAT SWITCH SYSTEM. In normal operation if the direction lever is placed in either forward or reverse, the lift truck will move at a speed proportional to the accelerator pedal's position. If the operator leaves the seat without setting the parking brake, within three seconds after leaving the seat, the SEAT SWITCH SYSTEM will automatically disengage the transmission. The directional lever, however, will remain in that forward or reverse location although internally the transmission will have shifted into neutral.

Before exiting the lift truck, the parking brake should always be applied.

WARNING

WHEN LEAVING MACHINE APPLY PARKING BRAKE!

PARKING BRAKE IS NOT AUTOMATICALLY APPLIED.

NOTE: Some trucks may be equipped (ask your dealer if this applies to your truck) with an alarm that will sound if the parking brake is not applied when leaving the machine.

NOTICE

Prior to operating the lift truck, be sure to understand and check the SEAT SWITCH SYSTEM.

While in normal operation and on level ground, select a direction with the directional lever and with the park brake released. You will note that the truck will move slowly in the selected direction. If you lift your hips off of the seat, within three seconds, the SEAT SWITCH SYSTEM will disengage the transmission allowing the truck to coast but not automatically stop.



To restore the lift truck to normal operation, while sitting in the operator's seat depress the brake pedal to hold the lift truck, return the directional lever to the neutral position, and then reselect a direction of travel (either forward or reverse). The transmission will then re-engage.

If seat or seat switch replacement becomes necessary, be sure to use genuine CROWN lift truck parts. Lift trucks should never be operated without an operational SEAT SWITCH SYSTEM.

Lift Truck Controls

Direction Control Lever



-  **1. Forward** - Push the lever forward for FORWARD direction travel.
-  **2. Neutral** - Move the lever to centre position for NEUTRAL.
-  **3. Reverse** - Pull the lever back for REVERSE direction travel.

Transmission Speed Range Lever



- 1. High** - Rotate the lever counterclockwise for HIGH speed range.
- 2. Low** - Rotate the lever clockwise for LOW speed range.

Transmission Inching Control Pedal

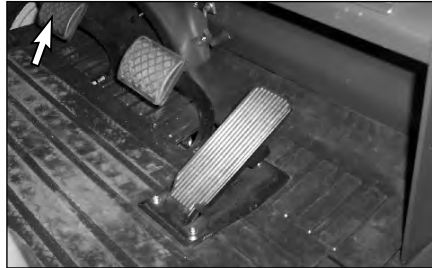



-  **Inching Control Pedal** - Pushing down on the inching pedal, modulates the hydraulic pressure to the clutch packs, permitting disc slippage.

Further pushing on the pedal completely relieves clutch pack pressure and applies the service brakes to stop and hold the lift truck.

NOTE: The purpose of the inching control pedal is to provide precise inching control at slow travel speed, with high engine rpm. This is used for fast hydraulic lift during load approach, pickup or positioning.

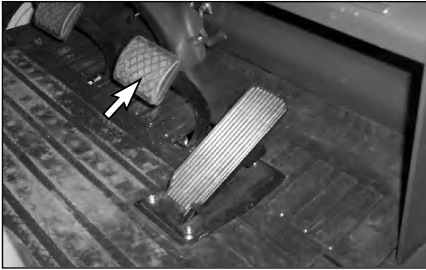

Service Brake Pedal



-  **Push DOWN** on the brake pedal to slow or stop the lift truck.
-  **RELEASE** the brake pedal to allow the lift truck to move.

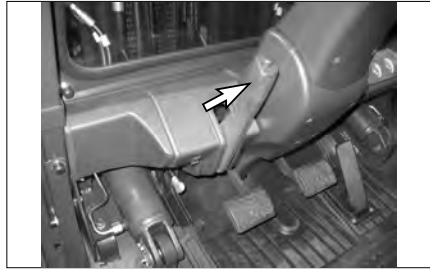

Parking Brake Lever

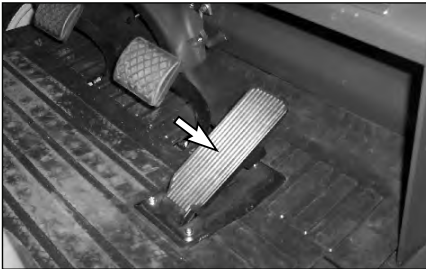

-  Pull the lever **BACK** to engage the parking brake.
-  Push the lever **FORWARD** to release the parking brake.

Accelerator Pedal



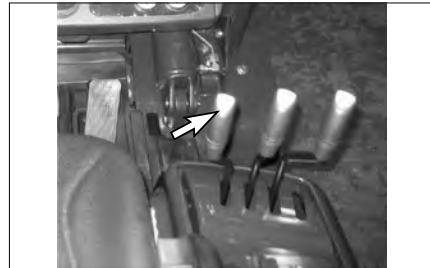

-  **Push DOWN** on the pedal to increase engine rpm (speed).
-  **RELEASE** the pedal to decrease engine rpm (speed).

Lift Control





NOTE: To prevent a sudden change of position of the load, operate all lift, tilt and attachment controls smoothly.

-  **1. Lower Position** - Push the lever **FORWARD** smoothly to lower the load.
-  **2. Hold Position** - When the lever is released it will return to the **HOLD** or centre position. Lifting or lowering action will stop.
-  **3. Lift Position** - Pull the lever **BACK** smoothly to lift the load.

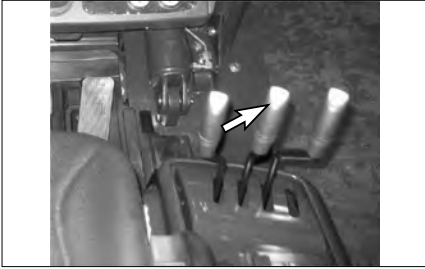

Tilt Control

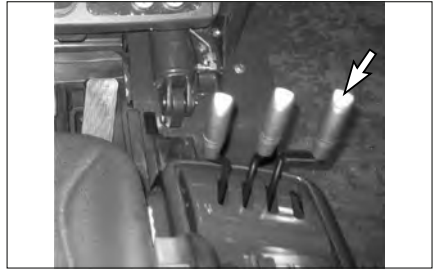

-  **1. Mast Tilt Forward** - Push the lever FORWARD smoothly to tilt the mast forward.
-  **2. Mast Hold** - When the lever is released it will return to the HOLD or centre position. Tilting action will stop.
-  **3. Mast Tilt Back** - Pull the lever BACK smoothly to tilt the mast backward.

Sideshift Attachment Control (If Equipped)



-  **1. Sideshift Left** - Push the lever FORWARD to shift the carriage to the left.
-  **2. Sideshift Hold** - When the lever is released it will return to the HOLD or centre position. Sideshifting action will stop.
-  **3. Sideshift Right** - Pull the lever BACK to shift the carriage to the right.

Refueling

Changing LP Tanks

WARNING

Only trained, authorised personnel should fill or exchange LP tanks.

Personnel engaged in filling of LP containers should wear protective clothing such as face shield, long sleeves and gauntlet gloves.

Do not refuel or store LP powered lift trucks near any underground entrance, elevator shafts or any other place where LP could collect in a pocket causing a potentially dangerous condition.

Examine all LP containers before filling and again before reuse, for damage to various valves, liquid gauge, fittings and hand valve wheels.

All defective or damaged LP containers must be removed from service.

Explosive fumes may be present during refueling.

Do not smoke in refueling areas.

Lift truck should be refueled only at designated safe locations. Safe outdoor locations are preferable to indoor locations.

Stop the engine and get off the lift truck during refueling.

The careless handling of LP containers can result in a serious accident.

Use extreme care when transporting containers to prevent damage to them.

1. Park the lift truck on level ground, with the parking brake applied, the transmission in NEUTRAL, the forks lowered and the engine running at low idle.

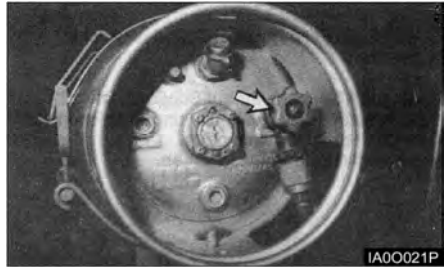

2. Close the fuel inlet valve at the LP tank. Run the engine until it stops, then turn off the ignition switch and the electrical disconnect switch (if equipped).
3. Disconnect the fuel supply line.

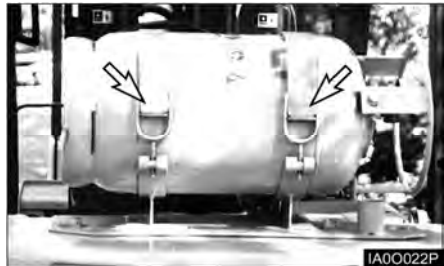

4. Loosen the retaining clamps and remove the tank.
5. Check the mounting to be sure the locating pin (dowel) is not missing or broken.

NOTICE

If the location pin (dowel) is missing or broken, be sure the pin is replaced.



6. Check to be sure that the LP warning plate is in position on the lift truck, and is legible.
7. Check to be sure the replacement tank is of the correct type.
8. Inspect the replacement tank for damage such as dents, scrapes or gouges and for indication of leakage at valves or threaded connections.

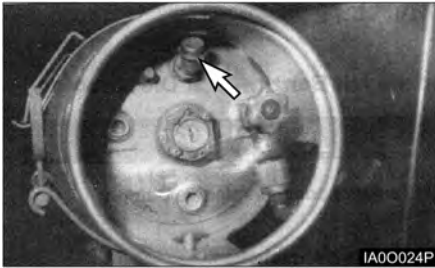

9. Check for debris in the relief valve, for damage to various valves and liquid level gauge.
10. Inspect the quick-disconnect couplings for deterioration, damage or missing flexible seals.

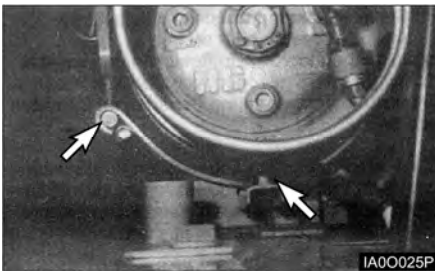

11. Position the replacement tank so that the locating pin (dowel) is in place.

⚠ WARNING

The LP tank must not extend past the counterweight.

12. Clamp the tank securely.
13. Connect the fuel supply line.
14. Open the fuel valve by slowly turning the valve counterclockwise. If the fuel valve is opened too quickly, a back pressure check valve will shut off the fuel supply. If this happens, close the fuel valve completely. Wait five seconds and then open the fuel valve very slowly.
15. Inspect the LP fuel lines and fittings with a soap solution after filling the tank or when looking for leaks.

Before Starting the Engine

Walk - Around Inspection

Make a thorough walk-around inspection before mounting the lift truck or starting the engine. Look for such items as loose bolts, debris buildup, oil or coolant leaks. Check condition of tyres, mast, carriage, forks or attachments. Have repairs made as needed and all debris removed.



1. Inspect the operator's compartment for loose items and cleanliness.
2. Inspect the instrument panel for broken or damaged indicator lights or gauges.
3. Test the horn and other safety devices for proper operation.



4. Inspect the mast and lift chains for wear, broken links, pins and loose rollers.
5. Inspect the carriage, forks or attachments for wear, damage and loose or missing bolts.
6. Inspect the tyres and wheels for cuts, gouges, foreign objects, inflation pressure and loose or missing bolts.



7. Inspect the overhead guard and cabin for damage and loose or missing mounting bolts.
8. Inspect the hydraulic system for leaks, worn hoses or damaged lines.
9. Look for transmission and drive axle leaks on the lift truck and on the ground.



Typical Example

LP Engine Truck

10. Inspect the engine compartment for oil, coolant and fuel leaks.
11. Inspect common parts and drive axle, mast etc for grounded, loosen or missing mounting bolts.

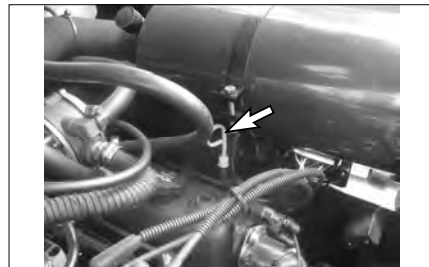

12. Measure the engine crankcase oil level with the dip stick. Maintain the oil level between the MAX. and MIN., (or FULL and ADD) notches on the dip stick.



13. Observe the engine coolant level in the coolant recovery bottle. With the engine cold, maintain the level to the COLD mark. If the recovery bottle is empty, also fill the radiator at the top tank.
14. In case of LPG truck, if needed, change LPG Fuel Tank as the procedure of changing LP tanks in Refueling Section.

⚠ WARNING

Personal injury may occur from accidents caused by improper seat adjustment. Always adjust the operator's seat before starting the lift truck engine.

Seat adjustment must be done at the beginning of each shift and when operators change.



15. To position the seat, PUSH the lever away from the seat track and move the seat forward or backward to a comfortable position.

Starting the Engine

Prestart Conditions

NOTE: The engine will not start unless the transmission directional control lever is in the NEUTRAL position.



1. Engage the parking brake, if not already engaged. Place the transmission directional control lever in the NEUTRAL position.

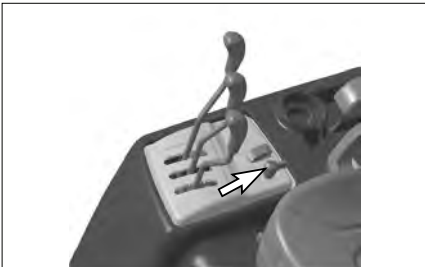

2. If Lift trucks are equipped with electrical disconnect switches, the engine will not start unless the disconnect switch is in the ON (closed) position. Before starting, turn the disconnect switch to the OFF(open) position.

NOTICE

When you restart the engine after turning off it, wait 4 to 5 seconds and restart it to protect the starter.

LP Engine

WARNING

LP fuel is flammable and can cause personal injury.

Inspect LP fuel lines and fitting for leaks.

Inspect tank for secure mounting.

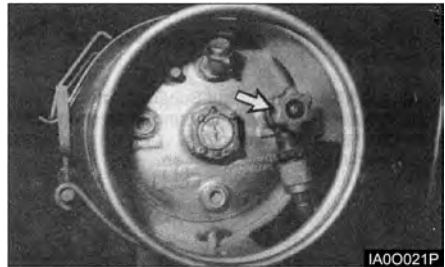

1. Open the tank fuel valve by slowly turning the valve counterclockwise. Observe the LP gauge(if equipped).
2. Turn the engine ignition switch to the START position. Release it when the engine starts.
3. If the engine does not start, do not press on the accelerator pedal. Turn the starter switch to OFF position, then repeat step 2 and depress the accelerator pedal slightly during cranking.
4. Allow the engine to warm up slowly.

Starting From a 12 Volt External Source

⚠ WARNING

Sparks occurring near the battery could cause vapors to explode.

Always connect the external power source ground cable to a point away from and below the battery, and well clear of fuel system components.



NOTICE

Do not reverse battery cables. It can cause damage to the alternator.

Always connect the external power source cables in parallel with the lift truck battery cables : POSITIVE(+) to POSITIVE(+) and NEGATIVE(-) to NEGATIVE(-).

Attach ground cable last, remove first. All lift trucks equipped with CROWN built internal combustion engines are NEGATIVE(-) ground

Electronic Controlled Spark-Ignition Engines

PSI 4.3L LP Engine

The primary components of the fuel system are the fuel supply, direct electronic pressure regulator (DEPR), fuel mixer, electronic throttle control (ETC) device, 2-Stage convertor, engine control module (ECM), and a catalytic converter. The system operates on a slightly positive fuel pressure. Primary fuel pressure can be measured at the LD 2-Stage convertor. Secondary fuel pressure command and actual fuel pressure is monitored by the ECM.

To obtain maximum effect from the catalyst and accurate control of the air fuel ratio, the emission certified engine is equipped with an onboard computer or Engine Control Module (ECM). The ECM is a 32 bit controller which receives input data from sensors mounted to the engine and fuel system and then outputs various signals to control engine operation.

One specific function of the controller is to maintain a closed loop fuel control which is accomplished by use of the Heated Exhaust Gas Oxygen sensor (HEGO) mounted in the exhaust system. The HEGO sensor sends a voltage signal to the controller which then outputs signals to the EPR to change the amount of fuel being delivered from the regulator or mixer to the engine.

The controller also performs diagnostic functions on the fuel system and notifies the operator of engine malfunctions by turning on a Malfunction Indicator Light (MIL) mounted in the dash. Malfunctions in the system are identified by a Diagnostic Trouble Code (DTC) number. In addition to notifying the operator of the malfunction in the system, the controller also stores the information about the malfunction in its memory. A technician can then utilize a computerized diagnostic scan tool to retrieve the stored diagnostic code and by using the diagnostic charts in this manual to determine the cause of the malfunction. In the event a technician does not have the computerized diagnostic tool, the MIL light can be used to identify the diagnostic code to activate the "blink" feature and count the number of blinks to determine the diagnostic code number to locate the fault in the system.

The primary components of the Gasoline Multi Point Fuel Injection (MPFI) fuel system are the gasoline fuel tank, electric fuel pump, fuel pressure and temperature sensor manifold, fuel filter and fuel rail.

This engine is equipped with a fuel injector rail that does not have a pressure regulator or a return circuit to the fuel tank. Fuel pressure for this engine is regulated by the engine's ECM. The ECM receives fuel pressure and temperature feedback from the gasoline fuel sensor manifold and uses this information to control the ground side of the fuel pump. Fuel pressure is regulated by the ECM pulse width modulating (PWM) the fuel pump. The fuel pressure and temperature sensor manifold has a return or "bleed" circuit that connects back to the equipment fuel tank. This circuit is used to bleed off any vapor that develops in the line and returns a small amount of fuel to the tank. The fuel comes from the fuel tank and passes through the fuel pump. Fuel exits the fuel pump, passes through the filter and then enters the fuel pressure and temperature manifold assembly. Fuel flows through the feed circuit and is delivered to the fuel injector rail. Fuel that enters the bleed circuits through the by-pass valve in the manifold is returned to the fuel tank.

EMS schematic of PSI 4.3L LP engine

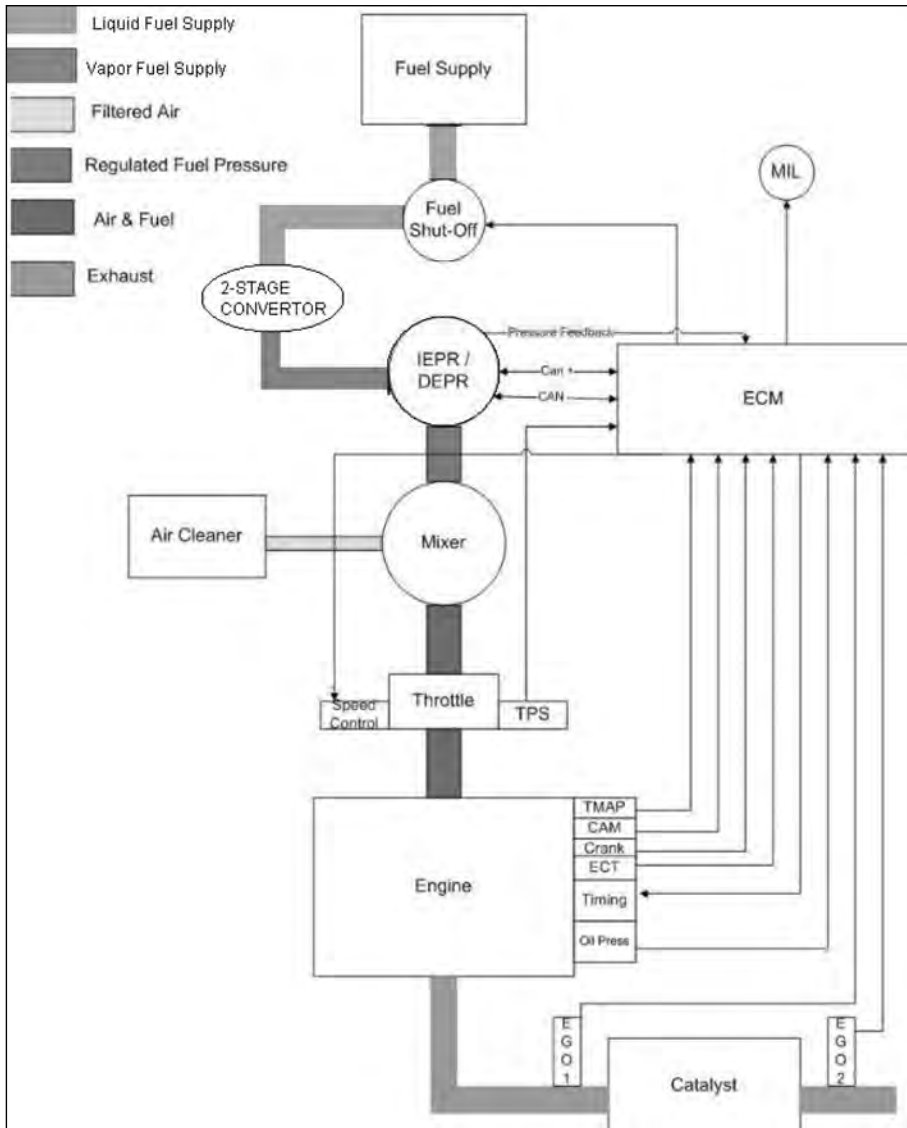

Basic Troubleshooting(LP)

The PSI 4.3L fuel systems are equipped with built-in fault diagnostics. Detected system faults can be displayed by the Malfunction Indicator Lamp (MIL) and are covered in the Advanced Diagnostics section. Items such as fuel level, plugged fuel lines, clogged fuel filters and malfunctioning pressure regulators may not set a fault code by the Engine Control Module (ECM).

Below are basic checks that should be made before referring to the Advanced Diagnostics section, if engine or drivability problems are encountered.

Locating a problem in a propane engine is done exactly the same way as with a gasoline engine.

Consider all parts of the Ignition and mechanical systems as well as the fuel system.

FUEL SYSTEM SYMPTOM DIAGNOSTICS

Checks	Action
<p>Before Using This Section</p>	<p>Before using this section, you should have performed On Board Diagnostic (OBD) Check and determined that:</p> <ol style="list-style-type: none"> 1. The ECM and MIL are operating correctly. 2. There are no Diagnostic Trouble Codes (DTCs) stored, or a DTC exists but without a MIL. <p>Several of the following symptom procedures call for a careful visual and physical check. These checks are very important as they can lead to prompt diagnosis and correction of a problem.</p>
<p>Fuel System Check</p>	<ol style="list-style-type: none"> 1. Verify the customer complaint. 2. Locate the correct symptom table. 3. Check the items indicated under that symptom. 4. Operate the equipment under the conditions the symptom occurs. Verify HEGO switching between lean and rich. IMPORTANT! Normal HEGO switching indicates the fuel system is in closed loop and operating correctly at that time. 5. Take a data snapshot using the DST under the condition that the symptom occurs to review at a later time.
<p>Visual and Physical Checks</p>	<ul style="list-style-type: none"> • Check all ECM system fuses and circuit breakers. • Check the ECM ground for being clean, tight and in its proper location. • Check the vacuum hoses for splits, kinks and proper connections. • Check thoroughly for any type of leak or restriction. • Check for air leaks at all the mounting areas of the intake manifold sealing surfaces. • Check for proper installation of the mixer assembly. • Check for air leaks at the mixer assembly. <p>Check the ignition wires for the following conditions:</p> <ul style="list-style-type: none"> • Cracking • Hardening • Proper routing • Carbon tracking. <p>Check the wiring for the following items: proper connections, pinches or cuts.</p> <p>The following symptom tables contain groups of possible causes for each symptom. The order of these procedures is not important. If the DST readings do not indicate a problem, then proceed in a logical order, easiest to check or most likely to cause the problem.</p>

INTERMITTENT

Checks	Action
DEFINITION: <i>The problem may or may not turn ON the (MIL) or store a Diagnostic Trouble Code (DTC).</i>	
Preliminary Checks	Do not use the DTC tables. If a fault is an intermittent, the use of the DTC tables with this condition may result in the replacement of good parts.
Faulty Electrical Connections or Wiring	<p>Faulty electrical connections or wiring can cause most intermittent problems. Check the suspected circuit for the following conditions:</p> <ul style="list-style-type: none"> • Faulty fuse or circuit breaker, connectors poorly mated, terminals not fully seated in the connector (backed out). Terminals not properly formed or damaged. • Wire terminals poorly connected. • Terminal tension is insufficient. • Carefully remove all the connector terminals in the problem circuit in order to ensure the proper contact tension. • If necessary, replace all the connector terminals in the problem circuit in order to ensure the proper contact tension (except those noted as “Not Serviceable”). See section <i>Wiring Schematics</i>. • Checking for poor terminal to wire connections requires removing the terminal from the connector body.
Operational Test	If a visual and physical check does not locate the cause of the problem, operate the vehicle with the DST connected. When the problem occurs, an abnormal voltage or scan reading indicates a problem circuit.
Intermittent MIL Illumination	<p>The following components can cause intermittent MIL and no DTC(s):</p> <ul style="list-style-type: none"> • A defective relay. • Switch that can cause electrical system interference. Normally, the problem will occur when the faulty component is operating. • The improper installation of add on electrical devices, such as lights, 2-way radios, electric motors, etc. • The ignition secondary voltage shorted to a ground. • The MIL circuit or the Diagnostic Test Terminal intermittently shorted to ground. • The MIL wire grounds.
Loss of DTC Memory	<p>To check for the loss of the DTC Memory:</p> <ol style="list-style-type: none"> 1. Disconnect the TMAP sensor. 2. Idle the engine until the MIL illuminates. 3. The ECM should store a TMAP DTC which should remain in the memory when the ignition is turned OFF. If the TMAP DTC does not store and remain, the ECM is faulty.

NO START

Checks	Action
DEFINITION: <i>The engine cranks OK but does not start.</i>	
Preliminary Checks	None
ECM Checks	Use the DST to : <ul style="list-style-type: none"> • Check for proper communication with both the ECM • Check all system fuses engine fuse holder. Refer to <i>Engine Controls Schematics</i>. • Check battery power, ignition power and ground circuits to the ECM. Refer to <i>Engine Control Schematics</i>. Verify voltage and/or continuity for each.
Sensor Checks	<ul style="list-style-type: none"> • Check the TMAP sensor. • Check the cam angle sensor for output (RPM).
Fuel System Checks	<p>Important: A closed LPG manual fuel shut off valve will create a no start condition.</p> <ul style="list-style-type: none"> • Check for air intake system leakage between the mixer and the throttle body. Verify proper operation of the low pressure lock-off solenoids. • Verify proper operation of the fuel control solenoids. • Check the fuel system pressures. • Refer to the <i>LPG Fuel System Diagnosis</i>. • Check for proper mixer air valve operation.
Ignition System Checks	<p>Note: LPG being a gaseous fuel requires higher secondary ignition system voltages for the equivalent gasoline operating conditions.</p> <ol style="list-style-type: none"> 1. Check for the proper ignition voltage output with <i>J 26792</i> or the equivalent. 2. Verify that the spark plugs are correct for use with LPG. <p>Check the spark plugs for the following conditions:</p> <ul style="list-style-type: none"> • Wet plugs. • Cracks. • Wear. • Improper gap. • Burned electrodes. • Heavy deposits. • Check for bare or shorted ignition wires. • Check for loose ignition coil connections at the coil.

NO START

Checks	Action
<p>Engine Mechanical Checks</p>	<p>Important: The LPG Fuel system is more sensitive to intake manifold leakage than the gasoline fuel system.</p> <p>Check for the following:</p> <ul style="list-style-type: none"> • Vacuum leaks. • Improper valve timing. • Low compression. • Improper valve clearance. • Worn rocker arms. • Broken or weak valve springs. <p>Worn camshaft lobes.</p>
<p>Exhaust System Checks</p>	<p>Check the exhaust system for a possible restriction:</p> <ul style="list-style-type: none"> • Inspect the exhaust system for damaged or collapsed pipes: • Inspect the muffler for signs of heat distress or for possible internal failure. • Check for possible plugged catalytic converter. Refer to <i>Restricted Exhaust System Diagnosis</i>.

HARD START

Checks	Action
<p>DEFINITION: <i>The engine cranks OK, but does not start for a long time. The engine does eventually run, or may start but immediately dies.</i></p>	
<p>Preliminary Checks</p>	<p>Make sure the vehicle's operator is using the correct starting procedure.</p>
<p>Sensor Checks</p>	<ul style="list-style-type: none"> • Check the Engine Coolant Temperature sensor with the DST. Compare the engine coolant temperature with the ambient air temperature on a cold engine. If the coolant temperature reading is more than 10 degrees greater or less than the ambient air temperature on a cold engine, check for high resistance in the coolant sensor circuit. Check the cam angle sensor. • Check the Throttle Position (TPS) and Foot Pedal Position (FPP) sensor connections.
<p>Fuel System Checks</p>	<p>Important: A closed LPG manual fuel shut off valve will create an extended crank OR no start condition.</p> <ul style="list-style-type: none"> • Verify the excess flow valve is not tripped or that the manual shut-off valve is not closed. <p>Check mixer assembly for proper installation and leakage.</p> <ul style="list-style-type: none"> • Verify proper operation of the low pressure lock-off solenoid. • Verify proper operation of the EPR. • Check for air intake system leakage between the mixer and the throttle body. Check the fuel system pressures. Refer to the <i>Fuel System Diagnosis</i>.
<p>Ignition System Checks</p>	<p>Note: LPG being a gaseous fuel requires higher secondary ignition system voltages for the equivalent gasoline operating conditions.</p> <ul style="list-style-type: none"> • Check for the proper ignition voltage output with <i>J 26792</i> or the equivalent. • Verify that the spark plugs are the correct type and properly gapped. <p>Check the spark plugs for the following conditions:</p> <ul style="list-style-type: none"> • Wet plugs. • Cracks. • Wear. • Burned electrodes. • Heavy deposits • Check for bare or shorted ignition wires. • Check for moisture in the distributor cap. • Check for loose ignition coil connections. <p>Important:</p> <ol style="list-style-type: none"> 1. If the engine starts but then immediately stalls, check the cam angle sensor. 2. Check for improper gap, debris or faulty connections.

HARD START

Checks	Action
<p>Engine Mechanical Checks</p>	<p>Important: The LPG Fuel system is more sensitive to intake manifold leakage than the gasoline fuel supply system.</p> <p>Check for the following:</p> <ul style="list-style-type: none"> • Vacuum leaks • Improper valve timing • Low compression • Improper valve clearance. • Worn rocker arms • Broken or weak valve springs • Worn camshaft lobes. <p>Check the intake and exhaust manifolds for casting ash.</p>
<p>Exhaust System Checks</p>	<p>Check the exhaust system for a possible restriction:</p> <ul style="list-style-type: none"> • Inspect the exhaust system for damaged or collapsed pipes. • Inspect the muffler for signs of heat distress or for possible internal failure. <p>Check for possible plugged catalytic converter. Refer to <i>Restricted Exhaust System Diagnosis</i>.</p>

CUTS OUT, MISSES

Checks	Action
<p>DEFINITION: A surging or jerking that follows engine speed, usually more pronounced as the engine load increases, but normally felt below 1500 RPM. The exhaust has a steady spitting sound at idle, low speed, or hard acceleration for the fuel starvation that can cause the engine to cut-out.</p>	
Preliminary Checks	None
Ignition System Checks	<ol style="list-style-type: none"> 1. Start the engine. 2. Check for proper ignition output voltage with spark tester J 26792. 3. Check for a cylinder misfire. 4. Verify that the spark plugs are the correct type and properly gapped. <p>Remove the spark plugs and check for the following conditions:</p> <ul style="list-style-type: none"> • Insulation cracks. • Wear. • Improper gap. • Burned electrodes. • Heavy deposits. <p>Visually/Physically inspect the secondary ignition for the following:</p> <ul style="list-style-type: none"> • Ignition wires for arcing and proper routing. • Cross- ring. • Ignition coils for cracks or carbon tracking
Engine Mechanical Checks	<p>Perform a cylinder compression check. Check the engine for the following:</p> <ul style="list-style-type: none"> • Improper valve timing. • Improper valve clearance. • Worn rocker arms. • Worn camshaft lobes. • Broken or weak valve springs. • Check the intake and exhaust manifold passages for casting ash.
Fuel System Checks	<p>Check the fuel system:</p> <ul style="list-style-type: none"> • Plugged fuel filter. • Low fuel pressure, etc. Refer to <i>LPG Fuel System Diagnosis</i>. • Check the condition of the wiring to the low pressure lock-off solenoid.
Additional Check	<p>Check for Electromagnetic Interference (EMI), which may cause a misfire condition. Using the DST, monitor the engine RPM and note sudden increases in rpms displayed on the scan tool but with little change in the actual engine rpm. If this condition exists, EMI may be present. Check the routing of the secondary wires and the ground circuit.</p>

HESITATION, SAG, STUMBLE

Checks	Action
<p>DEFINITION: <i>The engine has a momentary lack of response when putting it under load. The condition can occur at any engine speed. The condition may cause the engine to stall if it's severe enough.</i></p>	
Preliminary Checks	None
Fuel System Checks	<ul style="list-style-type: none"> • Check the fuel pressure. Refer to <i>LPG Fuel System Diagnosis</i>. • Check for low fuel pressure during a moderate or full throttle acceleration. If the fuel pressure drops below specification, there is possibly a faulty low pressure regulator or a restriction in the fuel system. • Check the TMAP sensor response and accuracy. • Check Shut-Off electrical connection. • Check the mixer air valve for sticking or binding. • Check the mixer assembly for proper installation and leakage. Check the EPR.
Ignition System Checks	<p>Note: LPG being a gaseous fuel requires higher secondary ignition system voltages for the equivalent gasoline operating conditions. If a problem is reported on LPG and not gasoline, do not discount the possibility of a LPG only ignition system failure and test the system accordingly.</p> <ul style="list-style-type: none"> • Check for the proper ignition voltage output with <i>J 26792</i> or the equivalent. Verify that the spark plugs are the correct type and properly gapped. • Check for faulty spark plug wires. • Check for fouled spark plugs.
Additional Check	<ul style="list-style-type: none"> • Check for manifold vacuum or air induction system leaks. • Check the alternator output voltage.

BACKFIRE

Checks	Action
<p>DEFINITION: The fuel ignites in the intake manifold, or in the exhaust system, making a loud popping noise.</p>	
Preliminary Checks	None
Ignition System Checks	<p>Important! LPG, being a gaseous fuel, requires higher secondary ignition system voltages for the equivalent gasoline operating conditions. The ignition system must be maintained in peak condition to prevent backfire.</p> <ul style="list-style-type: none"> • Check for the proper ignition coil output voltage using the spark tester J26792 or the equivalent. • Check the spark plug wires by connecting an ohmmeter to the ends of each wire in question. If the meter reads over 30,000 ohms, replace the wires. • Check the connection at ignition coil. • Check for deteriorated spark plug wire insulation. <p>Remove the plugs and inspect them for the following conditions:</p> <ul style="list-style-type: none"> • Wet plugs. • Cracks. • Wear. • Improper gap. • Burned electrodes. • Heavy deposits.
Engine Mechanical Check	<p>Important! The LPG Fuel system is more sensitive to intake manifold leakage than a gasoline fuel supply system.</p> <p>Check the engine for the following:</p> <ul style="list-style-type: none"> • Improper valve timing. • Engine compression. • Manifold vacuum leaks. • Intake manifold gaskets. • Sticking or leaking valves. • Exhaust system leakage. • Check the intake and exhaust system for casting flash or other restrictions.
Fuel System Checks	Perform a fuel system diagnosis. Refer to <i>LPG Fuel System Diagnosis</i> .

LACK OF POWER, SLUGGISHNESS, OR SPONGINESS

Checks	Action
DEFINITION: <i>The engine delivers less than expected power.</i>	
Preliminary Checks	<ul style="list-style-type: none"> • Refer to the <i>LPG Fuel system OBD System Check</i>. • Compare the customer's vehicle with a similar unit to verify customer has an actual problem. <i>Do not compare the power output of the vehicle operating on LPG to a vehicle operating on gasoline as the fuels do have different drive feel characteristics.</i> • Remove the air filter and check for dirt or restriction. • Check the vehicle transmission. • Refer to the OEM transmission diagnostics.
Fuel System Checks	<ul style="list-style-type: none"> • Check for a restricted fuel filter, contaminated fuel, or improper fuel pressure. Refer to <i>LPG Fuel System Diagnosis</i>. • Check for the proper ignition output voltage with the spark tester <i>J 26792</i> or the equivalent. • Check for proper installation of the mixer assembly. Check all air inlet ducts for condition and proper installation. • Check for fuel leaks between the EPR and the mixer. • Verify that the LPG tank manual shut-off valve is fully open. • Verify that liquid fuel (not vapor) is being delivered to the EPR.
Sensor Checks	<ul style="list-style-type: none"> • Check the Heated Exhaust Gas Oxygen Sensors (HEGO) for contamination and performance. Check for proper operation of the TMAP sensor. • Check for proper operation of the TPS and FPP sensors.
Exhaust System Checks	<p>Check the exhaust system for a possible restriction:</p> <ul style="list-style-type: none"> • Inspect the exhaust system for damaged or collapsed pipes. • Inspect the muffler for signs of heat distress or for possible internal failure. • Check for possible plugged catalytic converter.
Engine Mechanical Check	<p>Check the engine for the following:</p> <ul style="list-style-type: none"> • Engine compression. • Valve timing. • Improper or worn camshaft. • Refer to <i>Engine Mechanical</i> in the Service Manual.
Additional Check	<ul style="list-style-type: none"> • Check the ECM grounds for being clean, tight, and in their proper locations. • Check the alternator output voltage. <p>If all procedures have been completed and no malfunction has been found, review and inspect the following items:</p> <ul style="list-style-type: none"> • Visually and physically, inspect all electrical connections within the suspected circuit and/or systems. • Check the DST data.

ROUGH, UNSTABLE, OR INCORRECT IDLE, STALLING

Checks	Action
DEFINITION: <i>The engine runs unevenly at idle. If severe enough, the engine may shake.</i>	
Preliminary Checks	None.
Sensor Checks	<p>Check the Heated Exhaust Gas Oxygen Sensors (HEGO) performance:</p> <ul style="list-style-type: none"> • Check for silicone contamination from fuel or improperly used sealant. If contaminated, the sensor may have a white powdery coating result in a high but false signal voltage (rich exhaust indication). The ECM will reduce the amount of fuel delivered to the engine causing a severe driveability problem. <p>Check the Temperature Manifold Absolute Pressure (TMAP) sensor response and accuracy.</p>
Fuel System Checks	<ul style="list-style-type: none"> • Check for rich or lean symptom that causes the condition. • Drive the vehicle at the speed of the complaint. • Monitoring the oxygen sensors will help identify the problem. • Check for a sticking mixer air valve. • Verify proper operation of the EPR. • Perform a cylinder compression test. Refer to <i>Engine Mechanical</i> in the Service Manual. • Check the EPR fuel pressure. Refer to the <i>LPG Fuel System Diagnosis</i>. • Check mixer assembly for proper installation and connection.
Ignition System Checks	<ul style="list-style-type: none"> • Check for the proper ignition output voltage using the spark tester <i>J26792</i> or the equivalent. • Verify that the spark plugs are the correct type and properly gapped. <p>Remove the plugs and inspect them for the following conditions:</p> <ul style="list-style-type: none"> • Wet plugs. • Cracks. • Wear. • Improper gap. • Burned electrodes. • Blistered insulators. • Heavy deposits. <p>Check the spark plug wires by connecting an ohmmeter to the ends of each wire in question. If the meter reads over 30,000 ohms, replace the wires.</p>
Additional Checks	<p>Important: The LPG Fuel system is more sensitive to intake manifold leakage than the gasoline fuel supply system.</p> <ul style="list-style-type: none"> • Check for vacuum leaks. Vacuum leaks can cause a higher than normal idle and low throttle angle control command. • Check the ECM grounds for being clean, tight, and in their proper locations. Check the battery cables and ground straps. They should be clean and secure. Erratic voltage may cause all sensor readings to be skewed resulting in poor idle quality.

ROUGH, UNSTABLE, OR INCORRECT IDLE, STALLING

Checks	Action
Engine Mechanical Check	Check the engine for: <ul style="list-style-type: none">• Broken motor mounts.• Improper valve timing.• Low compression.• Improper valve clearance.• Worn rocker arms.• Broken or weak valve springs.• Worn camshaft lobes.

Advanced Diagnostics(PSI 4.3L LP Engine)

The Fuel system has built-in diagnostics for system trouble shooting. The system has a dash mounted malfunction indicator lamp (MIL) that provides indications of engine or fuel system related problem. Most engine control system related problems that affect emissions or driveability of the vehicle will set a (DTC) diagnostic trouble code and illuminate the MIL.

The MIL serves as notification to the operator of a problem related to the emission control system so the driver can arrange for service as soon as possible. It will also display DTCs that have been stored due to a system malfunction.

The MIL should illuminate when the key is in the ON position and the engine is not running. This feature verifies that the lamp is in proper working order. If the MIL does not illuminate with the vehicle key ON/engine OFF, repair it as soon as possible. Once the engine is in start or run mode, the MIL should turn off. If the lamp remains on while the engine is in the start or run mode a diagnostic trouble code may be set.

The MIL will be turned OFF after three (3) consecutive run cycles or by clearing the active code with the Diagnostic Scan Tool (DST).

Diagnostic Trouble Codes are set when the GCP (Electronic Control Module) runs a diagnostic self test and the test fails. When a DTC is set, the ECM will illuminate the MIL on the instrument panel and also save the DTC in memory. The ECM will continue to run the self test. If the system continues to fail the test, the lamp will stay illuminated and the DTC is stored as an active DTC. If the self test runs and passes, the DTC will be stored as historic DTC. All DTCs are stored as historic faults until they are cleared. Most DTCs will automatically clear from memory if the DTC does not reset within 50 to 100 consecutive engine run cycles.

While a Diagnostic Trouble Code is current for a sensor, the ECM may assign a default "limp home" value and use that value in its control algorithms. All of the system diagnostic self-tests run continuously during normal vehicle operation.

The Diagnostic Trouble Codes can be read by using either the MIL lamp or a laptop computer. Diagnostic Trouble Codes can be cleared from memory with a laptop computer, or by turning the ignition key to the OFF position and removing the ECM power fuse or battery cable for at least 15 seconds.

If more than one DTC is detected, start the diagnostic repair with the lowest DTC number set. Diagnose each problem to correction unless directed to do otherwise by the diagnostic chart. The DTCs are numbered in order of importance. Both DTC 112 and DTC122 pertain to the oxygen sensor, so it is possible that a repair that corrects DTC 112 may also correct the problem causing the DTC 122.

Diagnostic test charts contained in this manual refer to the DST to be connected and in the "System Data Mode." This simply means that the DST is connected and communicating with the PC. In some instances the chart will call out a special test mode. An example of this would be instructions for the DST to be connected and in the DBW (drive by wire) mode. Always be sure to follow the special instructions to avoid a false diagnosis of fuel system components.

Table 2. MI-07 Diagnostic Fault Codes (Flash Codes)

DFC	PROBABLE FAULT	FAULT ACTION *	CORRECTIVE ACTION FIRST CHECK
12	NONE Signifies the end of one pass through the fault list	NONE	None, used as end of the fault list identification
141 (14)	ECTRangeLow Coolant Sensor failure or shorted to GND	TurnOnMil	Check ECT sensor connector and wiring for a short to GND SECM (Signal) Pin B15 To ECT Pin 3 SECM (Sensor GND) Pin B1 to ECT Pin 1 SECM (System GND) Pin A16, B17
151 (15)	ECTRangeHigh Coolant sensor disconnected or open circuit	(1) TurnOnMil (2) DelayedEngine Shutdown (3) CheckEngineLight	Check if ECT sensor connector is disconnected or for an open ECT circuit SECM (Signal) Pin B15 to ECT Pin 3 SECM (Sensor GND) Pin B1 to ECT Pin 1
161 (16)	ECTOverTempFault Engine coolant temperature is high. The sensor has measured an excessive coolant temperature typically due to the engine overheating.	(1) TurnOnMil (2) DelayedEngine Shutdown (3) CheckEngineLight	Check coolant system for radiator blockage, proper coolant level and for leaks in the system. Possible ECT short to GND, check ECT signal wiring SECM (Signal) Pin B15 to ECT Pin 3 SECM (Sensor GND) Pin B1 to ECT Pin 1 SECM (System GND) Pin A16, B17 Check regulator for coolant leaks
171	ECT_IR_Fault Engine coolant temperature not changing as expected	None	Check for coolant system problems, e.g. defective or stuck thermostat
181	FuelSelectConflict Conflict in fuel select signals, normally set if both of the fuel select signals are shorted to ground	TurnOnMil	Check fuel select switch connection for a short to GND SECM (SIGNAL) Pin A12 SECM (SIGNAL) Pin A15 SECM (Sensor GND) Pin B1
193	CrankEdgesFault No crankshaft signal when engine is known to be rotating, broken crankshaft sensor leads or defective crank sensor	None	Check Crankshaft sensor connections SECM (SIGNAL) Pin B5 to Crank sensor Pin 3 SECM (Sensor GND) PIN B1 to Crank sensor Pin 2 Switched 12V to Crank sensor Pin 1 Check for defective Crank sensor

(*) Fault actions shown are default values specified by the OEM.

Table 2. MI-07 Diagnostic Fault Codes (Flash Codes) cont'd.

DFC	PROBABLE FAULT	FAULT ACTION*	CORRECTIVE ACTION FIRST CHECK
194	CrankSyncFault Loss of synchronization on the crankshaft sensor, normally due to noise on the signal or an intermittent connection on the crankshaft sensor	None	Check Crankshaft sensor connections SECM (SIGNAL) Pin B5 to Crank sensor Pin 3 SECM (Sensor GND) Pin B1 to Crank sensor Pin 2 Switched 12V to Crank sensor Pin 1 Check for defective Crank sensor
221 (22)	TPS1RangeLow TPS1 sensor voltage out of range low, normally set if the TPS1 signal has shorted to ground, circuit has opened or sensor has failed	TurnOnMil	Check throttle connector connection and TPS1 sensor for an open circuit or short to GND SECM Pin B23 (signal) to ETC Pin 6 SECM Pin B1 (sensor GND) to ETC Pin 2 SECM (system GND) Pin A16, B17
222	TPS2RangeLow TPS2 sensor voltage out of range low, normally set if the TPS2 signal has shorted to ground, circuit has opened or sensor has failed	TurnOnMil	Check throttle connector connection and TPS2 sensor for an open circuit or short to GND SECM Pin B4 (signal) to ETC Pin 5 SECM Pin B1 (sensor GND) to ETC Pin 2 SECM (system GND) Pin A16, B17
231 (23)	TPS1RangeHigh TPS1 sensor voltage out of range high, normally set if the TPS1 signal has shorted to power or the ground for the sensor has opened	TurnOnMil	Check throttle connector and TPS1 sensor wiring for a shorted circuit SECM Pin B23 (signal) to ETC Pin 6 SECM Pin B1 (sensor GND) to ETC Pin 2
232	TPS2RangeHigh TPS2 sensor voltage out of range high, normally set if the TPS2 signal has shorted to power or the ground for the sensor has opened	TurnOnMil	Check throttle connector and TPS1 sensor wiring for a shorted circuit SECM Pin B4 (signal) to ETC Pin 5 SECM pin B1 (sensor GND) to ETC Pin 2
241 (24)	TPS1AdaptLoMin Learned closed throttle end of TPS1 sensor range lower than expected	None	Check the throttle connector and pins for corrosion. To check the TPS disconnect the throttle connector and measure the resistance from: TPS Pin 2 (GND) to Pin 6 (TPS1 SIGNAL) (0.7 Ω ± 30%) TPS Pin 3 (PWR) to Pin 6 (TPS1 SIGNAL) (1.4 Ω ± 30%)

(*) Fault actions shown are default values specified by the OEM.

Table 2. MI-07 Diagnostic Fault Codes (Flash Codes) cont'd.

DFC	PROBABLE FAULT	FAULT ACTION *	CORRECTIVE ACTION FIRST CHECK
242	TPS2AdaptLoMin Learned closed throttle end of TPS2 sensor range lower than expected	None	Check the throttle connector and pins for corrosion. To check the TPS disconnect the throttle connector and measure the resistance from: TPS Pin 2 (GND) to Pin 5 (TPS2 SIGNAL) (1.3K Ω \pm 30%) TPS PIN 3 (PWR) to PIN 5 (TPS2 SIGNAL) (0.6K Ω \pm 30%)
251 (25)	TPS1AdaptHiMax Learned WOT end of TPS1 sensor range higher than expected	None	N/A
252	TPS2AdaptHiMax Learned WOT end of TPS2 sensor range higher than expected	None	N/A
271	TPS1AdaptHiMin Learned WOT end of TPS1 sensor range lower than expected	None	N/A
272	TPS2AdaptHiMin Learned WOT end of TPS2 sensor range lower than expected	None	N/A
281	TPS1AdaptLoMax Learned closed throttle end of TPS1 sensor range higher than expected	None	N/A
282	TPS2AdaptLoMax Learned closed throttle end of TPS2 sensor range higher than expected	None	N/A
291	TPS_Sensors_Conflict TPS sensors differ by more than expected amount NOTE: The TPS is not a serviceable item and can only be repaired by replacing the DV-EV throttle assembly.	(1) TurnOnMil (2) Engine Shutdown	Perform checks for DFCs 241 & 242

(*) Fault actions shown are default values specified by the OEM.

Table 2. MI-07 Diagnostic Fault Codes (Flash Codes) cont'd.

DFC	PROBABLE FAULT	FAULT ACTION *	CORRECTIVE ACTION FIRST CHECK
<p>331 (33)</p>	<p>MAPTimeRangeLow Manifold Absolute Pressure sensor input is low, normally set if the TMAP pressure signal wire has been disconnected or shorted to ground or the circuit has opened to the SECM</p>	<p>None</p>	<p>Check TMAP connector and MAP signal wiring for an open circuit TMAP Pin 4 to SECM Pin B18 (signal) TMAP Pin 1 to SECM Pin B1 (sensor GND) TMAP Pin 3 to SECM Pin B24 (XDRP +5 Vdc) Check the MAP sensor by disconnecting the TMAP connector and measuring at the sensor TMAP Pin 1(GND) to Pin 4 (pressure signal KPA) (2.4kΩ - 8.2kΩ) TMAP Pin 3 (power) to Pin 4 (pressure signal KPA) (3.4kΩ - 8.2kΩ)</p>
<p>332</p>	<p>MAPRangeLow Manifold Absolute Pressure sensor input is low, normally set if the TMAP pressure signal wire has been disconnected or shorted to ground or the circuit has opened to the SECM</p>	<p>(1) TurnOnMil (2) CutThrottle</p>	<p>Check TMAP connector and MAP signal wiring for an open circuit TMAP Pin 4 to SECM Pin B18 (signal) TMAP Pin 1 to SECM Pin B1 (sensor GND) TMAP Pin 3 to SECM Pin B24 (XDRP +5 Vdc) Check the MAP sensor by disconnecting the TMAP connector and measuring at the sensor: TMAP Pin 1(GND) to Pin 4 (pressure signal KPA) (2.4kΩ - 8.2kΩ) TMAP Pin 3 (power) to Pin 4 (pressure signal KPA) (3.4kΩ - 8.2kΩ)</p>
<p>341 (34)</p>	<p>MAPTimeRangeHigh Manifold Absolute Pressure Sensor Input is High, normally set if the TMAP pressure signal wire has become shorted to power, shorted to the IAT signal, the TMAP has failed or the SECM has failed.</p>	<p>None</p>	<p>Check TMAP connector and MAP signal wiring for a shorted circuit TMAP Pin 4 to SECM Pin B18 (signal) TMAP Pin 1 to SECM Pin B1 (sensor GND) TMAP Pin 3 to SECM Pin B24 (XDRP +5 Vdc) Check the MAP sensor by disconnecting the TMAP connector and measuring at the sensor TMAP Pin 1(GND) to Pin 4 (pressure signal KPA) (2.4kΩ - 8.2kΩ) TMAP Pin 3 (power) to Pin 4 (pressure signal KPA) (3.4kΩ - 8.2kΩ)</p>

Table 2. MI-07 Diagnostic Fault Codes (Flash Codes) cont'd.

DFC	PROBABLE FAULT	FAULT ACTION *	CORRECTIVE ACTION FIRST CHECK
342	MAPRangeHigh Manifold Absolute Pressure Sensor Input is High, normally set if the TMAP pressure signal wire has become shorted to power, shorted to the IAT signal, the TMAP has failed or the SECM has failed	(1) TurnOnMil (2) CutThrottle	Check TMAP connector and MAP signal wiring for a shorted circuit TMAP Pin 4 to SECM Pin B18 (signal) TMAP Pin 1 to SECM Pin B1 (sensor GND) TMAP Pin 3 to SECM Pin B24 (XDRP +5 Vdc) Check the MAP sensor by disconnecting the TMAP connector and measuring at the sensor: TMAP Pin 1(GND) to Pin 4 (pressure signal KPA) (2.4kΩ - 8.2kΩ) TMAP Pin 3 (power) to Pin 4 (pressure signal KPA) (3.4kΩ - 8.2kΩ)
351	MAP_IR_HI MAP sensor indicates higher pressure than expected	None	Check for vacuum leaks. Check that TMAP sensor is mounted properly. Possible defective TMAP sensor.
352	MAP_IR_LO MAP sensor indicates lower pressure than expected	None	Possible defective TMAP sensor.
353	MAP_STICKING MAP sensor not changing as expected	None	Check that TMAP sensor is mounted properly. Possible defective TMAP sensor.
371 (37)	IATRangeLow Intake Air Temperature Sensor Input is Low normally set if the IAT temperature sensor wire has shorted to chassis ground or the sensor has failed.	TurnOnMil	Check TMAP connector and IAT signal wiring for a shorted circuit TMAP Pin 2 to SECM Pin B12 (signal) TMAP Pin 1 to SECM Pin B1 (sensor GND) To check the IAT sensor of the TMAP disconnect the TMAP connector and measure the IAT resistance Resistance is approx 2400 ohms at room temperature.
381 (38)	IATRangeHigh Intake Air Temperature Sensor Input is High normally set if the IAT temperature sensor wire has been disconnected or the circuit has opened to the SECM.	TurnOnMil	Check TMAP connector and IAT signal wiring for a shorted circuit TMAP Pin 2 to SECM Pin B12 (signal) TMAP Pin 1 to SECM Pin B1 (sensor GND) To check the IAT sensor of the TMAP disconnect the TMAP connector and measure the IAT resistance Resistance is approx 2400 ohms at room temperature.
391	IAT_IR_Fault Intake Air Temperature not changing as expected	None	Check connections to TMAP sensor. Check that TMAP sensor is properly mounted to manifold.

(*) Fault actions shown are default values specified by the OEM.

Table 2. MI-07 Diagnostic Fault Codes (Flash Codes) cont'd.

DFC	PROBABLE FAULT	FAULT ACTION *	CORRECTIVE ACTION FIRST CHECK
421	EST1_Open EST1 output open, possibly open EST1 signal or defective spark module	TurnOnMil	Check coil driver wiring and connector for open circuit SECM Pin A9 (EST1) to OEM ignition system. See application note. Verify GND on ignition module Pin A (of both connectors) Verify +12 Vdc on ignition module Pin B (of both connectors) Refer to application manual for specific engine details.
431	EST1_Short EST1 output shorted high or low, EST1 signal shorted to ground or power or defective spark module	TurnOnMil	Check coil driver wiring and connector for shorts SECM Pin A9 (EST1) to ignition module Pin D (4-pin connector) Verify GND on ignition module Pin A (of both connectors) Verify +12 Vdc on ignition module Pin B (of both connectors) Refer to application manual for specific engine details.
461 (26)	ETC_Sticking Electronic Throttle Control is sticking. This can occur if the throttle plate (butterfly valve) inside the throttle bore is sticking. The plate sticking can be due to some type of obstruction, a loose throttle plate, or worn components shaft bearings. NOTE: The throttle assembly is not a serviceable item and can only be repaired by replacing the DV-EV throttle assembly.	(1) TurnOnMil (2) EngineShutdown (3) CutThrottle	Check for debris or obstructions inside the throttle body Perform the throttle test using the Service Tool and re-check for fault Check throttle-plate shaft for bearing wear Check the ETC driver wiring for an open circuit SECM Pin A17 to ETC + Pin 1 SECM Pin A18 to ETC - Pin 4 Check the ETC internal motor drive by disconnecting the throttle connector and measuring the motor drive resistance at the throttle TPS Pin 1 (+DRIVER) to Pin 4 (-DRIVER) ~3.0-4.0Ω
471	ETC_Open_Fault Electronic Throttle Control Driver has failed, normally set if either of the ETC driver signals have opened or become disconnected, electronic throttle or SECM is defective.	None	Check the ETC driver wiring for an open circuit SECM Pin A17 to ETC + Pin 1 SECM Pin A18 to ETC - Pin 4 Check the ETC internal motor drive by disconnecting the throttle connector and measuring the motor drive resistance at the throttle TPS Pin 1 (+DRIVER) to Pin 4 (-DRIVER) ~3.0-4.0Ω

(*) Fault actions shown are default values specified by the OEM.

Table 2. MI-07 Diagnostic Fault Codes (Flash Codes) cont'd.

DFC	PROBABLE FAULT	FAULT ACTION *	CORRECTIVE ACTION FIRST CHECK
<p>481 (28)</p>	<p>ETCSpringTest Electronic Throttle Control Spring Return Test has failed. The SECM will perform a safety test of the throttle return spring following engine shutdown. If this spring has become weak the throttle will fail the test and set the fault. NOTE: The throttle assembly is not a serviceable item and can only be repaired by replacing the DV-EV throttle assembly.</p>	<p>(1) TurnOnMil (2) EngineShutdown</p>	<p>Perform throttle spring test by cycling the ignition key and re-check for fault</p>
<p>491 (29)</p>	<p>HbridgeFault_ETC Electronic Throttle Control Driver has failed. Indeterminate fault on Hbridge driver for electronic throttle control. Possibly either ETC+ or ETC- driver signals have been shorted to ground</p>	<p>TurnOnMil</p>	<p>Check ETC driver wiring for a shorted circuit SECM Pin A17 to ETC + Pin 1 SECM Pin A18 to ETC - Pin 4 Perform the throttle test using the Service Tool and re-check for fault Check the ETC internal motor drive by disconnecting the throttle connector and measuring the motor drive resistance at the throttle TPS Pin 1 (+DRIVER) to Pin 4 (-DRIVER) ~3.0-4.0Ω</p>
<p>521 (52)</p>	<p>LowOilPressureFault Low engine oil pressure</p>	<p>(1) TurnOnMil (2) DelayedEngine Shutdown (3) CheckEngine Light</p>	<p>Check engine oil level Check electrical connection to the oil pressure switch SECM Pin B9 to Oil Pressure Switch</p>
<p>531 (53)</p>	<p>SysVoltRangeLow System voltage too low</p>	<p>TurnOnMil</p>	<p>Check battery voltage Perform maintenance check on electrical connections to the battery and chassis ground Check battery voltage during starting and with the engine running to verify charging system and alternator function Measure battery power at SECM with a multimeter (with key on) SECM Pin A23 (DRVP) to SECM Pin A16 (DRVG) SECM Pin A23 (DRVP) to SECM Pin B17 (DRVG)</p>

(*) Fault actions shown are default values specified by the OEM.

Table 2. MI-07 Diagnostic Fault Codes (Flash Codes) cont'd.

DFC	PROBABLE FAULT	FAULT ACTION *	CORRECTIVE ACTION FIRST CHECK
<p>541 (54)</p>	<p>SysVoltRangeHigh System voltage too high</p>	<p>TurnOnMil</p>	<p>Check battery and charging system voltage Check battery voltage during starting and with the engine running Check voltage regulator, alternator, and charging system Check battery and wiring for overheating and damage Measure battery power at SECM with a multimeter (with key on) SECM Pin A23 (DRVP) to SECM Pin A16 (DRVG) SECM Pin A23 (DRVP) to SECM Pin B17 (DRVG)</p>
<p>551 (55)</p>	<p>SensVoltRangeLow Sensor reference voltage XDRP too low</p>	<p>(1) TurnOnMil (2) EngineShutdown</p>	<p>Measure transducer power at the TMAP connector with a multimeter TMAP Pin 3 XDRP +5 Vdc to TMAP Pin 1 XDRG GND Verify transducer power at the SECM with a multimeter SECM Pin B24 +5 Vdc to SECM Pin B1 XDRG GND Verify transducer power at ETC with a multimeter ETC Pin 3 XDRP PWR to ETC Pin 2 XDRG GND Verify transducer power to the foot pedal with a multimeter.</p>
<p>561 (56)</p>	<p>SensVoltRangeHigh Sensor reference voltage XDRP too high</p>	<p>(1) TurnOnMil (2) EngineShutdown</p>	<p>Measure transducer power at the TMAP connector with a multimeter TMAP Pin 3 XDRP +5 Vdc to TMAP Pin 1 XDRG GND Verify transducer power at the SECM with a multimeter SECM Pin B24 +5 Vdc to SECM Pin B1 XDRG GND Verify transducer power at ETC with a multimeter ETC Pin 3 XDRP PWR to ETC Pin 2 XDRG GND Verify transducer power to the foot pedal with a multimeter.</p>
<p>571 (57)</p>	<p>HardOverspeed Engine speed has exceeded the third level (3 of 3) of overspeed protection</p>	<p>(1) TurnOnMil (2) HardRevLimit</p>	<p>Usually associated with additional ETC faults Check for ETC Sticking or other ETC faults Verify if the lift truck was motored down a steep grade</p>

(*) Fault actions shown are default values specified by the OEM.

Table 2. MI-07 Diagnostic Fault Codes (Flash Codes) cont'd.

DFC	PROBABLE FAULT	FAULT ACTION *	CORRECTIVE ACTION FIRST CHECK
572	MediumOverspeed Engine speed has exceeded the second level (2 of 3) of overspeed protection	(1) TurnOnMil (2) MediumRevLimit	Usually associated with additional ETC faults Check for ETC Sticking or other ETC faults Verify if the lift truck was motored down a steep grade
573	SoftOverspeed Engine speed has exceeded the first level (1 of 3) of overspeed protection	(1) TurnOnMil (2) SoftRevLimit	Usually associated with additional ETC faults Check for ETC Sticking or other ETC faults Verify if the lift truck was motored down a steep grade
611 (61)	APP1RangeLow APP1 sensor voltage out of range low, normally set if the APP1 signal has shorted to ground, circuit has opened or sensor has failed	(1) TurnOnMil (2) CheckEngine Light	Check foot pedal connector Check APP1 signal at SECM PIN B7
612 (65)	APP2RangeLow APP2 sensor voltage out of range low, normally set if the APP2 signal has shorted to ground, circuit has opened or sensor has failed	TurnOnMil	Check foot pedal connector Check APP2 signal at SECM PIN B16
621 (62)	APP1RangeHigh APP1 sensor voltage out of range high, normally set if the APP1 signal has shorted to power or the ground for the sensor has opened	1) TurnOnMil (2) CheckEngine Light	Check foot pedal connector Check APP1 signal at SECM PIN B7
622 (66)	APP2RangeHigh APP2 sensor voltage out of range high, normally set if the APP2 signal has shorted to power or the ground for the sensor has opened	TurnOnMil	Check foot pedal connector Check APP2 signal at SECM PIN B16
631 (63)	APP1AdaptLoMin Learned idle end of APP1 sensor range lower than expected	None	Check APP connector and pins for corrosion Cycle the pedal several times and check APP1 signal at SECM Pin B7
632 (67)	APP2AdaptLoMin Learned idle end of APP2 sensor range lower than expected	None	Check APP connector and pins for corrosion Cycle the pedal several times and check APP2 signal at SECM Pin B16
641 (64)	APP1AdaptHiMax Learned full pedal end of APP1 sensor range higher than expected	None	N/A
642 (68)	APP2AdaptHiMax Learned full pedal end of APP2 sensor range higher than expected	None	N/A

(*) Fault actions shown are default values specified by the OEM.

Table 2. MI-07 Diagnostic Fault Codes (Flash Codes) cont'd.

DFC	PROBABLE FAULT	FAULT ACTION *	CORRECTIVE ACTION FIRST CHECK
651	APP1AdaptHiMin Learned full pedal end of APP1 sensor range lower than expected	None	N/A
652	APP2AdaptHiMin Learned full pedal end of APP2 sensor range lower than expected	None	N/A
661	APP1AdaptLoMax Learned idle end of APP1 sensor range higher than expected	None	N/A
662	APP2AdaptLoMax Learned idle end of APP2 sensor range higher than expected	None	N/A
691 (69)	APP_Sensors_Conflict APP position sensors do not track well, intermittent connections to APP or defective pedal assembly	1) TurnOnMil (2) Level1PowerLimit	Check APP connector and pins for corrosion Cycle the pedal several times and check APP1 signal at SECM Pin B7 Cycle the pedal several times and check APP2 signal at SECM Pin B16
711 (71)	LSDFault_Dither1 Dither Valve 1 Fault, signal has opened or shorted to ground or power or defective dither 1 valve	TurnOnMil	Check FTV1 for an open wire or FTV connector being disconnected FTV1 Pin 1 (signal) to SECM Pin A1 FTV1 Pin 2 (power) to SECM (DRV) Pin A23 Check FTV1 for an open coil by disconnecting the FTV connector and measuring the resistance ($\sim 26\Omega \pm 2\Omega$)
712	LSDFault_Dither2 Dither Valve 2 Fault, signal has opened or shorted to ground or power or defective dither 2 valve	TurnOnMil	Check FTV1 for an open wire or FTV connector being disconnected or signal shorted to GND FTV2 Pin 1 (signal) to SECM Pin A2 FTV2 Pin 2 (power) to SECM (DRV) Pin A23 Check FTV1 for an open coil by disconnecting the FTV connector and measuring the resistance ($\sim 26\Omega \pm 2\Omega$)
714	LSDFault_CheckEngine Check Engine Lamp Fault, signal has opened or shorted to ground or power or defective check engine lamp	None	Check 'Check Engine Lamp' for an open wire or shorted to GND

(*) Fault actions shown are default values specified by the OEM.

Table 2. MI-07 Diagnostic Fault Codes (Flash Codes) cont'd.

DFC	PROBABLE FAULT	FAULT ACTION *	CORRECTIVE ACTION FIRST CHECK
715	LSDFault_CrankDisable Crank Disable Fault, signal has opened or shorted to ground or power or defective crank disable relay	None	N/A
717	LSDFault_LockOff Fuel lock off Valve Fault, signal has opened or shorted to ground or power or defective Fuel lock off valve	TurnOnMil	Check fuel lock off valve for an open wire or connector being disconnected or signal shorted to GND Lockoff Pin B (signal) to SECM Pin A11 Lockoff Pin A (power) to SECM (DRVP) Pin A23 Check CSV for an open coil by disconnecting the CSV connector and measuring the resistance ($\sim 26\Omega \pm 3\Omega$)
718	LSDFault_MIL Malfunction Indicator Lamp Fault, signal has opened or shorted to ground or power or defective MIL lamp	None	Check MIL lamp for an open wire or short to GND.
721 (72)	GasFuelAdaptRangeLo In LPG mode, system had to adapt rich more than expected	TurnOnMil	Check for vacuum leaks. Check fuel trim valves, e.g. leaking valve or hose Check for missing orifice(s).
731 (73)	GasFuelAdaptRangeHi In LPG mode, system had to adapt lean more than expected	TurnOnMil	Check fuel trim valves, e.g. plugged valve or hose. Check for plugged orifice(s).
741 (74)	GasO2NotActive Pre-catalyst O2 sensor inactive on LPG, open O2 sensor signal or heater leads, defective O2 sensor	(1) TurnOnMil (2) DisableGas O2Ctrl	Check that Pre-catalyst O2 sensor connections are OK. O2 (signal) Pin 3 to SECM Pin B13 O2 Pin 2 (HEATER GND) to SECM (DRVG GNG) Pins A16, B17 O2 Pin 1 (HEATER PWR) to SECM (DRVP + 12V) Pin A23 Verify O2 sensor heater circuit is operating by measuring heater resistance ($2.1\Omega \pm 0.4\Omega$) O2 Pin 2 (HEATER GND) to Pin 1 (HEATER PWR)

(*) Fault actions shown are default values specified by the OEM.

Table 2. MI-07 Diagnostic Fault Codes (Flash Codes) cont'd.

DFC	PROBABLE FAULT	FAULT ACTION *	CORRECTIVE ACTION FIRST CHECK
742	GasPostO2NotActive Post-catalyst O2 sensor inactive on LPG, open O2 sensor signal or heater leads, defective O2 sensor.	(1) TurnOnMil (2) DisableGas Post O2Ctrl	Check that Post-catalyst O2 sensor connections are OK. O2 (signal) Pin 3 to SECM Pin B19 O2 Pin 2 (HEATER GND) to SECM (DRVG GNG) Pins A16, B17 O2 Pin 1 (HEATER PWR) to Post O2 Heater Relay. Relay pin 87. This relay turns on only after engine has been running for some time and SECM has calculated that water condensation in exhaust has been removed by exhaust heat. Post O2 Heater Relay has SECM (DRVP + 12V) applied to the relay coil power. The relay coil ground is controlled by SECM Pin A20 to activate the relay to flow current through the post O2 heater. Verify O2 sensor heater circuit is operating by measuring heater resistance ($2.1\Omega \pm 0.4\Omega$) O2 Pin 2 (HEATER GND) to Pin 1 (HEATER PWR)
743	Reserved		
751	GasO2FailedLean Pre-catalyst O2 sensor indicates extended lean operation on LPG	(1) TurnOnMil (2) DisableGas O2Ctrl	Check for vacuum leaks. Check fuel trim valves, e.g. leaking valve or hose. Check for missing orifice(s).
752	GasPostO2FailedLean Pre-catalyst O2 sensor indicates extended lean operation on LPG	(1) TurnOnMil (2) DisableGas Post O2Ctrl	Correct other faults that may contribute to 752 (e.g. faults pertaining to fuel trim valves, Pre-Cat O2, Post Cat O2 sensor) Check for vacuum leaks Check for leaks in exhaust, catalytic converter, HEGO sensors; repair leaks. Check all sensor connections (see fault 742 corrective actions).
771 (77)	GasO2FailedRich Pre-catalyst O2 sensor indicates extended rich operation on LPG	(1) TurnOnMil (2) DisableGas O2Ctrl	Check fuel trim valves, e.g. plugged valve or hose. Check for plugged orifice(s).

(*) Fault actions shown are default values specified by the OEM.

Table 2. MI-07 Diagnostic Fault Codes (Flash Codes) cont'd.

DFC	PROBABLE FAULT	FAULT ACTION *	CORRECTIVE ACTION FIRST CHECK
772	GasPostO2FailedRich Pre-catalyst O2 sensor indicates extended rich operation on LPG	(1) TurnOnMil (2) DisableGas PostO2Ctrl	Correct other faults that may contribute to 772 (e.g. faults pertaining to FTVs, Pre-Cat O2, Post Cat O2 sensor) Look for leaks in exhaust, catalytic converter, HEGO sensors; repair leaks. Check all sensor connections (see fault 742 corrective actions).
843	Reserved		
911	O2RangeLow Pre-catalyst O2 sensor voltage out of range low, sensor signal shorted to ground	(1) TurnOnMil (2) DisableGas O2Ctrl	Check if O2 sensor installed before the catalyst is shorted to GND or sensor GND. O2 (signal) Pin 3 to SECM Pin B13 SECM (DRVG GND) Pins A16, B17 SECM (XDRG sensor GND) Pin B1
912	O2_PostCatRangeLow Post-catalyst O2 sensor voltage out of range low, sensor signal shorted to ground	(1) TurnOnMil (2) Disable LPG Post-catalyst O2Ctrl	Check if O2 installed after the catalyst sensor is shorted to GND or sensor GND. O2 (signal) Pin 3 to SECM Pin B19 Possible sources: SECM (DRVG GND) Pins A16, B17 and SECM (XDRG sensor GND) Pin B1
921	O2RangeHigh Pre-catalyst O2 sensor voltage out of range high, sensor signal shorted to power	(1) TurnOnMil (2) DisableGas O2Ctrl	Check if O2 sensor installed before catalyst is shorted to +5Vdc or battery. O2 (signal) Pin 3 to SECM Pin B13 SECM (XDRP + 5V) Pin B24 SECM (DRVP + 12V) Pin A23
922	O2_PostCatRangeHigh Post-catalyst O2 sensor voltage out of range low, sensor signal shorted to ground	(1) TurnOnMil (2) Disable LPG Post-catalyst O2Ctrl	Check if O2 sensor installed after catalyst is shorted to +5Vdc or battery. O2 (signal) Pin 3 to SECM Pin B19 Possible voltage sources: SECM (XDRP + 5V) Pin B24 and SECM (DRVP + 12V) Pin A23

(*) Fault actions shown are default values specified by the OEM.

Table 2. MI-07 Diagnostic Fault Codes (Flash Codes) cont'd.

DFC	PROBABLE FAULT	FAULT ACTION *	CORRECTIVE ACTION FIRST CHECK
931	FuelTempRangeLow Fuel Temperature Sensor Input is Low normally set if the fuel temperature sensor wire has shorted to chassis ground or the sensor has failed.	TurnOnMil	Check fuel temp sensor connector and wiring for a short to GND SECM (signal) Pin B14 to FTS Pin 1 SECM (sensor GND) Pin B1 to FTS Pin 2 SECM (system GND) Pin A16, B17
932	FuelTempRangeHigh Fuel Temperature Sensor Input is High normally set if the fuel temperature sensor wire has been disconnected or the circuit has opened to the SECM.	TurnOnMil	Check if fuel temp sensor connector is disconnected or for an open FTS circuit SECM (signal) Pin B14 to FTS Pin 1 SECM (sensor GND) Pin B1 to FTS Pin 2
933	TransOilTemp Excessive transmission oil temperature	(1) TurnOnMil (2) Delayed EngineShutdown	Refer to drivetrain manufacturer's transmission service procedures.
991	ServiceFault1 Service Interval 1 has been reached	None	Perform service procedure related to Service Interval 1 (determined by OEM)
992	ServiceFault2 Service Interval 2 has been reached	None	Perform service procedure related to Service Interval 2 (determined by OEM)
993	ServiceFault3 Service Interval 3 has been reached	None	Perform service procedure related to Service Interval 3 (determined by OEM)
994	ServiceFault4 Service Interval 4 has been reached—replace HEGO sensors	TurnOnMil	Replace Pre-catalyst HEGO sensor Replace Post-catalyst HEGO sensor
995	ServiceFault5 Service Interval 5 has been reached—replace timing belt	TurnOnMil	Replace engine timing belt

(*) Fault actions shown are default values specified by the OEM.

Lift Truck Operation

Power Shift Transaxle

1. Start the engine. See topic “Starting the Engine.”

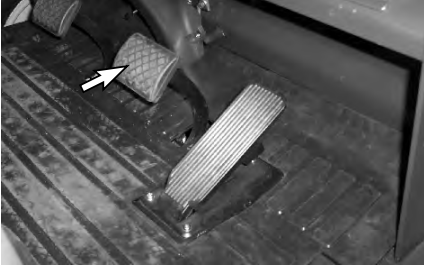

2. Push down on the service brake pedal to hold the lift truck until ready to move it.
3. Release the parking brake.

NOTE: The parking brake must be released before the directional control can be used.



4. Select the direction of travel by pushing the directional lever FORWARD for forward direction or by pulling the lever BACK for reverse direction.

⚠ WARNING

A lift truck with the engine running but without an operator can move slowly (creep) if the transmission is engaged.

This could result in personal injury.

Always place the transmission control lever in the NEUTRAL (centre) position and apply the parking brake before dismounting the lift truck.

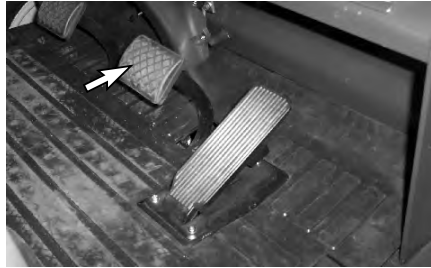

5. Release the service brake.
6. Push down on the accelerator pedal to obtain the desired travel speed. Release the pedal to decrease travel speed.

⚠ WARNING

Sudden reversal of a loaded lift truck traveling forward can cause the load to fall or the lift truck to tip.

Stop the loaded lift truck completely, before shifting to reverse.

Failure to comply could result in personal injury.

NOTE: Where conditions permit, directional changes can be made under full power at speeds up to 6 km/h (3.73mph). A speed of 6 km/h (3.73mph) is a fast walk. Directional shift changes at speeds above 6 km/h (3.73mph) are considered abusive.

Bring the lift truck to a complete stop where load stability or other factors prevent safe operation under full power shifts.

7. To change the lift truck direction of travel, release the accelerator pedal.
8. Push down on the service brake pedal to reduce the lift truck speed as necessary.



9. Move the directional lever to the desired direction of travel. Slowly push down on the accelerator pedal as the lift truck changes direction.
10. When the direction change is completed, continue to push down on the accelerator pedal to obtain the desired travel speed.

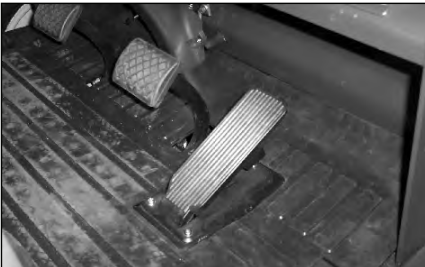

11. To stop the lift truck when traveling in either direction, release the accelerator pedal.
12. Push down on the service brake pedal and bring the lift truck to a smooth stop.

Inching

NOTE: The purpose of the inching pedal is to provide precise lift truck inching control at very slow travel speed and high engine rpm. This is used for fast hydraulic lift, during load approach, pick up or load positioning.

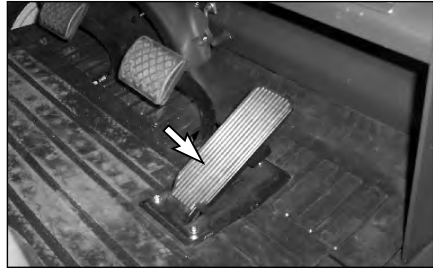

1. To inch (creep) in either direction, slowly push down on the inching pedal. This will start to apply the service brakes and allow the transmission clutch discs to slip.
2. Vary the position of the inching pedal and the accelerator pedal to control the inching speed and distance.
3. Pushing down further on the inching pedal will disengage the transmission completely and apply the service brakes fully to stop and hold the lift truck. This will provide full engine power for fast hydraulic lift.
4. Avoid overuse of the inching pedal as this may cause the automatic transmission oil to overheat or the clutch to slip. Do not use as a footrest or for long periods of time.
5. If user operates continuously pushing work or both brake pedal and accelerator pedal were depressed at the same time, it may cause the automatic transmission oil to overheat or the clutch to slip.

Steering Knob (If Equipped)

There is a steering knob available for inclusion with new truck deliveries. This option is solely intended for slow travel situations when two handed steering is not possible due to hydraulic operations.

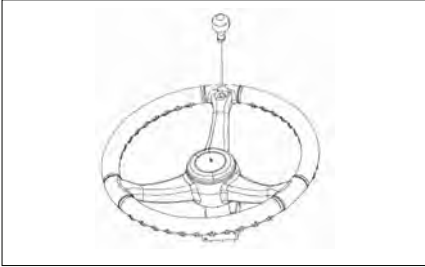

⚠ WARNING

Loss of stability can occur when a lift truck steering wheel is rotated quickly while the truck is in motion. A steering knob will assist with easy rotation of the steering wheel, but if a steering knob is improperly used (e.g., rotating the steering wheel quickly while the truck is in motion), this can contribute to truck instability and a tip over. A steering knob is intended for slow travel maneuverability **ONLY**.

Mono-Ped Control System (Option)

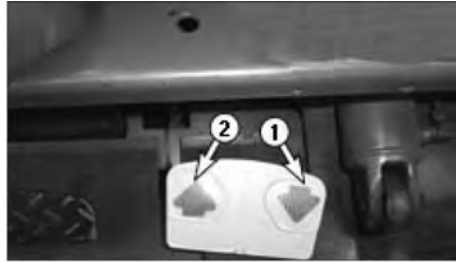

Forward-Push the left side (2) of the pedal for FORWARD direction travel.



Neutral-The lift truck should not move when the Mono-Ped pedal is released..



Reverse-Push the right side (1) of the pedal for REVERSE direction travel.

The MONO-PED pedal controls the speed and direction of the lift truck. Pushing on the right side of the pedal (1) causes the lift truck to move in REVERSE. The optional reverse lights and optional back-up alarm will be ON in the REVERSE position. Pushing on the left side of the pedal (2) causes the lift truck to move in FORWARD.

The speed of the truck increases as the pedal is depressed

Auto Shift Controller ASC - 206 (Standard)

Product Description

The Autoshift controller is an electrical control system, specially designed for use on forklift trucks with internal combustion engines.

Its primary purpose is to prevent the operator from operating the truck outside of the design parameters, e.g. selecting the reverse gear when traveling in excess of 6.0 km/h (3.73mph) in a forward direction, and vice versa.

The Autoshift controller is mounted on a convenient position away from excessive heat sources and retrofits into the truck's electrical system. An inductive speed sensor is mounted on the transmission case where it will pick up a pulse from a gear tooth pattern. This pulse is used to monitor the truck in motion and its travel speed. To enable the system to change gears smoothly, the shift points for offset speed are adjustable.

An operator no longer has to change gears with his hands, therefore he can be more productive.

The Autoshift controller prevents strain and abuse to the transmission by changing gears up and down automatically. It also prevents damage to the half shaft, excessive tyre wear and heat to the transmission.

Features

1. 2 - speed auto shift control
2. Prevent downshifting at high speed
3. Inhibit selecting direction at high speed outside of the design parameters.



Adjustments

SW1 (Low-High Shift Point)		SW2 (Direction Inhibit Point)	
NOTCH	Vehicle Speed	NOTCH	Vehicle Speed
0	2.5 km/h (1.55 mph)	0	3.3 km/h (2.05 mph)
1	3.0 km/h (1.86 mph)	1	3.6 km/h (2.24 mph)
2	3.5 km/h (2.17 mph)	2	3.9 km/h (2.42 mph)
3	4.0 km/h (2.49 mph)	3	4.2 km/h (2.61 mph)
4	4.5 km/h (2.80 mph)	4	4.5 km/h (2.80 mph)
5	5.0 km/h (3.11 mph)	5	4.8 km/h (2.98 mph)
6	5.5 km/h (3.42 mph)	6	5.1 km/h (3.17 mph)
7	6.0 km/h (3.73 mph)	7	5.4 km/h (3.36 mph)
8	6.5 km/h (4.04 mph)	8	5.7 km/h (3.54 mph)
9	7.0 km/h (4.35 mph)	9	6.0 km/h (3.73 mph)



Adjustment Switch

Low-High Shift Point (SW1)

ASC-206 allows you to set the 2 speed Auto Gear Shift Point, the maximum travel speed at which the Auto Shift Controller up-shift or down-shift the transmission automatically according to the vehicle speed. For adjustment of 2 speed Auto Gear Shift speed, the SW1 switch is used on the printed circuit board.

For example if SW1 put to 5th notch, the 2 Speed Auto Gear Shift speed will be 5.0 km/h(3.11 mph), which is factory setting value as a default.

Direction Inhibit Point (SW2)

Auto Shift allows you to set the Direction Inhibit Speed, the maximum travel speed at which the transmission can be reversed. For adjustment of direction inhibit speed, the SW2 switch is used on the printed circuit board.

For example SW2 is put to 7th notch, the Direction Inhibit Speed will be 5.4 km/h (3.36 mph), which is factory setting value as a default.

Diagnostics Features

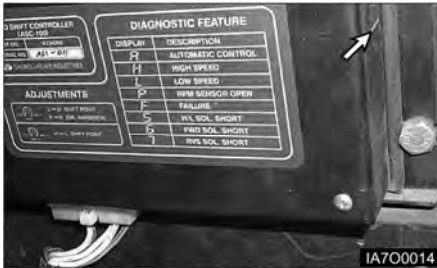

ASC-206 has internal indicator on the right side of the controller for displaying the selected gear and the abnormal condition.

WARNING

Do not diagnose or repair Auto Shift Controller Faults unless trained and authorised to do so. Improper performance of maintenance procedures is dangerous and could result in personal injury or death.

Below is a description applicable for many ASC-500 implementations.

Display for Operator

Display	Description	Remark
A	Automatic operation	
H	High speed	At 2nd shift gear
L	Low speed	At 1st shift gear
P	T/M Speed sensor open	Flashing
E	E/G Speed sensor open	Flashing
F	Controller fault	Flashing
5	FWD 2 Sol. Short or REV 2 Sol. Short	Flashing
6	FWD 1 Sol. Short	Flashing
7	REV 1 Sol. Short	Flashing

This information is given during normal operating when something special happens. For example, on ASC-500's with the speed sensor, one of the indicators is used to indicate a sensor problem.

Display for Troubleshooting

Display	Description	Remark
A	Automatic operation	
2	High speed s/w input	Lever input test
3	Forward s/w input	Lever input test
4	Reverse s/w input	Lever input test

This information is input for signal diagnostics. This test is used to verify operation of direction control lever.

Operation

This system can be basically operated in two preselected modes, automatic mode and manual mode. Automatic Mode is selected in factory-setting controller as a default.

Manual Mode (Fail-Safe Mode) is selected to operate the truck manually in case of emergency.

Automatic mode

Direction Inhibit

1. Start the engine with the direction control lever in NEUTRAL and the parking brake engaged.
2. Press down on the service brake pedal, disengage the parking brake and move the direction control lever to FORWARD.

NOTE: Release the parking brake before using the directional control lever.

3. Observe the LED on the Auto Shift Controller. The LED should indicate "A" while the direction control lever is in FORWARD, NEUTRAL and REVERSE. Report Auto Shift as faulty if the LED indicates anything other than "A".
4. Keep the service brake pushed down until ready to move the truck.
5. To change directions of a traveling lift truck when the Auto Shift Controller LED displays "A", shift the direction control lever to the opposite direction and wait for the lift truck to change direction.
6. If however, your travel speed is higher than the pre-selected direction change speed as direction inhibit point in the controller, Auto Shift will shift the transmission to NEUTRAL until the lift truck's travel speed slows to the pre-selected direction change speed, and then shift the transmission to the direction selected.
7. You should be prepared to help slow the lift truck to the pre-selected direction change speed by pressing down on the service brake pedal.

⚠ WARNING

When you want to change the travel direction, you must press down on the service brake pedal to reduce the travel speed. Be cautious that the lift truck's stopping distance may be longer than in manual mode because the lift truck continues to travel forward regardless of the selection of reverse with the direction control lever until the vehicle speed is sufficiently reduced.

- The direction of travel will change automatically when the vehicle speed is reduced as much as the pre-selected speed in the controller.

⚠ WARNING

Bring the loaded lift truck to a complete stop before changing travel direction. Changing travel direction while traveling may cause the lift truck to lose the load or tip over.

- When the direction change is completed, continue to push down on the accelerator pedal to obtain the desired travel speed.

NOTICE

The transmission of your lift truck may be reversed under full power up to a travel of 6.0 km/h (3.73 mph). But the Inhibit Speed of Auto Shift is set by the factory at 5.4 km/h (3.36 mph) because reversing the transmission at lower travel speeds prolongs the lift of the transmission, axle shafts and tyres.

Two-Speed Auto Shift Control

While traveling forward with the high speed gear, that is, 2nd gear selected, the ASC-206 can up-shift or down-shift the transmission automatically according to the vehicle speed by its own speed ratio control so that the appropriate gear may be engaged in every situation.

NOTICE

Two-Speed Auto Shift Control function can be accomplished only when the direction control lever is placed in the high speed (2nd gear) position.

Manual Mode (Fail-Safe mode)

In case that the controller is broken down or you don't want to use the functions of the Auto Shift Controller, you can select Manual Mode. In Manual Mode, you can operate your lift truck in the same manner as any lift truck without Auto Shift Controller. You can select the Manual mode or the Automatic mode by doing following procedures.

⚠ WARNING

In the manual mode, direction inhibition function can not be operated normally. The sudden reversal of a loaded lift truck traveling forward can cause the load to fall or the lift truck to tip over.

An operator can operate the truck manually by selecting the Manual mode with the Fail-Safe mode switches on the PCB (Printed Circuit Board). With the switch (1) in "MANUAL" position, direction inhibit function is disable.

If an operator moves the switch (2) from "AUTO" position to "MANUAL" position, then 2-speed auto shift function will become disabled.

Move the switches as indicated, up of Automatic (AUTO) operation or down for Manual (MANUAL) operation.

NOTE: In the factory-setting controller, AUTO mode is selected as a default on the PCB (Printed Circuit Board) as shown below.

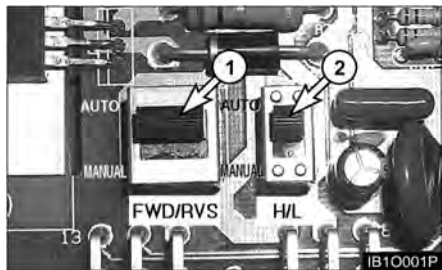

NOTE: After operating the truck manually by selecting the Manual Mode switch on PCB(Printed Circuit Board), the position of mode must be checked before operating the truck automatically.

Operating Techniques

Inching into Loads

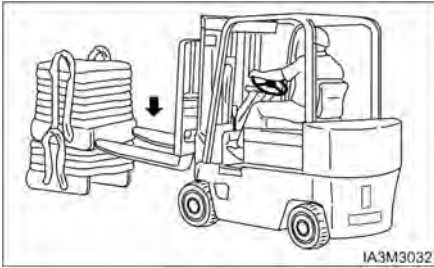

Typical Example

1. Move the lift truck slowly FORWARD into position and engage the load. The lift truck should be square with load, forks spaced evenly between pallet stringers and as far apart as load permits.



Typical Example

2. Move the lift truck FORWARD until the load touches the carriage.

Lifting the Load

1. Lift the load carefully and tilt the mast back a short distance.



Typical Example

2. Tilt the mast further back to cradle the load.



Typical Example

3. Operate the lift truck in reverse until the load is clear of the other material.
4. Lower the cradled load to the travel position.

NOTE: Lift and tilt speeds are controlled by engine rpm.

Traveling With the Load

NOTICE

Travel with the load as low as possible, while still maintaining ground clearance.



Typical Example

1. Travel with the load uphill on upgrades and downgrades.



Typical Example

2. For better vision, travel in reverse with bulky loads.

Unloading

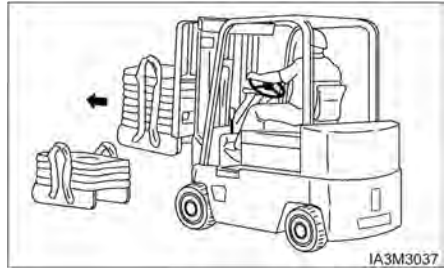

Typical Example

1. Move the lift truck into the unloading position.

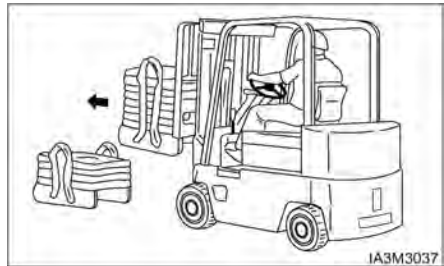

Typical Example

2. Tilt the mast FORWARD only when directly over the unloading area.

WARNING

Do not tilt the mast forward with the load unless directly over the unloading area, even if the power is off.

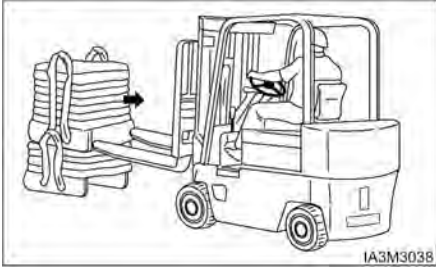

Typical Example

3. Deposit the load and BACK away carefully to disengage the forks.



Typical Example

4. Lower the carriage and forks to the travel position or to the park position.

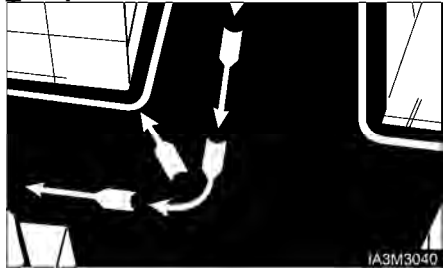

1. When turning sharp corners, keep close to the inside corner. Begin the turn when the inside drive wheel meets the corner.

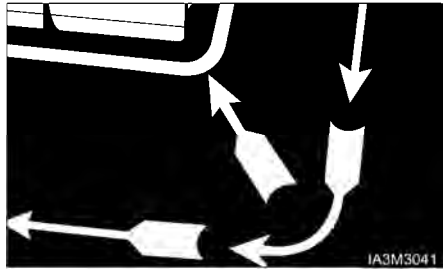

2. In narrow aisles, keep away from the stockpile when turning into the aisle. Allow for counterweight swing.

Lifting Drums or Round Objects

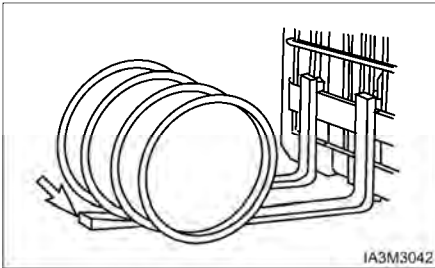

1. Block drums or round objects. Tilt the mast FORWARD and slide the fork tips along the floor

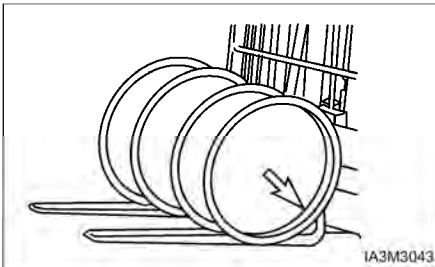

2. Before lifting, tilt the mast BACK slightly until the load is cradled on the forks.

Operating in hot weather

Keep the following points in mind when you operate the lift truck in hot weather.

1. Check the radiator. Clogging can cause overheating. Clean them out regularly with a blast of compressed air, also, check for leakage of water.
2. Check the fan belt tension and adjust to proper tension.
3. Even if the engine overheats and the coolant boils over, let the engine idle for a while with opening engine hood until temperature falls before shutting off the engine.

Parking the Lift Truck

Park the lift truck level, with the forks lowered and the mast tilted forward until the fork tips touch the floor. Block the drive wheels when parking on an incline.



1. Park in an authorised area only. Do not block traffic. If LP equipped, do not park near elevator shafts or any other area where LP could collect in a pocket (low area), causing a potentially dangerous condition.



2. Place the transmission controls in NEUTRAL.
3. Engage the parking brake.
4. Lower the forks to the ground.

WARNING

Blocking the wheels will prevent unexpected lift truck movement, which could cause personal injury.



5. Turn the key in the ignition switch to the OFF position and remove the key.

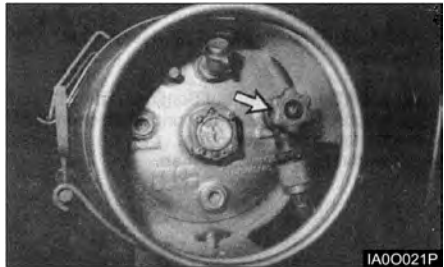

- NOTE:** If a LP equipped lift truck is stopped or parked for an indefinite or prolonged period of time, close the fuel shutoff valve on the LP tank. Run the engine until fuel in the line runs out and the engine stops. Turn off the ignition switch and disconnect switch (if equipped).
6. Actuate each loading lever several times to remove the residual pressure in the respective cylinders and hoses.
 7. Block the drive wheels if parking on an incline.

Lift Fork Adjustment

WARNING

When adjusting the fork spread, be careful not to pinch your hand between forks and the carriage slot.

Hook - on type Fork



1. Move up the hook pin to the free position.
2. Raise the hook pin in each fork to side the fork on the carriage bar.
3. Adjust the forks in the position most appropriate for the load and as wide as possible for load stability.
4. When adjusting the forks, make sure that the weight of the load is centred on the truck.
5. After adjustment, set the fork locks to keep the forks in place.

WARNING

Make sure the forks are locked before carrying a load.

If the fork/locking pin is not fully engaged, the fork could become unintentionally disengaged.

Storage Information

Before Storage

Before storing your lift truck, clean and inspect as the following procedures.

- Wipe away grease, oil, etc. adhering to the body of the truck with waste cloth, and use water, if needed.
- While cleaning the truck, check general condition of the truck. Especially check the truck body for dents or damage and tyres for wear or nails or stones in the tread.
- Fill the fuel tank with fuel specified.
- Check for leakage of hydraulic oil, engine oil, fuel, or coolant, etc.
- Apply grease, where needed.
- Check for looseness of nuts and bolts, especially hub nuts.
- Check mast rollers to see that they rotate smoothly.
- Prime the oil into the lift cylinders by actuating the lift lever all the way several times.
- Drain off coolant completely in cold weather, if antifreeze is not used.

Long Time Storage

Perform the following service and checks in addition to the "Parking the lift truck" services.

- Taking the rainy season into consideration, park the machine at a higher and hard ground.
- Avoid parking on soft grounds such as asphalt ground in summer.
- Dismount the battery from the machine. Even though the machine is parked indoors, if the place is hot or humid, the battery should be kept in a dry, cool place. Charge the battery once a month.
- Apply antirust to the exposed parts which tend to rust.
- Cover components such as the breather and air cleaner which may be caught with humidity.
- The machine should be operated at least once a week. Fill the cooling system, if cooling water is discharged, and mount the battery. Start the engine and warm up thoroughly. Move the machine a little forwards and backwards. Operate the hydraulic controls several times.

To Operate the Lift Truck After a Long Time Storage

- Remove covers and antirust from each of the components and exposed parts.
- Drain the engine crankcase, transmission (clutch type machine), differential and final reduction gear, clean the inside of them and add new oil.
- Drain off foreign matter and water from the hydraulic oil tank and fuel tank.
- Remove the head cover from the engine cylinder. Oil valves and rocker shaft and check each valve for proper operation.
- Add cooling water to the specified level.
- Charge the battery and mount it on the machine. Connect the cables.
- Perform pre-operational checks carefully. (refer to "Before Starting the Engine")
- Warm up the machine.

Transportation Hints

Lift Truck Shipping

Check travel route for overpass clearances. Make sure there is adequate clearance if the lift truck being transported is equipped with a high mast, overhead guard or cab.

To prevent the lift truck from slipping while loading, or shifting in transit, remove ice, snow or other slippery material from the loading dock and the truck bed before loading.

NOTICE

Obey all state and local laws governing the height, weight, width and length of a load. Observe all regulations governing wide loads.

NOTICE

Remove ice, snow or other slippery material from the shipping vehicle and the loading dock.

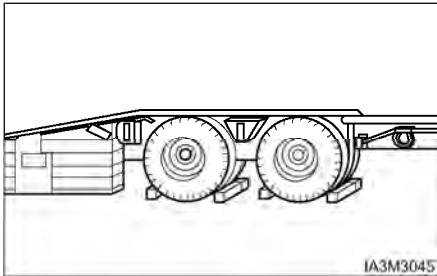

Always block the trailer or the rail car wheels before loading the lift truck.

Position the lift truck on the truck bed or the rail car.

Apply the parking brake and place the transmission control in NEUTRAL.

Turn the ignition switch to the OFF position and remove the key. If LP equipped, shut off the LP fuel tank.

Block the wheels and secure the lift truck with tiedowns.

Machine Lifting and Tiedown Information

NOTICE

Improper lifting or tiedowns can allow load to shift and cause injury and/or damage.

1. Weight and instructions given herein apply to lift trucks as manufactured by CROWN.
2. Use proper rated cables and slings for lifting. Position the crane for level lift truck lift.
3. Spreader bar widths should be sufficient to prevent contact with the lift truck.
4. Use the tiedown locations provided for lift truck tiedown.

Check the state and local laws governing weight, width and length of a load.

Contact your CROWN Lift Truck dealer for shipping instructions for your lift truck.

Lifting a Forklift using a Crane

WARNING

1. If lifting rope breaks, serious injury/damage may occur.

2. The lifting wire rope and stay must be long enough to avoid contact with the forklift. Short rope/stay can damage the vehicle. If it's too long, it may cause interference.

If sling and LP tank contact happens during refloatation operation, you should get rid of tank of vehicle with LP tank first, and then proceed.

Cover the rope/chain with rubber or cloth to prevent damage to the vehicle, as necessary.

3. Rope/chain and other lifting tools must have sufficient strength, and free of any defect or wear.

4. Avoid impact load to the lifting devices/tools.

1. Check the weight, length, width and height of the vehicle before lifting.

2. Park the crane at an appropriate position.

3. Connect the rope/chain to the points A and B of the figure below.

4. If the wire rope/chain contacts the vehicle, insert a rubber plate between the rope/chain and the vehicle to protect the vehicle.

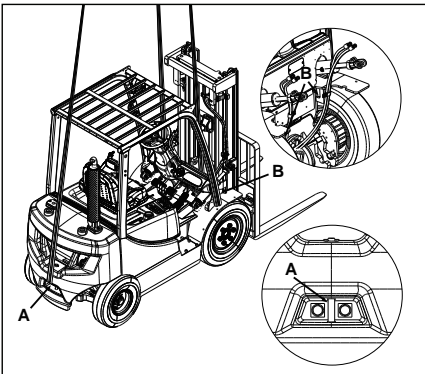

5. Lift up the vehicle slowly.

How to Fix Forklift to a Carrier

1. The rope/chain must have sufficient length for fixing.

2. Park the vehicle on a level ground.

3. Set the mast vertically. Lower the fork or attachment to the lowest position.

4. Set all the operating devices to Neutral Position. Turn OFF the start switch.

5. Apply the parking brake. Stop the tyres with blocks (C).

6. Connect towing hooks to the mast top B (if without mast, front drive axle fix frame or front fender bottom fixing hole D) and rear tow pin A, as shown in the figure below.

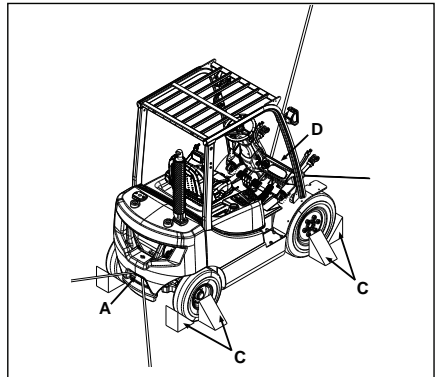
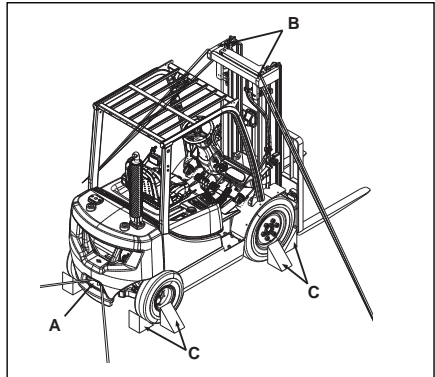

Towing Information

WARNING

Personal injury or death could result when towing a disabled lift truck incorrectly.

Block the lift truck wheels to prevent movement before releasing the brakes. The lift truck can roll free if it is not blocked.

Follow the recommendations below, to properly perform the towing procedure.

These towing instructions are for moving a disabled lift truck a short distance, at low speed, no faster than 2 km/h (1.2 mph), to a convenient location for repair. These instructions are for emergencies only. Always haul the lift truck if long distance moving is required.

Shield must be provided on the towing lift truck to protect the operator if the tow line or bar should break.

Do not allow riders on the lift truck being towed unless the operator can control the steering and/or braking.

Before towing, make sure the tow line or bar is in good condition and has enough strength for the towing situation involved. Use a towing line or bar with a strength of at least 1.5 times the gross weight of the towing lift truck for a disabled lift truck stuck in the mud or when towing on a grade.

Keep the tow line angle to a minimum. Do not exceed a 30° angle from the straight ahead position. Connect the tow line as low as possible on the lift truck that is being towed.

Quick lift truck movement could overload the tow line or bar and cause it to break. Gradual and smooth lift truck movement will work better.

Normally, the towing lift truck should be as large as the disabled lift truck. Satisfy yourself that the towing lift truck has enough brake capacity, weight and power, to control both lift trucks for the grade and the distance involved.

To provide sufficient control and braking when moving a disabled lift truck downhill, a larger towing lift truck or additional lift trucks connected to the rear could be required. This will prevent uncontrolled rolling.

The different situation requirements cannot be given as minimal towing lift truck capacity is required on smooth level surfaces to maximum on inclines or poor surface conditions.

Consult your CROWN Lift Truck dealer for towing a disabled lift truck.

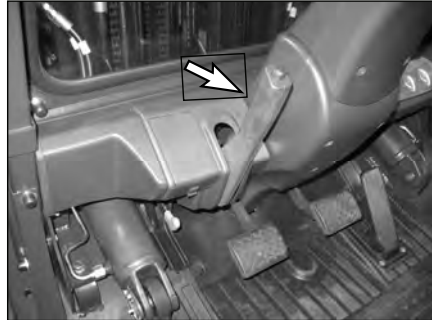

1. Release the parking brake.

NOTICE

Release the parking brake to prevent excessive wear and damage to the parking brake system.

2. Check that the service brake pedal is released.
3. Key switch is in the OFF position.
4. Direction control lever is in neutral.
5. Fasten the tow bar to the lift truck.
6. Remove the wheel blocks. Tow the lift truck slowly. Do not tow any faster than 2 km/h (1.2 mph).

WARNING

Be sure all necessary repairs and adjustments have been made before a lift truck that has been towed to a service area is put back into operation.

Jacking Information

⚠ WARNING

Jacking up Truck can be dangerous and should be done only by trained personnel using proper tools and procedures.

Block the lift truck wheels to prevent movement while lifting the wheels. The lift truck can roll free if it is not blocked.

Follow the recommendations below, to properly perform the jacking procedure.

NOTICE

Move Trucks to a Secure Non Traffic Maintenance Area with a Level Floor. No Load on Forks. Remove key from ignition switch.

Hydraulic Jack & Jack Stand Capacity

Hydraulic Jack Capacity

	Model	Height Minimum*	Minimum Requirement	
1 ton class	CGC15/18S-5, CGC15/18S-5, CGC20SC-5	100mm	2000Kg	4400lbs
	CD15/18S-5, CD20SC-5, CG15/18S-5, CG20SC-5	150mm		
2 ton class	CD20/25/30/33S-5, CD35C-5, CG20/25/30E-5, CG20/25/30/33P-5, CG35C-5	150mm	3000Kg	6600lbs
	CGC20/25/30/33E-5, CGC20/25/30/33P-5	120mm		
3 ton class	CD35/40/45S-5, CD50/55C-5, CD40/45/50/55SC-5, CG35/40/45S-5, CG50/55C-5, CG40/45/50/55SC-5	180mm	3900Kg	8600lbs
5 ton class	CD50/60/70/80/90S-5, CG50/60/70S-5	250mm	5800Kg	12800lbs
11 ton class	CD110/130/160S-5	300mm	10000 Kg	22050lbs
18/20 ton class	CDV180/200S-7	350 mm	14000 Kg	30900lbs
25 ton class	CDV250S-7	400 mm	19000 Kg	42000lbs

• The height of lift truck with a flat tyre is lower than with an inflated tyre. So Height Minimum of Jack must be less than the value of the above chart.

Stand Capacity should be more than the minimum requirement of Hydraulic Jack Capacity.

Hydraulic Jack & Jack Stand are commercially available and should be especially designed for forklift trucks.

Jacking Procedure

Steering Wheel

1. Raise Forks 3 to 6 in (76 to 152 mm) from Floor.
2. Place Wheel Chocks under Both Drive Wheels.
3. Locate Hydraulic Jack under Steering Axle as Shown in Figure A.
4. Jack Up Truck with Hydraulic Jack.
5. Set Jack Stand Height as Required Not to Exceed 16 in (405mm).

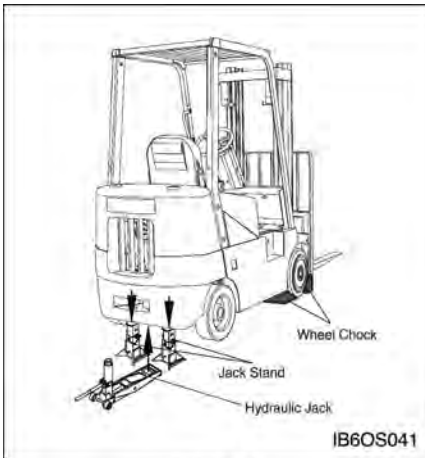

Figure A

Side

1. Lower Forks Completely.
2. Locate Hydraulic Jack under Frame as Shown in Figure B.
3. Jack Up One Side of Truck.
4. Place Hard Wood Block directly under First Stage Mast.
5. 1ton/2ton class - Use 6X6 in (150X150mm) Block
3ton/5ton class - Use 8X8 in (200X200mm) Block
11ton class - Use 12X12 in (300X300mm) Block
6. Jack Up Opposite Side of Truck.
7. Place Second Hard Wood Block under Other Side of First Stage Mast.
8. Do Not Tilt Mast after Blocked.

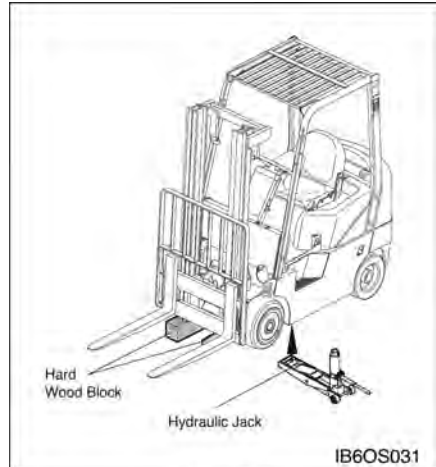

Figure B

WARNING

Locate Hydraulic Jack under Frame. Do NOT locate on side panel. Do NOT raise side of truck any more than required to insert hard wood block.

WARNING

Locate Hydraulic Jack and Jack Stands under steer axle. Do NOT locate Hydraulic Jack or Jack Stands on Counter Weight.

Inspection, Maintenance and Repair of Lift Truck Forks

The following section gives practical guidelines for inspection, maintenance and repair of lift truck forks. It also provides general information on the design and application of forks and the common cause of fork failures.

Lift truck forks can be dangerously weakened by improper repair or modification. They can also be damaged by the cumulative effects of age, abrasion, corrosion, overloading and misuse.

A fork failure during use can cause damage to the equipment and the load. A fork failure can also cause serious injury.

A good fork inspection and maintenance program along with the proper application can be very effective in preventing sudden failures on the job.

Repairs and modifications should be done only by the fork manufacturer or a qualified technician who knows the material used and the required welding and heat treatment process.

Users should evaluate the economics of returning the forks to the manufacturer for repairs or purchasing new forks. This will vary depending on many factors including the size and type of fork.

Forks should be properly sized to the weight and length of the loads, and to the size of the machine on which they are used. The general practice is to use a fork size such that the combined rated capacity of the number of forks used is equal to or greater than the "Standard(or rated) Capacity" of the lift truck.

The individual load rating, in most cases, will be stamped on the fork in a readily visible area. This is generally on the top or side of the fork shank.

- A fork rated at 1500 pounds at 24 inch load centre will be stamped 1500X24.
- A fork rated at 2000 kg at 600 mm load centre will be stamped 2000X600.

The manufacturer identification and year and date of manufacture is also usually shown.

Some countries have standards or regulations which apply specifically to the inspection and repair of forks.

Users may also refer to the International Organization For Standardization - ISO Technical Report 5057 - Inspection and Repair of Fork Arms and ISO Standard 2330 - Fork Arms-Technical Characteristics and Testing.

Users should be familiar with the requirements for inspection and maintenance of lift trucks as provided by Australian Standard AS2359.

Environment Protection

When servicing this lift truck, use an authorised servicing area and an approved container to collect coolant, oil, fuel, grease, electrolyte and any other potential environmental pollutant before any lines, fittings or related items are disconnected or removed. After servicing, dispose of those materials in an authorised place and container. When cleaning the lift truck, be sure to use an authorised area.

Causes of Fork Failure

Improper Modification or Repair

Fork failure can occur as a result of a field modification involving welding, flame cutting or other similar processes which affect the heat treatment and reduces the strength of the fork.

In most cases, specific processes and techniques are also required to achieve proper welding of the particular alloy steels involved. Critical areas most likely to be affected by improper processing are the heel section, the mounting components and the fork tip.

Bent or Twisted Forks

Forks can be bent out of shape by extreme overloading, glancing blows against walls or other solid objects or using the fork tip as a pry bar.

Bent or twisted forks are much more likely to break and cause damage or injury. They should be removed from service immediately.

Fatigue

Parts which are subjected to repeated or fluctuating loads can fail after a large number of loading cycles even though the maximum stress was below the static strength of the part.

The first sign of a fatigue failure is usually a crack which starts in an area of high stress concentration. This is usually in the heel section or on the fork mounting.

As the crack progresses under repetitive load cycling, the load bearing cross section of the remaining metal is decreased in size until it becomes insufficient to support the load and complete failure occurs.

Fatigue failure is the most common mode of fork failure. It is also one which can be anticipated and prevented by recognizing the conditions which lead up to the failure and by removing the fork service prior to failing.

- **Repetitive Overloading**

Repetitive cycling of loads which exceeds the fatigue strength of the material can lead to fatigue failure. The overload could be caused by loads in excess of the rated fork capacity and by use of the forks tips as pry bars. Also, by handling loads in a manner which causes the fork tips to spread and the forks to twist laterally about their mountings.

- **Wear**

Forks are constantly subjected to abrasion as they slide on floors and loads. The thickness of the fork blade is gradually reduced to the point where it may not be capable of handling the load for which it was designed.

- **Stress Risers**

Scratches, nicks and corrosion are points of high stress concentration where cracks can develop. These cracks can progress under repetitive loading in a typical mode of fatigue failure.

Overloading

Extreme overloading can cause permanent bending or immediate failure of the forks. Using forks of less capacity than the load or lift truck when lifting loads and using forks in a manner for which they were not designed are some common causes of overloading.

Fork Inspection



Establish a daily and 12 month inspection routine by keeping a record for the forks on each lift truck.

Initial information should include the machine serial number on each the forks are used, the fork manufacturer, type, original section size, original length and capacity. Also list any special characteristics specified in the fork design.

Record the date and results of each inspection, making sure the following information is included.

- Actual wear conditions, such as percent of original blade thickness remaining.
- Any damage, failure or deformation which might impair the use of the truck.
- Note any repairs or maintenance.

An ongoing record of this information will help in identifying proper inspection intervals for each operation, in identifying and solving problem areas and in anticipating time for replacement of the forks.

First Installation

1. Inspect forks to ensure they are the correct size for the truck on which they will be used. Make sure they are the correct length and type for the loads to be handled.

If the forks have been previously used, perform the "12 Month Inspection".

If the forks are rusted, see "Maintenance and Repair".

2. Make sure fork blades are level to each other within acceptable tolerances. See "Forks, Step 4," in the "2000 Service Hours or Yearly" in "Maintenance Intervals"
3. Make sure positioning lock is in place and working. Lock forks in position before using truck. See "Forks, Step 7" in the "2000 Service Hours or Yearly" in "Maintenance Intervals".

Daily Inspection

1. Visually inspect forks for cracks, especially in the heel section, around the mounting brackets, and all weld areas. Inspect for broken or jagged fork tips, bent or twisted blades and shanks.
2. Make sure positioning lock is in place and working. Lock the forks in position before using the truck. See "2000 Service Hours or Yearly" in "Maintenance Intervals".
3. Remove all defective forks from service.

12 Months Inspection

Forks should be inspected, at a minimum, every 12 months. If the truck is being used in a multi-shift or heavy duty operation, they should be checked every six months. See "Forks" in the "2000 Service Hours or Yearly" in "Maintenance Intervals."

Maintenance and Repair

1. Repair forks only in accordance with the manufacturer's recommendations.

Most repairs or modifications should be done only by the original manufacturer of the forks or an expert knowledgeable of the materials, design, welding and heat treatment process.

2. The following repairs or modifications SHOULD NOT be attempted.
 - Flame cutting holes or cutouts in fork blades.
 - Welding on brackets or new mounting hangers.
 - Repairing cracks or other damage by welding.
 - Bending or resetting.
3. The following repairs MAY be performed.
 - Forks may be sanded or lightly ground, to remove rust, corrosion or minor defects from the surfaces.
 - Heel sections may be ground with a carbon stone to remove minor surface cracks or defects. Polish the inside radius of the heel section to increase the

fatigue life of the fork. Always grind or polish in the direction of the blade and shank length.

- Repair or replace the positioning locks on hook type forks.
 - Repair or replace most fork retention devices used with other fork types.
4. A fork should be load tested before being returned to service on completion of repairs authorised and done in accordance with the manufacturer's recommendations.

Most manufacturers and standards require the repaired fork to be tested with a load 2.5 times the specified capacity and at the load centre marked on the fork arm.

With the fork restrained in the same manner as its mounting on the lift truck, apply the test load twice, gradually and without shock. Maintain the test for 30 seconds each time.

Check the fork arm before and after the second application of the test load. It shall not show any permanent deformation.

Consult the fork manufacturer for further information as may be applicable to the specific fork involved.

Testing is not required for repairs to the positioning lock or the markings.

Torque Specifications

Metric Hardware

Most of the nuts, bolts, studs, and threaded holes in your lift truck are metric. In this manual we provide specifications in both metric and U.S. customary measurement. Always replace metric hardware with metric hardware. See the parts books for proper replacement.

NOTE: For proper fit, use only metric tools on metric hardware. Non-metric tools might slip and cause injury.

Torque for Standard Hose Clamps – Worm Drive

NOTICE

The chart below gives the torques for initial installation of hose clamps on new hose and for reassembly or retightening of hose clamps on existing hose.

Clamp Width	Initial Installation Torque On New Hose	
	N·m ¹	lb·in
16 mm (.625 in)	7.5 ± 0.5	65 ± 5
13.5 mm (.531 in)	4.5 ± 0.5	40 ± 5
8 mm (.312 in)	0.9 ± 0.2	8 ± 2
Clamp Width	Reassembly Or Retightening Torque	
	N·m ¹	lb·in
16 mm (.625 in)	4.5 ± 0.5	40 ± 5
13.5 mm (.531 in)	3.0 ± 0.5	25 ± 5
8 mm (.312 in)	0.7 ± 0.2	6 ± 2

¹ 1 Newton meter (N·m) is approximately the same as 0.1 kg·m.

Torque for Standard Bolts, Nuts, and Taperlock Studs

NOTICE

The two charts below give general torques for bolts, nuts, and taperlock studs of SAE Grade 5 or better quality.

Torques for Bolts and Nuts With Standard Threads

Thread Size Inch	Standard Nut and Bolt Torque	
	N·m ¹	lb·ft
1/4	12 ± 4	9 ± 3
5/16	25 ± 7	18 ± 5
3/8	45 ± 7	33 ± 5
7/16	70 ± 15	50 ± 11
1/2	100 ± 15	75 ± 11
9/16	150 ± 20	110 ± 15
5/8	200 ± 25	150 ± 18
3/4	360 ± 50	270 ± 37
7/8	570 ± 80	420 ± 60
1	875 ± 100	640 ± 75
1 1/8	1100 ± 150	820 ± 110
1 1/4	1350 ± 175	1000 ± 130
1 3/8	1600 ± 200	1180 ± 150
1 1/2	2000 ± 275	1480 ± 200

¹ 1 Newton meter (N·m) is approximately the same as 0.1 kg·m.

Torques for Taperlock Studs

Thread Size Inch	Standard Taperlock Stud Torque	
	N·m ¹	lb·ft
1/4	8 ± 3	6 ± 2
5/16	17 ± 5	13 ± 4
3/8	35 ± 5	26 ± 4
7/16	45 ± 10	33 ± 7
1/2	65 ± 10	48 ± 7
5/8	110 ± 20	80 ± 15
3/4	170 ± 30	125 ± 22
7/8	260 ± 40	190 ± 30
1	400 ± 60	300 ± 45
1 1/8	500 ± 700	370 ± 50
1 1/4	650 ± 80	480 ± 60
1 3/8	750 ± 90	550 ± 65
1 1/2	870 ± 100	640 ± 75

¹ 1 Newton meter (N·m) is approximately the same as 0.1 kg·m.

Torque for Metric Fasteners

NOTICE

Be very careful never to mix metric with U.S. customary (standard) fasteners. Mismatched or incorrect fasteners will cause lift truck damage or malfunction and may even result in personal injury.

Original fasteners removed from the lift truck should be checked for any damages and kept for reassembly whenever possible. If new fasteners are needed, they must be of the same size and grade as the ones that are being replaced.

The material strength identification is usually shown on the bolt head by numbers (8.8, 10.9, etc.). This chart gives standard torques for bolts and nuts with Grade 8.8.

For mounting torques of main parts, Please refer to Service manual for detail.

NOTE: Metric hardware must be replaced with metric hardware. Check parts book.

Metric ISO² Thread

Thread Size Metric	Standard Torque	
	N·m ¹	lb·ft
M6	12 ± 4	9 ± 3
M8	25 ± 7	18 ± 5
M10	55 ± 10	41 ± 7
M12	95 ± 15	70 ± 11
M14	150 ± 20	110 ± 15
M16	220 ± 30	160 ± 22
M20	450 ± 70	330 ± 50
M24	775 ± 100	570 ± 75
M30	1600 ± 200	1180 ± 150
M36	2700 ± 400	2000 ± 300

¹ 1 Newton meter (N·m) is approximately the same as 0.1 kg·m.

² ISO - International Standards Organization.

Cooling System Specifications

Coolant Information

NOTE: The following information is generic and valid for lift trucks.

Engine operating temperatures have increased to improve engine efficiency. This means proper cooling system maintenance is especially important. Overheating, overcooling, pitting, cavitation erosion, cracked heads, piston seizures, and plugged radiators are classic cooling system failures. In fact, coolant is as important as the quality of fuel and lubricating oil.

Filling at over 20 liters (5 U.S. gallons) per minute can cause air pockets in the cooling system.

After draining and refilling the cooling system, operate the engine with the radiator cap removed until the coolant reaches normal operating temperature and the coolant level stabilises. Add coolant as necessary to fill the system to the proper level.

Never operate without a thermostat in the cooling system. Cooling system problems can arise without a thermostat.

NOTICE

CROWN recommends that the coolant mixture contain 50% commercially available automotive antifreeze, and 50% water.

The coolant mix with concentration of antifreeze smaller than 30% does not provide sufficient corrosion protection. Concentrations over 60% adversely affect freeze protection and heat transfer rates.

Never add coolant to an overheated engine, engine damage can result. Allow the engine to cool first.

If the machine is to be stored in, or shipped to, an area with freezing temperatures, the cooling system must be protected to the lowest expected outside (ambient) temperature.

The engine cooling system is normally protected to -28°C(-20°F) with antifreeze, when shipped from the factory unless special requirements are defined.

Check the specific gravity of the coolant solution frequently in cold weather to ensure adequate protection.

Clean the cooling system if it is contaminated, the engine overheats or foaming is observed in the radiator.

Old coolant should be drained, the system cleaned and new coolant added every 2000 service hours or yearly.

Refer to topic, "Cooling System - Clean, Change" in Every 2000 Service Hours or Yearly section.

Coolant Water

Hard water, or water with high levels of calcium and magnesium ions, encourages the formation of insoluble chemical compounds by combining with cooling system additives such as silicates and phosphates.

The tendency of silicates and phosphates to precipitate out-of-solution increases with increasing water hardness. Hard water, or water with high levels of calcium and magnesium ions encourages the formation of insoluble chemicals, especially after a number of heating and cooling cycles.

CROWN prefers the use of distilled water or deionized water to reduce the potential and severity of chemical insolubility.

Acceptable Water	
Water Content	Limits (PPM)
Chlorides (Cl)	50 maximum
Sulfates (SO ₄)	50 maximum
Total hardness	80mg/l
Total solids	250 maximum
PH	6.0 to 8.0

ppm = parts per million

Using water that meets the minimum acceptable water requirement may not prevent drop-out of these chemical compounds totally, but should minimise the rate to acceptable levels.

Antifreeze

NOTICE

CROWN recommends using automotive antifreeze suitable for gasoline engines having aluminum alloy parts. Antifreeze of poor quality will cause corrosion of the cooling system, and thus always use automotive antifreeze prepared by a reliable maker, and never use it mixed with antifreeze of different brand.

CROWN recommends that the coolant mix contain 50% commercially available automotive antifreeze, or equivalent and acceptable water to maintain and adequate water pump cavitation temperature for efficient water pump performance.

Premix coolant solution to provide protection to the lowest expected outside (ambient) temperature. Pure undiluted antifreeze will freeze at -23°C (-10°F).

Use a greater concentration (above 50%) of commercially available automotive antifreeze only as needed for anticipated outside (ambient) temperatures. Do not exceed the recommendations, provided with the commercially available automotive antifreezes, regarding the coolant mixture of antifreeze to water.

Make proper antifreeze additions.

Adding pure antifreeze as a makeup solution for cooling system top-up is an unacceptable practice. It increases the concentration of antifreeze in the cooling system which increase the concentration of dissolved solids and undissolved chemical inhibitors in the cooling system. Add antifreeze mixed with water to the same freeze protection as your cooling system.

Use the chart below to assist in determining the concentration of antifreeze to use.

Antifreeze Concentrations	
Protection Temperature	Concentration
Protection to -15°C (5°F)	30% antifreeze and 70% water
Protection to -23°C (-10°F)	40% antifreeze and 60% water
Protection to -37°C (-34°F)	50% antifreeze and 50% water
Protection to -51°C (-60°F)	60% antifreeze and 40% water

Fuel Specifications

General Fuel Information

Use only fuel as recommended in this section.

NOTICE

Fill the fuel tank at the end of each day of operation to drive out moisture laden air and to prevent condensation. Maintain a constant level near the top of the day tank to avoid drawing moisture into the tank as the level decreases. Do not fill the tank to the top. Fuel expands as it gets warm and can overflow.

Do not fill the fuel filters with fuel before installing them. Contaminated fuel will cause accelerated wear to the fuel system parts.

Drain the water and sediment from main fuel storage tank before it is refilled. This will help prevent water and/or sediment from being pumped from the fuel storage tank into the engine fuel tank.

LP Specifications

LP is "Liquefied Petroleum Gas". The exact composition of LP varies slightly between different parts of the country and different refineries.

HD5 is recommended for CROWN forklift trucks. Remember LP is heavier than air and will sink to the lowest spot possible. Avoid areas near floor drains or lubrication pits where escaped fuel may collect.

Composition of HD5	
Propane (C ₃ H ₈)	90.0 %
Propylene	up to 5 %
Butane (C ₄ H ₁₀)	2.0 %
iso-Butane	1.5 %
Methane (CH ₄)	1.5 %
Total	100 %

Lubricant Specifications

Lubricant Information

Certain abbreviations follow Society of Automotive Engineers (SAE) J754 nomenclature and some classifications follow SAE J183 abbreviations.

The MIL specifications are U.S.A. Military Specifications.

The recommended oil viscosities can be found in the Lubricant Viscosities chart in this publication.

Grease is classified by the National Lubricating Grease Institute (NLGI) based on ASTM D217-68 Worked Penetration characteristics which are given a defined consistency number.

Engine Oil (DEO and EO)

The following oil specifications provide guidelines for the selection of commercial products :

- Gasoline/LP Engine : API SJ or higher

NOTE: Engine Oil Service hours can be extended to 500 hours by using CROWN supplied specific oil. Please consult CROWN dealer about it.

NOTICE

Failure to follow the oil recommendations can cause shortened engine life due to carbon deposits or excessive wear.

Consult the EMA Lubricating Oils Data Book for a listing of oil brands.

NOTE: The percentage of sulphur in the fuel will affect the engine oil recommendations. For fuel sulphur effects, the Infrared Analysis or the ASTM D2896 procedure can be used to evaluate the residual neutralization properties of an engine oil. The sulphur products formation depends on the fuel sulphur content, oil formulation, crankcase blowby, engine operating conditions and ambient temperature.

Hydraulic Oil (HYDO)

The following commercial classifications can be used in the hydraulic system.

- ISO 6743/4
HM
- AFNOR NFE 48-603
HM
- DIN 51524 TEIL 2
H-LP
- HAGGLUNDS DENISON
HFO-HF2
- CINCINNATI
P68,69,70

Viscosity : ISO VG 32

Industrial premium hydraulic oils that have passed the Vickers vane pump test (35VQ25). These oils should have antiwear, antifoam, antirust and antioxidation additives for heavy duty use as stated by the oil supplier. ISO viscosity grade of 32 would normally be selected.

NOTICE

Make-up oil added to the hydraulic tanks must mix with the oil already in the systems. Use only petroleum products unless the systems are equipped for use with special products. If the hydraulic oil becomes cloudy, water or air is entering the system. Water or air in the system will cause pump failure. Drain the fluid, retighten all hydraulic suction line clamps, purge and refill the system. Consult your CROWN Lift Truck dealer for purging instructions.

Transmission Oil (TDTO)

NOTICE

This oil is formulated for transmissions and drive trains only, and should not be used in engines. Shortened engine life will result.

NOTE: Multi-grade oils are not blended by CROWN for use in transmissions. Multi-grade oils which use high molecular weight polymers as viscosity index improvers lose their viscosity effectiveness by permanent and temporary shear of the viscosity index improver and therefore, are not recommended for transmission and drive train compartments.

NOTE: Failure to follow this recommendation can cause shortened transmission life due to material incompatibility, inadequate frictional requirements for disk materials and/or excessive gear wear.

Select the oil that meets the following specification.

- GM DEXRON III
- FORD MERCON V

Drive Axle Oil

NOTE: Failure to follow the recommendation will cause shortened life due to excessive gear wear.

Oil Cooled Disc Brake (OCDB)

Select oil that meets below specifications.
: Universal Transmission Tractor Oil (UTTO)

The following UTTO products are authorised for use.

Supplier	Product Name
TOTAL	TRANSMISSION MP
MOBIL	MOBILFLUID 424

Brake Fluid

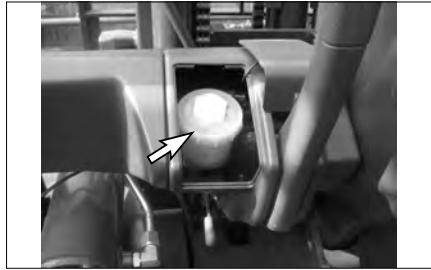

Oil Cooled Disc Brake Only

Use heavy duty hydraulic brake fluid certified by oil supplier to meet the latest version of following classifications.

- | | |
|---------------------|-----------|
| • ISO 6743/4 | HM |
| • AFNOR NFE 48-603 | HM |
| • DIN 51524 TEIL 2 | H-LP |
| • HAGGLUNDS DENISON | HFO-HF2 |
| • CINCINNATI | P68,69,70 |

Viscosity : ISO VG32

Brake reservoir oils that have passed the Vickers vane pump test (35VQ25). These oils should have antiwear, antifoam, antirust and antioxidation additives for heavy duty use as stated by the oil supplier. ISO viscosity grade of 32 would normally be selected.

The following products are authorised for use.

Supplier	Product Name
TOTAL	AZOLLAZS
SHELL	TELLUS
MOBIL	DTE20S'
CALTEX	RANDO HD
ESS	NOTO H
CASTROL	HYSPIN AWS

Lubricating Grease (MPGM)

Use Multipurpose Molybdenum Grease (MPGM) for all lubrication points. If MPGM grease can not be used, a multipurpose type grease which contains 3% to 5% molybdenum disulfide can be used.

NLGI No.2 grade is suitable for most temperatures. Use NLGI No.1 or No.0 grade for extremely low temperature.

Lubricant Viscosities and Refill Capacities

Lubricant Viscosities

Lubricant Viscosities for Ambient (Outside) Temperatures						
Compartment or System	Oil Viscosities	°C		°F		
		Min	Max	Min	Max	
Engine Crankcase (LP) and Lift Chains API SJ	SAE 5W30	-30	+30	-22	+86	
	SAE 10W30	-20	+30	-4	+86	
	SAE 5W40	-30	+40	-22	+104	
	SAE 10W40	-20	+40	-4	+104	
	SAE 15W40	-10	+40	+14	+104	
	SAE 15W50	-10	+50	+14	+122	
SAE 20W50	-5	+50	+23	+122		
Power Shift Transmission DEXRON III	DEXRON III	-20	+50	-4	+122	
Hydraulic and Power Steering System ISO 6743/4 HM	ISO VG32	-20	+30	-4	+86	
	ISO VG46	-10	+40	+14	+104	
	ISO VG68	0	+50	+32	+122	
Drive Axle Housing	Disc Brake (OCDB) UTTO	UTTO	-20	+80	-4	+176
Brake Reservoir (Only for OCDB) ISO 6743/4HM	ISO VG32	-20	+30	-4	+86	
	ISO VG46	-10	+40	+14	+104	
	ISO VG68	0	+50	+32	+122	

The SAE grade number indicates the viscosity of oil. A proper SAE grade number should be selected according to ambient temperature.

Refill Capacities

Refill Capacities-(Approximate)			
Compartment or System	Liters	U.S. Gal.	
Engine Crankcase w/Filter LP	4.3	1.1	
Cooling System w/Coolant Recovery Bottle LP	19.0	5.0	
Power Shift Transmission	13.0	3.4	
Hydraulic & Power Steering System	73.0	19.3	
Drive Axle	Disc Brake (OCDB)	14.0	3.7
Brake Reservoir (Only for OCDB)		0.6	0.16

Maintenance Intervals

NOTICE

Users should be familiar with the requirements for inspection and maintenance of lift trucks as provided by Australian Standard AS2359.

NOTICE

Never exceed the Maintenance Intervals specified in the manual. Defects and/or damage to the important functional components may be resulted in.

NOTICE

All maintenance and repair, except Every 10 Service Hours or Daily, on the lift truck must be performed by qualified and authorised personnel only.

NOTICE

Careless disposal of waste oil can harm the environment and can be dangerous to persons. Always dispose of waste oil to authorised personnel only.

When Required

Test Fuel System for Leaks (LP Engine Only)	118
Seat, Hood Latch & Support Cylinder - Check, Lubricate.....	118
Fuses, Bulbs & Circuit Breaker - Change, Reset	119
Fuse & Relay (LP Engine Only)	120
Circuit Breaker	120
Carriage Roller Extrusion - Check, Adjust	121
Battery Terminal - Clean, Inspect.....	121

Every 10 Service Hours or Daily

Inspect Engine for Fluid Leaks	122
Engine Oil Level - Check	122
Coolant Level - Check, Clean	122
Air Cleaner Indicator - Check	123
Walk - Around Inspection - Inspect	124
Mast Channels – Lubricate	125

Transmission Oil Level - Check	125
Hydraulic Oil Level – Check	126
Drive Axle Oil Level – Check	126
Brake Oil Level – Check	126

First 50 - 100 Service Hours or a Week

Transmission Oil, Oil Filter & Strainer - Clean, Change	128
Drive Axle Oil - Check, Clean, Change	130
Parking Brake - Test, Adjust.....	131

Every 250 Service Hours or Monthly

Engine Oil & Filter – Change.....	133
-----------------------------------	-----

Every 500 Service Hours or 3 Months

Air Intake System - Check, Clean	134
Tilt Cylinders - Check, Adjust, Lubricate	136
Mast Hinge Pins – Lubricate	137
Crosshead Rollers - Inspect	137
Carriage Side Rollers Thrust (If Equipped) - Lubricate	137
Carriage Sideshifter (If Equipped) – Lubricate.....	137
Mast, Carriage, Lift Chains, & Attachments - Check, Lubricate	138
Carriage Side Rollers - Lubricate	138
Parking Brake - Test, Adjust.....	139
Circulation Pump Belt (OCDB & LP Engine Only. If Equipped) - Check, Adjust.....	139
Drive Axle Oil & Strainer (OCDB Only) - Check, Clean, Change	139
Horn & Lights (If Equipped) – Check	140
Inspect Vacuum Lines and Fittings (LP Engine only)	140
Fuel Trim Valve(FTV) Inspection (PSI Engine only)	141
Inspect Electrical System (LP Engine only)	141
Overhead Guard – Inspect	141
Steer Suspension - Inspect	141
Steering Mechanism - Check, Lubricate	142
Wheel Bolts and Nuts – Inspect.....	142

Every 1000 Service Hours or 6 Months

Air Intake System - Change	143
Inspect Coolant Hoses (LP Engines Only)	143
LP Regulator/Converter Inspection (LP Engine Only)	143
Fuel Lines & Fittings - Check	144
Inspect Mixer Assembly (LP Engine Only).....	144
Inspect Throttle Assembly (LP Engine Only)	144

Hydraulic Return Filter - Change 144
 Air Breather - Change 144
 Transmission Oil, Oil Filter & Strainer - Clean,
 Change 144
 Lift Chains - Test, Check, Adjust 145
 Universal Joint - Inspect..... 147

Every 1500 Service Hours or 9 Months

Drive Axle Oil (Shoe Brake Only) - Check, Clean,
 Change..... 148
 Inspect Ignition System (LP Engine Only) 148
 Replace Spark Plugs (LP Engine Only)..... 148
 Replace LP Fuel Filter Element (LP Engine Only)
 149
 Fuel Filter (LP Engine Only) 149
 Testing Fuel Lock-off Operation (LP Engine Only)
 150

Every 2000 Service Hours or Yearly

Steer Wheel Bearings -Reassemble 151
 Cooling System - Clean, Change 152
 Fork – Inspect 153

Every 2500 Service Hours or 15 Months

Hydraulic Oil - Check, Clean, Change 155
 Inspect Battery System 155
 Checking the TMAP Sensor (LP Engine Only) 156
 Inspect for Intake Leaks (LP Engine Only) 156
 Replace PCV Valve and breather element - Change
 (LP Engine Only) 156
 Replace Oxygen Sensor (PSI Engine)..... 156

Environment Protection

Environment Protection..... 157

Maintenance Section

Quick Reference to Maintenance Schedule			EVERY									
ITEMS	SERVICES	PAGE	When Required	FIRST	EVERY							
				50-100 Service Hours or a Week	10 Service Hours or Daily	250 Service Hours or Monthly	500 Service Hours or 3 Months	1000 Service Hours or 6 Months	1500 Service Hours or 9 Months	2000 Service Hours or Yearly	2500 Service Hours or 15 Months	
Air Breather	Change	144										
Air Cleaner Indicator	Check	123			o							
Air Intake System	Change	143							o			
Air Intake System	Check, Clean	134						o				
Battery Terminal	Clean, Inspect	121	o									
Brake Oil Level	Check	126			o							
Carriage Roller Extrusion	Check, Adjust	121	o									
Carriage Side Rollers	Lubricate	138						o				
Carriage Side Rollers Thrust (If Equipped)	Lubricate	137						o				
Carriage Sideshifter (If Equipped)	Lubricate	137						o				
Checking the TMAP Sensor (LP Engine Only)		156										o
Circuit Breaker		120	o									
Circulation Pump Belt (OCDB & LP Engine Only. If Equipped)	Check, Adjust	139						o				
Coolant Level	Check, Clean	122			o							
Cooling System	Clean, Change	152									o	
Crosshead Rollers	Inspect	137						o				
Drive Axle Oil	Check, Clean, Change	130		o								
Drive Axle Oil & Strainer (OCDB Only)	Check, Clean, Change	139						o				
Drive Axle Oil (Shoe Brake Only)	Check, Clean, Change	148								o		
Drive Axle Oil Level	Check	126			o							
Engine Oil & Filter	Change	133				o						
Engine Oil Level	Check	122			o							
Fork	Inspect	153									o	
Fuel Filter (LP Engine Only)		149								o		
Fuel Lines & Fittings	Check	144							o			
Fuel Trim Valve(FTV) Inspection (PSI Engine only)		141						o				
Fuse & Relay (LP Engine Only)		120	o									
Fuses, Bulbs & Circuit Breaker	Change, Reset	119	o									
Horn & Lights (If Equipped)	Check	140						o				
Hydraulic Oil	Check, Clean, Change	155										o
Hydraulic Oil Level	Check	126			o							
Hydraulic Return Filter	Change	144							o			
Inspect Battery System		155										o
Inspect Coolant Hoses (LP Engines Only)		143							o			

Quick Reference to Maintenance Schedule			EVERY									
ITEMS	SERVICES	PAGE	When Required	FIRST	EVERY							
				50-100 Service Hours or a Week	10 Service Hours or Daily	250 Service Hours or Monthly	500 Service Hours or 3 Months	1000 Service Hours or 6 Months	1500 Service Hours or 9 Months	2000 Service Hours or Yearly	2500 Service Hours or 15 Months	
Inspect Electrical System (LP Engine only)		141					o					
Inspect Engine for Fluid Leaks		122			o							
Inspect for Intake Leaks (LP Engine Only)		156										o
Inspect Ignition System (LP Engine Only)		148								o		
Inspect Mixer Assembly (LP Engine Only)		144							o			
Inspect Throttle Assembly (LP Engine Only)		144							o			
Inspect Vacuum Lines and Fittings (LP Engine only)		140					o					
Lift Chains	Test, Check, Adjust	145							o			
LP Regulator/Converter Inspection (LP Engine Only)		143							o			
Mast Channels	Lubricate	125			o							
Mast Hinge Pins	Lubricate	137					o					
Mast, Carriage, Lift Chains, & Attachments	Check, Lubricate	138					o					
Overhead Guard	Inspect	141					o					
Parking Brake	Test, Adjust	131,139		o			o					
Replace LP Fuel Filter Element (LP Engine Only)		149							o			
Replace Oxygen Sensor (PSI Engine Only)		156										o
Replace PCV Valve and breather element	Change (LP Engine Only)	156										o
Replace Spark Plugs (LP Engine Only)		148								o		
Seat, Hood Latch & Support Cylinder	Check, Lubricate	118	o									
Steer Suspension	Inspect	141					o					
Steer Wheel Bearings	Reassemble	151									o	
Steering Mechanism	Check, Lubricate	142					o					
Test Fuel System for Leaks (LP Engine Only)		118	o									
Testing Fuel Lock-off Operation (LP Engine Only)		150							o			
Tilt Cylinders	Check, Adjust, Lubricate	136					o					
Transmission Oil Level	Check	125			o							
Transmission Oil, Oil Filter & Strainer	Clean, Change	128,144		o					o			
Universal Joint	Inspect	147							o			
Walk - Around Inspection	Inspect	124			o							
Wheel Bolts and Nuts	Inspect	142					o					

When Required

You must read and understand the warnings and instructions contained in the Safety section of this manual, before performing any operation or maintenance procedures.

Test Fuel System for Leaks (LP Engine Only)

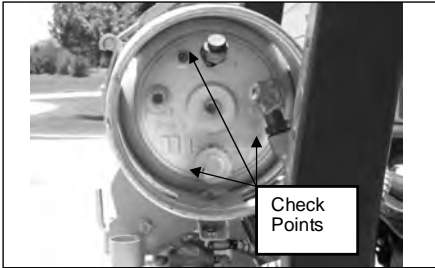

1. Obtain a leak check squirt bottle or pump spray bottle.
2. Fill the bottle with an approved leak check solution.
3. Spray a generous amount of the solution on the fuel system fuel lines and connections, starting at the storage container.
4. Wait approximately 15-60 seconds then perform a visual inspection of the fuel system. Leaks will cause the solution to bubble.
5. Repair any leaks before continuing.
6. Crank the engine through several revolutions. This will energize the fuel lock-off and allow fuel to flow to the pressure regulator/converter. Apply additional leak check solution to the regulator/converter fuel connections and housing. Repeat leak inspection as listed above.
7. Repair any fuel leaks before continuing.

WARNING

Prior to any service or maintenance activity, Test Fuel System for Leaks

Seat, Hood Latch & Support Cylinder - Check, Lubricate



1. Check the operation of the seat adjuster rod. Make sure that the seat slides freely on its track. Lightly oil the seat slider tracks if necessary.



2. Push the lever down to raise the hood and seat assembly. Make certain the support cylinder will hold the hood open.



3. Lightly oil the hood latch mechanism and the rod for the hood support cylinder.

Fuses, Bulbs & Circuit Breaker - Change, Reset

Fuses

NOTE: If a fuse filament separates, use only the same type and size fuses for replacement. If the filament in a new fuse separates, have the circuits and instruments checked.

NOTICE

Always replace fuses with ones of the correct ampere rating.

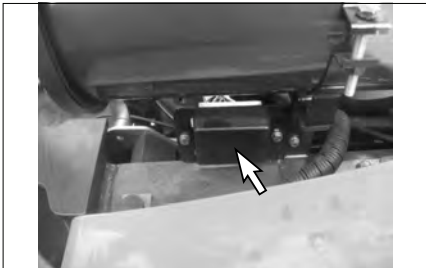

Remove the front cover from the fuse box. The fuses are located under the air cleaner.



Fuse - Protects an electrical circuit from an overload. Opens (filament separates) if an overload occurs.

Fuse Box (Open)



Typical Example

Gas

HEAD LAMP COMB LAMP	HORN	REAR LAMP OPTION	NOT USE	IGNITION VALVE SOLENOID COIL FUEL INJECTOR CALIBRATION MAIN POWER RELAY	HEAD LAMP RELAY COIL	F/R CONTROL
15A	10A	10A		10A	10A	10A
STOP LAMP STROBE LIGHT HORN SIGNAL LAMP	NOT USE	NOT USE	NOT USE	START RELAY COIL F/R RELAY COIL		
15A				15A		



A431940

Fuse Box (Close)

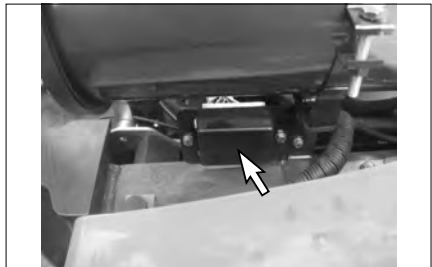

Typical Example

Fuses are identified as follows :

1. Horn - 10 A
2. Head Lamp ,Clearance Lamp, Tail Lamp - 15 A
3. Lamp Relay Coil, Fwd/Rev. Solenoid, Rear Lamp Relay & Back-up Lamp/Alarm - 15 A
4. Instrument Panel, Hour Meter, Preheat Controller, Fuel Shut off Solenoid - 15 A
5. Stop Lamp, Turn Signal Lamp, Strobe Lamp - 15 A
6. Starter Relay - 10 A

Bulbs

Bulbs are identified as follows:

[LP Gas Engine]

1. Bulb - head lamp halogen (12V - 35W)
- *2. Bulb - back up (12V - 8W)
- *3. Bulb - turn signal (12V - 23W)
- *4. Bulb - stop & tail (12V - 23/8W)

*Optional lamp or light

Fuse & Relay (LP Engine Only)

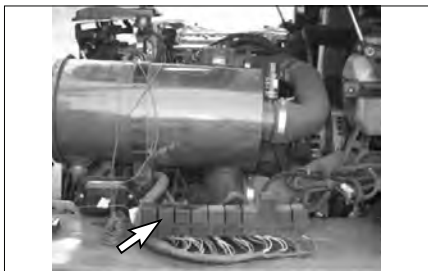

Circuit Breaker



1. Raise the hood and seat assembly. Make sure the support cylinder securely holds the hood open.



Typical Example LP Engine Truck

2. The main circuit breaker is located on the rear of the support for the controls.

NOTE: To reset circuit breakers push in on the button. The button should stay in if the breaker is reset. If the button will not stay in, or comes out shortly after reset, have the circuits checked.

Carriage Roller Extrusion - Check, Adjust

1. Set the mast vertical.
2. Lower the carriage completely.
3. On full free lift and full free triple lift models, the bottom of the inner mast must be flush with the

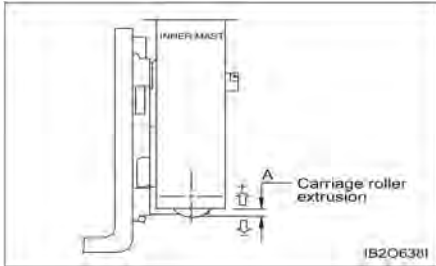

5. Measure the distance from the bottom of the inner upright to the bottom of carriage bearing.
6. The measurement (A) must be as follows in Chart below.

Height of carriage roller extrusion (A) [unit : mm]		
STD mast	FF mast	FFT mast
-7	43	43

Battery Terminal - Clean, Inspect



Batteries give off flammable fumes that can explode.

Do not smoke when observing the battery electrolyte levels.

Electrolyte is an acid and can cause personal injury if it contacts skin or eyes.

Always wear protective glasses when working with batteries.

LP Engine - 12V X 1



Typical Example

LP Engine Truck

1. Clean the top of the battery and terminals.
2. Check terminals for corrosion. Coat terminals with heavy grease.
3. Ensure the battery terminal is firmly tightened and rubber cap is installed.

Every 10 Service Hours or Daily

You must read and understand the warnings and instructions contained in the Safety section of this manual, before performing any operation or maintenance procedures.

Inspect Engine for Fluid Leaks

1. Start the engine and allow it to reach operating temperatures.
2. Turn the engine off.
3. Inspect the entire engine for oil and/or coolant leaks.
4. Repair as necessary before continuing.

Engine Oil Level - Check

⚠ WARNING

Hot oil and components can cause personal injury. Do not allow hot oil or components to contact skin.

Park the lift truck level, with the forks lowered, parking brake applied, transmission in NEUTRAL and the engine stopped.

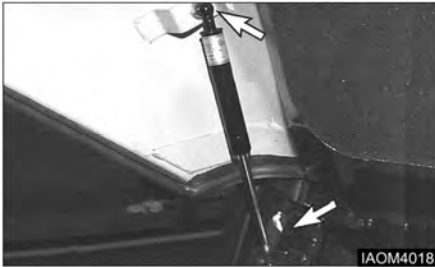

1. Raise the hood and seat assembly. Make certain the support cylinder securely holds the hood open.

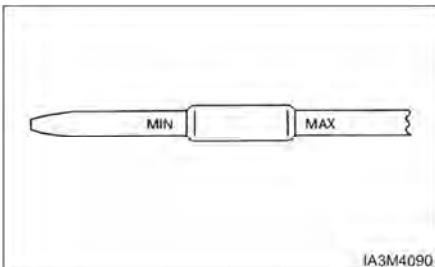

2. The oil level should be close as possible to upper point of the oil dip stick. Do not refill more than upper point.

Coolant Level - Check, Clean

Check Coolant Level

⚠ WARNING

At operating temperature, the engine coolant is hot and under pressure.

Steam can cause personal injury.

Check the coolant level only after the engine has been stopped and the filter cap is cool enough to touch with your bare hand.

Remove the filter cap slowly to relieve pressure.

Cooling system conditioner contains alkali. Avoid contact with the skin and eyes to prevent personal injury.



1. Observe the coolant level with engine cold. Maintain coolant level to the proper line on expansion bottle. If the expansion bottle has no coolant, it will be necessary to check coolant at the radiator filter neck.
2. Remove the radiator cap. Fill radiator to the top of the filter neck. Inspect radiator cap. Replace if damaged. Install the radiator cap.



3. Start and run the engine to stabilise the coolant level in the filter neck. If low add coolant until it reaches the top of the filter neck. Install the radiator cap. Observe coolant level in the expansion bottle. If necessary, add coolant to bring the coolant to the appropriate line on the expansion bottle.
4. Stop the engine.
5. Inspect the cooling system for leaks, hose cracks or loose connections.

⚠ WARNING

Pressure air can cause personal injury.

When using pressure air for cleaning, wear a protective face shield, protective clothing and protective shoes.

Maximum air pressure must be less than 205 kPa (30 psi) for cleaning purposes.

6. Blow any dust and lint from the radiator fins.

Air Cleaner Indicator - Check Checking Service Indicator

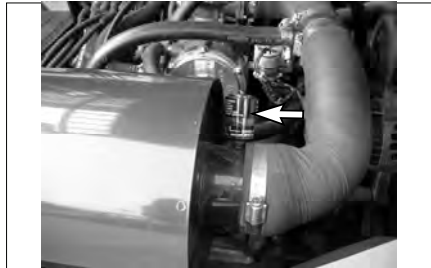

Typical Example

LP Engine Truck

1. Observe the air cleaner service indicator.
2. Service the air cleaner when the RED band in the service indicator, lock in the visible position. See topic, "Air Intake System - Check, Clean" in "Every 250 Service Hours or Monthly".

NOTE: Service the element more frequently, as required, in severe dust or lint conditions. Also, service it more frequently where the operator is required to wear a respirator.

3. Close hood and seat assembly.

Inspect Acceleration Pedal Operation(PSI Engine)

1. Verify foot pedal travel is smooth without sticking.

⚠ WARNING

When the acceleration pedal harness is connected or disconnected, should be worked key OFF condition.

If not, occurred malfunction, can cause the personal injury.

Inspect Engine for Exhaust Leaks

1. Start the engine and allow it to reach operating temperatures.
2. Perform visual inspection of exhaust system.
3. Repair any/all leaks found.

Walk - Around Inspection - Inspect

For maximum service life of the lift truck, make a thorough walk-around inspection.

Look around and under the truck for such items as loose or missing bolts, debris or dirt buildup, fuel, oil or coolant leaks and cut gouged tyres.

Have any repairs made and debris removed, as needed.



Typical Example

LP Engine Truck

1. Inspect the tyres and wheels for cuts, gouges, foreign objects, inflation pressure and loose or missing bolts.
2. Inspect the mast and lift chains for wear, broken links, pins and loose rollers.
3. Inspect the hydraulic system for leaks, worn hoses or damaged lines.
4. Look for transmission and differential leaks on the lift truck and on the ground.
5. Inspect the operator's compartment for loose items and cleanliness.
6. Inspect the instrument panel for broken gauges and indicator lights.
7. Test the horn and other safety devices for proper operation.
8. Inspect the cooling system for leaks, worn hoses and debris buildup.
9. Inspect engine compartment for oil, coolant and fuel leaks.
10. Inspect the forks.
 - Visually inspect forks for cracks, especially in the heel section, around the mounting brackets, and all weld areas.
 - Inspect for broken or jagged fork tips, bent or twisted blades and shanks.
 - Make sure positioning lock is in place and working. Lock the forks in position before using the truck. See Step 7 of " Forks " in " Every 2000 Service Hours or Yearly "
 - Remove all defective forks from service.

Mast Channels – Lubricate

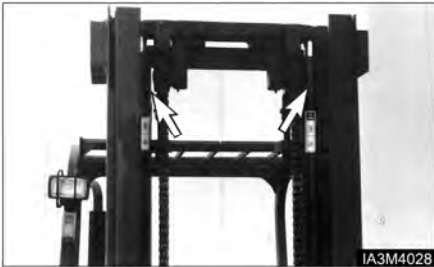

The channels on the roller-type mast require a break-in period. Apply a light film of lubricant on the channels where the rollers ride. This will prevent metal peel until the rollers set a pattern.

Transmission Oil Level - Check

WARNING

Hot oil and components can cause personal injury. Do not allow hot oil or components to contact skin.

1. Start and operate the lift truck until the engine reaches normal operating temperature.
2. Park the lift truck level with the forks lowered, parking brake applied and the transmission controls in NEUTRAL.
3. With the brake applied and the engine at low idle, shift the directional control lever to forward and then to reverse, to fill the clutches.
4. Shift the direction control lever to the NEUTRAL position.



5. Open the access door in floor plate.
6. Remove the dipstick/filter cap. Observe the oil level.
7. Maintain the oil level between the Min and Max marks on the dipstick/filter cap.

When the oil temperature is 40°C approximately, the cold side mark on the dipstick is applicable. When the oil temperature is 80°C approximately, the hot side mark on the dipstick is applicable.

8. Close the access door in floor plate.
9. Stop the engine.

Hydraulic Oil Level – Check

⚠ WARNING

At operating temperature, the hydraulic tank is hot and under pressure.

Hot oil can cause burns.

Remove the filter cap only when the engine is stopped, and the cap is cool enough to touch with your bare hand. Remove the filter cap slowly to relieve pressure.

1. Operate the lift truck for a few minutes to warm the oil. Park the lift truck on a level surface, with the forks lowered, mast tilted back, parking brake engaged, transmission in NEUTRAL and the engine stopped.
2. Raise the hood and seat assembly. Make sure the air lift cylinder securely holds the hood open.



3. Remove the dipstick/ filter cap. Maintain the oil level to the FULL mark on the breather/dip stick.

Drive Axle Oil Level – Check

⚠ WARNING

Hot oil and components can cause personal injury. Do not allow hot oil or components to contact skin.

Park the lift truck on a level surface. Apply the parking brake. The engine is at the low idle. Place the directional control lever in NEUTRAL.

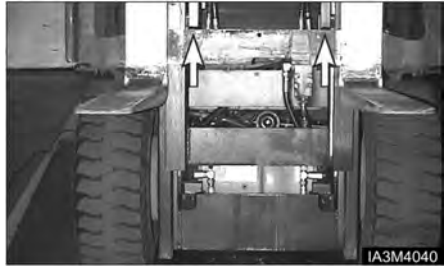

1. Lift the carriage high enough to access the drive axle housing oil level plug and fill plug.
2. Put blocks under the carriage.

Brake Oil Level – Check



The brake reservoir is located on the left side of the steering column.

1. Remove the filler cap.
2. Maintain the brake fluid level to the fluid level mark on the brake system reservoir.
3. Clean and install the filler cap

Oil Cooled Disc Brake (OCDB) Type

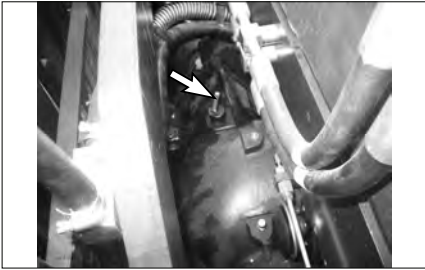

1. Remove the dip stick/filter cap. Observe the oil level.
2. Maintain the oil level between lower mark and upper mark on the dip stick/filter cap.
3. Install the dip stick/filter cap

First 50 - 100 Service Hours or a Week

You must read and understand the warnings and instructions contained in the Safety section of this manual, before performing any operation or maintenance procedures.

Transmission Oil, Oil Filter & Strainer - Clean, Change

⚠ WARNING

Hot oil and components can cause personal injury. Do not allow hot oil or components to contact skin.

Park the lift truck level, with the forks lowered, parking brake engaged, transmission in NEUTRAL and the engine stopped.

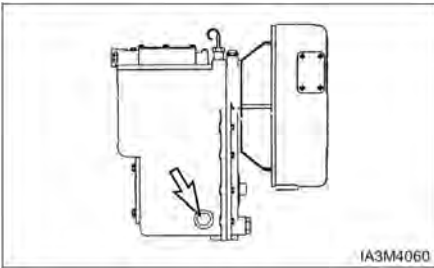

1. Remove the drain plug, spring and strainer. Allow the oil to drain.

NOTICE

Careless disposal of waste oil can harm the environment and can be dangerous to persons.

Always dispose of waste oil to authorised and licensed personnel only.

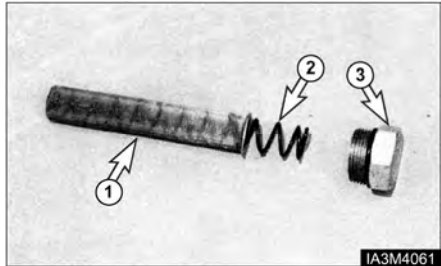

2. Wash the strainer (screen) ①, spring ② and drain plug ③ in clean, nonflammable solvent. Dry and install the strainer, spring and drain plug.
3. Raise the hood and seat assembly.

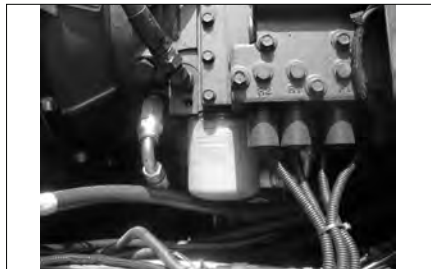

4. Remove and discard the oil filter. Wipe off the filter base. Make sure all of the old seal is removed.
5. Put a small amount of clean oil on the seal on the new filter. Install the filter by hand. When the filter contacts the base, tighten it an additional 3/4 turn.
6. Close the hood and seat assembly.



7. Open the access door in the floor plate.
8. Remove the dipstick/filter cap. Fill the transmission with oil. See "Refill Capacities" Install the dipstick/filter cap.



9. Start the engine.
10. With the service brake applied and engine at low idle, shift the transmission to forward and reverse to fill the clutches.
11. Shift the transmission into NEUTRAL. Apply the parking brake.
12. Remove the dipstick/ filter cap.
13. Maintain the oil level between the Min and Max marks on the dipstick/filter cap.

When the oil temperature is 40°C approximately, the cold side mark on the dipstick is applicable.
When the oil temperature is 80°C approximately, the hot side mark on the dipstick is applicable.
14. Check for oil leaks at the filter and drain plug.
15. Stop the engine.

Drive Axle Oil - Check, Clean, Change

Park the lift truck on a level surface, parking brake applied, transmission in neutral.

⚠ WARNING

Hot oil and components can cause personal injury. Do not allow hot oil or components to contact skin.

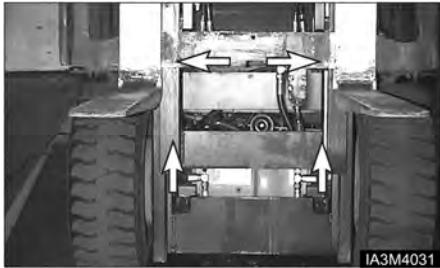

1. Lift the carriage high enough to access the drive axle housing fill plug with breather.
2. Block the bottom of the mast with a block of wood to hold the carriage in the raised position.
3. Turn the ignition switch OFF.

Oil Cooled Disc Brake (OCDB) Type



1. Remove drain plug. Allow the oil to drain into a suitable container. Clean the magnetic drain plug. Check O-ring seal and replace if necessary.
2. Install the drain plug.

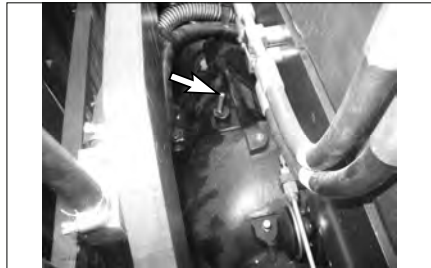

3. Remove the dip stick/filter cap. Fill the drive axle housing with oil. See "Lubricant Specification - Drive Axle Oil" and "Refill Capacity"
4. Start the lift truck. With the engine at low idle, place the directional control lever to the NEUTRAL.
5. Maintain the oil level between lower mark and upper mark on the dip stick/filter cap.
6. Install the dip stick/filter cap.

Parking Brake - Test, Adjust

Parking Brake Testing

NOTICE

OSHA requires the parking brake to hold the lift truck, with capacity load, on a 15% grade.

Testing requires a test load equal to the capacity of the truck and a 15% grade.

If the maximum grade in the workplace is less than its capacity, use the Parking Brake inspection procedure covered in 'Inspection from Operator's Seat, Engine On' in "Every 10 Service Hours or Daily" section.

1. Pick up capacity load and drive over to a 15% grade.
2. Drive forward up the 15% grade. Halfway up the grade, stop the lift truck with its service brakes.
3. Engage the parking brake and slowly release the service brake.

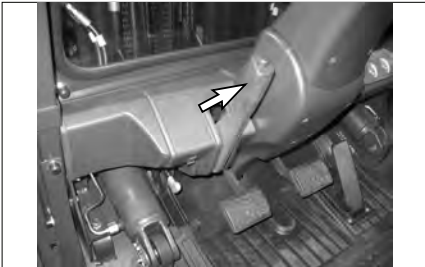

4. Engage the parking brake and shift the transmission to NEUTRAL. Slowly release the service brakes.
5. The parking brake adjustment is proper if it holds the lift truck on the grade. The parking brake needs adjusting if it does not hold the lift truck on the grade.
6. If the lift truck starts to move in reverse down the grade with the parking brake engaged, stop it with the service brakes, disengage the parking brake and reverse slowly down the grade controlling your speed with the service brakes.

WARNING

To prevent personal injury, the operator **MUST** be ready to use the service brake if the parking brake is not adjusted correctly and the lift truck starts to move.

Parking Brake Adjusting

1. Park the lift truck on a level surface, lowered the forks, shift the transmission to NEUTRAL and shut OFF the engine and block the wheels securely.
2. Chock the lift truck's tyres to prevent unintentional movement.

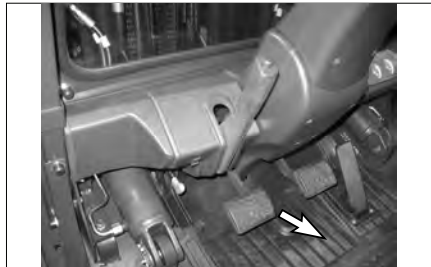

3. Remove the floor mat and floor plate.
4. Make sure the parking brake lever is released.

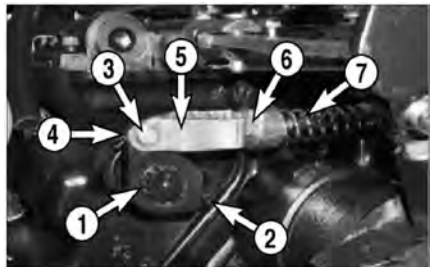

5. Make sure the brake lever (1) is held against stop pin (2). If the brake lever (1) is held against the stop pin (2), go to step 7. If the brake lever (1) is NOT held against the stop pin (2), go to step 6.

6. Remove the pin (3) and the cotter pin (4). Tighten the nut (6) to compress the spring (7) further and pull downward and turn the clevis (5) until the pin (3) fits into the brake lever when the lever (1) is held against the stop pin (2). Then install the pin (3) and the cotter pin (4) and return the nut (6) to the clevis (5).



7. Loosen lock nut (5). Tighten screw (6) to 6 to 7 N•m (50 to 60 lb•in). Loosen the screw (6) 1 1/6 turns and tighten the lock nut (5).

NOTICE

Turn the adjustment screw (6) clockwise to tighten. Turning the screw (6) too far counterclockwise could allow parts to fall into the bottom of the transmission.

The transmission would then require disassembly to remove the parts.

8. Reinstall the floor plate and floor mat.
9. Engage the parking brake, remove the tyre chocks and test the parking brake. Refer to 'Parking Brake Testing' in the preceding section.

To Adjust

Park the lift truck level, with the forks lowered, transmission in NEUTRAL, the engine stopped and the wheels securely blocked.

1. Release the parking brake.
2. Turn the adjustment knob, clockwise to tighten the brake.
3. Test the parking brake adjustment. Repeat the adjustment procedure, if necessary.

Every 250 Service Hours or Monthly

You must read and understand the warnings and instructions contained in the Safety section of this manual, before performing any operation or maintenance procedures.

Engine Oil & Filter – Change

LP Engine Crankcase

1. Operate lift truck a few minutes to warm oil. Park the lift truck with the forks lowered, parking brake applied, transmission in neutral and the engine stopped.
2. Raise rear of lift truck off ground and block securely.

⚠ WARNING

Hot oil and components can cause personal injury. Do not allow hot oil or components to contact skin.

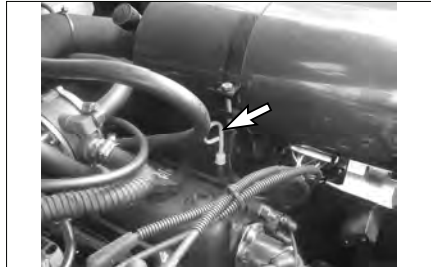

13. Stop the engine and measure the oil level. Maintain the oil level to the FULL mark on the dip stick.
14. Close hood and seat assembly.

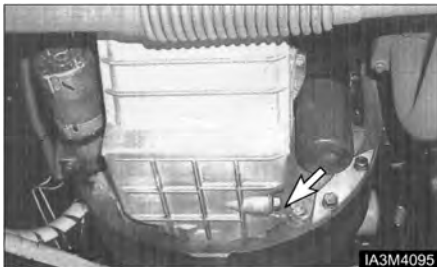

3. Remove the crankcase drain plug and allow oil to drain. Clean and install drain plug.
4. Raise the hood and seat assembly.
5. Remove and discard oil filter element.
6. Wipe sealing surface of oil filter element mounting base. Make sure the entire old gasket is removed.
7. Before installing a new filter element, apply a small amount of clean engine oil to the filter element gasket.
8. Install the new filter element. When the gasket contacts the base, tighten it 3/4 of a turn more. Do not overtighten.
9. Raise the lift truck, remove the blocking and lower the lift truck.
10. Fill the crankcase. See "Refill Capacities".
11. Start the engine and allow the oil to fill the filter and passages.
12. Check for oil leaks.

NOTICE

Engine Oil Service hours can be extended to 500 hours by using CROWN supplied specific oil. Please consult CROWN dealer about it.

Every 500 Service Hours or 3 Months

You must read and understand the warnings and instructions contained in the Safety section of this manual, before performing any operation or maintenance procedures.

Air Intake System - Check, Clean Servicing Filter Element

cleaner and engine. Check intake hose for cracks, damage and loose clamps. Tighten or replace parts as necessary to prevent leakage.

NOTICE

Never service precleaner with the engine running.

NOTICE

Do not allow dirty air to enter the intake hose when cleaning the inside of the air cleaner housing.



Typical Example

LP Engine Truck

Service the air cleaner when the red target in the service indicator stays locked in the visible position with the engine stopped.

1. To service the air cleaner, loosen the cover latches and remove the cover.

5. Check the air cleaner housing for loose latches.
6. Reset the air cleaner service indicator.
7. Install the air filter element.
8. Install the cover and tighten the cover latches.
9. Start the engine and observe the position of the indicator. If the indicator shows RED after the installation of the primary element, install another clean or a new element or, replace the secondary element. See topic, "Air Intake System - Change" in Every 1000 Service Hours or 6 months section.
10. Stop the engine and close the hood and seat assembly.



Typical Example

LP Engine Truck

2. Rotate the element slightly to separate it from its base and remove it from the air cleaner housing.
3. Clean and inspect the element or replace with a new element. See topic, "Cleaning Primary Filter Element".
4. Clean the inside of air cleaner housing and the cover. Inspect all connections between the air

Cleaning Primary Filter Elements

WARNING

Pressure air can cause personal injury.

When using pressure air for cleaning, wear a protective face shield, protective clothing and protective shoes.

The maximum air pressure must be below 205 kPa (30 psi) for cleaning purposes.

NOTICE

Do not clean the elements by bumping or tapping them.

Inspect filter elements after cleaning. Do not use a filter with damaged pleats, gaskets or seals.

When cleaning with pressure air, use 205 kPa (30 psi) maximum pressure to prevent filter element damage.

When cleaning with pressure water, use 280 kPa (40 psi) maximum pressure to prevent filter element damage.

Have spare elements on hand to use while cleaning used elements.

The primary element should be replaced after a year's service or after cleaning no more than 6 times.

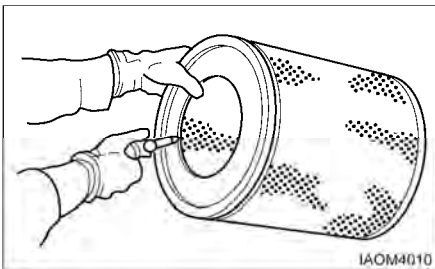

Direct air on the inside and outside of the element along the length of the pleats. Check the element for any tears, rips or damage.

Water-280 kPa (40 psi) Maximum

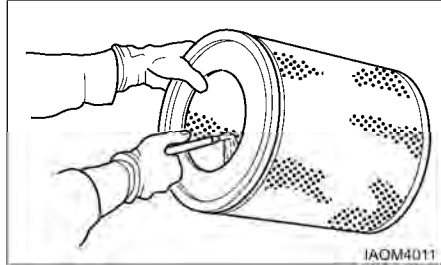

Direct water on the inside and outside of the element along the length of the pleats. Air dry it thoroughly and then examine it.

Detergent

1. Wash the element in warm water and mild household detergent.
2. Rinse the element with clean water. See instructions in preceding topic for cleaning with water.
3. Air dry it thoroughly, and then examine it.

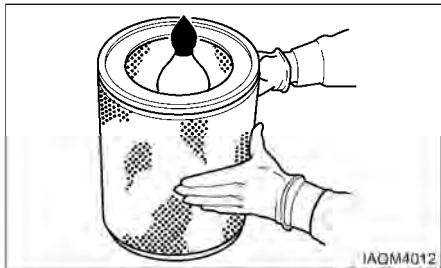

1. Insert a light inside the clean dry element and examine it. Discard the element if tears, rips or damage are found.
2. Wrap and store good elements in a clean, dry place.

Tilt Cylinders - Check, Adjust, Lubricate

Chassis Pivot Eyebolts

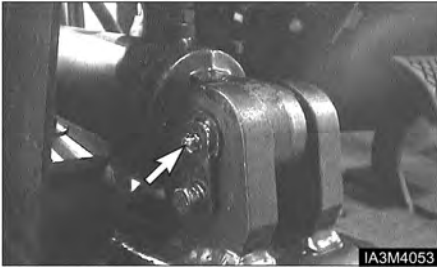

Typical Example

1. Lubricate two fittings for the pivot eyebolts, one on each tilt cylinder.
2. Check the pivot eye pins for loose retainer bolts and wear.

Mast Pivot Eyes



Typical Example

3. Lubricate two fittings for the mast pivot eyes, one on each side of the mast.
4. Check the pivot eye pins for loose retainer bolts and wear.

Cylinder Rod Extension

NOTE: The following description is for forward tilt. For cylinder rod back tilt, the collar should be stationary by the tilt eye. If it is not, the O-ring inside the collar may need to be replaced. To adjust back tilt, spacers must be added or removed.

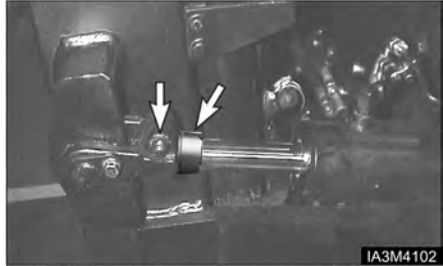

Typical Example

1. Check to make sure the tilt cylinders extend and retract evenly.
2. If one cylinder continues to move after the other cylinder has stopped in full forward or backward tilt, an adjustment must be made to one cylinder.



Typical Example

3. To adjust the cylinder rod extension, move the spacer to the rear and loosen the pinch bolt on the clevis.
4. Turn the cylinder rod in or out of the clevis to obtain the proper adjustment. Turning the rod into the clevis shortens the stroke. Turning the rod out of the clevis lengthens the stroke. When turning for extending rod, the overlapped length between clevis's thread and cylinder rod must be minimum 32 mm
5. Tighten the pinch bolts to a torque of $95 \pm 15 \text{ N}\cdot\text{m}$ ($70 \pm 10 \text{ lb}\cdot\text{ft}$). Check the cylinder rods again for even travel.

Mast Hinge Pins – Lubricate



Typical Example

1. Lower the forks and tilt the mast forward.
2. Lubricate the two fittings for the mast hinge pins,
3. one on each side of the mast.

Crosshead Rollers - Inspect

1. Operate the mast through a lift cycle. Watch the chains move over the crosshead rollers. Make sure the chain is tracking over the rollers properly.

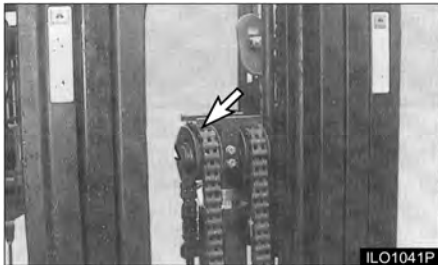

Typical Example

2. Check for damaged crosshead rollers, guards and retainer rings.

Carriage Side Rollers Thrust (If Equipped) - Lubricate

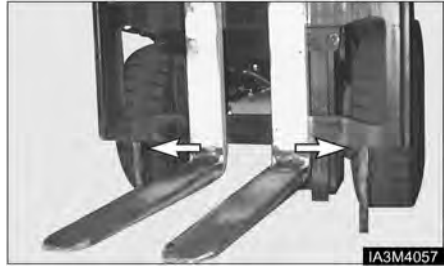

1. Raise the carriage high enough to gain access to the side thrust rollers on the back side of the carriage. Block the carriage in this position.

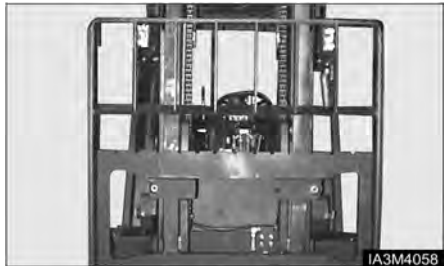

2. Lubricate 2 side thrust roller fittings, one on each side of the mast.
3. Raise the carriage, remove the blocking. Lower the carriage to the floor.

Carriage Sideshifter (If Equipped) – Lubricate

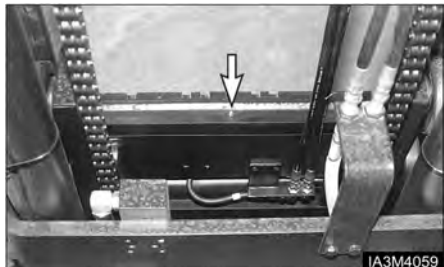

1. Lubricate 4 (6) fittings. The forks may have to be moved to gain access to all of the fittings.
2. Operate the sideshifter carriage through several complete cycles to distribute the grease the carriage to the floor.

Mast, Carriage, Lift Chains, & Attachments - Check, Lubricate

1. Operate the lift, tilt and attachment controls. Listen for unusual noises. These may indicate a need for repair.
2. Inspect for loose bolts and nuts on the carriage. Remove any debris from the carriage and mast.
3. Inspect the forks and attachments for free operation and damage. Have repairs made if necessary.

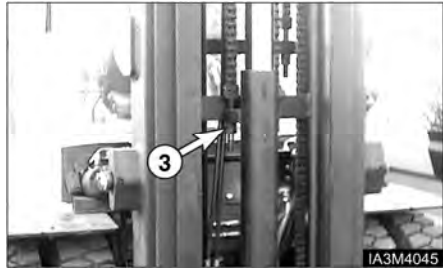

IA3M4045

7. In case of Full Free Lift Mast, Extend the primary cylinder to full length and then check the clearance and overlapped dimension between carriage stopper bolt or block (1) and Inner mast stopper block (2). Adjust the chain anchor bolt (3) so that clearance should be 14 ± 2 mm.
8. And adjust the overlapped dimension to be 10 ± 2 mm by moving or inserting washer.

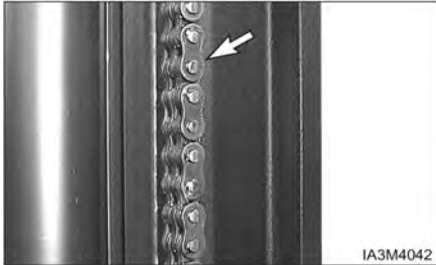

IA3M4042

4. Brush a film of oil on all links of the chain.
5. Raise and lower the carriage a few times to work lubricant into the chain links.

NOTICE

Lubricate chains more frequently than normal in applications where the lift truck is operating in a atmosphere which could cause corrosion of components or when lift truck must work in rapid lift cycles.

6. Inspect the chain anchors and individual links for wear, loose pins or cracked leaves.

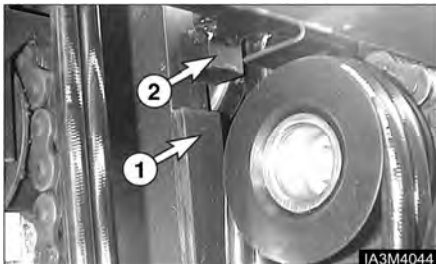

IA3M4044



GC35S-5, GC40S-5, GC45S-5



GC50C-5, GC55C-5

Lubricate 2 side roller fittings, one on each side of the carriage

Parking Brake - Test, Adjust

See topic, "Parking Brake - Test, Adjust" in "First 50-100 Service Hours."

Circulation Pump Belt (OCDB & LP Engine Only. If Equipped) - Check, Adjust

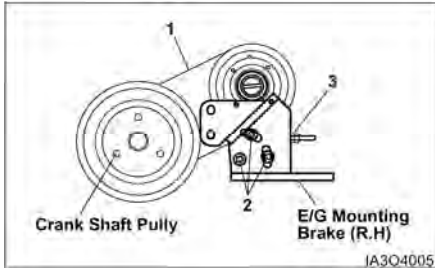

1. Check the condition and adjustment of the belt (1). Correct adjustment allows 10 mm (3/8 inch) deflection under 45 N of force.
2. To adjust the circulation pump belt, loosen the mounting bolts (2) and adjust the adjusting inner nut (3). Tighten the adjusting outer nut (4).
3. Lower the hood and seat assembly.

Drive Axle Oil & Strainer (OCDB Only) - Check, Clean, Change

WARNING

Hot oil and components can cause personal injury. Do not allow hot oil or components to contact skin.

Park the lift truck on a level surface. Apply the parking brake. Place the directional control level in NEUTRAL and stop the engine.



1. Remove drain plug. Allow the oil to drain into a suitable container. Clean the magnetic drain plug. Check O-ring seal and replace if necessary.
2. Install the drain plug.
3. Remove strainer assembly.



4. Washer the strainer assembly in clean, nonflammable solvent and dry it.
5. Install the strainer assembly and reconnect the hose and harness.

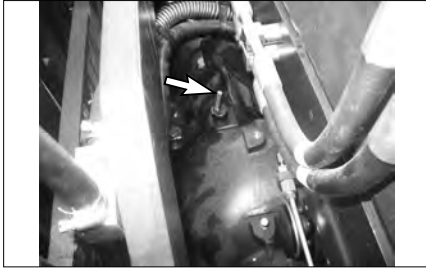

6. Remove the dip stick/filter cap. Fill the drive axle housing with oil. See "Lubricant Specification - Drive Axle Oil" and "Refill Capacity".
7. Start the lift truck. With the engine at low idle, place the directional control lever to the NEUTRAL.
8. Maintain the oil level between lower mark and upper mark on the dip stick/filter cap.
9. Install the dip stick/filter cap.

Horn & Lights (If Equipped) – Check

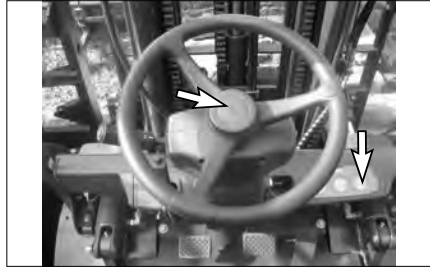

1. Press horn button, to determine if horn is operational.
2. Check and replace all defective gauges.
3. Check all lights such as warning, directional, backup, driving and flood lights for correct operation. Replace all burned out bulbs. Have repairs made if needed.

Inspect Vacuum Lines and Fittings (LP Engine only)

1. Visually inspect vacuum lines and fittings for physical damage such as brittleness, cracks and kinks. Repair/replace as required.
2. Solvent or oil damage may cause vacuum lines to become soft resulting in a collapsed line while the engine is running.
3. If abnormally soft lines are detected, replace as necessary.

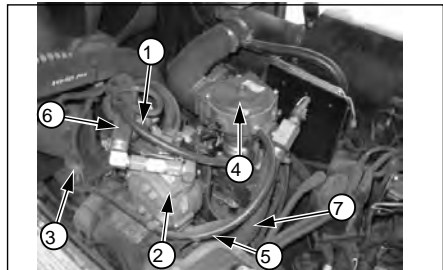

- (1) LP fuel lock-off, (2) LP regulator/convertor,
- (3) Fuel Trim Valve,
- (4) LP mixer, (5) Vacuum lines,
- (6) Coolant lines, (7) LP fuel line

Fuel Trim Valve(FTV) Inspection (PSI Engine only)

1. Visually inspect the Fuel trim valve(3) for abrasions or cracking. Replace as necessary.
2. To ensure the valve is not leaking a blow-by test can be performed.
3. With the engine off, disconnect the electrical connector to the FTV.
4. Disconnect the vacuum line from the FTV to the pressure regulator/converter, at the converter's tee connection.
5. Lightly blow through the vacuum line connected to the FTV. Air should not pass through the FTV when de-energized. If air leaks past the FTV when de-energized, replace the FTV.

Inspect Electrical System (LP Engine only)

1. Check for loose, dirty or damaged connectors and wires on the harness including: Fuel lock-off, TMAP sensor, O2 sensor, Electronic throttle, Control Relays, Fuel Trim Valve, Foot Pedal, and Distributor sensor.
2. Repair and/or replace as necessary.

Overhead Guard – Inspect



1. Check tightness of overhead guard mounting bolts at 95 N-m (70 lb-ft).
2. Check overhead guard for bent or cracked sections. Have repairs made if needed.

Steer Suspension - Inspect



1. Inspect the suspension mounting bolts. Tighten suspension mounting bolts, if necessary, to 240±30 N-m (180±20 lb-ft).



2. Look for leaks at the power steering hose connections.
3. Remove any trash buildup on the suspension or the steer axle.

Steering Mechanism - Check, Lubricate



1. Lubricate the steer axle king pins, total of four fittings. Two on the right side and two on the left side.
2. Lubricate the steering link bearings, total of four fittings. Two on the right side and two on the left side.
3. Check for any worn or loose components of the steering mechanism. Remove any debris or trash as required.

Wheel Bolts and Nuts – Inspect Inspect Tightness

NOTICE

Do not lubricate ball seas of wheels or ball faces of wheel nuts.

Be sure mounting faces of hub, wheel nuts and flat mounting surfaces are clean.

Tighten wheel nuts again after 24 hours of operation.

NOTE: Always tighten wheel lug nuts in a sequence opposite (180°) each other.

If equipped with dual wheels, follow the same nut tightening sequence for both wheels.

Drive Wheels



Install drive wheel. Put two nuts opposite (180°) each other. Tighten both.

Install the remaining nuts. Tighten all nuts in a sequence opposite (180°) each other. Tighten to $600 \pm 90 \text{ N}\cdot\text{m}$ ($440 \pm 60 \text{ lb}\cdot\text{ft}$).

Every 1000 Service Hours or 6 Months

You must read and understand the warnings and instructions contained in the Safety section of this manual, before performing any operation or maintenance procedures.

Air Intake System - Change

Changing Primary Element

See topic, "Air Intake System - Check, Clean" in "Every 500 Service Hours or Monthly".

Changing Secondary Element

Replace the secondary element after the primary element has been cleaned three times or yearly.

1. Remove the primary air cleaner element. See topic "Servicing Filter Element". Clean the inside of the air cleaner housing and cover.

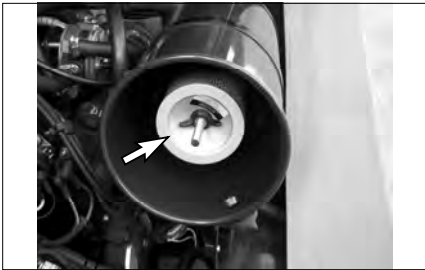

2. Remove the secondary element. Inspect the gasket between the air cleaner housing and the engine inlet. Replace the gasket if it is damaged.

NOTICE

Always replace the secondary element. Do not attempt to reuse it by cleaning.

3. Install a new secondary element. Install a new or cleaned primary element. Install the cover. Tighten the latches.
4. Start the engine and observe the air cleaner service indicator. If the indicator shows RED after installing a new secondary element and a cleaned primary (outer) element, replace the cleaned primary filter with a new element.
5. Stop the engine. Close the hood and seat assembly.

Inspect Coolant Hoses (LP Engines Only)

1. Visually inspect coolant hoses and clamps. Remember to check the two coolant lines that connect to the pressure regulator/converter.
2. Replace any hose that shows signs of swelling, cracking, abrasion or deterioration.

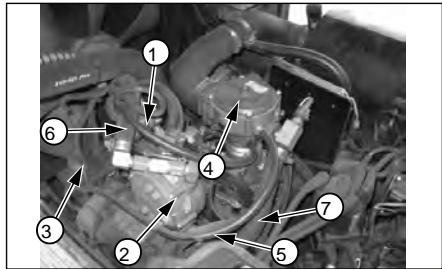

- (1) LP fuel lock-off, (2) LP regulator/converter
 (3) Fuel Trim Valve (FTV), (4) LP mixer
 (5) Vacuum lines, (6) Coolant lines, (7) LP fuel line

LP Regulator/Converter Inspection (LP Engine Only)

1. Visually inspect the pressure regulator/converter housing(2) for coolant leaks and detect the fuel pipe joints, LP mixer and regulator/converter for LP fuel leaks.

To detect the LP fuel leaks, smear detected parts with suds, visually inspect whether there are bubbles after the engine start.

- NOTE:** For pressure testing and internal inspection of the pressure regulator/converter, contact to the CROWN service.

Fuel Lines & Fittings - Check

Visually inspect fuel lines and fittings for physical damage. Replace as required.

Inspect Mixer Assembly (LP Engine Only)

Refer to the LP mixer section of the engine service manual for procedures.

Inspect Throttle Assembly (LP Engine Only)

1. Visually inspect the throttle assembly motor housing for coking, cracks and missing cover-retaining clips. Repair and/or replace as necessary.

NOTE: Refer to the LP mixer and throttle section of the service manual for procedures on removing the mixer and inspecting the throttle plate.

Hydraulic Return Filter - Change

⚠ WARNING

Hot oil and components can cause personal injury. Do not allow hot oil or components to contact skin.

Park the lift truck level with the forks lowered, parking brake engaged, transmission in NEUTRAL and the engine stopped.



1. Raise the hood and seat assembly. Loosen the bolts of the hydraulic tank cover, and remove the hydraulic tank cover with filter assembly.

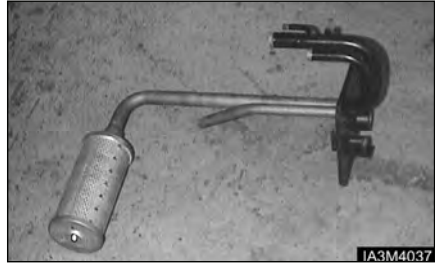

2. Remove filter assembly from the hydraulic tank cover.
3. Install new filter assembly in the hydraulic tank cover.
4. Inspect cover gasket for damage, replace it if necessary.
5. Clean and Install the cover and tighten retaining bolts.
6. Lower the hood and seat assembly.

Air Breather - Change

Park the lift trucks level, with the forks lowered, parking brake engaged, transmission in NEUTRAL and the engine stopped.

1. Raise the hood and seat assembly.
2. Remove and discard the air breather.



3. Install a new air breather.
4. Lower the hood and seat assembly.

Transmission Oil, Oil Filter & Strainer - Clean, Change

See topic, "Transmission Oil, Oil Filter & Strainer - Clean, Change" in "First 50 - 100 Service Hours or a Week".

Lift Chains - Test, Check, Adjust

Lift Chain Wear Test

Inspect the part of the chain that is normally operated over the cross head roller. When the chain bends over the roller, the movement of the parts against each other causes wears.

Inspect to be sure that chain link pins do not extend outside of the link hole. If any single link pin is extended beyond its connecting corresponding link, it should be suspected of being broken inside of its link hole. Lift chains are required to check for wear about every 1,000 service hours or 6 months.

Chain wear test is a measurement of wear of the chain links and pins. Take the following steps to check chain wear.

1. Lift the mast and carriage enough for getting tension on lift chains.



Typical example

2. Measure precisely ten links of chain distance at the centre of pins in millimeter.
3. Calculate chain wear rate*.
4. If the chain wear rate is 2% or more, replace the lift chain.

*Chain wear rate (%)

$$= \left(\frac{\text{Actual measurement} - \text{Pitch}^{**} \times 10}{\text{Pitch}^{**} \times 10} \right) \times 100$$

Pitch** X 10

**Chain Pitch for GC35/40/45S-5, GC50/55C-5

= 25.40 mm(1.0 in)

Check for Equal Tension



Typical example

Lift the carriage and the mast high enough for getting tension on lift chains. Check the chains, and make sure the tension is the same. Lift chains are required to check for equal tension about every 1,000 service hours or 6 months.

WARNING

Personal injury can be caused by sudden movement of the mast and carriage.

Keep hands and feet clear of any parts that can move.

Lift Chain Adjustment



Typical example for carriage equal tension

If the tension is not the same on both chains, take the procedure as follows.

NOTE: If carriage height is not correct, make adjustments by following procedures.

Carriage Chain Adjustment

Make sure that carriage height is correct. If correct, adjust the chain for equal tension. If not, adjust the chain for correct carriage height by adjusting anchor nuts(1),(2).

NOTE: See the previous section, "Carriage Roller Extrusion" in "When Required" for proper height of carriage.

1. Fully lower the carriage and tilt mast forward or lift the carriage and put blocks under the carriage to release the tension from the lift chains.
2. Loosen nut(1) and adjust nut(2) to get proper distance from bottom of inner upright to the bottom of carriage bearing.

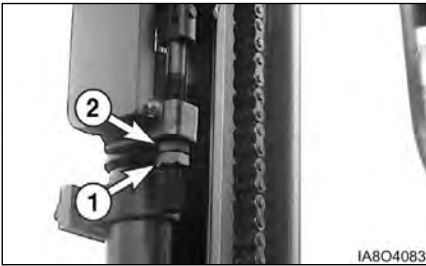

Typical example for carriage chain of STD mast

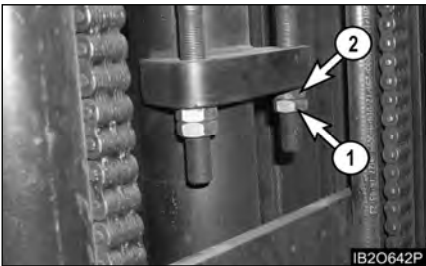

Typical example for carriage chain of FF,FFT mast

3. Make adjustment anchor nut(1),(2) for equal chain tension.
4. Set the mast vertical and raise the carriage and check equal chain tension. If not equal, repeat the same procedure as step 1 through step 3.
5. Put LOCTITE No. 242 Tread lock on the threads of the anchor nuts(1),(2) after the adjustment is completed.

Mast Chain Adjustment - FF, FFT Mast

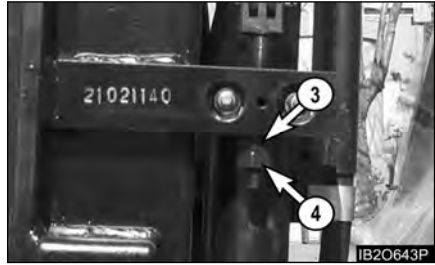

Typical example for FF mast

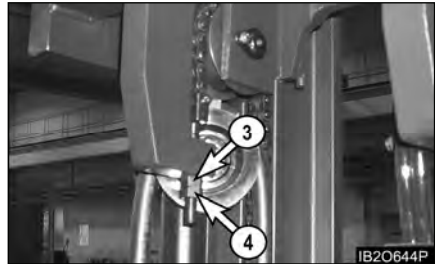

Typical example for FFT mast

Make sure that mast height is correct. If correct, adjust chain for equal tension. If not, adjust mast chain for correct mast height by adjusting anchor nuts (3), (4).

NOTE: See the previous section, "Carriage Roller Extrusion" in "When Required" for proper inner mast height.

1. Lift the inner mast and put blocks under the inner mast to release the tension from the lift chains.
2. Loosen nut(3) and adjust nut(4) to make inner mast rail flush with outer mast rail bottom.
3. Make adjustment anchor nuts(3),(4) for equal chain tension.
4. Raise the inner mast and check equal chain tension. If not equal, repeat the same procedure as step 1 through step 3.
5. Put LOCTITE No. 242 tread lock on the threads of the anchor nuts(3),(4) after the adjustment is completed.

Universal Joint - Inspect

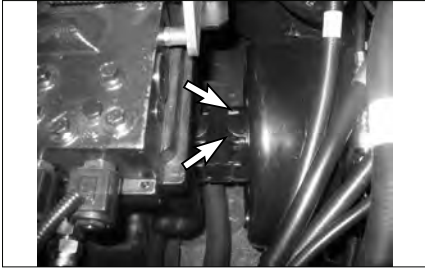

1. Inspect for loose retaining bolts. Check for worn or damaged bearings.

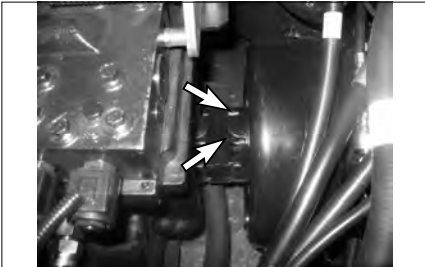

2. Have worn or damaged bearings replaced. Tighten the bolts if necessary.

Every 1500 Service Hours or 9 Months

You must read and understand the warnings and instructions contained in the Safety section of this manual, before performing any operation or maintenance procedures.

Drive Axle Oil (Shoe Brake Only) - Check, Clean, Change

See topic, "Drive Axle Oil - Check, Clean, Change" in "First 50-100 Service Hours or a Week".

Inspect Ignition System (LP Engine Only)

1. Disconnect Battery Cables.
2. Remove and inspect the spark plugs. Replace as required.
3. Test secondary cables with an Ohmmeter. If maximum resistance is higher than 25 kOhms, repair and/or replace.
4. Remove distributor cap and perform visual inspection. Replace cap and rotor if corrosion is found on the contacts.
5. Inspect the ignition coil for cracks and heat deterioration. Visually inspect the coil heat sink fins. If any fins are broken replace as required.



Replace Spark Plugs (LP Engine Only)

1. Disconnect Battery Cables.
2. Using a gentle twisting motion remove the high voltage cables from the spark plugs. Replace any damaged cables.
3. Remove the spark plugs.
4. Gap the new spark plugs to the proper specifications.
PSI Engine : 0.9 mm (0.035 inch)
5. Apply anti-seize compound to the spark plug threads and install.
PSI Engine : 30 N·m (22 lb·ft)

WARNING

Do not overtighten the spark plugs.

6. Re-install the high voltage cables.

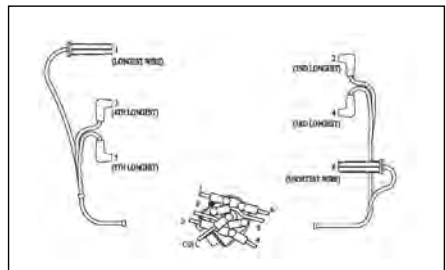

Replace LP Fuel Filter Element (LP Engine Only)

Park the lift truck in an authorised refueling area with the forks lowered, parking brake applied and the transmission in Neutral.

1. Close the fuel shutoff valve on the LP-Fuel tank. Run the engine until the fuel in the system runs out and the engine stops.
2. Turn off the ignition switch.
3. Scribe a line across the filter housing covers, which will be used for alignment purposes when re-installing the filter cover.

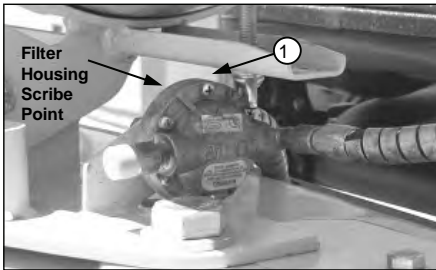

4. Remove the cover retaining screws (1)

Fuel Filter (LP Engine Only)

Disassembly

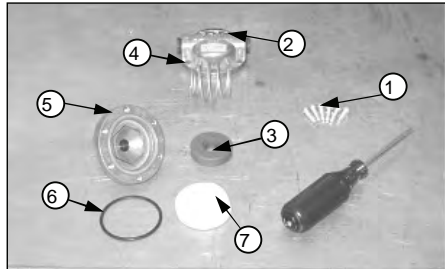

1. Remove top cover (2), magnet (3), spring (4), and filter element (7) from bottom cover (5).
2. Replace the filter element (7).
3. Check bottom cover O-ring seal (6) for damage. Replace if necessary.
4. Re-assemble the filter assembly aligning the scribe lines on the top and bottom covers.
5. Install the cover retaining screws, tightening the screws in an opposite sequence across the cover.
6. Open the fuel valve by slowly turning the valve counterclockwise.
7. Crank the engine several revolutions to open the fuel lock-off. **DO NOT START THE ENGINE.** Turn the ignition key switch to the off position.
8. Check the filter housing, fuel lines and fittings for leaks. Repair as necessary.

Testing Fuel Lock-off Operation (LP Engine Only)

1. Start engine.
2. Locate the electrical connector for the fuel lock
3. Disconnect the electrical connector.
4. The engine should run out of fuel and stop within a short period of time.
5. Turn the ignition key switch off and re-connect the fuel lock-off connector.

NOTE: The length of time the engine runs on trapped fuel vapor increases with any increase in distance between the fuel lock-off and the pressure regulator/converter.

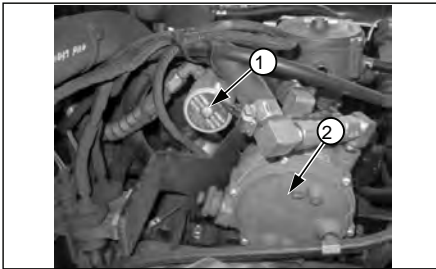

(1) LP fuel lock-off, (2) LP regulator/converter

Every 2000 Service Hours or Yearly

You must read and understand the warnings and instructions contained in the Safety section of this manual, before performing any operation or maintenance procedures.

Steer Wheel Bearings - Reassemble

Park the lift truck level with the forks lowered, parking brake engaged, transmission in NEUTRAL and the engine stopped.



Typical Example

1. Lift the steer wheels off the ground. Place stands or blocking under the frame and steer axle to support the lift truck.
2. Remove the hub cap.



Typical Example

3. Remove the cotter pin.

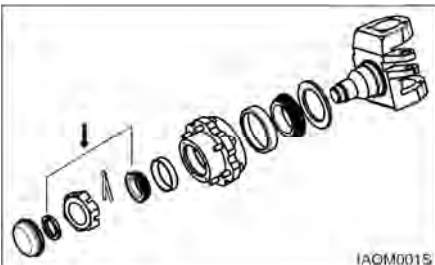

4. Remove the castle nut and washer.
5. Remove the wheel assembly. Examine the seal for damage and wear. Replace the seal if necessary.
6. Remove the inner bearing. Clean and lubricate the steering knuckle. Reassemble both the inner and outer bearing cones.
7. Install the inner bearing. Lubricate the seal and install the wheel assembly on the knuckle.
8. Install the outer wheel bearing and the outer washer. Install a new lock washer and fit the locknut.



Typical Example

9. Tighten the locknut to $135 \text{ N}\cdot\text{m}$ ($100 \text{ lb}\cdot\text{ft}$), while turning wheel hub to seat the bearing.
10. Loosen the locknut. Retorque it to $50 \pm 5 \text{ N}\cdot\text{m}$ ($37 \pm 4 \text{ lb}\cdot\text{ft}$). Bend the lockwasher tang to secure locknut.
11. Install the hub cap.
12. Raise the lift truck and remove the blocking. Lower the lift truck to the ground.

Cooling System - Clean, Change

⚠ WARNING

At operating temperature, the engine coolant is hot and under pressure.

Steam can cause personal injury.

Check the coolant level only after the engine has been stopped and the filter cap is cool enough to touch with your bare hand.

Remove the filter cap slowly to relieve pressure.

Cooling system conditioner contains alkali. Avoid contact with the skin and eyes to prevent personal injury.

Use all cleaning solutions with care.

The lift truck must be level, the forks lowered, the parking brake engaged, the transmission in NEUTRAL and the engine stopped and cool.



1. Turn the radiator cap slowly to relieve the pressure, then remove the cap.
2. Remove the block drain plug.

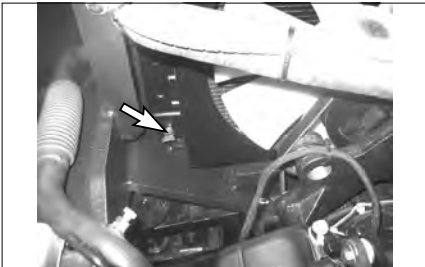

Typical Example

3. Open radiator drain valve. Allow the coolant to drain. Drain the recovery bottle.

4. Close radiator drain valve and install block drain plug. Fill the cooling system with 1 kg (2 lb) sodium bisulphate per 40 liters (10 gallons) of water. Most commercial cooling system cleaners can be used.
5. Start and run the engine for 30 minutes.
6. Stop the engine and drain the cleaning solution.
7. Flush the system with clean water, until draining water is clear.
8. Close the drain valve and install the block drain plug. Fill the system with neutralizing solution, 250g (1/2 lb) sodium carbonate per 40 liters (10 gallons) of water.
9. Start and run the engine for 10 minutes.
10. Stop the engine and drain the neutralizing solution.
11. Flush the system with clean water until draining water is clear.
12. Close the drain valve and install the block drain plug. Add coolant to the top of the filter neck.
13. Start and run the engine to stabilise the coolant level. See "Every 10 Service hours or Daily", "Coolant Level-Check", in this manual.

Fork – Inspect

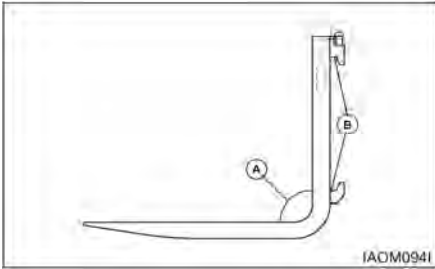

Forks should be inspected, at a minimum, every 12 months. If the truck is being used in a multi-shift or heavy duty operation, they should be checked every six months.

1. Inspect the forks carefully for cracks. Special attention should be given to the heel section (A), all weld areas and mounting brackets (B). Inspect the top and bottom hooks on forks used on hook type carriages and tubes on shaft mounted forks.

Forks with cracks should be removed from service. "Wet Test" magnetic particle inspection is generally preferred due to its sensitivity and the ease of interpreting the results. Portable equipment is usually recommended so it can be moved to the lift truck.

Inspectors should be trained and qualified in accordance with The American Society for Non Destructive Testing, Level II Qualifications.

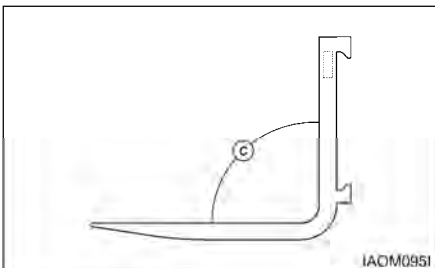

2. Check the angle between the upper face of the blade and the front face of the shank. The fork should be withdrawn from service if angle (C) exceeds 93 degrees or deviates by more than 3 degrees from an original angle other than 90 degrees, as may be found in some special application forks.

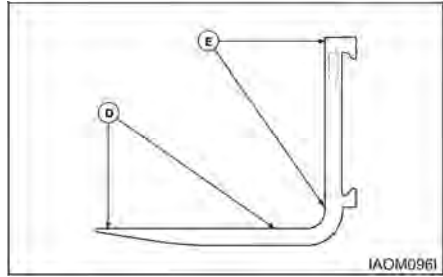

3. Check the straightness of the upper face of blade (D) and the front face of shank (E) with a straight edge.

The fork should be withdrawn from service if the deviation from straightness exceeds 0.5 percent of the length of the blade and/or the height of the shank respectively 5 mm/1000 mm (0.18"/36").

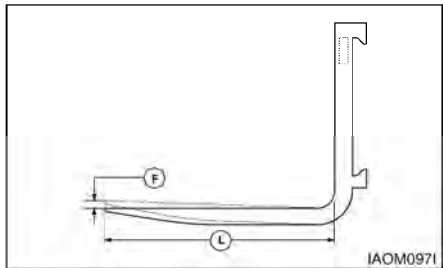

4. Check the difference in height of one fork tip to the other when mounted on the fork carrier. A difference in fork tip height can result in uneven support of the load and cause problems with entering loads.

The maximum recommended difference in fork tip elevation (F) is 6.5 mm (0.25") for pallet forks and 3 mm (0.125") for fully tapered forks. The maximum allowable difference in fork tip elevation between the two or more forks is 3 percent of blade length (L).

Replace one or both forks when the difference in fork tip height exceeds the maximum allowable difference. Contact your local CROWN Lift Truck Dealer for further information.

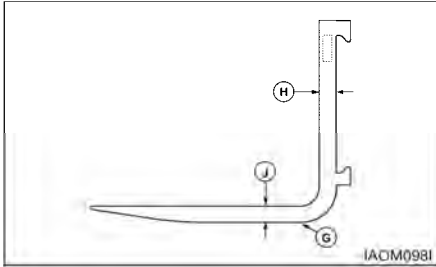

5. Check the fork blade (J) and shank (H) for wear with special attention to the heel (G). The fork should be withdrawn from service if the thickness is reduced to 90 percent or less of the original thickness.

Fork blade length may also be reduced by wear, especially on tapered forks and platens. Remove the forks from service when the blade length is no longer adequate for the intended loads.

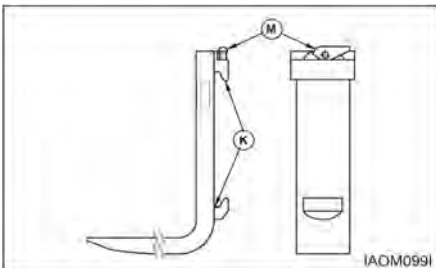

6. Check the fork mountings (K) for wear, crushing and other local deformation, which can cause excessive side to side wobble of the forks. Excessive clearance on hook type forks may allow them to fall from the carrier. Forks which show visible signs of such damage should be removed from service.
7. Check the positioning lock and other fork retention devices to make sure they are in place and working.

Hook type forks use a spring loaded pin (M), located in the top hook, to engage notches in the top carriage bar to hold the fork in place.

When adjusting the fork spacing, the forks are prevented from sliding off the end of the carriage by stop blocks. These stop blocks are at both ends of the carriage and in the path of the bottom fork hook. The load backrest extension may be used in place of the stop blocks in some cases.

Shaft mounted forks may use set collars or spacers on the shaft to either side of the fork. They may also use U bolts, pins, or similar devices which engage the fork through the top structure of the carriage.

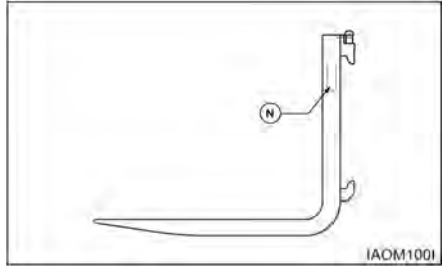

8. Check fork markings (N) for legibility. Renew markings as required to retain legibility.
9.
 - a. Lift the mast and operate the tilt control lever, until the top surface of the forks is parallel with the floor. Place two straight bars that are the same width as the carriage, across the forks as shown.
 - b. Measure the distance from the bottom of each end of the two bars to the floor. The forks must be parallel within 3 mm (.12 in) for Full Tapered and Polished (FTP) forks, all other forks 6.4 mm (.25 in), for their complete length.
 - c. Put one fork, one third from the tip, under a fixture that will not move. Then operate the tilt control with caution until the rear of the truck lifts just off the floor. Follow the same procedure with the second fork. Repeat Step a.

Every 2500 Service Hours or 15 Months

You must read and understand the warnings and instructions contained in the Safety section of this manual, before performing any operation or maintenance procedures.

Hydraulic Oil - Check, Clean, Change

WARNING

Hot oil and components can cause personal injury. Do not allow hot oil or components to contact skin.

Park the lift truck level with the forks lowered, mast tilted back (all cylinders retracted), parking brake engaged, transmission in NEUTRAL and the engine stopped.

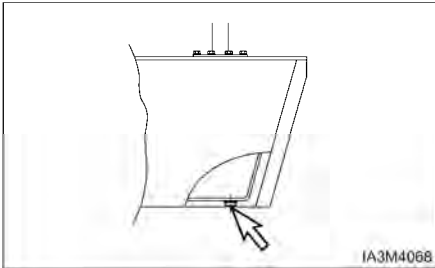

1. Remove the hydraulic tank drain plug. Allow the oil to drain. Clean and install the plug.
2. Raise the hood and seat assembly.
3. Remove dipstick/filter cap. Fill the hydraulic tank. See "Refill Capacities." Install the breather/dipstick.
4. Lower the hood and seat assembly.
5. Start the engine and operate the hydraulic controls, and the steering system, through a few cycles to fill the lines. Look for oil leaks.



6. Stop the engine and check the oil level. With all cylinders retracted, maintain the oil level to the

FULL mark on the dipstick.

Inspect Battery System

1. Clean battery outer surfaces with a mixture of baking soda and water.
2. Inspect battery outer surfaces for damage and replace as necessary.
3. Remove battery cable and clean, repair and/or replace as necessary.



Checking the TMAP Sensor (LP Engine Only)

1. Verify that the TMAP sensor (2) is mounted tightly into the manifold adapter (3), with no leakage.
2. If the TMAP is found to be loose, remove the TMAP retaining screw and the TMAP sensor from the manifold adapter.
3. Visually inspect the TMAP O-ring seal for damage. Replace as necessary.
4. Apply a thin coat of an approved silicon lubricant to the TMAP o-ring seal.
5. Re-install the TMAP sensor into the the manifold adapter and securely tighten the retaining screw.

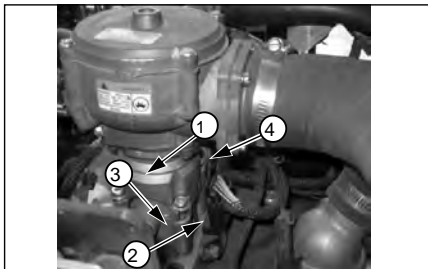

- (1) Adapter-Throttle body, (2) TMAP sensor,
(3) Adapter-Manifold, (4) Throttle body

Inspect for Intake Leaks (LP Engine Only)

1. Visually inspect the intake manifold, throttle assembly (4), and manifold adapters (3), for looseness and leaks. Repair as necessary.

Replace PCV Valve and breather element - Change (LP Engine Only)

2. Loosen the hose clamps and remove the PCV valve.
3. Assemble new PCV valve and hose.
4. Tighten the hose clamps

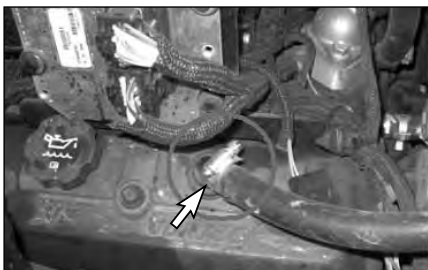

Replace Oxygen Sensor (PSI Engine)



Exhaust Tube

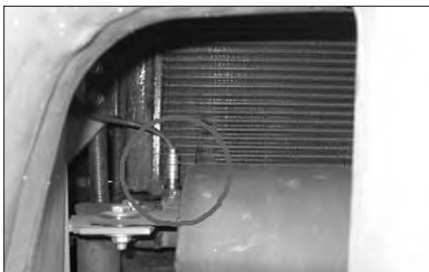

Muffler Ass'y

When indicated by MIL, replace oxygen sensors on the exhaust tube and muffler assembly.

1. Stop engine and wait until the exhaust pipe and exhaust pipe is cooled.
2. Disconnect the electrical connector of oxygen sensor.
3. Remove oxygen sensor.
4. Assemble new oxygen sensor Tightening torque : 45 N·m (32.5 lb·ft)
5. Connect the electrical connector of oxygen sensor.

Environment Protection

When servicing this lift truck, use an authorised servicing area and an approved container to collect coolant, oil, fuel, grease, electrolyte and any other potential environmental pollutant before any lines, fittings or related items are disconnected or removed. After servicing, dispose of those materials in an authorised place and container. When cleaning the lift truck, be sure to use an authorised area.

Index

#

12 Months Inspection 105

A

Accelerator Pedal 47
 Adjustments 87
 Air-205 kPa (30 psi) Maximum Pressure 135
 Air Breather - Change 144
 Air Cleaner Indicator - Check 123
 Air Intake System - Change 143
 Air Intake System - Check, Clean 134
 Antifreeze 109
 Attachment Abbreviations (Includes Special Forks) 40
 Auto Shift Controller ASC - 206 (Standard) 87
 Avoiding Lift Truck Tipovers 21

B

Batteries 15
 Battery Terminal - Clean, Inspect 121
 Before Operating the Lift Truck 12
 Before Starting the Engine 51
 Before Starting the Lift Truck 11
 Before Storage 96
 Bent or Twisted Forks 103
 Brake Fluid 112
 Brake Oil Level – Check 126
 Brake Pedal Adjustment Warning 8
 Bulbs 120
 Burn Prevention 15

C

Capacity Chart (Not used in Australia) 34,36
 Capacity Chart (with Side Shifter) (Not used in Australia) 35,37
 Carriage Chain Adjustment 146
 Carriage Roller Extrusion - Check, Adjust 121
 Carriage Side Rollers - Lubricate 138
 Carriage Side Rollers Thrust (If Equipped) - Lubricate 137
 Carriage Sideshifter (If Equipped) – Lubricate 137
 Causes of Fork Failure 103
 Centre of Gravity (CG) 21
 Changing LP Tanks 49
 Changing Primary Element 143
 Changing Secondary Element 143

Chassis Pivot Eyebolts 136
 Check Coolant Level 122
 Check for Equal Tension 145
 Checking Element 135
 Checking Service Indicator 123
 Checking the TMAP Sensor (LP Engine Only) 156
 Circuit Breaker 44,120
 Circulation Pump Belt (OCDB & LP Engine Only. If Equipped) - Check, Adjust 139
 Cleaning Primary Filter Elements 135
 Coolant Information 108
 Coolant Level - Check, Clean 122
 Coolant Water 109
 Coolant 15
 Cooling System - Clean, Change 152
 Cooling System Specifications 108
 Crosshead Rollers - Inspect 137
 Crushing or Cutting Prevention 14
 Cylinder Rod Extension 136

D

Daily Inspection 104
 Declaration of Conformity 30
 Detergent 135
 Direction Control Lever 46
 Disassembly 149
 Drive Axle Oil - Check, Clean, Change 130
 Drive Axle Oil & Strainer (OCDB Only) - Check, Clean, Change 139
 Drive Axle Oil (Shoe Brake Only) - Check, Clean, Change 148
 Drive Axle Oil Level – Check 126
 Drive Axle Oil 112
 Drive Wheels 142

E

Electrical Disconnect Switch (If Equipped) 44
 Electronic Controlled Spark-Ignition Engines 55
 Engine Compartment 43
 Engine Oil & Filter – Change 133
 Engine Oil (DEO and EO) 111
 Engine Oil Level - Check 122
 Environment Management 3
 Environment Protection 102,157
 Every 10 Service Hours or Daily 122
 Every 1000 Service Hours or 6 Months 143
 Every 1500 Service Hours or 9 Months 148
 Every 2000 Service Hours or Yearly 151
 Every 250 Service Hours or Monthly 133
 Every 2500 Service Hours or 15 Months 155
 Every 500 Service Hours or 3 Months 134

F

Falling Objects Protective Structure(FOPS).....	14
Fatigue	103
Fire or Explosion Prevention.....	15
First 50 - 100 Service Hours or a Week.....	128
First Installation.....	104
Fluid Penetration	14
Foreword	2
Fork – Inspect	153
Fork Inspection	104
Fuel Filter (LP Engine Only)	149
Fuel Lines & Fittings - Check.....	144
Fuel Specifications	110
Fuel Trim Valve(FTV) Inspection (PSI Engine only)	141
Fuse & Relay (LP Engine Only)	120
Fuses.....	119
Fuses, Bulbs & Circuit Breaker - Change, Reset	119

G

General Fuel Information	110
General Hazard Information	10

H

Hook - on type Fork.....	95
Horn & Lights (If Equipped) – Check	140
How to Fix Forklift to a Carrier.....	98
How to Survive in a Tipover (If Operator Restraint System Equipped)	29
Hydraulic Jack & Jack Stand Capacity	100
Hydraulic Oil - Check, Clean, Change	155
Hydraulic Oil (HYDO).....	111
Hydraulic Oil Level – Check.....	126
Hydraulic Return Filter - Change.....	144

I

Identification, Lift Capacity and Attachment Plate	39
If Optional Suspension Seat (weight adjusting type) Equipped	18
Important Safety Information	4
Improper Modification or Repair	103
Inching into Loads	90
Inching.....	85
Index.....	158
Inspect Acceleration Pedal Operation(PSI Engine)	123
Inspect Battery System.....	155
Inspect Coolant Hoses (LP Engines Only)	143

Inspect Electrical System (LP Engine only)	141
Inspect Engine for Exhaust Leaks	123
Inspect Engine for Fluid Leaks	122
Inspect for Intake Leaks (LP Engine Only).....	156
Inspect Ignition System (LP Engine Only).....	148
Inspect Mixer Assembly (LP Engine Only).....	144
Inspect Throttle Assembly (LP Engine Only)	144
Inspect Tightness	142
Inspect Vacuum Lines and Fittings (LP Engine only)	140
Inspection, Maintenance and Repair of Lift Truck Forks	102
Instrument Panel	41

J

Jacking Information	100
Jacking Procedure	101

L

Lift Chain Adjustment.....	145
Lift Chain Wear Test	145
Lift Chains - Test, Check, Adjust.....	145
Lift Control	47
Lift Fork Adjustment	95
Lift Truck Capacity Rating	39
Lift Truck Controls	46
Lift Truck Operation	84
Lift Truck Parking	13
Lift Truck Shipping	97
Lift Truck Stability Base	22
Lift Truck Stability	21
Lifting a Forklift using a Crane	98
Lifting Drums or Round Objects.....	93
Lifting the Load.....	90
Literature Information.....	2
Load Backrest Must Be In Place Warning.....	7
Loading or Unloading Trucks/Trailers.....	13
Long Time Storage.....	96
LP Engine Crankcase	133
LP Engine	53
LP Regulator/Converter Inspection (LP Engine Only)	143
LP Specifications.....	110
Lubricant Information	111
Lubricant Specifications.....	111
Lubricant Viscosities and Refill Capacities.....	113
Lubricant Viscosities	113
Lubricating Grease (MPGM)	112

M

Machine Lifting and Tiedown Information.....	97
--	----

Index Section

Maintenance and Repair	105
Maintenance Information	14
Maintenance Intervals	114
Maintenance	3
Make proper antifreeze additions	109
Mast Abbreviations	40
Mast Chain Adjustment - FF, FFT Mast	146
Mast Channels – Lubricate	125
Mast Hinge Pins – Lubricate	137
Mast Pivot Eyes	136
Mast, Carriage, Lift Chains, & Attachments - Check, Lubricate	138
Metric Hardware	106
Metric ISO ² Thread	107
Mono-Ped Control System (Option)	86
Mounting and Dismounting	11
Moving Fan Warning	9

N

No Riders Warning	9
No Standing On Forks Warning, No Standing Under Forks Warning	7
Noise and Vibration	33
Noise	33

O

Oil Cooled Disc Brake (OCDB) Type	127,130
Oil Cooled Disc Brake (OCDB)	112
Oil Cooled Disc Brake Only	112
Oils	15
Operating in hot weather	93
Operating Techniques	90
Operating the Lift Truck	12
Operation Information	11
Operation	2,88
Operator's Warning and Identification Plate	39
Operator Restraint System (If Equipped)	17
Operator's Station and Monitoring Systems	41
Operator's Warning Plate	39
Overhead Guard – Inspect	141
Overhead Guard Must Be In Place Warning	8
Overloading	103

P

Parking Brake - Test, Adjust	131,139
Parking Brake Adjusting	131
Parking Brake Lever	47
Parking Brake Testing	131
Parking brake	9
Parking the Lift Truck	94
Power Shift Transaxle	84

Pressure Air	14
Pressure Warning	7
Prestart Conditions	53
Product Description	87

R

Refill Capacities	113
Refueling	49
Replace LP Fuel Filter Element (LP Engine Only)	149
Replace Oxygen Sensor (PSI Engine)	156
Replace PCV Valve and breather element - Change (LP Engine Only)	156
Replace Spark Plugs (LP Engine Only)	148

S

Safety Rules	23
Safety	2,5
Seat Adjustment	17
Seat Belt	19
Seat Switch System (If Equipped)	45
Seat	44
Seat, Hood Latch & Support Cylinder - Check, Lubricate	118
Serial Number Locations	38
Serial Number	38
Service Brake Pedal	47
Servicing Filter Element	134
Sideshift Attachment Control (If Equipped)	48
Specifications	31
Stability and Centre of Gravity	21
Starting From a 12 Volt External Source	54
Starting the Engine	53
Starting the Lift Truck	12
Steer Suspension - Inspect	141
Steer Wheel Bearings -Reassemble	151
Steering Knob (If Equipped)	86
Steering Mechanism - Check, Lubricate	142
Storage Information	96

T

Table of Contents	1
Test Fuel System for Leaks (LP Engine Only)	118
Testing Fuel Lock-off Operation (LP Engine Only)	150
Tilt Control	48
Tilt Cylinders - Check, Adjust, Lubricate	136
Tilt Steering Column	44
To Adjust	132
To Operate the Lift Truck After a Long Time Storage	96

Torque for Metric Fasteners 107
Torque for Standard Bolts, Nuts, and Taperlock
Studs 106
Torque for Standard Hose Clamps – Worm Drive 106
Torque Specifications..... 106
Torques for Bolts and Nuts With Standard Threads
..... 106
Torques for Taperlock Studs 107
Towing Information 99
Training Required to Operate or Service Warning... 5
Transmission Inching Control Pedal 46
Transmission Oil (TDTO)..... 112
Transmission Oil Level - Check..... 125
Transmission Oil, Oil Filter & Strainer - Clean,
Change..... 128,144
Transmission Speed Range Lever 46
Transportation Hints 97
Traveling With the Load 91
Turning 92

U

Universal Joint - Inspect..... 147
Unloading 91

V

Vibration(weighted overall value) 33

W

Walk - Around Inspection 51
Walk - Around Inspection - Inspect 124
Warning Signs and Labels 5,17
Water-280 kPa (40 psi) Maximum Pressure 135
Wheel Bolts and Nuts – Inspect 142
When Required..... 118