

CROWN

Operator Manual





Original Instructions

All rights reserved under International and Pan American copyright conventions Copyright 1996-2023 Crown Equipment Corp.



General Information

You Must Be Trained	10
Intended Use of the Truck	11
Manuals for Operation	11
Symbols Overview	12
Text Marking Overview	13
Safety Messages	14
Know the Hazards	16



Your Truck

Your Stockpicker	26
Truck Overview	28
Capacity and Load Center	34
Your Truck Capacity	35
Capacity Plate	36
Reading Your Capacity Plate	38
Capacity Plates for Attachments	39
Extended Platform with Lanyard Boom	39



Truck Operation

Power On and Off	40
Turning On Your Truck using a Key	40
Turning Off Your Truck using a Key	40
Turning On Your Truck Using the Display	41
Manual Truck Lock	41
Turning Off Your Truck Using the Display	42
Emergency Disconnect	43
Display Overview	44
Display	48
Widgets	48
Safety Checklist	50
Safety Reminders	51
On-Screen Messages	51
InfoLink™ Options	52
Equipment Locked	52
2-Way Messaging	53
Impact Detection	54
Dynamic Coaching™	55
Operating Position	56
Harness and Lanyard	57
Side Gates	61
Rear Gates	61
Adjusting the Steering Wheel	62
Adjustable Operator Controls Option	62

Continued on next page...



Truck Operation

Braking	64
Parking Brake	64
Braking	65
Traveling	66
Travel Direction and Speed	68
Plugging	69
Horn	69
Steering	70
Load Handling	74
Raise/ Lower Paddle	76
Auxiliary Raise and Lower	76
Auxiliary Raise and Lower - Button Control	76
Adjusting the Fork Spread	77
Manual Lowering	77
Load Handling Option	78
Override Function	78
Pallet Clamp	79
Pallet Grab	80
Additional Options	82
Wire Guidance Option	82
End of Aisle Control	84
Manual Steering	84



Truck Operation

Manual Wire Sense	85
Rail Guidance Option	85
Zone Select	86
Cold Storage Option	88
It's Up to You	90
Daily Safety Check	96



Power Sources

Power Sources	100
Working with Power Sources	101
Power Source Status	102
Charging Power Sources	104
Charging a Flooded Lead Acid Battery	104
Charging a V-Force™ Lithium-ion Battery	104
Flooded Lead Acid Batteries	106
Removing the Battery	107
Installing the Battery	108

Continued on next page...



Safety Labels

Safety Labels

110



WARNING



You Must Be Trained and Certified

Only properly trained operators are permitted to operate a powered industrial truck.

Your employer must train you and certify that you are qualified to operate this powered industrial truck.
(OSHA §1910.178)



You could be killed or seriously injured if you are not adequately trained for lift truck operation!

Do not operate this truck until you have been trained and certified by your employer.

Intended Use of the Truck

Your stockpicker is designed for orderpicking. It is not as efficient as other type trucks if it is used to transport or stack loads.

The truck is not authorized for use on public roads.

Manuals for Operation

There are two separate books for this truck, the Operator and the Owner Manual. These manuals apply to the following truck models:

- SP 1510
- SP 1520

The Operator Manual contains safety and operating instructions, as well as general truck information. It is intended to complement operator training and to be used for future reference.



The Operator is anyone who has been authorized to use this truck. Refer to local, regional, national, or international regulations for operational standards.

The Owner Manual contains Owner responsibility, as well as information needed to maintain, store, or transport the truck.

The Owner is anyone who owns, leases, has been delegated responsibility of, or authorizes the use of the truck to others.

Symbol Overview

The symbol overview explains important elements used in the manual.

Icon	Type	What it means
	Legend Points	Product feature labeling
	Red Impact Marks	Shows personal injury
	Black Impact Marks	Shows product damage

Text Marking Overview

The text marking overview explains important text elements used in the manual.

Text Styling	Type	What it means
<i>Start</i>	Bold Italicized Text	Text as it appears on the screen
<i>For example:</i>	Italicized Text	Examples for further explanation
1. 2.	Work Steps	Steps that must be performed in specific order
▪	Bullet Points	Shows a list

Safety Messages

This operator manual contains important information about your truck and how to use it properly. Safety messages provide instructions on potential hazardous situations, how to avoid them, and the consequences of not avoiding these situations.

Follow all instructions and obey all safety notices in the manuals and on your truck.

Safe truck operation depends on you.

Danger

Indicates a hazardous situation that, if not avoided, will result in death or serious injury.

Warning

Indicates a hazardous situation that, if not avoided, could result in death or serious injury.

 **Caution**

Indicates a hazardous situation that, if not avoided, could result in minor or moderate injury and/or product damage.



⚠ **Danger**

Lead acid batteries produce gas that can explode

You can cause sparks which can damage the battery.

- Never let anything conductive like metal touch the top of the cells. Use an insulator such as plywood, when necessary.
- Never smoke or use an open flame around batteries.
- Make sure that the battery cells are filled to the proper level.
- Ventilate well when in an enclosed area and when charging.

Avoid contact with battery acid

Battery acid can cause severe burns.

- Use protective equipment such as gloves, eye shields, aprons, etc.
- In case of contact, remove clothing. Flush skin and eyes immediately and thoroughly with water.
- Get medical attention if your eyes are affected.



⚠ Danger

A damaged lithium-ion battery can be highly flammable.

Immediately exit the area for leaking gas or liquid, excessive heat, flames, or sudden noise coming from the battery.

Alert emergency personnel or notify your supervisor. In case of contact, get medical attention.

Do not smoke, use open flame, create an arc or sparks near the battery.



Hydrogen fuel cells contain colorless, odorless and tasteless hydrogen gas that is highly flammable and could explode.

A loud rushing sound may be the only warning of a hydrogen leak and possible fire.

At any indication of a leak, turn the truck off and move yourself and all bystanders at least 10 meters (33 feet) from the truck.

Never use water on or around a fuel cell fire. Use dry chemical (ABC) fire extinguishers only.

Alert emergency personnel or call 911.

Follow all warnings, instructions and training materials provided by the fuel cell manufacturer.

Continued on next page...

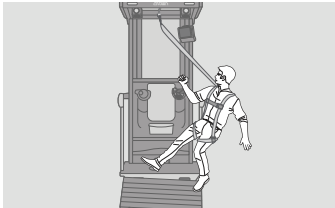

⚠ **Danger**

Falling from a raised platform can cause a serious injury or death.

- Before operating the truck attach the harness and lanyard.
- Put the gates down and keep your entire body inside the operator compartment.
- Work from the platform. If you must step onto a pallet, stay to the center, between the supporting forks. Never step on or near the edge of a pallet.

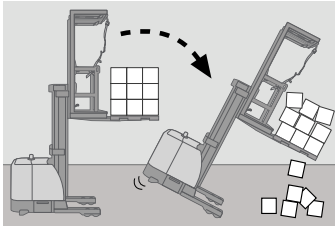

! Warning

Avoid falls and tipovers

Falls from docks and tipovers are very serious accidents, you can be crushed or even killed.

- The best way to prevent injury is to know where you are at all times. There is no sure way to avoid injury.
- Stay away from the edge of docks and ramps.
- When you're not picking, travel with the load or forks close to the floor.
- Make sure that dock boards and dock levelers are secure.
- Check that trailer wheels are chocked or the trailer is locked to the dock.
- Properly install jack stands under the front of the trailer when a tractor is not attached.

Continued on next page...

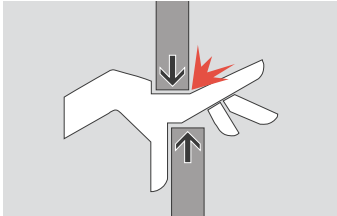

⚠ Warning

Body parts outside of the operator compartment can be crushed or even cut off

- Keep head, arms, hands, legs, and feet within the operator compartment.
- Stop the truck completely before picking, placing product, or getting off.

Use Your Truck Safely

Do not place yourself or others at risk.

- Keep others away from your truck.
- Never allow passengers on your truck. Do not allow anyone to ride on the load or forks.
- Do not stand underneath or near the forks.

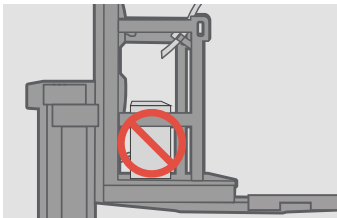

Keep the operator platform clear

Objects on the platform could trip you and affect truck operation.

Always keep the operator platform clear.



! Warning

Make sure the brakes work

If at any time the stopping distance is too long for you, do not drive your truck.

Notify your supervisor.

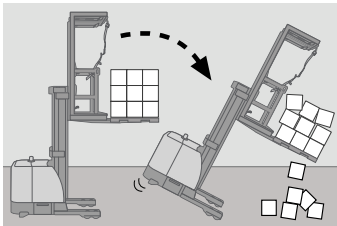
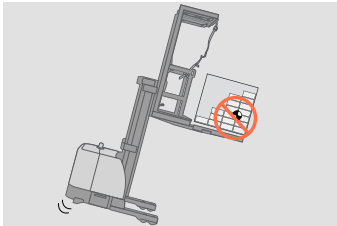

! Warning

Avoid tipovers

Loads placed in the front or side of a pallet or container can cause a tipover.

- Know the capacity of your truck. Do not exceed the capacity shown on your truck's capacity plate.
- Make sure that your load is evenly distributed and centered over the forks.
- Make sure the load that you are moving is stable.
- Secure your load.
- Do not exceed the maximum load center distance and lift height.

Continued on next page...

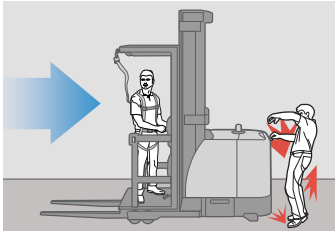

⚠ Warning

Distractions can cause accidents

You or people around you can be seriously injured.

- Always be alert to the area around you and look where you are going.
- You or others could be trapped or crushed by driving into fixed objects.
- Slow down in congested areas.
- Never use cell phones or similar devices while operating your truck.

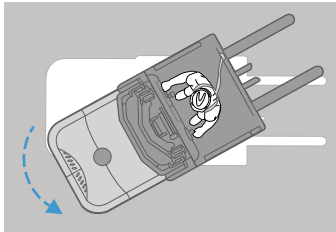

Warning

Prevent impacts with objects or others

The power unit swings wide in the opposite direction when you turn traveling forks first.

- Make sure that you have clearance.
- Keep your hands and feet in the operator compartment.
- Turn carefully and slowly.
- Watch out for people in the area.



Maintain control of your truck

- Slow down if you see debris or liquid on the floor.
- Do not run over objects on the floor.
- Be careful and prepare for a longer stopping distance.

Continued on next page...

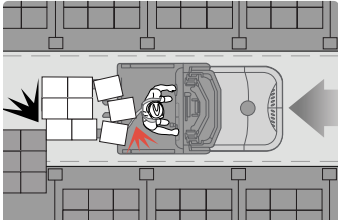
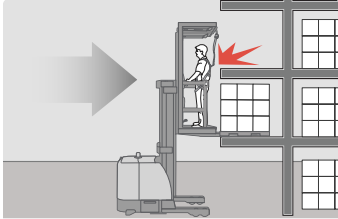

⚠ Warning

Check fork and pallet position

- Perform all hydraulic operations smoothly.
- Make sure that the forks are at the correct lift height to enter a pallet.
- Make sure that the path of the forks and load is clear.

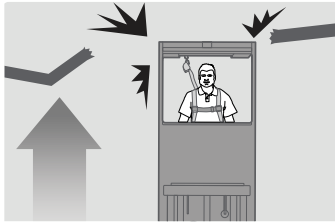

! Warning

Watch out for overhead obstructions

The truck can tip over causing serious injury or even death.

- Be careful traveling near obstructions such as pipes, ducts, doorways, rack tunnels, or low ceilings.
- Be careful when using the override function.

! Warning

Check the size and type of the battery

An incorrect battery can affect truck handling and stability causing an accident.

Make sure that you use the correct size, type, and weight of battery.

Check the battery retainer

Unsecured batteries can slide or roll out of the truck.

Make sure that all battery retainers are installed before operating your truck.

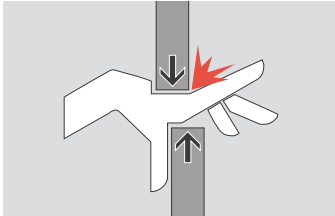

Warning

Body parts outside of the operator compartment can be crushed or even cut off

- Keep head, arms, hands, legs, and feet within the operator compartment.
- Stop the truck completely before getting off.

Use Your Truck Safely

Do not place yourself or others at risk.

- Keep others away from your truck.
- Never allow passengers on your truck. Do not allow anyone to ride on the load or forks.
- Do not stand underneath or near the forks.

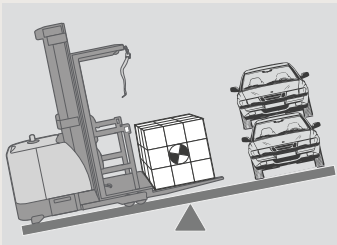

Your Truck Is Not An Automobile

With a load, it may weigh more than two automobiles.

- You don't steer the same.
- You don't brake the same.
- You don't accelerate the same.

Note: You cannot stop your truck with any part of your body, no matter how slow the truck is moving.

Make Sure You Are Ready

- Be certain that you understand how your truck works and the hazards that go with it.
- Make sure that your hands and shoes are clean and dry. Wear clothing that is proper for work.
- Do not operate your truck if you have any doubts.

Make Sure Your Truck Is Ready

Inspect your truck before using it. See **Daily Safety Check** on page 94 for an inspection guide. If your truck is not working correctly or is damaged, do not use it. Notify your supervisor.

Note: Similar looking trucks can be different. Be careful, trucks that look just like yours may not have the same controls, functions, or options.

Watch Out for Other People

- Keep others away from your truck while you're working.
- Never allow passengers on your truck. Do not allow anyone to ride on the load or forks.
- Slow down. Yield or stop for pedestrians.



Stockpicker

- 1 Lanyard
- 2 Display
- 3 Operator Controls
- 4 Brake



Stockpicker

- ① Lowering Valve (inside)
- ② Side Gates
- ③ Pallet Grab Release Pedal
- ④ Operator Platform
- ⑤ Pallet Grab

Continued on next page...

Power Unit-facing Controls



Note: Similar looking trucks can be different. Be careful, trucks that look just like yours may not have the same controls, functions, or options.

Left Controls

- ① Hand Grip
- ② Steering Wheel
- ③ Tiller Knob

Right Controls

- ① Wire Guidance
- ② Override Function
- ③ Display Navigation Knob
- ④ Forward/ Reverse Rocker
- ⑤ Horn (hidden in view)
- ⑥ Emergency Disconnect
- ⑦ Raise / Lower Paddle

Forks-facing Controls



Auxiliary Raise and Lower Buttons





Switch Panel options

- 1 Auto Position Select
- 2 Spot Light
- 3 Work Light
- 4 Dome Light
- 5 Fan
- 6 Auxiliary Forks Button
- 7 Pallet Grab Release



Battery Access

- 1 Battery Connector
- 2 Lowering Valve
(under rear cover)
- 3 Battery Retainer

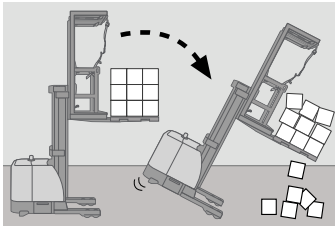
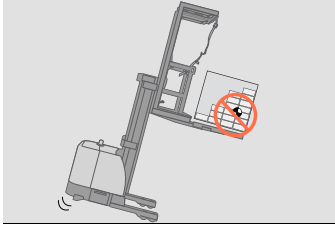

Warning

Avoid tipovers

Loads placed in the front or side of a pallet or container can cause a tipover.

- Know the capacity of your truck. Do not exceed the capacity shown on your truck's capacity plate.
- Make sure that your load is evenly distributed and centered over the forks.
- Make sure the load that you are moving is stable.
- Secure your load.
- Do not exceed the maximum load center distance and lift height.

Your Truck Capacity

Capacity is the load (including pallet, cart, container, etc.), that can be lifted to a given height at a given load center.

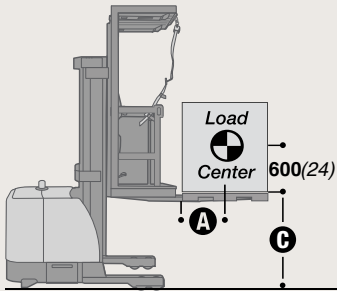

Load Center **A**

The horizontal load center is the distance from the end of the operator platform to the center of an evenly distributed load. See your capacity plate for the load center for your truck.

Note: The load center can differ from the visible center position on the forks.

Lift Height **C**

The height a load can be lifted for the specified capacity.

Anytime the forks move, the load moves. This can affect stability.

Note: Avoid sudden movement of the controls. Learn to use them smoothly at a moderate, even rate.

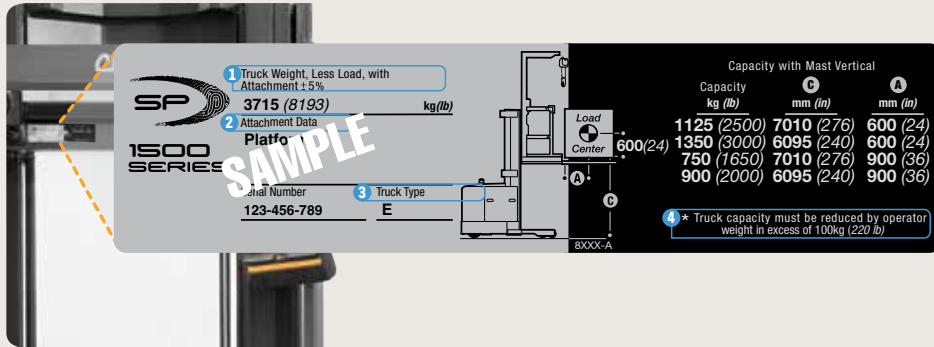

Capacity Plate

Check the capacity plate on your truck. The capacity plate is located on the overhead guard.

The capacity plate contains information such as truck capacity, truck weight without a load, and the lift height permitted. Make sure you use the correct units of measure.

Note: The information shown on this sample capacity plate may not apply to your truck.

1 Truck Weight Less Load with Max. Battery, and Attachment $\pm 5\%$

The weight of your truck without a load. Dock boards, elevators, and some floors can have limits for capacity. Make sure you know the weight of your truck. Remember to add the weight of any load on the forks.

2 Truck Type

Truck type is the fire safety rating for your truck. Watch for marked areas where your truck is not permitted. *For example, you must not operate a type E or ES truck into an area restricted to EE or EX trucks.*

3 Attachment Data

If an attachment on your truck does not match the information on your capacity plate, don't operate your truck. Notify your supervisor.

4 Truck capacity must be reduced by operator weight

Operators that weigh more than 100kg (220lb) must reduce the capacity of the truck.

Continued on next page...

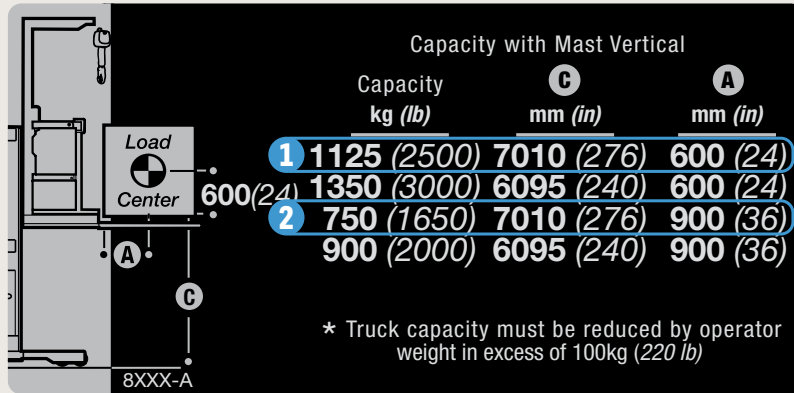

Reading Your Capacity Plate

- Capacity may be reduced as lift height **C** increases.
For example: On the sample plate, 1350kg (3000 lb) can be lifted to 6095mm (240 in). But above 6095mm (240 in), to 7010mm (276 in), capacity is reduced from 1350kg (3000 lb) to 1125kg (2500 lb).
- Capacity is reduced as load center **A** increases.
For example: On the sample plate, 1350kg (3000 lb) can be lifted if the load center is 600mm (24 in). But if the load center is increased to 900mm (36 in), capacity is reduced from 1350kg (3000 lb) to 900kg (2000 lb).

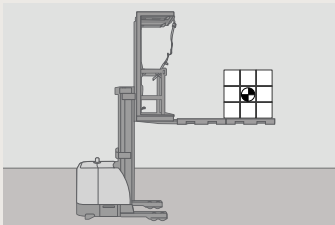

Note: As you load or unload your truck, your center of gravity moves.

If you must handle loads with longer load centers, an additional capacity plate will show the reduced capacities.

Contact Crown for capacities at lift heights or load centers not given on your capacity plate.

Caution

Avoid tipovers

You may not increase capacity if load center is less than shown on your capacity plate.



Capacity Plates for Attachments

There may be additional capacity plates for attachments. Make sure that you look at the capacity plate for the attachment you are using.

The capacity plate and the attachment capacity plate are located on the overhead guard.



Extended Platform with Lanyard Boom

The supplemental platform option contains a lanyard boom to extend the attachment point for your lanyard.



Power On and Off

Make sure that the battery is connected. If your truck is not working correctly, notify your supervisor.

Turning On Your Truck using a Key

- 1 Off
- 2 On

1. Turn on your truck by turning the key clockwise to **On**.
2. Check that the display is working.

Turning Off Your Truck using a Key

Turn off your truck by turning the key counterclockwise to **OFF**.

If you turn off your truck and do not log out, the truck will automatically log you out after approximately 10 seconds. **Logging Out (Do Not Travel)** appears on the screen.



Turning On Your Truck Using the Display

You can turn on the truck by one of the following methods:

- Enter your user code
- Pass your ID across the reader 
- Press **Start**.

If your ID is recognized, **Welcome** appears on the screen. If **User Not Authorized** appears, notify your supervisor.

Note: While logged in, you are the only user permitted to operate this truck.



Manual Truck Lock

The truck can be manually locked to prevent use or for service. **Equipment Locked** appears on the screen and you cannot use the truck. Notify your supervisor

Continued on next page...



Turning Off Your Truck Using the Display

To turn off your truck, log out or pass your ID across the reader. **Logging Out (Do not travel)** appears on the screen.

Note: Depending on your truck settings, completing another inspection can be required. For example, if you log out, and then log in to the same truck during the same shift.

Caution

Prevent unauthorized use

- Always log out before leaving your truck.
- Turn off your truck and remove the key.
- Do not share your user code with others.



Emergency Disconnect

Use the emergency disconnect to shut down the truck if it is not working properly. Do not use the emergency disconnect as a brake.

To cut power to the truck, push down the emergency disconnect button. While traveling, the truck will slow to a controlled stop.

To reconnect power to the truck, twist the emergency disconnect clockwise. Restart the truck. See **Power On and Off** on page 40.

Note: Turning off your truck does not cut off all power to your truck. Use the emergency disconnect any time your truck is not working properly. Do not use your truck and notify your supervisor.



Display Overview

Press the touchscreen or push the navigation buttons to see information about your truck. View hours of operation, power source status, and more on the screen.

When using the navigation buttons or display navigation knob, a blue indicator shows your movement on the screen.

Note: While traveling, you cannot interact with the display.



1 Menu or Back

Press the menu or back icon on the screen to view settings and go back to a previous menu.

2 Status Bar

Icons appear at the top of the screen to show the status of the truck.

3 Widgets

Information about your truck such as power source status or date and time are available as widgets.

4 Navigation Buttons

In addition to the touchscreen, you can use the up and down arrows to move through the screen.

5 Enter or Return Button

Use the enter or return button to go backward in menus and confirm selections on the screen.

Continued on next page...



Steer Angle Indicator

The travel direction and steer angle of your truck.



Communication Status

Wireless communication is active.



Power Source Status

The energy level of the power source.



Performance Mode

The operating level programmed for your truck.



Parking Brake

The parking brake is applied.



OnTrac™

Traction Control indicator.



Zone Select™

Height limits for specific areas.



Service Required

Notify your supervisor or service department if this icon appears.

Continued on next page...



Widgets

Information about your truck such as the travel direction, battery status, or hours of operation are available as widgets.

The indicators on the bottom of the screen show you the number of widgets that are enabled. Swipe left or right on the screen to change between the widgets.

Press a widget or the enter button to see options available for that widget.

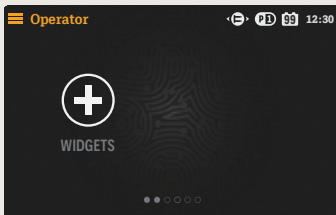

Adding a New Widget

1. Press **+** on the screen.
2. Scroll down to go through the options.
3. Select a widget.
4. Press **Save** to enable the widget.



Moving an Existing Widget

You can move widgets in different ways.

Press and hold a widget

Drag and drop the widget onto the desired location.

Tap a widget

Tapping a widget will give you the option to move the widget to the Home or first position.

Continued on next page...



Safety Checklist

You are required to conduct an inspection to make sure that the truck is safe to operate. See **Daily Safety Check** on page 94 for an inspection guide. A number of questions can appear on the screen, depending on your company's requirements. Answer all the questions within the time limit shown in the upper right corner.

You may be asked to verify your response by answering the follow-up question ***Are you sure?***

If your response indicates a problem, your truck may be disabled. Don't use your truck and notify your supervisor.

Note: If you are unable to start the inspection checklist, notify your supervisor.

If you need to interrupt the inspection process, press **Cancel** or  in the top left corner of the screen.

During an inspection, the truck will lock for the following situations:

- You allow time to expire twice
- You interrupt an inspection twice
- You allow time to expire and interrupt an inspection
- You answer the truck is not safe to operate during an inspection.

Note: Depending on your truck settings, completing another inspection can be required. For example, if you log out and then log in again to the same truck during the same shift.

⚠ Watch Out for Other People

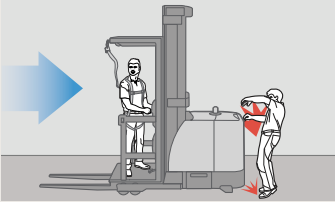

Safety Reminders

Before you can operate the truck, a reminder of safe truck operation will appear on the screen.



On-Screen Messages

Messages appear on the screen to show truck status or operating limits.

Continued on next page...



Equipment Locked

Equipment Locked can appear for various reasons such as impact detection.

You cannot use your truck. If your truck is locked, notify your supervisor.



Emergency Use

In an emergency situation, press 811 on the screen and press the enter button. The screen shows the amount of time in which you can operate the truck. When time expires and the truck is brought to a stop, **Equipment Locked** appears on the screen.



2-Way Messaging

With this feature, your company can send messages to you.

When you receive a message, the icon  appears at the top of the screen with a beep.

When the truck is stationary for 5 seconds, the message appears automatically.

Select one of the pre-programmed responses below the message to answer.

While traveling, an unanswered message disappears. The icon reappears at the top of the screen.



Impact Detection

With the Impact Detection feature, truck impacts are recorded. Depending on your company's settings, your truck can be programmed to only record the event, or record and shutdown the truck.

Impact Detected

When an impact is recorded, **Impact Detected** appears on the screen. After a short time this will disappear. Notify your supervisor.



Impact Shutdown

You can operate the truck for a short distance and time. When **Logging Out (Do not travel)** appears on the screen, you will be logged out within the time shown. The truck will shutdown and lock. **Equipment Locked** appears on the screen.

You cannot use your truck. If your truck is locked, notify your supervisor.



If strobe lights and audible alarms are installed for impact detection, they will illuminate and sound after an impact.



Dynamic Coaching™

The Dynamic Coaching feature provides audible and visual feedback on how you operate the truck. Your truck can show red and blue screens to reinforce safe operation.

Red Screens

Alerts of incorrect operation.

- **Impact Detected** (screen may show countdown to lockout)



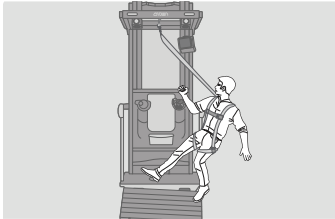

Danger

Falling from a raised platform can cause a serious injury or death.

- Before operating the truck attach the harness and lanyard.
- Put the gates down and keep your entire body inside the operator compartment.
- Work from the platform. If you must step onto a pallet, stay to the center, between the supporting forks. Never step on or near the edge of a pallet.



Harness and Lanyard

As soon as you get on the platform, put on your harness. Attach your harness and your lanyard to the anchorage bar.

① Lanyard

② Harness

The anchorage bar is intended for one person.

Check the harness, lanyard, snap hooks, and mounting points daily for wear or damage. Follow the manufacturers instructions for proper fit, inspection, and maintenance.

Note: If something is not working correctly or is damaged, do not use it. Notify your supervisor.

Fall Protection / Prevention Selection Chart

Fall Protection Devices	Operator Weight ³ kg (lbs.)			Contact Crown
	< 141 kg ¹ (<311 lbs.) ¹	141-181 kg ¹ (311 - 400 lbs.) ¹	>181 kg ¹ (>400 lbs.) ¹	
Full Body Harness	X	X	X	Contact Crown
Energy Absorber - max total length 1.8m (6ft)	X ²			
Self-Retracting Lanyard - max total length 2.4m (8ft)		X	X	

1. **Truck capacity shall be reduced by the operator(s) weight in excess of 100kg (220lbs).**
2. Energy Absorbing Lanyard is prohibited by CAL-OSHA in the state of California.
3. All components of the fall protection system shall be rated for the operator's weight.

Note: Pregnant women must not use fall protection devices.

Continued on next page...



Operating Position - Power Unit Controls

- 1 Hands on controls
- 2 Gates down
- 3 Foot on the brake pedal

Before you can operate your truck, you must cycle the controls.

1. Lift your left foot and return it to the brake pedal.
2. Slowly move the forward/reverse rocker and return it to neutral.

The truck is ready for operation.

Note: Your truck may weigh more than two automobiles. You cannot stop your truck with any part of your body, no matter how slow the truck is moving.



Operating Position - Forks Facing Controls

- 1 Hands on controls
- 2 Gates down
- 3 Foot on the brake pedal

Before you can operate your truck, you must cycle the controls.

1. Lift your right foot and return it to the brake pedal.
2. Slowly move the forward/reverse rocker and return it to neutral.

The truck is ready for operation.

Note: Your truck may weigh more than two automobiles. You cannot stop your truck with any part of your body, no matter how slow the truck is moving.

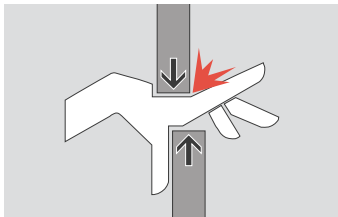

Warning

Body parts outside of the operator compartment can be crushed or even cut off

- Keep head, arms, hands, legs, and feet within the operator compartment.
- Stop the truck completely before picking, placing product, or getting off.

Use Your Truck Safely

Do not place yourself or others at risk.

- Keep others away from your truck.
- Never allow passengers on your truck. Do not allow anyone to ride on the load or forks.
- Do not stand underneath or near the forks.



Keep the operator platform clear

Objects on the platform could trip you and affect truck operation.

Always keep the operator platform clear.



Side Gates

Use the handle to open and close the gate. To operate the truck keep the gates down.

- Don't sit or climb on the gates.
- Keep your entire body within the operator compartment.



Rear Gates

Wear your harness and attach the lanyard whenever you are elevated and have a gate open.



Adjusting the Steering Wheel

Press the tilt button to adjust the steering wheel to a vertical or horizontal position. Make sure that the steering wheel locks in place.

Note: Do not make any adjustments while the truck is moving.



Adjustable Operator Controls Option

To adjust the operating controls, lift the adjustment lever.

Move the controls up or down. Make sure that it is locked in place.

Note: Do not make any adjustments while the truck is moving.



Warning

Make sure the brakes work

If at any time the stopping distance is too long for you, do not drive your truck.

Notify your supervisor.



Parking Brake

When the parking brake is applied, the parking brake symbol is shown in the status bar.

The parking brake is automatically applied after the truck comes to a stop.

Braking

Before you start working, test the brake.

In an open area, first check braking at a slow travel speed and then at a faster one.

Note: Depending on your truck you can use either foot to apply the brake.



Applying the Brake

To apply the brake, lift your heel or move your foot off the brake pedal. Keep a part of your foot in contact with the floorboard.



Releasing the Brake

To release the brake, step all the way down on the brake pedal.

Note: Braking is designed to stop your truck in the shortest distance. Use the brake in an emergency, on ramps, or in busy areas.

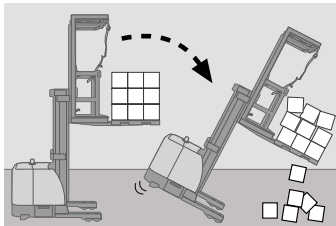

Warning

Avoid Falls and Tipovers

Falls from docks and tipovers are very serious accidents, you can be crushed or even killed.

- The best way to prevent injury is to know where you are at all times. There is no sure way to avoid injury.
- When you're not picking, travel with the load or forks close to the floor.
- Stay away from the edge of docks and ramps.
- Make sure that dock boards and dock levelers are secure.
- Check that trailer wheels are chocked or the trailer is locked to the dock.
- Properly install jack stands under the front of the trailer when a tractor is not attached.

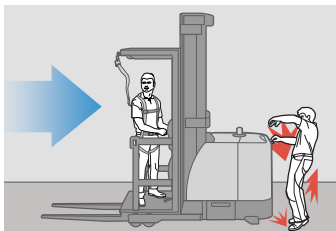

Distractions can cause accidents

You or people around you can be seriously injured.

- Always be alert to the area around you and look where you are going.
- You or others could be trapped or crushed by driving into fixed objects.
- Slow down in congested areas.
- Never use cell phones or similar devices while operating your truck.



Traveling

Travel in the direction that gives you the best visibility. Make sure that there is clearance for your entire truck.

Your truck has the following traveling directions:

- Power Unit First
- Forks First

The icon  appears in the status bar. Depending on your selected widgets, the screen can show your travel direction or steer angle.

Note: An unloaded truck can tip over as well. Be just as careful using an unloaded truck as you are using one that is loaded.

When you're not picking, travel with the forks close to the floor. Make sure that the load is centered. Make sure your pallet, cart, or fork mounted platform is secure.

While traveling, you cannot interact with the display.



Before you leave your truck, come to a complete stop and lower the forks. Turn off the truck using the display or key.

Park on level floors. If you must park on an incline, chock the wheels to prevent the truck from moving.

Continued on next page...



Travel Direction and Speed

Use the forward/reverse rocker to control your travel direction and speed. Travel at a speed that allows you to stop safely.

Note: The farther move the forward/reverse rocker from the neutral position, the faster the truck will travel.

When Traveling On Ramps or Grades

Stockpickers should not be used on ramps or grades. If you must drive on a grade,

- Slow down and do not turn on ramps or grades.
- Without a load, drive with the forks downgrade.
- Keep the fork height below 300mm (*12inches*).

When Traveling Onto an Elevator

- Do not drive onto an elevator unless you are authorized. Make sure that there are no people present. Enter forks first and come to a complete stop.
- **Make sure your truck with a load does not exceed the load limit for the elevator.**

Plugging

Plugging is another way to slow down or stop your truck. While the truck is moving in either direction, move the forward/reverse rocker in the opposite travel direction.

When traveling, you can also slow down or stop your truck by releasing the forward/reverse rocker.

Note: Braking vs. Plugging

Of the two, braking is designed to stop your truck in the shortest distance. Use the brake in an emergency, on ramps, or in busy areas.



Horn

Push the button on the underside of the handle to sound the horn. Warn pedestrians and other operators that you are nearby. Use the horn in areas such as intersections or crosswalks.

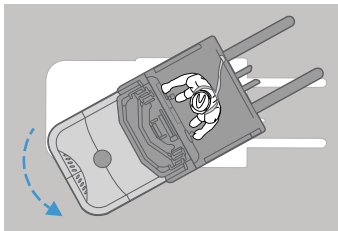

! Warning

Prevent impacts with objects or others

The power unit swings wide in the opposite direction when you turn traveling forks first.

- Make sure that you have clearance.
- Keep your hands and feet in the operator area.
- Turn carefully and slowly.
- Watch out for people in the area.



Maintain control of your truck

- Slow down if you see debris or liquid on the floor.
- Do not run over objects on the floor.
- Be careful and prepare for a longer stopping distance.



Steering

To control steering, rotate the steering wheel. Your truck is designed to slow down when turning.

An icon  in the status bar and the steering widget show your travel direction and steer angle.

Note: Steering is not the same in both travel directions. Be careful. Avoid sudden changes in direction. Drive slowly until you get used to all the controls.

Steering Direction

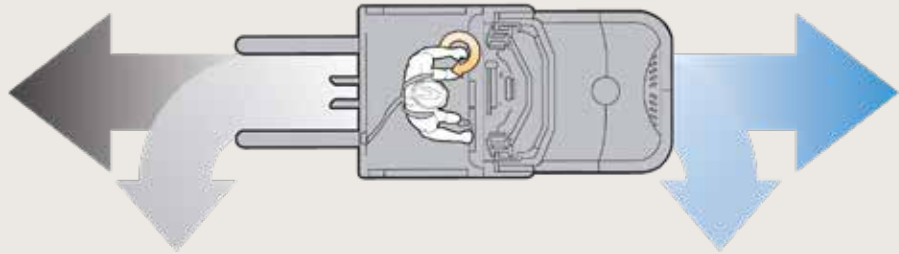

Power Unit-facing Controls

This shows the direction your truck will turn, when you turn the steering wheel clockwise.

Continued on next page...

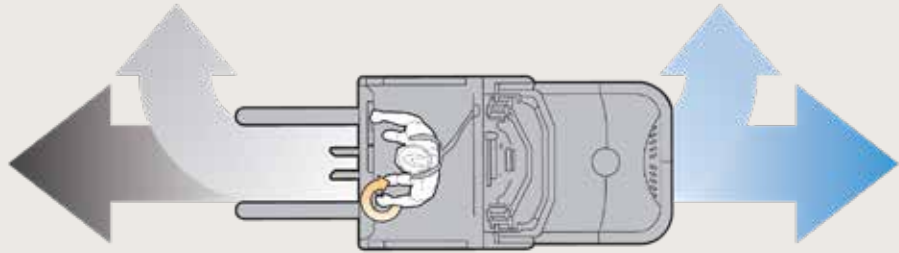

Forks-facing Controls

This shows the direction your truck will turn, when you turn the steering wheel clockwise.

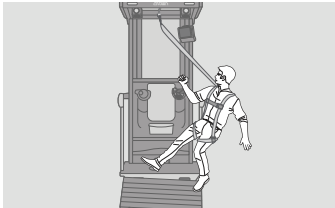

Danger

Falling from a raised platform can cause a serious injury or death.

- Before operating the truck attach the harness and lanyard.
- Put the gates down and keep your entire body inside the operator compartment.
- Work from the platform. If you must step onto a pallet, stay to the center, between the supporting forks. Never step on or near the edge of a pallet.

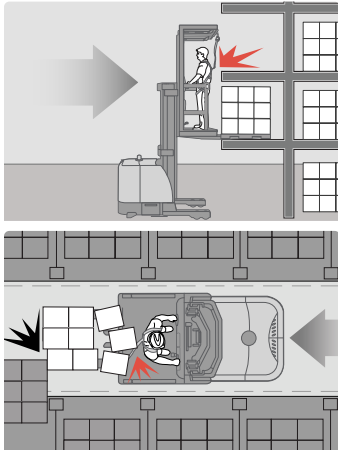

! Warning

Check fork and pallet position

- Perform all hydraulic operations smoothly.
- Make sure that the forks are at the correct lift height to enter a pallet.
- Make sure that the path of the forks and load is clear.

Load Handling

Your truck is equipped with standard platform functions raise and lower.

Make sure that your load is evenly distributed, stable, and centered over the forks. For stability, spread the forks as far as you can and make certain the pallet or fork mounted platform is secure.

The forks should be at least two-thirds (67%) the length of the load. Crown recommends the forks be three-fourths (75%) the length of the load. Make sure the forks do not extend beyond the load.

Continued on next page...



Raise/ Lower Paddle

Symbols next to the paddle show the load handling control. Pull or push the paddle to raise and lower the platform. *For example, pull the paddle toward you to raise the platform as shown in the bottom symbol. Push the paddle away from you to lower the platform.*

Note: The farther you move the paddle from neutral, the faster the platform will move.



Auxiliary Raise and Lower

Auxiliary raise and lower lets you move just the forks up or down on the auxiliary mast.

To move the forks, press and hold the aux forks button and pull or push the raise/lower paddle.



Auxiliary Raise and Lower - Button Control

Your truck may be equipped with auxiliary raise and lower button controls.

To move the forks, push both raise/lower buttons at the same time.



Adjusting the Fork Spread

Make sure that you spread the forks as far as possible.

To adjust the forks spread, the forks must be off the floor and without load.

Lift up and then slide the forks.

Note: Both forks must be an equal distances from the center of the platform.

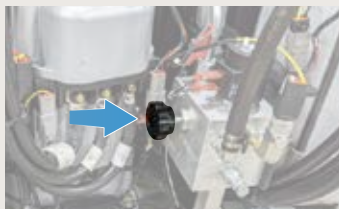

Manual Lowering

If you cannot lower the platform, have someone on the floor assist you by using the manual lowering valve. **Stay in contact with the person on the floor.**

Before lowering, make sure the forks, load, and platform are free from obstructions.

Note: Always be alert for an on-screen message or any other indications that the lift chains have become slack. A slack chain condition can cause serious injury by allowing the platform to drop suddenly.

Immediately alert the person on the floor of a slack chain condition. Stop lowering and raise carefully.

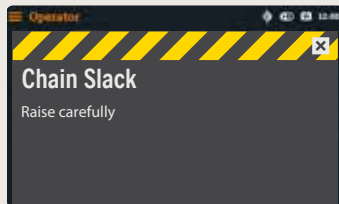



Warning

Watch out for overhead obstructions

The truck can tip over causing serious injury or even death.

- Be careful traveling near obstructions such as pipes, ducts, doorways, rack tunnels, or low ceilings.
- Be careful when using the override function.

Override Function

Your truck can be programmed to stop raising in areas with overhead restrictions.

Your truck can be programmed to stop lowering to the floor.

To continue raising or lowering past the height limit, use the override function.

1. Return the raise or lower control to neutral.
2. Press and hold the override switch and then slowly resume raise or lower.



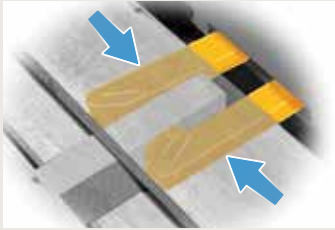

Pallet Clamp

Be careful using pallets. They can tip or slide on the forks even when properly centered and clamped. Make certain the center stringer of the pallet fits into the Pallet Clamp.

Make sure that you spread the forks as far as possible. Don't use pallets that have missing, loose, broken or undersized boards.



Manual clamp

To clamp the pallet, step down on the Pallet Clamp Bar. Make sure the pallet is secure.

To let go of the pallet, step down on the Pallet Release Pedal.



Continued on next page...

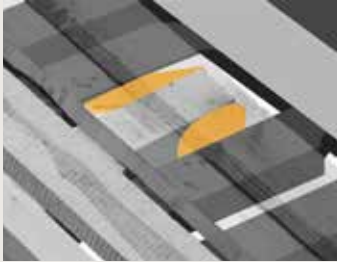

Pallet Grab

To grab the pallet, slowly drive into the pallet. Make sure pallet is secure. A pallet can move or tip, even when using the Pallet Grab.

Electric Grab Release

To let go of the pallet, press the Pallet Grab Release button on the Left Controls.

Manual Grab Release

To let go of the pallet, step down on the Pallet Release Bar.

Note: If you work with a fork mounted auxiliary platform instead of a pallet, your truck may not have a Pallet Grab. Make sure the platform is fastened to the truck.



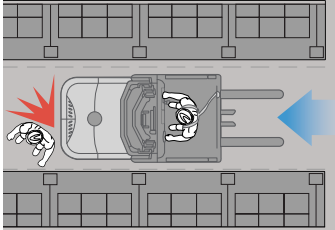

Warning

Stay alert

You must be just as careful using guided travel as you are traveling manually.

- Start slowly and look where you're going.
- Always be prepared to steer manually.
- Make sure your path is clear and nothing is sticking out of a rack.

Do not rely on automatic feature to control your truck.

A moving truck can cause serious injury or death. Always come to a complete stop and check for pedestrians before entering an intersection.



Wire Guidance Option

With the Wire Guidance feature, your truck is guided by a wire in the floor. Your company must train you how to enter, exit and drive in aisles. Make sure your path is clear and watch where you are going. Drive slowly and be alert for alarms or changes on the display showing wire guidance status.



Acquiring the Wire

Your direction of travel (power unit first or forks first) controls how you should approach the guidance wire.

1. Push the Wire Guidance switch to ON when you are close to a guided aisle.
2. Drive slowly with the platform about 300mm (12 inches) above the floor, and center the truck over the wire.

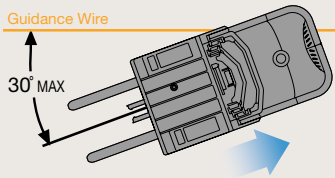

Traveling Guided Power Unit First

Drive slowly over the wire at an angle of 30° or less. When you hear a “beep” and the widget stays green, the truck takes control of steering. Start slowly.

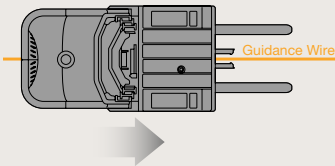

Traveling Guided Forks First

If you must acquire the wire while traveling forks first, make sure you align your truck straight over the wire.

1. Drive slowly along the wire until you hear a “beep” and the widget stays green.
2. Continue to drive slowly for two truck lengths before resuming normal guided driving.

Automatic Slow Down

While traveling using wire guidance, your truck may slow down automatically for the following conditions:

- A low signal strength from the wire.
- The truck moves slightly from the wire.
- The End of Aisle Control option is active.

Continued on next page...

Automatic Stop

While traveling using wire guidance, your truck may stop automatically for the following conditions:

- The signal strength from the wire is lost or is too low.
- You acquire the wire at an angle greater than 30°.
- The truck moves too far from the wire.
- The End of Aisle Control option is active.



End of Aisle Control

With this feature, your company can program your truck to slow down or stop automatically when it comes to the end of an aisle. You will hear a “beep” and **End of Aisle** appears on the screen.

If your truck stops,

1. Return the forward/reverse rocker to neutral.
2. Press the override switch and resume travel.



Manual Steering

Before you turn off Wire Guidance, make sure you are in the correct operating position.



Manual Wire Sense

Manual Wire Sense reminds you to turn ON wire guidance. With this feature, your truck will “beep” while traveling in manual steering mode on an active guidance wire. **Turn on Wire Guidance** appears on the screen.

Your company can program your truck to travel at a slow speed or slow to a stop while “beeping.”

Rail Guidance Option

With this feature, your truck is guided in narrow aisles along rails in the floor. When the guide wheels contact the rails, your truck will “beep” and **Guided** appears on the screen. You can now operate without steering your truck. Your company must train you how to enter, exit, and drive in aisles with rail guidance.

- Make sure your path is clear and watch where you are going.
- Drive straight into and out of aisles.
- Do not approach or leave at an angle.
- Do not try to steer while you are in a guided aisle.

Continued on next page...



Zone Select

With the Zone Select feature, your company can create height limits for different operating areas. Depending on your truck settings, you can choose different zones for areas you are working. The Zone Select widget turns orange and the icon [A] appears showing which zone is active.



Cold Storage Option

Your truck can be operated in cold storage areas only if it is marked with the freezer symbol.

Caution

Batteries can freeze and rupture

- Do not park trucks in temperatures below freezing.
- Watch the charge status of the battery.
- Charge or replace the battery before the energy is too low.

Watch out for excess water on the truck

Make sure that your truck is completely dry before reentering cold storage areas.

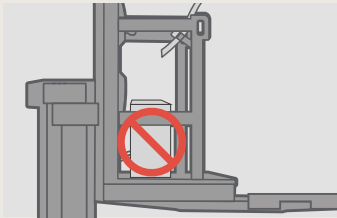
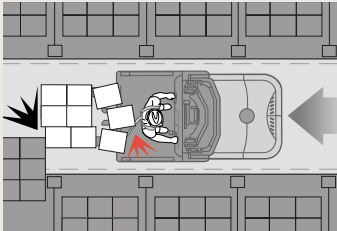

Be Cautious and Alert

- Look where you are going.
- You can be trapped or crushed by a fixed object.
- You can fall from the truck or the load can shift and hit you.
- Always keep the operator platform clear.
- Travel in the direction that gives you the best visibility. Slow down in congested areas.
- Never use cell phones or similar devices while operating your truck.
- Slow down for wet or slippery floors.
- Do not run over objects.
- Avoid sudden movement of controls. Learn to use them smoothly at a moderate, even rate.
- Travel at a speed that allows you to stop safely.
- Staying alert will help you be a better and safer operator.

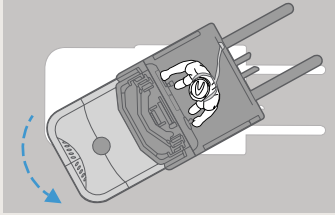
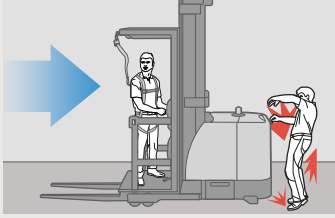

Watch Out for Other People

- Slow down. Yield or stop for pedestrians. Use the horn in areas such as intersections or crosswalks.
- Make sure that you do not trap or crush someone. *For example, never drive your truck toward anyone standing in front of a fixed object.*
- Keep others away from your truck while you are working.
- Watch out for power unit swing. Slow down when making turns.
- Travel in the direction that gives you the best visibility.
- Never allow passengers on your truck. Do not allow anyone to ride on the load or forks.

Continued on next page...

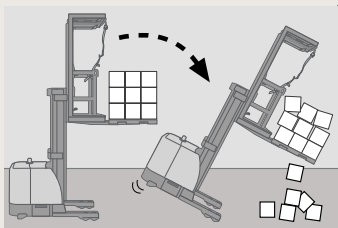
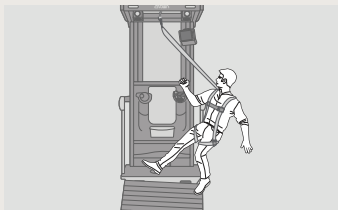
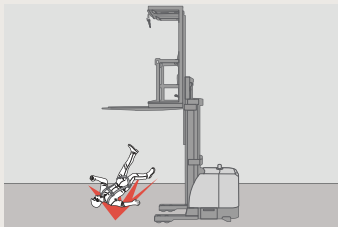

Avoid Falls and Tipovers

- Falling from a raised platform can cause a serious injury or death. Before operating the truck attach the harness and lanyard. Put the gates down and keep your entire body inside the operator compartment.
- Work from the platform. If you must step onto a pallet, stay to the center, between the supporting forks. Never step on or near the edge of a pallet.
- An unloaded truck can tip over as well. Be just as careful using an unloaded truck as you are using one that is loaded.
- Stay away from the edge of docks and ramps.
- Make sure that dock boards and dock levelers are secure. Be certain the trailer wheels are chocked or the trailer is locked to the dock.
- Properly install jack stands under the front of the trailer when a tractor is not attached.
- Make sure your truck, with a load, is not too heavy for where you are driving. *For example, elevators can have a different capacity than the floor.* Do not exceed any capacity.
- Make sure that your load is evenly distributed, stable, and centered over the forks. For stability, spread the forks as far as you can and make certain the pallet or fork mounted platform is securely fastened.
- Do not drive onto an elevator unless you are authorized. Make sure that there are no people present. Enter forks first and come to a complete stop.

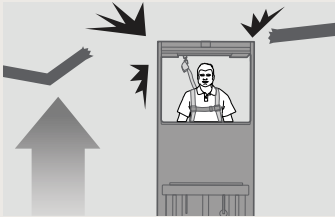
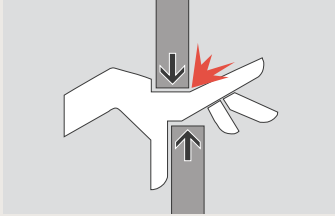

When Driving

- Your truck may weigh more than three automobiles. You cannot stop your truck with any part of your body. A foot or hand caught between the truck and a fixed object will be crushed or even cut off.
- Never stick a foot or any part of your body outside the operator compartment, no matter how slow the truck is moving.
- When you're not picking, travel with the forks close to the floor.
- When traveling, make sure that the load is centered.
- Make sure that there is clearance for your entire truck. Watch for overhead obstructions
- Stop the truck completely before getting off.

Continued on next page...

When Traveling On Ramps Or Grades

Stockpickers should not be used on ramps or grades. If you must drive on a grade,

- Slow down and do not turn on ramps or grades.
- With a load, drive with the forks pointed upgrade.
- Without a load, drive with the forks downgrade.
- Keep the fork height below 300mm (12inches).

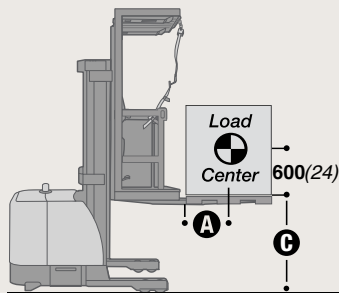
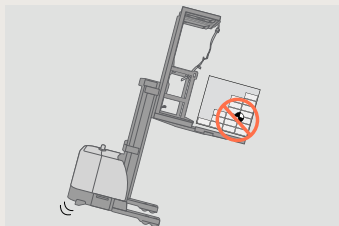

When Handling Loads

- Do not exceed the capacity shown on your truck's capacity plate.
- Make sure that the load is centered. The load center can differ from the visible center position on the forks.
- Make sure that the load you are moving is stable.
- Make sure that you spread the forks as far as possible.
- A pallet can move or tip, even when using the Pallet Grab. If you must step onto a pallet, stay to the center, between the supporting forks.
- Never step on or near the edge of a pallet. Be careful moving a wide or tall load.
- Do not stand underneath or near the forks.
- Stay away from all moving parts. *For example, do not reach into the mast area.*

When Leaving Your Truck

- Come to a complete stop and lower the forks.
- Log out, turn off your truck, and remove the key.
- Avoid parking on inclines. If you must park on an incline, chock the wheels to prevent the truck from moving.

Check Your Truck Before Starting Work

You must make sure that your truck is safe to use.

See your supervisor for requirements in your workplace and local laws for inspection.

Note: If anything does not look, work, feel, or sound right, do not operate your truck. Report the problem to your supervisor.

1. Walk around your truck and check it over.

- Check the harness, lanyard, snap hooks, and mounting points daily for wear or damage. Follow the manufacturers instructions for proper fit, inspection, and maintenance. **Note:** If something is not working correctly or is damaged, do not use it. Notify your supervisor.
- Turn on your truck and check that the display is working.
- Check that the power source is charged.
- Check the battery connector, battery terminals, and battery cables for damage.
For flooded lead acid batteries:
 - Check the battery compartment for spilled acid.
 - After checking the water level, make sure that the vent caps are in place.
- Make sure that the battery is secure and the battery retainers are in place.
- Make sure the flashing light is working.
- Inspect the lift chains and anchors for damage and corrosion. Make sure that the lift chains are well lubricated.

- Check that all wheels are in good condition.
- Make sure that attachments are not damaged.
- Look under your truck for signs of hydraulic leaks.
- Make sure that the forks and fork carriage are not damaged or badly worn.
- Check that the mast guards are in place without damage or cracks. Keep the mast guards clear using a clean cloth.
- Check the overhead guard for damage and cracks.
- Test the horn.
- Check the capacity plate on your truck. Make sure you use the correct units of measure.
Note: If an attachment on your truck does not match the information on your capacity plate, don't operate your truck. Notify your supervisor.
- Make sure that the emergency disconnect works.
- Check that all controls move smoothly. All controls should automatically revert to their neutral position.

Continued on next page...

2. Test drive your truck in an uncongested area.

- Make sure that the pedals work.
- In an open area, drive the truck slowly in both directions. Check braking and plugging in forward and reverse. First check at a slow travel speed, then at a faster one.
- If at any time the stopping distance is too long for you, do not drive your truck.
- Test all hydraulic functions.
- Check the indicator or steering widget on the screen. Make sure that steering is easy and smooth. Know your steer angle.



Danger

A damaged lithium-ion battery can be highly flammable. Immediately exit the area for leaking gas or liquid, excessive heat, flames, or sudden noise coming from the battery.

Alert emergency personnel or notify your supervisor. In case of contact, get medical attention.

Do not smoke, use open flame, create an arc or sparks near the battery.



Hydrogen fuel cells contain colorless, odorless and tasteless hydrogen gas that is highly flammable and could explode.

A loud rushing sound may be the only warning of a hydrogen leak and possible fire.

At any indication of a leak, turn the truck off and move yourself and all bystanders at least 10 meters (33 feet) from the truck.

Never use water on or around a fuel cell fire. Use dry chemical (ABC) fire extinguishers only.

Alert emergency personnel or call 911.

Follow all warnings, instructions and training materials provided by the fuel cell manufacturer.

Power Sources

Your truck can be designed to use the following power sources:

- Flooded Lead Acid Batteries
- Lithium-Ion Batteries
- Fuel Cell Power Packs

Only Crown approved power sources are permitted to be used in your truck. Only authorized service personnel are permitted to modify the power source installed in your truck.

Note: Follow the manufacturer's specification and instructions when handling power sources.

Working with Power Sources

Your company should provide an area that is safe to work on power sources. Use that area for all power source work and charging.

- Do not charge or refuel a power source unless you are trained and authorized.
- Do not remove or install a power source unless you are trained and authorized.



Power Source Status

The widget shows how much energy is available in the power source. The energy level is shown in the center of the widget and in the icon on the status bar.

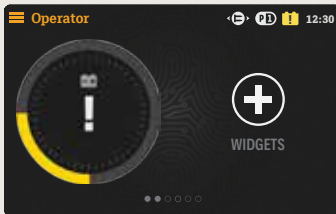

When the energy level is low, the widget turns yellow showing an exclamation point in the center. The icon on the status bar turns yellow and flashes. Change, recharge, or refuel the power source.

 **Caution****Avoid damaging the power source**

Power sources that are not properly maintained will fail prematurely.

Always follow the manufacturer's instructions for the power source.

Before Charging Power Sources

- Read the instructions for the charger and power source.
- Make sure that the charger has the correct voltage and amperage for the power source.
- Only charge a power source in an authorized area.

Charging a Flooded Lead Acid Battery

1. Turn off your truck.
2. Unplug the power source connector from the truck.
3. Follow the charging instructions from the power source manufacturer.

When charging is complete, unplug the charger and plug the power source connector into the truck.

Charging a V-Force™ Lithium-ion Battery

1. Turn off your truck.
2. Plug the charger into the battery charge port.
3. Follow the charging instructions for the V-Force lithium-ion battery.

Opportunity charge during breaks or whenever the truck is not being used.

When opportunity charging is complete or the battery is fully charged, unplug the charger from the battery charge port.

 **Caution**

Avoid damaging the truck and power source charger

Make sure that the power source charger is plugged into the power source connector, not the truck connector.



Danger

Lead acid batteries produce gas that can explode

You can cause sparks which can damage the battery.

- Never let anything conductive like metal touch the top of the cells. Use an insulator such as plywood, when necessary.
- Never smoke or use an open flame around batteries.
- Make sure that the battery cells are filled to the proper level.
- Ventilate well when in an enclosed area and when charging.

Avoid contact with battery acid

Battery acid can cause severe burns.

- Use protective equipment such as gloves, eye shields, aprons, etc.
- In case of contact, remove clothing. Flush skin and eyes immediately and thoroughly with water.
- Get medical attention if your eyes are affected.

Removing the Battery

Before removing a battery, perform the following steps:

1. Park on a level floor.
2. Lower the forks completely.



Disconnecting the Battery

- 1 Battery Connector
- 2 Battery Cable

To disconnect the battery, perform the following steps:

1. Turn off your truck and remove the key if equipped.
2. Disconnect the battery connector.
3. Place the battery connector and battery cable on top of the battery.

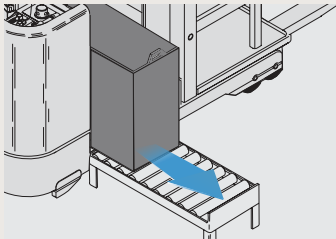
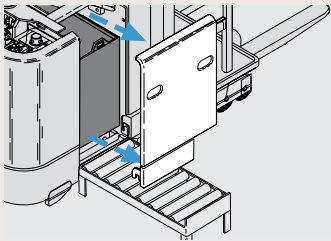

Rolling out the Battery

Make sure that the roller stand fits your truck and battery.

1. Place the roller stand next to the truck.
2. Lift up and pull out the battery retainer.
3. Move the battery onto the roller stand.

Continued on next page...

Warning

Check the size and type of the battery

An incorrect battery can affect truck handling and stability causing an accident.

Make sure that you use the correct size, type, and weight of battery.

Check the battery retainer

Unsecured batteries can slide or roll out of the truck.

Make sure that all battery retainers are installed before operating your truck.

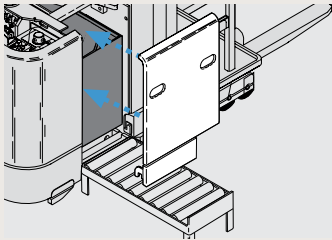

Installing the Battery

Make sure that the new battery is ready for use. Place the battery connector and battery cable on top of the battery.

1. Install the new battery.
2. Replace the battery retainer. Make sure that the retainers on both sides of the truck are in place.
3. Connect the battery to the truck.
4. Turn on your truck and check truck operation.

Follow the on-screen messages.

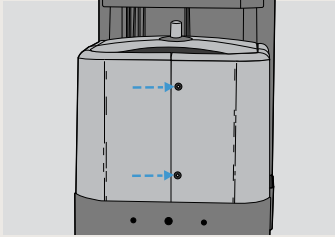

Note: Make sure you know your Truck Type. See **Capacity Plate** on page 36. For EE Truck Types, make sure to lock the battery retainer.

Each Warning Label On Your Truck Is Important
Read and obey all of them to protect yourself and others.

**ANCHORAGE POINT
ONE PERSON
22.2kN (5,000 lbs.) RATING**

▲ DANGER



A damaged lithium-ion battery can be highly flammable.
Immediately exit the area for leaking gas or liquid, excessive heat, flames, or sudden noise coming from the battery.

Alert emergency personnel and notify your supervisor. In case of contact, get medical attention.

Do not smoke, use open flame, create an arc or sparks near this battery.

600125-900-004A

▲ WARNING



Falling objects or lowering forks can cause serious injury or death.

Never stand under the forks.
While servicing, block the forks so they won't fall.

▲ DANGER



Hydrogen fuel cells contain colorless, odorless and tasteless hydrogen gas that is highly flammable and could explode. A loud rushing sound may be the only warning of a hydrogen leak and possible fire.

At any indication of a leak, turn the truck off and move yourself and all bystanders at least 10 meters (33 feet) from the truck.

Never use water on or around a fuel cell fire. Use dry chemical (ABC) fire extinguishers only.

Alert emergency personnel or call 911.

Follow all warnings, instructions and training materials provided by the fuel cell manufacturer.

8234-A

▲ DANGER



Batteries produce explosive gas.
Do not smoke, use open flame, or create an arc or sparks near this battery. Ventilate well in enclosed areas and when charging.

Batteries contain Sulfuric Acid which causes severe burns. Do not get in eyes, on skin, or clothing. In case of contact, flush immediately. Get medical attention if your eyes are affected.

107

▲ WARNING



06

▲ WARNING

Minimum battery size allowed
000 mm (00.00 in.) wide
000 mm (00.00 in.) long

Undersize battery can affect truck handling and stability. You could have an accident.

Use U.L. classified Type EO battery.

▲ DANGER



Falling from a raised platform can cause a serious injury or death.

Attach safety harness and lanyard before operating truck.

600157-900A

▲ WARNING



Standing or riding on the forks can cause a fall. You can be seriously injured or killed.

Never stand or ride on forks for any reason.

600156-900A

▲ DANGER

This truck is EE rated. Adding electrical devices could cause a fire or explosion, as well as void the EE rating.

Written approval must be obtained from Crown prior to adding electrical device(s).

Prior to use, inspection of installed device(s) must be performed by an appropriate nationally recognized testing laboratory (i.e. Underwriters Laboratories Inc) or the Authority Having Jurisdiction (see NFPA 505).

854-A

▲ WARNING

Operate this truck only with an approved electric power source.

This truck as designed and manufactured from the factory is qualified for use with a lead acid battery and if configured, Crown V-Force products.

Written approval must be obtained from Crown prior to installation of a new type of electric power source. OSHA 1910.178 (a)

8695-A

▲ WARNING



Avoid being crushed. Keep head, arms, hands, legs, and feet within the operator area. **Stop truck completely before getting off.**



Tipovers and falls can cause serious injury or even death. Do not overload truck. **Use extreme caution near docks or on dockplates.**

600155-900A

▲ WARNING



It's the law, you must be trained and certified to operate this truck.
(OSHA § 1910.178, Rev. 1999)

You or people around you could be seriously injured or even killed if you don't use this truck correctly.

Obey all warnings and instructions on the truck and in the operator manual*.
Inspect your truck before starting work, make sure it is in good working order.

* Additional copies of the Operators Manual and Truck Labels can be obtained from Crown Equipment Corp.

crown.com

600159-200A

Trademarks

The following trademarks are property of Crown Equipment Corp. in the United States and other countries.

Your truck is equipped with the following standard features and may be equipped with optional features.

The logo for ecologic™, featuring the word "ecologic" in a green, lowercase, sans-serif font with a trademark symbol.The logo for Crown Insite™, featuring the word "Crown" in a small, grey, sans-serif font above the word "Insite" in a larger, bold, grey, sans-serif font. A stylized signal icon is positioned above the "i" in "Insite".The logo for genā., featuring a stylized fingerprint icon in orange and yellow, followed by the word "genā." in a lowercase, sans-serif font.

Options:

The logo for InfoLink™, featuring the word "Info" in orange and "Link" in grey, with a stylized "i" icon in orange and grey.The logo for V FORCE, featuring a stylized "V" in orange and grey, followed by the word "FORCE" in a bold, italicized, black, sans-serif font.

