

# Operator Manual





## WARNING

**It's the law, you must be trained and certified to operate this truck.**

(OSHA § 1910.178, Rev. 1999)

You or others around you can be seriously injured or even killed if you don't use this truck correctly.

Read and obey all warnings and instructions in this Manual\* and on the truck.

Falling from a platform can cause serious injury or death.  
**Put on the operator harness and attach lanyard before operating the truck.**

Head, arms, hands, legs or feet outside the operator area can be pinned or crushed whenever the truck is moving. Stay within the operator area and **stop the truck completely before getting off.**

A dockboard can move or drop while you are on it. Or you could drive off a dock. Falls from docks or dockboards can cause serious injury or even death. **Make sure you are safe.**

Inspect your truck before starting work, make sure it is in good working order.

\* Additional copies of this Operator Manual and all Truck Labels can be obtained from Crown Equipment Corporation, New Bremen, Ohio 45869 U.S.A.

All rights reserved under International and Pan American copyright conventions  
Copyright 2007 Crown Equipment Corp.

# You Must be Trained



## IT'S THE LAW, YOU MUST BE TRAINED AND CERTIFIED

Federal law states that only properly trained operators are permitted to operate a powered industrial truck and that your employer must train you and certify that you are qualified to operate this powered industrial truck. (OSHA §1910.178, Rev. 1999)

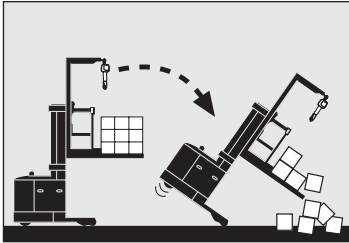

**Do not operate this truck** in your work place until you have been trained and certified by your employer.

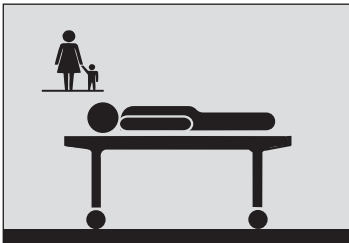

**You could be killed or seriously injured** if you are not adequately trained for lift truck operation!

# Protect Yourself

## Know the Hazards



### WEAR YOUR OPERATOR HARNESS

Falls from a platform can cause serious injury or even death.

- Put on your operator harness and attach the lanyard before operating your truck. Read the warnings on the harness.
- Check your harness and lanyard daily. Have them replaced if they have ever been used to stop a fall, or if they look damaged or worn.

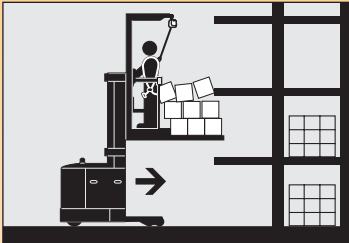

### LOOK WHERE YOU'RE DRIVING

- If you run into things you can be injured. You could fall from the truck or the load could shift and hit you. Make certain there is nothing in your path, on the floor or sticking out of the racks.
- Always be alert to the area around you and watch where you are driving.
- Be sure that any equipment added to your truck (terminal, fan, clipboard, etc.) does not block your vision or interfere with safe and efficient operation of your truck.



### USE YOUR TRUCK SAFELY

- Make sure your pallet, cart or fork mounted platform is secure and won't slide or tip.
- Keep hands and feet away from all moving parts such as masts or wheels. Don't sit or stand on the side gates.
- Never stand on or under the forks, or allow anyone else to stand on or under them. Never allow passengers on the truck. There is no safe place for them.
- Come to a complete stop before you leave your truck. Lower the forks to the floor and shut the truck off with the key switch.



## Know the Hazards

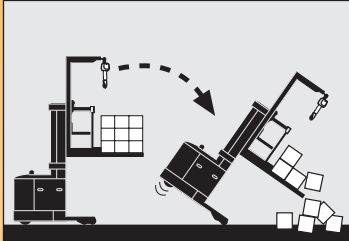

### AVOID FALLS AND TIPOVERS

Tipovers are very serious accidents, you can be crushed or even killed. The best way to prevent injury is to know where you are at all times and follow the rules of safe truck operation. There is no sure way to avoid injury during a tipover or a drop from a dock or dockboard.

- Be extremely careful when working around docks and dockboards. Stay away from the edge.
- When you're not picking, travel with the load or forks close to the ground. Watch for overhead obstructions. Perform all truck movements smoothly and at a speed that will give you time to react in an emergency.
- Stockpickers should not be used on ramps or grades. If you must drive on a grade, travel slowly and never turn the truck. If carrying a load, point the forks upgrade. If unloaded, point the forks downgrade. Keep the fork height below 300mm (12inches).
- An unloaded truck can tip over also. You must be just as careful using an unloaded truck as you are using a loaded one.



### DRIVE CAREFULLY

- Keep your hands on the controls and your entire body in the operator area. A foot or hand caught between the truck and a fixed object will be crushed or even cut off.
- Keep your truck under control at all times. Drive at a speed that allows you to stop safely. Be even more careful on slippery or uneven surfaces. Do not drive over objects on the floor.

# Contents

Warning	1
You Must be Trained	2
Protect Yourself	3
Contents	5
What's in it for You?	6
Your Stockpicker	7
Lift Truck Parts	9
Capacity & Load Center	11
Capacity Plate	13
Display Panel Standard	15
Driving on Wire Guidance	19
Power On & Off	21
Foot Brake	22
Traveling & Plugging	23
Raise & Lower	25
Platform Safety	27
Daily Safety Check	29
Be a Safe Driver	31
Battery Maintenance	35
Warning Labels	40

## Capacity & Display Center

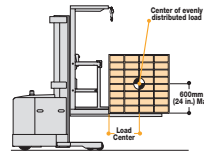

### WHAT IS YOUR TRUCK CAPACITY?

Capacity is the load (including pallet, cart, container etc.) that can be lifted to a given height at a given load center. See the capacity plate on your truck. Make certain you use the correct units of measure.

### WHAT IS LOAD CENTER?

Load center is the distance from the end of the operator platform to the center of an evenly distributed load.

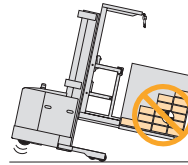

### LOADS MUST BE EVENLY DISTRIBUTED

Your truck could tip over, in any direction, if a load is placed or shifted to the front, back or side of a pallet, cart, platform or container. Make sure you spread the load evenly as you load a pallet.

SAMPLE

# What's in it for You?

## WHAT'S IN IT FOR YOU?

The better you understand your truck and how to use it, the better and safer operator you can be. Here are some guides to using this manual.

### QUICK LOCATORS

In addition to the "Contents" page you can use page headings to find topics. Some pages also have a picture of the truck in the corner showing features or functions covered on that page.

### "KNOW THE HAZARDS"

Watch for and read these special blocks. You will find information about possible safety hazards and how to avoid them.

### HOW-TO-DRAWINGS

On many pages you will find pictures as well as text to help you understand how to use your truck safely and productively.

### Know the Hazards

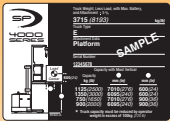

#### KNOW YOUR LOAD

Do not exceed the capacity shown on your truck's capacity plate. Be careful when handling long, high or wide loads. Do not handle unstable loads.

#### EXCEEDING TRUCK CAPACITY CAN CAUSE AN ACCIDENT

Know the capacity of your truck as shown on your capacity plate. Make certain you use the correct units

of measure. Pay attention to:

- Weight of load plus attachments
- Load center
- Lift height

#### CENTER THE LOAD

Your truck could tip over if a load is placed unevenly to the front, back or side of a pallet or cart. Make sure your load is evenly distributed and centered over the forks.



Capacity & Load

# Your Stockpicker

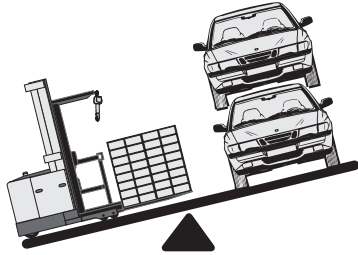

## STOCKPICKERS

Your Stockpicker is designed mainly for orderpicking. It is not as efficient as other type trucks if it is used to transport or stack loads.

## YOUR LIFT TRUCK IS NOT AN AUTOMOBILE

With a load it may weigh more than 2 automobiles.

- You don't brake the same.
- You don't accelerate the same.

## HOW TO DRIVE YOUR TRUCK

Wear your harness and attach the self-retracting lanyard or energy absorber. See chart below

Put the side gates down. Make sure the pallet, cart or platform is secure. Put your left hand on the steering wheel, right hand on the speed control and one foot on the brake pedal. Look in the direction you're going.

## GIVE YOUR BODY A BREAK

Take advantage of stop time. Flex your arms and legs. Staying alert will help you be a better and safer driver.

## FALL PROTECTION / PREVENTION SELECTION CHART

Fall Protection Devices	Operator Weight kg (lbs.)			Contact Crown
	< 141 kg <sup>1</sup> (<311 lbs.) <sup>1</sup>	141-181 kg <sup>1</sup> (311 - 400 lbs.) <sup>1</sup>	>181 kg <sup>1</sup> (>400 lbs.) <sup>1</sup>	
Full Body Harness	X	X	X	Contact Crown
Energy Absorber - max total length 1.8m (6ft)	X <sup>2</sup>			
Self-Retracting Lanyard - max total length 2.4m (8ft)		X	X <sup>3</sup>	

- 1) Truck capacity shall be reduced by the operator(s) weight in excess of 100kg (220 lbs)
- 2) Energy Absorbing Lanyard is prohibited by CAL-OSHA in the state of California.
- 3) All components of the fall protection system shall be rated for the operator's weight.



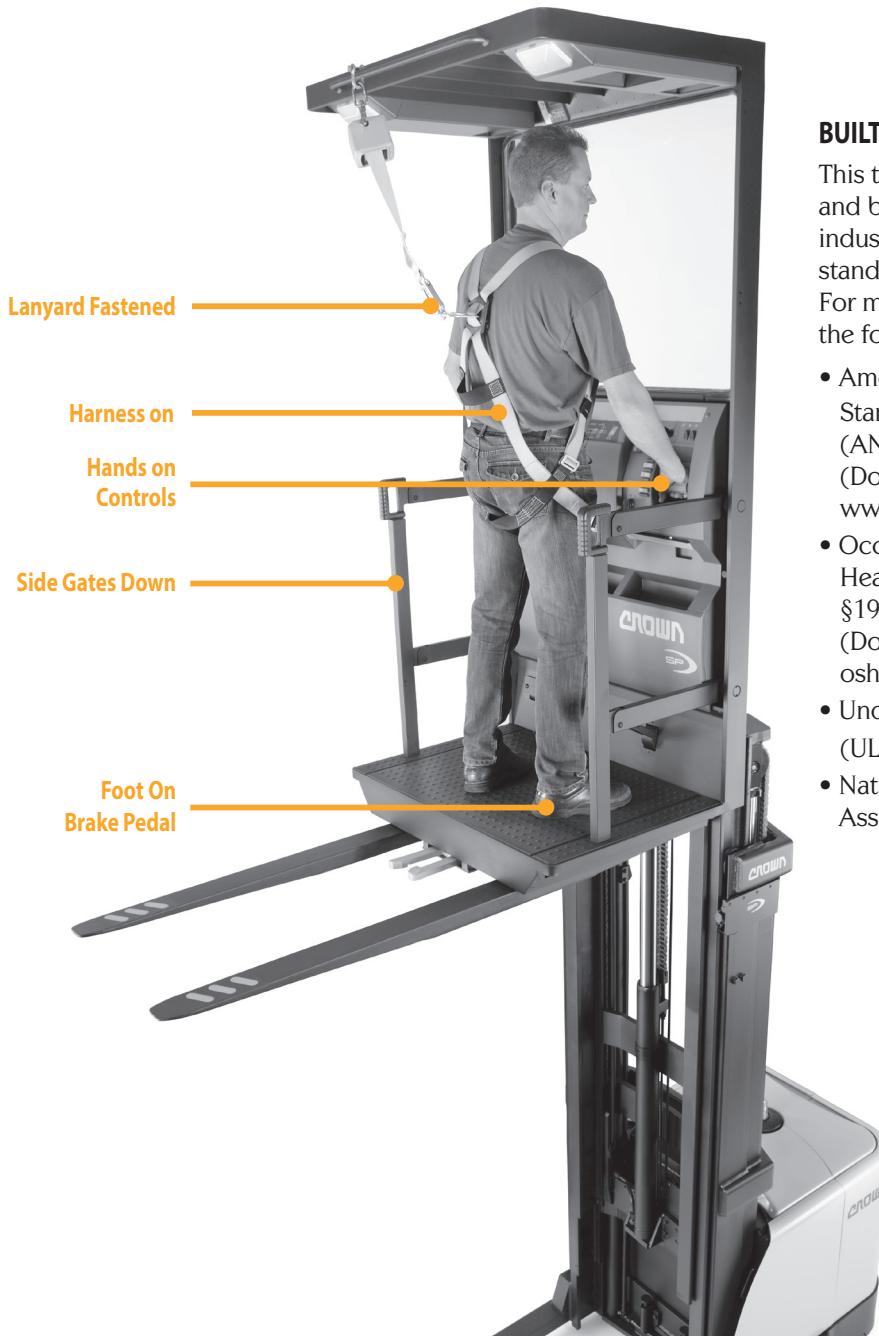

## **BUILT TO STANDARDS**

This truck was designed and built to current industry and government standards and guidelines. For more information see the following:

- American National Standards Institute (ANSI / ITSDF) B56.1 (Download free from [www.itsdf.org](http://www.itsdf.org))
- Occupational Safety and Health Act (OSHA) §1910.178 Rev. 1999 (Download free from [osha.gov](http://osha.gov))
- Underwriters Laboratory (UL) 583
- National Fire Prevention Association (NFPA) 505

# Lift Truck Parts

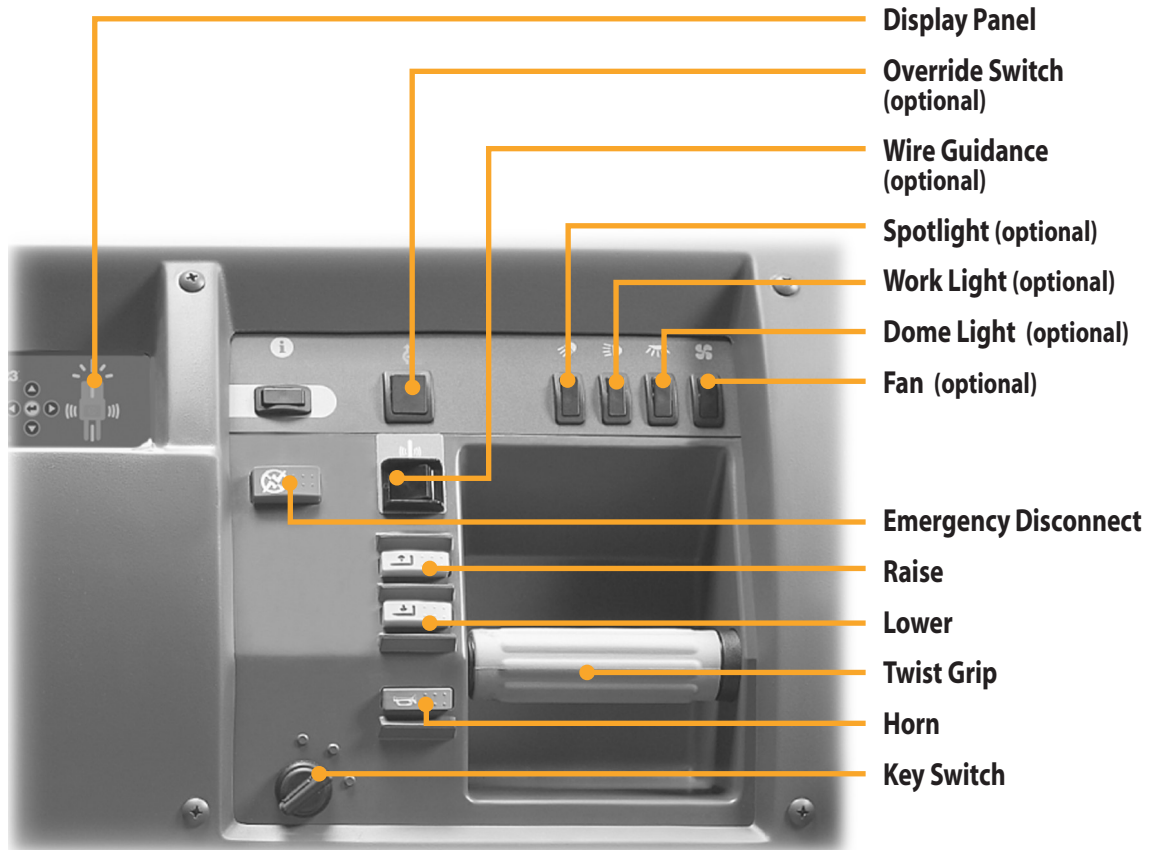

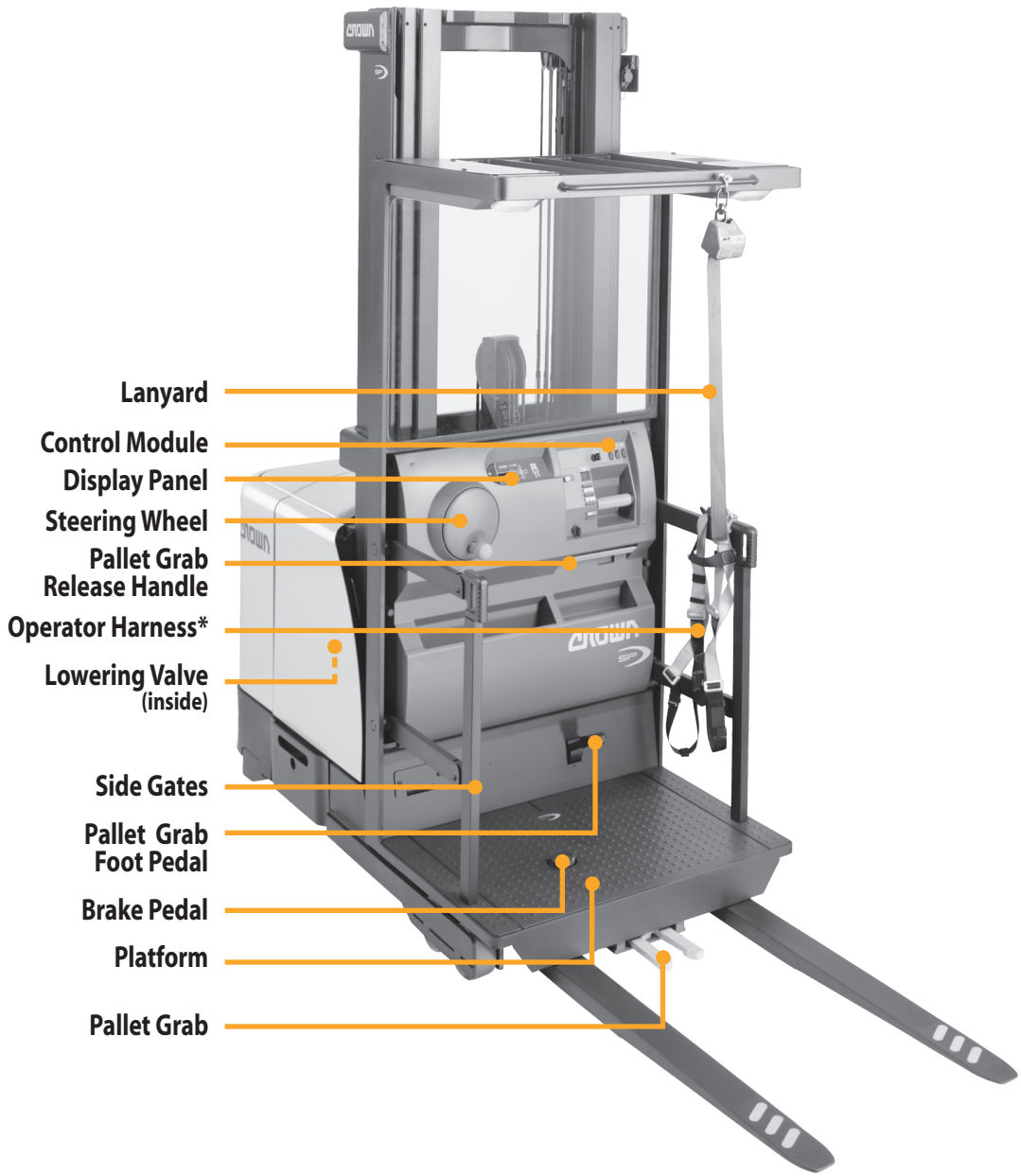

- Lanyard
- Control Module
- Display Panel
- Steering Wheel
- Pallet Grab Release Handle
- Operator Harness\*
- Lowering Valve (inside)
- Side Gates
- Pallet Grab Foot Pedal
- Brake Pedal
- Platform
- Pallet Grab

\*See page 7 for Lanyard & Harness information

# Capacity & Load Center

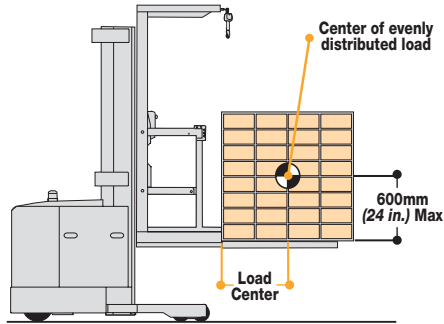
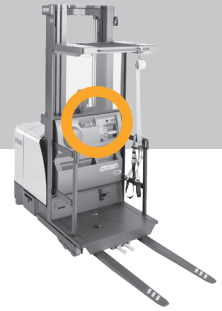

## WHAT IS YOUR TRUCK CAPACITY?

Capacity is the load (including pallet, cart, container etc.) that can be lifted to a given height at a given load center. See the capacity plate on your truck. Make certain you use the correct units of measure.

## WHAT IS LOAD CENTER?

Load center is the distance from the end of the operator platform to the center of an evenly distributed load.

## LOADS MUST BE EVENLY DISTRIBUTED

Your truck could tip over, in any direction, if a load is placed or shifted to the front, back or side of a pallet, cart, fork mounted platform or container. Make sure you spread the load evenly as you load a pallet.

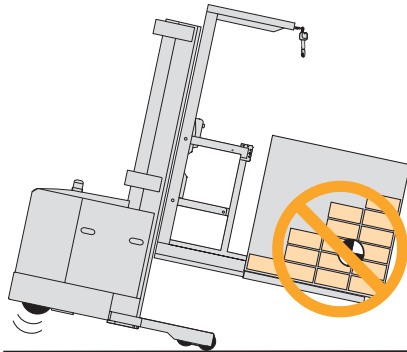

## Know the Hazards

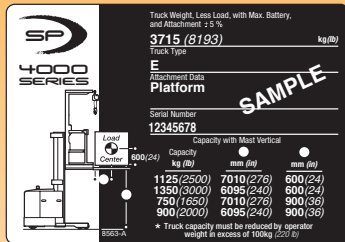

### KNOW YOUR LOAD

Do not exceed the capacity shown on your truck's capacity plate. Be careful when handling long, high or wide loads. Do not handle unstable loads.

### EXCEEDING TRUCK CAPACITY CAN CAUSE AN ACCIDENT

Know the capacity of your truck as shown on your capacity plate. Make certain you use the correct units of measure. Pay attention to:

- Weight of load plus attachments
- Load center
- Lift height
- Operator weight

### CENTER THE LOAD

Your truck could tip over if a load is placed or shifted to the front, back or side of a pallet or container. Make sure your load is evenly distributed and centered over the forks.



# Capacity Plate



## CAPACITY PLATE INFORMATION

The capacity plate is on a console in the operator area. It contains:

- Serial number
- Capacity information (load, load center and lift height)
- Truck type (a fire safety rating)
- Truck Weight, Less Load, with Max. battery, and Attachment  $\pm 5\%$
- Attachment information (if any)
- Mast collapsed height

## AFTER AUGUST 2017: READING YOUR CAPACITY PLATE

Capacity may be reduced as lift height **C** increases.  
*For example: On the sample plate, 1350kg (3000 lb) can be lifted to 6095mm (240 in). But above 6095 (240), to 7010 (276), capacity is reduced from 1350 (3000) to 1125 (2500).*

Capacity is reduced as load center **A** increases.  
*For example: On the sample plate, 1350kg (3000 lb) can be lifted if the load center is 600mm (24 in). But if the load center is increased to 900 (36), capacity is reduced from 1350 (3000) to 900 (2000).*

**SAMPLE CAPACITY PLATE**  
 The information shown on this sample plate does not apply to your truck.

Truck Weight, Less Load, with Max. Battery, and Attachment  $\pm 5\%$   
**3715 (8193)** kg (lb)

Truck Type  
**E**

Attachment Data  
**Platform**

Serial Number  
**12345678**

Capacity kg (lb)	Capacity with Mast Vertical	
	<b>C</b> mm (in)	<b>A</b> mm (in)
<b>1125 (2500)</b>	<b>7010 (276)</b>	<b>600 (24)</b>
<b>1350 (3000)</b>	<b>6095 (240)</b>	<b>600 (24)</b>
<b>750 (1650)</b>	<b>7010 (276)</b>	<b>900 (36)</b>
<b>900 (2000)</b>	<b>6095 (240)</b>	<b>900 (36)</b>

\* Truck capacity must be reduced by operator weight in excess of 100kg (220 lb)

### Note:

ANSI/ITSDF B56.1 requires that all data be shown first in Metric units and then USA units.

### CAUTION:

You may not increase capacity if load center is less than shown on your capacity plate.

Truck capacity must be reduced by operator weight over 100kg (220)lbs.

## OTHER LIFT HEIGHTS & LOAD CENTERS

Contact Crown for capacities at lift heights or load centers not given on your capacity plate.

## BEFORE AUGUST 2017: READING YOUR CAPACITY PLATE

Capacity may be reduced as lift height **A** increases. *For example: On the sample plate, 1350kg (3000 lb) can be lifted to 6095mm (240 in). But above 6095 (240), to 7010 (276), capacity is reduced from 1350 (3000) to 1125 (2500).*

Capacity is reduced as load center **B** increases. *For example: On the sample plate, 1350kg (3000 lb) can be lifted if the load center is 600mm (24 in). But if the load center is increased to 900 (36), capacity is reduced from 1350 (3000) to 900 (2000).*

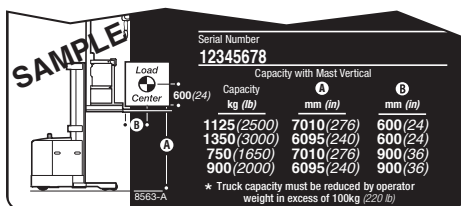

**Caution:** You may not increase capacity if load center is less than shown on your capacity plate. Truck capacity must be reduced by operator weight over 100kg (220)lbs.

**Note:** ANSI/ITSDF B56.1 requires that all data be shown first in Metric units and then USA units.

## ! Know the Hazards

### TRUCK WEIGHT

Dockboards, elevators and some floors have limited capacity. Check your capacity plate for the weight of your truck. Remember to add the weight of the load you have on the forks. Make certain you use the correct units of measure.

### TRUCK TYPE

Some truck types are not permitted in areas where there are fire hazards. Watch for marked areas. *For example: You must not drive a type E or ES truck into an area restricted to EE or EX trucks.*

### ATTACHMENT DATA

If an attachment on your truck does not match the information given here on your capacity plate, don't operate your truck. Your capacity plate may be wrong. Report the problem to your supervisor.

# Display

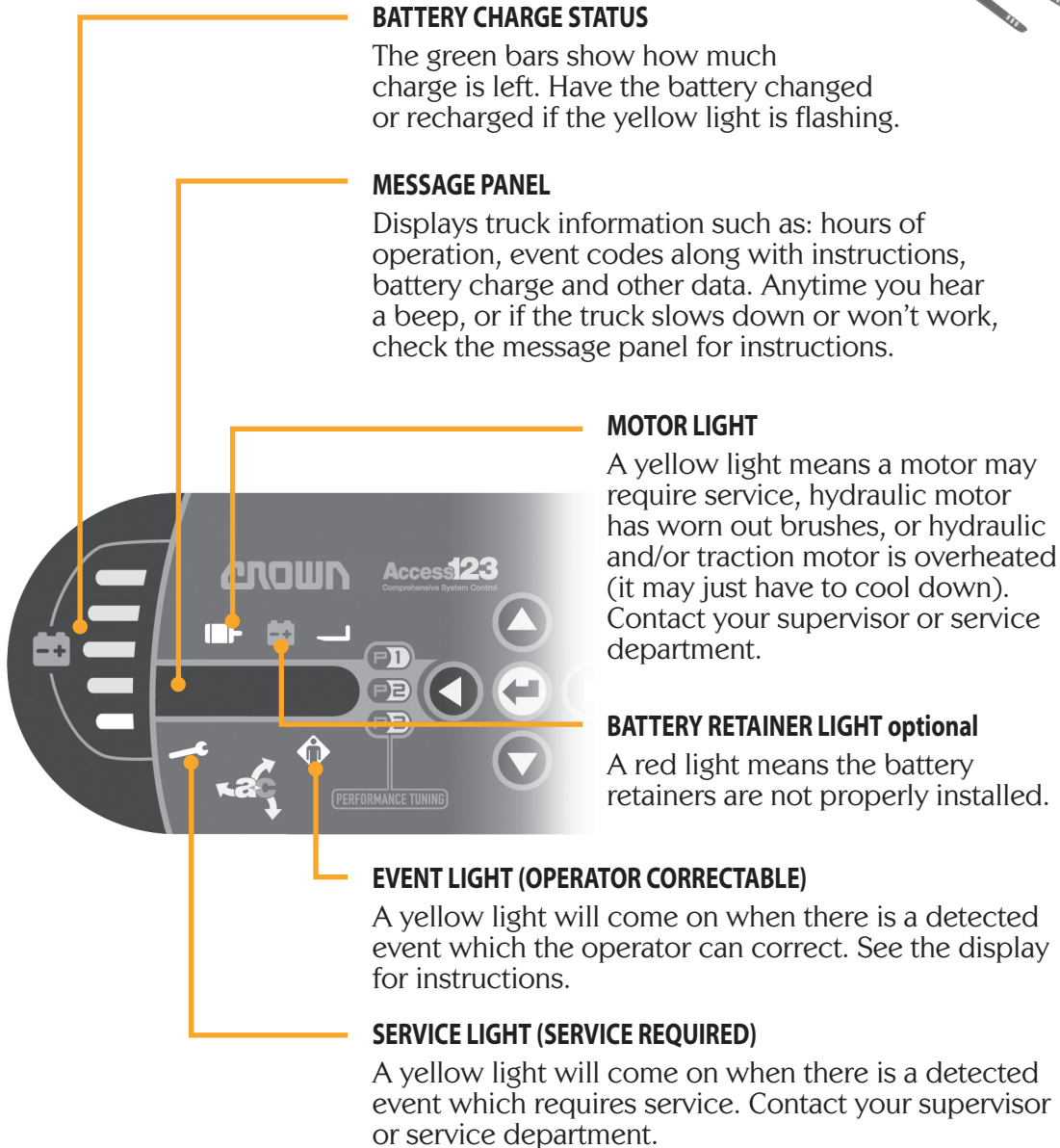
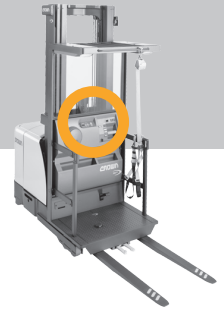



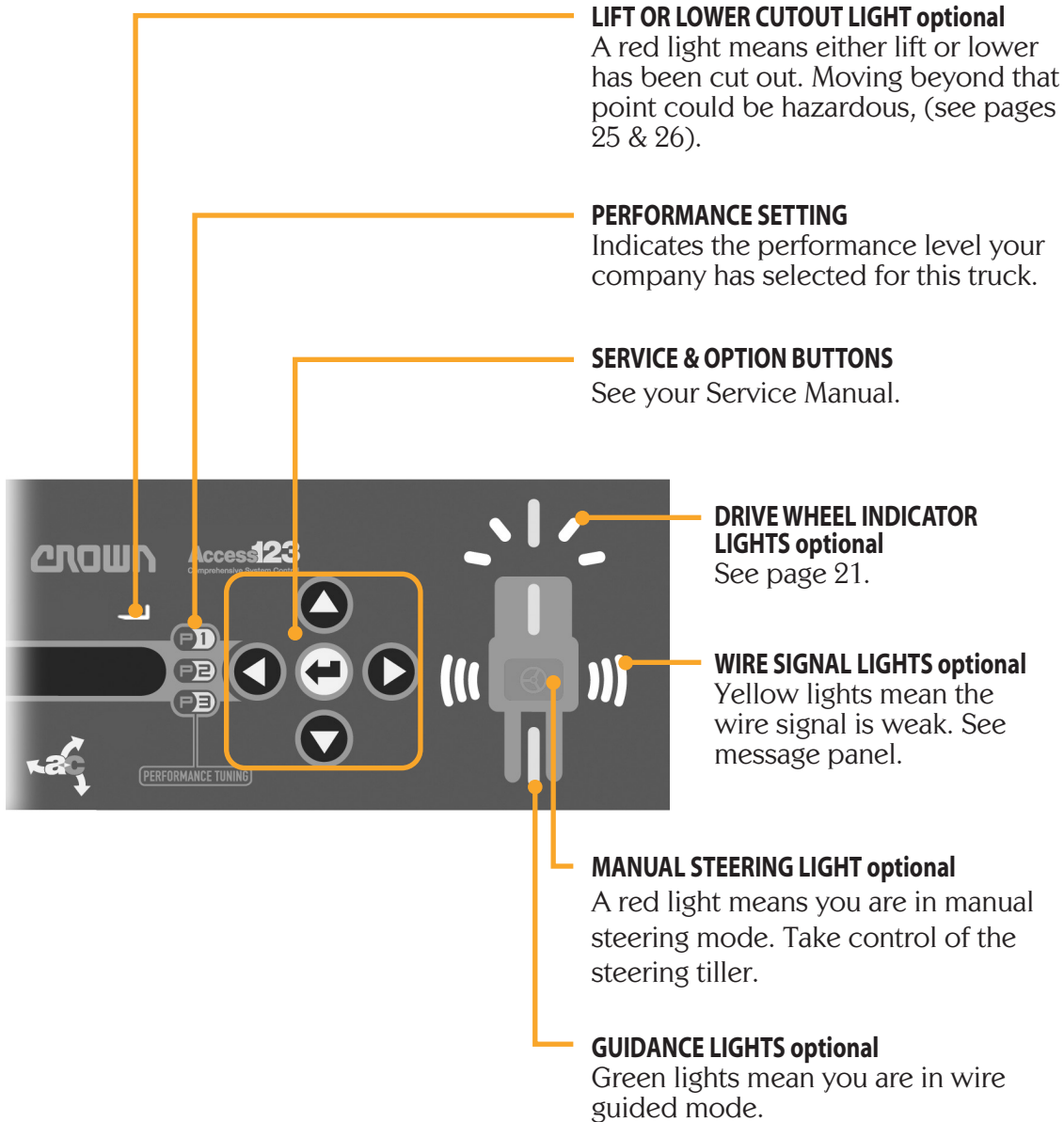

This page  
left blank  
intentionally.

This page  
left blank  
intentionally.

# Driving on Wire Guidance

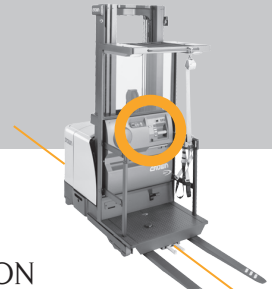

## ACQUIRING THE WIRE

Push the Wire Guidance switch to ON as you near a guided aisle. Drive slowly with the platform about 300mm (12 inches) above the floor, and center the truck over the wire. Your direction of travel (power unit first or forks first) controls how you should approach the guidance wire.

**Note:** Power unit first is the recommended direction of travel for acquiring the wire.

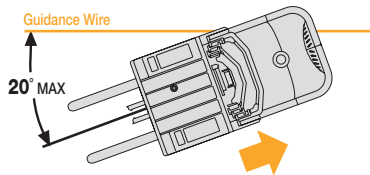

## POWER UNIT FIRST

Drive slowly over the wire at an angle of 20° or less. When you hear a "beep" and the red light turns off, the truck takes control of steering. Start slowly.

## FORKS FIRST

If you must acquire the wire while traveling forks first: Drive slowly along the wire (no angle allowed) until you hear a "beep" and the red light turns off.

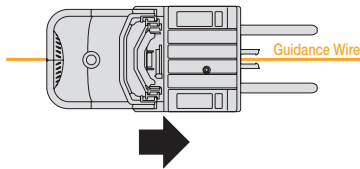

Continue to drive slowly for two truck lengths before resuming normal guided driving.

## AUTOMATIC SLOW DOWN

While traveling on guidance, your truck may slow down automatically for certain conditions.

- Low signal strength from the wire.
- Truck deviates slightly from the wire.
- End of Aisle Control (optional) is activated.

## AUTOMATIC STOP

Your truck may stop automatically for certain conditions.

- Signal strength from the wire is lost or is too low.
- Acquiring the wire at an angle greater than 30°.
- Truck deviates too far from the wire.
- End of Aisle Control (optional) is activated.

## FOR MANUAL STEERING

Take control of the steering handle, toggle the guidance switch OFF.

**Note:** Whenever guidance is OFF, the red light on the display will be on to remind you that you are in manual steering.

If the wire sensing option is turned on, the red light will flash and the "beeping" will speed up, to notify you that the truck senses a wire.

## WHEN DRIVING ON THE WIRE

Watch where you're going. Make sure your path is clear.

Drive slowly and be alert for "beeps" from the alarm or changes in the display that signal changes in guidance status.

## END OF AISLE CONTROL OPTION

With this feature, your employer can program your truck to either slow down or stop automatically when it comes to the end of an aisle. You will hear a "beep" and the indicator light will turn on.

Return the travel control to neutral, press the Override Switch and resume travel.

## Know the Hazards

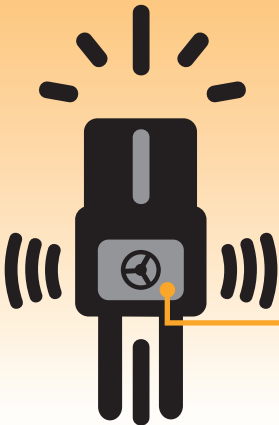

### STAY ALERT

You must be just as careful and alert while driving on guidance as you are when driving with manual steering.

- Start slowly and look where you're going.
- Always be prepared to steer manually.
- Make sure there is nothing in your path, on the floor or sticking out of the racks.

### LISTEN FOR THE "BEEP", CHECK THE DISPLAY

- Take control of the steering any time the red light is on, and check the display if you hear a "beep".

# Power On & Off

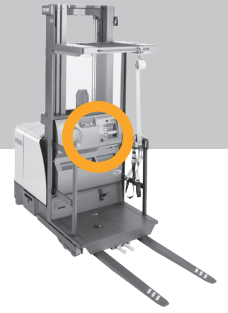

## KEY SWITCH

- Turn the key sideways to TEST. Check that the alarm and all display lights are working.
- Let go of the key and it will return to ON.
- Turn the key vertical to shut the truck off. Always turn the key to OFF when leaving the truck.



## EMERGENCY DISCONNECT

Anytime the truck isn't working right, first stop the truck and then press the emergency disconnect to cut power to all truck functions, including steering.

Don't use the truck. Report the problem to your supervisor.

Turn the key switch to OFF and back to ON to reconnect the battery and reset the emergency disconnect button.



## DRIVE WHEEL DIRECTION INDICATOR (without wire guidance opt.)

When you first step on the brake pedal, and until the truck begins to travel, the display will show the approximate drive wheel position.

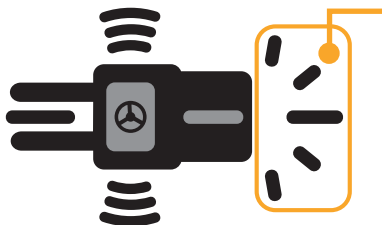

## DRIVE WHEEL DIRECTION INDICATORS (with wire guidance opt.)

The green light in the center shows you that the drive wheel is straight (within 1 degree).

The yellow lights to either side show the approximate position of the drive wheel while turning.



### **BRAKE OFF**

Step all the way down on the brake pedal. The brake is "off" and you can travel.

**Note:** Slowing or stopping the truck by plugging (see page 23), requires power to the drive motor. You must have the brake pedal all the way down for plugging to work.



### **BRAKE ON**

Take your foot off of the brake pedal to apply the brake. When you release the brake pedal, power is cut to the drive motor. Remember, with the brake applied, you can't use plugging, (see page 23).

## **Know the Hazards**



### **MAKE SURE YOUR BRAKES WORK**

Test the brake on your truck at the start of each shift. Know the distance it takes to stop before you start working.

If at any time the stopping distance is too long for you to stop safely, don't drive the truck. Report any problem to your supervisor.

# Traveling & Plugging

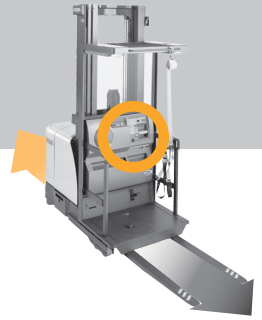

## TRAVEL, POWER UNIT FIRST

Rotate the top of the twist grip away from you to travel in the direction of the power unit (power unit first).

The farther you rotate the grip from the neutral position, the faster the truck will travel.



## TRAVEL, FORKS FIRST

Rotate the top of the twist grip toward you to travel in the direction of the forks (forks first).

The farther you rotate the grip from the neutral position, the faster the truck will travel.



## PLUGGING

Plugging is another way to slow down or stop your truck. While the truck is moving, in either direction, rotate the twist grip through neutral to the opposite direction of travel.

Plugging does not hurt your truck.



## STEERING RESTRICTIONS

For stability, steering angle is limited at certain lift heights. Check the display. The drive wheel direction indicator will flash if the truck is operating at a restricted steering height.

## TRAVEL RESTRICTIONS

For stability, travel speed is reduced for various combinations of lift height and drive wheel steering angle.





### **HORN**

Use the horn button to sound the horn. Use it to warn pedestrians and other drivers.

Use your horn when you come to an intersection or a crosswalk.

## **Know the Hazards**

### **EMERGENCY DISCONNECT**

The Emergency Disconnect cuts power to all truck functions, including steering. The parking brake will be applied.

See page 21 for correct use of emergency disconnect.

### **PLUGGING VS. BRAKING**

Of the two, the foot brake is designed to stop the truck in the shortest distance. Use the foot brake in an emergency, on ramps or in busy areas.

Plugging works only when you have the brake pedal all the way down. When you take your foot off the brake pedal you will not be able to plug.



### **SLOW DOWN FOR SPILLS OR WET FLOORS**

Powder or liquid spills can cause slippery floors. Slow down or you could lose control of steering and braking. Be careful and allow for a longer stopping distance.

Don't run over objects on the floor.

### **LOOK WHERE YOU'RE GOING**

Travel in the direction where you have the best visibility.

# Raise & Lower

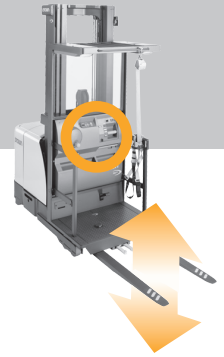

## RAISE

Push the Raise button to raise the platform and forks. Release the button when you reach the desired height.

If your truck has optional two speed lift, or variable speed lift, the farther you push the raise button the faster the forks will raise.



## LOWER

Push the Lower button to lower the platform and forks. Release the button when you reach the desired height.

Your truck has two lowering speeds. Push the lower button all the way for a fast lowering speed, and part way for a slower lowering speed.

**Note:** The model SP4000 is equipped with variable speed lowering as standard.



## OVERRIDE SWITCH OPTION

Your truck may be equipped with automatic cutout of raise and lower at selected heights.

If Raise or Lower stops and the red fork on the display panel is lit, you are at a raise or lower cutout height. You can use the Override Switch to travel past that height.

To travel past the cutout height, push the Override Switch while, at the same time, pushing either the Raise or Lower button.

Be very careful and watch that you don't raise, lower or drive into obstructions when using the Override Switch.

**Note:** The Override Switch is also used with the End of Aisle Control Option. See page 20.

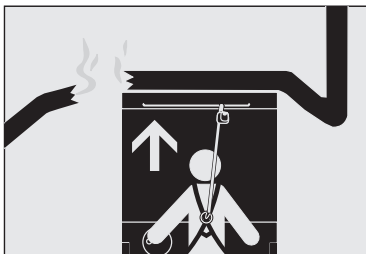

### CHECK YOUR DISPLAY

If your truck won't raise, lower, travel, or operates at a reduced speed, check the message panel on the display.

### MANUAL LOWERING

If normal lowering does not operate, a manual lowering valve is located behind the power unit door. Call for authorized assistance to help lower the platform to the ground.

**Note:** Always be alert to a display message or any other indications that the lift chains have become slack. A slack chain condition can cause serious injury by allowing the platform to drop suddenly. Stop lowering immediately if chains become slack.



## Know the Hazards



### AVOID FALLS FROM THE PLATFORM

Hitting something with the truck could cause you to fall.

**Wear your harness and lanyard at all times.**

### RAISE/LOWER CUTOUT OVERRIDE

Using the Cutout Override lets you travel or raise the platform into areas where there are obstructions and hazards such as pipes, ducts, conduits, low ceilings etc.

Hitting any obstruction could tip the truck over, causing serious injury or even death.

Watch out for obstructions anytime you're operating your truck. Be even more careful when using Cutout Override.

### SLACK CHAIN CONDITION

Always be alert for slack lift chains. This condition could allow the platform to drop suddenly and cause injury. Stop lowering immediately if chains become slack.

# Platform Safety



## WEAR YOUR HARNESS AND LANYARD

Put on your harness and fasten your lanyard as soon as you get on the platform, before you do anything else.

Check the harness, lanyard, snap hooks and mounting points daily for wear or breakage. If it doesn't look safe don't use the truck. Report the problem to your supervisor.

\*See page 7 for Harness and Lanyard information.

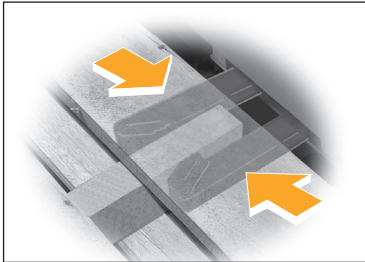

## CLAMP THE PALLET

Be careful of pallets. They can tip or slide on the forks even when properly centered and clamped. Make certain the center stringer of the pallet fits into the Pallet Grab.

Spread the forks as far as you can and don't use pallets that have missing, loose, broken or undersized boards.



### • Manual clamp

Step down on the Pallet Grab Foot Pedal to clamp the pallet. Make sure pallet is secure.

Let go of the pallet by lifting on the Pallet Grab Release Handle.

### • Electric clamp

Push the switch on the operator console to the left to clamp the pallet. Make sure pallet is secure.

Let go of the pallet by pushing the switch to the right. A light on the switch will illuminate on when the clamp is in the release position.

**Note:** If you work with a fork mounted auxiliary platform instead of a pallet, your truck may not have a Pallet Grab. Make certain the platform is fastened to the truck.

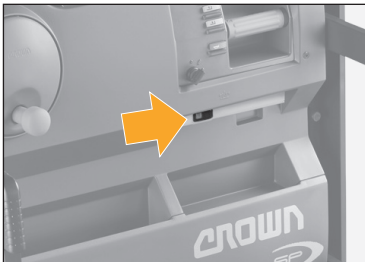

### KEEP THE SIDE GATES DOWN

- Keep the side gates down unless you are leaving the truck or picking from the side.
- Don't sit or climb on the side gates.
- Keep your entire body in the operator area.

## Know the Hazards



### FALLS CAN KILL

You can reduce the risk of injury by being extra careful while working on an elevated Stockpicker.

- Wear your harness and keep your lanyard fastened at all times.
- Put the side gates down and keep your entire body inside the operator area.
- For stability, spread the forks as far as you can and make certain the pallet or fork mounted platform is securely fastened.
- A pallet may move or tip, even when the pallet grab is used. Work from the platform. If you must step onto a pallet, stay to the center, between the supporting forks. Never step on or near the edge of a pallet.
- Watch where you're going. Running into an object could cause you to fall.

### CHECK YOUR PALLET

Check the pallet for missing, loose, broken or undersized boards. Don't use damaged pallets.

### WORK CLOSE TO THE RACK

When picking, keep your truck close to the rack to reduce the risk of slipping or dropping things.

# Daily Safety Check



## CHECK YOUR TRUCK BEFORE STARTING WORK

You must make sure your truck is safe to use.

### 1. Walk around your truck and check it over.

- Inspect your harness, lanyard, snap hooks and mounting points. Have them replaced if they look damaged or worn or have ever been used to stop a fall.
- Clean the safety shield and keep it clear.
- Check to make sure the battery is charged, water level is OK and vent caps are in place. Don't use an open flame to check the battery.
- Make certain the battery retainers on both sides of the truck are properly installed.
- See that all wheels are in good condition.
- Make sure the flashing light is working.
- Check that both forks are secure and not bent, cracked or badly worn.
- Inspect lift chains for damage.
- Look under the truck for signs of hydraulic leaks.
- Turn the key to TEST. See that the alarm and all display lights are working. Try the horn.
- Make sure the emergency disconnect works.

## **2. Test drive your truck in an uncongested area.**

- Try the hydraulic functions.
- Check that the steering is easy and smooth.
- Drive the truck slowly in both directions.
- Drive through the full speed range in both forward and reverse.
- Check braking and plugging distances in forward and reverse. Load size and floor conditions can affect these distances.
- Know the distance it takes to stop before you start working. If the braking distance is too long to stop safely, don't drive the truck.
- Check wire guidance operation.

**If anything doesn't look, work or feel right, don't drive the truck. Report the problem to your supervisor.**

*You can get checklist forms from your Crown dealer (part no. OF-3772). Used properly, this checklist can alert service people to needed repairs.*

# Be a Safe Driver

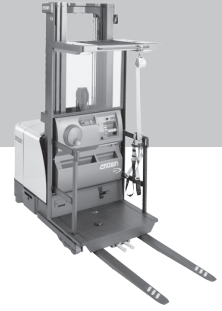

*The most  
important  
component  
is you.*



## **MAKE SURE YOU ARE READY TO DRIVE**

- Do not use this truck unless you are trained and certified.
- Be certain you understand how your truck works and the hazards that go with it. Don't drive the truck if you have any doubts.
- Know the capacity of your truck (Load Weight, Load Center and Lift Height). Make certain you use the correct units of measure.
- Some trucks are not allowed in areas where there are fire hazards. Be certain your truck is the correct fire safety type for the area.
- Make sure your hands and shoes are clean and dry, and your clothing is proper for the job.

## **MAKE SURE YOUR TRUCK IS READY**

- Inspect your truck before using it (see pages 29 and 30). If it's not working right, or something is broken, report the problem. Don't use the truck.
- In an open area, test the braking and plugging. Check at a slow travel speed first, then a faster one. Know the distance it takes to stop before you start work.





### **DRIVE CAUTIOUSLY, BE ALERT**

- Always wear your harness and have the lanyard fastened. See page 7 for Harness and Lanyard information.
- Make certain pallets and fork mounted platforms are secure.
- Never stick a foot, arm or any part of your body outside the operator area, no matter how slow the truck is moving. A foot or hand caught between the truck and a fixed object will be crushed or even cut off.
- Keep your hands on the controls and your foot on the brake pedal.
- Travel in the direction that gives you the best view. Look where you are going and slow down in congested areas.
- Slow down for wet or slippery floors. Don't run over things.
- Travel with the platform close to the ground when outside of an aisle. Place the load against the end of the platform.
- Look where you are going before you change direction of travel.
- See that you have room to drive and turn. Check for overhead objects also. Watch out for power unit and fork (load) swing. Slow down when making turns.
- Avoid sudden movement of controls. Learn to use them smoothly at a moderate, even rate.
- Check clearances before raising or lowering the forks or load. Watch for overhead obstructions.
- Be extra careful if you must use your truck in an area where there is a risk of falling objects.

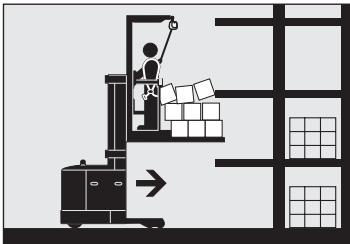

*Continued next page...*

# Be a Safe Driver continued

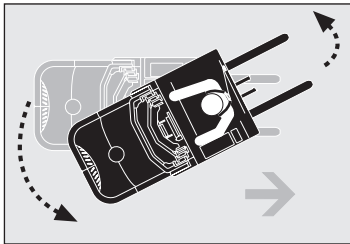
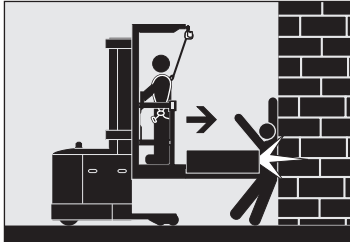
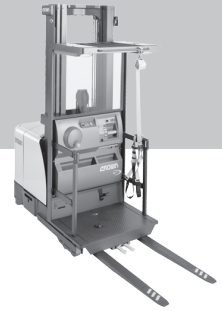

## WATCH OUT FOR OTHER PEOPLE

- Slow down. Yield or stop for pedestrians. Use your horn when you come to a crosswalk or intersection.
- Be careful that you don't pin or crush someone. *For example: Never drive your truck toward anyone standing in front of a fixed object.*
- Watch out for power unit and fork (load) swing when turning.
- Never allow passengers on your truck.
- Keep others away from your truck while you're working. Don't ever allow anyone on or under the load or forks.
- Don't let anyone use your truck unless they are trained and certified.
- Never lift anyone with the forks unless they are using an approved fork mounted work platform. Even then use extreme caution:
  - Use a securely attached and approved safety platform.
  - Make certain lifting mechanism is operating properly.
  - Make certain truck is in neutral and brake is applied.
  - Lift and lower slowly.
  - Watch for overhead obstructions.
  - Be sure you can see and hear the person being lifted.
  - Never transport anyone on the platform from one location to another.



### **AVOID FALLS AND TIPOVERS**

- Be extremely careful when working around docks, ramps and dockboards. Stay away from the edge.
- Check capacities. Be sure your truck, with load, isn't too heavy for where you are driving.
- Make sure the load you are moving is stable. Spread the forks as far as you can and center the load. Insert the forks as far under the load as you can. Be even more careful with long, high or wide loads. They can be less stable.
- Watch out for overhead obstructions.
- Stockpickers should not be used on ramps or grades. If you must drive on a grade, travel slowly and never turn the truck. If carrying a load, point the forks upgrade. If unloaded, point the forks downgrade. Keep the fork height below 300mm (12 inches).



### **LEAVING YOUR TRUCK**

- Stop your truck completely before getting off.
- Lower the forks to the floor and turn the truck off.
- Avoid parking on inclines. But if you must, block the wheels of your truck.

# Battery Maintenance

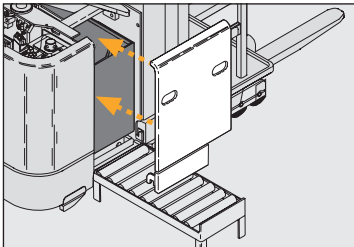
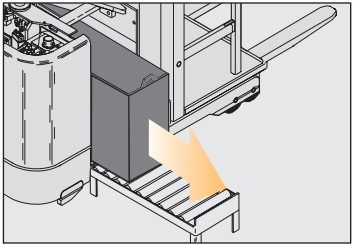
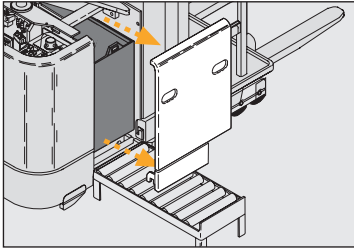
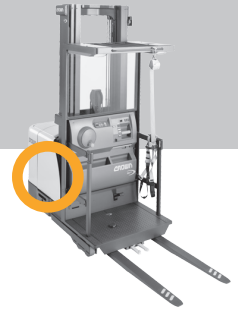

## WHEN YOU INSTALL OR CHANGE BATTERIES

- Turn the truck OFF. Check that all controls are in neutral. Disconnect the battery.
- Make certain you use the correct size and weight battery. Never operate a truck that has an underweight or undersized battery installed.
- Use a roller stand to install or remove a battery. Make sure the roller stand is the same height as the rollers in the truck's battery compartment. Also make sure the roller stand is at least as long as your battery.
- Never let anything metal touch the top of the cells. You could cause sparks or do damage to the battery. Use an insulator (such as plywood) when necessary.
- Use an approved spreader bar to place a battery on, or remove it from a stand. Make sure you adjust the spreader bar hooks to fit the battery.

## AFTER INSTALLING YOUR BATTERY

- Replace the battery retainers. Make certain all retainers on both sides of the truck are in place.
- Connect the battery. Turn the truck ON and check truck operation.

## Know the Hazards

### DANGER



**Batteries produce explosive gas.**  
Do not smoke, use open flame, or create an arc or sparks near this battery. Ventilate well in enclosed areas and when charging.

Batteries contain **Sulfuric Acid** which causes severe burns. Do not get in eyes, on skin, or clothing. In case of contact, flush immediately. Get medical attention if your eyes are affected.

107

### TRUCK BATTERIES CAN BE DANGEROUS

Your truck battery produces fumes that can explode. It also contains acid that could burn or disfigure you.

- Do not try to install, remove, charge or service your truck battery unless you are trained and authorized.
- Never smoke or use an open flame around batteries.
- Your company should provide an area where it is safe to work on batteries. Use that area for all battery work.
- Use protective equipment such as gloves, eye shields, aprons etc.

### BATTERY RETAINERS

The battery could slide out if all retainers are not in place. Check both sides of the truck.

### WARNING

**Minimum battery size allowed**  
**000 mm (00.00 in.) wide**  
**000 mm (00.00 in.) long**

Undersize battery can affect truck handling and stability. You could have an accident.

Use U.L. classified Type E battery

### BATTERY SIZE

Make certain you use the correct size and weight battery. Never operate a truck that has an underweight or undersized battery installed.

*Continued next page...*

# Battery Maintenance continued

## Know the Hazards



### **BEFORE CHARGING YOUR TRUCK BATTERY**

- Charge the battery only in areas designated for that use.
- See that the battery cells are filled to the proper level. Never use an open flame to check the battery.
- Make certain the charger is the same voltage and amperage as your battery.
- Read the battery charger instructions.
- Be sure the charger is turned OFF before connecting the battery to the charger. Otherwise you might create a spark which could cause the battery to explode. Also, make sure the truck key switch is turned off and all controls are in the off position.

# Warning Labels

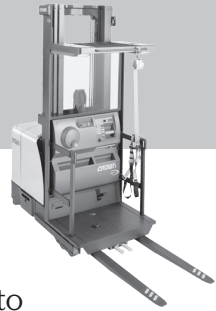

**EACH WARNING LABEL ON YOU TRUCK IS IMPORTANT**  
Read and obey all of them to protect yourself and others.

**WARNING**

**Stay clear of all moving parts.**  
Moving parts can cut or crush hands, feet, arms or legs.

07

**WARNING**

**Minimum battery size allowed**  
**000 mm (00.00 in.) wide**  
**000 mm (00.00 in.) long**

Undersize battery can affect truck handling and stability. You could have an accident.  
Use U.L. classified Type E battery

**DANGER**

**Batteries can produce explosive gas.** Do not smoke, use open flame, or create an arc or sparks near this battery. Ventilate well when in an enclosed area and when charging.

This battery contains **Sulfuric Acid** which causes severe burns. Do not get in eyes, on skin, or clothing. In case of contact, flush immediately and thoroughly with water. Get medical attention if your eyes are affected.

20

**WARNING**

**Manual Lowering Valve** ↑

**Before using valve:**

1. Make certain that area under forks is clear.
2. Warn operator to keep all body members within the operators compartment.
3. Make certain the forks are clear of the rack. Close valve immediately if chains become slack.

13

**WARNING**

**Avoid being crushed.** Keep head, arms, hands, legs, and feet within the operator area. **Stop truck completely before getting off.**

Tipovers and falls can cause serious injury or even death. Do not overload truck. **Use extreme caution near docks or on dockplates.**

264

**WARNING**

Falling objects or lowering forks can cause serious injury or death.  
**Never stand under the forks.**  
While servicing, block the forks so they won't fall.

10

**CAUTION**

Connect charger properly or truck can be damaged.

Make certain charger is plugged into the battery connector, not the truck connector.

47

**WARNING**

Standing or riding on the forks can cause a fall. You can be seriously injured or killed.  
**Never stand or ride on forks for any reason.**

16

**WARNING**

**STOP**

**It's the law, you must be trained and certified to operate this truck.** (OSHA § 1910.178, Rev. 1999)

You or people around you could be seriously injured or even killed if you don't use this truck correctly.

Obey all warnings & instructions on the truck and in the operator manual and on the truck.

\* Additional copies of the Operators Manual and Truck Labels can be obtained from Crown Equipment Corp., New Bremen, OH 45869

04

**DANGER**

Falling from a raised platform can cause a serious injury or death.  
**Attach safety harness and lanyard before operating truck.**

05

**crown.com**

All rights reserved under International and Pan American copyright conventions  
Copyright 2006 Crown Equipment Corp.



3500 • 4000 SERIES



*This operator manual has information for all models of series SP 3500 & SP 4000 plus some options and accessories. Some of the illustrations and information may not apply to your truck.*



[crown.com](http://crown.com)

*The most important component is you.*



New Bremen, Ohio 45869 USA

© 2007

PF18931

10/18

Printed in U.S.A.