

Operator Manual



You Must be Trained

WARNING

It's the law, you must be trained and certified to operate this truck.
(OSHA § 1910.178, Rev. 1999)

You or others around you can be seriously injured or even killed if you don't use this truck correctly.

Read and obey all warnings and instructions in this Manual* and on the truck.

Head, arms, hands, legs or feet outside the operator area can be pinned or crushed whenever the truck is moving. Stay within the operator area and **stop the truck completely before getting off.**

However, tipovers and falls from docks can cause serious injury or even death. **Immediately exit and move away from the truck in these emergencies.**

Inspect your truck before starting work, make sure it is in good working order.

* Additional copies of this Operator Manual and all Truck Labels can be obtained from Crown Equipment Corporation, New Bremen, Ohio 45869 U.S.A.

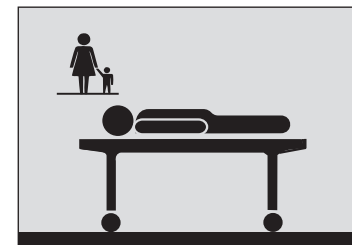
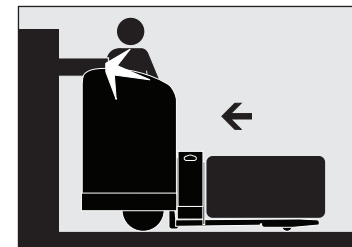

IT'S THE LAW, YOU MUST BE TRAINED AND CERTIFIED

Federal law states that only properly trained operators are permitted to operate a powered industrial truck and that your employer must train you and certify that you are qualified to operate this powered industrial truck. (OSHA §1910.178, Rev. 1999)

Do not operate this truck in your work place until you have been trained and certified by your employer.

You could be killed or seriously injured if you are not adequately trained for lift truck operation!

All rights reserved under International
and Pan American copyright conventions
Copyright 2007 Crown Equipment Corp.

Protect Yourself

! Know the Hazards



DRIVE CAREFULLY

- Keep your hands on the controls and feet on the pedals. Keep your body within the operator area.
- Never stick a foot or any part of your body outside the operator area, no matter slow the truck is moving. You cannot stop 4500kg or 10,000 pounds with any part of your body. A foot or hand caught between the truck and a fixed object will be crushed or even cut off.
- Don't put hands or arms over the load backrest.
- Stay away from the edge of docks and ramps. Make sure dockboards are secure. Check that trailer wheels are chocked. You could be seriously injured or even killed in a fall from a dock or dockboards.
- Keep your truck under control at all times. Drive at a speed that allows you to stop safely. Be even more careful on slippery or uneven surfaces. Do not drive over objects on the floor.
- Perform all tuck movements smoothly and at a speed that will give you time to react in an emergency.

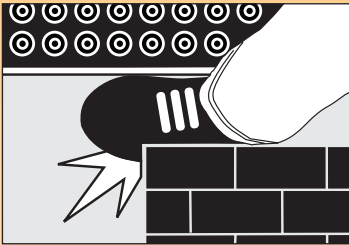

LOOK WHERE YOU'RE DRIVING

- You could be pinned or crushed by objects intruding or poking into the operator area.
- Always be alert to the area around you and watch where you are driving.

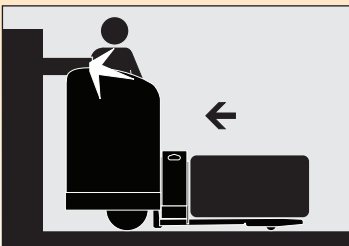

! Know the Hazards

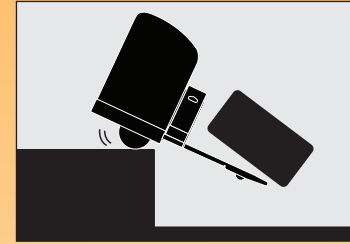

AVOID FALLS AND TIPOVERS

Falls from docks and tipovers are very serious accidents; you can be crushed or even killed. Immediately exit and move away from the truck in these emergencies.

Note: This is not like sit-down rider trucks, where it is recommended that the operator stay with the truck. The best way to prevent injury is to know where you are at all times and follow the rules of safe truck operation.

- Be extremely careful when working around docks, dockboards and trailers.



USE YOUR TRUCK SAFELY

- Keep your hands and feet away from all moving parts such as forks and wheels.
- Never allow passengers anywhere on the truck. There is no safe place for them.
- Before you leave your truck:
 - Come to a complete stop.
 - Lower the forks to the floor.
 - Shut the truck off with the key or disconnect the battery.

Contents

What's in it for You?

Warning	1
You Must be Trained	2
Protect Yourself	3
Contents	5
What's in it for You?	6
Your Rider Pallet Truck	7
Lift Truck Parts	9
Capacity Plate	11
Power On & Off	13
Display	14
Braking	15
Traveling & Plugging	17
Steering & Travel	21
Two Types of Steering	23
Additional Options	25
Daily Safety Check	27
Be a Safe Driver	29
Battery Maintenance	33
Warning Labels	38

WHAT'S IN IT FOR YOU?

The better you understand your truck and how to use it, the better and safer operator you can be. Here are some guides to using this manual.

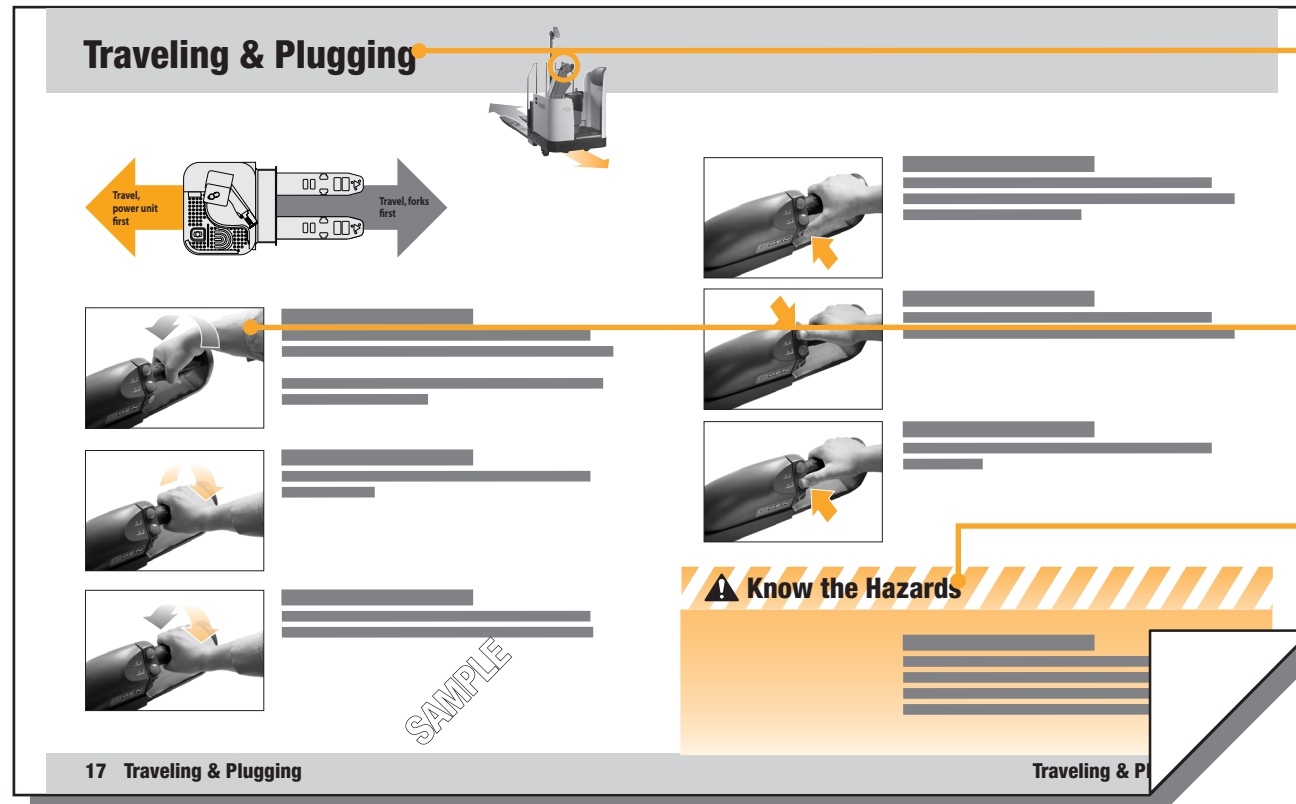

QUICK LOCATORS

In addition to the "Contents" page you can use page headings to find topics. Some pages also have a picture of the truck in the corner showing features or functions covered on that page.

HOW-TO-DRAWINGS

On many pages you will find pictures as well as text to help you understand how to use your truck safely and productively.

"KNOW THE HAZARDS"

Watch for and read these special blocks. You will find information about possible safety hazards and how to avoid them.

Your Rider Pallet Truck

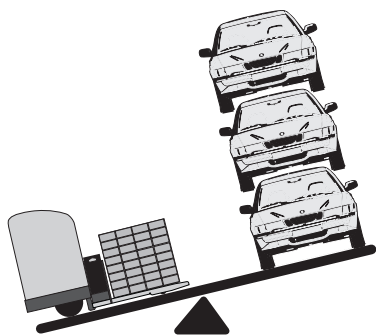

RIDER PALLET TRUCKS

Your rider pallet truck is designed to move loads over long distances.

YOUR PALLET TRUCK IS NOT AN AUTOMOBILE

With a load it may weigh more than 3 automobiles.

- You don't steer the same.
- You don't brake the same.
- You don't accelerate the same.

HOW TO DRIVE YOUR TRUCK

Stand sideways with both feet on the pedals and lean back against the pad. This, along with your hands on the controls, gives you both comfort and stability. Plus you can see and travel in either direction simply by turning your head.

GIVE YOUR BODY A BREAK

Take advantage of stop time. Get off the truck and flex your arms and legs. Staying alert will help you be a better and safer driver.

BUILT TO STANDARDS

This truck was designed and built to current industry and government standards and guidelines. For more information see the following:

- American National Standards Institute (ANSI/ITSDF) B56.1
- Occupational Safety and Health Act (OSHA) §1910.178, Rev. 1999
- Underwriters Laboratory (UL 583)
- National Fire Prevention Association (NFPA 505)

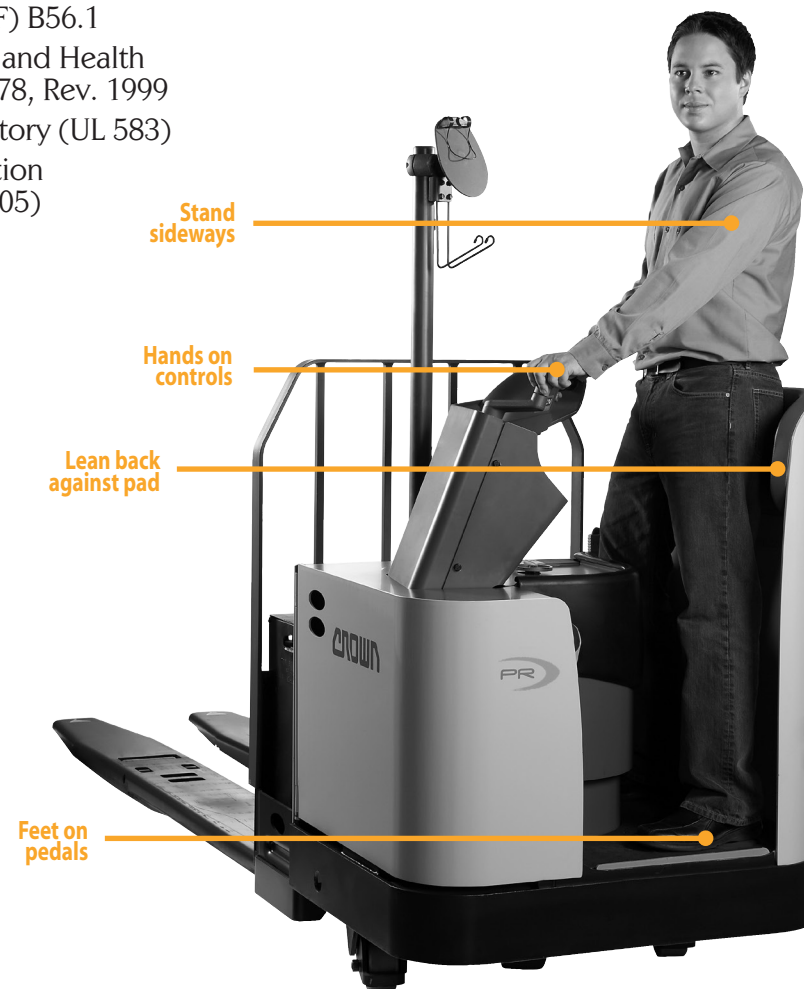

Lift Truck Parts

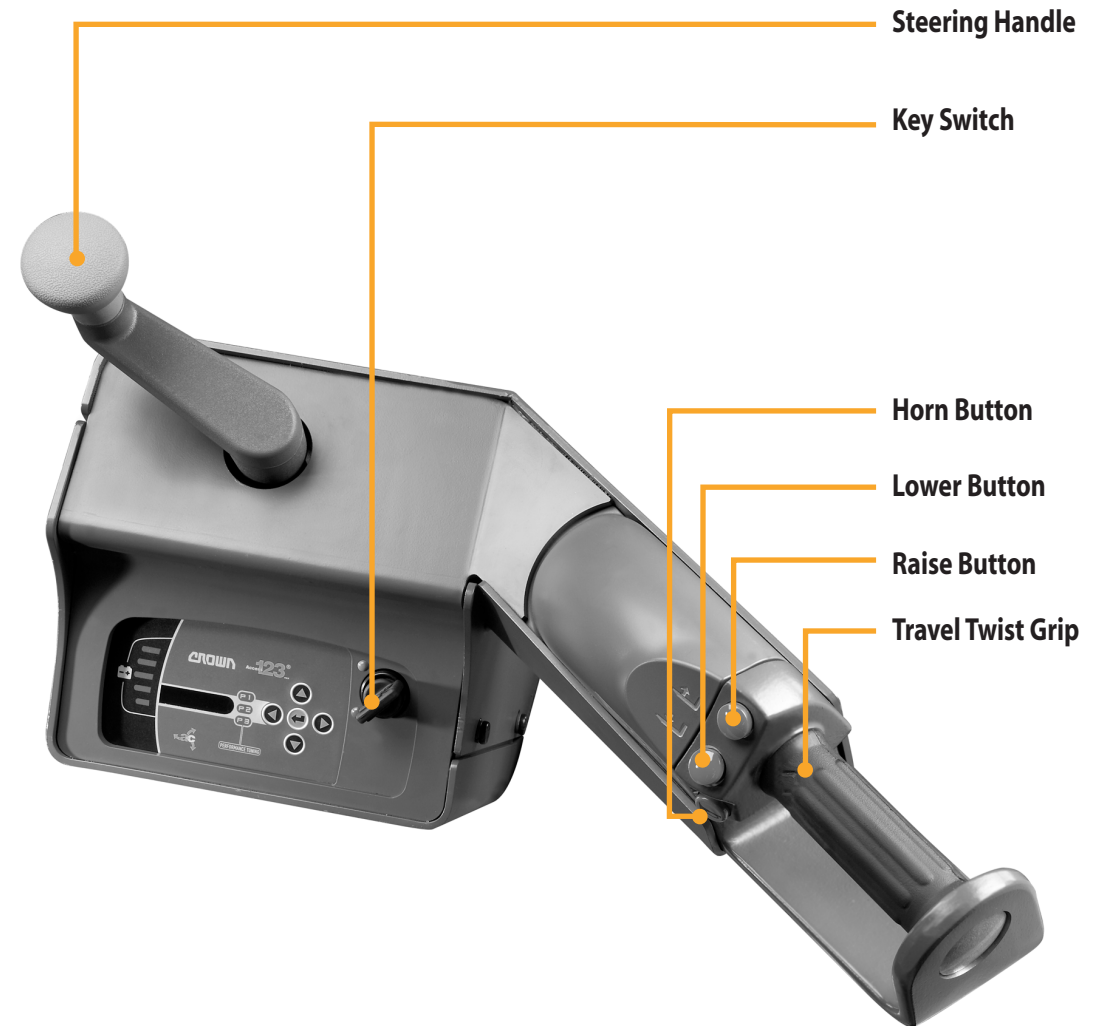
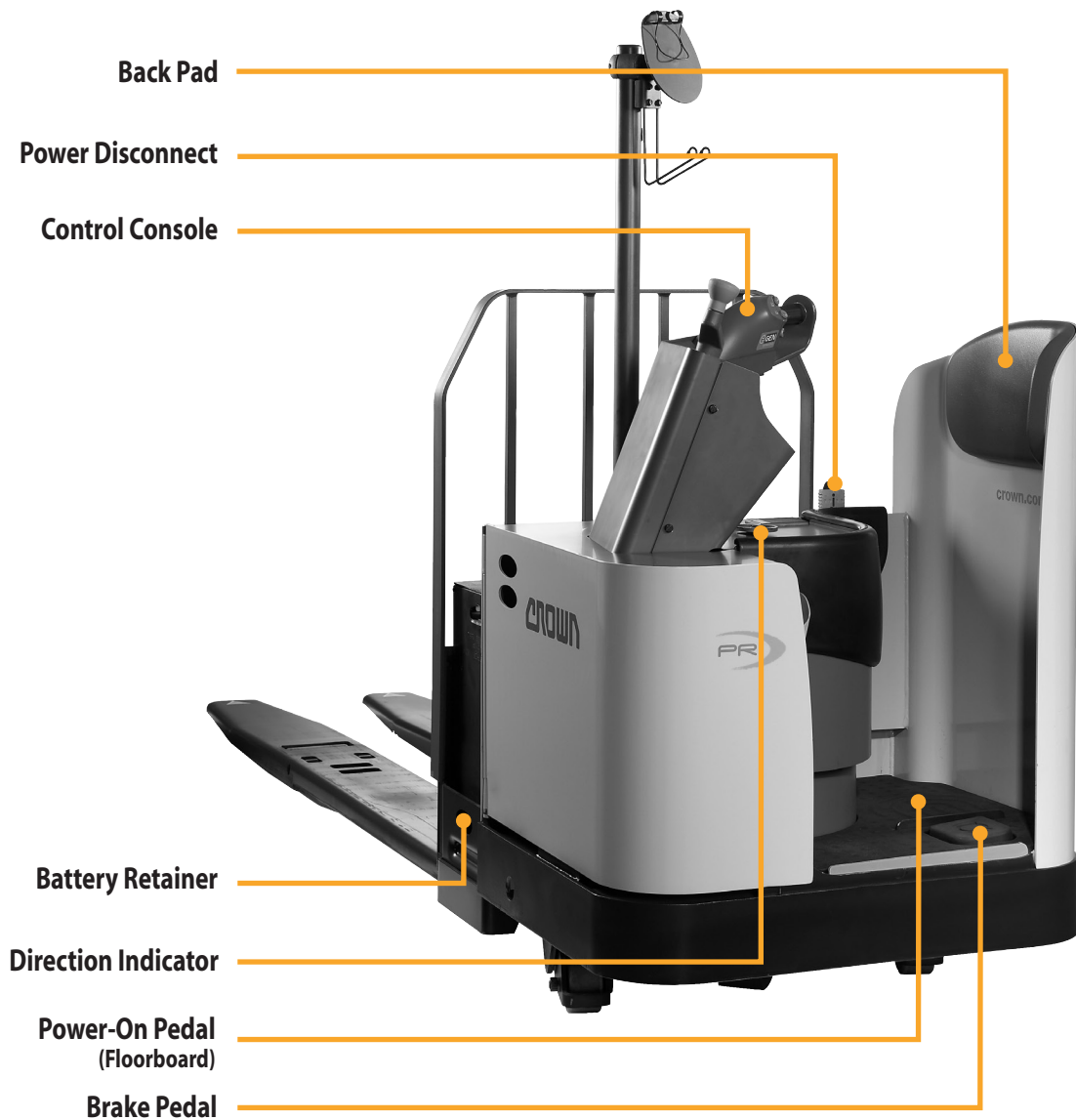

Capacity Plate



CAPACITY PLATE INFORMATION

The capacity plate is on the top of the power unit cover. It contains:

- Capacity information
- Truck type (a fire safety rating)
- Truck weight (does not include load)
- Grade rating
- Battery information
- Truck information

SAMPLE CAPACITY PLATE

The information shown on this sample plate does not apply to your truck.

WHAT IS YOUR TRUCK CAPACITY?

Capacity is the maximum load that can be lifted or transported with your truck. See the capacity plate on your truck. Make certain you use the correct units of measure.

Note: ANSI/ITSDF B56.1 requires that all data be shown first in Metric units and then USA units.

	Units of measure, kg/m (lb/in) Capacity with Equally Distributed Load	Hour Rate
	2720(6000)	3
	Truck Weight with Max. Battery	Max AMP Hr.
	1565(3452)	930
	Truck Weight Less Battery ± 5%	D.C. Voltage
	885(1952)	24
	Battery Weight	Battery Type
	Min 440(975) Max 680(1500)	E
	1234567890123456	Load Tire Tread width
	Model Number	330(12.9)
PR4540XX	Truck Type	
Serial Number	E	
6A123456		
<small>This truck as released conforms to the mandatory requirements of ASME B56.1 Crown Equipment Corporation New Bremen, Ohio 45869 USA</small>		
<small>268-E</small>		

! Know the Hazards

KNOW YOUR LOAD

Do not exceed the capacity shown on your truck's capacity plate. Be careful when handling long, high or wide loads. Do not handle unstable loads.

TRUCK WEIGHT

Dockboards, elevators and some floors have limited capacity. Check your capacity plate for the weight of your truck. Remember to add the weight of the load you have on the forks. Make certain you use the correct units of measure.

TRUCK TYPE

Some truck types are not permitted in areas where there are fire hazards. Watch for marked areas. *For example: You must not drive a type E or ES truck into an area restricted to EE or EX trucks.*

Power On & Off



Display



KEY SWITCH

Turn the key clockwise to turn the truck on.
Turn the key counter clockwise to turn the truck off.
Always turn the key off when leaving the truck.



POWER-ON PEDAL

Step down on the right pedal (floorboard). If the key is turned to ON, the steering pump will start running and you can operate the truck.

Note: You must keep the power-on pedal down for power steering and traction to work.



ENTRY BAR

Always keep your feet in the operator area and clear of the entry bar.

If you put your foot on the entry bar while traveling, the alarm will sound and the truck will slow to a stop.

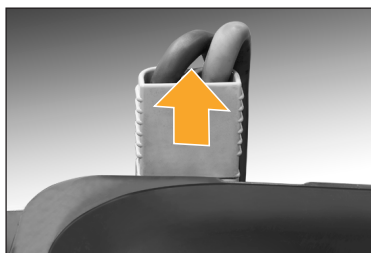

POWER DISCONNECT

Pull up on the battery connector to disconnect the battery and cut all power.

Always disconnect the battery any time the truck isn't working right. The key switch does not cut all power to the truck.

Don't use the truck if it's not working right. Report the problem to your supervisor.

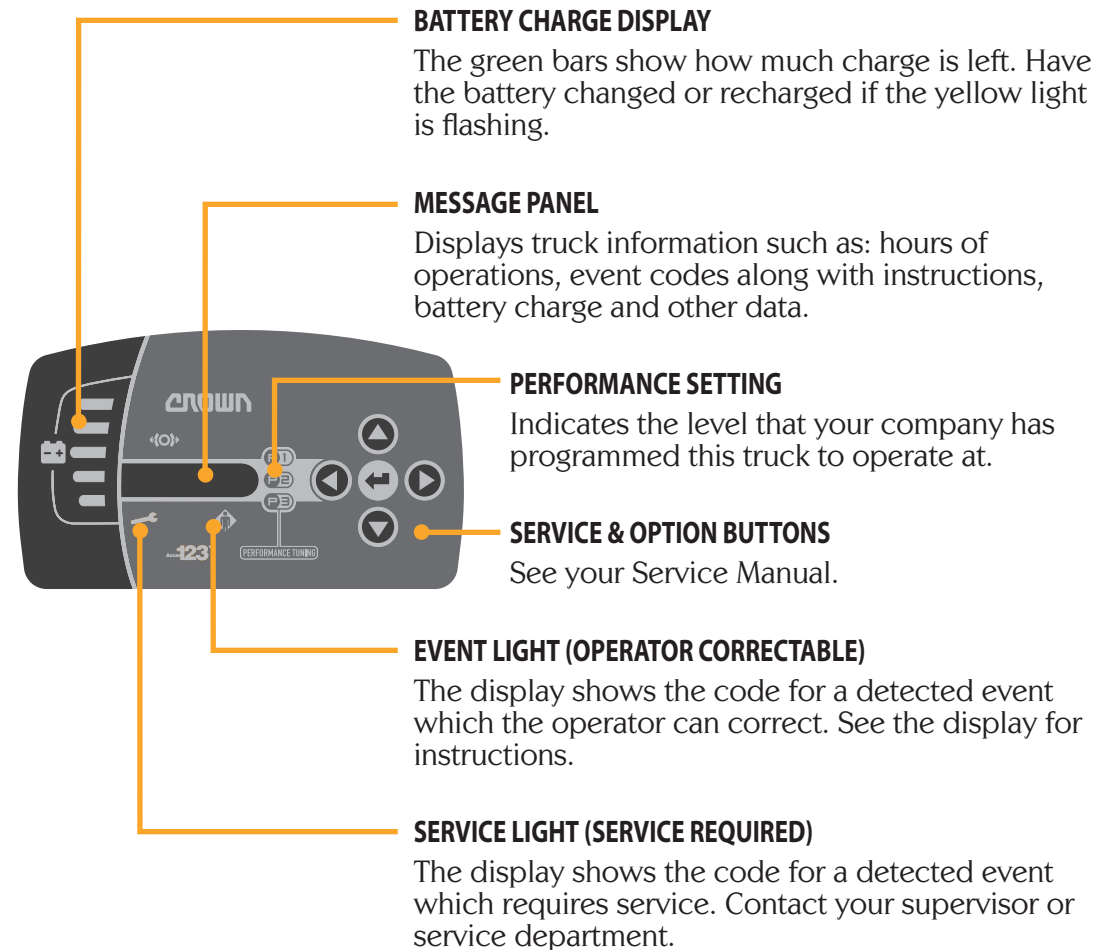

Braking



BRAKE OFF

Step all the way down on the left pedal. The brake is now "off" and you can travel.

Note: Slowing or stopping the truck by plugging (see page 17), requires the brake to be "off."



BRAKE ON

Lift your left heel. Let the left pedal come up all the way to apply the brake.

PARKING BRAKE

Bring the truck to a complete stop and let the left pedal come up all the way to apply the parking brake.

The parking brake is automatically applied when power is disconnected.

! Know the Hazards



WATCH YOUR FEET

Keep your feet inside the truck and on the pedals at all times. This truck weighs about 4500kg or 10,000 pounds. You cannot stop or even slow down that much weight with your foot or any part of your body, no matter how slow the truck is moving.

A foot or hand caught between the truck and a wall, post or any fixed object will be crushed or even cut off.

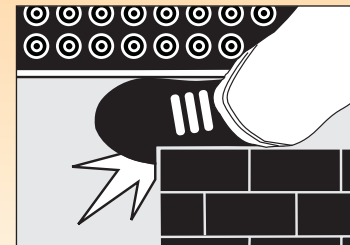

MAKE SURE YOUR BRAKE WORKS

Test the brake on your truck at the start of each shift. Know the distance it takes to stop before you start working.

If at any time the stopping distance is too long for you to stop safely, don't drive the truck. Report any problem to your supervisor.

Traveling & Plugging

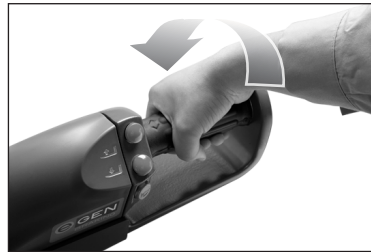
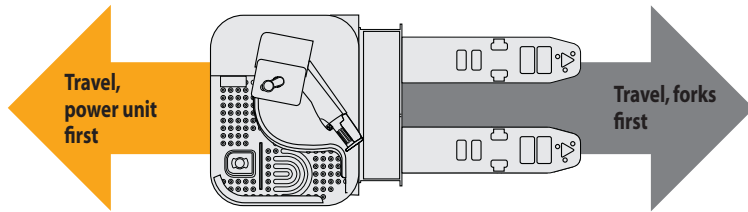

TRAVEL, FORKS FIRST

Rotate the top of the twist grip away from you to travel in the direction of the forks (forks first).

The farther you rotate the grip from the neutral position, the faster the truck will travel.

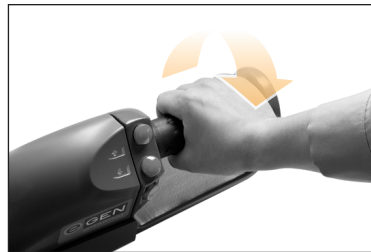

TRAVEL, POWER UNIT FIRST

Rotate the top of the twist grip toward you to travel in the direction of the power unit (power unit first).

The farther you rotate the grip from the neutral position, the faster the truck will travel.

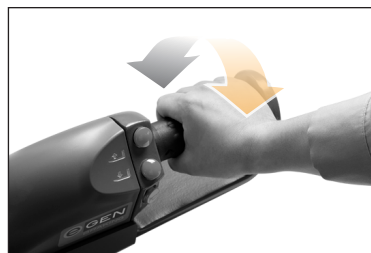

PLUGGING

Plugging is another way to slow down or stop your truck. While the truck is moving, in either direction, rotate the twist grip through neutral to the opposite direction of travel.

Plugging does not hurt your truck.

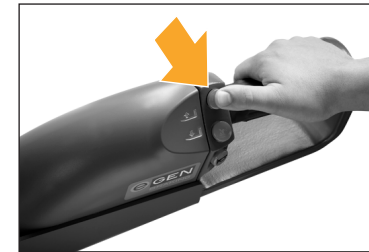

RAISE

Push the RAISE button until the forks are at the desired height.



LOWER

Push the LOWER button until the forks are at the desired height.

! Know the Hazards

LOOK WHERE YOU'RE GOING

Driver distractions can cause accidents resulting in injury or even death.

- Don't use cell phones or similar devices while operating the truck.
- Travel in the direction where you have the best visibility.

PLUGGING VS. BRAKING

Of the two, the foot brake is designed to stop the truck in the shortest distance. Use the foot brake in an emergency, on ramps or in busy areas.

Traveling & Plugging continued



HORN

Use the horn button to sound the horn. Use it to warn pedestrians and other drivers.

Use your horn when you come to an intersection or a crosswalk.

This page
left blank
Intentionally.

Know the Hazards

SIMILAR LOOKING TRUCKS CAN BE DIFFERENT

Your company has selected the options which are best for your work area.

If you ever drive a different truck, even one that looks just like yours, be careful. It may not have the same steering or options.

Steering & Travel



LIFT TRUCKS ARE NOT LIKE AUTOMOBILES

Your lift truck does not steer or drive like an automobile. Be sure you are trained to operate this truck. Drive slowly until you get used to the steering and all other controls.



STEERING AND DRIVING

You will need to drive your truck both in the direction of the forks (forks first) and also away from the forks (power unit first or forks trailing). Steering is not the same in both directions (see pages 21 and 22).

SIMILAR LOOKING TRUCKS CAN BE DIFFERENT

This style truck can be built with one of two different types of steering. Your company has selected the type which is best for your work area.

Caution: If you ever drive a different truck, even one that looks like yours, be careful. The steering may be different.

! Know the Hazards

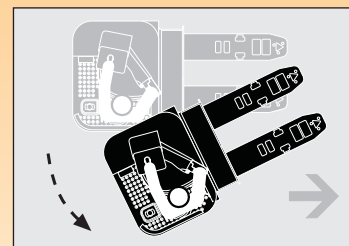

POWER UNIT SWING

Be careful turning while traveling forks first. The power unit will swing wide in the opposite direction. Make sure you have clearance, and watch out for people in the area.



SLOW DOWN FOR SPILLS OR WET FLOORS

Powder or liquid spills can cause slippery floors. Slow down or you could lose control or steering and braking. Be careful and allow for a longer stopping distance.

Don't run over objects on the floor.

Two Types of Steering



1 REAR DIRECTIONAL STEERING (Sometimes called Reverse Steering.)
Shows direction truck will turn when steering handle is turned clockwise.

2 FRONT DIRECTIONAL STEERING (Sometimes called Forward Steering.)
Shows direction truck will turn when steering handle is turned clockwise.

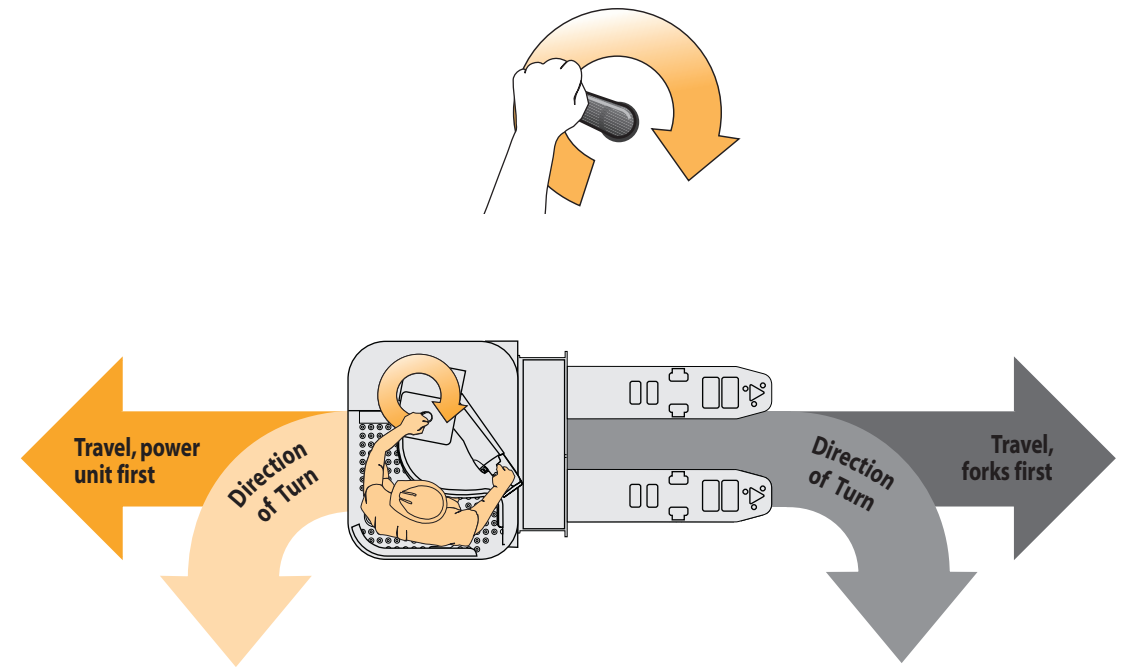
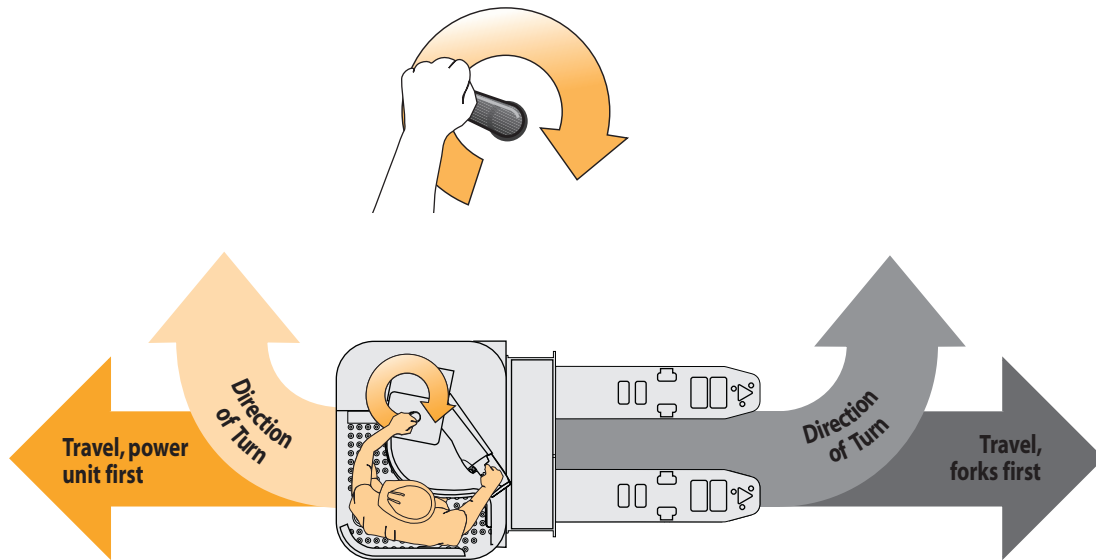

Additional Options



LOAD BACKREST OPTION

Your company may have requested a load backrest if you must handle loads that are unstable or not secure.

Don't place your hands or arms over the backrest. They could be pinned or crushed by the load.

There are three types of backrest.

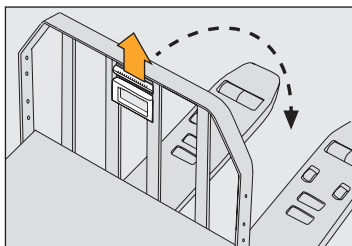

PIVOTING TYPE

Lift up on the handle and move the backrest forward if you need to service the battery. When you return the backrest to the upright position, make sure the handle is all the way down and the backrest can't tilt forward.

REMOVABLE TYPE

Can be removed or installed as required

BOLT ON TYPE

Need not be removed to service the battery.

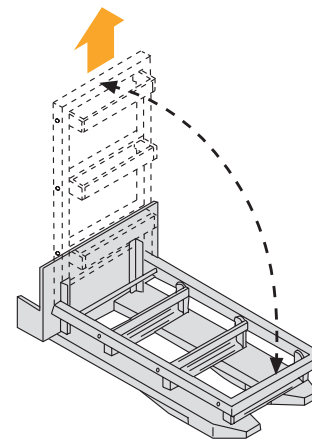

SKID ADAPTOR OPTION

Lift the skid adaptor until you can move it forward and lower it to the forks.

Make certain the skid adaptor is secure when you return it to the upright position.

! Know the Hazards

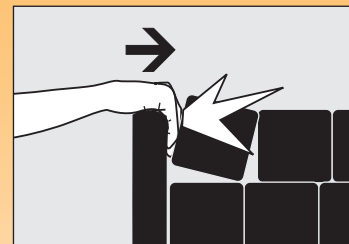

WATCH YOUR HANDS AND ARMS

Don't put your hands or arms over the load backrest.

SIMILAR LOOKING TRUCKS CAN BE DIFFERENT

Your company has selected the options which are best for your work area.

If you ever drive a different truck, even one that looks just like yours, be careful. It may not have the same steering or options.

Daily Safety Check

CHECK YOUR TRUCK BEFORE STARTING WORK

You must make sure your truck is safe to use.

1. Walk around your truck and check it over.

- Check to make sure the battery is charged, water level is OK and vent caps are in place. Don't use an open flame to check the battery.
- Make certain the battery retainers on both sides of the truck are properly installed.
- See that all wheels are in good condition.
- Clean the twist grip and steering handle.
- Check that both forks are straight and not cracked or badly worn.
- See that the load backrest is in place and fastened if your truck has that option.
- Look under the truck for signs of hydraulic leaks.
- Try the horn.
- Make sure the power disconnect works.
- Check that all controls work smoothly.

2. Test drive your truck in an uncongested area.

- Try all the hydraulic functions.
- Check the steering.
- Drive the truck slowly in both directions.
- Drive through the full speed range in both forward and reverse.
- Check braking and plugging distances in forward and reverse. Load size and floor conditions can affect these distances.
- Know the distance it takes to stop before you start working. If the braking distance is too long to stop safely, don't drive the truck.

If anything doesn't look, work or feel right, don't drive the truck. Report the problem to your supervisor.

You can get checklist forms from your Crown dealer (part no. OF3772). Used properly, this checklist can alert service people to needed repairs.

Be a Safe Driver

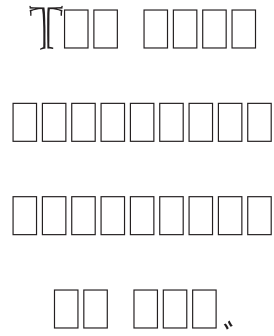

MAKE SURE YOU ARE READY TO DRIVE

- Do not use this truck unless you are trained and certified.
- Be certain you understand how your truck works and the hazards that go with it. Don't drive the truck if you have any doubts.
- Know the capacity of your truck. Make certain you use the correct units of measure.
- Some trucks are not allowed in areas where there are fire hazards. Be certain your truck is the correct fire safety type for the area.
- Make sure your hands and shoes are clean and dry, and your clothing is proper for the job.

MAKE SURE YOUR TRUCK IS READY

- Inspect your truck before using it (see pages 27 and 28). If it's not working right, or something is broken, report the problem to your supervisor. Don't use the truck.
- In an open area, test the braking. Check at a slow travel speed first, then a faster one. Know the distance it takes to stop before you start work.

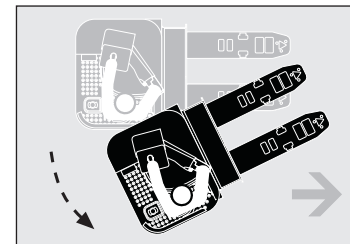
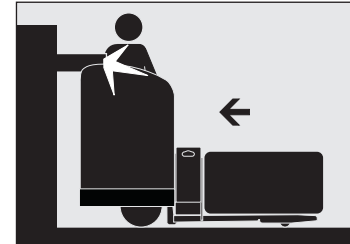

DRIVE CAUTIOUSLY, BE ALERT

- Never stick a foot or any part of your body outside the operator area, no matter how slow the truck is moving. You cannot stop 4500kg or 10,000 pounds with any part of your body. A foot or hand caught between the truck and a fixed object will be crushed or even cut off.
- Don't put your hands or arms over the backrest.
- Keep your hands on the controls and feet on the pedals.
- Travel in the direction that gives you the best view. Look where you are going and slow down in congested areas.
- Slow down for wet or slippery floors. Don't run over things.
- Look where you are going before you change direction of travel.
- See that you have room to drive and turn. Watch out for power unit swing.
- Slow down when making turns.
- Avoid sudden movement of controls. Learn to use them smoothly at a moderate, even rate.
- Be extra careful if you must use your truck in an area where there is a risk of falling objects.

Continued next page...

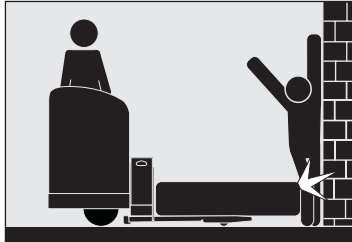

WATCH OUT FOR OTHER PEOPLE

- Slow down. Yield or stop for pedestrians. Use your horn when you come to a crosswalk or intersection.
- Be careful that you don't pin or crush someone. For example: Never drive your truck toward anyone standing in front of a fixed object.
- Never allow passengers on your truck.
- Keep others away from your truck while you're working. Don't ever allow anyone to ride on the load or forks.
- Don't let anyone use your truck unless they are trained and certified.

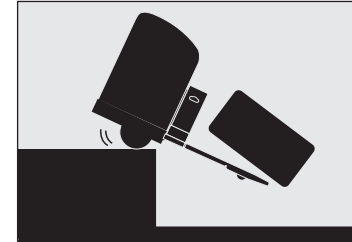

AVOID FALLS

- Stay away from the edge of docks and ramps.
- Check that bridgeplates and dockboards are secure. Be certain that either the trailer wheels are chocked or the trailer is locked to the dock. Check capacities. Be sure your truck, with load, isn't too heavy for where you are driving.
- Make sure the load you are moving is stable. Center the load. Be even more careful with long, high or wide loads. They can be less stable.
- When moving loads on grades or ramps, drive with your forks pointed upgrade. Without a load, drive with forks downgrade. Slow down, and don't turn on grades or ramps.
- Don't drive onto an elevator unless you are authorized. Check the capacity or load limit and make sure there are no people present. Enter load first and set the brake.

WHEN LEAVING YOUR TRUCK

- Stop your truck completely before getting off.
- Lower the forks. Turn the truck off or disconnect the battery.
- Avoid parking on inclines. But if you must, block the wheels of your truck.

Battery Maintenance

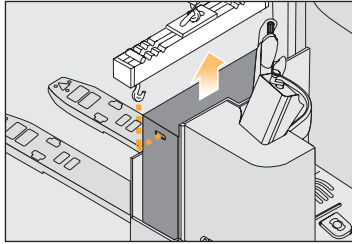

WHEN YOU INSTALL OR CHANGE BATTERIES

- Turn the truck OFF. Check that all controls are in neutral. Disconnect the battery.
- Make certain you use the correct size and weight battery. Never operate a truck that has an underweight or undersized battery installed.
- Never let anything metal touch the top of the cells. You could cause sparks or do damage to the battery. Use an insulator (such as plywood) when necessary.
- Use an approved spreader bar to place a battery in, or remove it from, the battery compartment or a stand. Make sure you adjust the spreader bar hooks to fit the battery.

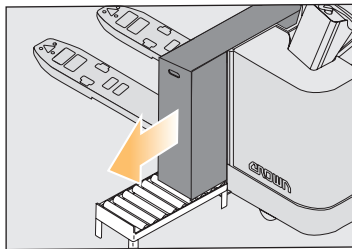

USING A ROLLER STAND

- If you use a roller stand to install or remove a battery make sure the roller stand is the same height as the rollers in the truck's battery compartment. Also make sure the roller stand is at least as long as your battery.

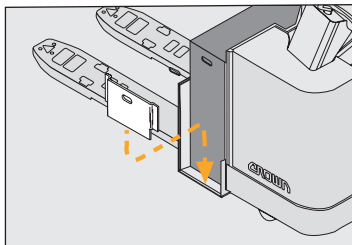

AFTER INSTALLING YOUR BATTERY

- Replace the battery retainers. Make certain the retainers on both sides of the truck are in place.
- Connect the battery. Turn the truck ON and check truck operation.

! Know the Hazards

! DANGER



Batteries produce explosive gas.
Do not smoke, use open flame, or create an arc or sparks near this battery. Ventilate well in enclosed areas and when charging.

Batteries contain **Sulfuric Acid** which causes severe burns. Do not get in eyes, on skin, or clothing. In case of contact, flush immediately. Get medical attention if your eyes are affected.

107

TRUCK BATTERIES CAN BE DANGEROUS

Your truck battery produces gas that can explode. It also contains acid that could burn or disfigure you.

- Do not try to install, remove, charge or service your truck battery unless you are trained and authorized.
- Never smoke or use an open flame around batteries.
- Your company should provide an area where it is safe to work on batteries. Use that area for all battery work.
- Use protective equipment such as gloves, eye shields, aprons etc.

BATTERY RETAINERS MUST BE IN PLACE

The battery could slide out if retainers are not in place. Check that both retainers are installed before operating your truck.

Know the Hazards



BEFORE CHARGING YOUR TRUCK BATTERY

- Charge the battery only in areas designated for that use.
- See that the battery cells are filled to the proper level. Never use an open flame to check the battery.
- Make certain the charger is the same voltage and amperage as your battery.
- Read the battery charger instructions.
- Be sure the charger is turned OFF before connecting the battery to the charger. Otherwise you might create a spark which could cause the battery to explode.
- Make sure the truck key switch is turned off and all other controls are in the off or neutral position.

WARNING

Minimum battery size allowed
000 mm (00.00 in.) wide
000 mm (00.00 in.) long

Undersize battery can affect truck handling and stability. You could have an accident.
Use U.L. classified Type EO battery.

BATTERY SIZE IS IMPORTANT

Make certain you use the correct size and weight battery. Never operate a truck that has an underweight or undersized battery installed.

Notes

Warning Labels



EACH WARNING LABEL ON YOUR TRUCK IS IMPORTANT
Read and obey all of them to protect yourself and others.

CAUTION

Connect charger properly or truck can be damaged.

Make certain charger is plugged into the battery connector, not the truck connector.

47

DANGER



Batteries can produce explosive gas. Do not smoke, use open flame, or create an arc or sparks near this battery. Ventilate well when in an enclosed area and when charging.

This battery contains **Sulfuric Acid** which causes severe burns. Do not get in eyes, on skin, or clothing. In case of contact, flush immediately and thoroughly with water. Get medical attention if your eyes are affected.

971-A

WARNING



Avoid being crushed. Keep head, arms, hands, legs, and feet within the operator area. **Stop truck completely before getting off.**



However, tipovers and falls from docks can cause serious injury or even death. **Immediately exit and move away from the truck in these emergencies.**

WARNING



It's the law, you must be trained and certified to operate this truck.
(OSHA § 1910.178, Rev. 1999)

You or people around you could be seriously injured or even killed if you don't use this truck correctly.

Obey all warnings & instructions on the truck and in the operator manual and on the truck. Inspect your truck before starting work, make sure it is in good working order.

* Additional copies of the Operators Manual and Truck Labels can be obtained from Crown Equipment Corp., New Bremen, OH 45869

04

WARNING



Stay clear of all moving parts.

Moving parts can cut or crush hands, feet, arms or legs.

07

WARNING

Minimum battery size allowed
000 mm (00.00 in.) wide
000 mm (00.00 in.) long

Undersize battery can affect truck handling and stability. You could have an accident.

Use U.L. classified Type EO battery.

crown.com

All rights reserved under International and Pan American copyright conventions
Copyright 2008 Crown Equipment Corp.



4500 SERIES



*This operator manual
has information for
all models of series
PR 4500 plus some
options and accessories.
Some of the illustrations
and information may
not apply to your truck.*



crown.com



New Bremen, Ohio 45869 USA © 2007

PF14867 Rev. 06/14

Printed in U.S.A.