

CROWN

Operator Manual



ESR



Original Operator Manual

All rights reserved under International and Pan American copyright conventions
Copyright 2015-2020
Crown Equipment Corp.



General Information

You Must Be Trained	10
Intended Use of the Truck	11
Manuals for Operation	11
Symbols Overview	12
Text Marking Overview	13
Safety Messages	14
Know the Hazards	16



Your Truck

Your Reach Truck	22
Truck Overview	24
Capacity and Load Center	30
Your Truck Capacity	31
Load Backrest	31
Capacity Plate	32
Reading Your Capacity Plate	34
Capacity Plates for Attachments	35



Truck Operation

Power On and Off	36
Turning On Your Truck Using the Display	36
Turning Off Your Truck Using the Display	37
Turning On Your Truck Using a Key	38
Turning Off Your Truck Using a Key	38
Emergency Disconnect	39
Display Overview	40
Display	44
Widgets	44
Safety Checklist	46
Safety Reminders	47
InfoLink® Options	48
Equipment Locked	48
Emergency Use	48
2-Way Messaging	49
Impact Detection	50
Dynamic Coaching™	51
Operating Position	52
Operator Presence Pedal	54
Adjusting the Steer Column	54
Adjusting the Armrest	55
Seat Options	56
Suspension Seat	56

Continued on next page...



Truck Operation

Suspension Seat with Optional Features	56
Adjusting the Headrest	57
Adjusting the Lumbar Support	57
Adjusting the Seat Position	57
Adjusting the Backrest	58
Adjusting the Flexback Seat Backrest	58
Adjusting the Suspension	59
Braking	60
Parking Brake	60
Braking	61
Traveling	62
Travel Direction	64
Travel Speed	64
Plugging	65
Horn	66
Steering	68
Steering Mode	70
Load Handling	72
Fingertip Control Levers	73
Dual-Lever Controls	74
Multi-Task Control Handle	75
Thumb Ball	75
Adjusting the Fork Spread	76



Truck Operation

Load Handling Options	78
Override Function	78
Auto Height Select	80
Load Presence	81
Tilt Position Assist	81
Sideshift Position Assist	81
Capacity Data Monitor Option	82
Additional Armrest Features	84
Armrest Control Pad Features	84
The 5th and 6th Function	86
Load Handling Clamps	87
Additional Options	88
Cold Storage Option	88
Load Backrest	89
Mirror	89
It's Up to You	90
Daily Safety Check	96

Continued on next page...



Power Sources

Power Sources	100
Working with Power Sources	100
Power Source Status	101
Charging Power Sources	102
Charging a Flooded Lead Acid Battery	102
Charging a V-Force™ Lithium-ion Battery	102
Flooded Lead Acid Batteries	104
Removing the Battery	105
Lifting the Battery	108
Installing the Battery	110



Safety Labels

Safety Labels	112
----------------------	------------

⚠ WARNING



You Must Be Trained and Certified

Only properly trained operators are permitted to operate a powered industrial truck.

Your employer must train you and certify that you are qualified to operate this powered industrial truck.

(OSHA §1910.178, Rev. 1999)



You could be killed or seriously injured if you are not adequately trained for lift truck operation!

Do not operate this truck until you have been trained and certified by your employer.

Intended Use of the Truck

Your reach truck is designed to lift, move, and stack loads.

The truck is not authorized for use on public roads.

Manuals for Operation

There are two separate books for this truck, the Operator and the Owner Manual. These manuals apply to the following truck models:

- ESR 1020
- ESR 1040
- ESR 1060

The Operator Manual contains safety and operating instructions, as well as general truck information. It is intended to complement operator training and to be used for future reference.







The Operator is anyone who has been trained and authorized to use this truck. Refer to local, regional, national, or international regulations for operational standards.

The Owner Manual contains Owner responsibility, as well as information needed to maintain, store, or transport the truck.

The Owner is anyone who owns, leases, has been delegated responsibility of, or authorizes the use of the truck to others.

Symbol Overview

The symbol overview explains important elements used in the manual.

Icon	Type	What it means
	Legend Points	Product feature labeling
	Blue Shaded Arrows	Travel - Power Unit First
	Gray Shaded Arrows	Travel - Forks First
	Blue Solid Arrows	Moving parts, <i>for example horn buttons</i>
	Red Impact Marks	Shows personal injury
	Black Impact Marks	Shows product damage

Text Marking Overview

The text marking overview explains important text elements used in the manual.

Text Styling	Type	What it means
<i>Start</i>	Bold Italicized Text	Text as it appears on the screen
<i>For example:</i>	Italicized Text	Examples for further explanation
1. 2.	Work Steps	Steps that must be performed in specific order
▪	Bullet Points	Shows a list

Safety Messages

This operator manual contains important information about your truck and how to use it properly. Safety messages provide instructions on potential hazardous situations, how to avoid them, and the consequences of not avoiding these situations.

Follow all instructions and obey all safety notices in the manuals and on your truck.

Safe truck operation depends on you.

Danger

Indicates a hazardous situation that, if not avoided, will result in death or serious injury.

Warning

Indicates a hazardous situation that, if not avoided, could result in death or serious injury.

 **Caution**

Indicates a hazardous situation that, if not avoided, could result in minor or moderate injury and/or product damage.



⚠ Warning

Body parts outside of the operator compartment can be crushed or even cut off

- Keep head, arms, hands, legs, and feet within the operator compartment.
- Stop the truck completely before getting off.



Use Your Truck Safely

Do not place yourself or others at risk.

- Keep others away from your truck.
- Never allow passengers on your truck. Do not allow anyone to ride on the load or forks.
- Do not stand underneath or near the forks.



⚠ Warning

Make sure the brakes work

If at any time the stopping distance is too long for you, do not drive your truck.

Notify your supervisor.

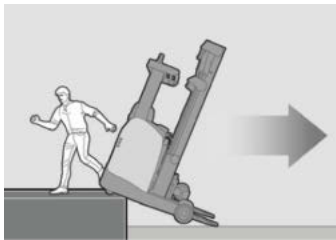
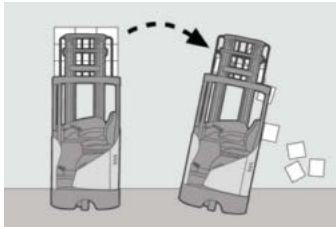
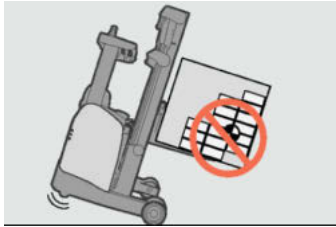

Warning

Avoid tipovers

Loads placed in the front or side of a pallet or container can cause a tipover.

- Know the capacity of your truck. Do not exceed the capacity shown on your truck's capacity plate.
- Make sure that your load is evenly distributed and centered over the forks.
- Make sure the load that you are moving is stable.
- Secure your load. Make sure that your load is resting against the vertical face of the forks or load backrest.
- Do not exceed the maximum load center distance and lift height.

In the event of a tipover

Immediately exit and move away from the truck in these emergencies. This is not like sit-down, counterbalanced trucks, where it is recommended that you stay with the truck.

Continued on next page...

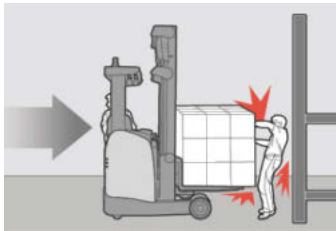
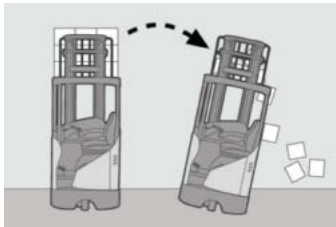
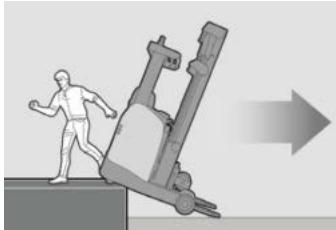

⚠ Warning

Avoid falls and tipovers

Falls from docks and tipovers are very serious accidents, you can be crushed or even killed.

- Immediately exit and move away from the truck in these emergencies. This is not like sit-down, counterbalanced trucks, where it is recommended that you stay with the truck.
- Stay away from the edge of docks and ramps.
- Make sure that dock boards and dock levelers are secure.
- Check that trailer wheels are chocked or the trailer is locked to the dock.
- Properly install jack stands under the front of the trailer when a tractor is not attached.

Distractions can cause accidents

You or people around you can be seriously injured.

- Always be alert to the area around you and look where you are going.
- You or others could be trapped or crushed by driving into fixed objects.
- Slow down in congested areas.
- Never use cell phones or similar devices while operating your truck.

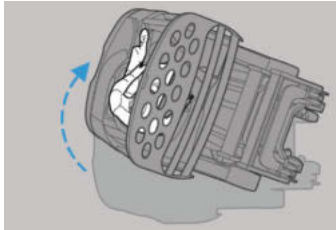

! Warning

Prevent impacts with objects or others

The power unit swings wide in the opposite direction when you turn traveling forks first.

- Make sure that you have clearance.
- Keep your hands and feet in the operator compartment.
- Turn carefully and slowly.
- Watch out for people in the area.

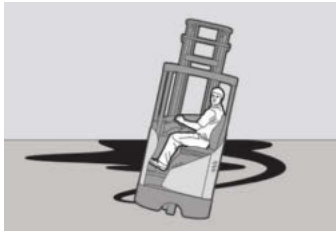

Maintain control of your truck

- Slow down if you see debris or liquid on the floor.
- Do not run over objects on the floor.
- Be careful and prepare for a longer stopping distance.

Continued on next page...

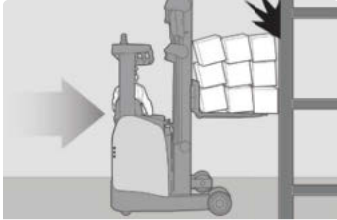

⚠ Warning

Check fork and pallet position

- Be careful when using reach, tilt, sideshift, or other operations.
- Perform all hydraulic operations smoothly.
- Make sure that the forks are at the correct tilt position and lift height to enter a pallet.
- Make sure that the path of the forks and load is clear.

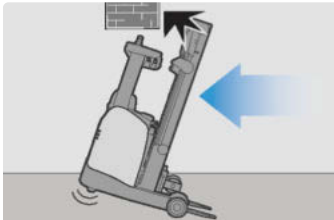

⚠ Warning

Watch out for overhead obstructions

The truck can tip over causing serious injury or even death.

- Be careful traveling near obstructions such as pipes, ducts, doorways, rack tunnels, or low ceilings.
- Be careful when using the override function.

 **Warning****Make sure the battery is secure**

Falling lifting equipment and batteries can result in severe injury and death.

- Make sure that your lifting equipment has sufficient capacity and refer to the manufacturer's operating instructions.
- Make sure that there is no one under or around a raised battery.
- Make sure that the chains and hook cannot fall onto the battery cells.

 **Warning****Check the size and type of the battery**

An incorrect battery can affect truck handling and stability causing an accident.

- Make sure that you use the correct size, type, and weight of battery.
- Do not use gel batteries for trucks with regenerative lowering.

Check the battery retainer

Unsecured batteries can slide or roll out of the truck.

Make sure that all battery retainers are installed before operating your truck

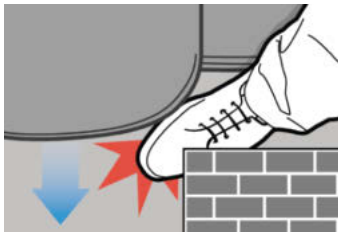

Warning

Body parts outside of the operator compartment can be crushed or even cut off

- Keep head, arms, hands, legs, and feet within the operator compartment.
- Stop the truck completely before getting off.

Use Your Truck Safely

Do not place yourself or others at risk.

- Keep others away from your truck.
- Never allow passengers on your truck. Do not allow anyone to ride on the load or forks.
- Do not stand underneath or near the forks

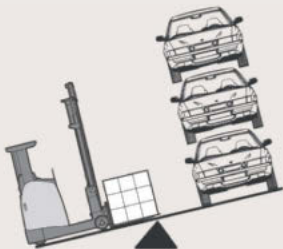

Your Truck Is Not an Automobile

With a load, it may weigh more than three automobiles.

- You don't steer the same.
- You don't brake the same.
- You don't accelerate the same.

Note: You cannot stop your truck with any part of your body, no matter how slow the truck is moving.

Make Sure You Are Ready

- Be certain that you understand how your truck works and the hazards that go with it.
- Make sure that your hands and shoes are clean and dry. Wear clothing that is proper for work.
- Do not operate your truck if you have any doubts.

Make Sure Your Truck Is Ready

Inspect your truck before using it. See **Daily Safety Check** on page 96 for an inspection guide. If your truck is not working correctly or is damaged, do not use it. Notify your supervisor.

Note: Similar looking trucks can be different. Be careful, trucks that look just like yours may not have the same controls, functions, or options.

Watch Out for Other People

- Keep others away from your truck while you're working.
- Never allow passengers on your truck. Do not allow anyone to ride on the load or forks.
- Slow down. Yield or stop for pedestrians.



Reach Truck

- 1 Mast Cover
- 2 Mast
- 3 Overhead Guard
- 4 Mast Guard
- 5 Seat
- 6 Motor Compartment
- 7 Drive Wheel



Reach Truck

- 1 Battery Compartment
- 2 Load Backrest Option
- 3 Mast Reach Carriage
- 4 Fork Carriage
- 5 Outrigger
- 6 Load Wheels
- 7 Forks

Continued on next page...



Operator Compartment

- 1 Display
- 2 Steering Wheel
- 3 Pedals
- 4 Armrest
- 5 Emergency Disconnect
- 6 Seat



Armrests

- 1 Multi-Task Control Handle
- 2 Dual-Lever Controls
- 3 Fingertip Controls

Continued on next page...



Pedals

- 1 Operator Presence Pedal
- 2 Brake Pedal
- 3 Accelerator Pedal



Battery Access

- ① Battery Release Lever
- ② Wing Screw
- ③ Removable Battery Retainer
- ④ Battery Cable Guide
- ⑤ Fixed Battery Retainer

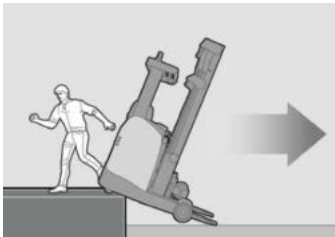
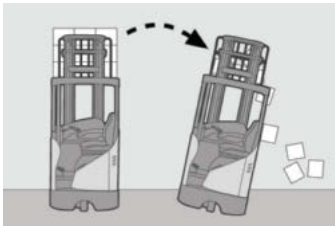
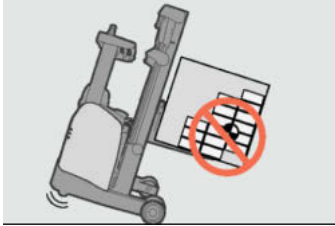

Warning

Avoid tipovers

Loads placed in the front or side of a pallet or container can cause a tipover.

- Know the capacity of your truck. Do not exceed the capacity shown on your truck's capacity plate.
- Make sure that your load is evenly distributed and centered over the forks.
- Make sure the load that you are moving is stable.
- Secure your load. Make sure that your load is resting against the vertical face of the forks or load backrest.
- Do not exceed the maximum load center distance and lift height.

In the event of a tipover

Immediately exit and move away from the truck in these emergencies. This is not like sit-down, counterbalanced trucks, where it is recommended that you stay with the truck.

Your Truck Capacity

Capacity is the load, including pallet or container, that can be lifted to a given height at a given load center.

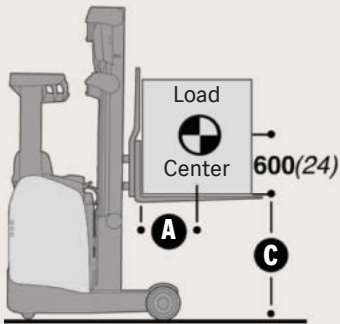

Load Center **A**

The horizontal load center is the distance from the load backrest or vertical face of the forks to the center of an evenly distributed load. See your capacity plate for the load center for your truck.

Note: The load center can differ from the visible center position on the forks.

Lift Height **C**

The height a load can be lifted for the specified capacity.

Anytime the forks move, the load moves. This can affect stability.

Note: Avoid sudden movement of the controls. Learn to use them smoothly at a moderate, even rate.



Load Backrest

Make sure that your load is resting against the vertical face of the forks or the load backrest.

Note: Be careful handling long, tall, or wide loads.



Capacity Plate

Check the capacity plate on your truck. The capacity plate is located on the overhead guard.

The capacity plate contains information such as truck capacity, truck weight without a load, and the lift height permitted. Make sure you use the correct units of measure.

Note: The information shown on this sample capacity plate may not apply to your truck.

1 Truck Weight Less Load with Max. Battery and Attachment \pm 5%

The weight of your truck without a load. Dock boards, elevators, and some floors can have limits for capacity. Make sure you know the weight of your truck. Remember to add the weight of any load on the forks.

2 Mast Collapsed Height

The height of the truck with the forks in the fully lowered position.

3 Truck Type

Truck type is the fire safety rating for your truck. Watch for marked areas where your truck is not permitted.
For example, you must not operate a type E or ES truck into an area restricted to EE or EX trucks.

4 Attachment Data

If an attachment on your truck does not match the information on your capacity plate, don't operate your truck. Notify your supervisor.

Continued on next page...

1000 SERIES

4450 (175,2) mm(in) E

Attachment Data

Sideshift 134, 504

Serial Number 5A203789

Capacity with Mast Vertical

Capacity kg(lb)	G mm(in)	2 A mm(in)
• 710 (1565)	11450 (450)	600 (24)
1 • 1330 (2932)	9150 (360)	600 (24)
• 2000 (4409)	7200 (283)	600 (24)

Manufactured by Crown in Germany
crown.com

8639-A

Reading Your Capacity Plate

- Capacity may be reduced as lift height **C** increases. For example: On the sample plate, 2000 kg (4409 lb) can be lifted to 7200 mm (283 in). But above 7200 mm (283 in), to 9150 (360 in), the capacity is reduced from 2000 kg (4409 lb) to 1330 kg (2932 lb).
- Capacity is reduced as load center **A** increases. If you must handle loads with longer load centers, an additional capacity plate will show the reduced capacities.

Contact Crown for capacities at lift heights or load centers not given on your capacity plate.



Capacity Plates for Attachments

There may be additional capacity plates for attachments. Make sure that you look at the capacity plate for the attachment you are using.

The capacity plate and the attachment capacity plate are located on the overhead guard.



Power On and Off

Make sure that the battery is connected. If your truck is not working correctly, notify your supervisor.

Turning On Your Truck Using the Display

You can turn on the truck by one of the following methods:

- Enter your user code
- Pass your ID across the reader
- Press **Start**

If your user code or ID is recognized, **Welcome** appears on the screen. If **User Not Authorized** appears, notify your supervisor.

Note: While logged in, you are the only user permitted to operate this truck.



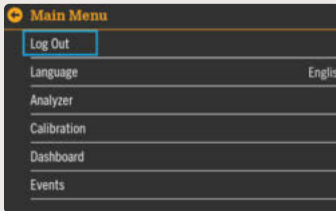

Turning Off Your Truck Using the Display

To turn off your truck, log out or pass your ID across the reader. **Logging Out (Do Not Travel)** appears on the screen.

Note: Depending on your truck settings, completing another inspection can be required. For example, if you log out, and then log in to the same truck during the same shift.

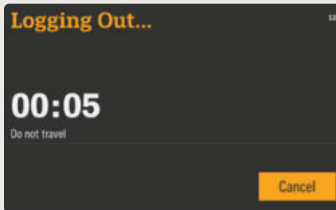

Continued on next page...



Turning On Your Truck Using a Key

- 1 On
- 2 Off

1. Turn on your truck by turning the key clockwise to **On**.
2. Check that the display is working.



Turning Off Your Truck Using a Key

Turn off your truck by turning the key counterclockwise to **OFF**. The truck will automatically log you out. **Logging Out (Do Not Travel)** appears on the screen.

Caution

Prevent unauthorized use

- Always log out before leaving your truck.
- Turn off your truck and remove the key.
- Do not share your user code with others.

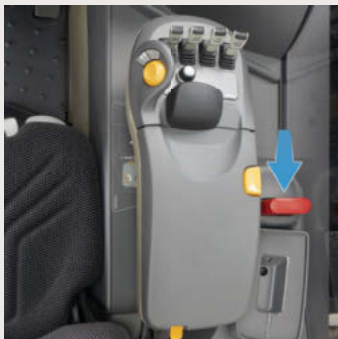

Emergency Disconnect

Use the emergency disconnect to shut down the truck if it is not working properly. Do not use the emergency disconnect as a brake.

To cut power to the truck, push down the emergency disconnect button. While traveling, the truck will slow to a controlled stop.

To reconnect power to the truck, pull up the emergency disconnect button and restart the truck. See **Power On and Off** on page 36.

Note: Turning off your truck does not cut off all power to your truck. Use the emergency disconnect any time your truck is not working properly. Do not use your truck and notify your supervisor.



Display Overview

Press the touchscreen or push the navigation buttons to see information about your truck. View hours of operation, power source status, and more on the screen.

When using the navigation buttons, a blue indicator shows your movement on the screen.

Note: While traveling, you cannot interact with the display.

1 Menu or Back

Press the menu or back icon on the screen to view settings and go back to a previous menu.

2 Status Bar

Icons appear at the top of the screen to show the status of the truck.

3 Widgets

Information about your truck such as power source status or date and time are available as widgets.

4 Navigation Buttons

In addition to the touchscreen, you can use the up, down, left, and right arrows to move through the screen.

5 Enter or Return Button

Use the enter or return button to go backward in menus and confirm selections on the screen.

6 Display Adjustment Button

Push the adjustment button to tilt the display to a comfortable position.

Note: Do not make any adjustments while the truck is moving.

Continued on next page...

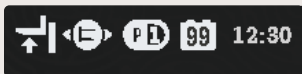

Status Icons

Icons appear in the status bar to show the status of the truck.

Steer Angle Indicator

The travel direction and steer angle of your truck.



Communication Status

Wireless communication is active.



Fork Height Indicator

The load backrest is above the collapsed height of the mast.



Power Source Status

The energy level of the power source.



Performance Mode

The operating level programmed for your truck.



Parking Brake

The parking brake is applied.



Brake Fluid Status

The brake fluid is low.



OnTrac™

Traction Control indicator.



Service Required

Notify your supervisor or service department if this icon appears.

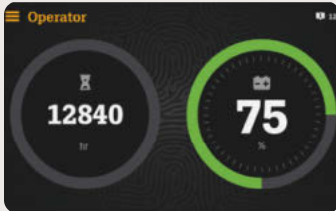

Widgets

Information about your truck such as the travel direction, power source status, or hours of operation are available as widgets.

The indicators on the bottom of the screen show you the number of widgets that are enabled. Swipe left or right on the screen to change between the widgets.

Press a widget or the enter button to see options available for that widget.

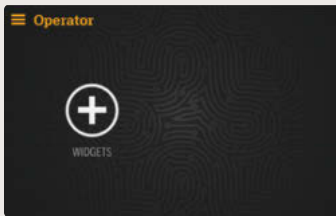

Adding a New Widget

1. Press **+** on the screen.
2. Scroll down to go through the options.
3. Select a widget.
4. Press **Save** to enable the widget.

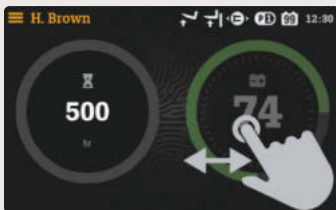

Moving an Existing Widget

1. Press and hold the widget.
2. Drag and drop the widget onto the desired location.

Continued on next page...

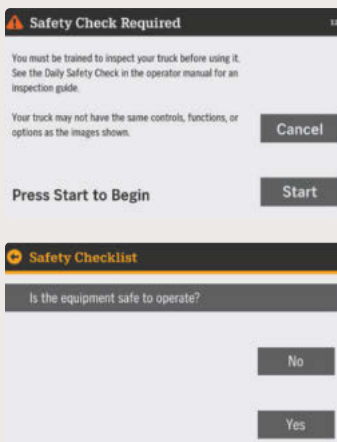

Safety Checklist

You are required to conduct an inspection to make sure that the truck is safe to operate. See **Daily Safety Check** on page 96 for an inspection guide. A number of questions can appear on the screen, depending on your company's requirements. Answer all the questions within the time limit shown in the upper right corner.

You may be asked to verify your response by answering the follow-up question ***Are you sure?***

If your response indicates a problem, your truck may be disabled. Don't use your truck and notify your supervisor.

Note: If you are unable to start the inspection checklist, notify your supervisor.

If you need to interrupt the inspection process, press **Cancel** or  in the top left corner of the screen.

During an inspection, the truck will lock for the following situations:

- You allow time to expire twice
- You interrupt an inspection twice
- You allow time to expire and interrupt an inspection
- You answer the truck is not safe to operate during an inspection.

Note: Depending on your truck settings, completing another inspection can be required. For example, if you log out and then log in again to the same truck during the same shift.

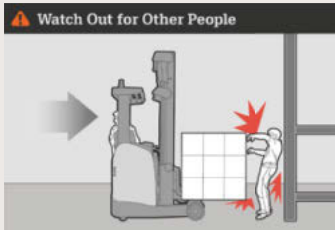

Safety Reminders

Before you can operate the truck, a reminder of safe truck operation will appear on the screen.

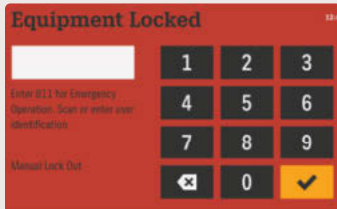

Equipment Locked

Equipment Locked can appear for various reasons such as impact detection.

You cannot use your truck. If your truck is locked, notify your supervisor.



Emergency Use

In an emergency situation, press 811 on the screen and press the enter button. The screen shows the amount of time in which you can operate the truck. When time expires and the truck is brought to a stop, **Equipment Locked** appears on the screen.

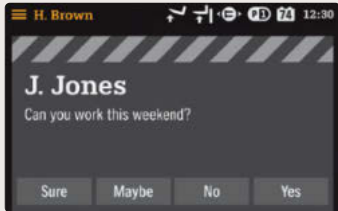
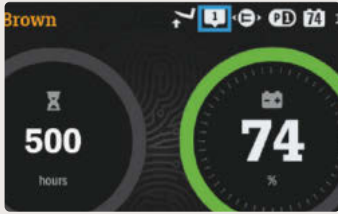

2-Way Messaging

With this feature, your company can send messages to you.

When you receive a message, the icon  appears at the top of the screen with a beep.

When the truck is stationary for 5 seconds, the message appears automatically.

Select one of the pre-programmed responses below the message to answer.

While traveling, an unanswered message disappears. The icon reappears at the top of the screen.

Continued on next page...



Impact Detection

With the Impact Detection feature, truck impacts are recorded. Depending on your company's settings, your truck can be programmed to only record the event, or record and shutdown the truck.

Impact Detected

When an impact is recorded, **Impact Detected** appears on the screen. After a short time this will disappear. Notify your supervisor.

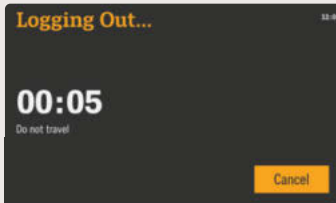

Impact Shutdown

You can operate the truck for a short distance and time. When **Logging Out (Do not travel)** appears on the screen, you will be logged out within the time shown. The truck will shutdown and lock. **Equipment locked** appears on the screen.

You cannot use your truck. If your truck is locked, notify your supervisor.

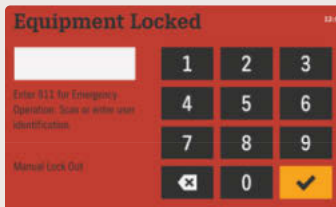

If strobe lights and audible alarms are installed for impact detection, they will illuminate and sound after an impact.



Dynamic Coaching™

The Dynamic Coaching feature provides audible and visual feedback on how you operate the truck. Your truck can show red and blue screens to reinforce safe operation.



Red Screens

Alerts of incorrect operation.

- **Impact Detected** (screen may show a countdown to lockout)
- **Keep Feet Within the Operator Compartment** (traveling with your foot removed from the operator presence pedal)
- **Stop Completely Before Exiting** (leaving the truck while it is still moving)

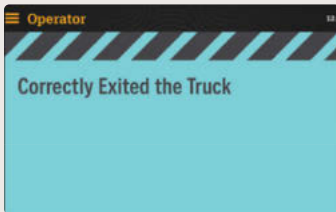

Blue Screens

Confirms correct operation.

- **Correctly Exited the Truck** (leaving the truck after a complete stop)

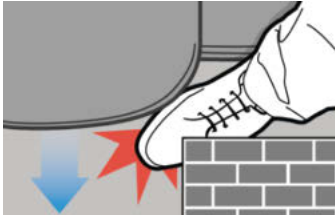
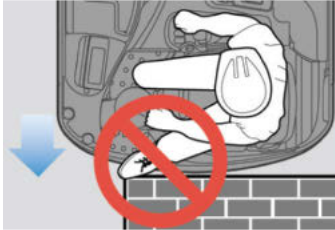

! Warning

Body parts outside of the operator compartment can be crushed or even cut off

- Keep head, arms, hands, legs, and feet within the operator compartment.
- Stop the truck completely before getting off.

Use your truck safely

Do not place yourself or others at risk.

- Keep others away from your truck.
- Never allow passengers. Do not allow anyone to ride on the load or forks.
- Do not stand underneath or near the forks.



Operating Position

Your operating position is the same in either travel direction.

- 1 Hands on Controls
- 2 Seated Position
- 3 Feet on Pedals

You can adjust the seat, steer column, and armrest pad. Make sure you can comfortably reach the controls.

Note: Do not make any adjustments while the truck is moving.

Before you can operate your truck, you must perform the following steps.

1. Place your left foot on the operator presence pedal.
2. Select your travel direction.
3. Slowly press and release the accelerator pedal.

The truck is ready for operation.

Note: Your truck may weigh more than three automobiles. You cannot stop your truck with any part of your body, no matter how slow the truck is moving.

Continued on next page...



Operator Presence Pedal

To operate the truck, place your left foot on the operator presence pedal.

You can adjust your feet for posture relief. If you remove your foot from the operator presence pedal while traveling, the alarm will sound and the truck will slow to a stop.

Return your foot to the operator presence pedal to continue traveling. Follow the on-screen messages.

Note: Do not use the operator presence pedal as a brake.

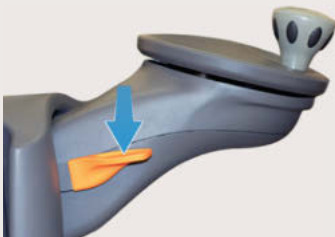

Adjusting the Steer Column

Adjust the steer column so you can comfortably reach all the controls. You can move the steer column up, down, forward or backward.

Before traveling, make sure that the steer column is locked in place.

1. Push the release lever.
2. Pull, push, lift, or lower the steer column to the most comfortable position.
3. Let go of the release lever.

Note: If you are unable to adjust your steer column, notify your supervisor.

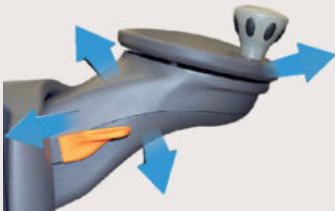



Adjusting the Armrest

- 1 Palm Rest
- 2 Button
- 3 Lever

Adjusting the palm rest

When operating the fingertip control levers, the palm rest can reduce stress in your hand and arm.

Place your hand on the palm rest and move it left, right, forward, and backward. Make sure you can comfortably reach the controls.

Adjusting the armrest position

Press and hold the button to slide the armrest forward or backward.

Make sure that the armrest is locked in place.

Adjusting the armrest pad

You can adjust the armrest pad for additional comfort.

To tilt the armrest pad, pull up the back of the pad until it locks in place.

To level the armrest pad, pull up the lever and push down the pad.



Seat Options

Adjust the seat so you can comfortably reach all the controls. Your truck will have one of the following seat options:

Suspension Seat

- 1 Backrest
- 2 Seat Position
- 3 Suspension



Suspension Seat with Optional Features

- 1 Headrest Option
- 2 Lumbar Support Option
- 3 Standard Backrest and Flexback Seat Backrest Option
- 4 Suspension
- 5 Seat Position



Adjusting the Headrest

Move the headrest up or down to a desired position.



Adjusting the Lumbar Support

To adjust the lumbar support, turn the knob on the side of your backrest.



Adjusting the Seat Position

To adjust the seat forward or backward, use the lever located in front of the seat.

1. Pull up the lever.
2. Slide the seat forward or backward.
3. Release the lever.
4. Move the seat slowly until the seat latches in place.



Continued on next page...



Adjusting the Backrest

To adjust the backrest, use the lever on the side of the seat.

1. Pull up the lever.
2. Lean forward or backward until you reach a comfortable position.
3. Release the lever.

Adjusting the Flexback Seat Backrest

The Flexback Seat Backrest can move freely or be locked in place.

- 1 Lock Button
- 2 Lever

To unlock the backrest, pull up and release the lever.

To lock the backrest in place, press the lock button.

Adjusting the Suspension

Depending upon the features of your seat, you can adjust the suspension using a knob or a lever located in the front of the seat. Adjust the suspension for your comfort and weight.



Adjusting the suspension using a knob

Rotate the knob clockwise or counterclockwise to reduce or increase the suspension. Continue to rotate the knob until the display shows your weight.



Adjusting the suspension using a lever

Pull the lever up to increase the suspension. Push the lever down to reduce the suspension.

1. Pull out the lever.
2. Move the lever up or down. Continue to move the lever until the orange indicator appears in the center.
3. Fold in the lever to set the suspension.



Warning

Make sure the brakes work

If at any time the stopping distance is too long for you, do not drive your truck.

Notify your supervisor.



Parking Brake

When the parking brake is applied, the parking brake symbol is shown in the status bar.

The parking brake is automatically applied after the truck comes to a stop.

To apply the parking brake manually, press the brake pedal immediately after the truck comes to a stop.



Braking

Before you start working, test the brake.

In an open area, first check braking at a slow travel speed and then at a faster one.

Applying the Brake

To apply the brake, press the brake pedal. The further you press the brake pedal the more your truck will brake to stop.

Note: Braking is designed to stop your truck in the shortest distance. Use the brake in an emergency, on ramps, or in busy areas.

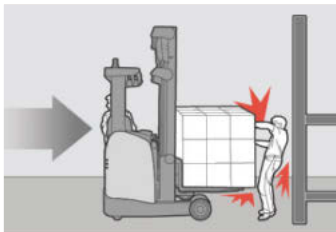
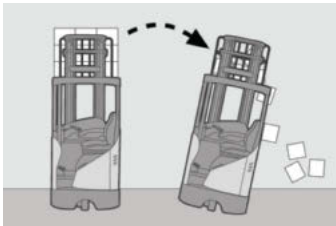
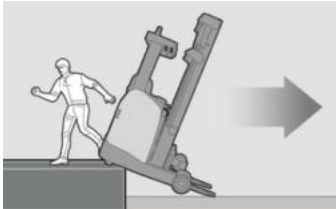

Warning

Avoid falls and tipovers

Falls from docks and tipovers are very serious accidents, you can be crushed or even killed.

- Immediately exit and move away from the truck in these emergencies. This is not like sit-down, counterbalanced trucks, where it is recommended that you stay with the truck.
- Stay away from the edge of docks and ramps.
- Make sure that dock boards and dock levelers are secure.
- Check that trailer wheels are chocked or the trailer is locked to the dock.
- Properly install jack stands under the front of the trailer when a tractor is not attached.

Distractions can cause accidents

You or people around you can be seriously injured.

- Always be alert to the area around you and look where you are going.
- You or others could be trapped or crushed by driving into fixed objects.
- Slow down in congested areas.
- Never use cell phones or similar devices while operating your truck.

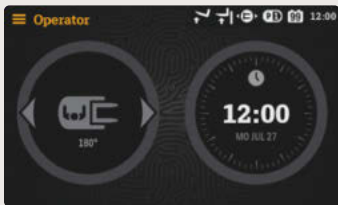

Traveling

Travel in the direction that gives you the best visibility. Make sure that there is clearance for your entire truck.

Your truck has the following traveling directions:

- Power Unit First
- Forks First

The icon  is shown in the status bar. Depending on your selected widgets, the screen can show your travel direction and steer angle.

Note: An unloaded truck can tip over as well. Be just as careful using an unloaded truck as you are using one that is loaded.

Before traveling, completely retract and lower the forks. Travel with the forks close to the floor and with the load resting against the vertical face of the forks or the load backrest.

Make sure that the load is centered and the forks are tilted back.

While traveling, you cannot interact with the display.

Before you leave your truck, come to a complete stop and lower the forks. Turn off the truck using the display or key.

Park on level floors. If you have to stop on an incline, chock the wheels to prevent the truck from moving.

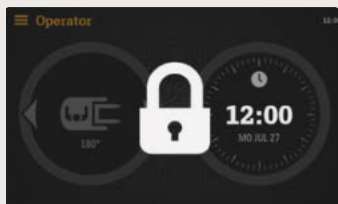

Continued on next page...



Travel Direction

1. Press the direction switch on the armrest to choose your travel direction.
2. Check the display to be sure which direction you have selected.

Note: Avoid sudden movement of the controls. Learn to use them smoothly at a moderate, even rate.



Travel Speed

Travel at a speed that allows you to stop safely. Press the accelerator pedal to control your travel speed.

Note: The farther you press the accelerator pedal, the faster your truck will move.

Press and hold the direction switch to travel at a reduced speed. *Travel Speed Limited* appears on the screen.

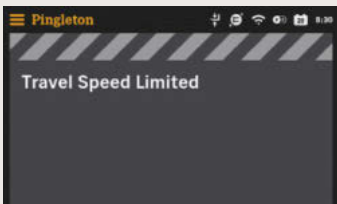

When Traveling on Ramps or Grades

- With a load, drive with the forks pointed upgrade.
- Without a load, drive with the forks downgrade.
- Slow down and do not turn on ramps or grades.

When Traveling onto an Elevator

- Do not drive onto an elevator unless you are authorized. Make sure that there are no people present. Enter forks first and come to a complete stop.
- Make sure your truck, with a load, is not too heavy for where you are driving. *For example, elevators can have a different capacity than the floor.* Do not exceed floor capacity.

Plugging

Plugging is another way to slow down or stop your truck. While the truck is moving in either direction, select the opposite travel direction. Use the accelerator pedal to control how quickly you slow down.

To slow to a stop while plugging, release the accelerator pedal.

When traveling, you can also slow down or stop your truck by releasing the accelerator pedal.

Note: Braking vs. Plugging

Of the two, braking is designed to stop your truck in the shortest distance. Use the brake in an emergency, on ramps, or in busy areas.

Continued on next page...



Horn

Push the button on the armrest to sound the horn. Warn pedestrians and other operators that you are nearby. Use the horn in areas such as intersections or crosswalks.



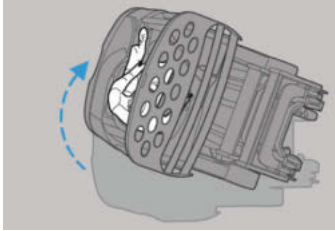

! Warning

Prevent impacts with objects or others

The power unit swings wide in the opposite direction when you turn traveling forks first.

- Make sure that you have clearance.
- Keep your hands and feet in the operator compartment.
- Turn carefully and slowly.
- Watch out for people in the area.

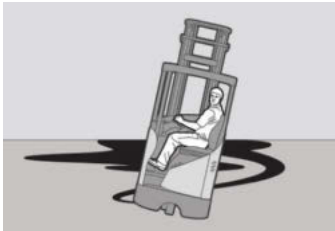

Maintain control of your truck

- Slow down if you see debris or liquid on the floor.
- Do not run over objects on the floor.
- Be careful and prepare for a longer stopping distance.



Steering

To control steering, rotate the steering wheel. Your truck is designed to slow down when turning.

The icon  in the status bar and the steering widget show your travel direction and steer angle.

Note: Steering is not the same in both travel directions. Be careful. Avoid sudden changes in direction. Drive slowly until you get used to all the controls.

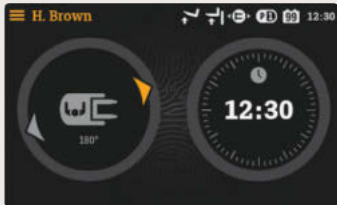

Continued on next page...

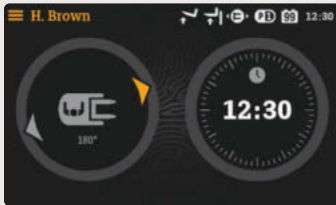

Steering Mode

Your truck can be built with two different steering modes.

Press the steering widget to select 180° or 360° steering. The active steering mode appears in the center of the widget.

180° steering mode

When using 180° steering, moving the steering wheel is limited to $\pm 90^\circ$.

360° steering mode

When using 360° steering, continuous steering is possible. The movement of the steering wheel is no longer limited. You can also change the travel direction with the steering wheel.

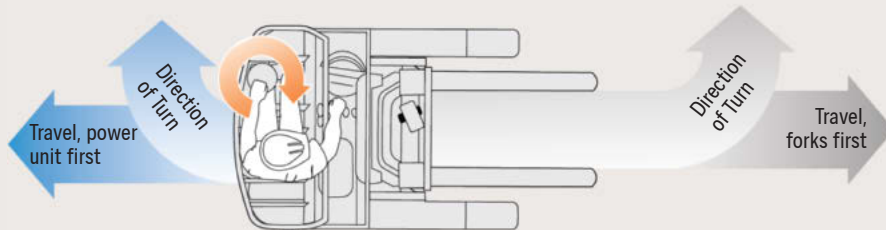

Steering Direction

Shows the direction that the truck turns when the steering wheel is rotated clockwise.

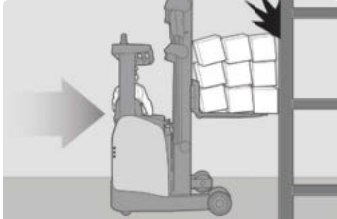

Warning

Check fork and pallet position

- Be careful when using reach, tilt, sideshift, or other operations.
- Perform all hydraulic operations smoothly.
- Make sure that the forks are at the correct tilt position and lift height to enter a pallet.
- Make sure that the path of the forks and load is clear.

Load Handling

Your truck is equipped with standard fork functions raise and lower, tilt (up and down), and reach (extend and retract). It can also have sideshift (left and right).

Make sure that your load is evenly distributed, stable, and centered over the forks.

The forks should be at least two-thirds (67%) the length of the load. Crown recommends the forks be three-fourths (75%) the length of the load. Make sure the forks do not extend beyond the load.

Use minimum fork tilt to pick up or place a load.

Be careful moving a wide or tall load. Make sure you or someone around you does not get pinned or crushed. Have a second person assist you.

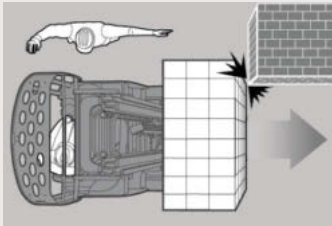



When the forks or the load backrest are raised above the mast collapsed height, travel speed is limited. The icon  in the status bar turns yellow.

Note: Make sure that there is clearance for the load and load backrest.



Fingertip Control Levers

A symbol on each fingertip control lever shows the load handling control.

- 1 Forks Raise and Lower
- 2 Mast Reach and Retract
- 3 Tilt Up and Down
- 4 Sideshift Right and Left

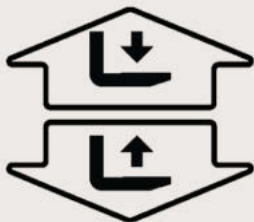

Pull or push the lever to use a load handling control. *For example, pull the lever toward you to raise the forks as shown in the bottom symbol. Push the lever away from you to lower the forks.*

Note: The farther you move the lever from neutral, the faster the load handling movement will be.

Continued on next page...



Dual-Lever Controls

Symbols on top of the levers show the load handling control.

Note: The further you move the lever from neutral, the faster the load handling movement will be.

Left Lever Functions

- 1 Forks Lower
- 2 Mast Retract
- 3 Mast Reach
- 4 Forks Raise

You can move the forks and the mast at the same time.



Right Lever Functions

- 5 Sideshift Left
- 6 Tilt Up
- 7 Tilt Down
- 8 Sideshift Right

You can only tilt or sideshift the forks one at a time.





Multi-Task Control Handle

Symbols on the armrest and the thumb ball show the load handling control.

Move the multi-task control handle to raise and lower the forks and for mast reach functions.

Note: The farther you move the multi-task control handle from neutral, the faster the forks will move.

- 1 Forks Lower
- 2 Mast Retract
- 3 Mast Reach
- 4 Forks Raise

You can move the forks and the mast at the same time.



Thumb Ball

Move the thumb ball to tilt and sideshift the forks.

Note: The farther you move the thumb ball from neutral, the faster the forks will move.

- 5 Tilt Up
- 6 Sideshift Left
- 7 Sideshift Right
- 8 Tilt Down

You can only tilt or sideshift the forks one at a time.

Continued on next page...



Adjusting the Fork Spread

Make sure that you spread the forks as far as possible.

To adjust the forks spread, the forks must be off the floor and without load.

1. Lift up the latches on the top of the forks.
2. Spread the forks as far as you can.
3. Make sure that the forks engage in the fork carriage slots.
4. Push down the latches.

Note: Both forks must be an equal distance from the center of the fork carriage.

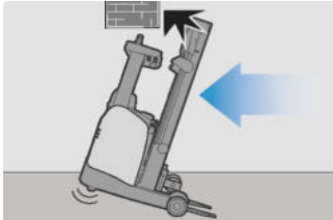

Warning

Watch out for overhead obstructions

The truck can tip over causing serious injury or even death.

- Be careful traveling near obstructions such as pipes, ducts, doorways, rack tunnels, or low ceilings.
- Be careful when using the override function.

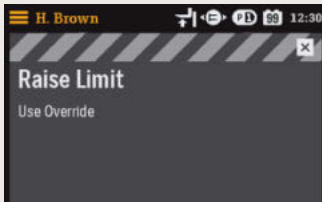

Override Function

Your truck can be programmed to stop raising in areas with overhead restrictions.

Your truck can be programmed to stop lowering to prevent a wide load from contacting the outriggers.

To continue raising or lowering past the height limit, use the override function.

1. Return the raise or lower control to neutral.
2. Press and hold the override button and then slowly resume raise or lower.



Continued on next page...



Auto Height Select

With the Auto Height Select feature, the forks stop at a selected height. The icon  in the status bar appears when Auto Height Select is active. Your company can program different rack heights for different operating areas in your facility.

Before using Auto Height Select, make sure that you select the correct operating area. Your company can create names for different operating areas. The operating area is shown in the top of the widget, *for example* **Group 2**.

Before entering a rack or pallet, make sure that the forks are in the correct position.



To select a preset rack height, press the one-touch button or the rack height select button on the armrest control pad. The selected rack height is enlarged and shown in white.

You can use Auto Height Select in two ways:

- Select a rack height and then raise or lower the forks.
- Select a rack height while raising or lowering the forks.

The forks will stop when they reach the preset rack height.

Note: The one-touch button is not available with the multi-task control handle. See **Armrest Control Pad Features** on page 84 for the Auto Height Select.

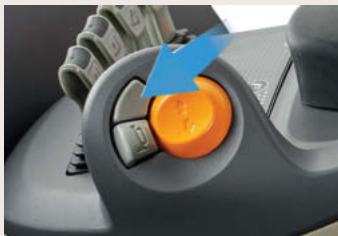





Load Presence

When using the Auto Height Select feature, you can manually select a loaded or unloaded fork height. When **Loaded** is selected the forks stop at a height adjusted for putting away loads.

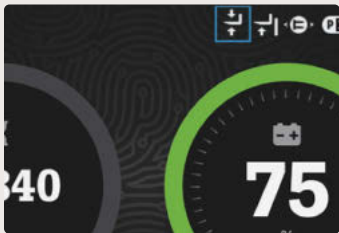
Press the load symbol on the widget to select a loaded or unloaded fork height.



Tilt Position Assist

With the Tilt Position Assist feature, the forks automatically stop at the level position. When the forks are level, the truck beeps. The icon  appears in the status bar and a message appears on the screen.

To continue using tilt, release and move the load handling control again.

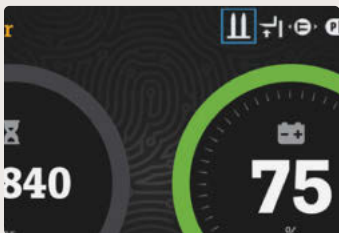

Sideshift Position Assist

With the Sideshift Position Assist feature, sideshift automatically stops at a centered position. When the forks are centered the truck beeps. The icon  appears in the status bar and a message appears on the screen.

To continue using sideshift, release and move the load handling control again.

Continued on next page...

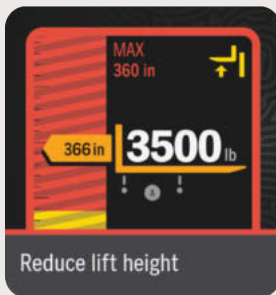

Capacity Data Monitor Option

The Capacity Data Monitor can only assist you when handling loads. Depending on your truck settings, the Capacity Data Monitor widget shows you the following information:

- Load weight
- Lift height
- Lift height limit

Note: The information the Capacity Data Monitor shows is for reference only. Make sure that you understand the capacity of your truck. See **Capacity Plate** on page 32.

To use the Capacity Data Monitor, the fork carriage must be level.

The color of the widget changes depending on the weight and lift height of the load you are handling.

- Gray - appears when the load you are handling is within the lift height limit.
- Yellow - appears when the load you are handling is near the lift height limit.
- Red - appears if the load you are handling exceeds capacity or is above the lift height limit.

Follow the messages on the screen.

 **Caution****Know the load you are handling**

Do not rely only on the capacity data monitor. Check the load center, weight, and height of the load you are handling.



Armrest Control Pad Features

With the armrest control pad, you can operate the following features:

- 1 Override Function
- 2 Display Navigation Knob
- 3 Auto Height Select
- 4 6th Function
- 5 5th Function
- 6 Work Light
- 7 Heated Seat
- 8 Additional Function



Using the Armrest Control Pad

Press a button on the armrest control pad to use a feature.

When the heated seat is on, a red light shines on the button.

Using the Display Navigation Knob

To navigate through screen menus and widgets, turn the Remote Display Control right or left.

To select, add, or change a widget, press the Remote Display Control.

Additional Functions

Your armrest control pad can have additional functions.

Contact your supervisor for additional functions on your truck.

Continued on next page...

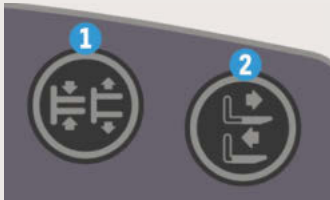

The 5th and 6th Function

Your truck can have a 5th and 6th function designed for additional load handling attachments.

Symbols on the armrest control pad show the load handling control, *for example a fork positioner or a telescopic fork*. Make sure that the function is active before using it.

- 1 6th Function Button
- 2 5th Function Button

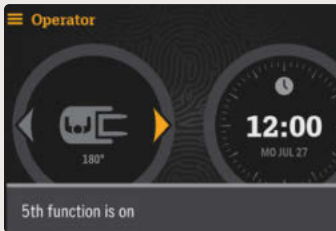

Turning On the 5th or 6th Function

Press the function button on the armrest control pad. The truck beeps and the button lights up. The screen shows the active function.

Turning Off the 5th or 6th Function

Press the function button on the armrest control pad. The truck beeps and the button light goes out. The standard function is restored.



Fingertip Control Levers

Move the two levers on the right forward-to-backward to operate the 5th and 6th functions.

- 3 6th Function
- 4 5th Function



Dual-Levers

Move the right lever left-to-right or forward-to-backward to operate the 5th or 6th functions.

Note: The direction you move the lever depends on the type of attachment that is installed.



Multi-Task Control Handle

Move the thumb ball in the directions shown to operate the 5th or 6th function.

Note: The direction you move the thumb ball depends on the type of attachment that is installed.

Load Handling Clamps

To use attachments such as clamps that grab loads, press and hold the function button on the armrest control pad while moving the related load handling control.

To return to the standard function,

1. Release the button on the armrest control pad.
2. Return the load handling control to neutral.

Note: Similar looking trucks can be different. Be careful, trucks that look just like yours may not have the same controls, functions, or options.

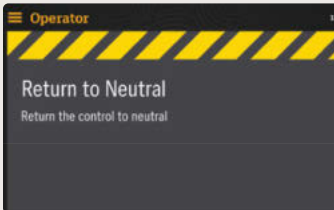



Cold Storage Option

Your truck can be operated in cold storage areas only if it is marked with the freezer symbol.

Caution

Batteries can freeze and rupture

- Do not park trucks in temperatures below freezing.
- Watch the charge status of the battery.
- Charge or replace the battery before the energy is too low.

Watch out for excess water on the truck

Make sure that your truck is completely dry before reentering cold storage areas.



Load Backrest

The load backrest can provide more load handling stability.

Make sure that the load is resting against the vertical face of the forks or load backrest.



Mirror

Adjust the mirror to a position that gives you better visibility. Use the mirror only while maneuvering.

When adjusting the mirror, keep in mind all operating positions.

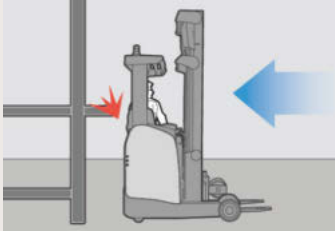

Be Cautious and Alert

- Look where you are going.
- You can be trapped or crushed by a fixed object.
- Travel in the direction that gives you the best visibility. Slow down in congested areas.
- Never use cell phones or similar devices while operating your truck.
- Slow down for wet or slippery floors.
- Do not run over objects.
- Avoid sudden movement of controls. Learn to use them smoothly at a moderate, even rate.
- Travel at a speed that allows you to stop safely.
- Staying alert will help you be a better and safer operator.

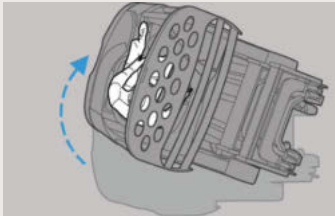
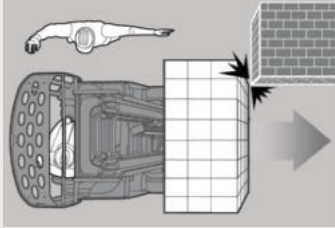
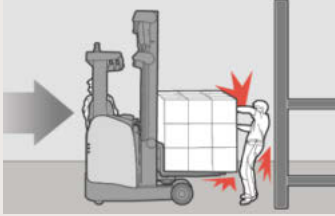

Watch Out for Other People

- Slow down. Yield or stop for pedestrians. Use the horn in areas such as intersections or crosswalks.
- Make sure that you do not trap or crush someone. *For example, never drive your truck toward anyone standing in front of a fixed object.*
- Be careful moving a wide or tall load. Make sure you or someone around you does not get trapped or crushed. Have a second person assist you.
- Keep others away from your truck while you are working.
- Watch out for power unit swing. Slow down when making turns.
- Travel in the direction that gives you the best visibility.
- Adjust the mirror to a position that gives you better visibility. Use the mirror only while maneuvering.
- Never allow passengers on your truck. Do not allow anyone to ride on the load or forks.

Continued on next page...

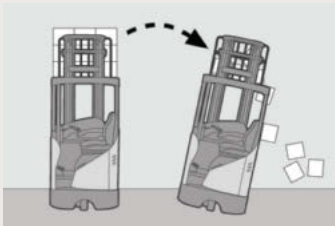
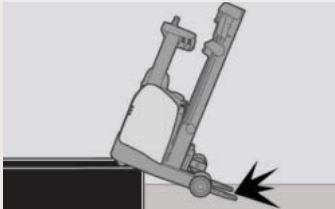
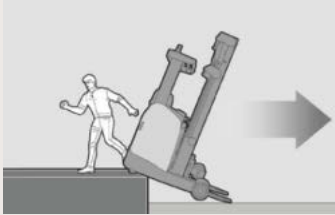

Avoid Falls and Tipovers

- You could be seriously injured or even killed in a fall. Immediately exit and move away from the truck in these emergencies. This is not like sit-down, counterbalanced trucks, where it is recommended that you stay with the truck.
- An unloaded truck can tip over as well. Be just as careful using an unloaded truck as you are using one that is loaded.
- Stay away from the edge of docks and ramps.
- Make sure that dock boards and dock levelers are secure. Be certain the trailer wheels are chocked or the trailer is locked to the dock.
- Properly install jack stands under the front of the trailer when a tractor is not attached.
- Make sure the load that you are moving is stable. Center the load. Be careful handling long, tall, or wide loads.
- Make sure your truck, with a load, is not too heavy for where you are driving. *For example, elevators can have a different capacity than the floor.* Do not exceed floor capacity.
- Do not drive onto an elevator unless you are authorized. Make sure that there are no people present. Enter forks first and come to a complete stop.

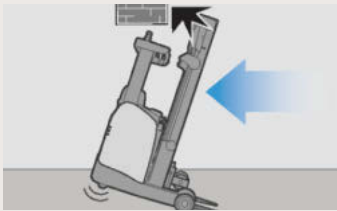
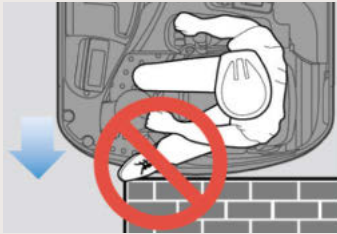
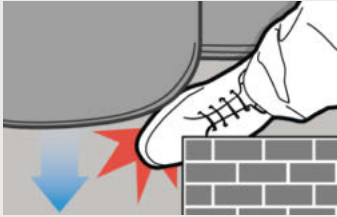

When Driving

- Your truck may weigh more than three automobiles. You cannot stop your truck with any part of your body. A foot or hand caught between the truck and a fixed object will be crushed or even cut off.
- Never stick a foot or any part of your body outside the operator compartment, no matter how slow the truck is moving.
- Before traveling, completely retract and lower the forks. Travel with the forks close to the floor and with the load resting against the vertical face of the forks or the load backrest.
- When traveling, make sure that the load is centered and the forks are tilted back.
- Make sure that there is clearance for your entire truck. Watch for overhead obstructions.
- Stop the truck completely before getting off.

Continued on next page...

When Traveling on Ramps or Grades

- With a load, drive with the forks pointed upgrade.
- Without a load, drive with the forks downgrade.
- Slow down and do not turn on ramps or grades.

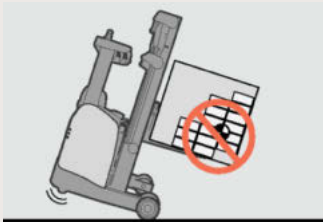

When Handling Loads

- Do not exceed the capacity shown on your truck's capacity plate.
- Travel with the load resting against the vertical face of the forks or load backrest. Make sure that the load is centered. The load center can differ from the visible center position on the forks.
- Make sure that the load you are moving is stable.
- Make sure that you spread the forks as wide as possible.
- Use minimum fork tilt to pick up or place a load. When raising or lowering outside a rack, keep the load backrest vertical or tilted back slightly.
- Do not stand underneath or near the forks.
- Stay away from all moving parts. *For example, do not reach into the mast area.*

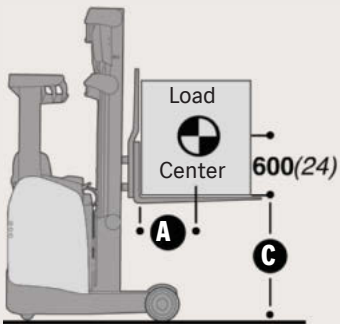

When Leaving Your Truck

- Come to a complete stop before leaving your truck.
- Completely retract and lower the forks.

- Log out or turn off your truck.
- Avoid parking on inclines. If you must park on an incline, chock the wheels. Check the display to make sure the parking brake is applied.

Check Your Truck Before Starting Work

You must make sure that your truck is safe to use.

See your supervisor for requirements in your workplace and local laws for inspection.

Note: If anything does not look, work, feel, or sound right, do not operate your truck. Report the problem to your supervisor.

1. Walk around your truck and check it over.

- Turn on your truck and check that the display is working.
- Check that the power source is charged.
- Check the battery connector, battery terminals, and battery cables for damage.

For flooded lead acid batteries:

- Check the battery compartment for spilled acid.
- Make sure the battery cable guide is installed.
- After checking the water level, make sure that the vent caps are in place.
- Make sure that the battery is secure and the battery retainers are in place.
- Inspect the lift chains and anchors for damage and corrosion. Make sure that the lift chains are well lubricated.
- Check that all wheels are in good condition.
- Check that the load backrest is in place and fastened. Make sure that the load backrest and other attachments are not damaged.

- Look under your truck for signs of hydraulic leaks.
- Make sure that the forks and fork carriage are not damaged or badly worn.
- Check the fork latches. Make sure that the forks are secured.
- Check that the mast guard and mast covers are in place without damage or cracks. Keep the mast guard clear using a clean cloth.
- Check the overhead guard for damage and cracks.
- Test the horn.
- Check the capacity plate on your truck. Make sure you use the correct units of measure.
Note: If an attachment on your truck does not match the information on your capacity plate, don't operate your truck. Notify your supervisor.
- Make sure that the emergency disconnect works.
- Check that all controls move smoothly. All controls should automatically return to their neutral position.

Continued on next page...

2. Test drive your truck in an uncongested area.

- Make sure that the pedals work.
- In an open area, drive the truck slowly in both directions. Check braking and plugging in forward and reverse. First check at a slow travel speed, then at a faster one.
- If at any time the stopping distance is too long for you, do not drive your truck.
- Test all hydraulic functions.
- Check the indicator or steering widget on the screen. Make sure that steering is easy and smooth. Know your steer angle.

Power Sources

Your truck can be designed to use the following power sources:

- Flooded Lead Acid Batteries including Gel Batteries
- Lithium-Ion Batteries

Only Crown approved power sources are permitted to be used in your truck. Only authorized service personnel are permitted to modify the power source installed in your truck.

Note: Follow the manufacturer's specification and instructions when handling power sources.

Working with Power Sources

Your company should provide an area that is safe to work on power sources. Use that area for all power source work and charging.

- Do not charge a power source unless you are trained and authorized.
- Do not remove or install a power source unless you are trained and authorized.
- Only use equipment approved for your truck and power source.

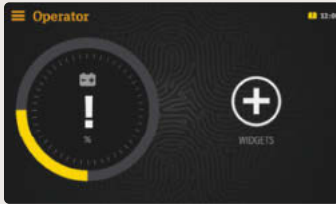
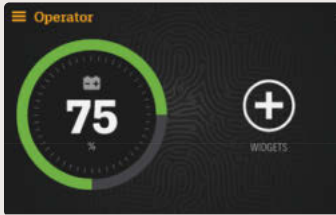

Power Source Status

The widget shows how much energy is available in the power source. The energy level is shown in the center of the widget and in the icon on the status bar.

When the energy level is low, the widget turns yellow showing an exclamation point in the center. The icon on the status bar turns yellow and flashes. Change or recharge the power source.

Caution

Avoid damaging the power source

Power sources that are not properly maintained will fail prematurely.

Always follow the manufacturer's instructions for the power source.

Before Charging Power Sources

- Read the instructions for the charger and power source.
- Make sure that the charger has the correct voltage and amperage for the power source.
- When charging power sources, use only chargers approved for the power source.
- Only charge a power source in an authorized area.

Charging a Flooded Lead Acid Battery

1. Turn off your truck.
2. Unplug the power source connector from the truck.
3. Follow the charging instructions from the power source manufacturer.

When charging is complete, unplug the charger and plug the power source connector into the truck.

Charging a V-Force™ Lithium-ion Battery

1. Turn off your truck.
2. Plug the charger into the battery charge port.
3. Follow the charging instructions for the V-Force lithium-ion battery.

Opportunity charge during breaks or whenever the truck is not being used.

When opportunity charging is complete or the battery is fully charged, unplug the charger from the battery charge port.

 **Caution****Avoid damaging the truck and power source charger**

Make sure that the power source charger is plugged into the power source connector, not the truck connector.

Avoid damaging the power source

Do not operate trucks with lithium-ion batteries in freezing temperatures.



Danger

Lead acid batteries produce gas that can explode

You can cause sparks which can damage the battery.

- Never let anything conductive like metal touch the top of the cells. Use an insulator such as plywood, when necessary.
- Never smoke or use an open flame around batteries.
- Make sure that the battery cells are filled to the proper level.
- Ventilate well when in an enclosed area and when charging.

Avoid contact with battery acid

Battery acid can cause severe burns.

- Use protective equipment such as gloves, eye shields, aprons, etc.
- In case of contact, remove clothing. Flush skin and eyes immediately and thoroughly with water.
- Get medical attention if your eyes are affected.



Removing the Battery

Before removing a battery, perform the following steps:

1. Park on a level floor.
2. Lower the forks completely.
3. Fully retract the mast reach carriage.
4. Pull up the battery release lever under your seat.
5. Extend the mast reach carriage to pull the battery forward.

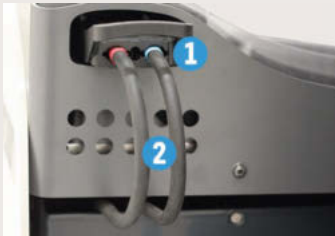

Disconnecting the Battery

- 1 Battery Connector
- 2 Battery Cable

To disconnect the battery, perform the following steps:

1. Turn off your truck and remove the key if equipped.
2. Disconnect the battery connector and place the battery cable and battery connector on top of the battery.

Continued on next page...



Removing the Battery Retainer

Your truck has a battery retainer on each side of the truck. Only one battery retainer is removable.

- 1 Wing Screw
- 2 Removable Battery Retainer

To remove the battery, perform the following steps:

1. Turn the wing screw on the side of the battery.
2. Remove the battery retainer.

The battery can now be removed.

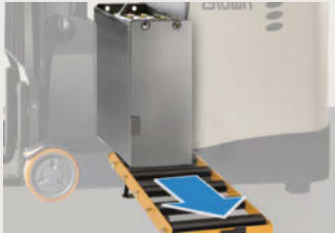

Rolling out the Battery

Make sure that the roller stand is the correct size for your truck and battery.

1. Place the roller stand next to the truck.
2. Move the battery onto the roller stand.

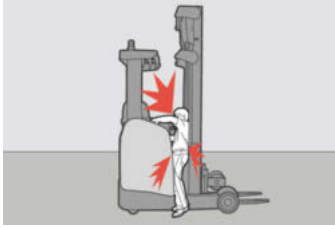

! Caution

Avoid body parts being crushed

Hands and feet can be crushed when the mast reach carriage extends and retracts.

Make sure no one reaches or climbs into the mast reach carriage area.

Continued on next page...

Warning

Make sure the battery is secure

Falling lifting equipment and batteries can result in severe injury and death.

- Make sure that your lifting equipment has sufficient capacity and refer to the manufacturer's operating instructions.
- Make sure that there is no one under or around a raised battery.
- Make sure that the chains and hook cannot fall onto the battery cells.



Lifting the Battery

Use an approved spreader bar to remove or place the battery on a stand.

- 1 Spreader Bar
- 2 Hooks
- 3 Battery

1. Adjust the spreader bar hooks to fit the battery.
2. Attach the battery to the spreader bar.
3. Lift and move the battery carefully.

 **Warning****Check the size and type of the battery**

An incorrect battery can affect truck handling and stability causing an accident.

- Make sure that you use the correct size, type, and weight of battery.
- Do not use gel batteries for trucks with regenerative lowering.

Avoid damaging the battery cable

Battery cable damage can result in short circuits.

- Make sure that the battery cable is the correct length.
- Make sure that the battery cable guide is installed and vertically aligned with the battery connector.
- Make sure that the battery cable does not hang off the battery.

Check the battery retainer

Unsecured batteries can slide or roll out of the truck.

Make sure that all battery retainers are installed and secure before operating your truck.

Continued on next page...



Installing the Battery

Make sure that the new battery is ready for use and equipped with a battery cable guide.

1. Place the new battery into the truck. Make sure the battery is resting against the fixed battery retainer.
2. Replace the removable battery retainer and tighten the wing screw.
3. Connect the battery to the truck. Make sure the battery cable guide is installed.

Note: Make sure that the battery cable is not strained or pulled too tight.

4. Turn on your truck.
5. Fully retract the mast reach carriage. Make sure that the battery release lever is engaged.
6. Check truck operation.

Follow the on-screen messages.

Note: Make sure you know your Truck Type. See Capacity Plate on page 32.

Each Warning Label on Your Truck Is Important
Read and obey all of them to protect yourself and others.

⚠ WARNING

STOP It's the law, you must be trained and certified to operate this truck.

(OSHA § 1910.178, Rev. 1995)

You or people around you could be seriously injured or even killed if you don't use this truck correctly.

Obey all instructions & warnings in the operator manual and on the truck.

⚠ WARNING Avoid being crushed. Keep head, arms, hands, legs, and feet within the operator area. Stop truck completely before getting off.

However, tipovers and falls from docks can cause serious injury or even death. Immediately exit and move away from the truck in these emergencies.

You can be trapped or crushed by objects protruding into the operator area. Look where you are going.

Inspect your truck before starting work, make sure it's in good working order.

* Additional copies of the Operators Manual and Truck Labels can be obtained from: Crown Equipment Corp. New Bremen, OH 45869

549-A

⚠ WARNING

A moving vehicle can be dangerous.

Serious injury or death to you or others around you can happen if you are not careful or don't know what you are doing.

Do not operate this truck unless you are trained and authorized.

Read and obey all Warnings and Instructions in the Operators Manual* and on the truck.

*Additional copies of the Operators Manual and Truck Labels can be obtained from: Crown Gabelstapler GmbH & Co. KG Roding, Germany

crown.com 004-993

⚠ WARNING

Protect yourself. Keep these inside!

Remember your training! This truck can weigh as much as 3 automobiles. You cannot stop that much weight with a foot or hand.

9002-4

⚠ WARNING

Adding electrical devices (radio, terminal, lights etc.) or changing existing components or wiring can affect truck operation and could cause an accident.

Contact authorized Crown personnel before adding to or changing the electrical system in any way.

⚠ WARNING



Falling objects or lowering forks can cause serious injury or death.

Never stand under the forks.

While servicing, block the forks so they won't fall.

10

⚠ WARNING



Standing or riding on the forks can cause a fall. You can be seriously injured or killed.

Never stand or ride on forks for any reason.

09-0

⚠ WARNING



Moving mast can pin or crush your head, hands, or arms.

Stay completely out of this area at all times.

104-00A

⚠ WARNING



CAUTION

Connect charger properly or truck can be damaged. Make certain charger is plugged into the battery connector, not the truck connector.

07-00A

⚠ DANGER



Batteries can produce explosive gas. Do not smoke, use open flame, or create an arc or sparks near this battery. Ventilate well when in an enclosed area and when charging.

This battery contains **Sulphuric Acid** which causes severe burns. Do not get in eyes, on skin, or clothing. In case of contact flush immediately and thoroughly with water. Get medical attention if your eyes are affected.

20-00A

⚠ WARNING

Operate this truck only with an approved electric power source.

This truck as designed and manufactured from the factory is qualified for use with a lead acid battery and if configured, Crown V-Force products.

Written approval must be obtained from Crown prior to installation of a new type of electric power source. OSHA 1910.178 (a)

8005-A

 **WARNING**

Minimum battery size allowed
000 mm (00.00 in.) wide
000 mm (00.00 in.) long

Undersize battery can affect truck handling and stability. You could have an accident.

Use U.L. classified Type EO battery.



Stay clear of all moving parts.

Moving parts can cut or crush hands, feet, arms or legs.

105

Continued on next page...

Trademarks

The following trademarks are property of Crown Equipment Corp. in the United States and other countries.

Your truck is equipped with the following standard features and may be equipped with optional features.

The logo for ecologic™, featuring the word "ecologic" in a green, lowercase, sans-serif font with a trademark symbol.The logo for genā., featuring a stylized orange fingerprint icon to the left of the word "genā." in a lowercase, sans-serif font.The logo for eGEN BRAKING, featuring a yellow "e" in a black circle to the left of the word "GEN" in white, bold, uppercase letters, with "BRAKING" in smaller yellow, uppercase letters below it, all on a dark grey background.The logo for OnTrac™, featuring the word "OnTrac" in a bold, black, sans-serif font with a trademark symbol.The logo for Crown Insite™, featuring the word "Crown" in a small, black, sans-serif font above the word "Insite" in a larger, bold, black, sans-serif font, with a stylized signal icon above the "i" and a trademark symbol.

Options:

The logo for XPRESS LOWER., featuring the word "XPRESS" in a bold, black, sans-serif font above the word "LOWER." in a smaller, black, sans-serif font, with a stylized orange "L" shape to the left.The logo for InfoLink™, featuring the word "Info" in a bold, orange, sans-serif font, a stylized orange "i" icon, and the word "Link" in a bold, black, sans-serif font, with a trademark symbol.The logo for TILT POSITION ASSIST., featuring the word "TILT" in a bold, black, sans-serif font above the words "POSITION ASSIST." in a smaller, black, sans-serif font, with a stylized orange and black graphic element to the left.The logo for VFORCE, featuring a stylized orange and black "V" shape to the left of the word "FORCE" in a bold, black, sans-serif font.

A Crown Equipment Brand



CROWN

600025-000 Rev. C
Printed in USA
© 2015-2020



Operator Manual
EN-NA