

Operator Manual





WARNING

It's the law, you must be trained and certified to operate this truck. (OSHA § 1910.178, Rev. 1999)

You or others around you can be seriously injured or even killed if you don't use this truck correctly.

Read and obey all warnings and instructions in this Manual* and on the truck.

Head, arms, hands, legs or feet outside the operator area can be pinned or crushed whenever the truck is moving.

Stay within the operator area and **stop the truck completely before getting on or off.**

A dockboard can move or drop while you are on it. Or you could drive off a dock. Falls from docks or dockboards can cause serious injury or even death. **Make sure you are safe.**

Inspect your truck before starting work, make sure it is in good working order.

* Additional copies of this Operator Manual and all Truck Labels can be obtained from Crown Equipment Corporation, New Bremen, Ohio 45869 U.S.A. **crown.com**

All rights reserved under International and Pan American copyright conventions
Copyright 2016 Crown Equipment Corp.

Table of Contents

General	5
Who should read this manual?	5
Intended Use	6
Floor Conditions	6
Safety	7
Drive Carefully	8
Protect yourself	9
Look out for other people	9
Traveling	10
Travel route and visibility	10
Traveling on inclines	11
Loading and unloading trucks	11
Transporting loads	11
When You leave your Truck	12
Moving mast parts	13
Capacity Plate	14
Capacity	14
Components	16
Truck Overview	16
Control Handle & Dashboard Panel	17
Display Panel	18
Battery discharge indicator and battery warning indicator light	18
Performance setting display	19
Display screen	19
Operator error indicator light	20
Service indicator light	20
Operator Menu	20
Navigation buttons, Enter Button	20
Operation	21
Turning the Truck On and Off	21
Turning the truck on and off with the Enter Button	21

Entering a PIN	22
Turning the truck on and off with the key switch	22
Changing parameters/displays after power-up	23
Adjusting the Seat Rest	24
Applying the Emergency Disconnect	25
Travel, Steering & Braking	26
Operator position	26
Travel	26
Forward Travel	27
Reverse Travel	27
Forward/Reverse Rockers	28
Travel speed settings	28
Braking	29
Hydraulic Functions	30
Lifting and lowering the forks	30
Daily Safety Inspection	31
Safety Inspection	32
Safety Inspection - Visual Inspection	32
Safety Inspection - Operational Test	33
Battery Maintenance	34
Charging the battery	36
When you Install or Change batteries	37
Messages	38
Warning Labels	39

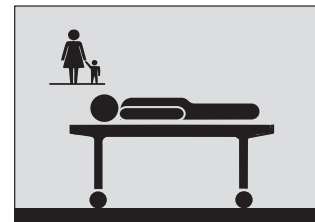

General

This operator manual describes the MPC 3000 pallet truck.

Who should read this manual?

This manual is for operators of this truck.

The operator manual is a part of the truck. Store this manual in a convenient location.

Details of maintenance and repair work are contained in the Service & Parts manual.

It's The Law, You Must Be Trained And Certified

Federal law states that only properly trained operators are permitted to operate a powered industrial truck and that your employer must train you and certify that you are qualified to operate this powered industrial truck. (OSHA §1910.178, Rev. 1999)

Do not operate this truck in your work place until you have been trained and certified by your employer.

You could be killed or seriously injured if you are not adequately trained for lift truck operation!

Intended Use

This truck without attachments is designed solely for collecting, lifting and transporting palletised goods. Any other application is considered contrary to the intended use of the truck.

- The truck should only be used as described in this manual, and operated within the operating restrictions and ambient conditions specified in this manual.
- The truck is not authorised for use on public roads.

Floor Conditions

Make sure floors meet the following conditions:

- Level and free of damage
- Clean, dry and free of debris
- Have adequate capacity appropriate for truck operation

Safety

Safety Messages

This Operator Manual contains important information about your truck and how to use it properly. Safety messages provide instructions about potential hazardous situations, how to avoid them, and the consequences of not avoiding a hazardous situation. Follow all instructions and obey all warnings and safety notices in the manuals and on your truck.

Safe truck operation depends on you.

DANGER

Indicates a hazardous situation that, if not avoided, will result in death or very serious injury.

WARNING

Indicates a hazardous situation that, if not avoided, could result in serious injury or even death.

CAUTION

Indicates a hazardous situation that, if not avoided, could result in moderate injury and/or product damage.

Drive Carefully

- When riding, keep your hands on the controls and feet on the platform. Keep your body within the operator area.
- Never place objects anywhere on the operator platform.
- Never stick a foot or any part of your body outside the truck, no matter how slow the truck is moving. You can not stop 4535 kg or 10,000 pounds with any part of your body. A foot or hand caught between the truck and a fixed object will be crushed or even cut off.
- You could be seriously injured or even killed in a fall from a dock or dockboard. Stay away from the edge of docks and ramps. Make sure dockboards are secure. Check that trailer wheels are chocked.
- Keep your truck under control at all times. Drive at a speed that allows you to stop safely. Be even more careful on slippery or uneven surfaces. Do not drive over objects on the floor.
- Perform all truck movements smoothly and at a speed that will give you time to react in an emergency.

Protect yourself

- Stop your truck completely before getting on or off.
- Always keep arms and legs inside the operator area when riding.
- Look where you are going. You or others could be pinned or crushed by fixed objects.
- Never ride on any part of your truck other than the operator platform.
- Make sure that your hands and shoes are clean and dry. Wear clothing that is proper for work.

Look out for other people

- Look out for pedestrians.
- Make sure you do not pin or crush someone.
- Never allow passengers on your truck.
- Keep others away from your truck while you're working. Don't allow anyone to ride on the load.

Traveling

- Observe the traffic regulations and speed restrictions at your place of work.
- Adapt your travel and speed to the situation at hand.
- Maintain a sufficient safety distance between vehicles, personnel and external objects to ensure you can stop the truck in time.
- Do not collide with other trucks or equipment.
- Do not start, brake or steer abruptly.
- Steer with particular care when travelling with the forks facing forward. The truck will swing wide in the opposite direction. Make sure you have clearance, and watch out for people in the area
- Never travel with raised forks except to stack or retrieve a load. During travel the forks should be *150 to 300 mm (6 to 12 inches)* above the floor.

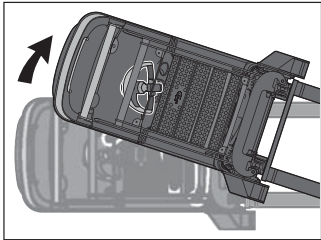

Travel route and visibility

- Never exceed the maximum capacity of the floor, lifts, dock plates or ramps. Calculate the overall weight of the truck based on the truck weight, the battery weight and the load.
- Do not travel over potholes, wet surfaces or loose material.
- Travel slowly and carefully near hidden corners and narrow stretches, when cornering and travelling through doors. Use the horn to warn other people.
- Note the minimum clearance height.
If the load obstructs your view, travel with the load trailing.
- Operate the truck only in areas with sufficient lighting

Traveling on inclines

- Do not turn on inclines. The truck could tip over.
- Keep the forks pointing uphill on inclines.
- Reduce speed when traveling down an incline. Be aware of the increased braking distance (compared to level ground).

Loading and unloading trailers

- Make sure the trailer you are loading or unloading cannot move (parking brake, wheel chocks or loading dock locks).
- Make sure the dock plate is secure.
- Drive with particular care on docks. The truck could tip over the edge.

Transporting loads

- Make sure that your load is resting against the face of the forks or load backrest. The forks should be *100 to 150 mm (4 to 6 inches)* above the floor. Travel with the load resting against the battery compartment.
- Make sure the load is centered over the forks and cannot swing or shift.
- Bulky, unsafe loads should also be secured to prevent them from falling.
- Do not lift loads that are too heavy. Note the truck's capacity (See Capacity Section).
- Do not carry any objects on the platform. They restrict your freedom of movement and constitute a tripping hazard.
- Do not use the truck to tow or push loads such as pallets lying on the floor.

When leaving your truck

- Come to a complete stop before leaving truck.
- Always park on stable, level flooring.
- Lower the forks. Turn the truck off or disconnect the battery.
- Avoid parking on inclines. But if you must, block the wheels of your truck.
- Do not block any intersections, crosswalks emergency exits or fire protection equipment.

Battery



Batteries can produce explosive gas.

Ventilate well when in an enclosed area and when charging.

Battery acid can burn

Avoid contact with battery acid. Always wear eye protection.

Objects falling on the battery can cause short circuits and fires

Prevent metal objects from falling on the battery.

Lead in Batteries

Lead exposure can be harmful. Batteries contain lead. Always wash your hands after working with batteries.

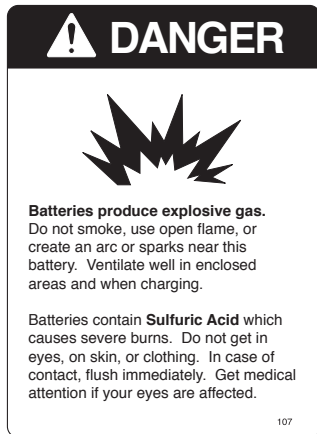

Moving mast parts

Risk of injury from moving mast parts

- Never reach into the mast area.
- Make sure there are no other people in the hazardous area.

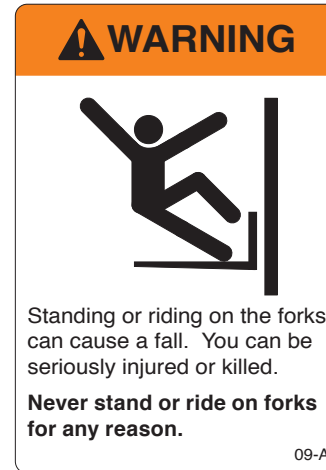

Falling loads, fork lifting and lowering

There is a risk of injury from falling loads and from fork lifting and lowering operations

- Never stand underneath or near the forks.
- Make sure there are no other people in the hazardous area.

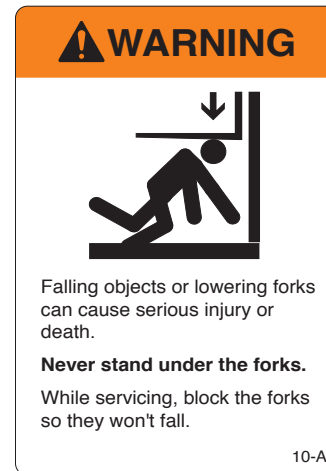

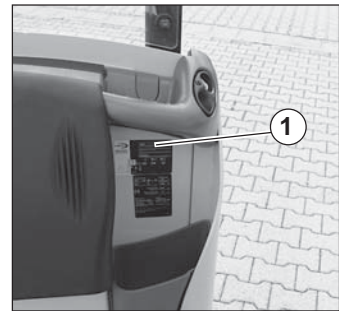
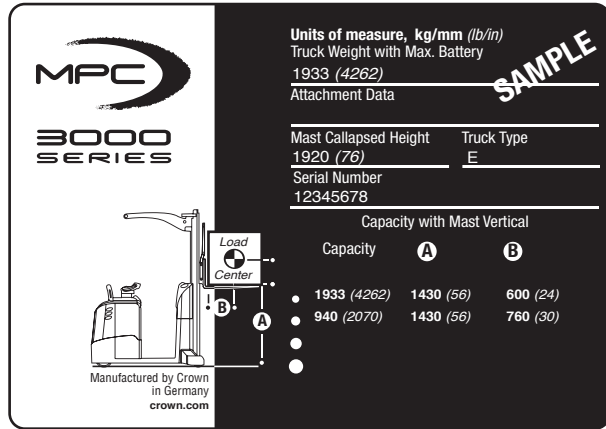

Fig. 1 Backrest
1. Capacity plate

Capacity Plate

The capacity plate ① is located on the backrest.

You may not exceed the 1200 kg (2645 lbs), capacity, even at low heights **A** or if the load center distance **B** is less than indicated on the capacity data plate.

Contact Crown if you require capacities for greater load center distances.

Capacity

The capacity of the truck indicates the maximum weight that can be lifted. For stability, the load must be evenly distributed and resting against the backrest.



WARNING

Reduced stability can cause accidents

Trucks that appear the same may have different capacities.

- The maximum capacity is indicated on the truck's data plate under "Rated Capacity".
- Make sure the load is centered over the forks.
- Never exceed the truck's maximum capacity.

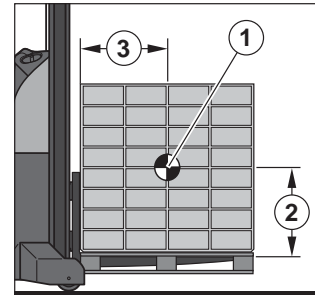

Fig. 2 Load center

1. Load center
2. Load center height
3. Load center distance

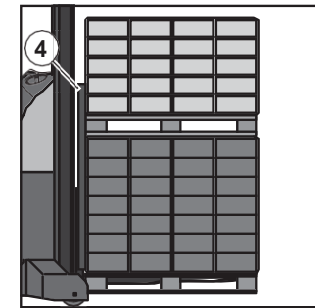

Fig. 3 Stacked loads

4. Extended load backrest

What Is Load Center?

Load center ① is the distance from the load backrest ③ or vertical face of the fork ② to the center of an evenly distributed load.

Transporting multiple pallets or wire baskets



WARNING

Unsecured loads can cause accidents

Do not start, stop or steer abruptly.

- Apply the lift or lower functions smoothly.
- Prevent the load from slipping off.
- Use an extended load backrest ④ to stabilize high loads and loosely packed loads that could fall.

Components Truck Overview

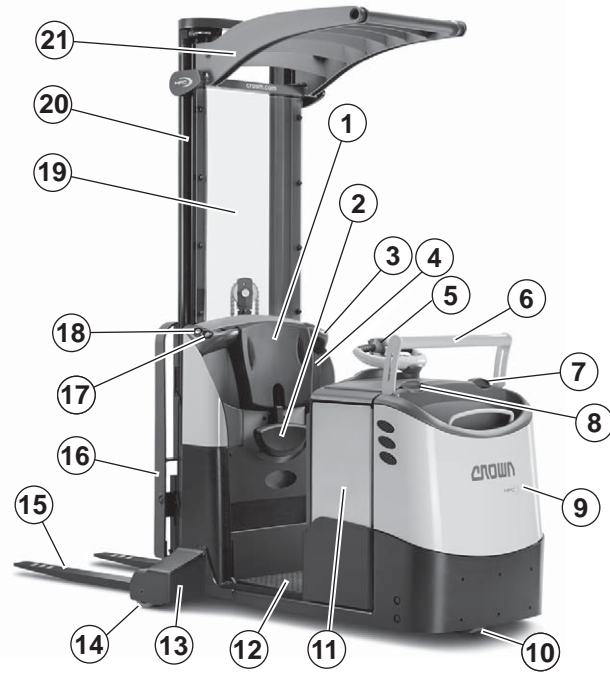

Fig. 4 Truck Overview

1	Backrest	11	Battery compartment
2	Seat rest	12	Platform
3	Grab handle	13	Wheel housing
4	Capacity Plate	14	Load wheel
5	Control handle	15	Fork
6	WorkAssist™ accessory tube	16	Extended load backrest
7	Battery cover latch	17	Lower switch
8	Emergency Disconnect switch	18	Lift switch
9	Motor compartment	19	Mast guard
10	Drive wheel	20	Mast
		21	Overhead guard

Control Handle and Dashboard Panel

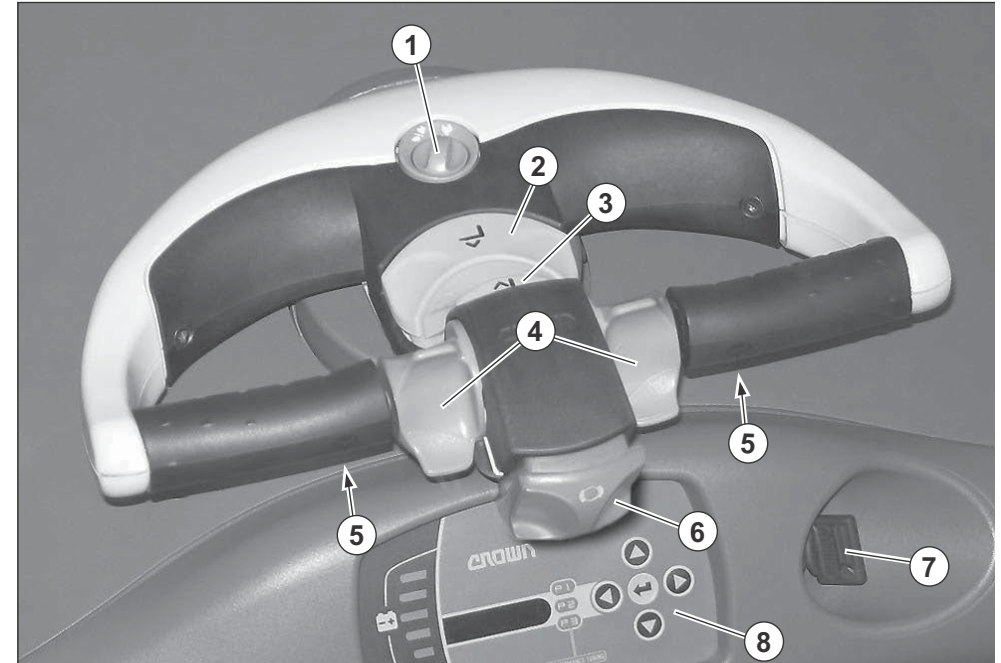

Fig. 5 Control handle overview

1	Travel speed switch	5	Horn button (<i>Underside, hidden view</i>)
2	Lower switch	6	Brake button
3	Lift switch	7	Key switch
4	Forward/Reverse Rockers	8	Display and switch panel

Display Panel

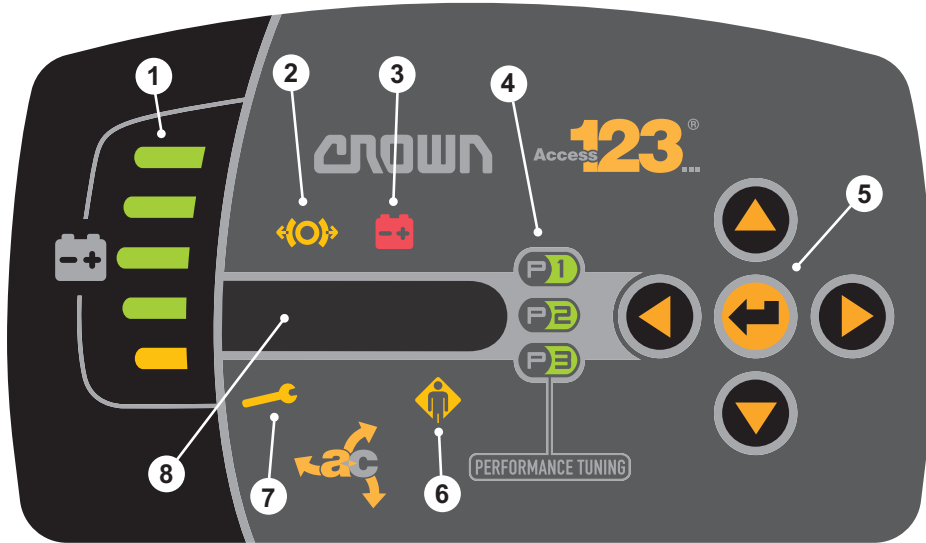

Fig. 6 Display panel

- | | |
|-------------------------------------|----------------------------------|
| 1 Battery Discharge Indicator (BDI) | 5 Navigation buttons |
| 2 Not used on this truck | 6 Operator error indicator light |
| 3 Battery warning indicator light | 7 Service indicator light |
| 4 Performance setting display | 8 Message Panel |

Battery discharge indicator (BDI) and battery warning indicator light

The battery discharge indicator ① consists of four green and one yellow LED.

When the battery warning indicator light

③ flashes, the battery must be charged immediately. The truck will stop in 5 minutes.

Performance setting display

When the truck starts, one of the three performance setting displays illuminates (④, Fig. 6). Different values for the maximum speed, acceleration etc. are assigned to the various performance settings.

Message Panel

The Message Panel (⑧, Fig. 6) shows truck information such as: hours of operation, event codes along with instructions, battery charge and other data

When the truck is turned on, the display is in message mode. Display: **MPC 3000**. Depending on the pre-setting, one of the following readings can be chosen as the display (see Fig. 6):

- **BDI = XX %** (Battery Discharge Indicator)
- **HOURS = XX h**
- **SPEED = XX mph**

Message mode means:

As soon as an event or condition occurs, a corresponding message is displayed.

Operator error indicator light

The operator error indicator light (⑥, Fig.6) lights up for the following reasons:

- PIN entry request
- Operator error

The display also shows an operator hint.

Service indicator light

The service indicator light (⑦, Fig.6) lights up for the following reasons:

- Error occurred (e.g. if an LED fails)
- Restricted operating status (e.g. motor over-temperature)
- Service interval exceeded

The event code can be selected from the operator menu.

Operator Menu

Navigation buttons, Enter button

The following table lists the navigation and entry button options (⑤, Fig.6) within the operator menu:





-  Press this button to access a higher level in the menu.
-  Press this button to access a lower level in the menu.
-  Press this button to scroll down an item in a menu.
-  Press this button to scroll up an item in a menu.
-  Press the Enter Button to acknowledge the message.



Fig. 8 Dashboard panel

1 Enter button

Operation

Turning the Truck On and Off

The following options are available for turning the truck on and off:

- Display Enter button (standard)
- Key switch
- Keypad
- InfoLink®



WARNING

Unauthorized use of the truck can result in accidents

- Always remove the key whenever you leave the truck.
- Do not share your PIN number with anyone.

Turning the truck on and off with the Display Enter button

Turning the truck on with the Enter button







1. Press the  Enter button for two seconds. The power-up routine is performed. All the displays light up for approx. 1 second and an audible signal sounds. The entry prompt **PIN** is displayed.
2. Enter your PIN.

Turning the truck off with the Enter button

Press the  Enter button for at least three seconds.

Entering a PIN

PINs ensure that only authorized drivers can operate the truck. A specific performance setting can also be assigned to the PIN.

1. Press the  button.
2. Select the digits with the  or  buttons.
3. Press the  button to advance a position. If necessary, go back a position using the  button.
4. When you have entered the last digit confirm by pressing the  Enter button

The truck is now operational.

The display screen is in message mode.

The performance setting is displayed (④, Fig. 6)

If the PIN is incorrect the following is displayed: **PIN**

The truck will not start until you have entered a valid PIN.

Turning the truck on and off with the key switch

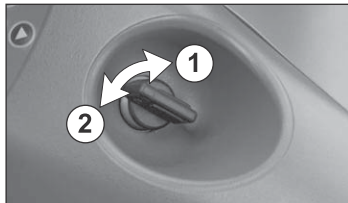

Fig. 9 Key switch

- 1 ON position
- 2 OFF position

Turning the truck on with the key switch

Turn the key switch ON ①.

The power-up routine is performed. All the displays light up for approx. 1 second and an audible signal sounds.

The truck is now operational.

If your truck requires a PIN code, the following applies *after* you have activated the key switch:

The **PIN** prompt is displayed.

Enter your PIN.

Turning the truck off with the key switch

Turn the key switch OFF ② (see Fig.9).

Changing parameters/displays after power-up

Changing the performance setting

If you have started the truck without entering a PIN, you can change the performance setting.

The performance setting controls speed and acceleration, for example. The performance settings can be created for the experience level of the operator.

For example: P1, and P2 for advanced operators and P3 for entry level operators.



To select a setting, proceed as follows:

1. Press the  button to access the **PERFORMANCE** menu.

PERFORMANCE is displayed.





2. Press the  button once.

SET P1, SET P2 or **SET P3** is displayed.

3. Using the  button select the performance setting and confirm by pressing the  Enter button .

Changing the display

You can change the display provided this function has been enabled beforehand.

1. Press the  button.
2. Using the  or  buttons select the required display, e.g. battery charge status **BDI**.
3. Confirm by pressing the  Enter button.

Adjusting the Seat Rest

Your truck may be fitted with a seat rest. Before traveling, you can adjust the seat rest or fold it down if you do not intend to use it.



Adjusting the Seat Rest while traveling can result in accidents

Always stop the truck before adjusting the Seat Rest.

Adjusting the Seat Rest

1. Pull the seat rest ① up.
2. Move the seat rest ① down and move it into the required position.

Folding the Seat Rest down

Pull the bar ② underneath the seat rest ① forward. The seat rest ① folds down.

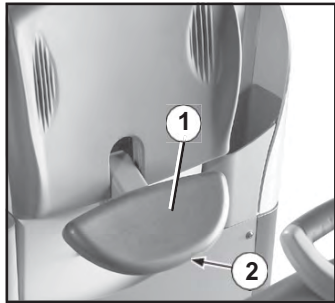

Fig. 7 Seat rest

- 1 Seat rest
- 2 Bar (under seat)

Second Level Step

For assistance reaching higher levels, swing the optional step down to the level position.

When either step is in the down position, the brake is applied and you cannot travel.



Applying the Emergency Disconnect

The Emergency Disconnect removes the power supply from the truck.

Apply the Emergency Disconnect in emergencies (e.g. if you smell burning or if the truck behaves in an unexpected manner).

Note: Do not use the Emergency Disconnect for braking.

Applying the Emergency Disconnect

Pull the Emergency Disconnect ①.

The power supply to the truck is disconnected.

The parking brake applies. Do not use the truck and inform your supervisor.

Resetting the Emergency Disconnect

1. Turn the key switch, if applicable, OFF.
2. Push the emergency disconnect down to restore power.

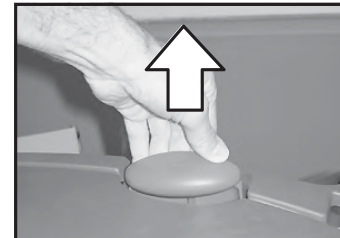

Fig. 10 Dashboard panel
1 Emergency Disconnect switch

Travel, Steering & Braking

Operator Position



WARNING

Watch your hands and arms

Keep your hands and arms on the power unit side of the backrest.

- Keep your entire body within the operator area.
- Keep both feet on the platform.

Travel



WARNING

Loss of control can result in accidents

- Keep the platform clean and dry (oil, loose sheets of paper, wrapping etc. increase the risk of slipping).
- Keep the platform clear of any kind of object. You can trip over them and they restrict your freedom of movement.
- Maintain a stable position on the platform.
- Apply an appropriate speed, especially around turns.

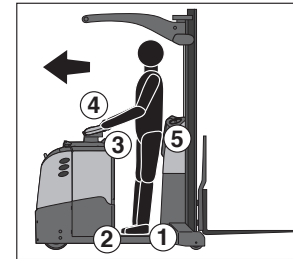
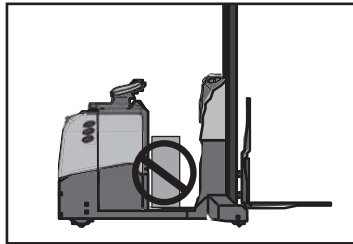

Fig. 11 5-point stance

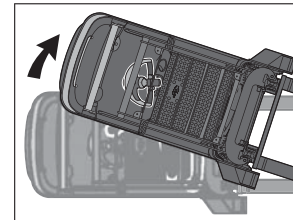

Fig. 12 4-point stance

Forward travel

The 5-point stance is recommended for forward travel.

5-point stance

The 5-point stance provides 5 contact points between the operator and the truck.

- Keep both feet on the platform.
- Keep both hands on the control handle.
- Lean back against the backrest.

Reverse Travel



WARNING

Power Unit swing when in reverse travel

- Be careful turning while traveling forks first. The power unit will swing wide in the opposite direction.
- Make sure you have clearance, and watch out for people in the area.

4-point stance

The 4-point stance provides 4 contact points between the operator and the truck.

- Stand sideways with both feet on the platform.
- Keep one hand on the control handle and,
- Keep the other hand on the grab handle.

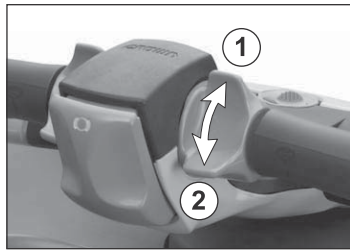

Fig. 13 Rockers

1. Forward travel
2. Reverse travel

Forward/Reverse Rockers

The Forward/Reverse Rockers are used to control forward and reverse speed.

Applying the rockers

For forward or reverse travel, move the rockers as shown in Fig. 13.

Note: The further you move the rockers, the faster the truck will travel.

Plugging - Slowing with Forward/Reverse rockers

Plugging is another way to slow down your truck.

1. While traveling, in either direction, move either Forward/Reverse rocker ① through neutral to the opposite direction of travel.
2. Release the rockers ① to avoid travelling in the opposite direction.

Note: The further you move the rockers ① the faster the deceleration rate. Plugging will not hurt your truck.

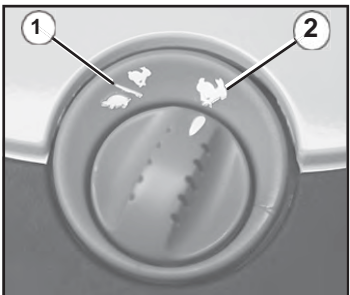

Fig. 14 Travel speed switch

Travel speed settings

You have a choice of two travel settings:

- Turtle / rabbit ① = Slow - for Maneuvering
- Rabbit ② = Fast - for Clear Travel

Changing the speed setting

Turn the travel speed switch to the desired position.

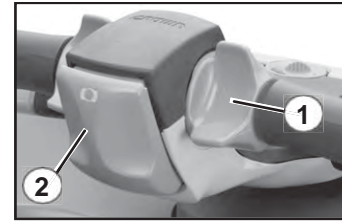

Fig. 15 Braking

1. Forward/Reverse Rockers
2. Brake switch

Braking

Press the brake switch ②.

The brake switch stops the truck in the shortest possible distance.

Parking brake

One second after the truck has come to rest the parking brake applies and remains activated until the travel switch is pressed.

Parking the truck

1. Lower the forks completely.
2. Turn the truck off. The brake is applied automatically.
3. When parking on ramps chock or wedge the wheels to prevent the truck from rolling away.

Note: Where possible, always park on stable, level floor. Do not block any traffic lanes, emergency exits, switchgear mechanisms or fire protection equipment.



Fig. 16 Horn

1. Horn button

Horn buttons

Press the horn button ① to warn other people, especially in the following situations:

- When exiting an aisle
- Where visibility is obstructed
- At travel intersections

Hydraulic Functions

Lifting and lowering the forks with the control handle

Note: When the forks are raised above 1000 mm (39 in.) (800 mm (31.5 in.) on trucks with a TL mast), the travel speed is restricted to 3km/h (2 mph).

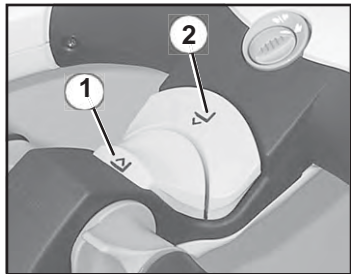

Fig. 17 Fork lift

1. Lift switch
2. Lower switch

Lift the Forks

Press the lift switch ①.

Lower the Forks

Press the lower switch ②.

Note: The further you press the switch, the faster the lowering speed.

Lifting and lowering the forks with optional switches on backrest

Two optional switches on either side of the backrest enable the forks to be raised and lowered when the operator is standing next to the truck.

Lift the Forks

Press the lift switch ③ until you reach the required height.

Note: The forks can be raised to a maximum height of 4,293 mm (169 in) on trucks with a TL mast.

Lower the Forks

Press the lower switch ④ until you reach the required height.

Note: When the operator is on the platform, the forks can be lowered completely. With the operator off the platform, the forks can only be lowered to a minimum height of 254 mm (10 in.).



Fig. 18 Switches on the backrest

3. Lift switch
4. Lower switch

Daily Safety Inspection

Carry out the safety inspection each time you start work or when changing shift.

Keep the truck clean. This will make it easier to check for damage.

Safety Inspection

The first part of the safety inspection is carried out with the truck turned off. For the second part the truck must be turned on.



DANGER

Risk of explosion and fire

Storage batteries emit gas during charging. This can collect and explode if exposed to sparks or open flames.

- Spilled fluids can be flammable.
- Do not use an open flame to check fluid levels.



WARNING

Operating a defective truck can result in accidents and injury!

- Check your truck before starting work
- You must make sure your truck is safe to use.

Safety Inspection - Visual

Safety Inspection - Visual	
Location	Action
Battery Latch	Check operation. Make sure the battery is secure.
Battery	Check battery compartment for spilled acid. Check the insulation of the battery terminals and battery cell connectors. Check the battery connector and cables for damage, check contacts for burning. Perform checks when charging and replacing the battery.
Transmission, Hydraulics	Check the floor underneath the truck for traces of leaks.
Forks, Fork Carriage, Fork Latches	Check the forks and the fork carriage for damage and cracks. Make sure the forks are secure. Check the fork latches are working securely.
Lift Chains, Chain Anchors	Check the lift chains for contamination and corrosion, and ensure they are adequately lubricated. Check the chain anchors for damage, cracks and corrosion. Check that the cotter pins in the chain bolt on the chain anchor are fitted and free of damage.
Load Backrest, any Attachments*	Ensure they are fitted securely and check for damage.
Overhead Guard	Check the overhead guard for damage.
Labels, Decals	Check that labels and decals are legible. Replace any illegible or missing labels and decals. See parts manual for labels.

Safety Inspection - Visual	
Location	Action
Wheels	Check wheels for damage and debris.
Grab Handles, Grab Bar, Work Assist™ Tube and Accessories	Check for damage and any attachment defects.

Safety Inspection - Operational



WARNING

Use caution during operational testing.

- Carry out the tests in an open area away from obstacles and other people.
- Watch out for people in the work area.
- Stay away from moving truck parts.

Stop the truck as soon as you discover any problems. Have the problem rectified by a trained, authorized service technician before operating the truck.

Safety Inspection - Operational

Safety Inspection - Operational	
Location	Action
Display Panel	Turn on the truck and test all the displays and alarms.
Steering	Test the steering.
Controls	Check the condition of all controls, buttons, handles and pedals. All controls should revert to the neutral position automatically.
Hydraulic Functions	Check operation.
Emergency Disconnect Switch	Test the Emergency Disconnect switch.
Horn	Check operation.
Brake	Check operation: - Change travel direction (<i>Plugging</i>). - Test the brake switch.

Battery Maintenance

The condition of the battery has a considerable impact on the performance of the truck. Optimum maintenance is key to maintaining the performance and useful life of the battery.

Note: Only trained and authorized personnel may remove and install, charge or service batteries.



Truck batteries can be dangerous

Your truck battery produces gas that can explode. It also contains acid that could burn or disfigure you.

- Do not try to install, remove, charge or service your truck battery unless you are trained and authorized.
- Never smoke or use an open flame around batteries. Avoid sparks.
- Your company should provide an area where it is safe to work on batteries. Use that area for all battery work.
- Use protective equipment such as gloves, eye shields, aprons etc.
- Rinse with plenty of water if battery acid comes into contact with your skin.
- Lead exposure can be harmful. Batteries contain lead. Always wash your hands after working with batteries.



Improper maintenance can damage the battery
Incorrectly serviced batteries will not reach full capacity and will fail prematurely.

- Always service the battery in accordance with the battery manufacturer's instructions.
- Always use a charger that is suitable for the battery voltage and capacity.
- Make sure the charger is turned off when you connect the battery.

Charging the battery

When the yellow luminous bar flashes on the battery discharge indicator, the battery must either be charged or replaced with a charged battery. At the same time the message **CHARGE BATTERY** is displayed.



DANGER

Batteries can produce explosive gas.

Batteries emit gas during charging. This can collect and explode if exposed to sparks or open flames.

- Always charge the battery in specifically designated and authorised areas.
- Make sure the charging area is well ventilated.

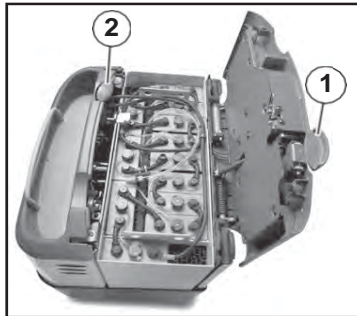

Fig. 19 Battery

1. Battery cover latch
2. Battery connector

Charging the battery

1. Bring the truck to the charging station.
2. Turn off the truck and remove the key if necessary.
3. Undo the battery cover latch ① and open it. Secure it in opened position if necessary.
4. Remove the battery connector ② and connect it to the charger.
5. To charge the battery, follow the manufacturers instructions for the battery and charger.
6. Once the battery has been charged turn off the charger. Disconnect the battery.
7. Attach the battery connector ② to the truck.
8. Position the battery cable so that it does not get trapped when the battery cover is closed.
9. Close the battery cover.
10. Turn on the truck and check the operation.



When you Install or Change batteries

- Turn the truck OFF. Brake applies automatically when truck is turned OFF. Check that all controls are in neutral and disconnect the battery.
- Make certain you use the correct size and weight battery. Never operate a truck that has an underweight or undersized battery installed.
- Never let anything metal touch the top of the cells. You could cause sparks or do damage to the battery. Use an insulator (such as plywood) when necessary.
- Remove your truck's side panels or battery retainers.

Using A Hoist

If you use a hoist to install or remove the battery from the the battery compartment or stand, use an approved spreader bar.

Note: Make sure you adjust the spreader bar hooks to fit the battery.

Using A Roller Stand

If you use a roller stand to install or remove a battery make sure the roller stand is the same height as the rollers in the truck's battery compartment. Also make sure the roller stand is at least as long as your battery.

After Installing Your Battery

- Replace the side panels or battery retainers. Make certain the retainers on both sides of the truck are in place.
- Connect the battery. Turn the truck ON and check truck operation.

Messages

The following is an overview of the operator messages and explanations.

Display	Action
PIN	Enter your PIN.
CHARGE BATTERY	Charge the battery.
TRUCK STOPS IN 5 MIN	The truck will stop in 5 minutes. Charge the battery.
TRUCK STOPPED	Discharged battery. Charge the battery.
BATTERY NOT LATCHED	Close the battery compartment.
RELEASE TRAVEL CONTROL	Release the travel switch, then turn on the truck.
PLATFORM FAILURE	Step off, then back onto the platform.
LIFT & LOWER ACTIVE	Select one function only.
TURTLE MODE	Travel speed switch is in "Turtle" position or travel speed is reduced due to raised forks, steer angle etc. Display for information purposes only.
HIGHTEMP STEERING MOTOR	Turn the truck off and leave it to cool down. Contact the Crown service department if the message appears frequently.
HIGHTEMP TRACTION MOTOR	
HIGHTEMP TCM	
HIGHTEMP STEERING CONTROLLER	

EACH WARNING LABEL ON YOUR TRUCK IS IMPORTANT

Read and obey all of them to protect yourself and others.

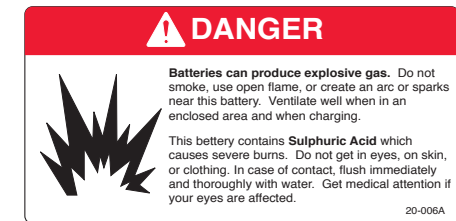
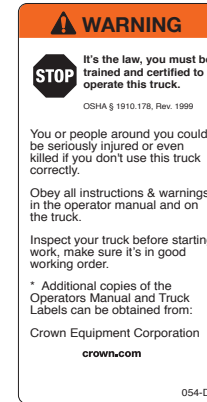
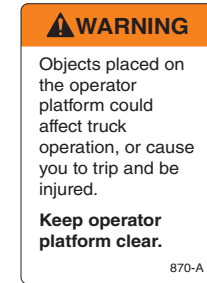
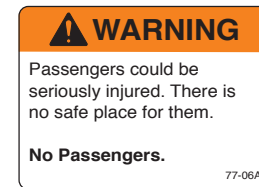
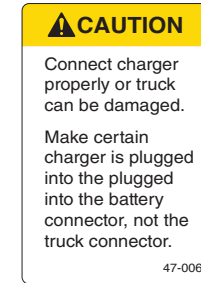

All rights reserved under International and Pan American copyright conventions
Copyright 2016 Crown Equipment Corp.



3000 SERIES



*This operator manual
has information for all
models of series MPC3000
plus same options and
accessories. Some of the
illustrations and information
may not apply to your truck.*

The most important component is you.



New Bremen, Ohio 45869 USA

©2016

PF19518 4/17

Printed in U.S.A.