

Operator Manual



WARNING

It's the law, you must be trained and certified to operate this truck. (OSHA § 1910.178, Rev. 1999)

You or others around you can be seriously injured or even killed if you don't use this truck correctly.

Read and obey all warnings and instructions in this Manual* and on the truck.

Head, arms, hands, legs or feet outside the operator area can be pinned or crushed whenever the truck is moving. Stay within the operator area and **stop the truck completely before getting off.**

However, tipovers and falls from docks can cause serious injury or even death. **Immediately exit and move away from the truck in these emergencies.**

You can be trapped or crushed by driving the operator area under racks or other objects. **Look where you are going.**

Inspect your truck before starting work, make sure it is in good working order.

* Additional copies of this Operator Manual and all Truck Labels can be obtained from Crown Equipment Corporation, New Bremen, Ohio 45869 U.S.A.

All rights reserved under International and Pan American copyright conventions
Copyright 2008 Crown Equipment Corp.

You Must be Trained



IT'S THE LAW, YOU MUST BE TRAINED AND CERTIFIED

Federal law states that only properly trained operators are permitted to operate a powered industrial truck and that your employer must train you and certify that you are qualified to operate this powered industrial truck. (OSHA §1910.178, Rev. 1999)

Do not operate this truck in your work place until you have been trained and certified by your employer.

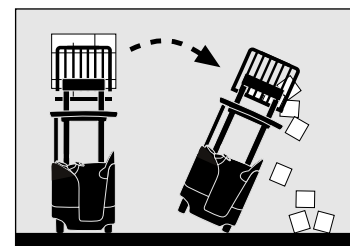

You could be killed or seriously injured if you are not adequately trained for lift truck operation!

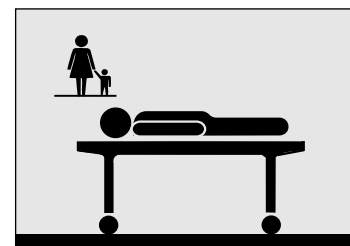

Protect Yourself

! Know the Hazards

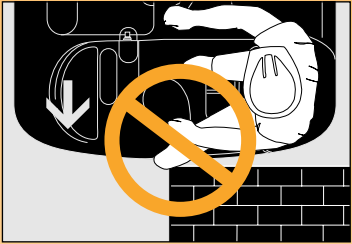

DRIVE CAREFULLY

- Keep your hands on the controls and feet on the pedals/pad. Keep your entire body in the operator area.
- Never stick a foot or any part of your body outside the operator area, no matter how slow the truck is moving. You cannot stop 3630 kg (8000 pounds) with any part of your body. A foot or hand caught between the truck and a fixed object will be crushed or even cut off.
- Stay away from the edge of docks and ramps. Make sure dockboards are secure. Check that trailer wheels are chocked. You could be seriously injured or even killed in a fall from a dock or dockboard.
- Keep your truck under control at all times. Drive at a speed that allows you to stop safely. Be even more careful on slippery or uneven surfaces. Do not drive over objects on the floor.

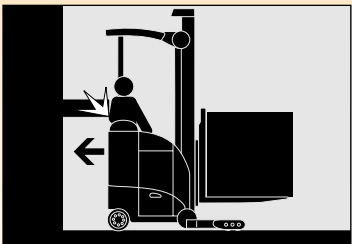
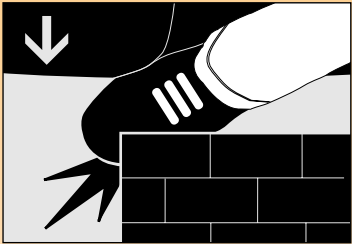

LOOK WHERE YOU'RE DRIVING

- Always be alert to the area around you and watch where you are driving. You could be pinned or crushed by objects intruding or poking into the operator area.

! Know the Hazards

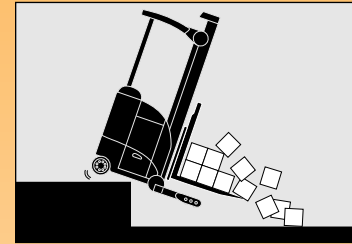

AVOID FALLS AND TIPOVERS

Falls from docks and tipovers are very serious accidents; you can be crushed or even killed. Immediately exit and move away from the truck in these emergencies.

Note: This is not like sit-down rider trucks, where it is recommended that the operator stay with the truck. The best way to prevent injury is to know where you are at all times and follow the rules of safe truck operation.

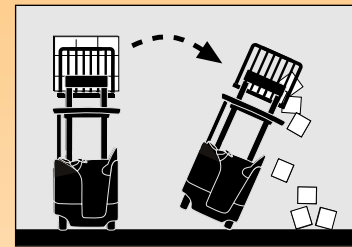

- Be extremely careful when working around docks, dockboards and trailers.
- Travel with the load or forks close to the ground and tilted back. Watch for overhead obstructions. Perform all truck movements smoothly and at a speed that will give you time to react in an emergency.
- An unloaded truck can tip over also. Be just as careful using an unloaded truck as you are using a loaded one.



USE YOUR TRUCK SAFELY

- Keep your hands and feet away from all moving parts such as masts, chains, forks or wheels. Make sure the overhead guard and load backrest are in place.
- Never stand on or under the forks, or allow anyone else to stand on or under them. The only way to lift people is with an approved platform. Never allow passengers on the truck. There is no safe place for them.
- Before you leave your truck:
 - Come to a complete stop and lower forks to the floor.
 - Shut the truck off with the key or power disconnect.

Warning	1
You Must be Trained	2
Protect Yourself	3
Contents	5
What's in it for You?	6
Your Narrow-Aisle Truck	7
Lift Truck Parts	9
Capacity & Load Center	11
Capacity Plate	13
Display Panel	15
Switch Panel	18
Power On & Off	19
Foot Brake	21
Traveling & Plugging	23
Steering & Travel	25
Two Types of Steering	26
Fork Functions	27
Daily Safety Check	31
Be a Safe Driver	33
Battery Maintenance	37
Warning Labels	42

WHAT'S IN IT FOR YOU?

The better you understand your truck and how to use it, the better and safer operator you can be. Here are some guides to using this manual.

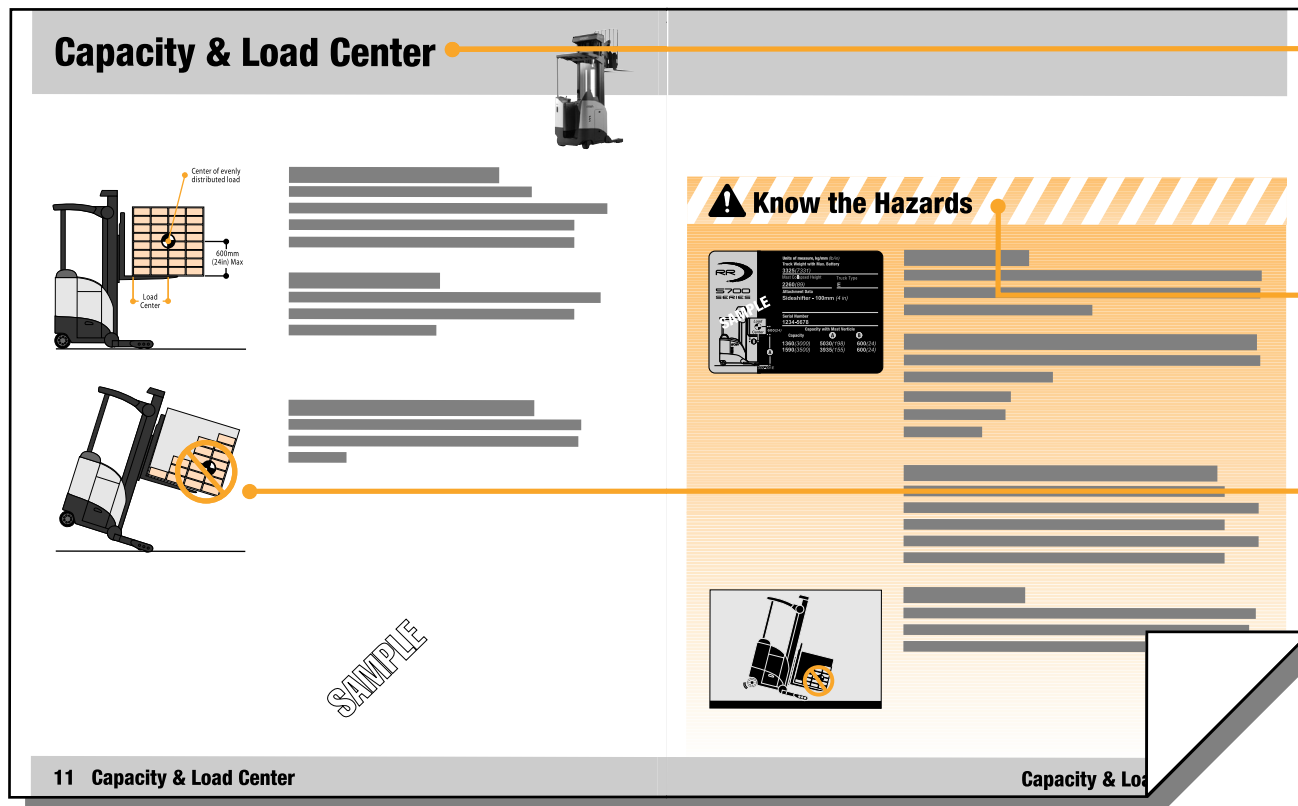

QUICK LOCATORS

In addition to the "Contents" page you can use page headings to find topics. Some pages also have a picture of the truck in the corner showing features or functions covered on that page.

"KNOW THE HAZARDS"

Watch for and read these special blocks. You will find information about possible safety hazards and how to avoid them.

HOW-TO-DRAWINGS

On many pages you will find pictures as well as text to help you understand how to use your truck safely and productively.

Your Narrow-Aisle Truck

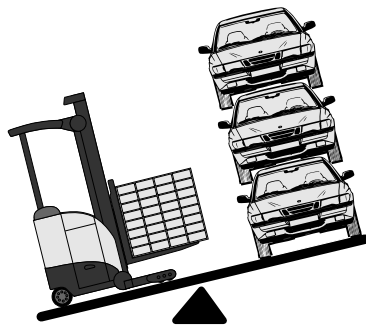

NARROW-AISLE TRUCKS

Your narrow-aisle rider truck lifts, moves and stacks loads. It is designed to work in warehouses built with narrower aisles to give maximum storage.

YOUR LIFT TRUCK IS NOT AN AUTOMOBILE

With a load it may weigh as much as 3 automobiles.

- You don't steer the same.
- You don't brake the same.
- You don't accelerate the same.

FORK FUNCTIONS, STANDARD AND OPTIONAL

Raising and Lowering the forks, Tilt (up and down), and Reach (in and out) are standard on the RR and RD models. Your truck may also be equipped with Sideshift (right and left), or other options such as Rack Height Select. Your company has decided which features are needed in your work area and should train you how to use them.

HOW TO DRIVE YOUR TRUCK

Your truck is designed with a tilted floorboard and padding in the operator area. You drive your truck by standing sideways and leaning back against the pad. This, along with your hands on the controls and feet on the pedals/pad, gives you stability. However, controls are located so you can vary your body position for best comfort and visibility.

GIVE YOUR BODY A BREAK

Take advantage of stop time. Get off the truck and flex your arms and legs. Staying alert will help you be a better and safer driver.

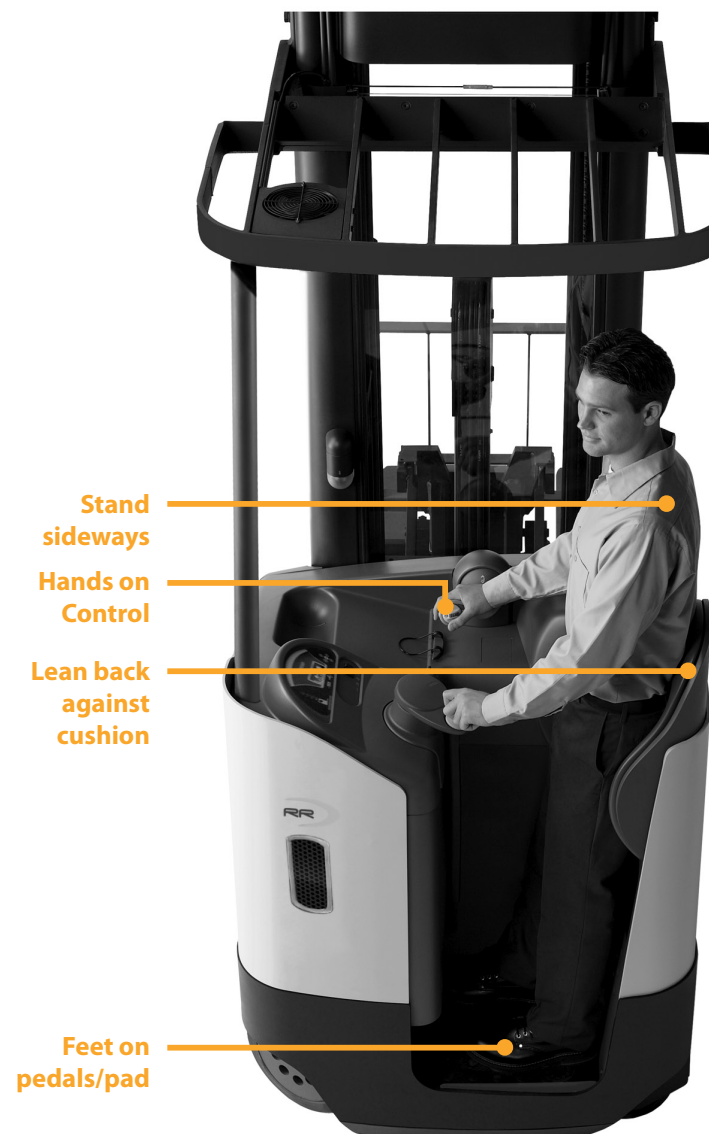

BUILT TO STANDARDS

This truck was designed and built to current industry and government standards and guidelines. For more information see the following:

- American National Standards Institute (ANSI/ITSDF) B56.1
- Occupational Safety and Health Act (OSHA) §1910.178, Rev. 1999
- Underwriters Laboratory (UL) 583
- National Fire Prevention Association (NFPA) 505

Lift Truck Parts

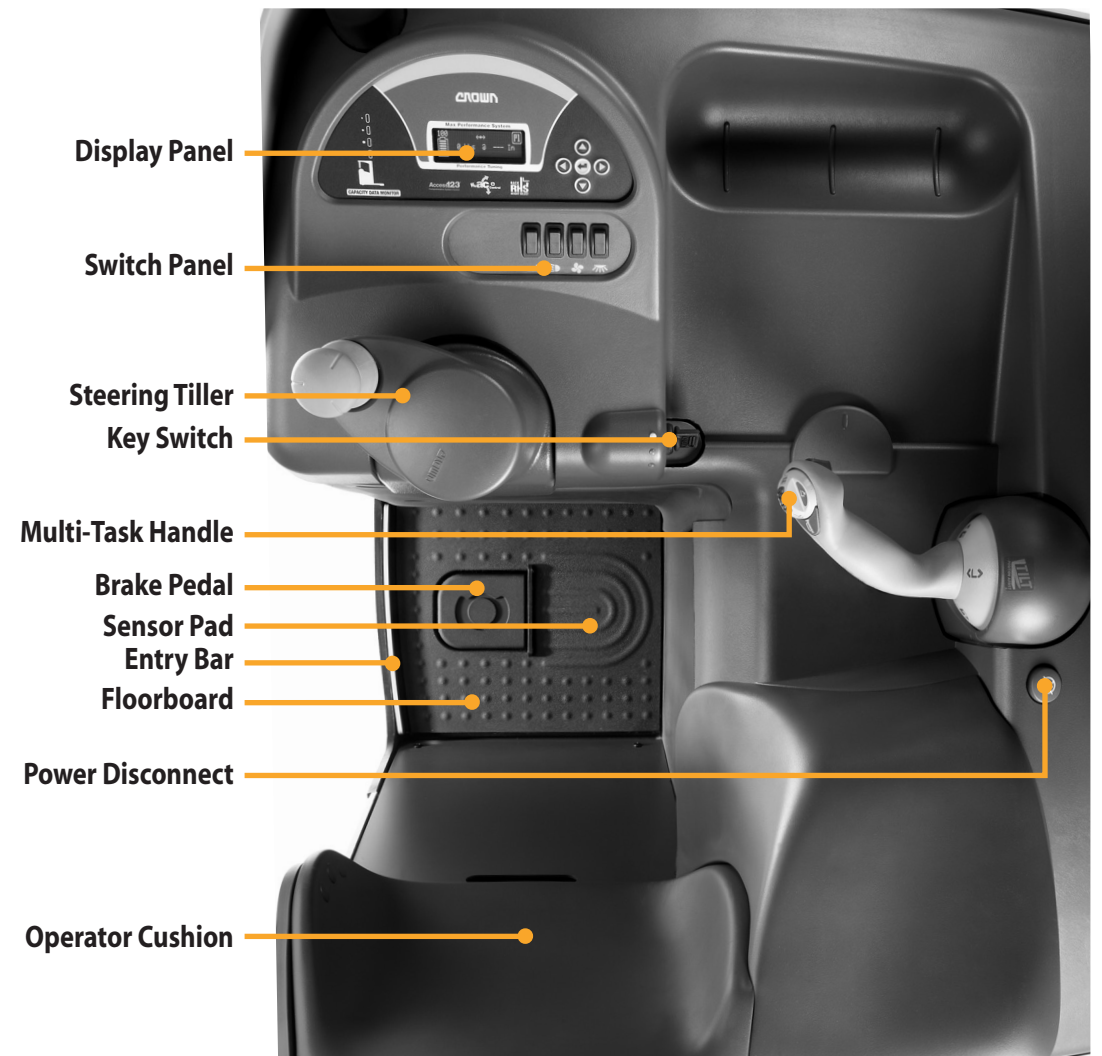
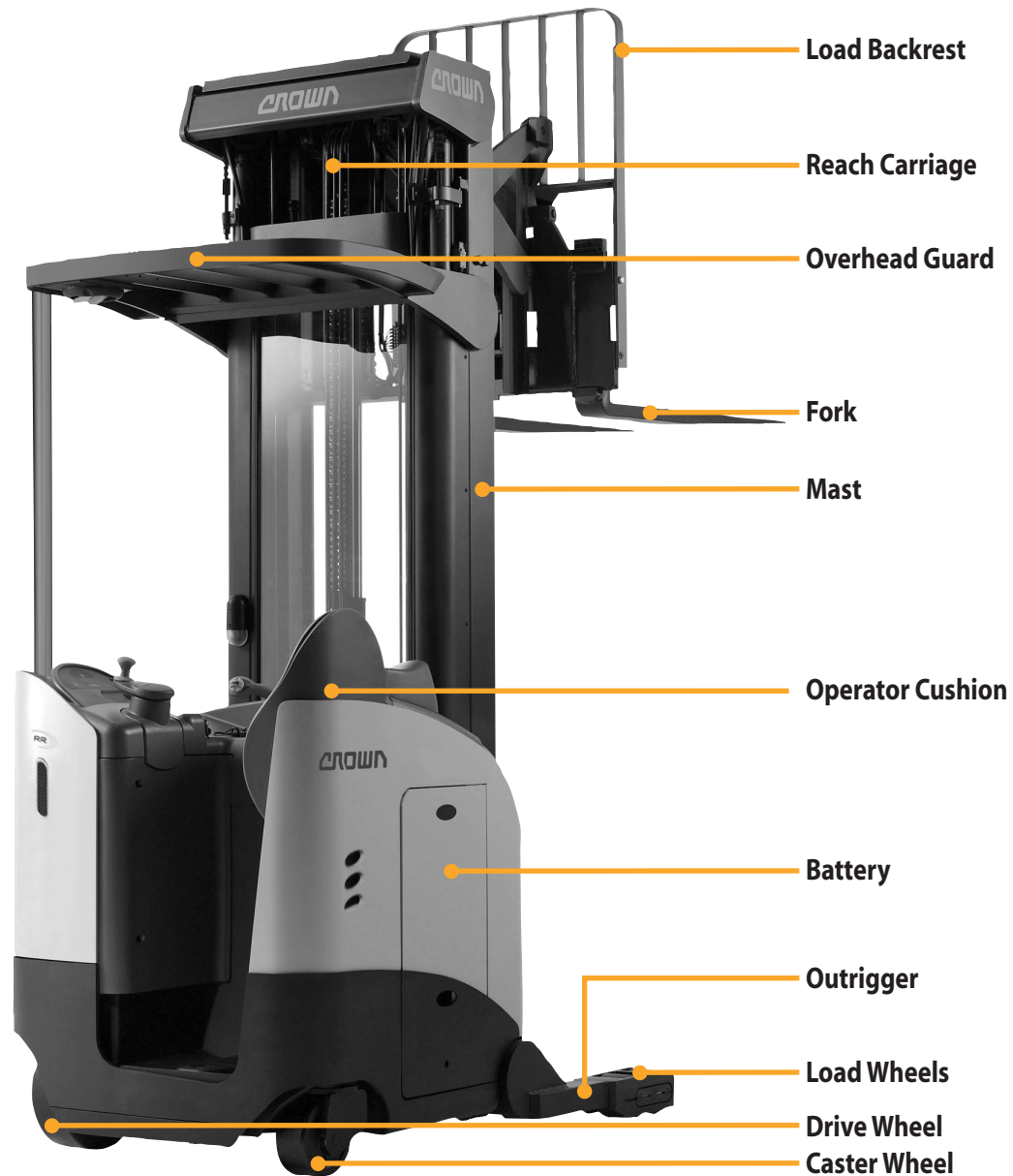

Capacity & Load Center

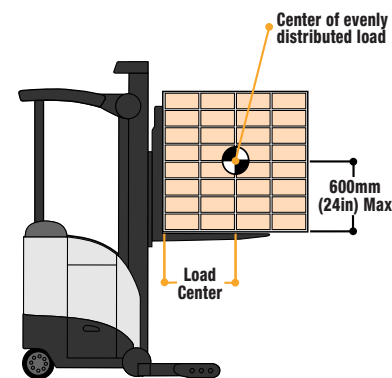

WHAT IS YOUR TRUCK CAPACITY?

Capacity is the load (including pallet or container) that can be lifted to a given height at a given load center. See the capacity plate on your truck. Make certain you use the correct units of measure.

WHAT IS LOAD CENTER?

Load center is the distance from the load backrest or vertical face of the forks to the center of an evenly distributed load.

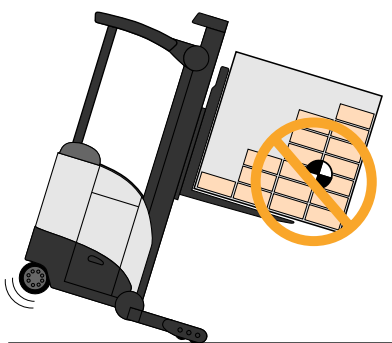

LOADS MUST BE EVENLY DISTRIBUTED

Your truck could tip over, in any direction, if a load is shifted to the front or side of a pallet or container.

! Know the Hazards

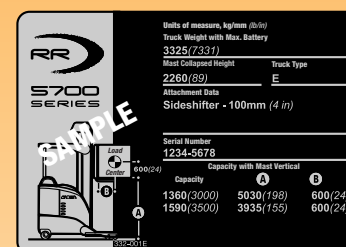

KNOW YOUR LOAD

Do not exceed the capacity shown on your truck's capacity plate. Be careful when handling long, high or wide loads. Do not handle unstable loads.

EXCEEDING TRUCK CAPACITY CAN CAUSE AN ACCIDENT

Know the capacity of your truck as shown on your capacity plate. Make certain you use the correct units of measure. Pay attention to:

- Weight of load
- Load center
- Lift height

CENTER THE LOAD

Your truck could tip over if a load is shifted to the front or side of a pallet or container. Make sure your load is evenly distributed, stable and centered over the forks.

HYDRAULIC OPERATIONS CAN AFFECT STABILITY

Be careful when using reach, tilt, sideshift or other operations. Remember that anytime the forks move, the load moves also. This can affect stability. Perform all hydraulic operations smoothly. (This also applies to any attachments your truck may have.)

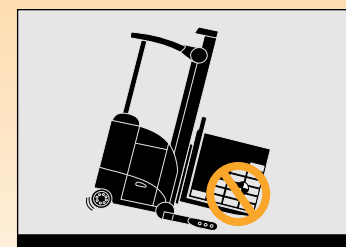

Capacity Plate



CAPACITY PLATE INFORMATION

The capacity plate is on a console in the operator area. It contains:

- Serial number
- Capacity information (load, load center and lift height)
- Truck type (a fire safety rating)
- Truck weight with max. battery (does not include load)
- Attachment information (if any)
- Mast collapsed height

READING YOUR CAPACITY PLATE

Capacity may be reduced as lift height **A** increases. For example: On the sample plate, 1590kg (3500 lb) can be lifted to 3935mm (155 in). But above 3935 (155), to 5030 (198), capacity is reduced from 1590 (3500) to 1360 (3000).

Capacity is reduced as load center **B** increases. If you must handle loads with longer load centers, an additional capacity plate will show the reduced capacities.

CAUTION

You may not increase capacity if load center is less than shown on your capacity plate.

Note:

ANSI/ITSDF B56.1 requires that all data be shown first in Metric units and then USA units.

OTHER LIFT HEIGHTS & LOAD CENTERS

Contact Crown for capacities at lift heights or load centers not given on your capacity plate.

! Know the Hazards

TRUCK WEIGHT

Dockboards, elevators and some floors have limited capacity. Check your capacity plate for the weight of your truck. Remember to add the weight of the load you have on the forks.

TRUCK TYPE

Some truck types are not permitted in areas where there are fire hazards. Watch for marked areas. For example: You must not drive a type E or ES truck into an area restricted to EE or EX trucks.

ATTACHMENT DATA

If an attachment on your truck does not match the information given here on your capacity plate, don't operate your truck. Your capacity plate may be wrong. Report the problem to your supervisor.

MAST COLLAPSED HEIGHT

Some work areas may have overhead obstructions. Mast Collapsed Height is the minimum height your truck can clear, providing the backrest and load are lowered below the top of the mast.

SAMPLE CAPACITY PLATE

The information shown on this sample plate does not apply to your truck.

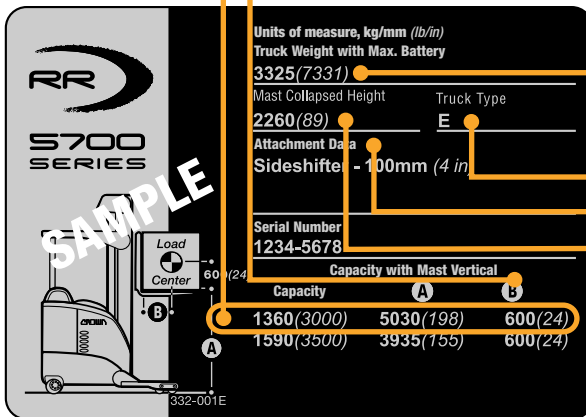

Display Panel

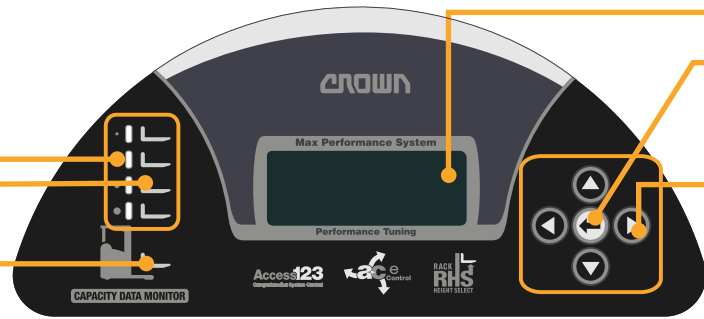

ENTER OR RETURN BUTTON

Use to navigate in and out of menus and select inputs.

NAVIGATION BUTTONS

Up, Down, Left and Right Arrows are used to scroll through menus.

FORKS DOWN LIGHT (see Caution)

The green fork means the mast is at its minimum collapsed height. Make certain the load will clear overhead obstructions.

CAPACITY DATA MONITOR (see Caution)

• **Fork height lights:** A yellow fork will light to show which lift zone the forks are in. If any of these lights are on, it means the load backrest is higher than the collapsed height of the mast. Make certain the load and load backrest will clear any obstructions above you.

The yellow light will flash and alarm will "beep" if you travel faster than the load positioning speed (2.4 km/h, 1.5 MPH) while the load backrest is above the collapsed height of the mast.

• **Max Lift height lights:** The green bars will light to show how high, or to which lift zone you can raise the load.

Overload warning: If load is too heavy for the lift zone the forks are in, the alarm will "beep" and message display will read **REDUCE LIFT HEIGHT**. Lower load carefully.

Caution: All information displayed by the fork position lights and/or the Capacity Data Monitor is for reference only. You must always be alert to load center, load distribution, load height and load weight. You must also be aware when the load or load backrest extends above the top of the mast, and how much overhead clearance is needed.

MESSAGE PANEL

The upper half of the message panel shows percent of charge remaining in the battery, and indicators relating to truck operation and service.



Service required. Contact your supervisor or service department.



Operator alert. See bottom line for instructions.



Indicates that load back rest is above collapsed height of the mast.



Drive wheel direction and angle indicator.



Traction Control indicator (OnTrac™).



Indicates the level your company has programmed this truck to operate.



Indicates energy is being returned to the battery.

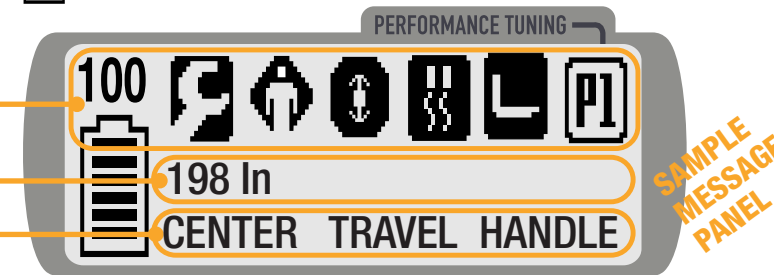

The bottom line of the message panel is usually blank. However if anything requires your attention, instructions will be displayed here. Anytime you hear a beep, or if the truck slows down or won't work, check message panel for instructions.

This line of the message panel shows selective truck information, when requested using the Service & Option Buttons. See your Service Manual.

Switch Panel

This page
left blank
intentionally.

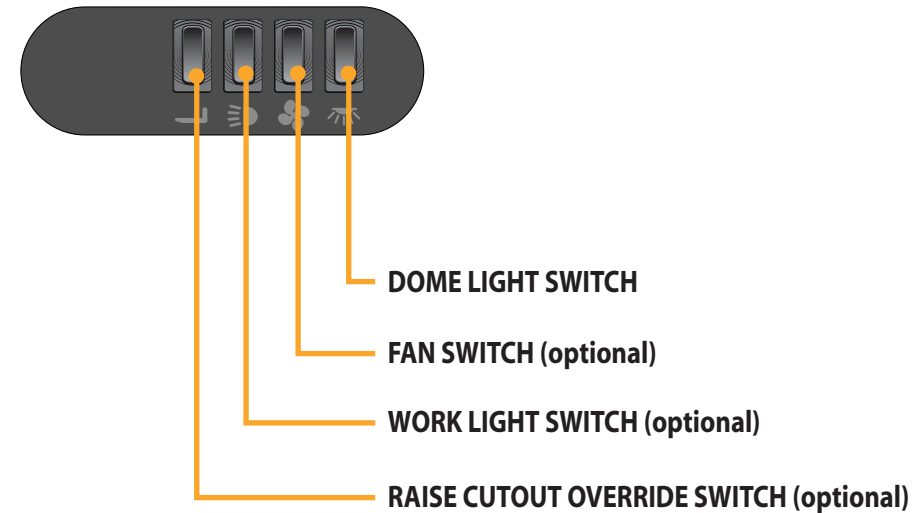

Your truck may be equipped with automatic cutout of raise at selected lift heights.

To raise past the cutout height, push the optional Raise Cutout Override switch while, at the same time, lifting the multi-task control handle (see page 27).

Caution: Make certain the load and load backrest will clear all overhead obstructions.

Power On & Off



KEY SWITCH

- To start the truck, turn the key clockwise to TEST (yellow dot). Check that all display lights are working.
- Let go of the key and it will return to ON (green dot).
- When leaving the truck, turn the key counterclockwise to OFF (red dot) to shut the truck off.

USER CODE (PIN number)

You may have to enter a user code (Personal Identification Number) before you can use the truck. Check the message display if the truck doesn't operate.



FOOT PEDALS/PAD

Place your left foot on the brake pedal, and your right foot on the sensor pad. Turn the key ON and lift your left foot for a moment to cycle the brake. Return your foot to the brake pedal.

Lift your right foot and return it to the sensor pad. The truck is ready for operation.



ENTRY BAR

Always keep your feet in the operator area and clear of the entry bar.

If you put your foot on the entry bar while traveling, the alarm will sound and the truck will slow to a stop.



POWER DISCONNECT

Push the Power Disconnect button to cut power to the truck.

Use the Power Disconnect to shut the truck down any time it isn't working right. Don't use the truck if it's not working right. Report the problem to your supervisor.

Turn the key switch to OFF and back to ON to reconnect the battery and reset the Power Disconnect button.

Foot Brake



BRAKE OFF

Step all the way down on the brake pedal. The brake is now "off".



BRAKE ON

Lift your heel or move your foot off the brake pedal to apply the brake. Keep a part of your foot in contact with the floorboard.

! Know the Hazards

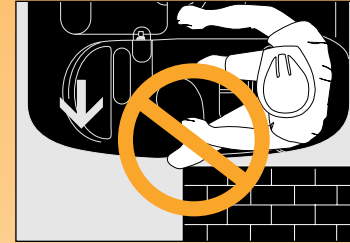

WATCH YOUR FEET

Keep your feet inside the truck and on the pedals/pad at all times. This truck weighs about 3630 kg or (8000 pounds) without a load on the forks. You cannot stop or even slow down that much weight with your foot or any part of your body, no matter how slow the truck is moving.

A foot or hand caught between the truck and a wall, post or any fixed object will be crushed or even cut off.

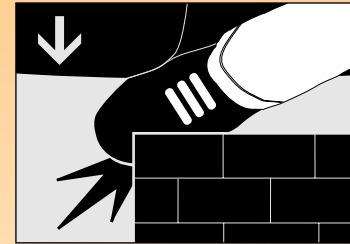

KEEP YOUR BALANCE

Put your hands on the controls and keep your feet on the floorboard. This, along with leaning back against the cushion, gives you better stability.

MAKE SURE YOUR BRAKE WORKS

Test the brake on your truck at the start of each shift. Know the distance it takes to stop before you start working.

If at any time the stopping distance is too long for you to stop safely, don't drive the truck. Report any problem to your supervisor.



Traveling & Plugging

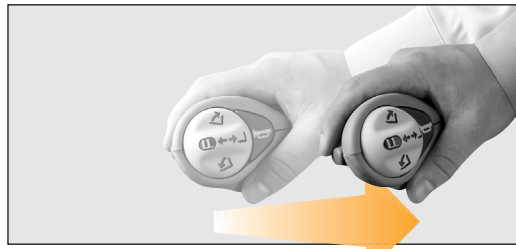

TRAVEL, POWER UNIT FIRST

Pull the multi-task handle toward you to travel in the direction of the power unit (power unit first).

The farther you pull the handle from the neutral position, the faster the truck will travel.

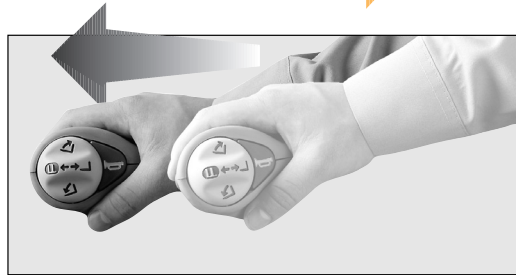

TRAVEL, FORKS FIRST

Push the multi-task handle away from you to travel in the direction of the forks (forks first).

The farther you push the handle from the neutral position, the faster the truck will travel.



PLUGGING

Plugging is another way to slow down or stop your truck.

While the truck is moving, in either direction, pull or push the multi-task handle through neutral to the opposite direction of travel.

Plugging will not hurt your truck.

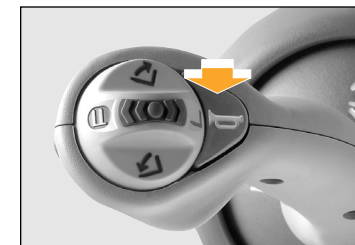
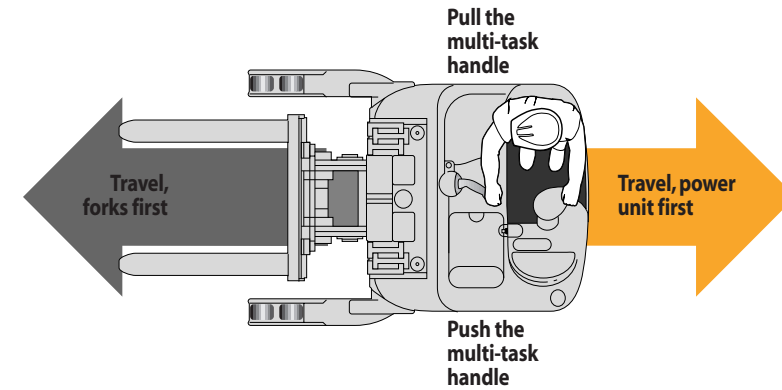

HORN

Press the button on the multi-task handle to sound the horn. Use it to warn pedestrians and other drivers. Use your horn when you come to an intersection or a crosswalk.

! Know the Hazards

PLUGGING VS. BRAKING

Of the two, the foot brake is designed to stop the truck in the shortest distance. Use the foot brake in an emergency, on ramps or in busy areas.

Steering & Travel



STEERING AND DRIVING

You will need to drive your truck in both the direction of the forks (forks first) and also in the direction of the power unit (power unit first). Steering is not the same in both directions. Be careful. Drive slowly until you get used to all the controls.

This truck is designed to slow down when turning.

Caution: RR Models 5200, and earlier, do not have this feature.

TRUCKS THAT LOOK ALIKE CAN BE DIFFERENT

This style truck can be built with one of two different types of steering. Your company has selected the type which is best for your work area.

Caution: If you ever drive a different RR Series truck, be careful. The steering may be different (see page 26).



! Know the Hazards

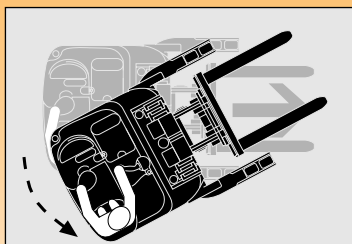

POWER UNIT SWING

Be careful turning while traveling forks first. The power unit will swing wide in the opposite direction. Make sure you have clearance, and watch out for people in the area.



SLOW DOWN FOR SPILLS OR WET FLOORS

Powder or liquid spills can cause slippery floors. Slow down or you could lose control of steering and braking. Be careful and allow for a longer stopping distance.

Don't run over objects on the floor.

Two Types of Steering

- 1 REAR DIRECTIONAL STEERING (Sometimes called Reverse Steering.)**
Shows direction truck will turn when steering handle is turned clockwise.

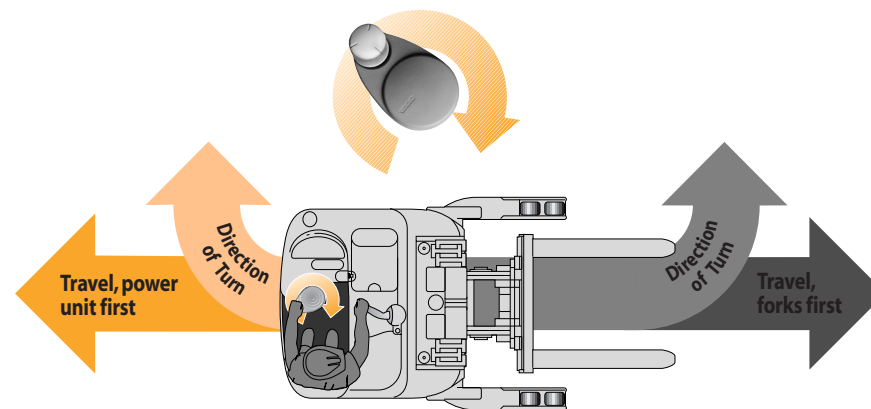

- 2 FRONT DIRECTIONAL STEERING (Sometimes called Forward Steering.)**
Shows direction truck will turn when steering handle is turned clockwise.

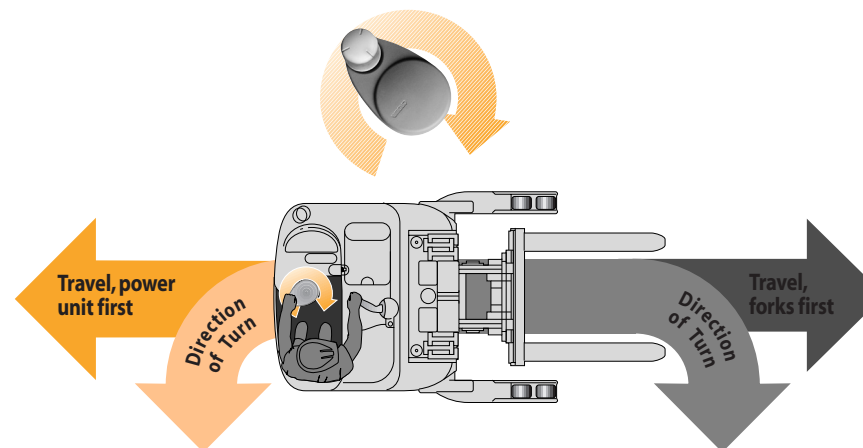

Fork Functions



FORK FUNCTIONS

Standard fork functions include Raising and Lowering the forks, Tilt (up and down), and Reach (extend and retract).

Some optional fork functions your truck may be equipped with are Sideshift (right or left), Rack Height Select which allows the truck to be programmed so the forks will stop at selected heights, and Tilt Position Assist to tilt the forks to a programmed position.



RAISE/LOWER

Lift the multi-task handle up to raise the forks. Push down on the handle to lower the forks.

The farther you move the multi-task handle from neutral, the faster the forks will move.

RAISE CUTOUT OPTION

Your truck may be equipped with an automatic cutout to prevent you from raising the forks into restricted areas.

If raise stops, check the message display. **CUTOUT, USE OVERRIDE** will show on the display if you are at a raise cutout height. See page 18 for using the optional Raise Cutout Override Switch.



RACK HEIGHT SELECT OPTION

This option allows a truck to be programmed so the forks will stop at a selected height.

1. Press the UP or DOWN ARROW button until the message display shows **RACK SELECT**.
2. Select the RIGHT ARROW to enter rack select mode.
3. Press the switch on the back of the multi-task handle to scroll through the lift heights that have been programmed into the truck. The message display will show the height in either millimeters or inches, along with the label number for the height.

Or, while raising or lowering, press and release the switch to select the next programmed rack height.

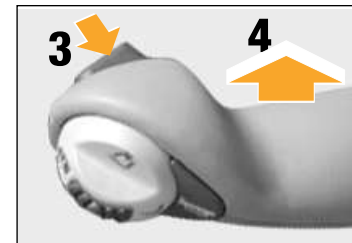

4. Make certain the path of the forks is clear. Lift and hold the multi-task handle. The forks will stop and there will be a one second beep when they reach the programmed height. Check to make certain the forks are at the correct position before entering the rack or pallet.

Know the Hazards

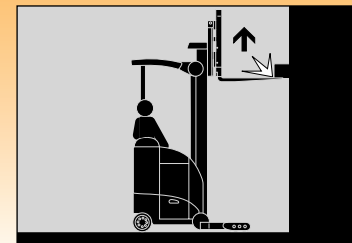

CHECK THE PATH OF THE FORKS

Be just as careful raising the forks with the rack height select option as when using manual raise. Make certain the path of the forks is clear and free of obstacles.

Check that the forks are at the proper position to enter the pallet, or that the pallet will clear the rack beam.

Fork Functions continued



THUMB BALL

All hydraulic fork functions, other than raise & lower, are controlled by the multi-task thumb ball.

TILT UP & DOWN



Roll the thumb ball up to tilt the fork tips up. Roll the ball down to tilt the fork tips down.

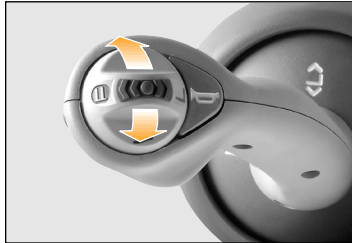

TILT POSITION ASSIST OPTION

If your truck is equipped with this option, the forks will go to the programmed tilt position chosen by your company for this truck.

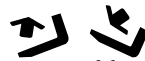

With the thumb ball in neutral, press and hold the switch on the back of the multi-task handle. Then roll the thumb ball either up or down.

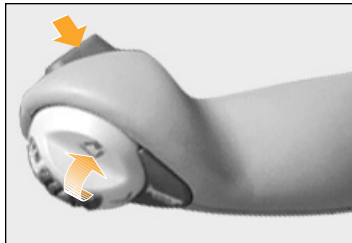

FORK POSITION WILL VARY DEPENDING ON LOAD

The tilt of the forks and raised height of the forks will change depending on how much load is on the forks.

Always check to see that the forks are at the correct tilt position and lift height to enter a pallet, or that the pallet and load will clear the rack beams.

Be just as careful when using programmed functions as when operating the truck manually.

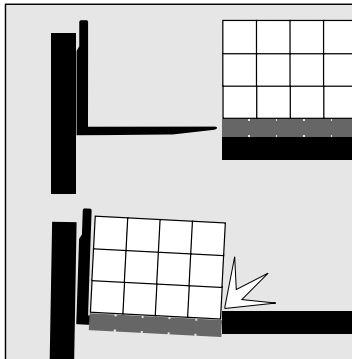

REACH/RETRACT



Roll the thumb ball away from you to reach (extend) the forks. Roll the ball toward you to retract the forks.

The farther you move the ball from neutral the faster the forks will move.

This motion of the thumb ball will have a second function if your truck has a sideshift option.

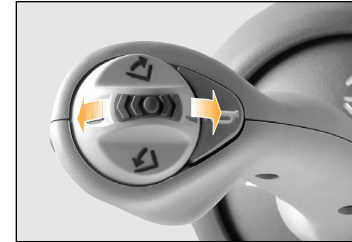

SIDESHIFT OPTION

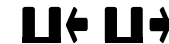

With the thumb ball in neutral, press and hold the switch on the back of the multi-task handle. Then roll the ball away from you to shift the forks to the left (away from you). Roll the ball toward you to shift the forks to the right (toward you).

The farther you move the ball from neutral the faster the forks will move.

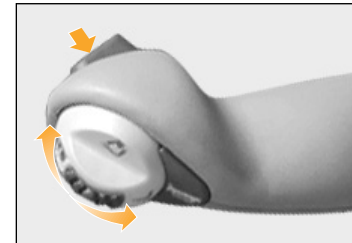

! Know the Hazards

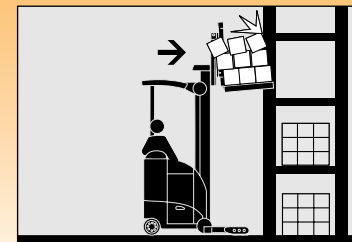

CHECK FORK AND PALLET POSITION

The fork position will vary depending on whether the forks are loaded or unloaded.

Make certain the forks are at the correct tilt position and lift height to enter a pallet, or that the pallet and load will clear the rack beams.

Daily Safety Check



CHECK YOUR TRUCK BEFORE STARTING WORK

You must make sure your truck is safe to use.

1. Walk around your truck and check it over.

- Check to make sure the battery is charged, water level is OK and vent caps are in place. Don't use an open flame to check the battery.
- Make certain the battery retainers on both sides of the truck are properly installed and adjusted.
- See that all wheels are in good condition.
- Clean the safety glass.
- Check that both forks are secure and not bent, cracked or badly worn.
- Inspect lift chains for damage.
- See that the load backrest and overhead guard are in place and fastened.
- Look under the truck for signs of hydraulic leaks.
- Turn the key to TEST (yellow dot). See that all display lights are working.
- Test the horn.
- Make sure the power disconnect works.

2. Test drive your truck in an uncongested area.

- Try all the hydraulic functions.
- Check that the steering is easy and smooth.
- Drive the truck slowly in both directions.
- Drive through the full speed range in both forward and reverse.
- Check braking and plugging distances in forward and reverse. Load size and floor conditions can affect these distances.
- Know the distance it takes to stop before you start working. If the braking distance is too long to stop safely, don't drive the truck.

If anything doesn't look or feel right, don't drive the truck. Report the problem to your supervisor.

You can get checklist forms from your Crown dealer (part no. OF-3772). Used properly, this checklist can alert service people to needed repairs.

Be a Safe Driver



The most important component is you.



MAKE SURE YOU ARE READY TO DRIVE

- Do not use this truck unless you are trained and certified.
- Be certain you understand how your truck works and the hazards that go with it. Don't drive the truck if you have any doubts.
- Know the capacity of your truck (Load Weight, Load Center and Lift Height). Make certain you use the correct units of measure.
- Some trucks are not allowed in areas where there are fire hazards. Be certain your truck is the correct fire safety type for the area.
- Make sure your hands and shoes are clean and dry, and your clothing is proper for the job.

MAKE SURE YOUR TRUCK IS READY

- Inspect your truck before using it (see pages 31 and 32). If it's not working right, or something is broken, report the problem to your supervisor. Don't use the truck.
- In an open area, test the brakes and plugging. Check at a slow travel speed first, then a faster one. Know the distance it takes to stop before you start work.

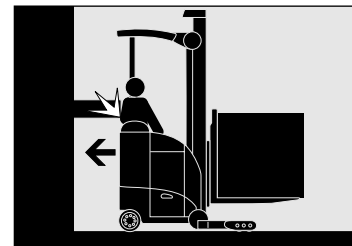
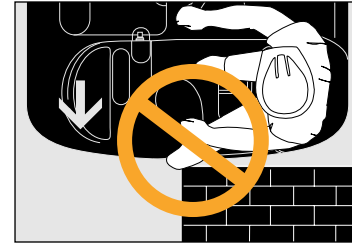

DRIVE CAUTIOUSLY, BE ALERT

- Never stick a foot or any part of your body outside the operator area, no matter how slow the truck is moving. You cannot stop 3680 kg (8000 pounds) with any part of your body. A foot or hand caught between the truck and a fixed object will be crushed or even cut off.
- Stand sideways with your back against the pad. Keep your hands on the controls and your feet on the pedals/pad.
- Travel in the direction that gives you the best view. Look where you are going and slow down in congested areas.
- Slow down for wet or slippery floors. Don't run over things.
- Travel with the forks close to the ground, retracted and tilted up. Place the load against the load backrest (vertical face of the forks).
- Look where you are going before you change direction of travel.
- See that you have room to drive and turn. Always check for overhead objects. Watch out for power unit swing.
- Slow down when making turns.
- Avoid sudden movement of controls. Learn to use them smoothly at a moderate, even rate.
- Check clearances before raising or lowering the forks or load.
- Be extra careful if you must use your truck in an area where there is a risk of falling objects.

Continued next page...

Be a Safe Driver continued



WATCH OUT FOR OTHER PEOPLE

- Slow down. Yield or stop for pedestrians. Use your horn when you come to a crosswalk or intersection.
- Be careful that you don't pin or crush someone. *For example: Never drive your truck toward anyone standing in front of a fixed object.*
- Never allow passengers on your truck.
- Keep others away from your truck while you're working. Don't ever allow anyone on or under the load or forks.
- Don't let anyone use your truck unless they are trained and certified.
- Never lift anyone with the forks unless they are using an approved platform. Even then use extreme caution:
 - Use a securely attached and approved safety platform.
 - Make certain lifting mechanism is operating properly.
 - Have load backrest vertical (never tilt when elevated).
 - Make certain truck is in neutral and brake is applied.
 - Lift and lower slowly.
 - Watch for overhead obstructions.
 - Be sure you can see and hear the person being lifted.
 - Never transport anyone on the platform from one location to another.

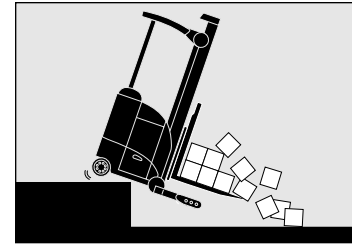
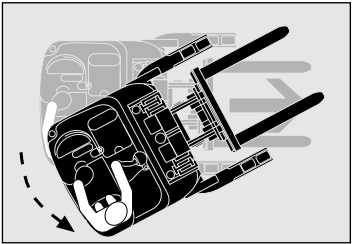

AVOID FALLS AND TIPOVERS

- Stay away from the edge of docks and ramps.
- Check that bridgeplates and dockboards are secure. Be certain that either the trailer wheels are chocked or the trailer is locked to the dock. Check capacities. Be sure your truck, with load, isn't too heavy for where you are driving.
- Make sure the load you are moving is stable. Spread the forks as far as you can and center the load. Insert the forks as far under the load as you can. Be even more careful with long, high or wide loads. They can be less stable.
- Use minimum fork tilt to pick up or place a load. When lifting or lowering outside a rack, keep the load backrest vertical or tilted back slightly.
- When moving loads on grades or ramps, drive with your forks pointed upgrade. Without a load, drive with forks downgrade. Slow down, and don't turn on grades or ramps.

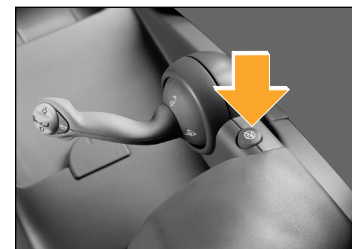
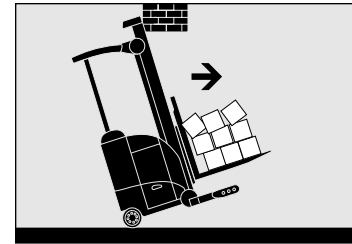

LEAVING YOUR TRUCK

- Stop your truck completely before getting off.
- Lower the forks to the floor. Turn the truck off or push the Power Disconnect button.
- Avoid parking on inclines. But if you must, block the wheels of your truck.

Battery Maintenance



Know the Hazards

 DANGER



Batteries produce explosive gas. Do not smoke, use open flame, or create an arc or sparks near this battery. Ventilate well in enclosed areas and when charging.

Batteries contain **Sulfuric Acid** which causes severe burns. Do not get in eyes, on skin, or clothing. In case of contact, flush immediately. Get medical attention if your eyes are affected.

107

TRUCK BATTERIES CAN BE DANGEROUS

Your truck battery produces gas that can explode. It also contains acid that could burn or disfigure you.

- Do not try to install, remove, charge or service your truck battery unless you are trained and authorized.
- Never smoke or use an open flame around batteries.
- Your company should provide an area where it is safe to work on batteries. Use that area for all battery work.
- Use protective equipment such as gloves, eye shields, aprons etc.

Know the Hazards



BEFORE CHARGING YOUR TRUCK BATTERY

- See that the battery cells are filled to the proper level. Never use an open flame to check the battery.
- Make certain the charger is the same voltage and amperage as your battery.
- Read the battery charger instructions.
- Be sure the charger is turned OFF before connecting the battery to the charger. Otherwise you might create a spark which could cause the battery to explode.

Continued next page...

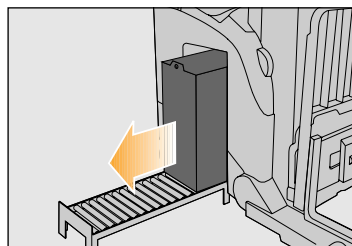
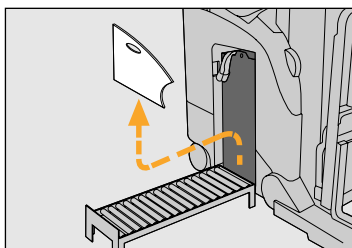

WHEN YOU INSTALL OR CHANGE BATTERIES

- Turn the truck OFF. Disconnect the battery. Check that all controls are in neutral.
- Make certain you use the correct size and weight battery. Never operate a truck that has an underweight or undersized battery installed.
- Use a roller stand to install or remove a battery. Make sure the roller stand is the same height as the rollers in the truck's battery compartment. Also make sure the roller stand is at least as long as your battery.
- Never let anything metal touch the top of the cells. You could cause sparks or do damage to the battery. Use an insulator (such as plywood) when necessary.
- Use an approved spreader bar to place a battery on, or to remove it from a stand. Make sure you adjust the spreader bar hooks to fit the battery.

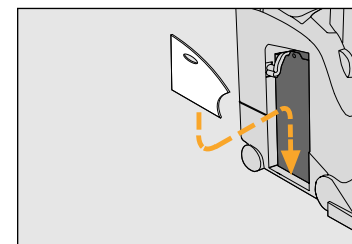

AFTER INSTALLING YOUR BATTERY

- Replace the battery retainer. Make certain the retainers on both sides of the truck are in place.
- Check that the battery retainers are properly adjusted to prevent the battery from shifting.
- Connect the battery. Turn the truck ON and check truck operation.

! Know the Hazards

! WARNING

Minimum battery size allowed
000 mm (00.00 in.) wide
000 mm (00.00 in.) long

Undersize battery can affect truck handling and stability. You could have an accident.
Use U.L. classified Type EO battery.

BATTERY SIZE

- Make certain you use the correct size and weight battery. Never operate a truck that has an underweight or undersized battery installed.

BATTERY RETAINERS

- The battery could slide out if retainers are not in place. Check both sides of the truck.
- Truck operation can be affected if the battery is able to shift. Make certain the battery retainers are properly adjusted.

Notes

Warning Labels



EACH WARNING LABEL ON YOUR TRUCK IS IMPORTANT

Read and obey all of them to protect yourself and others.

WARNING

STOP It's the law, you must be trained and certified to operate this truck.
(OSHA § 1910.178, Rev. 1999)
You or people around you could be seriously injured or even killed if you don't use this truck correctly.
Obey all instructions & warnings in the operator manual and on the truck.

Avoid being crushed.
Keep head, arms, hands, legs, and feet within the operator area. **Stop truck completely before getting off.**

However, tipovers and falls from docks can cause serious injury or even death. **Immediately exit and move away from the truck in these emergencies.**

You can be trapped or crushed by driving the operator area under racks or other objects. **Look where you are going.**
Inspect your truck before starting work, make sure it's in good working order.

* Additional copies of the Operators Manual and Truck Labels can be obtained from: Crown Equipment Corp., New Bremen, OH 45869

WARNING

Lifting people without a proper platform can cause a fall and serious injury.
Platform must be built and used as specified in OSHA 1910.178 and ANSI-B56.1.

WARNING

Stay clear of all moving parts.
Moving parts can cut or crush hands, feet, arms or legs.

WARNING

Falling objects or lowering forks can cause serious injury or death.
Never stand under the forks.
While servicing, block the forks so they won't fall.

WARNING

Standing or riding on the forks can cause a fall. You can be seriously injured or killed.
Never stand or ride on forks for any reason.

CAUTION

Connect charger properly or truck can be damaged.
Make certain charger is plugged into the battery connector, not the truck connector.

WARNING

Minimum battery size allowed
000 mm (00.00 in.) wide
000 mm (00.00 in.) long
Undersize battery can affect truck handling and stability. You could have an accident.
Use U.L. classified Type EO battery.

DANGER

Batteries can produce explosive gas. Do not smoke, use open flame, or create an arc or sparks near this battery. Ventilate well when in an enclosed area and when charging.
This battery contains **Sulfuric Acid** which causes severe burns. Do not get in eyes, on skin, or clothing. In case of contact, flush immediately and thoroughly with water. Get medical attention if your eyes are affected.

20

crown.com
All rights reserved under International and Pan American copyright conventions
Copyright 2008 Crown Equipment Corp.



5700 SERIES

*This operator manual
has information for
all models of series
RR 5700 plus some options
and accessories. Some of the
illustrations and information
may not apply to your truck.*



The most important component is you.



New Bremen, Ohio 45869 USA

© 2009

PF18340 Rev. 5/09

Printed in U.S.A.