

This operator manual has information for all models of series ST/SX plus some options and accessories. Some of the illustrations and information may not apply to your truck.



The most important component is you.



WARNING

It's the law, you must be trained and certified to operate this truck.

(OSHA § 1910.178, Rev. 1999)

You or others around you can be seriously injured or even killed if you don't use this truck correctly.

Read and obey all warnings and instructions in this Manual* and on the truck.

A dockboard can move or drop while you are on it. Or you could drive off a dock. Falls from docks or dockboards can cause serious injury or even death. **Make sure you are safe.**

Inspect your truck before starting work, make sure it is in good working order.

* Additional copies of this Operator Manual and all Truck Labels can be obtained from Crown Equipment Corporation, New Bremen, Ohio 45869 U.S.A.

All rights reserved under International
and Pan American copyright conventions
Copyright 2004 Crown Equipment Corp.

You Must be Trained



IT'S THE LAW, YOU MUST BE TRAINED AND CERTIFIED

Federal law states that only properly trained operators are permitted to operate a powered industrial truck and that your employer must train you and certify that you are qualified to operate this powered industrial truck. (OSHA §1910.178, Rev. 1999)

Do not operate this truck in your work place until you have been trained and certified by your employer.

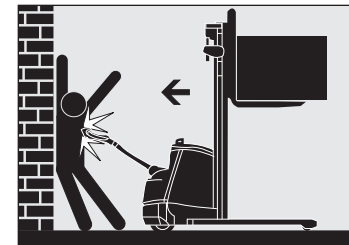

You could be killed or seriously injured if you are not adequately trained for lift truck operation!

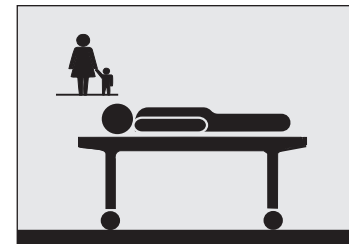

Protect Yourself

! Know the Hazards



LOOK WHERE YOU'RE GOING

Always be alert to the area around you and watch where you are driving. Be careful that you don't get pinned or crushed between the truck and a fixed object such as a wall or post.

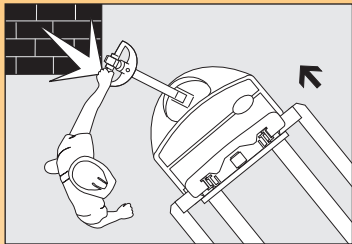

USE YOUR TRUCK CAREFULLY

- Watch your hands and your feet. A foot or hand caught between the truck and a fixed object will be crushed or even cut off.
- Keep to the side of the truck while traveling power unit first. Make certain the truck won't hit the back of your leg or foot. Don't let the truck run over your foot.
- If traveling forks first, keep both hands on the control handle and be careful when changing direction of travel. Keep your feet clear of the truck.
- Keep your truck under control at all times. Operate at a speed that allows you to stop safely. Be even more careful on slippery or uneven surfaces. Do not run over objects on the floor.
- Perform all truck movements smoothly and at a speed that will give you time to react in an emergency.

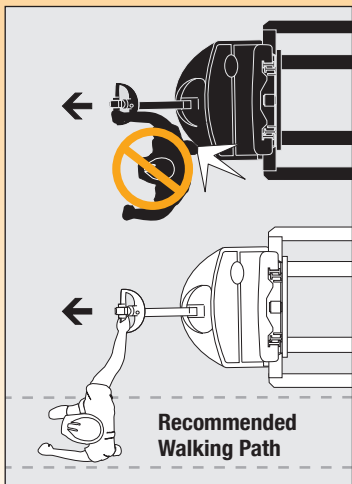

! Know the Hazards



AVOID FALLS AND TIPOVERS

Tipovers and falls are very serious accidents, you can be crushed or even killed. The best way to prevent injury is to know where you are at all times and follow the rules of safe truck operation.

- Be extremely careful when working around docks, dockboards and trailers.
- Stay away from the edge of docks and ramps.
- Make sure dockboards are secure.
- Check that trailer wheels are chocked.
- Travel with the load or forks close to the ground. Watch for overhead obstructions. Perform all truck movements smoothly and at a speed that will give you time to react in an emergency.
- An unloaded truck can tip over also. You must be just as careful using an unloaded truck as you are using a loaded one.



USE YOUR TRUCK SAFELY

- Keep your hands and feet away from all moving parts such as masts, chains, forks or wheels. Make sure the load backrest is in place, if your truck has that option.
- Never stand on or under the forks, or allow anyone else to stand on or under them. The only way to lift people is with an approved platform. Never ride on the truck or let anyone else ride. There is no safe place to sit or stand.
- Before you leave your truck:
 - Lower the forks to the floor.
 - Shut the truck off with the key or disconnect the battery.

Warning	1
You Must be Trained	2
Protect Yourself	3
Contents	5
What's in it for You?	6
Your Walkie Lift Truck	7
Lift Truck Parts	9
Capacity & Load Center	11
Capacity Plate	13
Power On & Off	15
Braking & Brake Override	16
Raising & Lowering	17
Steering & Travel	18
Traveling & Plugging	19
Daily Safety Check	21
Be a Safe Operator	23
Battery Maintenance	27
Warning Labels	30

WHAT'S IN IT FOR YOU?

The better you understand your truck and how to use it, the better and safer operator you can be. Here are some guides to using this manual.

Capacity & Load Center

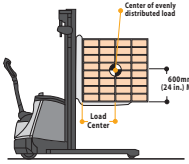

Center of evenly distributed load

600mm (24 in.) Max

Load Center



SAMPLE

Know the Hazards

SAMPLE CAPACITY PLATE
The information shown on this sample plate does not apply to your truck.

3000 SERIES		Units of measure, kg/mm, lb/ft	
Truck Weight (kg)	Max. Battery Capacity (kWh)	Capacity (kg)	Capacity (lb)
1185 (2610)	4552 (10000)	600 (1323)	1323 (2920)
1380 (3000)	5200 (11450)	600 (1323)	1323 (2920)
1580 (3480)	5850 (12890)	600 (1323)	1323 (2920)
1780 (3920)	6500 (14330)	600 (1323)	1323 (2920)

KNOW YOUR LOAD
Do not exceed the capacity shown on your truck's capacity plate. Be careful when handling long, high or wide loads. Do not handle unstable loads.

EXCEEDING TRUCK CAPACITY CAN CAUSE AN ACCIDENT
Know the capacity of your truck as shown on your capacity plate. Pay attention to:

- Weight of load
- Load center
- Lift height

HYDRAULIC OPERATIONS CAN AFFECT STABILITY
Be careful when using attachments such as sideshift, pivot or rotate. Remember that anytime the forks move, the load moves also. This can affect stability. Perform all hydraulic operations smoothly.

CENTER THE LOAD
Your truck could tip over, in any direction, if a load is shifted to the front or side of a pallet or container. Make certain your load is centered and distributed.



11 Capacity & Load Center
Capacity & Loa

QUICK LOCATORS

In addition to the "Contents" page you can use page headings to find topics. Some pages also have a picture of the truck in the corner showing features or functions covered on that page.

"KNOW THE HAZARDS"

Watch for and read these special blocks. You will find information about possible safety hazards and how to avoid them.

HOW-TO-DRAWINGS

On many pages you will find pictures as well as text to help you understand how to use your truck safely and productively.

Lift Truck Parts

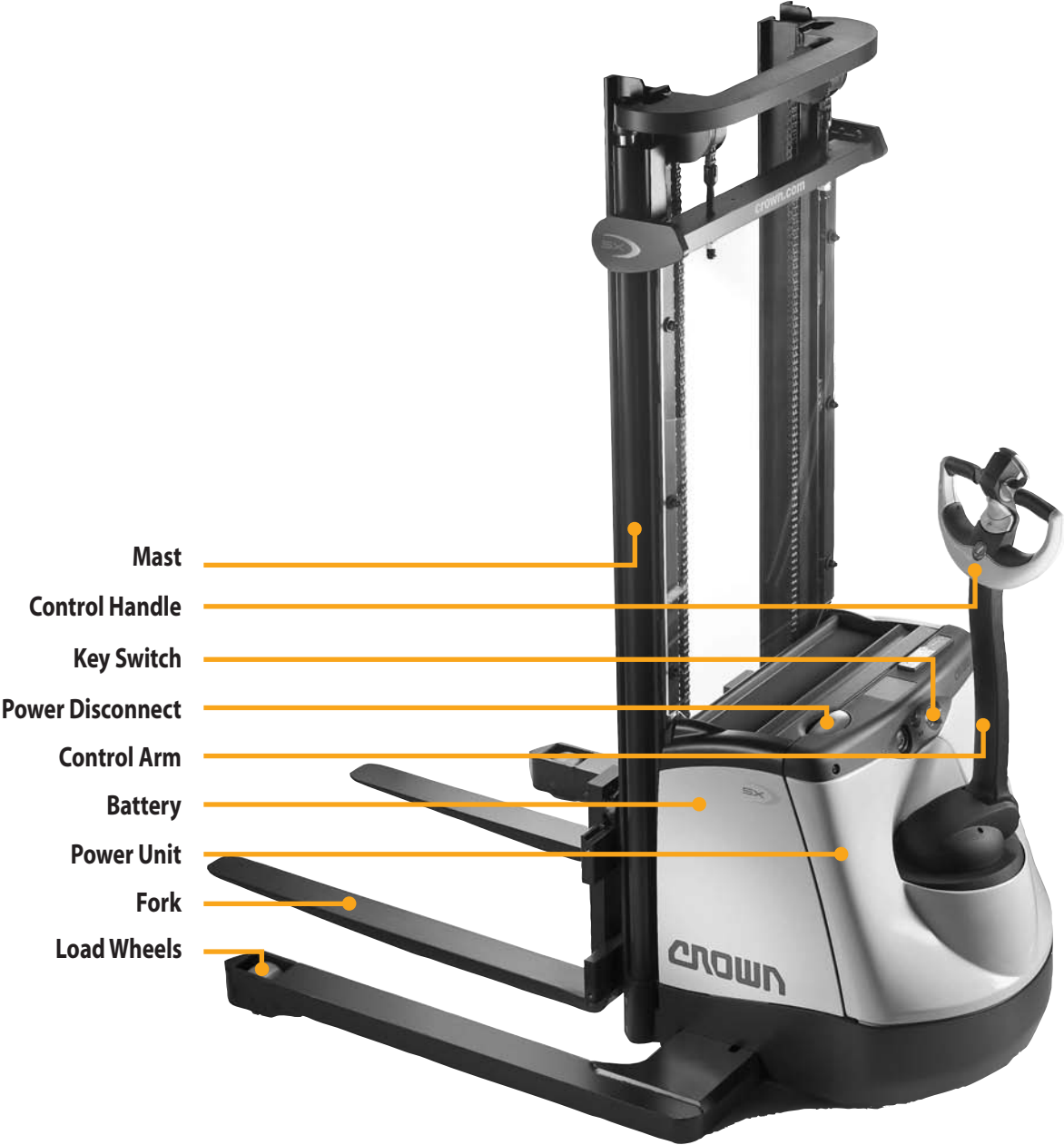
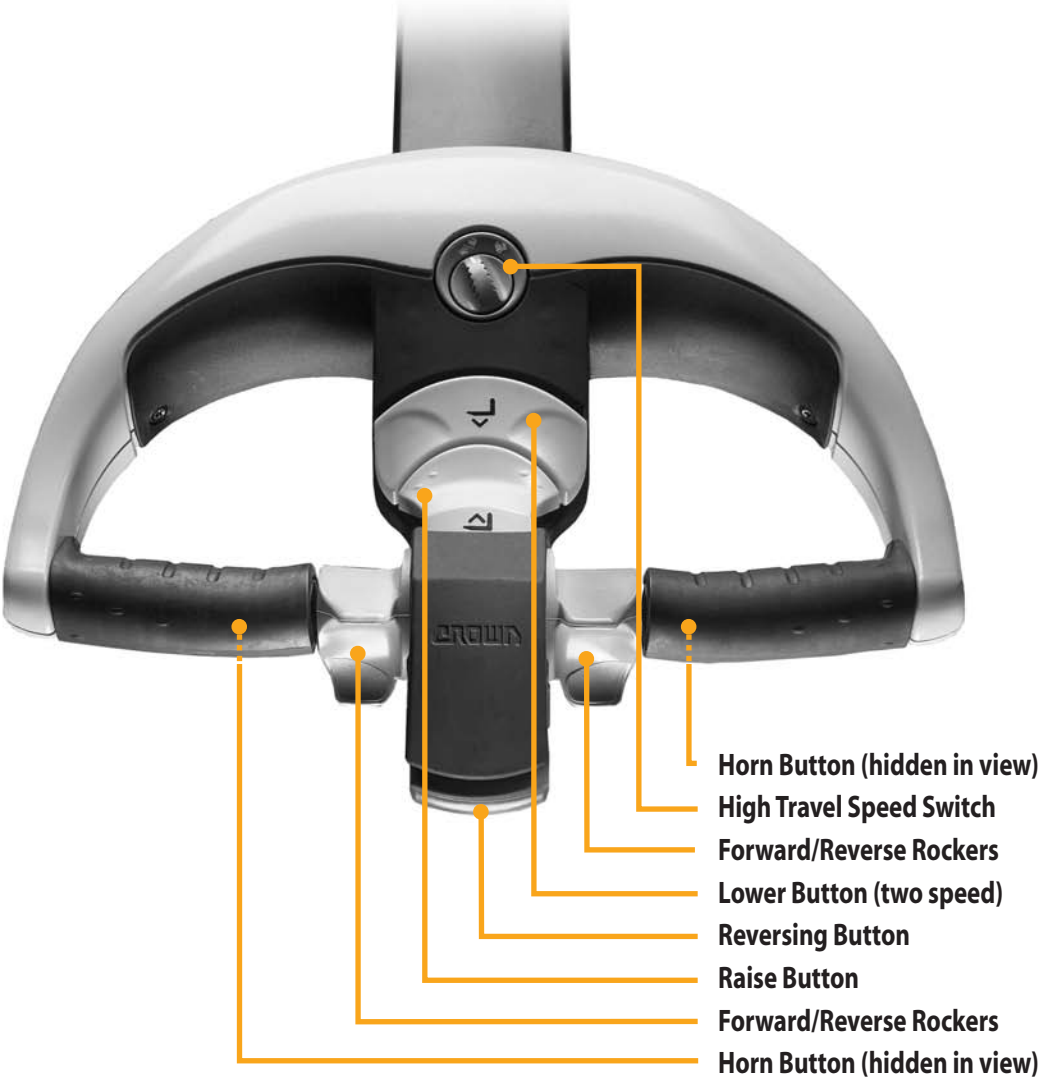

Your Walkie Lift Truck

WALKIE LIFT TRUCKS

Your walkie lift truck can be used to lift, move and stack loads. It is designed to travel short distances and operate in areas with limited space.

YOUR LIFT TRUCK IS NOT AN AUTOMOBILE

With a load it may weigh more than 2 automobiles.

- You don't steer the same.
- You don't brake the same.
- You don't accelerate the same.

HOW TO OPERATE YOUR TRUCK

Forks First

When traveling forks first use both hands to operate the control handle.

Watch your feet if you change direction of travel.

Power Unit First

When traveling power unit first stay to one side of the truck and slightly ahead of the power unit. Use the hand closest to the truck to operate the control handle.

Watch your feet.

Stay out of the path of the truck.

BUILT TO STANDARDS

This truck was designed and built to current industry and government standards and guidelines. For more information see the following:

- American National Standards Institute (ASME) B56.1
- Occupational Safety and Health Act (OSHA) §1910.178, Rev. 1999
- Underwriters Laboratory (UL) 583
- National Fire Prevention Association (NFPA) 505

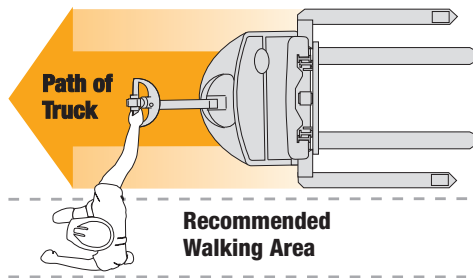
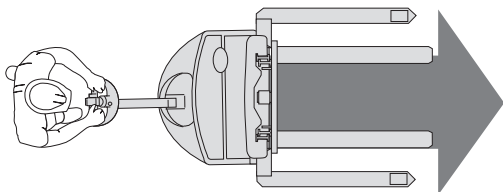
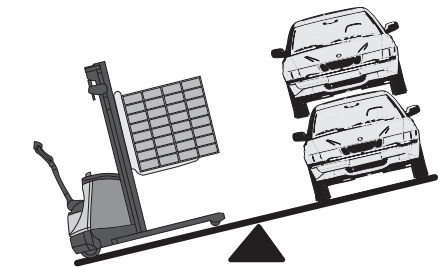

Capacity & Load

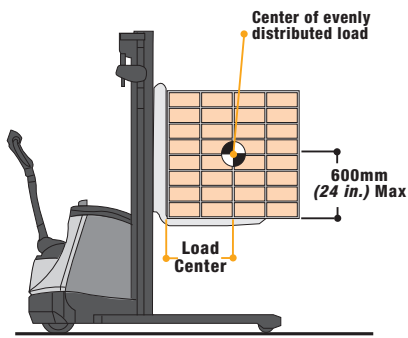

WHAT IS YOUR TRUCK CAPACITY?

Capacity is the load (including pallet or container) that can be lifted to a given height at a given load center. See the capacity plate on your truck. Make certain you use the correct units of measure.

WHAT IS LOAD CENTER?

Load center is the distance from the load backrest or vertical face of the fork to the center of an evenly distributed load.

LOADS MUST BE EVENLY DISTRIBUTED

Your truck could tip over if a load is shifted to the front or side of a pallet or container. Make sure your load is evenly distributed and centered over the forks.

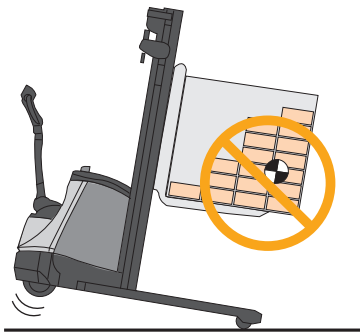

! Know the Hazards

SAMPLE CAPACITY PLATE

The information shown on this sample plate does not apply to your truck.

	Truck Weight with Max. Battery	Units of measure, kg/mm (lb/in)		
	1353 (2983)	Capacity with Mast Vertical		
	Attachment Data	Capacity		
	Sideshifter	1135 (2500)	4267 (168)	600 (24)
	Min. Inside Straddle	1360 (3000)	3912 (154)	600 (24)
965 (38)	998 (2200)	4267 (168)	660 (26)	
Serial Number	1225 (2700)	3912 (154)	660 (26)	
XXXXXXXX				

KNOW YOUR LOAD

Do not exceed the capacity shown on your truck's capacity plate. Be careful when handling long, high or wide loads. Do not handle unstable loads.

EXCEEDING TRUCK CAPACITY CAN CAUSE AN ACCIDENT

Know the capacity of your truck as shown on your capacity plate. Pay attention to:

- Weight of load
- Load center
- Lift height

HYDRAULIC OPERATIONS CAN AFFECT STABILITY

Be careful when using attachments such as sideshift, pivot or rotate. Remember that anytime the forks move, the load moves also. This can affect stability. Perform all hydraulic operations smoothly.

CENTER THE LOAD

Your truck could tip over, in any direction, if a load is shifted to the front or side of a pallet or container. Make certain your load is centered and evenly distributed.

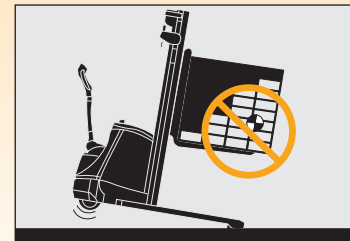

Capacity Plate



CAPACITY PLATE INFORMATION

The capacity plate is on the mast cross brace. It contains:

- Truck serial number
- Capacity information (load, load center and lift height)
- Truck weight with battery (does not include load)
- Attachment information (if any)

READING YOUR CAPACITY PLATE

Capacity may be reduced as lift height **A** increases.

For example: On the sample plate, 1360kg (3000 lb) can be lifted to 3912mm (154 in). But above 3912 (154), to 4267 (168), capacity is reduced from 1360 (3000) to 1135 (2500).

Capacity is reduced as load center **B** increases.

For example: On the sample plate, 1135kg (2500 lb) can be lifted if the load center is 600 mm (24in). But if the load center is increased to 660 (26), capacity is reduced from 1135 (2500) to 998 (2200).

Caution: You may not increase capacity if load center is less than shown on your capacity plate.

SAMPLE CAPACITY PLATE
The information shown on this sample plate does not apply to your truck.

	Truck Weight with Max. Battery	Units of measure, kg/mm (lb/in)	
	1353 (2983)	Capacity with Mast Vertical	
Attachment Data	Sideshifter	Capacity	
3000 SERIES	Min. Inside Straddle	1360 (3000)	4267 (168)
965 (38)	Truck Type	3912 (154)	600 (24)
Serial Number	XXX	998 (2200)	4267 (168)
XXXXXXXXXX		1225 (2700)	3912 (154)
			660 (26)

Note: ASME B56.1 requires that all data be shown first in Metric units and then USA units.

OTHER LIFT HEIGHTS AND LOAD CENTERS

Contact Crown for capacities at lift heights or load centers not given on your capacity plate.

Know the Hazards

TRUCK TYPE

Some truck types are not permitted in areas where there are fire hazards. Watch for marked areas. For example: You must not drive a type E or ES truck into an area restricted to EE or EX trucks.

TRUCK WEIGHT

Dockboards, elevators and some floors have limited capacity. Check your capacity plate for the weight of your truck. Remember to add the weight of the load you have on the forks. Make certain you use the correct units of measure.

ATTACHMENT DATA

If an attachment on your truck does not match the information given on your capacity plate, don't operate your truck. Your capacity plate may be wrong. Report the problem to your supervisor.

Power On & Off



KEY SWITCH

Turn the truck on by placing the control handle vertical and turning the key to ON (green dot).

Turn the truck off by turning the key to OFF (red dot).

Always turn the key to off when leaving the truck.



POWER DISCONNECT

Pull up on the battery connector handle to disconnect the battery and cut all power.

Always disconnect the battery any time the truck isn't working right. The key switch does not cut all power to the truck.

BATTERY CHARGE METER

The green and yellow lights show how much charge is left in your battery. A flashing red light will warn you that the battery is getting low.

Two flashing red lights mean you must have the battery changed or recharged. This also means you will not be able to raise the forks.

Maintenance free batteries, when used, are designed for deep discharge cycling. However, opportunity charging is permitted under certain conditions.

- Battery meter must indicate for at least 30% and 60% of discharge.
- Batteries are charged for at least 30 minutes, with an equal cool down period.
- Batteries receive a full charge at least once a week.

See service manual for more information.

Note: The battery meter may give a false reading for the first hour after opportunity charging.

Braking & Brake Override

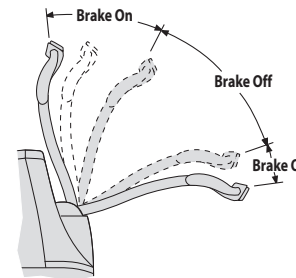

BRAKING

Move the control handle all the way down or all the way up to apply the brake.

When you let go of the control handle it will automatically go to the upper braking position. Check braking before you start working.

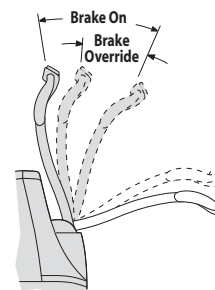

BRAKE OVERRIDE

If you must move your truck while in a confined area, this feature allows you to override the brake and drive slowly while the handle is in the upper "Brake On" area.

With the handle in the "Brake Override" zone of the braking area, first put the forward/reverse rocker in neutral, and then move it to the direction you want to travel.

Watch your feet. Make sure you don't get pinned between the truck and a fixed object. Stay out of the path of travel.

! Know the Hazards



MAKE SURE YOUR BRAKE WORKS

Test the brake on your truck at the start of each shift. Know the distance it takes to stop before starting work.

If at any time the stopping distance is too long for you to stop safely, don't use the truck. Report any problem to your supervisor.

BE CAREFUL WHILE USING BRAKE OVERRIDE

Hands or feet caught between the truck and a fixed object will be crushed or even cut off. Stay out of the path of travel.

Raising & Lowering

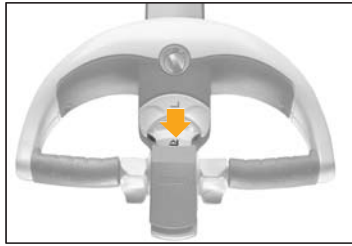

TO RAISE

Push the Raise Button and release when the forks are at the desired height.

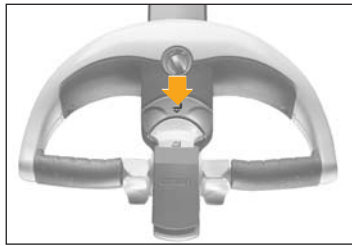

TO LOWER

Push the lower button all the way for fast lowering.
Push the button part way for a slower lowering speed.
Release the button when the forks are at the desired height.

Steering & Travel

STEERING

You control steering by moving the control handle from side to side.
For example: This picture shows the directions the truck can turn when the control handle is moved to the approximate position shown.

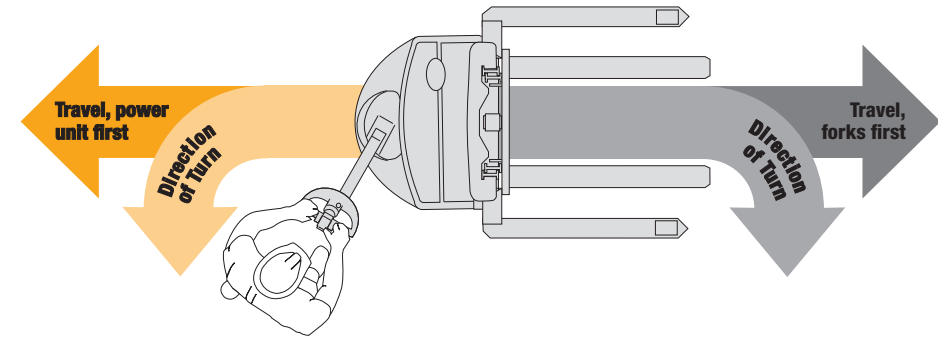

! Know the Hazards

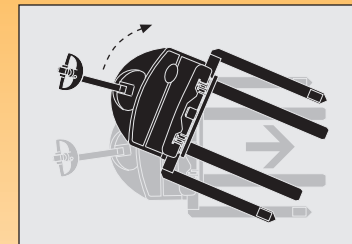

POWER UNIT SWING

Be careful turning while traveling forks first. The power unit will swing wide in the opposite direction. Make sure you have clearance, and watch out for people in the area.



SLOW DOWN FOR SPILLS OR WET FLOORS

Powder or liquid spills can cause slippery floors. Slow down or you could lose control of steering and braking. Be careful and allow for a longer stopping distance.

Don't run over objects on the floor.

Traveling & Plugging

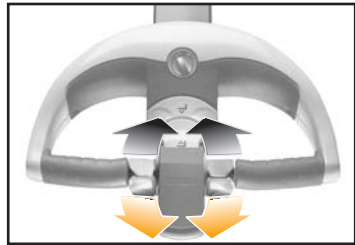

TRAVEL

Move either Forward/Reverse Rocker in the direction you want to travel.

The farther you move the rocker from the neutral position, the faster the truck will move.

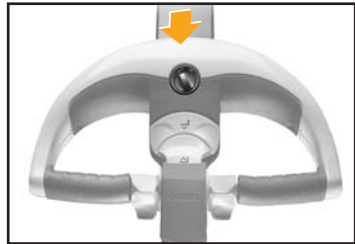

HIGH TRAVEL SPEED

For high travel speed, turn the travel speed switch to the high speed position (👉), and move either Forward/Reverse Rocker to the maximum travel speed position.

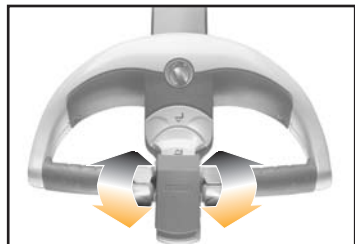

PLUGGING

Plugging is another way to slow down your truck. While the truck is moving, in either direction, move either Forward/Reverse rocker through neutral to the opposite direction of travel.

Plugging will not hurt your truck.

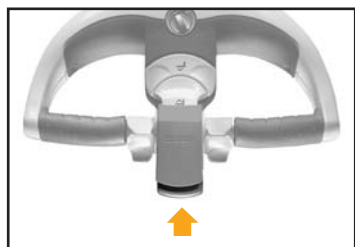

REVERSING BUTTON

If you accidentally hit the reversing button while working in close quarters, the truck will move in the direction of the forks until the button is released.

Be careful. The reversing button cannot prevent all injuries.

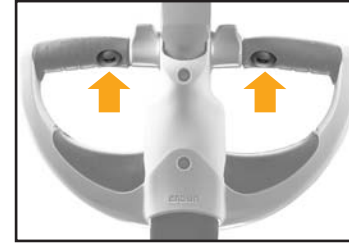

HORN

Push the switch on the underside of either grip to sound the horn. Use it to warn pedestrians and other drivers.

Use your horn when you come to an intersection or a crosswalk.

! Know the Hazards



LOOK WHERE YOU'RE GOING

Always be alert to the area around you and watch where you are walking. You could be pinned or crushed if you are caught between the truck and walls, racks or other fixed objects.

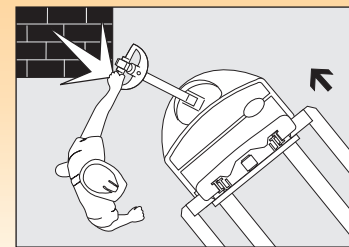

WATCH YOUR FEET AND HANDS

A foot or hand caught between the truck and a wall, post or any fixed object will be crushed or even cut off. Keep your feet clear of the wheels.

Daily Safety Check



CHECK YOUR TRUCK BEFORE STARTING WORK

You must make sure your truck is safe to use.

1. Walk around your truck and check it over.

- Check to make sure the battery is charged, water level is OK and vent caps are in place, unless sealed, maintenance-free batteries have been selected. Don't use an open flame to check the battery.
- See that all wheels are in good condition.
- Check that both forks are secure and not bent, cracked or badly worn.
- Inspect lift chains for damage.
- See that the load backrest is in place and secure, if your truck has that option.
- Look under the truck for signs of hydraulic leaks.
- Test the horn.
- Make sure the power disconnect works.
- Check that all controls work smoothly.

2. Test drive your truck in an uncongested area.

- Test the hydraulic functions.
- Check the steering.
- Operate the truck slowly in both directions.
- Operate through the full speed range in both forward and reverse.
- Check braking distance in forward and reverse. Load size and floor conditions can affect these distances.
- Know the distance it takes to stop before you start working. If the braking distance is too long to stop safely, don't use the truck.

If anything doesn't look, work or feel right, don't use the truck. Report the problem to your supervisor.

You can get checklist forms from your Crown dealer (part no. OF-3772). Used properly, this checklist can alert service people to needed repairs.

Be a Safe Operator



The most important component is you.



MAKE SURE YOU ARE READY

- Do not use this truck unless you are trained and certified.
- Be certain you understand how your truck works and the hazards that go with it. Don't use the truck if you have any doubts.
- Know the capacity of your truck. Make certain you use the correct units of measure
- Some trucks are not allowed in areas where there are fire hazards. Be certain your truck is the correct fire safety type for the area.
- Make sure your hands and shoes are clean and dry, and your clothing is proper for the job.

MAKE SURE YOUR TRUCK IS READY

- Inspect your truck before using it (see pages 21 and 22). If it's not working right, or something is broken, report the problem to your supervisor. Don't use the truck.
- In an open area, test the braking. Check at a slow travel speed first, then a faster one. Know the distance it takes to stop before you start work.

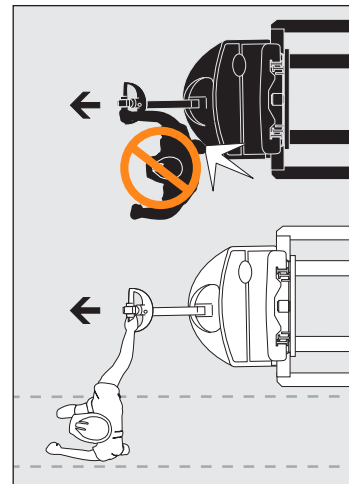
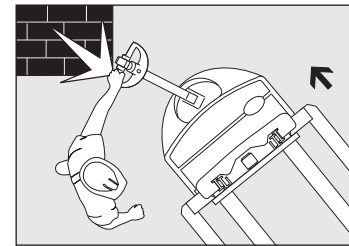
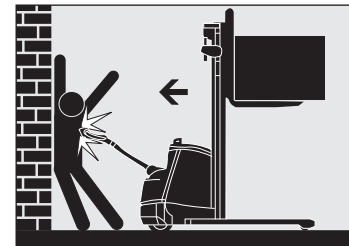

USE CAUTION, BE ALERT

- Watch where you're walking. Don't let any part of your body get pinned or crushed between the truck and a fixed object.
- Stay to the side of the truck when traveling power unit first. Make sure the truck won't hit your leg or run over your foot.
- When traveling forks first keep both hands on the control. Be careful when changing direction. Keep your feet clear of the truck.
- Travel in the direction that gives you the best view. Look where you are going and slow down in congested areas.
- Slow down for wet or slippery floors. Don't run over things. Watch out for rough floors.
- Travel with the forks close to the ground. Place the load against the load backrest or vertical face of the forks.
- Look where you are going before you change direction of travel.
- See that you have room to drive and turn. Watch out for power unit swing.
- Slow down when making turns.
- Avoid sudden movement of controls. Learn to use them smoothly at a moderate, even rate.
- Check clearances before raising or lowering the forks.
- Be extra careful if you must use your truck in an area where there is a risk of falling objects.
- Never ride on your truck.

Continued next page...

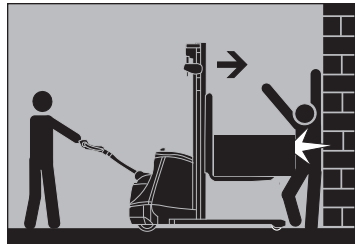

WATCH OUT FOR OTHER PEOPLE

- Slow down. Yield or stop for pedestrians. Use your horn when you come to a crosswalk or intersection.
- Be careful that you don't pin or crush someone. For example: Never drive your truck toward anyone standing in front of a fixed object.
- Never allow anyone to ride on your truck.
- Keep others away from your truck while you're working. Don't ever allow anyone on or under the load or forks.
- Don't let anyone use your truck unless they are trained and certified.
- Watch out for power unit swing.
- Never lift anyone with the forks unless they are using an approved platform. Even then use extreme caution:
 - Use a securely attached and approved safety platform.
 - Make certain lifting mechanism is operating properly.
 - Make certain truck is in neutral and brake is applied.
 - Lift and lower slowly.
 - Watch for overhead obstructions.
 - Be sure you can see and hear the person being lifted.
 - Never transport anyone on the platform from one location to another.

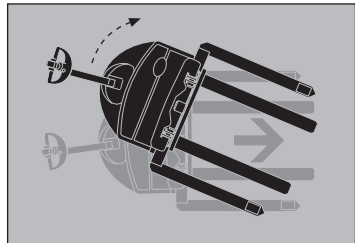

WHEN LEAVING YOUR TRUCK

- Lower the forks to the floor and turn the truck off.
- Avoid parking on inclines. But if you must, block the wheels of your truck.



AVOID FALLS

- Stay away from the edge of docks and ramps.
- Check that bridgeplates and dockboards are secure. Be certain that either the trailer wheels are chocked or the trailer is locked to the dock. Check capacities. Be sure your truck, with load, isn't too heavy for where you are driving.
- Make sure the load you are moving is stable. Spread the forks as far as you can and center the load. Insert the forks as far under the load as you can. Be even more careful with long, high or wide loads. They can be less stable.
- Don't take your truck onto an elevator unless you are authorized. Check the capacity or load limit and make sure there are no people present. Enter forks first and set the brake.

BE CAREFUL TRAVELING ON RAMPS AND GRADES

- Stay out of the path of the truck.
- With or without a load, drive with the forks pointed downgrade.
- If a load requires that you travel with the forks upgrade, be even more careful. Operate the controls from the side of the truck.
- Slow down and don't turn on ramps or grades.

Battery Maintenance



BATTERIES

Your truck will have either a single industrial battery or a battery pack containing either two or four automotive style batteries.

Check all batteries daily unless sealed, maintenance-free batteries have been selected.

CHARGERS

To use a separate external charger, follow the directions on the charger provided.

To use a charger built into the truck you must first have access to an AC electrical outlet. To charge the batteries:

- Turn the truck off. Do not disconnect the battery.
- Use an extension cord less than 7.5 meters (25 ft) long, with a wire size of 16 AWG or heavier.
- Plug one end of the extension cord into the charging socket on the console.
- Plug the other end of the cord into the AC outlet.
- Check the charging lights on the console.



WHAT THE LIGHTS MEAN

- A steady yellow light means there is power to the charger. If the light does not come on, or goes out, make sure the AC outlet is working and the extension cord is OK.
- A flashing yellow light means something is wrong with a battery or the charger. Notify your supervisor.
- A flashing green light means the charger is working.
- A steady green light means charging is finished.

! Know the Hazards

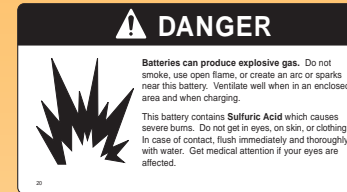

TRUCK BATTERIES CAN BE DANGEROUS

Your truck battery produces a gas that can explode. It also contains acid that could burn or disfigure you.

- Do not try to install, remove, charge or service your truck battery unless you are trained and authorized.
- Never smoke or use an open flame around batteries.
- Your company should provide an area where it is safe to work on batteries. Use that area for all battery work.
- Use protective equipment such as gloves, eye shields, aprons, etc.

BEFORE CHARGING YOUR TRUCK BATTERIES

- See that cells of serviceable batteries are filled to the proper level. Never use an open flame to check batteries.
- Make sure the truck key switch is turned OFF and all controls are in the off or neutral position.
- For a built-in charger, make certain the AC outlet is the same voltage as the battery charger.
- For an external charger, make certain the charger is the same voltage and amperage as your battery(s).
Read the battery charger instructions.

Be sure the charger is turned OFF before connecting the battery to the charger. Otherwise you might create a spark which could cause a battery to explode.

Continued next page...

Battery Maintenance continued

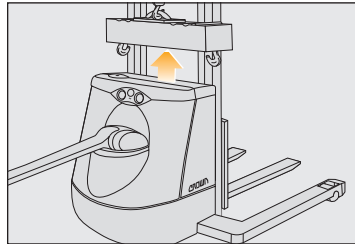

WHEN YOU INSTALL OR CHANGE AN INDUSTRIAL BATTERY (SX only)

- Turn the truck OFF and disconnect the battery.
- Make certain you use the correct size and weight battery. Never operate a truck that has an underweight or undersized battery installed.
- Never let anything metal touch the top of the cells. You could cause sparks or do damage to the battery. Use an insulator (such as plywood) when necessary.
- Use an approved spreader bar to place a battery in, or remove it from, the battery compartment. Make sure you adjust the spreader bar hooks to fit the battery.
- Connect the new battery. Turn the truck ON and check truck operation.

Know the Hazards

WARNING

Recommended battery size
175 to 185 mm (6.9 to 7.3 in.) wide
265 to 305 (10.4 to 12.1) long
225 to 285 (8.8 to 11.3) high
Min. batt. wt. 22.7 kg (50 lbs) each.

WARNING

Minimum battery size allowed
000 mm (00.00 in.) wide
000 mm (00.00 in.) long
Undersize battery can affect truck handling and stability. You could have an accident.
Use U.L. classified Type E battery.

BATTERY SIZE IS IMPORTANT

Make certain you use the correct size, weight and type of battery. Never operate a truck that has an underweight or undersized battery installed.

Warning Labels



EACH WARNING LABEL ON YOUR TRUCK IS IMPORTANT

Read and obey all of them to protect yourself and others.

WARNING

STOP It's the law, you must be trained and certified to operate this truck.
OSHA § 1910.178, Rev. 1999
You or people around you could be seriously injured or even killed if you don't use this truck correctly.
Obey all instructions & warnings in the operator manual and the truck.
Inspect your truck before start work, make sure it's in good working order.
* Additional copies of the Operators Manual and Truck Labels can be obtained from: Crown Equipment Corporation, New Bremen, OH 45869 USA

CAUTION

Connect charger properly or truck can be damaged.
Make certain charger is plugged into the battery

WARNING

Minimum battery size allowed
XXX mm (XX.XX in.) wide
XXX mm (XX.XX in.) long
Undersize battery can affect truck handling and stability. You could have an accident.
Use U.L. classified Type EO battery.

WARNING

No Riding.
Riding on this truck could cause serious injury.

WARNING

Stay clear of all moving parts.
Moving parts can cut or crush hands, feet, arms or legs.

WARNING

Never stand or ride on forks for any reason.
Falling objects or lowering forks cause serious injury or death.
While servicing, block the forks they won't fall.

WARNING

Batteries can produce explosive gas. Do not smoke, use open flame, or create an arc or sparks near this battery. Ventilate well when in an enclosed area and when charging.
This battery contains **Sulfuric Acid** which causes severe burns. Do not get in eyes, on skin, or clothing. In case of contact, flush immediately and thoroughly with water. Get medical attention if your eyes are affected.