

Model Documentation

**Natural Gas Transmission and
Distribution Module of the
National Energy Modeling System**

June 2010

**Office of Integrated Analysis and Forecasting
U.S. Energy Information Administration
U.S. Department of Energy
Washington, DC 20585**

This report was prepared by the U.S. Energy Information Administration, the independent statistical and analytical agency within the Department of Energy. The information contained herein should not be construed as advocating or reflecting any policy position of the Department of Energy or any other organization.

Contact Information

The Natural Gas Transmission and Distribution Module (NGTDM) of the National Energy Modeling System is developed and maintained by the U.S. Energy Information Administration (EIA), Office of Integrated Analysis and Forecasting. General questions about the use of the model can be addressed to Michael Schaal (202) 586-5590, Director of the Oil and Gas Division. Specific questions concerning the NGTDM may be addressed to:

Joe Benneche, EI-83
Forrestal Building, Room 2H026
1000 Independence Ave., S.W.
Washington, DC 20585
(202/586-6132)
Joseph.Benneche@eia.doe.gov

This report documents the archived version of the NGTDM that was used to produce the natural gas forecasts presented in the *Annual Energy Outlook 2010*, (DOE/EIA-0383(2010)). The purpose of this report is to provide a reference document for model analysts, users, and the public that defines the objectives of the model, describes its basic approach, and provides detail on the methodology employed.

The model documentation is updated annually to reflect significant model methodology and software changes that take place as the model develops. Significant formatting changes and updates were implemented in this version of the documentation by Margaret Leddy. The next version of the documentation is planned to be released in the first quarter of 2011.

Update Information

This edition of the model documentation of the Natural Gas Transmission and Distribution Module (NGTDM) reflects changes made to the module over the past year for the *Annual Energy Outlook 2010*. Aside from general data and parameter updates, the notable changes include:

- Added algorithm for assessing the potential penetration of compressed natural gas for personal vehicles at retail refueling stations and for adjusting the price accordingly.
- Reestimated equations for distributor tariffs and Canadian natural gas supply.
- Updated coalbed and shale undiscovered resource assumptions in Canada.

Contents

1. Background/Overview	1
NGTDM Overview	2
NGTDM Objectives	4
Overview of the Documentation Report	5
2. Demand and Supply Representation	6
A Brief Overview of NEMS and the NGTDM	6
Natural Gas Demand Representation	9
Natural Gas Supply Interface and Representation	14
Natural Gas Imports and Exports	21
Alaska Natural Gas Routine	29
3. Overview of Solution Methodology	34
NGTDM Regions and the Pipeline Flow Network	34
Overview of the NGTDM Submodules and Their Interrelationships	41
4. Interstate Transmission Submodule Solution Methodology	49
Network Characteristics in the ITS	49
Input Requirements of the ITS	52
Heuristic Process	53
5. Distributor Tariff Submodule Solution Methodology	81
Residential and Commercial Sectors	81
Industrial Sector	83
Electric Generation Sector	85
Transportation Sector	86
6. Pipeline Tariff Submodule Solution Methodology	92
Historical Year Initialization Phase	95
Forecast Year Update Phase	110
Storage Tariff Routine Methodology	134
Alaska and MacKenzie Delta Pipeline Tariff Routine	150
7. Model Assumptions, Inputs, and Outputs	155
Assumptions	155
Model Inputs	160
Model Outputs	163
Appendix A. NGTDM Model Abstract	165
Appendix B. References	173
Appendix C. NEMS Model Documentation Reports	175
Appendix D. Model Equations	176
Appendix E. Model Input Variables Mapped to Input Data Files	178
Appendix F. Derived Data	186
Appendix G. Variable Cross Reference Table	233
Appendix H. Coal-to-Gas Submodule	235

Tables

Table 2-1.	LNG Regasification Regions	28
Table 3-1.	Demand and Supply Types at Each Transshipment Node in the Network.....	38
Table 6-1.	Illustration of Fixed and Variable Cost Classification.....	104
Table 6-2.	Approaches to Rate Design.....	105
Table 6-3a.	Illustration of Allocation of Fixed Costs to Rate Components.....	106
Table 6-3b.	Illustration of Allocation of Variable Costs to Rate Components	106
Table 6-4.	Approach to Projection of Rate Base and Capital Costs.....	113
Table 6-5.	Approach to Projection of Revenue Requirements.....	123
Table 6-6.	Percentage Allocation Factors for a Straight Fixed Variable (SFV) Rate Design..	129
Table 6-7.	Approach to Projection of Storage Cost-of-Service	135

Figures

Figure 1-1.	Schematic of the National Energy Modeling System.....	2
Figure 1-2.	Natural Gas Transmission and Distribution Module (NGTDM) Regions.....	3
Figure 2-1.	Primary Data Flows Between Oil and Gas Modules of NEMS.....	7
Figure 2-2.	Electricity Market Module (EMM) Regions.....	11
Figure 2-3.	Natural Gas Transmission and Distribution Module/Electricity Market Module (NGTDM/EMM) Regions	12
Figure 2-4.	Oil and Gas Supply Module (OGSM) Regions	15
Figure 2-5.	Natural Gas Transmission and Distribution Module/Oil and Gas Supply Module (NGTDM/OGSM) Regions	16
Figure 2-7.	Generic Supply Curve.....	17
Figure 3-1.	Natural Gas Transmission and Distribution Module Network	35
Figure 3-2.	Transshipment Node	36
Figure 3-3.	Variables Defined and Determined for Network Arc	39
Figure 3-4.	NGTDM Process Diagram.....	42
Figure 3-5.	Principal Buyer/Seller Transaction Paths for Natural Gas Marketing.....	44
Figure 4-1.	Network “Tree” or Hierarchical, Acyclic Network of Primary Arcs	50
Figure 4-2.	Simplified Example of Supply and Storage Links Across Networks	51
Figure 4-3.	Interstate Transmission Submodule System Diagram	56
Figure 6-1.	Pipeline Tariff Submodule System Diagram	93

Abbreviations and Acronyms

AEO	Annual Energy Outlook
Bcf	Billion cubic feet
Bcfd	Billion cubic feet per day
BTU	British Thermal Unit
DTS	Distributor Tariff Submodule
EMM	Electricity Market Module
GAMS	Gas Analysis Modeling System
IFFS	Integrated Future Forecasting System
ITS	Interstate Transmission Submodule
MEFS	Mid-term Energy Forecasting System
MMBTU	Million British thermal units
Mcf	Thousand cubic feet
MMcf	Million cubic feet
MMcfd	Million cubic feet per day
MMBBL	Million barrels
NEMS	National Energy Modeling System
NGA	Natural Gas Annual
NGM	Natural Gas Monthly
NGTDM	Natural Gas Transmission and Distribution Module
OGSM	Oil and Gas Supply Module
PIES	Project Independence Evaluation System
PMM	Petroleum Market Module
PTS	Pipeline Tariff Submodule
STEO	Short-Term Energy Outlook
Tcf	Trillion cubic feet
WCSB	Western Canadian Sedimentary Basin

1. Background/Overview

The Natural Gas Transmission and Distribution Module (NGTDM) is the component of the National Energy Modeling System (NEMS) that is used to represent the U.S. domestic natural gas transmission and distribution system. NEMS was developed by the Office of Integrated Analysis and Forecasting of the U.S. Energy Information Administration (EIA). NEMS is the third in a series of computer-based, midterm energy modeling systems used since 1974 by the EIA and its predecessor, the Federal Energy Administration, to analyze and project U.S. domestic energy-economy markets. From 1982 through 1993, the Intermediate Future Forecasting System (IFFS) was used by the EIA for its integrated analyses. Prior to 1982, the Midterm Energy Forecasting System (MEFS), an extension of the simpler Project Independence Evaluation System (PIES), was employed. NEMS was developed to enhance and update EIA's modeling capability. Greater structural detail in NEMS permits the analysis of a broader range of energy issues. While NEMS was initially developed in 1992 the model is updated each year, from simple historical data updates to complete replacements of submodules.

The time horizon of NEMS is the midterm period that extends approximately 25 years to year 2035. In order to represent the regional differences in energy markets, the component modules of NEMS function at regional levels appropriate for the markets represented, with subsequent aggregation/disaggregation to the Census Division level for reporting purposes. The projections in NEMS are developed assuming that energy markets are in equilibrium¹ using a recursive price adjustment mechanism,² as were earlier EIA projection models. For each fuel and consuming sector, NEMS balances energy supply and demand, accounting for the economic competition between the various fuels and sources. NEMS is organized and implemented as a modular system.³ The NEMS modules represent each of the fuel supply markets, conversion sectors (e.g., refineries and power generation), and end-use consumption sectors of the energy system. NEMS also includes macroeconomic and international modules. A routine was also added to the system that simulates a carbon emissions cap and trade system with annual fees to limit carbon emissions from energy-related fuel combustion. The primary flows of information between each of these modules are the delivered prices of energy to the end user and the quantities consumed by product, Census Division, and end-use sector. The delivered fuel prices encompass all the activities necessary to produce, import, and transport fuels to the end user. The information flows also include other data such as economic activity, domestic production activity, and international petroleum supply availability.

The integrating routine of NEMS controls the execution of each of the component modules. The modular design provides the capability to execute modules individually, thus allowing independent analysis with, as well as development of, individual modules. This modularity allows the use of the methodology and level of detail most appropriate for each energy sector. Each forecasting year, NEMS solves by iteratively calling each module in sequence (once in

¹Markets are said to be in equilibrium when the quantities demanded equal the quantities supplied at the same price; that is, at a price that sellers are willing to provide the commodity and consumers are willing to purchase the commodity.

²The central theme of the approach used is that supply and demand imbalances will eventually be rectified through an adjustment in prices that eliminates excess supply or demand.

³The NEMS is composed of 13 modules including a system integration routine.

each NEMS iteration) until the delivered prices and quantities of each fuel in each region have converged within tolerance between the various modules, thus achieving an economic equilibrium of supply and demand in the consuming sectors. Module solutions are reported annually through the midterm horizon. A schematic of the NEMS is provided in **Figure 1-1**, while a list of the associated model documentation reports is in Appendix C, including a report providing an overview of the whole system.

Figure 1-1. Schematic of the National Energy Modeling System

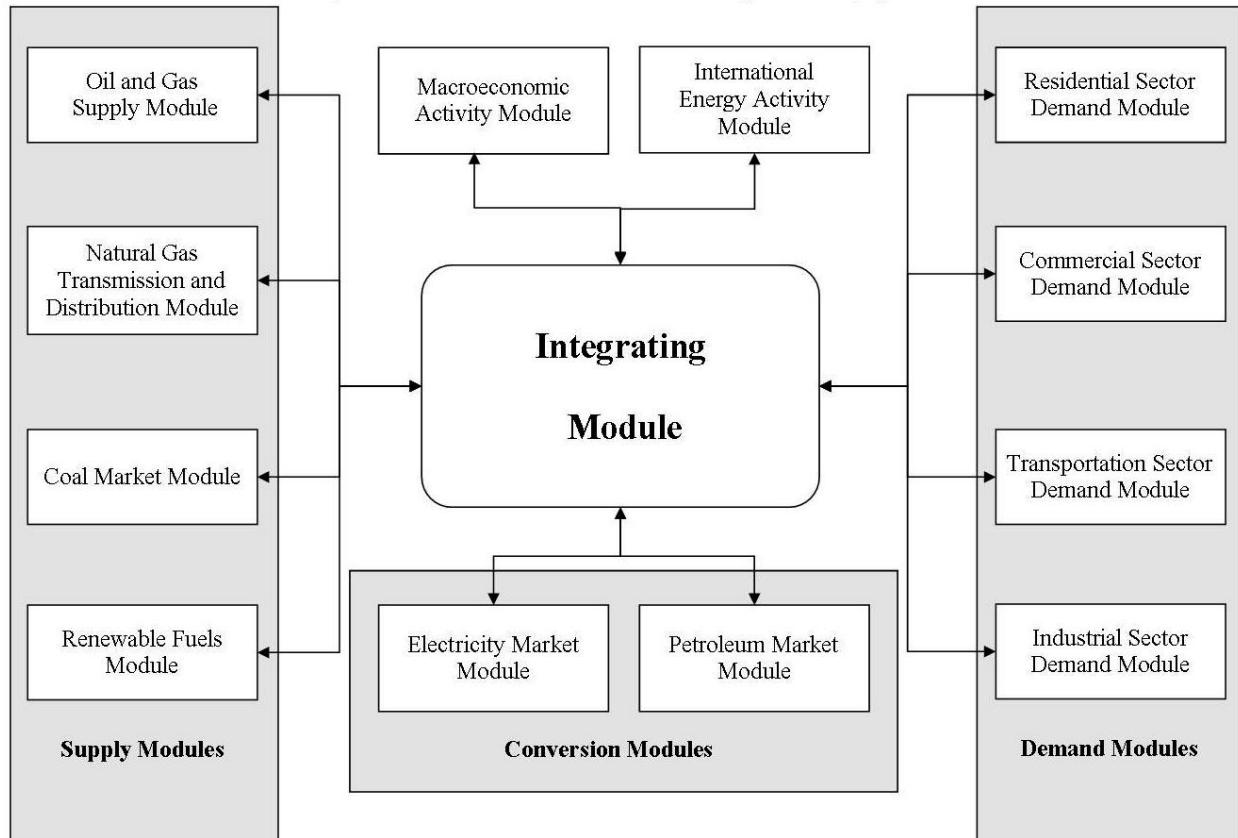

NGTDM Overview

The NGTDM module within the NEMS represents the transmission, distribution, and pricing of natural gas. Based on information received from other NEMS modules, the NGTDM also includes representations of the end-use demand for natural gas, the production of domestic natural gas, and the availability of natural gas traded on the international market. The NGTDM links natural gas suppliers (including importers) and consumers in the lower 48 States and across the Mexican and Canadian borders via a natural gas transmission and distribution network, while determining the flow of natural gas and the regional market clearing prices between suppliers and end-users. For two seasons of each forecast year, the NGTDM determines the production, flows, and prices of natural gas within an aggregate representation of the U.S./Canadian pipeline network, connecting domestic and foreign supply regions with 12 U.S. and 2 Canadian demand regions. Since the NEMS operates on an annual (not a seasonal) basis, NGTDM results are

generally passed to other NEMS modules as annual totals or quantity-weighted annual averages. Since the Electricity Market Module has a seasonal component, peak and off-peak⁴ prices are also provided for natural gas to electric generators.

Natural gas pricing and flow patterns are derived by obtaining a market equilibrium across the three main elements of the natural gas market: the supply element, the demand element, and the transmission and distribution network that links them. The methodology employed allows for the analysis of impacts of regional capacity constraints in the interstate natural gas pipeline network and the identification of primary pipeline and storage capacity expansion requirements. Key components of interstate pipeline tariffs are projected, along with distributor tariffs.

The lower-48 demand regions represented are the 12 NGTDM regions (**Figure 1-2**). These regions are an extension of the 9 Census Divisions, with Census Division 5 split into South Atlantic and Florida, Census Division 8 split into Mountain and Arizona/New Mexico, Census Division 9 split into California and Pacific, and Alaska and Hawaii handled independently. Within the U.S. regions, consumption is represented for five end-use sectors: residential, commercial, industrial, electric generation, and transportation (or natural gas vehicles), with the

Figure 1-2. Natural Gas Transmission and Distribution Module (NGTDM) Regions

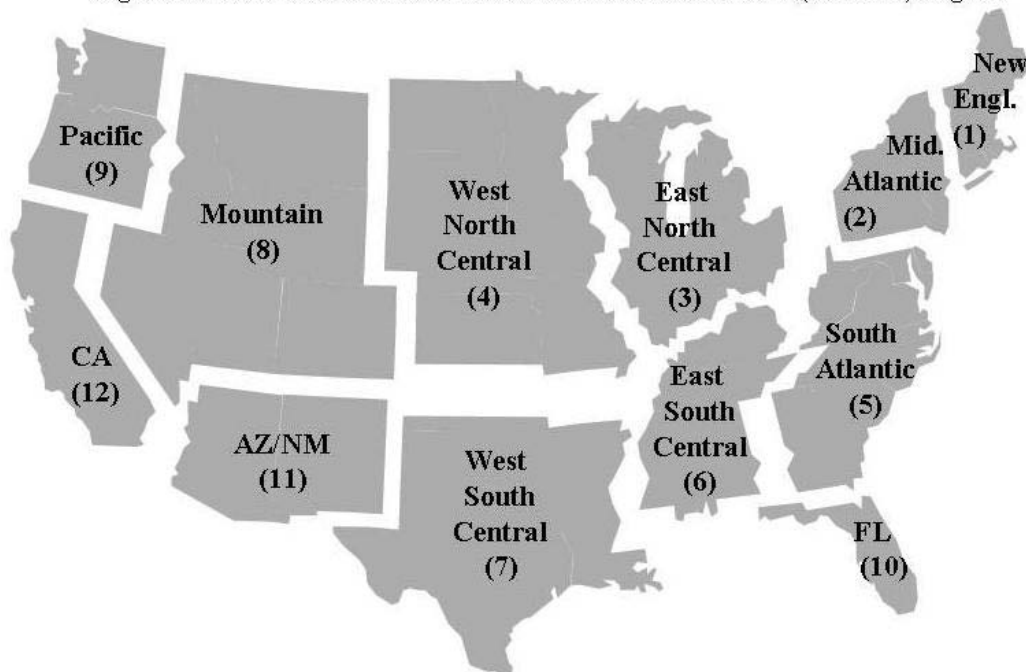

industrial and electric generator sectors further distinguished by core and noncore segments. One or more domestic supply regions are represented in each of the 12 NGTDM regions. Canadian supply and demand are represented by two interconnected regions -- East Canada and West Canada -- which connect to the lower 48 regions via seven border crossing nodes. The demarcation of East and West Canada is at the Manitoba/Ontario border. In addition, the model accounts for the potential construction of a pipeline from Alaska to Alberta and one from the MacKenzie Delta to Alberta, if market prices are high enough to make the projects economic.

⁴The peak period covers the period from December through March; the off-peak period covers the remaining months.

The representation of the natural gas market in Canada is much less detailed than for the United States since the primary focus of the model is on the domestic U.S. market. Liquefied natural gas imports into North America are modeled for the four existing facilities as of 2004, seven potentially new generic liquefied natural gas import regions directly into the United States (2004 and beyond), a potential import point in the Bahamas, potential import points in eastern and western Canada, and in western Mexico (if destined for the United States).⁵ Any new LNG facilities built since 2004 or under construction are forced in the model as planned expansions. Finally, LNG exports from Alaska's Nikiski plant are included, as well as three import/export border crossings at the Mexican border.

The module consists of three major components: the Interstate Transmission Submodule (ITS), the Pipeline Tariff Submodule (PTS), and the Distributor Tariff Submodule (DTS). The ITS is the integrating submodule of the NGTDM. It simulates the natural gas price determination process by bringing together all major economic factors that influence regional natural gas trade in the United States, including pipeline and storage capacity expansion decisions. The Pipeline Tariff Submodule (PTS) generates a representation of tariffs for interstate transportation and storage services, both existing and expansions. The Distributor Tariff Submodule (DTS) generates markups for distribution services provided by local distribution companies and for transmission services provided by intrastate pipeline companies. The modeling techniques employed are: a heuristic/iterative process for the ITS, an accounting algorithm for the PTS, and a series of historically based and econometrically based equations for the DTS.

NGTDM Objectives

The purpose of the NGTDM is to derive natural gas delivered and wellhead prices, as well as flow patterns for movements of natural gas through the regional interstate network. Although the NEMS operates on an annual basis, the NGTDM was designed to be a two-season model, to better represent important features of the natural gas market. The prices and flow patterns are derived by obtaining a market equilibrium across the three main elements of the natural gas market: the supply element, the demand element, and the transmission and distribution network that links them. The representations of the key features of the transmission and distribution network are the focus of the various components of the NGTDM. These key modeling objectives/capabilities include:

- Represent interregional flows of gas and pipeline capacity constraints
- Represent regional and import supplies
- Determine the amount and the location of required additional pipeline and storage capacity on a regional basis, capturing the economic tradeoffs between pipeline and storage capacity additions
- Provide a peak/off-peak, or seasonal analysis capability
- Represent transmission and distribution service pricing

⁵The LNG imports into Mexico to serve the Mexico market are set exogenously.

Overview of the Documentation Report

The archived version of the NGTDM that was used to produce the natural gas forecasts used in support of the *Annual Energy Outlook 2010*, DOE/EIA-0383(2010) is documented in this report. The purpose of this report is to provide a reference document for model analysts, users, and the public that defines the objectives of the model, describes its basic design, provides detail on the methodology employed, and describes the model inputs, outputs, and key assumptions. It is intended to fulfill the legal obligation of the EIA to provide adequate documentation in support of its models (Public Law 94-385, Section 57.b.2). Subsequent chapters of this report provide:

- A description of the interface between the NEMS and the NGTDM and the representation of demand and supply used in the module (Chapter 2)
- An overview of the solution methodology of the NGTDM (Chapter 3)
- The solution methodology for the Interstate Transmission Submodule (Chapter 4)
- The solution methodology for the Distributor Tariff Submodule (Chapter 5)
- The solution methodology for the Pipeline Tariff Submodule (Chapter 6)
- A description of module assumptions, inputs, and outputs (Chapter 7).

The archived version of the model is available through the National Energy Information Center (202-586-8800, infoctr@eia.doe.gov) and is identified as NEMS2010 (part of the National Energy Modeling System archive package as archived for the Annual Energy Outlook 2010, DOE/EIA-0383(2010)).

The document includes a number of appendices to support the material presented in the main body of the report. Appendix A presents the module abstract. Appendix B lists the major references used in developing the NGTDM. Appendix C lists the various NEMS Model Documentation Reports for the various modules that are mentioned throughout the NGTDM documentation. A mapping of equations presented in the documentation to the relevant subroutine in the code is provided in Appendix D. Appendix E provides a mapping between the variables that are assigned values through READ statements in the module and the data input files that are read. The input files contain detailed descriptions of the input data, including variable names, definitions, sources, units and derivations.⁶ Appendix F documents the derivation of all empirical estimations used in the NGTDM. Variable cross-reference tables are provided in Appendix G. Finally, Appendix H contains a description of the algorithm used to project new coal-to-gas plants and the pipeline quality gas produced.

⁶The NGTDM data files are available upon request by contacting Joe Benneche at Joseph.Benneche@eia.doe.gov or (202) 586-6132. Alternatively an archived version of the NEMS model (source code and data files) can be downloaded from <ftp://ftp.eia.doe.gov/pub/oiaf/aeo>.

2. Demand and Supply Representation

This chapter describes how supply and demand are represented within the NGTDM and the basic role that the Natural Gas Transmission and Distribution Module (NGTDM) fulfills in the NEMS. First, a general description of the NEMS is provided, along with an overview of the NGTDM. Second, the data passed to and from the NGTDM and other NEMS modules is described along with the methodology used within the NGTDM to transform the input values prior to their use in the model. The natural gas demand representation used in the module is described, followed by a section on the natural gas supply interface and representation, and concluding with a section on the representation of demand and supply in Alaska.

A Brief Overview of NEMS and the NGTDM

The NEMS represents all of the major fuel markets (crude oil and petroleum products, natural gas, coal, electricity, and imported energy) and iteratively solves for an annual supply/demand balance for each of the nine Census Divisions, accounting for the price responsiveness in both energy production and end-use demand, and for the interfuel substitution possibilities. NEMS solves for equilibrium in each forecast year by iteratively operating a series of fuel supply and demand modules to compute the end-use prices and consumption of the fuels represented, effectively finding the intersection of the theoretical supply and demand curves reflected in these modules.⁷ The end-use demand modules (for the residential, commercial, industrial, and transportation sectors) are detailed representations of the important factors driving energy consumption in each of these sectors. Using the delivered prices of each fuel, computed by the supply modules, the demand modules evaluate the consumption of each fuel, taking into consideration the interfuel substitution possibilities, the existing stock of fuel and fuel conversion burning equipment, and the level of economic activity. Conversely, the fuel conversion and supply modules determine the end-use prices needed in order to supply the amount of fuel demanded by the customers, as determined by the demand modules. Each supply module considers the factors relevant to that particular fuel, for example: the resource base for oil and gas, the transportation costs for coal, or the refinery configurations for petroleum products. Electric generators and refineries are both suppliers and consumers of energy.

Within the NEMS system, the NGTDM provides the interface for natural gas between the Oil and Gas Supply Module (OGSM) and the demand modules in NEMS, including the Electricity Market Module (EMM). Since the other modules provide little, if any, information on markets outside of the United States, the NGTDM uses supply curves for liquefied natural gas (LNG) imports based on output results from EIA's separate International Natural Gas Model (INGM) and includes a simple representation of natural gas markets in Canada and Mexico in order to project LNG and pipeline import levels into the United States. The NGTDM determines the price and flow of dry natural gas supplied internationally from the contiguous U.S. border⁸ or

⁷A more detailed description of the NEMS system, including the convergence algorithm used, can be found in "Integrating Module of the National Energy Modeling System: Model Documentation 2009." DOE/EIA-M057(2009), May 2009 or "The National Energy Modeling System: An Overview 2009," DOE/EIA-0581(2009), October 2009.

⁸Natural gas exports are also represented within the model.

domestically from the wellhead (and indirectly from natural gas processing plants) to the domestic end-user. In so doing, the NGTDM models the markets for the transmission (pipeline companies) and distribution (local distribution companies) of natural gas in the contiguous United States.⁹ The primary data flows between the NGTDM and the other oil and gas modules in NEMS, the Petroleum Market Module (PMM) and the OGSM are depicted in **Figure 2-1**.

Figure 2-1. Primary Data Flows Between Oil and Gas Modules of NEMS

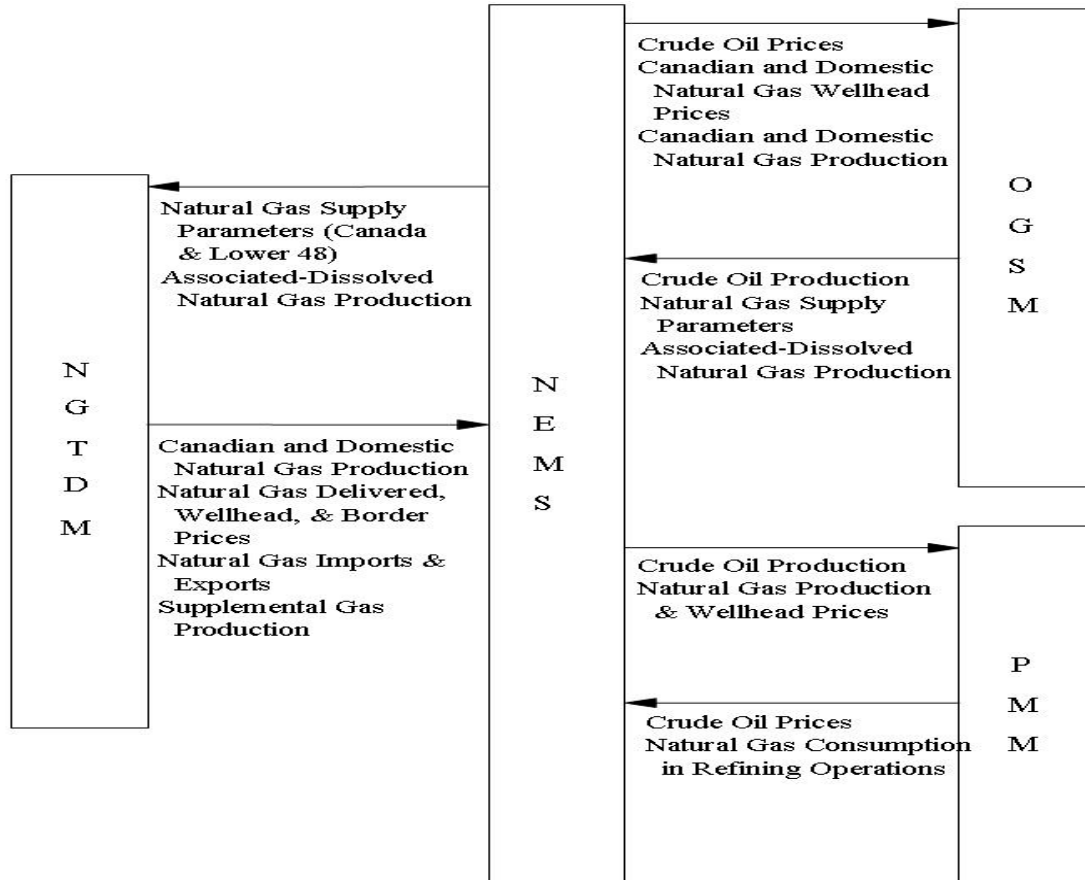

In each NEMS iteration, the demand modules in NEMS provide the level of natural gas that would be consumed at the burner-tip in each region by the represented sector at the delivered price set by the NGTDM in the previous NEMS iteration. At the beginning of each forecast year, the OGSM provides an expected level of natural gas produced (domestically or conventionally in Western Canada) at the wellhead given the oil and gas wellhead prices from the previous forecast year. The NGTDM uses this information to build “short-term” (annual or seasonal) supply and demand curves to approximate the supply or demand response to price. Given these short-term demand and supply curves, the NGTDM solves for the delivered, wellhead, and border prices that represent a natural gas market equilibrium, while accounting for

⁹Because of the distinct separation in the natural gas market between Alaska, Hawaii, and the contiguous United States, natural gas consumption in, and the associated supplies from, Alaska and Hawaii are modeled separately from the contiguous United States within the NGTDM.

the costs and market for transmission and distribution services (including its physical and regulatory constraints).¹⁰ These solution prices, and associated production levels, are in turn passed to the OGSM and the demand modules, including the EMM, as primary input variables for the next NEMS iteration and/or forecast year. Most of the calculations within OGSM are performed only once each NEMS iteration, after the NEMS has equilibrated. Information from OGSM is passed as needed to the NGTDM to solve for the following forecast year.

The NGTDM is composed of three primary components or submodules: the Interstate Transmission Submodule (ITS), the Pipeline Tariff Submodule (PTS), and the Distributor Tariff Submodule (DTS). The ITS is the central module of the NGTDM, since it is used to derive network flows and prices of natural gas in conjunction with a peak¹¹ and off-peak natural gas market equilibrium. Conceptually the ITS is a simplified representation of the natural gas transmission and distribution system, structured as a network composed of nodes and arcs. The other two primary components serve as satellite submodules to the ITS, providing parameters which define the tariffs to be charged along each of the interregional, intraregional, intrastate, and distribution segments. Data are also passed back to these satellite submodules from the ITS. Other parameters for defining the natural gas market (such as supply and demand curves) are derived based on information passed primarily from other NEMS modules. However in some cases, supply (e.g., synthetic gas production) and demand components (e.g., pipeline fuel) are modeled exclusively in the NGTDM.

The NGTDM is called once each NEMS iteration, but all submodules are not run for every call. The PTS is executed only once for each forecast year, on the first iteration of each year. The ITS and the DTS are executed once every NEMS iteration. The calling sequence of and the interaction among the NGTDM modules is as follows for each forecast year executed in NEMS:

First Iteration:

- a. The PTS determines the revenue requirements associated with interregional / interstate pipeline company transportation and storage services, using a cost based approach, and uses this information and cost of expansion estimates as a basis in establishing fixed rates and volume dependent tariff curves (variable rates) for pipeline and storage usage.
- b. The ITS establishes supply levels (e.g., for supplemental supplies) and supply curves for production and LNG imports based on information from other modules.

Each Iteration:

- a. The DTS sets markups for intrastate transmission and for distribution services using econometric relationships based on historical data, largely driven by changes in consumption levels.
- b. The ITS processes consumption levels from NEMS demand modules as required, (e.g., annual consumption levels are disaggregated into peak and off-peak levels) before determining a market equilibrium solution across the two-period NGTDM network.

¹⁰Parameters are provided by OGSM for the construction of supply curves for domestic non-associated and conventional Western Canadian natural gas production. The use of demand curves in the NGTDM is an option; the model can also respond to fixed consumption levels.

¹¹The peak period covers the period from December through March; the off-peak period covers the remaining months.

- c. The ITS employs an iterative process to determine a market equilibrium solution which balances the supply and demand for natural gas across a U.S./Canada network, thereby setting prices throughout the system and production and import levels. This operation is performed simultaneously for both the peak and off-peak periods.

Last Iteration:

- a. In the process of establishing a network/market equilibrium, the ITS also determines the associated pipeline and storage capacity expansion requirements. These expansion levels are passed to the PTS and are used in the revenue requirements calculation for the next forecast year. One of the inputs to the NGTDM is “planned” pipeline and storage expansions. These are based on reported pending and commenced construction projects and analysts’ judgment as to the likelihood of the project’s completion. For the first two forecast years, the model does not allow builds beyond these planned expansion levels.
- b. Other outputs from NGTDM are passed to report writing routines.

For the historical years (1990 through 2008), a modified version of the above process is followed to calibrate the model to history. Most, but not all, of the model components are known for the historical years. In a few cases, historical levels are available annually, but not for the peak and off-peak periods (e.g., the interstate flow of natural gas and regional wellhead prices). The primary unknowns are pipeline and storage tariffs and market hub prices. When prices are translated from the supply nodes, through the network to the end-user (or city gate) in the historical years, the resulting prices are compared against published values for city gate prices. These differentials (benchmark factors) are carried through and applied during the forecast years as a calibration mechanism. In the most recent historical year (2008) even fewer historical values are known; and the process is adjusted accordingly.

The primary outputs from the NGTDM, which are used as input in other NEMS modules, result from establishing a natural gas market equilibrium solution: delivered prices, wellhead and border crossing prices, non-associated natural gas production, and Canadian and LNG import levels. In addition, the NGTDM provides a forecast of lease and plant fuel consumption, pipeline fuel use, as well as pipeline and distributor tariffs, pipeline and storage capacity expansion, and interregional natural gas flows.

Natural Gas Demand Representation

Natural gas produced within the United States is consumed in lease and plant operations, delivered to consumers, exported internationally, or consumed as pipeline fuel. The consumption of gas as lease, plant, and pipeline fuel is determined within the NGTDM. Gas used in well, field, and lease operations and in natural gas processing plants is set equal to a historically observed percentage of dry gas production.¹² Pipeline fuel use depends on the

¹²The regional factors used in calculating lease and plant fuel consumption (PCTLP) are initially based on historical averages (1996 through 2008) and held constant throughout the forecast period. However, a model option allows for these factors to be scaled in the first one or two forecast years so that the resulting national lease and plant fuel consumption will match the annual published values presented in the latest available *Short-Term Energy Outlook* (STEO), DOE/EIA-0202), (Appendix E, STQLPIN). The adjustment attributable to benchmarking to STEO (if selected as an option) is phased out by the year STPHAS_YR (Appendix E). For *AEO2010* these factors were phased out by 2013. A similar adjustment is performed on the

amount of gas flowing through each region, as described in Chapter 4. The representation in the NGTDM of gas delivered to consumers is described below.

Classification of Natural Gas Consumers

Natural gas that is delivered to consumers is represented within the NEMS at the Census Division level and by five primary end-use sectors: residential, commercial, industrial, transportation, and electric generation.¹³ These demands are further distinguished by customer class (core or non-core), reflecting the type of natural gas transmission and distribution service that is assumed to be predominately purchased. A “core” customer is expected to generally require guaranteed or firm service, particularly during peak days/periods during the year. A “non-core” customer is expected to require a lower quality of transmission services (non-firm service) and therefore, consume gas under a less certain and/or less continuous basis. While customers are distinguished by customer class for the purpose of assigning different delivered prices, the NGTDM does not explicitly distinguish firm versus non-firm transmission service. Currently in NEMS, all customers in the transportation, residential, and commercial sectors are classified as core.¹⁴ Within the industrial sector the non-core segment includes the industrial boiler market and refineries; the core makes up the rest. The electric generating units defining each of the two customer classes modeled are as follows: (1) core – gas steam units or gas combined cycle units, (2) non-core – dual-fired turbine units, gas turbine units, or dual-fired steam plants (consuming both natural gas and residual fuel oil).¹⁵

For any given NEMS iteration and forecast year, the individual demand modules in NEMS determine the level of natural gas consumption for each region and customer class given the delivered price for the same region, class, and sector, as calculated by the NGTDM in the previous NEMS iteration. Within the NGTDM, each of these consumption levels (and its associated price) is used in conjunction with an assumed price elasticity as a basis for building an annual demand curve. [The price elasticities are set to zero if fixed consumption levels are to be used.] These curves are used within the NGTDM to minimize the required number of NEMS iterations by approximating the demand response to a different price. In so doing, the price where the implied market equilibrium would be realized can be approximated. Each of these market equilibrium prices is passed to the appropriate demand module during the next NEMS iteration to determine the consumption level that the module would actually forecast at this price. Once the NEMS converges, the difference between the actual consumption, as determined by the NEMS demand modules, and the approximated consumption levels in the NGTDM are insignificant.

factors used in calculating pipeline fuel consumption using STEO values from STQGPTR (Appendix E).

¹³Natural gas burned in the transportation sector is defined as compressed natural gas or liquefied natural gas that is burned in natural gas vehicles; and the electric generation sector includes all electric power generators whose primary business is to sell electricity, or electricity and heat, to the public, including combined heat and power plants, small power producers, and exempt wholesale generators.

¹⁴The NEMS is structurally able to classify a segment of these sectors as non-core, but currently sets the non-core consumption at zero for the residential, commercial, and transportation sectors.

¹⁵Currently natural gas prices for the core and non-core segments of the electric generation sector are set to the same average value.

For all but the electric sector, the NGTDM disaggregates the annual Census division regional consumption levels into the regional and seasonal representation that the NGTDM requires. The regional representation for the electric generation sector differs from the other NEMS sectors as described below.

Regional/Seasonal Representations of Demand

Natural gas consumption levels by all non-electric¹⁶ sectors are provided by the NEMS demand modules for the nine Census divisions, the primary integrating regions represented in the NEMS. Alaska and Hawaii are included within the Pacific Census Division. The EMM represents the electricity generation process for 13 electricity supply regions, the nine North American Electric Reliability Council (NERC) Regions and four selected NERC Subregions (**Figure 2-2**). Within the EMM, the electric generators' consumption of natural gas is disaggregated into subregions that can be aggregated into Census Divisions or into the regions used in the NGTDM.

Figure 2-2. Electricity Market Module (EMM) Regions



- | | |
|--|---|
| <ul style="list-style-type: none"> 1 East Central Area Reliability Coordination Agreement (ECAR) 2 Electric Reliability Council of Texas (ERCOT) 3 Mid-Atlantic Area Council (MAAC) 4 Mid-America Interconnected Network (MAIN) 5 Mid-Continent Area Power Pool (MAPP) 6. New York (NY) 7. New England (NE) | <ul style="list-style-type: none"> 8 Florida Reliability Coordinating Council (FL) 9 Southeastern Electric Reliability Council (SERC) 10 Southwest Power Pool (SPP) 11 Northwest Power Pool (NWP) 12, Rocky Mountain Power Area, Arizona, New Mexico, and Southern Nevada (RA) 13 California (CA) |
|--|---|

¹⁶The term “non-electric” sectors refer to sectors (other than commercial and industrial combined heat and power generators) that do not produce electricity using natural gas (i.e., the residential, commercial, industrial, and transportation demand sectors).

With the few following exceptions, the regional detail provided at a Census division level is adequate to build a simple network representative of the contiguous U.S. natural gas pipeline system. First, Alaska is not connected to the rest of the Nation by pipeline and is therefore treated separately from the contiguous Pacific Division in the NGTDM. Second, Florida receives its gas from a distinctly different route than the rest of the South Atlantic Division and is therefore isolated. A similar statement applies to Arizona and New Mexico relative to the Mountain Division. Finally, California is split off from the contiguous Pacific Division because of its relative size coupled with its unique energy related regulations. The resulting 12 primary regions represented in the NGTDM are referred to as the “NGTDM Regions” (as shown in **Figure 1-2**).

The regions represented in the EMM do not always align with State borders and generally do not share common borders with the Census divisions or NGTDM regions. Therefore, demand in the electric generation sector is represented in the NGTDM at a seventeen subregional (NGTDM/EMM) level which allows for a reasonable regional mapping between the EMM and the NGTDM regions (**Figure 2-3**). The seventeenth region is Alaska. Within the EMM, the disaggregation into subregions is based on the relative geographic location (and natural gas-fired generation capacity) of the current and proposed electricity generation plants within each region.

Figure 2-3. NGTDM/EMM Regions

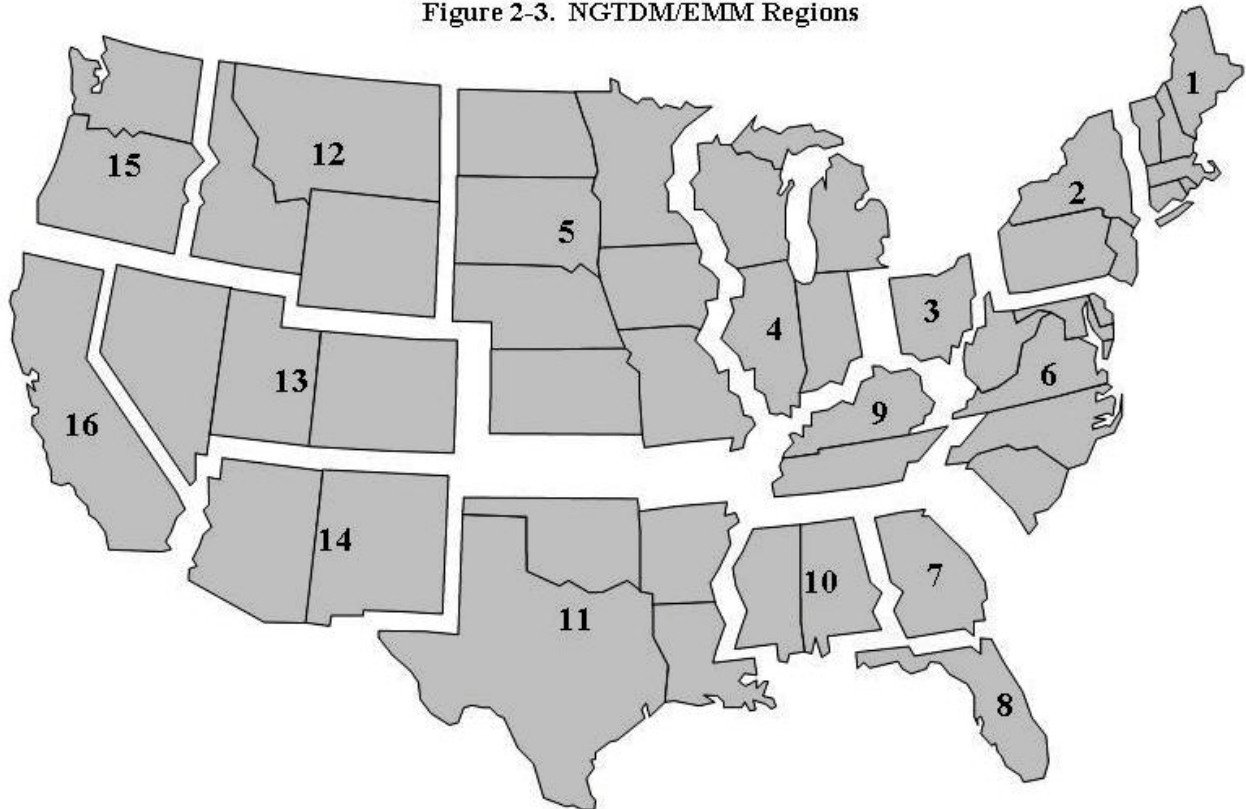

Annual consumption levels for each of the non-electric sectors are disaggregated from the nine Census divisions to the two seasonal periods and the twelve NGTDM regions by applying average historical shares (2001 to 2008) that are held constant throughout the forecast (census –

NG_CENSHR, seasons – PKSHR_DMD). For the Pacific Division, natural gas consumption estimates for Alaska are first subtracted to establish a consumption level for just the contiguous Pacific Division before the historical share is applied. The consumption of gas in Hawaii was considered to be negligible and is not handled separately. Within the NGTDM, a relatively simple series of equations (described later in the chapter) was included for approximating the consumption of natural gas by each non-electric sector in Alaska. These estimates, combined with the levels provided by the EMM for consumption by electric generators in Alaska, are used in the calculation of the production of natural gas in Alaska.

Unlike the non-electric sectors, the factors (core – PKSHR_UDMD_F, non-core – PKSHR_UDMD_I) for disaggregating the annual electric generator sector consumption levels (for each NGTDM/EMM region and customer type – core and non-core) into seasons are adjusted over the forecast period. Initially average historical shares (1994 to 2008, except for New England – 1997 to 2008) are established as base level shares (core – BASN_PKSHR_UF, non-core – BASN_PKSHR_UI). These are increased each year of the forecast by 0.5 percent, not to exceed 32 percent of the year.¹⁷

Natural Gas Demand Curves

While the primary analysis of energy demand takes place in the NEMS demand modules, the NGTDM itself directly incorporates price responsive demand curves to speed the overall convergence of NEMS and to improve the quality of the results obtained when the NGTDM is run as a stand-alone model. The NGTDM may also be executed to determine delivered prices for fixed consumption levels (represented by setting the price elasticity of demand in the demand curve equation to zero). The intent is to capture relatively minor movements in consumption levels from the provided base levels in response to price changes, not to accurately mimic the expected response of the NEMS demand modules. The form of the demand curves for the firm transmission service type for each non-electric sector and region is:

$$\text{NGDMD_CRVF}_{s,r} = \text{BASQTY_F}_{s,r} * (\text{PR} / \text{BASPR_F}_{s,r})^{\text{NONU_ELAS_F}_s} \quad (1)$$

where,

- BASPR_F_{s,r} = delivered price to core sector s in NGTDM region r in the previous NEMS iteration (1987 dollars per Mcf)
- BASQTY_F_{s,r} = natural gas quantity which the NEMS demand modules indicate would be consumed at price BASPR_F by core sector s in NGTDM region r (Bcf)
- NONU_ELAS_F_s = short-term price elasticity of demand for core sector s (set to zero for AEO2009)
- PR = delivered price at which demand is to be evaluated (1987 dollars per Mcf)
- NGDMD_CRVF_{s,r} = estimate of the natural gas which would be consumed by core sector s in region r at the price PR (Bcf)

¹⁷The peak period covers 33 percent of the year.

s = core sector (1-residential, 2-commercial, 3-industrial, 4-transportation)

Note: Demand curves can be represented with fixed consumption levels by setting elasticities equal to zero.

The form of the demand curve for the non-electric interruptible transmission service type is identical, with the following variables substituted: NGDMD_CRVI, BASPR_I, BASQTY_I, and NONU_ELAS_I (all set to zero for *AEO2010*). For the electric generation sector the form is identical as well, except there is no sector index and the regions represent the 16 NGTDM/EMM lower 48 regions, not the 12 NGTDM regions. The corresponding set of variables for the core and non-core electric generator demand curves are [NGUDMD_CRVF, BASUPR_F, BASUQTY_F, UTIL_ELAS_F] and [NGUDMD_CRVI, BASUPR_I, BASUQTY_I, UTIL_ELAS_I], respectively. For the *AEO2010* all of the electric generator demand curve elasticities were set to zero.

Domestic Natural Gas Supply Interface and Representation

The primary categories of natural gas supply represented in the NGTDM are non-associated and associated-dissolved gas from onshore and offshore U.S. regions; pipeline imports from Mexico; Eastern, Western (conventional and unconventional), and Arctic Canada production; LNG imports; natural gas production in Alaska (including that which is transported through Canada via pipeline¹⁸); synthetic natural gas produced from coal and from liquid hydrocarbons; and other supplemental supplies. Outside of Alaska (which is discussed in a later section) the only supply categories from this list which are allowed to vary within the NGTDM in response to a change in the current year's natural gas price are the non-associated gas from onshore and offshore U.S. regions, conventional gas from the Western Canada region, and LNG imports.¹⁹ The supply levels for the remaining categories are fixed at the beginning of each forecast year (i.e., before market clearing prices are determined), with the exception of associated-dissolved gas (determined in OGSM).²⁰ With the exception of LNG, the NGTDM applies average historical relationships to convert annual "fixed" supply levels to peak and off-peak values. These factors are held constant throughout the forecast period.

Within the OGSM, natural gas supply activities are modeled for 12 U.S. supply regions (6 onshore, 3 offshore, and 3 Alaskan geographic areas). The six onshore OGSM regions within the contiguous United States, shown in **Figure 2-4**, do not generally share common borders with the NGTDM regions. The NGTDM represents onshore supply for the 17 regions resulting from

¹⁸With the recent high natural gas prices several different options have been proposed for bringing stranded natural gas in Alaska to market (i.e., by pipeline, as LNG, and as liquids). The LNG option was deemed the least likely and is not considered in the model. The Petroleum Market Module forecasts the potential conversion of Alaska natural gas into liquids. The NGTDM allows for the building of a generic pipeline from Alaska into Alberta, although not at the same time as a MacKenzie Valley pipeline. The pipeline is assumed to have first access to the currently proved reserves in Alaska which are assumed to be producible at a relatively low cost given their association with oil production.

¹⁹Liquefied natural gas imports are set based on the price in the previous NEMS iteration and are effectively "fixed" when the NGTDM determines a natural gas market equilibrium solution; whereas the other two categories are determined as a part of the market equilibrium process in the NGTDM.

²⁰For programming convenience natural gas produced with oil shales (OGSHALENG) is also added to this category.

overlapping the OGSM and NGTDM regions (**Figure 2-5**). A separate component of the NGTDM models the foreign sources of gas that are transported via pipeline from Canada²¹ and Mexico. Seven Canadian and three Mexican border crossings demarcate the foreign pipeline interface in the NGTDM. Supplies from the four existing onshore domestic LNG regasification terminals as of 2007 are represented as specific supply sources in the NGTDM. The model sets and/or adds additional LNG regasification capacity in each of the coastal NGTDM regions consistent with completed and highly likely to be completed projects (i.e., ones that are currently under construction).²²

Figure 2-4. Oil and Gas Supply Module (OGSM) Regions



“Variable” Dry Natural Gas Production Supply Curve

The two “variable” (or price responsive) natural gas supply categories represented in the model are domestic non-associated production and total production from the Western Canadian Sedimentary Basin (WCSB). Non-associated natural gas is largely defined as gas that is produced from gas wells, and is assumed to vary in response to a change in the natural gas price. Associated-dissolved gas is defined as gas that is produced from oil wells and can be classified

²¹Conventional gas from Western Canada is modeled in the OGSM. The rest of the Canadian supplies are modeled in the NGTDM.

²²Structurally an LNG regasification terminal in the Bahamas would be represented as entering into Florida and be reported as pipeline imports, although modeled as LNG imports. No regasification terminals are considered for Alaska or Hawaii.

as a byproduct in the oil production process. Each domestic supply curve is defined through its associated parameters as being net of lease and plant fuel consumption (i.e., the amount of dry gas available for market after any necessary processing and before being transported via pipeline). For both of these categories, the supply curve represents annual production levels. The methodology for translating this annual form into a seasonal representation is presented in Chapter 4.

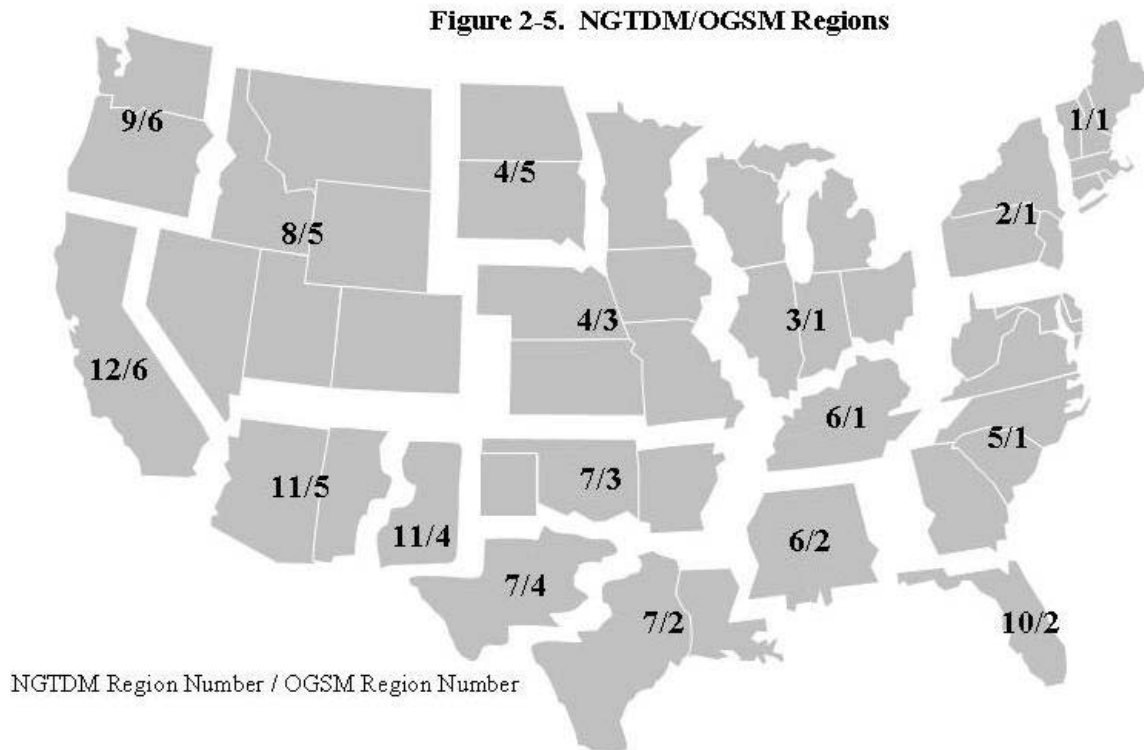

The supply curve for regional non-associated lower 48 natural gas production and for WCSB production is built from a price/quantity (P/Q) pair, where quantity is the “expected” production (XQBASE) or the base production level as defined by the product of reserves times the “expected” production-to-reserves ratio (as set in the OGSM) and price is the projected wellhead price (XPBASE, presented below) for the expected production. The basic assumption behind the curve is that the realized market price will increase from the base price if the current year’s production levels exceed the expected production; and the opposite will occur if current production is less. In addition, it is assumed that the relative price response will likely be greater for a marginal increase in production above the expected production, compared to below. To represent these assumptions, five segments of the curve are defined from the base point. The middle segment is centered around the base point, extends plus or minus a percent (PARAM_SUPCRV3, Appendix E) from the base quantity, and if activated, is generally set nearly horizontal (i.e., there is little price response to a quantity change). The next two segments, on either side of the middle, extend more vertically (with a positive slope), and reach plus or minus a percent (PARAM_SUPCRV5, Appendix E) beyond the end of the middle segment. The

remaining two segments extend the curve above and below even further, for the case with relatively large annual production changes, and can be assigned the same or different slopes from their adjacent segments. The slope of the upper segment(s) is generally set greater than or equal to that of the lower segment(s). An illustrative presentation of the supply curve is provided in **Figure 2-6**. The general structure for all five segments of the supply curve, in terms of defining price (NGSUP_PR) as a function of the quantity or production level (QVAR), is:

$$\text{NGSUP_PR} = \text{PBASE} * \left(\left(\frac{1}{\text{ELAS}} \right) * \left(\frac{\text{QVAR} - \text{QBASE}}{\text{QBASE}} \right) + 1 \right) \quad (2)$$

A more familiar form of this equation is the definition of the elasticity (ξ) as: $\xi = (\Delta Q/Q_0) / (\Delta P/P_0)$, where Δ symbolizes “the change in” and Q_0 and P_0 represent a base level price/quantity pair.

Each of the five segments is assigned different values for the variables ELAS, PBASE, and QBASE:

Figure 2-6. Generic Supply Curve

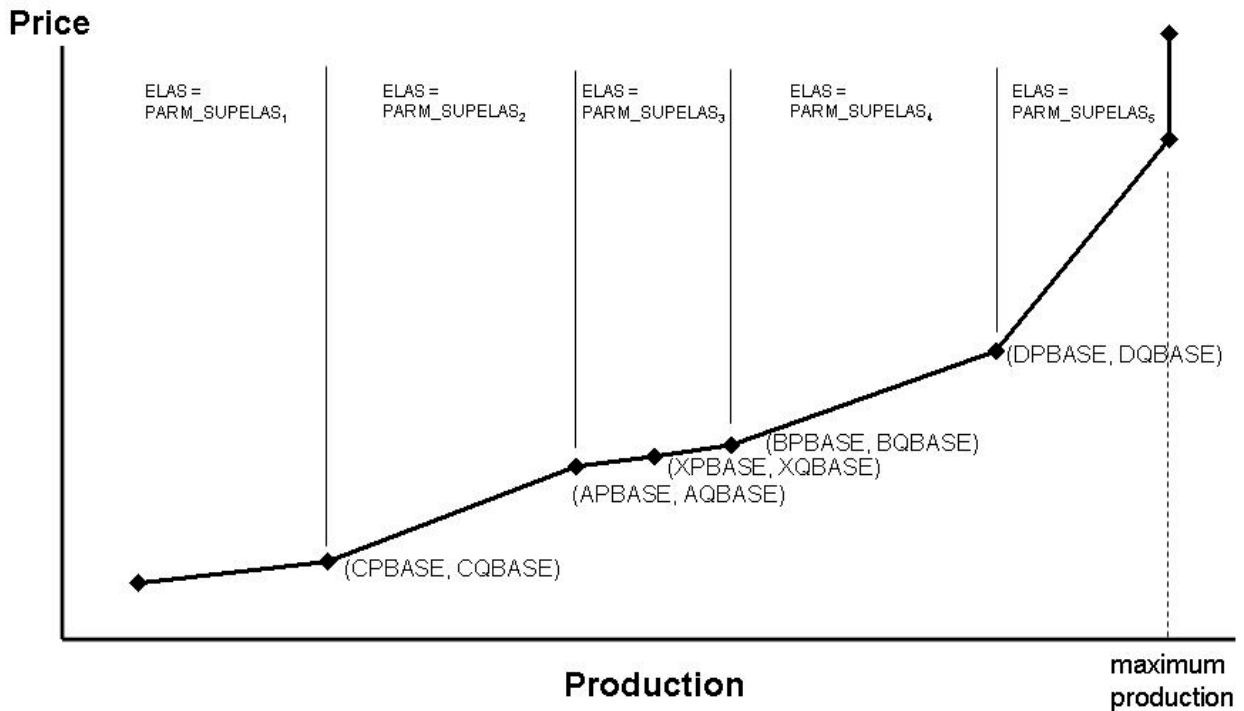

Lowest segment:

$$PBASE = CPBASE = APBASE * (1 - (PARM_SUPCRV5/PARM_SUPELAS2)) \quad (3)$$

$$QBASE = CQBASE = AQBASE * (1 - PARM_SUPCRV5) \quad (4)$$

$$ELAS = PARM_SUPELAS1 = 0.75 \quad (5)$$

Lower segment:

$$PBASE = APBASE = XPBASE * (1 - (PARM_SUPCRV3/PARM_SUPELAS3)) \quad (6)$$

$$QBASE = AQBASE = XQBASE * (1 - PARM_SUPCRV3) \quad (7)$$

$$ELAS = PARM_SUPELAS2 = 0.75 \quad (8)$$

Middle segment:
(in historical years)

$$PBASE = XPBASE = \text{historical wellhead price} \quad (9)$$

$$QBASE = XQBASE = QSUP_s / (1 - PERCNT_n) \quad (10)$$

(in forecast years)

$$PBASE = XPBASE \quad (11)$$

$$\begin{aligned} XPBASE = & e^{-10.6700} * UGRRESSHR^{0.633804} * \\ & oEXSPEND_{t-1}^{0.190494} * HDD^{0.882912} * \\ & ZOGRESNG_s^{-0.014253} * oIT_WOP_t^{0.279016} * \\ & ZWPRLAG_s^{0.398350} * e^{-10.6700 * -0.398350} * \\ & UGRRESSHRLAG^{-0.398350 * 0.633804} * oEXSPEND_{t-2}^{-0.398350 * 190494} * \\ & HDD^{-0.398350 * 0.882912} * ZOGRESNGLAG1_s^{-0.398350 * -0.014253} * \\ & oIT_WOP_{t-1}^{-0.398350 * 0.279016} \end{aligned} \quad (12)$$

$$QBASE = XQBASE = ZOGRESNG_s * ZOGPRRNG_s \quad (13)$$

$$ELAS = PARM_SUPELAS3 = 4.00 \quad (14)$$

Upper segment:

$$PBASE = BPBASE = XPBASE * (1 + (PARM_SUPCRV3/PARM_SUPELAS3)) \quad (15)$$

$$QBASE = BQBASE = XQBASE * (1 + PARM_SUPCRV3) \quad (16)$$

$$ELAS = PARM_SUPELAS4 = 0.75 \quad (17)$$

Uppermost segment:

$$PBASE = DPBASE = BPBASE * (1 + (PARM_SUPCRV5/PARM_SUPELAS4)) \quad (18)$$

$$QBASE = DQBASE = BQBASE * (1 + PARM_SUPCRV5) \quad (19)$$

$$ELAS = PARM_SUPELAS5 = 0.25 \quad (20)$$

where,

- NGSUP_PR = Wellhead price (1987\$/Mcf)
- QVAR = Production, including lease & plant (Bcf)
- XPBASE = Base wellhead price on the supply curve (Table F11, Appendix F) (1987\$/Mcf)
- XQBASE = Base wellhead production on the supply curve (Bcf)
- PBASE = Base wellhead price on a supply curve segment (1987\$/Mcf)
- QBASE = Base wellhead production on a supply curve segment (Bcf)
- ELAS = Elasticity (percent change in quantity over percent change in price) (analyst judgment)
- PARM_SUPCRV3 = (defined in preceding paragraph)
- PARM_SUPCRV5 = (defined in preceding paragraph)
- PARM_SUPELAS = Elasticity (percentage change in quantity over percentage change in price)
- ZWPRLAG_s = Lagged wellhead price for supply source s (1987/Mcf)
- ZOGTAXPREM_s = Tax stimulation variable provided by OGSM (currently set to zero)
- ZOGRESNG_s = Natural gas proved reserves for supply source s (Bcf)
- ZOGRESNGLAG1_s = Natural gas proved reserves in previous forecast year (Bcf)
- ZOGPRRNG_s = Natural gas production to reserves ratio for supply sources (fraction)
- UGGRESSHR = Share of gas reserves from unconventional sources (fraction)
- UGGRESSHRLAG = Previous year's share of gas reserves from unconventional sources (fraction)

- oEXSPEND = National average drilling cost per well (1987 dollars)
- HDD = Historical average heating degree days
- ZOGRESNG = Beginning-of-year reserves (Bcf)
- OGRESNGLAG = Previous year's beginning-of-year reserves (Bcf)
- oIT_WOP = International refinery acquisition cost (1987\$/bbl)
- PERCNT_n = Percent lease and plant
 - s = supply source
 - n = region/node
 - t = year

The parameters above will be set depending on the location of QVAR relative to the base quantity (XQBASE) (i.e., on which segment of the curve that QVAR falls). In the above equation, the QVAR variable includes lease and plant fuel consumption. Since the ITM domestic production quantity (VALUE) represents supply levels net of lease and plant, this value must be adjusted once it is sent to the supply curve function, and before it can be evaluated, to generate a corresponding supply price. The adjustment equation is:

$$QVAR = (VALUE - FIXSUP) / (1 - PERCNT_n)$$

[where, FIXSUP = ZOGCCAPPRD_s * (1 - PERCNT_n)]

where,

- QVAR = Production, including lease & plant consumption
- VALUE = Production, net of lease & plant consumption
- PERCNT_n = Percent lease and plant consumption in region/node n (set to PCTLP, set to zero for Canada)
- ZOGCCAPPRD_s = Coalbed gas production related to the Climate Change Action Plan (from OGSM)²³
- FIXSUP = ZOGCCAPPRD net of lease and plant consumption
 - s = NGTDM/OGSM supply region
 - n = region/node

Associated-Dissolved Natural Gas Production

Associated-dissolved natural gas refers to the natural gas that occurs in crude oil reservoirs either as free gas (associated) or as gas in solution with crude oil (dissolved). The production of associated-dissolved natural gas is tied directly with the production (and price) of crude oil. The OGSM projects the level of associated-dissolved natural gas production and the results are passed to the NGTDM for each iteration and forecast year of the NEMS. Within the NGTDM, associated-dissolved natural gas production is considered “fixed” for a given forecast year and is split into peak and off-peak values based on average (1994-2008) historical shares of total (including non-associated) peak production in the year (PKSHR_PROD).

²³This special production category is not included in the reserves and production-to-reserve ratios calculated in the OGSM, so it was necessary to account for it separately when relevant. It is no longer relevant and is set to zero.

Supplemental Gas Sources

Existing sources for synthetically produced pipeline-quality, natural gas and other supplemental supplies are assumed to continue to produce at historical levels. While the NGTDM has a new algorithm (see Appendix H) to project potential new coal-to-gas plants and their gas production, the annual production of synthetic natural gas from coal at the existing plant is exogenously specified (Appendix E, SNGCOAL), independent of the price of natural gas in the current forecast year. The *AEO2010* forecast assumes that the sole existing plant (the Great Plains Coal Gasification Plant in North Dakota) will continue to operate at recent historical levels indefinitely. Regional forecast values for other supplemental supplies (SNGOTH) are set at historical averages (2003 to 2007) and held constant over the forecast period. Synthetic natural gas is no longer produced from liquid hydrocarbons in the continental United States; although small amounts were produced in Illinois in some historical years. This production level (SNGLIQ) is set to zero for the forecast. The small amount produced in Hawaii is accounted for in the output reports (set to the historical average from 1997 to 2007). If the option is set for the first two forecast years of the model to be calibrated to the *Short Term Energy Outlook (STEO)* forecast, then these three categories of supplemental gas are similarly scaled so that their sum will equal the national annual forecast for total supplemental supplies published in the *STEO* (Appendix E, STOGPRSUP). To guarantee a smooth transition, the scaling factor in the last STEO year can be progressively phased out over the first STPHAS_YR (Appendix E) forecast years of the NGTDM. Regional peak and off-peak supply levels for the three supplemental gas supplies are generated by applying the same average (1990-2008) historical share (PKSHR_SUPLM) of national supplemental supplies in the peak period.

Natural Gas Imports and Exports Interface and Representation

The NGTDM sets the parameters for projecting gas imported through LNG facilities, most of the parameters and forecast values associated with the Canada gas market, and sets the projected values for imports from and exports to Mexico. The OGSM sets most of the parameters for establishing a supply curve for conventional natural gas in Western Canada.

Canada

A node for east and west Canada is included in the NGTDM equilibration network, as well as seven border crossings. The model includes a representation/accounting of the U.S. border crossing pipeline capacity, east and west seasonal storage transfers, east and west consumption, east and west LNG imports (described in a later section), eastern production, conventional/tight sands production in the west, and coalbed/shale production.

A few of the forecast elements used in representing the Canada gas market are set exogenously in the NGTDM. When required, such annual forecasts are split into peak and off-peak values using historically based or assumed peak shares that are held constant throughout the forecast. For example, the level of natural gas exports (Appendix E, CANEXP) are currently set exogenously to NEMS, are distinguished by seven Canada/U.S. border crossings, and are split between peak and off-peak periods by applying average (1992 to 2008, Appendix E,

PKSHR_ECAN) historical shares to the assumed annual levels. While most Canadian import levels into the U.S. are set endogenously, the flow from Eastern Canada into the East North Central region is secondary to the flow going in the opposite direction and is therefore set exogenously (Appendix E, Q23TO3). “Fixed” supply values for the entire Eastern Canada region are set exogenously (Appendix E, CN_FIXSUP)²⁴ and split into peak and off-peak periods using PKSHR_PROD (Appendix E).

Base level consumption of natural gas in Eastern and Western Canada (Appendix E, CN_DMD), including gas used in lease, plant, and pipeline operations, is set exogenously,²⁵ and ultimately split into seasonal periods using PKSHR_CDMD (Appendix E). These base level values are adjusted based on the world oil price. First, the level of natural gas associated with oil sands processing is set. Next, the projected level of oil produced from sands is set exogenously to the NGTDM. Starting in a recent historical year (Appendix E, YDCL_GASREQ), the associated gas requirement is set as an assumed ratio (Appendix E, INIT_GASREQ) of this level. It is assumed that over time this ratio will decline with technological improvements and as other fuel options become viable. The oil sands related gas consumption is subtracted from the base level total consumption and the remaining volumes are adjusted slightly based on differences in the world oil price in the model run versus the world oil price used in setting the base level consumption, using an assumed elasticity (Appendix E, CONNOL_ELAS).

Currently, the NGTDM exogenously sets a forecast of the physical capacity of natural gas pipelines crossing at seven border points from Canada into the United States (excluding any expansion related to the building of an Alaska pipeline). This option can also be used within the model, if border crossing capacity is set endogenously, to establish a minimum pipeline build level (Appendix E, ACTPCAP and PLANPCAP). The model allows for an endogenous setting of annual Canadian pipeline expansion at each Canada/U.S. border crossing point based on the annual growth rate of consumption in the U.S. market it predominately serves. The resulting physical capacity limit is then multiplied by a set of exogenously specified maximum utilization rates for each seasonal period to establish maximum effective capacity limits for these pipelines (Appendix E, PKUTZ and OPUTZ). “Effective capacity” is defined as the maximum seasonal, physically sustainable, capacity of a pipeline times the assumed maximum utilization rate. It should be noted that some of the natural gas on these lines passes through the United States only temporarily before reentering Canada, and therefore is not classified as imports.²⁶ If a decision is made to construct a pipeline from Alaska (or the MacKenzie Delta) to Alberta, the import pipeline capacity added from the time the decision is made until the pipeline is in service is tracked. This amount is subtracted from the size of the pipeline to Alberta to arrive at an approximation for the amount of additional import capacity that will be needed to bring the

²⁴Eastern Canada is expected to continue to provide only a small share of the total production in Canada and is almost exclusively offshore. The exogenously defined levels are largely based on projections generated by the National Energy Board of Canada.

²⁵These values were based on projections taken from the *International Energy Outlook 2009*.

²⁶A significant amount of natural gas flows into Minnesota from Canada on an annual basis only to be routed back to Canada through Michigan. The levels of gas in this category are specified exogenously (Appendix E, FLOW_THRU_IN) and split into peak and off-peak levels based on average (1990-2008 historically based shares for general Canadian imports (PKSHR_ICAN).

Alaska or MacKenzie²⁷ gas to the United States. This total volume is apportioned to the pipeline capacity at the western import border crossings according to their relative size at the time.

The vast majority of natural gas produced in Canada is from the WCSB. Therefore, a more detailed approach was used in modeling supplies from this region. The OGSM contains a series of estimated and accounting equations for forecasting conventional (including from tight formations)²⁸ wells drilled, reserves added, reserve levels, and expected production-to-reserve ratios in the WCSB. These beginning-of-year reserves and the expected production-to-reserve ratios are used within the NGTDM to build a supply curve for conventional natural gas production in Western Canada. The form of this supply curve is effectively the same as the one used to represent non-associated natural gas production in the lower 48 region. This curve is described later in this chapter, with the exceptions related to Canada noted. A primary difference is that the supply curve for the lower 48 States represents non-associated natural gas production net of lease and plant fuel consumption; whereas the Western Canada supply curve represents total conventional natural gas production inclusive of lease and plant fuel consumption.

Natural gas produced from unconventional sources (coal beds and shale) in Western Canada is based on an assumed production profile, with the area under the curve equal to the assumed ultimate recovery (CUR_ULTRES). The production level is initially specified in terms of the forecast year and is set using one functional form before reaching its peak production level and a second functional form after reaching its peak production level. Before reaching peak production, the production levels are assumed to follow a quadratic form, where the level of production is zero in the first year (LSTYR0) and reaches its peak level (PARMB) in the peak year (PKIYR). After peak production the production path is assumed to decline linearly to the last year (LSTYR) when production is again zero. The two curves meet in the peak year (PKIYR) when both have a value equal to the peak production level (PARMB). The actual production volumes are adjusted to reflect an assumed technological improvement and by a factor that depends on the difference between an assumed price trajectory and the actual price projected in the model. The specifics follow:

Before Peak Production

Assumptions:

$$\text{CUR_ULTRES} * \text{PERRES} =$$

$$\int_{\text{LSTYR0}}^{\text{PKIYR}} [\text{PARMA} * (\text{PRDIYR} - \text{PKIYR})^2 + \text{PARMB}] \text{dPRDIYR} \quad (21)$$

²⁷All of the gas from the MacKenzie Delta is not necessarily targeted for the U.S. market directly. Although it is anticipated that the additional supply in the Canadian system will reduce prices and increase the demand for Canadian gas in the United States. The methodology for representing natural gas production in the MacKenzie Delta and the associated pipeline is described in the section titled "Alaskan Natural Gas Routine."

²⁸Since current data tend to combine statistics for drilling and production from conventional sources and that from tight gas formations, the OGSM module does not distinguish the two at present. The conventional resource estimate was increased by 1.5 percent per year as a rough estimate of the future contribution from resource appreciation and from tight formations until more reliable estimates can be generated. For the rest of the discussion, the use of the term "conventional" should be assumed to include gas from tight formations.

$$0 = \text{PARMA} * (\text{LSTYR0} - \text{PKIYR})^2 + \text{PARMB} \quad (22)$$

Results:

$$\text{PRD2} = \text{PARMA} * (\text{PRDIYR} - \text{PKIYR})^2 + \text{PARMB} \quad (23)$$

where,

$$\text{PRD2} = \text{PARMA} * (\text{PRDIYR} - \text{PKIYR})^2 + \text{PARMB} \quad (24)$$

$$\text{PARMB} = - \text{PARMA} * (\text{PKIYR} - \text{LSTYR0})^2 \quad (25)$$

After Peak Production

Assumptions:

$$\text{CUR_ULTRES} * (1 - \text{PERRES}) = \int_{\text{PKIYR}}^{\text{LSTYR}} [(\text{PARMC} * \text{PRDIYR}) + \text{PARMD}] d\text{PRDIYR} \quad (26)$$

$$\text{PARMB} = (\text{PARMC} * \text{PKIYR}) + \text{PARMD} \quad (27)$$

$$0 = (\text{PARMC} * \text{LSTYR}) + \text{PARMD} \quad (28)$$

Results:

$$\text{PRD2} = (\text{PARMC} * \text{PRDIYR}) + \text{PARMD} \quad (29)$$

where,

$$\text{PARMC} = \frac{- \text{PARMB}^2}{2 * \text{CUR_ULTRES} * (1 - \text{PERRES})} \quad (30)$$

$$\text{PARMD} = - \text{PARMC} * \text{LSTYR} \quad (31)$$

given,

$$\text{CUR_ULTRES} = \text{ULTRES} * (1 + \text{RESTECH})^{(\text{MODYR} - \text{RESBASE})} * (1 + \text{RESADJ}) \quad (32)$$

and,

- PRD2 = Unadjusted Canada unconventional gas production (Bcf)
- CUR_ULTRES = Estimate of ultimate recovery of natural gas from unconventional Canada sources in the current forecast year (Bcf)
- ULTRES = Estimate of ultimate recovery of natural gas from unconventional Canada sources in the year RESBASE (33,000 Bcf for coalbed in 2002 and 131,000 Bcf for shale in 2011, based on a 2008 INGAA report by ICF).

- RESBASE = Year associated with CUR_ULTRES
- RESTECH = Factor to increase resource estimate over time due to technology (1.0)
- MODYR = Current forecast year
- RESADJ = Scenario specific resource adjustment factor (default value of 0.0)
- PERRES = Percent of ultimate resource produced before the peak year of production (0.50, fraction)
- PKIYR = Assumed peak year of production (2045)
- LSTYR0 = Last year of zero production (2004)
- PRDIYR = Implied year of production along cumulative production path after price adjustment

The actual production is set by taking the unadjusted unconventional gas production (PRD2) and multiplying it by a price adjustment factor, as well as a technology factor. The price adjustment factor (PRCADJ) is based on the degree to which the actual price in the previous forecast year compares against a prespecified expected price path (expcr), represented by the functional form: $expcr = (2.7 + [0.03*(MODYR-2008)])$. The price adjustment factor is set to the price in the previous forecast year, times a royalty adjustment factor (ROY_ADJ=0.90),²⁹ divided by the expected price, all raised to the 0.3 power. Technology is assumed to progressively increase production by 1 percent per year (TECHGRW) more than it would have been otherwise (e.g., in the fifth forecast year production is increased by 5 percent above what it would have been otherwise).³⁰ Once the production is established for a given forecast year, the value of PRDIYR is adjusted to reflect the actual production in the previous year and incremented by 1 for the next forecast year.

Mexico

The Mexico model is largely based on exogenously specified assumptions about consumption and production growth rates and LNG import levels. For the most part, natural gas imports from Mexico are set exogenously for each of the three border crossing points with the United States, with the exception of any gas that is imported into Baja, Mexico, in liquid form only to be exported to the United States. Exports to Mexico from the United States are established before the NGTDM equilibrates and represents the required level to balance the assumed consumption in (and exports from) Mexico against domestic production and LNG imports. The supply levels are also largely assumption based, but are set to vary to a degree with changes in the expected wellhead price in the United States. Peak and off-peak values for imports from and exports to Mexico are based on average historical shares (1994 or 1991 to 2008, PKSHR_IMEX and PKSHR_EMEX, respectively).

Mexican gas trade is a highly complex issue. A range of non-economic factors will influence, if not determine, future flows of gas between the United States and Mexico. Uncertainty

²⁹In response to an increase in the Alberta royalty rate, effective starting in 2009, a factor was added to approximate an expected general decline in incentive to produce gas in Western Canada as a result. Since some activity is expected to shift to other provinces in the region, the full impact of the average royalty change was not imposed on the whole region.

³⁰ If a rapid or slow technology case is being run, this value is increased or decreased accordingly.

surrounding Mexican/U.S. trade is great enough that not only is the magnitude of flow for any future year in doubt, but also the direction of net flows. Despite the uncertainty and the significant influence of non-economic factors that influence Mexican gas trade with the United States, a methodology to anticipate the path of future Mexican imports from, and exports to, the United States has been incorporated into the NGTDM. This outlook is generated using assumptions regarding regional supply from indigenous production and/or liquefied natural gas (LNG) and regional/sectoral demand growth for natural gas in Mexico.

Assumptions for the growth rate of consumption (Appendix E, PEMEX_GFAC, IND_GFAC, ELE_GFAC, RC_GFAC) were based on the projections from the *International Energy Outlook 2009*. Assumptions about base level domestic production (PRD_GFAC) are based in part on the same source and analyst judgment. The production growth rate is adjusted using an additive factor based on the degree to which the average lower 48 wellhead price varies from a set base price, as follows:

$$\text{PRC_FAC} = \text{MIN} \left\{ \left(\frac{\text{OGWPRNG}}{4.29} \right)^{0.03125} - 1, \quad 0.05 \right\} \quad (33)$$

where,

- PRC_FAC = Factor to add to assumed base level production growth rate (PRD_GFAC)
- OGWPRNG = Lower 48 average natural gas wellhead price in the current forecast year (1987\$/Mcf)
- 4.29 = Fixed base price, approximately equal to the average lower 48 natural gas wellhead price over the projection period (1987\$/Mcf), [set in the code and converted at \$6.00 (2001\$/Mcf)]
- 0.03125 = An assumed parameter
- 0.05 = Assumed minimum price factor

The volumes of LNG imported into Mexico for use in the country are initially set exogenously (Appendix E, MEXLNG). However, these values are scaled back if the projected total volumes available to North America (see below) are not sufficient to accommodate these levels. LNG imports into Baja destined for the U.S. are set endogenously with the LNG import volumes for the rest of North America, as discussed below. Finally, any excess supply in Mexico is assumed to be available for export to the United States, and any shortfall is assumed to be met by imports from the United States

Liquefied Natural Gas

LNG imports are set at the beginning of each NEMS iteration within the NGTDM by evaluating seasonal supply curves, based on outputs from EIA's International Natural Gas Model (INGM), at associated regasification tailgate prices set in the previous NEMS iteration. LNG exports to Japan from Alaska are set exogenously by OGSM through Spring of 2011 when the Kenai Peninsula LNG plant's export license will expire. The NGTDM does not assume or project

additional LNG exports from Alaska.³¹ LNG import levels are established for each region, and period (peak and off-peak) The basic process is as follows for each NEMS iteration (except for the first step): 1) at the beginning of each forecast year set up LNG supply curves for eastern and western North America for each period (peak and off-peak), 2) using the supply curves and the quantity-weighted average regasification tailgate price from the previous NEMS iteration, determine the amount of LNG available for import into North America, 3) subtract the volumes that are exogenously set and dedicated to the Mexico market (unless they exceed the total), and 4) allocate the remaining amount to the associated LNG terminals using a share based on the regasification capacity, the volumes imported last year, and the relative prices.

The LNG supply curves are developed off of a base price/quantity pair (Appendix E, LNGPPT, LNGQPT) from a reference case run of the INGM, using the same, or very similar, world oil price assumptions. The quantities equal the sum of the LNG imports into east or west North America in the associated period; and the prices equal the quantity-weighted average tailgate price at the regasification terminals. The mathematical specification of the curve is exactly like the one used for domestic production described earlier in this chapter, except the assumed elasticities are represented with different variables and have different values.³² This representation represents a first cut at integrating the information from INGM in the domestic projections.³³ The formulation for these LNG supply curves will likely be revised in future NEMS to better capture the market dynamics as represented in the INGM.

Once the North American LNG import volumes are established, the exogenously specified LNG imports into Mexico are subtracted,³⁴ along with the sum of any assumed minimum level (Appendix E, LNGMIN) for each of the representative terminals in the U.S., Canada, and Baja, Mexico (as shown in **Table 2-1**). The remainder is shared out to the terminals and then added to the terminal's assumed minimum import level to arrive at the final LNG import level by terminal and season. The shares are initially set as follows and then normalized to total to 1.0:

$$LSHR_{n,r} = \left\{ \frac{QLNGLAG_{n,r} - (LNGMIN_r * SH_{r,n})}{TOTQ_{n,c}} * PERQ + \frac{LNGCAP_r - LNGMIN_r * (1 - PERQ)}{TOTCAP_c} \right\} * \left\{ \frac{PLNG_{n,r}}{AVGPR_{n,c}} \right\}^{BETA} \quad (34)$$

where,

$LSHR_{n,r}$ = Initial share (before normalization) of LNG imports going to terminal r in period n from the east or west coast, fraction

³¹TransCanada and ExxonMobil filed an open season plan for an Alaska Pipeline Project which includes an option for shipping gas to Valdez for export as LNG. Previous EIA analysis indicated that the option for a pipeline to the lower 48 States is likely to provide a greater netback to the producers and is therefore a more viable option. This analysis and model assumption will be reviewed in the future.

³²For LNG the variables are called PARM_LNGxx, instead of PARM_SUPxx and are also traceable using Appendix E.

³³As first implemented, the resulting LNG import volumes were somewhat erratic, so a five-year moving average was applied to the quantity inputs to smooth out the trajectory and more closely approximate a trend line.

³⁴If the total available LNG import levels exceed the assumed LNG imports into Mexico, the volumes into Mexico are adjusted accordingly, not to be set below assumed minimums (Appendix E, MEXLNGMIN).

- QLNLGAG_{n,r} = LNG import level last year (Bcf)
 LNGMIN_r = Minimum annual LNG import level (Bcf)
 SH_{r,n} = Fraction of LNG imported in period n last year
 LNGCAP_r = Beginning of year LNG sendout capacity³⁵ (Bcf)
 TOTCAP_c = Total LNG sendout capacity on the east or west coast (Bcf)
 PERQ = Assumed parameter (0.5)
 PLNG_{n,r} = Regasification tailgate price (1987\$/Mcf)
 AVGP_{n,r} = Average regasification tailgate price on the east or west coast (1987\$/Mcf)
 BETA = Assumed parameter (1.2)
 r = Regasification terminal number (See Table 2-1)
 n = Network or period (peak or off-peak)
 c = East or west coast

Table 2-1. LNG Regasification Regions

Number	Regasification Terminal/Region
1	Everett, MA
2	Cove Point, MD
3	Elba Island, GA
4	Lake Charles, LA
5	New England
6	Middle Atlantic
7	South Atlantic
8	Florida/Bahamas

Number	Regasification Regions
9	Alabama/Mississippi
10	Louisiana/Texas
11	California
12	Washington/Oregon
13	Eastern Canada
14	Western Canada
15	Baja into the U.S.
--	--

Source: Office of Integrated Analysis and Forecasting, U.S. Energy Information Administration

Alaska Natural Gas Routine

The NEMS demand modules provide a forecast of natural gas consumption for the total Pacific Census Division, which includes Alaska. Currently natural gas that is produced in Alaska cannot be transported to the lower 48 States via pipeline. Therefore, the production and consumption of natural gas in Alaska is handled separately within the NGTDM from the contiguous States. Annual estimates of contiguous Pacific Division consumption levels are derived within the NGTDM by first estimating Alaska natural gas consumption for all sectors, and then subtracting these from the core market consumption levels in the Pacific Division provided by the NEMS demand modules. The use of natural gas in compressed natural gas vehicles in Alaska is assumed to be negligible or nonexistent. The Electricity Market Module provides a value for

³⁵Send-out capacity is the maximum annual volume of gas that can be delivered by a regasification facility into the pipeline system.

natural gas consumption in Alaska by electric generators. The series of equations for specifying the consumption of gas by Alaska residential and commercial customers follows:

$$AK_RN_y = \exp\{-2.677 + (0.888 * \ln(AK_RN_{y-1})) - (0.185 * \ln(AK_RN_{y-2})) + (0.626 * \ln(AK_POP_y))\} \quad (35)$$

$$AK_CN_y = 0.932946 + (0.937471 * AK_CN_{y-1}) \quad (36)$$

$$(res): AKQTY_F_{s=1,y} = \{e^{(6.983794*(1-0.364042))} * (AKQTY_F_{s=1,y-1} * 1000)^{0.364042} * AK_RN_y^{(0.601932(1-0.364042))}\} / 1000. \quad (37)$$

$$(com): AKQTY_F_{s=2,y} = \{e^{(9.425307*(1-0.736334))} * (AKQTY_F_{s=2,y-1} * 1000)^{0.736334} * AK_CN_y^{0.205020} * (AK_CN_{y-1} * 1000)^{(-0.736334*0.205020)}\} / 1000. \quad (38)$$

where,

- AKQTY_F_{s=1} = consumption of natural gas by residential (s=1) customers in Alaska in year y (MMcf, converted to Bcf)
- AKQTY_F_{s=2} = consumption of natural gas by commercial (s=2) customers in Alaska in the current forecast year y (MMcf, converted to Bcf)
- AK_RN = number of residential customers in year y (thousands, Table F1, Appendix F)
- AK_CN_y = number of commercial customers in year y (thousands, Table F2, Appendix F)
- AK_POP = exogenously specified projection of the population in Alaska (thousands, Appendix E)

Gas consumption by Alaska industrial customers is set exogenously, as follows:

$$(ind): AKQTY_F_{s=3,y} = AK_QIND_S_y \quad (39)$$

where,

- AKQTY_F_{s=3,y} = consumption of natural gas by industrial customers in year y (s=3), (Bcf)
- AK_QIND_S = consumption of natural gas by industrial customers in southern Alaska (Bcf), the sum of consumption at the Agrium fertilizer plant (assumed to close in 2007, Appendix E) and at the Kenai LNG liquefaction facility (assumed to close in 2011, Appendix E)
- s = sector
- y = year

The production of gas in Alaska depends on: 1) whether a pipeline is constructed from Alaska to Alberta, 2) whether a gas-to-liquids plant is built in Alaska, and 3) consumption in and exports

from Alaska. The production of gas related to the Alaska pipeline equals the volumes delivered to Alberta (which depend on assumptions about the pipeline capacity) plus what is consumed for lease, plant, and pipeline operations. If the Petroleum Market Module (PMM) determines that a gas-to-liquids facility will be built in Alaska, then the natural gas consumed in the process (AKGTL_NGCNS, set in the PMM) is added to production in the north, along with the associated lease and plant fuel consumed. Other production in North Alaska that is not related to the pipeline is largely lease and plant fuel associated with the crude oil extraction processes; whereas gas is produced in the south to satisfy consumption and export requirements. For simplicity the quantity of lease and plant fuel not related to the pipeline or GTL in Alaska is modeled in total and is assigned to North Alaska production. The details follow:

$$(S.AK): AK_PROD_{r=1} = AK_CONS_S + EXPJAP + QALK_LAP_S + QALK_PIP_S - AK_DISCR \quad (40)$$

$$(S.AK): AK_PROD_{r=2} = \{QALK_LAP_N = (0.0943884 * QALK_LAP_ (0.038873 * \sum_{s=1}^3 oOGPRCOAK_{s,y})\} / 1000 \quad (41)$$

$$(N.AK_2): AK_PROD_{r=3} = \frac{QAK_ALB_y}{1. - AK_PCTLSE_{r=3} - AK_PCTPLT_{r=3} - AK_PCTPIP_{r=3}} + AKGTL_NGCNS_t + AKGTL_LAP \quad (42)$$

where,

$$AK_CONS_S = \sum_{s=1}^4 (AKQTY_F_s + AKQTY_I_s) \quad (43)$$

$$QALK_LAP_S = 0.0 \quad (\text{total is assigned to the North}) \quad (44)$$

$$QALK_PIP_S = (AK_CONS_S + EXPJAP) * AK_PCTPIP_2 \quad (45)$$

$$AKGTL_LAP = oAKGTL_NGCNS_t * (AK_PCTLSE_3 + AK_PCTPLT_3) \quad (46)$$

where,

- AK_PROD_r = dry gas production in Alaska (Bcf)
- AK_CONS_S = total gas delivered to customers in South Alaska (Bcf)
- AKQTY_F_s = total gas delivered to core customers in Alaska in sector s (Bcf)
- AKQTY_I_s = total gas delivered to non-core customers in Alaska in sector s (Bcf)
- EXPJAP = quantity of gas liquefied and exported to Japan (from OGSM in Bcf)

- QALK_LAP_N = quantity of gas consumed for lease and plant operations, excluding that related to the pipeline and GTL (Bcf)
- QALK_LAP_NLAG = quantity of gas consumed for lease and plant operations in the previous year, excluding that related to the pipeline and GTL (Bcf)
- oOGPRCOAK_{s,y} = crude oil production in Alaska by sector
- QALK_PIP_r = quantity of gas consumed as pipeline fuel (Bcf)
- AK_DISCR = discrepancy, the average (2000-2006) historically based difference in reported supply levels and consumption levels in Alaska (Bcf)
- QAK_ALB_t = gas entering Alberta via pipeline that was produced on the North Slope (Bcf)
- AK_PCTLSE_r = (for r=1) not used, (for r=2) lease and plant consumption as a percent of gas consumption, (for r=3) lease consumption as a percent of gas production (fraction, Appendix E)
- AK_PCTPLT_r = (for r=1 and r=2) not used, (for r=3) plant fuel as a percent of gas production (fraction, Appendix E)
- AK_PCTPIP_r = (for r=1) not used, (for r=2) pipeline fuel as a percent of gas consumption, (for r=3) pipeline fuel as a percent of gas production (fraction, Appendix E)
- AKGTL_NGCNS_t = natural gas consumed in a gas-to-liquids plant in the North Slope (from PMM in Bcf)
- AKGTL_LAP = lease and plant consumption associated with the gas for a gas-to-liquids plant (Bcf)
- s = sectors (1=residential, 2=commercial, 3=industrial, 4=transportation, 5=electric generators)
- r = region (1 = south, 2 = north not associated with a pipeline to Alberta or gas-to-liquids process, 3 = north associated with a pipeline to Alberta and/or a gas-to-liquids plant)

Lease, plant, and pipeline fuel consumption are calculated as follows. For south Alaska, the calculation of pipeline fuel (QALK_PIP_S) and lease and plant fuel (QALK_LAP_S) are shown above. For the Alaska pipeline, all three components are set to the associated production times the percentage of lease (AK_PCTLSE₃), plant (AK_PCTPLT₃), or pipeline fuel (AK_PCTPIP₃). For the gas-to-liquids process, lease and plant fuel (AKGTL_LAP) is calculated as shown above and pipeline fuel is considered negligible. For the rest of north Alaska, pipeline fuel consumption is assumed to be negligible, while lease and plant fuel not associated with the pipeline or GTL (QALK_LAP_N) is set based on the trend line provided above.

Estimates for natural gas wellhead and delivered prices in Alaska are estimated in the NGTDM for proper accounting, but have a very limited impact on the NEMS system. The average Alaska wellhead price (AK_WPRC) over the North and South regions (not accounting for the impact should a pipeline be connected to Alberta) is set using the following estimated equation:

$$AK_WPRC(1) = WPRLAG^{0.934077} * oIT_WOP_{y,1}^{(0.280960*(1-0.934077))} \quad (47)$$

where,

AK_WPRC = natural gas wellhead price in Alaska, presuming no pipeline to Alberta (1987\$/Mcf) (Table F1, Appendix F)
 WPRLAG = AK_WPRC in the previous forecast year (\$/Mcf)
 oIT_WOP_{y,1} = world oil price (1987\$ per barrel)

The price for natural gas associated with a pipeline to Alberta is exogenously specified (FR_PMINWPR₁, Appendix E) and does not vary by forecast year. The average wellhead price for the State is calculated as the quantity-weighted average of AK_WPRC and FR_PMINWPR₁. Delivered prices in Alaska are set equal to the wellhead price (AK_WPRC) resulting from the equation above plus a fixed, exogenously specified markup (Appendix E -- AK_RM, AK_CM, AK_IN, AK_EM).

Within the model, the commencement of construction of the Alaska to Alberta pipeline is restricted to the years beyond an earliest start date (FR_PMINYR, Appendix E) and can only occur if a pipeline from the MacKenzie Delta to Alberta is not under construction. The same is true for the MacKenzie Delta pipeline relative to construction of the Alaska pipeline. Otherwise, the structural representation of the MacKenzie Delta pipeline is nearly identical to that of the Alaska pipeline, with different numerical values for model parameters. Therefore, the following description applies to both pipelines. Within the model the same variable names are used to specify the supporting data for the two pipelines, with an index of 1 for Alaska and an index of 2 for the MacKenzie Delta pipeline.

The decision to build a pipeline is triggered if the estimated cost to supply the gas to the lower 48 States is lower than an average of the lower 48 average wellhead price over the planning period of FR_PPLNYR (Appendix E) years.³⁶ Construction is assumed to take FR_PCNSYR (Appendix E) years. Initial pipeline capacity is assumed to accommodate a throughput delivered to Alberta of FR_PVOL (Appendix E). The first year of operation, the volume is assumed to be half of its ultimate throughput. If the trigger price exceeds the minimum price by FR_PADDTAR (Appendix E) after the initial pipeline is built, then the capacity will be expanded the following year by a fraction (FR_PEXPFAC, Appendix E) of the original capacity.

The expected cost to move the gas to the lower 48 is set as the sum of the wellhead price,³⁷ the charge for treating the gas, and the fuel costs (FR_PMINWPR, Appendix E), plus the pipeline tariff for moving the gas to Alberta and an assumed differential between the price in Alberta and the average lower 48 wellhead price (ALB_TO_L48, Appendix E). A risk premium is also included to largely reflect the expected initial price drop as a result of the introduction of the pipeline, as well as some of the uncertainties in the necessary capital outlays and in the ultimate selling price (FR_PRISK, Appendix E).³⁸ The cost-of-service based calculation for the pipeline

³⁶The prices are weighted, with a greater emphasis on the prices in the recent past. An additional check is made that the estimated cost is lower than the lower 48 price in the last two years of the planning period and lower than a weighted average of the expected prices in the three years after the planning period, during the construction period.

³⁷The required wellhead price in the MacKenzie Delta is progressively adjusted in response to changes in the U.S. national average drilling cost per well projections and across the forecast horizon in a higher or lower technology case, such that by the last year (2035) the price is higher or lower than the price in the reference case by a fraction equal to 0.25 times the technology factor adjustment rate (e.g., 0.50 for *AEO2010*).

³⁸If there is an annual decline in the average lower 48 wellhead price over the planning period for the Alaska pipeline, an additional adjustment is made to the expected cost (although it is not a cost item), equivalent to half of the drop in price averaged

tariff (NGFRPIPE_TAR) to move gas from each production source to Alberta is presented at the end of Chapter 6.

over the planning period, to account for the additional concern created by declining prices.

3. Overview of Solution Methodology

The previous chapter described the function of the NGTDM within the NEMS and the transformation and representation of supply and demand elements within the NGTDM. This chapter will present an overview of the NGTDM model structure and of the methodologies used to represent the natural gas transmission and distribution industries. First, a detailed description of the network used in the NGTDM to represent the U.S. natural gas pipeline system is presented. Next, a general description of the interrelationships between the submodules within the NGTDM is presented, along with an overview of the solution methodology used by each submodule.

NGTDM Regions and the Pipeline Flow Network

General Description of the NGTDM Network

In the NGTDM, a transmission and distribution network (**Figure 3-1**) simulates the interregional flow of gas in the contiguous United States and Canada in either the peak (December through March) or off-peak (April through November) period. This network is a simplified representation of the physical natural gas pipeline system and establishes the possible interregional transfers to move gas from supply sources to end-users. Each NGTDM region contains one transshipment node, a junction point representing flows coming into and out of the region. Nodes have also been defined at the Canadian and Mexican borders, as well as in eastern and western Canada. Arcs connecting the transshipment nodes are defined to represent flows between these nodes; and thus, to represent interregional flows. Each of these interregional arcs represents an aggregation of pipelines that are capable of moving gas from one region into another region. Bidirectional flows are allowed in cases where the aggregation includes some pipelines flowing one direction and other pipelines flowing in the opposite direction.³⁹ Bidirectional flows can also be the result of directional flow shifts within a single pipeline system due to seasonal variations in flows. Arcs leading from or to international borders generally⁴⁰ represent imports or exports. The arcs which are designated as “secondary” in **Figure 3-1** generally represent relatively low flow volumes and are handled somewhat differently and separately from those designated as “primary.”

Flows are further represented by establishing arcs from the transshipment node to each demand sector/subregion represented in the NGTDM region. Demand in a particular NGTDM region can only be satisfied by gas flowing from that same region’s transshipment node. Similarly, arcs are also established from supply points into transshipment nodes. The supply from each NGTDM/OGSM region is directly available to only one transshipment node, through which it must first pass if it is to be made available to the interstate market (at an adjoining transshipment

³⁹Historically, one out of each pair of bidirectional arcs in Figure 3-1 represents a relatively small amount of gas flow during the year. These arcs are referred to as “the bidirectional arcs” and are identified as the secondary arcs in Figure 3-1, excluding 3 to 15, 5 to 10, 15 to E. Canada, 20 to 7, 21 to 11, 22 to 12, and Alaska to W. Canada. The flows along these arcs are initially set at the last historical level and are only increased (proportionately) when a known (or likely) planned capacity expansion occurs.

⁴⁰Some natural gas flows across the Canadian border into the United States, only to flow back across the border without changing ownership or truly being imported. In addition, any natural gas that might flow from Alaska to the lower 48 states would cross the Canadian/U.S. border, but not be considered as an import.

node). During a peak period, one of the supply sources feeding into each transshipment node represents net storage withdrawals in the region during the peak period. Conversely during the off-peak period, one of the demand nodes represents net storage injections in the region during the off-peak period.

Figure 3-1. Natural Gas Transmission and Distribution Module Network





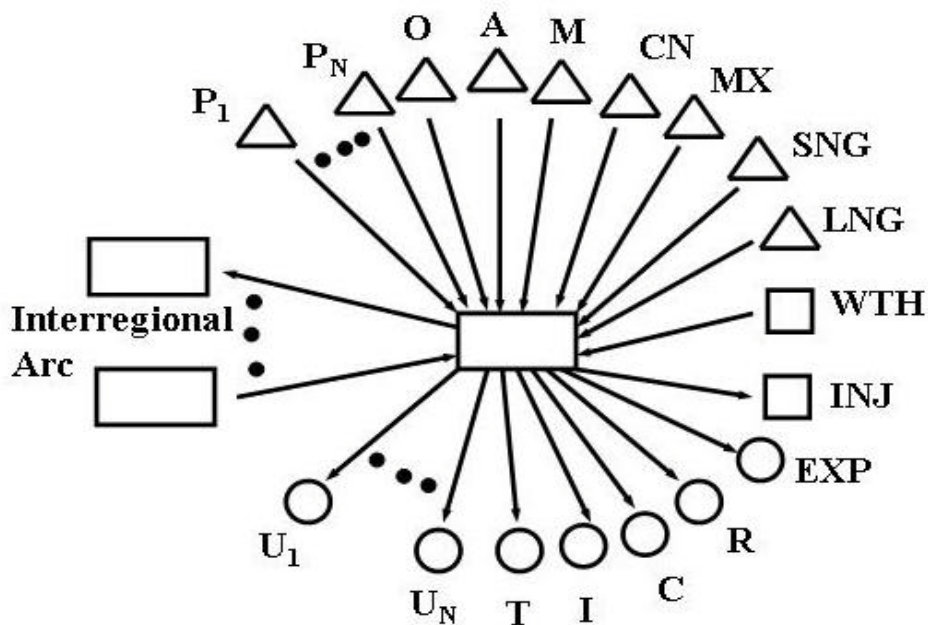

Figure 3-2 shows an illustration of all possible flows into and out of a transshipment node. Each transshipment node has one or more arcs to represent flows from or to other transshipment nodes. The transshipment node also has an arc representing flow to each end-use sector in the region (residential, commercial, industrial, electric generators, and transportation), including separate arcs to each electric generator subregion.⁴¹ Exports and (in the off-peak period) net storage injections are also represented as flow out of a transshipment node. Each transshipment node can have one or more arcs flowing in from each supply source represented within the region. These supply points represent U.S. or Canadian onshore or U.S. offshore production, liquefied natural gas imports, gas produced in Alaska and transported via pipeline, Mexican imports, (in the peak period) net storage withdrawals in the region, or supplemental gas supplies.

⁴¹Conceptually within the model, the flow of gas to each end-use sector passes through a common city gate point before reaching the end-user.

Figure 3-2. Transshipment Node



	Transshipment Node	P_i – Production in NGTDM/OGSM Region i
	Supply Point	O – Offshore Supplies
	Demand Point	A – Alaskan Supplies via pipeline to Alberta
	Storage Point	M – Mackenzie Delta Gas via pipeline to Alberta
		CN – Canadian Supplies
		MX – Mexican Imports
		SNG – Supplemental Supplies
		LNG – Liquefied Natural Gas Imports
		WTH – Storage Withdrawals (peak only)
		INJ – Storage Injections (off-peak only)
		EXP – Exports to either Canada or Mexico
		R – Residential Demand
		C – Commercial Demand
		I – Industrial Demand
		T – Transportation Demand
		U_i – Electric Generator Demand in NGTDM/EMM Region i

Two items accounted for but not presented in **Figure 3-2** are discrepancies or balancing items (i.e., average historically observed differences between independently reported natural gas supply and disposition levels (DISCR for the United States, CN_DISCR for Canada) and backstop supplies.⁴²

Many of the types of supply listed above are relatively low in volume and are set independently of current prices and before the NGTDM determines a market equilibrium solution. As a result, these sources of supply are handled differently within the model. Structurally within the model only the price responsive sources of supply (i.e., onshore and offshore lower 48 U.S. production, Western Canadian Sedimentary Basin (WCSB) production, and storage withdrawals) are explicitly represented with supply nodes and connecting arcs to the transshipment nodes when the NGTDM is determining a market equilibrium solution.

Once the types of end-use destinations and supply sources into and out of each transshipment node are defined, a general network structure is created. Each transshipment node does not necessarily have all supply source types flowing in, or all demand source types flowing out. For instance, some transshipment nodes will have liquefied natural gas available while others will not. The specific end-use sectors and supply types specified for each transshipment node in the network are listed in **Table 3-1**. This table also provides the mapping of Electricity Market Module regions and Oil and Gas Supply Module regions to NGTDM regions (**Figure 2-3** and **Figure 2-5** in Chapter 2). The transshipment node numbers in the US align with the NGTDM regions in **Figure 3-1**. Transshipment nodes 13 through 19 are pass-through nodes for the border crossings on the Canada/U.S. border, going from east to west.

As described earlier, the NGTDM determines the flow and price of natural gas in both a peak and off-peak period. The basic network structure separately represents the flow of gas during the two periods within the Interstate Transmission Submodule. Conceptually this can be thought of as two parallel networks, with three areas of overlap. First, pipeline expansion is determined only in the peak period network (with the exception of pipelines going into Florida from the East South Central Division). These levels are then used as constraints for pipeline flow in the off-peak period. Second, net withdrawals from storage in the peak period establish the net amount of natural gas that will be injected in the off-peak period, within a given forecast year. Similarly, the price of gas withdrawn in the peak period is the sum of the price of the gas when it was injected in the off-peak, plus an established storage tariff. Third, the supply curves provided by the Oil and Gas Supply Module are specified on an annual basis. Although, these curves are used to approximate peak and off-peak supply curves, the model is constrained to solve on the annual supply curve (i.e., when the annual curve is evaluated at the quantity-weighted average annual wellhead price, the resulting quantity should equal the sum of the production in the peak and off-peak periods). The details of how this is accomplished are provided in Chapter 4.

⁴²Backstop supplies are allowed when the flow out of a transshipment node exceeds the maximum flow into a transshipment node. A high price is assigned to this supply source and it is generally expected not to be required (or desired). Chapter 4 provides a more detailed description of the setting and use of backstop supplies in the NGTDM.

Table 3-1. Demand and Supply Types at Each Transshipment Node in the Network

Transshipment Node	Demand Types	Supply Types
1	R, C, I, T, U(1)	P(1/1), LNG Everett Mass., LNG generic, SNG
2	R, C, I, T, U(2), INJ	P(2/1), WTH, LNG generic, SNG
3	R, C, I, T, U(3), U(4), INJ	P(3/1), WTH, SNG
4	R, C, I, T, U(5), INJ	P(4/3), P(4/5), SNG, WTH, LNG generic
5	R, C, I, T, U(6), U(7), INJ	P(5/1), LNG Cove Pt Maryland, LNG Elba Island Georgia, Atlantic Offshore, WTH, LNG generic, SNG
6	R, C, I, T, U(9), U(10), INJ	P(6/1), P(6/2), WTH, LNG generic, SNG
7	R, C, I, T, U(11), INJ	P(7/2), P(7/3), P(7/4), LNG Lake Charles Louisiana, Offshore Louisiana, Gulf of Mexico, WTH, LNG generic, SNG
8	R, C, I, T, U(12), U(13), INJ	P(8/5), WTH, SNG
9	R, C, I, T, U(15), INJ	P(9/6), WTH, LNG generic, SNG
10	R, C, I, T, U(6), U(8), INJ	P(10/2), WTH, SNG
11	R, C, I, T, U(14), INJ	P(11/4), P(11/5), WTH, SNG
12	R, C, I, T, U(16), INJ	P(12/6), Pacific Offshore, WTH, LNG generic, SNG
13 – 19	--	--
20	Mexican Exports (TX)	Mexican Imports (TX)
21	Mexican Exports (AZ/NM)	Mexican Imports (AZ/NM)
22	Mexican Exports (CA)	Mexican Imports (CA)
23	Eastern Canadian consumption, INJ	Eastern Canadian supply, WTH
24	Western Canadian consumption, INJ	Western Canadian supply, WTH, Alaskan Supply via a pipeline, MacKenzie Valley gas via a pipeline

Specifications of a Network Arc

Each arc of the network has associated variable inputs and outputs. The variables that define an interregional arc are the pipeline direction, available capacity from the previous forecast year, the “fixed” tariffs and/or tariff curve, the flow on the arc from the previous year, the maximum capacity level, and the maximum utilization of the capacity (**Figure 3-3**). While a model solution is determined (i.e., the quantity of the natural gas flow along each interregional arc is determined), the “variable” or quantity dependent tariff and the required capacity to support the flow are also determined in the process.

For the peak period the maximum capacity build levels are set to a factor above the 1990 levels. The factor is set high enough so that this constraint is rarely, if ever, binding. However, the structure could be used to limit growth along a particular path. In the off-peak period the maximum capacity levels are set to the capacity level determined in the peak period. The maximum utilization rate along each arc is used to capture the impact that varying demand loads over a season have on the utilization along an arc.

Figure 3-3. Variables Defined and Determined for Network Arc

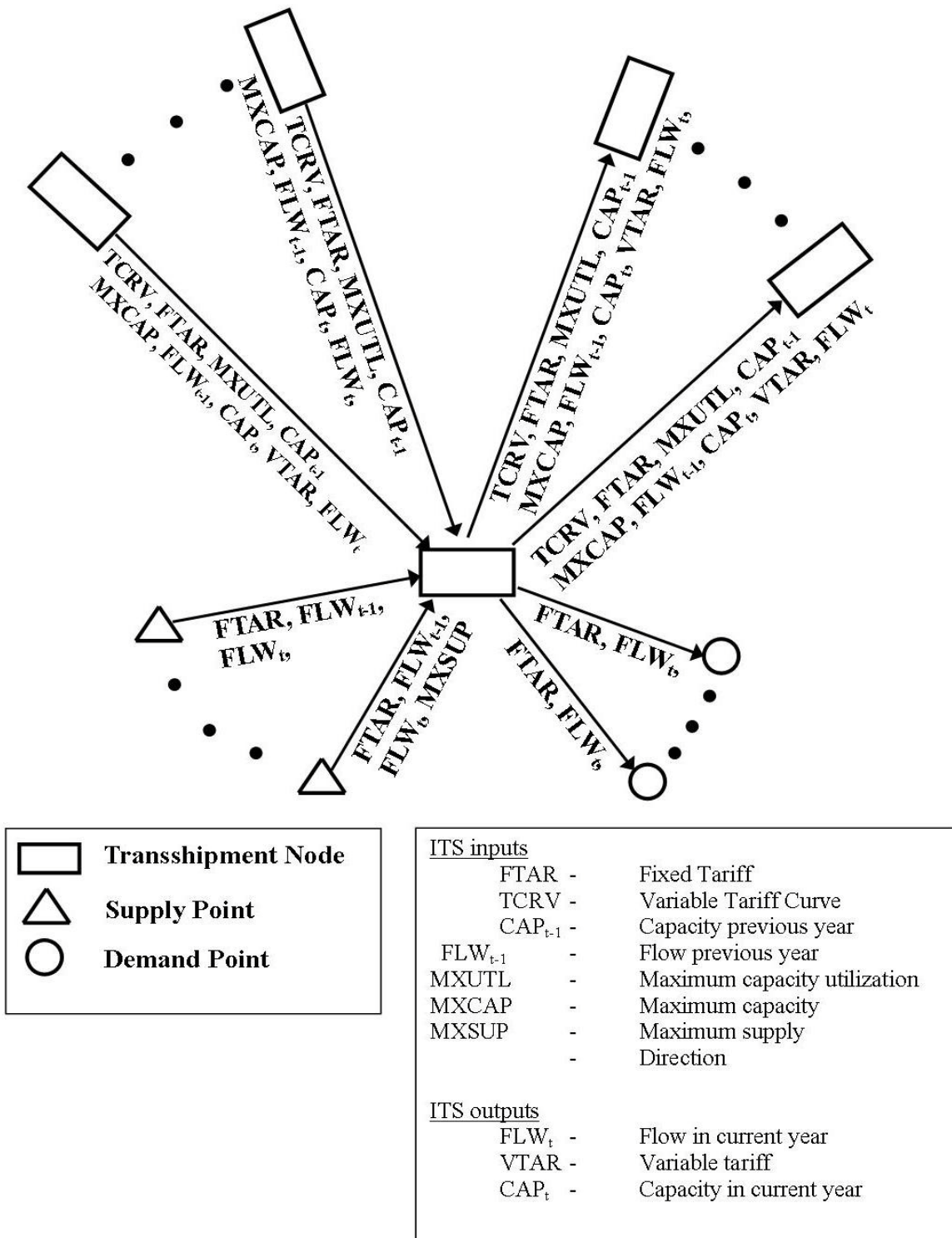

For the peak period, the maximum utilization rate is calculated based on an estimate of the ratio of January-to-peak period consumption requirements. For the off-peak the maximum utilization rates are set exogenously (HOPUTZ, Appendix E). Capacity and flow levels from the previous forecast year are used as input to the solution algorithm for the current forecast year. In some cases, capacity that is newly available in the current forecast year will be exogenously set (PLANPCAP, Appendix E) as “planned” (i.e., highly probable that it will be built by the given forecast year based on project progress and announcements). Any additional capacity beyond the planned level is determined during the solution process and is checked against maximum capacity levels and adjusted accordingly. Each of the interregional arcs has an associated “fixed” and “variable” tariff, to represent usage and reservation fees, respectively. The variable tariff is established by applying the flow level along the arc to the associated tariff supply curve, established by the Pipeline Tariff Submodule. During the solution process in the Interstate Transmission Submodule, the resulting tariff in the peak or off-peak period is added to the price at the source node to arrive at a price for the gas along the interregional arc right before it reaches its destination node. Through an iterative process, the relative values of these prices for all of the arcs entering a node are used as the basis for reevaluating the flow along each of these arcs.⁴³

For the arcs from the transshipment nodes to the final delivery points, the variables defined are tariffs and flows (or consumption). The tariffs here represent the sum of several charges or adjustments, including interstate pipeline tariffs in the region, intrastate pipeline tariffs, and distributor markups. Associated with each of these arcs is the flow along the arc, which is equal to the amount of natural gas consumed by the represented sector. For arcs from supply points to transshipment nodes, the input variables are the production levels from the previous forecast year, a tariff, and the maximum limit on supplies or production. In this case the tariffs theoretically represent gathering charges, but are currently assumed to be zero.⁴⁴ Maximum supply levels are set at a percentage above a baseline or “expected” production level (described in Chapter 4). Although capacity limits can be set for the arcs to and from end-use sectors and supply points, respectively, the current version of the module does not impose such limits on the flows along these arcs.

For the arcs from the transshipment nodes to the final delivery points, the variables defined are tariffs and flows (or consumption). The tariffs here represent the sum of several charges or adjustments, including interstate pipeline tariffs in the region, intrastate pipeline tariffs, and distributor markups. Associated with each of these arcs is the flow along the arc, which is equal to the amount of natural gas consumed by the represented sector. For arcs from supply points to transshipment nodes, the input variables are the production levels from the previous forecast year, a tariff, and the maximum limit on supplies or production. In this case the tariffs theoretically represent gathering charges, but are currently assumed to be zero.⁴⁵ Maximum

⁴³During the off-peak period in a previous version of the module, only the usage fee was used as a basis for determining the relative flow along the arcs entering a node. However, the total tariff was ultimately used when setting delivered prices.

⁴⁴Ultimately the gathering charges are reflected in the delivered prices when the model is benchmarked to historically reported city gate prices.

⁴⁵Ultimately the gathering charges are reflected in the delivered prices when the model is benchmarked to historically reported city gate prices.

supply levels are set at a percentage above a baseline or “expected” production level (described in Chapter 4). Although capacity limits can be set for the arcs to and from end-use sectors and supply points, respectively, the current version of the module does not impose such limits on the flows along these arcs.

Note that any of the above variables may have a value of zero, if appropriate. For instance, some pipeline arcs may be defined in the network that currently have zero capacity, yet where new capacity is expected in the future. On the other hand, some arcs such as those to end-use sectors are defined with infinite pipeline capacity because the model does not forecast limits on the flow of gas from transshipment nodes to end users.

Overview of the NGTDM Submodules and Their Interrelationships

The NEMS generates an annual forecast of the outlook for U.S. energy markets for the years 1990 through 2030. During the historical years, many of the modules in NEMS do not execute, but simply assign historically published values to the model’s output variables. The NGTDM similarly assigns historical values to most of the known module outputs during these years. However, some of the required outputs from the module are not known (e.g., the flow of natural gas between regions on a seasonal basis). Therefore, the model is run in a modified form to fill in such unknown, but required values. In doing so, historical values are generated for the unknown parameters that are consistent with the known historically based values (e.g., the unknown seasonal interregional flows sum to the known annual totals).

Although the NGTDM is executed for each iteration of each forecast year solved by the NEMS, it is not necessary that all of the individual components of the module be executed for all iterations. Of the NGTDM’s three components or submodules, the Pipeline Tariff Submodule is executed only once per forecast year since the submodule’s input values do not change from one iteration of NEMS to the next. However, the Interstate Transmission Submodule and the Distributor Tariff Submodule are executed every iteration of each forecast year because their input values can change by iteration. Within the Interstate Transmission Submodule an iterative process is used. The basic solution algorithm is repeated multiple times until the resulting wellhead prices and production levels from one iteration are within a user-specified tolerance of the resulting values from the previous iteration, and equilibrium is reached. A process diagram of the NGTDM is provided in **Figure 3-4**, showing the general calling sequence.

The Interstate Transmission Submodule is the primary submodule of the NGTDM. One of its functions is to forecast interregional pipeline and underground storage expansions and produce annual pipeline load profiles based on seasonal loads. Using this information from the previous forecast year and other data, the Pipeline Tariff Submodule uses an accounting process to derive revenue requirements for the current forecast year. This submodule builds pipeline and storage tariff curves based on these revenue requirements for use in the Interstate Transmission Submodule. These curves extend beyond the level of the current year’s capacity and provide estimates of the tariffs should capacity be expanded. The Distributor Tariff Submodule provides distributor tariffs for use in the Interstate Transmission Submodule. The Distributor Tariff Submodule must be called in each iteration because some of the distributor tariffs are based on

Figure 3-4. NGTDM Process Diagram

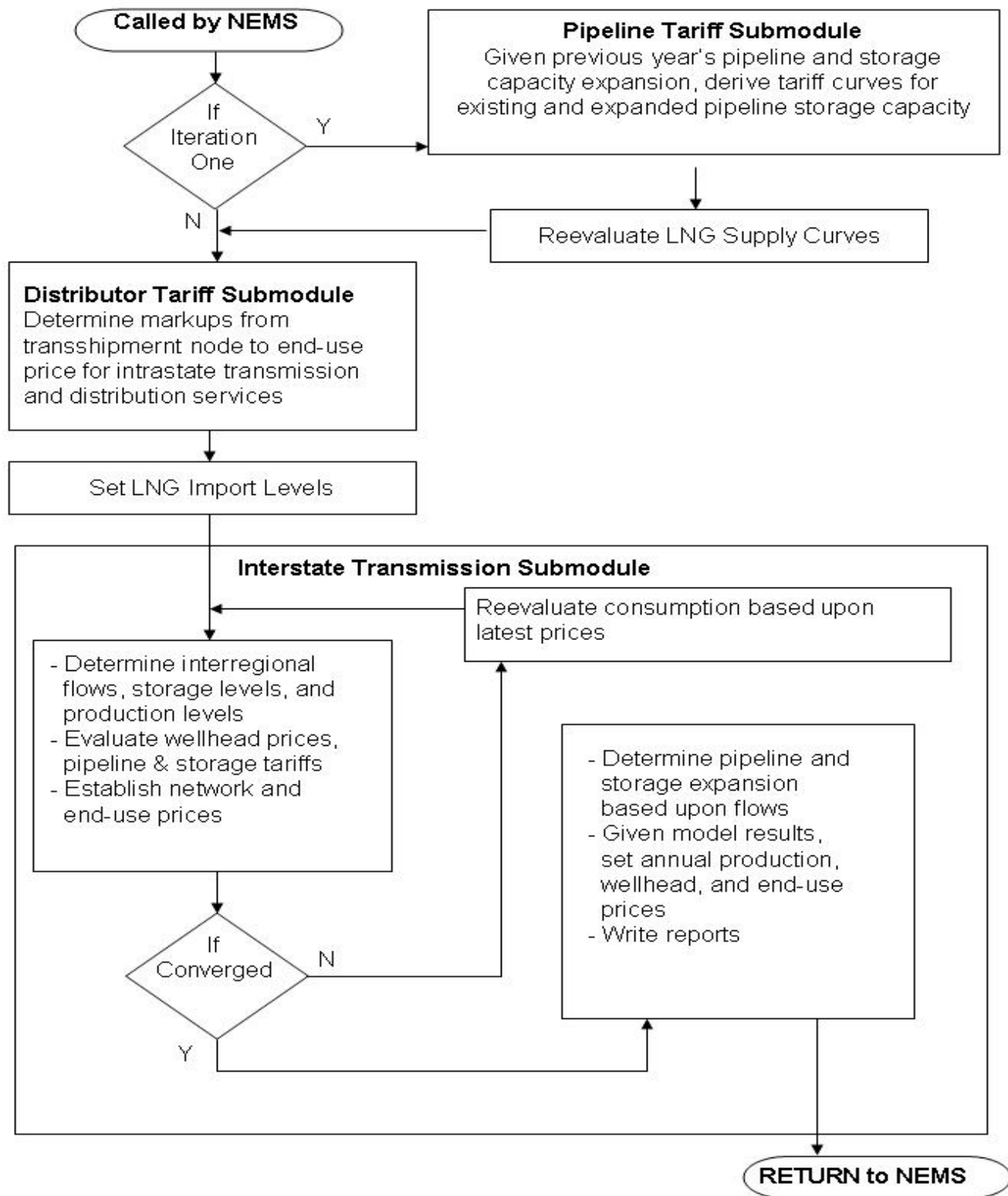

consumption levels that may change from iteration to iteration. Finally, using the information provided by these other NGTDM submodules and other NEMS modules, the Interstate Transmission Submodule solves for natural gas prices and quantities which reflect a market equilibrium for the current forecast year. A brief summary of each of the NGTDM submodules follows.

Interstate Transmission Module

The Interstate Transmission Submodule (ITS) is the main integrating module of the NGTDM. One of its major functions is to simulate the natural gas price determination process. The ITS brings together the major economic factors that influence regional natural gas trade on a seasonal basis in the United States, the balancing of the demand for and the domestic supply of natural gas, including competition from imported natural gas. These are examined in combination with the relative prices associated with moving the gas from the producer to the end-user where and when (peak versus off-peak) it is needed. In the process, the ITS models the decision-making process for expanding pipeline and/or seasonal storage capacity in the U.S. gas market, determining the amount of pipeline and storage capacity to be added between or within regions in the NGTDM. Storage serves as the primary link between the two seasonal periods represented.

The ITS employs an iterative heuristic algorithm to establish a market equilibrium solution. Given the consumption levels from other NEMS modules, the basic process followed by the ITS involves first establishing the backward flow of natural gas in each period from the consumers, through the network, to the producers, based primarily on the relative prices offered for the gas (from the previous ITS iteration). This process is performed for the peak period first since the net withdrawals from storage during the peak period will establish the net injections during the off-peak period. Second, using the model's supply curves, wellhead prices are set corresponding to the desired production volumes. Also, using the pipeline and storage tariff curves from the Pipeline Tariff Submodule, pipeline and storage tariffs are set corresponding to the associated flow of gas, as determined in the first step. These prices are then translated from the producers, back through the network, to the city gate and the end-users, by adding the appropriate tariffs along the way. A regional storage tariff is added to the price of gas injected into storage in the off-peak to arrive at the price of the gas when withdrawn in the peak period. Delivered prices are derived for residential, commercial, electric generation, and transportation customers, as well as for both the core and non-core industrial sectors, using the distributor tariffs provided by the Distributor Tariff Submodule. At this point consumption levels can be reevaluated given the resulting set of delivered prices. Either way, the process is repeated until the solution has converged.

In the end, the ITS derives average seasonal (and ultimately annual) natural gas prices (wellhead, city gate, and delivered), and the associated production and flows, that reflect an interregional market equilibrium among the competing participants in the market. In the process of determining interregional flows and storage injections/withdrawals, the ITS also forecasts pipeline and storage capacity additions. In the next forecast year, the Pipeline Tariff Submodule will adjust the requirements to account for the associated expansion costs. Other primary outputs

of the module include: lease, plant, and pipeline fuel use, Canadian import levels, and net storage withdrawals in the peak period.

The historical evolution of the price determination process simulated by the ITS is depicted schematically in **Figure 3-5**. At one point, the marketing chain was very straightforward, with end-users and local distribution companies contracting with pipeline companies, and the pipeline companies in turn contracting with producers. Prices typically reflected average costs of providing service plus some regulator-specified rate of return. Although this approach is still used as a basis for setting pipeline tariffs, more pricing flexibility has been introduced, particularly in the interstate pipeline industry and more recently by local distributors. Pipeline companies are also offering a range of services under competitive and market-based pricing arrangements. Additionally, newer players—for example marketers of spot gas and brokers for pipeline capacity—have entered the market, creating new links connecting suppliers with end-users. The marketing links are expected to become increasingly complex in the future.

Figure 3-5. Principal Buyer/Seller Transaction Paths for Natural Gas Marketing

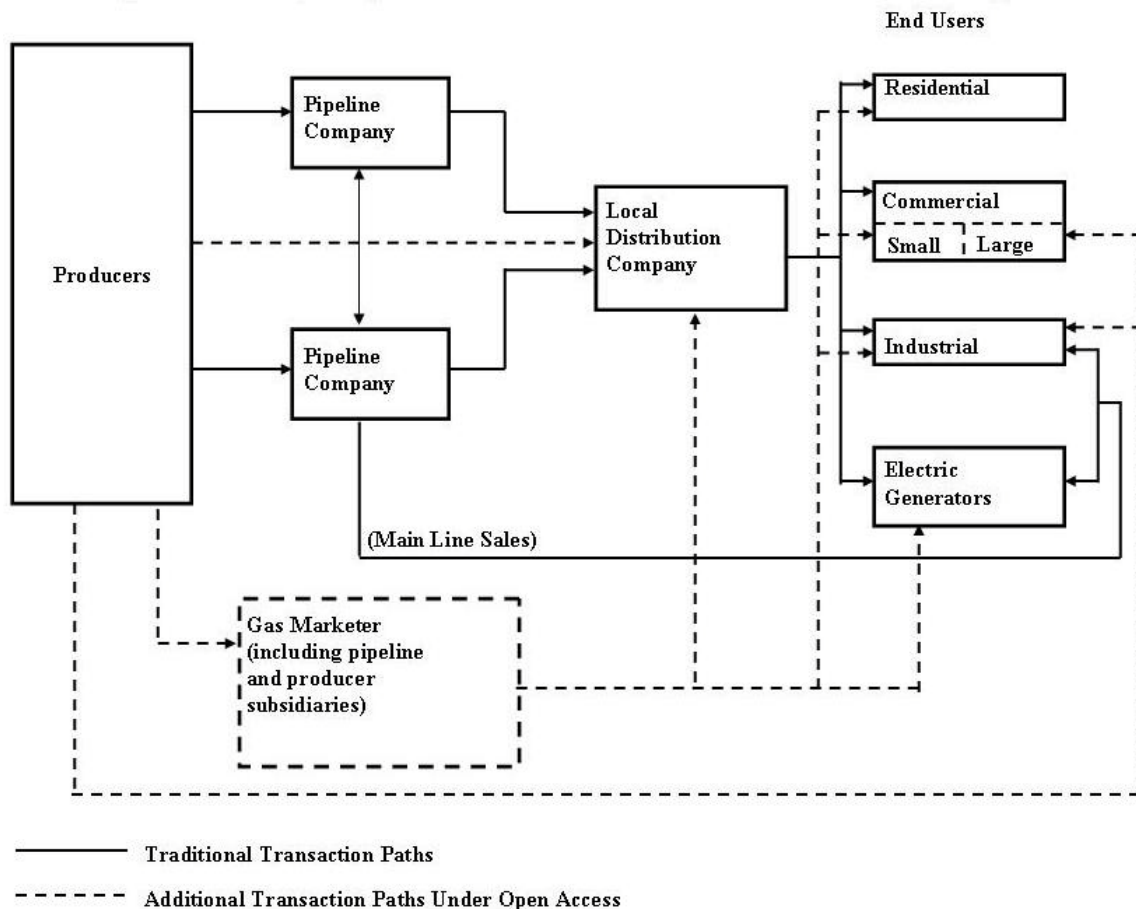

The level of competition for pipeline services (generally a function of the number of pipelines having access to a customer and the amount of capacity available) is currently driving the prices for interruptible transmission service and is having an effect on firm service prices. Currently,

there are significant differences across regions in pipeline capacity utilization.⁴⁶ These regional differences are evolving as new pipeline capacity has been and is being constructed to relieve capacity constraints in the Northeast, to expand markets in the Midwest and the Southeast, and to move more gas out of the Rocky Mountain region and the Gulf of Mexico. As capacity changes take place, prices of services should adjust accordingly to reflect new market conditions.

Federal and State initiatives are reducing barriers to market entry and are encouraging the development of more competitive markets for pipeline and distribution services. Mechanisms used to make the transmission sector more competitive include the widespread capacity releasing programs, market-based rates, and the formation of market centers with deregulated upstream pipeline services. The ITS is not designed to model any specific type of program, but to simulate the overall impact of the movement towards market based pricing of transmission services.

Pipeline Tariff Submodule

The primary purpose of the Pipeline Tariff Submodule (PTS) is to provide volume dependent curves for computing tariffs for interstate transportation and storage services within the Interstate Transmission Submodule. These curves extend beyond current capacity levels and relate incremental pipeline or storage capacity expansion to corresponding estimated rates. The underlying basis for each tariff curve in the model is a forecast of the associated regulated revenue requirement. An accounting system is used to track costs and compute revenue requirements associated with both reservation and usage fees under a current typical regulated rate design. Other than an assortment of macroeconomic indicators, the primary input to the PTS from other modules/submodules in NEMS is the level of pipeline and storage capacity expansions in the previous forecast year. Once an expansion is projected to occur, the submodule calculates the resulting impact on the revenue requirement. The PTS currently assumes rolled-in (or average), not incremental rates for new capacity (i.e., the cost of any additional capacity is lumped in with the remaining costs of existing capacity when deriving a single tariff for all the customers along a pipeline segment).

Transportation revenue requirements (and associated tariff curves) are established for interregional arcs defined by the NGTDM network. These network tariff curves reflect an aggregation of the revenue requirements for individual pipeline companies represented by the network arc. Storage tariff curves are defined at regional NGTDM network nodes, and similarly reflect an aggregation of individual company storage revenue requirements. Note that these services are unbundled and do not include the price of gas, except for the cushion gas used to maintain minimum gas pressure. Furthermore, the submodule cannot address competition for pipeline or storage services along an aggregate arc or within an aggregate region, respectively. It should also be noted that the PTS deals only with the interstate market, and thus does not capture the impacts of State-specific regulations for intrastate pipelines. Intrastate transportation charges are accounted for within the Distributor Tariff Submodule.

⁴⁶Further information can be found on the U.S. Energy Information Administration web page under "Pipeline Capacity and Usage" www.eia.doe.gov/pub/oil_gas/natural_gas/analysis_publications/ngpipeline/index.html.

Pipeline tariffs for transportation and storage services represent a more significant portion of the price of gas to industrial and electric generator end-users than to other sectors. Consumers of natural gas are grouped generally into two categories: (1) those that need firm or guaranteed service because gas is their only fuel option or because they are willing to pay for security of supply, and (2) those that do not need guaranteed service because they can either periodically terminate operations or use fuels other than natural gas. The first group of customers (core customers) is assumed to purchase firm transportation services, while the latter group (non-core customers) is assumed to purchase non-firm service (e.g., interruptible service, released capacity). Pipeline companies guarantee to their core customers that they will provide peak day service up to the maximum capacity specified under their contracts even though these customers may not actually request transport of gas on any given day. In return for this service guarantee, these customers pay monthly reservation fees (or demand charges). These reservation fees are paid in addition to charges for transportation service based on the quantity of gas actually transported (usage fees or commodity charges). The pipeline tariff curves generated by the PTS are used within the ITS when determining the relative cost of purchasing and moving gas from one source versus another in the peak and off-peak seasons. They are also used when setting the price of gas along the NGTDM network and ultimately to the end-users.

The actual rates or tariffs that pipelines are allowed to charge are largely regulated by the Federal Energy Regulatory Commission (FERC). FERC's ratemaking traditionally allows (but does not necessarily guarantee) a pipeline company to recover its costs, including what the regulators consider a fair rate of return on capital. Furthermore, FERC not only has jurisdiction over how cost components are allocated to reservation and usage categories, but also how reservation and usage costs are allocated across the various classes of transmission (or storage) services offered (e.g., firm versus non-firm service). Previous versions of the NGTDM (and therefore the PTS) included representations of natural gas moved (or stored) using firm and non-firm service. However, in an effort to simplify the module, this distinction has been removed in favor of moving from an annual to a seasonal model. The impact of the distinction of firm versus non-firm service on core and non-core delivered prices is indirectly captured in the markup established in the Distributor Tariff Submodule. More recent initiatives by FERC have allowed for more flexible processes for setting rates when a service provider can adequately demonstrate that it does not possess significant market power. The use of volume dependent tariff curves partially serves to capture the impact of alternate rate setting mechanisms. Additionally, various rate making policy options discussed by FERC would allow peak-season rates to rise substantially above the 100-percent load factor rate (also known as the full cost-of-service rate). In capacity-constrained markets, the basis differential between markets connected via the constrained pipeline route will generally be above the full cost of service pipeline rates. Ultimately, the NGTDM is trying to project market prices and uses cost-of-service rates as a means in the process of establishing market prices.

Distributor Tariff Submodule

The primary purpose of the Distributor Tariff Submodule (DTS) is to determine the price markup from the regional market hub to the end-user. For most customers, this consists of (1) distributor markups charged by local distribution companies for the distribution of natural gas from the city

gate to the end user and (2) markups charged by intrastate pipeline companies for intrastate transportation services. Intrastate pipeline tariffs are specified exogenously to the model and are currently set to zero (INTRAST_TAR, Appendix E). However, these tariffs are accounted for in the module indirectly. For most industrial and electric generator customers, gas is not purchased through a local distribution company, so they are not specifically charged a distributor tariff. In this case, the “distributor tariff” represents the difference between the average price obtained by local distribution companies at the city gate and the price obtained by the average industrial or electric generator customer. Distributor tariffs are distinguished within the DTS by sector (residential, commercial, industrial, transportation, and electric generator), region (NGTDM/EMM regions for electric generators and NGTDM regions for the rest), seasons (peak or off-peak), and as appropriate by service type or class (core or non-core).

Distribution markups represent a significant portion of the price of gas to residential, commercial, and transportation customers, and less so to the industrial and electric generation sectors. Each sector has different distribution service requirements, and frequently different transportation needs. For example, the core customers in the model (residential, transportation, commercial and some industrial and electric generator customers) are assumed to require guaranteed on-demand (firm) service because natural gas is largely their only fuel option. In contrast, large portions of the industrial and electric generator sectors may not rely solely on guaranteed service because they can either periodically terminate operations or switch to other fuels. These customers are referred to as non-core. They can elect to receive some gas supplies through a lower priority (and lower cost) interruptible transportation service. While not specifically represented in the model, during periods of peak demand, services to these sectors can be interrupted in order to meet the natural gas requirements of core customers. In addition, these customers frequently select to bypass the local distribution company pipelines and hook up directly to interstate or intrastate pipelines.

The rates that local distribution companies and intrastate carriers are allowed to charge are regulated by State authorities. State ratemaking traditionally allows (but does not necessarily guarantee) local distribution companies and intrastate carriers to recover their costs, including what the regulators consider a fair return on capital. These rates are derived from the cost of providing service to the end-use customer. The State authority determines which expenses can be passed through to customers and establishes an allowed rate of return. These measures provide the basis for distinguishing rate differences among customer classes and type of service by allocating costs to these classes and services based on a rate design. The DTS does not project distributor tariffs through a rate base calculation as is done in the PTS, partially due to limits on data availability.⁴⁷ In most cases, projected distributor tariffs in the model depend initially on base year values, which are established by subtracting historical city gate prices from historical delivered prices, and generally reflect an average over recent historical years.

Distributor tariffs for all but the transportation sector are set using econometrically estimated equations.⁴⁸ Transportation sector markups, representing sales for natural gas vehicles, are set

⁴⁷ In theory these cost components could be compiled from rate filings to state Public Utility Commissions; however, such an extensive data collection effort is beyond the available resources.

⁴⁸An econometric approach was used largely as a result of data limitations. EIA data surveys do not collect the cost

separately for fleet and personal vehicles and account for distribution to delivery stations, retail markups, federal and state motor fuels taxes, and the potential impact of retail competition with gasoline. In addition, the NGTDM assesses the potential construction of infrastructure to support fueling compressed natural gas vehicles.

components required to derive revenue requirements and cost-of-service for local distribution companies and intrastate carriers. These cost components can be compiled from rate filings to Public Utility Commissions; however, an extensive data collection effort is beyond the scope of NEMS at this time.

4. Interstate Transmission Submodule Solution Methodology

As a key component of the NGTDM, the Interstate Transmission Submodule (ITS) determines the market equilibrium between supply and demand of natural gas within the North American pipeline system. This translates into finding the price such that the quantity of gas that consumers would desire to purchase equals the quantity that producers would be willing to sell, accounting for the transmission and distribution costs, pipeline fuel use, capacity expansion costs and limitations, and mass balances. To accomplish this, two seasonal periods were represented within the module--a peak and an off-peak period. The network structures within each period consist of an identical system of pipelines, and are connected through common supply sources and storage nodes. Thus, two interconnected networks (peak and off-peak) serve as the framework for processing key inputs to generate the desired outputs. A heuristic approach is used to systematically move through the two networks solving for production levels, network flows, pipeline and storage capacity requirements,⁴⁹ supply prices, and delivered prices until mass balance and convergence are achieved. (The methodology used for calculating distributor tariffs is presented in Chapter 5.) Primary input requirements include seasonal consumption levels, capacity expansion cost curves, annual natural gas supply levels and/or curves, a representation of pipeline and storage tariffs, as well as values for pipeline and storage starting capacities, and network flows and prices from the previous year. Some of the inputs are provided by other NEMS modules, some are exogenously defined and provided in input files, and others are generated by the module in previous years or iterations and used as starting values. Wellhead, import, and delivered prices, supply quantities, and resulting flow patterns are obtained from the ITS and sent to other NGTDM submodules or other NEMS modules after some processing. Network characteristics, input requirements, and the heuristic process are presented more fully below.

Network Characteristics in the ITS

As described in an earlier chapter, the NGTDM network consists of 12 NGTDM regions (or transshipment nodes) in the lower 48 states, three Mexican border crossing nodes, seven Canadian border crossing nodes, and two Canadian supply/demand regions. Interregional arcs connecting the nodes represent an aggregation of pipelines that are capable of moving gas from one region (or transshipment node) into another. These arcs have been classified as either primary flow arcs or secondary flow arcs. The primary flow arcs (see **Figure 3-1**) represent major flow corridors for the transmission of natural gas. Secondary arcs represent either flow in the opposite direction from the primary flow (historically about 3 percent of the total flow) or relatively low flow volumes that are set exogenously or outside the ITS equilibration routine (e.g. Mexican imports and exports). In the ITS, this North American natural gas pipeline flow network has been restructured into a hierarchical, acyclic network representing just the primary flow of natural gas (**Figure 4-1**). The representation of flows along secondary arcs is described in the Solution Process section below. A hierarchical, acyclic network structure allows for the

⁴⁹In reality, capacity expansion decisions are made based on expectations of future demand requirements, allowing for regulatory approvals and construction lead times. In the model, additional capacity is available immediately, once it is determined that it is needed. The implicit assumption is that decision makers exercised perfect foresight, that planning and construction for the pipeline actually started before the pipeline came online.

systematic representation of the flow of natural gas (and its associated prices) from the supply sources, represented towards the bottom of the network, up through the network to the end-use consumer at the upper end of the network.

Figure 4-1. Network “Tree” or Hierarchical, Acyclic Network of Primary Arcs

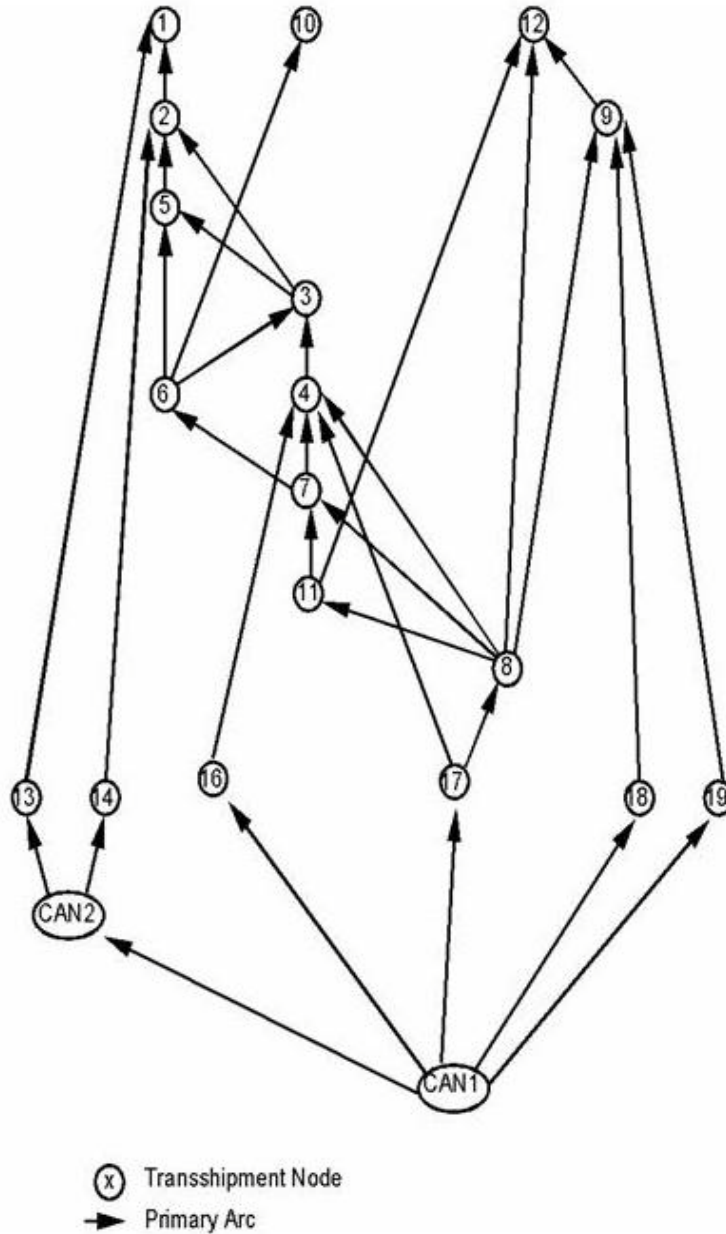

In the ITS, two interconnected acyclic networks are used to represent natural gas flow to end-use markets during the peak period (PK) and flow to end-use markets during the off-peak period (OP). These networks are connected regionally through common supply sources and storage nodes (**Figure 4-2**). Storage within the module only represents the transfer of natural gas produced in the off-peak period to meet the higher demands in the peak period. Therefore, net storage injections are included only in the off-peak period, while net storage withdrawals occur only in the peak period. Within a given forecast year, the withdrawal level from storage in the peak period establishes the level of gas injected in the off-peak period. Annual supply sources provide natural gas to both networks based on the combined network production requirements and corresponding annual supply availability in each region.

Figure 4-2. Simplified Example of Supply and Storage Links Across Networks

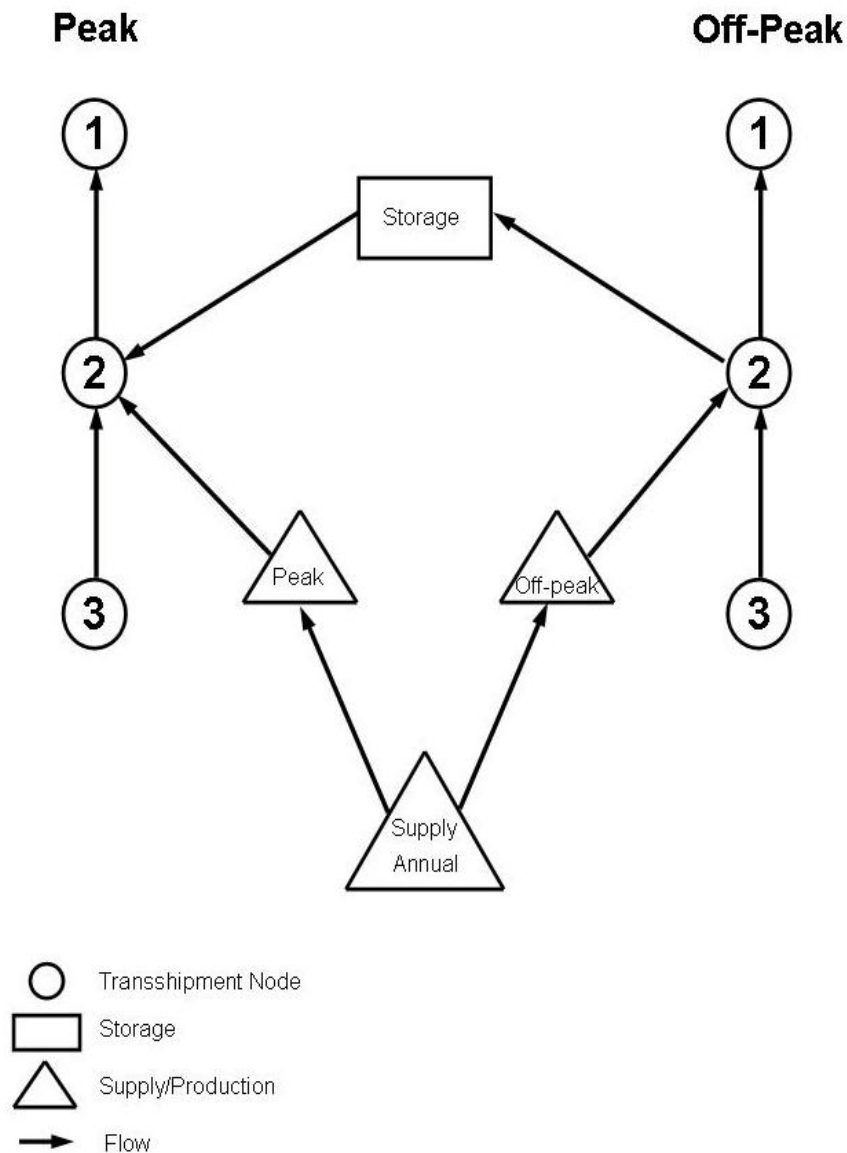

Input Requirements of the ITS

The following is a list of the key inputs required during ITS processing:

- Seasonal end-use consumption or demand curves for each NGTDM region and Canada
- Seasonal imports (except Canada) and exports by border crossing
- Canadian import capacities by border crossing
- Natural gas production in eastern Canada and unconventional production in western Canada, by season.
- Natural gas flow by pipeline from Alaska to Alberta.
- Natural gas flow by pipeline from the MacKenzie Delta to Alberta.
- Regional supply curve parameters for U.S. nonassociated and western Canadian conventional natural gas supply⁵⁰
- Seasonal supply quantities for U.S. associated-dissolved gas, synthetic gas, and other supplemental supplies by NGTDM region
- Seasonal network flow patterns from the previous year, by arc (including flows from storage, variable supply sources, and pipeline arcs)
- Seasonal network prices from the previous year, by arc (including flows from storage, variable supply sources, and pipeline arcs)
- Pipeline capacities, by arc
- Seasonal maximum pipeline utilizations, by arc
- Seasonal pipeline (and storage) tariffs representing variable costs or usage fees, by arc (and region)
- Pipeline capacity expansion/tariff curves for the peak network, by arc
- Storage capacity expansion/tariff curves for the peak network, by region
- Seasonal distributor tariffs by sector and region

Many of the inputs are provided by other NEMS submodules, some are defined from data within the ITS, and others are ITS model results from operation in the previous year. For example, supply curve parameters for lower 48 nonassociated onshore and offshore natural gas production, western Canadian conventional natural gas supply curves, and lower 48 associated-dissolved gas production are provided by the Oil and Gas Supply Module (OGSM). In contrast, Canadian data, with the exclusion of conventional western Canadian supply curves, are set as direct input to the ITS. U.S. end-use consumption levels are provided by NEMS demand modules; pipeline and storage capacity expansion/tariff curve parameters are provided by the Pipeline Tariff Submodule (PTS, see chapter 6); and seasonal distributor tariffs are defined by the Distributor Tariff Submodule (DTS, see Chapter 5). Seasonal network flow patterns and prices are determined within the ITS. They are initially set based on historical data, and then from model results in the previous model year.

Because the ITS is a seasonal model, most of the input requirements are on a seasonal level. In most cases, however, the information provided is not represented in the form defined above and needs to be processed into the required form. For example, regional end-use consumption levels

⁵⁰These supply sources are referred to as the “variable” supplies because they are allowed to change in response to price changes during the ITS solution process.

are initially defined by sector on an annual basis. The ITS disaggregates each of these sector-specific quantities into a seasonal peak and off-peak representation, and then aggregates across sectors within each season to set a total consumption level. Also, regional fixed supplies and some of the import/export levels represent annual values. A simple methodology has been developed to disaggregate the annual information into peak and off-peak quantities using item-specific peak sharing factors (e.g., PKSHR_ECAN, PKSHR_EMEX, PKSHR_ICAN, PKSHR_IMEX, PKSHR_SUPLM, PKSHR_ILNG, and PKSHR_YR). For more detail on these inputs see Chapter 2. A similar method is used to approximate the consumption and supply in the peak month of each period. This information is used to verify that sufficient sustained⁵¹ capacity is available for the peak day in each period; and if not, it is used as a basis for adding additional capacity. The assumption reflected in the model is that, if there is sufficient sustained capacity to handle the peak month, line packing⁵² and propane injection can be used to accommodate a peak day in this month.

Heuristic Process

The basic process used to determine supply and delivered prices in the ITS involves starting from the top of the hierarchical, acyclic network or “tree” (as shown in **Figure 4-1**) with end-use consumption levels, systematically moving down each network (in the opposite direction from the primary flow of gas) to define seasonal flows along network arcs that will satisfy the consumption, evaluating wellhead prices for the desired production levels, and then moving up each network (in the direction of the primary flow of gas) to define transmission, node, storage, and delivered prices.

While progressively moving down the peak or off-peak network, net regional demands are established for each node on each network. Net regional demands are defined as the sum of consumption in the region plus the gas that is exiting the region to satisfy consumption elsewhere, net of fixed⁵³ supplies in the region. The consumption categories represented in net regional demands include end-use consumption in the region, exports, pipeline fuel consumption, secondary and primary flows out of the region, and for the off-peak period, net injections into regional storage facilities. Regional fixed supplies include imports (except conventional gas from Western Canada), secondary flows into the region, and the regions associated-dissolved production, supplemental supplies, and other fixed supplies. The net regional demands at a node will be satisfied by the gas flowing along the primary arcs into the node, the local “variable” supply flowing into the node, and for the peak period, the gas withdrawn from the regional storage facilities on a net basis.

Starting with the node(s) at the top of the network tree (i.e., nodes 1, 10, and 12 in **Figure 4-1**), a sharing algorithm is used to determine the percent of the represented region’s net demand that is satisfied by each arc going into the node. The resulting shares are used to define flows along

⁵¹“Sustained” capacity refers to levels that can operationally be sustained throughout the year, as opposed to “peak” capacity which can be realized at high pressures and would not generally be maintained other than at peak demand periods.

⁵²Line packing is a means of storing gas within a pipeline for a short period of time by compressing the gas.

⁵³Fixed supplies are those supply sources that are not allowed to vary in response to changes in the natural gas price during the ITS solution process.

each arc (supply, storage, and interregional pipeline) into the region (or node). The interregional flows then become additional consumption requirements (i.e., primary flows out of a region) at the corresponding source node (region). If the arc going into the original node is from a supply or storage⁵⁴ source, then the flow represents the production or storage withdrawal level, respectively. The sharing algorithm is systematically applied (going down the network tree) to each regional node until flows have been defined for all arcs along a network, such that consumption in each region is satisfied.

Once flows are established for each network (and pipeline tariffs are set by applying the flow levels to the pipeline tariff curves), resulting production levels for the variable supplies are used to determine regional wellhead prices and, ultimately, storage, node, and delivered prices. By systematically moving up each network tree, regional wellhead prices are used with pipeline tariffs, while adjusting for price impacts from pipeline fuel consumption, to calculate regional node prices for each season. Next, intraregional and intrastate markups are added to the regional/seasonal node prices, followed by the addition of corresponding seasonal, sectoral distributor tariffs, to generate delivered prices. Seasonal prices are then converted to annual delivered prices using quantity-weighted averaging. To speed overall NEMS convergence,⁵⁵ the delivered prices can be applied to representative demand curves to approximate the demand response to a change in the price and to generate a new set of consumption levels. This process of going up and down the network tree is repeated until convergence is reached.

The order in which the networks are solved differs depending on whether movement is down or up the network tree. When proceeding down the network trees, the peak network flows are established first, followed by the off-peak network flows. This order has been established for two reasons. First, capacity expansion is decided based on peak flow requirements.⁵⁶ This in turn is used to define the upper limits on flows along arcs in the off-peak network. Second, net storage injections (represented as consumption) in the off-peak season cannot be defined until net storage withdrawals (represented as supplies) in the peak season are established. When going up the network trees, prices are determined for the off-peak network first, followed by the peak network. This order has been established mainly because the price of fuel withdrawn from storage in the peak season is based on the cost of fuel injected into storage in the off-peak season plus a storage tariff.

If net demands exceed available supplies on a network in a region, then a backstop supply is made available at a higher price than other local supply. The higher price is passed up the network tree to discourage (or decrease) demands from being met via this supply route. Thus, network flows respond by shifting away from the backstop region until backstop supply is no longer needed.

⁵⁴For the peak period networks only.

⁵⁵At various times, NEMS has not readily converged and various approaches have been taken to improve the process. If the NGTDM can anticipate the potential demand response to a price change from one iteration to the next, and accordingly moderate the price change, the NEMS will theoretically converge to an equilibrium solution in less iterations.

⁵⁶Pipeline capacity into region 10 (Florida) is allowed to expand in either the peak or off-peak period because the region experiences its peak usage of natural gas in what is generally the off-peak period for consumption in the rest of the country.

Movement down and up each network tree (defined as a cycle) continues within a NEMS iteration until the ITS converges. Convergence is achieved when the regional seasonal supply prices determined during the current cycle down the network tree are within a designated minimum percentage tolerance from the supply prices established the previous cycle down the network tree. In addition, the absolute change in production between cycles within supply regions with relatively small production levels are checked in establishing convergence. In addition, the presence of backstop will prevent convergence from being declared. Once convergence is achieved, only one last movement up each network tree is required to define final regional/seasonal node and delivered prices. If convergence is not achieved, then a set of “relaxed” supply prices is determined by weighting regional production results from both the current and the previous cycle down the network tree, and obtaining corresponding new annual and seasonal supply prices from the supply curves in each region based on these “relaxed” production levels. The concept of “relaxation” is a means of speeding convergence by solving for quantities (or prices) in the current iteration based on a weighted-average of the prices (or quantities) from the previous two iterations, rather than just using the previous iteration’s values.⁵⁷

The following subsections describe many of these procedures in greater detail, including: net node demands, pipeline fuel consumption, sharing algorithm, wellhead prices, tariffs, arc, node, and storage prices, backstop, convergence, and delivered and import prices. A simple flow diagram of the overall process is presented in **Figure 4-3**.

Net Node Demands

Seasonal net demands at a node are defined as total seasonal demands in the region, net of seasonal fixed supplies entering the region. Regional demands consist of primary flows exiting the region (including net storage injections in the off-peak), pipeline fuel consumption, end-use consumption, discrepancies (or historical balancing item), Canadian consumption, exports, and other secondary flows exiting the region. Fixed supplies include associated-dissolved gas, Alaskan gas supplies to Alberta, synthetic natural gas, other supplemental supplies, LNG imports, fixed Canadian supplies (including MacKenzie Delta gas), and other secondary flows entering the region. Seasonal net node demands are represented by the following equations:

Peak:

$$\begin{aligned}
 \text{NODE_DMD}_{\text{PK},r} &= \text{PFUEL}_{\text{PK},r} + \text{FLOW}_{\text{PK},a} + \text{NODE_CDMD}_{\text{PK},r} \\
 &+ \sum_{\text{nonu}} (\text{PKSHR_DMD}_{\text{nonu},r} * (\text{ZNGQTY_F}_{\text{nonu},r} + \text{ZNGQTY_I}_{\text{nonu},r})) + \\
 &+ \sum_{\text{jutil} < r} (\text{PKSHR_UDMD}_{\text{jutil}} * (\text{ZNGUQTY_F}_{\text{jutil}} + \text{ZNGUQTY_I}_{\text{jutil}}))
 \end{aligned} \tag{48}$$

⁵⁷The model typically solves within 3 to 6 cycles.

Figure 4-3. Interstate Transmission Submodule System Diagram

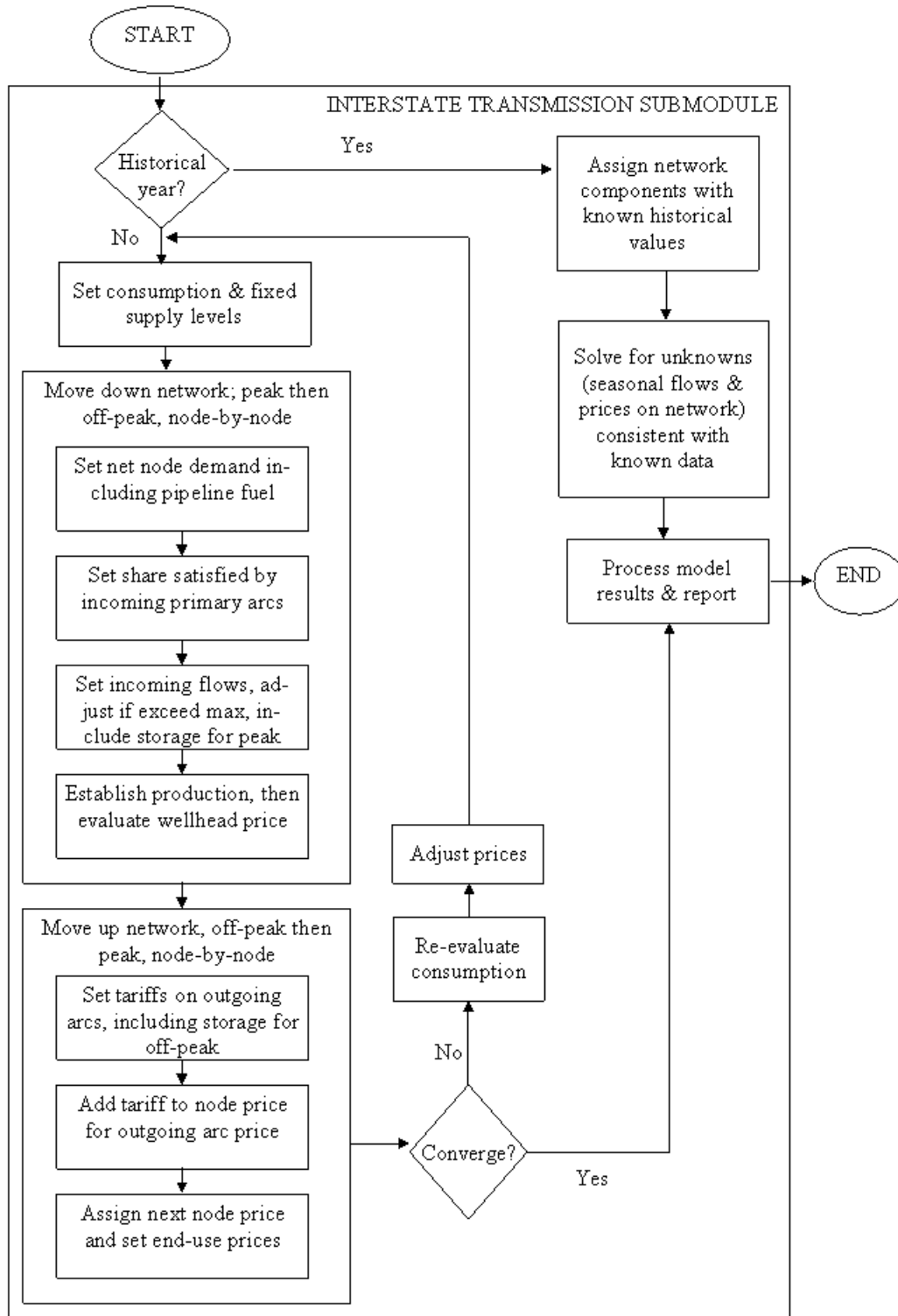

$$\text{NODE_CDMD}_{\text{PK},r} = \text{YEAR_CDMD}_{\text{PK},r} - (\text{PKSHR_PROD}_s * \text{ZADGPRD}_s) - (\text{PKSHR_ILNG} * \text{OGQNGIMP}_{L,t}) \quad (49)$$

$$\begin{aligned} \text{YEAR_CDMD}_{\text{PK},r} = & \text{DISCR}_{\text{PK},r,t} + \text{CN_DISCR}_{\text{PK},\text{cn}} \\ & ((\text{PKSHR_CDMD}) * \text{CN_DMD}_{\text{cn},r}) + \\ & (\text{PK1} * \text{SAFLOW}_{a,t}) - (\text{PK2} * \text{SAFLOW}_{a',t}) - \\ & (\text{PKSHR_YR} * \text{QAK_ALB}_t) - (\text{PKSHR_SUPLM} * \text{ZTOTSUP}_r) - \\ & (\text{PKSHR_PROD}_s * \text{CN_FIXSUP}_{\text{cn},t}) \end{aligned} \quad (50)$$

Off-Peak:

$$\begin{aligned} \text{NODE_DMD}_{\text{OP},r} = & \text{PFUEL}_{\text{OP},r} + \text{FLOW}_{\text{OP},a} + \text{FLOW}_{\text{PK},\text{st}} + \text{NODE_CDMD}_{\text{OP},r} + \\ & \sum_{\text{nonu}} ((1 - \text{PKSHR_DMD}_{\text{nonu},r}) * (\text{ZNGQTY_F}_{\text{nonu},r} + \text{ZNGQTY_I}_{\text{nonu},r})) + \end{aligned} \quad (51)$$

$$\sum_{\text{jutil} < r} ((1 - \text{PKSHR_UDMD}_{\text{jutil}}) * (\text{ZNGUQTY_F}_{\text{jutil}} + \text{ZNGUQTY_I}_{\text{jutil}})) +$$

$$\text{NODE_CDMD}_{\text{OP},r} = \text{YEAR_CDMD}_{\text{OP},r} - ((1 - \text{PKSHR_PROD}_s) * \text{ZADGPRD}_s) - ((1 - \text{PKSHR_ILNG}) * \text{OGQNGIMP}_{L,t}) \quad (52)$$

$$\begin{aligned} \text{YEAR_CDMD}_{\text{OP},r} = & \text{DISCR}_{\text{OP},r,t} + \text{CN_DISCR}_{\text{OP},\text{cn}} + \\ & ((1 - \text{PKSHR_CDMD}) * \text{CN_DMD}_{\text{cn},r}) + \\ & ((1 - \text{PK1}) * \text{SAFLOW}_{a,t}) - ((1 - \text{PK2}) * \text{SAFLOW}_{a',t}) - \\ & ((1 - \text{PKSHR_YR}) * \text{QAK_ALB}_t) - \\ & ((1 - \text{PKSHR_SUPLM}) * \text{ZTOTSUP}_r) - \\ & ((1 - \text{PKSHR_PROD}_s) * \text{CN_FIXSUP}_{\text{cn},t}) \end{aligned} \quad (53)$$

where,

- $\text{NODE_DMD}_{n,r}$ = net node demands in region r, for network n (Bcf)
- $\text{NODE_CDMD}_{n,r}$ = net node demands remaining constant each NEMS iteration in region r, for network n (Bcf)
- $\text{YEAR_CDMD}_{n,r}$ = net node demands remaining constant within a forecast year in region r, for network n (Bcf)
- $\text{PFUEL}_{n,r}$ = Pipeline fuel consumption in region r, for network n (Bcf)
- $\text{FLOW}_{n,a}$ = Seasonal flow on network n, along arc a [out of region r] (Bcf)

- ZNGQTY_F_{nonu,r} = Core demands in region r, by nonelectric sectors nonu (Bcf)
 ZNGQTY_I_{nonu,r} = Noncore demands in region r, by nonelectric sectors nonu(Bcf)
 ZNGUQTY_F_{jutil} = Core utility demands in NGTDM/EMM subregion jutil [subset of region r] (Bcf)
 ZNGUQTY_I_{jutil} = Noncore utility demands in NGTDM/EMM subregion jutil [subset of region r] (Bcf)
 ZADGPRD_s = Onshore and offshore associated-dissolved gas production in supply subregion s (Bcf)
 DISCR_{n,r,t} = Lower 48 discrepancy in region r, for network n, in forecast year t (Bcf)⁵⁸
 CN_DISCR_{n,cn} = Canada discrepancy in Canadian region cn, for network n (Bcf)
 CN_DMD_{cn,t} = Canada demand in Canadian region cn, in forecast year t (Bcf, Appendix E)
 SAFLOW_{a,t} = Secondary flows out of region r, along arc a [includes Canadian and Mexican exports, Canadian gas that flows through the U.S., and lower 48 bidirectional flows] (Bcf)
 SAFLOW_{a',t} = Secondary flows into region r, along arc a' [includes Mexican imports, Canadian imports into the East North Central Census Division, Canadian gas that flows through the U.S., and lower 48 bidirectional flows] (Bcf)
 QAK_ALB_t = Natural gas flow from Alaska into Alberta via pipeline (Bcf)
 ZTOTSUP_r = Total supply from SNG liquids, SNG coal, and other supplemental in forecast year t (Bcf)
 OGQNGIMP_{L,t} = LNG imports from LNG region L, in forecast year t (Bcf)
 CN_FIXSUP_{cn,t} = Fixed supply from Canadian region cn, in forecast year t (Bcf, Appendix E)
 PK1, PK2 = Fraction of flow corresponding to peak season (composed of PKSHR_ECAN, PKSHR_EMEX, PKSHR_ICAN, PKSHR_IMEX, or PKSHR_YR)
 PKSHR_DMD_{nonu,r} = Average (2001-2008) fraction of annual consumption in each nonelectric sector in region r corresponding to the peak season
 PKSHR_UDMD_{jutil} = Average (1994-2008, except New England 1997-2008) fraction of annual consumption in the electric generator sector in region r corresponding to the peak season
 PKSHR_PROD_s = Average (1994-2008) fraction of annual production in supply region s corresponding to the peak season (fraction, Appendix E)
 PKSHR_CDMD = Fraction of annual Canadian demand corresponding to the peak season (fraction, Appendix E)
 PKSHR_YR = Fraction of the year represented by the peak season
 PKSHR_SUPLM = Average (1990-2008) fraction of supplemental supply corresponding to the peak season

⁵⁸Projected lower 48 discrepancies are primarily based on the average historical level from 1999 to 2007. Discrepancies are adjusted in the STEO years to account for STEO discrepancy (Appendix E, STDISCR) and annual net storage withdrawal (Appendix E, NNETWITH) forecasts, and differences between NEMS and STEO total consumption levels Appendix E, STENDCON). These adjustments are phased out over a user-specified number of years (Appendix E, STPHAS_YR).

PKSHR_ILNG = Fraction of LNG imports corresponding to the peak season
 PKSHR_ECAN = Fraction of Canadian exports transferred in peak season
 PKSHR_ICAN = Fraction of Canadian imports transferred in peak season
 PKSHR_EMEX = Fraction of Mexican exports transferred in peak season
 PKSHR_IMEX = Fraction of Mexican imports transferred in peak season
 r = region/node
 n = network (peak or off-peak)
 PK,OP = Peak and off-peak network, respectively
 nonu = Nonelectric sector ID: residential, commercial, industrial, transportation
 jutil = Utility sector subregion ID in region r
 a,a' = Arc ID for arc entering (a') or exiting (a) region r
 s = Supply subregion ID into region r (1-21)
 cn = Canadian supply subregion ID in region r (1-2)
 L = LNG import region ID into region r (1-12)
 st = Arc ID corresponding to storage supply into region r
 t = Current forecast year

Pipeline Fuel Use and Intraregional Flows

Pipeline fuel consumption represents the natural gas consumed by compressors to transmit gas along pipelines within a region. In the ITS, pipeline fuel consumption is modeled as a regional demand component. It is estimated for each region on each network using a historically based factor, corresponding net demands, and a multiplicative scaling factor. The scaling factor is used to calibrate the results to equal the most recent national *Short-Term Energy Outlook (STEO)* forecast⁵⁹ for pipeline fuel consumption (Appendix E, STQGPTR), net of pipeline fuel consumption in Alaska (QALK_PIP), and is phased out by a user-specified year (Appendix E, STPHAS_YR). The following equation applies:

$$PFUEL_{n,r} = PFUEL_FAC_{n,r} * NODE_DMD_{n,r} * SCALE_PF \quad (54)$$

where,

PFUEL_{n,r} = Pipeline fuel consumption in region r, for network n (Bcf)
 PFUEL_FAC_{n,r} = Average (2003-2008) historical pipeline fuel factor in region r, for network n (calculated historically for each region as equal PFUEL/NODE_DMD)
 NODE_DMD_{n,r} = Net demands (excluding pipeline fuel) in region r, for network n (Bcf)
 SCALE_PF = STEO benchmark factor for pipeline fuel consumption
 n = network (peak and off-peak)
 r = region/node

⁵⁹EIA produces a separate quarterly forecast for primary national energy statistics over the next several years. For certain forecast items, the NEMS is calibrated to produce an equivalent (within 2 to 5 percent) result for these years. For *AEO2010*, the years calibrated to *STEO* results were 2009 and 2010.

After pipeline fuel consumption is calculated at each node on the network, the regional/seasonal value is added to net demand at the respective node. Flows into a node ($FLOW_{n,a}$) are then defined using net demands and a sharing algorithm (described below). The regional pipeline fuel quantity (net of intraregional pipeline fuel consumption)⁶⁰ is distributed over the pipeline arcs entering the region. This is accomplished by sharing the net pipeline fuel quantity over all of the interregional pipeline arcs entering the region, based on their relative levels of natural gas flow:

$$ARC_PFUEL_{n,a} = (PFUEL_{n,r} - INTRA_PFUEL_{n,r}) * \frac{FLOW_{n,a}}{TFLOW} \quad (55)$$

where,

- ARC_PFUEN_{n,a} = Pipeline fuel consumption along arc a (into region r), for network n (Bcf)
- PFUEL_{n,r} = Pipeline fuel consumption in region r, for network n (Bcf)
- INTRA_PFUEN_{n,r} = Intraregional pipeline fuel consumption in region r, for network n (Bcf)
- FLOW_{n,a} = Interregional pipeline flow along arc a (into region r), for network n (Bcf)
- TFLOW = Total interregional pipeline flow [into region r] (Bcf)
- n = network (peak and off-peak)
- r = region/node
- a = arc

Pipeline fuel consumption along an interregional arc and within a region on an intrastate pipeline will have an impact on pipeline tariffs and node prices. This will be discussed later in the Arc, Node, and Storage Prices subsection.

The flows of natural gas on the interstate pipeline system within each NGTDM region (as opposed to between two NGTDM regions) are established for the purpose of setting the associated revenue requirements and tariffs. The charge for moving gas within a region (INTRAREG_TAR), but on the interstate pipeline system, is taken into account when setting city gate prices, described below. The algorithm for setting intraregional flows is similar to the method used for setting pipeline fuel consumption. For each region in the historical years, a factor is calculated reflective of the relationship between the net node demand and the intraregional flow. This factor is applied to the net node demand in each forecast year to approximate the associated intraregional flow. Pipeline fuel consumption is excluded from the net node demand for this calculation, as follows:

⁶⁰Currently, intraregional pipeline fuel consumption (INTRA_PFUEN) is set equal to the regional pipeline fuel consumption level (PFUEL); therefore, pipeline fuel consumption along an arc (ARC_PFUEN) is set to zero. The original design was to allocate pipeline fuel according to flow levels on arcs and within a region. It was later determined that assigning all of the pipeline fuel to a region would simplify benchmarking the results to the STEO and would not change the later calculation of the price impacts of pipeline fuel use.

Calculation intraregional flow factor in an historical year:

$$\text{FLO_FAC}_{n,r} = \text{INTRA_FLO}_{n,r} / (\text{NODE_DMD}_{n,r} - \text{PFUEL}_{n,r}) \quad (56)$$

Forecast of intraregional flow:

$$\text{INTRA_FLO}_{n,r} = \text{FLO_FAC}_{n,r} * (\text{NODE_DMD}_{n,r} - \text{PFUEL}_{n,r}) \quad (57)$$

where,

- INTRA_FLO_{n,a} = Intraregional, interstate pipeline flow within region r, for network n (Bcf)
- PFUEL_{n,r} = Pipeline fuel consumption in region r, for network n (Bcf)
- NODE_DMD_{n,r} = Net demands (with pipeline fuel) in region r, for network n (Bcf)
- FLO_FAC_{n,r} = Average (1990 - 2007) historical relationship between net node demand and intraregional flow
- n = network (peak and off-peak)
- r = region/node

Historical annual intraregional flows are set for the peak and off-peak periods based on the peak and off-peak share of net node demand in each region.

Sharing Algorithm, Flows, and Capacity Expansion

While moving systematically downward from node to node through the acyclic network, a sharing algorithm is used to allocate net demands (NODE_DMD_{n,r}) across all arcs feeding into the node. These “inflow” arcs carry flows from local supply sources, storage (net withdrawals during peak period only), or other regions (interregional arcs). If any of the resulting flows exceed their corresponding maximum levels,⁶¹ then the excess flows are reallocated to the unconstrained arcs, and new shares are calculated accordingly. At each node within a network, the sharing algorithm determines the percent of net demand (SHR_{n,a,t}) that is satisfied by each of the arcs entering the region.

The sharing algorithm dictates that the share (SHR_{n,a,t}) of demand for one arc into a node is proportional to the share defined in the previous model year.⁶² This proportion is a multiplicative value represented as the ratio of the inverse price (defined the previous cycle up the network tree) along the arc, to the average of all inverse prices along all arcs going into that node. The price term (ARC_SHRPR_{n,a}) represents the unit cost associated with an arc going into a node, and is defined as the sum of the unit cost at the source node (NODE_SHRPR_{n,r}) and the tariff charge along the arc (ARC_SHRFEE_{n,a}). (A description of how these components are developed is presented later.) The variable γ is an assumed parameter that is always positive. This parameter can be used to prevent (or control) broad shifts in flow patterns from one forecast

⁶¹Maximum flows include potential pipeline or storage capacity additions, and maximum production levels.

⁶²When planned pipeline capacity is added at the beginning of a forecast year, the value of SHR_{t-1} is adjusted to reflect a percent usage (PCTADJSHR, Appendix E) of the new capacity. This adjustment is based on the assumption that last year’s share would have been higher if not constrained by the existing capacity levels.

year to the next. Larger values of γ increase the sensitivity of $SHR_{n,a,t}$ to relative prices; a very large value of γ would result in behavior equivalent to cost minimization. The algorithm is presented below:

$$SHR_{n,a,t} = \frac{\frac{ARC_SHRPR_{n,a}^{-\gamma}}{\sum_b ARC_SHRPR_{n,b}^{-\gamma}}}{N} * SHR_{n,a,t-1} \quad (58)$$

where,

- $SHR_{n,a,t}, SHR_{n,a,t-1}$ = The fraction of demand represented along inflow arc a on network n, in year t (or year t-1) [Note: The value for year t-1 has a lower limit set to 0.01]
- $ARC_SHRPR_{n,a \text{ or } b}$ = The last price calculated for natural gas from inflow arc a (or b) on network n [i.e., from the previous cycle while moving up the network] (87\$/Mcf)
- N = Total number of arcs into a node
- γ = Coefficient defining degree of influence of relative prices (represented as GAMMAFAC, Appendix E)
- t = forecast year
- n = network (peak or off-peak)
- a = arc into a region
- r = region/node
- b = set of arcs into a region

[Note: The resulting shares ($SHR_{n,a,t}$) along arcs going into a node are then normalized to ensure that they add to one.]

Seasonal flows are generated for each arc using the resulting shares and net node demands, as follows:

$$FLOW_{n,a} = SHR_{n,a,t} * NODE_DMD_{n,r} \quad (59)$$

where,

- $FLOW_{n,a}$ = Interregional flow (into region r) along arc a, for network n (Bcf)
- $SHR_{n,a,t}$ = The fraction of demand represented along inflow arc a on network n, in year t
- $NODE_DMD_{n,r}$ = Net node demands in region r, for network n (Bcf)
- n = network (peak or off-peak)
- a = arc into a region
- r = region/node

These flows must not exceed the maximum flow limits ($MAXFLO_{n,a}$) defined for each arc on each network. The algorithm used to define maximum flows may differ depending on the type of arc (storage, pipeline, supply, Canadian imports) and the network being referenced. For

example, maximum flows for all *peak* network arcs are a function of the maximum permissible annual capacity levels ($MAXPCAP_{PK,a}$) and peak utilization factors. However, maximum *pipeline* flows along the *off-peak* network arcs are a function of the annual capacity defined by peak flows and off-peak utilization factors. Thus, maximum flows along the off-peak network depend on whether or not capacity was added during the peak period. Also, maximum flows from *supply* sources in the off-peak network are limited by maximum annual capacity levels and off-peak utilization. (Note: *storage* arcs do not enter nodes on the off-peak network; therefore, maximum flows are not defined there.) The following equations define maximum flow limits and maximum annual capacity limits:

Maximum peak flows (note: for storage arcs, $PKSHR_YR=1$):

$$MAXFLO_{PK,a} = MAXPCAP_{PK,a} * (PKSHR_YR * PKUTZ_a) \quad (60)$$

such that $MAXPCAPPK,a$

for *Supply*⁶³:

$$MAXPCAP_{PK,a} = ZOGRESNG_s * ZOGPRRNG_s * MAXPRRFAC * (1 - (PCTLP_r * SCALE_LP_t)) \quad (61)$$

for *Pipeline*:

$$MAXPCAP_{PK,a} = PTMAXPCAP_{i,j} \quad (62)$$

for *Storage*:

$$MAXPCAP_{PK,a} = PTMAXPSTR_{st} \quad (63)$$

for *Canadian imports*:

$$MAXPCAP_{PK,a} = CURPCAP_{a,t} \quad (64)$$

Maximum off-peak pipeline flows:

$$MAXFLO_{OP,a} = MAXPCAP_{OP,a} * ((1 - PKSHR_YR) * OPUTZ_a) \quad (65)$$

such that $MAXPCAP_{OP,a}$ is either *current capacity*:

⁶³In historical years, historical production values are used in place of the product of ZOGRESNG and ZOGPRRNG.

$$\text{MAXPCAP}_{\text{OP},a} = \text{CURPCAP}_{a,t} \quad (66)$$

or *current capacity plus capacity additions*,

$$\text{MAXPCAP}_{\text{OP},a} = \text{CURPCAP}_{a,t} + ((1 + \text{XBLD}) * \left(\frac{\text{FLOW}_{\text{PK},a}}{\text{PKSHR_YR} * \text{PKUTZ}_a} - \text{CURPCAP}_{a,t} \right)) \quad (67)$$

or, for *pipeline arc entering region 10 (Florida), peak maximum capacity*,

$$\text{MAXPCAP}_{\text{OP},a} = \text{MAXPCAP}_{\text{PK},a} \quad (68)$$

Maximum off-peak flows from supply sources:

$$\text{MAXFLO}_{\text{OP},a} = \text{MAXPCAP}_{\text{PK},a} * ((1 - \text{PKSHR_YR}) * \text{OPUTZ}_a) \quad (69)$$

where,

- $\text{MAXFLO}_{n,a}$ = Maximum flow on arc a, in network n [PK-peak or OP-off-peak] (Bcf)
- $\text{MAXPCAP}_{n,a}$ = Maximum annual physical capacity along arc a for network n (Bcf)
- $\text{CURPCAP}_{a,t}$ = Current annual physical capacity along arc a in year t (Bcf)
- ZOGRESNG_s = Natural gas reserve levels for supply source s [defined by OGSM] (Bcf)
- ZOGPRRNG_s = Expected natural gas production-to-reserves ratio for supply source s [defined by OGSM] (fraction)
- MAXPRRFAC = Factor to set maximum production-to-reserves ratio [MAXPRRCAN for Canada] (Appendix E)
- PCTLP_t = Average (1996-2008) fraction of production consumed as lease and plant fuel in forecast year t
- SCALE_LP_t = Scale factor for STEO year percent lease and plant consumption for forecast year t to force regional lease and plant consumption forecast to total to STEO forecast.
- $\text{PTMAXPCAP}_{i,j}$ = Maximum pipeline capacity along arc defined by source node i and destination node j [defined by PTS] (Bcf)
- PTMAXPSTR_{st} = Maximum storage capacity for storage source st [defined by PTS] (Bcf)
- $\text{FLOW}_{\text{PK},a}$ = Flow along arc a for the peak network (Bcf)
- PKSHR_YR = Fraction of the year represented by peak season
- PKUTZ_a = Pipeline utilization along arc a for the peak season (fraction, Appendix E)
- OPUTZ_a = Pipeline utilization along arc a for the off-peak season (fraction, Appendix E)
- XBLD = Percent increase over capacity builds to account for weather (fraction, Appendix E)

- a = arc
- t = forecast year
- n = network (peak or off-peak)
- PK, OP = peak and off-peak network, respectively
- s,st = supply or storage source
- i,j = regional source (i) and destination (j) link on arc a

If the model has been restricted from building capacity through a specified forecast year (Appendix E, NOBLDYR), then the maximum pipeline and storage flow for either network will be based only on current capacity and utilization for that year.

If the flows defined by the sharing algorithm above exceed these maximum levels, then the excess flow is reallocated along adjacent arcs that have excess capacity. This is achieved by determining the flow distribution of the qualifying adjacent arcs, and distributing the excess flow according to this distribution. These adjacent arcs are checked again for excess flow and, if found, the reallocation process is performed again on all arcs with space remaining. This applies to supply and pipeline arcs on all networks, as well as storage withdrawal arcs on the peak network. To handle the event where insufficient space or supply is available on all inflowing arcs to meet demand, a backstop supply (BKSTOP_{n,r}) is available at an incremental price (RBKSTOP_PADJ_{n,r}). The intent is to dissuade use of the particular route, or to potentially lower demands. Backstop pricing will be defined in another section below.

With the exception of import and export arcs,⁶⁴ the resulting interregional flows defined by the sharing algorithm for the peak network are used to determine if *pipeline* capacity expansion should occur. Similarly, the resulting storage withdrawal quantities in the peak season define the *storage* capacity expansion levels. Thus, initially capacity expansion is represented by the difference between new capacity levels (ACTPCAP_a) and current capacity (CURPCAP_{a,t}, previous model year capacity plus planned additions). In the module, these initial new capacity levels are defined as follows:

Storage:

$$ACTPCAP_a = \frac{FLOW_{PK,a}}{PKUTZ_a} \quad (70)$$

Pipeline:

$$ACTPCAP_a = MAXPCAP_{OP,a} \quad (71)$$

⁶⁴For AEO2010 capacity expansion on Canadian import arcs were set exogenously (PLANPCAP, Appendix E).

Pipeline arc entering region 10 (Florida):

$$\text{ACTPCAP}_a = \text{MAX between } \frac{\text{FLOW}_{\text{PK},a}}{\text{PKSHR_YR} * \text{PKUTZ}_a} \quad (72)$$

$$\text{and } \frac{\text{FLOW}_{\text{OP},a}}{(1 - \text{PKSHR_YR}) * \text{OPUTZ}_a}$$

where,

- ACTPCAP_a = Annual physical capacity along an arc a (Bcf)
- MAXPCAP_{OP,a} = Maximum annual physical capacity along pipeline arc a for network n [see equation above] (Bcf)
- FLOW_{n,a} = Flow along arc a on network n (Bcf)
- PKUTZ_a = Maximum peak utilization of capacity along arc a (fraction, Appendix E)
- OPUTZ_a = Maximum off-peak utilization of capacity along arc a (fraction, Appendix E)
- PKSHR_YR = Fraction of the year represented by the peak season
 - a = pipeline and storage arc
 - n = network (peak or off-peak)
 - PK = peak season
 - OP = off-peak season

A second check and potential adjustment are made to these capacity levels to insure that capacity is sufficient to handle estimated flow in the peak month of each period.⁶⁵ Since capacity is defined as sustained capacity, it is assumed that the peak month flows should be in accordance with the maximum capacity requirements of the system, short of line packing, propane injections, and planning for the potential of above average temperature months.⁶⁶ Peak month consumption and supply levels are set at an assumed fraction of the corresponding period levels. Based on historical relationships, an initial guess is made at the fraction of each period's net storage withdrawals removed during the peak month. With this information, peak month flows are set at the same time flows are set for each period, while coming down the network tree, and following a similar process. At each node a net monthly demand is set equal to the sum of the monthly flows going out of the node, plus the monthly consumption at the node, minus the monthly supply and net storage withdrawals. The period shares are then used to set initial monthly flows, as follows:

$$\text{MTHFLW}_{n,a} = \text{MTH_NETNOD}_{n,r} * \frac{\text{SHR}_{n,a,t}}{\sum_c \text{SHR}_{n,c,t}} \quad (73)$$

where,

⁶⁵Currently this is only done in the model for the peak period of the year.

⁶⁶To represent that the pipeline system is built to accommodate consumption levels outside the normal range due to colder than normal temperatures, the net monthly demand levels are increased by an assumed percentage (XBLD, Appendix E).

- MTHFLW_{n,a} = Monthly flow along pipeline arc a (Bcf)
- MTH_NETNOD_{n,r} = Monthly net demand at node r (Bcf)
- SHR_{n,a,t} = Fraction of demand represented along inflow arc a
- c = set of arcs into a region representing pipeline arcs
- n = network (peak or off-peak)
- a = arc into a region
- r = region/node
- t = forecast year

These monthly flows are then compared against a monthly capacity estimate for each pipeline arc and reallocated to the other available arcs if capacity is exceeded, using a method similar to what is done when flows for a period exceed maximum capacity. These adjusted monthly flows are used later in defining the net node demand for nodes lower in the network tree. Monthly capacity is estimated by starting with the previously set ACTPCAP for the pipeline arc divided by the number of months in the year, to arrive at an initial monthly capacity estimate (MTH_CAP). This number is increased if the total of the monthly capacity entering a node exceeds the monthly net node demand, as follows:

$$MTH_CAPADD_{n,a} = MTH_TCAPADD_n * \frac{INIT_CAPADD_{n,a}}{\sum_c INIT_CAPADD_{n,c}} \quad (74)$$

where,

- MTH_CAPADD_{n,a} = Additional added monthly capacity to accommodate monthly flow estimates (Bcf)
- MTH_TCAPADD_n = Total initial monthly capacity entering a node minus monthly net node demand (Bcf), if value is negative then it is set to zero
- INIT_CAPADD_{n,a} = MTHFLW_a - MTH_CAP_a, if value is negative then it is set to zero (Bcf)
- n = network (peak or off-peak)
- a = arc into a region
- c = set of arcs into a region representing pipeline arcs

The additional added monthly capacity is multiplied by the number of months in the year and added to the originally estimated pipeline capacity levels for each arc (ACTPCAP). Finally, if the net node demand is not close to zero at the lowest node on the network tree (node number 24 in western Canada), then monthly storage levels are adjusted proportionally throughout the network to balance the system for the next time quantities are brought down the network tree.

Wellhead and Henry Hub Prices

Ultimately, all of the network-specific consumption levels are transferred down the network trees and into supply nodes, where corresponding supply prices are calculated. The Oil and Gas Supply Module (OGSM) provides only annual price/quantity supply curve parameters for each supply subregion. Because this alone will not provide a wellhead price differential between seasons, a special methodology has been developed to approximate seasonal prices that are

consistent with the annual supply curve. First, in effect the quantity axis of the annual supply curve is scaled to correspond to seasonal volumes (based on the period's share of the year); and the resulting curves are used to approximate seasonal prices. (Operationally within the model this is done by converting seasonal production values to annual equivalents and applying these volumes to the annual supply curve to arrive at seasonal prices.) Finally, the resulting seasonal prices are scaled to ensure that the quantity-weighted average annual wellhead price equals the price obtained from the annual supply curve when evaluated using total annual production. To obtain seasonal wellhead prices, the following methodology is used. Taking one supply region at a time, equivalent annual production levels (ANNSUP) are determined for each seasonal model result, as follows:

Peak:

$$\text{ANNSUP} = \frac{\text{NODE_QSUP}_{\text{PK},s}}{\text{PKSHR_YR}} \quad (75)$$

Off-peak:

$$\text{ANNSUP} = \frac{\text{NODE_QSUP}_{\text{OP},s}}{(1 - \text{PKSHR_YR})} \quad (76)$$

where,

- ANNSUP = Equivalent annual production level (Bcf)
- NODE_QSUP_{n,s} = Seasonal (n=PK-peak or OP-off-peak) production level for supply region s (Bcf)
- PKSHR_YR = Fraction of year represented by peak season
- PK = peak season
- OP = off-peak season
- s = supply region

Next, estimated seasonal prices (SPSUP_n) are obtained using these equivalent annual production levels and the annual supply curve function. These initial seasonal prices are then averaged, using quantity weights, to generate an equivalent *average* annual supply price (SPAVG_s). An *actual* annual price (PSUP_s) is also generated, by evaluating the price on the annual supply function for a quantity equal to the sum of the seasonal production levels. The *average* annual supply price is then compared to the *actual* price. The corresponding ratio (FSF) is used to adjust the estimated seasonal prices to generate final seasonal supply prices (NODE_PSUP_{n,s}) for a region.

For a *supply source* s,

$$\text{FSF} = \frac{\text{PSUP}_s}{\text{SPAVG}_s} \quad (77)$$

and,

$$\text{NODE_PSUP}_{n,s} = \text{SPSUP}_n * \text{FSF} \quad (78)$$

where,

$$\begin{aligned} \text{FSF} &= \text{Scaling factor for seasonal prices} \\ \text{PSUP}_s &= \text{Annual supply price from the annual supply curve for supply} \\ &\quad \text{region } s \text{ (87\$/Mcf)} \\ \text{SPAVG}_s &= \text{Quantity-weighted average annual supply price using peak and off-} \\ &\quad \text{peak prices and production levels for supply region } s \text{ (87\$/Mcf)} \\ \text{NODE_PSUP}_{n,s} &= \text{Adjusted seasonal supply prices for supply region } s \text{ (87\$/Mcf)} \\ \text{SPSUP}_n &= \text{Estimated seasonal supply prices [for supply region } s \text{] (87\$/Mcf)} \\ n &= \text{network (peak or off-peak)} \\ s &= \text{supply source} \end{aligned}$$

During the STEO years (2009 and 2010 for *AEO2010*), national average wellhead prices (lower 48 only) generated by the model are compared to the national STEO wellhead price forecast to generate a benchmark factor (SCALE_WPR_t). This factor is used to adjust the regional (annual and seasonal) lower 48 wellhead prices to equal STEO results. This benchmark factor is only applied during the STEO years. The benchmark factor is applied as follows:

Annual:

$$\text{PSUP}_s = \text{PSUP}_s * \text{SCALE_WPR}_t \quad (79)$$

Seasonal:

$$\text{NODE_PSUP}_{n,s} = \text{NODE_PSUP}_{n,s} * \text{SCALE_WPR}_t \quad (80)$$

where,

$$\begin{aligned} \text{PSUP}_s &= \text{Annual supply price from the annual supply curve for supply} \\ &\quad \text{region } s \text{ (87\$/Mcf)} \\ \text{NODE_PSUP}_{n,s} &= \text{Adjusted seasonal supply prices for supply region } s \text{ (87\$/Mcf)} \\ \text{SCALE_WPR}_t &= \text{STEO benchmark factor for wellhead price in year } t \\ n &= \text{network (peak or off-peak)} \\ s &= \text{supply source} \\ t &= \text{forecast year} \end{aligned}$$

A similar adjustment is made for the Canadian supply price, with an additional multiplicative factor applied (STSCAL_CAN , Appendix E) which is set to align Canadian import levels with STEO results.

While the NGTDM does not explicitly represent the Henry Hub within its modeling structure, the module reports a projected value for reporting purposes. The price at the Henry Hub is set using an econometrically estimated equation as a function of the lower 48 average natural gas wellhead price, as follows:

$$oOGHHPRNG_t = 1.00439 * e^{0.090246} * oOGWPRNG_{s=13,t}^{1.00119} \quad (81)$$

where,

- $oOGHHPRNG_t$ = Natural gas price at the Henry Hub (87\$/MMBtu)
- $oOGWPRNG_{s,t}$ = Average natural gas wellhead price for supply region 13, representing the lower 48 average (87\$/Mcf)
- s = supply source/region
- t = forecast year

Details about the generation of this estimated equation and associated parameters are provided in **Table F12**, Appendix F.

Arc Fees (Tariffs)

Fees (or tariffs) along arcs are used in conjunction with supply, storage, and node prices to determine competing arc prices that, in turn, are used to determine network flows, transshipment node prices, and delivered prices. Arc fees exist in the form of pipeline tariffs, storage fees, and gathering charges. Pipeline tariffs are transportation rates along interregional arcs, and reflect the average rate charged over all of the pipelines represented along an arc. Storage fees represent the charges applied for storing, injecting, and withdrawing natural gas that is injected in the off-peak period for use in the peak period, and are applied along arcs connecting the storage sites to the peak network. Gathering charges are applied to the arcs going from the supply points to the transshipment nodes.

Pipeline and storage tariffs consist of both a fixed (volume independent) term and a variable (volume dependent) term. For pipelines the fixed term ($ARC_FIXTAR_{n,a,t}$) is set in the PTS at the beginning of each forecast year to represent pipeline usage fees and does not vary in response to changes in flow in the current year. For storage, the fixed term establishes a minimum and is set to \$0.001 per Mcf. The variable term is obtained from tariff/capacity curves provided by two PTS functions and represents reservation fees for pipelines and all charges for storage. These two functions are $NGPIPE_VARTAR$ and $X1NGSTR_VARTAR$. When determining network flows a different set of tariffs ($ARC_SHRFEE_{n,a}$) are used than are used when setting delivered prices ($ARC_ENDFEE_{n,a}$).

In the peak period ARC_SHRFEE equals ARC_ENDFEE and the total tariff (reservation plus usage fee). In the off-peak period, ARC_ENDFEE represents the total tariff as well, but ARC_SHRFEE represents the fee that drives the flow decision. In previous AEOs this was set to just the usage fee. The assumption behind this structure was that delivered prices will ultimately reflect reservation charges; but that during the off-peak period in particular, decisions regarding the purchase and transport of gas are made largely independently of where pipeline is reserved and the associated fees. For *AEO2010* the ARC_SHRFEE was set similarly to ARC_ENDFEE because the usage fees seemed to be underestimating off-peak market prices. (This decision will be reexamined in the future.) During the peak period, the gas is more likely to flow along routes where pipeline is reserved; and therefore the flow decision is more greatly influenced by the

relative reservation fees.⁶⁷ The following arc tariff equations apply:

Pipeline:

$$\begin{aligned} \text{ARC_ENDFEE}_{n,a} &= \text{ARC_FIXTAR}_{n,a,t} + \text{NGPIPE_VARTAR}(n, a, i, j, \text{FLOW}_{n,a}) \\ \text{ARC_SHRFEE}_{n,a} &= \text{ARC_FIXTAR}_{n,a,t} + \text{NGPIPE_VARTAR}(n, a, i, j, \text{FLOW}_{n,a}) \end{aligned} \quad (82)$$

Storage:

$$\begin{aligned} \text{ARC_SHRFEE}_{n,a} &= \text{ARC_FIXTAR}_{n,a,t} + \text{X1NGSTR_VARTAR}(\text{st}, \text{FLOW}_{n,a}) \\ \text{ARC_ENDFEE}_{n,a} &= \text{ARC_FIXTAR}_{n,a,t} + \text{X1NGSTR_VARTAR}(\text{st}, \text{FLOW}_{n,a}) \end{aligned} \quad (83)$$

where,

- ARC_SHRFEE_{n,a} = Total arc fees along arc a for network n [used with sharing algorithm] (87\$/Mcf)
- ARC_ENDFEE_{n,a} = Total arc fees along arc a for network n [used with delivered pricing] (87\$/Mcf)
- ARC_FIXTAR_{n,a,t} = Fixed (or usage) fees along an arc a for a network n in time t (87\$/Mcf)
- NGPIPE_VARTAR = PTS function to define pipeline tariffs representing reservation fees for specified arc at given flow level
- X1NGSTR_VARTAR = PTS function to define storage fees at specified storage region for given storage level
- FLOW_{n,a} = Flow of natural gas on the arc in the given period
- n = network (peak or off-peak)

A methodology for defining gathering charges has not been developed but may be developed in a separate effort at a later date.⁶⁸ In order to accommodate this, the supply arc indices in the variable ARC_FIXTAR_{n,a} have been reserved for this information (currently set to 0). Since the historical wellhead price represents a first-purchase price, the cost of gathering is frequently already included and no further charge should be added.

Arc, Node, and Storage Prices

Prices at the transshipment nodes (or node prices) represent intermediate prices that are used to determine regional delivered prices. Node prices (along with tariffs) are also used to help make

⁶⁷Reservation fees are frequently considered “sunk” costs and are not expected to influence short-term purchasing decisions as much, but still must ultimately be paid by the end-user. Therefore within the ITS, the arc prices used in determining flows can have tariff components defined differently than their counterparts (arc and node prices) ultimately used to establish delivered prices.

⁶⁸In a previous version of the NGTDM, “gathering” charges were used to benchmark the regional wellhead prices to historical values. It is possible that they may be used (at least in part) to fulfill the same purpose in the ITS. In the past an effort was made, with little success, to derive representative gathering charges. Currently, the gathering charge portion of the tariff along the supply arcs is assumed to be zero.

model decisions, primarily within the flow-sharing algorithm. In both cases it is not required (as described above) to set delivered or arc prices using the same price components or methods as used to define prices needed to establish flows along the networks (e.g., in setting $ARC_SHRPR_{n,a}$ in the share equation). Thus, *process-specific* node prices ($NODE_ENDPR_{n,r}$ and $NODE_SHRPR_{n,r}$) are generated using *process-specific* arc prices ($ARC_ENDPR_{n,a}$ and $ARC_SHRPR_{n,a}$) which, in turn, are generated using *process-specific* arc fees/tariffs ($ARC_ENDFEE_{n,a}$ and $ARC_SHRFEE_{n,a}$).

The following equations define the methodology used to calculate arc prices. Arc prices are first defined as the average node price at the source node plus the arc fee (pipeline tariff, storage fee, or gathering charge). Next, the arc prices along pipeline arcs are adjusted to account for the cost of pipeline fuel consumption. These equations are as follows:

$$ARC_SHRPR_{n,a} = NODE_SHRPR_{n,rs} + ARC_SHRFEE_{n,a} \quad (84)$$

$$ARC_ENDPR_{n,a} = NODE_ENDPR_{n,rs} + ARC_ENDFEE_{n,a}$$

with adjustment:

$$ARC_SHRPR_{n,a} = \frac{(ARC_SHRPR_{n,a} * FLOW_{n,a})}{(FLOW_{n,a} - ARC_PFUEL_{n,a})} \quad (85)$$

$$ARC_ENDPR_{n,a} = \frac{(ARC_ENDPR_{n,a} * FLOW_{n,a})}{(FLOW_{n,a} - ARC_PFUEL_{n,a})}$$

where,

- $ARC_SHRPR_{n,a}$ = Price calculated for natural gas along inflow arc a for network n [used with sharing algorithm] (87\$/Mcf)
- $ARC_ENDPR_{n,a}$ = Price calculated for natural gas along inflow arc a for network n [used with delivered pricing] (87\$/Mcf)
- $NODE_SHRPR_{n,r}$ = Node price for region i on network n [used with sharing algorithm] (87\$/Mcf)
- $NODE_ENDPR_{n,r}$ = Node price for region i on network n [used with delivered pricing] (87\$/Mcf)
- $ARC_SHRFEE_{n,a}$ = Tariff along inflow arc a for network n [used with sharing algorithm] (87\$/Mcf)
- $ARC_ENDFEE_{n,a}$ = Tariff along inflow arc a for network n [used with delivered pricing] (87\$/Mcf)
- $ARC_PFUEL_{n,a}$ = Pipeline fuel consumption along arc a, for network n (Bcf)
- $FLOW_{n,a}$ = Network n flow along arc a (Bcf)
- n = network (peak or off-peak)
- a = arc
- rs = region corresponding to source link on arc a

Although each type of node price may be calculated differently (e.g., average prices for delivered price calculation, marginal prices for flow sharing calculation, or some combination of these for each), the current model uses the quantity-weighted averaging approach to establish node prices for both the delivered pricing and flow sharing algorithm pricing. All arcs entering a node are included in the average. Node prices then are adjusted to account for intraregional pipeline fuel consumption. The following equations apply:

$$\text{NODE_SHRPR}_{n,r2} = \frac{\sum_a (\text{ARC_SHRPR}_{n,a} * \text{FLOW}_{n,a})}{\sum_a \text{FLOW}_{n,a}} \quad (86)$$

$$\text{NODE_ENDPR}_{n,r2} = \frac{\sum_a (\text{ARC_ENDPR}_{n,a} * \text{FLOW}_{n,a})}{\sum_a \text{FLOW}_{n,a}}$$

and,

$$\text{NODE_SHRPR}_{n,rd} = \frac{(\text{NODE_SHRPR}_{n,rd} * \text{NODE_DMD}_{n,rd})}{(\text{NODE_DMD}_{n,rd} - \text{INTRA_PFUEL}_{n,rd})} \quad (87)$$

$$\text{NODE_ENDPR}_{n,rd} = \frac{(\text{NODE_ENDPR}_{n,rd} * \text{NODE_DMD}_{n,rd})}{(\text{NODE_DMD}_{n,rd} - \text{INTRA_PFUEL}_{n,rd})}$$

where,

- NODE_SHRPR_{n,r} = Node price for region r on network n [used with flow sharing algorithm] (87\$/Mcf)
- NODE_ENDPR_{n,r} = Node price for region r on network n [used with delivered pricing] (87\$/Mcf)
- ARC_SHRPR_{n,a} = Price calculated for natural gas along inflow arc a for network n [used with flow sharing algorithm] (87\$/Mcf)
- ARC_ENDPR_{n,a} = Price calculated for natural gas along inflow arc a for network n [used with delivered pricing] (87\$/Mcf)
- FLOW_{n,a} = Network n flow along arc a (Bcf)
- INTRA_PFUEL_{n,r} = Intraregional pipeline fuel consumption in region r, for network n (Bcf)
- NODE_DMD_{n,r} = Net node demands (w/ pipeline fuel) in region r, for network n (Bcf)
- n = network (peak or off-peak)
- a = arc
- rd = region r destination link along arc a

Once node prices are established for the off-peak network, the cost of the gas injected into storage can be defined. Thus, for every region where storage is available, the storage node price

is set equal to the off-peak regional node price. This applies for both the delivered pricing and the flow sharing algorithm pricing:

$$\begin{aligned} \text{NODE_SHRPR}_{\text{PK},i} &= \text{NODE_SHRPR}_{\text{OP},r} \\ \text{NODE_ENDPR}_{\text{PK},i} &= \text{NODE_ENDPR}_{\text{OP},r} \end{aligned} \tag{88}$$

where,

- $\text{NODE_SHRPR}_{\text{PK},i}$ = Price at node i [used with flow sharing algorithm] (87\$/Mcf)
- $\text{NODE_SHRPR}_{\text{OP},r}$ = Price at node r in off-peak network [used with flow sharing algorithm] (87\$/Mcf)
- $\text{NODE_ENDPR}_{\text{PK},i}$ = Price at node i [used with delivered pricing] (87\$/Mcf)
- $\text{NODE_ENDPR}_{\text{OP},r}$ = Price at node r in off-peak network [used with delivered pricing] (87\$/Mcf)
- PK, OP = peak and off-peak network, respectively
- i = node ID for storage
- r = region ID where storage exists

Backstop Price Adjustment

Backstop supply⁶⁹ is activated when seasonal net demand within a region exceeds total available supply for that region. When backstop occurs, the corresponding *share* node price ($\text{NODE_SHRPR}_{n,r}$) is adjusted upward in an effort to reduce the demand for gas from this source. If this initial price adjustment ($\text{BKSTOP_PADJ}_{n,r}$) is not sufficient to eliminate backstop, on the next cycle down the network tree, an additional adjustment ($\text{RBKSTOP_PADJ}_{n,r}$) is added to the original adjustment, creating a cumulative price adjustment. This process continues until the backstop quantity is reduced to zero, or until the maximum number of ITS cycles has been completed. If backstop is eliminated, then the cumulative price adjustment level is maintained, as long as backstop does not resurface, and until ITS convergence is achieved. Maintaining a backstop adjustment is necessary because complete removal of this high-price signal would cause demand for this source to increase again, and backstop would return. However, if the need for backstop supply recurs following a cycle which did not need backstop supply, then the price adjustment ($\text{BKSTOP_PADJ}_{n,r}$) factor is reduced by one-half and added to the cumulative adjustment variable, with the process continuing as described above. The objective is to eliminate the need for backstop supply while keeping the associated price at a minimum. The equations for adjusting the node price are:

$$\text{NODE_SHRPR}_{n,r} = \text{NODE_SHRPR}_{n,r} + \text{RBKSTOP_PADJ}_{n,r} \tag{89}$$

$$\text{RBKSTOP_PADJ}_{n,r} = \text{RBKSTOP_PADJ}_{n,r} + \text{BKSTOP_PADJ}_{n,r} \tag{90}$$

⁶⁹Backstop supply can be thought of as a high-priced alternative supply when no other options are available. Within the model, it also plays an operational role in sending a price signal when equilibrating the network that additional supplies are unavailable along a particular path in the network.

where,

- NODE_SHRPR_{n,r} = Node price for region r on network n [used with flow sharing algorithm] (87\$/Mcf)
- RBKSTOP_PADJ_{n,r} = Cumulative price adjustment due to backstop (87\$/Mcf)
- BKSTOP_PADJ_{n,r} = Incremental backstop price adjustment (87\$/Mcf)
- n = network (peak or off-peak)
- r = region

Currently, this cumulative backstop adjustment (RBKSTOP_PADJ_{n,r}) is maintained for each NEMS iteration, and set to zero only on the first NEMS iteration of each model year. Also, it is not used to adjust the NODE_ENDPR because it is an adjustment for making flow allocation decisions, not for pricing gas for the end-user.

ITS Convergence

The ITS is considered to have converged when the regional/seasonal wellhead prices are within a defined percentage tolerance (PSUP_DELTA) of the prices set during the last ITS cycle and, for those supply regions with relatively small production levels (QSUP_SMALL), production is within a defined tolerance (QSUP_DELTA) of the production set during the last ITS cycle. If convergence does not occur, then a new wellhead price is determined based on a user-specified weighting of the seasonal production levels determined during the current cycle and during the previous cycle down the network. The equations used to define the new production levels are:

$$\begin{aligned} \text{NODE_QSUP}_{n,s} = & (\text{QSUP_WT} * \text{NODE_QSUP}_{n,s}) + \\ & ((1 - \text{QSUP_WT}) * \text{NODE_QSUPPREV}_{n,s}) \end{aligned} \quad (91)$$

where,

- NODE_QSUP_{n,s} = Production level at supply source s on network n for current ITS cycle (Bcf)
- NODE_QSUPPREV_{n,s} = Production level at supply source s on network n for previous ITS cycle (Bcf)
- QSUP_WT = Weighting applied to production level for current ITS cycle (Appendix E)
- n = network (peak or off-peak)
- s = supply source

Seasonal prices (NODE_PSUP_{n,s}) for these quantities are then determined using the same methodology defined above for obtaining wellhead prices.

End-Use Sector Prices

The NGTDM provides regional end-use or delivered prices for the Electricity Market Module (electric generation sector) and the other NEMS demand modules (nonelectric sectors). For the nonelectric sectors (residential, commercial, industrial, and transportation), prices are established

at the NGTDM region and then averaged (when necessary) using quantity-weights to obtain prices at the Census Division level. For the electric generation sector, prices are provided on a seasonal basis and are determined for core and noncore services at two different regional levels: the Census Division level and the NGTDM/EMM level (Chapter 2, **Figure 2-3**).

The first step toward generating these delivered prices is to translate regional, seasonal node prices into corresponding city gate prices ($CGPR_{n,r}$). To accomplish this, seasonal intraregional and intrastate tariffs are added to corresponding regional end-use node prices ($NODE_ENDPR$). This sum is then adjusted using a city gate benchmark factor ($CGBENCH_{n,r}$) which represents the average difference between historical city gate prices and model results during the historical years of the model. These equations are defined below:

$$CGPR_{n,r} = NODE_ENDPR_{n,r} + INTRAREG_TAR_{n,r} + INTRAST_TAR_r + CGBENCH_{n,r} \quad (92)$$

such that:

$$CGBENCH_{n,r} = \text{avg}(HCG_BENCH_{n,r,HISYR}) = \text{avg}(HCGPR_{n,r,HISYR} - CGPR_{n,r}) \quad (93)$$

where,

- $CGPR_{n,r}$ = City gate price in region r on network n in each HISYR (87\$/Mcf)
- $NODE_ENDPR_{n,r}$ = Node price for region r on network n (87\$/Mcf)
- $INTRAREG_TAR_{n,r}$ = Intraregional tariff for region r on network n (87\$/Mcf)
- $INTRAST_TAR_r$ = Intrastate tariff in region r (87\$/Mcf)
- $CGBENCH_{n,r}$ = City gate benchmark factor for region r on network n (87\$/Mcf)
- $HCGPR_{n,r,EHISYR}$ = Historical city gate price in region r on network n in historical year EHISYR (87\$/Mcf)
- n = network (peak and off-peak)
- r = region (lower 48 only)
- HISYR = historical year, over which average is taken (2004-2008, excluding the outlier year of 2006)
- avg = straight average of indicated value over all historical years of the model.

The intraregional tariffs are the sum of a usage fee ($INTRAREG_FIXTAR$), provided by the Pipeline Tariff Submodule, and a reservation fee that is set using the same function $NGPIPE_VARTAR$ that is used in setting interregional tariffs and was described previously. The benchmark factor represents an adjustment to calibrate city gate prices to historical values.

Seasonal distributor tariffs are then added to the city gate prices to get seasonal, sectoral delivered prices by the NGTDM regions for nonelectric sectors and by the NGTDM/EMM subregions for the electric generation sector. The prices for residential, commercial, and electric generation sectors (core and noncore) are then adjusted using STEO benchmark factors

(SCALE_FPR_{sec,t} , SCALE_IPR_{sec,t})⁷⁰ to calibrate the results to equal the corresponding national STEO delivered prices. Each seasonal sector price is then averaged to get an annual, sectoral delivered price for each representative region. The following equations apply.

Nonelectric Sectors (except core transportation):

$$NGPR_SF_{n,sec,r} = CGPR_{n,r} + DTAR_SF_{n,sec,r} + SCALE_FPR_{sec,t} \quad (94)$$

$$NGPR_SI_{n,sec,r} = CGPR_{n,r} + DTAR_SI_{n,sec,r} + SCALE_IPR_{sec,t}$$

$$NGPR_F_{sec,r} = NGPR_SF_{PK,sec,r} * PKS HR_DMD_{sec,r} + NGPR_SF_{OP,sec,r} * (1. - PKS HR_DMD_{sec,r}) \quad (95)$$

$$NGPR_I_{sec,r} = NGPR_SI_{PK,sec,r} * PKS HR_DMD_{sec,r} + NGPR_SI_{OP,sec,r} * (1. - PKS HR_DMD_{sec,r})$$

where,

- NGPR_SF_{n,sec,r} = Seasonal (n) core nonelectric sector (sec) price in region r (87\$/Mcf)
- NGPR_SI_{n,sec,r} = Seasonal (n) noncore nonelectric sector (sec) price in region r (87\$/Mcf)
- NGPR_F_{sec,r} = Annual core nonelectric sector (sec) price in region r (87\$/Mcf)
- NGPR_I_{sec,r} = Annual noncore nonelectric sector (sec) price in region r (87\$/Mcf)
- CGPR_{n,r} = City gate price in region r on network n (87\$/Mcf)
- DTAR_SF_{n,sec,r} = Seasonal (n) distributor tariff to core nonelectric sector (sec) in region r (87\$/Mcf)
- DTAR_SI_{n, sec,r} = Seasonal (n) distributor tariff to noncore nonelectric sector (sec) in region r (87\$/Mcf)
- PKSHR_DMD_{sec,r} = Average (2001-2008) fraction of annual consumption for nonelectric sector in peak season for region r
- SCALE_FPR_{sec,t} = STEO benchmark factor for core delivered prices for sector sec, in year t (87\$/Mcf)
- SCALE_IPR_{sec,t} = STEO benchmark factor for noncore delivered prices for sector sec, in year t (87\$/Mcf)
- n = network (peak or off-peak)
- sec = nonelectric sector
- r = region (lower 48 only)

⁷⁰The STEO scale factors are linearly phased out over a user-specified number of years (Appendix E, STPHAS_YR) after the last STEO year. STEO benchmarking is not done for the industrial price, because of differences in the definition of the price in the STEO versus the price in the AEO, nor for the transportation sector since the STEO does not include a comparable value.

Electric Generation Sector:

$$NGUPR_SF_{n,j} = CGPR_{n,r} + UDTAR_SF_{n,j} + SCALE_FPR_{sec,t} \quad (96)$$

$$NGUPR_SI_{n,j} = CGPR_{n,r} + UDTAR_SI_{n,j} + SCALE_IPR_{sec,t}$$

$$NGUPR_F_j = NGUPR_SF_{PK,j} * PKSHR_UDMD_j + NGUPR_SF_{OP,j} * (1. - PKSHR_UDMD_j) \quad (97)$$

$$NGUPR_I_j = NGUPR_SI_{PK,j} * PKSHR_UDMD_j + NGUPR_SI_{OP,j} * (1. - PKSHR_UDMD_j)$$

where,

- NGUPR_SF_{n,j} = Seasonal (n) core utility sector price in region j (87\$/Mcf)
- NGUPR_SI_{n,j} = Seasonal (n) noncore utility sector price in region j (87\$/Mcf)
- NGUPR_F_j = Annual core utility sector price in region j (87\$/Mcf)
- NGUPR_I_j = Annual noncore utility sector price in region j (87\$/Mcf)
- CGPR_{n,r} = City gate price in region r on network n (87\$/Mcf)
- UDTAR_SF_{n,j} = Seasonal (n) distributor tariff to core utility sector in region j (87\$/Mcf)
- UDTAR_SI_{n,j} = Seasonal (n) distributor tariff to noncore utility sector in region j (87\$/Mcf)
- PKSHR_UDMD_j = Average (1994-2008, except for New England 1997-2008) fraction of annual consumption for the electric generator sector in peak season, for region j
- SCALE_FPR_{sec,t} = STEO benchmark factor for core delivered prices for sector sec, in year t (87\$/Mcf)
- SCALE_IPR_{sec,t} = STEO benchmark factor for noncore delivered prices for sector sec, in year t (87\$/Mcf)
- n = network (peak or off-peak)
- sec = utility sector (electric generation only)
- r = region (lower 48 only)
- j = NGTDM/EMM subregion

For *AEO2010*, the natural gas price that was finally sent to the Electricity Market Module for both core and noncore customers was the quantity-weighted average of the core and noncore prices derived from the above equations. This was done to alleviate some difficulties within the Electricity Market Module as selections were being made between different types of natural gas generation equipment.

Core Transportation Sector:

A somewhat different methodology is used to determine natural gas delivered prices for the core (F) transportation sector. The core transportation sector consists of a personal vehicles

component and a fleet vehicles component. Like the other nonelectric sectors, seasonal distributor tariffs are added to the regional city gate prices to determine seasonal delivered prices for both components. Annual core prices are then established for each component in a region by averaging the corresponding seasonal prices, as follows:

$$NGPR_TRPV_SF_{n,r} = CGPR_{n,r} + DTAR_TRPV_SF_{n,r} + SCALE_FPR_{sec,t} \quad (98)$$

$$NGPR_TRFV_SF_{n,r} = CGPR_{n,r} + DTAR_TRFV_SF_{n,r} + SCALE_FPR_{sec,t}$$

$$NGPR_TRPV_F_r = NGPR_TRPV_SF_{PK,r} * PKSHR_DMD_{sec,r} + NGPR_TRPV_SF_{OP,r} * (1. - PKSHR_DMD_{sec,r}) \quad (99)$$

$$NGPR_TRFV_F_r = NGPR_TRFV_SF_{PK,r} * PKSHR_DMD_{sec,r} + NGPR_TRFV_SF_{OP,r} * (1. - PKSHR_DMD_{sec,r})$$

where,

- NGPR_TRPV_SF_{n,r} = Seasonal (n) price of natural gas used by personal vehicles (core) in region r (87\$/Mcf)
- NGPR_TRFV_SF_{n,r} = Seasonal (n) price of natural gas used by fleet vehicles (core) in region r (87\$/Mcf)
- DTAR_TRPV_SF_{n,r} = Seasonal (n) distributor tariff to core transportation (personal vehicles) sector in region r (87\$/Mcf)
- DTAR_TRFV_SF_{n,r} = Seasonal (n) distributor tariff to core transportation (fleet vehicles) sector in region r (87\$/Mcf)
- CGPR_{n,r} = City gate price in region r on network n (87\$/Mcf)
- NGPR_TRPV_F_r = Annual price of natural gas used by personal vehicles (core) in region r (87\$/Mcf)
- NGPR_TRFV_F_r = Annual price of natural gas used by fleet vehicles (core) in region r (87\$/Mcf)
- PKSHR_DMD_{sec,r} = Fraction of annual consumption for the transportation sector (sec=4) in the peak season for region r (set to PKSHR_YR)
- SCALE_FPR_{sec,t} = STEO benchmark factor for core delivered prices for sector sec, in year t (set to 0 for transportation sector), (87\$/Mcf)
- n = network (peak or off-peak)
- sec = transportation sector =4
- r = region (lower 48 only)

Once the personal vehicles price for natural gas is established, the two core component prices are averaged (using quantity weights) to produce an annual core price for each region (NGPR_F_{sec=4,r}). Seasonal core prices are also determined by quantity-weighted averaging of the two seasonal components (NGPR_SF_{n,sec=4,r}).

Regional delivered prices can be used within the ITS cycle to approximate a demand response. The submodule can then be resolved with adjusted consumption levels in an effort to speed

NEMS convergence. Finally, once the ITS has converged, regional prices are averaged using quantity weights into Census Division prices and sent to the corresponding NEMS modules.

Import Prices

The price associated with Canadian imports at each of the module's border crossing points is established during the ITS convergence process. Each of these border-crossing points is represented by a node in the network. The import price for a given season and border crossing is therefore equal to the price at the associated node. For reporting purposes, these node prices are averaged using quantity weights to derive an average annual Canadian import price. The prices for imports at the three Mexican border crossings are set to the average wellhead price in the nearest NGTDM region plus a markup (or markdown) that is based on the difference between similar import and wellhead prices historically. The structure for setting LNG import prices is similar to setting Mexican import prices, although regional city gate prices are used instead of wellhead prices. For the facilities for which historical prices are not available (i.e., generic new facilities), an assumption was made about the difference between the regional city gate price and the LNG import price (LNGDIFF, Appendix E).

5. Distributor Tariff Submodule Solution Methodology

This chapter discusses the solution methodology for the Distributor Tariff Submodule (DTS) of the Natural Gas Transmission and Distribution Module (NGTDM). Within each region, the DTS develops seasonal, market-specific distributor tariffs (or city gate to end-use markups) that are applied to projected seasonal city gate prices to derive end-use or delivered prices. Since most industrial and electric generator customers do not purchase their gas through local distribution companies, their “distributor tariff” represents the difference between the average price paid by local distribution companies at the city gate and the average price paid by the industrial or electric generator customer.⁷¹ Distributor tariffs are defined for both core and noncore markets within the industrial and electric generator sectors, while residential, commercial, and transportation sectors have distributor tariffs defined only for the core market, since noncore customer consumption in these sectors is assumed to be insignificant and set to zero. The core transportation sector is composed of two categories of compressed natural gas (CNG) consumers (fleet vehicles and personal vehicles); therefore, separate distributor tariffs are developed for each of these two categories.

For the residential, commercial, industrial, and electric generation sectors distributor tariffs are based on econometrically estimated equations and are driven in part by sectoral consumption levels.⁷² This general approach was taken since in the past data were not reasonably obtainable to develop a detailed cost-based accounting methodology similar to the approach used for interstate pipeline tariffs in the Pipeline Tariff Submodule. Such an approach is currently being reexamined and is only expected to be applied to the residential and commercial sectors. Distribution charges for CNG in vehicles are set to the sum of historical tariffs for delivering natural gas to refueling stations, federal and state motor fuels taxes and credits, and estimates of dispensing charges. The specific methodologies used to calculate each sector’s distributor tariffs are discussed in the remainder of this chapter.

Residential and Commercial Sectors

Residential and commercial distributor tariffs are projected using econometrically estimated equations. The primary explanatory variables are commercial natural gas consumption for the commercial tariff and natural gas consumption per household for the residential sector tariff. In both cases lagged values influence the results significantly, as follows:

⁷¹It is not unusual for these “markups” to be negative.

⁷²Historical distributor tariffs for a sector in a particular region/season can be estimated by taking the difference between the average sectoral end-use price and the average city gate price in the region/season (Appendix E, HCGPR).

$$\begin{aligned}
DTAR_SF_{s=1,r,n} &= e^{PRSREG14_r + PRSREGPK14_{r,n}} * \\
&\left(\frac{BASQTY_SF_{s=1,r,n} + BASQTY_SI_{s=1,r,n}}{NUMRS_{r,t}} \right)^{-0.707463} * \\
DTAR_SFPREV_{s=1,r,n} &= e^{0.329051} * e^{-0.329051 * (PRSREG14_r + PRSREGPK14_{r,n})} * \\
&\left(\frac{BASQTY_SFPREV_{s=1,r,n} + BASQTY_SIPREV_{s=1,r,n}}{NUMRS_{r,t-1}} \right)^{(-0.329051 * -0.707463)}
\end{aligned} \tag{100}$$

$$\begin{aligned}
DTAR_SF_{s=2,r,n} &= e^{PCMREG11_r + PCMREGPK11_{r,n}} * FLRSPC12_{r,t}^{0.654472} * DTAR_SFPREV_{s=2,r,n}^{0.262602} * \\
&(BASQTY_SF_{s=2,r,n} + BASQTY_SI_{s=2,r,n})^{-0.255252} * \\
&e^{-0.262602 * (PCMREG11_r + PCMREGPK11_{r,n})} * FLRSPC12_{r,t-1}^{-0.262602 * 0.654472} * \\
&*(BASQTY_SFPREV_{s=2,r,n} + BASQTY_SIPREV_{s=2,r,n})^{-0.262602 * -0.255252}
\end{aligned} \tag{101}$$

where,

$$NUMRS_{r,t} = oRSGASCUST_{cd,t} * RECS_ALIGN_r * NUM_REGSHR_r \tag{102}$$

and,

$$FLRSPC12_{r,t} = (MC_COMMFLSP_{1,cd,t} - MC_COMMFLSP_{8,cd,t}) * SHARE_r \tag{103}$$

where,

- DTAR_SF_{s,r,n} = core distributor tariff in current forecast year for sector s, region r, and network n (1987\$/Mcf)
- DTAR_SFPREV_{s,r,n} = core distributor tariff in previous forecast year (1987\$/Mcf). [For first forecast year set at the 2008 historical value.]
- BASQTY_SF_{s,r,n} = sector (s) level firm gas consumption for region r, and network n (Bcf)
- BASQTY_SI_{s,r,n} = sector (s) level nonfirm gas consumption for region r, and network n (Bcf) (assumed at 0 for residential and commercial)
- BASQTY_SFPREV_{s,r,n} = sector (s) level gas consumption for region r, and network n in previous year (Bcf) (assumed at 0 for residential and commercial)
- BASQTY_SIPREV_{s,r,n} = sector (s) level nonfirm gas consumption for region r, and network n in previous year (Bcf)
- NUMRS = number of residential customers in year t
- PRSREG14_r,
PCMREG11_r = residential and commercial regional constant terms (Tables F6 and F7, Appendix F)
- PRSREGPK14_{r,n} = residential, regional, peak period, constant term (Table F6, Appendix F)

- PCMREGPK11_{r,n} = commercial, regional, peak period, constant term (Table F7, Appendix F)
- oRSGASCUST_{cd,t-1} = number of residential gas customers by census division in the previous forecast year (from NEMS residential demand module)
- RECS_ALIGN_r = factor to align residential customer count data from EIA's 2005 Residential Consumption Survey (RECS), the data on which oRSGASCUST is based, with similar data from the EIA's Natural Gas Annual, the data on which the DTAR_SF estimation is based.
- NUM_REGSHR_r = share of residential customers in NGTDM region r relative to the number in the larger or equal sized associated census division, set to values in last historical year, 2005. (fraction, Appendix E)
- FLRSPC12_r = commercial floorspace by NGTDM region (total net of for manufacturing) (billion square feet)
- MC_COMMFLSP_{1,cd,t} = commercial floorspace by Census Division (total, including manufacturing)
- MC_COMMFLSP_{8,cd,t} = commercial floorspace by Census Division (manufacturing)
- SHARE_r = assumed fraction of the associated census division's commercial floorspace within each of the 12 NGTDM regions based on population data (1.0, 1.0, 1.0, 1.0, 0.66, 1.0, 1.0, 0.59, 0.24, 0.34, 0.41, 0.75)
- s = sector (=1 for residential, =2 for commercial)
- cd = census division
- r = region (12 NGTDM regions)
- n = network (peak or off-peak)
- t = forecast year (e.g., 2010)

Parameter values and details about the estimation of these equations can be found in Tables F6 and F7 of Appendix F.

Industrial Sector

For the industrial sector, a single distributor tariff (i.e., no distinction between core and noncore) is estimated for each season and region as a function of the industrial consumption level in that season and region. Next, core seasonal tariffs are set by assuming a differential between the core price and the estimated distributor tariff for the season and region, based on historical estimates.⁷³ The noncore price is set to insure that the quantity-weighted average of the core and noncore price in a season and region will equal the originally estimated tariff for that season and region. Historical prices for the industrial sector are estimated based on the data that are available from the Manufacturing Energy Consumption Survey (MECS) (Table F5, Appendix F). The industrial prices within EIA's Natural Gas Annual only represent industrial customers who purchase gas through their local distribution company, a small percentage of the total; whereas the prices in the MECS represent a much larger percentage of the total industrial sector. The equation for the single seasonal/regional industrial distributor tariff follows:

⁷³Historical core and noncore prices from the Manufacturing Energy Consumption Survey were used as a basis for setting this differential in the last historical year.

$$\begin{aligned}
TAR = & PIN_REG14_r + PIN_REGPK14_{r,n} + \\
& (-0.000294853 * QCUR_n) + (0.523668 * TARLAG_n) + \\
& -0.523668 * [PIN_REG14_r + PIN_REGPK14_{r,n} + \\
& (-0.000294853 * QLAG_n)]
\end{aligned} \tag{104}$$

The core and noncore distributor tariffs are set using:

$$DTAR_SF_{s=3,r,n} = TAR + FDIFF_{cr} \tag{105}$$

$$DTAR_SI_{s=3,r,n} = \frac{(TAR * QCUR_n) - (DTAR_SF_{s=3,r,n} * BASQTY_SF_{s=3,r,n})}{BASQTY_SI_{s=3,r,n}} \tag{106}$$

where,

- TAR = seasonal distributor tariff for industrial sector in region r (87\$/Mcf)
- TARLAG_n = seasonal distributor tariff for the industrial sector (s=3) in region r in the previous forecast year (87\$/Mcf)
- FDIFF_{cr} = historical average difference between core and average industrial price (1987\$/Mcf, Appendix E)
- PIN_REG14_r = estimated constant term (Table F4, Appendix F)
- PIN_REGPK14_{r,n} = estimated coefficient, set to zero for the off-peak period and for any region where the coefficient is not statistically significant
- DTAR_SF_{n,s,r} = seasonal distributor tariff for the core industrial sector (s=3) in region r (87\$/Mcf)
- DTAR_SI_{n,s,r} = seasonal distributor tariff for the noncore industrial sector (s=3) in region r (87\$/Mcf)
- DTAR_SFPREV_{n,s,r} = seasonal distributor tariff for the core industrial sector (s=3) in region r (87\$/Mcf) in the previous forecast year [In the first forecast year set to the estimated average historical value from 2004 to 2007 [Appendix F, Table F5] (87\$/Mcf)]
- BASQTY_SF_{n,s=3,r} = seasonal core natural gas consumption for industrial sector(s=3) in the current forecast year (Bcf)
- BASQTY_SI_{n,s=3,r} = seasonal noncore natural gas consumption for industrial sector (s=3) in the current forecast year (Bcf)
- QCUR_n = sum of BASQTY_SF and BASQTY_SI for industrial in a particular season and region
- QLAG_n = sum of BASQTY_SFPREV and BASQTY_SIPREV for industrial in a particular season and region, the value of QCUR in the last forecast year
- s = end-use sector index (s=3 for industrial sector)
- n = network (peak or off-peak)
- r = NGTDM region
- cr = the census region associated with the NGTDM region

Parameter values and details about the estimation of these two equations can be found in Table F5, Appendix F.

Electric Generation Sector

Distributor tariffs for the electric generation sector do not represent a charge imposed by a local distribution company; rather they represent the difference between the average city gate price in each NGTDM region and the natural gas price paid on average by electric generators in each NGTDM/EMM region, and are often negative. A single markup or tariff (i.e., no distinction between core and noncore) is projected for each season and region using econometrically estimated equations, as was done for the industrial sector. However, the current version of the model (as used for *AEO2010*) assigns this same value to both the core and noncore segments.⁷⁴ The estimated equations for the distributor tariffs for electric generators are a function of natural gas consumption by the sector relative to that consumed by the other sectors. The greater the electric consumption share, the greater the price difference between the electric sector and the average, as they will need to reserve more space on the pipeline system. The specific equations follow:

$$\begin{aligned} \text{UDTAR_SF}_{n=1,j} = & (-0.264537 + 0.052096) + \text{PELREG25}_j + \\ & (0.963446 * \text{share}_{j,t}) + (0.211449 * \text{UDTAR_SFPREV}_{n=1,j}) \\ & - 0.211449 * [(-0.264537 + 0.052096) + \text{PELREG25}_j + \\ & (0.963446 * \text{share}_{j,t-1})] \end{aligned} \quad (107)$$

$$\begin{aligned} \text{UDTAR_SF}_{n=2,j} = & (-0.298195 + 0.032857) + \text{PELREG20}_j + (0.000739858 * \\ & (\text{BASUQTY_SF}_{n=2,j} + \text{BASUQTY_SI}_{n=2,j})) + \\ & (0.290671 * \text{UDTAR_SFPREV}_{n=2,j}) - 0.290671 * \\ & [(-0.298195 + 0.032857) + \text{PELREG20}_j + (0.000739858 * \\ & (\text{BASUQTY_SFPREV}_{n=2,j} + \text{BASUQTY_SIPREV}_{n=2,j}))] \end{aligned} \quad (108)$$

where

$$\text{share}_{j,t} = \frac{\text{BASUQTY_SF}_{n=2,j} * \text{BASUQTY_SI}_{n=2,j}}{\text{OTHR}_{\text{ngt}}} \quad (109)$$

⁷⁴This distinction was eliminated several years ago because of operational concerns in the Electricity Market Module. In addition, there are some remaining issues concerning the historical data necessary to generate separate price series for the two segments.

$$\text{share}_{j,t-1} = \frac{\text{BASUQTY_SFPREV}_{n=2,j} * \text{BASUQTY_SIPREV}_{n=2,j}}{\text{OTHLRAG}_{ngt}} \quad (110)$$

and

$$\text{UDTAR_SI}_{n,j} = \text{UDTAR_SF}_{n,j} \text{ for all } n \text{ and } j,$$

where,

- UDTAR_SF_{n,j} = seasonal core electric generation sector distributor tariff, current forecast year (\$/Mcf)
- UDTAR_SI_{n,j} = seasonal noncore electric generation sector distributor tariff, current forecast year (\$/Mcf)
- UDTAR_SFPREV_{n,j} = seasonal core electric generation sector distributor tariff, previous forecast year (\$/Mcf)
- BASUQTY_SF_{n,j} = core electric generator gas consumption, current forecast year (Bcf)
- BASUQTY_SI_{n,j} = noncore electric generator gas consumption, current forecast year (Bcf)
- BASUQTY_SFPREV_{n,j} = core electric generator gas consumption in previous forecast year (Bcf)
- BASUQTY_SIPREV_{n,j} = noncore electric generator gas consumption in previous forecast year (Bcf)
- PELREG25_j = regional constant terms for peak period (Table F8, Appendix F)
- PELREG20_j = regional constant terms for off-peak period (Table F8, Appendix F)
- OTHR_{ngt} = non-electric natural gas deliveries
- OTHLRAG_{ngt} = non-electric natural gas deliveries in the previous year
- ngt = NGTDM region
- n = network (peak or off-peak)
- j = NGTDM/EMM region (see chapter 2)

Parameter values and details about the estimation of these two equations can be found in Table F8, Appendix F.

Transportation Sector

Consumers of compressed natural gas (CNG) have been classified into two end-use categories within the core transportation sector: fleet vehicles and personal vehicles (i.e., CNG sold at retail). A distributor tariff is set for both categories to capture 1) the cost of the natural gas delivered to the dispensing station above the city gate price, 2) the per-unit cost or charge for dispensing the gas, and 3) federal and state motor fuels taxes and credits.

For both categories, the distribution charge for the CNG delivered to the station is based on the historical difference between the price reported for the transportation sector in EIA's *Natural Gas Annual* (which should reflect this delivered price) and the city gate price. Similarly federal and state motor fuels taxes are assumed to be the same for both categories and held constant in

nominal dollars.⁷⁵ The Highway Bill of 2005 raised the motor fuels tax for CNG.⁷⁶ The model adjusts the distribution costs accordingly. A potential difference in the pricing for the two categories is the assumed per-unit dispensing charge. Currently the refueling options available for personal natural gas vehicles are largely limited to the same refueling facilities used by fleet vehicles. Therefore, the assumption in the model is that the dispensing charge will be similar for fleet and personal vehicles (RETAIL_COST₂) unless there is a step increase in the number of retail stations selling natural gas in response to an expected increase in the number of personal vehicles. In such a case, an additional markup is added to the natural gas price to personal vehicles to account for the profit of the builder (RET_MARK), as described below. The distributor tariffs for CNG vehicles are set as follows:

$$\begin{aligned}
 \text{DTAR_TRFV_SF}_{n,r} &= \{ \text{HDTAR_SF}_{n,s=4,r,\text{EHISYR}} \\
 &\quad * (1 - \text{TRN_DECL})^{\text{YR_DECL}} \} + \text{RETAIL_COST}_2 \\
 &\quad + \frac{(\text{STAX}_r + \text{FTAX})}{\text{MC_PCWGDP}_i / \text{MC_PCWGDP}_{87}}
 \end{aligned} \tag{111}$$

$$\begin{aligned}
 \text{DTAR_TRPV_SF}_{n,r} &= \{ \text{HDTAR_SF}_{n,s=4,r,\text{EHISYR}} \\
 &\quad * (1 - \text{TRN_DECL})^{\text{YR_DECL}} \} + \text{RETAIL_COST}_2 \\
 &\quad + \text{CNG_RETAIL_MARKUP}_r + \frac{(\text{STAX}_r + \text{FTAX})}{\text{MC_PCWGDP}_i / \text{MC_PCWGDP}_{87}}
 \end{aligned} \tag{112}$$

where,

- DTAR_TRFV_SF_{n,r} = distributor tariff for the fleet vehicle transportation sector (87\$/Mcf)
- DTAR_TRPV_SF_{n,r} = distributor tariff for the personal vehicle transportation sector (87\$/Mcf)
- HDTAR_SF_{n,s,r,EHISYR} = historical (2006) distributor tariff for the transportation sector to deliver the CNG to the station⁷⁷ (87\$/Mcf)
- TRN_DECL = fleet vehicle distributor decline rate, set to zero for *AEO2010* (fraction, Appendix E)
- YR_DECL = difference between the current year and the last historical year over which the decline rate is applied
- RETAIL_COST₂ = assumed additional charge related to providing the dispensing service to customers, at a fleet refueling station (87\$/Mcf, Appendix E)
- CNG_RETAIL_MARKUP_r = markup for natural gas sold at retail stations (described below)

⁷⁵Motor vehicle fuel taxes are assumed constant in current year dollars throughout the forecast to reflect current laws. Within the model these taxes are specified in 1987 dollars.

⁷⁶The Safe, Accountable, Flexible, Efficient Transportation Equity Act: A Legacy for Users (SAFETEA-LU), Section 1113. The bill also allowed for an excise tax credit of \$0.50 per gasoline gallon equivalent to be paid to the seller of the CNG through September of 2009. The model assumes that the subsidy will be past through to consumers.

⁷⁷EIA published, annual, State level data are used to set regional historical end-use prices for CNG vehicles. Since monthly data are not available for this sector, seasonal differentials for the industrial sector are applied to annual CNG data to approximate seasonal CNG prices.

STAX _r	=	State motor vehicle fuel tax for CNG (current year \$/Mcf, Appendix E)
FTAX	=	Federal motor vehicle fuel tax minus federal excise motor fuel credit for CNG (current year \$/Mcf, Appendix E)
MC_PCWGDP _t	=	GDP conversion from current year dollars to \$87 [from the NEMS macroeconomic module]
n	=	network (peak or off-peak)
s	=	end-use sector index (s=4 for transportation sector)
r	=	NGTDM region
EHISYR	=	index defining last year that historical data are available
t	=	forecast year

A new algorithm was developed for *AEO2010* which projects whether construction of CNG fueling stations is economically viable in any of the NGTDM regions and, if so, sets the added charge that will result. In addition, the model provides the NEMS Transportation Sector Module with a projection of the fraction of retail refueling stations which sell natural gas. This is a key driver in the transportation module for projecting the number of compressed natural gas vehicles purchased and the resulting consumption level. While demand for CNG for personal vehicles is increased when fueling infrastructure is built, at the same time the viability of fueling infrastructure depends on sufficient demand to support it. A reduced form of the NEMS Transportation Sector Module was created for use in the NGTDM to estimate the increase in demand for CNG due to infrastructure construction, in order to project the revenue from a infrastructure building project, and then to assess its viability.

The basic algorithm involves 1) assuming a set increase in the number of stations selling CNG, 2) assuming CNG will be priced at a discount to the price of motor gasoline once it starts penetrating, 3) estimating the expected demand for CNG given the increased supply availability and price, 4) calculating the expected revenue per station that will cover capital expenditures (i.e., discounting for taxes, gas purchase costs, and other operating costs), 5) checking the revenue against infrastructure costs to determine viability, and 6) if viable, assuming the infrastructure will be added and the retail price changed accordingly.

The algorithm starts by testing the effects of building a large number of CNG stations (i.e., primarily by offering CNG at existing gasoline stations). The increase in availability that is tested is assumed to be a proportion of the number of gasoline stations in the region, as follows:

$$\text{TOTPUMPS} = \text{NSTAT}_r * (\text{MAX_CNG_BUILD} + \text{CNGAVAIL}_{t-1}) \quad (113)$$

where,

TOTPUMPS	=	the number of retail stations selling CNG in the region
NSTAT _r	=	the number of gasoline stations in the region at the beginning of the projection period (Appendix E)
CNGAVAIL _{t-1}	=	fraction of total retail refueling stations selling CNG last year
MAX_CNG_BUILD	=	assumed fraction of stations that can add CNG refueling this year (Appendix E).

r = census division
t = year

The assumed regional retail markup to cover capital costs if CNG infrastructure is built is set as follows:

$$\text{TEST_MARKUP}_r = \text{minimum}\{5.0, \text{MAX_CNGMARKUP}\} \quad (114)$$

where,

$$\text{MAX_CNGMARKUP}_r = 0.75 * \{ \text{PMGTR}_{r,t-1} - (\text{PGFTRPV}_{r,t-1} - \text{CNG_RETAIL_MARKUP}_r) \} \quad (115)$$

where,

TEST_MARKUP_r = assumed regional retail markup (87\$/MMBtu)
 MAX_CNG_MARKUP_r = assumed maximum markup that can be added to base line cost of dispensing CNG to cover capital expenditures (87\$/MMBtu)
 [Note: base line costs include taxes and fuel and basic operating costs]
 PMGTR_r = retail price of motor gasoline (87\$/MMBtu)
 PMGFTRPV = retail price of CNG (87\$/MMBtu)
 CNG_RETAIL_MARKUP_r = retail CNG markup above base line costs added last year (87\$/MMBtu)
 0.75 = assumed economic rent that can be captured relative to the difference between the retail price of motor gasoline and the retail price of CNG (fraction)
 5.0 = assumed minimum retail CNG markup (87\$/MMBtu)

For each model year and region, the present value of projected revenue is determined with the following equation:

$$\text{REVENUE} = \sum_{n=1}^{\text{CNG_HRZ}} \frac{\text{TEST_MARKUP}_r * \text{DEMAND} * 1000000}{\text{TOTPUMPS} * (1 + \text{CNG_WACC})^n} \quad (116)$$

where,

REVENUE = the net revenue per station (above the basic operating expenses) after infrastructure is added in the region (1987 dollars)
 CNG_HRZ = the time horizon for the revenue calculation, corresponding to the number of years over which the capital investment is assumed to need to be recovered (Appendix E)
 TEST_MARKUP_r = assumed regional retail markup above baseline costs (87\$/MMBtu)
 DEMAND = estimated consumption of CNG by personal vehicles if the infrastructure is added and the implied retail price is charged (trillion BTU), described at the end of this section
 TOTPUMPS = the number of retail stations selling CNG in the region

CNG_WACC = assumed weighted average cost of capital for financing the added CNG infrastructure (Appendix E)

The model compares the present value of the projected revenue per station from an infrastructure build to the assumed cost of a station (CNG_BUILDCOST, Appendix E) to make the decision of whether stations are built or not. The cost of a station reflects the estimated cost of building a single pumping location in an existing retail refueling station, considering the tax value of depreciation and a payback number of years (CNG_HRZ, Appendix E) and an assumed weighted average cost of capital (CNG_WACC, Appendix E). If the revenue is sufficient in a region then the availability of CNG stations in that region are increased and the retail markup is set to the markup that was tested. The equations for new retail markup and availability when stations have been built are given in the following:

$$\text{CNGAVAIL}_{r,t} = \text{CNGAVAIL}_{r,t-1} + \text{MAX_CNG_BUILD} \quad (117)$$

$$\text{RET_MARK}_r = \text{TEST_MARKUP} \quad (118)$$

where,

- CNGAVAIL_{r,t} = fraction of regional retail refueling stations selling CNG
- MAX_CNG_BUILD = incremental fraction of retail refueling stations selling CNG with added infrastructure in the year
- RET_MARK_r = CNG retail markup above baseline costs (87\$/MMBtu)
- TEST_MARKUP = assumed CNG retail markup above baseline costs, based on the difference between baseline CNG costs and motor gasoline prices (87\$/MMBtu)
- r = Census Division
- t = year

These variables stay at last year's values if no stations have been built. The retail markup by NGTDM region (CNG_RETAIL_MARKUP), as used in the transportation sector distributor tariff equation, is set by assigning the retail markup (RET_MARK) from the associated Census Division.

The demand response for CNG use in personal vehicles was estimated by doing multiple runs of the Transportation Sector Module. The key variable that was varied was the availability of CNG refueling stations. Test runs were made over a range of availability values for nine different cases. The cases were defined with three different motor gasoline to CNG price differentials (a maximum, a minimum, and the average between the two) in combination with three different CNG vehicle purchase subsidies (\$0, \$20,000, \$40,000 in 2009 dollars per vehicle).⁷⁸ For each of the resulting nine sets of runs the CNG demand response in the Pacific Census Division was estimated as a function of station availability in a log-linear form with a constant term. The

⁷⁸Based on current laws and regulations in the AEO2010 Reference Case, the subsidy is set to \$0. A nonzero subsidy option was included for potential scenario analyses.

demand response in the Pacific Division was estimated by linearly interpolating between the points in the resulting three dimensional grid for a given availability (fraction of stations offering CNG), price differential between CNG and motor gasoline, and allowed subsidy for purchasing a CNG vehicle. The estimated consumption levels in the other Census Divisions were set by scaling the Pacific Division consumption based on size (as measured by total transportation energy demand) relative to the Pacific Division.

6. Pipeline Tariff Submodule Solution Methodology

The Pipeline Tariff Submodule (PTS) sets rates charged for storage services and interstate pipeline transportation. The rates developed are based on actual costs for transportation and storage services. These cost-based rates are used as a basis for developing tariff curves for the Interstate Transmission Submodule (ITS). The PTS tariff calculation is divided into two phases: an historical year initialization phase and a forecast year update phase. Each of these two phases includes the following steps: (1) determine the various components, in nominal dollars, of the total cost-of-service, (2) classify these components as fixed and variable costs based on the rate design (for transportation), (3) allocate these fixed and variable costs to rate components (reservation and usage costs) based on the rate design (for transportation), and (4) for transportation: compute rates for services during peak and off-peak time periods; for storage: compute annual regional tariffs. For the historical year phase, the cost of service is developed from historical financial data on 28 major U.S. interstate pipeline companies; while for the forecast year update phase the costs are estimated using a set of econometric equations and an accounting algorithm. The pipeline tariff calculations are described first, followed by the storage tariff calculations, and finally a description of the calculation of the tariffs for moving gas by pipeline from Alaska and from the MacKenzie Delta to Alberta. A general overview of the methodology for deriving rates is presented in the following box. The PTS system diagram is presented in **Figure 6-1**.

The purpose of the historical year initialization phase is to provide an initial set of transportation revenue requirements and tariffs. The last historical year for the PTS is currently 2006, which need not align with the last historical year for the rest of the NGTDM. Ultimately the ITS requires pipeline and storage tariffs; whether they are based on historical or projected financial data is mechanically irrelevant. The historical year information is developed from existing pipeline company transportation data. The historical year initialization process draws heavily on three databases: (1) a pipeline financial database (1990-2006) of 28 major interstate natural gas pipelines developed by Foster Associates,⁷⁹ (2) “a competitive profile of natural gas services” database developed by Foster Associates,⁸⁰ and (3) a pipeline capacity database developed by the Office of Oil and Gas, EIA.⁸¹ The first database represents the existing physical U.S. interstate pipeline and storage system, which includes production processing, gathering, transmission, storage, and other. The physical system is at a more disaggregate level than the NGTDM network. This database provides detailed company-level financial, cost, and rate base parameters. It contains information on capital structure, rate base, and revenue requirements by major line item of the cost of service for the historical years of the model. The second Foster database contains detailed data on

⁷⁹Foster Financial Reports, 28 Major Interstate Natural Gas Pipelines, 2000, 2004 and 2007 Editions, Foster Associates, Inc., Bethesda, Maryland. The primary sources of data for these reports are FERC Form 2 and the monthly FERC Form 11 pipeline company filings. These reports can be purchased from Foster Associates.

⁸⁰Competitive Profile of Natural Gas Services, Individual Pipelines, December 1997, Foster Associates, Inc., Bethesda, Maryland. Volumes III and IV of this report contain detailed information on the major interstate pipelines, including a pipeline system map, capacity, rates, gas plant accounts, rate base, capitalization, cost of service, etc. This report can be purchased from Foster Associates.

⁸¹A spreadsheet compiled by James Tobin of the Office of Oil and Gas containing historical and proposed state-to-state pipeline construction project costs, mileage, capacity levels and additions by year from 1996 to 2011, by pipeline company (data as of August 16, 2007).

gross and net plant in service and depreciation, depletion, and amortization for individual plants (production processing and gathering plants, gas storage plants, gas transmission plants, and other plants) and is used to compute sharing factors by pipeline company and year to single out financial cost data for transmission plants from the “total plants” data in the first database.

Figure 6-1. Pipeline Tariff Submodule System Diagram

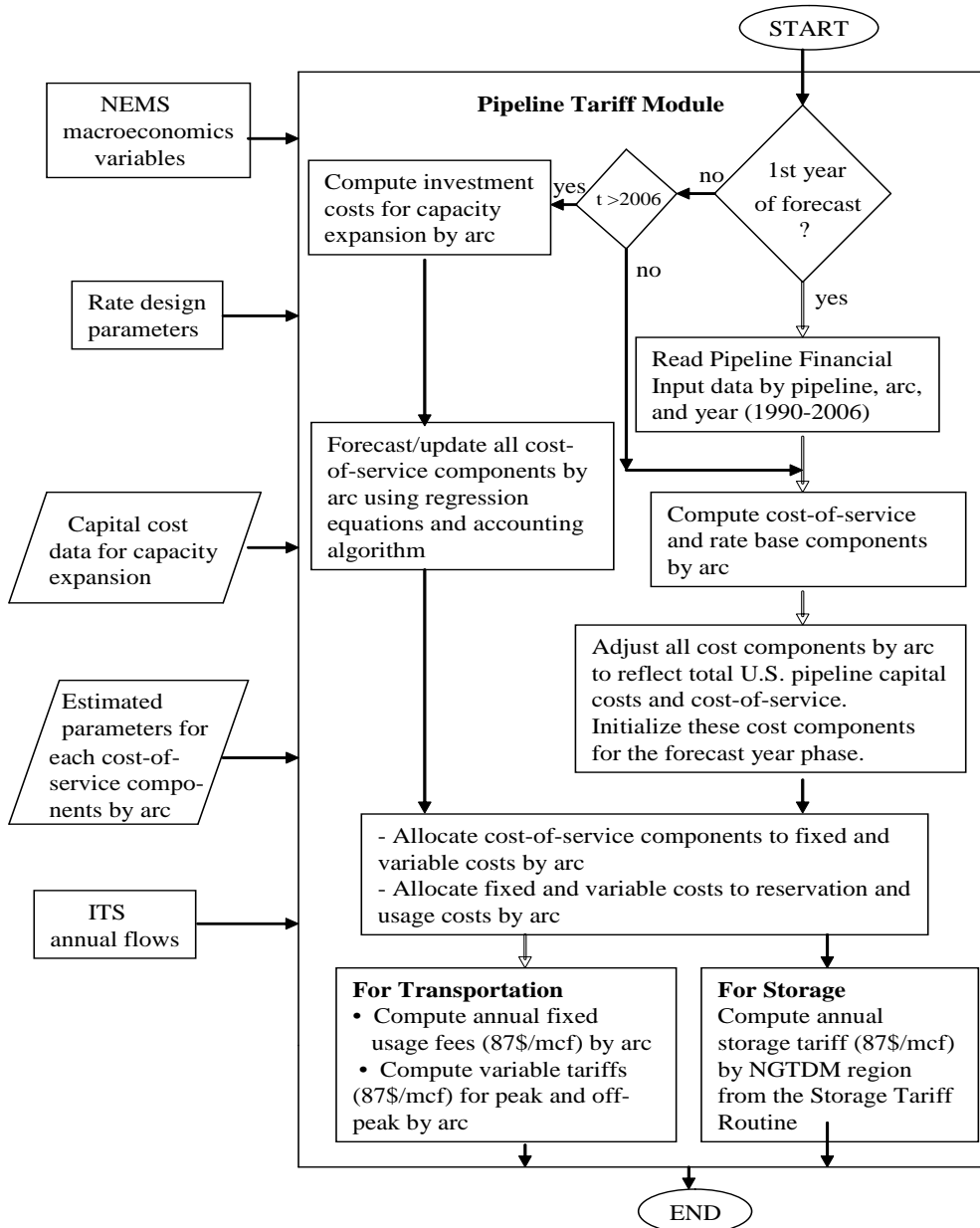

The third database contains pipeline financial construction projects by pipeline company, state-to-state transfer, and year (1996-2011). This database is used to determine factors to allocate the pipeline company financial data to the NGTDM interstate pipeline arcs based on capacity level in each historical year. These three databases are pre-processed offline to generate the pipeline transmission financial data by pipeline company, NGTDM interstate arc, and historical year (1990-2006) used as input into the PTS.

PTS Process for Deriving Rates

For Each Pipeline Arc

- Read historical financial database for 28 major interstate natural gas pipelines by pipeline company, arc, and historical year (1990-2006).
- Derive the total pipeline cost of service (TCOS)
 - Historical years
 - Aggregate pipeline TCOS items to network arcs
 - Adjust TCOS components to reflect all U.S. pipelines based on annual “Pipeline Economics” special reports in the Oil & Gas Journal
 - Forecast years
 - Include capital costs for capacity expansion
 - Estimate TCOS components from forecasting equations and accounting algorithm
- Allocate total cost of service to fixed and variable costs based on rate design
- Allocate costs to rate components (reservation and usage costs) based on rate design
- Compute rates for services for peak and off-peak time periods

For Each Storage Region:

- Derive the total storage cost of service (STCOS)
 - Historical years: read regional financial data for 33 storage facilities by node (NGTDM region) and historical year (1990-1998)
 - Forecast years:
 - Estimate STCOS components from forecasting equations and accounting algorithm
 - Adjust STCOS to reflect total U.S. storage facilities based on annual storage capacity data reported by EIA
- Compute annual regional storage rates for services

Historical Year Initialization Phase

The following section discusses two separate processes that occur during the historical year initialization phase: (1) the computation and initialization of the cost-of-service components, and (2) the computation of rates for services. The computation of historical year cost-of-service components and rates for services involves four distinct procedures as outlined in the above box and discussed below. Rates are calculated in nominal dollars and then converted to real dollars for use in the ITS.

Computation and Initialization of Pipeline Cost-of-Service Components

In the historical year initialization phase of the PTS, rates are computed using the following four-step process: (Step 1) derivation and initialization of the total cost-of-service components, (Step 2) classification of cost-of-service components as fixed and variable costs, (Step 3) allocation of fixed and variable costs to rate components (reservation and usage costs) based on rate design, and (Step 4) computation of rates at the arc level for transportation services.

Step 1: Derivation and Initialization of the Total Cost-of-Service Components

The total cost-of-service for existing capacity on an arc consists of a just and reasonable return on the rate base plus total normal operating expenses. Derivations of return on rate base and total normal operating expenses are presented in the following subsections. The total cost of service is computed as follows:

$$TCOS_{a,t} = TRRB_{a,t} + TNOE_{a,t} \tag{119}$$

where,

- TCOS_{a,t} = total cost-of-service (dollars)
- TRRB_{a,t} = total return on rate base (dollars)
- TNOE_{a,t} = total normal operating expenses (dollars)
- a = arc
- t = historical year

Just and Reasonable Return. In order to compute the return portion of the cost-of-service at the arc level, the determination of capital structure and adjusted rate base is necessary. Capital structure is important because it determines the cost of capital to the pipeline companies associated with a network arc. The weighted average cost of capital is applied to the rate base to determine the return component of the cost-of-service, as follows:

$$TRRB_{a,t} = WAROR_{a,t} * APRB_{a,t} \tag{120}$$

where,

- TRRB_{a,t} = total return on rate base after taxes (dollars)
- WAROR_{a,t} = weighted-average after-tax return on capital (fraction)
- APRB_{a,t} = adjusted pipeline rate base (dollars)

a = arc
t = historical year

In addition, the return on rate base $TRRB_{a,t}$ is broken out into the three components as shown below.

$$PFEN_{a,t} = \sum_p [(PFES_{a,p,t} / TOTCAP_{a,p,t}) * PFER_{a,p,t} * APRB_{a,p,t}] \quad (121)$$

$$CMEN_{a,t} = \sum_p [(CMES_{a,p,t} / TOTCAP_{a,p,t}) * CMER_{a,p,t} * APRB_{a,p,t}] \quad (122)$$

$$LTDN_{a,t} = \sum_p [(LTDS_{a,p,t} / TOTCAP_{a,p,t}) * LTDR_{a,p,t} * APRB_{a,p,t}] \quad (123)$$

such that,

$$TRRB_{a,t} = (PFEN_{a,t} + CMEN_{a,t} + LTDN_{a,t}) \quad (124)$$

where,

PFEN_{a,t} = total return on preferred stock (dollars)
 PFES_{a,p,t} = value of preferred stock (dollars)
 TOTCAP_{a,p,t} = total capitalization (dollars)
 PFER_{a,p,t} = coupon rate for preferred stock (fraction) [read as D_PFER]
 APRB_{a,p,t} = adjusted pipeline rate base (dollars) [read as D_APRB]
 CMEN_{a,t} = total return on common stock equity (dollars)
 CMES_{a,p,t} = value of common stock equity (dollars)
 CMER_{a,p,t} = common equity rate of return (fraction) [read as D_CMER]
 LTDN_{a,t} = total return on long-term debt (dollars)
 LTDS_{a,p,t} = value of long-term debt (dollars)
 LTDR_{a,p,t} = long-term debt rate (fraction) [read as D_LTDR]
 p = pipeline company
 a = arc
 t = historical year

Note that the first terms (fractions) in parentheses on the right hand side of equations 121 to 123 represent the capital structure ratios for each pipeline company associated with a network arc. These fractions are computed exogenously and read in along with the rates of return and the adjusted rate base. The total returns on preferred stock, common equity, and long-term debt at the arc level are computed immediately after all the input variables are read in. The capital structure ratios are exogenously determined as follows:

$$GPFESTR_{a,p,t} = PFES_{a,p,t} / TOTCAP_{a,p,t} \quad (125)$$

$$GCMESTR_{a,p,t} = CMES_{a,p,t} / TOTCAP_{a,p,t} \quad (126)$$

$$GLTDSTR_{a,p,t} = LTDS_{a,p,t} / TOTCAP_{a,p,t} \quad (127)$$

where,

$$\begin{aligned}
 \text{GPFESTR}_{a,p,t} &= \text{capital structure ratio for preferred stock for existing pipeline} \\
 &\quad \text{(fraction) [read as D_GPFES]} \\
 \text{GCMESTR}_{a,p,t} &= \text{capital structure ratio for common equity for existing pipeline} \\
 &\quad \text{(fraction) [read as D_GCMES]} \\
 \text{GLTDSTR}_{a,p,t} &= \text{capital structure ratio for long-term debt for existing pipeline} \\
 &\quad \text{(fraction) [read as D_GLTDS]} \\
 \text{PFES}_{a,p,t} &= \text{value of preferred stock (dollars)} \\
 \text{CMES}_{a,p,t} &= \text{value of common stock (dollars)} \\
 \text{LTDS}_{a,p,t} &= \text{value of long-term debt (dollars)} \\
 \text{TOTCAP}_{a,p,t} &= \text{total capitalization (dollars), equal to the sum of value of} \\
 &\quad \text{preferred stock, common stock equity, and long-term debt} \\
 p &= \text{pipeline company} \\
 a &= \text{arc} \\
 t &= \text{historical year}
 \end{aligned}$$

In the financial database, the estimated capital (capitalization) for each interstate pipeline is by definition equal to its adjusted rate base. Hence, the estimated capital $\text{TOTCAP}_{a,p,t}$ defined in the above equations is equal to the adjusted rate base $\text{APRB}_{a,p,t}$.

$$\text{TOTCAP}_{a,p,t} = \text{APRB}_{a,p,t} \quad (128)$$

where,

$$\begin{aligned}
 \text{TOTCAP}_{a,p,t} &= \text{total capitalization (dollars)} \\
 \text{APRB}_{a,p,t} &= \text{adjusted rate base (dollars)} \\
 a &= \text{arc} \\
 p &= \text{pipeline company} \\
 t &= \text{historical year}
 \end{aligned}$$

Substituting the adjusted rate base $\text{APRB}_{a,t}$ for the estimated capital $\text{TOTCAP}_{a,t}$ in equations 125 to 127, the values of preferred stock, common stock, and long-term debt by pipeline and arc can be computed by applying the capital structure ratios to the adjusted rate base, as follows:

$$\begin{aligned}
 \text{PFES}_{a,p,t} &= \text{GPFESTR}_{a,p,t} * \text{APRB}_{a,p,t} \\
 \text{CMES}_{a,p,t} &= \text{GCMESTR}_{a,p,t} * \text{APRB}_{a,p,t} \\
 \text{LTDS}_{a,p,t} &= \text{GLTDSTR}_{a,p,t} * \text{APRB}_{a,p,t} \\
 \text{GPFESTR}_{a,p,t} + \text{GCMESTR}_{a,p,t} + \text{GLTDSTR}_{a,p,t} &= 1.0
 \end{aligned} \quad (129)$$

where,

$$\begin{aligned}
 \text{PFES}_{a,p,t} &= \text{value of preferred stock in nominal dollars} \\
 \text{CMES}_{a,p,t} &= \text{value of common equity in nominal dollars} \\
 \text{LTDS}_{a,p,t} &= \text{long-term debt in nominal dollars} \\
 \text{GPFESTR}_{a,p,t} &= \text{capital structure ratio for preferred stock for existing pipeline} \\
 &\quad \text{(fraction)} \\
 \text{GCMESTR}_{a,p,t} &= \text{capital structure ratio of common stock for existing pipeline}
 \end{aligned}$$

$GLTDSTR_{a,p,t}$ = (fraction)
 capital structure ratio of long term debt for existing pipeline
 (fraction)
 $APRB_{a,p,t}$ = adjusted rate base (dollars)
 p = pipeline
 a = arc
 t = forecast year

The cost of capital at the arc level ($WAROR_{a,t}$) is computed as the weighted average cost of capital for preferred stock, common stock equity, and long-term debt for all pipeline companies associated with that arc, as follows:

$$WAROR_{a,t} = \frac{\sum_p [(PFES_{a,p,t} * PFER_{a,p,t} + CMES_{a,p,t} * CMER_{a,p,t} + LTDS_{a,p,t} * LTDR_{a,p,t})] / APRB_{a,t}}{APRB_{a,t}} \quad (130)$$

$$APRB_{a,t} = PFES_{a,t} + CMES_{a,t} + LTDS_{a,t} \quad (131)$$

where,

$WAROR_{a,t}$ = weighted-average after-tax return on capital (fraction)
 $PFES_{a,p,t}$ = value of preferred stock (dollars)
 $PFER_{a,p,t}$ = preferred stock rate (fraction)
 $CMES_{a,p,t}$ = value of common stock equity (dollars)
 $CMER_{a,p,t}$ = common equity rate of return (fraction)
 $LTDS_{a,p,t}$ = value of long-term debt (dollars)
 $LTDR_{a,p,t}$ = long-term debt rate (fraction)
 $APRB_{a,p,t}$ = adjusted rate base (dollars)
 p = pipeline
 a = arc
 t = historical year

The adjusted rate base by pipeline and arc is computed as the sum of net plant in service and total cash working capital (which includes plant held for future use, materials and supplies, and other working capital) minus accumulated deferred income taxes. This rate base is computed offline and read in by the PTS. The computation is as follows:

$$APRB_{a,p,t} = NPIS_{a,p,t} + CWC_{a,p,t} - ADIT_{a,p,t} \quad (132)$$

where,

$APRB_{a,p,t}$ = adjusted rate base (dollars)
 $NPIS_{a,p,t}$ = net capital cost of plant in service (dollars) [read as D_NPIS]
 $CWC_{a,p,t}$ = total cash working capital (dollars) [read as D_CWC]
 $ADIT_{a,p,t}$ = accumulated deferred income taxes (dollars) [read as D_ADIT]
 p = pipeline company
 a = arc
 t = historical year

The net plant in service by pipeline and arc is the original capital cost of plant in service minus the accumulated depreciation. It is computed offline and then read in by the PTS. The computation is as follows:

$$\text{NPIS}_{a,p,t} = \text{GPIS}_{a,p,t} - \text{ADDA}_{a,p,t} \quad (133)$$

where,

$$\begin{aligned} \text{NPIS}_{a,p,t} &= \text{net capital cost of plant in service (dollars)} \\ \text{GPIS}_{a,p,t} &= \text{original capital cost of plant in service (dollars) [read as D_GPIS]} \\ \text{ADDA}_{a,p,t} &= \text{accumulated depreciation, depletion, and amortization (dollars) [read as D_ADDA]} \\ p &= \text{pipeline company} \\ a &= \text{arc} \\ t &= \text{historical year} \end{aligned}$$

The adjusted rate base at the arc level is computed as follows:

$$\begin{aligned} \text{APRB}_{a,t} &= \sum_p \text{APRB}_{a,p,t} = \sum_p (\text{NPIS}_{a,p,t} + \text{CWC}_{a,p,t} - \text{ADIT}_{a,p,t}) \\ &= (\text{NPIS}_{a,t} + \text{CWC}_{a,t} - \text{ADIT}_{a,t}) \end{aligned} \quad (134)$$

with,

$$\begin{aligned} \text{NPIS}_{a,t} &= \sum_p (\text{GPIS}_{a,p,t} - \text{ADDA}_{a,p,t}) \\ &= (\text{GPIS}_{a,t} - \text{ADDA}_{a,t}) \end{aligned} \quad (135)$$

where,

$$\begin{aligned} \text{APRB}_{a,p,t} &= \text{adjusted rate base (dollars) at the arc level} \\ \text{NPIS}_{a,p,t} &= \text{net capital cost of plant in service (dollars) at the arc level} \\ \text{CWC}_{a,t} &= \text{total cash working capital (dollars) at the arc level} \\ \text{ADIT}_{a,t} &= \text{accumulated deferred income taxes (dollars) at the arc level} \\ \text{GPIS}_{a,p,t} &= \text{original capital cost of plant in service (dollars) at the arc level} \\ \text{ADDA}_{a,t} &= \text{accumulated depreciation, depletion, and amortization (dollars) at the arc level} \\ p &= \text{pipeline company} \\ a &= \text{arc} \\ t &= \text{historical year} \end{aligned}$$

Total Normal Operating Expenses. Total normal operating expense line items include depreciation, taxes, and total operating and maintenance expenses. Total operating and maintenance expenses include administrative and general expenses, customer expenses, and other operating and maintenance expenses. In the PTS, taxes are disaggregated further into Federal, State, and other taxes and deferred income taxes. The equation for total normal operating expenses at the arc level is given as follows:

$$\text{TNOE}_{a,t} = \sum_p (\text{DDA}_{a,p,t} + \text{TOTAX}_{a,p,t} + \text{TOM}_{a,p,t}) \quad (136)$$

where,

$$\begin{aligned}
 \text{TNOE}_{a,t} &= \text{total normal operating expenses (dollars)} \\
 \text{DDA}_{a,p,t} &= \text{depreciation, depletion, and amortization costs (dollars) [read as D_DDA]} \\
 \text{TOTAX}_{a,p,t} &= \text{total Federal and State income tax liability (dollars)} \\
 \text{TOM}_{a,p,t} &= \text{total operating and maintenance expense (dollars) [read as D_TOM]} \\
 p &= \text{pipeline} \\
 a &= \text{arc} \\
 t &= \text{historical year}
 \end{aligned}$$

Depreciation, depletion, and amortization costs, and total operating and maintenance expense are available directly from the financial database. The equations to compute these costs at the arc level are as follows:

$$\text{DDA}_{a,t} = \sum_p \text{DDA}_{a,p,t} \quad (137)$$

$$\text{TOM}_{a,t} = \sum_p \text{TOM}_{a,p,t} \quad (138)$$

Total taxes at the arc level are computed as the sum of Federal and State income taxes, other taxes, and deferred income taxes, as follows:

$$\text{TOTAX}_{a,t} = \sum_p (\text{FSIT}_{a,p,t} + \text{OTTAX}_{a,p,t} + \text{DIT}_{a,p,t}) \quad (139)$$

$$\text{FSIT}_{a,t} = \sum_p \text{FSIT}_{a,p,t} = \sum_p (\text{FIT}_{a,p,t} + \text{SIT}_{a,p,t}) \quad (140)$$

where,

$$\begin{aligned}
 \text{TOTAX}_{a,t} &= \text{total Federal and State income tax liability (dollars)} \\
 \text{FSIT}_{a,p,t} &= \text{Federal and State income tax (dollars)} \\
 \text{OTTAX}_{a,p,t} &= \text{all other taxes assessed by Federal, State, or local governments except income taxes and deferred income tax (dollars) [read as D_OTTAX]} \\
 \text{DIT}_{a,p,t} &= \text{deferred income taxes (dollars) [read as D_DIT]} \\
 \text{FIT}_{a,p,t} &= \text{Federal income tax (dollars)} \\
 \text{SIT}_{a,p,t} &= \text{State income tax (dollars)} \\
 p &= \text{pipeline company} \\
 a &= \text{arc} \\
 t &= \text{historical year}
 \end{aligned}$$

Federal income taxes are derived from returns to common stock equity and preferred stock (after-tax profit) and the Federal tax rate. The after-tax profit at the arc level is determined as follows:

$$\text{ATP}_{a,t} = \sum_p (\text{PFER}_{a,p,t} * \text{PFES}_{a,p,t} + \text{CMER}_{a,p,t} * \text{CMES}_{a,p,t}) \quad (141)$$

where,

$ATP_{a,t}$ = after-tax profit (dollars) at the arc level
 $PFER_{a,p,t}$ = preferred stock rate (fraction)
 $PFES_{a,p,t}$ = value of preferred stock (dollars)
 $CMER_{a,p,t}$ = common equity rate of return (fraction)
 $CMES_{a,p,t}$ = value of common stock equity (dollars)
 a = arc
 t = historical year

and the Federal income taxes at the arc level are

$$FIT_{a,t} = \frac{FRATE * ATP_{a,t}}{(1. - FRATE)} \quad (142)$$

where,

$FIT_{a,t}$ = Federal income tax (dollars) at the arc level
 $FRATE$ = Federal income tax rate (fraction) (Appendix E)
 $ATP_{a,t}$ = after-tax profit (dollars)

State income taxes are computed by multiplying the sum of taxable profit and the associated Federal income tax by a weighted-average State tax rate associated with each pipeline company. The weighted-average State tax rate is based on peak service volumes in each State delivered by the pipeline company. State income taxes at the arc level are computed as follows:

$$SIT_{a,t} = SRATE * (FIT_{a,t} + ATP_{a,t}) \quad (143)$$

where,

$SIT_{a,t}$ = State income tax (dollars) at the arc level
 $SRATE$ = average State income tax rate (fraction) (Appendix E)
 $FIT_{a,t}$ = Federal income tax (dollars) at the arc level
 $ATP_{a,t}$ = after-tax profits (dollars) at the arc level

Thus, total taxes at the arc level can be expressed by the following equation:

$$TOTAX_{a,t} = (FSIT_{a,t} + OTTAX_{a,t} + DIT_{a,t}) \quad (144)$$

where,

$TOTAX_{a,t}$ = total Federal and State income tax liability (dollars) at the arc level
 $FSIT_{a,t}$ = Federal and State income tax (dollars) at the arc level
 $OTTAX_{a,t}$ = all other taxes assessed by Federal, State, or local governments except income taxes and deferred income taxes (dollars), at the arc level
 $DIT_{a,t}$ = deferred income taxes (dollars) at the arc level
 a = arc
 t = historical year

All other taxes and deferred income taxes at the arc level are expressed as follows:

$$OTTAX_{a,t} = \sum_p OTTAX_{a,p,t} \quad (145)$$

$$DIT_{a,t} = \sum_p DIT_{a,p,t} \quad (146)$$

Adjustment from 28 major pipelines to total U.S. Note that all cost-of-service and rate base components computed so far are based on the financial database of 28 major interstate pipelines. According to the U.S. natural gas pipeline construction and financial reports filed with the FERC and published in the Oil and Gas Journal,⁸² there were more than 100 interstate natural gas pipelines operating in the United States in 2006. The total annual gross plant in service and operating revenues for all these pipelines are much higher than those for the 28 major interstate pipelines in the financial database. All the cost-of-service and rate base components at the arc level computed in the above sections are scaled up as follows: For the capital costs and adjusted rate base components,

$$\begin{aligned} GPIS_{a,t} &= GPIS_{a,t} * HFAC_GPIS_t \\ ADDA_{a,t} &= ADDA_{a,t} * HFAC_GPIS_t \\ NPIS_{a,t} &= NPIS_{a,t} * HFAC_GPIS_t \\ CWC_{a,t} &= CWC_{a,t} * HFAC_GPIS_t \\ ADIT_{a,t} &= ADIT_{a,t} * HFAC_GPIS_t \\ APRB_{a,t} &= APRB_{a,t} * HFAC_GPIS_t \end{aligned} \quad (147)$$

For the cost-of-service components,

$$\begin{aligned} PFEN_{a,t} &= PFEN_{a,t} * HFAC_REV_t \\ CMEN_{a,t} &= CMEN_{a,t} * HFAC_REV_t \\ LTDN_{a,t} &= LTDN_{a,t} * HFAC_REV_t \\ DDA_{a,t} &= DDA_{a,t} * HFAC_REV_t \\ FSIT_{a,t} &= FSIT_{a,t} * HFAC_REV_t \\ OTTAX_{a,t} &= OTTAX_{a,t} * HFAC_REV_t \\ DIT_{a,t} &= DIT_{a,t} * HFAC_REV_t \\ TOM_{a,t} &= TOM_{a,t} * HFAC_REV_t \end{aligned} \quad (148)$$

where,

$$\begin{aligned} GPIS_{a,t} &= \text{original capital cost of plant in service (dollars)} \\ HFAC_GPIS_t &= \text{adjustment factor for capital costs to total U.S. (Appendix E)} \\ ADDA_{a,t} &= \text{accumulated depreciation, depletion, and amortization (dollars)} \end{aligned}$$

⁸²*Pipeline Economics*, Oil and Gas Journal, 1994, 1995, 1997, 1999, 2001, 2002, 2003, 2004, 2005, 2006.

$NPIS_{a,t}$ = net capital cost of plant in service (dollars)
 $CWC_{a,t}$ = total cash working capital (dollars)
 $ADIT_{a,t}$ = accumulated deferred income taxes (dollars)
 $APRB_{a,t}$ = adjusted pipeline rate base (dollars)
 $PFEN_{a,t}$ = total return on preferred stock (dollars)
 $HFAC_REV_t$ = adjustment factor for operation revenues to total U.S.
 (Appendix E)
 $CMEN_{a,t}$ = total return on common stock equity (dollars)
 $LTDN_{a,t}$ = total return on long-term debt (dollars)
 $DDA_{a,t}$ = depreciation, depletion, and amortization costs (dollars)
 $FSIT_{a,t}$ = Federal and State income tax (dollars)
 $OTTAX_{a,t}$ = all other taxes assessed by Federal, State, or local governments
 except income taxes and deferred income taxes (dollars)
 $DIT_{a,t}$ = deferred income taxes (dollars)
 $TOM_{a,t}$ = total operations and maintenance expense (dollars)
 a = arc
 t = historical year

Except for the Federal and State income taxes and returns on capital, all the cost-of-service and rate base components computed at the arc level above are also used as initial values in the forecast year update phase that starts in 2007.

Step 2: Classification of Cost-of-Service Line Items as Fixed and Variable Costs

The PTS breaks each line item of the cost of service (computed in Step 1) into fixed and variable costs. Fixed costs are independent of storage/transportation usage, while variable costs are a function of usage. Fixed and variable costs are computed by multiplying each line item of the cost of service by the percentage of the cost that is fixed and the percentage of the cost that is variable. The classification of fixed and variable costs is defined by the user as part of the scenario specification. The classification of line item cost R_i to fixed and variable cost is determined as follows:

$$R_{i,f} = ALL_f * R_i / 100 \quad (149)$$

$$R_{i,v} = ALL_v * R_i / 100 \quad (150)$$

where,

$R_{i,f}$ = fixed cost portion of line item R_i (dollars)
 ALL_f = percentage of line item R_i representing fixed cost
 R_i = total cost of line item i (dollars)
 $R_{i,v}$ = variable cost portion of line item R_i (dollars)
 ALL_v = percentage of line item R_i representing variable cost
 i = line item index
 f,v = fixed or variable
 100 = $ALL_f + ALL_v$

An example of this procedure is illustrated in **Table 6-1**.

The resulting fixed and variable costs at the arc level are obtained by summing all line items for each cost category from the above equations, as follows:

$$FC_a = \sum_i R_{i,f} \quad (151)$$

$$VC_a = \sum_i R_{i,v} \quad (152)$$

where,

FC_a = total fixed cost (dollars) at the arc level
 VC_a = total variable cost (dollars) at the arc level
 a = arc

Table 6-1. Illustration of Fixed and Variable Cost Classification

Cost of Service Line Item	Total (dollars)	Cost Allocation Factors (percent)		Cost Component (dollars)	
		Fixed	Variable	Fixed	Variable
Total Return					
Preferred Stock	1,000	100	0	1,000	0
Common Stock	30,000	100	0	30,000	0
Long-Term Debt	29,000	100	0	29,000	0
Normal Operating Expenses					
Depreciation	30,000	100	0	30,000	0
Taxes					
Federal Tax	25,000	100	0	25,000	0
State Tax	5,000	100	0	5,000	0
Other Tax	1,000	100	0	1,000	0
Deferred Income Taxes	1,000	100	0	1,000	0
	105,000	60	40	63,000	42,000
Total Operations & Maintenance					
Total Cost-of-Service	227,000			185,000	42,000

Step 3: Allocation of Fixed and Variable Costs to Rate Components

Allocation of fixed and variable costs to rate components is conducted only for transportation services because storage service is modeled in a more simplified manner using a one-part rate. The rate design to be used within the PTS is specified by input parameters, which can be modified by the user to reflect changes in rate design over time. The PTS allocates the fixed and variable costs computed in Step 2 to rate components as specified by the rate design. For transportation service, the components of the rate consist of a reservation and a usage fee. The reservation fee is a charge assessed based on the amount of capacity reserved.

It typically is a monthly fee that does not vary with throughput. The usage fee is a charge assessed for each unit of gas that moves through the system.

The actual reservation and usage fees that pipelines are allowed to charge are regulated by the Federal Energy Regulatory Commission (FERC). How costs are allocated determines the extent of differences in the rates charged for different classes of customers for different types of services. In general, if more fixed costs are allocated to usage fees, more costs are recovered based on throughput.

Costs are assigned either to the reservation fee or to the usage fee according to the rate design specified for the pipeline company. The rate design can vary among pipeline companies. Three typical rate designs are described in **Table 6-2**. The PTS provides two options for specifying the rate design. In the first option, a rate design for each pipeline company can be specified for each forecast year. This option permits different rate designs to be used for different pipeline companies while also allowing individual company rate designs to change over time. Since pipeline company data subsequently are aggregated to network arcs, the composite rate design at the arc-level is the quantity-weighted average of the pipeline company rate designs. The second option permits a global specification of the rate design, where all pipeline companies have the same rate design for a specific time period but can switch to another rate design in a different time period.

Table 6-2. Approaches to Rate Design

Modified Fixed Variable (Three-Part Rate)	Modified Fixed Variable (Two-Part Rate)	Straight Fixed Variable (Two-Part Rate)
<ul style="list-style-type: none"> ● Two-part reservation fee. - Return on equity and related taxes are held at risk to achieving throughput targets by allocating these costs to the usage fee. Of the remaining fixed costs, 50 percent are recovered from a peak day reservation fee and 50 percent are recovered through an annual reservation fee. ● Variable costs allocated to the usage fee. In addition, return on equity and related taxes are also recovered through the usage fee. 	<ul style="list-style-type: none"> ● Reservation fee based on peak day requirements - all fixed costs except return on equity and related taxes recovered through this fee. ● Variable costs plus return on equity and related taxes are recovered through the usage fee. 	<ul style="list-style-type: none"> ● One-part capacity reservation fee. All fixed costs are recovered through the reservation fee, which is assessed based on peak day capacity requirements. ● Variable costs are recovered through the usage fee.

The allocation of fixed costs to reservation and usage fees entails multiplying each fixed cost line item of the total cost of service by the corresponding fixed cost rate design classification factor. A similar process is carried out for variable costs. This procedure is illustrated in **Tables 6-3a and 6-3b** and is generalized in the equations that follow. The classification of transportation line item costs $R_{i,f}$ and $R_{i,v}$ to reservation and usage cost is determined as follows:

$$R_{i,f,r} = ALL_{f,r} * R_{i,f} / 100 \quad (153)$$

$$R_{i,f,u} = ALL_{f,u} * R_{i,f} / 100 \quad (154)$$

$$R_{i,v,r} = ALL_{v,r} * R_{i,v} / 100 \quad (155)$$

$$R_{i,v,u} = ALL_{v,u} * R_{i,v} / 100 \quad (156)$$

Table 6-3a. Illustration of Allocation of Fixed Costs to Rate Components

Cost of Service Line Item	Total (dollars)	Allocation Factors (percent)		Cost Assigned to Rate Component (dollars)	
		Reservation	Usage	Reservation	Usage
Total Return					
Preferred Stock	1,000	100	0	0	1,000
Common Stock	30,000	100	0	0	30,000
Long-Term Debt	29,000	100	0	29,000	0
Normal Operating Expenses					
Depreciation	30,000	100	0	30,000	0
Taxes					
Federal Tax	25,000	0	100	0	25,000
State Tax	5,000	0	100	0	5,000
Other Tax	1,000	100	0	1,000	0
Deferred Income Taxes	1,000	100	0	1,000	0
Total Operations & Maintenance	63,000	100	0	63,000	0
Total Cost-of-Service	185,000			124,000	61,000

Table 6-3b. Illustration of Allocation of Variable Costs to Rate Components

Cost of Service Line Item	Total (dollars)	Allocation Factors (percent)		Cost Assigned to Rate Component (dollars)	
		Reservation	Usage	Reservation	Usage
Total Return					
Preferred Stock	0	0	100	0	0
Common Stock	0	0	100	0	0
Long-Term Debt	0	0	100	0	0
Normal Operating Expenses					
Depreciation	0	0	100	0	0
Taxes					
Federal Tax	0	0	100	0	0
State Tax	0	0	100	0	0
Other Tax	0	0	100	0	0
Deferred Income Taxes	0	0	100	0	0
Total Operations & Maintenance	42,000	0	100	0	42,000
Total Cost-of-Service	42,000			0	42,000

where,

- R = line item cost (dollars)
- ALL = percentage of reservation or usage line item R representing fixed or variable cost (Appendix E -- AFR, AVR, AFU, AVU)
- 100 = $ALL_{f,r} + ALL_{f,u}$
- 100 = $ALL_{v,r} + ALL_{v,u}$
- i = line item number index
- f = fixed cost index
- v = variable cost index
- r = reservation cost index
- u = usage cost index

At this stage in the procedure, the line items comprising the fixed and variable cost components of the reservation and usage fees can be summed to obtain total reservation and usage components of the rates.

$$RCOST_a = \sum_i (R_{i,f,r} + R_{i,v,r}) \quad (157)$$

$$UCOST_a = \sum_i (R_{i,f,u} + R_{i,v,u}) \quad (158)$$

where,

- RCOST_a = total reservation cost (dollars) at the arc level
- UCOST_a = total usage cost (dollars) at the arc level
- a = arc

After ratemaking Steps 1, 2 and 3 are completed for each arc by historical year, the rates are computed below.

Computation of Rates for Historical Years

The reservation and usage costs-of-service (RCOST and UCOST) developed above are used separately to develop two types of rates at the arc level: *variable tariffs* and *annual fixed usage fees*.

Variable Tariff Curves

Variable tariffs are proportional to reservation charges and are broken up into peak and off-peak time periods. Variable tariffs are derived directly from variable tariff curves which are developed based on reservation costs, utilization rates, annual flows, and other parameters.

In the PTS code, these variable tariff curves are defined by FUNCTION (NGPIPE_VARTAR) which is used by the ITS to compute the variable peak and off-peak tariffs by arc and by forecast year. The pipeline tariff curves are a function of peak or off-peak flow and are specified using a base point [price and quantity (PNOD, QNOD)] and an assumed price elasticity, as follows:

$$NGPIPE_VARTAR_{a,t} = PNOD_{a,t} * (Q_{a,t} / QNOD_{a,t})^{ALPHA_PIPE} \quad (159)$$

such that,

For peak transmission tariffs:

$$PNOD_{a,t} = \frac{RCOST_{a,t} * PKS_HR_YR}{(QNOD_{a,t} * MC_PCWGDP_t)} \quad (160)$$

$$QNOD_{a,t} = PT_NETFLOW_{a,t} \quad (161)$$

For off-peak transmission tariffs:

$$PNOD_{a,t} = \frac{RCOST_{a,t} * (1.0 - PKS_HR_YR)}{(QNOD_{a,t} * MC_PCWGDP_t)} \quad (162)$$

$$QNOD_{a,t} = PT_NETFLOW_{a,t} \quad (163)$$

where,

- NGPIPE_VARTAR_{a,t} = function to define pipeline tariffs (87\$/Mcf)
- PNOD_{a,t} = base point, price (87\$/Mcf)
- QNOD_{a,t} = base point, quantity (Bcf)
- Q_{a,t} = flow along pipeline arc (Bcf), dependent variable for the function
- ALPHA_PIPE = price elasticity for pipeline tariff curve for current capacity
- RCOST_{a,t} = reservation cost-of-service (dollars)
- PTNETFLOW_{a,t} = natural gas network flow (throughput, Bcf)
- PKSHR_YR = portion of the year represented by the peak season (fraction)
- MC_PCWGDP_t = GDP chain-type price deflator (from the Macroeconomic Activity Module)
- a = arc
- t = historical year

Annual Fixed Usage Fees

The annual fixed usage fees (volumetric charges) are derived directly from the usage costs, utilization rates for peak and off-peak time periods, and annual arc capacity. These fees are computed as the average fees over each historical year, as follows:

$$FIXTAR_{a,t} = UCOST_{a,t} / [(PKSHR_YR * PTPKUTZ_{a,t} * PTCURPCAP_{a,t} + (1.0 - PKSHR_YR) * PTOPUTZ_{a,t} * PTCURPCAP_{a,t}) * MC_PCWGDP_t] \quad (164)$$

where,

- $FIXTAR_{a,t}$ = annual fixed usage fees for existing and new capacity (87\$/Mcf)
 $UCOST_{a,t}$ = annual usage cost of service for existing and new capacity (dollars)
 $PKSHR_YR$ = portion of the year represented by the peak season (fraction)
 $PTPKUTZ_{a,t}$ = peak pipeline utilization (fraction)
 $PTCURPCAP_{a,t}$ = current pipeline capacity (Bcf)
 $PTOPUTZ_{a,t}$ = off-peak pipeline utilization (fraction)
 MC_PCWGDP_t = GDP chain-type price deflator (from the Macroeconomic Activity Module)
a = arc
t = historical year

Canadian Tariffs

In the historical year phase, Canadian tariffs are set to the historical differences between the import prices and the Western Canada Sedimentary Basin (WCSB) wellhead price.

Computation of Storage Rates

The annual storage tariff for each NGTDM region and year is defined as a function of storage flow and is specified using a base point [price and quantity (PNOD, QNOD)] and an assumed price elasticity, as follows:

$$X1NGSTR_VARTAR_{r,t} = PNOD_{r,t} * (Q_{r,t} / QNOD_{r,t})^{ALPHA_STR} \quad (165)$$

such that,

$$PNOD_{r,t} = \frac{STCOS_{r,t}}{(MC_PCWGDP_t * QNOD_{r,t} * 1,000,000.) * STRATIO_{r,t} * STCAP_ADJ_{r,t} * ADJ_STR} \quad (166)$$

$$QNOD_{r,t} = PTCURPSTR_{r,t} * PTSTUTZ_{r,t} \quad (167)$$

where,

- $X1NGSTR_VARTAR_{r,t}$ = function to define storage tariffs (87\$/Mcf)
 $Q_{r,t}$ = peak period net storage withdrawals (Bcf)
 $PNOD_{r,t}$ = base point, price (87\$/Mcf)
 $QNOD_{r,t}$ = base point, quantity (Bcf)
 $ALPHA_STR$ = price elasticity for storage tariff curve (ratio, Appendix E)

- $STCOS_{r,t}$ = existing storage capacity cost of service, computed from historical cost-of-service components
 MC_PCWGDP_t = GDP chain-type price deflator (from the Macroeconomic Activity Module)

STRATIO _{r,t}	=	portion of revenue requirement obtained by moving gas from the off-peak to the peak period (fraction, Appendix E)
STCAP_ADJ _{r,t}	=	adjustment factor for the cost of service to total U.S. (ratio), defined as annual storage working gas capacity divided by Foster storage working gas capacity
ADJ_STR	=	storage tariff curve adjustment factor (fraction, Appendix E)
PTSTUTZ _{r,t}	=	storage utilization (fraction)
PTCURPSTR _{r,t}	=	annual storage working gas capacity (Bcf)
r	=	NGTDM region
t	=	historical year

Forecast Year Update Phase

The purpose of the forecast year update phase is to project, for each arc and subsequent year of the forecast period, the cost-of-service components that are used to develop rates for the peak and off-peak periods. For each year, the PTS forecasts the adjusted rate base, cost of capital, return on rate base, depreciation, taxes, and operation and maintenance expenses. The forecasting relationships are discussed in detail below.

After all of the components of the cost-of-service at the arc level are forecast, the PTS proceeds to: (1) classify the components of the cost of service as fixed and variable costs, (2) allocate fixed and variable costs to rate components (reservation and usage costs) based on the rate design, and (3) compute arc-specific rates (variable and fixed tariffs) for peak and off-peak periods.

Investment Costs for Generic Pipelines

The PTS projects the capital costs to expand pipeline capacity at the arc level, as opposed to determining the costs of expansion for individual pipelines. The PTS represents arc-specific generic pipelines to generate the cost of capacity expansion by arc. Thus, the PTS tracks costs attributable to capacity added during the forecast period separately from the costs attributable to facilities in service in the historical years. The PTS estimates the capital costs associated with the level of capacity expansion forecast by the ITS in the previous forecast year based on exogenously specified estimates for the average pipeline capital costs at the arc level (AVG_CAPCOST_a) associated with expanding capacity for compression, looping, and new pipeline. These average capital costs per unit of expansion (2000 dollars per Mcf) were computed based on a pipeline construction project cost database⁸³ compiled by the Office of Oil and Gas. These costs are adjusted for inflation from 2007 throughout the forecast period (i.e., they are held constant in real terms).

The average capital cost to expand capacity on a network arc is estimated given the level of capacity additions in year t provided by the ITS and the associated assumed average unit

⁸³ A spreadsheet compiled by James Tobin of EIA's Office of Oil and Gas containing historical and proposed state-to-state pipeline construction project costs, mileage, and capacity levels and additions by year from 1996 to 2011, by pipeline company (data as of August 16, 2007).

capital cost. This average unit capital cost represents the investment cost for a generic pipeline associated with a given arc, as follows:

$$CCOST_{a,t} = AVG_CAPCOST_a * MC_PCWGDP_t / MC_PCWGDP_{2000} \quad (168)$$

where,

$$\begin{aligned} CCOST_{a,t} &= \text{average pipeline capital cost per unit of expanded capacity} \\ &\quad \text{(nominal dollars per Mcf)} \\ AVG_CAPCOST_a &= \text{average pipeline capital cost per unit of expanded capacity in} \\ &\quad \text{2000 dollars per Mcf (Appendix E)} \\ MC_PCWGDP_t &= \text{GDP chain-type price deflator (from the Macroeconomic} \\ &\quad \text{Activity Module)} \\ a &= \text{arc} \\ t &= \text{forecast year} \end{aligned}$$

The new capacity expansion expenditures allowed in the rate base within a forecast year are derived from the above average unit capital cost and the amount of incremental capacity additions determined by the ITS for each arc, as follows:

$$NCAE_{a,t} = CCOST_{a,t} * CAPADD_{a,t} * 1,000,000 * (1 + PCNT_R) \quad (169)$$

where,

$$\begin{aligned} NCAE_{a,t} &= \text{capital cost to expand capacity on a network arc (dollars)} \\ CCOST_{a,t} &= \text{average capital cost per unit of expansion (dollars per Mcf)} \\ CAPADD_{a,t} &= \text{capacity additions for an arc as determined in the ITS (Bcf/yr)} \\ PCNT_R &= \text{assumed average percentage (fraction) for pipeline replacement} \\ &\quad \text{costs (Appendix E)} \\ t &= \text{forecast year} \end{aligned}$$

To account for additional costs due to pipeline replacements, the PTS increases the capital costs to expand capacity by a small percentage (PCNT_R). Once the capital cost of new plant in service is computed by arc in year t, this amount is used in an accounting algorithm for the computation of gross plant in service for new capacity expansion, along with its depreciation, depletion, and amortization. These will in turn be used in the computation of updated cost-of-service components for the existing and new capacity for an arc.

Forecasting Cost-of-Service ⁸⁴

The primary purpose in forecasting cost-of-service is to capture major changes in the composition of the revenue requirements and major changes in cost trends through the forecast period. These changes may be caused by capacity expansion or maintenance and life extension of nearly depreciated plants, as well as by changes in the cost and availability of capital.

The projection of the cost-of-service is approached from the viewpoint of a long-run marginal cost analysis for gas pipeline systems. This differs from the determination of cost-

⁸⁴All cost components in the forecast equations in this section are in nominal dollars, unless explicitly stated otherwise.

of-service for the purpose of a rate case. Costs that are viewed as fixed for the purposes of a rate case actually vary in the long-run with one or more external measures of size or activity levels in the industry. For example, capital investments for replacement and refurbishment of existing facilities are a long-run marginal cost of the pipeline system. Once in place, however, the capital investments are viewed as fixed costs for the purposes of rate cases. The same is true of operations and maintenance expenses that, except for short-run variable costs such as fuel, are most commonly classified as fixed costs in rate cases. For example, customer expenses logically vary over time based on the number of customers served and the cost of serving each customer. The unit cost of serving each customer, itself, depends on changes in the rate base and individual cost-of-service components, the extent and/or complexity of service provided to each customer, and the efficiency of the technology level employed in providing the service.

The long-run marginal cost approach generally projects total costs as the product of unit cost for the activity multiplied by the incidence of the activity. Unit costs are projected from cost-of-service components combined with time trends describing changes in level of service, complexity, or technology. The level of activity is projected in terms of variables external to the PTS (e.g., annual throughput) that are both logically and empirically related to the incurrence of costs. Implementation of the long-run marginal cost approach involves forecasting relationships developed through empirical studies of historical change in pipeline costs, accounting algorithms, exogenous assumptions, and inputs from other NEMS modules. These forecasting algorithms may be classified into three distinct areas, as follows:

- The projection of adjusted rate base and cost of capital for the combined existing and new capacity.
- The projection of components of the revenue requirements.
- The computation of variable and fixed rates for peak and off-peak periods.

The empirically derived forecasting algorithms discussed below are determined for each network arc.

Projection of Adjusted Rate Base and Cost of Capital

The approach for projecting adjusted rate base and cost of capital at the arc level is summarized in **Table 6-4**. Long-run marginal capital costs of pipeline companies reflect changes in the AA utility bond index rate. Once projected, the adjusted rate base is translated into capital-related components of the revenue requirements based on projections of the cost of capital, total operating and maintenance expenses, and algorithms for depreciation and tax effects.

The projected adjusted rate base for the combined existing and new pipelines at the arc level in year t is computed as the amount of gross plant in service in year t minus previous year's accumulated depreciation, depletion, and amortization plus total cash working capital minus accumulated deferred income taxes in year t .

Table 6-4. Approach to Projection of Rate Base and Capital Costs

Projection Component	Approach
1. Adjusted Rate Base	
a. Gross plant in service in year t	
I. Capital cost of existing plant in service	Gross plant in service in the last historical year (2006)
II. Capacity expansion costs for new capacity	Accounting algorithm [equation 172]
b. Accumulated Depreciation, Depletion & Amortization	Accounting algorithm [equations 178, 179, 181] and empirically estimated for existing capacity [equation 180]
c. Cash and other working capital	User defined option for the combined existing and new capacity [equation 182]
d. Accumulated deferred income taxes	Empirically estimated for the combined existing and new capacity [equation 133]
f. Depreciation, depletion, and amortization	Existing Capacity: empirically estimated [equation 180] New Capacity: accounting algorithm [equation 181]
2. Cost of Capital	
a. Long-term debt rate	Projected AA utility bond yields adjusted by historical average deviation constant for long-term debt rate
b. Preferred equity rate	Projected AA utility bond yields adjusted by historical average deviation constant for preferred equity rate
c. Common equity return	Projected AA utility bond yields adjusted by historical average deviation constant for common equity return
3. Capital Structure	Held constant at average historical values

$$APRB_{a,t} = GPIS_{a,t} - ADDA_{a,t-1} + CWC_{a,t} - ADIT_{a,t} \quad (170)$$

where,

- $APRB_{a,t}$ = adjusted rate base in dollars
- $GPIS_{a,t}$ = total capital cost of plant in service (gross plant in service) in dollars
- $ADDA_{a,t}$ = accumulated depreciation, depletion, and amortization in dollars
- $CWC_{a,t}$ = total cash working capital including other cash working capital in dollars
- $ADIT_{a,t}$ = accumulated deferred income taxes in dollars
- a = arc
- t = forecast year

All the variables in the above equation represent the aggregate variables for all interstate pipelines associated with an arc. The aggregate variables on the right hand side of the adjusted rate base equation are forecast by the equations below. First, total (existing and new) gross plant in service in the forecast year is determined as the sum of existing gross plant in service and new capacity expansion expenditures added to existing gross plant in

service. New capacity expansion can be compression, looping, and new pipelines. For simplification, the replacement, refurbishment, retirement, and cost associated with new facilities for complying with Order 636 are not accounted for in projecting total gross plant in service in year t. Total gross plant in service for a network arc is forecast as follows:

$$\text{GPIS}_{a,t} = \text{GPIS_E}_{a,t} + \text{GPIS_N}_{a,t} \quad (171)$$

where,

$$\begin{aligned} \text{GPIS}_{a,t} &= \text{total capital cost of plant in service (gross plant in service) in} \\ &\quad \text{dollars} \\ \text{GPIS_E}_{a,t} &= \text{gross plant in service in the last historical year (2006)} \\ \text{GPIS_N}_{a,t} &= \text{capital cost of new plant in service in dollars} \\ a &= \text{arc} \\ t &= \text{forecast year} \end{aligned}$$

In the above equation, the capital cost of existing plant in service ($\text{GPIS_E}_{a,t}$) reflects the amount of gross plant in service in the last historical year (2006). The capital cost of new plant in service ($\text{GPIS_N}_{a,t}$) in year t is computed as the accumulated new capacity expansion expenditures from 2007 to year t and is determined by the following equation:

$$\text{GPIS_N}_{a,t} = \sum_{s=2004}^t \text{NCAE}_{a,s} \quad (172)$$

where,

$$\begin{aligned} \text{GPIS_N}_{a,t} &= \text{gross plant in service for new capacity expansion in dollars} \\ \text{NCAE}_{a,s} &= \text{new capacity expansion expenditures occurring in year s after} \\ &\quad \text{2006 (in dollars) [equation 169]} \\ s &= \text{the year new expansion occurred} \\ a &= \text{arc} \\ t &= \text{forecast year} \end{aligned}$$

Next, net plant in service in year t is determined as the difference between total capital cost of plant in service (gross plant in service) in year t and previous year's accumulated depreciation, depletion, and amortization.

$$\text{NPIS}_{a,t} = \text{GPIS}_{a,t} - \text{ADDA}_{a,t-1} \quad (173)$$

where,

$$\begin{aligned} \text{NPIS}_{a,t} &= \text{total net plant in service in dollars} \\ \text{GPIS}_{a,t} &= \text{total capital cost of plant in service (gross plant in service) in} \\ &\quad \text{dollars} \\ \text{ADDA}_{a,t} &= \text{accumulated depreciation, depletion, and amortization in} \\ &\quad \text{dollars} \\ a &= \text{arc} \\ t &= \text{forecast year} \end{aligned}$$

Accumulated depreciation, depletion, and amortization for the combined existing and new capacity in year t is determined by the following equation:

$$ADDA_{a,t} = ADDA_E_{a,t} + ADDA_N_{a,t} \quad (174)$$

where,

- $ADDA_{a,t}$ = accumulated depreciation, depletion, and amortization in dollars
- $ADDA_E_{a,t}$ = accumulated depreciation, depletion, and amortization for existing capacity in dollars
- $ADDA_N_{a,t}$ = accumulated depreciation, depletion, and amortization for new capacity in dollars
- a = arc
- t = forecast year

With this and the relationship between the capital costs of existing and new plants in service from equation 171, total net plant in service ($NPIS_{a,t}$) is set equal to the sum of net plant in service for existing pipelines and new capacity expansions, as follows:

$$NPIS_{a,t} = NPIS_E_{a,t} + NPIS_N_{a,t} \quad (175)$$

$$NPIS_E_{a,t} = GPIS_E_{a,t} - ADDA_E_{a,t-1} \quad (176)$$

$$NPIS_N_{a,t} = GPIS_N_{a,t} - ADDA_N_{a,t-1} \quad (177)$$

where,

- $NPIS_{a,t}$ = total net plant in service in dollars
- $NPIS_E_{a,t}$ = net plant in service for existing capacity in dollars
- $NPIS_N_{a,t}$ = net plant in service for new capacity in dollars
- $GPIS_E_{a,t}$ = gross plant in service in the last historical year (2006)
- $ADDA_E_{a,t}$ = accumulated depreciation, depletion, and amortization for existing capacity in dollars
- $ADDA_N_{a,t}$ = accumulated depreciation, depletion, and amortization for new capacity in dollars
- $GPIS_N$ = gross plant in service for new capacity in dollars
- a = arc
- t = forecast year

Accumulated depreciation, depletion, and amortization for a network arc in year t is determined as the sum of previous year's accumulated depreciation, depletion, and amortization and current year's depreciation, depletion, and amortization.

$$ADDA_{a,t} = ADDA_{a,t-1} + DDA_{a,t} \quad (178)$$

where,

- $ADDA_{a,t}$ = accumulated depreciation, depletion, and amortization in dollars
- $DDA_{a,t}$ = annual depreciation, depletion, and amortization costs in dollars
- a = arc
- t = forecast year

Annual depreciation, depletion, and amortization for a network arc in year t is the sum of depreciation, depletion, and amortization for the combined existing and new capacity associated with the arc.

$$DDA_{a,t} = DDA_E_{a,t} + DDA_N_{a,t} \quad (179)$$

where,

- DDA_{a,t} = annual depreciation, depletion, and amortization in dollars
- DDA_E_{a,t} = depreciation, depletion, and amortization costs for existing capacity in dollars
- DDA_N_{a,t} = depreciation, depletion, and amortization costs for new capacity in dollars
- a = arc
- t = forecast year

A regression equation is used to determine the annual depreciation, depletion, and amortization for existing capacity associated with an arc, while an accounting algorithm is used for new capacity. For existing capacity, this expense is forecast as follows:

$$DDA_E_{a,t} = \beta_{0,a} + \beta_1 * NPIS_E_{a,t-1} + \beta_2 * NEWCAP_E_{a,t} \quad (180)$$

where,

- DDA_E_{a,t} = annual depreciation, depletion, and amortization costs for existing capacity in nominal dollars
- β_{0,a} = DDA_C_a, constant term estimated by arc (Appendix F, Table F3.3, β_{0,a} = B_ARC_{xx_yy})
- β₁ = DDA_NPIS, estimated coefficient for net plant in service for existing capacity (Appendix F, Table F3.3)
- β₂ = DDA_NEWCAP, estimated coefficient for the change in gross plant in service for existing capacity (Appendix F, Table F3.3)
- NPIS_E_{a,t} = net plant in service for existing capacity (dollars)
- NEWCAP_E_{a,t} = change in gross plant in service for existing capacity between t and t-1 (dollars)
- a = arc
- t = forecast year

The accounting algorithm used to define the annual depreciation, depletion, and amortization for new capacity assumes straight-line depreciation over a 30-year life, as follows:

$$DDA_N_{a,t} = GPIS_N_{a,t} / 30 \quad (181)$$

where,

- DDA_N_{a,t} = annual depreciation, depletion, and amortization for new capacity in dollars
- GPIS_N_{a,t} = gross plant in service for new capacity in dollars [equation 172]
- 30 = 30 years of plant life
- a = arc
- t = forecast year

Next, total cash working capital ($CWC_{a,t}$) for the combined existing and new capacity by arc in the adjusted rate base equation consists of cash working capital, material and supplies, and other components that vary by company. Total cash working capital for pipeline transmission for existing and new capacity at the arc level is deflated using the chain weighted GDP price index with 2000 as a base. This level of cash working capital ($R_CWC_{a,t}$) is determined using a log-linear specification with correction for serial correlation given the economies in cash management in gas transmission. The estimated equation used for R_CWC (Appendix F, Table F3) is determined as a function of total operation and maintenance expenses, as defined below:

$$R_CWC_{a,t} = CWC_K * e^{(\beta_{0,a} * (1-\rho) + CWC_TOM * \log(R_TOM_{a,t}) + \rho * \log(R_CWC_{a,t-1}) - \rho * CWC_TOM * \log(R_TOM_{a,t-1}))} \quad (182)$$

where,

- $R_CWC_{a,t}$ = total pipeline transmission cash working capital for existing and new capacity (2000 real dollars)
- $\beta_{0,a}$ = CWC_C_a , estimated arc specific constant for gas transported from node to node (Appendix F, Table F3.2, $\beta_{0,a} = B_ARC_{xx_yy}$)
- CWC_TOM = estimated R_TOM coefficient (Appendix F, Table F3.2)
- $R_TOM_{a,t}$ = total operation and maintenance expenses in 2000 real dollars
- CWC_K = correction factor estimated in stage 2 of the regression equation estimation process (Appendix F, Table F3)
- ρ = autocorrelation coefficient from estimation (Appendix F, Table F3.2 -- CWC_RHO)
- a = arc
- t = forecast year

Last, the level of accumulated deferred income taxes for the combined existing and new capacity on a network arc in year t in the adjusted rate base equation depends on income tax regulations in effect, differences in tax and book depreciation, and the time vintage of past construction. The level of accumulated deferred income taxes for the combined existing and new capacity is derived as follows:

$$ADIT_{a,t} = \beta_{0,a} + \beta_1 * NEWCAP_{a,t} + \beta_2 * NEWCAP_{a,t} + \beta_3 * NEWCAP_{a,t} + ADIT_{a,t-1} \quad (183)$$

where,

- $ADIT_{a,t}$ = accumulated deferred income taxes in dollars
- $\beta_{0,a}$ = $ADIT_C_a$, constant term estimated by arc (Appendix F, Table F3.5, $\beta_{0,a} = B_ARC_{xx_yy}$)
- β_1 = $BNEWCAP_PRE2003$, estimated coefficient on the change in gross plant in service in the pre-2003 period because of changes in tax policy in 2003 and 2004 (Appendix F, Table F3.5). It is zero otherwise.

β_2 = BNEWCAP_2003_2004, estimated coefficient on the change in gross plant in service for the years 2003/2004 because of changes in tax policy in 2003 and 2004 (Appendix F, Table F3.5). It is zero otherwise.

β_3 = BNEWCAP_POST2004, estimated coefficient on the change in gross plant in service in the post-2004 period because of changes in tax policy in 2003 and 2004 (Appendix F, Table F3.5). It is zero otherwise.

NEWCAP_{a,t} = change in gross plant in service for the combined existing and new capacity between years t and t-1 (in dollars)

a = arc

t = forecast year

Cost of capital. The capital-related components of the revenue requirement at the arc level depend upon the size of the adjusted rate base and the cost of capital to the pipeline companies associated with that arc. In turn, the company level costs of capital depend upon the rates of return on debt, preferred stock and common equity, and the amounts of debt and equity in the overall capitalization. Cost of capital for a company is the weighted average after-tax rate of return (WAROR) which is a function of long-term debt, preferred stock, and common equity. The rate of return variables for preferred stock, common equity, and debt are related to forecast macroeconomic variables. For the combined existing and new capacity at the arc level, it is assumed that these rates will vary as a function of the yield on AA utility bonds (provided by the Macroeconomic Activity Module as a percent) in year t adjusted by a historical average deviation constant, as follows:

$$PFER_{a,t} = MC_RMPUAANS_t / 100.0 + ADJ_PFER_a \quad (184)$$

$$CMER_{a,t} = MC_RMPUAANS_t / 100.0 + ADJ_CMER_a \quad (185)$$

$$LTDR_{a,t} = MC_RMPUAANS_t / 100.0 + ADJ_LTDR_a \quad (186)$$

where,

PFER_{a,t} = rate of return for preferred stock

CMER_{a,t} = common equity rate of return

LTDR_{a,t} = long-term debt rate

MC_RMPUAANS_t = AA utility bond index rate provided by the Macroeconomic Activity Module (percentage)

ADJ_PFER_a = historical average deviation constant (fraction) for rate of return for preferred stock (1994-2003, over 28 major gas pipeline companies) (D_PFER/100., Appendix E)

ADJ_CMER_a = historical average deviation constant (fraction) for rate of return for common equity (1994-2003, over 28 major gas pipeline companies) (D_CMER/100., Appendix E)

ADJ_LTDR_a = historical average deviation constant (fraction) for long term debt rate (1994-2003, over 28 major gas pipeline companies) (D_LTDR/100., Appendix E)

a = arc

t = forecast year

The weighted average cost of capital in the forecast year is computed as the sum of the capital-weighted rates of return for preferred stock, common equity, and debt, as follows:

$$\text{WAROR}_{a,t} = \frac{(\text{PFER}_{a,t} * \text{PFES}_{a,t}) + (\text{CMER}_{a,t} * \text{CMES}_{a,t}) + (\text{LTDR}_{a,t} * \text{LTDS}_{a,t})}{\text{TOTCAP}_{a,t}} \quad (187)$$

$$\text{TOTCAP}_{a,t} = (\text{PFES}_{a,t} + \text{CMES}_{a,t} + \text{LTDS}_{a,t}) \quad (188)$$

where,

- WAROR_{a,t} = weighted-average after-tax rate of return on capital (fraction)
- PFER_{a,t} = rate or return for preferred stock (fraction)
- PFES_{a,t} = value of preferred stock (dollars)
- CMER_{a,t} = common equity rate of return (fraction)
- CMES_{a,t} = value of common stock (dollars)
- LTDR_{a,t} = long-term debt rate (fraction)
- LTDS_{a,t} = value of long-term debt (dollars)
- TOTCAP_{a,t} = sum of the value of long-term debt, preferred stock, and common stock equity dollars)
- a = arc
- t = forecast year

The above equation can be written as a function of the rates of return and capital structure ratios as follows:

$$\text{WAROR}_{a,t} = (\text{PFER}_{a,t} * \text{GPFESTR}_{a,t}) + (\text{CMER}_{a,t} * \text{GCMESTR}_{a,t}) + (\text{LTDR}_{a,t} * \text{GLTDSTR}_{a,t}) \quad (189)$$

where,

$$\text{GPFESTR}_{a,t} = \text{PFES}_{a,t} / \text{TOTCAP}_{a,t} \quad (190)$$

$$\text{GCMESTR}_{a,t} = \text{CMES}_{a,t} / \text{TOTCAP}_{a,t} \quad (191)$$

$$\text{GLTDSTR}_{a,t} = \text{LTDS}_{a,t} / \text{TOTCAP}_{a,t} \quad (192)$$

and,

- WAROR_{a,t} = weighted-average after-tax rate of return on capital (fraction)
- PFER_{a,t} = coupon rate for preferred stock (fraction)
- CMER_{a,t} = common equity rate of return (fraction)
- LTDR_{a,t} = long-term debt rate (fraction)
- GPFESTR_a = ratio of preferred stock to estimated capital for existing and new capacity (fraction) [referred to as capital structure for preferred stock]
- GCMESTR_a = ratio of common stock to estimated capital for existing and new capacity (fraction)[referred to as capital structure for common stock]
- GLTDSTR_a = ratio of long term debt to estimated capital for existing and new capacity (fraction)[referred to as capital structure for long term debt]
- PFES_{a,t} = value of preferred stock (dollars)

$CMES_{a,t}$ = value of common stock (dollars)
 $LTDS_{a,t}$ = value of long-term debt (dollars)
 $TOTCAP_{a,t}$ = estimated capital equal to the sum of the value of preferred stock, common stock equity, and long-term debt (dollars)
 a = arc
 t = forecast year

In the financial database, the estimated capital for each interstate pipeline is by definition equal to its adjusted rate base. Hence, the estimated capital ($TOTCAP_{a,t}$) defined in equation 188 is equal to the adjusted rate base ($APRB_{a,t}$) defined in equation 170:

$$TOTCAP_{a,t} = APRB_{a,t} \quad (193)$$

where,

$TOTCAP_{a,t}$ = estimated capital in dollars
 $APRB_{a,t}$ = adjusted rate base in dollars
 a = arc
 t = forecast year

Substituting the adjusted rate base variable $APRB_{a,t}$ for the estimated capital $TOTCAP_{a,t}$ in equations 190 to 192, the values of preferred stock, common stock, and long term debt by arc can be derived as functions of the capital structure ratios and the adjusted rate base. Capital structure is the percent of total capitalization (adjusted rate base) represented by each of the three capital components: preferred equity, common equity, and long-term debt. The percentages of total capitalization due to common stock, preferred stock, and long-term debt are considered fixed throughout the forecast. Assuming that the total capitalization fractions remain the same over the forecast horizon, the values of preferred stock, common stock, and long-term debt can be derived as follows:

$$\begin{aligned}
 PFES_{a,t} &= GPFESTR_a * APRB_{a,t} \\
 CMES_{a,t} &= GCMESTR_a * APRB_{a,t} \\
 LTDS_{a,t} &= GLTDSTR_a * APRB_{a,t}
 \end{aligned} \quad (194)$$

where,

$PFES_{a,t}$ = value of preferred stock in nominal dollars
 $CMES_{a,t}$ = value of common equity in nominal dollars
 $LTDS_{a,t}$ = long-term debt in nominal dollars
 $GPFESTR_a$ = ratio of preferred stock to adjusted rate base for existing and new capacity (fraction) [referred to as capital structure for preferred stock]
 $GCMESTR_a$ = ratio of common stock to adjusted rate base for existing and new capacity (fraction)[referred to as capital structure for common stock]
 $GLTDSTR_a$ = ratio of long term debt to adjusted rate base for existing and new capacity (fraction)[referred to as capital structure for long term debt]
 $APRB_{a,t}$ = adjusted pipeline rate base (dollars)

a = arc
t = forecast year

In the forecast year update phase, the capital structures (GPFESTR_a, GCMESTR_a, and GLTDSTR_a) at the arc level in the above equations are held constant over the forecast period. They are defined below as the average adjusted rate base weighted capital structures over all pipelines associated with an arc and over the historical time period (1997-2006).

$$GPFESTR_a = \frac{\sum_{t=1997}^{2006} \sum_p (GPFESTR_{a,p,t} * APRB_{a,p,t})}{\sum_{t=1997}^{2006} \sum_p APRB_{a,p,t}} \quad (195)$$

$$GCMESTR_a = \frac{\sum_{t=1997}^{2006} \sum_p (GCMESTR_{a,p,t} * APRB_{a,p,t})}{\sum_{t=1997}^{2006} \sum_p APRB_{a,p,t}} \quad (196)$$

$$GLTDSTR_a = \frac{\sum_{t=1997}^{2006} \sum_p (GLTDSTR_{a,p,t} * APRB_{a,p,t})}{\sum_{t=1997}^{2006} \sum_p APRB_{a,p,t}} \quad (197)$$

where,

- GPFESTR_a = historical average capital structure for preferred stock for existing and new capacity (fraction), held constant over the forecast period
- GCMESTR_a = historical average capital structure for common stock for existing and new capacity (fraction), held constant over the forecast period
- GLTDSTR_a = historical average capital structure for long term debt for existing and new capacity (fraction), held constant over the forecast period
- GPFESTR_{a,p,t} = capital structure for preferred stock (fraction) by pipeline company in the historical years (1997-2006) (Appendix E)
- GCMESTR_{a,p,t} = capital structure for common stock (fraction) by pipeline company in the historical years (1997-2006)(Appendix E)
- GLTDSTR_{a,p,t} = capital structure for long term debt (fraction) by pipeline company in the historical years (1997-2006) (Appendix E)
- APRB_{a,p,t} = adjusted rate base (capitalization) by pipeline company in the historical years (1997-2006) (Appendix E)
- p = pipeline company
- a = arc
- t = historical year

The weighted average cost of capital in the forecast year in equation 189 is forecast as follows:

$$\text{WAROR}_{a,t} = (\text{PFER}_{a,t} * \text{GPFESTR}_a) + (\text{CMER}_{a,t} * \text{GCMESTR}_a) + (\text{LTDR}_{a,t} * \text{GLTDSTR}_a) \quad (198)$$

where,

- WAROR_{a,t} = weighted-average after-tax rate of return on capital (fraction)
- PFER_{a,t} = coupon rate for preferred stock (fraction), function of AA utility bond rate [equation 184]
- CMER_{a,t} = common equity rate of return (fraction), function of AA utility bond rate [equation 185]
- LTDR_{a,t} = long-term debt rate (fraction), function of AA utility bond rate [equation 186]
- GPFESTR_a = historical average capital structure for preferred stock for existing and new capacity (fraction), held constant over the forecast period
- GCMESTR_a = historical average capital structure for common stock for existing and new capacity (fraction), held constant over the forecast period
- GLTDSTR_a = historical average capital structure for long term debt for existing and new capacity (fraction), held constant over the forecast period
- a = arc
- t = forecast year

The weighted-average after-tax rate of return on capital (WAROR_{a,t}) is applied to the adjusted rate base (APRB_{a,t}) to project the total return on rate base (after taxes), also known as the after-tax operating income, which is a major component of the revenue requirement.

Projection of Revenue Requirement Components

The approach to the projection of revenue requirement components is summarized in **Table 6-5**. Given the rate base, rates of return, and capitalization structure projections discussed above, the revenue requirement components are relatively straightforward to project. The capital-related components include total return on rate base (after taxes); Federal and State income taxes; deferred income taxes; other taxes; and depreciation, depletion, and amortization costs. Other components include total operating and maintenance expenses, and regulatory amortization, which is small and thus assumed to be negligible in the forecast period. The total operating and maintenance expense variable includes expenses for transmission of gas for others; administrative and general expenses; and sales, customer accounts and other expenses. The total cost of service (revenue requirement) at the arc level for a forecast year is determined as follows:

Table 6-5. Approach to Projection of Revenue Requirements

Projection Component	Approach
1. Capital-Related Costs	
a. Total return on rate base	Direct calculation from projected rate base and rates of return
b. Federal/State income taxes	Accounting algorithms based on tax rates
c. Deferred income taxes	Difference in the accumulated deferred income taxes between years t and t-1
2. Depreciation, Depletion, and Amortization	Estimated equation and accounting algorithm
3. Total Operating and Maintenance Expenses	Estimated equation
4. Other Taxes	Previous year's other taxes adjusted to inflation rate and growth in capacity

$$TCOS_{a,t} = TRRB_{a,t} + DDA_{a,t} + TOTAX_{a,t} + TOM_{a,t} \quad (199)$$

where,

- $TCOS_{a,t}$ = total cost-of-service or revenue requirement for existing and new capacity (dollars)
- $TRRB_{a,t}$ = total return on rate base for existing and new capacity after taxes (dollars)
- $DDA_{a,t}$ = depreciation, depletion, and amortization for existing and new capacity (dollars)
- $TOTAX_{a,t}$ = total Federal and State income tax liability for existing and new capacity (dollars)
- $TOM_{a,t}$ = total operating and maintenance expenses for existing and new capacity (dollars)
- a = arc
- t = forecast year

The total return on rate base for existing and new capacity is computed from the projected weighted cost of capital and estimated rate base, as follows:

$$TRRB_{a,t} = WAROR_{a,t} * APRB_{a,t} \quad (200)$$

where,

- $TRRB_{a,t}$ = total return on rate base (after taxes) for existing and new capacity in dollars
- $WAROR_{a,t}$ = weighted-average after-tax rate of return on capital for existing and new capacity (fraction)
- $APRB_{a,t}$ = adjusted pipeline rate base for existing and new capacity in dollars
- a = arc
- t = forecast year

The return on rate base for existing and new capacity on an arc can be broken out into the three components:

$$PFEN_{a,t} = GPFESTR_a * PFER_{a,t} * APRB_{a,t} \quad (201)$$

$$CMEN_{a,t} = GCMESTR_a * CMER_{a,t} * APRB_{a,t} \quad (202)$$

$$LTDN_{a,t} = GLTDSTR_a * LTDR_{a,t} * APRB_{a,t} \quad (203)$$

where,

- PFEN_{a,t} = total return on preferred stock for existing and new capacity (dollars)
- GPFESTR_a = historical average capital structure for preferred stock for existing and new capacity (fraction), held constant over the forecast period
- PFER_{a,t} = coupon rate for preferred stock for existing and new capacity (fraction)
- APRB_{a,t} = adjusted rate base for existing and new capacity (dollars)
- CMEN_{a,t} = total return on common stock equity for existing and new capacity (dollars)
- GCMESTR_a = historical average capital structure for common stock for existing and new capacity (fraction), held constant over the forecast period
- CMER_{a,t} = common equity rate of return for existing and new capacity (fraction)
- LTDN_{a,t} = total return on long-term debt for existing and new capacity (dollars)
- GLTDSTR_a = historical average capital structure ratio for long term debt for existing and new capacity (fraction), held constant over the forecast period
- LTDR_{a,t} = long-term debt rate for existing and new capacity (fraction)
- a = arc
- t = forecast year

Next, annual depreciation, depletion, and amortization DDA_{a,t} for a network arc in year t is calculated as the sum of depreciation, depletion, and amortization for the combined existing and new capacity associated with the arc. DDA_{a,t} is defined earlier in equation 179.

Next, total taxes consist of Federal income taxes, State income taxes, deferred income taxes, and other taxes. Federal income taxes and State income taxes are calculated using average tax rates. The equation for total taxes is as follows:

$$TOTAX_{a,t} = FSIT_{a,t} + DIT_{a,t} + OTTAX_{a,t} \quad (204)$$

$$FSIT_{a,t} = FIT_{a,t} + SIT_{a,t} \quad (205)$$

where,

- TOTAX_{a,t} = total Federal and State income tax liability for existing and new capacity (dollars)
- FSIT_{a,t} = Federal and State income tax for existing and new capacity (dollars)
- FIT_{a,t} = Federal income tax for existing and new capacity (dollars)

$SIT_{a,t}$ = State income tax for existing and new capacity (dollars)
 $DIT_{a,t}$ = deferred income taxes for existing and new capacity (dollars)
 $OTTAX_{a,t}$ = all other Federal, State, or local taxes for existing and new capacity (dollars)
 a = arc
 t = forecast year

Federal income taxes are derived from returns to common stock equity and preferred stock (after-tax profit) and the Federal tax rate. The after-tax profit is determined as follows:

$$ATP_{a,t} = APRB_{a,t} * (PFER_{a,t} * GPFESTR_a + CMER_{a,t} * GCMESTR_a) \quad (206)$$

where,

$ATP_{a,t}$ = after-tax profit for existing and new capacity (dollars)
 $APRB_{a,t}$ = adjusted pipeline rate base for existing and new capacity (dollars)
 $PFER_{a,t}$ = coupon rate for preferred stock for existing and new capacity (fraction)
 $GPFESTR_a$ = historical average capital structure for preferred stock for existing and new capacity (fraction), held constant over the forecast period
 $CMER_{a,t}$ = common equity rate of return for existing and new capacity (fraction)
 $GCMESTR_a$ = historical average capital structure for common stock for existing and new capacity (fraction), held constant over the forecast period
 a = arc
 t = forecast year

and the Federal income taxes are:

$$FIT_{a,t} = (FRATE * ATP_{a,t} / 1. - FRATE) \quad (207)$$

where,

$FIT_{a,t}$ = Federal income tax for existing and new capacity (dollars)
 $FRATE$ = Federal income tax rate (fraction, Appendix E)
 $ATP_{a,t}$ = after-tax profit for existing and new capacity (dollars)
 a = arc
 t = forecast year

State income taxes are computed by multiplying the sum of taxable profit and the associated Federal income tax by a weighted-average State tax rate associated with each pipeline company. The weighted-average State tax rate is based on peak service volumes in each State served by the pipeline company. State income taxes are computed as follows:

$$SIT_{a,t} = SRATE * (FIT_{a,t} + ATP_{a,t}) \quad (208)$$

where,

$SIT_{a,t}$ = State income tax for existing and new capacity (dollars)
 $SRATE$ = average State income tax rate (fraction, Appendix E)
 $FIT_{a,t}$ = Federal income tax for existing and new capacity (dollars)
 $ATP_{a,t}$ = after-tax profits for existing and new capacity (dollars)
 a = arc
 t = forecast year

Deferred income taxes for existing and new capacity at the arc level are the differences in the accumulated deferred income taxes between year t and year $t-1$.

$$DIT_{a,t} = ADIT_{a,t} - ADIT_{a,t-1} \quad (209)$$

where,

$DIT_{a,t}$ = deferred income taxes for existing and new capacity (dollars)
 $ADIT_{a,t}$ = accumulated deferred income taxes for existing and new capacity (dollars)
 a = arc
 t = forecast year

Other taxes consist of a combination of ad valorem taxes (which grow with company revenue), property taxes (which grow in proportion to gross plant), and all other taxes (assumed constant in real terms). Other taxes in year t are determined as the previous year's other taxes adjusted for inflation and capacity expansion.

$$OTTAX_{a,t} = OTTAX_{a,t-1} * EXPFAC_{a,t} * (MC_PCWGDP_t / MC_PCWGDP_{t-1}) \quad (210)$$

where,

$OTTAX_{a,t}$ = all other taxes assessed by Federal, State, or local governments except income taxes for existing and new capacity (dollars)
 $EXPFAC_{a,t}$ = capacity expansion factor (growth in capacity) from previous year's capacity
 MC_PCWGDP_t = GDP chain-type price deflator (from the Macroeconomic Activity Module)
 a = arc
 t = forecast year

The capacity expansion factor is expressed as follows:

$$EXPFAC_{a,t} = PTCURPCAP_{a,t} / PTCURPCAP_{a,t-1} \quad (211)$$

where,

$EXPFAC_{a,t}$ = capacity expansion factor (growth in capacity)
 $PTCURPCAP_{a,t}$ = current pipeline capacity (Bcf) for existing and new capacity
 a = arc
 t = forecast year

Last, the total operating and maintenance costs for existing and new capacity by arc ($R_TOM_{a,t}$) are determined using a log-linear form, given the economies of scale inherent in gas transmission. The estimated equation used for R_TOM (Appendix F, Table F3) is determined as a function of gross plant in service, $GPIS_a$, a level of accumulated depreciation relative to gross plant in service, $DEPSHR_a$, and a time trend, $TECHYEAR$, that proxies the state of technology, as defined below:

$$R_TOM_{a,t} = TOM_K * e^{(\beta_{0,a} * (1-\rho) + G_2 + G_3 + G_4 + G_5 + G_6 - \rho * (G_7 + G_8 + G_4 + G_9))} \quad (212)$$

where,

- $R_TOM_{a,t}$ = total operating and maintenance cost for existing and new capacity (2000 real dollars)
- TOM_K = correction factor estimated in stage 2 of the regression equation estimation process (Appendix F, Table F3)
- $\beta_{0,a}$ = TOM_C , constant term estimated by arc (Appendix F, Table F3.6, $\beta_{0,a} = B_ARC_{xx_yy}$)
- $G_2 = \beta_1 * \log(GPIS_{a,t-1})$
- $G_3 = \beta_2 * DEPSHR_{a,t-1}$
- $G_4 = \beta_3 * 2006.0$
- $G_5 = \beta_4 * (TECHYEAR - 2006.0)$
- $G_6 = \rho * \log(R_TOM_{a,t-1})$
- $G_7 = \beta_1 * \log(GPIS_{a,t-2})$
- $G_8 = \beta_2 * DEPSHR_{a,t-2}$
- $G_9 = \beta_4 * (TECHYEAR - 1.0 - 2006.0)$
- \log = natural logarithm operator
- ρ = estimated autocorrelation coefficient (Appendix F, Table F3.6 - TOM_RHO)
- β_1 = TOM_GPIS_1 , estimated coefficient on the change in gross plant in service (Appendix F, Table F3.6)
- β_2 = TOM_DEPSHR , estimated coefficient for the accumulated depreciation of the plant relative to the GPIS (Appendix F, Table F3.6)
- β_3 = TOM_BYEAR , estimated coefficient for the time trend variable $TECHYEAR$ (Appendix F, Table F3.6)
- β_4 = $TOM_BYEAR_EIA = TOM_BYEAR$, estimated future rate of decline in R_TOM due to technology improvements and efficiency gains. EIA assumes that this coefficient is the same as the coefficient for the time trend variable $TECHYEAR$ (Appendix F, Table F3.6)
- $DEPSHR_{a,t}$ = level of the accumulated depreciation of the plant relative to the gross plant in service for existing and new capacity at the beginning of year t. This variable is a proxy for the age of the capital stock.
- $GPIS_{a,t}$ = capital cost of plant in service for existing and new capacity in dollars (not deflated)

TECHYEAR = MODYEAR (time trend in 4 digit Julian units, the minimum value of this variable in the sample being 1997, otherwise TECHYEAR=0 if less than 1997)

a = arc

t = forecast year

For consistency the total operating and maintenance costs are converted to nominal dollars:

$$TOM_{a,t} = R_TOM_{a,t} * \frac{MC_PCWGDP_t}{MC_PCWGDP_{2000}} \quad (213)$$

where,

$TOM_{a,t}$ = total operating and maintenance costs for existing and new capacity (nominal dollars)

$R_TOM_{a,t}$ = total operating and maintenance costs for existing and new capacity (2000 real dollars)

MC_PCWGDP_t = GDP chain-type price deflator (from the Macroeconomic Activity Module)

a = arc

t = forecast year

Once all four components ($TRRB_{a,t}$, $DDA_{a,t}$, $TOTAX_{a,t}$, $TOM_{a,t}$) of the cost-of-service $TCOST_{a,t}$ of equation 199 are computed by arc in year t, each of them will be disaggregated into fixed and variable costs which in turn will be disaggregated further into reservation and usage costs using the allocation factors for a straight fixed variable (SFV) rate design summarized in **Table 6-6**.⁸⁵ Note that the return on rate base ($TRRB_{a,t}$) has three components ($PFEN_{a,t}$, $CMEN_{a,t}$, and $LTDN_{a,t}$ [equations 201, 202, and 203]).

Disaggregation of Cost-of-Service Components into Fixed and Variable Costs

Let $Item_{i,a,t}$ be a cost-of-service component (i=cost component index, a=arc, and t=forecast year). Using the first group of rate design allocation factors ξ_i (**Table 6-6**), all the components of cost-of-service computed in the above section can be split into fixed and variable costs, and then summed over the cost categories to determine fixed and variable costs-of-service as follows:

$$FC_{a,t} = \sum_i (\xi_i * Item_{i,a,t}) \quad (214)$$

$$VC_{a,t} = \sum_i [(1.0 - \xi_i) * Item_{i,a,t}] \quad (215)$$

$$TCOS_{a,t} = FC_{a,t} + VC_{a,t} \quad (216)$$

⁸⁵ The allocation factors of SFV rate design are given in percent in this table for illustration purposes. They are converted into ratios immediately after they are read in from the input file by dividing by 100.

Table 6-6. Percentage Allocation Factors for a Straight Fixed Variable (SFV) Rate Design

Cost-of-service Items (percentage) [Item _{i,a,t} , i=cost component index, a=arc, t=year]	Break up cost-of- service items into fixed and variable costs		Break up fixed cost items into reservation and usage costs		Break up variable cost items into reservation and usage costs	
	Item _{i,a,t}	FC _{i,a,t}	VC _{i,a,t}	RFC _{i,a,t}	UFC _{i,a,t}	RVC _{i,a,t}
Cost Allocation Factors	ξ_i	100 - ξ_i	λ_i	100 - λ_i	μ_i	100- μ_i
After-tax Operating Income						
Return on Preferred Stocks	100	0	100	0	0	100
Return on Common Stocks	100	0	100	0	0	100
Return on Long-Term Debt	100	0	100	0	0	100
Normal Operating Expenses						
Depreciation	100	0	100	0	0	100
Income Taxes	100	0	100	0	0	100
Deferred Income Taxes	100	0	100	0	0	100
Other Taxes	100	0	100	0	0	100
Total O&M	60	40	100	0	0	100

where,

- TCOS_{a,t} = total cost-of-service for existing and new capacity (dollars)
- FC_{a,t} = fixed cost for existing and new capacity (dollars)
- VC_{a,t} = variable cost for existing and new capacity (dollars)
- Item_{i,a,t} = cost-of-service component index at the arc level
- ξ_i = first group of allocation factors (ratios) to disaggregate the cost-of-service components into fixed and variable costs
- i = subscript to designate a cost-of-service component (i=1 for PFEN, i=2 for CMEN, i=3 for LTDN, i=4 for DDA, i=5 for FSIT, i=6 for DIT, i=7 for OTTAX, and i=8 for TOM)
- a = arc
- t = forecast year

Disaggregation of Fixed and Variable Costs into Reservation and Usage Costs

Each type of cost-of-service component (fixed or variable) in the above equations can be further disaggregated into reservation and usage costs using the second and third groups of rate design allocation factors λ_i and μ_i (**Table 6-6**), as follows:

$$RFC_{a,t} = \sum_i (\lambda_i * \xi_i * Item_{i,a,t}) \quad (217)$$

$$UFC_{a,t} = \sum_i [(1.0 - \lambda_i) * \xi_i * Item_{i,a,t}] \quad (218)$$

$$RVC_{a,t} = \sum_i [\mu_i * (1.0 - \xi_i) * Item_{i,a,t}] \quad (219)$$

$$UVC_{a,t} = \sum_i [(1.0 - \mu_i) * (1.0 - \xi_i) * Item_{i,a,t}] \quad (220)$$

$$TCOS_{a,t} = RFC_{a,t} + UFC_{a,t} + RVC_{a,t} + UVC_{a,t} \quad (221)$$

where,

- TCOS_{a,t} = total cost-of-service for existing and new capacity (dollars)
- RFC_{a,t} = fixed reservation cost for existing and new capacity (dollars)
- UFC_{a,t} = fixed usage cost for existing and new capacity (dollars)
- RVC_{a,t} = variable reservation cost for existing and new capacity (dollars)
- UVC_{a,t} = variable usage cost for existing and new capacity (dollars)
- Item_{i,a,t} = cost-of-service component index at the arc level
- ξ_i = first group of allocation factors to disaggregate cost-of-service components into fixed and variable costs
- λ_i = second group of allocation factors to disaggregate fixed costs into reservation and usage costs
- μ_i = third group of allocation factors to disaggregate variable costs into reservation and usage costs
- i = subscript to designate a cost-of-service component (i=1 for PFEN, i=2 for CMEN, i=3 for LTDN, i=4 for DDA, i=5 for FSIT, i=6 for DIT, i=7 for OTTAX, and i=8 for TOM)
- a = arc
- t = forecast year

The summation of fixed and variable reservation costs (RFC and RVC) yields the total reservation cost (RCOST). This can be disaggregated further into peak and off-peak reservation costs, which are used to develop variable tariffs for peak and off-peak time periods. The summation of fixed and variable usage costs (UFC and UVC), which yields the total usage cost (UCOST), is used to compute the annual average fixed usage fees. Both types of rates are developed in the next section. The equations for the reservation and usage costs can be expressed as follows:

$$RCOST_{a,t} = (RFC_{a,t} + RVC_{a,t}) \quad (222)$$

$$UCOST_{a,t} = (UFC_{a,t} + UVC_{a,t}) \quad (223)$$

where,

- RCOST_{a,t} = reservation cost for existing and new capacity (dollars)
- UCOST_{a,t} = annual usage cost for existing and new capacity (dollars)
- RFC_{a,t} = fixed reservation cost for existing and new capacity (dollars)
- UFC_{a,t} = fixed usage cost for existing and new capacity (dollars)
- RVC_{a,t} = variable reservation cost for existing and new capacity (dollars)
- UVC_{a,t} = variable usage cost for existing and new capacity (dollars)
- a = arc
- t = forecast period

As **Table 6-6** indicates, all the fixed costs are included in the reservation costs and all the variable costs are included in the usage costs.

Computation of Rates for Forecast Years

The reservation and usage costs-of-service RCOST and UCOST determined above are used separately to develop two types of rates at the arc level: variable tariffs and annual fixed usage fees. The determination of both rates is described below.

Variable Tariff Curves

Variable tariffs are proportional to reservation charges and are broken up into peak and off-peak time periods. Variable tariffs are derived directly from variable tariff curves which are developed based on reservation costs, utilization rates, annual flows, and other curve parameters.

In the PTS code, these variable curves are defined by a FUNCTION (NGPIPE_VARTAR) which is called by the ITS to compute the variable tariffs for peak and off-peak by arc and by forecast year. In this pipeline function, the tariff curves are segmented such that tariffs associated with *current capacity* and *capacity expansion* are represented by separate but similar equations. A uniform functional form is used to define these tariff curves for both the *current capacity* and *capacity expansion segments* of the tariff curves. It is defined as a function of a base point [price and quantity (PNOD, QNOD)] using different *process-specific* parameters, peak or off-peak flow, and a price elasticity. This functional form is presented below:

current capacity segment:

$$\text{NGPIPE_VARTAR}_{a,t} = \text{PNOD}_{a,t} * (\text{Q}_{a,t} / \text{QNOD}_{a,t})^{\text{ALPHA_PIPE}} \quad (224)$$

capacity expansion segment:

$$\text{NGPIPE_VARTAR}_{a,t} = \text{PNOD}_{a,t} * (\text{Q}_{a,t} / \text{QNOD}_{a,t})^{\text{ALPHA2_PIPE}} \quad (225)$$

such that,

for peak transmission tariffs:

$$\text{PNOD}_{a,t} = \frac{\text{RCOST}_{a,t} * \text{PKSHR_YR}}{(\text{QNOD}_{a,t} * \text{MC_PCWGDP}_t)} \quad (226)$$

$$\text{QNOD}_{a,t} = \text{PT NETFLOW}_{a,t} \quad (227)$$

for off-peak transmission tariffs:

$$PNOD_{a,t} = \frac{RCOST_{a,t} * (1.0 - PKSHR_YR)}{(QNOD_{a,t} * MC_PCWGDP_t)} \quad (228)$$

$$QNOD_{a,t} = PT_NETFLOW_{a,t} \quad (229)$$

where,

NGPIPE_VARTAR_{a,t} = function to define pipeline tariffs (87\$/Mcf)

PNOD_{a,t} = base point, price (87\$/Mcf)

QNOD_{a,t} = base point, quantity (Bcf)

Q_{a,t} = flow along pipeline arc (Bcf)

ALPHA_PIPE = price elasticity for pipeline tariff curve for current capacity (Appendix E)

ALPHA2_PIPE = price elasticity for pipeline tariff curve for capacity expansion segment (Appendix E)

RCOST_{a,t} = reservation cost-of-service (million dollars)

PTNETFLOW_{a,t} = natural gas network flow (throughput, Bcf)

PKSHR_YR = portion of the year represented by the peak season (fraction)

MC_PCWGDP_t = GDP chain-type price deflator (from the Macroeconomic Activity Module)

a = arc

t = forecast year

Annual Fixed Usage Fees

The annual fixed usage fees (volumetric charges) are derived directly from the usage costs, peak and off-peak utilization rates, and annual arc capacity. These fees are computed as the average fees over each forecast year, as follows:

$$FIXTAR_{a,t} = UCOST_{a,t} / [(PKSHR_YR * PTPKUTZ_{a,t} * PTCURPCAP_{a,t} + (1.0 - PKSHR_YR) * PTOPUTZ_{a,t} * PTCURPCAP_{a,t}) * MC_PCWGDP_t] \quad (230)$$

where,

FIXTAR_{a,t} = annual fixed usage fees for existing and new capacity (87\$/Mcf)

UCOST_{a,t} = annual usage cost for existing and new capacity (million dollars)

PKSHR_YR = portion of the year represented by the peak season (fraction)

PTPKUTZ_{a,t} = peak pipeline utilization (fraction)

PTCURPCAP_{a,t} = current pipeline capacity (Bcf)

PTOPUTZ_{a,t} = off-peak pipeline utilization (fraction)

MC_PCWGDP_t = GDP chain-type price deflator (from the Macroeconomic Activity Module)

a = arc

t = forecast year

As can be seen from the allocation factors in **Table 6-6**, usage costs (UCOST) are less than 10 percent of reservation costs (RCOST). Therefore, annual fixed usage fees which are proportional to usage costs are expected to be less than 10 percent of the variable tariffs. In general, these fixed fees are within the range of 5 percent of the variable tariffs which are charged to firm customers.

Canadian Fixed and Variable Tariffs

Fixed and variables tariffs along Canadian import arcs are defined using input data. Fixed tariffs are obtained directly from the data (Appendix E, ARC_FIXTAR_{n,a,t}), while variables tariffs are calculated in the FUNCTION subroutine (NGPIPE_VARTAR) and are based on pipeline utilization and a maximum expected tariff, CNMAXTAR. If the pipeline utilization along a Canadian arc for any time period (peak or off-peak) is less than 50 percent, then the pipeline tariff is set to a low level (70 percent of CNMAXTAR). If the Canadian pipeline utilization is between 50 and 90 percent, then the pipeline tariff is set to a level between 70 and 80 percent of CNMAXTAR. The sliding scale is determined using the corresponding utilization factor, as follows:

$$\text{NGPIPE_VARTAR}_{a,t} = \text{CNMAXTAR} - [\text{CNMAXTAR} * (1.0 - 0.9) * 2.0] - [\text{CNMAXTAR} * (0.9 - \text{CANUTIL}_{a,t}) * 0.25] \quad (231)$$

If the Canadian pipeline utilization is greater than 90 percent, then the pipeline tariff is set to between 80 and 100 percent of CNMAXTAR. This is accomplished again using Canadian pipeline utilization, as follows:

$$\text{NGPIPE_VARTAR}_{a,t} = \text{CNMAXTAR} - [\text{CNMAXTAR} * (1.0 - \text{CANUTIL}_{a,t}) * 2.0] \quad (232)$$

where,

$$\text{CANUTIL}_{a,t} = \frac{Q_{a,t}}{\text{QNOD}_{a,t}} \quad (233)$$

for peak period:

$$\text{QNOD}_{a,t} = \text{PTCURPCAP}_{a,t} * \text{PKSHR_YR} * \text{PTPKUTZ}_{a,t} \quad (234)$$

for off-peak period:

$$\text{QNOD}_{a,t} = \text{PTCURPCAP}_{a,t} * (1.0 - \text{PKSHR_YR}) * \text{PTOPUTZ}_{a,t} \quad (235)$$

and,

- NGPIPE_VARTAR_{a,t} = function to define pipeline tariffs (87\$/Mcf)
- CNMAXTAR = maximum effective tariff (87\$/Mcf, ARC_VARTAR, Appendix E)
- CANUTIL_{a,t} = pipeline utilization (fraction)

$QNOD_{a,t}$ = base point, quantity (Bcf)
 $Q_{a,t}$ = flow along pipeline arc (Bcf)
 $PKSHR_YR$ = portion of the year represented by the peak season (fraction)
 $PTPKUTZ_{a,t}$ = peak pipeline utilization (fraction)
 $PTCURPCAP_{a,t}$ = current pipeline capacity (Bcf)
 $PTOPUTZ_{a,t}$ = off-peak pipeline utilization (fraction)
 a = arc
 t = forecast year

For the eastern and western Canadian storage regions, the “variable” tariff is set to zero and only the assumed “fixed” tariff (Appendix E, ARC_FIXTAR) is applied.

Storage Tariff Routine Methodology

Background

This section describes the methodology that replaces a placeholder function which was used to assign a storage tariff for each region in the *Annual Energy Outlook 2000* version of the Pipeline Tariff Submodule. All variables and equations presented below are used for the forecast time period (1999-2030). If the time period t is less than 1999, the associated variables are set to the initial values read in from the input file (Foster’s storage financial database⁸⁶ by region and year, 1990-1998).

This section starts with the presentation of the natural gas storage cost-of-service equation by region. The equation sums four components to be forecast: after-tax⁸⁷ total return on rate base (operating income); total taxes; depreciation, depletion, and amortization; and total operating and maintenance expenses. Once these four components are computed, the regional storage cost of service is projected and, with the associated effective storage capacity provided by the ITS, a storage tariff curve can be established (as described at the end of this section).

Cost-of-Service by Storage Region

The cost-of-service (or revenue requirement) for existing and new storage capacity in an NGTDM region can be written as follows:

$$STCOS_{r,t} = STBTOI_{r,t} + STDDA_{r,t} + STTOTAX_{r,t} + STTOM_{r,t} \quad (236)$$

where,

$STCOS_{r,t}$ = total cost-of-service or revenue requirement for existing and new capacity (dollars)

⁸⁶ Natural Gas Storage Financial Data, compiled by Foster Associates, Inc., Bethesda, Maryland for EIA under purchase order #01-99EI36663 in December of 1999. This data set includes financial information on 33 major storage companies. The primary source of the data is FERC Form 2 (or Form 2A for the smaller pipelines). These data can be purchased from Foster Associates.

⁸⁷ ‘After-tax’ in this section refers to ‘after taxes have been taken out.’

- $STBTOI_{r,t}$ = total return on rate base for existing and new capacity (after-tax operating income) (dollars)
 $STDDA_{r,t}$ = depreciation, depletion, and amortization for existing and new capacity (dollars)
 $STTOTAX_{r,t}$ = total Federal and State income tax liability for existing and new capacity (dollars)
 $STTOM_{r,t}$ = total operating and maintenance expenses for existing and new capacity (dollars)
 r = NGTDM region
 t = forecast year

The storage cost-of-service by region is first computed in nominal dollars and subsequently converted to 1987\$ for use in the computation of a base for regional storage tariff, PNOD (87\$/Mcf). PNOD is used in the development of a regional storage tariff curve. An approach is developed to project the storage cost-of-service in nominal dollars by NGTDM region in year t and is provided in **Table 6-7**.

Table 6-7. Approach to Projection of Storage Cost-of-Service

Projection Component	Approach
1. Capital-Related Costs	
a. Total return in rate base	Direct calculation from projected rate base and rates of return
b. Federal/State income taxes	Accounting algorithms based on tax rates
c. Deferred income taxes	Difference in the accumulated deferred income taxes between years t and t-1
2. Depreciation, Depletion, and Amortization	Estimated equation and accounting algorithm
3. Total Operating and Maintenance Expenses	Estimated equation

Computation of total return on rate base (after-tax operating income), $STBTOI_{r,t}$

The total return on rate base for existing and new capacity is computed from the projected weighted cost of capital and estimated rate base, as follows:

$$STBTOI_{r,t} = STWAROR_{r,t} * STAPRB_{r,t} \quad (237)$$

where,

- $STBTOI_{r,t}$ = total return on rate base (after-tax operating income) for existing and new capacity in dollars
 $STWAROR_{r,t}$ = weighted-average after-tax rate of return on capital for existing and new capacity (fraction)
 $STAPRB_{r,t}$ = adjusted storage rate base for existing and new capacity in dollars
 r = NGTDM region
 t = forecast year

The return on rate base for existing and new storage capacity in an NGTDM region can be broken out into three components as shown below.

$$STPFEN_{r,t} = STGPFESTR_r * STPFER_{r,t} * STAPRB_{r,t} \quad (238)$$

$$STCMEN_{r,t} = STGCMESTR_r * STCMER_{r,t} * STAPRB_{r,t} \quad (239)$$

$$STLTDN_{r,t} = STGLTDSTR_r * STLTD_{r,t} * STAPRB_{r,t} \quad (240)$$

where,

- STPFEN_{r,t} = total return on preferred stock for existing and new capacity (dollars)
- STPFER_{r,t} = coupon rate for preferred stock for existing and new capacity (fraction)
- STGPFESTR_r = historical average capital structure for preferred stock for existing and new capacity (fraction), held constant over the forecast period
- STAPRB_{r,t} = adjusted rate base for existing and new capacity (dollars)
- STCMEN_{r,t} = total return on common stock equity for existing and new capacity (dollars)
- STGCMESTR_r = historical average capital structure for common stock for existing and new capacity (fraction), held constant over the forecast period
- STCMER_{r,t} = common equity rate of return for existing and new capacity (fraction)
- STLTDN_{r,t} = total return on long-term debt for existing and new capacity (dollars)
- STGLTDSTR_r = historical average capital structure ratio for long term debt for existing and new capacity (fraction), held constant over the forecast period
- STLTD_{r,t} = long-term debt rate for existing and new capacity (fraction)
- r = NGTDM region
- t = forecast year

Note that the total return on rate base is the sum of the above equations and can be expressed as:

$$STBTOI_{r,t} = (STPFEN_{r,t} + STCMEN_{r,t} + STLTDN_{r,t}) \quad (241)$$

It can be seen from the above equations that the weighted average rate of return on capital for existing and new storage capacity, STWAROR_{r,t}, can be determined as follows:

$$STWAROR_{r,t} = STPFER_{r,t} * STGPFESTR_r + STCMER_{r,t} * STGCMESTR_r + STLTD_{r,t} * STGLTDSTR_r \quad (242)$$

The historical average capital structure ratios STGPFESTR_r, STGCMESTR_r, and STGLTDSTR_r in the above equation are computed as follows:

$$STGPFESTR_r = \frac{\sum_{t=1990}^{1998} STPFES_{r,t}}{\sum_{t=1990}^{1998} STAPRB_{r,t}} \quad (243)$$

$$STGCMESTR_r = \frac{\sum_{t=1990}^{1998} STCMES_{r,t}}{\sum_{t=1990}^{1998} STAPRB_{r,t}} \quad (244)$$

$$STGLTDSTR_r = \frac{\sum_{t=1990}^{1998} STLTDs_{r,t}}{\sum_{t=1990}^{1998} STAPRB_{r,t}} \quad (245)$$

where,

- STGPFESTR_r = historical average capital structure for preferred stock for existing and new capacity (fraction), held constant over the forecast period
- STGCMESTR_r = historical average capital structure for common stock for existing and new capacity (fraction), held constant over the forecast period
- STGLTDSTR_r = historical average capital structure ratio for long term debt for existing and new capacity (fraction), held constant over the forecast period
- STPFES_{r,t} = value of preferred stock for existing capacity (dollars) [read in as D_PFES]
- STCMES_{r,t} = value of common stock equity for existing capacity (dollars) [read in as D_CMES]
- STLTDS_{r,t} = value of long-term debt for existing capacity (dollars) [read in as D_LTDS]
- STAPRB_{r,t} = adjusted rate base for existing capacity (dollars) [read in as D_APRB]
- r = NGTDM region
- t = forecast year

In the STWAROR equation, the rate of return variables for preferred stock, common equity, and debt (STPFER_{r,t}, STCMER_{r,t}, and STLTD_{r,t}) are related to forecast macroeconomic variables. These rates of return can be determined as a function of nominal AA utility bond index rate (provided by the Macroeconomic Module) and a regional historical average constant deviation as follows:

$$STPFER_{r,t} = MC_RMPUAANS_t / 100.0 + ADJ_STPFER_r \quad (246)$$

$$\text{STCMER}_{r,t} = \text{MC_RMPUAANS}_t / 100.0 + \text{ADJ_STCMER}_r \quad (247)$$

$$\text{STLTDR}_{r,t} = \text{MC_RMPUAANS}_t / 100.0 + \text{ADJ_STLTDR}_r \quad (248)$$

where,

- STPFER_{r,t} = rate of return for preferred stock
- STCMER_{r,t} = common equity rate of return
- STLTDR_{r,t} = long-term debt rate
- MC_RMPUAANS_t = AA utility bond index rate provided by the Macroeconomic Activity Module (percentage)
- ADJ_STPFER_r = historical weighted average deviation constant (fraction) for preferred stock rate of return (1990-1998)
- ADJ_STCMER_r = historical weighted average deviation constant (fraction) for common equity rate of return (1990-1998)
- ADJ_STLTDR_r = historical weighted average deviation constant (fraction) for long term debt rate (1990-1998)
- r = NGTDM region
- t = forecast year

The historical weighted average deviation constants by NGTDM region are computed as follows:

$$\text{ADJ_STLTDR}_r = \frac{\sum_{t=1990}^{1998} \left(\frac{\text{STLTDR}_{r,t} - \text{MC_RMPUAANS}_t / 100.0}{\text{STLTDR}_{r,t}} \right) * \text{STGPIS}_{r,t}}{\sum_{t=1990}^{1998} \text{STGPIS}_{r,t}} \quad (249)$$

$$\text{ADJ_STPFER}_r = \frac{\sum_{t=1990}^{1998} \left(\frac{\text{STPFER}_{r,t} - \text{MC_RMPUAANS}_t / 100.0}{\text{STPFER}_{r,t}} \right) * \text{STGPIS}_{r,t}}{\sum_{t=1990}^{1998} \text{STGPIS}_{r,t}} \quad (250)$$

$$\text{ADJ_STCMER}_r = \frac{\sum_{t=1990}^{1998} \left(\frac{\text{STCMER}_{r,t} - \text{MC_RMPUAANS}_t / 100.0}{\text{STCMER}_{r,t}} \right) * \text{STGPIS}_{r,t}}{\sum_{t=1990}^{1998} \text{STGPIS}_{r,t}} \quad (251)$$

where,

- ADJ_STLTDR_r = historical weighted average deviation constant (fraction) for long term debt rate
- ADJ_STCMER_r = historical weighted average deviation constant (fraction) for common equity rate of return
- ADJ_STPFER_r = historical weighted average deviation constant (fraction) for preferred stock rate of return

- $STPFEN_{r,t}$ = total return on preferred stock for existing capacity (dollars)
 [read in as D_PFEN]
 $STCMEN_{r,t}$ = total return on common stock equity for existing capacity
 (dollars) [read in as D_CMEN]
 $STLTDN_{r,t}$ = total return on long-term debt for existing capacity (dollars)
 [read in as D_LTDN]
 $STPFES_{r,t}$ = value of preferred stock for existing capacity (dollars) [read in
 as D_PFES]
 $STCMES_r$ = value of common stock equity for existing capacity (dollars)
 [read in as D_CMES]
 $STLTDS_r$ = value of long-term debt for existing capacity (dollars) [read in
 as D_LTDS]
 $MC_RMPUAANS_t$ = AA utility bond index rate provided by the Macroeconomic
 Activity Module (percentage)
 $STGPIS_{r,t}$ = original capital cost of plant in service (dollars) [read in as
 D_GPIS]
 r = NGTDM region
 t = forecast year

Computation of adjusted rate base, $STAPRB_{r,t}$ ⁸⁸

The adjusted rate base for existing and new storage facilities in an NGTDM region has three components and can be written as follows:

$$STAPRB_{r,t} = STNPIS_{r,t} + STCWC_{r,t} - STADIT_{r,t} \quad (252)$$

where,

- $STAPRB_{r,t}$ = adjusted storage rate base for existing and new capacity
 (dollars)
 $STNPIS_{r,t}$ = net plant in service for existing and new capacity (dollars)
 $STCWC_{r,t}$ = total cash working capital for existing and new capacity
 (dollars)
 $STADIT_{r,t}$ = accumulated deferred income taxes for existing and new
 capacity (dollars)
 r = NGTDM region
 t = forecast year

The net plant in service is the level of gross plant in service minus the accumulated depreciation, depletion, and amortization. It is given by the following equation:

$$STNPIS_{r,t} = STGPIS_{r,t} - STADDA_{r,t-1} \quad (253)$$

⁸⁸In this section, any variable ending with “_E” will signify that the variable is for the existing storage capacity as of the end of 1998, and any variable ending with “_N” will mean that the variable is for the new storage capacity added from 1999 to 2025.

where,

- STNPIS_{r,t} = net plant in service for existing and new capacity (dollars)
- STGPIS_{r,t} = gross plant in service for existing and new capacity (dollars)
- STADDA_{r,t} = accumulated depreciation, depletion, and amortization for existing and new capacity (dollars)
- r = NGTDM region
- t = forecast year

The gross and net plant-in-service variables can be written as the sum of their respective existing and new gross and net plants in service as follows:

$$STGPIS_{r,t} = STGPIS_E_{r,t} + STGPIS_N_{r,t} \quad (254)$$

$$STNPIS_{r,t} = STNPIS_E_{r,t} + STNPIS_N_{r,t} \quad (255)$$

where,

- STGPIS_{r,t} = gross plant in service for existing and new capacity (dollars)
- STNPIS_{r,t} = net plant in service for existing and new capacity (dollars)
- STGPIS_E_{r,t} = gross plant in service for existing capacity (dollars)
- STGPIS_N_{r,t} = gross plant in service for new capacity (dollars)
- STNPIS_E_{r,t} = net plant in service for existing capacity (dollars)
- STNPIS_N_{r,t} = net plant in service for new capacity (dollars)
- r = NGTDM region
- t = forecast year

For the same reason as above, the accumulated depreciation, depletion, and amortization for t-1 can be split into its existing and new accumulated depreciation:

$$STADDA_{r,t-1} = STADDA_E_{r,t-1} + STADDA_N_{r,t-1} \quad (256)$$

where,

- STADDA_{r,t} = accumulated depreciation, depletion, and amortization for existing and new capacity (dollars)
- STADDA_E_{r,t} = accumulated depreciation, depletion, and amortization for existing capacity (dollars)
- STADDA_N_{r,t} = accumulated depreciation, depletion, and amortization for new capacity (dollars)
- r = NGTDM region
- t = forecast year

The accumulated depreciation for the current year t is expressed as last year's accumulated depreciation plus this year's depreciation. For the separate existing and new storage capacity, their accumulated depreciation, depletion, and amortization can be expressed separately as follows:

$$STADDA_E_{r,t} = STADDA_E_{r,t-1} + STDDA_E_{r,t} \quad (257)$$

$$STADDA_N_{r,t} = STADDA_N_{r,t-1} + STDDA_N_{r,t} \quad (258)$$

where,

- STADDA_{E,r,t} = accumulated depreciation, depletion, and amortization for existing capacity (dollars)
- STADDA_{N,r,t} = accumulated depreciation, depletion, and amortization for new capacity (dollars)
- STDDA_{E,r,t} = depreciation, depletion, and amortization for existing capacity (dollars)
- STDDA_{N,r,t} = depreciation, depletion, and amortization for new capacity (dollars)
- r = NGTDM region
- t = forecast year

Total accumulated depreciation, depletion, and amortization for the combined existing and new capacity by storage region in year t is determined as the sum of previous year's accumulated depreciation, depletion, and amortization and current year's depreciation, depletion, and amortization for that total capacity.

$$STADDA_{r,t} = STADDA_{r,t-1} + STDDA_{r,t} \quad (259)$$

where,

- STADDA_{r,t} = accumulated depreciation, depletion, and amortization for existing and new capacity in dollars
- STDDA_{r,t} = annual depreciation, depletion, and amortization for existing and new capacity in dollars
- r = NGTDM region
- t = forecast year

Computation of annual depreciation, depletion, and amortization, STDDA_{r,t}

Annual depreciation, depletion, and amortization for a storage region in year t is the sum of depreciation, depletion, and amortization for the combined existing and new capacity associated with that region.

$$STDDA_{r,t} = STDDA_{E,r,t} + STDDA_{N,r,t} \quad (260)$$

where,

- STDDA_{r,t} = annual depreciation, depletion, and amortization for existing and new capacity in dollars
- STDDA_{E,r,t} = depreciation, depletion, and amortization costs for existing capacity in dollars
- STDDA_{N,r,t} = depreciation, depletion, and amortization costs for new capacity in dollars
- r = NGTDM region
- t = forecast year

A regression equation is used to determine the annual depreciation, depletion, and amortization for existing capacity associated with an NGTDM region, while an accounting

algorithm is used for new storage capacity. For existing capacity, this depreciation expense by NGTDM region is forecast as follows:

$$\begin{aligned} \text{STDDA_E}_{r,t} = & \text{STDDA_CREG}_r + \text{STDDA_NPIS} * \text{STNPIS_E}_{r,t-1} \\ & + \text{STDDA_NEWCAP} * \text{STNEWCAP}_{r,t} \end{aligned} \quad (261)$$

where,

- STDDA_E_{r,t} = annual depreciation, depletion, and amortization costs for existing capacity in dollars
- STDDA_CREG_r = constant term estimated by region (Appendix F, Table F3)
- STDDA_NPIS = estimated coefficient for net plant in service for existing capacity (Appendix F, Table F3)
- STDDA_NEWCAP = estimated coefficient for the change in gross plant in service for existing capacity (Appendix F, Table F3)
- STNPIS_E_{r,t} = net plant in service for existing capacity (dollars)
- STNEWCAP_{r,t} = change in gross plant in service for existing capacity (dollars)
- r = NGTDM region
- t = forecast year

The accounting algorithm used to define the annual depreciation, depletion, and amortization for new capacity assumes straight-line depreciation over a 30-year life, as follows:

$$\text{STDDA_N}_{r,t} = \text{STGPIS_N}_{r,t} / 30 \quad (262)$$

where,

- STDDA_N_{r,t} = annual depreciation, depletion, and amortization for new capacity in dollars
- STGPIS_N_{r,t} = gross plant in service for new capacity in dollars
- 30 = 30 years of plant life
- r = NGTDM region
- t = forecast year

In the above equation, the capital cost of new plant in service (STGPIS_N_{r,t}) in year t is computed as the accumulated new capacity expansion expenditures from 1999 to year t and is determined by the following equation:

$$\text{STGPIS_N}_{r,t} = \sum_{s=1999}^t \text{STNCAE}_{r,s} \quad (263)$$

where,

- STGPIS_N_{r,t} = gross plant in service for new capacity expansion in dollars
- STNCAE_{r,s} = new capacity expansion expenditures occurring in year s after 1998 (in dollars)
- s = the year new expansion occurred
- r = NGTDM region
- t = forecast year

The new capacity expansion expenditures allowed in the rate base within a forecast year are

derived for each NGTDM region from the amount of incremental capacity additions determined by the ITS:

$$STNCAE_{r,t} = STCCOST_{r,t} * STCAPADD_{r,t} * 1,000,000. \quad (264)$$

where,

- STNCAE_{r,t} = total capital cost to expand capacity for an NGTDM region (dollars)
- STCCOST_{r,t} = capital cost per unit of natural gas storage expansion (dollars per Mcf)
- STCAPADD_{r,t} = storage capacity additions as determined in the ITS (Bcf/yr)
- r = NGTDM region
- t = forecast year

The capital cost per unit of natural gas storage expansion in an NGTDM region (STCCOST_{r,t}) is computed as its 1998 unit capital cost times a function of a capacity expansion factor relative to the 1998 storage capacity. This expansion factor represents a relative change in capacity since 1998. Whenever the ITS forecasts storage capacity additions in year t in an NGTDM region, the increased capacity is computed for that region from 1998 and the unit capital cost is computed. Hence, the capital cost to expand capacity in an NGTDM region can be estimated from any amount of capacity additions in year t provided by the ITS and the associated unit capital cost. This capital cost represents the investment cost for generic storage companies associated with that region. The unit capital cost (STCCOST_{r,t}) is computed by the following equations:

$$STCCOST_{r,t} = STCCOST_CREG_r * e^{(BETAREG_r * STEXPFAC_{98_r})} * (1.0 + STCSTFAC) \quad (265)$$

where,

- STCCOST_{r,t} = capital cost per unit of natural gas storage expansion (dollars per Mcf)
- STCCOST_CREG_r = 1998 capital cost per unit of natural gas storage expansion (1998 dollars per Mcf)
- BETAREG_r = expansion factor parameter (set to STCCOST_BETAREG, Appendix E)
- STEXPFAC_{98_r} = relative change in storage capacity since 1998
- STCSTFAC = factor to set a particular storage region's expansion cost, based on an average [Appendix E]
- r = NGTDM region
- t = forecast year

The relative change in storage capacity is computed as follows:

$$STEXPFAC_{98_r} = \frac{PTCURPSTR_{r,t}}{PTCURPSTR_{r,1998}} - 1.0 \quad (266)$$

where,

$PTCURPSTR_{r,t}$ = current storage capacity (Bcf)
 $PTCURPSTR_{r,1998}$ = 1998 storage capacity (Bcf)
 r = NGTDM region
 t = forecast year

Computation of total cash working capital, $STCWC_{r,t}$

The total cash working capital represents the level of working capital at the beginning of year t deflated using the chain weighted GDP price index with 1996 as a base year. This cash working capital variable is expressed as a non-linear function of total gas storage capacity (base gas capacity plus working gas capacity) as follows:

$$R_STCWC_{r,t} = e^{(STCWC_CREG_r * (1-\rho))} * DSTTCAP_{r,t-1}^{STCWC_TOTCAP} * R_STCWC_{r,t-1}^{\rho} * DSTTCAP_{r,t-2}^{-\rho * STCWC_TOTCAP} \quad (267)$$

where,

$R_STCWC_{r,t}$ = total cash working capital at the beginning of year t for existing and new capacity (1996 real dollars)
 $STCWC_CREG_r$ = constant term, estimated by region (Appendix F, Table F3)
 ρ = autocorrelation coefficient from estimation (Appendix F, Table F3 — $STCWC_RHO$)
 $DSTTCAP_{r,t}$ = total gas storage capacity (Bcf)
 $STCWC_TOTCAP$ = estimated $DSTTCAP$ coefficient (Appendix F, Table F3)
 r = NGTDM region
 t = forecast year

This total cash working capital in 1996 real dollars is converted to nominal dollars to be consistent with the convention used in this submodule.

$$STCWC_{r,t} = R_STCWC_{r,t} * \frac{MC_PCWGDP_t}{MC_PCWGDP_{1996}} \quad (268)$$

where,

$STCWC_{r,t}$ = total cash working capital at the beginning of year t for existing and new capacity (nominal dollars)
 $R_STCWC_{r,t}$ = total cash working capital at the beginning of year t for existing and new capacity (1996 real dollars)
 MC_PCWGDP_t = GDP chain-type price deflator (from the Macroeconomic Activity Module)
 r = NGTDM region
 t = forecast year

Computation of accumulated deferred income taxes, $STADIT_{r,t}$

The level of accumulated deferred income taxes for the combined existing and new capacity in year t in the adjusted rate base equation is a stock (not a flow) and depends on income tax regulations in effect, differences in tax, and book depreciation. It can be expressed as a

linear function of its own lagged variable and the change in the level of gross plant in service between time t and t-1. The forecasting equation can be written as follows:

$$\text{STADIT}_{r,t} = \text{STADIT_C} + (\text{STADIT_ADIT} * \text{STADIT}_{r,t-1}) + (\text{STADIT_NEWCAP} * \text{NEWCAP}_{r,t}) \quad (269)$$

where,

- STADIT_{r,t} = accumulated deferred income taxes in dollars
- STADIT_C = constant term from estimation (Appendix F, Table F3)
- STADIT_ADIT = estimated coefficient for lagged accumulated deferred income taxes (Appendix F, Table F3)
- STADIT_NEWCAP = estimated coefficient for change in gross plant in service (Appendix F, Table F3)
- NEWCAP_{r,t} = change in gross plant in service for the combined existing and new capacity between years t and t-1 (in dollars)
- r = NGTDM region
- t = forecast year

Computation of Total Taxes, STTOTAX_{r,t}

Total taxes consist of Federal income taxes, State income taxes, deferred income taxes, and other taxes. Federal income taxes and State income taxes are calculated using average tax rates. The equation for total taxes is as follows:

$$\text{STTOTAX}_{r,t} = \text{STFSIT}_{r,t} + \text{STDIT}_{r,t} + \text{STOTTAX}_{r,t} \quad (270)$$

$$\text{STFSIT}_{r,t} = \text{STFIT}_{r,t} + \text{STSIT}_{r,t} \quad (271)$$

where,

- STTOTAX_{r,t} = total Federal and State income tax liability for existing and new capacity (dollars)
- STFSIT_{r,t} = Federal and State income tax for existing and new capacity (dollars)
- STFIT_{r,t} = Federal income tax for existing and new capacity (dollars)
- STSIT_{r,t} = State income tax for existing and new capacity (dollars)
- STDIT_{r,t} = deferred income taxes for existing and new capacity (dollars)
- STOTTAX = all other taxes assessed by Federal, State, or local governments for existing and new capacity (dollars)
- r = NGTDM region
- t = forecast year

Federal income taxes are derived from returns to common stock equity and preferred stock (after-tax profit) and the Federal tax rate. The after-tax profit is the operating income excluding the total long-term debt, which is determined as follows:

$$\text{STATP}_{r,t} = \text{STAPRB}_{r,t} * (\text{STPFER}_{r,t} * \text{STGPFESTR}_r + \text{STCMER}_{r,t} * \text{STGCMESTR}_r) \quad (272)$$

$$\text{STATP}_{r,t} = (\text{STPFEN}_{r,t} + \text{STCMEN}_{r,t}) \quad (273)$$

where,

- $\text{STATP}_{r,t}$ = after-tax profit for existing and new capacity (dollars)
- $\text{STAPRB}_{r,t}$ = adjusted pipeline rate base for existing and new capacity (dollars)
- $\text{STPFER}_{r,t}$ = coupon rate for preferred stock for existing and new capacity (fraction)
- STGPFESTR_r = historical average capital structure for preferred stock for existing and new capacity (fraction), held constant over the forecast period
- $\text{STCMER}_{r,t}$ = common equity rate of return for existing and new capacity (fraction)
- STGCMESTR_r = historical average capital structure for common stock for existing and new capacity (fraction), held constant over the forecast period
- $\text{STPFEN}_{r,t}$ = total return on preferred stock for existing and new capacity (dollars)
- $\text{STCMEN}_{r,t}$ = total return on common stock equity for existing and new capacity (dollars)
- r = NGTDM region
- t = forecast year

and the Federal income taxes are

$$\text{STFIT}_{r,t} = (\text{FRATE} * \text{STATP}_{r,t}) / (1. - \text{FRATE}) \quad (274)$$

where,

- $\text{STFIT}_{r,t}$ = Federal income tax for existing and new capacity (dollars)
- FRATE = Federal income tax rate (fraction, Appendix E)
- $\text{STATP}_{r,t}$ = after-tax profit for existing and new capacity (dollars)
- r = NGTDM region
- t = forecast year

State income taxes are computed by multiplying the sum of taxable profit and the associated Federal income tax by a weighted-average State tax rate associated with each NGTDM region. State income taxes are computed as follows:

$$\text{STSIT}_{r,t} = \text{SRATE} * (\text{STFIT}_{r,t} + \text{STATP}_{r,t}) \quad (275)$$

where,

- $\text{STSIT}_{r,t}$ = State income tax for existing and new capacity (dollars)
- SRATE = average State income tax rate (fraction, Appendix E)
- $\text{STFIT}_{r,t}$ = Federal income tax for existing and new capacity (dollars)
- $\text{STATP}_{r,t}$ = after-tax profits for existing and new capacity (dollars)
- r = NGTDM region
- t = forecast year

Deferred income taxes for existing and new capacity at the arc level are the differences in the accumulated deferred income taxes between year t and year t-1.

$$\text{STDIT}_{r,t} = \text{STADIT}_{r,t} - \text{STADIT}_{r,t-1} \quad (276)$$

where,

- STDIT_{r,t} = deferred income taxes for existing and new capacity (dollars)
- STADIT_{r,t} = accumulated deferred income taxes for existing and new capacity (dollars)
- r = NGTDM region
- t = forecast year

Other taxes consist of a combination of ad valorem taxes (which grow with company revenue), property taxes (which grow in proportion to gross plant), and all other taxes (assumed constant in real terms). Other taxes in year t are determined as the previous year's other taxes adjusted for inflation.

$$\text{STOTTAX}_{r,t} = \text{STOTTAX}_{r,t-1} * (\text{MC_PCWGDP}_t / \text{MC_PCWGDP}_{t-1}) \quad (277)$$

where,

- STOTTAX_{r,t} = all other taxes assessed by Federal, State, or local governments except income taxes for existing and new capacity (dollars) [read in as D_OTTAX_{r,t}, t=1990-1998]
- MC_PCWGDP_t = GDP chain-type price deflator (from the Macroeconomic Activity Module)
- r = NGTDM region
- t = forecast year

Computation of total operating and maintenance expenses, STTOM_{r,t}

The total operating and maintenance costs (including administrative costs) for existing and new capacity in an NGTDM region are determined in 1996 real dollars using a log-linear form with correction for serial correlation. The estimated equation is determined as a function of working gas storage capacity for region r at the beginning of period t. In developing the estimations, the impact of regulatory change and the differences between producing and consuming regions were analyzed.⁸⁹ Because their impacts were not supported by the data, they were not accounted for in the estimations. The final estimating equation is:

$$\begin{aligned} R_STTOM_{r,t} &= e^{(\text{STTOM_C} * (1-\rho))} * \text{DSTWCAP}_{r,t-1}^{\text{STTOM_WORKCAP}} * \\ &\quad R_STTOM_{r,t-1}^{\rho} * \text{DSTWCAP}_{r,t-2}^{-\rho * \text{STTOM_WORKCAP}} \end{aligned} \quad (278)$$

where,

⁸⁹The gas storage industry changed substantially when in 1994 FERC Order 636 required jurisdictional pipeline companies to operate their storage facilities on an open-access basis. The primary customers and use of storage in producing regions are significantly different from consuming regions.

$R_STTOM_{r,t}$ = total operating and maintenance cost for existing and new capacity (1996 real dollars)
 $STTOM_C$ = constant term from estimation (Appendix F, Table F3)
 ρ = autocorrelation coefficient from estimation (Appendix F, Table F3 -- $STTOM_RHO$)
 $DSTWCAP_{r,t}$ = level of gas working capacity for region r during year t
 $STTOM_WORKCAP$ = estimated $DSTWCAP$ coefficient (Appendix F, Table F3)
 r = NGTDM region
 t = forecast year

Finally, the total operating and maintenance costs are converted to nominal dollars to be consistent with the convention used in this submodule.

$$STTOM_{r,t} = R_STTOM_{r,t} * \frac{MC_PCWGDP_t}{MC_PCWGDP_{1996}} \quad (279)$$

where,

$STTOM_{r,t}$ = total operating and maintenance costs for existing and new capacity (nominal dollars)
 $R_STTOM_{r,t}$ = total operating and maintenance costs for existing and new capacity (1996 real dollars)
 MC_PCWGDP_t = GDP chain-type price deflator (from the Macroeconomic Activity Module)
 r = NGTDM region
 t = forecast year

Computation of Storage Tariff

The regional storage tariff depends on the storage cost of service, current working gas capacity, utilization rate, natural gas storage activity, and other factors. The functional form is similar to the pipeline tariff curve, in that it will be built from a regional base point [price and quantity (PNOD,QNOD)]. The base regional storage tariff (PNOD_{r,t}) is determined as a function of the cost of service (STCOS_{r,t} (equation 236)) and other factors discussed below. QNOD_{r,t} is set to an effective working gas storage capacity by region, which is defined as a regional working gas capacity times its utilization rate. Hence, once the storage cost of service is computed by region, the base point can be established. Minor adjustments to the storage tariff routine will be necessary in order to obtain the desired results.

In the model, the storage cost of service used represents only a portion of the total storage cost of service, the revenue collected from the customers for withdrawing during the peak period the quantity of natural gas stored during the off-peak period. This portion is defined as a user-set percentage (STRATIO, Appendix E) representing the portion (ratio) of revenue requirement obtained by storage companies for storing gas during the off-peak and withdrawing it for the customers during the peak period. This would include charges for injections, withdrawals, and reserving capacity.

The cost of service $STCOS_{r,t}$ is computed using the Foster storage financial database which represents only the storage facilities owned by the interstate natural gas pipelines in the U.S. which have filed a Form 2 financial report with the FERC. Therefore, an adjustment to this cost of service to account for all the storage companies by region is needed. For example, at the national level, the Foster database shows the underground storage working gas capacity at 2.3 Tcf in 1998 and the EIA storage gas capacity data show much higher working gas capacity at 3.8 Tcf. Thus, the average adjustment factor to obtain the “actual” cost of service across all regions in the U.S. is 165 percent. This adjustment factor, $STCAP_ADJ_{r,t}$, varies from region to region.

To complete the design of the storage tariff computation, two more factors need to be incorporated: the regional storage tariff curve adjustment factor and the regional efficiency factor for storage operations, which makes the storage tariff more competitive in the long-run.

Hence, the regional average storage tariff charged to customers for moving natural gas stored during the off-peak period and withdrawn during the peak period can be computed as follows:

$$PNOD_{r,t} = \frac{STCOS_{r,t}}{(MC_PCWGDP_t * QNOD_{r,t} * 1,000,000.) * STRATIO_{r,t} * STCAP_ADJ_{r,t} * ADJ_STR * (1.0 - STR_EFF/100.)^t} \quad (280)$$

where,

$$STCAP_ADJ_{r,t} = \frac{PTCURPSTR_{r,t}}{FS_PTCURPSTR_{r,t}} \quad (281)$$

$$QNOD_{r,t} = PTCURPSTR_{r,t} * PTSTUTZ_{r,t} \quad (282)$$

and,

- $PNOD_{r,t}$ = base point, price (87\$/Mcf)
- $STCOS_{r,t}$ = storage cost of service for existing and new capacity (dollars)
- $QNOD_{r,t}$ = base point, quantity (Bcf)
- MC_PCWGDP_t = GDP chain-type price deflator (from the Macroeconomic Activity Module)
- $STRATIO_{r,t}$ = portion of revenue requirement obtained by moving gas from the off-peak to the peak period (fraction, Appendix E)
- $STCAP_ADJ_{r,t}$ = adjustment factor for the cost of service to total U.S. (ratio)
- ADJ_STR = storage tariff curve adjustment factor (fraction, Appendix E)
- STR_EFF = efficiency factor (percent) for storage operations (Appendix E)
- $PTSTUTZ_{r,t}$ = storage utilization (fraction)
- $PTCURPSTR_{r,t}$ = current storage capacity (Bcf)

$FS_PTCURPSTR_{r,t}$ = Foster storage working gas capacity (Bcf) [read in as D_WCAP]
 r = NGTDM region
 t = forecast year

Finally, the storage tariff curve by region can be expressed as a function of a base point [price and quantity (PNOD, QNOD)], storage flow, and a price elasticity, as follows:

current capacity segment:

$$X1NGSTR_VARTAR_{r,t} = PNOD_{r,t} * (Q_{r,t} / QNOD_{r,t})^{ALPHA_STR} \quad (283)$$

capacity expansion segment:

$$X1NGSTR_VARTAR_{r,t} = PNOD_{r,t} * (Q_{r,t} / QNOD_{r,t})^{ALPHA2_STR} \quad (284)$$

where,

$X1NGSTR_VARTAR_{r,t}$ = function to define storage tariffs (87\$/Mcf)
 $PNOD_{r,t}$ = base point, price (87\$/Mcf)
 $QNOD_{r,t}$ = base point, quantity (Bcf)
 $Q_{r,t}$ = regional storage flow (Bcf)
 $ALPHA_STR$ = price elasticity for storage tariff curve for current capacity (Appendix E)
 $ALPHA2_STR$ = price elasticity for storage tariff curve for capacity expansion segment (Appendix E)
 r = NGTDM region
 t = forecast year

Alaska and MacKenzie Delta Pipeline Tariff Routine

A single routine (FUNCTION NGFRPIPE_TAR) estimates the potential per-unit pipeline tariff for moving natural gas from either the North Slope of Alaska or the MacKenzie Delta to the market hub in Alberta, Canada for the years beyond the specified in-service date. The tariff estimates are based on a simple cost-of-service rate base methodology, given the infrastructure's initial capital cost at the beginning of the construction period (FR_CAPITL0 in billion dollars, Appendix E), the assumed number of years for the project to be completed (FRPCNSYR, Appendix E), the associated discount rate for the project (FR_DISCRT, Appendix E), the initial capacity (FR_PVOL, Appendix E), and the number of years over which the final cost of capitalization is assumed completely amortized (INVEST_YR=15). The input values vary depending on whether the tariff being calculated is associated with a pipeline for Alaska or for MacKenzie Delta gas. The cost of service consists of the following four components: depreciation, depletion, and amortization; after-tax operating income (known as the return on rate base); total operating and maintenance expenses; and total income taxes. The computation of each of the four components in nominal dollars per Mcf is described below:

Depreciation, depletion, and amortization, FR_DDA_t

The depreciation is computed as the final cost of capitalization at the start of operations divided by the amortization period. The depreciation equation is provided below:

$$FR_DDA_t = FR_CAPITL1 / INVEST_YR \quad (285)$$

where,

$$\begin{aligned} FR_DDA_t &= \text{depreciation, depletion, and amortization costs (thousand} \\ &\quad \text{nominal dollars)} \\ FR_CAPITL1 &= \text{final cost of capitalization at the start of operations (thousand} \\ &\quad \text{nominal dollars)} \\ INVEST_YR &= \text{investment period allowing recovery (parameter,} \\ &\quad \text{INVEST_YR=15)} \\ t &= \text{forecast year} \end{aligned}$$

The structure of the final cost of capitalization, $FR_CAPITL1$, is computed as follows:

$$FR_CAPITL1 = FR_CAPIT0 / FR_PCNSYR * \quad (286)$$
$$[(1+r) + (1+r)^2 + \dots + (1+r)^{FR_PCNSYR}]$$

where,

$$\begin{aligned} FR_CAPITL1 &= \text{final cost of capitalization at the start of operations (thousand} \\ &\quad \text{nominal dollars)} \\ FR_CAPITL0 &= \text{initial capitalization (thousand } FR_CAPYR \text{ dollars), where} \\ &\quad \text{FR_CAPYR is the year dollars associated with this assumed} \\ &\quad \text{capital cost (Appendix E)} \\ FR_PCNSYR &= \text{number of construction years (Appendix E)} \\ r &= \text{cost of debt, fraction, which is equal to the nominal AA utility} \\ &\quad \text{bond rate (MC_RMPAANS, in percent) plus a debt premium in} \\ &\quad \text{percent (debt premium set to } FR_DISCRT \text{, Appendix E)} \end{aligned}$$

The net plant in service is tied to the depreciation by the following formulas:

$$\begin{aligned} FR_NPIS_t &= FR_GPIS_t - FR_ADDA_t \\ FR_ADDA_t &= FR_ADDA_{t-1} + FR_DDA_t \end{aligned} \quad (287)$$

where,

$$\begin{aligned} FR_GPIS_t &= \text{original capital cost of plant in service (gross plant in service)} \\ &\quad \text{in thousand nominal dollars, set to } FR_CAPITL1. \\ FR_NPIS_t &= \text{net plant in service (thousand nominal dollars)} \\ FR_ADDA_t &= \text{accumulated depreciation, depletion, and amortization in} \\ &\quad \text{thousand nominal dollars} \\ t &= \text{forecast year} \end{aligned}$$

After-tax operating income (return on rate base), FR_TRRB_t

This after-tax operating income also known as the return on rate base is computed as the net plant in service times an annual rate of return (FR_ROR , Appendix E). The net plant in service, FR_NPIS_t , gets updated each year and is equal to the initial gross plant in service minus accumulated depreciation. Net plant in service becomes the adjusted rate base when other capital related costs such as materials and supplies, cash working capital, and accumulated deferred income taxes are equal to zero.

The return on rate base is computed as follows:

$$FR_TRRB_t = WACC_t * FR_NPIS_t \quad (288)$$

where,

$$WACC_t = FR_DEBTRATIO * COST_OF_DEBT_t + (1.0 - FR_DEBTRATIO) * COST_OF_EQUITY_t \quad (289)$$

and

$$COST_OF_DEBT_t = (AABOND_t + FR_DISCRT) / 100. \quad (290)$$

$$COST_OF_EQUITY_t = (AABOND_t + FR_ROR_PREM) / 100. \quad (291)$$

where,

- FR_TRRB_t = after-tax operating income or return on rate base (thousand nominal dollars)
- $WACC_t$ = weighted average cost of capital (fraction), nominal
- FR_NPIS_t = net plant in service (thousand nominal dollars)
- $COST_OF_DEBT_t$ = cost of debt (fraction)
- $COST_OF_EQUITY_t$ = cost of equity (fraction)
- $AABOND_t$ = nominal AA utility bond rate, $MC_RMPUAAS_t$, (in percent) provided by the Macroeconomic Activity Module
- FR_DISCRT = user-set debt premium, percent (Appendix E)
- FR_ROR_PREM = user-set risk premium, percent (Appendix E)
- t = forecast year

Total taxes, FR_TAXES_t

Total taxes consist of Federal and State income taxes and taxes other than income taxes. Each tax category is computed based on a percentage times net profit. These percentages are drawn from the Foster financial report's 28 major interstate natural gas pipeline companies. The percentage for income taxes (FR_TXR) is computed as the average over five years (1992-1996) of tax to net operating income ratio from the Foster report. Likewise, the percentage (FR_OTXR) for taxes other than income taxes is computed as the average over five years (1992-1996) of taxes other than income taxes to net operating income ratio from the same report. Total taxes are computed as follows:

$$FR_TAXES_t = (FR_TXR + FR_OTXR) * FR_NETPFT_t \quad (292)$$

where,

- FR_TAXES_t = total taxes (thousand nominal dollars)
- FR_NETPFT_t = net profit (thousand nominal dollars)
- FR_TXR = 5-year average Lower 48 pipeline income tax rate, as a proxy (Appendix E)
- FR_OTXR = 5-year average Lower 48 pipeline other income tax rate, as a proxy (Appendix E)
- t = forecast year

Net profit, FR_NETPFT, is computed as the return on rate base (FR_TRRB_t) minus the long-term debt (FR_LTD_t), which is calculated as the return on rate base times long-term debt rate times the debt to capital structure ratio. The net profit and long-term debt equations are provided below:

$$FR_NETPFT_t = (FR_TRRB_t - FR_LTD_t) \quad (293)$$

$$FR_LTD_t = FR_DEBTRATIO * (AABOND_t + FR_DISCRT) / 100.0 * FR_NPIS_t \quad (294)$$

where,

- FR_LTD_t = long-term debt (thousand nominal dollars)
- FR_NPIS_t = net plant in service (thousand nominal dollars)
- FR_DEBTRATIO = 5-year average Lower 48 pipeline debt structure ratio (Appendix E)
- FR_NETPFT_t = net profit (thousand nominal dollars)
- FR_TRRB_t = return on rate base (thousand nominal dollars)
- AABOND_t = nominal AA utility bond rate, MC_RMPUAAS_t, (in percent) provided by the Macroeconomic Activity Module
- FR_DISCRT = user-set debt premium, percent (Appendix E)
- t = forecast year

In the above equations, the long-term debt rate is assumed equal to the AA utility bond rate plus a 1 percent, which represents a risk premium generally charged by financial institutions. When AA utility bond rates are needed for years beyond the last forecast year (LASTYR), the variable AABOND_t becomes the average over a number of years (FR_ESTNYR, Appendix E) of the AA utility bond rates for the last forecast years.

Cost of Service, FR_COS_t

The cost of service is the sum of four cost-of-service components computed above, as follows:

$$FR_COS_t = (FR_TRRB_t + FR_DDA_t + FR_TAXES_t + FR_TOM_{FR_CAPYR} * (MC_PCWGDP_t / MC_PCWGDP_{FR_CAPYR}) * FR_PVOL * 1000.0) \quad (295)$$

where,

- FR_COS_t = cost of service (thousand nominal dollars)
- FR_TRRB_t = return on rate base (thousand nominal dollars)
- FR_DDA_t = depreciation (thousand nominal dollars)
- FR_TAXES_t = total taxes (thousand nominal dollars)
- FR_TOM_{FR_CAPYR} = total operating and maintenance expenses (in nominal dollars per Mcf, set constant in real terms) (Appendix E)
- MC_PCWGDP_t = GDP price deflator (from Macroeconomic Activity Module)
- FR_PVOL = initial pipeline capacity (Bcf/year)
- t = forecast year

Hence, the annual pipeline tariff in nominal dollars is computed by dividing the above cost of service by total pipeline capacity, as follows:

$$COS_t = FR_COS_t / (FR_PVOL * 1000.0) \quad (296)$$

where,

- COS_t = per-unit cost of service or annual pipeline tariff (nominal dollars/Mcf)
- t = forecast year

To convert this nominal tariff to real 1987\$/Mcf, the GDP implicit price deflator variable provided by the Macroeconomic Activity Module is needed. The real tariff equation is written as follows:

$$COSR_t = COS_t / MC_PCWGDP_t \quad (297)$$

where,

- COSR_t = annual real pipeline tariff (1987 dollars/Mcf)
- MC_PCWGDP_t = GDP price deflator (from Macroeconomic Activity Module)
- t = forecast year

Last, the annual average tariff is computed as the average over a number of years (FR_AVGTARYR, Appendix E) of the first successive annual cost of services.

7. Model Assumptions, Inputs, and Outputs

This last chapter summarizes the model and data assumptions used by the Natural Gas Transmission and Distribution Module (NGTDM) and lists the primary data inputs to and outputs from the NGTDM.

Assumptions

This section presents a brief summary of the assumptions used within the NGTDM. Generally, there are two types of data assumptions that affect the NGTDM solution values. The first type can be derived based on historical data (past events), and the second type is based on experience and/or events that are likely to occur (expert or analyst judgment). A discussion of the rationale behind assumed values based on analyst judgment is beyond the scope of this report. Most of the FORTRAN variables related to model input assumptions, both those derived from known sources and those derived through analyst judgment, are identified in this chapter, with background information and actual values referenced in Appendix E.

The assumptions summarized in this section are mentioned in Chapters 2 through 6. They are used in NGTDM equations as starting values, coefficients, factors, shares, bounds, or user specified parameters. Six general categories of data assumptions have been defined: classification of market services, demand, transmission and distribution service pricing, pipeline tariffs and associated regulation, pipeline capacity and utilization, and supply (including imports). These assumptions, along with their variable names, are summarized below.

Market Service Classification

Nonelectric sector natural gas customers are classified as either core or noncore customers, with core customers defined as the type of customer that is expected to generally transport their gas under firm (or near firm) transportation agreements and noncore customers to generally transport their gas under non-firm (interruptible or short-term capacity release) transportation agreements. The residential, commercial, and transportation (natural gas vehicles) sectors are assumed to be core customers. The transportation sector is further subdivided into fleet and personal vehicle customers. Industrial and electric generator end users fall into both categories, with industrial boilers and refineries assumed to be noncore and all other industrial users assumed to be core, and gas steam units or gas combined cycle units assumed to be core and all other electric generators assumed to be noncore. Currently the core/noncore distinction for electric generators is not being used in the model.

Demand

The peak period is defined (*using PKOPMON*) to run from December through March, with the off-peak period filling up the remainder of the year.

The Alaskan natural gas consumption levels for residential and commercial sectors are primarily defined as a function of the number of customers (*AK_RN, AK_CM, Tables F1, F2*), which in turn are set based on an exogenous projection of the population in Alaska (*AK_POP*). Alaskan gas consumption is disaggregated into North and South Alaska in order to separately compute the natural gas production forecasts in these regions. Lease, plant, and pipeline fuel related to an Alaska pipeline or a gas-to-liquids facility are set at an assumed percentage of their associated gas volumes (*AK_PCTPLT, AK_PCTPIP, AK_PCTLSE*). The remaining lease and plant fuel is assumed to be consumed in the North and set based on historical trends. The amount of gas consumed by other sectors in North Alaska is small enough to assume as zero and to allow for the setting of South Alaska volumes equal to the totals for the State. Industrial consumption in South Alaska is set to the exogenously specified sum of the level of gas consumed at the Agrium fertilizer plant and at the liquefied natural gas plant (*AK_QIND_S*). Pipeline fuel in the South is set as a percentage (*AK_PCTPIP*) of consumption and exports. Production in the south is set to total consumption levels in the region. In the north production equals the flow along an Alaska pipeline to Alberta, any gas needed to support the production of gas-to-liquids, associated lease, plant, and pipeline fuel for these two applications, and the other calculated lease and plant fuel. The forecast for reporting discrepancy in Alaska (*AK_DISCR*) is set to an average historical value. To compute natural gas prices by end-use sector for Alaska, fixed markups derived from historical data (*AK_RM, AK_CM, AK_IN, AK_EM*) are added to the average Alaskan natural gas wellhead price over the North and South regions. The wellhead price is set using a simple estimated equation (*AK_F*). Historically based percentages and markups are held constant throughout the forecast period.

The shares (*NG_CENSHR*) for disaggregating nonelectric Census Division demands to NGTDM regions are held constant throughout the forecast period and are based on average historical relationships (*SQRS, SQCM, SQIN, SQTR*). Similarly, the shares for disaggregating end-use consumption levels to peak and off-peak periods are held constant throughout the forecast, and are directly (*United States -- PKSHR_DMD, PKSHR_UDMD_F, PKSHR_UDMD_I*) or partially (*Canada -- PKSHR_CDMD*) historically based. Canadian consumption levels are set exogenously (*CN_DMD*) based on another published forecast, and adjusted if the associated world oil price changes. Consumption, base level production, and domestically consumed LNG imports into Mexico are set exogenously (*PEMEX_GFAC, IND_GFAC, ELE_GFAC, RC_GFAC, PRD_GFAC, MEXLNG*). After the base level production is adjusted based on the average U.S. wellhead price, exports to Mexico are set to balance supply and consumption. Historically based shares (*PKSHR_ECAN, PKSHR_EMEX, PKSHR_ICAN, PKSHR_IMEX, PKSHR_ILNG*) are applied to projected/historical values for natural gas exports and imports (*SEXP, SIMP, CANEXP, Q23TO3, FLO_THRU_IN, OGQNGEXP*). These historical based shares are generated from monthly historical data (*QRS, QCM, QIN, QEU, MON_QEXP, MON_QIMP*).

Lease and plant fuel consumption in each NGTDM region is computed as an historically derived percentage (*using SQLP*) of dry gas production (*PCTLP*) in each NGTDM/OGSM region. These percentages are held constant throughout the forecast period. Pipeline fuel use is

derived using historically (*SQPF*) based factors (*PFUEL_FAC*) relating pipeline fuel use to the quantity of natural gas exiting a regional node. Values for the most recent historical year are derived from monthly-published figures (*QLP_LHIS*, *NQPF_TOT*).

Pricing of Distribution Services

End-use prices for residential, commercial, industrial, transportation, and electric generation customers are derived by adding markups to the regional hub price of natural gas. Each regional end-use markup consists of an intraregional tariff (*INTRAREG_TAR*), an intrastate tariff (*INTRAST_TAR*), a distribution tariff (*endogenously defined*), and a city gate benchmark factor [endogenously defined based on historical seasonal city gate prices (HCGPR)]. Historical distributor tariffs are derived for all sectors as the difference between historical city gate and end-use prices (*SPRS*, *SPCM*, *SPIN*, *SPEU*, *SPTR*, *PRS*, *PCM PIN*, *PEU*).⁹⁰ Historical industrial end-use prices are derived in the module using an econometrically estimated equation (Table F5).⁹¹ The residential, commercial, industrial, and electric generator distributor tariffs are also based on econometrically estimated equations (Tables F4, F6, F7, and F8). The distributor tariff for the personal (PV) and fleet vehicle (FV) components of the transportation sector are set using historical data, a decline rate (*TRN_DECL*), state and federal taxes (*STAX*, *FTAX*), and assumed dispensing costs/charges (*RETAIL_COST*), and for personal vehicles at retail stations, a capital cost recovery markup (*CNG_RETAIL_MARKUP*).

Prices for exports (and fixed volume imports) are based on historical differences between border prices (*SPIM*, *SPEX*, *MON_PIMP*, *MON_PEXP*) and their closest market hub price (as determined in the module when executed during the historical years).

Pipeline and Storage Tariffs and Regulation

Peak and off-peak transportation rates for interstate pipeline services (both between NGTDM regions and within a region) are calculated assuming that the costs of new pipeline capacity will be rolled into the existing rate base. Peak and off-peak market transmission service rates are based on a cost-of-service/rate-of-return calculation for current pipeline capacity times an assumed utilization rate (*PKUTZ*, *OPUTZ*). To reflect recent regulatory changes related to alternative ratemaking and capacity release developments, these tariffs are discounted (based on an assumed price elasticity) as pipeline utilization rates decline.

In the computation of natural gas pipeline transportation and storage rates, the Pipeline Tariff Submodule uses a set of data assumptions based on historical data or expert judgment. These include the following:

⁹⁰All historical prices are converted from nominal to real 1987 dollars using a price deflator (*GDP_B87*).

⁹¹Traditionally industrial prices have been derived by collecting sales data from local distribution companies. More recently, industrial customers have not relied on LDCs to purchase their gas. As a result, annually published industrial natural gas prices only represent a rather small portion of the total population. In the module, these published prices are adjusted using an econometrically estimated equation based on EIA's survey of manufacturers to derive a more representative set of industrial prices.

- Factors (*AFX, AFR, AVR*) to allocate each company's line item costs into the fixed and variable cost components of the reservation and usage fees
- Capacity reservation shares used to allocate cost of service components to portions of the pipeline network
- Average pipeline capital cost (2000 dollars) per unit of expanded capacity by arc (*AVGCOST*) used to derive total capital costs to expand pipeline capacity
- Storage capacity expansion cost parameters (*STCCOST_CREG, STCCOST_BETAREG, STCSTFAC*) used to derive total capital costs to expand regional storage capacity
- Input coefficients (*ALPHA_PIPE, ALPH2_PIPE, ALPHA_STR, ALPHA2_STR, ADJ_STR, STR_EFF*) for transportation and storage rates
- Pipeline tariff curve parameters by arc (*PKSHR_YR, PTPKUTZ, PTOPUTZ, ALPHA_PIPE, ALPHA2_PIPE*)
- Storage tariff curve parameters by region (*STRATIO, STCAP_ADJ, PTSTUTZ, ADJ_STR, STR_EFF, ALPHA_STR, ALPHA2_STR*)

In order to determine when a pipeline from either Alaska or the MacKenzie Delta to Alberta could be economic, the model estimates the tariff that would be charged on both pipelines should they be built, based on a number of assumed values. A simple cost-of-service/rate-of-return calculation is used, incorporating the following: initial capitalization (*FR_CAPITLO*), return on debt (*FR_DISCRT*) and return on equity (*FR_ROR_PREM*) (both specified as a premium added to BAA bond rate), total debt as a fraction of total capital (*FR_DEBRATIO*), operation and maintenance expenses (*FR_TOMO*), federal income tax rate (*FR_TXR*), other tax rate (*FR_OTXR*), levelized cost period (*FR_AVGTARYR*), and depreciation period (*INVEST_YR*). In order to establish the ultimate charge for the gas in the lower 48 States assumptions were made for the minimum wellhead price (*FR_PMINWPC*) including production, treatment, and fuel costs, as well as the average differential between Alberta and the lower 48 (*ALB_TO_L48*) and a risk premium (*FR_PRISK*) to reflect cost and market uncertainties. The market price in the lower 48 states must be maintained over a planning horizon (*FR_PPLNYR*) before construction would begin. Construction is assumed to take a set number of years (*FR_PCNSYR*) and result in a given initial capacity (*FR_PVOL*). An additional expansion is assumed on the condition of an increase in the market price (*FR_PADDTAR, FR_PEXPFAC*).

Pipeline and Storage Capacity and Utilization

Historical and planned interregional, intraregional, and Canadian pipeline capacities are assigned in the module for the historical years and the first few years (*NOBLDYN*) into the forecast (*ACTPCAP, PACTPCAP, PLANPCAP, SPLANPCAP, PER_YROPEN, CNPER_YROPEN*). The flow of natural gas along these pipeline corridors in the peak and off-peak periods of the historical years is set, starting with historical shares (*HPKSHR_FLOW*), to be consistent with the annual flows (*HAFLOW, SAFLOW*) and other known seasonal network volumes (e.g., consumption, production).

A similar assignment is used for storage capacities (*PLANPCAP, ADDYR*). The module only represents net storage withdrawals in the peak period and net storage injections in the off-peak period, which are known historically (*HNETWTH, HNETINJ, SNETWTH, NWTOT, NINJTOT*).

For the forecast years, the use of both pipeline and storage capacity in each seasonal period is limited by exogenously set maximum utilization rates (*PKUTZ, OPUTZ, SUTZ*), although these are

currently not active for pipelines. They were originally intended to reflect an expected variant in the load throughout a season. Adjustments are now being made within the module, during the flow sharing algorithm, to reflect the seasonal load variation.

The decision concerning the share of gas that will come from each incoming source into a region for the purpose of satisfying the regions consumption levels (and some of the consumption upstream) is based on the relative costs of the incoming sources and assumed parameters (*GAMMAFAC*, *MUFAC*). During the process of deciding the flow of gas through the network, an iterative process is used that requires a set of assumed parameters for assessing and responding to nonconvergence (*PSUP_DELTA*, *QSUP_DELTA*, *QSUP_SMALL*, *QSUP_WT*, *MAXCYCLE*).

Supply

The supply curves for domestic lower 48 nonassociated dry gas production and conventional and tight gas production from the Canadian Sedimentary Basin are based on an expected production level as set in the Oil and Gas Supply Module. A set of parameters (*PARM_SUPCRV3*, *PARM_SUPCRV5*, *SUPCRV*, *PARM_SUPELAS*) defines the price change from a base or expected price as production deviates from this expected level. These supply curves are limited by minimum and maximum levels, calculated as a factor (*PARM_MINPR*, *MAXPRRFAC*, *MAXPRRCAN*) times the expected production levels. Domestic associated-dissolved gas production is provided by the Oil and Gas Supply Module. Eastern Canadian production from other than the Canadian Western Canadian Sedimentary Basin is set exogenously (*CN_FIXSUP*). Natural gas production in Canada from both coal beds and shale is based on assumed production withdrawal profiles from their perspective resource base totals (*ULTRES*, *ULTSHL*) at an assumed exogenously specified price path and is adjusted relative to how much the actual western Canadian price differs from the assumed. Production from the frontier areas in Canada (i.e., the MacKenzie Delta) is set based on the assumed size of the pipeline to transport the gas to Alberta, should the pipeline be built. Production from Alaska is a function of the consumption in Alaska and the potential capacity of a pipeline from Alaska to Alberta and/or a gas-to-liquids facility.

Imports from Mexico and Canada at each border crossing point are represented as follows: (1) Mexican imports are set exogenously (*EXP_FRMEX*) with the exception of LNG imported into Baja for U.S. markets; (2) Canadian imports are set endogenously (except for the imports into the East North Central region, *Q23TO3*) and limited to Canadian pipeline capacities (*ACTPCAP*, *CNPER_YROPEN*), which are set in the module, and expand largely in response to the introduction of Alaskan gas into the Alberta system. Total gas imports from Canada exclude the amount of gas that travels into the United States and then back into Canada (*FLO_THRU_IN*).

Liquefied natural gas imports are represented with an east and west supply curves to North America generated based on output results from EIA's International Natural Gas Model and shared to representative regional terminals based on regasification capacity, last year's imports, and relative prices. Regasification capacity is set based on known facilities, either already constructed or highly likely to be (*LNGCAP*).

The three supplemental production categories (synthetic production of natural gas from coal and liquids and other supplemental fuels) are represented as constant supplies within the

Interstate Transmission Submodule, with the exception of any production from potential new coal-to-gas plants. Synthetic production from the existing coal plant is set exogenously (*SNGCOAL*). Forecast values for the other two categories are held constant throughout the forecast and are set to historical values (*SNGLIQ*, *SUPPLM*) within the module. The algorithm for determining the potential construction of new coal-to-gas plants uses an extensive set of detailed cost figures to estimate the total investment and operating costs of a plant (including accounting for emissions costs, electricity credits, and lower costs over time due to learning) for use within a discounted cash flow calculation. If positive cash flow is estimated to occur the number of generic plants built is based on a Mansfield-Blackman market penetration algorithm. Throughout the forecast, the annual synthetic gas production levels are split into seasonal periods using an historically (*NSUPLM_TOT*) based share (*PKSHR_SUPLM*).

The supply component uses an assortment of input values in defining historical production levels and prices (or revenues) by the regions and categories required by the module (*QOF_ALST*, *QOF_ALFD*, *QOF_LAST*, *QOF_LAFD*, *QOF_CA*, *ROF_CA*, *QOF_LA*, *ROF_LA*, *QOF_TX*, *ROF_TX*, *AL_ONSH*, *AL_OFST*, *AL_OFFD*, *LA_ONSH*, *LA_OFST*, *LA_OFFD*, *ADW*, *NAW*, *TGD*, *MISC_ST*, *MISC_GAS*, *MISC_OIL*, *SMKT_PRD*, *SDRY_PRD*, *HQSUP*, *HPSUP*, *WHP_LHIS*, *SPWH*). A set of seasonal shares (*PKSHR_PROD*) have been defined based on historical values (*MONMKT_PRD*) to split production levels of supply sources that are nonvariant with price (*CN_FIXSUP* and others) into peak and off-peak categories.

Discrepancies that exist between historical supply and disposition level data are modeled at historical levels (*SBAL_ITM*) in the NGTDM and kept constant throughout the forecast years at average historical levels (*DISCR*, *CN_DISCR*).

Model Inputs

The NGTDM inputs are grouped into six categories: mapping and control variables, annual historical values, monthly historical values, Alaskan and Canadian demand/supply variables, supply inputs, pipeline and storage financial and regulatory inputs, pipeline and storage capacity and utilization related inputs, end-use pricing inputs, and miscellaneous inputs. Short input data descriptions and identification of variable names that provide more detail (via Appendix E) on the sources and transformation of the input data are provided below.

Mapping and Control Variables

- Variables for mapping from States to regions (*SNUM_ID*, *SCH_ID*, *SCEN_DIV*, *SITM_REG*, *SNG_EM*, *SNG_OG*, *SIM_EX*, *MAP_PRDST*)
- Variables for mapping import/export borders to States and to nodes (*CAN_XMAPUS*, *CAN_XMAPCN*, *MEX_XMAP*, *CAN_XMAP*)
- Variables for handling and mapping arcs and nodes (*PROC_ORD*, *ARC_2NODE*, *NODE_2ARC*, *ARC_LOOP*, *SARC_2NODE*, *SNODE_2ARC*, *NODE_ANGTS*, *CAN_XMAPUS*)
- Variables for mapping supply regions (*NODE_SNGCOAL*, *MAPLNG_NG*, *OCSMAP*, *PMMMAP_NG*, *SUPSUB_NG*, *SUPSUB_OG*)
- Variables for mapping demand regions (*EMMSUB_NG*, *EMMSUB_EL*, *NGCENMAP*)

Annual Historical Values

- Offshore natural gas production and revenue data (QOF_ALST, QOF_ALFD, QOF_LAST, QOF_LAFD, QOF_CA, ROF_CA, QOF_LA, ROF_LA, QOF_TX, ROF_TX, QOF_AL, ROF_AL, QOF_MS, ROF_MS, QOF_GM, ROF_GM, PRICE_CA, PRICE_LA, PRICE_AL, PRICE_TX, GOF_LA, GOF_AL, GOF_TX, GOF_CA, AL_ONSH, AL_OFST, AL_OFFD, LA_ONSH, LA_OFST, LA_OFFD, AL_ONSH2, AL_OFST2, AL_ADJ)
- State-level supply prices (SPIM, SPWH)
- State/sub-state-level natural gas production and other supply/storage data (ADW, NAW, TGD, TGW, MISC_ST, MISC_GAS, MISC_OIL, SMKT_PRD, SDRY_PRD, SIMP, SNET_WTH, SUPPLM)
- State-level consumption levels (SBAL_ITM, SEXP, SQPF, SQLP, SQRS, SQCM, SQIN, SQEU, SQTR)
- State-level end-use prices (SPEX, SPRS, SPCM, SPIN, SPEU, SPTR)
- Miscellaneous (GDP_B87, OGHHPRNG)

Monthly Historical Values

- State-level natural gas production data (MONMKT_PRD)
- Import/export volumes and prices by source (MON_QIMP, MON_PIMP, MON_QEXP, MON_PEXP, HQIMP)
- Storage data (NWITH_TOT, NINJ_TOT, HNETWTH, HNETINJ)
- State-level consumption and prices (CON & PRC -- QRS, QCM, QIN, QEU, PRS, PCM, PIN, PEU)
- Electric power gas consumption and prices (CON_ELCD, PRC_EPMCD, CON_EPMGR, PRC_EPMGR)
- Miscellaneous monthly/seasonal data (NQPF_TOT, NSUPLM_TOT, WHP_LHIS, QLP_LHIS, HCGPR)

Alaskan, Canadian, & Mexican Demand/Supply Variables

- Alaskan lease, plant, and pipeline fuel parameters (AK_PCTPLT, AK_PCTPIP, AK_PCTLSE)
- Alaskan consumption parameters (AK_QIND_S, AK_RN, AK_CM, AK_POP, AK_HDD, HI_RN)
- Alaskan pricing parameters (AK_RM, AK_CM, AK_IN, AK_EM)
- Canadian production and end-use consumption (CN_FIXSUP, CN_DMD, PKSHR_PROD, PKSHR_CDMD)
- Exogenously specified Canadian import/export related volumes (CANEXP, Q23TO3, FLO_THRU_IN)
- Historical western Canadian production and wellhead prices (HQSUP, HPSUP)
- Unconventional western Canadian production parameters (ULTRES, ULTSHL, RESBASE, PKIYR, LSTYRO, PERRES, RESTECH, TECHGRW)
- Mexican production, LNG imports, and end-use consumption (PEMEX_GFAC, IND_GFAC, ELE_GFAC, RC_GFAC, PRD_GFAC, MEXLNG)

Supply Inputs

- Liquefied natural gas supply curves and pricing (LNGCAP, PARM_LNGCRV3, PARM_LNGCRV5, PARM_LNGELAS, LNGPPT, LNGOPT, LNGMIN, PERQ, BETA, LNGTAR)
- Supply curve parameters (SUPCRV, PARM_MINPR, PARM_SUPCRV3, PARM_SUPCRV5, PARM_SUPELAS, MAXPRRFAC, MAXPRRNG, PARM_MINPR)
- Synthetic natural gas projection (SNGCOAL, SNGLIQ, NRCI_INV, NRCI_LABOR, NRCI_OPER, INFL_RT, FEDTAX_RT, STAX_RT, INS_FAC, TAX_FAC, MAINT_FAC, OTH_FAC, BEQ_OPRAVG, BEQ_OPRHRSK, EMRP_OPRAVG, EMRP_OPRHRSK, EQUITY_OPRAVG, EQUITY_OPRHRSK, BEQ_BLDVAVG, BEQ_BLDHRSK, EMRP_BLDVAVG, EMRP_BLDHRSK, EQUITY_BLDVAVG, EQUITY_BLDHRSK, BA_PREM, PCLADJ, CTG_CAPYR\$, PRJSDCOM, CTG_BLDYRS, CTG_PRJLIFE, CTG_OSBLFAC, CTG_PCTENV, CTG_PCTCNTG, CTG_PCTLND, CTG_PCTSPECL, CTG_PCTWC, CTG_STAFF_LCFAC, CTG_OH_LCFAC, CTG_FSIYR, CTG_INCBLD, CTG_DCLCAPCST, CTG_DCLOPRCST, CTG_BASHHV, CTG_BASCOL, CTG_BCLTON, CTG_BASSIZ, CTG_BASCGS, CTG_BASCGSCO2, CTG_BASCGG, CTG_BASCGGCO2, CTG_NCL, CTG_NAM, CTG_CO2, LABORLOC, CTG_PUCAP, XBM_ISBL, XBM_LABOR, CTG_BLDX, CTG_IINDX, CTG_SINVST)

Pipeline and Storage Financial and Regulatory Inputs

- Rate design specification (*AFX_PFEN, AFR_PFEN, AVR_PFEN, AFX_CMEN, AFR_CMEN, AVR_CMEN, AFX_LTDN, AFR_LTDN, AVR_LTDN, AFX_DDA, AFR_DDA, AVR_DDA, AFX_FSIT, AFR_FSIT, AVR_FSIT, AFX_DIT, AFR_DIT, AVR_DIT, AFX_OTTAX, AFR_OTTAX, AVR_OTTAX, AFX_TOM, AFR_TOM, AVR_TOM*)
- Pipeline rate base, cost, and volume parameters (*D_TOM, D_DDA, D_OTTAX, D_DIT, D_GPIS, D_ADDA, D_NPIS, D_CWC, D_ADIT, D_APRB, D_GPFES, D_GCMES, D_GLTDS, D_PFER, D_CMER, D_LTDR*)
- Storage rate base, cost, and volume parameters (*D_TOM, D_DDA, D_ADDA, D_OTTAX, D_FSIT, D_DIT, D_LTDN, D_PFEN, D_CMEN, D_GPIS, D_NPIS, D_CWC, D_ADIT, D_APRB, D_LTDS, D_PFES, D_CMES, D_TCAP, D_WCAP*)
- Pipeline and storage revenue requirement forecasting equation parameters (*Table F3*)
- Rate of return set for generic pipeline companies (*MC_RMPUAANS, ADJ_PFER, ADJ_CMER, ADJ_LTDR*)
- Rate of return set for existing and new storage capacity (*MC_RMPUAANS, ADJ_STPFER, ADJ_STCMER, ADJ_STLTDR*)
- Federal and State income tax rates (*FRATE, SRATE*)
- Depreciation schedule (*30 year life*)
- Pipeline capacity expansion cost parameter for capital cost equations (*AVGCOST*)
- Pipeline capacity replacement cost parameter (*PCNT_R*)
- Storage capacity expansion cost parameters for capital cost equations (*STCCOST_CREG, STCCOST_BETAREG, STCSTFAC*)
- Parameters for interstate pipeline transportation rates (*PKSHR_YR, PTPKUTZ, PTOPUTZ, ALPHA_PIPE, ALPHA2_PIPE*)
- Canadian pipeline and storage tariff parameters (*ARC_FIXTAR, ARC_VARTAR, CN_FIXSHR*)
- Parameters for storage rates (*STRATIO, STCAP_ADJ, PTSTUTZ, ADJ_STR, STR_EFF, ALPHA_STR, ALPHA2_STR*)
- Parameters for Alaska-to-Alberta and MacKenzie Delta-to-Alberta pipelines (*FR_CAPITL0, FR_CAPYR, FR_PCNSYR, FR_DISCRT, FR_PVOL, INVEST_YR, FR_ROR_PREM, FR_TOM0, FR_DEBTRATIO, FR_TXR, FR_OTXR, FR_ESTNYR, FR_AVGTARYR*)

Pipeline and Storage Capacity and Utilization Related Inputs

- Canadian natural gas pipeline capacity and planned capacity additions (*ACTPCAP, PTACTPCAP, PLANPCAP, CNPER_YROPEN*)
- Maximum peak and off-peak primary and secondary pipeline utilizations (*PKUTZ, OPUTZ, SUTZ, MAXUTZ, XBLD*)
- Interregional planned pipeline capacity additions along primary and secondary arcs (*PLANPCAP, SPLANPCAP, PER_YROPEN*)
- Maximum storage utilization (*PKUTZ*)
- Existing storage capacity and planned additions (*PLANPCAP, ADDYR*)
- Net storage withdrawals (peak) and injections (off-peak) in Canada (*HNETWTH, HNETINJ*)
- Historical flow data (*HPKSHR_FLOW, HAFLOW, SAFLOW*)
- Alaska-to-Alberta and MacKenzie Delta-to-Alberta pipeline (*FR_PMINYR, FR_PVOL, FR_PCNSYR, FR_PPLNYR, FR_PEXPFAC, FR_PADDTAR, FR_PMINWPR, FR_PRISK, FR_PDRPFAC, FR_PTREAT, FR_PFUEL*)

End-Use Pricing Inputs

- Residential, commercial, industrial, and electric generator distributor tariffs (*OPTIND, OPTCOM, OPTRES, OPTELP, OPTELO, RECS_ALIGN, NUM_REGSHR, HHDD*)
- Intrastate and intraregional tariffs (*INTRAST_TAR, INTRAREG_TAR*)
- Historical city gate prices (*HCGPR*)

- State and Federal taxes, costs to dispense, and other compressed natural gas pricing and infrastructure development parameters (*STAX, FTAX, RETAIL_COST, NSTAT, TRN_DECL, MAX_CNG_BUILD, CNG_HRZ, CNG_WACC, CNG_BUILD_COST*)

Miscellaneous

- Network processing control variables (*MAXCYCLE, NOBLDYR, ALPHAFAC, GAMMAFAC, PSUP_DELTA, QSUP_DELTA, QSUP_SMALL, QSUP_WT, PCT_FLO, SHR_OPT, PCTADJSHR*)
- Miscellaneous control variables (*PKOPMON, NGDGBRPT, SHR_OPT, NOBLDYR*)
- STEO input data (*STEOYRS, STQGPTR, STQLPIN, STOGWPRNG, STPNGRS, STPNGIN, STPNGCM, STPNGEL, STOGPRSUP, NNETWITH, STDISCR, STENDCON, STSCAL_CAN, STINPUT_SCAL, STSCAL_PFUEL, STSCAL_LPLT, STSCAL_WPR, STSCAL_DISCR, STSCAL_SUPLM, STSCAL_NETSTR, STSCAL_FPR, STSCAL_IPR, STPHAS_YR, STLNGIMP*)

Model Outputs

Once a set of solution values are determined within the NGTDM, those values required by other modules of NEMS are passed accordingly. In addition, the NGTDM module results are presented in a series of internal and external reports, as outlined below.

Outputs to NEMS Modules

The NGTDM passes its solution values to different NEMS modules as follows:

- Pipeline fuel consumption and lease and plant fuel consumption by Census Division (to NEMS PROPER and REPORTS)
- Natural gas wellhead prices by Oil and Gas Supply Module region (to NEMS REPORTS, Oil and Gas Supply Module, and Petroleum Market Module)
- Core and noncore natural gas prices by sector and Census Division (to NEMS PROPER and REPORTS, and NEMS demand modules)
- Fraction of retail fueling stations that sell compressed natural gas (to Transportation Sector Module)
- Dry natural gas production and supplemental gas supplies by Oil and Gas Supply Module region (NEMS REPORTS and Oil and Gas Supply Module)
- Peak/off-peak, core/ noncore natural gas prices to electric generators by NGTDM/Electricity Market Module region (to NEMS PROPER and REPORTS and Electricity Market Module)
- Coal consumed, electricity generated, and CO₂ produced in the process of converting coal into pipeline quality synthetic gas in newly constructed plants (to Coal Market Module, Electricity Market Module, and NEMS PROPER)
- Dry natural gas production by PADD region (to Petroleum Market Module)
- Nonassociated dry natural gas production by NGTDM/Oil and Gas Supply Module region (to NEMS REPORTS and Oil and Gas Supply Module)
- Canadian natural gas wellhead price and production (to Oil and Gas Supply Module)
- Natural gas imports, exports, and associated prices by border crossing (to NEMS REPORTS and Oil and Gas Supply Module)

Internal Reports

The NGTDM produces reports designed to assist in the analysis of NGTDM model results. These reports are controlled with a user-defined variable (NGDBG RPT), include the following information, and are written to the indicated output file:

- Primary peak and off-peak flows, shares, and maximum constraints going into each node (NGOBAL)
- Historical and forecast values historically based factors applied in the module (NGOBENCH)
- Intermediate results from the Distributor Tariff Submodule (NGODTM)
- Intermediate results from the Pipeline Tariff Submodule (NGOPTM)
- Convergence tracking and error message report (NGOERR)
- Aggregate/average historical values for most model elements (NGOHIST)
- Node and arc level prices and quantities along the network by cycle (NGOTREE)

External Reports

In addition to the reports described above, the NGTDM produces external reports to support recurring publications. These reports contain the following information:

- Natural gas end-use prices and consumption levels by end-use sector, type of service (core and noncore), and Census Division (and for the United States)
- Natural gas used to in a gas-to-liquids conversion process in Alaska
- Natural gas wellhead prices and production levels by NGTDM region (and the average for the lower 48 States), including a price for the Henry Hub
- Natural gas end-use and city gate prices and margins
- Natural gas import and export volumes and import prices by source or destination
- Pipeline fuel consumption by NGTDM region (and for the United States)
- Natural gas pipeline capacity (entering and exiting a region) by NGTDM region and by Census Division
- Natural gas flows (entering and exiting a region) by NGTDM region and Census Division
- Natural gas pipeline capacity between NGTDM regions
- Natural gas flows between NGTDM regions
- Natural gas underground storage and pipeline capacity by NGTDM region
- Unaccounted for natural gas⁹²

⁹²Unaccounted for natural gas is a balancing item between the amount of natural gas consumed and the amount supplied. It includes reporting discrepancies, net storage withdrawals (in historical years), and differences due to convergence tolerance levels.

Appendix A. NGTDM Model Abstract

Model Name: Natural Gas Transmission and Distribution Module

Acronym: NGTDM

Title: Natural Gas Transmission and Distribution Module

Purpose: The NGTDM is the component of the National Energy Modeling System (NEMS) that represents the mid-term natural gas market. The purpose of the NGTDM is to derive natural gas supply and end-use prices and flow patterns for movements of natural gas through the regional interstate network. The prices and flow patterns are derived by obtaining a market equilibrium across the three main components of the natural gas market: the supply component, the demand component, and the transmission and distribution network that links them.

Status: ACTIVE

Use: BASIC

Sponsor:

- Office: Integrated Analysis and Forecasting
- Division: Oil and Gas Division, EI-83
- Model Contact: Joe Benneche
- Telephone: (202) 586-6132

Documentation: Energy Information Administration, *Model Documentation of the Natural Gas Transmission and Distribution Module (NGTDM) of the National Energy Modeling System (NEMS)*, DOE/EIA-M062 (Washington, DC, June 2010).

Previous Documentation: Energy Information Administration, *Model Documentation of the Natural Gas Transmission and Distribution Module (NGTDM) of the National Energy Modeling System (NEMS)*, DOE/EIA-M062 (Washington, DC, June 2009).

Energy Information Administration, *Model Documentation of the Natural Gas Transmission and Distribution Module (NGTDM) of the National Energy Modeling System (NEMS)*, DOE/EIA-M062 (Washington, DC, January 2009).

Energy Information Administration, *Model Documentation of the Natural Gas Transmission and Distribution Module (NGTDM) of the National Energy Modeling System (NEMS)*, DOE/EIA-M062 (Washington, DC, October 2007).

Energy Information Administration, *Model Documentation of the Natural Gas Transmission and Distribution Module (NGTDM) of the National Energy Modeling System (NEMS)*, DOE/EIA-M062 (Washington, DC, August 2006).

Energy Information Administration, *Model Documentation of the Natural Gas Transmission and Distribution Module (NGTDM) of the National Energy Modeling System (NEMS)*, DOE/EIA-M062 (Washington, DC, May 2005).

Energy Information Administration, *Model Documentation of the Natural Gas Transmission and Distribution Module (NGTDM) of the National Energy Modeling System (NEMS)*, DOE/EIA-M062 (Washington, DC, March 2004)

Energy Information Administration, *Model Documentation of the Natural Gas Transmission and Distribution Module (NGTDM) of the National Energy Modeling System (NEMS)*, DOE/EIA-M062 (Washington, DC, May 2003)

Energy Information Administration, *Model Documentation of the Natural Gas Transmission and Distribution Module (NGTDM) of the National Energy Modeling System (NEMS)*, DOE/EIA-M062 (Washington, DC, January 2002).

Energy Information Administration, *Model Documentation of the Natural Gas Transmission and Distribution Model (NGTDM) of the National Energy Modeling System (NEMS)*, DOE/EIA-M062 (Washington, DC, January 2001).

Energy Information Administration, *Model Documentation of the Natural Gas Transmission and Distribution Model (NGTDM) of the National Energy Modeling System (NEMS)*, DOE/EIA-M062 (Washington, DC, January 2000).

Energy Information Administration, *Model Documentation of the Natural Gas Transmission and Distribution Model (NGTDM) of the National Energy Modeling System (NEMS)*, DOE/EIA-M062 (Washington, DC, February 1999).

Energy Information Administration, *Model Documentation of the Natural Gas Transmission and Distribution Model (NGTDM) of the National Energy Modeling System (NEMS)*, DOE/EIA-M062/1 (Washington, DC, December 1997).

Energy Information Administration, *Model Documentation of the Natural Gas Transmission and Distribution Model (NGTDM) of the National Energy Modeling System (NEMS)*, DOE/EIA-M062/1 (Washington, DC, December 1996).

Energy Information Administration, *Model Documentation of the Natural Gas Transmission and Distribution Model (NGTDM) of the National Energy Modeling System (NEMS)*, DOE/EIA-M062/1 (Washington, DC, December 1995).

Energy Information Administration, *Model Documentation, Natural Gas Transmission and Distribution Model (NGTDM) of the National Energy Modeling System, Volume II: Model Developer's Report*, DOE/EIA-M062/2 (Washington, DC, January 1995).

Energy Information Administration, *Model Documentation of the Natural Gas Transmission and Distribution Model (NGTDM) of the National Energy Modeling System (NEMS)*, DOE/EIA-M062/1 (Washington, DC, February 1995).

Energy Information Administration, *Model Documentation of the Natural Gas Transmission and Distribution Model (NGTDM) of the National Energy Modeling System (NEMS)*, DOE/EIA-M062/1 (Washington, DC, February 1994).

Reviews

Conducted: Paul R. Carpenter, PhD, The Brattle Group. "Draft Review of Final Design Proposal Seasonal/North American Natural Gas Transmission Model." Cambridge, MA, August 15, 1996.

Paul R. Carpenter, PhD, Incentives Research, Inc. "Review of the *Component Design Report Natural Gas Annual Flow Module (AFM) for the Natural Gas Transmission and Distribution Model (NGTDM) of the National Energy Modeling System (NEMS)*." Boston, MA, Aug 25, 1992.

Paul R. Carpenter, PhD, Incentives Research, Inc. "Review of the *Component Design Report Capacity Expansion Module (CEM) for the Natural Gas Transmission and Distribution Model (NGTDM) of the National Energy Modeling System (NEMS)*." Boston, MA, Apr 30, 1993.

Paul R. Carpenter, PhD, Incentives Research, Inc. "Review of the *Component Design Report Pipeline Tariff Module (PTM) for the Natural Gas Transmission and Distribution Model (NGTDM) of the National Energy Modeling System (NEMS)*." Boston, MA, Apr 30, 1993.

Paul R. Carpenter, PhD, Incentives Research, Inc. "Review of the *Component Design Report Distributor Tariff Module (DTM) for the Natural*

Gas Transmission and Distribution Model (NGTDM) of the National Energy Modeling System (NEMS).” Boston, MA, Apr 30, 1993.

Paul R. Carpenter, PhD, Incentives Research, Inc. “Final Review of the National Energy Modeling System (NEMS) Natural Gas Transmission and Distribution Model (NGTDM).” Boston, MA, Jan 4, 1995.

Archival: The NGTDM is archived as a component of the NEMS on compact disc storage compatible with the PC multiprocessor computing platform upon completion of the NEMS production runs to generate the *Annual Energy Outlook 2009*, DOE/EIA-0383(2009). The archive package can be downloaded from <ftp://ftp.eia.doe.gov/pub/oiaf/aeo>.

Energy System

Covered: The NGTDM models the U.S. natural gas transmission and distribution network that links the suppliers (including importers) and consumers of natural gas, and in so doing determines the regional market clearing natural gas end-use and supply (including border) prices.

Coverage: Geographic: Demand regions are the 12 NGTDM regions, which are based on the nine Census Divisions with Census Division 5 split further into South Atlantic and Florida, Census Division 8 split further into Mountain and Arizona/New Mexico, and Census Division 9 split further into California and Pacific with Alaska and Hawaii handled separately. Production is represented in the lower 48 at 17 onshore and 3 offshore regions. Import/export border crossings include three at the Mexican border, seven at the Canadian border, and 12 liquefied natural gas import terminals. In a separate component, potential liquefied natural gas production and liquefaction for U.S. import is represented for 14 international ports. A simplified Canadian representation is subdivided into an eastern and western region, with potential LNG import facilities on both shores. Consumption, production, and LNG imports to serve the Mexico gas market are largely assumption based and serve to set the level of exports to Mexico from the United States.

Time Unit/Frequency: Annually through 2030, including a peak (December through March) and off-peak forecast.

Product(s): Natural gas

Economic Sector(s): Residential, commercial, industrial, electric generators and transportation

Data Input Sources:

- (Non-DOE)**
- The Safe, Accountable, Flexible, Efficient Transportation Equity Act: A Legacy for Users (SAFETEA-LU), Section 1113.
— Federal vehicle natural gas (VNG) taxes
 - Canadian Association of Petroleum Producers Statistical Handbook

- Historical Canadian supply and consumption data
- Mineral Management Service, Federal Offshore Statistics 1995.
 - Alabama and Louisiana state and federal offshore production before 1990
- Mineral Management Service.
 - Revenues and volumes for offshore production in Texas, California, and Louisiana
- Foster Pipeline and Storage Financial Cost Data
 - pipeline and storage financial data
- State of Alaska Historical and Projected Oil and Gas Consumption, Alaska Department of Natural Resources
 - North slope end-use consumption by sector
- Data Resources Inc., U.S. Quarterly Model
 - Various macroeconomic data
- *Oil and Gas Journal*, “Pipeline Economics”
 - Pipeline annual capitalization and operating revenues
- Board of Governors of the Federal Reserve System Statistical Release, “Selected Interest Rates and Bond Prices”
 - Real average yield on 10 year U.S. government bonds
- National Energy Board, “Canada’s Energy Future: Scenarios for Supply and Demand to 2025,” 2003.
 - Partial basis for setting offshore production projections for Canada and for resource assumptions
- Hart Energy Network’s Motor Fuels Information Center at www.hartenergynetwork.com/motorfuels/state/doc/glance/glnctax.htm
 - compressed natural gas vehicle taxes by state
- National Oceanic and Atmospheric Association
 - State level heating degree days
- U.S. Census
 - State level population data for heating degree day weights
- Natural Gas Week
 - Canada storage withdrawal and capacity data
- PEMEX Prospective de Gas Natural
 - Historical Mexico raw gas production by region
- Informes y Publicaciones, Anuario Estadísticas, Estadísticas Operativas, Producción de gas natural
 - Historical Mexico raw gas production by region
- Sener Prospectiva del Mercado de gas natural 2006-2015
 - Mexico LNG import projections

Data Input Sources:

(DOE) Forms and/or Publications:

- U.S. Crude Oil, Natural Gas, and Natural Gas Liquids Reserves, DOE/EIA-0216.
 - Annual estimate of gas production for associated-dissolved and nonassociated categories by State/sub-state.
- Natural Gas Annual, DOE/EIA-0131.

- By state -- natural gas consumption by sector, dry production, imports, exports, storage injections and withdrawals, balancing item, state transfers, number of residential customers, fraction of industrial market represented by historical prices, and wellhead, city gate, and end-use prices.
- Supplemental supplies
- Natural Gas Monthly, DOE/EIA-0130.
 - By month and state – natural gas consumption by sector, marketed production, net storage withdrawals, end-use prices by sector, city gate prices
 - By month – quantity and price of imports and exports by country, wellhead prices, lease and plant consumption, pipeline consumption, supplemental supplies
- Electric Power Monthly, DOE/EIA-0226.
 - Monthly volume and price paid for natural gas by electric generators
- *Annual Energy Review*, DOE/EIA-0384
 - Gross domestic product and implicit price deflator
- EIA-846, “Manufacturing Energy Consumption Survey”
 - Base year average annual core industrial end-use prices
- *Short-Term Energy Outlook*, DOE/EIA-0131.
 - National natural gas projections for first two years beyond history
 - Historical natural gas prices at the Henry Hub
- Department of Energy, *Natural Gas Imports and Exports*, Office of Fossil Energy
 - Import and export volumes and prices by border location
- Department of Energy, *Alternate Fuel Price Report*, Office of Energy Efficiency and Renewable Energy
 - Sample of retail prices paid for compressed natural gas for vehicles.
- EIA-191, “Underground Gas Storage Report”
 - Used in part to develop working gas storage capacity data
- EIA-457, “Residential Energy Consumption Survey”
 - Number of residential natural gas customers
- International Energy Outlook, DOE/EIA-0484.
 - Projection of natural gas consumption in Canada and Mexico.
- International Energy Annual, DOE/EIA-0484.
 - Historical natural gas data on Canada and Mexico.

Models and other:

- National Energy Modeling System (NEMS)
 - Domestic supply, imports, and demand representations are provided as inputs to the NGTDM from other NEMS models

General Output Descriptions:

- Average natural gas end-use prices levels by sector and region
- Average natural gas production volumes and prices by region
- Average natural gas import volumes and prices by region and type

- Pipeline fuel consumption by region
- Lease and plant fuel consumption by region
- Lease and plant fuel consumption by region
- The flow of gas between regions by peak and off-peak period
- Pipeline capacity additions and utilization levels by arc
- Storage capacity additions by region

Related Models: NEMS (part of)

Part of Another Model: Yes, the National Energy Modeling System (NEMS).

- Model Features:**
- Model Structure: Modular; three major components: the Interstate Transmission Submodule (ITS), the Pipeline Tariff Submodule (PTS), and the Distributor Tariff Submodule (DTS).
 - ITS Integrating submodule of the NGTDM. Simulates the natural gas price determination process by bringing together all major economic and technological factors that influence regional natural gas trade in the United States. Determines natural gas production and imports, flows and prices, pipeline capacity expansion and utilization, storage capacity expansion and utilization for a simplified network representing the interstate natural gas pipeline system
 - PTS Develops parameters for setting tariffs in the ITM for transportation and storage services provided by interstate pipeline companies
 - DTS Develops markups for distribution services provided by LDC's and intrastate pipeline companies.
 - Modeling Technique:
 - ITS Heuristic algorithm, operates iteratively until supply/demand convergence is realized across the network
 - PTS Econometric estimation and accounting algorithm
 - DTSEconometric estimation
 - Canada and Mexico supplies based on a combination of estimated equations and basic assumptions.

Model Interfaces: NEMS

Computing Environment:

- Hardware Used: Personal Computer
- Operating System: UNIX simulation
- Language/Software Used: FORTRAN
- Storage Requirement: 2,700K bytes for input data storage; 1,100K bytes for source code storage; and 17,500K bytes for compiled code storage

- Estimated Run Time: Varies from NEMS iteration and from computer processor, but rarely exceeds a quarter of a second per iteration and generally is less than 5 hundredths of a second.

Status of Evaluation Efforts:

Model developer's report entitled "Natural Gas Transmission and Distribution Model, Model Developer's Report for the National Energy Modeling System," dated November 14, 1994.

Date of Last Update: November 2009.

Appendix B. References

Carpenter, Paul R., "Review of the Gas Analysis Modeling System (GAMS), Final Report of Findings and Recommendations" (Boston: Incentives Research, Inc., August 1991).

Decision Focus Incorporate, *Generalized Equilibrium Modeling: The Methodology of the SRI-GULF Energy Model* (Palo Alto, CA, May 1977).

Energy Information Administration, "Analytical Framework for a Natural Gas Transmission and Distribution Forecasting System," prepared by SAIC for the Analysis and Forecasting Branch within the Reserves and Natural Gas Division of the Office of Oil and Gas (Washington, DC, March 1991).

Energy Information Administration, Office of Integrated Analysis and Forecasting, "Component Design Report, Natural Gas Annual Flow Module for the Natural Gas Transmission and Distribution Model of the National Energy Modeling System" (Washington, DC, June 25, 1992).

Energy Information Administration, *Deliverability on the Interstate Natural Gas Pipeline System*, DOE/EIA-0618(98) (Washington, DC, May 1998).

Energy Information Administration, *Documentation of the Gas Analysis Modeling System*, DOE/EIA-M044(92) (Washington, DC, December 1991).

Energy Information Administration, Office of Integrated Analysis and Forecasting, "Component Design Report, Capacity Expansion Module for the Natural Gas Transmission and Distribution Model of the National Energy Modeling System" (Washington, DC, December 29, 1992).

Energy Information Administration, Office of Integrated Analysis and Forecasting, "Component Design Report, Distributor Tariff Module for the Natural Gas Transmission and Distribution Model of the National Energy Modeling System" (Washington, DC, January 11, 1993).

Energy Information Administration, Office of Integrated Analysis and Forecasting, "Component Design Report, Pipeline Tariff Module for the Natural Gas Transmission and Distribution Model of the National Energy Modeling System" (Washington, DC, December 29, 1992).

Energy Information Administration, "An Evaluation of Problem Formulations and Mathematical Programming Software for the Gas Market Model of NEMS," Prepared by SAIC for the Office of Integrated Analysis and Forecasting (Washington, DC, April 1992).

Energy Information Administration, *Intermediate Future Forecasting System*, DOE/EIA-0430 (Washington, DC, October 1983).

Energy Information Administration, *Model Methodology and Data Description of the Production of Onshore Lower-48 Oil and Gas Model*, DOE/EIA-M034(92) (Washington, DC, April 1992).

Energy Information Administration, *National Energy Modeling System, An Overview 1998*, DOE/EIA-0581(98) (Washington, DC, February 1998).

Energy Information Administration, *Natural Gas 1992: Issues and Trends* DOE/EIA-0560(92) (Washington, DC, March 1993).

Energy Information Administration, *Natural Gas 1994: Issues and Trends* DOE/EIA-0560(94) (Washington, DC, July 1994).

Energy Information Administration, *Natural Gas 1995: Issues and Trends* DOE/EIA-0560(95) (Washington, DC, November 1995).

Energy Information Administration, *Natural Gas 1996: Issues and Trends* DOE/EIA-0560(96) (Washington, DC, December 1996).

Energy Information Administration, Office of Integrated Analysis and Forecasting, "Requirements for a National Energy Modeling System," (Working Paper) (Washington, DC, May 1992).

Forbes, Kevin, Science Applications International Corporation, "Efficiency in the Natural Gas Industry," Task 93-095 Deliverable under Contract No. DE-AC01-92-EI21944 for Natural Gas Analysis Branch of the Energy Information Administration, January 31, 1995.

Foster's Associates Inc., *Foster financial report of 28 Major Interstate Natural Gas Pipelines, 1996*.

Gas Technology Institute, "Liquefied Natural Gas (LNG) Methodology Enhancements in NEMS," report submitted to Energy Information Administration, March 2003.

Greene, William H., *Econometric Analysis* (New York: MacMillan, 1990).

Gujarati, Damodar, *Basic Econometrics* (McGraw Hill).

Interstate Natural Gas Association of America (INGAA), "Availability, Economics & Production Potential of North American Unconventional Natural Gas Supplies," November 2008, written by ICF.

National Energy Board, *Canada's Energy Future: Scenarios for Supply and Demand to 2025*, 2003

Oil and Gas Journal, "Pipeline Economics," published annually in various editions.

Woolridge, Jeffrey M., *Introductory Econometrics: A Modern Approach*, South-Western College Publishing, 2000.

Appendix C. NEMS Model Documentation Reports

The National Energy Modeling System is documented in a series of 15 model documentation reports, most of which are updated on an annual basis. Copies of these reports are available by contacting the National Energy Information Center, 202/586-8800.

Energy Information Administration, *National Energy Modeling System Integrating Module Documentation Report*, DOE/EIA-M057.

Energy Information Administration, *Model Documentation Report: Macroeconomic Activity Module of the National Energy Modeling System*.

Energy Information Administration, *Documentation of the D.R.I. Model of the U.S. Economy*.

Energy Information Administration, *National Energy Modeling System International Energy Model Documentation Report*.

Energy Information Administration, *World Oil Refining, Logistics, and Demand Model Documentation Report*.

Energy Information Administration, *Model Documentation Report: Residential Sector Demand Module of the National Energy Modeling System*.

Energy Information Administration, *Model Documentation Report: Commercial Sector Demand Module of the National Energy Modeling System*.

Energy Information Administration, *Model Documentation Report: Industrial Sector Demand Module of the National Energy Modeling System*.

Energy Information Administration, *Model Documentation Report: Transportation Sector Demand Module of the National Energy Modeling System*.

Energy Information Administration, *Documentation of the Electricity Market Module*.

Energy Information Administration, *Documentation of the Oil and Gas Supply Module*.

Energy Information Administration, *EIA Model Documentation: Petroleum Market Module of the National Energy Modeling System*.

Energy Information Administration, *Model Documentation: Coal Market Module*.

Energy Information Administration, *Model Documentation Report: Renewable Fuels Module*.

Appendix D. Model Equations

This appendix presents the mapping of each equation (by equation number) in the documentation with the subroutine in the NGTDM code where the equation is used or referenced..

Chapter 2 Equations	
EQ. #	SUBROUTINE (or FUNCTION *)
1	NGDMD_CRVF* (core), NGDMD_CRVI* (noncore)
2-20	NGSUP_PR*
21-32	NGCAN_FXADJ
33	NGOUT_MEX
34	NGSETLNG_INGM
35-48	NGTDM_DMDALK
Chapter 4 Equations	
EQ. #	SUBROUTINE (or FUNCTION *)
48, 51	NGSET_NODEDMD, NGDOWN_TREE
49, 52	NGSET_NODECDMD
50, 53	NGSET_YEARCDMD
54, 55	NGDOWN_TREE
56	NGSET_INTRAFLO
57	NGSET_INTRAFLO
58	NGSHR_CALC
59	NGDOWN_TREE
60	NGSET_MAXFLO*
61-64	NGSET_MAXPCAP
65-69	NGSET_MAXFLO*
70-72	NGSET_ACTPCAP
73-74	NGSHR_MTHCHK
75-78	NGSET_SUPPR

79-80	NGSTEO_BENCHWPR
81	NGSTEO_BENCHWPR
84-83	NGSET_ARCFEE
84-87	NGUP_TREE
88	NGSET_STORPR
85-90	NGUP_TREE
91	NGCHK_CONVNG
92	NGSET_SECPR
93	NGSET_BENCH, HNGSET_CGPR
94-99	NGSET_SECPR
Chapter 5 Equations	
EQ. #	SUBROUTINE (or FUNCTION *)
100-110	NGDTM_FORECAST_DTARF
111-112	NGDTM_FORECAST_TRNF
113-118	NGTDM_CNGBUILD
Chapter 6 Equations	
EQ. #	SUBROUTINE (or FUNCTION *)
119-124, 128-146, 195-197	NGPREAD
125-127, 147-148	NGPIPREAD
168-186, 198, 200-213	NGPSET_PLCOS_COMPONENTS
149-158, 164, 199, 214-223, 230	NGPSET_PLINE_COSTS
159-163, 224-229, 230-235	NGPIPE_VARTAR*
243-245	NGSTREAD
236-242, 246-248, 252-279	NGPSET_STCOS_COMPONENTS
249-251	NGPST_DEVCONST
165-167, 280-284	X1NGSTR_VARTAR*
187-194	(accounting relationships, not part of code)
285-297	NGFRPIPE_TAR*

Appendix E. Model Input Variable Mapped to Data Input Files

This appendix provides a list of the FORTRAN variables, and their associated input files, that are assigned values through FORTRAN READ statements in the source code of the NGTDM. Information about all of these variables and their assigned values (including sources, derivations, units, and definitions) are provided in the indicated input files of the NGTDM. The data file names and versions used for the *AEO2010* are identified below. These files are located on the EIA NEMS-F8 NT server. Electronic copies of these input files are available as part of the NEMS2010 archive package. The archive package can be downloaded from <ftp://ftp.eia.doe.gov/pub/oiaf/aeo>. In addition, the files are available upon request from Joe Benneche at (202) 586-6132 or Joseph.Benneche@eia.doe.gov.

ngcan.txt	V1.68	nghismn.txt	V1.30	ngptar.txt	V1.26
ngcap.txt	V1.32	nglngdat.txt	V1.79	nguser.txt	V1.150
ngdtar.txt	V1.38	ngmap.txt	V1.7		
nghisan.txt	V1.35	ngmisc.txt	V1.155		

Variable	File	Variable	File
ACTPCAP	NGCAN	AL_ONSH2	NGHISAN
ACTPCAP	NGCAP	ALB_TO_L48	NGMISC
ADDYR	NGCAP	NLNGA	NGLNGDAT
ADIT_C	NGPTAR	NLNGB	NGLNGDAT
ADJ_PIP	NGPTAR	ALPHAFAC	NGUSER
ADJ_STR	NGPTAR	ALPHA2_PIPE	NGPTAR
ADW	NGHISAN	ALPHA2_STR	NGPTAR
AFR_CMEN	NGPTAR	ALPHA_PIPE	NGPTAR
AFR_DDA	NGPTAR	ALPHA_STR	NGPTAR
AFR_DIT	NGPTAR	AMAP	NGMAP
AFR_FSIT	NGPTAR	ARC_2NODE	NGMAP
AFR_LTDN	NGPTAR	ARC_FIXTAR	NGCAN
AFR_OTTAX	NGPTAR	ARC_LOOP	NGMAP
AFR_PFEN	NGPTAR	ARC_VARTAR	NGCAN
AFR_TOM	NGPTAR	AVG_CAPCOST	NGPTAR
AFX_CMEN	NGPTAR	AVR_CMEN	NGPTAR
AFX_DDA	NGPTAR	AVR_DDA	NGPTAR
AFX_DIT	NGPTAR	AVR_DIT	NGPTAR
AFX_FSIT	NGPTAR	AVR_FSIT	NGPTAR
AFX_LTDN	NGPTAR	AVR_LTDN	NGPTAR
AFX_OTTAX	NGPTAR	AVR_OTTAX	NGPTAR
AFX_PFEN	NGPTAR	AVR_PFEN	NGPTAR
AFX_TOM	NGPTAR	AVR_TOM	NGPTAR
AK_C	NGMISC	BAJA_CAP	NGMISC
AK_CM	NGMISC	BAJA_FIX	NGMISC
AK_CN	NGMISC	BAJA_LAG	NGMISC
AK_D	NGMISC	BAJA_MAX	NGMISC
AK_E	NGMISC	BAJA_PRC	NGMISC
AK_EM	NGMISC	BAJA_STEP	NGMISC
AK_ENDCONS_N	NGMISC	BAJA_STAGE	NGMISC
AK_F	NGMISC	BA_PREM	NGMISC
AK_G	NGMISC	BEQ_BLD AVG	NGMISC
AK_IN	NGMISC	BEQ_BLDHRSK	NGMISC
AK_HDD	NGMISC	BEQ_OPRHRSK	NGMISC
AK_PCTLSE	NGMISC	BEQ_OPRAVG	NGMISC
AK_PCTPIP	NGMISC	BNEWCAP_PRE2003	NGPTAR
AK_PCTPLT	NGMISC	BNEWCAP_2003_2004	NGPTAR
AK_POP	NGMISC	BNEWCAP_POST2004	NGPTAR
AK_QIND_S	NGMISC	BTU	NGLNGDAT
AK_RM	NGMISC	CANEXP	NGCAN
AK_RN	NGMISC	CAN_XMAPCN	NGMAP
AKPIP1	NGMISC	CAN_XMAPUS	NGMAP
AKPIP2	NGMISC	CM_ADJ	NGDTAR
AL_ADJ	NGHISAN	CM_ALP	NGDTAR
AL_FYR	NGHISAN	CM_LNQ	NGDTAR
AL_LYR	NGHISAN	CM_PKALP	NGDTAR
AL_OFFD	NGHISAN	CM_RHO	NGDTAR
AL_OFST	NGHISAN	CNCAPSW	NGUSER
AL_OFST2	NGHISAN	CNG_BUILDCOST	NGDTAR
AL_ONSH	NGHISAN	CNG_HRZ	NGDTAR

Variable	File	Variable	File
CNG_MARKUP	NGDTAR	D_ADIT	NGPTAR
CNG_RETAIL_MARKUP	NGDTAR	D_APRB	NGPTAR
CNG_WACC	NGDTAR	D_CMEN	NGPTAR
CNPER_YROPEN	NGCAP	D_CMER	NGPTAR
CN_DMD	NGCAN	D_CMES	NGPTAR
CN_FIXSHR	NGCAN	D_CWC	NGPTAR
CN_FIXSUP	NGCAN	D_CONST	NGPTAR
CN_UNPRC	NGCAN	D_DDA	NGPTAR
CNPLANYR	NGCAN	D_DIT	NGPTAR
CON	NGHISMN	D_FLO	NGPTAR
CON_ELCD	NGHISMN	D_FSIT	NGPTAR
CON_EPMGR	NGHISMN	D_GCMES	NGPTAR
CONNOL_ELAS	NGCAN	D_GLTDS	NGPTAR
CTG_BASCGG	NGMISC	D_GPFES	NGPTAR
CTG_BASCGGCO2	NGMISC	D_GPIS	NGPTAR
CTG_BASCGS	NGMISC	D_LTDN	NGPTAR
CTG_BASCGSCO2	NGMISC	D_LTDR	NGPTAR
CTG_BASCOL	NGMISC	D_LTDS	NGPTAR
CTG_BASHHV	NGMISC	D_MXPKFLO	NGPTAR
CTG_BASSIZ	NGMISC	D_NPIS	NGPTAR
CTG_BCLTON	NGMISC	D_OTTAX	NGPTAR
CTG_BLDX	NGMISC	D_PFEN	NGPTAR
CTG_BLDYRS	NGMISC	D_PFER	NGPTAR
CTG_CAPYR\$	NGMISC	D_PFES	NGPTAR
CTG_CO2	NGMISC	D_TOM	NGPTAR
CTG_DCLCAPCST	NGMISC	DDA_C	NGPTAR
CTG_DCLOPRCST	NGMISC	DDA_NEWCAP	NGPTAR
CTG_FSTYR	NGMISC	DDA_NPIS	NGPTAR
CTG_IINDX	NGMISC	DECL_GASREQ	NGCAN
CTG_INCBLD	NGMISC	DEXP_FRMEX	NGMISC
CTG_INVLOC	NGMISC	DFAC_TOMEX	NGMISC
CTG_NAM	NGMISC	DOLS	NGLNGDAT
CTG_NCL	NGMISC	DUM_CAPCOST	NGPTAR
CTG_OH_LCFAC	NGMISC	DUM_CAP	NGPTAR
CTG_OSBLFAC	NGMISC	DUM_CAPYR	NGPTAR
CTG_PCTCNTG	NGMISC	EL_ALP	NGDTAR
CTG_PCTENV	NGMISC	EL_CNST	NGDTAR
CTG_PCTLND	NGMISC	EL_PARM	NGDTAR
CTG_PCTSPECL	NGMISC	EL_RESID	NGDTAR
CTG_PCTWC	NGMISC	EL_RHO	NGDTAR
CTG_PRJLIFE	NGMISC	ELE_GFAC	NGMISC
CTG_PUCAP	NGMISC	EMMSUB_EL	NGMAP
CTG_SINVST	NGMISC	EMMSUB_NG	NGMAP
CTG_STAFF_LCFAC	NGMISC	EMRP_BLD AVG	NGMISC
CWC_C	NGPTAR	EMRP_BLDHRSK	NGMISC
CWC_DISC	NGPTAR	EMRP_OPRHRSK	NGMISC
CWC_K	NGPTAR	EMRP_OPRAVG	NGMISC
CWC_RHO	NGPTAR	EPMYR1	NGHISMN
CWC_TOM	NGPTAR	EPMYR2	NGHISMN
D_ADDA	NGPTAR	EQGCELGR	NGMISC

Variable	File	Variable	File
EQGFELGR	NGMISC	FUTWTS	NGMISC
EQGIELGR	NGMISC	GAMMAFAC	NGUSER
EQUITY_BLDAVG	NGMISC	GOF_AL	NGHISTAN
EQUITY_BLDHRSK	NGMISC	GOF_CA	NGHISTAN
EQUITY_OPRHRSK	NGMISC	GOF_LA	NGHISTAN
EQUITY_OPRAVG	NGMISC	GOF_TX	NGHISTAN
EXP_A	NGPTAR	GDP_B87	NGMISC
EXP_B	NGPTAR	HAFLOW	NGMISC
EXP_C	NGPTAR	HCG_BENCH	NGDTAR
EXP_FRMEX	NGMISC	HCGPR	NGHISAN
FDGOM	NGHISMN	HDYWHTLAG	NGDTAR
FDIFF	NGDTAR	HELE_SHR	NGMISC
FE_CCOST	NGMISC	HFAC_GPIS	NGPTAR
FE_EXPFAC	NGMISC	HFAC_REV	NGPTAR
FE_FR_TOM	NGMISC	HHDD	NGDTAR
FE_PFUEL_FAC	NGMISC	HI_RN	NGMISC
FE_R_STTOM	NGMISC	HIND_SHR	NGMISC
FE_R_TOM	NGMISC	HNETINJ	NGCAN
FE_STCCOST	NGMISC	HNETINJ	NGHISMN
FE_STEXPAC	NGMISC	HNETWTH	NGCAN
FEDTAX_RT	NGMISC	HNETWTH	NGHISMN
FID_WA	NGMISC	HOPUTZ	NGCAP
FLO_THRU_IN	NGCAN	HPEMEX_SHR	NGMISC
FMT_ND	NGMISC	HPIMP	NGHISAN
FR_AVGTARYR	NGMISC	HPKSHR_FLOW	NGMISC
FR_BETA	NGMISC	HPKUTZ	NGCAP
FR_CAPITLO	NGMISC	HPLNG	NGHISMN
FR_CAPYR	NGMISC	HPSUP	NGCAN
FR_DEBTRATIO	NGMISC	HQIMP	NGHISAN
FR_DISCRT	NGMISC	HQLNG	NGHISMN
FR_ESTNYR	NGMISC	HQSUP	NGCAN
FR_OTXR	NGMISC	HRC_SHR	NGMISC
FR_PADDTAR	NGMISC	HW_ADJ	NGDTAR
FR_PCNSYR	NGMISC	HW_BETA0	NGDTAR
FR_PDRPFAC	NGMISC	HW_BETA1	NGDTAR
FR_PEXPFAC	NGMISC	HW_RHO	NGDTAR
FR_PFUEL	NGMISC	HYEAR	NGHIST
FR_PMINWPR	NGMISC	IEA_PRD	NGMISC
FR_PMINYR	NGMISC	IEA_CON	NGMISC
FR_PPLNYR	NGMISC	IMP_TOMEX	NGMISC
FR_PRISK	NGMISC	IND_GFAC	NGMISC
FR_PTREAT	NGMISC	INS_FAC	NGMISC
FR_PVOL	NGMISC	INTRAREG_TAR	NGDTAR
FR_ROR_PREM	NGMISC	INTRAST_TAR	NGDTAR
FR_TOM0	NGMISC	IN_ALP	NGDTAR
FR_TXR	NGMISC	IN_CNST	NGDTAR
FRATE	NGPTAR	IN_DIST	NGDTAR
FREE_YRS	NGDTAR	IN_LNQ	NGDTAR
FSRGN	NGMAP	IN_PKALP	NGDTAR
FSTYR	NGHISTAN	IN_RHO	NGDTAR

Variable	File	Variable	File
INFL_RT	NGMISC	MISC_GAS	NGHISAN
INIT_GASREQ	NGCAN	MISC_OIL	NGHISAN
JOULE	NGLNGDAT	MISC_ST	NGHISAN
LA_OFFD	NGHISAN	MONMKT_PRD	NGHISMN
LA_OFST	NGHISAN	MON_PEXP	NGHISMN
LA_ONSH	NGHISAN	MON_PIMP	NGHISMN
LABORLOC	NGMISC	MON_QEXP	NGHISMN
LCURCAP	NGMISC	MON_QIMP	NGHISMN
LEVELYRS	NGPTAR	MUFAC	NGUSER
LNGA	NGLNGDAT	NAW	NGHISAN
LNGB	NGLNGDAT	NCASE	NGLNGDAT
LNGCAP	NGLNGDAT	NELE_SHR	NGMISC
LNGCRVOPT	NGLNGDAT	NG_CENMAP	NGMAP
LNGDATA	NGMISC	NGCFEL	NGHISMN
LNGDIFF	NGMISC	NGDBGCNTL	NGUSER
LNGDIF_GULF	NGLNGDAT	NGDBGRPRT	NGUSER
LNGFIX	NGLNGDAT	NIND_SHR	NGMISC
LNGHYR	NGLNGDAT	NINJ_TOT	NGHISMN
LNGMIN	NGLNGDAT	NLNGA	NGLNGDAT
LNGPPT, TMPPPT	NGLNGDAT	NLNGB	NGLNGDAT
LNGPS	NGLNGDAT	NLNGPTS	NGLNGDAT
LNGQPT, TMPQPT	NGLNGDAT	NNETWITH	NGUSER
LNGQS	NGLNGDAT	NOBLDYR	NGUSER
LNGTAR	NGLNGDAT	NODE_2ARC	NGMAP
LNG_XMAP	NGMAP	NODE_ANGTS	NGMAP
LSTYR_MMS	NGHISAN	NODE_SNGCOAL	NGMAP
MAINT_FAC	NGMISC	NPROC	NGMAP
MAPLNG_NEW	NGMAP	NQPF_TOT	NGHISMN
MAPLNG_NG	NGMAP	NGRGN	NGMAP
MAPLNGE_W	NGLNGDAT	NPEMEX_SHR	NGMISC
MAP_NG	NGMAP	NRCI_INV	NGMISC
MAP_NRG_CRG	NGDTAR	NRCI_LABOR	NGMISC
MAP_OG	NGMAP	NRCI_OPER	NGMISC
MAP_PRDST	NGHISMN	NRC_SHR	NGMISC
MAP_STSUB	NGHISAN	NSUPLM_TOT	NGHISMN
MAX_CNG_BUILD	NGDTAR	NSTAT	NGDTAR
MAXCYCLE	NGUSER	NUM_REGSHR	NGDTAR
MAXPLNG	NGLNGDAT	NUMRS	NGDTAR
MAXPRRFAC	NGMISC	NWTH_TOT	NGHISMN
MAXPRRNG	NGMISC	NYR_MISS	NGHISAN
MAXUTZ	NGCAP	OCSMAP	NGMAP
MBAJA	NGMISC	oEL_MRKUP_BETA	NGDTAR
MDPIP1	NGMISC	oOGHHPRNG	NGMISC
MDPIP2	NGMISC	OPTIND	NGDTAR
MEXEXP_SHR	NGMISC	OPTCOM	NGDTAR
MEXIMP_SHR	NGMISC	OPTRES	NGDTAR
MEXLNG	NGMISC	OPTELP	NGDTAR
MEXLNGMIN	NGLNGDAT	OPTELO	NGDTAR
MEX_XMAP	NGMAP	OPUTZ	NGCAP
MINYR	NGPTAR	OTH_FAC	NGMISC

Variable	File	Variable	File
PARM_LNGCRV3	NGLNGDAT	QGIEL	NGMISC
PARM_LNGCRV5	NGLNGDAT	QGIELGR	NGMISC
PARM_LNGELAS	NGLNGDAT	QLP_LHIS	NGHISMN
PARM_MINPR	NGUSER	QMD_ALB	NGMISC
PARM_SUPCRV3	NGUSER	QNGEL	NGMISC
PARM_SUPCRV5	NGUSER	QNGIMP	NGLNGDAT
PARM_SUPELAS	NGUSER	QOF_AL	NGHISAN
PCLADJ	NGMISC	QOF_ALFD	NGHISAN
PCNT_R	NGPTAR	QOF_ALST	NGHISAN
PCTADJSHR	NGUSER	QOF_CA	NGHISAN
PCTFLO	NGUSER	QOF_GM	NGHISAN
PCURCAP	NGMISC	QOF_LA	NGHISAN
PEMEX_GFAC	NGMISC	QOF_LAFD	NGHISAN
PEMEX_PRD	NGMISC	QOF_LAST	NGHISAN
PERMG	NGDTAR	QOF_TX	NGHISAN
PER_YROPEN	NGCAP	QOF_MS	NGHISAN
PIPE_FACTOR	NGPTAR	QSUP_DELTA	NGUSER
PKOPMON	NGMISC	QSUP_SMALL	NGUSER
PKSHR_CDMD	NGCAN	QSUP_WT	NGUSER
PKSHR_PROD	NGCAN	RC_GFAC	NGMISC
PKUTZ	NGCAP	RCURCAP	NGMISC
PLANPCAP	NGCAN	RECS_ALIGN	NGDTAR
PLANPCAP	NGCAP	RETAIL_COST	NGDTAR
PMMMAP_NG	NGMAP	REV	NGHISMN
PNGIMP	NGLNGDAT	ROF_AL	NGHISAN
PRC_EPMCD	NGHISMN	ROF_CA	NGHISAN
PRC_EPMGR	NGHISMN	ROF_GM	NGHISAN
PRCWTS	NGMISC	ROF_LA	NGHISAN
PRCWTS2	NGMISC	ROF_MS	NGHISAN
PRD_GFAC	NGMISC	ROF_TX	NGHISAN
PRD_MLHIS	NGHISMN	RS_ADJ	NGDTAR
PRICE_AL	NGHISAN	RS_ALP	NGDTAR
PRICE_CA	NGHISAN	RS_COST	NGDTAR
PRICE_LA	NGHISAN	RS_LNQ	NGDTAR
PRICE_TX	NGHISAN	RS_PARM	NGDTAR
PRJSDECOM	NGMISC	RS_PKALP	NGDTAR
PROC_ORD	NGMAP	RS_RHO	NGDTAR
PSUP_DELTA	NGUSER	SAFLOW	NGMISC
PTCURPCAP	NGCAP	SARC_2NODE	NGMAP
PTMAXPCAP	NGCAN	SBAL_ITM	NGHISAN
PTMBYR	NGPTAR	SCEN_DIV	NGHISAN
PTMSTBYR	NGPTAR	SCH_ID	NGHISAN
PUTL_POW	NGHISAN	SCURCAP	NGMISC
PUTLFYR	NGHISAN	SDRY_PRD	NGHISAN
PUTLLYR	NGHISAN	SELE_SHR	NGMISC
Q23TO3	NGCAN	SEXP	NGHISAN
QAK_ALB	NGMISC	SHR_OPT	NGUSER
QGCELGR	NGMISC	SIMP	NGHISAN
QGFEL	NGMISC	SIM_EX	NGHISAN
QGFELGR	NGMISC	SIND_SHR	NGMISC

Variable	File	Variable	File
SITM_RG	NGHISAN	STENDCON	NGUSER
SMKT_PRD	NGHISAN	STEOYRS	NGUSER
SNET_WTH	NGHISAN	STLNGIMP	NGUSER
SNGCOAL	NGMISC	STLNGRG	NGUSER
SNGCOAL	NGHISAN	STLNGRGN	NGUSER
SNGLIQ	NGHISAN	STLNGYR	NGUSER
SNG_EM	NGHISAN	STLNGYRN	NGUSER
SNG_OG	NGHISAN	STOGPRSUP	NGUSER
SNODE_2ARC	NGMAP	STOGWPRNG	NGUSER
SNUM_ID	NGHISAN	STPHAS_YR	NGUSER
SPCM	NGHISAN	STPNGCM	NGUSER
SPCNEWFAC	NGPTAR	STPNGEL	NGUSER
SPCNODID	NGPTAR	STPNGRS	NGUSER
SPCNODN	NGPTAR	STQGPTR	NGUSER
SPCPNOBAS	NGPTAR	STQLPIN	NGUSER
SPEMEX_SHR	NGMISC	STR_2NODE	NGMAP
SPEU	NGHISAN	STR_EFF	NGPTAR
SPEX	NGHISAN	STRATIO	NGPTAR
SPIM	NGHISAN	STR_FACTOR	NGPTAR
SPIN	NGHISAN	STSCAL_CAN	NGUSER
SPIN_PER	NGHISAN	STSCAL_DISCR	NGUSER
SPLANPCAP	NGCAP	STSCAL_FPR	NGUSER
SPRS	NGHISAN	STSCAL_IPR	NGUSER
SPTR	NGHISAN	STSCAL_LPLT	NGUSER
SPWH	NGHISAN	STSCAL_NETSTR	NGUSER
SQCM	NGHISAN	STSCAL_PFUEL	NGUSER
SQEU	NGHISAN	STSCAL_SUPLM	NGUSER
SQGFELGR	NGMISC	STSCAL_WPR	NGUSER
SQGIELGR	NGMISC	STTAX_RT	NGMISC
SQIN	NGHISAN	STTOM_C	NGPTAR
SQLP	NGHISAN	STTOM_RHO	NGPTAR
SQPF	NGHISAN	STTOM_WORKCAP	NGPTAR
SQRS	NGHISAN	STTOM_YR	NGPTAR
SQTR	NGHISAN	SUPARRAY	NGMAP
SRATE	NGPTAR	SUPCRV	NGUSER
SRC_SHR	NGMISC	SUPREG	NGMAP
SSUPLM	NGHISAN	SUPSUB_NG	NGMAP
STADIT_ADIT	NGPTAR	SUPSUB_OG	NGMAP
STADIT_C	NGPTAR	SUPTYPE	NGMAP
STADIT_NEWCAP	NGPTAR	SUTZ	NGCAP
STCCOST_BETAREG	NGPTAR	TAX_FAC	NGMISC
STCCOST_CREG	NGPTAR	TFD	NGDTAR
STCSTFAC	NGPTAR	TFDYR	NGDTAR
STCWC_CREG	NGPTAR	TOM_BYEAR	NGPTAR
STCWC_RHO	NGPTAR	TOM_BYEAR_EIA	NGPTAR
STCWC_TOTCAP	NGPTAR	TOM_C	NGPTAR
STDDA_CREG	NGPTAR	TOM_DEPSHR	NGPTAR
STDDA_NEWCAP	NGPTAR	TOM_GPIS1	NGPTAR
STDDA_NPIS	NGPTAR	TOM_K	NGPTAR
STDISCR	NGUSER	TOM_RHO	NGPTAR

Variable	File	Variable	File
TOM_YR	NGPTAR	NONU_ELAS_I	NGDTAR
TRN_DECL	NGDTAR	WHP_LHIS	NGHISMN
TST1,TST2	NGDTAR	WPR4CAST_FLG	NGUSER
TST2YR	NGDTAR	XBLD	NGCAP
TTRNCAN	NGCAN	XBM_ISBL	NGMISC
UTIL_ELAS_F	NGDTAR	XBM_LABOR	NGMISC
UTIL_ELAS_I	NGDTAR	YDCL_GASREQ	NGCAN
NONU_ELAS_F	NGDTAR	YR1\$4	NGMISC

Appendix F. Derived Data

Table F1

Data: Parameter estimates for the Alaskan natural gas consumption equations for the residential and commercial sectors and the Alaskan natural gas wellhead price.

Author: Tony Radich, EIA, June 2007, reestimated by Margaret Leddy, EIA, July 2009

Source: *Natural Gas Annual*, DOE/EIA-0131.

Derivation: Annual data from 1974 through 2008 were transformed into logarithmic form, tested for unit roots, and examined for simple correlations. When originally estimated, heating degree day quantity was calculated using a five-year average, but was statistically insignificant in both the residential and commercial cases and dropped from the final estimations. Lags of dependent variables were added as needed to remove serial correlation from residuals. Heteroskedasticity-consistent standard error estimators were also used as needed.

Residential Natural Gas Consumption

The forecast equation for residential natural gas consumption is estimated below:

$$LN_CONS_RES = (6.983794*(1 - 0.364042) + (0.601932*(1 - 0.364042) *LN_RES_CUST) + (0.364042*(LN_CONS_RES(-1)*1000)))/1000.$$

where,

- LN_CONS_RES = natural log of Alaska residential natural gas consumption in MMcf
- LN_RES_CUST = natural log of thousands of Alaska residential gas customers. See the forecast equation for Alaska residential gas customers in Table F2.
- (-1) = first lag

All variables are annual from 1974 through 2008.

Regression Diagnostics and Parameters Estimates:

Dependent Variable: LN_CONS_RES

Method: Least Squares

Date: 07/03/07

Sample (adjusted): 1974 – 2008

Included observations: 35 after adjustments

Newey-West HAC Standard Errors & Covariance (lag truncation=3)

Variable	Coefficient	Std. Error	t-Statistic	Prob.
C	6.983794	0.608314	11.48058	0.0000
LN_RES_CUST	0.601932	0.136919	4.396257	0.0001
AR(-1)	0.364042	0.117856	3.088872	0.0041

R-squared	0.788754	Mean dependent var	9.486861
Adjusted R-squared	0.775552	S.D. dependent var	0.329138
S.E. of regression	0.155932	Akaike info criterion	-0.79697
Sum squared resid	0.778077	Schwarz criterion	-0.66366
Log likelihood	16.94702	Hannan-Quinn criter.	-0.75095
F-statistic	59.74123	Durbin-Watson stat	1.957789
Prob(F-statistic)	0.00000		

The equation for the Alaska residential natural gas consumption translates into the following forecast equation in the code:

$$AKQTY_F(1) = (\exp(6.983794 * (1 - 0.364042)) * (AK_RN(t))^{0.601932} * (1 - 0.364042)) * (PREV_AKQTY(1,t-1)*1000)^{0.364042}/1000.$$

where,

- AKQTY_F(1) = residential Alaskan natural gas consumption, (Bcf)
- PREV_AKQTY(1,t-1) = previous year's residential Alaskan natural gas consumption, (Bcf)
- AK_RN(t) = residential consumers (thousands) at current year. See Table F2
- AKPR_F(1) = Alaska residential natural gas prices in 1987\$ per Mcf
- PREV_AKPR(1,t-1) = previous year's Alaska residential natural gas price in 1987\$ per Mcf

Commercial Natural Gas Consumption

The forecast equation for commercial natural gas consumption is estimated below:

$$LN_CONS_COM = (9.425307*(1 - 0.736334) + (0.205020*LN_COM_CUST) + (-0.736334*0.205020)*LN_COM_CUST(-1) + (0.736344*LN_CONS_COM(-1)*1000))/1000.$$

where,

- LN_CONS_COM = natural log of Alaska commercial natural gas consumption in MMcf
- LN_COM_CUST = natural log of thousands of Alaska commercial gas customers. See the forecast equation in Table F2.
- (-1) = first lag

Regression Diagnostics and Parameters Estimates:

Dependent Variable: LN_CONS_COM
Method: Least Squares
Date: 07/22/09 Time: 09:36
Sample (adjusted): 1974 2008
Included observations: 35 after adjustments
Convergence achieved after 9 iterations
Newey-West HAC Standard Errors & Covariance (lag truncation=3)

Variable	Coefficient	Std. Error	t-Statistic	Prob.
C	9.425307	0.229458	41.07648	0.0000
LN_COM_CUST	0.205020	0.115140	1.780615	0.0845
AR(1)	0.736334	0.092185	7.987556	0.0000
R-squared	0.696834	Mean dependent var		9.885287
Adjusted R-squared	0.677886	S.D. dependent var		0.213360
S.E. of regression	0.121093	Akaike info criterion		-1.302700
Sum squared resid	0.469232	Schwarz criterion		-1.169385
Log likelihood	25.79725	Hannan-Quinn criter.		-1.256680
F-statistic	36.77630	Durbin-Watson stat		1.680652
Prob(F-statistic)	0.000000			

The equation in the code for the Alaska commercial natural gas consumption follows:

$$AKQTY_F(2) = (\exp(9.425307 * (1 - 0.736334)) * (AK_CN(t)**(0.205020)) * (AK_CN(t-1)**(-0.736334 * 0.205020)) * (PREV_AKQTY(2,t-1)*1000.))**(0.736334))/1000.$$

where,

- AKQTY_F(2) = commercial Alaskan natural gas consumption, (Bcf)
- PREV_AKQTY(2,t-1) = previous year's commercial Alaskan natural gas consumption, (Bcf)
- AK_CN(t) = commercial consumers (thousands) at current year. See Table F2

Natural Gas Wellhead Price

The forecast equation for natural gas wellhead price is determined below:

$$AK_WPRC_t = AK_F_1 + (AK_F_2 * T_2)$$

Dependent Variable: LN_WELLHEAD_PRICE
Method: Least Squares
Date: 07/22/09 Time: 13:25
Sample (adjusted): 1974 2008
Included observations: 35 after adjustments
Convergence achieved after 6 iterations

	Coefficient	Std. Error	t-Statistic	Prob.
LN_IRAC87	0.280760	0.101743	2.759499	0.0094
AR(1)	0.934077	0.040455	23.08940	0.0000
R-squared	0.881227	Mean dependent var		0.135244
Adjusted R-squared	0.877628	S.D. dependent var		0.540629
S.E. of regression	0.189122	Akaike info criterion		-0.437408
Sum squared resid	1.180310	Schwarz criterion		-0.348531
Log likelihood	9.654637	Hannan-Quinn criter.		-0.406727
Durbin-Watson stat	2.121742			

Inverted AR Roots .93

The forecast equation becomes:

$$AK_WPRC_t = AK_WPRC_{t-1}^{0.934077} * oIT_WOP_{y,1}^{(0.280760*(1-0.934077))}$$

where,

- AK_WPRC_t = average natural gas wellhead price (1987\$/Mcf) in current year.
- AK_F = Parameters for Alaskan natural gas wellhead price (Appendix E).
- oIT_WOP_{y,1} = World oil price (International Refinery Acquisition Cost) (1987\$/barrel)
- t = year index

Data used in estimating parameters in Tables F1 and F2

	(mmcf)	(mmcf)	1987\$/Mcf	1987\$/Mcf	1987\$/Mcf	Thousand		Thousand	Thousand	(2000=1)	87\$/bbl	Mbbl
	Res_Cons	Com_Con	Res_Price	Com_Price	Wellhead Price	Population	HDD, Alaska	Res_Cust	Com_Cust	GDP defl	IRAC	oil_prod
1973	5024	12277	3.61	1.79	0.34	336.4	12865	23	3	0.3185	9.38	
1974	4163	13106	3.33	1.83	0.36	348.1	12655	22	4	0.3473	26.39	
1975	10393	14415	3.14	1.87	0.58	384.1	12391	25	4	0.38	26.83	
1976	10917	14191	3	1.89	0.71	409.8	11930	28	4	0.402	24.55	
1977	11282	14564	2.93	2.29	0.68	418	12521	30	5	0.4275	24.88	
1978	12166	15208	2.82	2.11	0.83	411.6	11400	33	5	0.4576	23.31	
1979	7313	15862	2.53	1.52	0.77	413.7	11149	36	6	0.4955	32.01	
1980	7917	16513	2.34	1.44	0.99	419.8	10765	37	6	0.5404	45.9	
1981	7904	16149	2.41	1.73	0.77	434.3	11248	40	6	0.5912	45.87	587337
1982	10554	24232	2.09	1.86	0.74	464.3	11669	48	7	0.6273	39.15	618910
1983	10434	24693	2.62	2.18	0.82	499.1	10587	55	8	0.6521	32.89	625527
1984	11833	24654	2.69	2.24	0.79	524	12161	63	10	0.6766	31.25	630401
1985	13256	20344	2.95	2.48	0.78	543.9	11237	65	10	0.6971	28.34	666233
1986	12091	20874	3.34	2.6	0.51	550.7	11398	66	11	0.7125	14.38	681310
1987	12256	20224	3.21	2.41	0.94	541.3	11704	67.648	11.484	0.732	18.13	715955
1988	12529	20842	3.35	2.51	1.23	535	11116	68.612	11.649	0.7569	14.08	738143
1989	13589	21738	3.38	2.39	1.27	538.9	10884	69.54	11.806	0.7856	16.85	683979
1990	14165	21622	3.4	2.36	1.24	553.17	11101	70.808	11.921	0.8159	19.52	647309
1991	13562	20897	3.62	2.51	1.28	569.05	11582	72.565	12.071	0.8444	16.21	656349
1992	14350	21299	3.21	2.24	1.19	586.72	11846	74.268	12.204	0.8639	15.42	627322
1993	13858	20003	3.28	2.3	1.18	596.91	11281	75.842	12.359	0.8838	13.37	577495
1994	14895	20698	2.92	2.01	1.03	600.62	11902	77.67	12.475	0.9026	12.58	568951
1995	15231	24979	2.88	1.8	1.3	601.58	10427	79.474	12.584	0.9211	13.62	541654
1996	16179	27315	2.67	1.81	1.26	605.21	11498	81.348	12.732	0.9385	16.1	509999
1997	15146	26908	2.89	1.87	1.4	609.66	11165	83.596	12.945	0.9541	14.22	472949
1998	15617	27079	2.78	1.83	1	617.08	11078	86.243	13.176	0.9647	9.14	428850
1999	17634	27667	2.72	1.63	1.02	622	12227	88.924	13.409	0.9787	12.91	383199
2000	15987	26485	2.62	1.51	1.29	627.53	10908	91.297	13.711	1	20.28	355199
2001	16818	15849	3.02	2.26	1.42	632.24	12227	93.896	14.002	1.024	15.73	351411
2002	16191	15691	3.1	2.4	1.5	640.54	10908	97.077	14.342	1.0419	16.66	359335
2003	16853	17270	3.02	2.46	1.66	647.75	10174	100.4	14.502	1.064	19.06	355582
2004	18200	18373	3.26	2.77	2.29	656.83	10296	104.36	13.999	1.0946	24.01	332465
2005	18029	16903	3.71	3.19	3.08	663.25	10103	108.4	14.12	1.13	31.65	315420
2006	20616	18544	4.29	2.98	3.64	670.05	11269	112.27	14.384	1.1657	37.06	270486
2007	19843	18756	5.31	4.63	3.44	668.74	10815	115.5	13.408	1.1966	41.01	263595
2008	21440	18717.5	5.21	4.73	3.88	671.31	11640	118	13	1.225	55.44	249874

Table F2

Data: Equations for the number of residential and commercial customers in Alaska

Author: Tony Radich, EIA, June, 2007 and Margaret Leddy, July 2009.

Source: *Natural Gas Annual* (1985-2000), DOE/EIA-0131, see Table F1.

Derivation:

a. Residential customers

Since 1967, the number of residential households has increased steadily, mirroring the population growth in Alaska. Because the current year’s population is highly dependent on the previous year’s value, the number of residential consumers was estimated based on its lag values. The forecast equation is determined as follows:

$$NRS_t = -2.677 + 0.888 * NRS_{t-1} - 0.185 * NRS_{t-2} + 0.626 * POP$$

where,

- NRS = natural log of thousands of Alaska residential gas customers (AK_RN in code)
- POP = natural log of Alaska population in thousands (AK_POP in code, Appendix E)
- t = year

Regression Diagnostics and Parameters Estimates:

Dependent Variable: NRS
 Method: Least Squares
 Date: 07/03/07
 Sample (adjusted): 1969-2005
 Included observations: 37 after adjustments

Variable	Coefficient	Std. Error	t-Statistic	Prob.
C	-2.677338	0.946058	-2.829994	0.0079
NRS(-1)	0.887724	0.166407	5.334659	0.0000
NRS(-2)	-0.184504	0.141213	-1.306569	0.2004
POP	0.626436	0.201686	3.105990	0.0039
R-squared	0.995802	Mean dependent var	3.950822	
Adjusted R-squared	0.995421	S.D. dependent var	0.602330	
S.E. of regression	0.040760	Akaike info criterion	-3.460402	
Sum squared resid	0.054827	Schwarz criterion	-3.286248	
Log likelihood	68.01743	F-statistic	2609.424	
Durbin-Watson stat	1.656152	Prob(F-statistic)	0.000000	

This translates into the following forecast equation in the code:

$$AK_RN_t = \exp[-2.677 + (0.888 * \log(AK_RN_{t-1})) - (0.185 * \log(AK_RN_{t-2})) + (0.626 * \log(AK_POP_t))]$$

b. Commercial customers

The number of commercial consumers, based on billing units, also showed a strong relationship to its lag value. The forecast equation was determined using data from 1985 to 2008 as follows:

$$COM_CUST_t = 0.932946 + 0.937471 * COM_CUST_{t-1}$$

where,

COM_CUST = number of Alaska commercial gas customers, in thousands(AK_CM in the code)
t = year

Regression Diagnostics and Parameters Estimates:

Dependent Variable: COM_CUST
Method: Least Squares
07/14/09
Sample (adjusted): 1974-2008
Included observations: 35 after adjustments
Newey-West HAC Standard Errors & Covariance (lag truncation=3)

Variable	Coefficient	Std. Error	t-Statistic	Prob.
C	0.932946	0.294368	3.169323	0.0033
COM_CUST(-1)	0.937471	0.023830	39.33956	0.0000
R-squared	0.982050	Mean dependent var		10.63666
Adjusted R-squared	0.981506	S.D. dependent var		3.534514
S.E. of regression	0.480669	Akaike info criterion		1.428171
Sum squared resid	7.624424	Schwarz criterion		1.517048
Log likelihood	-22.99300	Hannan-Quinn criter.		1.458852
F-statistic	1805.422	Durbin-Watson		1.859586
Prob(F-statistic)	0.000000			

This translates into the following forecast equation in the code:

$$AK_CN_t = 0.932946 + (0.937471 * AK_CN_{t-1})$$

Table F3

Data: Coefficients for the following Pipeline Tariff Submodule forecasting equations for pipeline and storage: total cash working capital for the combined existing and new capacity; depreciation, depletion, and amortization expenses for existing capacity; accumulated deferred income taxes for the combined existing and new capacity; and total operating and maintenance expense for the combined existing and new capacity.

Author: Science Applications International Corporation (SAIC)

Source: Foster Pipeline Financial Data, 1997-2006
Foster Storage Financial Data, 1990-1998

Variables:

For Transportation:

- R_CWC = total pipeline transmission cash working capital for existing and new capacity (2000 real dollars)
- DDA_E = annual depreciation, depletion, and amortization costs for existing capacity (nominal dollars)
- NPIS_E = net plant in service for existing capacity in dollars (nominal dollars)
- NEWCAP_E = change in existing gross plant in service (nominal dollars) between t and t-1 (set to zero during the forecast year phase since $GPIS_{E_{a,t}} = GPIS_{E_{a,t+1}}$ for year $t \geq 2007$)
- ADIT = accumulated deferred income taxes (nominal dollars)
- NEWCAP = change in gross plant in service between t and t-1 (nominal dollars)
- R_TOM = total operating and maintenance cost for existing and new capacity (2000 real dollars)
- GPIS = capital cost of plant in service for existing and new capacity (nominal dollars)
- DEPSHR = level of the accumulated depreciation of the plant relative to the gross plant in service for existing and new capacity at the beginning of year t. This variable is a proxy for the age of the capital stock.
- TECHYEAR = MODYEAR (time trend in Julian units, the minimum value of this variable in the sample being 1997, otherwise TECHYEAR=0 if less than 1997)
- a = arc
- t = forecast year

For Storage:

- R_STCWC = total cash working capital at the beginning of year t for existing and new capacity (1996 real dollars)
- DSTTCAP = total gas storage capacity (Bcf)
- STDDA_E = annual depreciation, depletion, and amortization costs for existing capacity (nominal dollars)

STNPIS_E = net plant in service for existing capacity (nominal dollars)
 STNEWCAP = change in gross plant in service for existing capacity (nominal dollars)
 STADIT = accumulated deferred income taxes (nominal dollars)
 NEWCAP = change in gross plant in service for the combined existing and new capacity between years t and t-1 (nominal dollars)
 R_STTOM = total operating and maintenance cost for existing and new capacity (1996 real dollars)
 DSTWCAP = level of gas working capacity for region r during year t (Bcf)
 r = NGTDM region
 t = forecast year

References: For transportation: “Memorandum describing the estimated and forecast equations for TOM, DDA, CWC, and ADIT for the new PTM,” by SAIC, June 23-July 22, 2008.

For storage: “Memorandum describing the estimated and forecast equations for TOM, DDA, CWC, and ADIT for the new PTM,” by SAIC, May 31, 2000.

Derivation: Estimations were done by using an accounting algorithm in combination with estimation software. Projections are based on a series of econometric equations which have been estimated using the Time Series Package (TSP) software. Equations were estimated by arc for pipelines and by NGTDM region for storage, as follows: total cash working capital for the combined existing and new capacity; depreciation, depletion, and amortization expenses for existing capacity; accumulated deferred income taxes for the combined existing and new capacity; and total operating and maintenance expense for the combined existing and new capacity. These equations are defined as follows:

(1) Total Cash Working Capital for the Combined Existing and New Capacity

For Transportation:

The equation was estimated using FERC Form 2 data over the period 1997 through 2006. In this analysis, the data were aggregated to the ARC level so that the results would be more consistent with the previous model.

Because of economies in cash management, a log-linear specification between total operating and maintenance expenses, R_TOM_a , and the level of cash working capital, R_CWC_a was assumed. To control for arc specific effects, a binary variable was created for each of the arcs. The associated coefficient represents the arc specific constant term.

The underlying notion of this equation is the working capital represents funds to maintain the capital stock and is therefore driven by changes in R_TOM

The forecasting equation is presented in two stages.

Stage 1:

$$\begin{aligned} \text{Ln}(\text{R_CWC}_{a,t}) &= \text{CWC_C}_a * (1 - \rho) + \text{CWC_TOM} * \text{Ln}(\text{R_TOM}_{a,t}) + \\ &\rho * \text{Ln}(\text{R_CWC}_{a,t-1}) - \rho * \text{CWC_TOM} * \text{Ln}(\text{R_TOM}_{a,t-1}) \end{aligned}$$

Stage 2:

$$\text{R_CWC}_{a,t} = \text{CWC_K} * \exp(\text{Ln}(\text{R_CWC}_{a,t}))$$

where,

- R_CWC = total pipeline transmission cash working capital for existing and new capacity (2000 real dollars)
- CWC_C_a = estimated arc specific constant for gas transported from node to node (see Table F3.2)
- CWC_TOM = estimated R_TOM coefficient (see Table F3.2)
- R_TOM = total operation and maintenance expenses in 2000 real dollars
- CWC_K = correction factor estimated in stage 2 of the regression equation estimation process
- ρ = autocorrelation coefficient from estimation (see Table F3.2 -- CWC_RHO)

Ln is a natural logarithm operator and CWC_K is the correction factor estimated in equation two.

The results of this regression are reported below:

Dependent variable: R_CWC
Number of observations: 388

Mean of dep. var.	= 16494.6	LM het. Test	= 134.702 [.000]
Std. dev. of dep. var.	= 25325.7	Durbin-Watson	= 2.29770 [<1.00]
Sum of squared residuals	= .889658E+10	Jarque-Bera test	= 6662.16 [.000]
Variance of residuals	= .229886E+08	Ramsey's RESET2	= .935403 [.334]
Std. error of regression	= 4794.64	Schwarz B.I.C.	= 3841.43
R-squared	= .964161	Log likelihood	= -3838.45
Adjusted R-squared	= .964161		

	Estimated	Standard		
Variable	Coefficient	Error	t-statistic	P-value
CWC_K	1.0183	8.31E-03	122.485	[.000]

For Storage:

$$\begin{aligned} \text{R_STCWC}_{r,t} &= e^{(\beta_{0,r} * (1 - \rho))} * \text{DSTTCAP}_{r,t-1}^{\beta_1} * \\ &\text{R_STCWC}_{r,t-1}^{\rho} * \text{DSTTCAP}_{r,t-2}^{\rho * \beta_1} \end{aligned}$$

where,

- β_{0,a} = constant term estimated by region (see Table F3.1, β_{0,r} = REG_r)
- = STCWC_CREG (Appendix E)

$\beta_1 = 1.07386$
 $= \text{STCWC_TOTCAP (Appendix E)}$
t-statistic = (2.8)
 $\rho = 0.668332$
 $= \text{STCWC_RHO (Appendix E)}$
t-statistic = (6.8)
DW = 1.53
R-Squared = 0.99

(2) *Total Depreciation, Depletion, and Amortization for Existing Capacity*

(a) existing capacity (up to 2000 for pipeline and up to 1998 for storage)

For Transportation:

The equation was estimated using FERC Form 2 data over the period 1997 through 2006. In this analysis, the data were aggregated to the ARC level so that the results would be more consistent with the previous model.

A linear specification was chosen given that DDA_E is generally believed to be proportional to the level of net plant. The forecasting equation was estimated with a correction for first order serial correlation.

$$\text{DDA_E}_{a,t} = \text{DDA_C}_a * \text{ARC}_a + \text{DDA_NPIS} * \text{NPIS}_{a,t-1} + \text{DDA_NEWCAP} * \text{NEWCAP_E}_{a,t}$$

where,

$\text{DDA_C}_a =$ constant term estimated by arc for the binary variable ARC_a (see Table F3.3, $\text{DDA_C}_a = \text{B_ARC}_{xx_yy}$)
 $\text{ARC}_a =$ binary variable created for each arc to control for arc specific effects
 $\text{DDA_NPIS} =$ estimated coefficient (see Table F3.3)
 $\text{DDA_NEWCAP} =$ estimated coefficient (see Table F3.3)

The standard errors in Table F3.3 are computed from heteroscedastic-consistent matrix (Robust-White). The results of this regression are reported below:

Dependent variable: DDA_E
Number of observations: 388

Mean of dep. var.	= 25425.8	R-squared	= .995346
Std. dev. of dep. var.	= 33735.0	Adjusted R-squared	= .994731
Sum of squared residuals	= .231467E+10	LM het. Test	= 29.9545 [.000]
Variance of residuals	= .599656E+07	Durbin-Watson	= 2.06404 [<1.00]
Std. error of regression	= 2448.79		

For Storage:

$$\text{STDDA_E}_{r,t} = \beta_{0,r} + \beta_1 * \text{STNPIS_E}_{r,t-1} + \beta_2 * \text{STNEWCAP}_{r,t}$$

where,

$$\begin{aligned} \beta_{0,a} &= \text{constant term estimated by region (see Table F3.4, } \beta_{0,r} = \text{REG}_r) \\ &= \text{STDDA_CREG (Appendix E)} \\ \beta_1, \beta_2 &= (0.032004, 0.028197) \\ &= \text{STDDA_NPIS, STDDA_NEWCAP (Appendix E)} \\ \text{t-statistic} &= (10.3) \quad (16.9) \\ \text{DW} &= 1.62 \\ \text{R-Squared} &= 0.97 \end{aligned}$$

(b) new capacity (generic pipelines and storage)

A regression equation is not used for the new capacity; instead, an accounting algorithm is used (presented in Chapter 6).

(3) Accumulated Deferred Income Taxes for the Combined Existing and New Capacity

For Transportation:

The equation was estimated using FERC Form 2 data over the period 1997 through 2006. In this analysis, the data were aggregated to the ARC level so that the results would be more consistent with the previous model. To control for arc specific effects, a binary variable ARC_a was created for each of the arcs. The associated coefficient represents the arc specific constant term.

Because the level of deferred income taxes is a stock (and not a flow) it was hypothesized that a formulation that focused on the change in the level of accumulated deferred income taxes from the previous year, $\text{deltaADIT}_{a,t}$, would be appropriate. Specifically, a linear relationship between the change in ADIT and the change in the level of gross plant in service, $\text{NEWCAP}_{a,t}$, and the change in tax policy, POLICY_CHG , was assumed. The form of the estimating equation was:

$$\text{delta ADIT}_{a,t} = \text{ADIT_C}_a * \text{ARC}_a + \beta_1 * \text{NEWCAP}_{a,t} + \beta_2 * \text{NEWCAP}_{a,t} + \beta_3 * \text{NEWCAP}_{a,t}$$

where,

$$\begin{aligned} \text{ADIT_C}_a &= \text{constant term estimated by arc for the binary variable } \text{ARC}_a \text{ (see Table F3.5, } \text{ADIT_C}_a = \text{B_ARC}_{xx_yy}) \\ \beta_1 &= \text{BNEWCAP_PRE2003, estimated coefficient on the change in gross plant in service in the pre-2003 period because of changes in tax policy in 2003 and 2004 (Appendix F, Table F3.5). It is zero otherwise.} \\ \beta_2 &= \text{BNEWCAP_2003_2004, estimated coefficient on the change in gross plant in service for the years 2003 and 2004 because of changes in tax policy (Appendix F, Table F3.5). It is zero otherwise.} \\ \beta_3 &= \text{BNEWCAP_POST2004, estimated coefficient on the change in gross plant in service in the post-2004 period because of changes in tax policy (Appendix F, Table F3.5). It is zero otherwise.} \end{aligned}$$

The estimation results are:

Dependent variable: DELTAADIT

Number of observations: 388

Mean of dep. var.	= 6614.01	R-squared	= .464738
Std. dev. of dep. var.	= 17285.5	Adjusted R-squared	= .381652
Sum of squared residuals	= .618928E+11	LM het. test	= 3.97751 [.046]
Variance of residuals	= .184755E+09	Durbin-Watson	= 2.45034 [<1.00]
Std. error of regression	= 13592.4		

For Storage:

$$STADIT_{r,t} = \beta_0 + \beta_1 * STADIT_{r,t-1} + \beta_2 * NEWCAP_{r,t}$$

where,

$$\begin{aligned} \beta_0 &= -212.535 \\ &= STADIT_C \text{ (Appendix E)} \\ \beta_1, \beta_2 &= (0.921962, 0.212610) \\ &= STADIT_ADIT, STADIT_NEWCAP \text{ (Appendix E)} \\ \text{t-statistic} &= (58.8) \quad (8.4) \\ \text{DW} &= 1.69 \\ \text{R-Squared} &= 0.98 \end{aligned}$$

(4) Total Operating and Maintenance Expense for the Combined Existing and New Capacity

For Transportation:

The equation was estimated using FERC Form 2 data over the period 1997 through 2006. In this analysis, the data were aggregated to the ARC level so that the results would be more consistent with the previous model. To control for arc specific effects, a binary variable ARC_a was created for each of the arcs. The associated coefficient represents the arc specific constant term.

The forecasting equation is presented in two stages.

Stage 1:

$$\begin{aligned} \text{Ln}(R_TOM_{a,t}) &= TOM_C_a * ARC_a * (1 - \rho) + TOM_GPIS1 * \text{Ln}(GPIS_{a,t-1}) \\ &+ TOM_DEPSHR * DEPSHR_{a,t-1} + TOM_BYEAR * 2006 \\ &+ TOM_BYEAR_EIA * (\text{TECHYEAR} - 2006.0) + \rho * \text{Ln}(R_TOM_{a,t-1}) \\ &- \rho * (TOM_GPIS1 * \text{Ln}(GPIS_{a,t-2}) + TOM_DESHR * DEPSHR_{a,t-2}) \\ &+ TOM_BYEAR * 2006 + TOM_BYEAR_EIA * (\text{TECHYEAR} - 1 - 2006.0) \end{aligned}$$

Stage 2:

$$R_TOM_{a,t} = TOM_K * \exp(\text{Ln}(R_TOM_{a,t}))$$

where Ln is a natural logarithm operator and TOM_K is the correction factor estimated in equation two, and where,

- TOM_C_a = constant term estimated by arc for the binary variable ARCa (see Table F3.6, TOM_Ca = B_ARCxx_yy)
- ARCa = binary variable created for each arc to control for arc specific effects
- TOM_GPIS1 = estimated coefficient (see Table F3.6)
- TOM_DEPSHR = estimated coefficient (see Table F3.6)
- TOM_BYEAR = estimated coefficient (see Table F3.6)
- TOM_BYEAR_EIA = future rate of decline in R_TOM due to technology improvements and efficiency gains. EIA assumes that this rate is the same as TOM_BYEAR (see Table F3.6)
- ρ = first-order autocorrelation, TOM_RHO (see Table F3.6)

The results of this regression are reported below:

Dependent variable: R_TOM
 Number of observations: 388

Mean of dep. var.	= 53469.6	LM het. test	= 27.8965 [.000]
Std. dev. of dep. var.	= 76957.1	Durbin-Watson	= 2.01629 [<1.00]
Sum of squared residuals	= .668232E+11	Jarque-Bera test	= 12675.2 [.000]
Variance of residuals	= .172670E+09	Ramsey's RESET2	= 4.05701 [.045]
Std. error of regression	= 13140.4	Schwarz B.I.C.	= 4232.60
R-squared	= .970897	Log likelihood	= -4229.62
Adjusted R-squared	= .970897		

	Estimated	Standard		
Variable	Coefficient	Error	t-statistic	P-value
TOM_K	1.06222	7.64E-03	138.964	[.000]

For Storage:

$$R_STTOM_{r,t} = e^{(\beta_0 * (1-\rho))} * DSTWCAP_{r,t-1}^{\beta_1} * R_STTOM_{r,t-1}^{\rho} * DSTWCAP_{r,t-2}^{-\rho * \beta_1}$$

where,

- β₀ = -6.6702
= STTOM_C (Appendix E)
- β₁ = 1.44442
= STTOM_WORCAP (Appendix E)
- t-statistic = (33.6)
- ρ = 0.761238
= STTOM_RHO (Appendix E)
- t-statistic = (10.2)
- DW = 1.39
- R-Squared = 0.99

Table F3.1. Summary Statistics for Storage Total Cash Working Capital Equation

Variable	Coefficient	Standard Error	t-statistic
REG2	-2.30334	5.25413	-.438386
REG3	-1.51115	5.33882	-.283049
REG4	-2.11195	5.19899	-.406224
REG5	-2.07950	5.06766	-.410346
REG6	-1.24091	4.97239	-.249559
REG7	-1.63716	5.27950	-.310097
REG8	-2.48339	4.68793	-.529740
REG9	-3.23625	4.09158	-.790954
REG11	-2.15877	4.33364	-.498143

Table F3.2. Summary Statistics for Pipeline Total Cash Working Capital Equation

Variable	Coefficient	Standard-Error	t-statistic	P-value
CWC_TOM	0.35310	0.07014	5.0345	[.000]
B_ARC01_01	5.04152	0.71517	7.0494	[.000]
B_ARC02_01	5.39751	0.72786	7.4156	[.000]
B_ARC02_02	6.64570	0.84873	7.8301	[.000]
B_ARC02_03	4.56419	0.65549	6.9630	[.000]
B_ARC02_05	5.24602	0.73618	7.1260	[.000]
B_ARC03_02	5.20288	0.72069	7.2194	[.000]
B_ARC03_03	6.36528	0.83110	7.6589	[.000]
B_ARC03_04	4.27578	0.63151	6.7707	[.000]
B_ARC03_05	4.91343	0.71107	6.9100	[.000]
B_ARC03_15	5.17822	0.63747	8.1231	[.000]
B_ARC04_03	5.83397	0.77124	7.5644	[.000]
B_ARC04_04	6.41997	0.84831	7.5680	[.000]
B_ARC04_07	4.44604	0.62740	7.0865	[.000]
B_ARC04_08	4.30983	0.65167	6.6135	[.000]
B_ARC05_02	5.74734	0.78805	7.2931	[.000]
B_ARC05_03	5.14797	0.72339	7.1165	[.000]
B_ARC05_05	6.30224	0.83528	7.5450	[.000]
B_ARC05_06	3.41516	0.54915	6.2191	[.000]
B_ARC06_03	6.03671	0.78486	7.6915	[.000]
B_ARC06_05	6.01792	0.80111	7.5120	[.000]
B_ARC06_06	7.01316	0.88780	7.8995	[.000]
B_ARC06_07	3.67953	0.64160	5.7350	[.000]
B_ARC06_10	4.86190	0.71418	6.8077	[.000]
B_ARC07_04	5.85413	0.78874	7.4221	[.000]
B_ARC07_06	6.62201	0.85030	7.7879	[.000]
B_ARC07_07	7.10135	0.90310	7.8633	[.000]

Variable	Coefficient	Standard-Error	t-statistic	P-value
B_ARC07_08	3.76397	0.57873	6.5038	[.000]
B_ARC07_11	6.12863	0.83019	7.3822	[.000]
B_ARC07_21	5.03982	0.69773	7.2232	[.000]
B_ARC08_04	5.16331	0.72619	7.1101	[.000]
B_ARC08_07	4.14699	0.61693	6.7220	[.000]
B_ARC08_08	5.82311	0.77980	7.4675	[.000]
B_ARC08_09	5.39339	0.68308	7.8957	[.000]
B_ARC08_11	5.32219	0.71984	7.3936	[.000]
B_ARC08_12	4.47294	0.66835	6.6925	[.000]
B_ARC09_08	4.27450	0.60906	7.0182	[.000]
B_ARC09_09	5.66480	0.73291	7.7292	[.000]
B_ARC09_12	5.14626	0.64450	7.9850	[.000]
B_ARC09_20	2.74279	0.45112	6.0800	[.000]
B_ARC11_07	5.80482	0.78120	7.4307	[.000]
B_ARC11_08	4.52590	0.70994	6.3751	[.000]
B_ARC11_11	6.37190	0.86105	7.4001	[.000]
B_ARC11_12	6.16567	0.83187	7.4118	[.000]
B_ARC11_22	4.48821	0.71410	6.2852	[.000]
B_ARC15_02	5.27130	0.67281	7.8348	[.000]
B_ARC16_04	5.21659	0.62876	8.2966	[.000]
B_ARC17_04	4.35043	0.61107	7.1194	[.000]
B_ARC19_09	5.33735	0.66420	8.0358	[.000]
B_ARC20_09	4.77958	0.66351	7.2034	[.000]
B_ARC21_07	4.24360	0.65313	6.4973	[.000]
CWC_RHO	0.53205	0.06967	7.6365	[.000]

Table F3.3. Summary Statistics for Pipeline Depreciation, Depletion, and Amortization Equation

Variable	Coefficient	Standard-Error	t-statistic	P-value
DDA_NEWCAP	7.47E-03	2.43E-03	3.0742	[.002]
DDA_NPIS	0.023425	2.87E-03	8.1500	[.000]
B_ARC01_01	4684.38	874.58	5.3562	[.000]
B_ARC02_01	5068.55	784.48	6.4611	[.000]
B_ARC02_02	43686.60	4920.31	8.8788	[.000]
B_ARC02_03	2046.48	258.35	7.9213	[.000]
B_ARC02_05	7860.65	941.79	8.3465	[.000]
B_ARC03_02	5858.28	691.18	8.4758	[.000]
B_ARC03_03	33005.60	3388.68	9.7400	[.000]
B_ARC03_04	1032.95	141.33	7.3091	[.000]
B_ARC03_05	2377.84	881.68	2.6969	[.007]
B_ARC03_15	7640.25	847.84	9.0114	[.000]
B_ARC04_03	19775.30	2156.87	9.1685	[.000]
B_ARC04_04	35429.20	6002.27	5.9026	[.000]
B_ARC04_07	1917.37	184.53	10.3904	[.000]

Variable	Coefficient	Standard-Error	t-statistic	P-value
B_ARC04_08	754.06	431.93	1.7458	[.081]
B_ARC05_02	15646.30	2142.45	7.3030	[.000]
B_ARC05_03	6443.29	763.76	8.4362	[.000]
B_ARC05_05	44922.60	4484.45	10.0174	[.000]
B_ARC05_06	445.61	64.17	6.9446	[.000]
B_ARC06_03	11947.80	1416.84	8.4327	[.000]
B_ARC06_05	22527.80	2562.86	8.7901	[.000]
B_ARC06_06	67126.20	7538.25	8.9048	[.000]
B_ARC06_07	1145.32	77.32	14.8130	[.000]
B_ARC06_10	15792.10	1935.92	8.1574	[.000]
B_ARC07_04	15019.30	1631.11	9.2080	[.000]
B_ARC07_06	48011.60	4709.37	10.1949	[.000]
B_ARC07_07	80216.90	8877.77	9.0357	[.000]
B_ARC07_08	842.58	114.52	7.3576	[.000]
B_ARC07_11	4709.35	1288.06	3.6562	[.000]
B_ARC07_21	1446.04	296.56	4.8761	[.000]
B_ARC08_04	4889.97	1706.28	2.8659	[.004]
B_ARC08_07	1442.25	226.47	6.3685	[.000]
B_ARC08_08	34601.50	3386.09	10.2187	[.000]
B_ARC08_09	5950.12	937.22	6.3487	[.000]
B_ARC08_11	1080.84	441.00	2.4509	[.014]
B_ARC08_12	7589.89	1577.46	4.8115	[.000]
B_ARC09_08	2853.65	262.76	10.8602	[.000]
B_ARC09_09	15045.10	1738.30	8.6551	[.000]
B_ARC09_12	3113.85	563.15	5.5293	[.000]
B_ARC09_20	278.96	24.95	11.1829	[.000]
B_ARC11_07	4007.98	904.89	4.4293	[.000]
B_ARC11_08	323.76	90.19	3.5899	[.000]
B_ARC11_11	5584.89	1772.42	3.1510	[.002]
B_ARC11_12	4017.62	1353.17	2.9690	[.003]
B_ARC11_22	257.59	73.76	3.4921	[.000]
B_ARC15_02	2123.88	206.93	10.2636	[.000]
B_ARC16_04	8004.69	901.94	8.8750	[.000]
B_ARC17_04	3314.88	830.01	3.9938	[.000]
B_ARC19_09	4206.56	758.70	5.5444	[.000]
B_ARC20_09	6229.81	573.74	10.8582	[.000]
B_ARC21_07	673.28	137.02	4.9136	[.000]

Table F3.4. Summary Statistics for Storage Depreciation, Depletion, and Amortization Equation

Variable	Coefficient	St-Error	t-statistic
REG2	4485.56	1204.28	3.72467
REG3	6267.52	1806.17	3.47006

Variable	Coefficient	St-Error	t-statistic
REG4	3552.55	728.230	4.87833
REG5	2075.31	646.561	3.20976
REG6	1560.07	383.150	4.07169
REG7	4522.42	1268.87	3.56412
REG8	1102.49	622.420	1.77129
REG9	65.2731	10.1903	6.40542
REG11	134.692	494.392	.272439

Table F3.5. Summary Statistics for Pipeline Accumulated Deferred Income Tax Equation

Variable	Coefficient	Standard-Error	t-statistic	P-value
BNEWCAP_PRE2003	0.06633	0.03834	1.7302	[.084]
BNEWCAP_2003_2004	0.13172	0.02083	6.3229	[.000]
BNEWCAP_POST2004	0.10840	0.03353	3.2331	[.001]
B_ARC01_01	3546.33	1277.05	2.7770	[.005]
B_ARC02_01	2805.20	980.47	2.8611	[.004]
B_ARC02_02	15357.50	4590.07	3.3458	[.001]
B_ARC02_03	770.72	235.52	3.2725	[.001]
B_ARC02_05	2493.95	958.68	2.6014	[.009]
B_ARC03_02	1366.76	505.92	2.7016	[.007]
B_ARC03_03	6246.11	7175.64	0.8705	[.384]
B_ARC03_04	-13.60	203.75	-0.0667	[.947]
B_ARC03_05	3192.03	1091.65	2.9241	[.003]
B_ARC03_15	2536.04	440.97	5.7511	[.000]
B_ARC04_03	5635.78	2423.59	2.3254	[.020]
B_ARC04_04	6127.70	14993.90	0.4087	[.683]
B_ARC04_07	-389.42	1191.05	-0.3270	[.744]
B_ARC04_08	1800.98	419.74	4.2907	[.000]
B_ARC05_02	6682.19	1960.07	3.4092	[.001]
B_ARC05_03	1851.71	728.19	2.5429	[.011]
B_ARC05_05	6436.64	3821.57	1.6843	[.092]
B_ARC05_06	149.36	67.08	2.2267	[.026]
B_ARC06_03	2493.10	1842.75	1.3529	[.176]
B_ARC06_05	5259.47	2703.87	1.9452	[.052]
B_ARC06_06	25135.10	13215.30	1.9020	[.057]
B_ARC06_07	-258.53	269.12	-0.9606	[.337]
B_ARC06_10	13057.70	10507.60	1.2427	[.214]
B_ARC07_04	207.28	5684.25	0.0365	[.971]
B_ARC07_06	14234.50	7710.71	1.8461	[.065]
B_ARC07_07	16235.40	8316.46	1.9522	[.051]
B_ARC07_08	120.73	241.24	0.5005	[.617]
B_ARC07_11	-404.57	3506.85	-0.1154	[.908]
B_ARC07_21	504.77	514.21	0.9816	[.326]
B_ARC08_04	4698.22	1164.65	4.0340	[.000]
B_ARC08_07	374.94	513.42	0.7303	[.465]
B_ARC08_08	5216.94	9522.10	0.5479	[.584]

Variable	Coefficient	Standard-Error	t-statistic	P-value
B_ARC08_09	-3657.94	7168.32	-0.5103	[.610]
B_ARC08_11	-1847.00	2448.05	-0.7545	[.451]
B_ARC08_12	815.85	3760.84	0.2169	[.828]
B_ARC09_08	543.53	423.19	1.2844	[.199]
B_ARC09_09	-1776.45	6614.97	-0.2686	[.788]
B_ARC09_12	-2795.49	5562.40	-0.5026	[.615]
B_ARC09_20	56.20	51.27	1.0961	[.273]
B_ARC11_07	-1121.87	2765.19	-0.4057	[.685]
B_ARC11_08	278.37	204.73	1.3597	[.174]
B_ARC11_11	53.96	5185.21	0.0104	[.992]
B_ARC11_12	-1044.80	4464.75	-0.2340	[.815]
B_ARC11_22	342.87	261.52	1.3111	[.190]
B_ARC15_02	432.81	174.96	2.4738	[.013]
B_ARC16_04	2749.05	409.64	6.7110	[.000]
B_ARC17_04	938.04	404.58	2.3186	[.020]
B_ARC19_09	-3797.37	7409.57	-0.5125	[.608]
B_ARC20_09	1186.53	925.78	1.2817	[.200]
B_ARC21_07	521.18	239.87	2.1728	[.030]

Table F3.6. Summary Statistics for Pipeline Total Operating and Maintenance Expense Equation

Variable	Coefficient	Standard-Error	t-statistic	P-value
TOM_GPIS1	0.23972	0.15799	1.51735	[.129]
TOM_DEPSHR	1.68654	0.53457	3.15494	[.002]
TOM_BYEAR	-0.01940	0.00681	-2.84789	[.004]
B_ARC01_01	44.7797	11.9848	3.7364	[.000]
B_ARC02_01	44.7115	11.9764	3.7333	[.000]
B_ARC02_02	46.4333	11.7549	3.9501	[.000]
B_ARC02_03	44.3039	12.1426	3.6486	[.000]
B_ARC02_05	45.3652	11.9692	3.7902	[.000]
B_ARC03_02	44.7814	11.9887	3.7353	[.000]
B_ARC03_03	46.1669	11.7664	3.9236	[.000]
B_ARC03_04	43.4816	12.1179	3.5882	[.000]
B_ARC03_05	44.9024	11.9589	3.7547	[.000]
B_ARC03_15	44.0941	11.9811	3.6803	[.000]
B_ARC04_03	45.4945	11.8313	3.8453	[.000]
B_ARC04_04	46.4768	11.7444	3.9574	[.000]
B_ARC04_07	43.9806	12.1067	3.6328	[.000]
B_ARC04_08	44.5637	12.0842	3.6878	[.000]
B_ARC05_02	45.8240	11.8476	3.8678	[.000]
B_ARC05_03	45.1983	12.0063	3.7645	[.000]
B_ARC05_05	46.2891	11.7591	3.9364	[.000]
B_ARC05_06	43.1822	12.2636	3.5212	[.000]
B_ARC06_03	45.4105	11.8536	3.8310	[.000]
B_ARC06_05	45.9127	11.8228	3.8834	[.000]

Variable	Coefficient	Standard-Error	t-statistic	P-value
B_ARC06_06	46.6199	11.6802	3.9913	[.000]
B_ARC06_07	43.4451	12.1860	3.5652	[.000]
B_ARC06_10	45.0323	11.9259	3.7760	[.000]
B_ARC07_04	45.6760	11.8400	3.8578	[.000]
B_ARC07_06	46.2710	11.7324	3.9439	[.000]
B_ARC07_07	46.8815	11.6548	4.0225	[.000]
B_ARC07_08	43.6420	12.2298	3.5685	[.000]
B_ARC07_11	45.7598	11.9356	3.8339	[.000]
B_ARC07_21	44.3585	12.0907	3.6688	[.000]
B_ARC08_04	45.3073	11.9278	3.7985	[.000]
B_ARC08_07	44.0762	12.1667	3.6227	[.000]
B_ARC08_08	45.8295	11.8340	3.8727	[.000]
B_ARC08_09	44.6735	11.9899	3.7259	[.000]
B_ARC08_11	44.9321	12.0755	3.7209	[.000]
B_ARC08_12	44.1254	12.0243	3.6697	[.000]
B_ARC09_08	43.9405	12.1195	3.6256	[.000]
B_ARC09_09	45.2793	11.9099	3.8018	[.000]
B_ARC09_12	44.2248	12.0491	3.6704	[.000]
B_ARC09_20	42.1715	12.4002	3.4009	[.001]
B_ARC11_07	45.4185	11.9628	3.7966	[.000]
B_ARC11_08	43.8384	12.2498	3.5787	[.000]
B_ARC11_11	46.0778	11.9084	3.8694	[.000]
B_ARC11_12	45.8489	11.9400	3.8399	[.000]
B_ARC11_22	43.7290	12.4101	3.5237	[.000]
B_ARC15_02	43.7788	12.0757	3.6254	[.000]
B_ARC16_04	43.9751	11.9802	3.6706	[.000]
B_ARC17_04	43.8481	12.0309	3.6446	[.000]
B_ARC19_09	44.4506	12.0143	3.6998	[.000]
B_ARC20_09	44.5341	12.0296	3.7020	[.000]
B_ARC21_07	43.6168	12.1490	3.5902	[.000]
TOM_RHO	0.3021	0.0436	6.9255	[.000]

Table F4

Data: Equation for industrial distribution tariffs

Author: Ernest Zampelli, SAIC, 2009.

Source: The source for the peak and off-peak consumption data used in this estimation was the Natural Gas Monthly, DOE/EIA-0130. State level city gate prices by month were averaged using quantity-weights to arrive at seasonal (peak and off-peak), regional level (12 NGTDM regions) prices. The quantity-weights for the city gate prices consisted of residential consumption plus commercial consumption that is represented by on-system sales plus industrial consumption that is represented by on-system sales. Prices for the estimations were derived as described in Table F5.

Variables:

- TIN_{r,n,t} = industrial distributor tariff in region r, network n (1987 dollars per Mcf) [DTAR_SF3]
- PREG_r = 1, if observation is in region r during peak period (n=1), =0 otherwise
- QIN_{r,t} = industrial gas consumption in region r in year t (MMcf) [BASQTY_SF3+BASQTY_SI3]
- r = NGTDM region
- t = year
- α₀, α_r, α_{r,n} = estimated parameters for regional constants [PINREGPK14_r]
- β = estimated parameter for consumption
- ρ = autocorrelation coefficient

[Note: Variables in brackets correspond to comparable variables used in the main body of the documentation and in the model code.]

Derivation: The industrial distributor tariff equation was estimated using backcasted data for the 12 NGTDM regions over the 1990 to 2008 time period. The equation was estimated in linear form with corrections for cross sectional heteroscedasticity and first order serial correlation using TSP version 5.0. The form of the estimating equation follows:

$$\ln \text{TIN}_{r,n,t} = \sum_r (\alpha_r + \alpha_{r,pk}) * \text{REG}_{r,pk} + \beta * \text{QIN}_{r,t} + \rho * \text{TIN}_{r,t-1} - \rho * (\sum_r (\alpha_r + \alpha_{r,pk}) * \text{REG}_{r,pk} + \beta * \text{QIN}_{r,t-1})$$

Regression Diagnostics and Parameter Estimates:

FIRST-ORDER SERIAL CORRELATION OF THE ERROR

Dependent Variable: TIN87
 Number of observations: 456

Mean of dep. Var.	0.349767	R-squared	0.624978
Std. dev. Of dep. Var.	= 1.40434	Adj Adjusted R-squared	0.619118
Sum of squared resid.	337.076	Durbin-Watson	2.05539

Variance of resid.	0.752402	Schwarz B.I.C.	602.956
Std. error of regression	0.867411	Log likelihood	-578.466

	Parameter	Estimate	Std. Error	t-statistic	P-value	
α_1	ENCNTL	0.203182	0.068652	2.95959	[.003]	PINREG14
α_9	WAOR	0.326413	0.069688	4.68391	[.000]	PINREG14
α_{11}	AZNM	0.59703	0.094422	6.323	[.000]	PINREG14
α_{12}	CA	0.801976	0.106045	7.56258	[.000]	PINREG14
$\alpha_{2,pk}$	MIDATL_PK	0.611241	0.107767	5.67186	[.000]	PINREGPK14
$\alpha_{5,pk}$	SATLFL_PK	0.330115	0.111154	2.96987	[.003]	PINREGPK14
β_1	QIND	-2.95E-04	4.33E-05	6.80574	[.000]	
ρ	RHO	0.523668	0.040467	12.9407	[.000]	

Data used for estimation

		New Engl.	Mid Atl.	E.N. Central	W.N. Central	S.Atl Fl	E.S. Central	W.S. Central	Mtn-AZNM	WA/OR	Florida	AZ/NM	CA/HI
		1	2	3	4	5	6	7	8	9	10	11	12
1990 QIN	peak	25.238	156.14	453.96	140.9	185.23	152.15	948.57	56.599	46.146	30.06	13.198	177.12
1990 QIN	off-peak	56.095	270.87	730.76	245.05	351.31	272.39	1987.3	93.839	81.168	54.881	24.473	388.08
1991 QIN	peak	39.282	168.91	481.69	149.95	171.26	158.54	979.32	66.408	47.282	30.235	14.3	201.54
1991 QIN	off-peak	82.376	282.18	729.31	254.99	330.64	288.33	2003.6	109.22	87.502	53.163	24.25	401.08
1992 QIN	peak	54.227	204.09	498.51	155.99	185.1	166.54	1018.4	74.334	49.691	29.904	13.778	217.12
1992 QIN	off-peak	108.78	354.7	777.87	263.94	353.2	304.97	1942.1	128.69	88.594	54.925	23.066	377.45
1993 QIN	peak	61.814	224.11	529.31	166.97	185.5	176.42	1045.5	83.593	54.178	34.299	13.167	214.7
1993 QIN	off-peak	123.32	366.69	786.37	283.17	358.16	305.77	2109.2	148.52	98.713	66.051	25.02	445.02
1994 QIN	peak	60.862	243.6	553.36	190.76	182.9	170.14	1088.8	91.076	58.07	42.837	13.711	210.07
1994 QIN	off-peak	111.77	398.1	795.93	320.33	380.72	299.53	2069.5	149.79	112.1	84.036	30.899	446.68
1995 QIN	peak	67.612	274.81	564.08	174.94	198.2	181.21	1094.8	92.348	62.974	49.496	18.42	216.02
1995 QIN	off-peak	117.09	462.71	842.05	302.97	408.65	323.96	2206	154.12	115.93	83.981	30.338	471.9
1996 QIN	peak	54.363	285.51	578.99	166.26	193.94	178.95	1196.9	93.314	66.644	46.056	17.943	231.69
1996 QIN	off-peak	112.99	481.59	876.22	283.25	385.99	324.38	2332	168.08	135.35	90.666	31.894	461.85
1997 QIN	peak	48.405	234.18	527.5	180.9	213.68	185.66	1158.6	77.997	70.675	41.903	18.414	232.69
1997 QIN	off-peak	86.131	402.1	814.07	291.91	398.91	334.13	2246.7	136.03	130.89	83.234	35.325	487.2
1998 QIN	peak	52.54	226.19	506.96	165.78	200.57	186.74	1119.4	94.347	83.184	40.685	18.07	232.48
1998 QIN	off-peak	95.549	375.1	771.51	298.64	370.18	328.87	2140.8	154.17	152.69	81.23	35.135	513.67
1999 QIN	peak	55.157	197.85	523.25	160.89	221.22	201	1023.2	77.398	81.611	43.813	18.686	203.63
1999 QIN	off-peak	100.84	332.74	804.58	274.65	340.85	366.69	2032.3	146.67	150.74	90.394	34.188	522.78
2000 QIN	peak	54.493	152.64	539.34	163.07	194.49	200.21	1080.9	87.687	57.099	35.056	17.259	218.27
2000 QIN	off-peak	86.042	262.25	788.24	285.56	364.74	347.3	2230.3	139.76	102.92	69.631	33.847	558.47
2001 QIN	peak	49.565	139.45	480.99	150.12	155.17	168.54	1051.7	104.16	50.923	30.792	19.007	211.11
2001 QIN	off-peak	85.579	228.74	699.46	258.24	303.54	299.32	1974.5	167.1	93.96	63.919	35.375	455.88
2002 QIN	peak	52.54	144.33	470.45	121.75	173.22	176.85	1011.8	91.637	51.527	28.746	14.516	241.23
2002 QIN	off-peak	81.724	234.44	758.81	221.6	328.78	305.4	2005.8	169.31	86.7	54.823	26.005	499.44
2003 QIN	peak	39.744	139.83	481.39	158.53	175.69	176.28	982.91	89.808	47.009	25.345	13.858	252.4
2003 QIN	off-peak	46.063	215.76	678.89	260.18	298.39	286.67	1906.9	146.28	86.394	47.99	25.8	527.13
2004 QIN	peak	37.198	136.43	491.51	156.64	176.4	173.92	973.99	91.339	49.641	23.374	16.187	271.43
2004 QIN	off-peak	45.242	214.24	688.46	265.89	305.66	303.33	1907	146.72	89.858	40.229	26.574	564.84

		New Engl.	Mid Atl.	E.N. Central	W.N. Central	S.Atl Fl	E.S. Central	W.S. Central	Mtn- AZNM	WA/OR	Florida	AZ/NM	CA/HI
		1	2	3	4	5	6	7	8	9	10	11	12
2005 QIN	peak	40.728	135.24	478.91	158.08	172.16	168.5	808.09	93.829	48.327	23.015	14.013	267.71
2005 QIN	off-peak	45.586	205.31	681.74	260.6	290.89	283.02	1538.7	159.82	88.192	40.118	27.785	514.11
2006 QIN	peak	35.807	124.55	429.28	162.89	161.04	157.39	787.35	97.212	50.66	24.302	13.762	244.48
2006 QIN	off-peak	47.391	207.44	673.41	298.82	305.01	292.01	1573.2	151.07	90.187	45.419	22.924	488.02
2007 QIN	peak	39.898	129.41	455.49	173.06	161.02	166.6	834.3	97.509	51.108	23.489	13.67	243.44
2007 QIN	off-peak	47.76	206.79	665.3	304.43	293.52	287.93	1612	156.13	91.117	42.303	23.336	490.16
2008 QIN	peak	41.994	131.75	450.39	195.27	158.12	162.98	834.03	101.53	55.157	25.683	13.962	255.11
2008 QIN	off-peak	45.87	195.97	644.85	323.08	290.82	281.62	1594.9	157.55	89.092	45.653	24.509	509.07
1990 TIN	peak	1.099	0.6688	0.3058	-0.1288	0.7025	0.1655	-0.5898	0.0125	0.6006	0.5055	0.3569	0.7677
1990 TIN	off-peak	0.2422	0.2975	0.3219	-0.2679	0.3332	0.0103	-0.8011	-0.6182	0.3989	0.6069	0.4618	0.4976
1991 TIN	peak	1.1651	0.7854	0.3182	-0.1239	0.6413	0.1569	-0.6598	-0.2375	0.5443	0.4694	0.4572	0.9729
1991 TIN	off-peak	0.2206	0.1636	0.1991	-0.3464	0.1277	-0.0513	-0.6584	-0.7412	0.4784	0.5472	0.3259	0.5807
1992 TIN	peak	1.2819	0.6984	0.2446	-0.0567	0.628	0.1737	-0.6297	-0.1706	0.5218	0.5658	1.2426	1.078
1992 TIN	off-peak	-0.1136	-0.164	-0.0413	-0.3214	0.0843	-0.1326	-0.5803	-0.9941	0.5634	0.4786	0.9993	0.2713
1993 TIN	peak	1.1049	0.5098	0.1875	-0.0766	0.6265	0.1938	-0.5649	-0.1407	0.4983	0.5495	0.7831	0.3072
1993 TIN	off-peak	-0.5318	-0.1649	0.0392	-0.3932	0.0085	-0.1049	-0.4782	-0.5373	0.4175	0.689	0.6653	-0.1804
1994 TIN	peak	1.1511	0.6644	0.3775	0.043	0.5115	0.3493	-0.4724	-0.4511	0.4197	0.0552	0.989	0.4388
1994 TIN	off-peak	-0.7697	0.0425	0.2089	-0.4502	-0.1338	-0.0533	-0.3722	-0.6965	0.1884	0.2237	0.5148	0.1871
1995 TIN	peak	0.9682	0.5415	0.1336	0.0336	0.5657	0.368	-0.5873	-0.1514	0.2735	-0.0042	1.0843	1.3996
1995 TIN	off-peak	-0.6908	0.1533	-0.0909	-0.4184	0.0587	-0.091	-0.5336	-0.1512	0.2563	0.1373	0.8486	0.7801
1996 TIN	peak	1.0885	0.4724	-0.0801	0.1501	0.3852	-0.0597	-0.2293	0.0624	0.3147	0.0629	0.7245	0.7635
1996 TIN	off-peak	-0.5643	-0.1022	-0.0573	-0.4768	0.0265	0.0109	-0.287	0.0885	0.0274	0.2877	0.6701	0.549
1997 TIN	peak	0.9536	0.5591	0.1766	-0.1368	0.4308	0.1911	-0.4936	0.04	0.5014	-0.2748	0.3125	1.0975
1997 TIN	off-peak	-0.3627	-0.9394	-0.1531	-0.7348	-0.0943	-0.0291	-0.2262	0.2046	0.0767	0.1115	0.1918	0.4767
1998 TIN	peak	0.7314	0.029	0.1798	-0.0513	0.1833	0.0944	-0.2879	-0.1103	0.1663	-0.0655	0.544	1.0797
1998 TIN	off-peak	-0.8255	-0.5106	0.0985	-0.5266	-0.3471	-0.2757	-0.1983	0.0953	0.0643	-0.0713	0.176	0.4421
1999 TIN	peak	0.381	0.1165	0.1777	-0.0447	-0.0503	0.1269	-0.4494	0.5426	0.1491	0.6896	0.5158	0.6471
1999 TIN	off-peak	-0.8161	-0.787	-0.2143	-0.5001	-0.4758	-0.2064	-0.2569	0.2023	0.0292	-0.0932	0.0834	0.2283
2000 TIN	peak	0.4368	0.3257	-0.1319	-0.1978	-0.0355	-0.0918	-0.5133	0.3527	0.5765	-0.0681	-0.0613	0.6967
2000 TIN	off-peak	-0.6324	-0.5654	-0.2139	-0.637	-0.4437	-0.2846	-0.3444	0.3139	-0.0557	0.2312	-0.0438	0.5583
2001 TIN	peak	-0.0298	0.5579	0.0726	-0.3949	-0.0079	-0.2461	-0.7083	0.157	-0.2738	-0.3584	-0.0328	-0.4836
2001 TIN	off-peak	-0.1169	0.2263	0.2662	-0.493	-0.4109	-0.0722	-0.3964	0.7435	0.3807	0.8896	0.7614	0.8027
2002 TIN	peak	0.6619	0.4506	-0.1471	-0.2	-0.0309	0.19	-0.5569	0.8717	0.7349	0.8584	1.2169	1.054
2002 TIN	off-peak	-0.875	0.1446	-0.447	-0.351	-0.4161	-0.0017	-0.4194	0.9103	-0.0871	0.4439	0.6581	0.6936
2003 TIN	peak	0.7842	1.1901	0.0288	-0.3011	0.018	0.3513	-0.222	0.5963	0.2737	-0.4933	0.3882	1.0483
2003 TIN	off-peak	0.2361	0.7713	0.1791	-0.4924	-0.4897	-0.3577	-0.2159	0.6595	0.1605	0.5482	0.6927	0.8708
2004 TIN	peak	1.2662	0.958	0.1488	-0.1974	0.0588	0.1299	-0.4422	0.2895	0.3958	0.1907	0.4129	1.176
2004 TIN	off-peak	0.17	0.2825	-0.2684	-0.6077	-0.4935	-0.1755	-0.1804	0.2801	0.0213	0.433	0.4578	0.4561
2005 TIN	peak	1.1769	0.9548	-0.071	0.0804	0.1706	0.2596	-0.513	0.4996	0.5463	-0.0684	0.4173	1.3857
2005 TIN	off-peak	6.2644	0.1607	-0.6005	-0.8601	-0.6412	-0.2335	-0.2605	0.2672	0.0206	-0.6922	0.4917	0.3082
2006 TIN	peak	0.7955	0.6048	-0.3683	0.1022	-0.2335	0.0381	-0.6599	0.3446	0.3204	0.599	0.3567	1.2178
2006 TIN	off-peak	0.2617	-0.7368	-0.1778	-0.7105	-0.4412	-0.3876	-0.4774	0.2411	0.1519	1.1891	1.1094	0.9437
2007 TIN	peak	1.3417	0.2697	-0.3644	0.0452	0.1393	-0.1848	-0.7233	-0.0415	0.6403	0.7626	0.7061	0.907
2007 TIN	off-peak	0.2215	-0.0402	-0.1513	-0.3497	-0.1962	-0.1132	-0.7936	0.3232	0.5507	0.9501	0.8721	0.8912
2008 TIN	peak	1.1063	0.3597	-0.1709	0.1381	0.1855	-0.1638	-0.62	0.1363	0.8461	1.0509	0.5912	0.9421
2008 TIN	off-peak	0.5047	0.3785	0.2288	-0.1025	-0.0856	-0.255	-0.6044	0.071	-0.1388	1.2117	1.1816	1.1883

Table F5

Data: Historical industrial sector natural gas prices by type of service, NGTDM region.

Derivation: The historical industrial natural gas prices published in the *Natural Gas Annual (NGA)* only reflect gas purchased through local distribution companies. In order to approximate the average price to all industrial customers by service type and NGTDM region (HPGFINGR, HPGIINGR), data available at the Census Region level⁹³ from the Manufacturing Energy Consumption Survey (MECS)⁹⁴ for the years 1988, 1991, 1994, 1998, and 2002 were used to estimate an equation for the regional MECS price as a function of the regional NGA industrial price and the regional supply price (quantity-weighted average of the gas wellhead price and import price). The procedure is outlined below.

- 1) Assign average Census Division industrial price using econometrically derived equation:

$$PIN_NG_{nr} = 1.00187 * \exp(0.039682) * PW_NRG_{nr}^{0.231404} * HPIN_{nr}^{0.726227}$$

- 2) Assign prices to the NGTDM regions that represent subregions of Census Divisions by multiplying the Census Division price from step 1 by the subregion price (as published in the NGA), divided by the Census Division price (as published in the NGA). For the Pacific Division, the industrial price in Alaska from the NGA, with quantity weights, is used to approximate a Pacific Division price for the lower-48 (i.e., CA, WA, and OR), before this step is performed.
- 3) Core industrial prices are derived by applying an historical, regional, average average-to-firm price markup (FDIFF, in 1987\$/Mcf, Northeast 0.11, North Central 0.14, South 0.67, West 0.39) to the established average regional industrial price (from step 2). Noncore prices are calculated so that the quantity-weighted average of the core and noncore prices equal the original regional estimate. The data used to generate the average-to-firm markups are presented below.
- 4) Finally, the peak and off-peak prices from the NGA are scaled to align with the core and noncore prices generated from step 3 on an average annual basis, to arrive at peak/off-peak, core/noncore industrial prices for the NGTDM regions.

⁹³Through a special request, the Census Bureau generated MECS data by Census Region and by service type (core versus noncore) based on an assumption of which industrial classifications are more likely to consume most of their purchased natural gas in boilers (core) or non-boiler applications (noncore).

⁹⁴A request was issued to the Census Bureau to obtain similar data from other MECS surveys to improve this estimation.

	Prices (87\$/mcf)			Consumption (Bcf)		
	1988	1991	1994	1988	1991	1994
Core						
Northeast	3.39	3.05	3.04	335	299	310
North Central	3.04	2.37	2.42	864	759	935
South	2.91	2.40	2.53	643	625	699
West	3.21	2.70	2.55	217	204	227
Noncore						
Northeast	3.05	2.78	2.67	148	146	187
North Central	2.60	2.01	2.17	537	648	747
South	1.96	1.57	1.75	2517	2592	2970
West	2.54	2.19	1.91	347	440	528

	Price (87\$/mcf)				
	1988	1991	1994	1998	2002
Northeast	3.297223	3.018058	2.941269	2.834076	3.498869
North Central	2.880355	2.247968	2.351399	2.247715	2.985983
South	2.162684	1.766014	1.939298	1.947017	2.634691
West	2.804912	2.398525	2.133228	2.217645	2.831414

Variables:

- PIN_NG = Industrial natural gas prices by NGTDM region (1987\$/Mcf)
- PW_CDV = Average supply price by Census Division (1987\$/Mcf)
- PI_CDV = Industrial natural gas price from the NGA by Census Division (1987\$/Mcf)
- FDIFF = Average (1988, 1991, 1994) difference between the firm industrial price and the average industrial price by Census Region (1987\$/Mcf)
- PIN_FNG = Industrial core natural gas prices by NGTDM region (1987\$/Mcf)
- PIN_ING = Industrial noncore natural gas prices by NGTDM region (1987\$/Mcf)
- HPGFINGR = Industrial core natural gas prices by period and NGTDM region (1987\$/Mcf)
- HPGIINGR = Industrial noncore natural gas prices by period and NGTDM region (1987\$/Mcf)

Regression Diagnostics and Parameter Estimates:

Dependent variable: LNMECS87
Number of observations: 20

Mean of dep. var. = .921802	LM het. test = .021529 [.883]
Std. dev. of dep. var. = .190034	Durbin-Watson = 1.22472 [<.086]
Sum of squared residuals = .067807	Jarque-Bera test = .977466 [.613]

Variance of residuals = .398866E-02 Ramsey's RESET2 = .044807 [.835]
 Std. error of regression = .063156 F (zero slopes) = 77.5121 [.000]
 R-squared = .901177 Schwarz B.I.C. = -23.9958
 Adjusted R-squared = .889550 Log likelihood = 28.4894

Variable	Estimated Coefficient	Standard Error	t-statistic	P-value
C	.039682	.072242	.549291	[.590]
LNSUPPLYP87	.231404	.105606	2.19120	[.043]
LNNGAP87	.726227	.073700	9.85385	[.000]

Form of Forecasting Equation:

$$MECS87 = 1.00187 * e^{0.039682} SUPPLYP87^{0.231404} NGAP87^{0.726227}$$

where:

MECS87 = Manufacturer's Energy Consumption Survey in US\$87

SUPPLYP87 = supply price in US\$87

NGAP87 = natural gas annual price in US\$87

Table F6

Data: Equation for residential distribution tariffs

Author: Ernest Zampelli, SAIC, with Margaret Leddy, EIA, 2009.

Source: The source for the peak and off-peak data used in this estimation was the *Natural Gas Monthly*, DOE/EIA-0130. State level city gate and residential prices by month were averaged using quantity-weights to arrive at seasonal (peak and off-peak), regional level (12 NGTDM regions) prices. The quantity-weights for the city gate prices consisted of residential consumption plus commercial consumption that is represented by on-system sales plus industrial consumption that is represented by on-system sales. The source for the number of residential customers was the *Natural Gas Annual*, DOE/EIA-0131.

Variables:

- TRS_{r,n,t} = residential distributor tariff in region r, network n (1987 dollars per Mcf) [DTAR_SF1]
- REG_r = 1, if observation is in region r, =0 otherwise
- PREG_{r,n} = 1, if observation is in region r during peak period (n=1), =0 otherwise
- QRS_{r,t}_NUMR = residential gas consumption for region r in year t (MMcf per thousand customers) [(BASQTY_SF1+BASQTY_SI1)/NUMRS]
- r = NGTDM region
- n = network (1=peak, 2=off-peak)
- t = year
- α_r, α_{r,n} = estimated parameters for regional dummy variables [PRSREG14, PRSREGPK14]
- β₁, β₂ = estimated parameters
- ρ = autocorrelation coefficient

[Note: Variables in brackets correspond to comparable variables used in the main body of the documentation and in the model code.]

Derivation: The residential distributor tariff equation was estimated using panel data for the 12 NGTDM regions over the 1990 to 2008 time period. The equation was estimated in log-linear form with corrections for cross sectional heteroscedasticity and first order serial correlation using TSP version 5.0. The form of the estimating equation follows:

$$\ln \text{TRS}_{r,n,t} = \sum_r (\alpha_r * \text{REG}_r + \alpha_{r,n} * \text{PREG}_{r,n}) + \beta_1 * \ln \text{QRS_NUMR}_{r,t} + \rho * \ln \text{TRS}_{r,t-1} - \rho * (\sum_r (\alpha_r * \text{REG}_r + \alpha_{r,pk} * \text{REG}_{r,pk}) + \beta_1 * \ln \text{QRS_NUMR}_{r,t-1})$$

Regression Diagnostics and Parameter Estimates:

FIRST-ORDER SERIAL CORRELATION OF THE ERROR

Objective function: Exact ML (keep first obs.)

Balanced data: N = 24, T_I = 18, NOB = 456

CONVERGENCE ACHIEVED AFTER 5 ITERATIONS

Dependent variable: LNTRS87
 Number of observations: 456

Mean of dep. Var.	10.1167	R-squared	0.967824
Std. dev	5.26773	Adjusted R-squared	0.966652
Sum of Squares	406.326	Durbin-Watson	1.93786
Variance	0.925573	Schwarz B.I.C.	673.203
Std. error	0.962067	Log Likelihood	-621.161

	Parameter	Standard Estimate	Error	t-statistic	p-value	Variables
α_1	NE	-5.87975	0.273234	-21.5191	[.00]	PRSREG14
α_2	MIDATL	-5.83948	0.265921	-21.9595	[.00]	PRSREG14
α_3	ENCNTL	-6.31284	0.259723	-24.306	[.00]	PRSREG14
α_4	WNCNTL	-6.35329	0.263212	-24.1376	[.00]	PRSREG14
α_5	SATLFL	-5.96901	0.271087	-22.0188	[.00]	PRSREG14
α_6	ESCNTL	-6.30601	0.276343	-22.8195	[.00]	PRSREG14
α_7	WSCNTL	-6.31104	0.283857	-22.2331	[.00]	PRSREG14
α_8	MTNAZNM	-6.53819	0.266362	-24.5463	[.00]	PRSREG14
α_9	WAOR	-6.08373	0.26829	-22.6759	[.00]	PRSREG14
α_{10}	FL	-5.98841	0.299046	-20.025	[.00]	PRSREG14
α_{11}	AZNM	-6.22784	0.280458	-22.2059	[.00]	PRSREG14
α_{12}	CA	-6.38441	0.278592	-22.9167	[.00]	PRSREG14
$\alpha_{1,pk}$	NE_PK	0.29399	0.055413	5.30542	[.00]	PRSREGPK14
$\alpha_{7,pk}$	WSCNTL_PK	-0.223868	0.035458	-6.31355	[.00]	PRSREGPK14
$\alpha_{10,pk}$	FL_PK	-0.259818	0.042887	-6.05814	[.00]	PRSREGPK14
β_1	LNQRS_NUMR	-0.707463	0.026308	-26.8913	[.00]	
ρ	RHO	0.329051	0.04463	7.37288	[.00]	

Data used for estimation

		New Engl	Mid Atl	E.N. Cntrl	W.N. Cntrl	S.Atl- FL	E.S. Cntrl	W.S. Cntrl	Mtn- AZNM	WA/OR	Florida	AZ/N M	CA/HI	
		1	2	3	4	5	6	7	8	9	10	11	12	
1990	QRS_NUMR	peak	0.0547	0.0540	0.0715	0.0624	0.0466	0.0461	0.0406	0.0532	0.0485	0.0153	0.0395	0.0341
1990	QRS_NUMR	off-peak	0.0382	0.0373	0.0488	0.0389	0.0294	0.0284	0.0268	0.0372	0.0328	0.0131	0.0216	0.0265
1991	QRS_NUMR	peak	0.0528	0.0517	0.0759	0.0684	0.0484	0.0488	0.0431	0.0575	0.0485	0.0142	0.0372	0.0304
1991	QRS_NUMR	off-peak	0.0367	0.0343	0.0484	0.0390	0.0297	0.0271	0.0268	0.0387	0.0350	0.0134	0.0226	0.0286
1992	QRS_NUMR	peak	0.0585	0.0556	0.0749	0.0614	0.0503	0.0491	0.0411	0.0539	0.0456	0.0165	0.0391	0.0302
1992	QRS_NUMR	off-peak	0.0440	0.0390	0.0525	0.0399	0.0326	0.0287	0.0263	0.0339	0.0293	0.0140	0.0210	0.0251
1993	QRS_NUMR	peak	0.0602	0.0613	0.0801	0.0697	0.0554	0.0518	0.0439	0.0592	0.0545	0.0145	0.0374	0.0315
1993	QRS_NUMR	off-peak	0.0420	0.0393	0.0509	0.0420	0.0314	0.0298	0.0292	0.0389	0.0341	0.0142	0.0221	0.0260
1994	QRS_NUMR	peak	0.0623	0.0657	0.0810	0.0690	0.0541	0.0524	0.0424	0.0526	0.0493	0.0151	0.0358	0.0306
1994	QRS_NUMR	off-peak	0.0360	0.0368	0.0439	0.0343	0.0269	0.0236	0.0242	0.0363	0.0330	0.0127	0.0222	0.0287
1995	QRS_NUMR	peak	0.0547	0.0601	0.0784	0.0658	0.0536	0.0505	0.0396	0.0474	0.0446	0.0158	0.0302	0.0270
1995	QRS_NUMR	off-peak	0.0354	0.0370	0.0502	0.0399	0.0290	0.0258	0.0241	0.0402	0.0324	0.0126	0.0211	0.0269
1996	QRS_NUMR	peak	0.0585	0.0637	0.0834	0.0735	0.0583	0.0551	0.0446	0.0528	0.0510	0.0173	0.0336	0.0268
1996	QRS_NUMR	off-peak	0.0381	0.0411	0.0521	0.0410	0.0314	0.0284	0.0252	0.0379	0.0356	0.0139	0.0213	0.0261
1997	QRS_NUMR	peak	0.0544	0.0584	0.0751	0.0644	0.0493	0.0479	0.0429	0.0549	0.0465	0.0128	0.0386	0.0282
1997	QRS_NUMR	off-peak	0.0378	0.0396	0.0499	0.0377	0.0310	0.0261	0.0250	0.0365	0.0349	0.0118	0.0193	0.0247
1998	QRS_NUMR	peak	0.0492	0.0507	0.0642	0.0562	0.0453	0.0439	0.0384	0.0516	0.0486	0.0136	0.0388	0.0315
1998	QRS_NUMR	off-peak	0.0333	0.0344	0.0390	0.0308	0.0243	0.0218	0.0203	0.0352	0.0307	0.0124	0.0203	0.0284
1999	QRS_NUMR	peak	0.0484	0.0575	0.0714	0.0588	0.0452	0.0437	0.0334	0.0477	0.0497	0.0124	0.0325	0.0321
1999	QRS_NUMR	off-peak	0.0365	0.0349	0.0388	0.0310	0.0235	0.0214	0.0198	0.0358	0.0364	0.0124	0.0212	0.0289
2000	QRS_NUMR	peak	0.0553	0.0605	0.0730	0.0606	0.0545	0.0480	0.0369	0.0487	0.0488	0.0144	0.0318	0.0281
2000	QRS_NUMR	off-peak	0.0338	0.0371	0.0416	0.0321	0.0282	0.0222	0.0210	0.0338	0.0338	0.0120	0.0215	0.0271
2001	QRS_NUMR	peak	0.0526	0.0566	0.0681	0.0614	0.0467	0.0473	0.0399	0.0511	0.0502	0.0146	0.0345	0.0293
2001	QRS_NUMR	off-peak	0.0317	0.0331	0.0361	0.0298	0.0239	0.0203	0.0188	0.0311	0.0384	0.0117	0.0173	0.0242
2002	QRS_NUMR	peak	0.0501	0.0531	0.0657	0.0477	0.0477	0.0463	0.0390	0.0504	0.0453	0.0136	0.0319	0.0275
2002	QRS_NUMR	off-peak	0.0340	0.0354	0.0437	0.0298	0.0260	0.0207	0.0200	0.0337	0.0334	0.0114	0.0165	0.0251
2003	QRS_NUMR	peak	0.0596	0.0628	0.0738	0.0610	0.0539	0.0489	0.0399	0.0460	0.0407	0.0145	0.0296	0.0254
2003	QRS_NUMR	off-peak	0.0352	0.0354	0.0395	0.0302	0.0248	0.0186	0.0173	0.0317	0.0305	0.0112	0.0167	0.0254
2004	QRS_NUMR	peak	0.0554	0.0595	0.0700	0.0579	0.0519	0.0446	0.0350	0.0460	0.0437	0.0136	0.0318	0.0274
2004	QRS_NUMR	off-peak	0.0324	0.0336	0.0358	0.0274	0.0232	0.0175	0.0170	0.0310	0.0282	0.0112	0.0165	0.0241
2005	QRS_NUMR	peak	0.0580	0.0610	0.0679	0.0558	0.0493	0.0421	0.0337	0.0449	0.0422	0.0128	0.0276	0.0248
2005	QRS_NUMR	off-peak	0.0326	0.0331	0.0340	0.0268	0.0238	0.0193	0.0167	0.0298	0.0291	0.0118	0.0162	0.0231
2006	QRS_NUMR	peak	0.0472	0.0498	0.0559	0.0470	0.0401	0.0363	0.0287	0.0432	0.0420	0.0133	0.0257	0.0247
2006	QRS_NUMR	off-peak	0.0303	0.0302	0.0353	0.0269	0.0228	0.0183	0.0158	0.0291	0.0288	0.0109	0.0153	0.0228
2007	QRS_NUMR	peak	0.0525	0.0573	0.0658	0.0544	0.0416	0.0378	0.0352	0.0465	0.0427	0.0108	0.0286	0.0252
2007	QRS_NUMR	off-peak	0.0307	0.0325	0.0337	0.0252	0.0217	0.0165	0.0163	0.0273	0.0296	0.0112	0.0141	0.0216
2008	QRS_NUMR	peak	0.0494	0.0547	0.0707	0.0590	0.0386	0.0408	0.0349	0.0468	0.0428	0.0113	0.0277	0.0254
2008	QRS_NUMR	off-peak	0.0306	0.0317	0.0361	0.0277	0.0218	0.0180	0.0164	0.0289	0.0314	0.0108	0.0142	0.0203
1990	TRS	peak	3.6760	2.9270	1.4950	1.4870	2.8770	1.8320	1.8440	1.4940	2.7420	4.2730	2.7510	2.5910
1990	TRS	off-peak	4.2920	3.9070	2.1610	2.0420	3.7000	2.7630	3.1870	1.6740	3.3910	6.0990	4.0950	2.5900
1991	TRS	peak	3.8580	3.0710	1.5460	1.5030	2.7920	2.0470	1.9220	1.5220	2.4170	4.7700	2.7800	2.9120
1991	TRS	off-peak	4.3450	3.9210	2.1390	2.1330	3.6220	2.9470	3.1570	1.6830	3.1230	6.4680	4.0200	3.0940
1992	TRS	peak	3.9900	3.2370	1.5190	1.6130	2.9790	2.0900	1.9000	1.5730	2.5760	4.6260	2.6760	2.7850
1992	TRS	off-peak	3.6690	3.6470	1.9730	2.0930	3.1870	2.5860	3.0970	1.4450	3.2840	6.5210	3.9350	2.7530
1993	TRS	peak	3.9840	3.1560	1.6010	1.5160	2.8960	1.9550	1.8000	1.5360	2.5670	5.1360	2.6810	2.7720

		New Engl	Mid Atl	E.N. Cntrl	W.N. Cntrl	S.Atl- FL	E.S. Cntrl	W.S. Cntrl	Mtn- AZNM	WA/OR	Florida	AZ/N M	CA/HI	
		1	2	3	4	5	6	7	8	9	10	11	12	
1993	TRS	off-peak	3.4660	3.7990	2.2280	2.1760	3.4420	2.5520	2.8060	1.6700	2.9370	6.9080	3.8560	2.8690
1994	TRS	peak	4.3200	3.3570	1.7530	1.7100	2.9340	2.1770	1.8680	1.3710	2.7280	4.8060	3.0040	2.8970
1994	TRS	off-peak	4.0480	4.5910	2.4650	2.1150	3.8240	3.2240	3.4930	1.7200	3.1210	6.9390	4.0060	3.2270
1995	TRS	peak	4.3840	3.4580	1.5190	1.7170	2.8970	2.1680	1.9570	1.6400	2.8750	4.7130	3.2000	3.4820
1995	TRS	off-peak	3.9280	4.5050	1.8910	2.2180	3.5490	2.8230	3.3510	2.0110	3.4030	6.8480	4.1980	3.5560
1996	TRS	peak	3.8480	2.9510	1.1980	1.6720	2.4000	1.4720	1.6930	1.3960	2.5840	4.3760	2.2360	2.8240
1996	TRS	off-peak	3.3810	4.0990	2.0690	2.2300	3.7550	2.8310	3.1560	1.8070	2.8590	6.7440	3.4580	3.2030
1997	TRS	peak	4.1520	3.5400	1.6820	1.6830	3.0150	2.1750	1.7270	1.3090	2.4020	4.9070	2.2810	2.6230
1997	TRS	off-peak	3.9500	3.6640	1.9900	2.0120	3.7830	3.1870	3.2030	2.0860	2.6190	7.2690	4.4730	3.2570
1998	TRS	peak	4.1920	3.6370	1.6310	1.8530	2.8100	2.3650	2.2210	1.7530	2.7180	4.9900	2.5800	3.4000
1998	TRS	off-peak	3.8750	4.4150	2.4350	2.5870	4.3290	3.3490	3.7340	2.6690	2.9550	7.0020	5.0260	3.5230
1999	TRS	peak	4.5400	3.5790	1.6090	1.8280	2.2510	2.3340	2.0300	2.0610	2.5170	5.1450	2.9300	3.2050
1999	TRS	off-peak	2.9730	3.9290	2.1630	2.5180	4.1220	3.2540	3.5640	2.4600	2.8430	7.0190	4.1240	2.9570
2000	TRS	peak	3.4780	2.6260	1.3300	1.7640	2.9330	1.9350	1.6290	1.5840	2.4100	4.8420	2.3290	2.7830
2000	TRS	off-peak	3.3290	3.2110	2.1490	2.5550	3.7280	3.3450	3.4710	2.1590	2.8180	7.0260	2.8720	3.1270
2001	TRS	peak	3.2120	2.3090	1.5260	1.6640	2.8370	2.1000	1.8620	1.6630	2.5110	5.4520	2.2250	2.1490
2001	TRS	off-peak	4.9460	4.6330	2.4270	3.1620	4.5320	4.2770	3.8720	3.5840	4.1920	8.9800	4.7060	3.0550
2002	TRS	peak	3.7640	2.7380	1.1940	1.7340	3.3020	2.4890	2.2040	1.8240	3.8420	5.8830	3.6020	2.7520
2002	TRS	off-peak	3.2470	3.7330	1.6310	2.4940	4.2360	3.7710	3.4580	2.6590	3.7140	8.0970	5.1640	2.8060
2003	TRS	peak	2.8990	2.6470	1.2620	1.3670	2.7200	2.0770	1.6310	1.2820	2.4060	5.4760	2.6430	2.6300
2003	TRS	off-peak	5.0460	4.5470	2.4860	2.9230	5.0450	4.2260	4.5170	2.6500	2.8130	9.0950	5.0360	2.8620
2004	TRS	peak	4.2430	3.0180	1.5790	1.7960	3.2720	2.5540	2.0840	1.6130	2.7030	6.2020	2.8610	2.6840
2004	TRS	off-peak	4.3290	4.3030	2.4110	3.0740	5.2460	4.4120	4.6340	2.6030	3.2130	8.9690	5.1570	2.4710
2005	TRS	peak	3.8100	2.7510	1.6910	1.8170	3.5340	3.0220	2.3030	1.9140	3.0020	6.3850	2.9430	2.8880
2005	TRS	off-peak	3.5140	3.6810	2.4400	2.8820	4.8630	4.0820	4.5110	2.6600	3.1680	8.0480	4.4630	2.5390
2006	TRS	peak	4.1674	3.0854	1.8191	2.1886	3.7211	3.1532	2.4995	1.9928	3.2816	7.1162	3.4649	2.8602
2006	TRS	off-peak	4.9894	3.8223	2.6320	3.1132	5.8028	4.5369	5.0629	2.5369	4.0883	9.1225	6.3525	3.1435
2007	TRS	peak	4.2450	2.9210	1.4840	1.9800	4.0090	2.7770	1.8480	1.3170	3.7210	6.5900	3.5560	2.5620
2007	TRS	off-peak	4.5860	4.4580	2.9650	3.8120	6.4080	4.7960	4.6350	2.6640	4.4890	9.2700	6.1070	3.2740
2008	TRS	peak	4.0512	2.7083	1.6148	1.6891	3.6540	2.6547	1.9872	1.3749	3.1634	5.9300	3.1931	2.5593
2008	TRS	off-peak	4.1304	3.9991	3.2474	3.2537	5.1162	4.3193	4.3641	2.1515	2.6637	8.0648	6.1432	3.4586

QRS_NUMR (MMcf/thousand customers), TRS (nom\$/Mcf)

Table F7

Data: Equation for commercial distribution tariffs

Author: Ernest Zampelli, SAIC, with Margaret Leddy, EIA Intern, 2009.

Source: The source for the peak and off-peak data used in this estimation was the *Natural Gas Monthly*, DOE/EIA-0130. State level city gate and commercial prices by month were averaged using quantity-weights to arrive at seasonal (peak and off-peak), regional level (12 NGTDM regions) prices. The quantity-weights for the city gate prices consisted of residential consumption plus commercial consumption that is represented by on-system sales plus industrial consumption that is represented by on-system sales. Historical commercial floorspace data by census division were extracted from the NEMS model and allocated to NGTDM region using Census population figures.

Variables:

- TCM_{r,n,t} = commercial distributor tariff in region r, network n (1987 dollars per Mcf) [DTAR_SF₂]
 - REG_r = 1, if observation is in region r, =0 otherwise
 - PREG_{r,n} = 1, if observation is in region r during peak period (n=1), =0 otherwise
 - QCM_t = commercial gas consumption for region r in year t (Bcf) [BASQTY_SF₂+BASQTY_SI₂]
 - FLR = commercial floorspace for region r in year t (estimated in thousand square feet) [FLRSPC12]
 - r = NGTDM region
 - n = network (1=peak, 2=off-peak)
 - t = year
 - α_r, α_{r,n} = estimated parameters for regional dummy variables [PCMREG11, PCMREGPK11]
 - β₁, β₂ = estimated parameters
 - ρ = autocorrelation coefficient
- [Note: Variables in brackets correspond to comparable variables used in the main body of the documentation and in the model code.]

Derivation: The commercial distributor tariff equation was estimated using panel data for the 12 NGTDM regions over the 1990 to 2008 time period. The equation was estimated in log-linear form with corrections for cross sectional heteroscedasticity and first order serial correlation using TSP version 5.0. The form of the estimated equation follows:

$$\ln TCM_{r,n,t} = \sum_r (\alpha_r * REG_r + \alpha_{r,n} * PREG_{r,n}) + \beta_1 * \ln QCM_{r,t} + \beta_2 * FLR_{r,t} + \rho * \ln TCM_{r,t-1} - \rho * (\sum_r (\alpha_r * REG_r + \alpha_{r,pk} * REG_{r,pk}) + \beta_1 * \ln QCM_{r,t-1} + \beta_2 * FLR_{r,t-1})$$

Regression Diagnostics and Parameter Estimates

FIRST-ORDER SERIAL CORRELATION OF THE ERROR

Objective function: Exact ML (keep first obs.)

Balanced data: NI = 24, T_I = 18, NOB = 456

CONVERGENCE ACHIEVED AFTER 4 ITERATIONS

Dependent Variable: LNTCM87

Number of Observations: 456

Mean of dep. Var.	3.48451	R-squared	0.839823
Std. dev. Of dep. Var.	2.41234	Adjusted R-squared	0.834362
Sum of squared resid.	424.142	Durbin-Watson	1.89992
Variance of resid.	0.963959	Schwarz B.I.	680.019
Std. error of regression	0.981814	Log likelihood	-631.039

	Parameter	Estimate	Standard Error	t-statistic	P-value	Variables
C	WT	-8.0918	0.907329	-8.91826	[.000]	
α_2	MIDATL	-0.326308	0.128571	-2.53796	[.011]	PCMREG11
α_3	ENCNTL	-0.610797	0.072653	-8.40698	[.000]	PCMREG11
α_4	WNCNTL	-0.481121	0.058571	-8.21437	[.000]	PCMREG11
α_5	SATLFL	-0.307471	0.056995	-5.39468	[.000]	PCMREG11
α_7	WSCNTL	-0.589616	0.054402	-10.8382	[.000]	PCMREG11
α_8	MTNAZNM	-0.198443	0.062069	-3.19713	[.001]	PCMREG11
α_9	WAOR	0.181097	0.050697	3.57214	[.000]	PCMREG11
α_{11}	AZNM	0.340494	0.073076	4.65942	[.000]	PCMREG11
$\alpha_{1, pk}$	NE_PK	0.521381	0.062912	8.28745	[.000]	PCMREGPK11
$\alpha_{2, pk}$	MIDATL_PK	0.331471	0.127717	2.59537	[.009]	PCMREGPK11
$\alpha_{4, pk}$	WNCNTL_PK	0.168313	0.059084	2.8487	[.004]	PCMREGPK11
$\alpha_{5, pk}$	SATLFL_PK	0.094251	0.04026	2.34106	[.019]	PCMREGPK11
β_1	LNQCM	-0.255252	0.030113	-8.47648	[.000]	
β_2	LNFLRSPC	0.654472	0.063335	10.3335	[.000]	
P	RHO	0.262602	0.046298	5.672	[.000]	

Data Used for Estimation

			<u>New</u>	<u>E.N.</u>	<u>W.N.</u>	<u>S.Atl.</u>	<u>E.S.</u>	<u>W.S.</u>	<u>Mtn.</u>					
			<u>Engl</u>	<u>Mid Atl</u>	<u>Central</u>	<u>Central</u>	<u>FL</u>	<u>Central</u>	<u>Central</u>	<u>AZNM</u>	<u>WA/OR</u>	<u>Florida</u>	<u>AZ/NM</u>	<u>CA/HI</u>
			<u>1</u>	<u>2</u>	<u>3</u>	<u>4</u>	<u>5</u>	<u>6</u>	<u>7</u>	<u>8</u>	<u>9</u>	<u>10</u>	<u>11</u>	<u>12</u>
1990	QCM	peak	50.702	225.727	363.979	158.78	104.795	64.205	123.073	70.934	31.657	14.377	27.129	124.499
1990	QCM	off-peak	46.197	210.527	272.783	133.9	95.357	52.988	136.534	55.788	27.463	21.929	24.966	162.814
1991	QCM	peak	52.431	240.779	389.764	174.636	119.211	69.138	135.11	77.299	33.212	15.381	27.091	109.933
1991	QCM	off-peak	44.81	205.606	259.876	140.112	104.974	51.969	136.889	59.404	30.854	23.883	25.499	179.823
1992	QCM	peak	58.797	258.729	389.749	160.471	130.872	69.572	129.532	73.593	30.754	16.542	27.587	115.948
1992	QCM	off-peak	54.863	223.63	285.696	136.312	114.759	55.553	144.09	54.01	26.616	25.185	27.386	171.204
1993	QCM	peak	62.955	263.797	417.357	183.552	139.668	74.956	127.876	83.275	37.857	15.877	26.666	109.418
1993	QCM	off-peak	53.941	217.65	285.2	135.19	114.561	58.537	143.033	63.332	29.81	25.274	28.8	142.988
1994	QCM	peak	81.637	277.035	435.558	183.876	140.908	78.309	131.159	79.291	35.082	15.983	25.835	106.205
1994	QCM	off-peak	65.49	216.703	266.294	126.431	112.213	53.953	137.169	64.074	30.86	23.952	28.316	157.984
1995	QCM	peak	76.215	276.423	435.727	179.973	145.808	79.208	138.753	75.801	33.618	16.417	23.874	107.87

1995	QCM	off-peak	67.61	237.63	304.927	141.591	119.43	56.769	161.712	70.048	31.369	23.966	28.27	173.09
1996	QCM	peak	83.827	313.808	472.014	200.78	151.005	87.213	137.639	84.531	39.155	17	26.292	94.063
1996	QCM	off-peak	76.934	244.341	318.668	146.94	127.337	63.481	143.815	70.397	34.581	24.81	29.161	143.137
1997	QCM	peak	87.474	310.615	430.933	177.184	145.461	80.715	150.581	87.898	36.259	14.768	29.735	104.089
1997	QCM	off-peak	86.52	323.091	318.495	131.695	131.57	67.459	165.892	70.361	35.892	21.932	27.8	151.585
1998	QCM	peak	81.016	315.528	377.177	166.759	145.491	73.844	130.091	82.481	39.038	14.951	30.173	103.752
1998	QCM	off-peak	75.129	297.464	271.941	110.653	129.274	58.077	135.423	69.962	32.509	22.708	28.821	180.148
1999	QCM	peak	67.359	338.075	418.183	169.409	149.014	75.425	131.558	77.402	42.437	15.044	28.344	107.393
1999	QCM	off-peak	69.204	329.129	272.593	112.772	124.029	60.734	132.178	69.559	36.808	21.225	30.06	139.057
2000	QCM	peak	73.832	325.878	442.701	176.849	162.458	82.263	142.995	83.228	41.696	18.964	28.655	100.862
2000	QCM	off-peak	65.099	343.864	295.301	117.174	132.34	57.024	149.45	71.213	37.355	28.94	30.492	147.348
2001	QCM	peak	71.523	302.101	425.938	180.594	149.405	80.918	142.139	89.824	43.634	19.51	29.762	101.531
2001	QCM	off-peak	59.804	313.038	264.085	109.585	130.14	55.323	126.901	65.419	41.41	29.776	28.492	146.013
2002	QCM	peak	68.688	312.911	396.521	146.678	156.642	79.205	159.778	90.571	39.305	21.952	29.56	95.781
2002	QCM	off-peak	64.483	331.715	315.57	114.949	130.452	56.679	165.192	71.264	34.864	33.851	27.621	144.247
2003	QCM	peak	71.875	356.411	463.848	183.626	167.751	86.377	160.605	84.059	38.293	21.442	27.868	103.947
2003	QCM	off-peak	58.077	292.065	287.958	114.893	135.926	56.7	152.34	70.774	35.662	32.841	28.169	130.716
2004	QCM	peak	68.893	363.206	440.994	179.74	173.127	81.783	145.987	87.071	40.592	22.459	30.501	99.599
2004	QCM	off-peak	51.264	307.24	275.545	111.692	135.297	57.993	138.538	69.221	34.077	33.862	28.116	133.801
2005	QCM	peak	70.213	327.836	437.907	171.136	172.672	77.357	130.156	86.622	41.084	22.602	28.283	95.392
2005	QCM	off-peak	50.497	262.713	267.596	107.04	136.68	59.729	125.781	72.027	36.292	35.088	27.792	139.528
2006	QCM	peak	615	281.804	370.675	149.732	150.928	70.975	116.586	86.332	42.136	19.713	28.424	98.725
2006	QCM	off-peak	48.961	260.996	283.934	112.054	138.16	56.975	119.799	71.874	37.002	30.912	27.773	147.522
2007	QCM	peak	71.396	320.203	413.106	170.778	166.547	73.67	134.163	94.547	43.895	19.704	30.407	106.351
2007	QCM	off-peak	51.966	277.585	271.611	109.291	139.916	55.854	125.364	68.919	38.797	31.537	27.102	146.576
2008	QCM	peak	70.293	325.242	449.261	188.182	163.287	78.276	134.931	97.198	44.943	19.835	30.333	107.471
2008	QCM	off-peak	53.059	279.316	284.837	117.382	145.067	57.531	132.614	75.535	41.024	30.8	27.407	147.784
1990	TCM	peak	2.813	2.189	1.156	1.045	2.114	1.538	1.23	1.026	1.973	2.081	1.72	2.472
1990	TCM	off-peak	2.267	2.04	1.464	0.841	1.985	1.7	1.206	0.835	2.096	2.091	1.754	1.707
1991	TCM	peak	2.744	2.232	1.219	1.098	2.012	1.676	1.251	1.06	1.853	2.141	1.786	2.901
1991	TCM	off-peak	2.262	2.02	1.508	0.924	1.893	1.751	1.247	0.837	2.022	2.073	1.952	2.075
1992	TCM	peak	2.927	2.366	1.214	1.188	2.131	1.759	1.381	1.088	1.933	2.034	1.735	2.921
1992	TCM	off-peak	1.67	2.016	1.302	0.886	1.656	1.541	1.089	0.576	2.184	2.004	1.635	1.552
1993	TCM	peak	2.766	2.275	1.302	1.139	2.078	1.675	1.337	1.14	1.874	2.508	1.788	3.114
1993	TCM	off-peak	1.158	1.962	1.552	1.065	1.78	1.555	1.14	0.884	1.969	2.577	1.769	2.341
1994	TCM	peak	3.245	2.583	1.461	1.361	2.135	1.912	1.303	0.965	2.053	2.072	2.022	4.214
1994	TCM	off-peak	1.439	2.48	1.74	0.863	1.857	1.862	1.447	0.981	2.022	2.33	2.081	3.367
1995	TCM	peak	3.098	2.591	1.257	1.285	2.11	1.871	1.318	1.216	2.189	2.072	2.183	3.984
1995	TCM	off-peak	1.548	2.409	1.307	1.052	1.819	1.692	1.186	1.344	2.259	2.066	2.137	2.984
1996	TCM	peak	2.678	2.398	0.955	1.308	1.832	1.145	1.146	0.979	1.914	1.895	1.382	3.029
1996	TCM	off-peak	1.284	2.119	1.437	1.076	1.921	1.912	1.172	1.022	1.803	2.303	1.505	2.486
1997	TCM	peak	3.027	2.527	1.4	1.246	2.197	1.746	1.217	0.868	1.609	1.947	1.437	2.989
1997	TCM	off-peak	1.696	1.013	1.395	0.823	2.101	1.992	1.435	1.198	1.62	2.398	1.687	2.48
1998	TCM	peak	2.896	1.996	1.349	1.323	2.146	1.965	1.565	1.314	1.854	2.28	1.838	3.432
1998	TCM	off-peak	1.472	1.511	1.687	1.19	2.218	1.832	1.667	1.776	1.858	2.245	2.288	2.868
1999	TCM	peak	2.777	1.834	1.34	1.342	1.827	1.904	1.321	1.594	1.789	2.281	1.988	2.988
1999	TCM	off-peak	1.43	0.72	1.459	1.041	1.987	1.826	1.525	1.651	1.78	2.275	1.819	2.571
2000	TCM	peak	2.259	2.747	1	1.279	2.095	1.495	0.893	1.118	1.809	1.995	1.156	2.631
2000	TCM	off-peak	0.813	0.605	1.45	1.193	1.899	1.871	1.266	1.271	1.383	1.936	1.172	2.354
2001	TCM	peak	2.098	2.475	1.138	1.21	2.305	1.771	0.929	1.275	1.711	3.091	1.251	2.07
2001	TCM	off-peak	2.078	2.587	1.78	1.632	2.56	2.621	1.571	2.726	2.982	3.909	2.108	2.264
2002	TCM	peak	2.706	1.559	1.149	1.227	2.225	2.076	1.422	1.432	2.871	3.062	2.485	2.427

2002	TCM	off-peak	1.314	1.334	1.297	1.355	2.017	2.278	1.359	1.719	2.31	3.008	2.35	1.829
2003	TCM	peak	2.089	2.276	0.954	0.993	1.803	1.659	1.024	0.864	1.678	2.797	1.556	2.2
2003	TCM	off-peak	3.082	2.185	1.659	1.503	2.311	2.148	1.982	1.721	1.592	3.326	2.066	2.056
2004	TCM	peak	3.193	2.492	1.199	1.325	2.245	1.946	1.419	1.1	2.304	3.214	1.682	2.226
2004	TCM	off-peak	2.287	2.095	1.474	1.438	2.138	2.26	1.918	1.636	2.201	3.257	2.14	1.48
2005	TCM	peak	2.904	2.128	1.219	1.374	2.298	2.567	1.625	1.446	2.097	2.751	1.743	2.493
2005	TCM	off-peak	1.809	1.685	1.291	1.201	1.862	2.202	1.719	1.562	1.68	2.565	1.576	1.542
2006	TCM	peak	2.946	2.283	1.431	1.656	2.37	2.464	1.602	1.565	2.576	3.708	2.171	2.506
2006	TCM	off-peak	2.776	0.888	1.544	1.415	2.637	2.512	2.109	1.688	2.852	3.253	3.197	2.171
2007	TCM	peak	3.096	1.824	1.183	1.529	2.646	2.142	1.172	0.935	2.857	2.81	2.169	2.074
2007	TCM	off-peak	2.425	1.682	1.749	1.809	2.563	2.807	1.735	1.789	3.096	3.261	2.813	2.199
2008	TCM	peak	2.844	1.496	1.188	1.338	2.21	2.098	1.18	1.001	2.283	2.79	1.733	2.195
2008	TCM	off-peak	2.318	1.474	2.178	1.547	1.79	2.553	1.447	1.241	1.311	3.016	2.834	2.523
1990	FLR	peak	2.506	6.547	8.226	3.54	5.906	2.749	5.426	1.738	1.747	2.463	1.047	5.307
1990	FLR	off-peak	2.506	6.547	8.226	3.54	5.906	2.749	5.426	1.738	1.747	2.463	1.047	5.307
1991	FLR	peak	2.525	6.615	8.346	3.584	6.092	2.792	5.477	1.8	1.866	2.499	1.047	5.381
1991	FLR	off-peak	2.525	6.615	8.346	3.584	6.092	2.792	5.477	1.8	1.866	2.499	1.047	5.381
1992	FLR	peak	2.539	6.667	8.45	3.624	6.207	2.825	5.532	1.838	1.922	2.562	1.057	5.465
1992	FLR	off-peak	2.539	6.667	8.45	3.624	6.207	2.825	5.532	1.838	1.922	2.562	1.057	5.465
1993	FLR	peak	2.555	6.694	8.538	3.662	6.311	2.859	5.601	1.877	1.942	2.605	1.07	5.556
1993	FLR	off-peak	2.555	6.694	8.538	3.662	6.311	2.859	5.601	1.877	1.942	2.605	1.07	5.556
1994	FLR	peak	2.566	6.73	8.637	3.698	6.42	2.9	5.668	1.925	1.976	2.645	1.089	5.618
1994	FLR	off-peak	2.566	6.73	8.637	3.698	6.42	2.9	5.668	1.925	1.976	2.645	1.089	5.618
1995	FLR	peak	2.582	6.76	8.755	3.746	6.532	2.95	5.762	1.971	2.029	2.698	1.12	5.658
1995	FLR	off-peak	2.582	6.76	8.755	3.746	6.532	2.95	5.762	1.971	2.029	2.698	1.12	5.658
1996	FLR	peak	2.601	6.802	8.881	3.803	6.677	3.012	5.864	2.019	2.096	2.758	1.159	5.691
1996	FLR	off-peak	2.601	6.802	8.881	3.803	6.677	3.012	5.864	2.019	2.096	2.758	1.159	5.691
1997	FLR	peak	2.625	6.844	9.014	3.857	6.838	3.084	5.963	2.084	2.163	2.825	1.195	5.719
1997	FLR	off-peak	2.625	6.844	9.014	3.857	6.838	3.084	5.963	2.084	2.163	2.825	1.195	5.719
1998	FLR	peak	2.651	6.898	9.16	3.92	7.026	3.161	6.089	2.153	2.215	2.911	1.235	5.801
1998	FLR	off-peak	2.651	6.898	9.16	3.92	7.026	3.161	6.089	2.153	2.215	2.911	1.235	5.801
1999	FLR	peak	2.698	6.967	9.333	3.995	7.254	3.243	6.247	2.249	2.274	3.005	1.286	5.933
1999	FLR	off-peak	2.698	6.967	9.333	3.995	7.254	3.243	6.247	2.249	2.274	3.005	1.286	5.933
2000	FLR	peak	2.739	7.054	9.526	4.081	7.353	3.328	6.447	2.274	2.095	3.275	1.403	6.315
2000	FLR	off-peak	2.739	7.054	9.526	4.081	7.353	3.328	6.447	2.274	2.095	3.275	1.403	6.315
2001	FLR	peak	2.792	7.148	9.719	4.176	7.591	3.427	6.628	2.362	2.143	3.397	1.456	6.481
2001	FLR	off-peak	2.792	7.148	9.719	4.176	7.591	3.427	6.628	2.362	2.143	3.397	1.456	6.481
2002	FLR	peak	2.854	7.258	9.902	4.255	7.83	3.515	6.812	2.438	2.196	3.525	1.509	6.642
2002	FLR	off-peak	2.854	7.258	9.902	4.255	7.83	3.515	6.812	2.438	2.196	3.525	1.509	6.642
2003	FLR	peak	2.897	7.354	10.059	4.344	8.026	3.587	6.983	2.504	2.241	3.629	1.558	6.78
2003	FLR	off-peak	2.897	7.354	10.059	4.344	8.026	3.587	6.983	2.504	2.241	3.629	1.558	6.78
2004	FLR	peak	2.933	7.438	10.205	4.414	8.203	3.656	7.146	2.557	2.255	3.76	1.611	6.921
2004	FLR	off-peak	2.933	7.438	10.205	4.414	8.203	3.656	7.146	2.557	2.255	3.76	1.611	6.921
2005	FLR	peak	2.971	7.509	10.359	4.482	8.375	3.727	7.297	2.604	2.314	3.884	1.675	7.018
2005	FLR	off-peak	2.971	7.509	10.359	4.482	8.375	3.727	7.297	2.604	2.314	3.884	1.675	7.018
2006	FLR	peak	3.02	7.591	10.538	4.551	8.596	3.804	7.456	2.686	2.354	3.986	1.727	7.142
2006	FLR	off-peak	3.02	7.591	10.538	4.551	8.596	3.804	7.456	2.686	2.354	3.986	1.727	7.142
2007	FLR	peak	3.056	7.676	10.706	4.62	8.859	3.883	7.619	2.786	2.417	4.076	1.775	7.247
2007	FLR	off-peak	3.056	7.676	10.706	4.62	8.859	3.883	7.619	2.786	2.417	4.076	1.775	7.247
2008	FLR	peak	3.097	7.758	10.891	4.69	9.086	3.961	7.808	2.876	2.459	4.181	1.832	7.372
2008	FLR	off-peak	3.097	7.758	10.891	4.69	9.086	3.961	7.808	2.876	2.459	4.181	1.832	7.372

Table F8

Data: Equation for electric generator distribution tariffs or markups.

Author: Ernest Zampelli, SAIC, 2008.

Source: The original source for the natural gas prices to electric generators used with city gate prices to calculate markups was the *Electric Power Monthly*, DOE/EIA-0226. The original source for the rest of the data used was the *Natural Gas Monthly*, DOE/EIA-0130, with heating degree data from the National Oceanic and Atmospheric Administration. State level city gate and electric generator prices by month were averaged using quantity-weights to arrive at seasonal (peak and off-peak), regional level (12 NGTDM and 16 NGTDM/EMM regions, respectively) prices. The quantity-weights for the city gate prices consisted of residential consumption plus commercial consumption that is represented by on-system sales plus industrial consumption that is represented by on-system sales. The consumption data were generated within the historical routines in the NEMS system based on state level data from the original source; and therefore may differ from the original source.

Variables:

- MARKUP_{r,t} = electric generator distributor tariff (or markup) in region r, year t (1987 dollars per Mcf) [UDTAR_SF]
- QELEC_{r,t} = electric generator consumption of natural gas [sum of BASUQTY_SF and BASUQTY_SI]
- HDD_{r,t} = number of heating degree days in the period in region r, year t
- REG_r = 1, if observation is in region r, =0 otherwise
- OTHR(NGT) = non-electric natural gas deliveries
- OTHLAG(NGT) = non-electric natural gas deliveries in the previous year
- β_{0,r} = coefficient on REG_r [PELREG20 or PELREG25 equivalent to the product of REG_r and β_{0r}]
- β₀, β₁ = Estimated parameters
- ρ = autocorrelation coefficient
- r = NGTDM/EMM region
- t = year
- n = season (1=peak, 2=off-peak)

[Note: Variables in brackets correspond to comparable variables used in the main body of the documentation and/or in the model code.]

Derivation: The peak and off-peak electric markup equations were estimated using panel data for the 16 EMM regions over the 1990 to 2008 time period. The equations were estimated in linear form allowing for region-specific intercepts and with corrections for cross sectional heteroscedasticity and first order serial correlation using TSP version 5.0. Because the reported point estimates of the parameters yielded projections of the electric generator distributor tariffs that were considered inconsistent with analyst's expectations (i.e., that did not align well with more recent historical levels), the constant term in each equation was adjusted within either one or

one half of a standard deviation of the error, well within the 95% confidence interval limits for the parameters.

Peak Equation

$$\text{MARKUP}_{r,t} = \beta_0 + \sum_r \beta_{0r} \text{REG}_r + \beta_1 \text{share}_{r,t} + \rho * \text{MARKUP}_{r,t-1} - \rho * (\beta_0 + \sum_r \beta_{0r} \text{REG}_r + \beta_1 \text{share}_{r,t-1})$$

(all parameters, data, and variables representing the peak period)

Off-peak Equation

$$\text{MARKUP}_{r,t} = \beta_0 + \sum_r \beta_{0r} \text{REG}_r + \beta_1 \text{QELEC}_{r,t} + \rho * \text{MARKUP}_{r,t-1} - \rho * (\beta_0 + \sum_r \beta_{0r} \text{REG}_r + \beta_1 \text{QELEC}_{r,t-1})$$

(all parameters, data, and variables representing the off-peak period)

Regression Diagnostics and Parameter Estimates

For Peak Equation

FIRST-ORDER SERIAL CORRELATION OF THE ERROR

Balanced data: N=16, T_I= 18, NOB= 304
Objective function: Exact ML (keep first obs.)

CONVERGENCE ACHIEVED AFTER 4 ITERATIONS

Dependent Variable: TEU87
Number of observations: 304

	Mean of dep. Var.	-0.69339		R-squared	0.358124
	Std. dev. Of dep. Var.	1.21166		Adjusted R-squared	0.340717
	Sum of squared resid.	285.87		Durbin-Watson	1.91736
	Variance of resid.	0.96905		Schwarz B.I.C.	447.801
	Std. error of regression	0.984404		Log Likelihood	-422.074
	Parameter	Estimate	Standard Error	t-statistic	P-value
C	WT	-0.264537	0.052096	-5.07788	[.000]
α1	REG1	-0.496555	0.17424	-2.84983	[.004] PELREG25
α3	REG3	-0.352125	0.108191	-3.25465	[.001] PELREG25
α4	REG4	-0.872404	0.144407	-6.0413	[.000] PELREG25
α8	REG8	-0.667624	0.19435	-3.43517	[.001] PELREG25
α10	REG10	-0.459666	0.193645	-2.37376	[.018] PELREG25
α11	REG11	-0.375593	0.085025	-4.41745	[.000] PELREG25
β1	ELEC_SHARE	0.963446	0.273532	3.52224	[.000]
ρ	RHO	0.211449	0.057325	3.68862	[.000]

For Off-peak Equation

FIRST-ORDER SERIAL CORRELATION OF THE ERROR

Balanced data: N= 16, T_I=18, NOB= 288
 Objective function: Exact ML (keep first obs.)

CONVERGENCE ACHIEVED AFTER 5 ITERATIONS

Dependent variable: MARKUP
 Number of observations: 288

Mean of dep. var. = -1.52068	R-squared = .667839
Std. dev. of dep. var. = 1.66638	Adjusted R-squared = .654601
Sum of squared residuals = 264.732	Durbin-Watson = 1.87093
Variance of residuals = .959173	Schwarz B.I.C. = 430.662
Std. error of regression = .979374	Log likelihood = -396.685

Parameter	Estimate	Standard Error	t-statistic	P-value
WT	-0.2982	0.06571	-4.5378	[.000]
REG1	-1.1393	0.15459	-7.3698	[.000]
REG2	-0.6786	0.15169	-4.4736	[.000]
REG4	-1.026	0.1156	-8.8755	[.000]
REG5	-0.5697	0.08329	-6.8402	[.000]
REG6	-0.3031	0.08475	-3.5761	[.000]
REG7	-0.2447	0.16265	-1.5045	[.132]
REG9	-0.2774	0.13812	-2.0087	[.045]
REG10	-0.522	0.11727	-4.4513	[.000]
REG11	-1.0502	0.23763	-4.4194	[.000]
QELEC	7.40E-04	1.93E-04	3.82549	[.000]
RHO	0.29067	0.05828	4.98768	[.000]

Data used for estimation

YEAR	REG	Peak		Off-Peak		REG	Peak		Off-peak	
		TEU87	SHARE	TEU87	QELEC		TEU87	SHARE	TEU87	QELEC
1990	1	-0.3776	0.0240	-0.6636	4345	9	-0.3358	0.0007	-0.4524	113
1991	1	-0.2599	0.0248	-0.8933	4821	9	-0.1057	0.0005	-1.1455	88
1992	1	-0.3759	0.0062	-0.7928	1384	9	-0.3427	0.0004	-0.7484	85
1993	1	-0.5677	0.0159	-1.1712	3842	9	0.3827	0.0003	-1.4410	54
1994	1	-0.5948	0.0131	-1.6324	3486	9	0.2313	0.0006	-1.1701	119
1995	1	-0.8356	0.0546	-1.5811	14407	9	0.0990	0.0017	-0.3127	381

YEAR	REG	Peak		Off-Peak		REG	Peak		Off-peak	
		TEU87	SHARE	TEU87	QELEC		TEU87	SHARE	TEU87	QELEC
1996	1	-0.5154	0.0506	-1.3731	13409	9	-0.3626	0.0020	-0.3659	472
1997	1	-0.7841	0.1762	-1.2256	51998	9	-0.3732	0.0021	-0.5354	479
1998	1	-0.4431	0.2022	-1.3809	58557	9	0.2060	0.0030	-0.7031	645
1999	1	-1.7138	0.1059	-1.2938	26046	9	-0.2067	0.0041	-0.3726	904
2000	1	-2.1179	0.1659	-1.4535	48407	9	-0.6076	0.0111	-0.0934	2628
2001	1	-1.3220	0.2463	-2.3777	75438	9	-1.2304	0.0030	-0.5441	660
2002	1	-0.5510	0.3187	-1.3401	106290	9	-0.7063	0.0104	-0.2300	2379
2003	1	-0.0508	0.2835	-0.3563	94894	9	0.3232	0.0147	-0.2210	3573
2004	1	0.0713	0.3181	-1.2976	104762	9	-0.4556	0.0109	-0.2360	2471
2005	1	0.0906	0.2894	-1.0141	95785	9	0.4537	0.0144	-0.2235	3166
2006	1	-1.3922	0.3374	-1.5311	102425	9	-0.9647	0.0128	-0.5969	2513
2007	1	-0.0675	0.3118	-1.2133	105040	9	-0.5895	0.0198	-0.7896	4159
2008	1	0.2135	0.3174	-0.8076	105523	9	0.0013	0.0198	0.3821	4361
1990	2	-0.0107	0.0563	-0.9667	49269	10	-1.1285	0.0710	-1.3298	11601
1991	2	-0.1006	0.0585	-1.0496	53774	10	-1.0794	0.0902	-1.0473	15411
1992	2	-0.2725	0.0558	-0.9097	56615	10	-1.1691	0.0887	-1.2022	15977
1993	2	-0.2040	0.0437	-0.8994	45929	10	-0.3487	0.0428	-0.4562	7757
1994	2	-0.4703	0.0323	-1.0273	35946	10	-0.5402	0.0874	-1.0983	16180
1995	2	-0.4694	0.0606	-0.9506	68709	10	-0.5420	0.1461	-1.0356	30229
1996	2	0.3468	0.0196	-0.6823	23078	10	0.8741	0.0731	-0.7603	14330
1997	2	-0.4063	0.0956	-0.8097	111473	10	-0.6502	0.0744	-0.8224	14076
1998	2	-0.5986	0.0986	-0.8395	108448	10	-0.5702	0.0849	-0.7017	15755
1999	2	-0.3547	0.0938	-1.3048	108385	10	-0.4756	0.1353	-0.6058	28161
2000	2	-0.0545	0.1051	-1.3121	120398	10	-0.5729	0.1534	-0.5650	34599
2001	2	-0.5208	0.1064	-1.9690	114877	10	-1.8635	0.1925	-1.5269	40322
2002	2	-0.7295	0.1348	-0.8053	147720	10	-0.8261	0.3100	-0.5549	75764
2003	2	0.7224	0.0956	-0.3709	114636	10	0.2848	0.2407	-0.5898	54492
2004	2	0.2898	0.1006	-0.4469	118317	10	-0.2572	0.2586	-0.4052	58439
2005	2	0.3364	0.1030	0.1603	118810	10	0.9032	0.2677	0.2278	57967
2006	2	-0.7705	0.1367	-1.5230	139218	10	-1.5477	0.2422	-1.1642	46825
2007	2	-0.6196	0.1480	-1.4009	173475	10	-0.6116	0.3571	-0.8465	84512
2008	2	-0.2222	0.1629	-0.3571	192761	10	-0.3350	0.3861	-0.2874	96870
1990	3	-0.0265	0.0004	-0.8098	150	11	-0.5675	0.2121	-0.6391	348317
1991	3	-0.6868	0.0011	-0.9863	453	11	-0.5143	0.2035	-0.4949	345670
1992	3	-0.8750	0.0023	-1.3215	933	11	-0.4206	0.2065	-0.4435	358236
1993	3	-1.0333	0.0029	-0.6591	1267	11	-0.4045	0.1966	-0.4175	347802
1994	3	-0.1275	0.0018	-0.2724	803	11	-0.3912	0.1941	-0.3629	351650
1995	3	-0.8519	0.0018	-1.3085	852	11	-0.5645	0.2084	-0.4944	385006
1996	3	-0.0274	0.0009	-1.5881	441	11	-0.2522	0.1781	-0.2774	345742
1997	3	-0.8091	0.0009	-1.6772	390	11	-0.7086	0.1951	-0.3869	378755
1998	3	-0.6048	0.0022	-1.1771	905	11	-0.2427	0.2101	-0.1021	393645
1999	3	-0.7432	0.0047	-2.1856	2044	11	-0.3645	0.2489	-0.2033	449101
2000	3	-1.3201	0.0051	-1.5505	2425	11	-0.1223	0.2588	-0.1690	505658
2001	3	-0.9225	0.0030	-0.8115	1314	11	-0.8772	0.2478	-0.6591	473729
2002	3	-0.5962	0.0049	-1.1389	1997	11	-0.4203	0.2750	-0.2707	535955
2003	3	-0.3611	0.0080	-0.8236	3748	11	0.2046	0.2715	0.0315	519099
2004	3	-0.5225	0.0064	-1.0625	2867	11	-0.2933	0.2735	-0.0881	504805
2005	3	-0.4296	0.0110	-1.6976	4946	11	-0.0184	0.3066	-0.1750	509138
2006	3	-1.0412	0.0074	-0.1217	2708	11	-0.6854	0.3050	-0.3899	476923
2007	3	-0.4863	0.0154	-0.6384	6512	11	-0.5395	0.3201	-0.5404	556944

YEAR	REG	Peak		Off-Peak		REG	Peak		Off-peak	
		TEU87	SHARE	TEU87	QELEC		TEU87	SHARE	TEU87	QELEC
2008	3	-0.3776	0.0156	0.2198	6740	11	-0.4538	0.3166	-0.5462	553098
1990	4	-2.1274	0.0115	-1.6134	12507	12	-0.4119	0.0018	-0.6195	109
1991	4	-1.5598	0.0122	-1.3796	14257	12	0.1272	0.0011	1.0563	75
1992	4	-1.5923	0.0149	-1.6131	17570	12	0.9492	0.0007	0.0295	52
1993	4	-1.4748	0.0100	-1.4627	12607	12	0.7199	0.0014	0.4487	113
1994	4	-1.2284	0.0150	-1.2438	19761	12	-0.5903	0.0024	-0.5528	190
1995	4	-0.8665	0.0188	-1.0598	24476	12	5.1529	0.0012	1.2524	94
1996	4	-1.1738	0.0118	-0.8669	16247	12	3.9574	0.0023	1.6101	201
1997	4	-1.6262	0.0448	-1.3612	58118	12	-1.2722	0.0082	-0.7548	714
1998	4	-1.1334	0.0501	-0.7509	57723	12	0.1028	0.0092	-0.9030	834
1999	4	-0.7200	0.0442	-0.8226	56207	12	-1.5781	0.0081	-1.4508	662
2000	4	-0.5579	0.0479	-0.6756	62975	12	-1.8280	0.0095	-1.3530	858
2001	4	-1.4547	0.0455	-0.5776	55548	12	-1.4727	0.0337	-1.0640	2970
2002	4	-0.2397	0.0568	-0.2338	68645	12	0.6778	0.0229	0.3778	2007
2003	4	-0.9889	0.0473	-0.6059	62462	12	0.3199	0.0457	0.3274	4011
2004	4	-0.9718	0.0541	-1.0969	69588	12	-0.7440	0.0543	-1.0013	4912
2005	4	-1.0366	0.0500	-1.1807	63610	12	-0.2162	0.0502	-0.7381	4504
2006	4	-1.4649	0.0448	-0.5929	47859	12	-0.1508	0.0320	-0.1487	2901
2007	4	-0.7135	0.0632	-0.4266	77514	12	-0.3193	0.0506	-0.1088	4979
2008	4	-0.0133	0.0584	0.5851	74105	12	0.0244	0.0558	-0.1369	5648
1990	5	-0.6044	0.0112	-0.8672	6373	13	-0.4834	0.0325	-1.3436	6024
1991	5	-0.5815	0.0133	-0.9330	8286	13	-1.0272	0.0320	-1.7432	6670
1992	5	-0.4839	0.0109	-0.8619	6399	13	-1.0099	0.0382	-1.8802	7817
1993	5	-0.4073	0.0081	-0.7009	5385	13	-0.3530	0.0408	-0.7985	9414
1994	5	-0.3821	0.0094	-1.0542	6504	13	-0.6805	0.0400	-1.2303	8987
1995	5	-0.4791	0.0138	-0.8840	9114	13	-0.7448	0.0656	-0.8361	14538
1996	5	-0.1446	0.0093	-0.9667	6650	13	-0.1907	0.0503	-0.4411	12223
1997	5	-0.5892	0.0106	-1.1793	7062	13	-0.5944	0.0901	-0.3939	22609
1998	5	-0.3021	0.0109	-0.8913	6674	13	-0.4387	0.1094	-0.0344	28589
1999	5	-0.4403	0.0177	-0.8039	11065	13	-0.0457	0.1414	-0.0173	35236
2000	5	-0.5165	0.0222	-0.8477	14453	13	1.1555	0.1872	0.3177	53316
2001	5	-1.1987	0.0199	-0.9580	12861	13	0.5444	0.2096	0.7702	71984
2002	5	-0.4654	0.0246	-0.5629	15274	13	0.5517	0.1870	0.5187	60221
2003	5	0.2322	0.0189	-0.3846	12589	13	0.5313	0.2006	0.4560	61671
2004	5	-0.2098	0.0240	-0.6909	15570	13	-0.0507	0.2005	0.4308	63763
2005	5	0.1001	0.0354	-1.1634	22697	13	0.0616	0.2336	0.5676	78793
2006	5	-0.6295	0.0297	-0.9116	17160	13	-0.6198	0.2520	-1.0588	86810
2007	5	-0.2002	0.0558	-0.6816	38129	13	-0.8638	0.2715	-0.7843	103729
2008	5	-0.0137	0.0509	-0.2921	37600	13	-0.1040	0.2686	-0.0193	106092
1990	6	0.2038	0.0140	-0.6493	4929	14	-0.1395	0.1373	-0.5886	12438
1991	6	-0.1078	0.0214	-0.9051	7745	14	-0.6790	0.1167	-0.8818	10493
1992	6	-0.0012	0.0233	-0.6984	9267	14	-0.3219	0.1210	-0.4044	11050
1993	6	-0.0136	0.0282	-0.6736	11985	14	-0.0845	0.1334	-0.2063	11940
1994	6	-0.2279	0.0282	-0.9668	12285	14	-0.1570	0.1453	-0.1683	13070
1995	6	-0.1256	0.0394	-0.7109	17900	14	-0.1221	0.1457	-0.1606	12795
1996	6	-0.0171	0.0198	-0.6932	9242	14	0.4377	0.1093	0.1891	10038
1997	6	-0.5760	0.0255	-0.9110	11761	14	-0.0253	0.1218	-0.1975	12934
1998	6	-0.0218	0.0244	-0.9378	10608	14	0.0794	0.1593	-0.0766	18096
1999	6	-0.0604	0.0395	-0.8253	18558	14	-0.0450	0.2056	-0.0884	22906
2000	6	-0.7373	0.0370	-0.5195	18430	14	0.2735	0.2735	0.0600	33130

YEAR	REG	Peak		Off-Peak		REG	Peak		Off-peak	
		TEU87	SHARE	TEU87	QELEC		TEU87	SHARE	TEU87	QELEC
2001	6	0.1141	0.0274	-1.2246	11734	14	-0.0712	0.3410	-0.3330	49709
2002	6	-0.3073	0.0512	-0.7477	24047	14	0.3820	0.3351	-0.1146	45071
2003	6	0.0588	0.0388	-0.6174	19583	14	0.2793	0.3563	0.3409	46914
2004	6	-0.5580	0.0590	-0.9295	30136	14	0.1486	0.4207	0.1920	68621
2005	6	-0.4221	0.0734	-0.6883	37750	14	0.5664	0.4064	0.5221	58711
2006	6	-1.2810	0.0590	-0.7176	25542	14	-0.2429	0.4527	-0.2404	69334
2007	6	-0.0019	0.0871	-0.5499	42601	14	0.0410	0.4621	-0.4749	79295
2008	6	0.3521	0.0802	-0.3612	37951	14	0.0178	0.4964	0.6378	90767
1990	7	-0.0453	0.0007	-0.1941	94	15	-0.3131	0.0183	-0.3618	2164
1991	7	-0.3702	0.0006	-0.1823	86	15	0.0880	0.0165	-0.2904	2058
1992	7	0.2260	0.0003	-0.3439	40	15	-0.2000	0.0408	0.4600	5139
1993	7	0.3665	0.0007	-0.5390	113	15	0.4863	0.0787	-0.0494	12225
1994	7	0.3347	0.0013	-0.1948	206	15	-0.3489	0.0712	-0.2117	10910
1995	7	1.4987	0.0016	-0.1880	260	15	-0.2892	0.0505	-0.1407	7633
1996	7	1.3261	0.0010	-0.5806	169	15	0.5601	0.0031	-0.2264	503
1997	7	-0.1494	0.0020	-1.0593	324	15	-0.0408	0.0443	0.6377	7463
1998	7	-1.1704	0.0053	-0.1256	845	15	-0.3494	0.0831	-0.3317	16441
1999	7	-1.0622	0.0041	-1.2579	683	15	-0.1439	0.0623	-0.2291	12472
2000	7	0.5974	0.0038	-0.4311	676	15	-0.0529	0.1564	0.2409	30436
2001	7	-1.0344	0.0118	-1.2510	1815	15	-0.0513	0.2538	0.2362	55814
2002	7	-0.1346	0.0264	-0.9353	4295	15	-0.4371	0.2182	-1.0368	43369
2003	7	-0.0972	0.0292	-0.0723	5169	15	-0.2051	0.2274	-0.8783	43328
2004	7	-0.2099	0.0378	-0.2033	6873	15	-0.7553	0.2481	-0.9003	51717
2005	7	0.2544	0.0693	0.4930	12391	15	-0.5195	0.2752	-0.8339	59457
2006	7	-1.6609	0.0807	-0.6130	12976	15	-1.1716	0.1930	-1.4609	38736
2007	7	-0.2912	0.1255	-0.4200	21396	15	-0.7815	0.2225	-1.0760	47994
2008	7	0.7825	0.1221	0.2443	21532	15	-0.6074	0.3023	-0.8074	75889
1990	8	-0.1527	0.5088	-0.1152	53286	16	0.7132	0.1594	0.2657	112091
1991	8	-0.3576	0.5238	-0.2468	57485	16	0.6437	0.1997	0.3323	143281
1992	8	-0.5670	0.4991	-0.1678	54046	16	0.1166	0.2203	0.0194	168049
1993	8	-0.3808	0.4361	-0.2548	44256	16	0.2366	0.2204	0.0718	169302
1994	8	-0.5493	0.4061	-0.4092	45372	16	-0.0507	0.2318	-0.0039	176595
1995	8	-0.4050	0.4837	-0.3658	69305	16	0.3856	0.1739	0.0835	118577
1996	8	-0.2264	0.4500	-0.4308	58986	16	0.4178	0.1109	0.0647	70594
1997	8	-1.4694	0.5834	-1.0501	88893	16	0.1536	0.1797	-0.1570	129870
1998	8	-1.0010	0.5625	-0.8253	80992	16	0.4012	0.2478	0.3339	206154
1999	8	-0.4457	0.5590	-0.2673	83337	16	0.2705	0.3143	-0.0417	279871
2000	8	-0.7927	0.6378	-0.4285	109654	16	2.5255	0.2874	0.2525	234992
2001	8	-1.0325	0.6003	-0.3797	88543	16	1.3570	0.3455	1.4798	313455
2002	8	0.2722	0.6850	0.1990	128140	16	0.6568	0.2671	0.4133	220247
2003	8	0.2109	0.7242	0.0726	146449	16	0.4043	0.2566	0.1331	209051
2004	8	-0.2426	0.7347	-0.0193	151060	16	-0.0914	0.2625	-0.1212	229231
2005	8	-0.6949	0.7502	-0.4298	162118	16	0.4505	0.2500	-0.2700	204659
2006	8	-0.2976	0.7793	0.3766	184654	16	-0.5448	0.2636	0.1449	214445
2007	8	0.7957	0.7895	0.8910	190563	16	-0.0668	0.2760	-0.1310	236331
2008	8	0.4678	0.7967	0.3156	209708	16	0.0072	0.2927	0.0054	262782

Table F11

Data: Equation for base price on natural gas supply curves

Author: Dana Van Wagener, EI-83, 2008.

Source: Natural gas price data from EIA's *Natural Gas Annual*, DOE/EIA-0131. Drilling cost data from the Joint Association Survey of the American Petroleum Institute. Total reserves data came from EIA's *U.S. Crude Oil, Natural Gas, and Natural Gas Liquids Reserves*, (DOE/EIA-0216), with unconventional reserves from Office of Integrated Analysis and Forecasting. Heating degree data and international refinery acquisition prices from EIA's *Annual Energy Review*, (DOE/EIA-0384). The values for 2008 represent best estimates based on available monthly data and the *Short-Term Energy Outlook* projections at the time.

Variables:

- PBASE = base wellhead price for gas supply curve (1987 dollars per Mcf)
- ZWPRLAG = annual lagged value of PBASE (1987 dollars per Mcf)
- UGRRSSHR = share of gas reserves from unconventional sources (fraction)
- UGRESSHRLAG = annual lagged value of UGRESSHR (fraction)
- oEXSPEND = national average drilling cost per well (1987 dollars)
- HDD = heating degree-days
- ZOGRESNG = beginning-of-year natural gas reserves (Bcf)
- ZOGRESNGLAG = annual lagged value of ZOGRESNG (Bcf)
- oIT_WOP = international refinery acquisition price (1987\$/bbl)
- r = supply region
- t = year
- α = estimated parameters
- ρ = autocorrelation coefficient

Derivation: Using TSP version 5.0 and data from 1990 through 2008, the following equation was estimated in log-linear form using ordinary least squares regression, with a correction for autocorrelation:

$$\ln PBASE = CNST + (\alpha_1 * \ln UGRESSHR) + \alpha_2 * \ln oEXSPEND_{t-1} + (\alpha_3 * \ln HDD_t) + (\alpha_4 * \ln ZOGRESNG_r) + (\alpha_5 * \ln oIT_WOP_t) + (\rho * ZWPRLAG_r) + (-\rho) * \{CNST + (\alpha_1 * \ln UGRESSHRLAG) + \alpha_2 * \ln oEXSPEND_{t-2} + (\alpha_3 * \ln HDD_{t-1}) + (\alpha_4 * \ln ZOGRESNGLAG_r) + (\alpha_5 * \ln oIT_WOP_{t-1})\}$$

Regression Diagnostics and Parameter Estimates

Dependent variable: lnPBASE

Number of observations: 324

Mean of dep. var. = 4.18945	R-squared = .878705
Std. dev. of dep. var. = 2.67566	Adjusted R-squared = .876409
Sum of squared residuals = 280.814	Durbin-Watson = 1.95162
Variance of residuals = .885850	Schwarz B.I.C. = 455.986
Std. error of regression = .941196	Log likelihood = -435.753

Parameter	Estimate	Standard Error	t-statistic	P-value
CONST	-10.67	2.49141	-4.2827	[.000]
α_1	0.6338	0.15979	3.96661	[.000]
α_2	0.19049	0.09567	1.99107	[.046]
α_3	0.88291	0.29128	3.03114	[.002]
α_4	-0.0143	0.00888	-1.6048	[.109]
α_5	0.27902	0.05536	5.03965	[.000]
P	0.39835	0.05604	7.10837	[.000]

Data used for estimation

T	r	PBASE	UGRSH	EXPEND	HDD	RESNG	IT_WOP	r	PBASE	UGRSH	EXPEND	HDD	RESNG	IT_WOP
1990	2	2.091	23.461	5926050	4016	1987	18.465	11	1.408	23.461	5926050	4016	7123	18.465
1991	2	1.901	22.282	5616970	4200	2051	14.464	11	1.378	22.282	5616970	4200	7421	14.464
1992	2	1.689	23.866	4136156	4441	1940	14.152	11	1.500	23.866	4136156	4441	6932	14.152
1993	2	2.209	24.466	4561994	4700	1847	12.397	11	1.731	24.466	4561994	4700	6749	12.397
1994	2	2.190	27.257	4472175	4483	1973	11.867	11	1.533	27.257	4472175	4483	6576	11.867
1995	2	2.196	26.762	4572795	4531	2031	12.970	11	1.279	26.762	4572795	4531	6478	12.970
1996	2	1.981	28.374	7342492	4713	1641	15.219	11	1.786	28.374	7342492	4713	6138	15.219
1997	2	2.015	31.572	8567128	4542	1878	13.317	11	1.903	31.572	8567128	4542	6629	13.317
1998	2	1.996	33.124	7927718	3951	1983	8.401	11	1.563	33.124	7927718	3951	6287	8.401
1999	2	1.657	33.819	5663539	4169	1978	12.184	11	1.728	33.819	5663539	4169	5743	12.184
2000	2	2.817	37.737	9631812	4460	1888	19.201	11	2.877	37.737	9631812	4460	6473	19.201
2001	2	3.663	41.734	14786824	4203	1904	14.554	11	2.945	41.734	14786824	4203	7616	14.554
2002	2	2.402	45.826	12630281	4273	1919	16.289	11	2.220	45.826	12630281	4273	8172	16.289
2003	2	4.100	46.479	16127725	4459	2394	18.633	11	3.564	46.479	16127725	4459	9028	18.633
2004	2	4.679	49.542	27146222	4290	2689	23.309	11	3.899	49.542	27146222	4290	9720	23.309
2005	2	5.292	52.653	33473882	4315	2560	31.652	11	4.889	52.653	33473882	4315	11086	31.652
2006	2	4.510	53.467	48672776	3996	2994	37.082	11	4.141	53.467	48672776	3996	12596	37.082
2007	2	4.329	56.425	59966536	4255	3261	38.998	11	3.974	56.425	59966536	4255	15093	38.998
2008	2	5.438	62.130	68177224	4469	3870	63.453	11	4.415	62.130	68177224	4469	17689	63.453
1990	3	2.489	23.461	5926050	4016	1646	18.465	12	1.193	23.461	5926050	4016	16152	18.465
1991	3	2.261	22.282	5616970	4200	1713	14.464	12	1.055	22.282	5616970	4200	15382	14.464
1992	3	2.162	23.866	4136156	4441	1732	14.152	12	1.071	23.866	4136156	4441	16549	14.152
1993	3	1.998	24.466	4561994	4700	1679	12.397	12	1.506	24.466	4561994	4700	18038	12.397
1994	3	1.734	27.257	4472175	4483	1617	11.867	12	1.404	27.257	4472175	4483	18446	11.867

T	r	PBASE	UGRSH	EXPEND	HDD	RESNG	IT_WOP	r	PBASE	UGRSH	EXPEND	HDD	RESNG	IT_WOP
1995	3	1.512	26.762	4572795	4531	1763	12.970	12	1.090	26.762	4572795	4531	18184	12.970
1996	3	1.832	28.374	7342492	4713	1685	15.219	12	1.469	28.374	7342492	4713	19604	15.219
1997	3	1.789	31.572	8567128	4542	2448	13.317	12	1.715	31.572	8567128	4542	20345	13.317
1998	3	1.609	33.124	7927718	3951	2523	8.401	12	1.372	33.124	7927718	3951	21346	8.401
1999	3	1.466	33.819	5663539	4169	2662	12.184	12	1.520	33.819	5663539	4169	22957	12.184
2000	3	2.102	37.737	9631812	4460	2819	19.201	12	2.512	37.737	9631812	4460	25461	19.201
2001	3	2.686	41.734	14786824	4203	3244	14.554	12	2.569	41.734	14786824	4203	29780	14.554
2002	3	1.976	45.826	12630281	4273	3473	16.289	12	1.769	45.826	12630281	4273	34581	16.289
2003	3	3.134	46.479	16127725	4459	3847	18.633	12	2.930	46.479	16127725	4459	37428	18.633
2004	3	3.076	49.542	27146222	4290	4031	23.309	12	3.384	49.542	27146222	4290	39780	23.309
2005	3	4.041	52.653	33473882	4315	3727	31.652	12	4.587	52.653	33473882	4315	40237	31.652
2006	3	3.703	53.467	48672776	3996	3547	37.082	12	3.713	53.467	48672776	3996	43544	37.082
2007	3	3.554	56.425	59966536	4255	3741	38.998	12	3.563	56.425	59966536	4255	44577	38.998
2008	3	5.992	62.130	68177224	4469	4039	63.453	12	5.199	62.130	68177224	4469	56201	63.453
1990	4	1.400	23.461	5926050	4016	9996	18.465	13	1.247	23.461	5926050	4016	17	18.465
1991	4	1.188	22.282	5616970	4200	9506	14.464	13	1.231	22.282	5616970	4200	21	14.464
1992	4	1.305	23.866	4136156	4441	9251	14.152	13	1.093	23.866	4136156	4441	32	14.152
1993	4	1.491	24.466	4561994	4700	9601	12.397	13	1.408	24.466	4561994	4700	39	12.397
1994	4	1.298	27.257	4472175	4483	9276	11.867	13	1.671	27.257	4472175	4483	47	11.867
1995	4	1.080	26.762	4572795	4531	9099	12.970	13	0.739	26.762	4572795	4531	27	12.970
1996	4	1.496	28.374	7342492	4713	8518	15.219	13	1.763	28.374	7342492	4713	16	15.219
1997	4	1.572	31.572	8567128	4542	7627	13.317	13	1.680	31.572	8567128	4542	13	13.317
1998	4	1.289	33.124	7927718	3951	6944	8.401	13	1.806	33.124	7927718	3951	4	8.401
1999	4	1.345	33.819	5663539	4169	6352	12.184	13	1.885	33.819	5663539	4169	6	12.184
2000	4	2.348	37.737	9631812	4460	5708	19.201	13	1.969	37.737	9631812	4460	4	19.201
2001	4	2.613	41.734	14786824	4203	5267	14.554	13	2.616	41.734	14786824	4203	7	14.554
2002	4	1.832	45.826	12630281	4273	5017	16.289	13	2.789	45.826	12630281	4273	17	16.289
2003	4	2.976	46.479	16127725	4459	4939	18.633	13	3.082	46.479	16127725	4459	16	18.633
2004	4	3.299	49.542	27146222	4290	4770	23.309	13	2.601	49.542	27146222	4290	19	23.309
2005	4	4.211	52.653	33473882	4315	4597	31.652	13	2.752	52.653	33473882	4315	7	31.652
2006	4	3.517	53.467	48672776	3996	4257	37.082	13	2.773	53.467	48672776	3996	10	37.082
2007	4	3.375	56.425	59966536	4255	3875	38.998	13	2.662	56.425	59966536	4255	13	38.998
2008	4	5.661	62.130	68177224	4469	3965	63.453	13	4.822	62.130	68177224	4469	13	63.453
1990	5	1.602	23.461	5926050	4016	285	18.465	15	1.516	23.461	5926050	4016	1967	18.465
1991	5	1.439	22.282	5616970	4200	289	14.464	15	1.187	22.282	5616970	4200	2106	14.464
1992	5	1.665	23.866	4136156	4441	262	14.152	15	1.356	23.866	4136156	4441	1915	14.152
1993	5	1.530	24.466	4561994	4700	278	12.397	15	1.482	24.466	4561994	4700	1784	12.397
1994	5	1.403	27.257	4472175	4483	289	11.867	15	1.281	27.257	4472175	4483	1691	11.867
1995	5	1.264	26.762	4572795	4531	268	12.970	15	1.001	26.762	4572795	4531	1622	12.970
1996	5	1.462	28.374	7342492	4713	233	15.219	15	1.302	28.374	7342492	4713	1473	15.219
1997	5	1.655	31.572	8567128	4542	239	13.317	15	1.350	31.572	8567128	4542	1406	13.317
1998	5	1.632	33.124	7927718	3951	249	8.401	15	1.335	33.124	7927718	3951	1488	8.401
1999	5	1.731	33.819	5663539	4169	218	12.184	15	1.578	33.819	5663539	4169	1502	12.184
2000	5	2.875	37.737	9631812	4460	199	19.201	15	2.511	37.737	9631812	4460	1696	19.201
2001	5	2.522	41.734	14786824	4203	201	14.554	15	2.781	41.734	14786824	4203	2234	14.554
2002	5	1.921	45.826	12630281	4273	210	16.289	15	1.883	45.826	12630281	4273	2308	16.289
2003	5	2.450	46.479	16127725	4459	198	18.633	15	3.137	46.479	16127725	4459	2384	18.633
2004	5	3.828	49.542	27146222	4290	178	23.309	15	3.324	49.542	27146222	4290	1988	23.309
2005	5	5.427	52.653	33473882	4315	139	31.652	15	4.475	52.653	33473882	4315	2262	31.652
2006	5	4.089	53.467	48672776	3996	157	37.082	15	3.877	53.467	48672776	3996	2357	37.082
2007	5	3.925	56.425	59966536	4255	171	38.998	15	3.721	56.425	59966536	4255	2374	38.998

T	r	PBASE	UGRSH	EXPEND	HDD	RESNG	IT_WOP	r	PBASE	UGRSH	EXPEND	HDD	RESNG	IT_WOP
2008	5	7.950	62.130	68177224	4469	109	63.453	15	5.930	62.130	68177224	4469	2192	63.453
1990	6	2.797	23.461	5926050	4016	2325	18.465	16	1.514	23.461	5926050	4016	12202	18.465
1991	6	2.505	22.282	5616970	4200	2263	14.464	16	1.188	22.282	5616970	4200	13847	14.464
1992	6	2.427	23.866	4136156	4441	2602	14.152	16	1.356	23.866	4136156	4441	15199	14.152
1993	6	2.707	24.466	4561994	4700	3070	12.397	16	1.482	24.466	4561994	4700	15760	12.397
1994	6	2.039	27.257	4472175	4483	3579	11.867	16	1.281	27.257	4472175	4483	15490	11.867
1995	6	1.678	26.762	4572795	4531	4270	12.970	16	1.001	26.762	4572795	4531	14120	12.970
1996	6	2.012	28.374	7342492	4713	4262	15.219	16	1.302	28.374	7342492	4713	14514	15.219
1997	6	2.052	31.572	8567128	4542	4564	13.317	16	1.351	31.572	8567128	4542	13598	13.317
1998	6	1.973	33.124	7927718	3951	4721	8.401	16	1.336	33.124	7927718	3951	12773	8.401
1999	6	1.643	33.819	5663539	4169	4799	12.184	16	1.578	33.819	5663539	4169	12205	12.184
2000	6	2.570	37.737	9631812	4460	4867	19.201	16	2.511	37.737	9631812	4460	12328	19.201
2001	6	3.356	41.734	14786824	4203	4509	14.554	16	2.781	41.734	14786824	4203	13678	14.554
2002	6	3.678	45.826	12630281	4273	4384	16.289	16	1.883	45.826	12630281	4273	13807	16.289
2003	6	3.457	46.479	16127725	4459	5013	18.633	16	3.137	46.479	16127725	4459	13596	18.633
2004	6	4.283	49.542	27146222	4290	5002	23.309	16	3.324	49.542	27146222	4290	13647	23.309
2005	6	5.191	52.653	33473882	4315	5120	31.652	16	4.475	52.653	33473882	4315	14811	31.652
2006	6	4.736	53.467	48672776	3996	6459	37.082	16	3.877	53.467	48672776	3996	14322	37.082
2007	6	4.545	56.425	59966536	4255	6796	38.998	16	3.721	56.425	59966536	4255	13955	38.998
2008	6	5.228	62.130	68177224	4469	7749	63.453	16	5.502	62.130	68177224	4469	13350	63.453
1990	7	1.995	23.461	5926050	4016	971	18.465	17	2.117	23.461	5926050	4016	937	18.465
1991	7	1.753	22.282	5616970	4200	1008	14.464	17	2.132	22.282	5616970	4200	869	14.464
1992	7	1.624	23.866	4136156	4441	1146	14.152	17	1.983	23.866	4136156	4441	864	14.152
1993	7	1.894	24.466	4561994	4700	1076	12.397	17	1.971	24.466	4561994	4700	763	12.397
1994	7	1.815	27.257	4472175	4483	997	11.867	17	1.216	27.257	4472175	4483	780	11.867
1995	7	1.301	26.762	4572795	4531	925	12.970	17	1.375	26.762	4572795	4531	770	12.970
1996	7	1.989	28.374	7342492	4713	1018	15.219	17	1.419	28.374	7342492	4713	697	15.219
1997	7	2.039	31.572	8567128	4542	960	13.317	17	1.849	31.572	8567128	4542	577	13.317
1998	7	1.810	33.124	7927718	3951	1339	8.401	17	1.495	33.124	7927718	3951	540	8.401
1999	7	1.551	33.819	5663539	4169	1203	12.184	17	1.765	33.819	5663539	4169	431	12.184
2000	7	2.323	37.737	9631812	4460	1408	19.201	17	3.521	37.737	9631812	4460	320	19.201
2001	7	3.397	41.734	14786824	4203	1734	14.554	17	4.954	41.734	14786824	4203	722	14.554
2002	7	2.121	45.826	12630281	4273	1836	16.289	17	2.052	45.826	12630281	4273	811	16.289
2003	7	3.133	46.479	16127725	4459	1884	18.633	17	3.467	46.479	16127725	4459	758	18.633
2004	7	3.542	49.542	27146222	4290	1865	23.309	17	3.778	49.542	27146222	4290	716	23.309
2005	7	4.471	52.653	33473882	4315	1862	31.652	17	4.825	52.653	33473882	4315	726	31.652
2006	7	5.516	53.467	48672776	3996	2123	37.082	17	4.059	53.467	48672776	3996	760	37.082
2007	7	5.294	56.425	59966536	4255	2193	38.998	17	3.896	56.425	59966536	4255	737	38.998
2008	7	5.269	62.130	68177224	4469	2436	63.453	17	6.075	62.130	68177224	4469	660	63.453
1990	8	1.987	23.461	5926050	4016	1798	18.465	19	1.665	23.461	5926050	4016	27360	18.465
1991	8	1.721	22.282	5616970	4200	2583	14.464	19	1.508	22.282	5616970	4200	28250	14.464
1992	8	1.744	23.866	4136156	4441	3151	14.152	19	1.477	23.866	4136156	4441	27379	14.152
1993	8	1.845	24.466	4561994	4700	3325	12.397	19	1.807	24.466	4561994	4700	25617	12.397
1994	8	1.613	27.257	4472175	4483	2478	11.867	19	1.694	27.257	4472175	4483	25447	11.867
1995	8	1.282	26.762	4572795	4531	2089	12.970	19	1.275	26.762	4572795	4531	25966	12.970
1996	8	1.770	28.374	7342492	4713	2032	15.219	19	1.830	28.374	7342492	4713	26144	15.219
1997	8	1.782	31.572	8567128	4542	2072	13.317	19	1.997	31.572	8567128	4542	26018	13.317
1998	8	1.456	33.124	7927718	3951	2050	8.401	19	1.772	33.124	7927718	3951	24949	8.401
1999	8	1.541	33.819	5663539	4169	2018	12.184	19	1.662	33.819	5663539	4169	23473	12.184
2000	8	2.760	37.737	9631812	4460	1956	19.201	19	2.469	37.737	9631812	4460	22880	19.201
2001	8	2.946	41.734	14786824	4203	1850	14.554	19	2.884	41.734	14786824	4203	23662	14.554

T	r	PBASE	UGRSH	EXSPEND	HDD	RESNG	IT_WOP	r	PBASE	UGRSH	EXSPEND	HDD	RESNG	IT_WOP
2002	8	2.334	45.826	12630281	4273	1831	16.289	19	2.255	45.826	12630281	4273	22298	16.289
2003	8	3.842	46.479	16127725	4459	2163	18.633	19	3.820	46.479	16127725	4459	20516	18.633
2004	8	4.322	49.542	27146222	4290	2475	23.309	19	3.996	49.542	27146222	4290	18647	23.309
2005	8	5.913	52.653	33473882	4315	2494	31.652	19	5.470	52.653	33473882	4315	15920	31.652
2006	8	4.639	53.467	48672776	3996	2627	37.082	19	4.325	53.467	48672776	3996	14678	37.082
2007	8	4.452	56.425	59966536	4255	2663	38.998	19	4.151	56.425	59966536	4255	13283	38.998
2008	8	6.224	62.130	68177224	4469	2701	63.453	19	4.985	62.130	68177224	4469	12362	63.453
1990	9	1.490	23.461	5926050	4016	27768	18.465	20	2.499	23.461	5926050	4016	291	18.465
1991	9	1.420	22.282	5616970	4200	27482	14.464	20	2.490	22.282	5616970	4200	243	14.464
1992	9	1.488	23.866	4136156	4441	25484	14.152	20	2.302	23.866	4136156	4441	182	14.152
1993	9	1.744	24.466	4561994	4700	24150	12.397	20	2.284	24.466	4561994	4700	151	12.397
1994	9	1.583	27.257	4472175	4483	24453	11.867	20	1.947	27.257	4472175	4483	146	11.867
1995	9	1.272	26.762	4572795	4531	26101	12.970	20	1.374	26.762	4572795	4531	112	12.970
1996	9	1.796	28.374	7342492	4713	26564	15.219	20	1.420	28.374	7342492	4713	95	15.219
1997	9	1.876	31.572	8567128	4542	27835	13.317	20	1.887	31.572	8567128	4542	115	13.317
1998	9	1.554	33.124	7927718	3951	28460	8.401	20	1.736	33.124	7927718	3951	59	8.401
1999	9	1.708	33.819	5663539	4169	28681	12.184	20	1.959	33.819	5663539	4169	56	12.184
2000	9	2.826	37.737	9631812	4460	29823	19.201	20	3.119	37.737	9631812	4460	67	19.201
2001	9	2.919	41.734	14786824	4203	32042	14.554	20	4.954	41.734	14786824	4203	81	14.554
2002	9	2.228	45.826	12630281	4273	34107	16.289	20	2.052	45.826	12630281	4273	55	16.289
2003	9	3.646	46.479	16127725	4459	33352	18.633	20	3.467	46.479	16127725	4459	62	18.633
2004	9	3.924	49.542	27146222	4290	34182	23.309	20	3.778	49.542	27146222	4290	62	23.309
2005	9	5.100	52.653	33473882	4315	36651	31.652	20	4.825	52.653	33473882	4315	49	31.652
2006	9	4.198	53.467	48672776	3996	42120	37.082	20	4.059	53.467	48672776	3996	50	37.082
2007	9	4.029	56.425	59966536	4255	44451	38.998	20	3.896	56.425	59966536	4255	60	38.998
2008	9	5.169	62.130	68177224	4469	50732	63.453	20	6.755	62.130	68177224	4469	57	63.453
1990	10	1.435	23.461	5926050	4016	20284	18.465	21	1.175	23.461	5926050	4016	70556	18.465
1991	10	1.316	22.282	5616970	4200	20290	14.464	21	1.031	22.282	5616970	4200	70332	14.464
1992	10	1.481	23.866	4136156	4441	19248	14.152	21	0.949	23.866	4136156	4441	69857	14.152
1993	10	1.646	24.466	4561994	4700	18191	12.397	21	1.052	24.466	4561994	4700	68469	12.397
1994	10	1.466	27.257	4472175	4483	17093	11.867	21	1.103	27.257	4472175	4483	67312	11.867
1995	10	1.270	26.762	4572795	4531	17752	12.970	21	0.795	26.762	4572795	4531	66193	12.970
1996	10	1.856	28.374	7342492	4713	17953	15.219	21	0.913	28.374	7342492	4713	67350	15.219
1997	10	1.925	31.572	8567128	4542	17659	13.317	21	1.066	31.572	8567128	4542	64211	13.317
1998	10	1.526	33.124	7927718	3951	17798	8.401	21	0.979	33.124	7927718	3951	60598	8.401
1999	10	1.696	33.819	5663539	4169	17874	12.184	21	1.242	33.819	5663539	4169	58465	12.184
2000	10	2.794	37.737	9631812	4460	17083	19.201	21	2.284	37.737	9631812	4460	57160	19.201
2001	10	2.948	41.734	14786824	4203	18002	14.554	21	2.559	41.734	14786824	4203	56059	14.554
2002	10	2.176	45.826	12630281	4273	17812	16.289	21	1.728	45.826	12630281	4273	56671	16.289
2003	10	3.455	46.479	16127725	4459	18979	18.633	21	3.068	46.479	16127725	4459	55911	18.633
2004	10	3.734	49.542	27146222	4290	19861	23.309	21	3.284	49.542	27146222	4290	54593	23.309
2005	10	4.710	52.653	33473882	4315	21830	31.652	21	4.494	52.653	33473882	4315	54727	31.652
2006	10	4.004	53.467	48672776	3996	22956	37.082	21	3.702	53.467	48672776	3996	56230	37.082
2007	10	3.843	56.425	59966536	4255	24031	38.998	21	3.592	56.425	59966536	4255	56000	38.998
2008	10	5.125	62.130	68177224	4469	27249	63.453	21	5.508	62.130	68177224	4469	52179	63.453

Table F12

Data: Equation for natural gas price at the Henry Hub

Author: Eddie Thomas, EI-83, 2008

Source: Annual natural gas wellhead prices and chain-type GDP price deflators data from EIA's *Annual Energy Review 2007*, DOE/EIA-0384(2007), published June 2008. Henry Hub spot price data from EIA's Short-Term Energy Outlook database series NGHHUUS; the annual Henry Hub prices equal the arithmetic average of the monthly data.

Variables:

HHPRICE = Henry Hub spot natural gas price (1987 dollars per MMBtu)
EIAPRICE = Average U.S. natural gas wellhead price (1987 dollars per Mcf)
HHPRICE_HAT = estimated values for Henry Hub price (1987 dollars per MMBtu)
 α = estimated parameter
const1 = constant term
const2 = constant term

Derivation: Using TSP version 5.0 and annual price data from 1995 through 2007, the first equation was estimated in log-linear form using ordinary least squares. The second equation estimates an adjustment factor that is applied in cases where the value of "y" is predicted from an estimated equation where the dependent variable is the natural log of y. The adjustment is due to the fact that generally predictions of "y" using the first equation only tend to be biased downward.

- 1) $\ln \text{HHPRICE} = \text{const1} + (\alpha * \ln \text{EIAPRICE})$
- 2) $\text{HHPRICE} = \text{const2} * \text{HHPRICE_HAT}$

Regression Diagnostics and Parameter Estimates

First Equation

Dependent variable: $\ln \text{HHPRICE}$
Current sample: 1 to 13
Number of observations: 13

Mean of dep. var.	= 1.00473	LM het. test	= .317007 [.573]
Std. dev. of dep. var.	= .447616	Durbin-Watson	= 2.74129 [<.934]
Sum of squared residuals	= .048856	Jarque-Bera test	= .475878 [.788]
Variance of residuals	= .444143E-02	Ramsey's RESET2	= .103879 [.754]
Std. error of regression	= .066644	F (zero slopes)	= 530.339 [.000]
R-squared	= .979680	Schwarz B.I.C.	= -15.2838
Adjusted R-squared	= .977833	Log likelihood	= 17.8487

Variable	Estimated Coefficient	Standard Error	t-statistic	P-value
CONST	.090246	.043801	2.06036	[.064]
lnEIAPRICE	1.00119	.043475	23.0291	[.000]

Second Equation

Dependent variable: HHPRICE
 Current sample: 1 to 13
 Number of observations: 13

Mean of dep. var.	= 2.98879	LM het. test	= 2.14305 [.143]
Std. dev. of dep. var.	= 1.29996	Durbin-Watson	= 2.97238 [<1.00]
Sum of squared residuals	= .420043	Jarque-Bera test	= .138664 [.933]
Variance of residuals	= .035004	Ramsey's RESET2	= .655186 [.435]
Std. error of regression	= .187092	Schwarz B.I.C.	= -2.58158
R-squared	= .979456	Log likelihood	= 3.86405
Adjusted R-squared	= .979456		

Variable	Estimated Coefficient	Standard Error	t-statistic	P-value
HHPRICE_HAT	1.00439	.016114	62.3290	[.000]

Data used for Estimation:

Year	Henry Hub Spot Natural Gas Price (\$/MMBtu, in 1987 dollars)	Average U.S. Wellhead Natural Gas Price (\$/Mcf, in 1987 dollars)
1995	1.34	1.23
1996	2.14	1.70
1997	1.91	1.79
1998	1.58	1.50
1999	1.70	1.65
2000	3.16	2.73
2001	2.83	2.89
2002	2.36	2.09
2003	3.77	3.40
2004	3.95	3.68
2005	5.62	4.79
2006	4.23	4.03
2007	4.26	3.90

Appendix G. Variable Cross Reference Table

With the exception of the Pipeline Tariff Submodule (PTS) all of the equations in this model documentation report are the same as those used in the model FORTRAN code. Table G-1 presents cross references between model equation variables defined in this document and in the FORTRAN code for the PTS.

Table G-1. Cross Reference of PTM Variables Between Documentation and Code

Documentation	Code Variable	Equation #
$R_{i,f}$	Not represented	149
$R_{i,v}$	Not represented	150
ALL_f	AFX_ i, where i = PFEN, CMEN, LTDN, DDA, FSIT, DIT, OTTAX, TOM	149
ALL_v	AVA_ i, where i = PFEN, CMEN, LTDN, DDA, FSIT, DIT, OTTAX, TOM	150
R_i	PFEN, CMEN, LTDN, DDA, FSIT, DIT, OTTAX, TOM	149, 150
FC_a	Not represented	151
VC_a	Not represented	152
$R_{i,f,r}$	RFC_ i, where i = PFEN, CMEN, LTDN, DDA, FSIT, DIT, OTTAX, TOM	153
$R_{i,f,u}$	UFC_ i, where i = PFEN, CMEN, LTDN, DDA, FSIT, DIT, OTTAX, TOM	154
$R_{i,v,r}$	RVC_ i, where i = PFEN, CMEN, LTDN, DDA, FSIT, DIT, OTTAX, TOM	155
$R_{i,v,u}$	UVC_ i, where i = PFEN, CMEN, LTDN, DDA, FSIT, DIT, OTTAX, TOM	156
$ALL_{f,r}$	AFR_ i, where i = PFEN, CMEN, LTDN, DDA, FSIT, DIT, OTTAX, TOM	153
$ALL_{f,u}$	AFU_ i, where i = PFEN, CMEN, LTDN, DDA, FSIT, DIT, OTTAX, TOM	154
$ALL_{v,r}$	AVR_ i, where i = PFEN, CMEN, LTDN, DDA, FSIT, DIT, OTTAX, TOM	155
$ALL_{v,u}$	AVU_ i, where i = PFEN, CMEN, LTDN, DDA, FSIT, DIT, OTTAX, TOM	156

Documentation	Code Variable	Equation #
ξ_i	AFX_i, where i = PFEN, CMEN, LTDN, DDA, FSIT, DIT, OTTAX, TOM	214, 215, 217-220
Item _{i,a,t}	PFEN, CMEN, LTDN, DDA, FSIT, DIT, OTTAX, TOM	214, 215, 217-220
FC _{a,t}	Not represented	214
VC _{a,t}	Not represented	215
TCOS _{a,t}	Not represented	216, 221
RFC _{a,t}	RFC_i, where i = PFEN, CMEN, LTDN, DDA, FSIT, DIT, OTTAX, TOM	217
UFC _{a,t}	UFC_i, where i = PFEN, CMEN, LTDN, DDA, FSIT, DIT, OTTAX, TOM	217
RVC _{a,t}	RVC_i, where i = PFEN, CMEN, LTDN, DDA, FSIT, DIT, OTTAX, TOM	219
UVC _{a,t}	UVC_i, where i = PFEN, CMEN, LTDN, DDA, FSIT, DIT, OTTAX, TOM	220
λ_i	AFR_i, where i = PFEN, CMEN, LTDN, DDA, FSIT, DIT, OTTAX, TOM	217, 218
μ_i	AVR_i, where i = PFEN, CMEN, LTDN, DDA, FSIT, DIT, OTTAX, TOM	219, 220
a - arc, t - year, i - cost-of-service component index		

Appendix H. Coal-to-Gas Submodule

A Coal-to-Gas (CTG) algorithm has been incorporated into the NGTDM to project potential new CTG plants at the census division level and the associated pipeline quality gas production. The Coal-to-Gas process with no carbon sequestration is adopted as the generic facility for the CTG. The CTG_INVEST subroutine calculates the annualized capital costs, operating costs, and other variable costs for a generic coal-to-gas plant producing 100 MMcf/day (Appendix E, CTG_PUCAP) of pipeline quality synthetic gas from coal. The capital costs are converted into a per unit basis by dividing by the plant's assumed output of gas. Capital and operating costs are assumed to decline over the forecast due to technological improvements. To determine whether it is profitable to build a CTG plant, the per unit capital and operating costs plus the coal costs are compared to the average market price of natural gas and electricity. If a CTG plant is profitable, the actual number of plants to be built is set using the Mansfield-Blackman market penetration algorithm. Any new generic plant is assumed to be built in the regions with the greatest level of profitability and to produce pipeline quality natural gas and cogenerated electricity (cogen) for sale to the grid.

Electricity generated by a CTG facility is partially consumed in the facility, while the remainder is assumed to be sold to the grid at wholesale market prices (EWSPRCN, 87\$/MWh, from the EMM). Cogeneration for each use is set for a generic facility using assumed ratios of electricity produced to coal consumed (Appendix E, own—CTG_BASECGS, grid—CTG_BASCGG). The revenue from cogen sales is treated as a credit (CGNCRED) by the model to offset the costs (feedstock, fixed, and operation costs) of producing CTG syngas. The annualized transmission cost (CGNTRNS) for cogen sent to the grid is accounted for in the operating cost of the CTG facility.

The primary inputs to the CTG model include a mine-mouth coal price (PCLGAS, 87\$/MMBtu, from the Coal Market Module (CMM)) and a regional wholesale equivalent natural gas price (NODE_ENDPR, 87\$/Mcf). A carbon tax (JCLIN, 87\$/MMBtu from the Integration Module) is added to the coal price as well as a penalty for SO₂ and HG. If the CTG plant is deemed to be economic, the final quantity of coal demanded (QCLGAS, Quad Btu/yr) is sent back to the CMM for feedback. The final outputs from the model are coal consumed, gas produced, electricity consumed, and electricity sold to the grid.

Investment decisions for building new CTG facilities are based on the total investment cost of a CTG plant (CTG_INV CST). Actual cash flows associated with the operation of the individual plants are considered, as well as cash flows associated with capital for the construction of new plants. Terms for capital-related financial charges (CAPREC) and fixed operating costs (FXOC) are included.

$$\text{CTG_INV CST} = \text{CAPREC} + \text{FXOC} \quad (298)$$

Once a build decision is made, a Mansfield-Blackman algorithm for market penetration is used to determine the limit on the number of plants allowed to build in a given year. The

investment costs are further adjusted to account for learning and for resource competition. The methodologies used to calculate the capital-related financial charges and the fixed operating costs, the Mansfield-Blackman model, and investment costs adjustments are presented in detail below.

Capital-Related Financial Charges for Coal-to-Gas

A discounted cash flow calculation is used to determine the annual capital charge for a CTG plant investment. The annual capital recovery charge assumes a discount rate equal to the cost of capital, which includes the cost of equity (CTGCOE) and interest payments on any loans or other debt instruments used as part of capital project financing (CTGCOD) with an assumed interest rate of the Industrial BAA bond rate (MC_RMCORPBAA, from MACRO) plus an additional risk premium (Appendix E, BA_PREM). Together, this translates into the capital recovery factor (CTG_RECRAT) which is calculated on an after-tax basis.

Some of the steps associated with the capital-related financial charge estimates are conducted exogenous to NEMS (Step 0 below), either by the analyst in preparing the input data or during input data preprocessing. The individual steps in the plant capital-related cost estimation algorithm are:

- 0) Estimation of the inside battery limit field cost (ISBL)
 - 1) Year-dollar and location adjustments for ISBL Field Costs
 - 2) Estimation of outside battery limit field cost (OSBL) and Total Field Cost
 - 3) Estimation of Total Project Cost
 - 4) Calculate Annual Capital Recovery
 - 5) Convert capital related financial costs to a “per-unit” basis

Step 0 involves several adjustments which must be made prior to input into the NGTDM; steps 1-4 are performed within the NGTDM.

Step 0 - Estimation of ISBL Field Cost

The inside battery limits (CTG_ISBL) field costs include direct costs such as major equipment, bulk materials, direct labor costs for installation, construction subcontracts, and indirect costs such as distributables. The ISBL investment and labor costs were provided for plants sited at a generic U.S. Gulf Coast (PADD III) location, and are in 2004 dollars.

Step 1 - Year-Dollar and Location Adjustments to ISBL Field Costs

Before utilizing the ISBL investment cost information, the raw data must be converted according to the following steps:

- a) Adjust the ISBL field and labor costs from 2004 dollars, first to the year-dollar reported by NEMS, using the Nelson-Farrar refining industry cost-inflation indices. Then the GDP chain-type price indices provided by the NEMS Macroeconomic Activity Model are used to convert from report-year dollars to 1987 year dollars used internally by the NEMS.

b) Convert the ISBL field costs in 1987 dollars from a PADD III basis (Appendix E, XBM_ISBL) to costs in the NGTDM demand regions using location multipliers (Appendix E, CTG_INVLOC). The location multipliers represent differences in material costs between the various regions.

$$CTG_ISBL = CTG_INVLOC * BM_ISBL / 1000 \quad (299)$$

Step 2 - Estimation of OSBL and Total Field Cost

The outside battery-limit (OSBL) costs for CTG are included in the inside battery-limit costs. The total field cost (CTG_TFCST) is the sum of ISBL and OSBL

$$CTG_TFCST = (1 - CTG_OSBLFAC) * CTG_ISBL \quad (300)$$

The OSBL field cost is estimated as a fraction (Appendix E, CTG_OSBLFAC) of the ISBL costs.

Step 3 - Estimation of Total Project Cost

The total project investment (CTG_TPI) is the sum of the total field cost (Eq. 3) and other one-time costs (CTG_OTC).

$$CTG_TPI = CTG_TFCST + CTG_OTC \quad (301)$$

Other one-time costs include the contractor's cost (such as home office costs), the contractor's fee and a contractor's contingency, the owner's cost (such as pre-startup and startup costs), and the owner's contingency and working capital. The other one-time costs are estimated as a function of total field costs using cost factors (OTCFAC):

$$CTG_OTC = OTCFAC * CTG_TFCST \quad (302)$$

where,

$$OTCFAC = CTG_PCTENV + CTG_PCTCNTG + CTG_PCTLND + CTG_PCTSPECL + CTG_PCTWC \quad (303)$$

and,

CTG_PCTENV	=	Home, office, contractor fee
CTG_CNTG	=	Contractor & owner contingency
CTG_PCTLND	=	Land
CTG_PCTSPECL	=	Prepaid royalties, license, start-up costs
CTG_PCTWC	=	Working capital

The total project investment given above represents the total project cost for 'overnight construction.' The total project investment at project completion and startup will be discussed below.

Closely related to the total project investment are the fixed capital investment (CTG_FCI) and total depreciable investment (CTG_TDI). The fixed capital investment is equal to the total project investment less working capital. It is used to estimate capital-related fixed operating costs.

$$WRKCAP = CTG_PCTWC * CTG_TFCST \quad (304)$$

Thus,

$$CTG_FCI = CTG_TPI - WRKCAP \quad (305)$$

For the CTG plant, the total depreciable investment (CTG_TDI) is assumed to be equal to the total project investment.

Step 4 - Annual Capital Recovery

The annual capital recovery (ACAPRCV) is the difference between the total project investment (TPI) and the recoverable investment (RCI), all in terms of present value (e.g., at startup). The TPI estimated previously is for overnight construction (ONC). In reality, the TPI is spread out through the construction period. Land costs (LC) will occur as a lump-sum payment at the beginning of the project, construction expenses (TPI - WC - LC = FCI - LC) will be distributed during construction, and working capital (WC) expenses will occur as a lump-sum payment at startup. Thus, the TPI at startup (present value) is determined by discounting the construction expenses (assumed as discrete annual disbursements) and adding working capital (WC):

$$TPI_START = FVI_CONSTR * LAND + FV_CONSTR * (CTG_FCI - LAND) + WRKCAP \quad (306)$$

where,

FVI_CONSTR = Future-value compounding factor for an instantaneous payment made n years before the startup year

FV_CONSTR = Future-value compounding factor for discrete uniform payments made at the beginning of each year starting n years before the startup year.

The future-value factors are a function of the number of compounding periods (n), and the interest rate (r) assumed for compounding. In this case, (n) equals the construction time in years before startup, and the compounding rate used is the cost of capital (CTG_RECRAT).

The recoverable investment (RCI_START) includes the value of the land and the working capital (assumed not to depreciate over the life of the project), as well as the salvage value (PRJSDECOM) of the used equipment:

$$RCI_START = PV_PRJ * (LAND + WRKCAP + PRJSDECOM) \quad (307)$$

The present value of RCI is subtracted from the TPI at startup to determine the present value of the project investment (PVI):

$$PVI_START = TPI_START - RCI_START \quad (308)$$

Thus, the annual capital recovery (ACAPRCV) is given by:

$$ACAPRCV = LC_LIFE * PVI_START \quad (309)$$

where,

LC_LIFE = uniform- value leveling factor for a periodic payment (annuity)
made at the end of each year for (n) years in the future

The depreciation tax credit (DTC) is based on the depreciation schedule for the investment and the total depreciable investment (TDI). The simplest method used for depreciation calculations is the straight-line method, where the total depreciable investment is depreciated by a uniform annual amount over the tax life of the investment. Generic equations representing the present value and the levelized value of the annual depreciation charge are:

$$ADEPREC = CTG_TDI / CTG_PRJLIFE \quad (310)$$

$$ADEPTAXC = ADEPREC * FEDST_TAX \quad (311)$$

$$ACAPCHRGAT = ACAPRCV - ADEPTAXC \quad (312)$$

$$DCAPCHRGAT = ACAPCHRGAT / 365 \quad (313)$$

where,

ADEPREC = annual levelized depreciation
ADEPTAXC = levelized depreciation tax credit, after federal and state taxes
ACAPCHRGAT = annual capital charge, after tax credit
DCAPCHRGAT = daily capital charge, after tax credit

Step 5 - Convert Capital Costs to a ‘per-day’, ‘per-capacity’ Basis

The annualized capital-related financial charge is converted to a daily charge, and then converted to a “per-capacity” basis by dividing the result by the operating capacity of the unit being evaluated. The result is a fixed operation cost on a per-mcf basis (CAPREC).

CTG Plant Fixed Operating Costs

Fixed operating costs (FXOC), a component of total product cost, are costs incurred at the plant that do not vary with plant throughput, and any other costs which cannot be controlled at the plant level. These include such items as wages, salaries and benefits; the cost of maintenance, supplies and repairs; laboratory charges; insurance, property taxes and rent; and other overhead costs. These components can be factored from either the operating labor requirement or the capital cost.

Like capital cost estimations, operating cost estimations, involve a number of distinct steps. Some of the steps associated with the FXOC estimate are conducted exogenous to NEMS (Step 0 below), either by the analyst in preparing the input data or during input data preprocessing. The individual steps in the plant fixed operating cost estimation algorithm are:

- 0) Estimation of the annual cost of direct operating labor
- 1) Year-dollar and location adjustment for operating labor costs (OLC)
- 2) Estimation of total labor-related operating costs (LRC)
- 3) Estimation of capital-related operating costs (CRC)
- 4) Convert fixed operating costs to a “per-unit” basis

Step 0 involves several adjustments which must be made prior to input into the NGTDM; steps 1-4 are performed within the NGTDM.

Step 0 – Estimation of Direct Labor Costs

Direct labor costs are reported based on a given processing unit size. Operation and labor costs were provided for plants sited at a generic U.S. Gulf Coast (PADD III) location, and are in 2004 dollars.

Step 1 – Year-Dollar and Location Adjustment for Operating Labor Costs

Before the labor cost data can be utilized, it must be converted via the following steps:

- a) Adjust the labor costs from 2004 dollars, first to the year-dollar reported by NEMS using the Nelson-Farrar refining-industry cost-inflation indices. Then the GDP chain-type price indices provided by the NEMS Macroeconomic Activity Model are used to convert from report-year dollars to 1987 dollars used internally by the NEMS (Appendix E, XBM_LABOR).
- b) Convert the 1987 operating labor costs from a PADD III (Gulf Coast) basis into regional (other U.S. PADDs) costs using regional location factors. The location multiplier (Appendix E, LABORLOC) represents differences in labor costs between the various locations and includes adjustments for construction labor productivity.

$$\text{CTG_LABOR} = \text{LABORLOC} * \text{BM_LABOR} \quad (314)$$

Location multipliers are translated to the NGTDM demand regions.

Step 2 - Estimation of Labor-Related Fixed Operating Costs

Fixed operating costs related to the cost of labor include the salaries and wages of supervisory and other staffing at the plant, charges for laboratory services, and payroll benefits and other plant overhead. These labor-related fixed operating costs (FXOC_LABOR) can be factored from the direct operating labor cost. This relationship is expressed by:

$$\text{FXOC_STAFF} = \text{CTG_LABOR} * \text{CTG_STAFF_LCFAC} \quad (315)$$

$$\begin{aligned} \text{FXOC_OH} = & (\text{CTG_LABOR} + \text{FXOC_STAFF}) \\ & * \text{CTG_OH_LCFAC} \end{aligned} \quad (316)$$

$$\text{FXOC_LABOR} = \text{CTG_LABOR} + \text{FXOC_STAFF} + \text{FXOC_OH} \quad (317)$$

where,

FXOC_STAFF = Supervisory and staff salary costs

FXOC_OH = Benefits and overhead

Step 3 - Estimation of Capital-Related Fixed Operating Costs

Capital-related fixed operating costs (FXOC_CAP) include insurance, local taxes, maintenance, supplies, non-labor related plant overhead, and environmental operating costs. These costs can be factored from the fixed capital investment (CTG_FCI). This relationship is expressed by:

$$\text{FXOC_INS} = \text{CTG_FCI} * \text{INS_FAC} \quad (318)$$

$$\text{FXOC_TAX} = \text{CTG_FCI} * \text{TAX_FAC} \quad (319)$$

$$\text{FXOC_MAINT} = \text{CTG_FCI} * \text{MAINT_FAC} \quad (320)$$

$$\text{FXOC_OTH} = \text{CTG_FCI} * \text{OTH_FAC} \quad (321)$$

$$\begin{aligned} \text{FXOC_CAP} = & \text{FXOC_INS} + \text{FXOC_TAX} + \\ & \text{FXOC_MAINT} + \text{FXOC_OTH} \end{aligned} \quad (322)$$

where,

INS_FAC = Yearly Insurance

TAX_FAC = Local Tax Rate

MAINT_FAC = Yearly Maintenance

OTH_FAC = Yearly Supplies, Overhead, Etc.

Step 4 - Convert Fixed Operating Costs to a “per-capacity” Basis

On a “per-capacity” basis, the FXOC is the sum of capital-related operating costs and labor-related operating costs, divided by the operating capacity of the unit being evaluated.

Mansfield-Blackman Model for Market Penetration

The Mansfield-Blackman model for market penetration has been incorporated to limit excessive growth of CTG (on a national level) once they become economically feasible.¹⁰² The indices associated with this modeling algorithm are user inputs that define the characteristics of the CTG process. They include an innovation index of the industry (Appendix E, CTG_IINDEX), the relative profitability of the investment within the industry (Appendix E, CTG_PINDEX), the relative size of the investment (per plant) as a percentage of

¹⁰² E. Mansfield, “Technical Change and the Rate of Imitation,” *Econometrica*, Vol. 29, No. 4 (1961), pp. 741-765.
A.W. Blackman, “The Market Dynamics of Technological Substitution,” *Technological Forecasting and Social Change*, Vol. 6 (1974), pp. 41-63.

total company value (Appendix E, CTG_SINVST), and a maximum penetration level (total number of units, Appendix E, CTG_BLDX).¹⁰³

$$KFAC = -\text{LOG}((CTG_BLDX / NCTGBLT) - 1) \quad (323)$$

$$PHI = -0.3165 + (0.23221 * CTG_IINDEX) + (0.533 * CTG_PINDEX) - (0.027 * CTG_SINVST) \quad (324)$$

$$SHRBLD = 1 / (1 + \text{EXP}(-KFAC - (YR * PHI))) \quad (325)$$

$$CTGBND = CTG_BLDX * SHRBLD \quad (326)$$

where,

- CTG_BLDX = maximum number of plants allowed
- NCTGBLT = number of plants already built
- SHRBLD = the share of the maximum number of plants that can be built in a given year
- CTGBND = the upper bound on the number of plants to build

Investment Cost Adjustments

To represent cost improvements over time (due to learning), a decline rate (CTG_DCLCAPCST) is applied to the original CTG capital costs after builds begin.

$$CTG_INVADJ = CTG_INVBAS * (1 - CTG_DCLCAPCST)^{(YR - CTG_BASYR)} \quad (327)$$

where,

- CTG_INVBAS = the initial CTG investment cost
- CTG_BASYR = the first year CTG plants are allowed to build
- CTG_INVADJ = the adjusted CTG investment cost

However, once the capacity builds exceed 1.1 bcf/day, a supplemental algorithm is applied to increase costs in response to impending resource depletions (such as competition for water).¹⁰⁴

$$CTG_CSTADD = 15 * \text{TANH}(0.4 * (\text{MAX}(0, (CTGPRODC / 1127308) - 1))) \quad (328)$$

where,

- CTGPRODC = current CTG production
- CTG_CSTADD = the additional cost

¹⁰³ These have been defined in a memorandum from Andy Kydes (EIA) to Han-Lin Lee (EIA), entitled "Development of a model for optimistic growth rates for the coal-to-liquids (CTG) technology in NEMS," dated March 23, 2002.

¹⁰⁴ The basic algorithm is defined in a memorandum from Andy Kydes (EIA) to William Brown (EIA), entitled "CTL run-- add to total CTLCSST in ADJCTLCST sub," dated September 29, 2006.