

**International Energy Module
of the National Energy Modeling System:
Model Documentation 2009**

October 26, 2009

**Office of Integrated Analysis and Forecasting
Energy Information Administration
U.S. Department of Energy
Washington, DC 20585**

This report was prepared by the Energy Information Administration, the independent statistical and analytical agency within the Department of Energy. The information contained herein should not be construed as advocating or reflecting any policy position of the Department of Energy or any other organization.

Update Information

This edition of the *International Energy Module of the National Energy Modeling System: Model Documentation 2009* (IEM) reflects changes made to the module for the *Annual Energy Outlook 2009*. The changes include the following:

- The IEM has been modified to use exogenous global and U.S. crude-like¹ liquids supply and demand curves (one curve per year from 2007 to 2030). The global curves are isoelastic curves fit to previous *International Energy Outlook* results. The U.S. curves are isoelastic curves fit to previous NEMS results.
- A revised world oil price feedback algorithm has been implemented to estimate the effects of changes in U.S. petroleum liquids production and consumption on the world oil price (WOP). Based on the difference between U.S. crude-like liquids production (consumption) and the expected U.S. crude-like liquids production (consumption) at the current WOP, curves for crude-like petroleum liquids demand (supply) are shifted in each year. Using the shifted curves, a new WOP price path is calculated.

¹In this document, “crude-like liquids” include crude oil, lease condensate, shale oil, bitumen, and extra heavy oil.

Contents

1. Introduction.....	1
Purpose of this Report.....	1
Model Summary	1
Model Archival Citation	1
Organization of This Report	2
2. Model Purpose	3
Model Objectives	3
Model Inputs and Outputs.....	4
Inputs.....	4
Outputs	5
Relationship of the International Energy Module to Other NEMS Modules	5
3. Model Rationale.....	7
Theoretical Approach	7
Fundamental Assumptions.....	7
4. Model Structure	10
Structural Overview	11
Key Computations and Equations.....	19
Recalculating World Oil Prices and U.S. Crude Oil and Product Import Supply Curves	19
Imported Petroleum Products in the United States	21
World Supply and Demand, Including Conventional and Unconventional Liquids	23
Appendix A. Input Data and Variable Descriptions	24
Appendix B. Mathematical Description	31
Appendix C. References	39
Appendix D. Model Abstract.....	40
Introduction.....	40
Appendix E. Data Quality.....	45
Introduction.....	45
Source and Quality of Input Data	45

Tables

Table 1. IEM Model Inputs.....	5
Table 2. IEM Model Outputs.....	5
Table 3. IEM Regional Representation of U.S. Imports.....	28
Table 4. Crude Oil Categories for IEM Import Supply Curves.....	29
Table 5. Petroleum Products Categories for IEM Import Supply Curves	30

Figures

Figure 1. Map of the U.S. Petroleum Allocation for Defense Districts.....	4
Figure 2. IEM Relationship to Other NEMS Modules	6
Figure 3. Global Total Petroleum Liquids Demand Curve.....	9
Figure 4. Flowchart for Main IEM Routine.....	13
Figure 5. Flowchart for OMS_Sim Subroutine.....	14
Figure 6. Flowchart for Sup_Crv_Adj Subroutine	15
Figure 7. Flowchart for World_Oil_Report Subroutine	16
Figure 8. Flowchart for World_Compute_New Subroutine	17
Figure 9. Flowchart for World_Curves Subroutine	18
Figure 10. Algorithm Used to Recalculate World Oil Prices in the IEM.....	19

1. Introduction

Purpose of This Report

This report documents the objectives, analytical approach, and development of the National Energy Modeling System (NEMS) International Energy Module (IEM). It catalogues and describes the model assumptions; computational methodology; parameter estimation techniques; and model source code that are utilized to generate projections in the reference and side cases, as well as other scenarios.

The document serves three purposes. First, it is a reference document providing a detailed description for model analysts, users, and the public. Second, it meets the legal requirement of the Energy Information Administration (EIA) to provide adequate documentation in support of its models (*Public Law 93-275, section 57.b.1*). Third, it facilitates continuity in model development by providing documentation from which energy analysts can undertake model enhancements, data updates, and parameter refinements as future projects.

Model Summary

The NEMS International Energy Module is a calculation tool. It uses assumptions of economic growth and expectations of future U.S. and world petroleum liquids production and consumption, by year, to model the interaction of U.S. and international liquids markets. The NEMS IEM computes world oil prices, provides a supply curve of world crude-like liquids, generates a worldwide oil supply/demand balance for each year of the forecast period, and computes import quantities of crude oil and light and heavy petroleum products for the United States by region.

Model Archival Citation

This documentation refers to the NEMS International Energy Module as archived for the *Annual Energy Outlook 2009 (AEO2009)*.

Model Contact

Adrian Geagla
Office of Integrated Analysis and Forecasting
International, Economic, and Greenhouse Gases Division
Phone: (202) 586-2873
Email: adrian.geagla@eia.doe.gov

Organization of This Report

Chapter 2 of this report, “Model Purpose,” identifies the analytical issues the IEM addresses, the general types of activities and relationships it embodies, its primary inputs and outputs, and its interactions with other NEMS modules. Chapter 3 describes in greater detail the rationale behind the model design, the modeling approach chosen for each IEM component, and the assumptions used in the model development process, citing theoretical or empirical evidence to support those choices. Chapter 4 details the model structure, using graphics and text to illustrate model flows and key computations.

The Appendices to this report provide supporting documentation for the input data and parameter files. Appendix A lists and defines the input data used to generate parameter estimates and endogenous projections, along with the outputs of most relevance to the NEMS system. Appendix B contains a mathematical description of the computational algorithms, including the complete set of model equations and variable transformations. Appendix C is a bibliography of reference materials used in the development process. Appendix D provides the model abstract and Appendix E discusses data quality and estimation methods.

2. Model Purpose

Model Objectives

Understanding the interactive effects of changes in U.S. and world energy markets has always been a key EIA focus. The IEM was incorporated into NEMS in order to enhance the capabilities of NEMS in addressing the interaction of the global and U.S. oil markets. Components of the IEM accomplish the following:

- Calculation of the world oil price (WOP), which is defined as the price of light, low sulfur crude oil delivered to Cushing, Oklahoma (Petroleum Allocation Defense District 2-see Figure 1). Changes in the WOP are computed in response to:
 - The difference between projected U.S. total crude-like liquids production and the expected U.S. total crude-like liquids production at the current WOP (estimated using the current WOP and the exogenous U.S. total crude-like liquids supply curve for each year).
 - The difference between projected U.S. total crude-like liquids consumption and the expected U.S. total crude-like liquids consumption at the current WOP (estimated using the current WOP and the exogenous U.S. total crude-like liquids demand curve).
- Calculation of the average world oil price and provision of supply curves for total world crude-like liquids. The IEM projects international crude oil market conditions, including demand, price, and supply availability, as well as the effects of the U.S. petroleum market on the world market.

Figure 1. Map of the U.S. Petroleum Allocation for Defense Districts

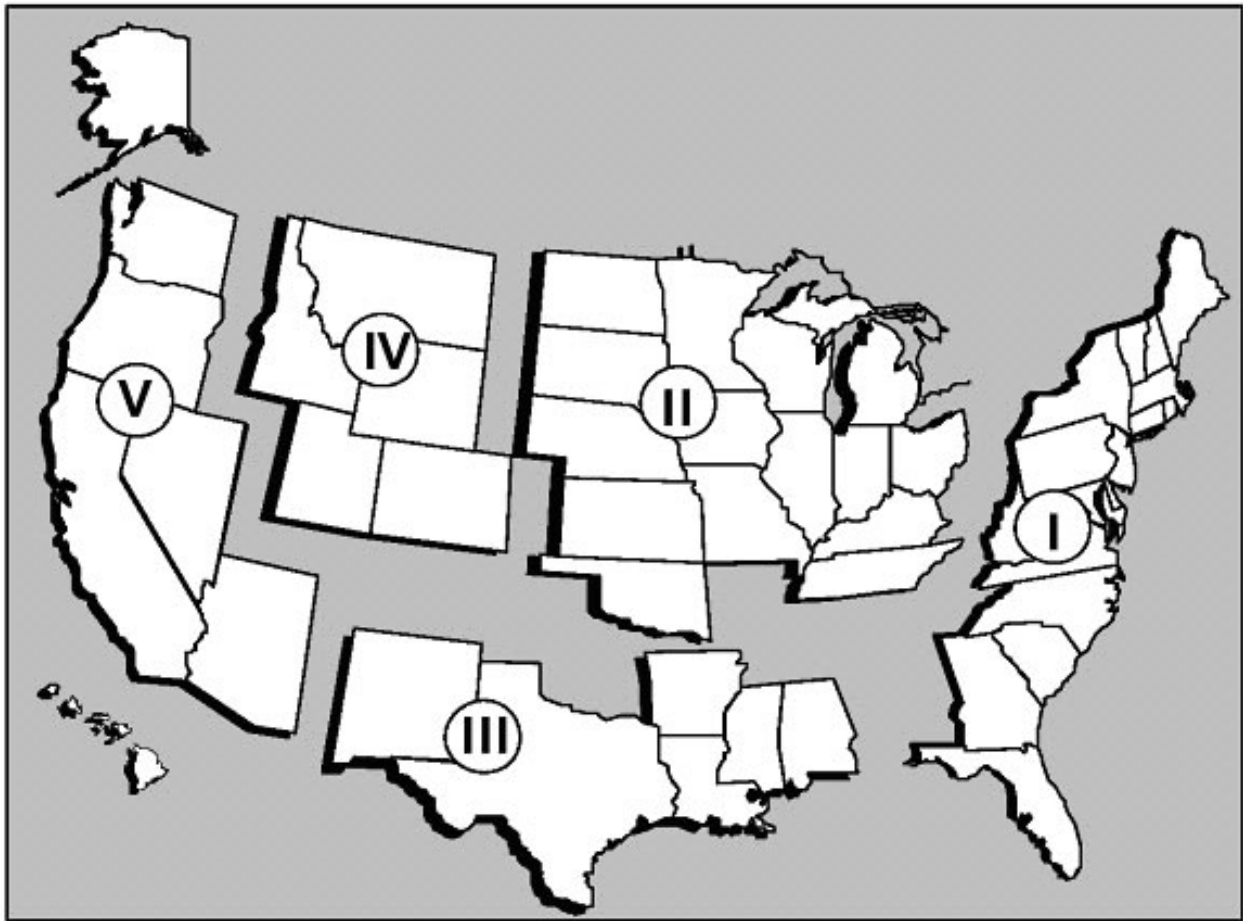

Model Inputs and Outputs

Inputs

The primary inputs to the IEM include expected U.S. and global petroleum liquids production and consumption; elasticities associated with petroleum liquids demand and supply curves; world oil prices; refinery utilization factors; and linear regression coefficients for independent variables used in computing petroleum product prices. Additional detail on model inputs is provided in Appendix A. The major inputs are summarized in Table 1.

Table 1. IEM Model Inputs

Model Inputs	Source
Expected U.S. crude-like liquids supply and demand curves by year	Exogenous values included in input file omsecon.txt
Expected world crude-like liquids supply and demand curves by year	Exogenous values included in input file omsecon.txt
Total liquids supply and distribution by region (country) by year	Exogenous values included in input file omsecon.txt
GDP Deflators	Macroeconomic Activity Module
U.S. crude-like liquids supply and demand by year	Petroleum Market Module
World crude-like liquids supply and demand by year	Petroleum Market Module
U.S. crude oil imports	Petroleum Market Module
U.S. product imports	Petroleum Market Module

Outputs

The primary outputs of the IEM are world oil prices, world supply curves, and import quantities. Table 2 summarizes these outputs.

Table 2. IEM Model Outputs

Model Outputs	Destination
Computed world oil price	Petroleum Market Module
World crude oil supply curves	Petroleum Market Module
U.S. crude oil and light and heavy petroleum product import quantities by source	Petroleum Market Module

Relationship of the International Energy Module to Other NEMS Modules

The IEM uses information from other NEMS components; it also provides information to other NEMS components. The information it uses is primarily about annual U.S. and world projected production and consumption quantities of crude-like liquids. The information it provides includes world crude oil supply curves, a computed world oil price, and U.S. import prices of crude oil and products by source (region and/or country). It should be noted, however, that the present focus of the IEM is on the international oil market. Any interactions between the U.S. and foreign regions in fuels other than oil (for example, coal trade) are modeled in the particular NEMS module that deals with that fuel.

For U.S. crude-like liquids production and consumption in any year of the projection period, the IEM uses production projections generated by the Oil and Gas Supply Module and provided through the Petroleum Market Module (see Figure 2).

U.S. and world expected petroleum liquids supply and demand curves, for any year in the projection period, are exogenously provided through data included in the input file omsecon.txt, as described in Appendix A, “Input Data and Variable Descriptions.”

Figure 2. IEM Relationship to Other NEMS Modules

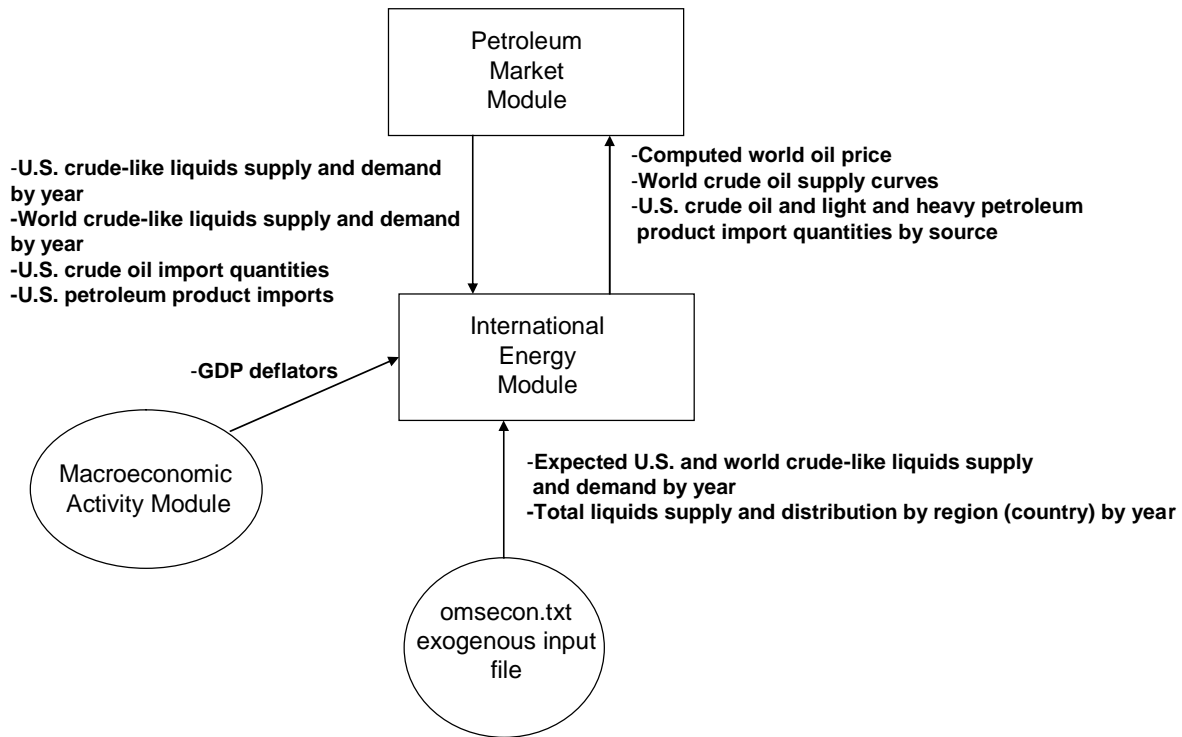

3. Model Rationale

Theoretical Approach

The NEMS International Energy Module is a calculation tool that uses assumptions of economic growth and expectations of future U.S. and world crude-like liquids supply and demand, by year, to model the interaction of U.S. and international oil markets. The IEM employs an equilibrium algorithm to calculate the world oil price. Based on U.S. crude-like liquids production and consumption and other input data, the IEM computes a new world oil price (WOP).

The IEM also determines total imports into the United States of crude oil and heavy and light petroleum products from different regions of the world. Once the NEMS reaches convergence, the IEM produces data on total U.S. imports of crude oil and light and heavy refined products by region or country. IEM input data contain the historical percentages of U.S. imports of crude oil and heavy and light products by region of origin. Using these values and total U.S. imports of crude oil and heavy and light products provided by the PMM, the IEM generates a report, with import by source for every year in the forecast.

Fundamental Assumptions

For the *AEO2009*, the IEM begins with basic assumptions about the liquids demand and supply curves for the United States and the world, based upon the results published in the *AEO2008* and the *International Energy Outlook 2008*. Appendix A contains a full sample of the IEM input data file assumptions. The following data series are input into the IEM for each year between 2007 and 2030:

- 1) Global Total Crude-Like Liquids Demand Curves
- 2) U.S. Total Crude-Like Liquids Demand Curves
- 3) Global Total Crude-Like Liquids Supply Curves
- 4) U.S. Total Crude-Like Liquids Supply Curves

For each year of the projection (2007 through 2030), all supply and demand curves are expressed as functions:

$$Q = P$$

where P is the price, Q is the quantity, ϵ is the elasticity (assumed to be constant for each curve, but whose values may vary from year to year), and K is a constant that is determined by the coordinates of a point on the curve. All values for quantities are expressed in units of one million barrels per day, and prices are expressed in real 2007 dollars per barrel.

Global Total Crude-Like Liquids Supply Curves and US Total Crude-Like Liquids Supply Curves. These curves are built exogenously with data from the Oil and Gas Supply Module, Generate World Oil Balances (GWOB)² and previous runs of NEMS. For both of these supply curves, the value of the elasticities in each year between 2008 and 2030 is assumed to be 0.25.

Global Total Crude-Like Liquids Demand Curves and US Total Crude-Like Liquids Demand Curves. For each year of period 2008 to 2030, these curves are constructed in the same format as the supply curves:

$$Q = P$$

where P is the price, Q is the quantity, ϵ is the elasticity assumed to be constant for each curve (but which can vary from year to year), and K is a constant that can be determined by the coordinates of a point on the curve. Values for P , the expected world oil prices, are provided by assumption. Values for Q are assumed based upon previous NEMS and GWOB model runs.

Demand elasticities (ϵ) are calculated on an annual basis from 2008 through 2030 using past projections of prices and world liquids supply and demand from the *AEO2008*. For each year of the projection period, elasticities are computed using an optimization algorithm.

That is, using results from the *AEO2008* as follows (see Figure 3):

P1 – World oil price in Reference Case Scenario

Q1 – Global total crude-like liquids demand in Reference Case Scenario

P2 – World oil price in High Oil Price Case Scenario

Q2 – Global total crude-like liquids demand in High Oil Price Case Scenario

P3 – World oil price in Low Oil Price Case Scenario

Q3 – Global total crude-like liquids demand in Low Oil Price Case Scenario

Points A (Q1, P1), B (Q2, P2), C (Q3, P3) are plotted as is shown in Figure 3, as are points U (Q4, P2) and V (Q5, P3). Curve BAC is then approximated using isoelastic curve UAV in such a way that the sum of the lengths of segments BU and VC has a minimum value.

² GWOB is a spreadsheet-based application used to create a "bottom up" projection of world liquids supply—based on current production capacity, planned future additions to capacity, resource data, geopolitical constraints, and prices—and is used to generate conventional crude oil production cases. The scenarios (oil price cases) are developed through an iterative process of examining demand levels at given prices and considering the price and income sensitivity on both the demand and supply sides of the equation. Projections of conventional liquids production for 2009 through 2015 are based on analysis of investment and development trends around the globe. Data from EIA's Short-Term Energy Outlook are integrated to ensure consistency between short- and long-term modeling efforts. Projections of unconventional liquids production are based on exogenous analysis.

Figure 3. Global Total Petroleum Liquids Demand Curve

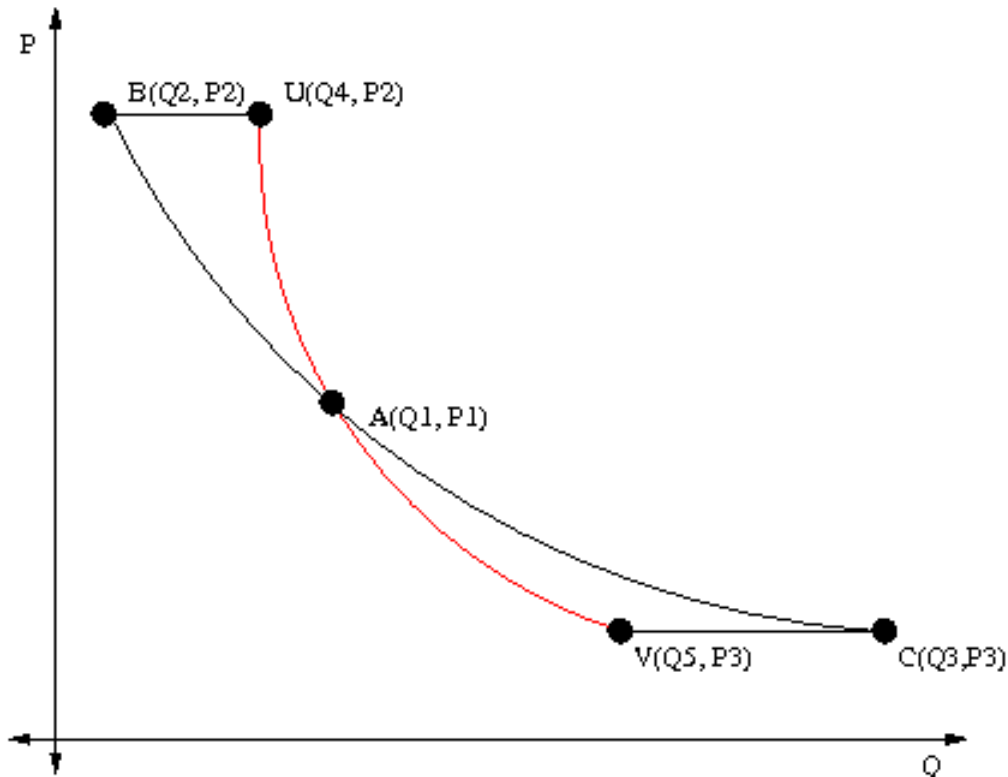

$$Q4 = (P2) , Q5 = (P3) , Q1 = (P1)$$

$$Q4/Q1 = (P2/P1) , \text{ therefore } Q4 = Q1 (P2/P1)$$

$$Q5/Q1 = (P3/P1) , \text{ therefore } Q5 = Q1 (P3/P1)$$

$$BU = \text{abs } |Q2 - Q4| = \text{abs } |Q2 - Q1 (P2/P1) |$$

$$VC = \text{abs } |Q3 - Q5| = \text{abs } |Q3 - Q1 (P3/P1) |$$

$$\text{Let } F () = BU + VC = \text{abs } |Q2 - Q1 (P2/P1) | + \text{abs } |Q3 - Q1 (P3/P1) |$$

Find $\lambda < 0$ such that the sum of lengths of segments BU and VC has a minimum value and so that:

$$\text{Min } \lambda < 0 F () = \text{Min } \lambda < 0 (\text{abs } |Q2 - Q1 (P2/P1) | + \text{abs } |Q3 - Q1 (P3/P1) |)$$

This optimization problem can be solved using a wide range of tools. Thus, the value of this minimum can be found and, more importantly, the value of λ for which the minimum value of function F is achieved can also be found. In this case, $\lambda = -0.11$.

U.S. Liquids Imports Assumptions. The IEM makes a number of assumptions about U.S. imports of crude oil and light and heavy refined petroleum products by region or country. The initial run of the IEM includes assumed total U.S. crude oil imports (in million barrels per day) and the percent of U.S. light and heavy refined petroleum product imports, as follows:

Total Crude Oil Imports starting in 2004

2004	2005	2006	2007	2008	2009	2010
10.06	10.09	10.07	10.03	10.27	9.94	9.95

Percentage of Total Crude Oil Imports by Region

	2004	2005	2006	2007	2008
Canada	0.156590684	0.157534247	0.157843137	0.160358566	0.160358566
Mexico	0.158572844	0.151663405	0.147058824	0.141434263	0.142430279

Percentage of Light Refined Products by Region

	2004	2005	2006	2007	2008
Canada	0.247191011	0.250000000	0.243781095	0.243654822	0.236453202
N.Europe	0.174157304	0.168367347	0.164179105	0.167512690	0.167487684

Percentage of Heavy Refined Products by Region

	2004	2005	2006	2007	2008
Canada	0.05882353	0.056910569	0.05	0.052083333	0.06
N.Europe	0.176470588	0.162601626	0.158333333	0.1875	0.17

4. Model Structure

Structural Overview

The main purpose of the NEMS IEM is to re-estimate world oil prices and supply curves and to provide a report on the quantity of U.S. liquids imports by region or country. The IEM calculates the world oil price based on differences between U.S. total crude-like consumption and production and the expected U.S. total crude-like liquids consumption and production at the current world oil price. It also calculates the average world oil price and provides global crude-like liquids supply curves. All of this must be achieved by keeping world oil markets in balance. Supply import curves are isoelastic curves, and points on the curve are adjusted as other NEMS modules (specifically the Petroleum Market Module, Oil & Gas Supply Module, various end-use demand modules, and the Integrating Module) provide information about the U.S. liquids projection.

The basic structure of the main IEM routine is illustrated in Figure 4. A call from the NEMS Integrating Module to the IEM initiates importation of the supporting information needed to complete the projection calculations for world liquids markets. A substantial amount of support information for the IEM is calculated exogenously. Various techniques, including simple and logarithmic linear regressions, are used to estimate the coefficients and elasticities that are applied within the IEM. The results are saved in the omsecon.txt input file, and are read into the IEM. The IEM main routine or “world” runs the subroutine OMS_Dat_In to import world and U.S. projections of liquids production and consumption from the OMSInput.wk1 file. Next, the World_Data_In subroutine is executed to import U.S. and world total liquids supply and demand curves from the omsecon.txt file.

Once the necessary data has been imported, the OMS_Sim subroutine is executed (Figure 5). The purpose of this routine is to recalculate the average world oil price based on the weighted average of five generic crude oil types. Next, the model calculates the total U.S. demand for liquids by summing up demand for individual liquids products. Similarly, U.S. conventional and unconventional production totals are calculated by summing up individual product projections, plus adjusting for refinery processing gain and exports. The “call on OPEC” is then computed by subtracting U.S. conventional supply, U.S. unconventional production, OPEC production, and a discrepancy factor from U.S. demand. Subsequently, OPEC production is recalculated by adjusting for the “call on OPEC” amount.

In the next step, the Crd_Sup_Crv and Prd_Sup_Crv subroutines are executed to import crude-like and petroleum product supply curves by PADD. After these two subroutines are completed, the Sup_Crv_Adj subroutine is executed (Figure 6). Here, U.S. crude import curve and petroleum product prices are adjusted according to the steps of the production curve, crude type, and PADD. Finally, the world oil price is re-estimated as the weighted average of the petroleum product import quantities and prices for each projection year.

If the NEMS run is in its final iteration year, the World_Oil_Report subroutine is executed (Figure 7). In this subroutine, the U.S. crude oil import quantities, U.S. light refined product import quantities, and U.S. heavy refined product import quantities are calculated. In each case, the total U.S. imports of crude and the appropriate product imports for light and refined products are calculated based upon the PMM output. Next, the quantities imported from each region in

the model are calculated based upon the regional shares calculated exogenously to the IEM and input from the omsecon.txt file.

The main IEM routine then queries the current calendar year (CURCALYR) variable to make sure it is a projection year (in the case of the *AEO2009*, greater than or equal to 2009), if it is, the World_Compute_New subroutine is executed (Figure 8). In World_Compute_New, the total world demand and supply is recalculated, and the world crude-like price is calculated for each of nine supply curve points. Then the global crude-like liquids supply quantity is calculated to ensure that quantities and prices are in equilibrium for each quantity-price pair.

Once again, the main IEM routine checks to see if the current calendar year is greater than or equal to 2009 and if it is, the World_Curves subroutine is executed (Figure 9). World_Curves is a simple subroutine that takes a GDP-deflator to convert the prices from 2007dollars into 1987 dollars for use in the NEMS PMM. Finally, price and quantity points on the import supply curves are all set to the corresponding price and quantities previously calculated by crude type and product type.

Flow Diagrams

Figure 4. Flowchart for Main IEM Routine

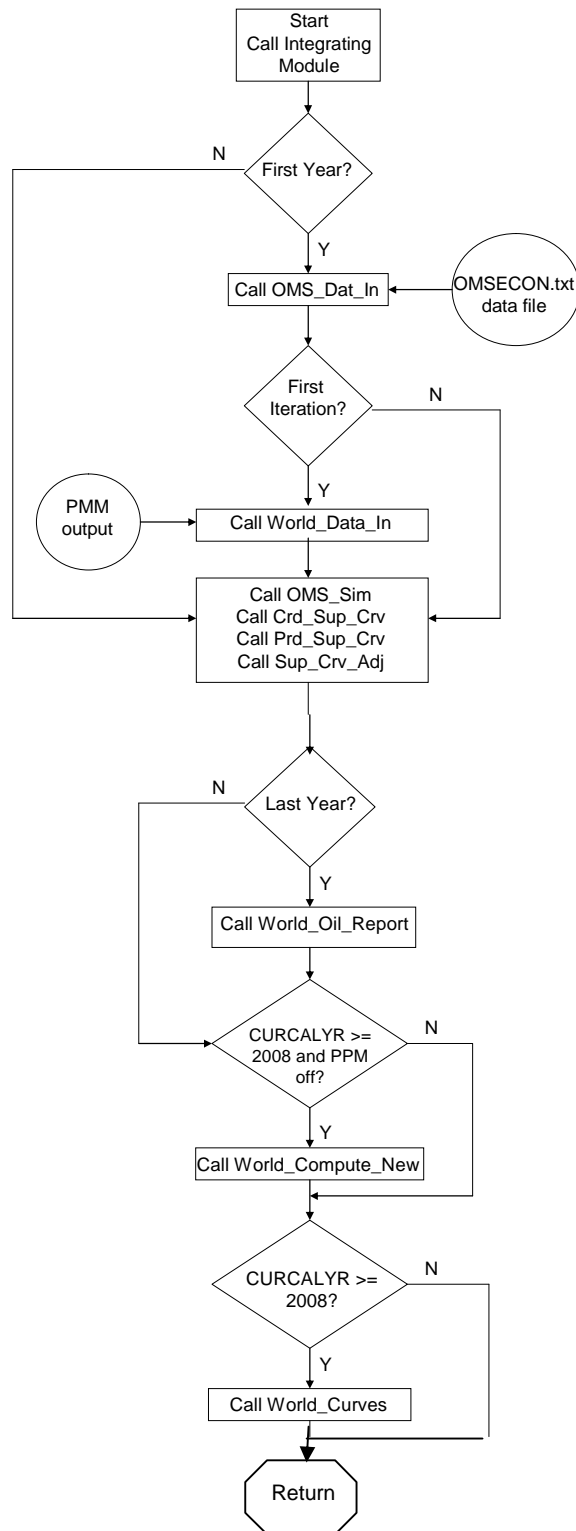

Figure 5. Flowchart for OMS_Sim Subroutine: Adjusts OPEC Supply to Balance World Oil Supply and Demand Based on U.S. Projections

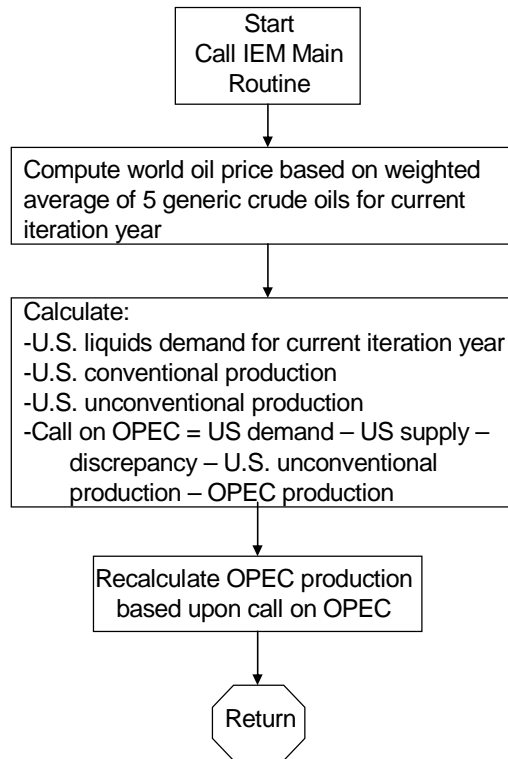

Figure 6. Flowchart for Sup_Crv_Adj Subroutine: Calculates U.S. Crude Prices and Petroleum Product Import Prices for Each Step on the Production Curve and PADD and Recalculates World Oil Price

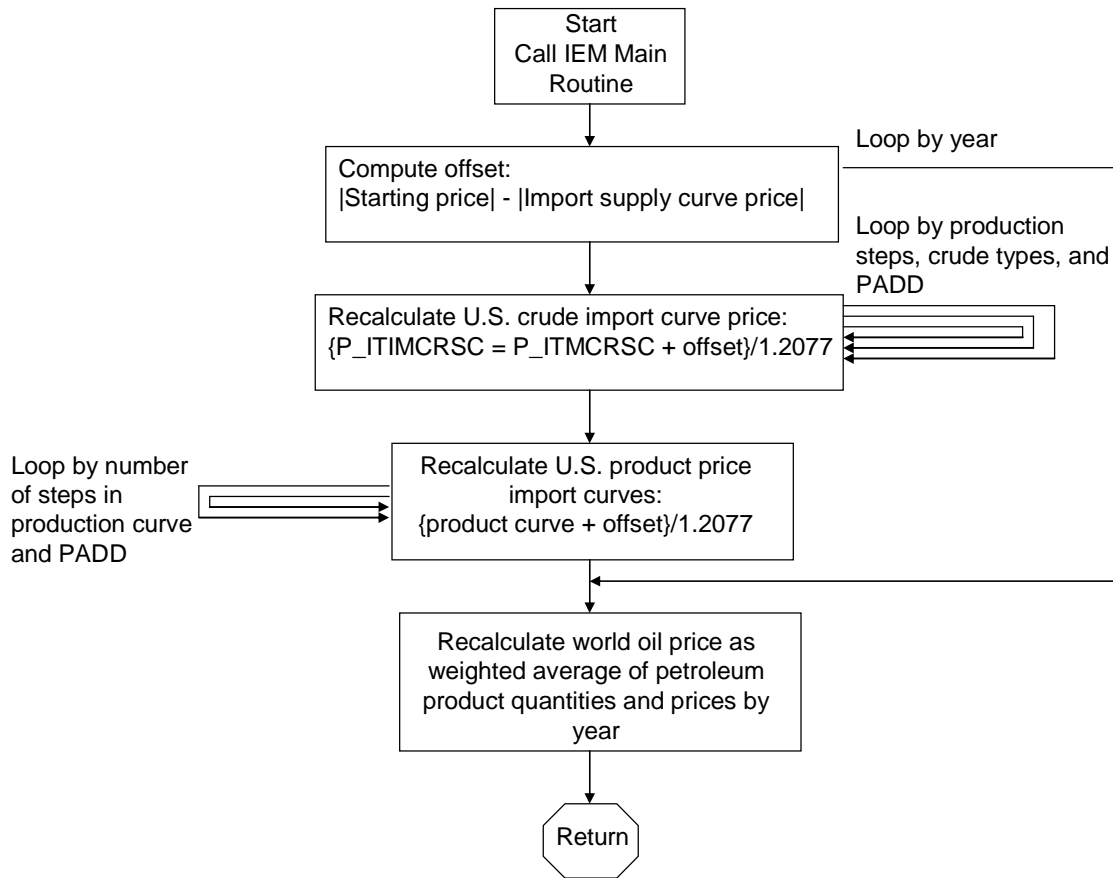

Figure 7. Flowchart for World_Oil_Report Subroutine: Calculates U.S. Imports of Crude Oil and Light and Heavy Refined Products

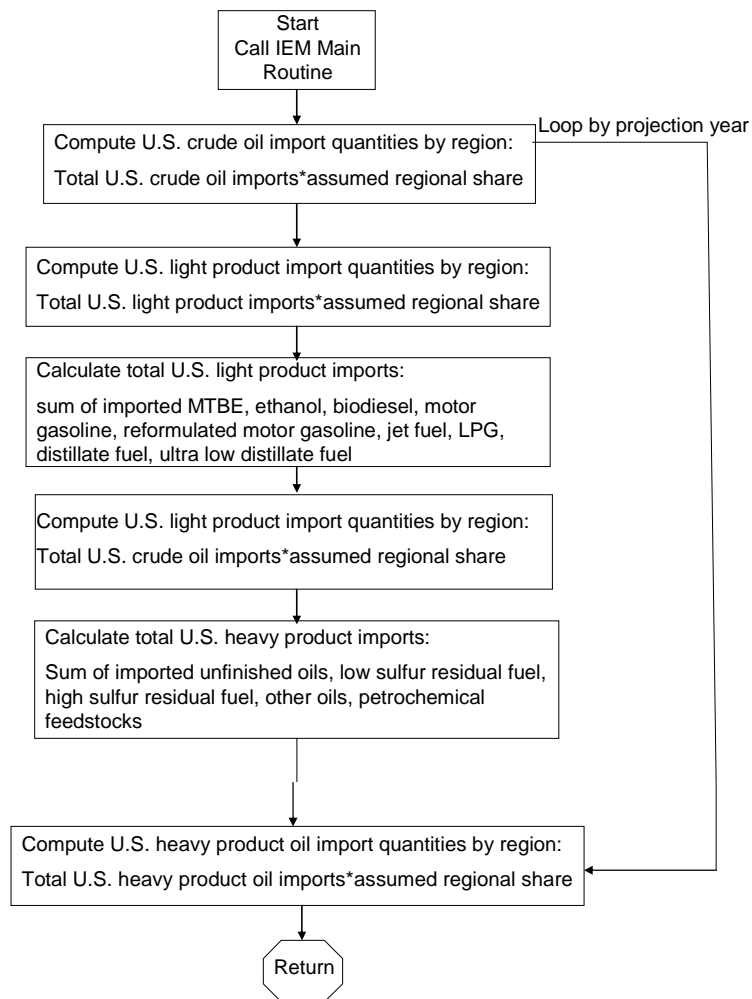

Figure 8. Flowchart for World_Compute_New Subroutine: Recalculates World Oil Prices Based on New Supply and Demand Estimates

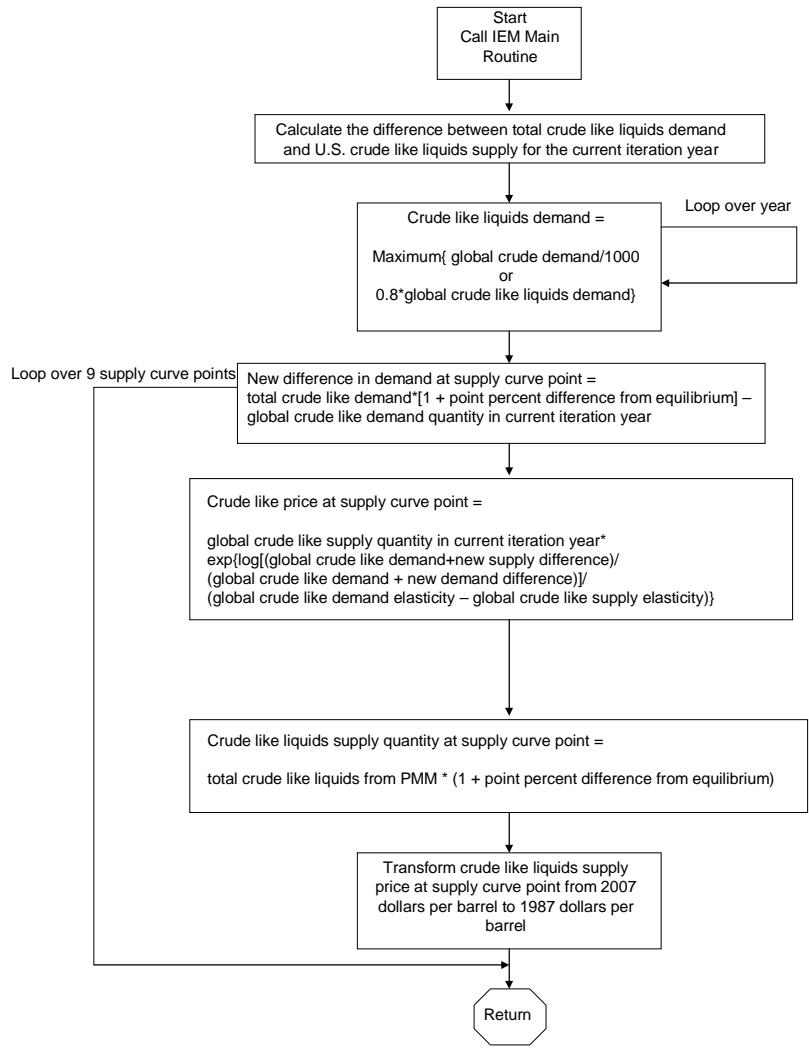
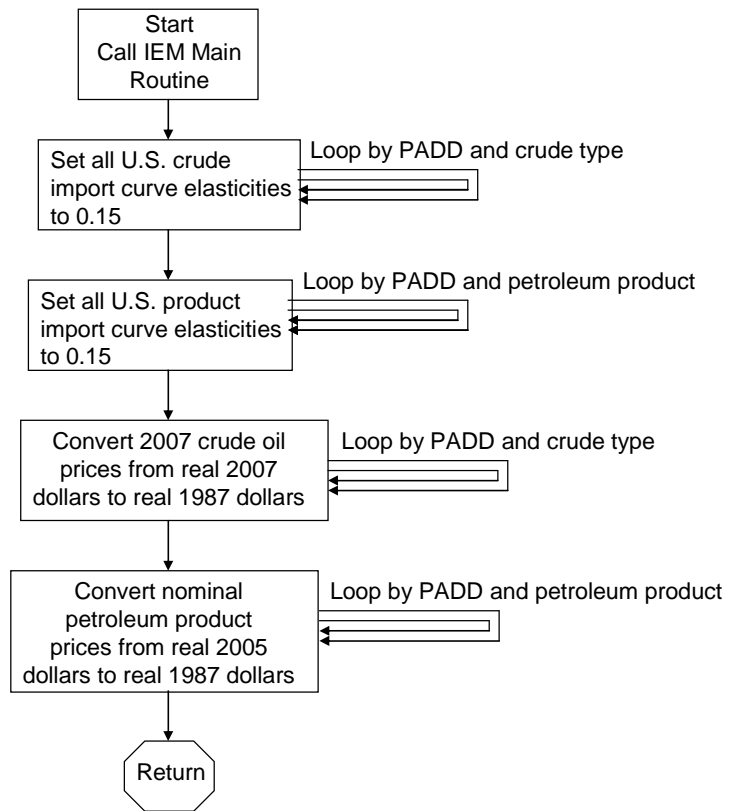

Figure 9. Flowchart for World_Curves Subroutine: Converts 2007 Dollars per Barrel to Real 1987 Dollars per Barrel



Key Computations and Equations

This section provides detailed solution algorithms arranged by sequential subroutine as executed in the NEMS International Energy Module. General forms of the fundamental equations involved in the key computations are presented, followed by discussion of the details considered by the full forms of the equations provided in Appendix B.

Recalculating World Oil Prices and U.S. Crude Oil and Product Import Supply Curves

This section explains the algorithm the IEM uses to compute world oil prices (WOP). The WOP, it is important to note, is assumed to be the price of low sulfur light crude (FLL) delivered at Cushing, Oklahoma, in PADD2.

All computations performed in the IEM start with year 2009. The IEM reads the input file (omsecon.txt), and all data and assumptions described in the Model Assumptions section of this report are stored and ready to be accessed for future computations. A visual representation of the algorithm is presented in Figure 4.

Figure 10. Algorithm Used to Recalculate World Oil Prices in the IEM

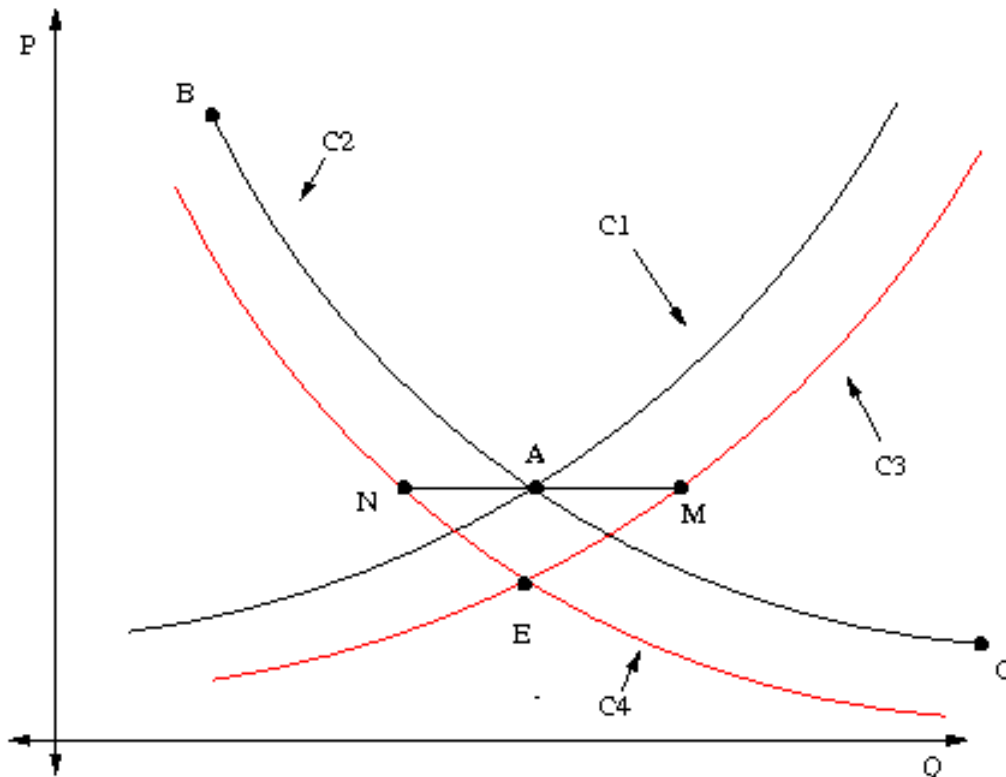

For each year of the forecasted period, the IEM uses the following methodology to compute the WOP. Let $C1$ and $C2$ be the expected world supply and demand curves of petroleum products. These curves are built according to the rules explained in the previous section – Structural Overview.

Let (P_0, Q_0) be the coordinates of equilibrium point A , based on the expected supply and demand curves $C1$ and $C2$.

Under a specific scenario, the change in the world petroleum products demand will be determined by the difference Q_d between U.S. petroleum products consumption (from the PMM) and expected petroleum products demand Q_0 at the current WOP P_0 . Point N is the translation of point A along horizontal axis with vector value of Q_d . Therefore, coordinates of point N are: $(P_0, Q_0 + Q_d)$. The new demand curve for world petroleum products will be the curve C4 that passes through point N. It is isoelastic, with same elasticity as the initial demand curve C2.

Observation: The new demand curve C4 is not the translation of initial demand curve C2.

In a similar way, under a specific scenario, the change in the world petroleum products supply will be determined by the difference Q_s between U.S. petroleum products production (from the PMM) and expected petroleum products supply Q_0 at the current WOP P_0 . Point M is the translation of point A along horizontal axis with vector value of Q_s . Therefore, coordinates of point M are: $(P_0, Q_0 + Q_s)$. The new supply curve for world petroleum products will be the curve C3 that passes through point M. It is isoelastic, with same elasticity as the initial supply curve C1.

Observation: The new supply curve C3 is not the translation of initial demand curve C1.

New equilibrium point E, at the intersection of the new supply and demand curves, will have coordinates (P^*, Q^*) , where P^* is the new WOP and Q^* is the new total petroleum liquids quantity corresponding to point E.

The following method is used to compute P^* and Q^* .

ϵ_s and ϵ_d will be the symbols used for supply and demand elasticities of expected supply and demand curves.

$$\begin{aligned} Q_0 + Q_s &= (P_0)^{\epsilon_s} \\ Q^* &= (P^*)^{\epsilon_s} \end{aligned}$$

$$\text{Therefore } Q^* = (Q_0 + Q_s) (P^*/P_0)^{\epsilon_s} \quad (i)$$

$$\begin{aligned} Q_0 + Q_d &= (P_0)^{\epsilon_d} \\ Q^* &= (P^*)^{\epsilon_d} \end{aligned}$$

$$\text{Therefore } Q^* = (Q_0 + Q_d) (P^*/P_0)^{\epsilon_d} \quad (ii)$$

From relations (i) and (ii) we conclude that

$$(Q_0 + Q_d)/(Q_0 + Q_s) = (P^*/P_0)^{\epsilon_d - \epsilon_s} \quad (iii)$$

Relation (iii) is an equation that must be solved for P^* . Its solution is given by the following expression:

$$P^* = P_0 e^{\frac{\ln((Q_0 + Q_s)/(Q_0 + Q_d))}{(\epsilon_d - \epsilon_s)}}$$

Also,

$$Q^* = (Q_0 + Q_s) (P^*/P_0)^{**} s$$

These computations are performed for each year from 2009 through 2030, until the convergence test is met.

Imported Petroleum Products in the United States

This section explains the procedure used to compute prices for imported petroleum products in the United States. Concrete examples are illustrated in Appendix B.

Linear regression in simple or logarithmic form is used to compute the differential between World Oil Price and a specific petroleum product price. In each case, the independent variables are chosen in such a way that they provide a logical explanation and a better fit for historical data. Independent variables considered for these linear regressions are: world oil price (WOP) and regional refinery utilization factors for Asia-Pacific, Europe, Japan, U.S., and rest of world (whole world without U.S.).

Multiple sources (*International Petroleum Monthly*, Energy Information Administration public website, *Bloomberg*, International Energy Agency, and *BP Statistical Review of World Energy*) are used to gather historical data on petroleum product prices imported in the U.S. The “least squares method” is used for each linear regression. This activity is performed outside of the IEM and the appropriate coefficients are saved in the omsecon.txt input file as noted above.

The data input section of the omsecon.txt file used for computing petroleum product prices consists of a table with values for refinery utilization factors for different regions in the world. It also includes, a series of tables, one for each PADD, that hold the values of the coefficients of independent variables of linear regression that are used to compute product prices. In this set of tables each line corresponds to a petroleum product in the same order as listed in Table 5. Some of these regressions are simple linear and some are logarithmic linear.

Global Regional Refinery Utilization Mean 1995 - 2005

Asia-Pac.	0.852928
Europe	0.787325
Japan	0.853428
OAP	0.895728
USA	0.905742
World	0.840266
RestWorld	0.823726

*

PADD1 Coefficients for independent variables

Constant	WTI_REAL	UTIL_USA	UTIL_ROW	C5
0.0	0.766	4.222	2.206	0.0
0.0	0.943	0.0	7.659	0.0
0.0	0.922	0.0	7.659	0.0
-19.437	-0.752	0.0	0.0	0.0

Example 1. Reformulated Blendstock for Oxygenate Blending (RBOB)

The simple linear regression performed in each year of the forecasted period for each PADD is based on world oil price and motor gasoline price as dependent variables. Therefore, the equation that provides the price for RBOB in PADD1 is:

$$LiquidRBOB_P(1, W_I_YR) = NEW_WOP(W_I_YR) + (Liquid_Coeff(13,1,1) + Liquid_Coeff(13,2,1)*NEW_WOP(W_I_YR) + 0.451*cGal_LiquidMG_P(1, W_I_YR))$$

Equivalent with:

$$LiquidRBOB_P(1, W_I_YR) = NEW_WOP(W_I_YR) - 19.437 - 0.752 *NEW_WOP(W_I_YR) + 0.451*cGal_LiquidMG_P(1, W_I_YR)$$

Example 2. Motor Gasoline

This is an example of linear regression in logarithmic form. Dependent variables considered are: world oil price, refinery utilization factor in the U.S.A., and refinery utilization factor in the rest of the world. The equation that provides the price for motor gasoline in PADD1 (used in the Example 1. above) is:

$$LiquidMG_P(1, W_I_YR) = NEW_WOP(W_I_YR) + EXP(Liquid_Coeff(1,2,1)*LOG(NEW_WOP(W_I_YR)) + Liquid_Coeff(1,3,1)*LOG(Util_USA) + Liquid_Coeff(1,4,1)*LOG(Util_Rest_of_World))$$

Equivalent with:

$$LiquidMG_P(1, W_I_YR) = NEW_WOP(W_I_YR) + EXP(0.766*LOG(NEW_WOP(W_I_YR)) + 4.222*LOG(Util_USA) + 2.206*LOG(Util_Rest_of_World))$$

Example 3. Low Sulfur Distillate

This is a linear regression in logarithmic form. Dependent variables are: world oil price and refinery utilization factor in the rest of the world. The equation that provides the price for low sulfur distillate in PADD1 is:

$$\begin{aligned} \text{LiquidDL_P}(1, W_I_YR) = & \text{NEW_WOP}(W_I_YR) + \\ & \text{EXP}(\text{Liquid_Coeff}(6, 2, 1) * \text{LOG}(\text{NEW_WOP}(W_I_YR))) + \\ & \text{Liquid_Coeff}(6, 4, 1) * \text{LOG}(\text{Util_Rest_of_World}) \end{aligned}$$

Equivalent with:

$$\begin{aligned} \text{LiquidDL_P}(1, W_I_YR) = & \text{NEW_WOP}(W_I_YR) + \\ & \text{EXP}(0.922 * \text{LOG}(\text{NEW_WOP}(W_I_YR))) + 7.659 * \text{LOG}(\text{Util_Rest_of_World}) \end{aligned}$$

World Supply and Demand, Including Conventional and Unconventional Liquids

NEMS also provides an international petroleum supply and disposition summary table. Exogenous data used to build this report is contained in omsinput.wk1 file. Each oil price case has its own version of this file. The supply portion of this report is divided into conventional and unconventional production. Table 2.2, Section A lists all regions considered in this report.

Because U.S. production of conventional liquids is a dynamic value (and an output from NEMS), the OPEC Middle East region is considered the “swing producer.” For this reason, the total world production reflects the corresponding value from the *International Energy Outlook 2008* for each oil price case. Likewise, because the U.S. consumption of liquids is a dynamic value (and an output from NEMS), all other world regions have been proportionally updated so that the total world liquids consumption corresponds to the values reported in the *International Energy Outlook 2008* for each oil price case.

Appendix A. Input Data and Variable Descriptions

The following variables represent data input from omsecon.txt file.

Classification: Input variable.

<i>GTL_P_Demand(MX_W_YR):</i>	Global petroleum liquids demand prices;
<i>GTL_Q_Demand(MX_W_YR):</i>	Global petroleum liquids demand quantities;
<i>GTL_DElasticity(MX_W_YR):</i>	Global petroleum liquids demand elasticities;
<i>USTL_P_Demand(MX_W_YR):</i>	U.S. petroleum liquids demand prices;
<i>USTL_Q_Demand(MX_W_YR):</i>	U.S. petroleum liquids demand quantities;
<i>USTL_DElasticity(MX_W_YR):</i>	U.S. petroleum liquids demand elasticities;
<i>GTL_P_Supply(MX_W_YR):</i>	Global petroleum liquids supply prices;
<i>GTL_Q_Supply(MX_W_YR):</i>	Global petroleum liquids supply quantities;
<i>GTL_SElasticity(MX_W_YR):</i>	Global petroleum liquids supply elasticities;
<i>USTL_P_Supply(MX_W_YR):</i>	U.S. petroleum liquids supply prices;
<i>USTL_Q_Supply(MX_W_YR):</i>	U.S. petroleum liquids supply quantities; and
<i>USTL_SElasticity(MX_W_YR):</i>	U.S. petroleum liquids supply elasticities.

The following arrays hold the new prices for oils and liquids (relative to NEW_WOP) by PADD and year:

Classification: Calculated variable.

OilCLL_P(6,MX_W_YR),
OilCMH_P(6,MX_W_YR),
OilCHL_P(6,MX_W_YR),
OilCHH_P(6,MX_W_YR),
OilCHV_P(6,MX_W_YR),
LiquidMG_P(6,MX_W_YR),
LiquidRG_P(6,MX_W_YR),
LiquidLG_P(6,MX_W_YR),
LiquidJF_P(6,MX_W_YR),
LiquidDS_P(6,MX_W_YR),
LiquidDL_P(6,MX_W_YR),
LiquidDU_P(6,MX_W_YR),
LiquidRL_P(6,MX_W_YR),
LiquidRH_P(6,MX_W_YR),
LiquidPF_P(6,MX_W_YR),
LiquidOT_P(6,MX_W_YR),
LiquidUFARB_P(6,MX_W_YR),
LiquidUFNPP_P(6,MX_W_YR),
LiquidUFHGM_P(6,MX_W_YR),
LiquidME_P(6,MX_W_YR),
LiquidCBOB_P(6,MX_W_YR),

LiquidMT_P(6,MX_W_YR),
LiquidRBOB_P(6,MX_W_YR).

U.S. total crude-like liquid production and consumption for 2009-2030 and expected U.S. total crude-like liquid production and consumption for current year:

Classification: Input from PMM

USTL_Production (MX_W_YR),
USTL_Consumption (MX_W_YR)

Classification: Calculated variable

expected_USTL_S, expected_USTL_D.

Current quantities imported in the U.S. for each liquid by type, PADD and year:

Classification: Input from PMM

OilCLL(6,MX_W_YR,2),
OilCMH(6,MX_W_YR,2),
OilCHL(6,MX_W_YR,2),
OilCHH(6,MX_W_YR,2),
OilCHV(6,MX_W_YR,2),
LiquidMG(6,MX_W_YR,2),
LiquidRG(6,MX_W_YR,2),
LiquidLG(6,MX_W_YR,2),
LiquidJF(6,MX_W_YR,2),
LiquidDS(6,MX_W_YR,2),
LiquidDL(6,MX_W_YR,2),
LiquidDU(6,MX_W_YR,2),
LiquidRL(6,MX_W_YR,2),
LiquidRH(6,MX_W_YR,2),
LiquidPF(6,MX_W_YR,2),
LiquidOT(6,MX_W_YR,2),
LiquidUFARB(6,MX_W_YR,2),
LiquidUFNPP(6,MX_W_YR,2),
LiquidUFHGM(6,MX_W_YR,2),
LiquidME(6,MX_W_YR,2),
LiquidCBOB(6,MX_W_YR,2),
LiquidMT(6,MX_W_YR,2),
LiquidRBOB(6,MX_W_YR,2).

Multipliers, from WTI to each oil type (U.S. generic):

Classification: Input variable

Nat_PMPI_FLL,
Nat_PMPI_FHL,
Nat_PMPI_FMH,
Nat_PMPI_FHH,
Nat_PMPI_FHV.

Multipliers, from each oil type (U.S. generic) to oil type by PADD:

Classification: Input variable

OIL_PADD1_PM,
OIL_PADD2_PM,
OIL_PADD3_PM,
OIL_PADD4_PM,
OIL_PADD5_PM.

Global regional refinery utilization:

Classification: Input variable

Util_Asia_Pacific,
Util_Europe,
Util_Japan,
Util_OAP,
Util_USA,
Util_World, Util_Rest_of_World.

Percentages, by source, of crude oils and light and heavy refinery products imported in the U.S.:

Classification: Input variable

IOCanadaPct(MX_W_YR2),
IOMexicoPct(MX_W_YR2),
IONorthSeaPct(MX_W_YR2),
IOOPECpct(MX_W_YR2),
IOOPLatinAmericaPct(MX_W_YR2),
IOOPNorthAfricaPct(MX_W_YR2),
IOOPWestAfricaPct(MX_W_YR2),
IOOPIndonesiaPct(MX_W_YR2),
IOOPPersianGulfPct(MX_W_YR2),
IOOtherMiddleEastPct(MX_W_YR2),
IOOtherLatinAmericaPct(MX_W_YR2),

IOOtherAfricaPct(MX_W_YR2),
IOOtherAsiaPct(MX_W_YR2),
ILPCanadaPct(MX_W_YR2),
ILPNorthEuropePct(MX_W_YR2),
ILPSouthEuropePct(MX_W_YR2),
ILPOPECPct(MX_W_YR2),
ILPOPAmericasPct(MX_W_YR2),
ILPOPNoAfricaPct(MX_W_YR2),
ILPOPWestAfricaPct(MX_W_YR2),
ILPOPIndonesiaPct(MX_W_YR2),
ILPOPPersianGulfPct(MX_W_YR2),
ILPCaribbeanPct(MX_W_YR2),
ILPAsiaPct(MX_W_YR2),
ILPOtherPct(MX_W_YR2),
IHPCanadaPct(MX_W_YR2),
IHPNorthEuropePct(MX_W_YR2),
IHPSouthEuropePct(MX_W_YR2),
IHPOPECPct(MX_W_YR2),
IHPOPAmericasPct(MX_W_YR2),
IHPOPNoAfricaPct(MX_W_YR2),
IHPOPWestAfricaPct(MX_W_YR2),
IHPOPIndonesiaPct(MX_W_YR2),
IHPOPPersianGulfPct(MX_W_YR2),
IHPCaribbeanPct(MX_W_YR2),
IHPAsiaPct(MX_W_YR2),
IHPOtherPct(MX_W_YR2).

Quantities of crudes, light and heavy refinery products imported in the U.S.:

Classification: Computed variable

ICOCANADA (MNUMYR),
ICOMEXICO(MNUMYR),
ICONORTHSEA(MNUMYR),
ICOOPAMERICAS(MNUMYR),
ICOOPWESTAFRICA(MNUMYR),
ICOOPINDONESIA(MNUMYR),
ICOOPPERSIANGULF(MNUMYR),
ICOOTHERMIDEAST(MNUMYR),
ICOOTHERAMERICAS(MNUMYR),
ICOOTHERAFRICA(MNUMYR),
ICOOTHERASIA (MNUMYR),
ICOTOTAL(MNUMYR),
IHPCANADA(MNUMYR),
IHPNORTHEUROPE(MNUMYR),
IHPSOUTHEUROPE (MNUMYR),
IHPOPEC(MNUMYR),

IHPOPAMERICAS (MNUMYR),
IHPOPNOAFRICA(MNUMYR),
IHPOPWESTAFRICA (MNUMYR),
IHPOPPERSIANGULF (MNUMYR),
IHPASIA(MNUMYR),
IHPOTHER(MNUMYR),
ILPNORTHEUROPE(MNUMYR),
ILPSOUTHEUROPE (MNUMYR),
ILPOPEC(MNUMYR),
ILPOPNOAFRICA(MNUMYR),
ILPOPWESTAFRICA (MNUMYR),
ILPOPINDONESIA(MNUMYR),
ILPOPPERSIANGULF(MNUMYR),
ILPCARIBBEAN(MNUMYR),
ILPASIA (MNUMYR),
ILPOTHER(MNUMYR),
ILPTOTAL (MNUMYR).

Supply curves for imported crudes and petroleum products in the U.S.:

Classification: Computed variable

CRDICURVES (5, MNUMPR, 3, MNUMYR),
PRDICURVES (18, MNUMPR, 3, MNUMYR).

Table 3. IEM Regional Representation of U.S. Imports

Crude Oil	Light Refined Products	Heavy Refined Products
Canada	Canada	Canada
Mexico	Northern Europe	Northern Europe
North Sea	Southern Europe	Southern Europe
OPEC	OPEC	OPEC
Latin America	Latin America	Latin America
North Africa	North Africa	North Africa
West Africa	West Africa	West Africa
Indonesia	Indonesia	Indonesia
Persian Gulf	Persian Gulf	Persian Gulf

Crude Oil	Light Refined Products	Heavy Refined Products
Other Middle East	Caribbean Basin	Caribbean Basin
Other Latin America	Asian Exporters	Asian Exporters
Other Africa	Other	Other
Other Asia		

Table 4. Crude Oil Categories for IEM Import Supply Curves

GROUP	CODE	SULFUR CONTENT	API GRAVITY
Low Sulfur Light	FLL	0 – 0.2	25 – 66
		0.2 – 0.5	32 - 66
Medium Sulfur Heavy	FMH	0.2 – 1.1	21 - 32
High Sulfur Light	FHL	0.5 – 1.1	32 – 56
		1.1 – 1.3	30 – 56
		1.3 – 1.99	35 - 56
High Sulfur Heavy	FHH	1.3 – 1.99	21 - 35
High Sulfur Very Heavy	FHV	>2.7	<21

Table 5. Petroleum Products Categories for IEM Import Supply Curves

INDEX	GROUP	CODE
1	Motor Gasoline	MG - TRG
2	Reformulated Motor Gasoline	RG - RFG
3	Liquefied Petroleum Gases	LG - LPG
4	Jet Fuel	JF - JTA
5	Distillate	DS - N2H
6	Low Sulfur Distillate	DL - DSL
7	Ultra Low Sulfur Distillate	DU - DSU
8	Low Sulfur Residual Fuel	RL - N6H
9	High Sulfur Residual Fuel	RH - N6I
10	Petrochemical Feedstocks	PF - PCF
11	Other	OT - OTH
12	Methanol	ME - MET
13	Reformulated Blendstock for Oxygenate Blending (RBOB)	XG - SSR
14	MTBE	MT - MTB
15	Unfinished Oils - Residual Fuel	NA - ARB
16	Unfinished Oils - Naphtha	NA - NPP
17	Unfinished Oils - Heavy Gas Oil	NA - HGM
18	Conventional Blendstock for Oxygenate Blending (CBOB)	CB - SSE

Appendix B. Mathematical Description

This section provides the formulas and associated mathematical description which represent the detailed solution algorithms. The section is arranged by sequential submodule as executed in the NEMS International Energy Module.

SUBROUTINE: OMS_SIM

Description: The OMS_Sim subroutine is first used to re-compute the world oil price paths based on a weighted average of the five generic crude oil types as estimated in the NEMS PMM. It is then used to calculate revised OPEC production numbers for the current iteration based on the latest demand and supply estimates for the United States. The associated sequence of equations begins with the re-estimation of the average world oil price:

Equations:
$$\text{World oil price} = \frac{(\text{U.S. imports of crude}_i \times \text{U.S. price of imported crude}_i)}{(\text{U.S. imports of crude}_i)}$$

where,

i = low sulfur light, medium sulfur heavy, high sulfur light, high sulfur heavy, high sulfur very heavy. U.S. imports for the various crude oils are aggregated across PADD before the formula is applied.

Next, OMS_Sim calculates total U.S. demand for liquids:

$$\text{Total U.S. liquids demand} = \text{SPR_Fill} + (\text{U.S. product demand}_c)$$

where,

c = motor gasoline; jet fuel; distillate fuel; low sulfur residual fuel; high sulfur residual; kerosene; petrochemical feedstocks; LPG; petroleum coke; asphalt and road oil; still gas; and other. U.S. demand for the various products is aggregated across the U.S. Census Division before the formula is applied. Demand is calculated in units of million barrels per day.

After total U.S. demand is projected, conventional and unconventional production is calculated:

*Total U.S. conventional production = total U.S. domestic crude production +
total U.S. NGL production + other U.S. input to refineries + refinery
processing gain
– U.S. domestic ethanol production – crude production (EOR) + (liquid
hydrogen for transportation/ conversion factor for crude oil production)*

Conventional production is measured in units of million barrels per day.

*Total U.S. unconventional production = production of corn ethanol +
production of cellulosic ethanol + biodiesel_x + Alaskan GTL production +
CTL production + biomass-to-liquids production + crude production (EOR)*

where,

x = white grease, yellow grease, and seed oil.

Finally, the call on OPEC is computed:

$$\begin{aligned}
 \text{Call_on_OPEC} &= \text{Total U.S. domestic demand} - \\
 &\quad \text{Total U.S. domestic conventional supply} - \text{Discrepancy} - \\
 &\quad \text{Total U.S. domestic unconventional supply} - \text{OPEC production} \\
 \text{OPEC Production} &= \text{OPEC production} + \text{Call_on_OPEC}
 \end{aligned}$$

SUBROUTINE: SUP_CRV_ADJ

Description: In this subroutine, the PADD-level U.S. import supply curve prices and U.S. product import quantities are adjusted based upon the difference between assumed and expected world oil prices. The expected world oil prices are then re-estimated as the weighted average of petroleum product import quantities and prices by year.

Equations: First, the difference between the starting price and curve price is calculated:

$$Offset = |Start_Price_{t+1}| - |Curve_Price_{t+1}|$$

where,

t = year.

Next, the routine loops over PADD, crude type, and the number of supply curve steps to recalculate the U.S. crude-like import supply curve prices based on the Offset:

$$P_ITIMCRSC_{t,i,j,k} = \{P_ITIMCRSC_{t,i,j,k} + Offset\}/1.2077$$

where,

t = time (1 to current iteration year index)

i = PADD (1 to 5)

j = crude type (low sulfur light, medium sulfur heavy, high sulfur light, high sulfur heavy, high sulfur very heavy)

k = the number of production curve steps (1-3).

Once the supply curve prices are recalculated, the U.S. product price import curves are also recalculated:

$$ITIMxxSC_{t,i,j,2} = \{ITIMxxSC_{t,i,j,2} + Offset\}/1.2077$$

where,

xx = product type (Motor Gasoline, Reformulated Motor Gasoline, Liquefied Petroleum Gases, Kerosene-Jet Fuel, Distillate, Low Sulfur Distillate, Ultra Low Sulfur Distillate, Low Sulfur Residual Fuel, High Sulfur Residual Fuel, Petrochemical Feedstocks, Other, Methanol, Conventional Blendstock for Oxygenate Blending (CBOB), Reformulated Blendstock for Oxygenate Blending (RBOB), MTBE, Unfinished Oils – Residual Fuel, Unfinished Oils – Naphtha, and Unfinished Oils – Heavy Gas Oil)

t = time (1 to current iteration year)

i = PADD (1 to 5)

j = production step (1 to 9)

The '2' in the subscript indicates a price (as opposed to a quantity) is being calculated.

Finally, for each projection year, the world oil price is recalculated based on the weighted average of crude-like production and price:

$$IT_WOP_{t,2} = \{ RFIPQC_{xx6,t,1} * RFIPQC_{xx6,t,2} / \{ RFIPQC_{xx6,t,2} \}$$

where,

for variable IT_WOP,

t = projection year

'2' = price

For the RFIPQC_{xx} variable,

xx = crude type (low sulfur light, medium sulfur heavy, high sulfur light, high sulfur heavy, high sulfur very heavy)

'6' = PADD (PADD '6' is total United States)

'1' = price

'2' = quantity.

SUBROUTINE: WORLD_OIL_REPORT

Description: In the World_Oil_Report subroutine, the U.S. import quantities of crude oil and light and heavy refined products are computed by region or country based on output from the NEMS PMM. The routine calculates the country/regional quantities by applying shares estimated exogenously to total U.S. imports of the three petroleum forms for each projection year.

Equations:

$$\begin{aligned} &U.S. \text{ Crude Oil Imports from Region } r = \\ &Share \text{ of total crude oil imports from region } r * Total \text{ U.S. crude oil imports} \end{aligned}$$

where,

r = Canada, Mexico, North Sea, OPEC, Latin American OPEC, North African OPEC, West African OPEC, Indonesia (OPEC), Persian Gulf OPEC, other (non-OPEC) Middle East, other (non-OPEC) Latin America, other (non-OPEC) Africa, and other (non-OPEC) Asia.

The subroutine then computes the total imported light refined petroleum products:

$$\begin{aligned} & \textit{Total U.S. light refined product imports} = \\ & \textit{U.S. blending component imports} + \textit{MTBE imports} + \textit{ethanol imports} \\ & \quad + \textit{biodiesel imports} + \\ & \quad (\textit{motor gasoline imports} + \textit{reformulated gasoline imports} + \textit{jet fuel} \\ & \quad \textit{imports} + \\ & \quad \textit{LPG imports} + \textit{distillate fuel oil imports} + \textit{ultra low sulfur distillate} \\ & \quad \textit{fuel imports})/1000 \end{aligned}$$

The next step is to compute the quantity imported by region by applying shares to total U.S. light refined products over the projection period. The shares are exogenously determined for each region.

$$\begin{aligned} & \textit{U.S. light refined product imports from region } r = \\ & \textit{Share of total light refined product imports from region } r * \\ & \quad \textit{Total U.S. light refined product imports} \end{aligned}$$

where,

r = Canada, Mexico, Northern Europe, Southern Europe, OPEC, Latin American OPEC, North African OPEC, West African OPEC, Indonesia (OPEC), Persian Gulf OPEC, Caribbean, Asia, and other.

The subroutine then computes the total imported heavy refined products:

$$\begin{aligned} & \textit{Total U.S. heavy refined product imports} = \\ & \quad \textit{U.S. total unfinished crude oil imports} + \\ & \quad (\textit{low sulfur residual fuel imports} + \textit{high sulfur residual fuel imports} + \\ & \quad \textit{other imports} + \textit{petroleum feedstocks imports})/1000 \end{aligned}$$

Finally, the subroutine computes the quantity imported by region by applying shares to total U.S. heavy refined products over the projection period. The shares are exogenously determined for each region.

$$\begin{aligned} & \text{U.S. heavy refined product imports from region } r = \\ & \text{Share of total heavy refined product imports from region } r * \\ & \text{Total U.S. heavy refined product imports} \end{aligned}$$

where,

r = Canada, Northern Europe, Southern Europe, OPEC, Latin American OPEC, North African OPEC, West African OPEC, Indonesia (OPEC), Persian Gulf OPEC, Caribbean, Asia, and other.

SUBROUTINE: WORLD_COMPUTE_NEW

Description: In this subroutine, the world equilibrium price of crude-like liquids is recalculated based on new supply and demand differences (from changes to the United States based upon output from the Petroleum Market Module). The calculated new prices are converted from 2007 dollars per barrel to 1987 dollars per barrel for use by the Petroleum Market Module (PMM).

Equations First, the new U.S. supply difference is calculated as:

$$\text{New_Supply_Diff}_i = \text{Total U.S. lower 48 crude production}_{15,i} - \text{U.S. crude-like supply}_i$$

where,

i = current iteration year and

'15' for total U.S. lower 48 crude oil production is an Oil and Gas Submodule region index, in this case referring to the complete United States.

Next, the total global liquids demand is computed for each projection year as:

$$\text{PMM_CL_Demand}_y = \text{Maximum } | \text{GLBCRDDMD}_y / 1,000, 0.8 * \text{GCL_Q_Demand}_y |$$

where,

PMM_CL_Demand = total global crude-like liquids demand for PMM

GLBCRDDMD = total global crude oil demand

GCL_Q_Demand is the global crude-like liquids demand

“y” is the projection year.

The new demand difference is computed for each of nine crude supply curve points:

$$\text{New_Demand_Diff}_{y,iP} = \text{PMM_CL_Demand}_y * (1 + \text{percentage point difference from equilibrium}_{iP})$$

where,

iP = the curve point (1-9) and the percentage point difference from equilibrium has 9 values (-0.27, -0.09, -0.03, -0.01, 0.0, 0.01, 0.03, 0.09, 0.27)

The new demand and supply differences are then used to calculate new equilibrium point crude-like oil prices.

$$\text{Crude-like price at supply curve point}_{y,iP,1} =$$

$$\text{GCL_P_Supply}_y *$$

$$e^{(\log[\text{GCL_Q_Demand}_y + \text{new_supply_diff}_y] / (\text{GCL_Q_Demand}_y + \text{new_demand_diff}_y)) / (\text{GCL_DElasticity}_y - \text{GCL_SElasticity}_y)}$$

where,

GCL_Q_Demand is the global crude-like demand quantity

GCL_DElasticity is the elasticity associated with global crude-like demand

GCL_SElasticity is the elasticity associated with global crude-like supply

“y” is the projection year.

The crude-like liquids supply quantity is next calculated for each crude supply curve point:

$$\text{CRUDEPOINTS}_{y,iP,2} = \text{PMM_CL_Demand}_y * (1 + \text{percentage point difference from equilibrium}_{iP})$$

The crude-like liquids supply prices are then transformed from 2007 dollars per barrel to 1987 dollars per barrel.

$$\text{CRUDEPOINTS}_{y,iP,1} = \text{CRUDEPOINTS}_{y,iP,2} / \text{MC_JPGDP}_{2007/1987}$$

where,

y is the projection year

iP is the curve point (9 points ranging from -0.27 to 0.27 in increments)

'1' indicates prices, and

MC_JPGDP is the gross domestic product deflator from 2007 to 1987 dollars.

SUBROUTINE: WORLD_CURVES

Description: The World_Curves subroutine is used to convert the prices from 2007 dollars per barrel to real 1987 dollars per barrel for pass-back to the NEMS PMM. The U.S. import price series for the five generic crude oil types and 18 petroleum products are converted to 1987 dollars by PADD.

Equations: The crude import price curves are calculated as:

$$\text{Crude import curve price}_{c,p} = \text{crude oil price}_c / \text{conversion factor}$$

where,

c = crude type ((low sulfur light, medium sulfur heavy, high sulfur light, high sulfur heavy, high sulfur very heavy) and p = PADD (1-5).

Product prices are similarly converted:

$$\text{Product import curve price}_{r,p} = \text{product price}_r / \text{conversion factor}$$

where,

r = product type (Motor Gasoline, Reformulated Motor Gasoline, Liquefied Petroleum Gases, Kerosene-Jet Fuel, Distillate, Low Sulfur Distillate, Ultra Low Sulfur Distillate, Low Sulfur Residual Fuel, High Sulfur Residual Fuel, Petrochemical Feedstocks, Other, Methanol, Conventional Blendstock for Oxygenate Blending (CBOB), Reformulated Blendstock for Oxygenate Blending (RBOB), MTBE, Unfinished Oils – Residual Fuel, Unfinished Oils – Naphtha, and Unfinished Oils – Heavy Gas Oil) and,

p = PADD (1-5).

Quantity points on the import supply curves are all set to the corresponding quantity previously calculated for crude type and product type.

Appendix C. References

Energy Information Administration, *International Petroleum Monthly* (various editions), web site (www.eia.doe.gov/ipm).

Bloomberg.com: Energy, Bloomberg News Service: Energy, web site www.bloomberg.com/energy.

BP Statistical Review of World Energy 2008 (London, UK, June 2008).

International Energy Agency, *IEA Statistics: Oil Information 2009* (Paris, France, 2009).

Walter Nicholson, *Microeconomic Theory: Basic Principles and Extensions* (Harcourt College Publishers, Fort Worth: Texas, 1972).

Franklin J. Stermole and John M. Stermole, *Economic Evaluation and Investment Decision Methods: Eleventh Edition* (Investment Evaluations Corporation, Lockwood, CO, 2006).

Alpha C. Chiang, *Fundamental Methods of Mathematical Economics* (McGraw-Hill Book Company, NY: NY, 1967).

Wayne L. Winston, *Operations Research: Applications and Algorithms* (Brooks/Cole—Thomson Learning, Belmont, CA, 2004).

Appendix D. Model Abstract

Introduction

This section gives a brief summary of the International Energy Module and its role within the National Energy Modeling System. Specific information on the following topics is provided:

- Model Name
- Model Acronym
- Description
- Purpose of the Model
- Most Recent Update
- Part of Another Model
- Model Interfaces
- Official Model Representative
- Documentation
- Archive Media and Manuals
- Energy System Described
- Coverage
- Modeling Features
- Model Inputs
- Non-DOE Input Sources
- DOE Input Sources
- Computing Environment
- Independent Expert Review Conducted
- Status of Evaluation Efforts by Sponsor

Model Name:

International Energy Module

Model Acronym:

IEM

Description:

The NEMS International Energy Module is a calculation tool that uses assumptions of economic growth and expectations of future U.S. and world petroleum liquids production and consumption, by year, to model the interaction of U.S. and international liquids markets. The

IEM projects international oil conditions, including demand, price and supply, and the impact of changes in the U.S. petroleum market on world markets. It is used to recalculate world oil prices in response to changes in U.S. petroleum liquids production and consumption. In addition, the IEM provides supply curves of crude oil imported to the United States in each of the five Petroleum Allocation for Defense Districts (PADDs) for five generic crude oil grades: low sulfur light, high sulfur light, medium sulfur heavy, high sulfur heavy, and high sulfur very heavy. Finally, the IEM provides U.S. import supply curves for as many as 18 petroleum products³ by PADD. The model employs a general equilibrium algorithm to calculate the world oil price, and generates U.S. crude oil and petroleum product supply curves based on a series of simple and logarithmic linear regression equations that are developed exogenously and used as IEM model input. U.S. petroleum product import quantities are calculated by region or country for crude oil and light and heavy refined products based on a sharing algorithm that applies the share of the total each region is assumed to supply.

Purpose of the Model:

As a component of the National Energy Modeling System, the NEMS IEM calculates:

- The world oil price (WOP), which is defined as the price of light, low sulfur crude oil delivered to Cushing, Oklahoma (PADD2). Changes in the WOP are computed in response to:
 - The difference between U.S. total crude-like liquids production and the expected U.S. total crude-like liquids production at the current WOP (estimated using the current WOP and the exogenous U.S. total liquids supply curve for each year).
 - The difference between U.S. total liquids consumption and the expected U.S. total liquids consumption at the current WOP (estimated using the current WOP and the exogenous U.S. total liquids demand curve).
- Total U.S. imports of crude oil and light and heavy refined petroleum products by country or region.

Most Recent Model Update:

December 2008.

Part of Another Model?

National Energy Modeling System (NEMS)

³ The 18 petroleum products are: Motor Gasoline, Reformulated Motor Gasoline, Liquefied Petroleum Gases, Kerosene-Jet Fuel, Distillate, Low Sulfur Distillate, Ultra Low Sulfur Distillate, Low Sulfur Residual Fuel, High Sulfur Residual Fuel, Petrochemical Feedstocks, Other, Methanol, Conventional Blendstock for Oxygenate Blending (CBOB), Reformulated Blendstock for Oxygenate Blending (RBOB), MTBE, Unfinished Oils – Residual Fuel, Unfinished Oils – Naphtha, and Unfinished Oils – Heavy Gas Oil.

Model Interfaces:

The IEM receives inputs from other NEMS models, including the NEMS Petroleum Market Module, and NEMS Macroeconomic Activity Module. The Generate World Oil Balance application is also a source of input to the IEM. Outputs are provided to the NEMS Integrating Module and the NEMS Petroleum Market Module.

Official Model Representative:

Adrian Geagla
Energy Information Administration
EI-81/Forrestal Building
U. S. Department of Energy
1000 Independence Avenue, SW
Washington, D.C. 20585

telephone: (202) 586-2873

fax: (202) 586-3045

e-mail: adrian.geagla@eia.doe.gov

Documentation:

Energy Information Administration, U.S. Department of Energy, *Model Documentation 2009 Report: International Energy Module (IEM) of the National Energy Modeling System*, DOE/EIA-M071(2009) (Washington, D.C., October 2009).

Archive Media and Installation Manual(s):

The IEM, as part of the NEMS system, has been archived for the reference case published in the *Annual Energy Outlook 2009*, DOE/EIA-0581 (2009). The NEMS archive contains all of the nonproprietary modules of NEMS as used in the reference case. The NEMS archive is available on an as-is basis (<ftp://eia.doe.gov/pub/oiaf/aeo/aeo2009.zip>).

Energy System Described:

U.S. import supply curves for five generic crude oil types; U.S. import supply curves for as many as 18 petroleum products; and U.S. crude oil and light and heavy refined product import quantities by region or country for each year.

Coverage:

- Geographic: Five Petroleum Area Defense Districts (PADDs), United States, and global (by region or country)
- Time Unit/Frequency: Annual through 2030
- Products: World oil prices; U.S. import supply curves for five generic crude oil grades by PADD; U.S. import supply curves for eighteen petroleum products by PADD; total U.S. crude oil and light and heavy refined petroleum product import quantities by country and region

- Economic Sectors: Not applicable

Modeling Features:

- **Model Structure:** The NEMS International Energy Module is a calculation tool that uses assumptions of economic growth and expectations of future U.S. and world petroleum liquids production and consumption, by year, to model the interaction of U.S. and international liquids markets. The IEM projects international oil market conditions, including demand, price and supply, and the impact of changes in the U.S. petroleum market on world markets.
- **Modeling Technique:** The model employs a general equilibrium algorithm to calculate the world oil price, and generates U.S. crude oil and petroleum product supply curves based on a series of simple and logarithmic linear regression equations that are developed exogenously and used as IEM model input.
- **Special Features:** The computational techniques used in the IEM enable it to accommodate a wide range of scenarios and policy analyses including but not limited to demand-side, supply-side, tax credits, and macro scenarios.

Model Inputs:

- Expected U.S. and world crude-like liquids supply and demand curves by year
- Elasticities for U.S. and world crude-like liquids supply and demand curves by year
- Expected world oil prices by year
- Shares of total U.S. crude oil and light and heavy refined product imports supplied by region
- GDP deflators
- Projected U.S. petroleum liquids consumption and production
- Projected U.S. crude oil and petroleum product import quantities

Non-DOE Input Sources:

- None

DOE Input Sources:

NEMS Petroleum Market Module

- U.S. petroleum liquids production and consumption by year
- U.S. petroleum liquids supply and demand by year
- U.S. crude oil imports
- U.S. product imports
- GDP deflators

Generate World Oil Balance Application

- Total crude-like liquids supply and distribution by region by year by year

Input file omsecon.txt

- Expected U.S. petroleum liquids supply and demand curves by year
- Expected world petroleum liquids supply and demand curves by year

Computing Environment:

- Hardware Used: HP Proliant Multiprocessor Server
- Operating System: Windows Server 2003, Standard Edition with MKS Toolkit UNIX emulation
- Language/Software Used: Intel Visual Fortran, Version 9
- Memory Requirement: 4,000K
- Storage Requirement: 126.5 Megabytes
- Estimated Run Time: 32 seconds for a 1990-2030 run in non-iterating NEMS mode
- Special Features: None

Independent Expert Reviews Conducted:

None

Status of Evaluation Efforts by Sponsor:

None

Appendix E. Data Quality

Introduction

The NEMS International Energy Module develops projections of world oil prices; of supply curves for five grades of oils and 18 products for imports in the United States; and of U.S. imports by source of oil and light and heavy products. These projections are based upon the data elements as detailed in Appendix A of this report. The input data, parameter estimates, and module variables are described in Appendix A. The documentation details transformations, estimation methodologies, and resulting inputs required to implement the model algorithms in Chapter 4: Model Structure. The quality of the principal sources of input data is discussed in Appendix E. Information regarding the quality of parameter estimates and user inputs is provided where available.

Source and Quality of Input Data

Source of Input Data

- *AEO2008* and *IEO2008* – Final results from these publications are used to compute yearly elasticities for world and U.S. demand curves of petroleum products.
- Generate World Oil Balances (GWOB) – This application is used in the International Energy Module to provide annual regional/country level production detail for conventional and unconventional liquids.
- *International Petroleum Monthly*, Energy Information Administration public website, Bloomberg database, International Energy Agency database, *BP Statistical Review of World Energy*, FACTS Global Energy publications, STEO results – All these sources of information were used to gather historical data used in linear regressions to forecast oil and petroleum product prices; to compute refinery utilization factors; and to build a report for imports of oil, and light and heavy petroleum products imports in the U.S. by source.

Data Quality Verification

As a part of the input and editing procedure, an extensive program of edits and verifications was used, including:

- World and U.S. production and consumption of petroleum liquids range, prices, elasticities checks based on previous values, responses and knowledge of industry
- Consistency checks
- Technical edits to detect and correct errors, extreme variability