



Hurricane and Flood Mitigation Handbook for Public Facilities

P-2181

March 2022



FEMA

Direct comments on the Handbook to:

DHS/FEMA
Federal Insurance and Mitigation Administration (FIMA) Risk Management Directorate
Building Science Branch
400 C Street, S.W., Sixth Floor
Washington, DC 20472-3020

This Handbook replaces Hurricane Mitigation: A Handbook for Public Facilities, May 2005.

Cover photograph: Barrett's Landing Park, Tropical Depression Ernesto, August 2006. Photo courtesy of FEMA Contractor Deborah Mills, STARRII

FEMA P-2181 Hurricane and Flood Mitigation for Public Facilities contains information that is proprietary to and copyrighted by the American Society of Civil Engineers. It also contains information that is proprietary to and copyrighted by the International Code Council, Inc. All information is used with permission.

For more information, see the FEMA Building Science Frequently Asked Questions website at <http://www.fema.gov/frequently-asked-questions-building-science>.

If you have any additional questions on FEMA Building Science Publications, contact the helpline at FEMA-Buildingsciencehelp@fema.dhs.gov or 866-927-2104.

You also may sign up for the FEMA Building Science email subscription list, updated regularly with publication releases and FEMA Building Science activities. Subscribe at: https://service.govdelivery.com/accounts/USDHSFEMA/subscriber/new?topic_id=USDHSFEMA_193.

Visit the Building Science Branch of the Risk Management Directorate at FEMA's Federal Insurance and Mitigation Administration at <https://www.fema.gov/building-science>.

To order publications, contact the FEMA Distribution Center:

Call: 1-800-480-2520 (Monday–Friday, 8 a.m.–5 p.m., EST)
Fax: 719-948-9724
Email: FEMApubs@gpo.gov

Find additional FEMA documents in the FEMA Library at:
<https://www.fema.gov/about/news-multimedia>.

Please scan this QR code to visit the FEMA Building Science web page.



Contributors

Federal Emergency Management Agency

Timothy Cali, Community Infrastructure Resilience Branch

Samuel Capasso III, Esq. LLM, Community Infrastructure Resilience Branch

Rachel Chain, Earthquake Wind and Programs and Community Infrastructure Resilience Branches

Shane Crawford, PhD, Building Science Branch

Mary DeBacker, Region 5

James Demby, PE, Dam Safety

Jonathon Foster, Earthquake Wind and Programs Branch

Victor Hare, PE, Earthquake Wind and Programs and Community Infrastructure Resilience Branches

Bill Harris, PE, Region 4

Renita Hosler, External Affairs

John Ingargiola, EI, CFM, CBO, Building Science Branch

Jason Lehecka, External Affairs

Juan Nieves, Building Science Branch

Genaro Perez-de Leon, EI, MSCE, COR-II, Earthquake Wind and Programs and Community Infrastructure Resilience Branches

Nancy Pogensky, RA, Region 2

Mark Reagan, JD, PE, Region 5

Janan Reilly, MS, Region 1, Hazard Mitigation Assistance Branch

Gabriel Riggle, LEED AP ND, Community Infrastructure Resilience Branch

Glenny Rodriguez, Region 2, Mitigation Division

Larissa Santoro, LEED AP, Earthquake Wind and Programs and Community Infrastructure Resilience Branches

Lauren Schmied, Engineering Resources Branch

Pataya Scott, PhD, Earthquake Wind and Programs Branch

Aman Singh, PE, Public Assistance Division

Cadijah Walcott, Knauss Sea Grant Fellow

Jonathan Westcott, PE, Building Science Branch

Gregory Wilson, Building Science Branch

Derek Winstead, Hazard Mitigation Cadre

Mariam Yousuf, EIT, CFM, CPESC, COR-II, Building Science Branch

Contract Support

Stuart Adams, EIT, CFM, ENV SP,
Stantec

Diana Castro, PE, CFM, Atkins

Minden Chan, Dewberry

Jon Chipperfield, PhD, PE, Atkins

Donnell Clark, Dewberry

David Conrad, PE, SE, Atkins

Zachary Corcoran, J.D., Stantec

Joe Estrada, PE, Dewberry

James Filson, PE, Dewberry

Hugh Freebairn, PE, Dewberry

Hannah Gill, PE, CFM, Dewberry

Brett Heim, PE, Dewberry

Daniel Johnson, PE, Dewberry

David Low, PE, DK Low & Associates

Desiderio Maldonado, PE, Atkins

Laurel McGinley, PE, PMP, Dewberry

Deborah Mills, CFM, Dewberry

Brian O'Connor, PE, CFM, CDMSmith

Manual Perotin, PE, PMP, CFM,
CDMSmith

Adam Reeder, PE, CFM, CDMSmith

Benjamin Revette, PE, Dewberry

Michael Riemer, PE, LEED AP BD+C,
Atkins

Kelly Rosofsky, Dewberry

Devin Schultze, PE, CFM, CDMSmith

John Squerciati, PE, CFM, Dewberry

Douglas Sullivan, Dewberry

Frederic Tucker, PE, Dewberry

Danylo Villhauer, PE, LEED AP, Dewberry

Adam Zysk, PE, Dewberry

Editors, Layout, and Illustrators

Tina Brand, Atkins

Heather Browning, Atkins

Jillian Browning, Dewberry

Clayton Dunford, Stantec

Susanne Dunleavy, Stantec

Kathryn Saucier, Atkins

Jenifer Sullivan, Atkins

Darieux Zagara, Creative Engagement
Solutions

Table of Contents

Contributors	ii
Introduction	1
Intended Audience	2
Handbook Organization	2
Icons	3
FEMA Mitigation Program Funding	4
FEMA’s Public Assistance Program	4
FEMA’s Hazard Mitigation Assistance Grant Programs	4
Mitigation Project Cost Effectiveness	6
Causes of Damage from Hurricane Flooding and Wind Hazards	7
Sources of Flooding	7
Flood Characteristics and Flood Forces	9
Other Flood Characteristics and Impacts	13
Hurricane Wind	15
Fact Sheets	21
Fact Sheet 1.0: Roads	1-1
Hurricane and Flood Impacts	1-1
Mitigation Fact Sheets	1-1
Mitigation Solutions	1-3
Icons	1-4
Fact Sheet 1.1: Road and Highway Surfaces	1-6
Mitigation Solution: Stabilize Roadway	1-7
Mitigation Solution: Reduce Flood Hazard on Roadway	1-11
Mitigation Solution: Reduce Frost Heave	1-14
Fact Sheet 1.2: Road Shoulders and Embankments	1-19
Mitigation Solution: Protect Shoulders	1-21
Mitigation Solution: Protect Embankment Slopes	1-23

Fact Sheet 1.3: Drainage and Culverts	1-29
Mitigation Solution: Increase Design Capacity.....	1-32
Mitigation Solution: Reduce Embankment Erosion.....	1-36
Mitigation Solution: Improve Alignment.....	1-41
Mitigation Solution: Reduce Obstructions.....	1-46
Mitigation Solution: Relocate or Replace with Water Crossing.....	1-49
Fact Sheet 1.4: Bridges	1-53
Mitigation Solution: Improve Flow Under the Bridge Crossing.....	1-55
Mitigation Solution: Construct Erosion and Scour Countermeasures.....	1-60
Mitigation Solution: Reduce Debris Damage.....	1-66
Mitigation Solution: Relocate the Bridge.....	1-73
Fact Sheet 1.5: Roadway Lights, Poles, and Signage	1-75
Mitigation Solution: Traffic Signal Controllers.....	1-76
Mitigation Solution: Traffic Signal Support Structures and Luminares.....	1-78
Mitigation Solution: Roadway Sign Support Structures.....	1-81
Fact Sheet 2.0: Water Control Facilities	2-1
Hurricane and Flood Mitigation.....	2-1
Mitigation Fact Sheets.....	2-1
Mitigation Strategies.....	2-3
Icons.....	2-4
Fact Sheet 2.1: Channels, Aqueducts, and Canals	2-9
Mitigation Solution: Armor Channels and Canals.....	2-11
Mitigation Solution: Stabilize Channels and Canals.....	2-12
Mitigation Solution: Lessen the Energy of Flood Flow.....	2-13
Mitigation Solution: Prevent Pipe and Tunnel Issues.....	2-14
Fact Sheet 2.2: Basins	2-17
Stormwater Basins.....	2-17
Bioretention Areas.....	2-18
Dry Swales.....	2-19
Wet Ponds.....	2-20
Extended Detention Ponds.....	2-22
Mitigation Solutions.....	2-23

Fact Sheet 2.3: Mitigation of Dams and Reservoirs	2-27
Dam Hazard Potential Classifications.....	2-27
Importance of Emergency Planning for Dams.....	2-31
Mitigation Solution: Improve Stability.....	2-33
Mitigation Solution: Increase Spillway Capacity.....	2-37
Mitigation Solution: Increase Temporary Storage Capacity.....	2-39
Mitigation Solution: Control Surface Erosion.....	2-42
Mitigation Solution: Reduce Seepage and Internal Erosion.....	2-48
Mitigation Solution: Address Foundation Issues.....	2-53
Fact Sheet 3.0: Buildings, Systems and Equipment	3-1
Hurricane and Flood Impacts.....	3-1
Mitigation Fact Sheets.....	3-1
Mitigation Solutions.....	3-2
Icons.....	3-7
Fact Sheet 3.1: Foundations	3-10
Mitigation Solution: Relocate.....	3-13
Mitigation Solution: Elevate.....	3-15
Mitigation Solution: Floodproof.....	3-19
Mitigation Solution: Retrofit the Structure.....	3-23
Fact Sheet 3.2: Wall Systems and Openings	3-28
Mitigation Solution: For Wall Systems.....	3-30
Mitigation Solution: For Door Openings.....	3-33
Mitigation Solutions: For Window Openings.....	3-38
Fact Sheet 3.3.1: Roof Systems—Sloped Roofs	3-43
Mitigation Solution: Strengthen or Improve.....	3-46
Mitigation Solution: Add or Increase.....	3-58
Mitigation Solution: Secure or Eliminate.....	3-59
Fact Sheet 3.3.2: Roof Systems—Low-Slope Roofs	3-63
Mitigation Solution: Secure or Eliminate.....	3-66
Mitigation Solution: Add or Increase.....	3-68
Mitigation Solution: Strengthen or Improve.....	3-70
Mitigation Solution: Upgrade.....	3-76

Fact Sheet 3.4.1: Building Utility Systems—Heating, Ventilation and Air Conditioning	3-78
Key Terms and Definitions.....	3-79
Mitigation Solution: Elevate or Relocate.....	3-81
Mitigation Solution: Dry Floodproof.....	3-83
Mitigation Solution: Wet Floodproof.....	3-85
Fact Sheet 3.4.2: Building Utility Systems—Electrical	3-87
Mitigation Solution: Elevate or Relocate.....	3-90
Mitigation Solution: Dry Floodproof.....	3-92
Fact Sheet 3.4.3: Building Utility Systems—Plumbing	3-94
Mitigation Solution: Elevate or Relocate.....	3-100
Mitigation Solution: Seal or Isolate.....	3-103
Mitigation Solution: Secure.....	3-105
Mitigation Solution: Dry Floodproof.....	3-107
Fact Sheet 3.4.4: Building Utility Systems—Conveyances	3-109
Mitigation Solution: Protect.....	3-112
Fact Sheet 4.0: Public Utilities	4-1
Hurricane and Flood Impacts.....	4-1
Mitigation Fact Sheets.....	4-1
Mitigation Solutions.....	4-2
Icons.....	4-3
Fact Sheet 4.1: Drinking Water Systems	4-6
Mitigation Solution: For Water Intake, Distribution and Storage.....	4-9
Mitigation Solution: For Drinking Water Treatment Facilities.....	4-11
Mitigation Solution: For Booster Stations and Other Pumps.....	4-14
Mitigation Solution: For Chemical and Fuel Storage Tanks.....	4-16
Mitigation Solution: For Instrumentation and Electrical Controls.....	4-18
Mitigation Solution: For Power Supplies.....	4-20
Fact Sheet 4.2: Wastewater Treatment Systems	4-23
Mitigation Solution: For Lift Stations.....	4-25
Mitigation Solution: For Headworks.....	4-28
Mitigation Solution: For Wastewater Treatment Plants.....	4-30
Mitigation Solution: For Chemical and Fuel Supplies.....	4-33
Mitigation Solution: For Instrumentation and Electrical Controls.....	4-36
Mitigation Solution: For Power Supplies.....	4-38

Fact Sheet 4.3: Electric Power Generation, Transmission and Distribution	4-41
Mitigation Solution: For Transmission and Distribution.....	4-43
Mitigation Solution: For Substations	4-51
Mitigation Solution: For Power Plants	4-54
Mitigation Solution: For the Smart Grid.....	4-59
Fact Sheet 4.4: Communication Towers, Masts and Antennas	4-65
Mitigation Solution: Anchor.....	4-67
Mitigation Solution: Strengthen.....	4-70
Mitigation Solution: Elevate or Relocate	4-75
Fact Sheet 5.0: Parks, Recreational and Other Facilities	5-1
Hurricane and Flood Impacts.....	5-1
Mitigation Fact Sheets	5-2
Mitigation Solutions	5-3
Icons.....	5-4
Fact Sheet 5.1: Parks and Recreational Facilities	5-8
Mitigation Solution: For Accessory Structures.....	5-10
Mitigation Solution: For Sport Courts.....	5-13
Mitigation Solution: For Landscaping.....	5-14
Fact Sheet 5.2: Mass Transit Facilities	5-18
Mitigation Solution: For Tunnels.....	5-22
Mitigation Solution: For Railways.....	5-29
Mitigation Solution: For Catenary Overhead System.....	5-33
Fact Sheet 5.3: Earth Slope Stabilization	5-36
Slides	5-37
Mitigation Solution: Excavate	5-39
Mitigation Solution: Reinforce or Strengthen.....	5-42
Mitigation Solution: Install Drainage	5-47
Mitigation Solution: Install Retaining Walls.....	5-50
Mitigation Solution: Install Nature-Based Solutions.....	5-55
Fact Sheet 5.4: Shorelines	5-59
Mitigation Solution: Structurally Stabilize Shorelines.....	5-60
Mitigation Solution: Use Non-Structural Stabilization.....	5-68

Fact Sheet 5.5: Coastal Facilities..... 5-72

 Mitigation Solution: Monitor, Inspect, Repair..... 5-74

 Mitigation Solution: Retrofit, Reinforce..... 5-75

 Mitigation Solution: Elevate 5-81

 Mitigation Solution: Upgrade, Relocate..... 5-83

Appendices..... i

 1. Codes..... App-13

 2. Standards..... App-15

 3. Best Practices App-16

 4. Mitigation App-17

 How to Obtain Hurricane and Flood Mitigation Handbook for Public Facilities..... App-25

 How to Send Comments on the Handbook..... App-25

 How to Get More Information App-25

Figures

Figure 0.0.1. Measuring high-water marks can help establish flood depth.....	9
Figure 0.0.2. The different types of standing water forces.....	11
Figure 0.0.3. Hydrodynamic forces.....	11
Figure 0.0.4. Flood-borne debris impact.....	14
Figure 0.0.5. ASCE 7-22 Hurricane-Prone Region.....	15
Figure 1.0.1. Road System Components.....	1-2
Figure 1.1.1. Reshaping the roadway can improve drainage and decrease flood impacts.....	1-8
Figure 1.1.2. Geosynthetics can be used to improve drainage and subgrade strength.....	1-9
Figure 1.1.3. Geotextiles that do not drain well can be hydraulically connected to a drain.....	1-10
Figure 1.1.4. Increasing the roadway elevation above the base flood elevation.....	1-11
Figure 1.1.5. Relocating the roadway away from the flood source can help protect the road from flooding.....	1-12
Figure 1.1.6. Permeable pavement includes pavers, permeable concrete, and permeable asphalt (USGS, 2018).....	1-13
Figure 1.1.7. “Rock caps” can improve both drainage and structural stability of roads susceptible to frost heaves (Yu and Beck, 2009).....	1-14
Figure 1.1.8. A capillary barrier can help prevent surfaces from frost heaving (Roberson et al., 2006).....	1-15
Figure 1.1.9. Improve subgrade soils by injecting a polymer into the soil to fill voids (Source: Fakhar and Asmaniza, 2016).....	1-16
Figure 1.2.1. Geosynthetics can be used to stabilize roadways.....	1-22
Figure 1.2.2. Riprap can help reduce erosion of roadway slopes adjacent to streams.....	1-23
Figure 1.2.3. Bioengineered slopes can protect against erosion.....	1-24
Figure 1.2.4. Spillways can concentrate flows at selected locations to help control erosion.....	1-25
Figure 1.2.5. A wall constructed of gabion baskets protects the toe of the slope.....	1-26
Figure 1.2.6. Changing slope geometry to a more gradual slope can reduce erosion.....	1-27
Figure 1.3.1. Components of a culvert.....	1-31
Figure 1.3.2. Alternative stream crossing designs.....	1-32
Figure 1.3.3. Increasing ditch capacity can help protect against overland flooding.....	1-33
Figure 1.3.4. An arch culvert or a box culvert can provide increased flow capacity.....	1-34
Figure 1.3.5. Replacing a culvert with a bridge can protect the stream bed and the road.....	1-34
Figure 1.3.6. Installing multiple culverts can increase flow capacity.....	1-35
Figure 1.3.7. Shaping the culvert entrance can reduce erosion at the intake.....	1-36
Figure 1.3.8. A cutoff wall can reduce undermining.....	1-37
Figure 1.3.9. Wingwalls, headwalls and endwalls can protect embankment slopes.....	1-37

Figure 1.3.10. Ditch lining can reduce erosion and improve flow capacity..... 1-38

Figure 1.3.11. Check dams help slow water and decrease scouring..... 1-39

Figure 1.3.12. Energy dissipaters can be installed at culvert discharges to decrease erosion and scour..... 1-40

Figure 1.3.13. Realigning the culvert to the stream centerline can reduce damage to the culvert..... 1-41

Figure 1.3.14. Approach berms can direct flow away from embankments..... 1-42

Figure 1.3.15. Flow diverters can realign the stream channel..... 1-43

Figure 1.3.16. Installing additional culverts can reduce velocity and clogging..... 1-44

Figure 1.3.17. Realigning the stream can protect embankments..... 1-45

Figure 1.3.18. A debris barrier can protect a culvert from damage..... 1-46

Figure 1.3.19. A sediment basin can help settle suspended sediment and decrease culvert clogging potential..... 1-47

Figure 1.3.20. Install a relief culvert as a second route for floodwaters if the main culvert gets clogged..... 1-48

Figure 1.3.21. A low-water crossing in place of a culvert will accommodate flows during emergency events..... 1-49

Figure 1.3.22. Installing an overflow section in the roadway can accommodate stream overflows..... 1-50

Figure 1.4.1. Basic bridge structure..... 1-53

Figure 1.4.2. Reducing the number of spans can increase the flow amount under the bridge. In this figure, the dashed piers would be removed to accomplish this..... 1-55

Figure 1.4.3. Increasing the size of a bridge opening by raising the bridge deck can increase flow volume under the bridge..... 1-56

Figure 1.4.4. Lengthening a bridge can provide additional overflow capacity beneath the bridge..... 1-57

Figure 1.4.5. Building a relief opening can help prevent flooding of bridges..... 1-58

Figure 1.4.6. Low water crossings can be cost effective in areas with low traffic where flooding is seasonal..... 1-59

Figure 1.4.7. Riprap can protect bridge piers and abutments against erosion and scour..... 1-60

Figure 1.4.8. Wingwalls can help direct the flow of water and prevent erosion and scour at the bridge. 1-61

Figure 1.4.9. Spur dikes can direct flood flows, reducing erosion and scour around bridges..... 1-62

Figure 1.4.10. Realigning piers and abutments can decrease the damage from erosion and scour..... 1-63

Figure 1.4.11. Increasing footing depth can protect bridge foundations against scour..... 1-64

Figure 1.4.12. Installing flow deflectors immediately upstream of bridge piers can help protect them against scour..... 1-65

Figure 1.4.13. Debris deflectors can protect bridge piers and abutments from impact damages and debris accumulation..... 1-66

Figure 1.4.14. Endnoses installed on the upstream end of piers (shown by red arrows) can protect piers from debris impacts..... 1-67

Figure 1.4.15. Steel plate batters protect piers from the impact of floating debris. 1-68

Figure 1.4.16. Replace a multiple timber pier structure with a concrete column to protect against debris impact..... 1-69

Figure 1.4.17. Replacing a solid deck with an open deck can reduce trapped debris. 1-70

Figure 1.4.18. Debris catchments trap debris before it reaches bridge piers and abutments..... 1-71

Figure 1.4.19. A debris sweeper can be attached directly to a pier to deflect debris (FHWA, 2005). 1-72

Figure 1.4.20. Pile-mounted debris sweepers can effectively direct debris away from bridge piers (FHWA, 2005). 1-72

Figure 1.5.1. Elevating signal controller cabinets protects them against flooding. 1-76

Figure 1.5.2. Mast arm poles protect traffic signals against wind damage..... 1-78

Figure 1.5.3. Vibration dampers can protect poles and signals against wind vibration damage..... 1-80

Figure 1.5.4. Increase sign connectors and pole embedment depth. Left image is before mitigation occurs. Right image is after mitigation occurs. 1-82

Figure 1.5.5. Helical anchors can be used as foundation support for street signs and light poles. 1-83

Figure 2.0.1. Channels, aqueducts and canals collect, carry, and distribute water. 2-2

Figure 2.0.2. Basins are in-ground structures used to hold water. 2-2

Figure 2.0.3. Dams are used to retain and control the flow of water. 2-3

Figure 2.1.1. Concrete lining of a channel. 2-11

Figure 2.1.2. Typical ACB cross-section..... 2-12

Figure 2.1.3. Typical cross-section of slope protection. 2-12

Figure 2.1.4. Energy dissipators such as stone drop structures can help slow the movement of water to decrease erosion and scour..... 2-13

Figure 2.2.1. Typical stormwater basin cut..... 2-18

Figure 2.2.2. Typical bioretention facility..... 2-19

Figure 2.2.3. Typical dry swale with check dams..... 2-20

Figure 2.2.4. Wet pond plan view..... 2-21

Figure 2.2.5. Wet pond section view..... 2-21

Figure 2.2.6. Extended Detention Pond..... 2-22

Figure 2.3.1. This dam is considered low hazard potential because, if it failed, it would only impact the forest around it. 2-28

Figure 2.3.2. This dam is considered high hazard potential because its failure would impact the community directly downstream and could result in loss of life and property..... 2-28

Figure 2.3.3. Example of failed downstream slope..... 2-33

Figure 2.3.4. Use of compacted fill to reduce the downstream slope angle..... 2-33

Figure 2.3.5. Buttressing can give additional stability to embankment dams..... 2-35

Figure 2.3.6. Anchoring can give resistance to overturning and sliding..... 2-36

Figure 2.3.7. To increase spillway capacity, widen an existing spillway or build a second spillway..... 2-38

Figure 2.3.8. Raising the height of a dam can increase temporary flood storage capacity. 2-40

Figure 2.3.9. Wave action can erode the upstream slope of a dam..... 2-42

Figure 2.3.10. Initial embankment overtopping can lead to a complete overflow..... 2-43

Figure 2.3.11. Headcut erosion could lead to an accidental release from the impoundment..... 2-43

Figure 2.3.12. Riprap layouts can be designed to protect against wave action.(Source: NRCS, 1983).... 2-44

Figure 2.3.13. Riprap blankets can protect against wave action. (Source: USFWS, 2008) 2-44

Figure 2.3.14. ACBs (left) and RCC (right) can protect spillways from overtopping erosion. 2-45

Figure 2.3.15. A parapet wall can give additional freeboard to protect against wave overtopping..... 2-46

Figure 2.3.16. Cutoff walls can improve the stability of some unarmored auxiliary spillways..... 2-47

Figure 2.3.17. Blanket drains increase seepage flow paths and reduce the risk of seepage-related piping. 2-48

Figure 2.3.18. Filter diaphragms can prevent seepage around conduits..... 2-49

Figure 2.3.19. Reverse filters can be used to address sinkholes..... 2-50

Figure 2.3.20. Seepage cutoff walls can be achieved through deep soil mixing..... 2-51

Figure 2.3.21. Plan view of a secant pile wall. 2-52

Figure 2.3.22. Plan and profile of a grout curtain design. 2-53

Figure 2.3.23. Foundation cutoff walls can help control seepage through a dam foundation..... 2-54

Figure 3.0.1. Small public building elements (before mitigation)..... 3-2

Figure 3.0.2. Large public building elements (before mitigation)..... 3-2

Figure 3.0.3. Large public building elements with primary electrical system components mitigated. 3-5

Figure 3.0.4. Flood risk for large public building reduced by relocating primary HVAC components from a subgrade basement level to a higher floor. 3-6

Figure 3.1.1. Foundation characteristics..... 3-11

Figure 3.1.2. Relocation of a small flood-prone public building..... 3-13

Figure 3.1.3. Elevation of small public building on piles in coastal flood zone..... 3-16

Figure 3.1.4. Abandoning the lowest floor can elevate usable space above the BFE..... 3-17

Figure 3.1.5. Constructing a raised floor or filling in a basement can elevate occupied space above the BFE..... 3-18

Figure 3.1.6. Wet floodproofing opening retrofit diagram for a small public building..... 3-19

Figure 3.1.7. Dry floodproofing sealants diagram for a portion of a building..... 3-20

Figure 3.1.8. Dry floodproofing sealants and secondary drainage diagram..... 3-21

Figure 3.1.9. Grouted micropile (left) and helical pile (right) can strengthen existing building foundations..... 3-23

Figure 3.1.10. Improve connections—select approaches to address minor wood pile-to-beam misalignments. 3-24

Figure 3.2.1. Connectors help create an adequate building load path. 3-30

Figure 3.2.2. Features of typical high-wind siding and standard siding. 3-32

Figure 3.2.3. Examples of weather stripping (far left and center left) and drip protection (center right and far right) to prevent wind-driven rain entry at doors. 3-33

Figure 3.2.4. Examples of hinged (left) and lift out (right) flood shields with gaskets at entry doors. Some flood shields are automatic while others must be placed manually. 3-34

Figure 3.2.5. Recommended details for upgrading garage doors. 3-36

Figure 3.2.6. Use screw anchors to fasten window frames directly to concrete. 3-38

Figure 3.2.7. Connection of wall sheathing to window header (left) and window header to exterior wall (right) as part of a wall framing system. 3-39

Figure 3.2.8. Examples of storm shutter styles. 3-40

Figure 3.3.1.1. Basic elements of typical sloped roofs featuring gable-end roof system (top) and hip roof system (bottom). 3-43

Figure 3.3.1.2. Conceptual gable end retrofit without overhangs. 3-47

Figure 3.3.1.3. Conceptual gable end retrofit with overhangs. 3-48

Figure 3.3.1.4. Examples of proper roof connectors and fasteners for a wood-framed truss. 3-49

Figure 3.3.1.5. Examples of proper sheathing panel layouts for gable-end roof (top) and hip roofs (bottom) 3-51

Figure 3.3.1.6. Strong underlayment installation details applied to asphalt shingle roof sheathing in high-wind regions. 3-52

Figure 3.3.1.7. Proper and improper locations of shingle fasteners. 3-53

Figure 3.3.1.8. The Dos and Don'ts of driving roof nails through asphalt shingles. 3-53

Figure 3.3.1.9. Improving soffits can decrease wind damage to sloped roofs. 3-55

Figure 3.3.1.10. Sheet metal straps (circled) attached to an existing gutter to increase wind uplift resistance. 3-56

Figure 3.3.1.11. Protecting gable end vents using shutters (left) and sealing gable rake vents using metal plugs as indicated by red arrows (right). 3-61

Figure 3.3.2.1. Basic components of typical low-slope roofs featuring overhangs (left) and parapet walls (right). 3-63

Figure 3.3.2.2. Condenser bolted down to concrete curb (blue arrows) with tie-down cables (red arrows), but the lightning protection system is no longer secured by its connector (green arrow). 3-68

Figure 3.3.2.3. Both vertical faces of coping were attached with exposed fasteners (1/4-inch diameter stainless steel fasteners spaced 12" on center) instead of concealed cleats following Typhoon Paka (1997) in Guam to prevent the flashing from tearing in future storms. 3-72

Figure 3.3.2.4. Sheet metal straps (circled) attached to an existing gutter to increase wind uplift resistance. 3-73

Figure 3.3.2.5. Rooftop periodic gas line supports using a steel angle welded to a pipe that was anchored to the roof deck for lateral and uplift resistance (left). Use of intermittent membrane flashing to secure a lightning protection system conductor (center). Cables attached prevent rooftop equipment cowling from blowing off (right)..... 3-74

Figure 3.4.1.1. Basic components of a large public building fluid-based HVAC system. Note HVAC components on upper floors are not shown in this simplified graphic..... 3-79

Figure 3.4.1.2. Basic components of a small public building supplied by two forced-air HVAC systems. 3-79

Figure 3.4.1.3. Elevation of indoor and outdoor HVAC components on platforms above flood protection level for small public building..... 3-81

Figure 3.4.1.4. Elevation of indoor HVAC components from basement to first floor above flood protection level for large public building, with outdoor HVAC components relocated to the rooftop..... 3-82

Figure 3.4.1.5. Dry floodproofing with a watertight wall and access gate can be used to protect HVAC and plumbing equipment (left); alternate dry floodproofing protective enclosures for protecting equipment (right). 3-83

Figure 3.4.2.1. Typical small public building electrical system components with an onsite standby or emergency generator..... 3-88

Figure 3.4.2.2. Simplified diagram showing primary components of a large public building electrical system with standby generator (before mitigation)..... 3-88

Figure 3.4.2.3. Simplified diagram showing elevation of main and standby power components on elevated platforms above flood protection level for large public building..... 3-90

Figure 3.4.2.4. Combination meter socket and circuit breaker service disconnect (circled in red) used to allow the main panel to be elevated and protected from flooding when the meter (circled in yellow) cannot be moved..... 3-91

Figure 3.4.3.1. Typical small public building drinking water plumbing system components served by the public water system..... 3-95

Figure 3.4.3.2. Typical small public building wastewater DWV system components served by the public sanitary sewer system..... 3-95

Figure 3.4.3.3. Alternative small public building drinking water plumbing system components supplied by a well..... 3-96

Figure 3.4.3.4. Alternative small public wastewater DWV system components served by onsite waste disposal (septic)..... 3-96

Figure 3.4.3.5. Simplified large public building drinking water plumbing, wastewater DWV, and fire suppression system components with utilities supplied by public water and sanitary sewer..... 3-97

Figure 3.4.3.6. Typical small public building liquid fuel system. 3-97

Figure 3.4.3.7. Typical small public building flammable gas system liquid propane (LP) with tank and pressure regulator (left side); natural gas (NG) with meter (right side)..... 3-98

Figure 3.4.3.8. Typical large public building supplied with liquid fuel (LP) or flammable gas (NG) systems..... 3-98

Figure 3.4.3.9. Elevation of primary plumbing system components to the upper floor of an existing small public building..... 3-100

Figure 3.4.3.10. Elevation of primary fuel system components on pedestals for a small public building..... 3-101

Figure 3.4.3.11. Outdoor fuel tank elevated on supporting frame (left); fuel tank elevated on structural fill (right). 3-101

Figure 3.4.3.12. Backflow protection valves including a combination check valve and gate valve (left) and floor drain with ball float valve (right)..... 3-103

Figure 3.4.3.13. Protection of private well using a sanitary well cap (left) or concrete well cap (middle), and protection of septic tank with lids and gasketed access covers, concrete risers and riser caps (right)..... 3-104

Figure 3.4.3.14. Secure and seal underground tanks to protect them from flood damage..... 3-105

Figure 3.4.4.1. Typical elements of hydraulic elevators common in low-rise construction (left) and traction elevators common in high-rise construction (right). (Source: Otis Elevator Company) 3-110

Figure 3.4.4.2. Typical elements of escalators used in some large public buildings. (Source: Otis Elevator Company)..... 3-111

Figure 3.4.4.3. Float switch in pit to stop cab descent. (Source: Otis Elevator Company) 3-113

Figure 3.4.4.4. Inclined (left) and vertical (right) platform lifts move people between floors of a building. (U.S. Access Board, 2015)..... 3-115

Figure 4.1.1. The typical water treatment process has opportunities for hazard mitigation. (Source: City of Rockville, Maryland, 2012) 4-7

Figure 4.1.2. Constructing a floodwall around a water treatment plant can protect buildings and equipment from flood damage. (Source: U.S. Army Corps of Engineers, 2013)..... 4-12

Figure 4.1.3. Installing an emergency backup generator can provide power to help a water treatment plant continue to operate during a flood. (Source: U.S. Environmental Protection Agency [EPA], 2014)..... 4-13

Figure 4.1.4. Water-tight doors can be used to protect pumps and other equipment in pump houses and booster stations..... 4-15

Figure 4.1.5. Secure tanks with non-corrosive straps to prevent flotation. (Source: U.S. Environmental Protection Agency [EPA], 2014)..... 4-17

Figure 4.1.6. Elevating instrumentation can protect it from flood damage.(Source: U.S. Environmental Protection Agency [EPA], 2014)..... 4-18

Figure 4.1.7. Microgrids can provide power to a facility to reduce its dependence on the main electrical grid. (Source: Sandia National Laboratories, 2020) 4-21

Figure 4.2.1. Extend vent pipes and electrical controls above the flood elevation at lift stations..... 4-25

Figure 4.2.2. Constructing a flood wall that extends above the 500-year flood elevation can help protect a wastewater treatment plant from flood damage. The blue lines indicate the approximate location of the planned floodwall for this treatment facility. (U.S. Environmental Protection Agency [EPA], 2021)..... 4-31

Figure 4.2.3. Raise tanks above the 500-year flood elevation and secure them with non-corrosive hardware to keep them from floating. 4-34

Figure 4.2.4. Elevating instrumentation can protect it from damage during flooding. (Source: U.S. EPA, 2014) 4-36

Figure 4.2.5. Installing renewable energy resources like solar panels can provide a standby source of power for wastewater treatment facilities. (National Renewable Energy Laboratory [NREL], 2017) 4-39

Figure 4.3.1. Cross-section of conductor types..... 4-43

Figure 4.3.2. Dampers and detuners can help mitigate against gallop. 4-44

Figure 4.3.3. Interphase spacers can be used to help mitigate conductor gallop. (Source: INMR, 2021)..... 4-45

Figure 4.3.4. An armless composite utility pole helps mitigate against wind damage. (Source: Ramon Velasquez, 2013) 4-46

Figure 4.3.5. Typical utility pole with multiple guy wires and anchors. 4-47

Figure 4.3.6. Poles can be directly embedded in the ground deep enough to help prevent overturning, then backfilled with materials that can help increase foundation stability. (Source: Yenumula et al., 2017)..... 4-47

Figure 4.3.7. Comparison of loop-fed line versus radial-fed line systems. (Source: Bharti, 2015)..... 4-49

Figure 4.3.8. Installation of underground power lines..... 4-50

Figure 4.3.9. Elevating a control house in coastal areas can protect it against damage from storm surge and flooding. (Source: Modular Connections, 2020)..... 4-51

Figure 4.3.10. The existing battery bank can be modified or augmented to provide additional backup power to the substation. (Source: OSHA, No Date) 4-52

Figure 4.3.11. Indoor gas-insulated switchgears can be used in environments where water can penetrate the control house. (Source: Siemens Energy, 2021) 4-53

Figure 4.3.12. Hurricane Maria severely damaged a solar array in Puerto Rico in 2017. 4-55

Figure 4.3.13. Individual building-based solar and wind form the backbone of widely distributed generation. (Source: U.S. Bureau of Labor Statistics, 2021)..... 4-56

Figure 4.3.14. A solar array on Vandenberg Air Force Base helps power facilities on the base.(Source: Defense Logistics Agency, photo by Airman First Class Clayton Wear, No Date)..... 4-57

Figure 4.3.15. Pole-mounted automatic transmission and distribution line feeder reclosers can help identify and isolate faults so power can be restored quickly..... 4-59

Figure 4.3.16. Dedicated fiber-optic cables embedded in power cables can provide additional communication channels for SCADA systems. (Source: Transmission-line.net, 2010)... 4-60

Figure 4.3.17. Simplified AMI system (Source: Christopher Villareal, 2020)..... 4-61

Figure 4.3.18. Data collection gateways should be protected against wind by placing them in storm shelters..... 4-62

Figure 4.4.1. The collapse of a tower with antennas can damage the roof membrane, causing it to peel..... 4-65

Figure 4.4.2. Rooftop antennas often are mounted using ballast sleds..... 4-68

Figure 4.4.3. Antennas can be secured to the building structure to improve wind resistance..... 4-68

Figure 4.4.4. Exterior and interior of an equipment shelter. 4-70

Figure 5.1.1. Bolted brackets or clamps can be used to anchor some structures. 5-10

Figure 5.1.2. Chains or steel cables attached to ground anchors can be used to anchor park structures..... 5-11

Figure 5.1.3. Some park equipment can be embedded deep enough into the ground to improve stability..... 5-12

Figure 5.1.4. Poles and posts embedded in concrete can help resist wind..... 5-12

Figure 5.1.5. New courts can be overlaid on existing cracked tennis and basketball courts. 5-13

Figure 5.1.6. A bioswale can help retain floodwaters (left), and a culvert pipe can direct flow under a road or trail (right). 5-14

Figure 5.1.7. Greenways can help direct and absorb floodwaters. 5-16

Figure 5.1.8. Nature-based solutions or hybrid approaches to streambank stabilization (combining hardscapes with nature-based solutions) can protect trails and other park facilities... 5-16

Figure 5.2.1. Subway tunnel cross section..... 5-22

Figure 5.2.2. Inflatable plugs can prevent flooding in tunnels. (Source: Department of Homeland Security, 2017)..... 5-23

Figure 5.2.3. Elevated vent covers help protect against subway flooding while also acting as public sculptures. (Source: Jim Henderson, 2009)..... 5-24

Figure 5.2.4. Flood gates and flood barriers can help protect buildings and structures against rising water..... 5-25

Figure 5.2.5. Recessed passive barriers float into place automatically to protect against flooding..... 5-25

Figure 5.2.6. Deployable covers for subway access stairways can help prevent flooding of underground stations. (Source: Metropolitan Transportation Authority, 2021)..... 5-26

Figure 5.2.7. Floodwalls can help protect buildings from being flooded. 5-27

Figure 5.2.8. Rail system components..... 5-29

Figure 5.2.9. Catenary system..... 5-33

Figure 5.3.1. Examples and description of slides. (Source: Washington Geological Survey)..... 5-37

Figure 5.3.2. Removing soil and replacing it with lightweight fill can help decrease loads that drive soil downslope..... 5-39

Figure 5.3.3. Benching or terracing can help improve slope stability. 5-40

Figure 5.3.4. Reducing the slope angle removes some of the driving forces that can cause instability. (Source: USGS, 2004)..... 5-41

Figure 5.3.5. Geosynthetics can be used to reinforce and strengthen slopes. (Source: FHWA, 2009).... 5-42

Figure 5.3.6. A toe berm adds resistance to sliding material. 5-43

Figure 5.3.7. Deep soil mixing (DSM) creates a soil-concrete column to provide additional stability against sliding..... 5-44

Figure 5.3.8. Soil nailing can allow slope stabilization at steep angles. (Source: FHWA, 2015)..... 5-45

Figure 5.3.9. Soil nailing can be combined with vegetation to improve slope stability and aesthetics for both shallow and deep failure surfaces. (Source: FHWA, 2015) 5-45

Figure 5.3.10. Interceptor trench drains can be used to direct surface runoff away from slopes..... 5-47

Figure 5.3.11. Horizontal drains help lower the water table, which reduces driving forces by decreasing soil water content. (Source: USGS, 2008)..... 5-48

Figure 5.3.12. Check dams can be constructed of logs, rocks, or other materials to slow the flow of water in a channel on a slope. (Source: U.S. Forest Service, 2007)..... 5-49

Figure 5.3.13. MSE walls use geotextiles and granular soil backfill to retain slopes. (Source: FHWA, 2009)..... 5-50

Figure 5.3.14. Soldier pile walls can be used to reinforce failure planes. (Source: FHWA, 1999)..... 5-51

Figure 5.3.15. Gabions can be used to improve slope stability by resisting the sideways forces behind them. (Source: FHWA, 2001) 5-52

Figure 5.3.16. Crib walls can be constructed easily to retain soil on a slope. (Source: U.S. Forest Service, 2007)..... 5-53

Figure 5.3.17. Using vegetated stakes alone or in combination with a brush mat can help control erosion on slopes. (Source: NRCS, 1996)..... 5-55

Figure 5.3.18. Live fascine bundles can be used with stakes to help control erosion.(Source: USDA Forest Service, 2006)..... 5-56

Figure 5.3.19. Live crib walls can provide stability and help control erosion. (Source: NRCS, 1996)..... 5-56

Figure 5.4.1. Example seawall cross-sections..... 5-61

Figure 5.4.2. Example of an anchored sheet-pile bulkhead..... 5-62

Figure 5.4.3. Typical cross section of an armor stone revetment..... 5-63

Figure 5.4.4. Typical plan view of a breakwater system..... 5-64

Figure 5.4.5. Example sand accretion and erosion patterns around a groin system..... 5-65

Figure 5.4.6. Rock cores can be used to build dunes that resist erosion from waves and surge..... 5-67

Figure 5.4.7. Beach nourishment replaces sand lost through longshore drift or erosion and increases resilience. (Source: USACE, 2020)..... 5-68

Figure 5.4.8. Nature-based solutions for shoreline stabilization via a “Living Shorelines” approach. (Source: Adapted from NOAA, 2016)..... 5-69

Figure 5.5.1. Piles can be wrapped with PVC to protect them from damage (Source: Marine Fix Supply, 2018)..... 5-75

Figure 5.5.2. Fit aging piles with jacket encasements to strengthen and protect them (Source: Shoreline Plastics, No Date). 5-76

Figure 5.5.3. Improve pier performance during future storms by replacing storm-damaged pre-cast concrete pier deck panels with reinforced cast-in-place concrete (Source: U.S. Army Corps of Engineers, No Date)..... 5-76

Figure 5.5.4. Reinforce wharves, docks and boardwalks by splicing and reinforcing the structural components of piers and piles (Source: Professional Diving Services, 2020)..... 5-77

Figure 5.5.5. Rendering of downtown San Francisco Terminal Expansion Project containing a marine terminal dock complex with in-water structural components joined together withshore-based structures (Source: Water Emergency Transportation Authority, 2021). 5-78

Figure 5.5.6. An example of revetments protecting a boat launch ramp system. 5-79

Figure 5.5.7. An example of an outdoor dry-stack storage facility (Source: Brendan McGinley, 2021). ... 5-79

Figure 5.5.8. An example of an indoor dry-stack facility. 5-80

Figure 5.5.9. Elevating piers can help protect them from the impacts of floods (Source: USACE, 2020)..... 5-81

Tables

Table 0.0.1. Icons Used to Represent Considerations about Hazard Mitigation Strategies	3
Table 0.0.2. FEMA has four Hazard Mitigation Assistance programs.....	5
Table 0.0.3. Example Mitigation Strategies and Their Effectiveness and Cost.....	6
Table 1.0.1. Icons Used to Represent Considerations about Hazard Mitigation Strategies	1-4
Table 1.1.1. Common Mitigation Solutions	1-6
Table 1.2.1. Common Mitigation Solutions for Road Shoulders and Embankments	1-20
Table 1.3.1. Road Culvert and Drainage Mitigation Solutions	1-30
Table 1.4.1. Common Mitigation Solutions for Various Types of Bridge Damage.....	1-54
Table 1.5.1. Common Mitigation Strategies for Various Types of Damage	1-75
Table 2.0.1. Icons Used to Represent Considerations about Hazard Mitigation Strategies	2-4
Table 2.1.1. Channel, Aqueduct and Canal Mitigation Solution	2-9
Table 2.2.1. Basin Mitigation Solutions.....	2-17
Table 2.3.1. Common Mitigation Solutions for Dams and Reservoirs	2-29
Table 3.0.1. Icons Used to Represent Considerations about Hazard Mitigation Strategies	3-7
Table 3.1.1. Common Mitigation Solutions	3-12
Table 3.2.1. Wall Systems and Openings Mitigation Solutions.....	3-29
Table 3.3.1.1. Mitigation Solutions for Sloped-Roof Systems.....	3-45
Table 3.3.2.1. Mitigation Solutions for Low Slope Roof Systems.....	3-65
Table 3.4.1.1. Common HVAC System Mitigation Solutions.....	3-80
Table 3.4.2.1. Common Electrical System Mitigation Solutions.....	3-89
Table 3.4.3.1. Common Plumbing System Mitigation Solutions	3-99
Table 3.4.4.1. Common Mitigation Solutions for Conveyance Systems	3-111
Table 4.0.1. Icons Used to Represent Considerations about Hazard Mitigation Strategies	4-3
Table 4.1.1. Common Mitigation Solutions for Drinking Water Systems.....	4-8
Table 4.2.1. Common Wastewater Treatment System Mitigation Solutions.....	4-23
Table 4.3.1. Common Mitigation Solutions for Electric Power Systems	4-41
Table 4.4.1. Common Mitigation Solutions for Communications Systems.....	4-66
Table 5.0.1. Icons Used to Represent Considerations about Hazard Mitigation Strategies	5-4
Table 5.1.1. Common Mitigation Solutions for Parks and Recreational Facilities	5-9
Table 5.2.1. Additional Information on Mass Transit Facility Vulnerabilities and Mitigation Solutions.....	5-19
Table 5.2.2. Table 5.2.2. Common Mitigation Solutions for Mass Transit Facilities	5-21
Table 5.3.1. Common Mitigation Solutions for Earth Slope Stabilization.....	5-38
Table 5.4.1. Common Shoreline Mitigation Solutions.....	5-59
Table 5.5.1. Common Mitigation Solutions for Damage to Coastal Facilities	5-73

Introduction

The Hurricane and Flood Mitigation Handbook for Public Facilities (referred to as the Handbook) presents 30 fact sheets in addition to this introductory fact sheet that provide technical guidance and recommendations for applying mitigation best practices. The fact sheets contain information aimed at improving public facilities and other infrastructure vulnerable to damage caused by flood and wind.

This Handbook presents best practices developed from decades of hurricane and flood disaster evaluations. The work of the Federal Emergency Management Agency (FEMA) Mitigation Assessment Teams (MATs), which analyze damaged structures after a disaster to identify ways to increase resilience, enhances the material presented here.

NOTE

This Handbook defines “infrastructure” as physical structures, facilities and systems that support a community, its population and its economy.

To reduce future damage, apply best practices during construction or post-disaster repair or reconstruction. The measures outlined in this Handbook help protect existing buildings and infrastructure from hurricane and flood damage. Use these measures to lessen the damage to community assets and infrastructure.

This Handbook does not offer in-depth direction or engineering design, nor does it list every possible mitigation measure for different types of facilities and infrastructure. It does, however, include references to FEMA documents and other technical publications that have design guidance.

The Handbook’s purpose is to guide local governments and those who will directly use these strategies to reduce losses from disasters. Identifying and applying long-term mitigation measures can increase community resilience to floods and hurricanes.

None of the mitigation measures in this Handbook are pre-approved or automatically eligible for FEMA funding. Applicants should work with their state and local authorities as well as their Public Assistance (PA) Program and hazard mitigation specialists to determine what methods work best for their projects. Appendix J of the *FEMA Public Assistance Program and Policy Guide* (PAPPG) includes some measures that are considered cost-effective under the Public Assistance program.

Intended Audience

This Handbook can help state, local, tribal and territorial (SLTT) governments, public facilities, private nonprofits, and others seeking ways to reduce hurricane and flood risk to public infrastructure facilities. It also may serve as a resource for:

- Disaster recovery specialists
- Hazard mitigation specialists
- Grant applicants organizing a hurricane or flood recovery effort
- Design professionals (e.g., architects, engineers), contractors, facility owners and operators, planners and others responsible for designing, constructing, operating or maintaining public facilities, including publicly owned housing
- Any others interested in facility mitigation measures, FEMA recovery programs, compliance with National Flood Insurance Program (NFIP) floodplain management requirements, consensus-based building codes, specifications and standards

Handbook Organization

The Handbook is organized in sections by facility type. Each section contains fact sheets specific to one type of facility or infrastructure. Each fact sheet presents elements specific to that infrastructure type, such as hazard-related damage, mitigation objectives, mitigation opportunities, design issues, effectiveness, limitations and best practices.







This handbook categorizes facilities into series, which are listed below:

1. **Roads:** Road and highway surfaces, drainage and culverts, slope protection, bridges and other infrastructure such as signs and signals
2. **Water Control Facilities:** Dams and reservoirs, levees, floodwalls, channels, canals, irrigation facilities, pumping facilities, shorelines and stormwater management facilities
3. **Buildings and Equipment:** Publicly owned buildings, including police and fire stations, schools, municipal buildings, publicly owned housing, hospitals, and houses of worship; public sector equipment and building contents, including furnishings and building mechanical equipment; building structures and utility systems, contents and furnishings; and equipment and vehicles
4. **Utilities Systems:** Drinkable water treatment and delivery systems, including piping and pump or lift stations; wastewater treatment plants; nonprofit electrical power generation, transmission and distribution systems; and communication systems
5. **Parks, Shorelines, Recreational and Other Facilities:** Publicly owned parks, shorelines, and recreational facilities; marine facilities, including ports and harbors; mass transit (non-road) transportation facilities; and landslide-prone areas

Icons

The fact sheets include ideas/points to consider about developing and starting each option. Symbols/icons that represent these common considerations are summarized in Table 0.0.1.

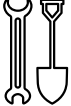
Table 0.0.1. Icons Used to Represent Considerations about Hazard Mitigation Strategies

Icon	Considerations about Hazard Mitigation Strategies
	Cost – The cost to carry out the mitigation option may be high, which could make using the option cost prohibitive.
	Engineering – A qualified engineer would likely need to design the mitigation option.
	Environmental and Historic Preservation – The mitigation option likely will need to comply with local, state and/or federal environmental and historic preservation requirements.
	Floodplain Management – Carrying out the mitigation option might impact the floodplain, triggering compliance with floodplain management requirements.
	Operations and Maintenance – The mitigation option might require additional operations and maintenance activities beyond those currently being performed.
	Permitting – Evaluate the local, state or federal permits required to carry out the mitigation option.

FEMA Mitigation Program Funding

FEMA defines “hazard mitigation” as those capabilities necessary to reduce loss of life and property by lessening the impact of disasters. FEMA’s mitigation grant programs help make communities more resilient against natural hazards such as hurricanes and floods. FEMA develops and updates Hazard Mitigation and Public Assistance program handbooks and publications as needed to offer guidance and help participants understand how to meet FEMA grant program requirements. FEMA publications listed in Appendix D give details on each program.





FEMA’s Public Assistance Program

The FEMA Public Assistance (PA) program, authorized by Section 406 of the Robert T. Stafford Disaster Relief and Emergency Assistance Act (Stafford Act), provides recovery assistance to communities impacted by a declared disaster event. The PA program assists state, local, tribal and territorial governments and some private nonprofits so that communities can respond quickly to and recover from major disasters or emergencies declared by the President. Through the PA program, FEMA gives supplemental federal disaster assistance to restore disaster-damaged publicly owned facilities and the facilities of some private nonprofit organizations. The PA program also encourages protection of these damaged facilities from future events by providing additional assistance for mitigation measures (Section 406, PA Hazard Mitigation).

FEMA’s Hazard Mitigation Assistance Grant Programs

FEMA’s Hazard Mitigation Assistance (HMA) programs provide a chance to reduce the risk to individuals and property from natural hazards while also reducing reliance on federal disaster funds. The four HMA programs share the common goal of reducing the loss of life and property due to natural hazards, as summarized in Table 0.0.2.

Table 0.0.2. FEMA has four Hazard Mitigation Assistance programs.

HMA Program Comparison				
	HMGP Hazard Mitigation Grant Program	HMGP Post Fire Hazard Mitigation Grant Program Post Fire	BRIC Building Resilient Infrastructure and Communities	FMA Flood Mitigation Assistance
Program Type	Post-disaster	Post-disaster	Pre-disaster	Pre-disaster
Funding Availability	Presidentially declared disaster	FMAG-declared disaster	6% set aside from federal post-disaster grant funding	Annual appropriations
Competitive?	No	No	Yes	Yes
Eligible Applicants	States, federally recognized tribes, territories and DC	States, federally recognized tribes, territories and DC	States, federally recognized tribes, territories and DC	States, federally recognized tribes, territories and DC
Eligible Subapplicants	States agencies, local governments, tribes and PNP organizations	States agencies, local governments, tribes and PNP organizations	States agencies, local governments, and tribes	States agencies, local governments, and tribes
Hazard Mitigation Plan Requirement	Yes	Yes	Yes	Yes
NFIP Participation	Communities with projects in SFHAs	Communities with projects in SFHAs	Communities with projects in SFHAs	Subapplicants and properties

Mitigation Project Cost Effectiveness

Regardless of the hazard mitigation program(s) providing grant funding, all hazard mitigation projects funded through FEMA must be cost-effective to be eligible. Projects looking for funding do not all have the same level of costs and benefits. Projects that have the greatest benefit for the lowest cost generally are more likely to have funding approved than other projects. For projects with long useful lives, consider the benefits of the project under future conditions as well as current conditions.

Project evaluations may be based on cost effectiveness. Table 0.0.3 outlines examples of applying the approach to different mitigation projects.

Table 0.0.3. Example Mitigation Strategies and Their Effectiveness and Cost

Mitigation	Effectiveness	Relative Cost
Install hurricane clips, fasteners, anchors, straps and connectors that are compatible with the roof system and the environment (i.e., using noncorrosive metals in corrosive environments).	Highly Effective	Low Relative Cost
Raise equipment that may incur damage by flooding to the roof of an existing building and protect against future hurricane wind exposure (i.e., adding tie downs, creating an enclosure, etc.).	Highly Effective	Medium Cost
Perform road repairs, including a new sub-base, thicker base and improved road surface.	Highly Effective	Medium Cost
Install flood wall and dry floodproofing at a critical facility.	Highly Effective	High Cost
Retrofit building foundations with flood vents.	Moderately Effective	Medium Cost
Upsize road culverts in flood-prone areas.	Moderately Effective	Low Cost
Install back-flow valves in basement or first floor interior drains.	Highly Effective	Low to Medium Cost
Install weatherstripping.	Low Effectiveness	Low Cost

Causes of Damage from Hurricane Flooding and Wind Hazards

This section talks about damage that can happen from hurricanes and floods. This damage happens because storm surge, wind and wind-driven rain have impacted structures that were not designed and built to withstand these forces.

It is important to create mitigation measures that reduce in the susceptibility of facilities and infrastructure to hurricane- or flood-related damage. Determining the best mitigation measure depends on the possible risk and the cause of the damage. Communities that start hazard mitigation projects to reduce risks they face from hurricanes and flooding should consider future conditions so that the mitigation measures will have long-lasting risk reduction benefits..

Sources of Flooding

Coastal Storm Surge

Storm surge flooding damage, which hurricanes can cause, typically occurs along the coastline and in low-lying areas. Storm surge often is the greatest threat to life and property from a hurricane. Storm surge results from water pushed toward the shore by the force of winds moving cyclonically, or counterclockwise in the Northern Hemisphere, around the storm. The low air pressure associated with intense storms causes the sea water surface to rise as the storm moves toward the shore. The advancing surge also can combine with normal tides to create a hurricane storm tide, which may raise the water surface elevation 15 feet or more.

Riverine Flooding

Riverine flooding usually happens because of heavy or prolonged rainfall or snowmelt occurring in upstream inland areas. In some cases, especially in and around urban areas, inadequate drainage can also cause flooding. In coastal areas where rivers are subject to tidal effects, flooding can result from wind-driven and prolonged high tides, poor drainage, storm surges with waves, and tsunamis.

Flash Floods

Flash floods are sudden, unexpected, localized floods of great volume and short duration, typically caused by unusually heavy rain. Flash floods can occur without warning and reach their peak in a matter of minutes. They often carry large loads of mud and rock and can even sweep away vehicles and trees.

Debris Flows and Alluvial Fan Floods

According to the U.S. Geological Survey (USGS), an alluvial fan happens when a fast-moving mountain stream empties out onto a relatively flat plain. All of the sediment the stream was carrying falls out as the water slows down. Flooding on alluvial fans results from quickly moving flows that cause erosion and carry sediment and debris. This type of flooding is the result of strong, sudden summer storms and often occurs with little to no warning. The flow paths are unpredictable, which makes predicting where flooding will occur difficult. Debris flows, also called mudslides, are like flash floods, but with higher concentrations of sediment. Debris flows move quickly and can occur without warning. Debris flows can result in alluvial fans, but they also can occur in other locations, usually steep hillsides, where heavy rainfall or saturated soil causes the soil to move down the slope.

Urban Floods and Pluvial Floods

Urban floods occur when the drainage system or water retention system in a city or town fails to hold the water from heavy rain. The lack of natural drainage in an urban area also can contribute to flooding. Water flows out into the street, making driving through it very dangerous. Pluvial flooding occurs when an extremely heavy downpour of rain overloads drainage systems and ground surfaces cannot absorb the excess water, causing puddles and ponds to appear. Pluvial flooding is like urban flooding, but the term also includes rural or less-populated areas.

Erosion-Prone Areas

Erosion-prone areas may include coastal flood zones with highly erodible soils, as well as riverine flood zones along banks or meandering streams. Areas with little to no vegetation can also be prone to erosion.

Sea Level Rise

Global sea level rise occurs from warmer temperatures melting ice at the poles. Sea level rise is not globally uniform and varies regionally. The Sea Level Rise Viewer, developed by the National Oceanic and Atmospheric Administration (NOAA) Office for Coastal Management, offers access to data and information about the risks of sea level rise, storm surge and flooding along the coastal United States. Some potential impacts of sea level rise include erosion, coastal flooding and loss of habitat.

Ice Jam and Debris Areas

Ice jams occur when the current carries pieces of ice floating on a river, and these ice pieces build up at an obstruction to block the flow of water. Ice jams often occur near river bends, mouths of tributaries, points where the river slope decreases, downstream of dams and upstream of bridges. Flooding occurs because the river or stream overflows its banks. Ice jams typically occur in the Northeast, Midwest and Alaska during periods of rapid thaw.

Flood Characteristics and Flood Forces

By examining flood characteristics, it is easier to determine which mitigation measure will work best for a specific location. A review of characteristics should include water depth and water surface elevation, flood velocity, duration and rate of water rise. Use these characteristics outlined below, to determine potential flood damage and anticipate how well different mitigation measures will work.

Water Depth and Water Surface Elevation

The water depth and water surface elevation from flooding are directly related, even though the measurement occurs at two different points. Measure flood depth from the floodwater surface down to the ground level. In contrast, measure water surface elevation up from an established survey point called a datum. Determining the potential depth of flooding is a critical step because it often is the primary factor in evaluating flood damage potential.

Buildings and other structures are susceptible to floods of various depths. Floods of greater depth occur less often than those of lower depths. Flood insurance studies (FISs) show potential flood elevations from major flooding for most communities that participate in the NFIP.

When evaluating the depth of flooding a structure is likely to face, use the flood levels shown in the FIS, historical flood levels, and flood information from other sources. Calculate the depth of flooding likely to affect a structure by finding out the height of the floodwater above ground level. Erosion caused by moving floodwater can lower the ground level and increase flood depths and flood risks. Figure 0.0.1 illustrates historic flood depths documented by measuring high-water marks on a building.



Figure 0.0.1. Measuring high-water marks can help establish flood depth.

NOTE

Additional information on flood hazard characteristics, flood load calculations, and design requirements is available in:

American Society of Civil Engineers (ASCE) 7, *Minimum Design Loads and Associated Criteria for Buildings and Other Structures*

ASCE 24, *Flood Resistant Design and Construction*

FEMA P-55, *Coastal Construction Manual: Principles and Practices of Planning, Siting, Designing, Constructing, and Maintaining Residential Buildings in Coastal Areas*. Available at: <https://www.fema.gov/media-library/assets/documents/3293>

FEMA P-259, *Engineering Principles and Practices of Retrofitting Flood-Prone Residential Structures*

FEMA P-936, *Floodproofing Non-Residential Buildings*

For those areas outside the limits of an FIS or state, community or privately prepared local floodplain study, determining flood depth may require an engineering evaluation of local drainage conditions. The designer should contact the local municipal engineer, building official or floodplain administrator for guidance on calculating flood depth in areas outside existing study limits or in a Special Flood Hazard Area (SFHA).

Flood Velocity

HYDROSTATIC LOADS

Hydrostatic loads are forces or pressures associated with standing or slowly moving flood water and are one of the leading causes of flood damage. The force of standing water can cause shifting or movement of buildings and utilities if water levels on opposite sides (e.g., inside and outside buildings) are substantially different. As shown in Figure 0.0.2, there are two types of hydrostatic loads:

- **Lateral hydrostatic load:** Standing water or slowly moving water can cause hydrostatic forces to push against the sides of a structure if floodwater levels on both sides of a wall are not equal.
- **Vertical hydrostatic load (buoyancy):** Poorly anchored buildings, which are lighter than water, may be subject to flotation (also called buoyancy). If designed to be watertight, submerged portions of buildings and building system components also are subject to flotation. Note that large buildings may be subject to uplift.

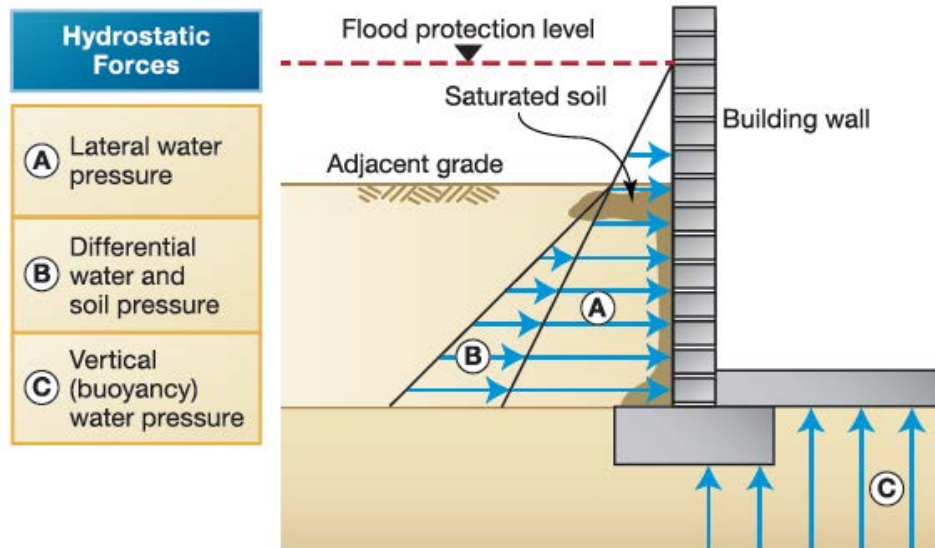

Figure 0.0.2. The different types of standing water forces.

HYDRODYNAMIC LOADS

Hydrodynamic loads are forces imposed on a building or other structure when moving water flows against and around it. As shown in Figure 0.0.3, these forces include force against the structure on the upstream side, drag effect along the sides and negative force on the downstream side. Hydrodynamic forces are one of the main causes of flood damage.

Moving floodwater imposes hydrodynamic forces on submerged foundations and building elements, including utility system components located below flood levels. The force of flowing water can destroy solid walls and dislodge buildings that are poorly anchored. Floodwater also can move large amounts of sediment and debris that can cause additional damage. Floodwater moving at a velocity greater than 10 feet per second is considered high-velocity flow.

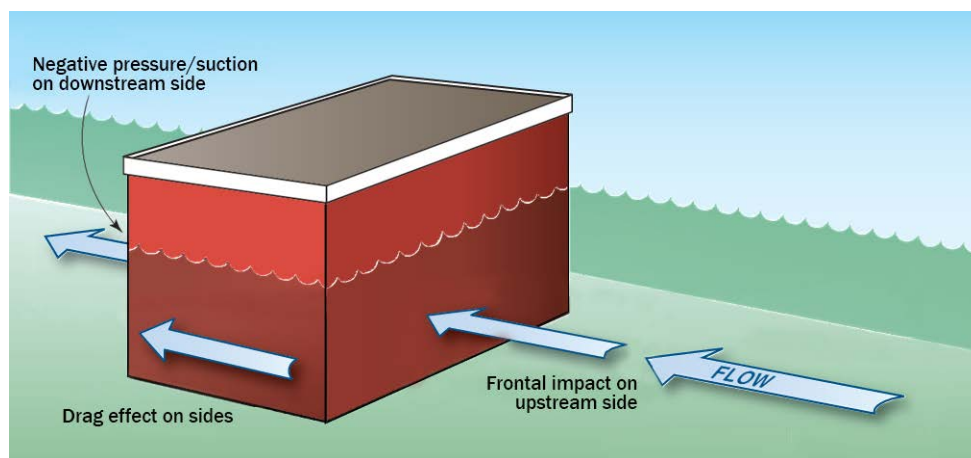

Figure 0.0.3. Hydrodynamic forces.

Moving floodwater in coastal areas usually is associated with one or more of the following:

- Storm surge and wave runup flowing toward land through breaks in dunes or levees or across low-lying areas
- Outflow (toward the ocean) of floodwater that was driven into a bay or upland area by a storm
- Strong currents along the shoreline driven by storm waves moving in an angular direction to the shore

WAVE FORCES

Wave forces can be separated into four categories:

- Non-breaking waves, which usually can be considered as hydrostatic forces against walls and hydrodynamic forces against piles
- Breaking waves, which are short duration but large magnitude forces against walls and piles
- Broken waves, which are similar to hydrodynamic forces caused by flowing or surging water
- Uplift, which is often caused by wave runup, deflection or peaking against the underside of horizontal surfaces

WAVE ACTION

Wave action describes the behavior of waves along shorelines. The height of waves that are part of the base flood can vary by flood zone. In Zone V, wave heights equal or exceed 3 feet, while in Coastal A Zones, wave heights are between 1.5 feet and 3 feet. Waves can affect buildings and other structures in the following ways:

- **Breaking wave forces:** The force created by waves breaking against a vertical surface causes the most severe damage to coastal buildings. This force often is ten or more times greater than the force created by high winds during a storm event. Elevated coastal structures supported on open foundations (piles or columns) withstand coastal storms better than other types of foundations because water and debris usually can flow more easily through open foundations, which helps minimize exposure to breaking waves.
- **Wave runup and wave slam:** Wave runup occurs as waves break and run up beaches, sloping surfaces and vertical surfaces. Wave runup can drive large volumes of water against or around coastal buildings. The action of wave crests striking the elevated portion of a structure is known as “wave slam.” Wave slam introduces potentially large lateral and vertical forces on the lower portions of elevated structures, typically resulting in damaged floor and wall systems.

Duration and Rate of Rise

Duration is the measure of how long flooding remains above normal levels. The duration of riverine flooding is a function of watershed size and the steepness of the terrain. For example, rivers that drain large watersheds and those with relatively flat topography can experience high surface water elevations for weeks or months. Coastal flooding typically is of shorter duration—usually only one or two tide cycles depending on how fast a storm moves through an area—and can result from surge. (Coastal areas experience two high tides and two low tides every 24 hours and 50 minutes, which is a lunar day, so one tide cycle is approximately 12 hours and 25 minutes.) Lengthy contact with floodwater may make it even harder to correct flood damage because building materials may be ruined.

Rate of Rise is the measure of how quickly floodwater rises above normal levels. Areas with steep topography and small drainage areas may experience flash flooding, during which floodwater can rise quickly with little or no warning. Large rivers typically rise more slowly. In coastal areas, the rate of rise is affected by how fast storms approach the shore, the shape of the coastal sea floor, and the shape of the land. Building protection measures that require speedy action by building managers or occupants may not be easy to put into place in areas where water rises quickly.

Other Flood Characteristics and Impacts

Flood-Borne Debris Impact

Flood-borne debris is capable of damaging or destroying unreinforced masonry walls, light wood frame construction, and small-diameter posts and piles, as well as the structures they support, as shown in Figure 0.0.4. Flood-borne debris produced by coastal storms and riverine floods can include material from damaged carports, decks, porches, stairs, ramps, breakaway wall panels, buildings, shipping containers, fuel tanks, equipment, vehicles, boats and docks.

Debris trapped by cross-bracing, closely spaced piles, grade beams or other building components can exert flood and wave forces on the foundation of an elevated structure. Impact forces may result from ice, trees and other objects transported by floodwater. Examples of facilities that may be affected by flood-borne debris include coastal buildings, waterfront piers, bridge piers, drainage pipes and utility equipment. Predicting what flood-borne debris may consist of is difficult. The force of the impact from flood-borne debris depends on how rigid or flexible the foundation is, but also depends on the nature of the debris itself, how quickly the floodwater is moving and the duration of the impact.

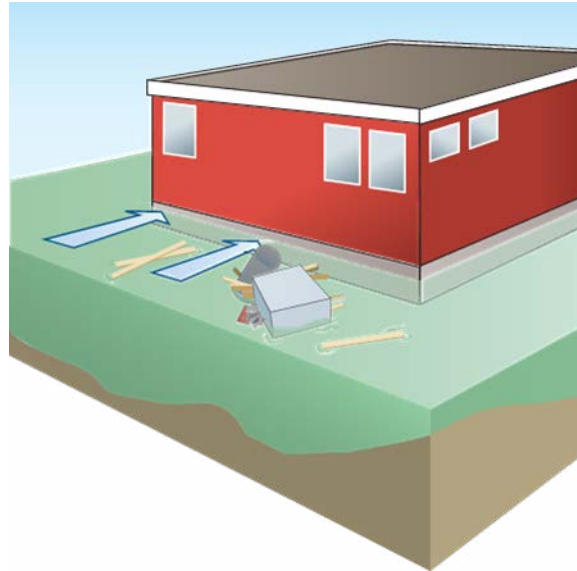

Figure 0.0.4. Flood-borne debris impact.

Erosion and Scour

Damage occurs when moving floodwater erodes (shift or remove) soils and scour (undermine) foundations that support facilities. In some areas, the effects of erosion and scour can result in severe damage or even collapse of buildings and infrastructure. Examples of facilities that may be damaged by erosion and scour include roadways, side ditches, embankments, culverts, bridge approaches, bridge piers and abutments, drainage/irrigation channels, shoreline protective structures, building foundations, equipment, buried utility lines, and beaches and dunes. Erosion and scour can occur over time simply from exposure to regular coastal systems, weather, water flows and tidal variations, and it can be more severe and damage facilities worse than during hurricanes and coastal storms.

Coastal Environment Corrosion

Damage occurs when exposure to salt spray, brackish rain and constant moisture cause wasting and weakening of metal connectors and fasteners on coastal buildings and other facilities. Damage that is severe enough to cause the metal to fail can occur within a few years after the connector is installed. In areas located even several miles from the shoreline, corrosion damage can significantly increase the risk of metal failure and severe structural damage during hurricanes. Examples of facilities that may be damaged by coastal corrosion include piers, docks, metal traffic and light poles, building connectors and fasteners, and straps used to anchor or support outdoor equipment and utilities. Corrosion also damages electrical equipment, often requiring the replacement of saturated transformers, switchgear, starters, control centers and control panels.

Hurricane Wind

Infrastructure and buildings in hurricane-prone regions can be damaged by the force of high wind, wind-borne debris impacts and possibly penetration of wind-driven rain. Wind damage associated with hurricanes and severe coastal storms usually is the most severe in coastal areas in the storm’s right front quadrant. However, the right rear quadrant also can have significant wind. Wind damage associated with hurricanes typically extends far inland and can affect a wide area. The mitigation measures outlined in this Handbook are specific to protecting existing buildings and other structures from hurricane damage.

The American Society of Civil Engineers/Structural Engineering Institute (ASCE/SEI) 7, Minimum Design Loads and Associated Criteria for Buildings and Other Structures, defines the hurricane-prone region of the United States as the Atlantic Ocean and Gulf of Mexico coasts where the basic wind speed for Risk Category II buildings is greater than 115 miles per hour (mph), as well as Hawaii, Puerto Rico, Guam, the U.S. Virgin Islands and American Samoa, as shown in Figure 0.0.5.

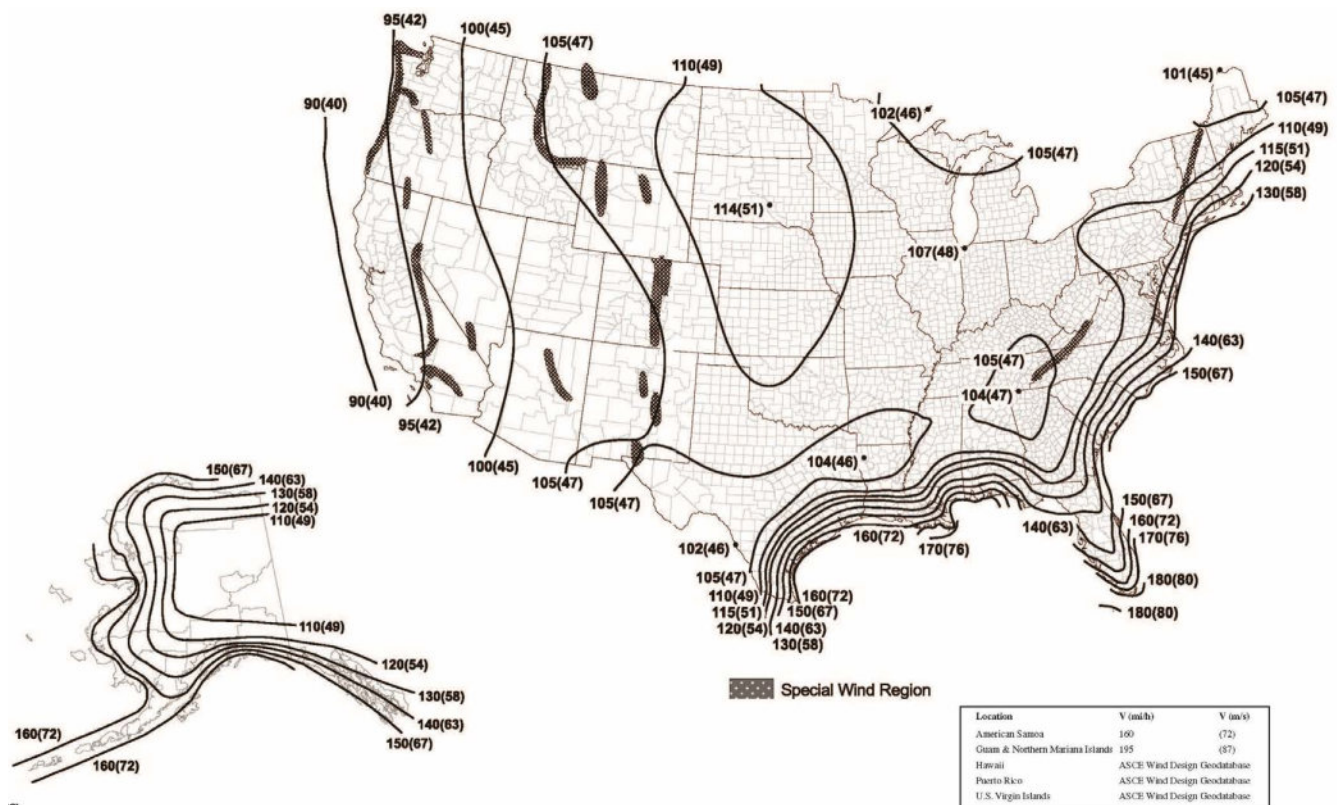

(Source: ASCE, used with permission for illustration purposes)

Figure 0.0.5. ASCE 7-22 Hurricane-Prone Region.

High winds can produce large amounts of debris that may become wind-borne and damage buildings, potentially even exposing the building interior to the storm outside. Once a building is exposed, wind-driven rain can enter, causing water damage to the interior and contents. A broken window or glass door also may allow wind forces to increase within the building, leading to structural damage.

New buildings built in a wind-borne debris region are required to have either impact-resistant glass or an impact protective system (i.e., window and door shutters, screens) to protect against damage and impacts. Owners of existing buildings should consider replacing openings with impact-resistant glass or adding impact protective systems to mitigate this risk.

THE APPLIED TECHNOLOGY COUNCIL WIND SPEED WEBSITE

Products that help determine the potential storm wind speed for a given location can provide a valuable service. One such product is the Applied Technology Council (ATC) wind speed website:

<http://www.atcouncil.org/windspeed.html>

ATC is a nonprofit corporation that develops applications for hazard mitigation. The ATC website gives wind speeds for various recurrence intervals for the four risk categories specified in building codes and standards.

Roadway or parking lot lighting, highway signals, utility lines and similar structures can be vulnerable to wind forces or wind-borne debris. Mitigation measures for these public facilities include multiple support posts or stronger panels and fasteners.

ASCE 7-16 defines the wind-borne debris region in the United States as areas within 1 mile of the coastal mean high-water line where the basic wind speed is equal to or greater than 130 mph and in areas where the basic wind speed is equal to or greater than 140 mph. As the terrain becomes more open and wind is unobstructed, there is more potential for damage due to wind forces.

Conversely, in densely populated areas, built-up environments have a lot of potential wind-borne debris. In addition to the wind speed and location within the hurricane-prone region, the exposure category also is important in identifying infrastructure or building vulnerability to wind-related damage.

EXPOSURE CATEGORIES FROM ASCE 7-16

- B:** Urban and suburban areas, wooded areas
- C:** Open terrain (includes shoreline in hurricane-prone regions)
- D:** Flat, unobstructed areas and water surfaces

Levels of Protection

Many states and communities regulate the construction of buildings by adopting and enforcing building codes. Most locally adopted building codes in the United States are based on model building codes

developed from an American National Standards Institute (ANSI)-approved consensus-based process. The basis of wind design in these model codes often incorporates the wind provisions of ASCE 7. Examples of model building codes endorsed by the International Code Council (ICC) include:

- International Building Code (IBC) (ICC)
- International Existing Building Code (IEBC) (ICC)
- International Residential Code (IRC) (ICC)

During the past few decades, building codes have progressed to support design and construction practices that result in new buildings being more resistant to high winds. The challenge is the existing infrastructure in hurricane-prone regions, which was designed and built without codes, with outdated codes or with less-stringent codes and standards. This means that much of the current infrastructure in the hurricane-prone areas of the United States was constructed using outdated codes and standards, assuming no or few retrofits have been done to date. Owners and building managers need to learn about their buildings' vulnerabilities to define existing levels of risk and how and to what extent the risks can be mitigated.

The most recent hazard-resistant codes provide the minimum protection for wind hazards. This Handbook describes options for adding mitigation to newer structures and retrofits for older structures not designed to current codes. While codes provide the minimum standard, a best practice is to design for wind velocities and surface water elevations greater than the current minimum requirements. Additional information can be found in Appendix B, Codes, Standards, Best Practices and Mitigation. On the other end of the spectrum, safe rooms and storm shelters offer near-absolute protection from hurricanes if designed and built per FEMA P-361, *Safe Rooms for Tornadoes and Hurricanes: Guidance for Community and Residential Safe Rooms*, and ICC 500/*National Storm Shelter Association (NSSA) Standard for the Design and Construction of Storm Shelters*.

Wind damage at a specific site will vary based on the wind speed; the duration the wind lasted; and the age, material, type and quality of construction. The most common forms of wind damage are described below.

Wind Damage

WIND PRESSURES

Wind pressure is a function of wind speed, topography, exposure, upwind terrain conditions and the height above ground, structure size, and the shape of the structure that the wind is affecting. Wind pressure on the windward side acts inwardly, creating positive (pushing) pressure; wind pressure on the leeward side acts outwardly, creating negative (suction) pressure. Wind pressures are cyclical and will tend to cause failures from the fatigue of materials. Damage occurs when wind pressure exceeds the strength of connections and materials, leading to racking, sliding, collapse and overturning of buildings and other structures.

WIND-BORNE DEBRIS

Wind can move and pick up objects, creating wind-borne debris and thrusting these flying objects into structures. The debris can be small—rocks or stones—or larger—pieces of lumber, lightweight columns, tree limbs and outside-mounted equipment. In areas that experience strong hurricane-force winds, impact damage from wind-borne debris, such as lumber, may pierce walls and roofs and shatter glass.

WIND-DRIVEN RAIN

Wind-driven rain damage associated with hurricanes occurs when rain penetrates various building openings, including damaged walls or roofs, and joints, such as soffits or around windows and doors. Wind-driven rain can lead to extensive water damage of interiors and contents.

REFERENCES:

American Society of City Engineers (ASCE). 2020. ASCE 7-16, *Wind Loads: Guide to the Wind Load Provisions of ASCE 7-16*. Available at: <https://sp360.asce.org/PersonifyEbusiness/Merchandise/Product-Details/productId/260531339>.

American Society of Civil Engineers/Structural Engineering Institute (ASCE/SEI). 2014. ASCE/SEI 24-14, *Flood Resistant Design and Construction*. Available at: <https://ascelibrary.org/doi/book/10.1061/9780784413791>.

Federal Emergency Management Agency (FEMA). 2010. FEMA P-758, *Substantial Improvement/Substantial Damage Desk Reference*. Available at: https://www.fema.gov/sites/default/files/documents/fema_nfip_substantial-improvement-substantial-damage-desk-reference.pdf.

FEMA. 2017. *Understanding Substantial Damage in the International Building Code, International Existing Building Code, or International Residential Code*. Available at: https://www.fema.gov/sites/default/files/2020-07/pa_job-aid-understanding_sd.pdf.

FEMA. 2017. *Understanding Substantial Structural Damage in the International Existing Building Code*. Available at: https://www.fema.gov/sites/default/files/2020-07/pa_job-aid_understanding_ssd_International.pdf.

FEMA. 2018. FEMA P-213, *Answers to Questions About Substantially Improved/Substantially Damaged Buildings*. Available at: https://www.fema.gov/emergency-managers/risk-management/building-science/publications?name=P-213&field_keywords_target_id=All&field_document_type_target_id=All&field_audience_target_id=All

FEMA. 2019. FEMA Recovery Interim Policy FP-104-009-11, Version 2.1, *Consensus-Based Codes, Specifications and Standards for Public Assistance*. Available at: <https://www.fema.gov/assistance/public/policy-guidance-fact-sheets/section-1235b-consensus-based-codes-and-standards>.

FEMA. Various. *Flood Insurance Manual*. Available at: <https://www.fema.gov/flood-insurance/work-with-nfip/manuals>.

FEMA. Various. NFIP Technical Bulletins. Current editions available at: <https://www.fema.gov/nfip-technical-bulletins>.

- Technical Bulletin 3, *Non-Residential Floodproofing—Requirements and Certification for Buildings Located in Special Flood Hazard Areas*. Available at: https://www.fema.gov/emergency-managers/risk-management/building-science/publications?name=Technical+Bulletin+3&field_keywords_target_id=All&field_document_type_target_id=All&field_audience_target_id=All.
- Technical Bulletin 7, *Wet Floodproofing Requirements for Structures Located in Special Flood Hazard Areas*. Available at: https://www.fema.gov/emergency-managers/risk-management/building-science/publications?name=Technical+Bulletin+7&field_keywords_target_id=All&field_document_type_target_id=All&field_audience_target_id=All

FEMA and International Code Council (ICC). 2014. *Reducing Flood Losses Through the International Codes: Coordinating Building Codes and Floodplain Management Regulations*, 4th Edition. Available at: <https://www.fema.gov/media-library/assets/documents/96634>.

International Code Council (ICC). 2018. International Building Code. Available at: <https://www.iccsafe.org/>.

ICC. 2018. International Existing Building Code. Available at: <https://www.iccsafe.org/>.

ICC. 2018. International Residential Code. Available at: <https://www.iccsafe.org/>.

Renfroe, N. and J. Smith. 2016. "Threat/Vulnerability Assessments and Risk Analysis." *Whole Building Design Guide*. Available at: <https://www.wbdg.org/resources/threat-vulnerability-assessments-and-risk-analysis>.

Fact Sheets

Fact Sheet 1.0: Roads

The mitigation objective of this Fact Sheet is to introduce mitigation strategies for roadways, bridges and associated support infrastructure needed for transportation and societal lifelines to reduce their vulnerability to flooding, storm surge and wind hazards.

Hurricane and Flood Impacts

Damage to roads and highways from hurricanes and floods exceeds millions and sometimes billions of dollars annually. Roadways through low-lying areas commonly are built on earthen embankments with one or more culverts extending through the embankments to handle normal drainage, runoff and flood flow. When flows are greater than expected, the capacity of culverts and drainage infrastructure to carry the additional flows can be exceeded. Consequently, the road surface can become flooded or the road embankment can act as a dam, creating flood conditions upstream of the embankment.

Similarly, bridges could flood if the volume of water in the flood flow is greater than the volume of water that can reasonably pass underneath or around the bridge at ordinary velocities. Flood-borne debris, such as trees or other barriers, can wedge in bridge openings, which causes a damming effect that can result in floodwaters washing over the bridge deck. Debris also can strike bridge piers and abutments, causing structural damage. Uplift forces may even lift the bridge deck from its supports.

Other impacts associated with hurricanes also can damage road infrastructure. Storm surge and wave action from hurricanes can erode roadways and embankments that are close to the shoreline. High wind and windborne debris may damage traffic signals, streetlights and signs, causing breakage, blow-down, or collapse of supports. Debris from these events can land in the roadway, blocking traffic flow.

Mitigation Fact Sheets

Roadway-related infrastructure is grouped into five fact sheets in this Handbook, each corresponding to different components of a roadway (Figure 1.0.1). The five roadway-related fact sheets are:

1. **Road Surfaces**—The portion of roads designed to carry traffic. Roads are paved or unpaved. Other public facilities may include bike paths, pedestrian ways, sidewalks and maintained trails.
2. **Road Shoulders and Embankments**—Road shoulders provide side support for pavement or unpaved surface layers and create a space at the edge of the roadway for stopped vehicles, emergency use, and out-of-control vehicles. Road shoulders also can be an essential part of the road surface drainage system. The road shoulder may be located on an embankment, where the embankment is also a structural support, in some cases supporting land next to a river or stream or supporting other raised land with a natural, stable slope.



3. **Culverts and Drainage Infrastructure**—Culverts are pipes or other structures crossing through an embankment under a road. Culverts move water from the road surface, road shoulders, roadside ditches and any other basins through or past the road itself. Roadside drainage ditches or swales collect and channel water away from the road surface for vehicle safety and protect the integrity of the roadway. Stormwater drainage systems around buildings, parking lots, railroads, airports and other facilities use similar features as road drainage.
4. **Bridges**—Bridge decks support the road and are connected to it at bridge approaches. Bridges span over roads, water bodies, railroads or unstable soils such as those in wetland areas. Bridge structures consist of piers, footings, headers, girders, the bridge deck and a wall or guardrail. Bridge abutments protect the area under the bridge approach. Embankments sometimes are supported with additional retaining structures called wing walls.
5. **Lights, Poles, and Signage**—Other roadway accessories include traffic control and safety structures, such as traffic signals, streetlighting and signs. Many of these structures are controlled electronically, and the controller box may be positioned next to the road on the ground. Traffic signals and signs are raised to be visible to travelers, making them vulnerable to high winds.

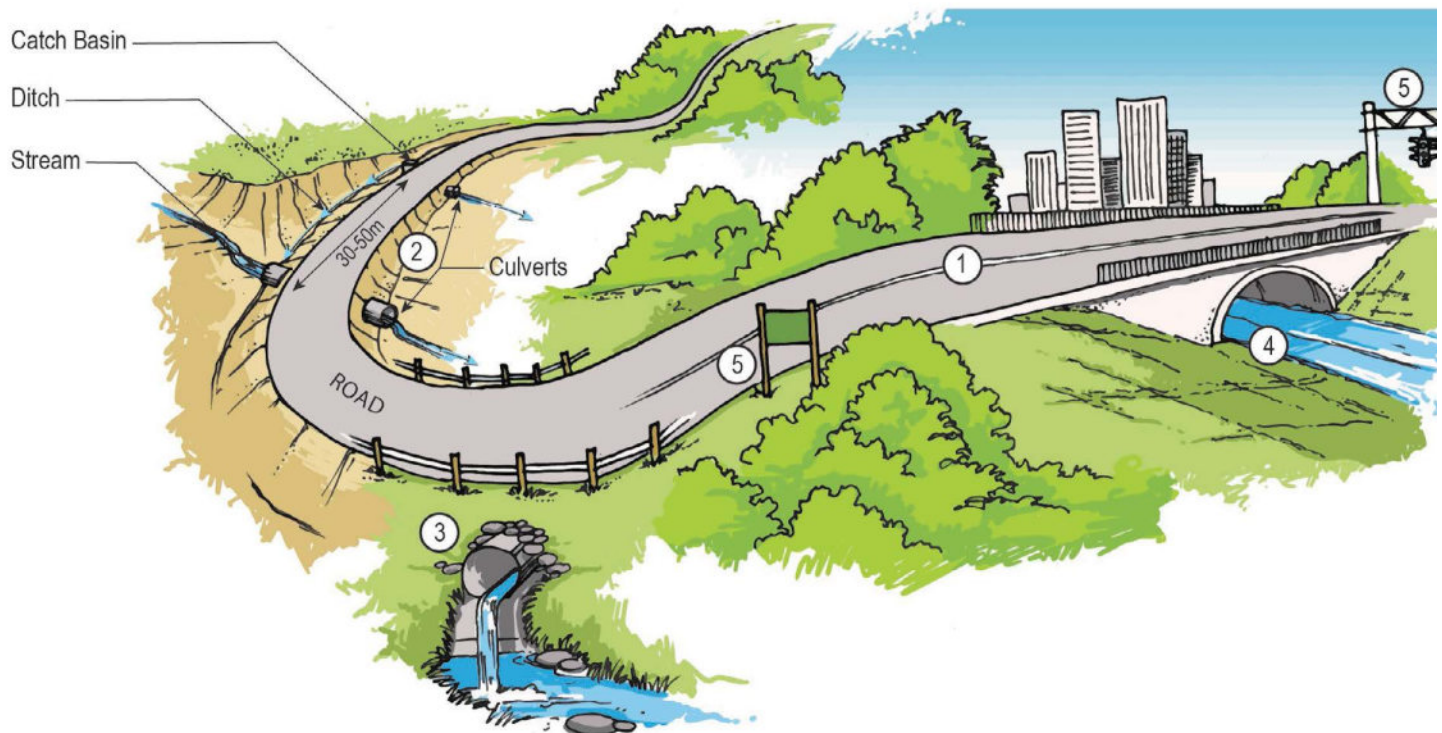

Figure 1.0.1. Road System Components.

Mitigation Solutions

Roadways are important facilities that must remain usable during and immediately after a natural disaster so that needed services can continue to function. Decreasing the likelihood of flooding, reducing damage and controlling erosion can improve the resilience of roadways. The methods used will depend on many factors, including cost, physical limitations, and environmental requirements. Possible strategies are detailed in the fact sheets that follow, including:

- Elevating roadways
- Improving drainage
- Strengthening underlying soils
- Installing erosion control measures
- Realigning roads and structures
- Strengthening support structures
- Decreasing debris damage
- Armoring vulnerable structures and embankments
- Moving electronic controls and equipment up off the ground
- Providing a source of standby power







NOTE:

Roadway and highway drainage and culvert systems to reduce future damage are tied to roadway classifications, such as interstates and primary and secondary roadway categories. State Department of Transportation manuals outline drainage standards.

Icons

The fact sheets include points to consider about developing and implementing each option. Icons represent these common considerations, which are summarized in Table 1.0.1 below.

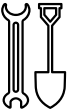
Table 1.0.1. Icons Used to Represent Considerations about Hazard Mitigation Strategies

Icon	Considerations about Hazard Mitigation Strategies
	Cost – The cost to carry out the mitigation option may be high, which could make using the option cost prohibitive.
	Engineering – A qualified engineer would likely need to design the mitigation option.
	Environmental and Historic Preservation – The mitigation option likely will need to comply with local, state and/or federal environmental and historic preservation requirements.
	Floodplain Management – Carrying out the mitigation option might impact the floodplain, triggering compliance with floodplain management requirements.
	Operations and Maintenance – The mitigation option might require additional operations and maintenance activities beyond those currently being performed.
	Permitting – Evaluate the local, state or federal permits required to carry out the mitigation option.

REFERENCES:

- AASHTO LRFDLTS. Current edition. Standard Specifications for Structural Supports for Highway Signs, Luminaries, and Traffic Signals.
- Federal Emergency Management Agency (FEMA). 2001. *Flood Hazard Mitigation Handbook for Public Facilities*. Available at: <https://www.hSDL.org/?abstract&did=34754#:~:text=This%20Flood%20Hazard%20Mitigation%20Handbook,and%20mitigation%20ideas%20for%20local>
- FEMA. 2005. *Hurricane Mitigation: A Handbook for Public Facilities*. Available at: <https://www.hSDL.org/?abstract&did=34831>
- FEMA. 2007. FEMA P-543, *Design Guide for Improving Critical Facility Safety from Flooding and High Winds: Providing Protection to People and Buildings*. Available at: https://www.fema.gov/sites/default/files/2020-08/fema543_design_guide_complete.pdf
- FEMA. 2010. FEMA P-797, Hazard Mitigation Field Book: Roadways. Available at: <https://www.fema.gov/media-library/assets/documents/19299>
- FEMA. 2013. Mitigation Ideas: A Resource for Reducing Risk to Natural Hazards. Available at: https://www.fema.gov/sites/default/files/2020-06/fema-mitigation-ideas_02-13-2013.pdf
- FEMA. No Date Environmental and Historic Preservation (EHP) Fact Sheet: Culverts. Available at: http://www.tamus.edu/rebuildtexas/wp-content/uploads/sites/52/2017/09/6_Culverts_Final-clean-11-12-12_508.pdf
- Federal Highway Administration (FHWA). 1998. Geosynthetic Design and Construction Guidelines, FHWA-HI-95-038. Available at: <https://www.fhwa.dot.gov/engineering/geotech/pubs/011431.pdf>
- FHWA. 2005. HEC-09 Debris Control Structures Evaluation and Countermeasures, Third Edition. Available at: <https://www.fhwa.dot.gov/engineering/hydraulics/pubs/04016/hec09.pdf>
- FHWA. 2005. HEC-15 Design of Roadside Channels with Flexible Linings, Third Edition. Available at: <https://www.fhwa.dot.gov/engineering/hydraulics/pubs/05114/05114.pdf>
- FHWA. 2005. Hydraulic Design of Highway Culverts, Hydraulic Design Series No. 5, FHWA-NHI-01-020. Available at: <https://www.fhwa.dot.gov/engineering/hydraulics/pubs/12026/hif12026.pdf>
- FHWA. 2006. HEC 14 Hydraulic Design of Energy Dissipaters for Culverts and Channels, Third Edition. Available at: <https://www.fhwa.dot.gov/engineering/hydraulics/pubs/06086/hec14.pdf>
- FHWA. 2010. HEC 26 Culvert Design for Aquatic Organism Passage. Available at: <https://www.fhwa.dot.gov/engineering/hydraulics/pubs/11008/hif11008.pdf>
- FHWA. 2016. HEC 17 Highways in the River Environment- Floodplains, Extreme Events, Risk and Resilience, Second Edition. Available at: <https://www.fhwa.dot.gov/engineering/hydraulics/pubs/hif16018.pdf>
- FHWA. 2020. Department of Transportation Master Site to All State Standard Drawings. Available at: <https://flh.fhwa.dot.gov/resources/standard/state.htm>
- Pennsylvania Department of Transportation. 2012. Debris Control for Bridges and Culverts, Technical Information Sheet #152. Available at: https://gis.penndot.gov/BPR_pdf_files/Documents/LTAP/TS_152.pdf
- State Department of Transportation Geotechnical Manuals.
- State Department of Transportation Traffic Sign Design Manuals.

Fact Sheet 1.1: Road and Highway Surfaces

The mitigation objective of this Fact Sheet is to reduce damage to the road by moving water off the road surface.

Large amounts of standing and moving water, which are typical with flooding and hurricanes, have the power to damage the surface of a roadway. Increasing the ability of the roadway and the shoulder to withstand the forces of water help mitigate roadway surface erosion. The road surface and the shoulder protect the road base, subbase and subgrade, providing the roadway's stability to support traffic.

Table 1.1.1 summarizes common strategies for reducing the vulnerability of road and highway surfaces to flood and hurricane hazards. The sections below discuss these strategies.

Table 1.1.1. Common Mitigation Solutions

Solutions and Options	Unpaved Roadway	Paved Roadway
Mitigation Solution: Stabilize Roadway		
Option 1: Resurface Roadway	✓	
Option 2: Reshape Roadway	✓	
Option 3: Construct Shoulder Protection	✓	✓
Option 4: Improve Subgrade Drainage Using Geosynthetic Drainage Systems		✓
Option 5: Improve Subgrade Strength Using Geosynthetics	✓	✓
Mitigation Solution: Reduce Flood Hazard on Roadway		
Option 1: Increase Roadway Elevation	✓	✓
Option 2: Relocate or Reroute Roadways	✓	✓
Option 3: Use Permeable Pavement	✓	✓
Mitigation Solution: Reduce Frost Heave		
Option 1: Improve Drainage	✓	✓
Option 2: Increase Pavement Thickness		✓
Option 3: Stabilize or Improve Subgrade Soils	✓	✓



Mitigation Solution: Stabilize Roadway

Roadway surface damage can be mitigated by increasing the ability of the roadway and shoulder to withstand the forces of water. The following sections present different options to achieve this end.

Option 1: Resurface Roadway

Hardening the road surface, repairing the existing road pavement, or reinforcing the paved surface will reduce the damage caused by inundation and debris.

When evaluating this option, keep these considerations in mind:

- Replace damaged, unpaved road surfaces with asphalt or concrete.
- State Department of Transportation manuals can be used to determine which paving materials are best under a given set of conditions.
- Costs could vary widely based on the surfacing material selected. For example, concrete tends to cost more than asphalt up front and uses different paving techniques.
- With paved roadways, consider adding geotextile drainage blankets between the pavement and subbase to strengthen the subgrade.
- To reinforce the subgrade, geotextiles—such as special woven fabrics—can be used and connected to drains. They generally do not drain well.
- Resurfacing may be more effective when completed along with Options 3, 4, or 5, below.

CONSIDERATIONS:



Option 2: Reshape Roadway

Reshape the entire cross-section to make it easier for water to run off the sides of the road. Where space is available, add shoulders if none exist. Slope the roadway from the center line of the road to the outside edge of the shoulder to aid with draining water off the road. Add drainage structures to move water from the road shoulder (Figure 1.1.1).

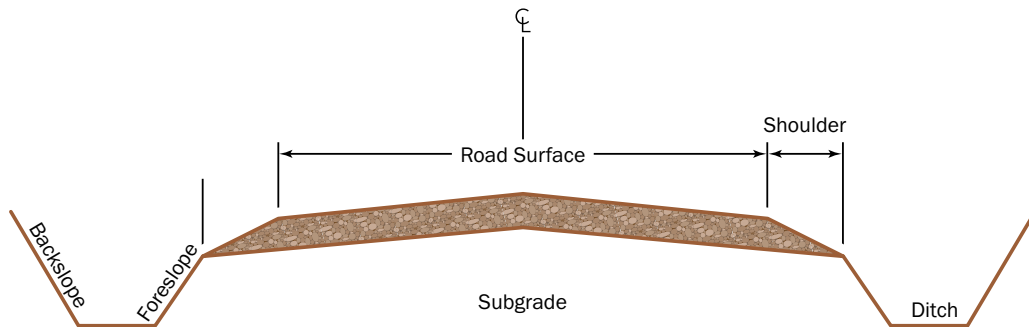

Figure 1.1.1. Reshaping the roadway can improve drainage and decrease flood impacts.

When evaluating this option, keep these considerations in mind:

- Road design may be subject to different requirements, including proper drainage, compaction and surfacing materials.
- When engaging in new construction, consider stabilizing disturbed areas.
- This option may be more effective when completed along with Options 3, 4, or 5, below.

CONSIDERATIONS:



Option 3: Construct Shoulder Protection

Keep the roadway subgrade strong by constructing shoulder protection. When subgrade soils get saturated, they can become weaker, resulting in the road being unable to support traffic loads. Protecting the roadway shoulders can reduce the amount of water that can reach the roadway subgrade, reducing damage to the roadway.

When evaluating this option, keep these considerations in mind:

- Protect unpaved shoulders by adding a layer of clean gravel, crushed stone, or pulverized asphalt.
- If a paved road has gravel shoulders, paving the shoulders or installing a layer of asphalt will reduce the porousness of the shoulder and reduce the material loss from traffic on the shoulder.
- Installing a geosynthetic material on the shoulder slope or constructing retaining walls at the bottom of the shoulder slope can help with stabilization. Geosynthetics used for this purpose should provide both reinforcement and drainage.
- Revegetating the shoulder slope with native plants that have deep root systems will help to stabilize the slope and reduce soil erosion, which helps protect the shoulder from damage.

CONSIDERATIONS:



Option 4: Improve Subgrade Drainage Using Geosynthetic Drainage Systems

Improve roadway strength and durability by using geosynthetic drainage blankets between the pavement section and subbase (Figure 1.1.2).

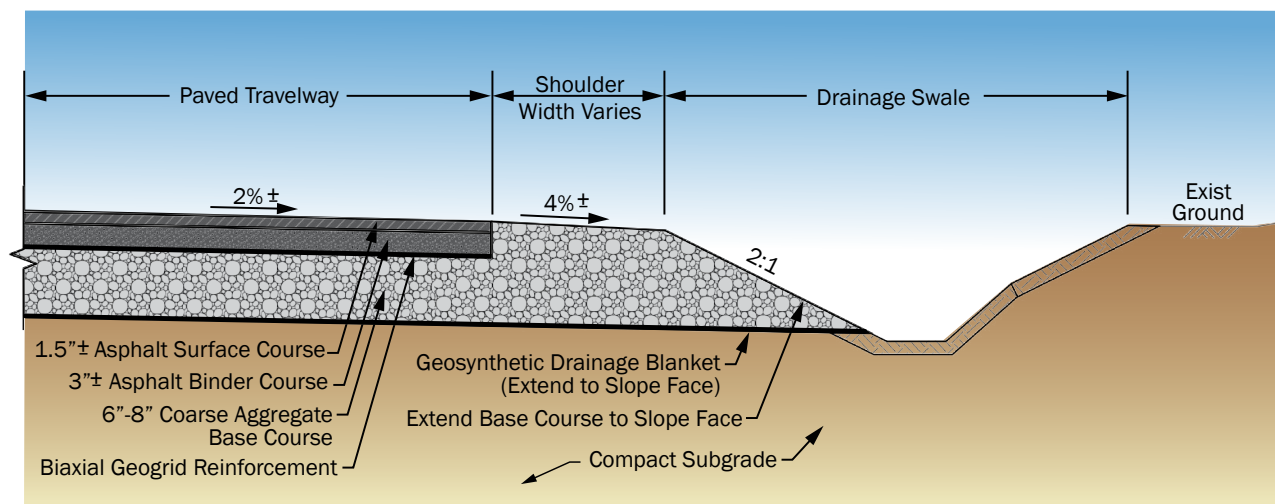

Figure 1.1.2. Geosynthetics can be used to improve drainage and subgrade strength.

When evaluating this option, keep these considerations in mind:

- Use drainage blankets with free-draining base course material or natural subgrade soils.
- Drainage blankets are especially effective at removing water from the pavement section before it weakens the support of the subgrade.
- Not all geosynthetics promote drainage (e.g., some woven geotextiles do not). If a geosynthetic that is not suitable for drainage is used, it should connect to a drain (Figure 1.1.3).

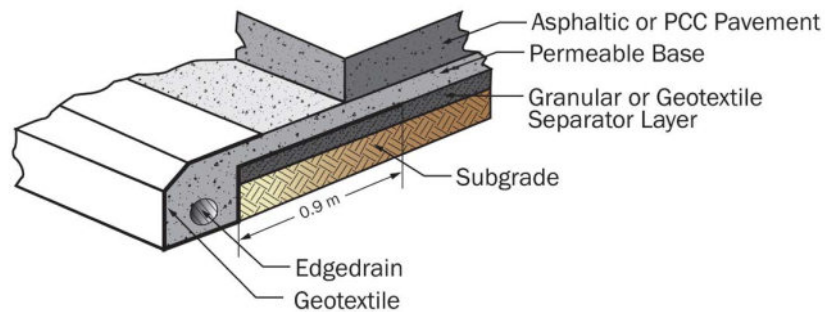

Figure 1.1.3. Geotextiles that do not drain well can be hydraulically connected to a drain.

CONSIDERATIONS:



Option 5: Improve Subgrade Strength Using Geosynthetics

If the road is in an area that naturally has poor subgrade soil support (in a swampland, for instance), place a geosynthetic over the subgrade soil and under the road base material to improve roadway strength.

When evaluating this option, keep these considerations in mind:

- The geosynthetic prevents silt and clay soils in the subgrade from mixing with the more granular base courses, destabilizing the subgrade and interfering with drainage.
- Not all geosynthetics reinforce soil strength. Geotextiles that provide separation and reinforcement functions, such as woven geotextiles, may be appropriate for improving subgrade strength. However, they generally do not drain well. If drainage also is desired, they should connect to a drain.

CONSIDERATIONS:



Mitigation Solution: Reduce Flood Hazard on Roadway

Keeping floodwaters off the roadway surface mitigates roadway surface damage. The following sections present different options to achieve this end.

Option 1: Increase Roadway Elevation

To reduce flooding on a roadway and keep the road in service during a flood, consider increasing the roadway elevation. This may be particularly important for access to critical facilities and to maintain open evacuation routes.

When evaluating this option, keep these considerations in mind:

- Elevate often-flooded sections of roadway above the base flood elevation at a minimum. This may require removing the existing pavement, adding enough material to raise the finished roadway surface above flood elevation, and constructing a new pavement section (Figure 1.1.4).
- Elevating the roadway should be combined with measures to protect the embankment slopes.
- If flood levels often are several feet above the roadway surface, elevating the roadway may not be the best option.
- If elevating the roadway on an embankment creates a dam and raises the flood level upstream, elevate the roadway on piles or add a culvert under the roadway.
- Adding material to a floodplain must be reviewed and approved by the local floodplain manager.

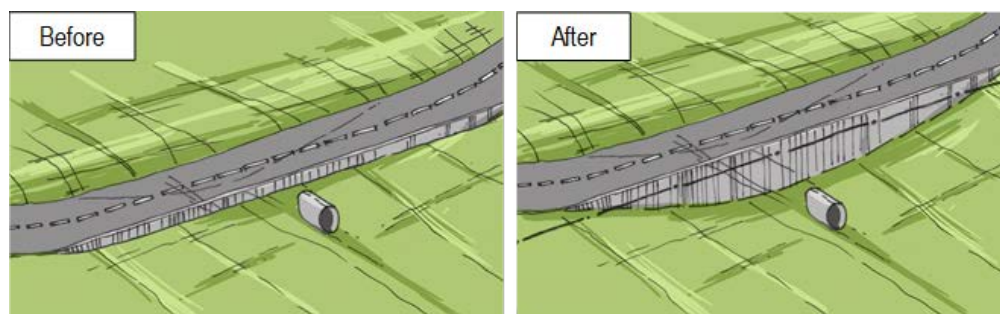

Figure 1.1.4. Increasing the roadway elevation above the base flood elevation

CONSIDERATIONS:



Option 2: Relocate or Reroute Roadway

To reduce flooding on a roadway, consider relocating or rerouting the roadway away from flood-prone areas, areas at risk for landslides, or areas where wave action occurs (Figure 1.1.5).

When evaluating this option, keep these considerations in mind:

- Relocating roadways may be costly.
- This option may be most effective where roads are more-frequently flooded or where a short length of the roadway is flooded.
- The right of way must be available, or land must be acquired to construct a new right of way.
- The relocation might require additional engineering design.
- The relocated roadway must comply with environmental and floodplain management regulations.

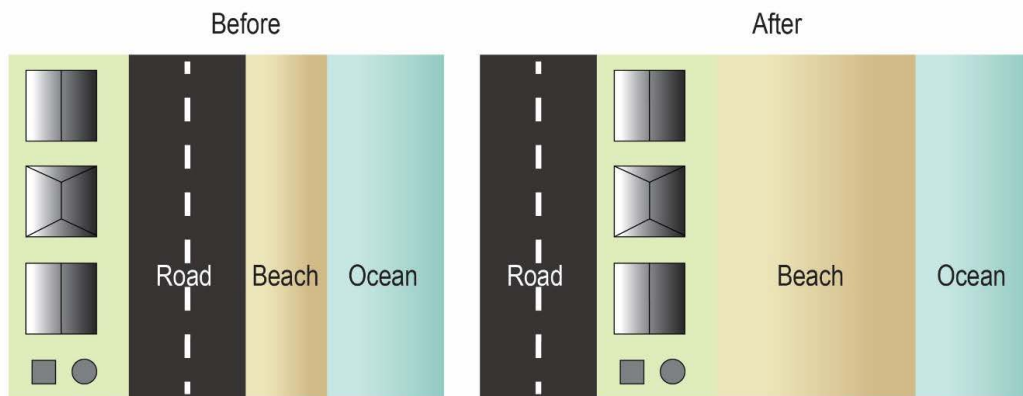

Figure 1.1.5. Relocating the roadway away from the flood source can help protect the road from flooding.

CONSIDERATIONS:



Option 3: Use Permeable Pavement

Permeable pavement combines a porous surface, such as permeable concrete, permeable asphalt, or pavers, with an underlying stone layer (Figure 1.1.6). The permeable pavement catches rainfall or runoff and stores it in the stone layer, slowly allowing the water to soak into the soil below the stone layer or releasing it through a drain.

When evaluating this option, keep these considerations in mind:

- Permeable pavement typically is most suitable for parking lots, roads with low traffic volumes, sidewalks and driveways. Some types also may be suitable for highway shoulders.
- Permeable pavement can filter some pollutants contained in runoff water.
- By controlling the rate of runoff, permeable pavement can help reduce the required size of regional best management practices.
- The thickness of the aggregate base may vary depending on the quantity of rainfall a location typically receives or is expected to receive. Locations with greater rainfall require thicker aggregate bases.
- During winter in cold climates, permeable pavements may resist frost heave better than traditional pavements.
- Maintain permeable pavement regularly to prevent clogging. Maintenance practices may differ from those of traditional pavement; follow manufacturers' instructions for maintenance.
 - In cold climates in winter, less road salt generally is needed than for traditional pavements over the winter season. However, salt application may result in poor performance of concrete porous pavement systems.
 - Sand cannot be used for winter maintenance.



Figure 1.1.6. Permeable pavement includes pavers, permeable concrete, and permeable asphalt (USGS, 2018).

CONSIDERATIONS:

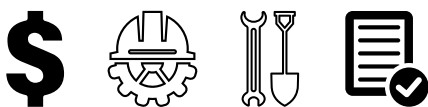

Mitigation Solution: Reduce Frost Heave

Damage from floods to infrastructure, particularly transportation infrastructure, can worsen in the Spring when freeze-thaw cycles coincide with thaw-related flooding. These freeze-thaw cycles often lead to “frost heaves,” where areas of the ground surface appear to push up, resulting in cracking of pavements, misalignments of culverts and other associated damage.

Option 1: Improve Drainage

When roads thaw, layers nearest to the ground surface thaw first, while material deeper in the ground remains frozen. This results in water becoming trapped near the ground surface. If temperatures drop below freezing, this trapped water re-freezes and can cause heaving.

USE FREELY DRAINING SOIL

Under normal freezing conditions, little to no heaving occurs in clean, free-draining sands, gravels, crushed rock and similar granular materials (FHWA, 2017). The large void spaces allow water to travel freely and freeze without forming the ice lenses responsible for frost heaves.

When evaluating this option, keep these considerations in mind:

- Identify frost-susceptible areas:
 - Where frost heaves have been observed
 - Where subgrade soils are likely to include inorganic soils having more than 3% of fine grains
 - Where the water table is within 3 meters (10 feet) of the pavement surface
 - Where water is likely to accumulate beneath the roadway but above the frost depth
- Remove the frost-susceptible soils and replace with freely draining material having less than 3% of fine grains.
- “Rock caps” can help drainage while also providing additional structural stability (Figure 1.1.7). They are made of crushed rock material and may be placed on top of a geotextile where there are fine subgrade soils (Pavement Interactive, 2020).

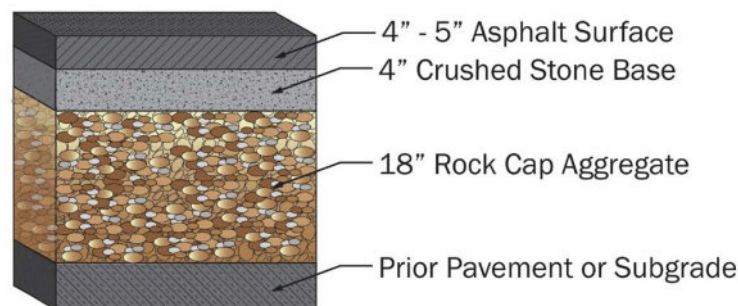

Figure 1.1.7. “Rock caps” can improve both drainage and structural stability of roads susceptible to frost heaves (Yu and Beck, 2009).

INSTALL DRAINAGE

Draining water away from the upper layers of soil beneath the road surface can help to reduce frost heaves.

When evaluating this option, keep these considerations in mind:

- Install deep drains that maintain the water table below the level of the freezing zone.
- Install a capillary barrier to prevent moisture rise in the freezing zone.
 - Capillary barriers are either an open-graded gravel layer between two layers of geotextiles or a horizontal geocomposite drain (FHWA, 2017) (Figure 1.1.8).
 - Capillary barriers should be installed by removing the frost-prone soils to a depth below the frost line to reduce frost heave damage to the road surface. The frost-susceptible soil can be replaced and compacted above the capillary drain to the road surface elevation.
 - The capillary barrier must be hydraulically connected to a drain.

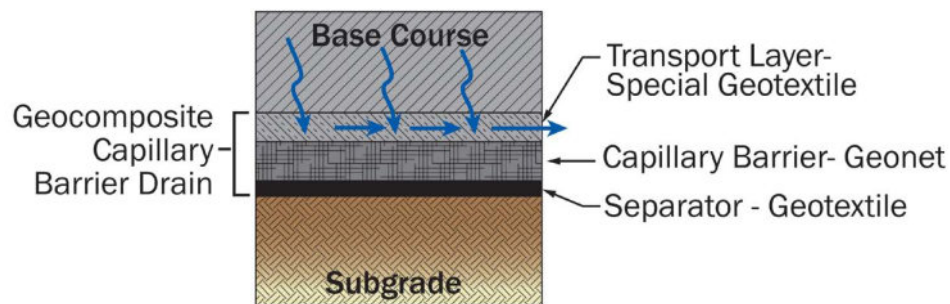

Figure 1.1.8. A capillary barrier can help prevent surfaces from frost heaving (Roberson et al., 2006).

CONSIDERATIONS:



Option 2: Increase Pavement Thickness

In locations where frost heaves occur, road pavement thickness can be increased to help offset the reduction in subgrade strength during the Spring freeze-thaw period (FHWA, 2017). A general rule of thumb is that the pavement thickness should be at least one-half the depth of frost-prone soils.

CONSIDERATIONS:

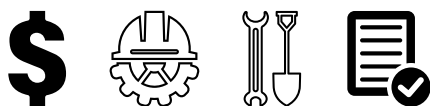

Option 3: Stabilize or Improve Subgrade Soils

Stabilize weak soils by using an admixture to improve strength and decrease or remove passages through which moisture can pass.

When evaluating this option, keep these considerations in mind:

- Mix cementing agents such as Portland cement, lime fly-ash, lime, or bitumen with the weak subgrade soils to bond soil particles together.
- Inject polymers, such as polyurethane, into the subgrade soils (Figure 1.1.9).
 - 5/8-inch holes are drilled through the road surface.
 - The polymer is injected into the soils and flows through the void spaces, expanding to fill the holes.
 - As the polymer expands, it creates a layer of insulation that reduces heat loss and prevents the occurrence of localized freezing.

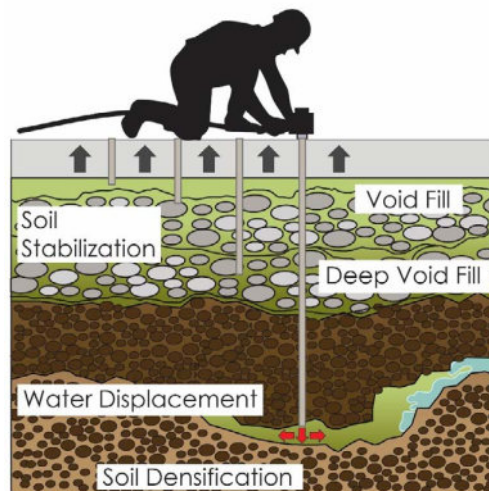

Figure 1.1.9. Improve subgrade soils by injecting a polymer into the soil to fill voids (Source: Fakhar and Asmaniza, 2016).

CONSIDERATIONS:



REFERENCES:

Detailed technical information on road and highway surface mitigation methods, considerations, and general design practices can be found in these publications:

- Concrete Network.com. 2020. Frost Heave and Foundations. Available at: https://www.concretenetwork.com/concrete/frost_protected_shallow_foundings/frost_actions_and_foundations.htm
- Concrete Stabilization Technologies, Inc. 2020. Frost Heave Mitigation. Available at: <https://cststabilization.com/frost-heave-mitigation/>
- Edgar, T., C. Potter, and R. Mathis. 2015. "Frost Heave Mitigation Using Polymer Injection and Frost Depth Prediction." 16th International Conference on Cold Regions Engineering. Available at: <https://ascelibrary.org/doi/10.1061/9780784479315.037>.
- Fakhar, A. and A. Asmaniza. 2016. "Road Maintenance Experience Using Polyurethane (PU) Foam Injection System and Geogrete Soil Stabilization as Ground Rehabilitation." IOP Conference Series: Materials Science and Engineering, Vol. 136. Available at: <https://iopscience.iop.org/article/10.1088/1757-899X/136/1/012004>
- Federal Emergency Management Agency (FEMA). 2001. *Flood Hazard Mitigation Handbook for Public Facilities*. Available at: <https://www.hsdl.org/?abstract&did=34754#:~:text=This%20Flood%20Hazard%20Mitigation%20Handbook,and%20mitigation%20ideas%20for%20local>
- FEMA. 2005. *Hurricane Mitigation: A Handbook for Public Facilities*. Available at: <https://www.hsdl.org/?abstract&did=34831>
- FEMA. 2010. FEMA B-797, Hazard Mitigation Field Book, Roadways. Available at: https://www.fema.gov/sites/default/files/2020-07/b797_hazmit_handbook.pdf
- Federal Highway Administration (FHWA). 1995, revised 1998. Geosynthetic Design and Construction Guidelines, FHWA-HI-95-038. Available at: <https://www.fhwa.dot.gov/engineering/geotech/pubs/O11431.pdf>
- FHWA. 2015. Gravel Roads Construction & Maintenance Guide. Available at: <https://www.fhwa.dot.gov/construction/pubs/ots15002.pdf>
- FHWA. 2017. Geotechnical Aspects of Pavements Reference Manual, Chapter 7.0 Design Details and Construction Conditions Requiring Special Design Attention. Available at: <https://www.fhwa.dot.gov/engineering/geotech/pubs/05037/>
- FHWA. 2020. Department of Transportation Master Site to All State Standard Drawings. Available at: <https://flh.fhwa.dot.gov/resources/standard/state.htm>
- Pavement Interactive. 2020. Reference Desk: Frost Action Mitigation. Available at: <https://pavementinteractive.org/reference-desk/design/design-parameters/frost-action-mitigation/>
- Roberson, R., et al. 2006. NCHRP Report No. 113 Geocomposite Capillary Barrier Drain (GCBD) for Limiting Moisture Changes in Pavements. Available at: http://onlinepubs.trb.org/onlinepubs/archive/studies/idea/finalreports/highway/NCHRP113_Final_Report.pdf
- Stitchdiary. December 12, 2018. "5 Facts You Need to Know About Geotextiles." Available at: <https://medium.com/@stitchdiary/5-facts-you-need-to-know-about-geotextiles-46984cce506e>

U.S. Geological Survey. 2018. Scientific Investigations Report 2018-5037 Hydraulic, Water-Quality, and Temperature Performance of Three Types of Permeable Pavement under High Sediment Loading Conditions. Available at: <https://pubs.usgs.gov/sir/2018/5037/sir20185037.pdf>

Yu, X., and R. Beck. 2009. FHWA Report No. OH-2009/4 The Performance and Economic Benefits of Thick Granular Base for Flexible Pavement Design in Ohio. Available at: <http://worldcat.org/arcviewer/2/OHI/2009/08/18/H1250610088170/viewer/file1.pdf>

Fact Sheet 1.2: Road Shoulders and Embankments

The mitigation objective of this Fact Sheet is to protect the roadway by stabilizing the road shoulder or the road embankment to reduce the likelihood of damage from erosion and scour during or after a flood. Road shoulders provide side support to the traveled section of the roadway and prevent the road edge from washing out. A loss of side support can result in a washout and make it impossible for the roadway to support traffic. These techniques also can help improve the stability of slopes on the sides of roadways.

Damages to roadways and embankments can be mitigated by:

- Hardening the shoulder by placing asphalt or compacted gravel to protect it from erosion;
- Increasing the volume of water ditches can carry and slowing the water velocity; and
- Protecting embankment slopes from erosion and scour.

Table 1.2.1 summarizes some common mitigation strategies to reduce the likelihood of damage to shoulders and embankments caused by floods and hurricanes. While these strategies generally are stand-alone, they also can be combined with strategies from other fact sheets to achieve the desired result. Also, see Fact Sheet 5.3, *Earth Slope Stabilization*, for other slope mitigation ideas.



Table 1.2.1. Common Mitigation Solutions for Road Shoulders and Embankments

<i>Solutions and Options</i>	<i>Erosion and Scour</i>	<i>Inundation</i>
Mitigation Solution: Protect Shoulders		
Option 1: Harden the Shoulder Surface	✓	
Option 2: Use Mechanical Soil Stabilization	✓	
Option 3: Use Chemical Soil Stabilization	✓	
Mitigation Solution: Protect Embankment Slopes		
Option 1: Use Riprap for Slope Protection	✓	
Option 2: Use Bioengineered Slope Protection	✓	
Option 3: Install Spillways	✓	✓
Option 4: Construct a Wall	✓	✓
Option 5: Change the Geometry of the Roadway	✓	✓

Mitigation Solution: Protect Shoulders

Stabilize exposed soils on shoulders to reduce the likelihood of damage from erosion and scour. Road shoulders typically are natural earth from the area, graded materials, or graded materials stabilized with a binding agent. The shoulder surface may be bare of plants or may include a low-maintenance ground cover. Generally, the slope is shallow. Exposed soils are vulnerable to erosion. Mitigation solutions harden the shoulder surface and stabilize the exposed soils.

Option 1: Harden the Shoulder Surface

When subjected to low-velocity flows, finer-grain materials may wash away while stones and larger-grain (coarse) materials will stay in place. This leaves the shoulder vulnerable to damage. Harden the shoulder surface by placing and compacting additional material.

When evaluating this option, keep these considerations in mind:

- Add structural protection to soil shoulders by placing a layer of clean gravel or crushed stone that meets state or local DOT specifications.
- Better protect the finer materials by adding a layer of gravel to the shoulder surface. The surface will remain more uniform.

CONSIDERATIONS:



Option 2: Use Mechanical Soil Stabilization

Use mechanical methods—geosynthetics or walls—to stabilize exposed soils on shoulders, reducing the likelihood of damage from erosion and scour.

When evaluating this option, keep these considerations in mind:

- Where shoulders are exposed to overflow from nearby water sources, stabilize them by using geosynthetics and revetments (Figure 1.2.1).
- Include geotextile fabric under riprap stones to stabilize slopes or use geogrid reinforcement under the soil to shore up shoulders.

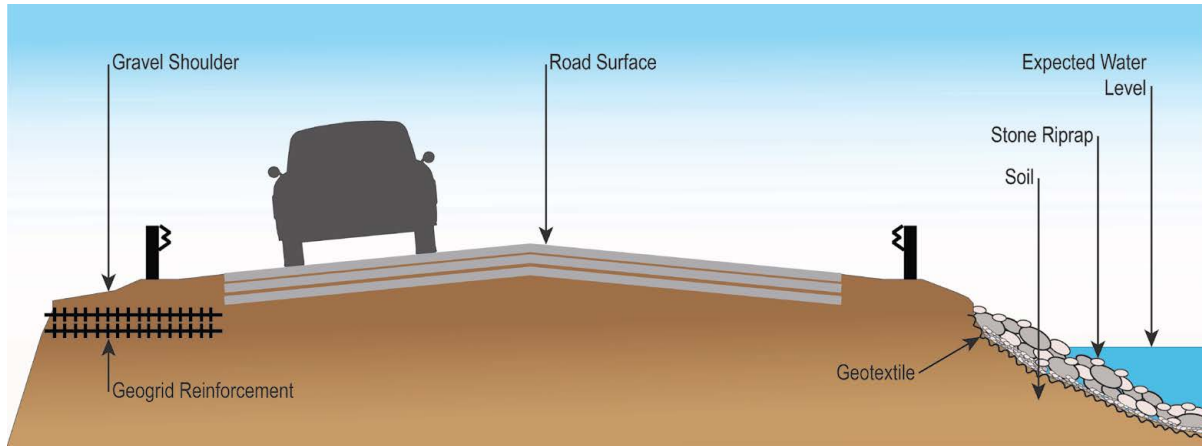

Figure 1.2.1. Geosynthetics can be used to stabilize roadways.

CONSIDERATIONS:



Option 3: Use Chemical Soil Stabilization

Chemical stabilization is done by mixing bonding agents with the shoulder soil. This method can be effective in mitigating damage from erosion caused by low-velocity flows. Some commonly used chemical stabilizers are lime, fly ash, and Portland cement.

When evaluating this option, keep these considerations in mind:

- Chemical stabilization methods require site-specific design analysis and construction methods.
- It is critical to develop an appropriate mix for stabilization agents.
- Especially when using lime, the effectiveness of chemical stabilization can degrade over time due to the leaching of the chemical additive.
- Chemical stabilization can be costly.

CONSIDERATIONS:



Mitigation Solution: Protect Embankment Slopes

The objective of slope protection mitigation is to improve the embankment slope stability or redirect higher-velocity flows to avoid erosion. Embankments provide stability to the roadway. When erosion channels form in embankments, water can infiltrate the road base and subgrade. Washouts and scour can destabilize the road, making it impossible for the road to support traffic. In some cases, a geotechnical analysis is needed to identify the best methods of mitigation.

Option 1: Use Riprap for Slope Protection

Erosion of road slopes next to streams can be reduced by protecting the embankment with a layer of riprap, which is made of large stones, rocks, or manufactured materials that are heavy enough to resist erosion and disburse the energy of higher-velocity stream flow (Figure 1.2.2).

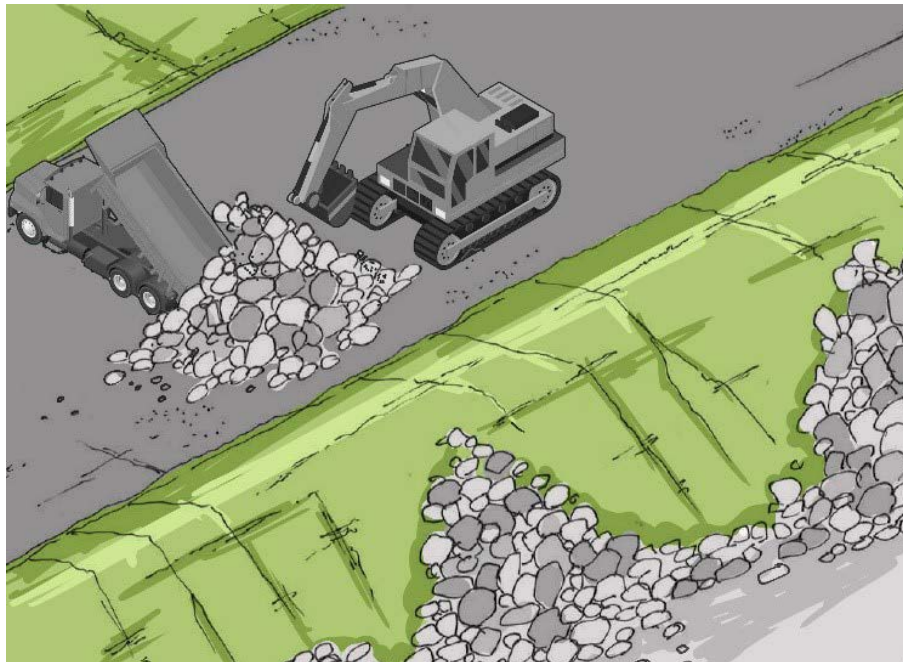

Figure 1.2.2. Riprap can help reduce erosion of roadway slopes adjacent to streams.

When evaluating this option, keep these considerations in mind:

- Riprap is not effective for very steep slopes. Place it on a slope with an angle no greater than one unit vertical to two units horizontal (1V:2H).
- Support riprap at the bottom of the embankment (called the toe) to prevent slumping or toe failure.
- Enhance the effectiveness of this method by installing the riprap over a layer of geosynthetic erosion fabric.
- Place appropriately sized riprap along the embankment slope in large enough quantities to prevent scouring and protect the embankment slope from future flood damage.

- The water velocity will determine the size and volume of the riprap needed.
- Riprap may prevent plant growth in nearby wetlands and on streambanks. Woody cuttings and living branch bundles (i.e., live stakes and fascines) can be placed between the riprap to increase plant growth.

CONSIDERATIONS:**Option 2: Use Bioengineered Slope Protection**

Provide bioengineered embankment slope protection by covering the slope with deep-rooting vegetation (Figure 1.2.3).

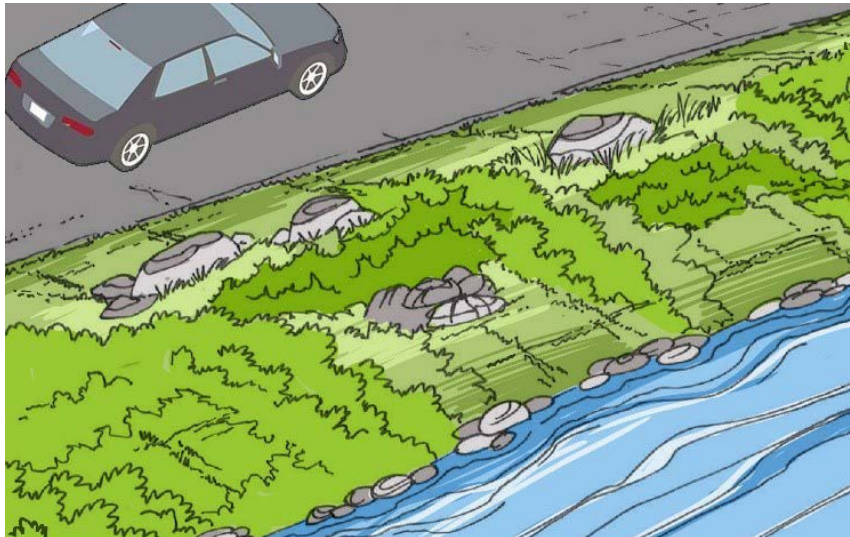

Figure 1.2.3. Bioengineered slopes can protect against erosion.

When evaluating this option, keep these considerations in mind:

- Bioengineered slope protection projects generally are most effective when the plants' establishment takes place over several years, where high water velocities and high flow levels are not likely to uproot plantings and where animals are not likely to graze.
- Carefully selected grasses, shrubs and other ground covers can be effective in reducing soil erosion.
- The selection and design of bioengineered embankment protection should consider the steepness of the embankment, the expected water flow rates, and the growing season of the vegetation.
- Where an embankment is next to and in contact with a live stream, strategically attach large woody parts of plants (i.e., root wads) at outer bends of streams to hold the soil in place and protect it from erosion.

CONSIDERATIONS:**Option 3: Install Spillways**

Concentrate flows in a collection structure and install half-round, or spillway, pipes or rock channels down steep slopes to eliminate erosion (Figure 1.2.4).

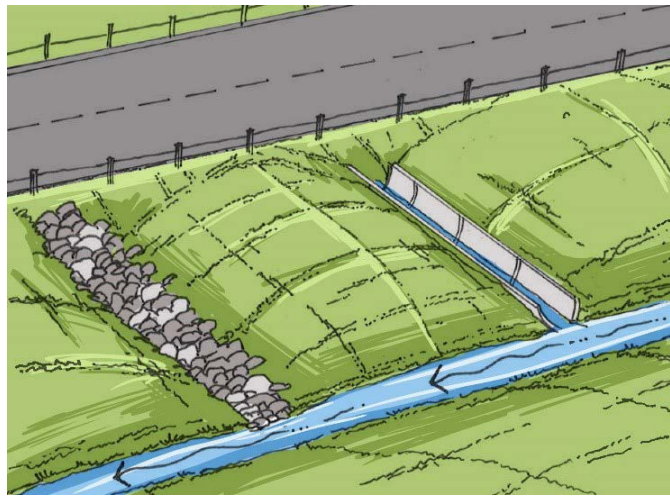

Figure 1.2.4. Spillways can concentrate flows at selected locations to help control erosion.

When evaluating this option, keep these considerations in mind:

- This measure is most effective for intermittent streams or surface water collection. It is very effective when the pipes connect to drainage collection structures or roadway ditches.
- Adding an energy dissipater at the bottom of the slope also will help reduce erosion.

CONSIDERATIONS:

Option 4: Construct a Wall

Construct a wall to protect the slope from erosion, sloughing and slumping. Walls can be constructed of various materials, including rock, gabion baskets (wire cages filled with stone), sheet piles (interlocking sections of wall material), concrete, etc. (Figure 1.2.5).

When evaluating this option, keep these considerations in mind:

- This measure is suitable for areas where there are high-velocity, high-volume flood events.
- Building a wall may prevent the regrowth of riparian areas.

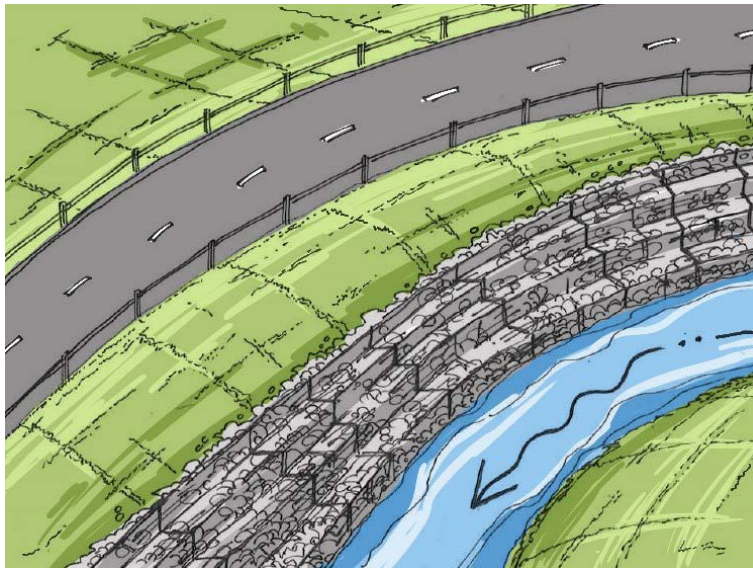

Figure 1.2.5. A wall constructed of gabion baskets protects the toe of the slope.

CONSIDERATIONS:



Option 5: Change the Geometry of the Roadway

Adjust the angle of an embankment slope by rounding and slope reduction to lessen erosion (Figure 1.2.6).

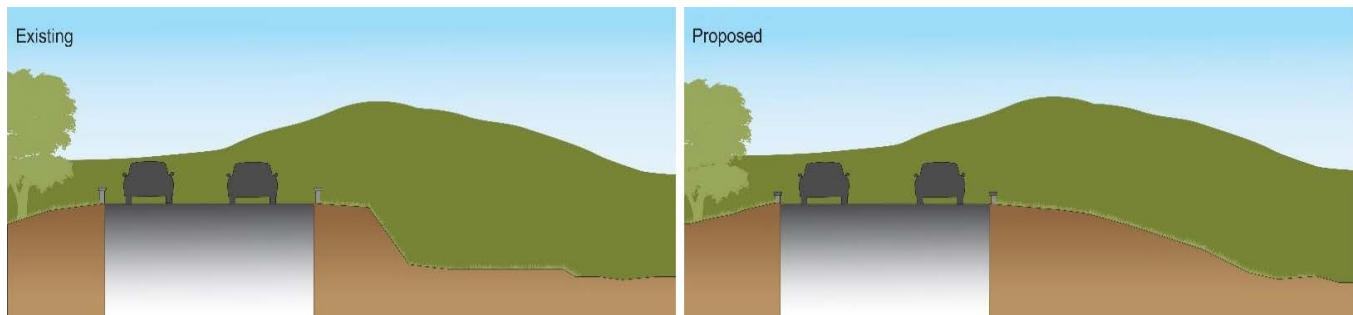

Figure 1.2.6. Changing slope geometry to a more gradual slope can reduce erosion.

When evaluating this option, keep these considerations in mind:

- Reducing the embankment's angle generally reduces the velocity of the water running across the roadway and down the slope.
- If drainage ditch dimensions are changed by modifying a slope, the amount of water the ditch can carry may be impacted.
- This mitigation is most effective in areas of road flooding with low-velocity flows and where the new geometry provides the same or increased drainage capacity compared with the old design.

CONSIDERATIONS:



REFERENCES:

Detailed technical information on shoulder and embankment mitigation methods, considerations, and general design practices can be found in these publications:

Federal Emergency Management Agency (FEMA). 2001. *Flood Hazard Mitigation Handbook for Public Facilities*. Available at: <https://www.hSDL.org/?abstract&did=34754#:~:text=This%20Flood%20Hazard%20Mitigation%20Handbook,and%20mitigation%20ideas%20for%20local>

FEMA. 2005. *Hurricane Mitigation: A Handbook for Public Facilities*. Available at: <https://www.hSDL.org/?abstract&did=34831>

FEMA. 2007. *Engineering with Nature: Alternative Techniques to Riprap Bank Stabilization*. Available at: https://www.fema.gov/pdf/about/regions/regionx/Engineering_With_Nature_Web.pdf

FEMA. 2010. FEMA B-797, *Hazard Mitigation Field Book, Roadways*. Available at: https://www.fema.gov/sites/default/files/2020-07/b797_hazmit_handbook.pdf

FEMA. 2010. FEMA P-679, *Technical Manual: Outlet Works Energy Dissipators*. Available at: https://www.dwr.nd.gov/pdfs/energy_dissipators.pdf

Federal Highway Administration (FHWA). 1995, revised 1998. *Geosynthetic Design and Construction Guidelines, FHWA-HI-95-038*. Available at: <https://www.fhwa.dot.gov/engineering/geotech/pubs/011431.pdf>

FHWA. 2001, revised 2005. *Hydraulic Design of Highway Culverts, Hydraulic Design Series No. 5, FHWA-NHI-01-020*. Available at: <https://www.fhwa.dot.gov/engineering/hydraulics/pubs/12026/hif12026.pdf>

FHWA. 2020. *Department of Transportation Master Site to All State Standard Drawings*. Available at: <https://fh.fhwa.dot.gov/resources/standard/state.htm>

Fact Sheet 1.3: Drainage and Culverts

The mitigation objective of this Fact Sheet is to reduce roadway flooding and erosion that occur when the capacity, alignment or operation of roadway drainage structures become overwhelmed or fail.

Choosing a solution for drainage issues requires that you determine the cause of the damage since different causes require different mitigation solutions. Studies, such as hydrologic and hydraulic (H&H) analyses, help determine the scale of the solution and the upstream and downstream effects of the solution. The most common drainage issues for roadways include:

- **Insufficient capacity.** High water levels from storm surge or heavy rains may exceed the capacity of ditches or culverts. Roadway flooding may cause the road shoulder to be damaged or the embankment through which the culvert passes to be damaged.
- **High-velocity flows.** Turbulence at the culvert inlet and outlet can cause scour and erosion. Floodwaters or storm surge action also can scour roadway ditches and drainage structures.
- **Debris impact and plugging.** Floodwater often carries debris, which can become caught or wedged in ditches and culverts as the water rises or recedes. Sediment and debris in culverts and drainage structures will reduce flow. Lodged debris can interfere with the flow of water, and floating debris also can cause damage to road and highway structures.

Table 1.3.1 summarizes some common mitigation strategies to reduce the likelihood of damage to roadway drainage structures caused by floods and hurricanes. While these strategies generally are stand-alone, they may be combined with methods from other fact sheets to reach a desired result.



Table 1.3.1. Road Culvert and Drainage Mitigation Solutions

Solutions and Options	Erosion and Scour	Inundation and Washout	Debris Impacts and Plugging
Mitigation Solution: Increase Design Capacity			
Option 1: Increase Ditch Capacity	✓	✓	✓
Option 2: Replace a Culvert with a Box or Arch Culvert	✓	✓	✓
Option 3: Replace a Culvert with a Bridge	✓	✓	✓
Option 4: Add Pipe Culverts	✓	✓	✓
Mitigation Solution: Reduce Embankment Erosion			
Option 1: Shape Culvert Entrance	✓	✓	
Option 2: Construct a Cutoff Wall	✓	✓	
Option 3: Install Appropriate Culvert End Sections	✓	✓	
Option 4: Install Lining in the Ditch	✓	✓	
Option 5: Install Check Dams	✓	✓	
Option 6: Construct an Energy Dissipater	✓	✓	
Mitigation Solution: Improve Alignment			
Option 1: Realign Culvert	✓	✓	✓
Option 2: Install Approach Berms	✓	✓	
Option 3: Install Flow Diverters	✓	✓	
Option 4: Install Additional Culverts	✓	✓	
Option 5: Realign the Stream Channel	✓	✓	
Mitigation Solution: Reduce Obstructions			
Option 1: Install an Entrance Debris Barrier	✓		✓
Option 2: Install a Sediment Catch Basin Upstream			✓
Option 3: Install a Relief Culvert	✓	✓	✓
Mitigation Solution: Relocate or Replace with Water Crossing			
Option 1: Relocate Culvert	✓	✓	
Option 2: Add a Low Water Crossing	✓		
Option 3: Add a High-Water Overflow Crossing	✓		

Refer to the culvert diagram, below, for an illustration of components of the system (Figure 1.3.1).

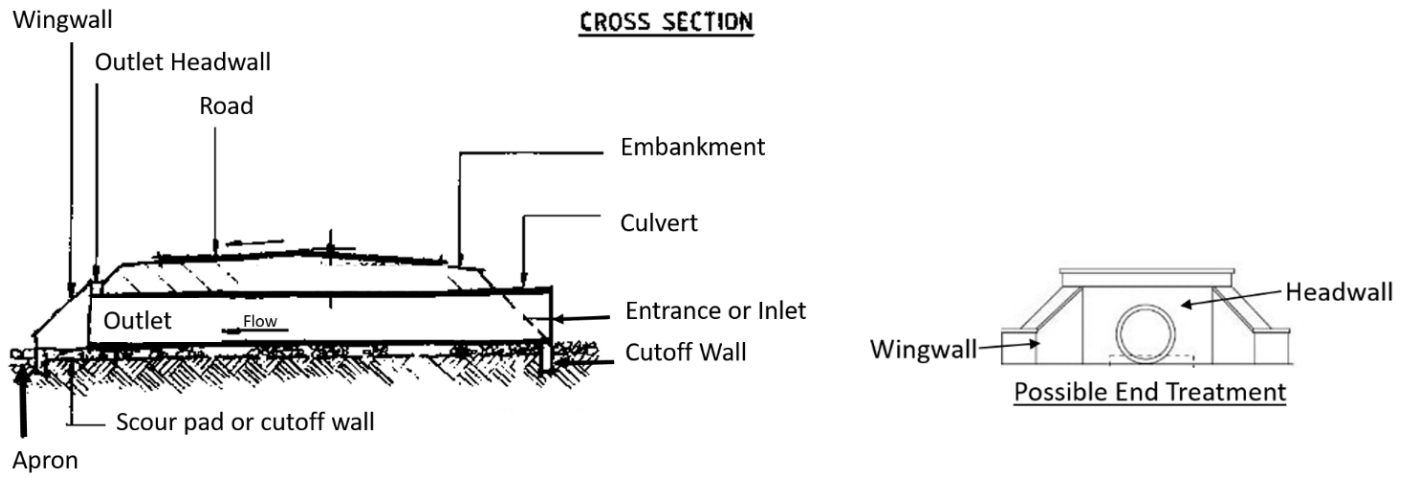

Figure 1.3.1. Components of a culvert.

Mitigation Solution: Increase Design Capacity

Damage to or failure of drainage structures can occur from flooding across the roadway caused by inadequate culvert capacity or ineffective end sections, which leads to embankment erosion. Figure 1.3.2 shows example cross-sections for different types of drainage structures.

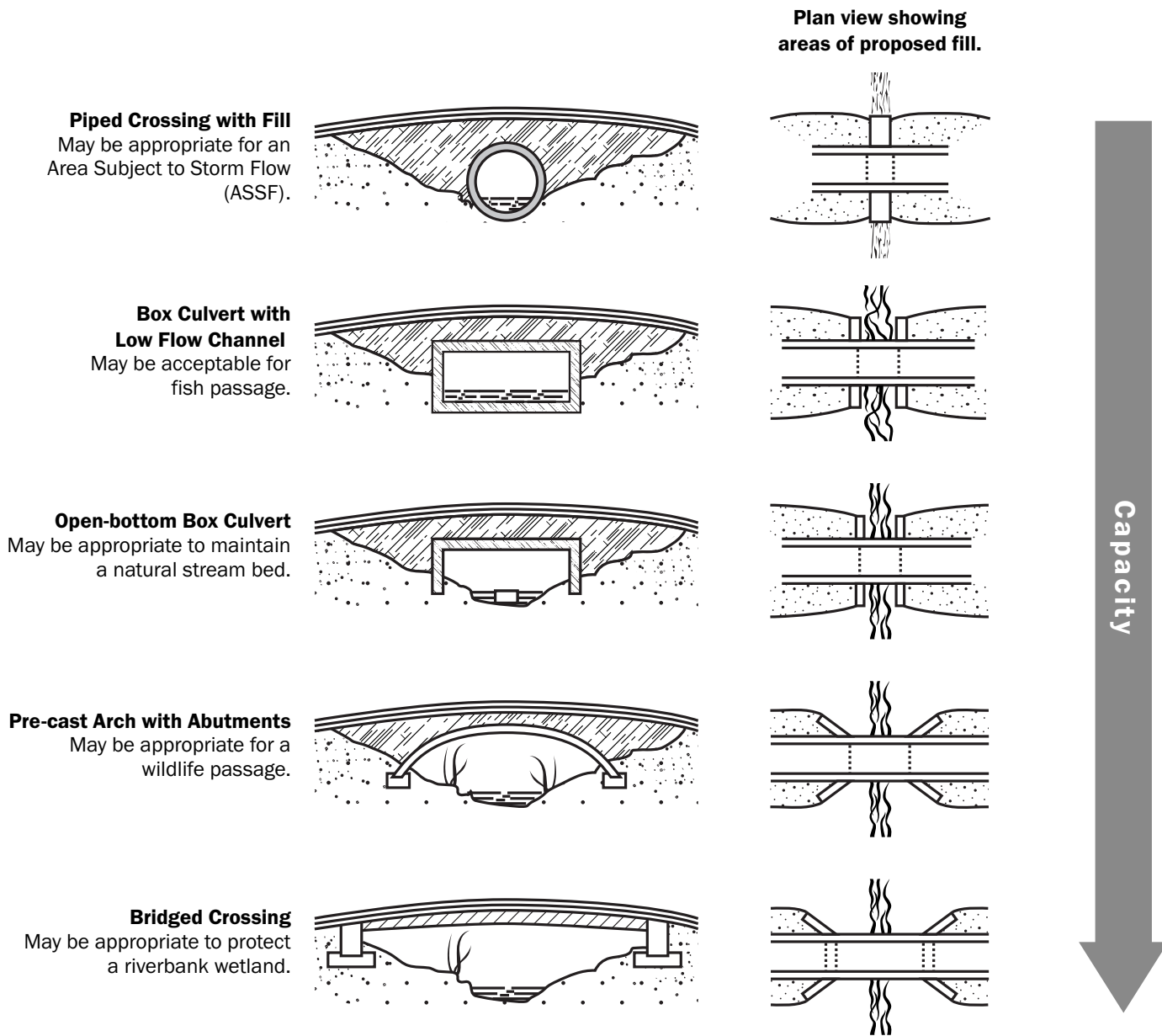

Figure 1.3.2. Alternative stream crossing designs.

The following considerations apply to all the options that follow:

- The capacity of a culvert, channel or stream is a function of the cross-sectional area and the water velocity.
- Erosion and scour are a function of the water velocity and soil characteristics.
- Enlarging the cross-sectional area can decrease water velocities and reduce erosion and scour. Still, it may mean more structural support is necessary.
- Many states have adopted stream crossing standards to balance ecological and wildlife habitat needs in and around the stream with the needs of road users. Always consult state standards for specific requirements.

Option 1: Increase Ditch Capacity

Reducing overflow and overland flooding increases the ditch capacity by increasing the ditch depth or width (Figure 1.3.3).

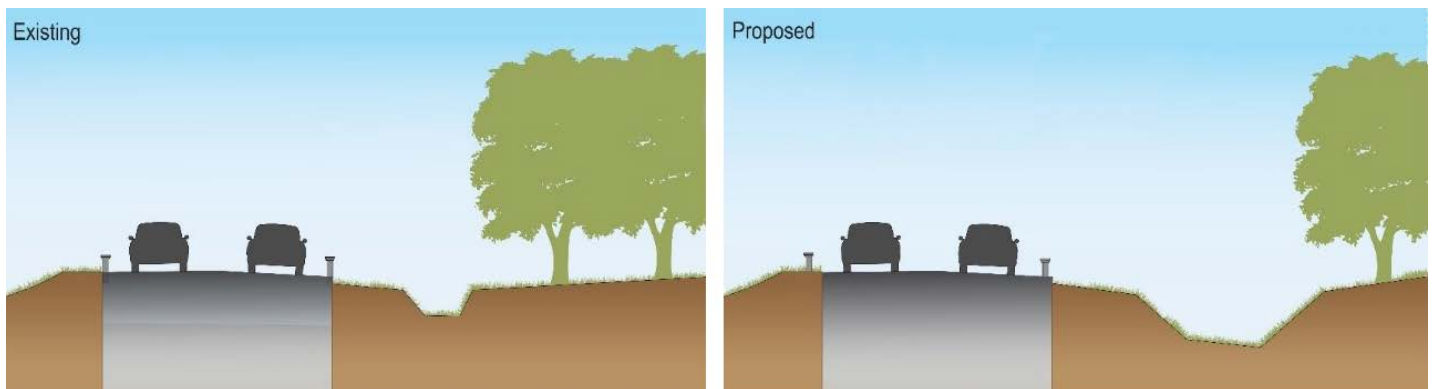
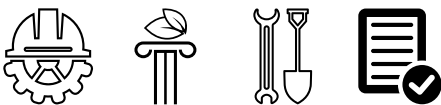

Figure 1.3.3. Increasing ditch capacity can help protect against overland flooding.

CONSIDERATIONS:



Option 2: Replace a Culvert with a Box or Arch Culvert

A box or arch culvert provides additional capacity in low fill situations. A box or arch culvert can be designed for very minimal fill height (Figure 1.3.4).

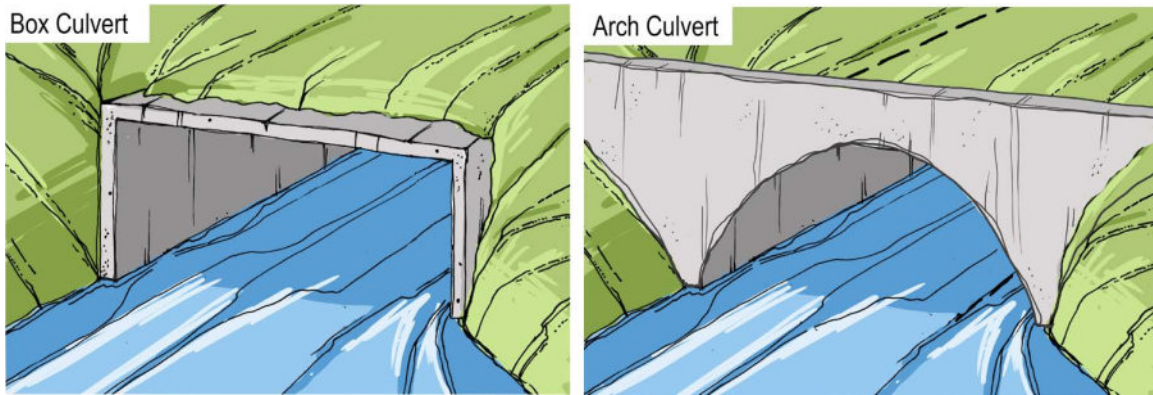

Figure 1.3.4. An arch culvert or a box culvert can provide increased flow capacity.

CONSIDERATIONS:



Option 3: Replace a Culvert with a Bridge

Whether the land upstream of the culvert has significant development or there are habitat reasons to protect the stream bed, replacing a culvert with a bridge may be appropriate (Figure 1.3.5).

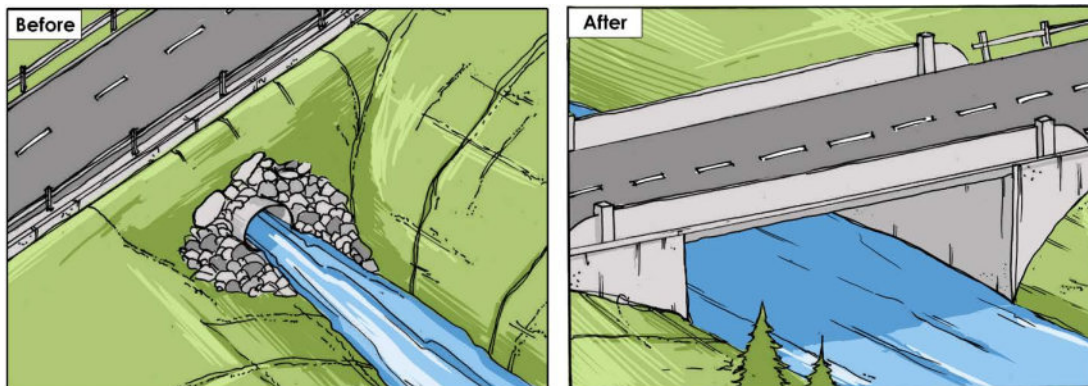

Figure 1.3.5. Replacing a culvert with a bridge can protect the stream bed and the road.

CONSIDERATIONS:



Option 4: Add Pipe Culverts

Multiple culverts may be the best choice when using a single, larger pipe is too costly or when site constraints, such as how deep the pipe must be covered, require a smaller pipe size. Multiple culverts also may be more suitable than a single, large-diameter culvert pipe for low fill areas.

Install additional culverts, along with the existing culvert, at either the same level or—to minimize sediment buildup—at differing elevations (Figure 1.3.6).

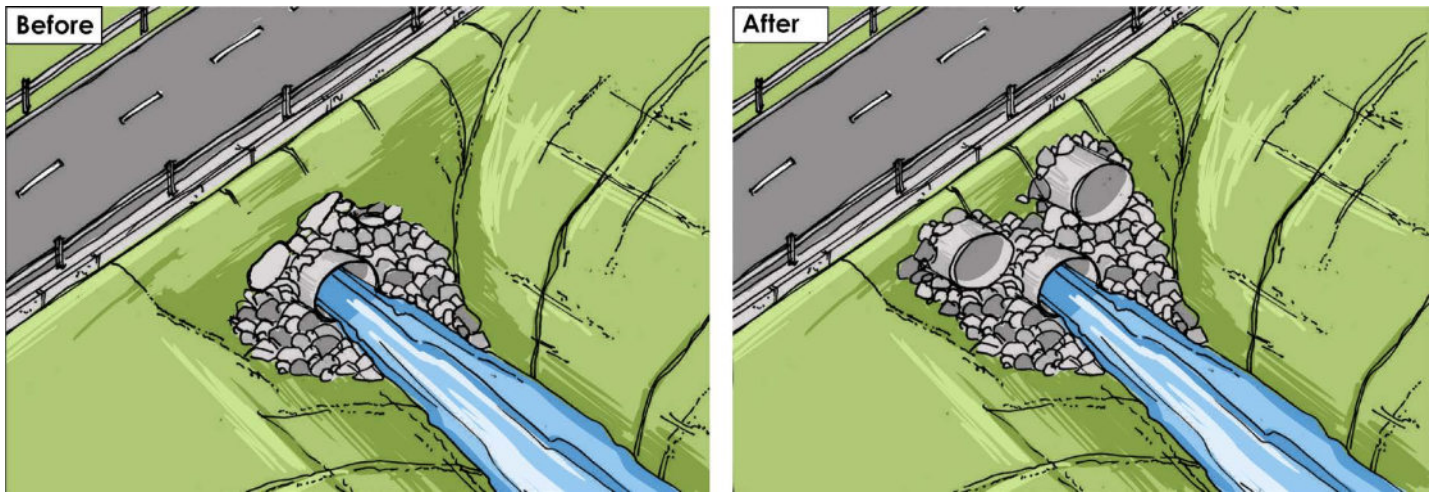

Figure 1.3.6. Installing multiple culverts can increase flow capacity.

CONSIDERATIONS:



Mitigation Solution: Reduce Embankment Erosion

Embankment erosion may be a result of inadequate culvert end sections.

Option 1: Shape Culvert Entrance

Shaping the culvert entrance is most effective for large culverts and moderately effective for small culverts. It is crucial to prevent undermining at the culvert entrance. To do this, shape the culvert entrance to match the embankment slope or stream path by beveling or skewing the entrance (Figure 1.3.7). Turbulence at the entrance and through the culvert will be lessened, which reduces bank erosion, and culvert efficiency will increase.

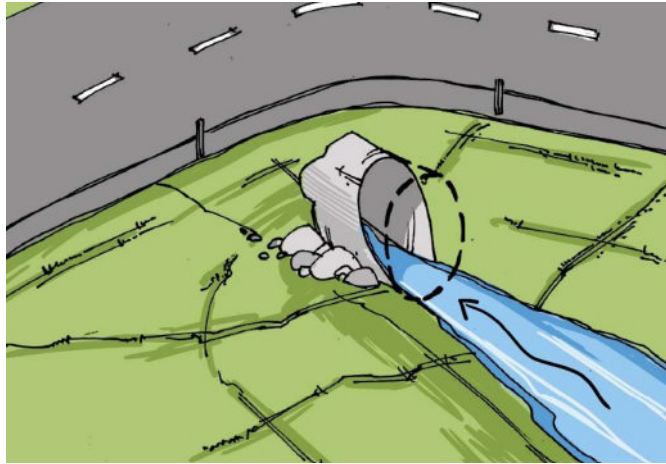

Figure 1.3.7. Shaping the culvert entrance can reduce erosion at the intake.

CONSIDERATIONS:



Option 2: Construct a Cutoff Wall

This mitigation measure is most effective for large culverts. Install a low-height steel sheet pile or concrete cutoff wall to reduce undermining or erosion at the culvert entrance (Figure 1.3.8). Cutoff walls should extend below the culvert entrance to at least one and a half times the culvert diameter.

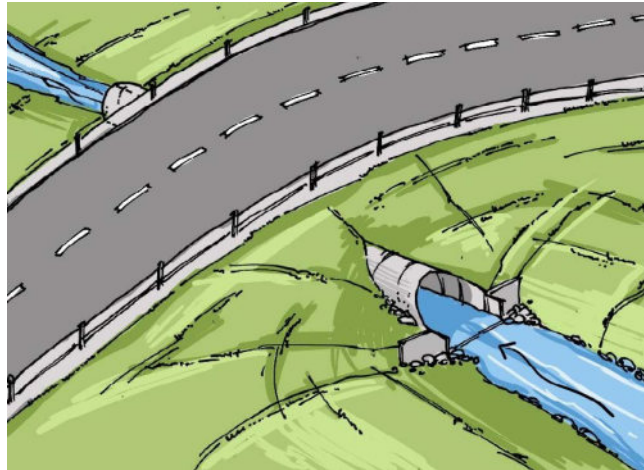

Figure 1.3.8. A cutoff wall can reduce undermining.

CONSIDERATIONS:



Option 3: Install Appropriate Culvert End Sections

To direct flow into and out of the culvert and protect embankment slopes at the culvert entrance and exit, install endwalls, wingwalls or flared end sections (Figure 1.3.9).

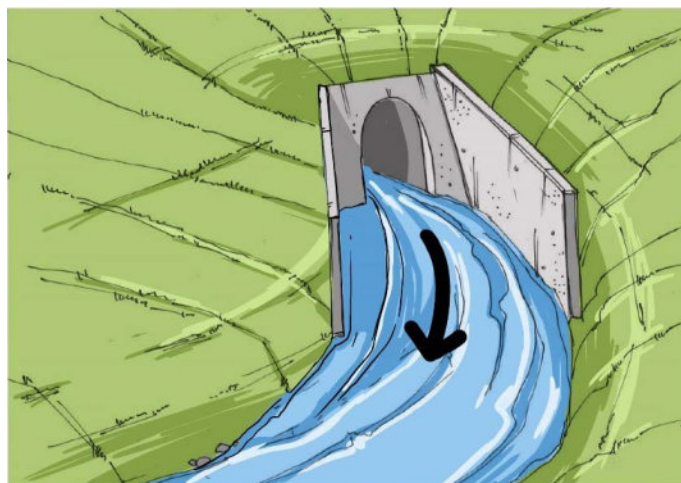
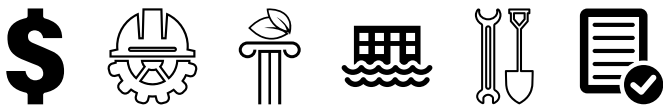

Figure 1.3.9. Wingwalls, headwalls and endwalls can protect embankment slopes.

When evaluating this option, keep these considerations in mind:

- Use straight or “U”-shaped endwalls, headwalls or flared wingwalls when the centerline of the stream aligns with the culvert.
- Use “U”-shaped endwalls, headwalls or wingwalls when an abrupt change in flow direction is necessary.
- Construct an “L”-shaped headwall to redirect the flow to the angle of the culvert.
- Wingwalls are preferred when flow volumes and velocities are high and for culvert pipes that are 36 inches or larger.
- Straight headwalls may decrease culvert capacities but rounding the entrance corners may offset any capacity decrease.
- If stream velocities are high, scour of embankment sides may result from eddies at the culvert end sections.
- Attaching fabricated flared end sections to culvert entrances and outlets may cause the culvert joints to separate if the culvert cannot support additional weight.

CONSIDERATIONS:



Option 4: Install Lining in the Ditch

Lining the ditch with rock, matting, asphalt or vegetation can help to reduce ditch erosion from high-velocity and high-volume flood flows (Figure 1.3.10).

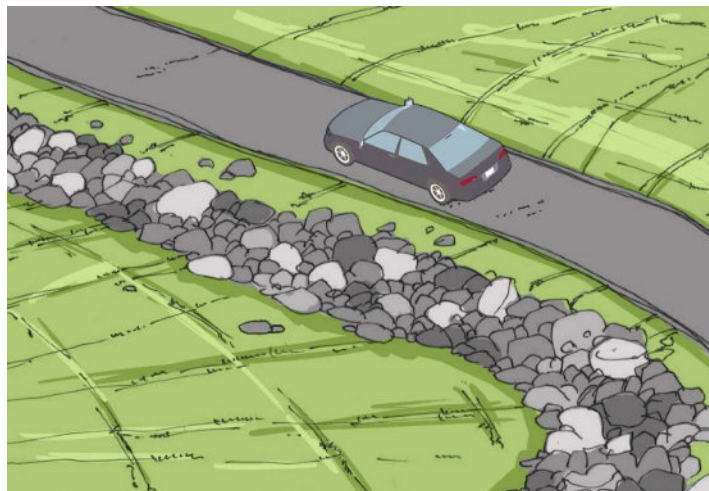

Figure 1.3.10. Ditch lining can reduce erosion and improve flow capacity.

When evaluating this option, keep these considerations in mind:

- Larger and coarser-grained materials will protect against high-velocity flows.
- Grass-lined ditches provide bio infiltration and sediment reduction. However, grass linings require time to become established before they are fully effective.
- Concrete-lined ditches increase the velocity of runoff flows. Asphalt and concrete with high lime contents may not be appropriate because the water may leach the lime from the liner, which can cause water quality issues.

CONSIDERATIONS:



Option 5: Install Check Dams

Install low-height barriers (check dams) to slow stormwater flow and reduce scouring and erosion from the flow (Figure 1.3.11).

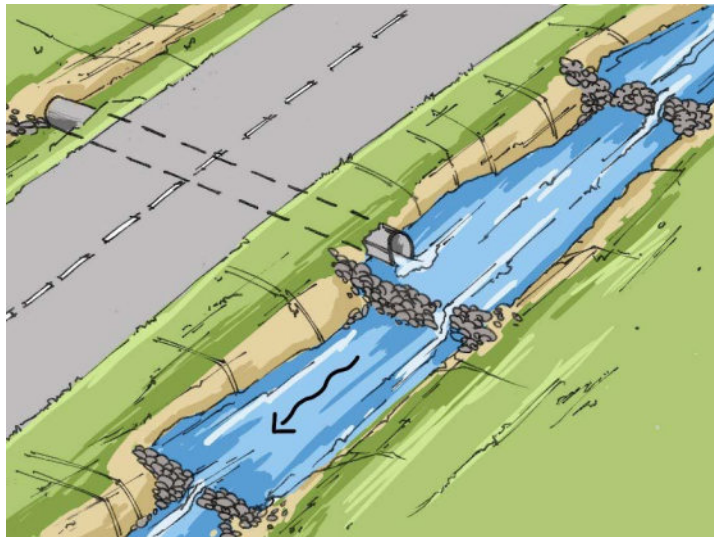

Figure 1.3.11. Check dams help slow water and decrease scouring.

When evaluating this option, keep these considerations in mind:

- Properly installed check dams will slow the water flow, trap a portion of the bed load, and allow the settling of a portion of the suspended sediments. Each of these impacts can reduce potential downstream erosion.
- Check dams, usually made of quarried stone, are suitable for small streams and artificial drainage channels.
- This measure may work best for temporary erosion and silt control. Check dams in locations not easily accessed by equipment may be difficult to maintain.

CONSIDERATIONS:**Option 6: Construct an Energy Dissipater**

Mitigate erosion and scour at the culvert exit with energy dissipation, which uses structures placed in the stream or waterway to reduce the velocity of the flow (Figure 1.3.12). General types of energy dissipation measures include:

- An apron, which is a hardened surface such as concrete or grouted riprap, at the culvert exit, which reduces turbulent flow that can scour the toe of the embankment or undermine the culvert;
- Baffle structures, which are used to shift the zone of high-velocity flow from the culvert downstream so that it does not pose a risk to the embankment; and
- Increasing tailwater depth by digging a discharge pool or stilling basin to control turbulent flow at the culvert exit.

Energy dissipater designs may include concrete or rock sloping aprons, “bucket” outlets that divert the flow downstream, stilling basins, or other elaborate structures.

CONSIDERATIONS:

Figure 1.3.12. Energy dissipaters can be installed at culvert discharges to decrease erosion and scour.

Mitigation Solution: Improve Alignment

Changing the culvert's horizontal (side to side) and vertical (up and down) alignment to match the centerline and slope of the stream can reduce erosion caused by misalignment. Aligning the culvert inlet and outlet along the axis of the stream can maximize culvert efficiency.

Option 1: Realign Culvert

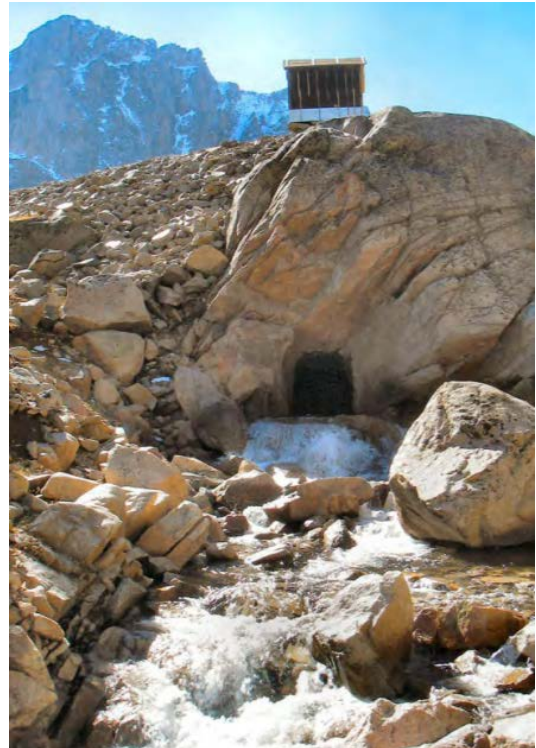
To reduce or eliminate erosion along the embankment, which can damage the culvert, realign the culvert (either vertically or horizontally) to match the centerline of the stream (Figure 1.3.13).

- All realignments should take into consideration the whole drainage system.
- Realignment also may require moving the culvert to match the current stream location.
- Stream or road geometry and permit conditions may prevent changing the culvert alignment.

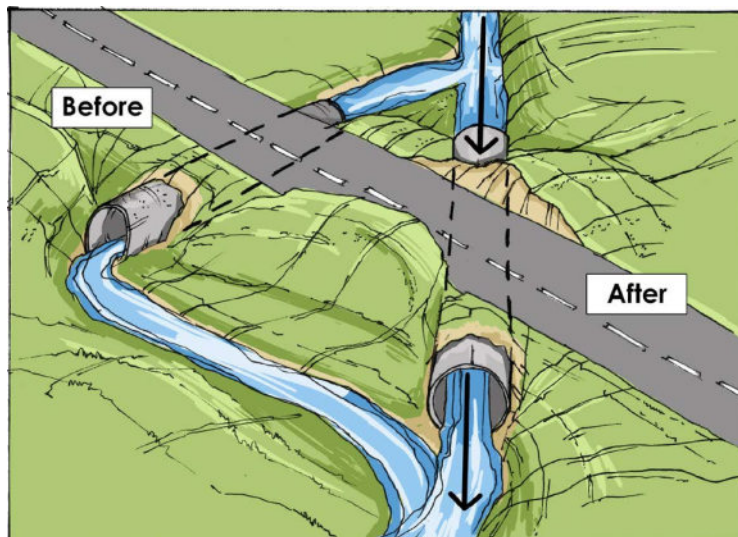

Figure 1.3.13. Realigning the culvert to the stream centerline can reduce damage to the culvert.

CONSIDERATIONS:



Option 2: Install Approach Berms

On the stream overbanks, which are formed when streams overflow their banks and deposit sediment on the floodplain, install approach berms to direct the flow into and at the same angle as the culvert, away from the embankment (Figure 1.3.14). Berms need to be placed on stream overbanks near or at the edge of the flood channel so that water surface elevations are not significantly increased at the culvert or upstream.

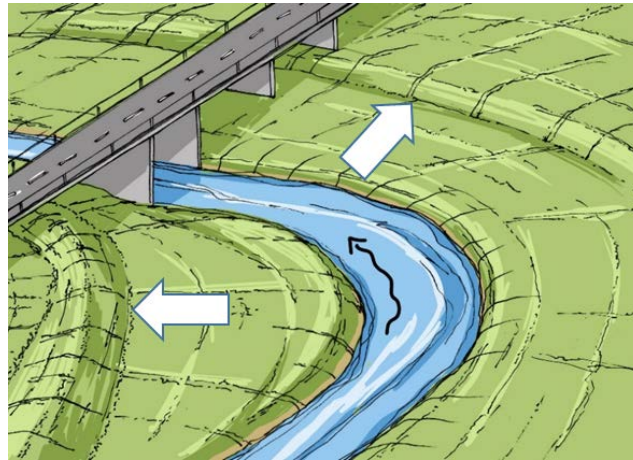

Figure 1.3.14. Approach berms can direct flow away from embankments.

CONSIDERATIONS:



Option 3: Install Flow Diverters

Flow diverters (barbs) in the stream can redirect streamflow away from the stream bank into the culvert (Figure 1.3.15). Natural materials, such as root balls or anchored logs, can be effective, habitat-friendly flow diverters and reduce channel movement. The size of diverters should not increase water surface elevation for high flows either at or upstream of the culvert.

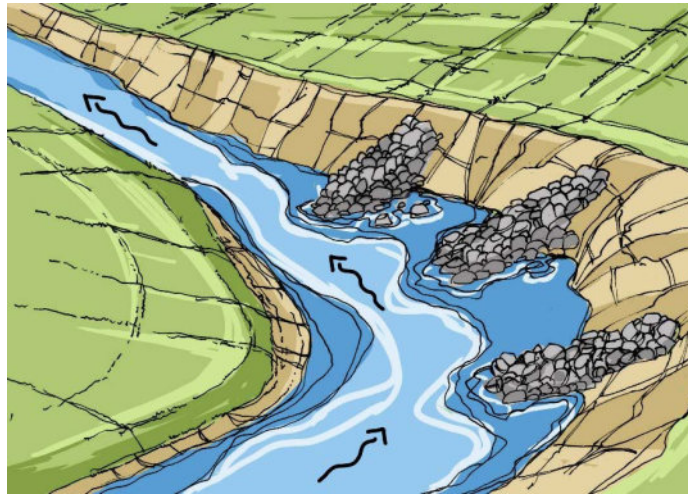

Figure 1.3.15. Flow diverters can realign the stream channel.

CONSIDERATIONS:



Option 4: Install Additional Culverts

Install additional culverts at the road crossing site (Figure 1.3.16). Elevating additional culverts so that they are only used during flood events can reduce clogging to the original culvert at the lower elevation. This measure can be useful when height limits exist.

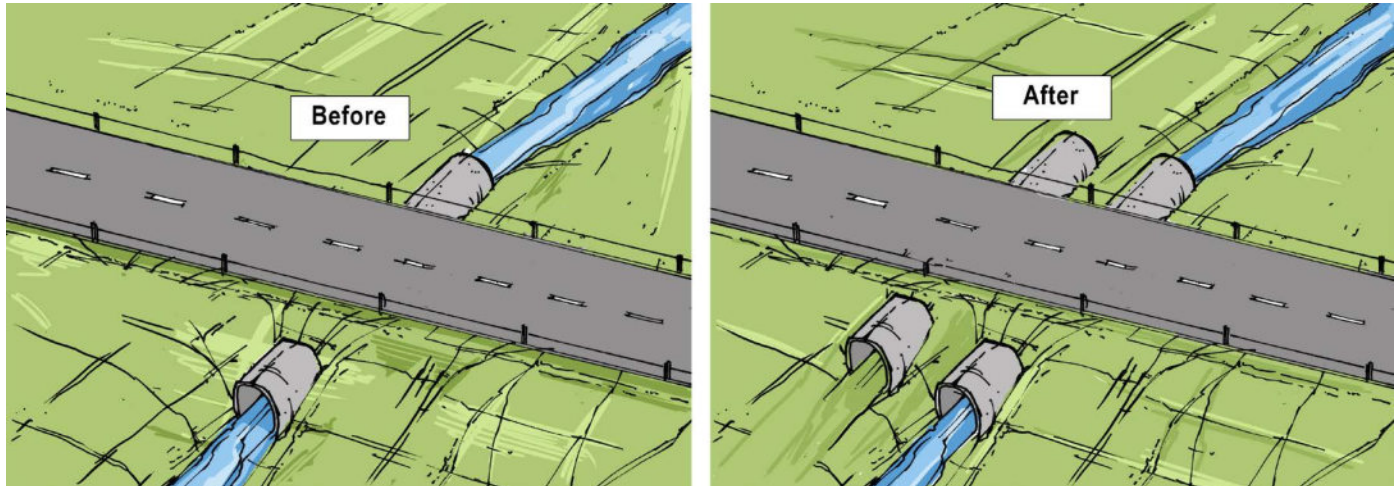

Figure 1.3.16. Installing additional culverts can reduce velocity and clogging.

CONSIDERATIONS:



Option 5: Realign the Stream Channel

Streamflow should be directed at the same angle as the culvert and away from the embankment to reduce erosion along the embankment and subsequent damage to the culvert (Figure 1.3.17). Embankment slope protection and other mitigation measures may be necessary to achieve maximum effectiveness.

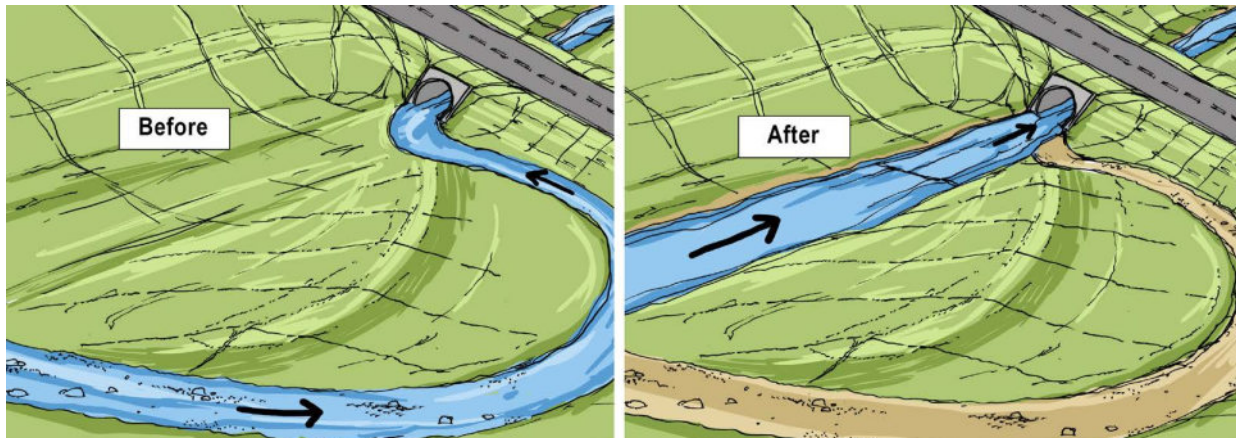

Figure 1.3.17. Realigning the stream can protect embankments.

CONSIDERATIONS:



Mitigation Solution: Reduce Obstructions

A culvert blocked with debris and silt may be damaged or even fail during flooding, causing embankment erosion. Debris at the culvert entrance or caught inside the culvert restricts water flow, raising the upstream water surface elevation, leading to culvert damage or even washout. Protect the culvert entrance from debris to prevent damage.

Option 1: Install an Entrance Debris Barrier

Manage debris flow through a culvert by installing an entrance debris barrier (debris deflector or debris crib) or debris fins to redirect floating debris for easy passage through the culvert (Figure 1.3.18).

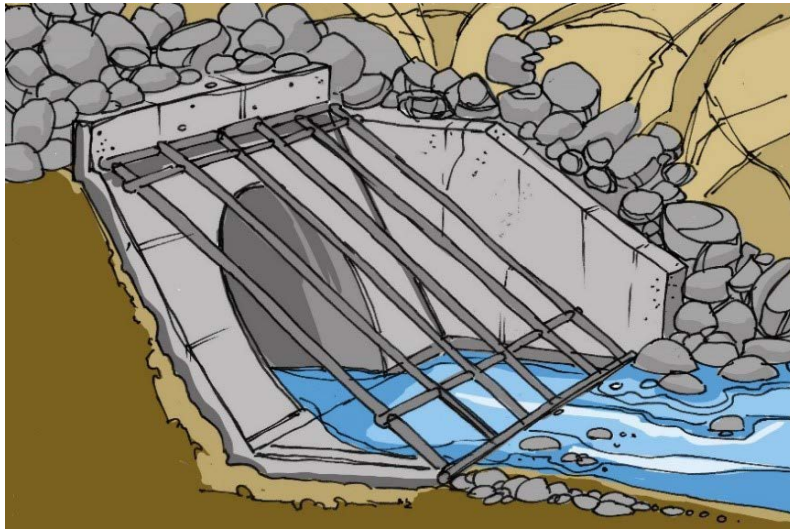

Figure 1.3.18. A debris barrier can protect a culvert from damage.

When evaluating this option, keep these considerations in mind:

- A debris barrier may be a “V”-shaped or semicircular rack at the culvert entrance or a straight rack at the end of wingwalls. A debris crib with a drop inlet also may be used to prevent debris from blocking culverts.
- When debris builds up around the barrier, it can block the culvert and flooding can occur during high flows. Maintenance is an important component.
- There must be adequate stream channel storage available for debris accumulation.

CONSIDERATIONS:



Option 2: Install a Sediment Catch Basin Upstream

Build a sediment basin or pond upstream from a culvert to allow floating sediment time to settle into the basin before entering the culvert (Figure 1.3.19).



Figure 1.3.19. A sediment basin can help settle suspended sediment and decrease culvert clogging potential.

When evaluating this option, keep these considerations in mind:

- Basins and ponds should be located to be accessible for maintenance and sized to provide enough storage.
- This measure is most effective where heavy silt or sand is transported during floods, causing streambed to scour.

CONSIDERATIONS:



Option 3: Install a Relief Culvert

Installing one or more relief culverts can provide another route for floodwaters if the main culvert gets plugged (Figure 1.3.20). Place the relief culvert at the crossing site and in the embankment above the flow line of the main culvert.

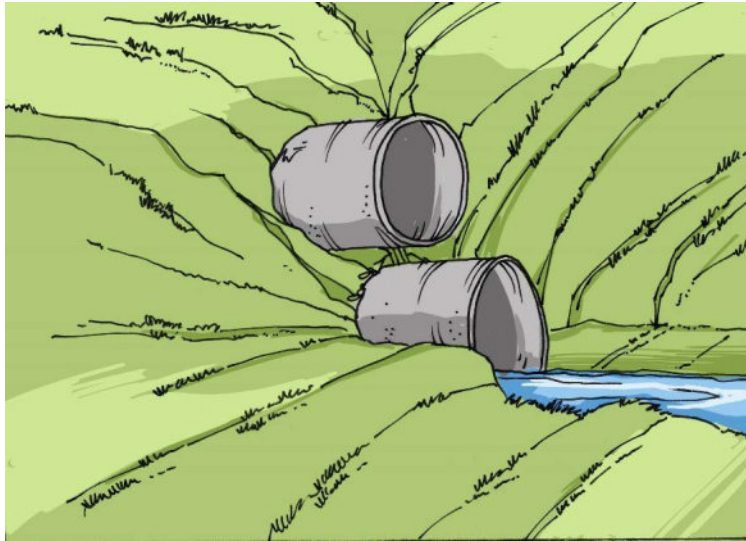

Figure 1.3.20. Install a relief culvert as a second route for floodwaters if the main culvert gets clogged.

CONSIDERATIONS:



Mitigation Solution: Relocate or Replace with Water Crossing

Culverts may need to be relocated to accommodate a migrating stream or an area likely to have high-velocity flooding and bank erosion. Additionally, a culvert is replaceable with another water crossing that allows the roadway to handle the estimated flows.

Option 1: Relocate Culvert

Relocate culverts to sites that are less likely to be affected by high-velocity water flows.

When evaluating this option, keep these considerations in mind:

- Move the crossing outside of an area affected by riverine flooding, storm surge or coastal wave action.
- Avoid moving the crossing to a location that will direct flow toward downstream properties, where flooding could happen, or streambeds or stream banks could be damaged.

CONSIDERATIONS:



Option 2: Add a Low-Water Crossing

Replace a culvert with a dip in the roadway to accommodate the anticipated flows (low-water crossing during emergency events) or add a roadway depression over a culvert (Figure 1.3.21).

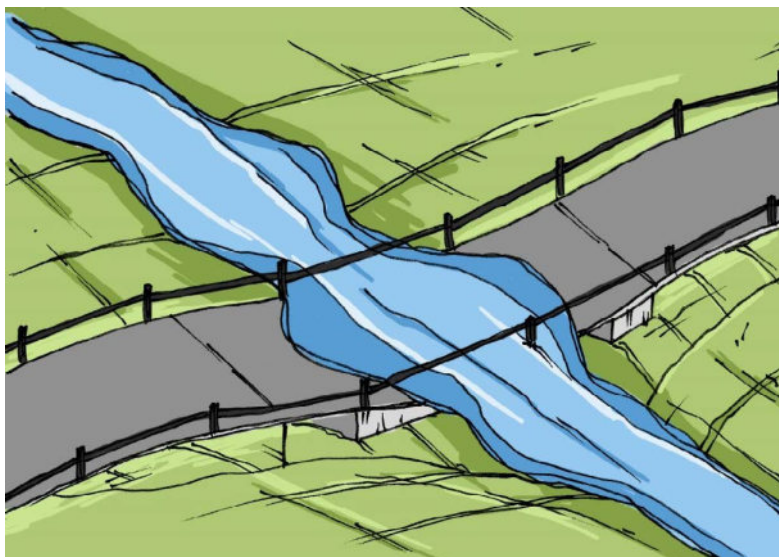

Figure 1.3.21. A low-water crossing in place of a culvert will accommodate flows during emergency events.

When evaluating this option, keep these considerations in mind:

- This option should not be considered if the roadway connects to a critical facility.
- This measure works best in areas where flooding is seasonal.
- It is appropriate only for corridors with low traffic counts.
- Signs and barricades are necessary when water exceeds a depth that is safe for vehicles to pass.
- Design and construct roadway embankments to withstand anticipated water flows.
- The profile of the crossing should match the shape of the stream crossing as closely as possible.

CONSIDERATIONS:



Option 3: Add a High-Water Overflow Crossing

Install an overflow section (high-water overflow crossing) in the roadway to accommodate stream overflowing (Figure 1.3.22).

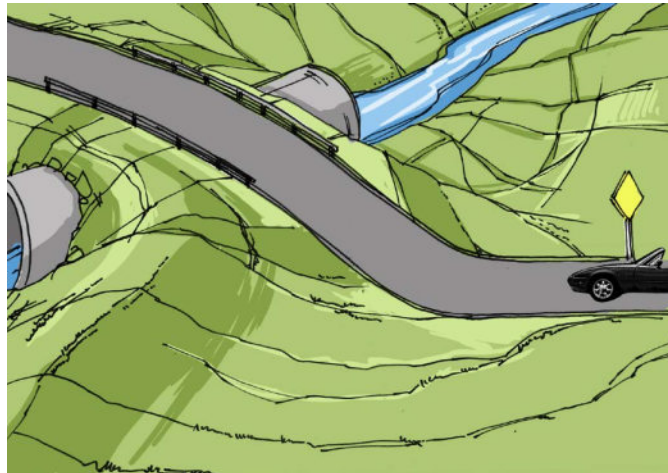

Figure 1.3.22. Installing an overflow section in the roadway can accommodate stream overflows.

When evaluating this option, keep these considerations in mind:

- Locate high-water overflow crossings at natural side channels or in line with heavy flow areas located on stream banks.
- Design the overflow section to limit overflow depth.
- Select a road surface material that protects the road base from saturation.
- Protect the downstream side of the embankment from scouring by the overflowing water by using a toe apron, stilling basin, downstream pool or riprap.
- This measure reduces road or culvert damage by providing an overflow spillway. Still, in a flood event, the road could be impassible.

CONSIDERATIONS:



REFERENCES:

Detailed technical information on culvert and drainage methods, considerations, and general design practices can be found in these publications:

- Federal Emergency Management Agency (FEMA). 2007. *Engineering with Nature Alternative Techniques to Riprap Bank Stabilization*. Available at: https://www.fema.gov/pdf/about/regions/regionx/Engineering_With_Nature_Web.pdf
- FEMA. 2010. FEMA B-797, *Hazard Mitigation Field Book, Roadways*. Available at: https://www.fema.gov/sites/default/files/2020-07/b797_hazmit_handbook.pdf
- FEMA. 2010. FEMA P-679, *Technical Manual: Outlet Works Energy Dissipators*. Available at: https://www.dwr.nd.gov/pdfs/energy_dissipators.pdf
- Federal Highway Administration (FHWA). 2005. HEC 09 *Debris Control Structures Evaluation and Countermeasures, Third Edition*. Available at: <https://www.fhwa.dot.gov/engineering/hydraulics/pubs/04016/hec09.pdf>
- FHWA. 2005. HEC 15 *Design of Roadside Channels with Flexible Linings, Third Edition*. Available at: <https://www.fhwa.dot.gov/engineering/hydraulics/pubs/05114/05114.pdf>
- FHWA. 2006. HEC 14 *Hydraulic Design of Energy Dissipators for Culverts and Channels, Third Edition*. Available at: <https://www.fhwa.dot.gov/engineering/hydraulics/pubs/06086/hec14.pdf>
- FHWA. 2010. HEC 26 *Culvert Design for Aquatic Organism Passage*. Available at: <https://www.fhwa.dot.gov/engineering/hydraulics/pubs/11008/hif11008.pdf>
- FHWA. 2012. HDS 5 *Hydraulic Design of Highway Culverts, Third Edition*. Available at: <https://www.fhwa.dot.gov/engineering/hydraulics/pubs/12026/hif12026.pdf>
- FHWA. 2016. HEC 17 *Highways in the River Environment—Floodplains, Extreme Events, Risk, and Resilience, Second Edition*. Available at: <https://www.fhwa.dot.gov/engineering/hydraulics/pubs/hif16018.pdf>
- Green Roads for Water. No Date. “Location and height of road embankments and controlled overflow sections.” Available at: <https://roadsforwater.org/guideline/roads-in-floodplains/location-and-height-of-road-embankments-and-controlled-overflow-sections/>

Fact Sheet 1.4: Bridges

The mitigation objective of this Fact Sheet is to prevent or minimize damage to bridges from flooding, erosion and scour, and debris strikes resulting from floods and hurricanes.

Mitigation for bridges depends on which part of the bridge is damaged and what caused the damage.

Figure 1.4.1 shows basic bridge structure.

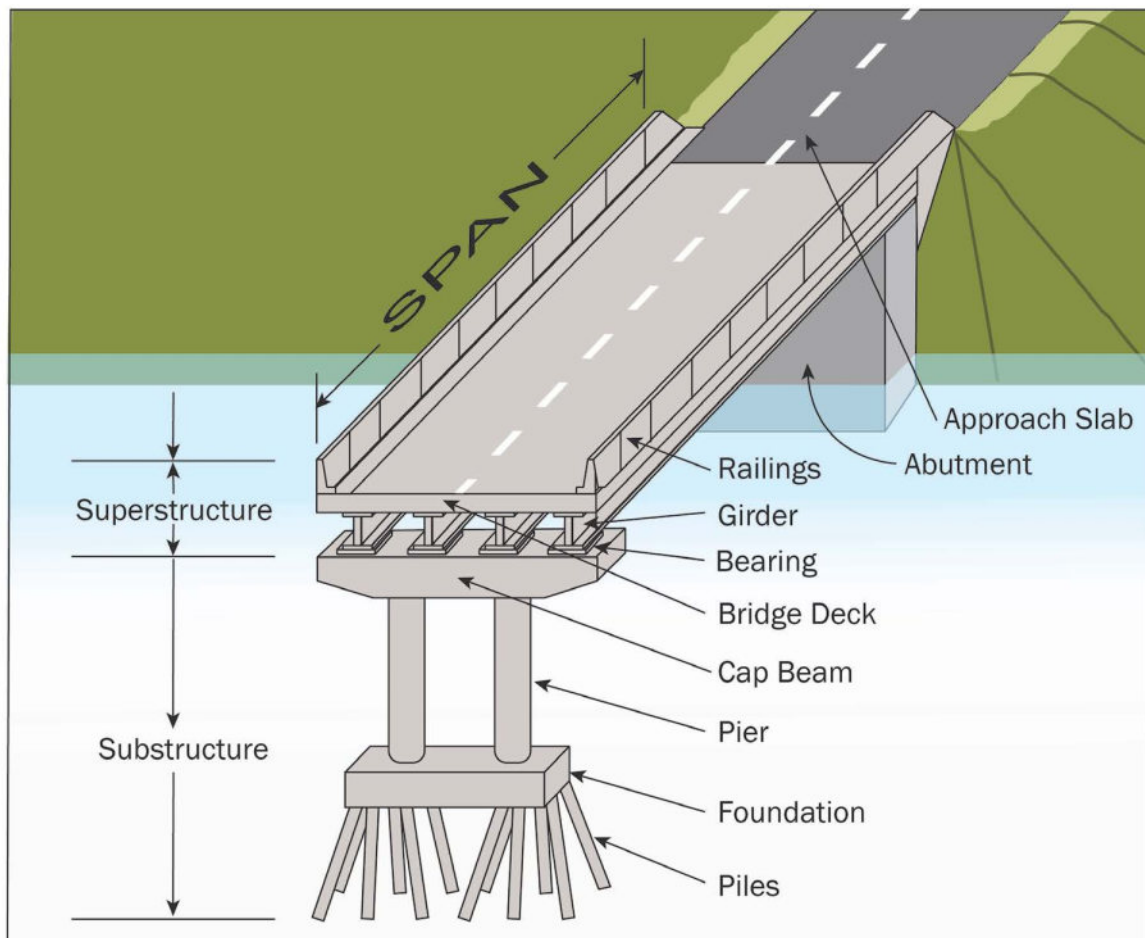

Figure 1.4.1. Basic bridge structure.

Table 1.4.1 summarizes some common mitigation strategies for reducing the likelihood that floods and hurricanes might damage bridges and bridge components.



Table 1.4.1. Common Mitigation Solutions for Various Types of Bridge Damage

Solutions and Options	Erosion and Scour	Flooding and Washout	Debris Blockage and Impact
Mitigation Solution: Improve Flow under the Bridge Crossing			
Option 1: Replace Multi-Spans with a Single-Span Bridge	✓	✓	✓
Option 2: Elevate the Bridge Deck	✓	✓	✓
Option 3: Increase the Bridge Length	✓	✓	✓
Option 4: Build a Relief Opening	✓	✓	✓
Option 5: Use a Low-Flow Crossing	✓		✓
Mitigation Solution: Construct Erosion and Scour Countermeasures			
Option 1: Install Riprap	✓		✓
Option 2: Construct Bridge Wingwalls	✓		✓
Option 3: Construct Spur Dikes	✓		✓
Option 4: Realign Piers and Abutments	✓		✓
Option 5: Increase the Footing Depth	✓		✓
Option 6: Install Flow Deflectors	✓		✓
Mitigation Solution: Reduce Debris Damage			
Option 1: Install Debris Deflectors	✓		✓
Option 2: Install Semicircular or Triangular Endnoses	✓		✓
Option 3: Install Batters	✓		✓
Option 4: Replace Timber Pile Bent Pier Structure with Solid Concrete Column Pier	✓		✓
Option 5: Replace Steel Truss Bridges with Open Deck Bridges	✓		✓
Option 6: Construct Debris Catchments	✓	✓	✓
Option 7: Install Debris Sweepers	✓	✓	✓
Mitigation Solution: Relocate the Bridge			
Option 1: Relocate the Bridge	✓	✓	✓

Mitigation Solution: Improve Flow Under the Bridge Crossing

If the opening under a bridge is too small or is blocked, the bridge can flood, damaging the bridge deck, railings and trusses. Increasing the amount of water that can pass through a bridge opening or modifying the bridge deck design to help control the water flow can prevent damage to the bridge.

Option 1: Replace Multi-Spans with a Single-Span Bridge

Replacing bridges built from multiple spans with one clear span eliminates the number of piers within the floodwater area (Figure 1.4.2), providing additional space for the water to flow.



Figure 1.4.2. Reducing the number of spans can increase the flow amount under the bridge. In this figure, the dashed piers would be removed to accomplish this.

When evaluating this option, keep these considerations in mind:

- This mitigation method can increase the amount of floodwater that can safely move under the bridge while reducing upstream backwater and damming.
- Redesign of the bridge may be required with this option to thicken the substructure and increase the roadway profile and approach slab.
- An engineer should evaluate hydraulic conditions to determine if increased flow also will increase water velocity and scour.

CONSIDERATIONS:



Option 2: Elevate the Bridge Deck

Increasing the size of the bridge opening by raising the bridge deck will increase the space available for floodwater to pass through, which can decrease the likelihood of damage from flooding (Figure 1.4.3). Generally, if a bridge has been damaged by overtopping or fast water velocities in the past, it is a good candidate for increasing the size of the bridge opening. Make sure to raise the bridge deck and superstructure above the estimated level of the potential worst-case scenario future flood.

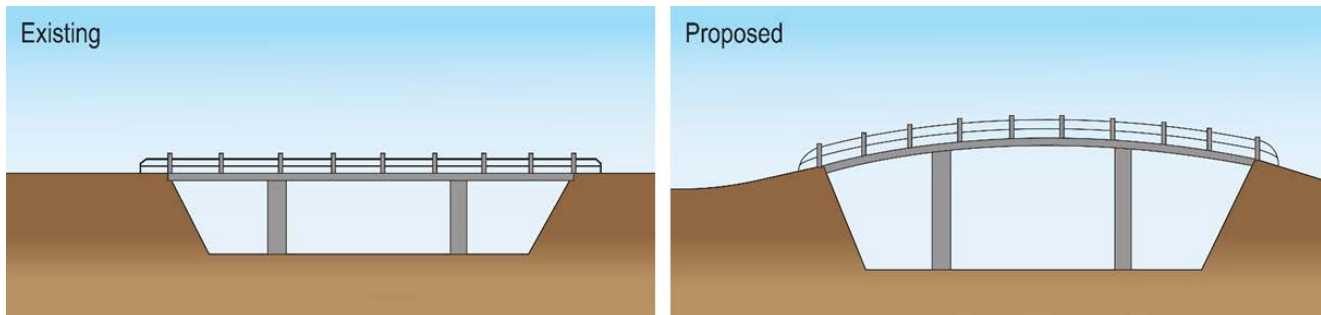

Figure 1.4.3. Increasing the size of a bridge opening by raising the bridge deck can increase flow volume under the bridge.

There are multiple considerations when evaluating this option:

- Adjust the bridge approach slab to meet the new height of the bridge deck. This could involve making the approaches to the bridge longer and higher.
- The piers and abutments may need to be redesigned and rebuilt to support the raised bridge deck. If the bridge deck will only be raised one or two feet, it may be possible to jack up the bridge beams and install pedestals. Abutments may require taller end walls and a new approach slab.
- If raising the bridge structure leads to a larger amount of floodwater going under the bridge rather than overtopping the roadway, this could increase flow velocities under the bridge, which could increase the likelihood of scour.
- The ends of the bridge at the crossing and the stream channel geometry must be evaluated to determine if this option is feasible.
- An engineer should complete hydraulic and hydrologic (H&H) studies to evaluate if and how a bridge opening size could be increased. If elevating the deck is feasible, the design should be done by a licensed professional engineer.
- If the bridge must be lengthened in addition to raising the deck, the project may not be cost effective unless the bridge is an older structure and due for replacement soon.

CONSIDERATIONS:



Option 3: Increase the Bridge Length

Lengthening a bridge by installing additional bridge openings or bridge spans can increase the flow volume below a bridge (Figure 1.4.4).

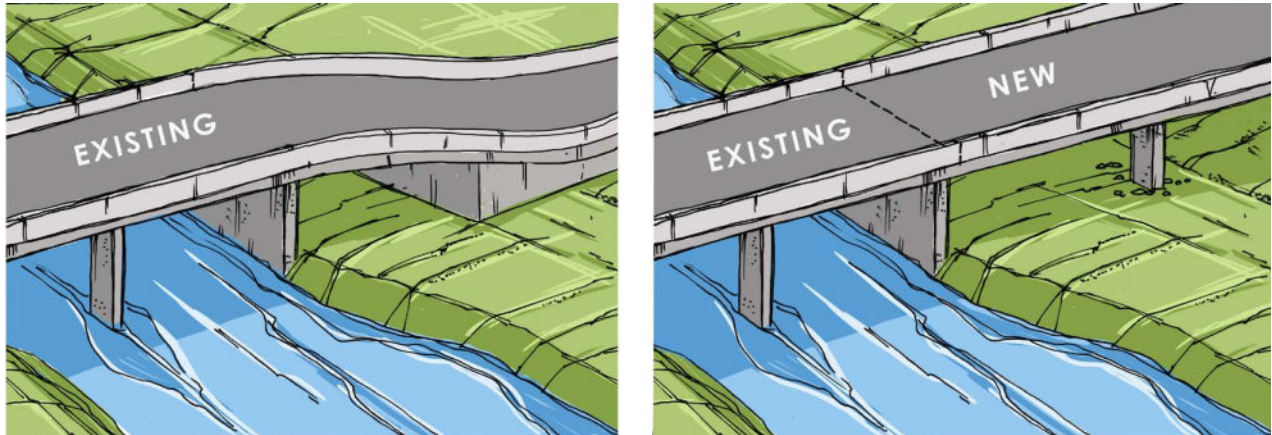

Figure 1.4.4. Lengthening a bridge can provide additional overflow capacity beneath the bridge.

When evaluating this option, keep these considerations in mind:

- Place additional openings or spans where past or future stream alignments cross the site.
- This measure can mitigate the effects of a widening streambed or the formation of sand bars or other temporary islands (referred to as “braid bars”) in the waterway beneath the bridge.

CONSIDERATIONS:



Option 4: Build a Relief Opening

Building one or more relief openings beneath the road surface and embankments (also known as the road prism) can increase the flow volume of the crossing. Place the extra opening at the appropriate height and location. The water level downstream of the bridge must not block water flowing through the crossing (Figure 1.4.5).

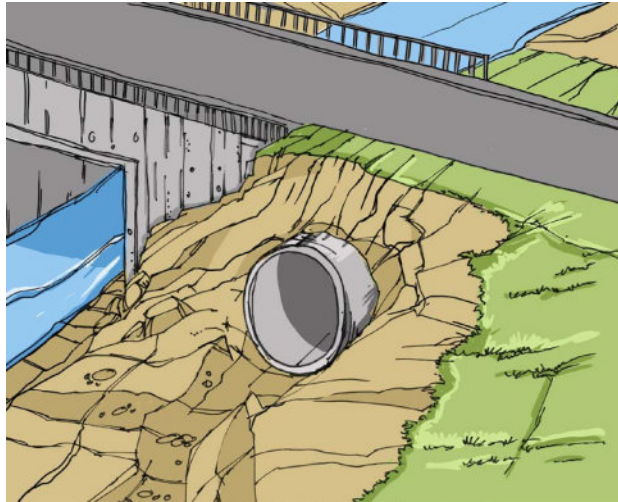

Figure 1.4.5. Building a relief opening can help prevent flooding of bridges.

When evaluating this option, keep these considerations in mind:

- The relief opening may be a culvert, box culvert, bridge, or a combination of culverts or bridges. See Mitigation Fact Sheet 1.3, *Drainage and Culverts*, for more information on culverts and drainage.
- Locate the opening at natural side channels and in line with heavy flow areas in the stream.

CONSIDERATIONS:



Option 5: Use a Low Water Crossing

Low water crossings allow water to flow over the bridge (Figure 1.4.6). The road and bridge will be impassable during flooding events.

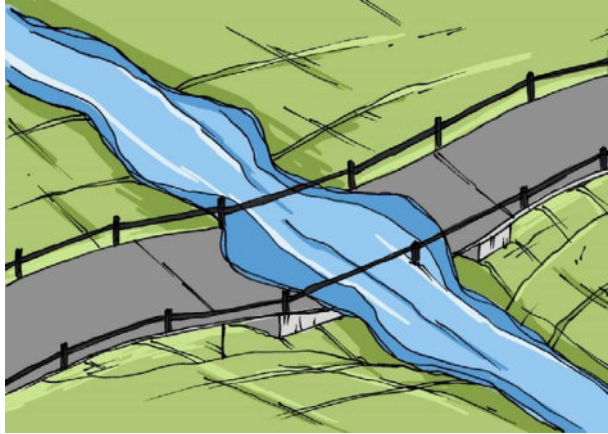

Figure 1.4.6. Low water crossings can be cost effective in areas with low traffic where flooding is seasonal.

When evaluating this option, keep these considerations in mind:

- Do not consider this option if the roadway connects to a critical facility.
- This measure works best in areas where flooding is seasonal.
- It is appropriate only for corridors with low traffic counts.
- Signs and barricades are necessary when water exceeds a depth that is safe for vehicles to pass.
- Design and construct roadway embankments to withstand anticipated water flows.
- The profile of the crossing should match the shape of the stream crossing as closely as possible.

CONSIDERATIONS:



Mitigation Solution: Construct Erosion and Scour Countermeasures

High-velocity water flows, flooding, and overtopping can erode and damage bridge approach slabs and abutments. These flows also can cause scour around piers and abutments, which can damage the bridge and even cause structural soundness problems. Reducing flow velocities and eliminating overtopping and erosion can help prevent flood damage to bridges.

Option 1: Install Riprap

Placing riprap at bridge approaches, abutments and piers can reduce erosion during high-velocity water flow from flooding (Figure 1.4.7).

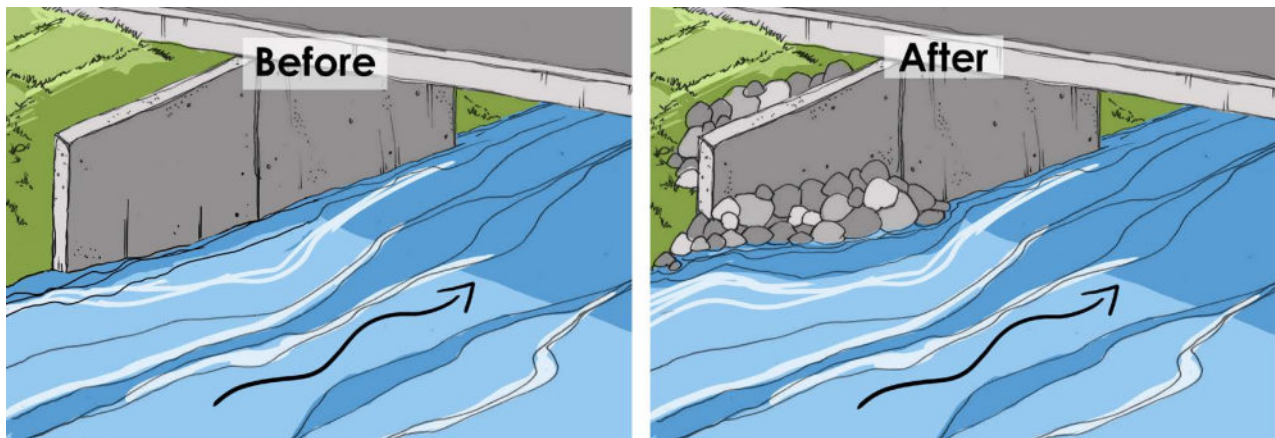

Figure 1.4.7. Riprap can protect bridge piers and abutments against erosion and scour.

When evaluating this option, keep these considerations in mind:

- Size the riprap so it will not slide or be dislodged by fast-flowing water.
- Riprap should be supported at the base of the slope to prevent sliding.
- Riprap may be required to meet environmental regulations.
- Riprap may need to be designed by a licensed professional engineer; verify with the local Department of Transportation.
- Riprap also can protect piers and abutments against debris impacts.
- See Mitigation Fact Sheet 1.2, *Road Shoulders and Embankments*, for additional riprap design and placement information.

CONSIDERATIONS:



Option 2: Construct Bridge Wingwalls

Installing bridge entrance and outlet wingwalls to redirect the flow into the bridge opening can reduce or eliminate erosion under the bridge piers, abutments and embankment (Figure 1.4.8).

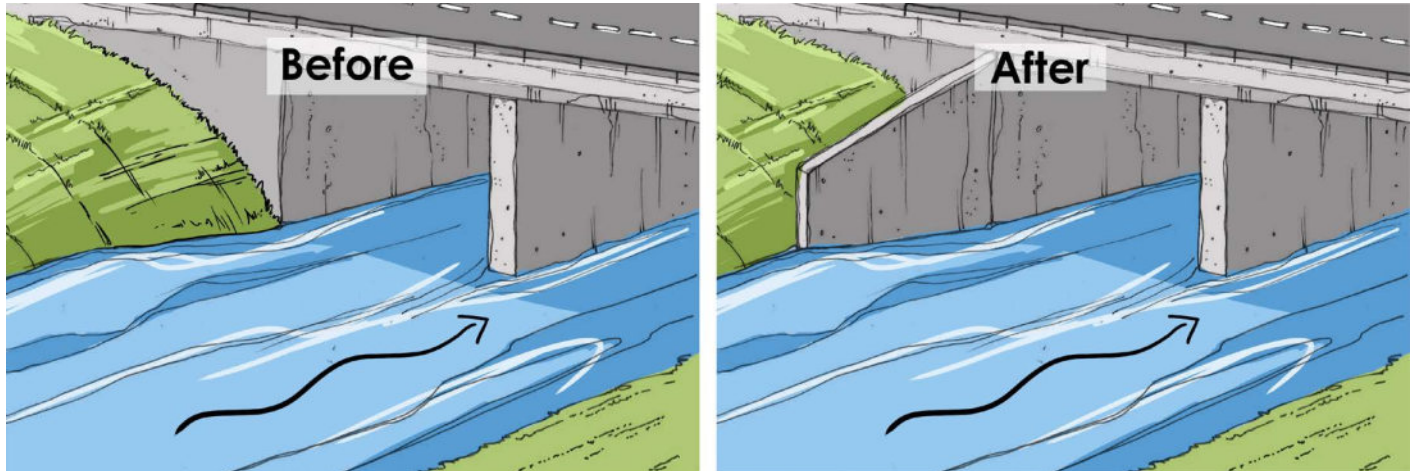
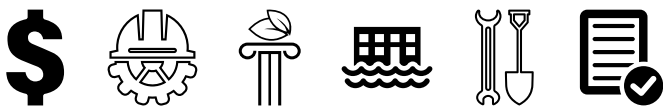

Figure 1.4.8. Wingwalls can help direct the flow of water and prevent erosion and scour at the bridge.

When evaluating this option, keep these considerations in mind:

- Angle flared wingwalls in the direction of the stream. Depending on the angle of wingwalls, flow volume may increase, which helps decrease flooding potential. Protect embankments against erosion from increased flows using riprap or bioengineered methods (discussed in Fact Sheet 1.2 *Road Shoulders and Embankments*).
- This measure could require deep bridge foundations or permanent sheet pile installation to avoid scour.
- Rounding or beveling abutment corners may increase flow volumes.
- If stream velocities are high, lateral scour of embankments may result from eddies at the ends of wingwalls. Wingwall shape and angles relative to the stream can reduce eddies.

CONSIDERATIONS:



Option 3: Construct Spur Dikes

Spur dikes are embankments designed to direct flood flows into a bridge opening (Figure 1.4.9). They are “tied into” the road embankment at an appropriate point landward from the bridge opening and then extend upstream.

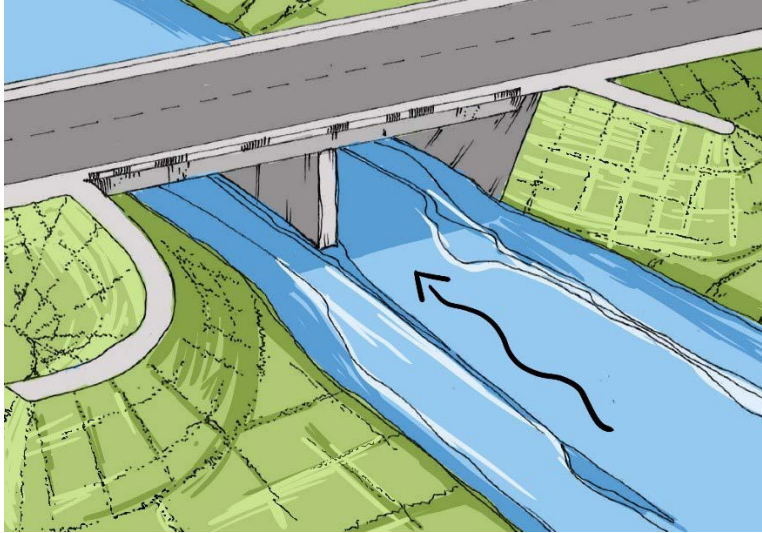

Figure 1.4.9. Spur dikes can direct flood flows, reducing erosion and scour around bridges.

When evaluating this option, keep these considerations in mind:

- The typical shape of a spur dike is either straight or elliptical.
- Install spur dikes at an angle to redirect the flow into the bridge opening, thereby eliminating the potential for erosion along and under the bridge piers and abutments and along the bridge embankment.
- Place spur dikes on the stream overbanks, so water surface elevations are not increased significantly.
- If stream velocities are high, scour of spur dike embankments may result from eddies at their upstream ends and along their sides. Design spur dike shapes and angles to reduce eddies.

CONSIDERATIONS:



Option 4: Realign Piers and Abutments

Realigning bridge piers and abutments to be parallel to flood flow can reduce or eliminate erosion along and under the bridge piers and abutments and along the embankment (Figure 1.4.10).

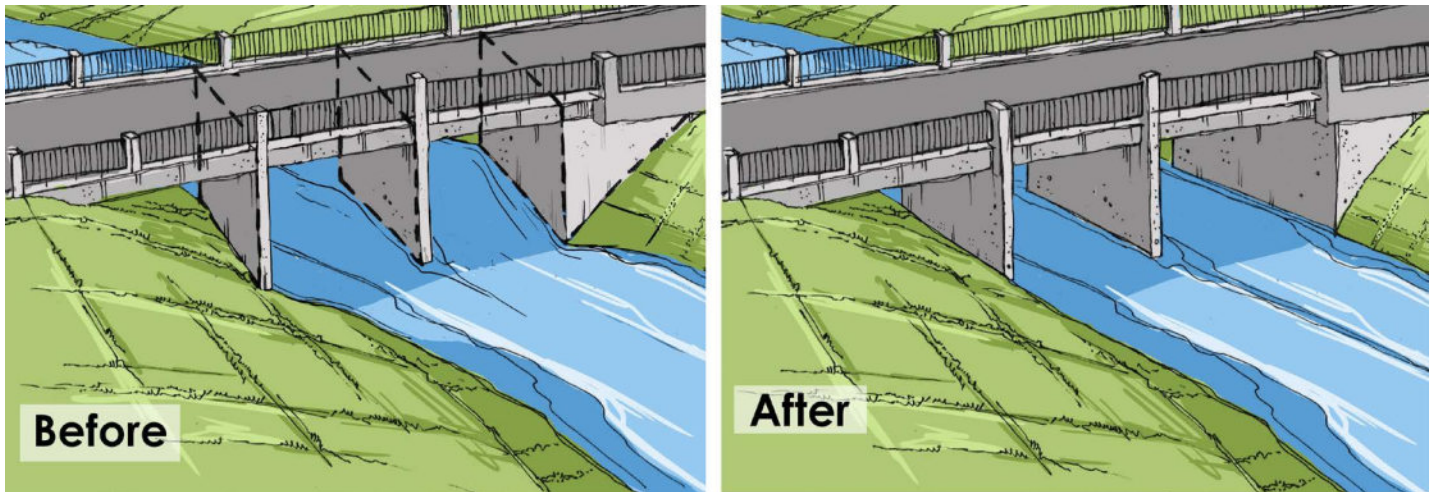

Figure 1.4.10. Realigning piers and abutments can decrease the damage from erosion and scour.

When evaluating this option, keep these considerations in mind:

- Realigning the bridge may mean moving it to the area of the current stream channel and aligning the bridge opening to the centerline of the stream.
- Flow volumes may increase when piers are aligned.
- It may be most cost-effective to replace the bridge.

CONSIDERATIONS:



Option 5: Increase Footing Depth

Increasing the depth of the footing used to support the bridge structure can help mitigate the damage from scour on bridge foundations (Figure 1.4.11).

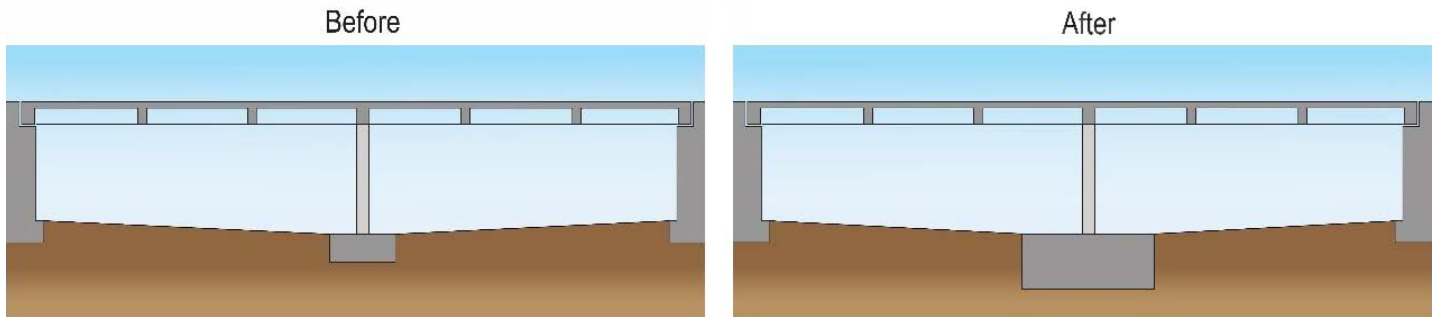
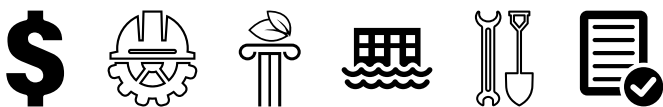

Figure 1.4.11. Increasing footing depth can protect bridge foundations against scour.

When evaluating this option, keep these considerations in mind:

- Extend the depth of pier and abutment footings below the scour depth of the 0.2%-annual-chance flood or bedrock. Thickening the footing or lowering the top of the footing and increasing the column length are ways to make this happen.
- The depth of scour depends on flood flow velocities and flow depth along the footing and the makeup of the streambed materials.
- Streambed characteristics may limit the depth of the pier and abutment footings. If the depth of footings cannot be increased, or if the cost is too great, consider changing the foundation type to deep foundations such as drilled shafts or piles.
- Inspect footings periodically after floods for erosion and scour.

CONSIDERATIONS:



Option 6: Install Flow Deflectors

Installing “V”-shaped flow deflectors on or immediately upstream from the upstream sections of piers and abutments can help reduce velocities of flow that directly contacts each pier or abutment. They can protect footings from scour (Figure 1.4.12).

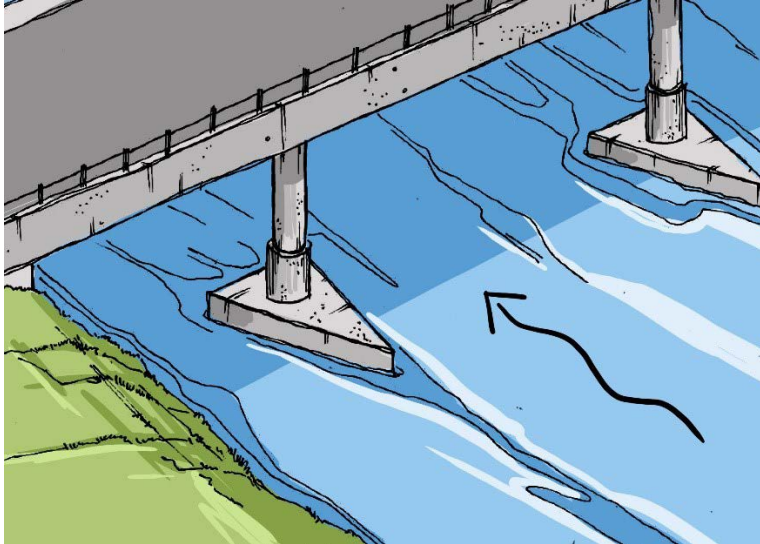

Figure 1.4.12. Installing flow deflectors immediately upstream of bridge piers can help protect them against scour.

When evaluating this option, keep these considerations in mind:

- Flow deflectors are very effective for high-speed flood flows.
- Install a concrete collar on the lower section of piers immediately above the footings.
- Extend the bottom sections of abutments and wingwalls to help deflect flood flows away from them and to reduce streambed scour along and under them.
- Pier collars and abutment subwalls are moderately effective. When used with extended abutments and wingwalls, they may provide additional protection from rock and debris impact.
- A qualified engineer should review hydraulic models with these changes included to evaluate potential impacts on the hydraulic capacity of the stream.
- Inspect flow deflectors periodically after floods for impact damage and erosion.

CONSIDERATIONS:



Mitigation Solution: Reduce Debris Damage

Flood-borne debris can lead to damage and even failure of bridges from impacts and debris accumulation, which result in flooding and washouts. Directing debris around and away from bridge piers and abutments can prevent impact damage, debris accumulation, and scour.

Option 1: Install Debris Deflectors

Debris deflectors or debris fins installed on the upstream ends of piers and abutments angled to direct floating debris into areas of high flood flow velocities can reduce damage (Figure 1.4.13).

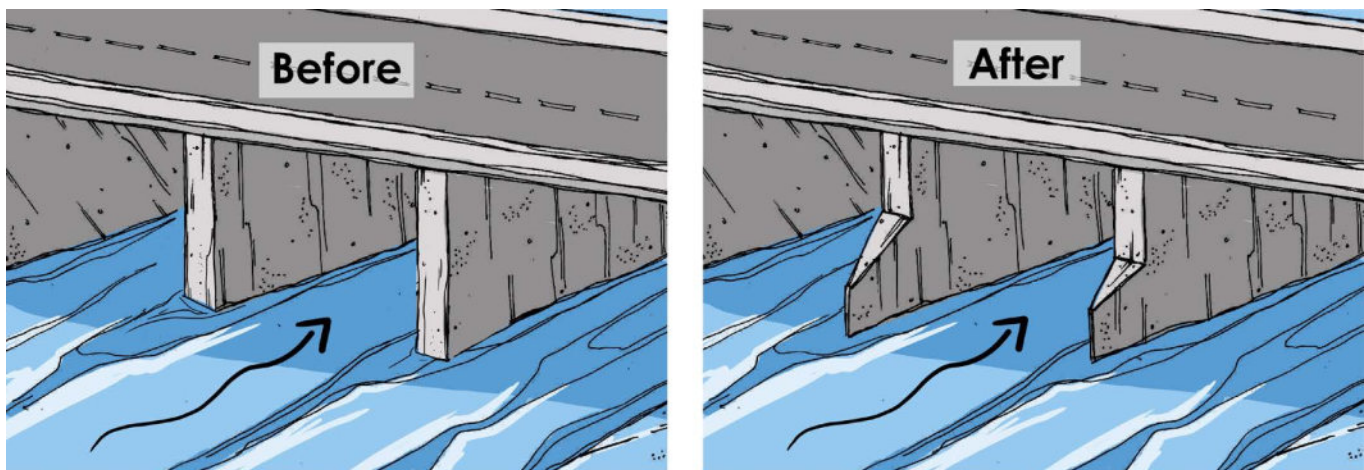

Figure 1.4.13. Debris deflectors can protect bridge piers and abutments from impact damages and debris accumulation.

When evaluating this option, keep these considerations in mind:

- Debris deflectors and fins should be “V”-shaped and extend upstream far enough to orient the floating debris for easy passage through the bridge.
- Design debris deflectors or fins to prevent debris accumulation and protect the piers and abutments from being struck by floating debris.
- Design debris deflectors so that they do not push debris farther downstream to another location. This is more effective when the flood flow velocities are high, and the area is known to have large amounts of debris in the watershed.
- The bridge deck must be high enough to pass floating debris.

CONSIDERATIONS:



Option 2: Install Semicircular or Triangular Endnoses

Semicircular or triangular endnoses are typically sheet metal attached to the pier on the upstream end to redirect flood flow (Figure 1.4.14).

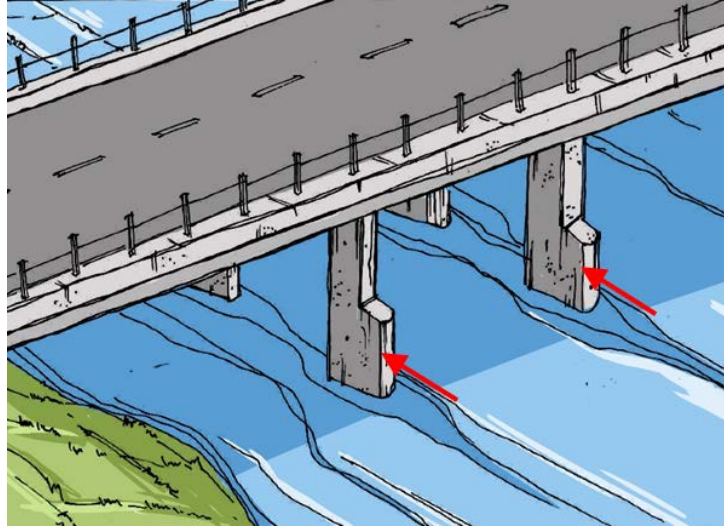

Figure 1.4.14. Endnoses installed on the upstream end of piers (shown by red arrows) can protect piers from debris impacts.

When evaluating this option, keep these considerations in mind:

Endnose design should prevent debris buildup and protect piers and abutments from being struck by floating debris.

Bridge decks should be high enough above flood stage for floating debris to pass under the bridge.

Remove any debris that builds up in the bridge opening as soon as it is safe following the flood.

Periodically inspect piers after floods for signs of streambed erosion.

CONSIDERATIONS:



Option 3: Install Batters

Install steel plate batters on the upstream ends of concrete piers with semicircular or “V”-shaped endnoses, or on wingwall ends and wingwall-abutment junctions, to protect them from the impact of floating debris (Figure 1.4.15).

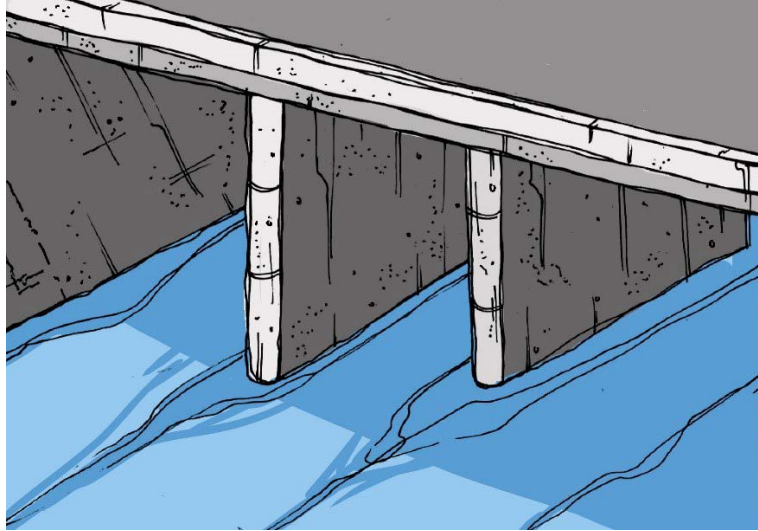

Figure 1.4.15. Steel plate batters protect piers from the impact of floating debris.

When evaluating this option, keep these considerations in mind:

- Steel plates are welded or bolted to the piers.
- Cathodic protection, which is a technique used to control erosion of a metal surface, may be required to protect the steel against corrosion.

CONSIDERATIONS:



Option 4: Replace Timber Pile Bent Pier Structure with Solid Concrete Column Pier

Replacing a multiple timber piling or pier configuration, called a timber pile bent pier structure, with a single solid concrete column pier (Figure 1.4.16) can prevent debris accumulation in the pile bent pier area and protect the pier from debris impact.

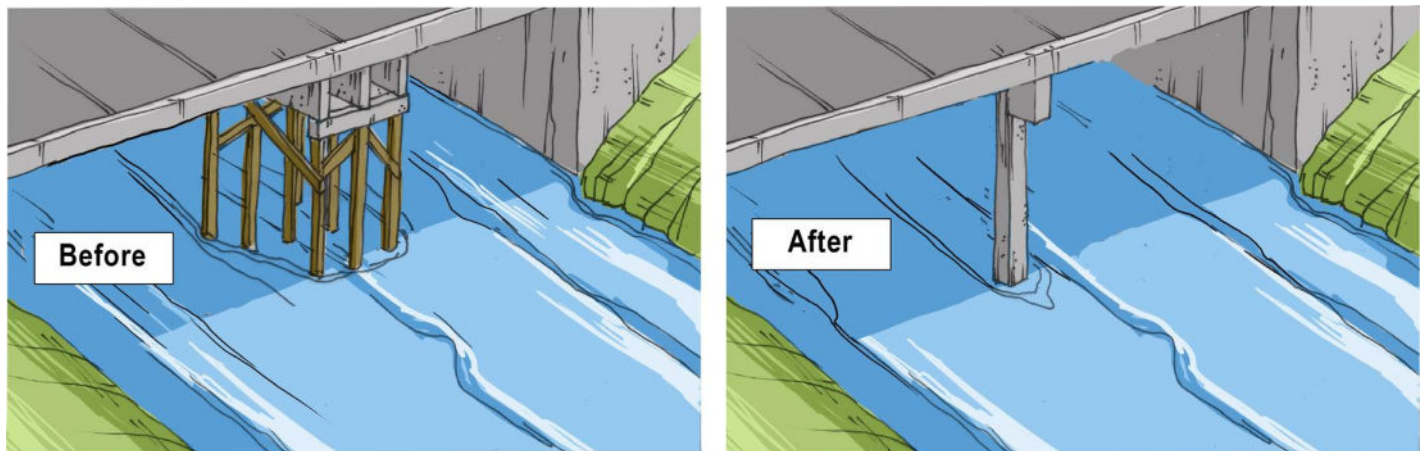

Figure 1.4.16. Replace a multiple timber pier structure with a concrete column to protect against debris impact.

When evaluating this option, keep these considerations in mind:

- This measure is effective in areas that have a large amount of debris upstream of the bridge.
- The concrete pier is assumed to be larger than the timber pilings, decreasing the flow area. A qualified professional engineer should complete a hydraulic and hydrology analysis to evaluate the effect of the pier replacement on the flow area.

CONSIDERATIONS:



Option 5: Minimize Below-Deck Framing

An open deck bridge will not trap floating debris to the same extent that a steel truss bridge will when overtopped (Figure 1.4.17). Minimizing the framing underneath the bridge can reduce trapped debris.

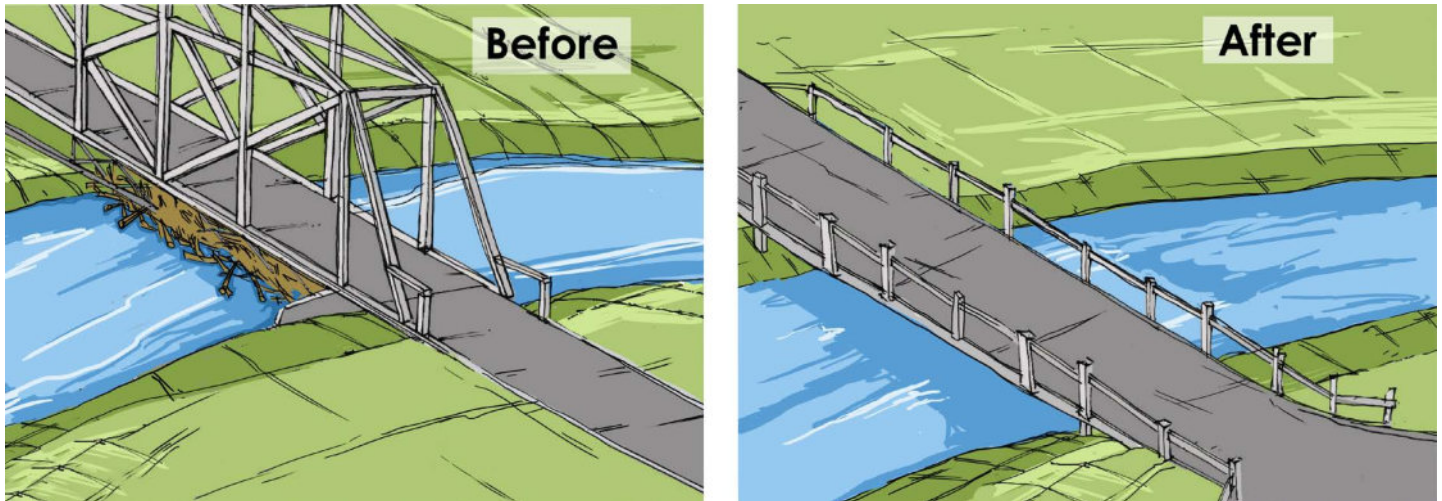

Figure 1.4.17. Replacing a solid deck with an open deck can reduce trapped debris.

When evaluating this option, keep these considerations in mind:

- Bridge piers and abutments may require redesign to adapt to an open deck bridge. A licensed professional engineer will need to evaluate the feasibility of this measure and prepare the design.
- The roadway may need to be raised to keep the lower steel at or above the truss's bottom (low chord) elevation.
- This method can be costly.
- A licensed professional engineer will need to evaluate the feasibility of this measure and prepare the design.
- This method requires permits and compliance with environmental regulations.

CONSIDERATIONS:



Option 6: Construct Debris Catchments

Debris catchments, such as debris barriers (trash racks) or low-height dams, may be constructed on small branch streams upstream from a bridge (Figure 1.4.18).

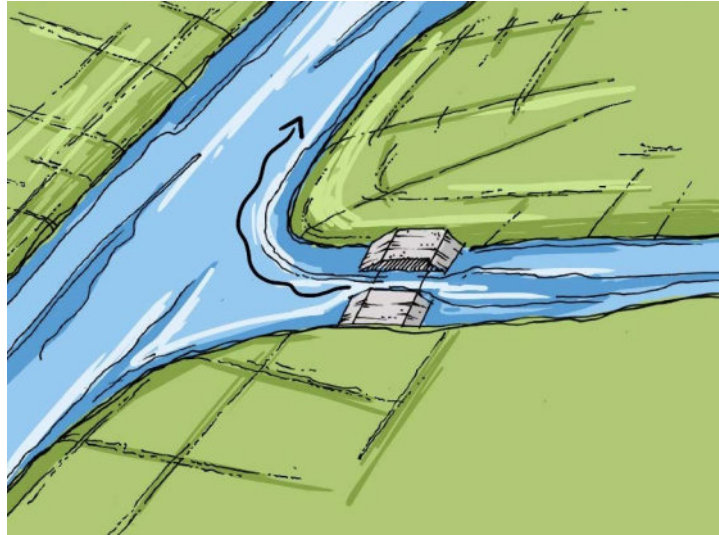

Figure 1.4.18. Debris catchments trap debris before it reaches bridge piers and abutments.

When evaluating this option, keep these considerations in mind:

- Design the catchment structures to trap debris while passing the stream flow.
- If a debris catchment dam is constructed, it must include an emergency spillway.
- This approach is less effective on larger streams.
- This method is effective where the source of debris is from heavily vegetated drainage areas upstream of the bridge where there are adequate storage areas above the catchment structures.
- Debris that builds up upstream of the catchment structures must be removed as soon as it is safe after the flood peak has passed.

CONSIDERATIONS:



Option 7: Install Debris Sweepers

Debris sweepers are cylinders with vertical vanes that rotate and float up and down with the water surface to sweep debris away from bridge piers and through bridge openings (Figure 1.4.19 and Figure 1.4.20).



Figure 1.4.19. A debris sweeper can be attached directly to a pier to deflect debris (FHWA, 2005).

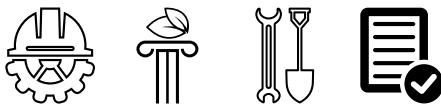

Figure 1.4.20. Pile-mounted debris sweepers can effectively direct debris away from bridge piers (FHWA, 2005).

When evaluating this option, keep these considerations in mind:

- Water flow causes the sweeper to rotate on its vertical axis.
- The sweeper can be attached directly to the pier or a pile driven into the streambed.
- Sweepers are less effective when flow speeds are low and can get clogged. Additionally, sweepers attached directly to piers are more likely to fail than sweepers mounted on piles.
- Piles are driven into the streambed likely will require special permits and compliance with environmental regulations.

CONSIDERATIONS:



Mitigation Solution: Relocate the Bridge

Option 1: Relocate the Bridge

Bridge relocation to a site with less exposure to damaging flows can be cost effective in areas with repeated coastal storms, surge and flooding as long as access is still maintained. This measure is used most often where more-frequent floods regularly overtop the bridge deck, where the flood level is above the roadway surface for a short distance, and when the necessary right of way is available. Moving the bridge allows access during emergencies and storm events.

CONSIDERATIONS:



REFERENCES:

Detailed technical information on bridge mitigation methods, considerations and general design practices can be found in these publications.

Federal Emergency Management Agency (FEMA). 2007. FEMA P-543, *Design Guide for Improving Critical Facility Safety from Flooding and High Winds: Providing Protection to People and Buildings*. Available at: https://www.fema.gov/sites/default/files/2020-08/fema543_design_guide_complete.pdf

FEMA. 2013. *Mitigation Ideas: A Resource for Reducing Risk to Natural Hazards*. Available at: https://www.fema.gov/sites/default/files/2020-06/fema-mitigation-ideas_02-13-2013.pdf

FEMA. 2020. FEMA B-797, *Hazard Mitigation Field Book, Roadways*. Available at: https://www.fema.gov/sites/default/files/2020-07/b797_hazmit_handbook.pdf

Federal Highway Administration (FHWA). 2005. HEC 09 *Debris Control Structures, Evaluation and Countermeasures, Third Edition*. Available at: <https://www.fhwa.dot.gov/engineering/hydraulics/pubs/04016/hec09.pdf>

Pennsylvania Department of Transportation (PennDOT). 2012. *Debris Control for Bridges and Culverts*, Technical Information Sheet #152. Available at: https://gis.penndot.gov/BPR_pdf_files/Documents/LTAP/TS_152.pdf

Fact Sheet 1.5: Roadway Lights, Poles, and Signage

The mitigation objective of this Fact Sheet is to keep critical transportation networks working that are needed to move public safety resources and supplies during and after a disaster by reducing damage to roadway lights, poles, traffic signals, and signs, all of which help to control traffic on roadways.

Table 1.5.1 identifies some common mitigation strategies that can help improve the performance of these structures during hurricanes and floods.

Table 1.5.1. Common Mitigation Strategies for Various Types of Damage

Solutions and Options	Wind	Erosion and Scour	Flooding and Washout	Debris Impact
Mitigation Solution: Traffic Signal Controllers				
Option 1: Elevate Controller Housing		✓	✓	
Option 2: Provide Backup Power Supply	✓			
Mitigation Solution: Traffic Signal Support Structures and Luminaires				
Option 1: Install Mast Arm Poles	✓			
Option 2: Strengthen Poles and Improve Foundations	✓			✓
Option 3: Install Vibration Dampers	✓			
Mitigation Solution: Roadway Sign Support Structures				
Option 1: Strengthen Roadside Signs	✓	✓		✓
Option 2: Increase Foundation Installation Depth	✓	✓		
Option 3: Improve Foundations	✓	✓		



Mitigation Solution: Traffic Signal Controllers

Traffic signal controllers are electrical systems that run traffic signals. Typically, they are installed in a controller cabinet that is mounted on the ground on a concrete pad or on a pole mount off the ground. Traffic signal controllers may be damaged by flooding or erosion. In fact, storm surge or flooding over an electrical signal controller can destroy the controller, shutting down the function of the traffic signal.

Option 1: Elevate Controller Cabinets

Raising ground-level and pole-mounted traffic signal controller cabinets above the estimated level of the design flood elevation will reduce contact with floodwaters (Figure 1.5.1), keeping the traffic signal working during and after a hurricane or flood.

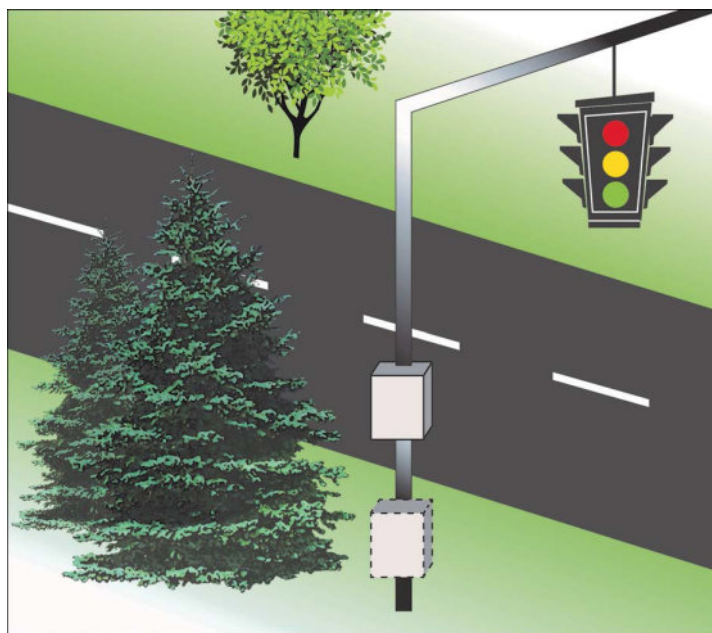
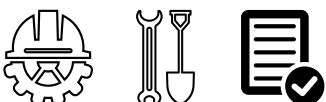

Figure 1.5.1. Elevating signal controller cabinets protects them against flooding.

When evaluating this option, keep these considerations in mind:

- A pole-mounted cabinet is easily removed and reattached to the pole at a higher position.
- Ground-level signal controller cabinets may be raised and anchored on a concrete pedestal or steel post.
- State or local departments of transportation may have height restrictions on cabinets. Verify if height restrictions are in place and, if so, what the restrictions are.

CONSIDERATIONS:



Option 2: Provide Backup Power Supply

Loss of a traffic signal due to a power outage can result in a potentially dangerous situation, causing traffic accidents, gridlock, and blocked routes for emergency vehicles. Taking steps to provide backup power to traffic signals can help to mitigate these potential problems.

When evaluating this option, keep these considerations in mind:

- Installing an uninterruptible power supply (UPS) at intersections with traffic signals will allow signals to continue operating when electrical power is lost from high wind gusts or storm surge. A UPS system provides emergency power to the traffic signal controller cabinet from a backup battery, enabling continued operation.
- Because a UPS is battery powered, this solution is short term, providing power only for a few hours to 24 hours, depending on the system and the battery.
- Installing quick-connects allows a portable generator to be installed to power traffic signals.
- Generators used to power traffic signals must be refueled regularly. When they are, they can provide power for several days to weeks until electricity is restored.

CONSIDERATIONS:

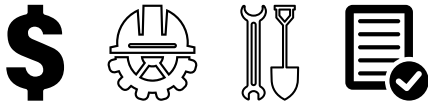

Mitigation Solution: Traffic Signal Support Structures and Luminaires

Traffic signals may include traffic lights, crosswalk signals, etc. They may be mounted in several different ways, including:

- Luminaires are overhead lights mounted in combination on traffic signal poles or mounted on individual poles.
- Traffic signal support structures and luminaires may be cantilevered (a single pole with a truss or steel arm that extends horizontally over the roadway) or non-cantilevered (a truss or strain cable that spans over the roadway and is supported by one strain pole on each side).
- Signals also may be mounted to bridge structures and overhead sign trusses.
- Traffic signal support structures are sensitive to vibration and forces caused by high winds.
- Damage from high wind pressure and windborne debris strikes can be reduced by strengthening poles to increase resistance.
- Damping or installing lighter-weight signals and lights will reduce vibration.

Option 1: Install Mast Arm Poles

Strain poles can be made from wood, steel or concrete. Strain poles that support overhead traffic signals on suspended cables are especially prone to damage because hangers and other connections are subjected to greatly increased wind. Replacing strain cables and strain poles with a cantilevered mast arm pole will reduce damage from hurricane-force winds (Figure 1.5.2).

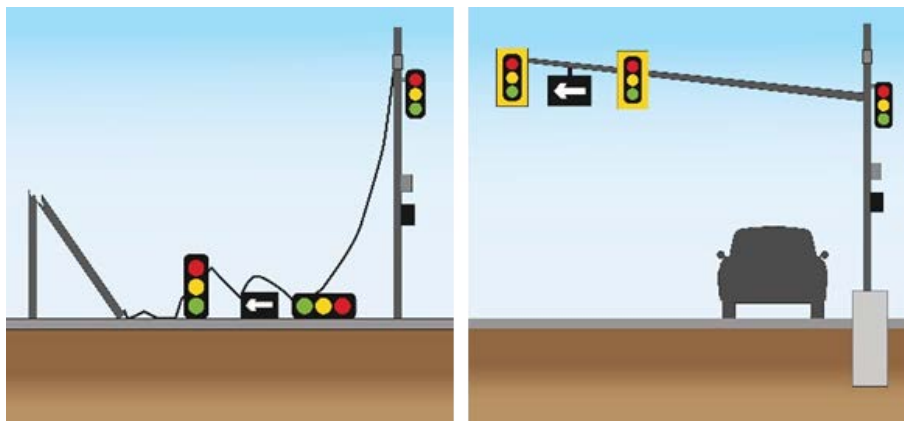
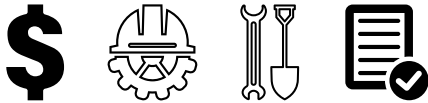

Figure 1.5.2. Mast arm poles protect traffic signals against wind damage.

When evaluating this option, keep these considerations in mind:

- When designed and constructed correctly, mast arm poles are an effective form of mitigation for strain poles.
- The success of this option can be increased when combined with other measures, such as improving pole foundations.

CONSIDERATIONS:



Option 2: Strengthen Poles and Improve Foundations

Strengthening poles can be done either by replacing a damaged pole with one of a similar material having a higher-class rating or by using a pole with a higher strength for the same class rating. A well-supported pole must be anchored to a properly designed and constructed foundation.

When evaluating this option, keep these considerations in mind:

- Instead of replacing damaged strain poles with the same pole, a stronger pole should be chosen.
- The foundation of the pole should be designed to avoid blowing down in the wind or collapsing when the ground is saturated.
- Wind pressure causes uplift and drag forces on the foundation and the pole anchors. Make sure that the foundation will not be lifted out of the ground and the pole is securely anchored to the foundation.
- Adding resistance into the design of the foundation reduces the chance of pole failure.

CONSIDERATIONS:



Option 3: Install Vibration Dampers

Vibration dampers, such as a damping plate, can be installed on the cantilever arm to reduce mast arm sway (Figure 1.5.3).

- Vibration occurs due to the pole's signal loading and wind pressure.
- Determine the appropriate size and location for the dampening plate for each assembly.

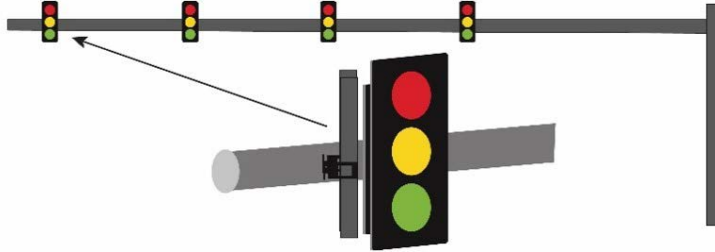
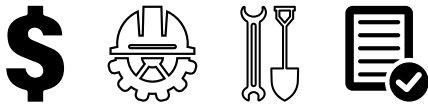

Figure 1.5.3. Vibration dampers can protect poles and signals against wind vibration damage.

CONSIDERATIONS:



Mitigation Solution: Roadway Sign Support Structures

High wind pressures and impact forces from windborne debris cause breakage or blow-off of roadside signs and supports. Reduce the risk of damage from high winds and windborne debris by reinforcing or strengthening roadside signs and supports to increase their resistance to these forces.

Option 1: Strengthen Roadside Signs

Strengthen overhead and roadside signs by replacing panels and supports with a stronger system including:

- Use improved sign construction materials such as aluminum and high-strength plastics.
- Use multiple support posts or adding structural framing behind the sign to reduce sign failure.
- Use stronger panels and fasteners.
- Increase the size and number of connectors and fasteners.
- Employ redundant, strong, corrosion-resistant connections and fasteners to support overhead and roadside signs to prevent blow-off.
- Consider designing for higher wind speeds.

CONSIDERATIONS:

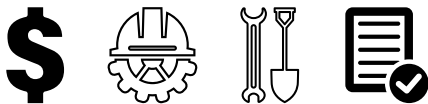

Option 2: Increase Foundation Installation Depth

Increasing pole embedment will better protect sign poles from erosion and failure (Figure 1.5.4).

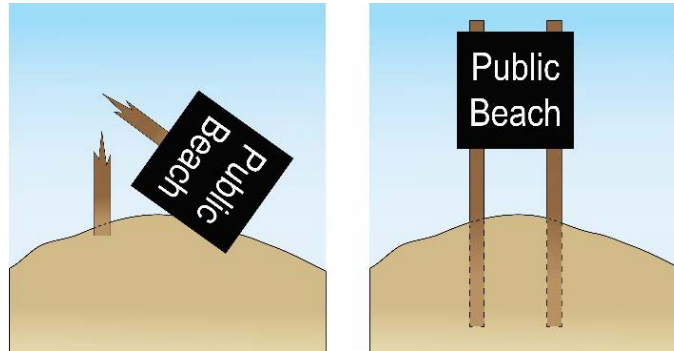

Figure 1.5.4. Increase sign connectors and pole embedment depth. Left image is before mitigation occurs. Right image is after mitigation occurs.

- Sign poles must be properly embedded or supported on engineered foundations to avoid overturning or collapse.
- Depth of embedment will vary based on sign height, width, and type of material. State DOT regulations and state building codes should include additional information about requirements.

CONSIDERATIONS:



Option 3: Improve Foundations

Engineered sign foundations should be appropriate for the design load for the sign.

- Types of concrete foundations that might be used include drilled shafts and piles (deep foundations) or spread footings (shallow foundations).
- Typically, deep foundations could be used for large signs, critical signs, or signs expected to be subject to heavy wind or debris loads.
- Screw-in helical anchors consist of a pipe or tube shaft and round helix plates typically made from galvanized steel (Figure 1.5.5).
 - They are screwed into the ground at a specified angle using rotary equipment until the design depth is reached.
 - Helical anchors are typically used for light poles, pole top-mount traffic signal supports and other small structures.
 - Helical anchors may provide a more cost-effective option to concrete drilled shafts and piles.

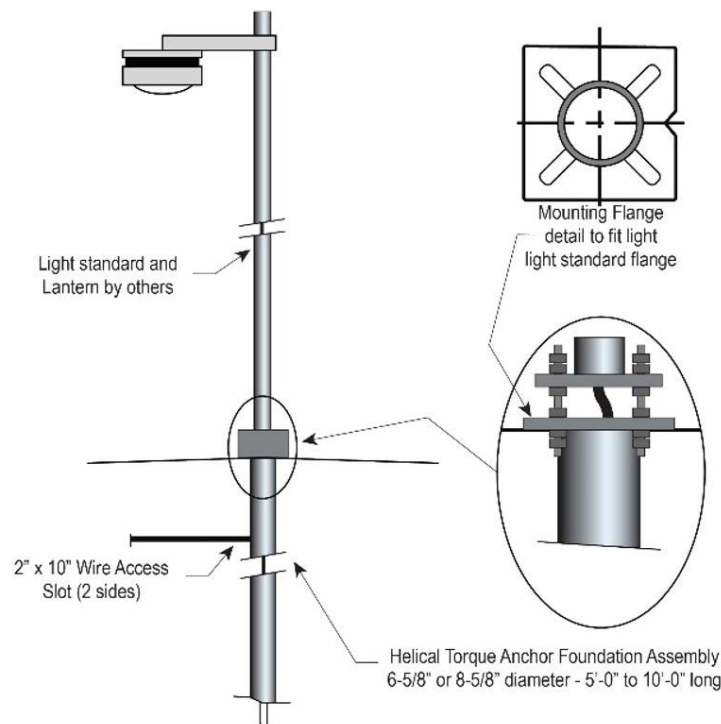

Figure 1.5.5. Helical anchors can be used as foundation support for street signs and light poles.

CONSIDERATIONS:



REFERENCES:

AASHTO LRFDLTS, *Standard Specifications for Structural Supports for Highway Signs, Luminaries, and Traffic Signals* (current edition).

Federal Emergency Management Agency. 2007. FEMA P-543, *Design Guide for Improving Critical Facility Safety from Flooding and High Winds: Providing Protection to People and Buildings*. Available at: https://www.fema.gov/sites/default/files/2020-08/fema543_design_guide_complete.pdf

State Building Codes.

State Department of Transportation Geotechnical Manuals.

State Department of Transportation Traffic Sign Design Manuals.

Fact Sheet 2.0: Water Control Facilities

The mitigation objective of this Fact Sheet series is to protect lives and property by effectively controlling the flow of water retained in impoundments and flowing through channels

Hurricane and Flood Mitigation

Public water control facilities help to control the flow of water by retaining or directing it to protect lives and property. Under Presidential Policy Directive 21 (PPD 21), the National Infrastructure Protection Plan (NIPP), water control facilities are one of sixteen critical infrastructure sectors. They can be used to provide hydroelectric power generation, habitats for wildlife, inland passage for barges and ships, irrigation, and recreation opportunities such as boating, swimming, and fishing. They also support other critical infrastructure sectors. The water control facilities discussed in this section of the handbook include channels, aqueducts and canals, basins and dams. Levees are another type of water control facility, but because they generally are the responsibility of USACE, they are not discussed in this fact sheet series. Additional information about levee maintenance and mitigation is available on the USACE website.

Hurricanes and floods can adversely impact water control facilities when inundation, overtopping, erosion, scour, or debris impact structures. Inundation from storm surge and heavy rains may exceed the capacity of the structures, resulting in overtopping and breaches. Flowing water can cause erosion and scour, which can lead to overtopping or undermining of the structures, or seepage through the structures. Floodwaters can carry large quantities of sediment and debris which can clog drainage structures and canals, resulting in overtopping.

Mitigation Fact Sheets

This section of the handbook groups water control facilities into three Fact Sheets. Some features presented, such as armoring, are relevant to other public facilities and may be referenced in other Fact Sheets in the handbook. The three Water Control Facilities Fact Sheets are as follows:

- **2.1 Channels, Aqueducts, and Canals** can be earthen or lined with materials such as concrete or stone (Figure 2.0.1). These inland conveyance structures collect, carry, and distribute water for purposes such as irrigation, transportation, and water supply.



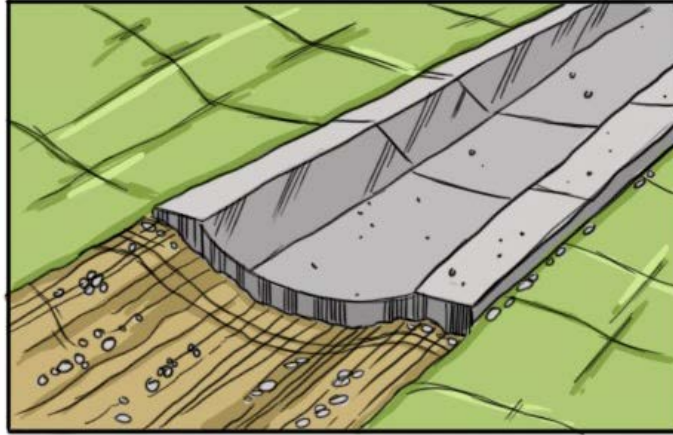

Figure 2.0.1. Channels, aqueducts and canals collect, carry, and distribute water.

- **2.2 Basins** are in-ground structures that hold water (Figure 2.0.2). Basins collect stormwater that can be used immediately or released as needed, help sediment settle out of water before it is used for drinking purposes, or direct and control water flow.
- **2.3 Dams and Reservoirs** – Dams can be earthen or “hard” materials such as concrete. Dams retain water in basins behind them, such as reservoirs, and control the release of water downstream (Figure 2.0.3).

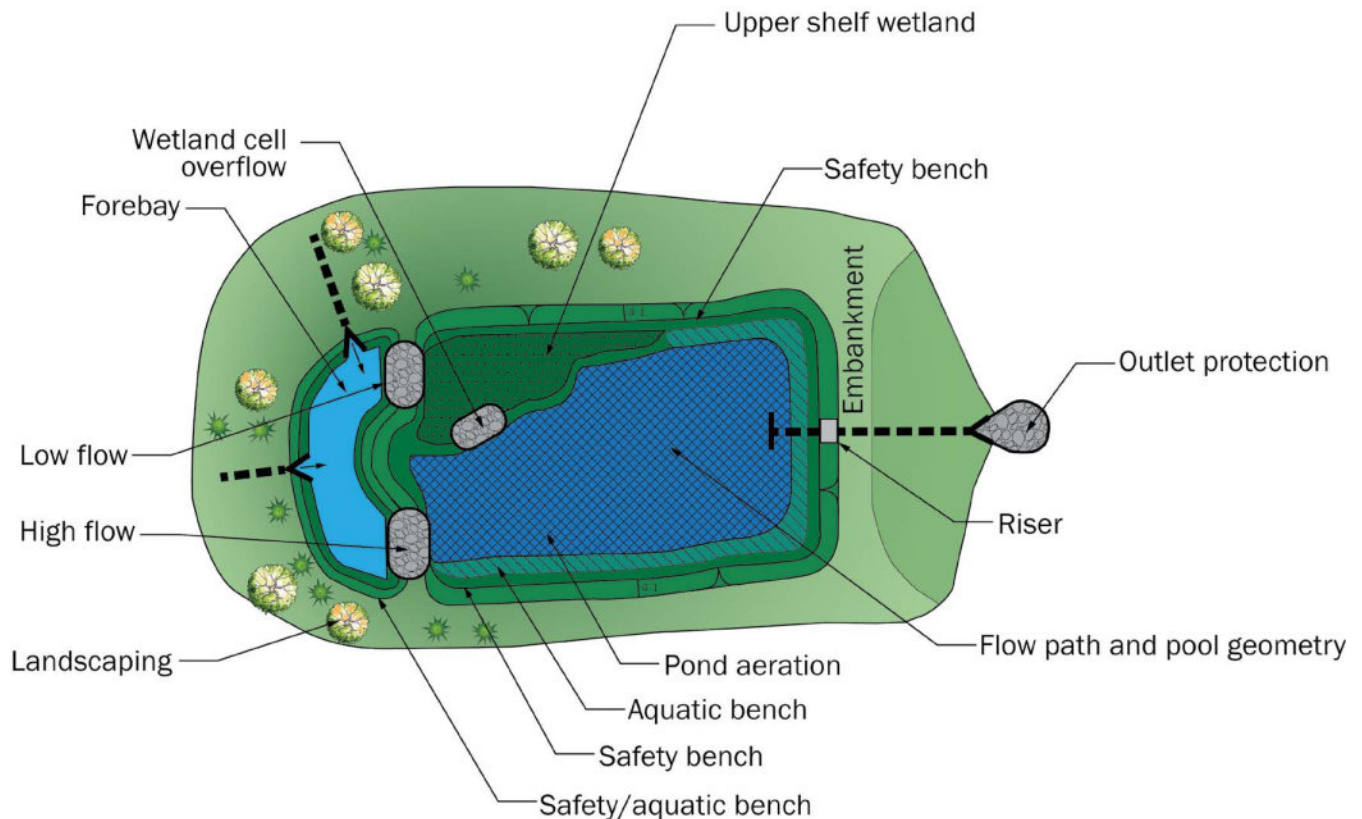

Figure 2.0.2. Basins are in-ground structures used to hold water.

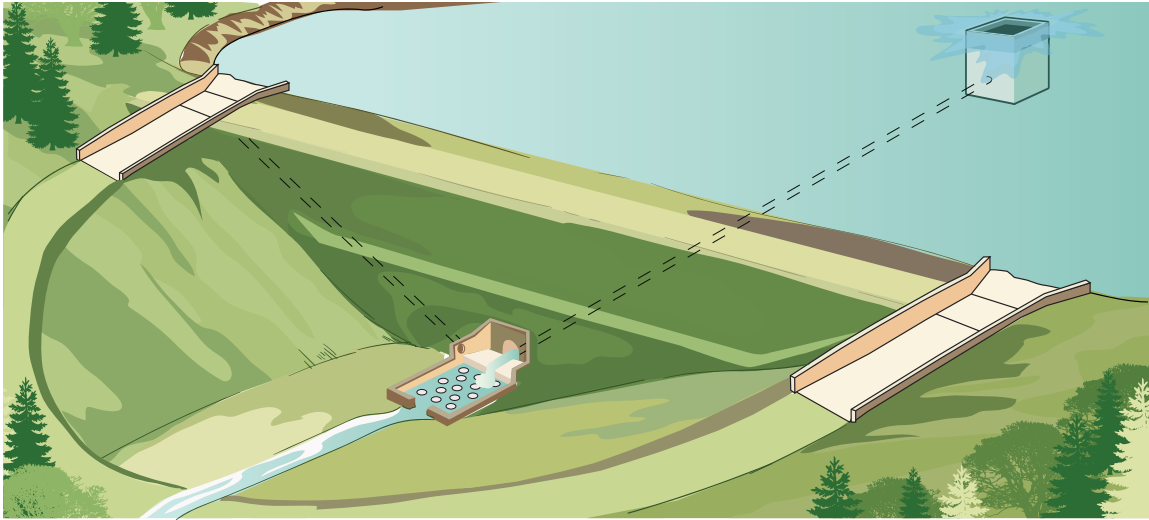

Figure 2.0.3. Dams are used to retain and control the flow of water.

Mitigation Strategies

Water control facilities must remain in operation during severe flooding events, such as those caused by hurricanes and severe rainstorms. Structurally retrofitting these structures can improve their resilience by increasing their stability and capacity, controlling seepage and erosion, and lessening debris impacts. The applicable mitigation measures may depend on project constraints such as the availability of land, materials, and environmental requirements. There are many potential mitigation strategies that can be employed, including:

- Armoring or lining
- Improving slope or bank stability
- Increasing height or freeboard
- Increasing capacity of spillways and other structures
- Installing or improving drainage systems
- Installing gates and valves
- Installing screens
- Realigning channels and structures
- Using bioengineering strategies (e.g., seeding, erosion control mats)
- Deepening or dredging
- Using clay cores
- Installing sheet piles
- Pressure grouting

In addition to structural mitigation measures, implementing non-structural measures is also often essential to safe and efficient operation of water control facilities. Non-structural measures are generally cost-effective compared with structural measures because the latter often require large capital investments. Non-structural measures are generally included in a safety program for such facilities, and may include:

- Implementing a surveillance and monitoring program
- Preparing and regularly updating an emergency action plan







Non-Structural Mitigation for Safety of Dams and Reservoirs

A good resource for guidance on non-structural mitigation and resilience measures for dams and reservoirs may be found at the Association of State Dam Safety Officials (ASDSO) website (www.damsafety.org). Specific guidance on Emergency Action Plans is given at <https://damsafety.org/dam-owners/emergency-action-planning#Rerces>.

Icons

The fact sheets include ideas/points to consider about developing and starting each option. Symbols/icons that represent these common considerations are summarized in Table 2.0.1.

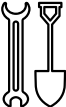
Table 2.0.1. Icons Used to Represent Considerations about Hazard Mitigation Strategies

Icon	<i>Considerations about Hazard Mitigation Strategies</i>
	Cost – The cost to carry out the mitigation option may be high, which could make using the option cost prohibitive.
	Engineering – A qualified engineer would likely need to design the mitigation option.
	Environmental and Historic Preservation – The mitigation option likely will need to comply with local, state and/or federal environmental and historic preservation requirements.
	Floodplain Management – Carrying out the mitigation option might impact the floodplain, triggering compliance with floodplain management requirements.
	Operations and Maintenance – The mitigation option might require additional operations and maintenance activities beyond those currently being performed.
	Permitting – Evaluate the local, state or federal permits required to carry out the mitigation option.

REFERENCES:

Recommended practice and guidance concerning listed topics can be found in the following publications and trade publications:

Bryant, S.D., and C.D. Jewell. 1996. *Analysis of Siphon Lake Drain Performance for a Small Earthen Dam*, Association of State Dam Safety Officials 1996 Annual Conference Proceedings.

Clemson Cooperative Extension. 2020. *Stormwater Pond Design, Construction and Sedimentation*. Available at: <https://www.clemson.edu/extension/water/stormwater-ponds/problem-solving/construct-repair-dredge/index.html>

Federal Emergency Management Agency (FEMA). Prepared by Interagency Committee on Dam Safety 1979. Reprinted 2004. FEMA 93, *Federal Guidelines for Dam Safety*. Available at: https://www.fema.gov/sites/default/files/2020-08/fema_dam-safety_P-93.pdf.

Federal Emergency Management Agency (FEMA). 2001. *Flood Hazard Mitigation Handbook for Public Facilities*. Available at: <https://www.hSDL.org/?abstract&did=34754>

Federal Emergency Management Agency (FEMA). 2005. *FEMA 511, Reducing Damage from Localized Flooding*. Available at: <https://www.fema.gov/pdf/fima/FEMA511-complete.pdf>.

Federal Emergency Management Agency (FEMA). 2011. FEMA 10, *Filters for Embankment Dams, Best Practices for Design and Construction*. Available at: <https://www.hSDL.org/?abstract&did=696738>

Federal Emergency Management Agency (FEMA). 2012. FEMA P-919, *Summary of Existing Guidelines for Hydrologic Safety of Dams*. Available at: <https://www.fema.gov/media-library/assets/documents/28555>.

Federal Emergency Management Agency (FEMA). 2013. FEMA P-94, *Selecting and Accommodating Inflow Design Floods for Dams*. Available at: https://www.fema.gov/sites/default/files/2020-08/fema_dam-safety_inflow-designs_P-94.pdf.

Federal Emergency Management Agency (FEMA). 2014. FEMA P-1015, *Technical Manual: Overtopping Protection for Dams, Best Practices for Design, Construction, Problem Identification and Evaluation, Inspection, Maintenance, Renovation, and Repair*. Available at: <https://www.fema.gov/emergency-managers/risk-management/dam-safety/publications>.

Federal Highway Administration. 2006. *Hydraulic Design of Energy Dissipators for Culverts and Channels, Hydraulic Engineering Circular Number 14 (HEC 14), Third Edition*. Available at: <https://www.fhwa.dot.gov/engineering/hydraulics/pubs/06086/heC14.pdf>.

International Code Council. 2018. *International Plumbing Code*. Available at: <https://codes.iccsafe.org/content/IPC2018P3>.

Li, Yuchen, Zhou, Zhiyong, Li, Zhengnong. 2006. "Equivalent Along-Wind Loads of Aqueduct Bridges." *The Fourth International Symposium on Computational Wind Engineering*. Available at: <https://citeseerx.ist.psu.edu/viewdoc/download?doi=10.1.1.1041.2984&rep=rep1&type=pdf>

Miller, C.F. and J.A. Dickerson. 1999. *The Use of Native Warm Season Grasses for Critical Area Stabilization*. Available at: <http://citeseerx.ist.psu.edu/viewdoc/download?doi=10.1.1.631.944&rep=rep1&type=pdf>.

U.S. Army Corps of Engineers. 1989. *Retaining and Flood Walls, EM 1110-2-2502*. Available at: https://www.publications.usace.army.mil/portals/76/publications/engineermanuals/em_1110-2-2502.pdf.

- U.S. Army Corps of Engineers. 1992. *Design, Construction, and Maintenance of Relief Wells, EM 1110-2-1914*. Available at: https://www.publications.usace.army.mil/Portals/76/Publications/EngineerManuals/EM_1110-2-1914.pdf.
- U.S. Army Corps of Engineers. 1994. *Standard Practice for Concrete for Civil Works Structures, EM 1110-2-2000*. Available at: https://www.publications.usace.army.mil/Portals/76/Publications/EngineerManuals/EM_1110-2-2000.pdf.
- U.S. Army Corps of Engineers. 1995(a). *Engineering and Design Structural Design of Concrete Lines Flood Control Channels (EM 1110-2-2007)*. Available at: <https://www.cedengineering.com/userfiles/Structural%20Design%20of%20Concrete%20Lined%20Flood%20Control%20Channels.pdf>.
- U.S. Army Corps of Engineers. 1995(b). *Construction Control for Earth and Rock-fill Dams, EM 1110-2-1911*. Available at: https://www.publications.usace.army.mil/Portals/76/Publications/EngineerManuals/EM_1110-2-1911.pdf.
- U.S. Army Corps of Engineers. 2004. *Engineering and Design - General Design and Construction Considerations for Earth and Rock-Fill Dams, EM 1110-2-2300*. Available at: https://www.publications.usace.army.mil/Portals/76/Publications/EngineerManuals/EM_1110-2-2300.pdf.
- U.S. Department of Agriculture, Natural Resources Conservation Service (NRCS). August 1997. Revised March 2001. *National Engineering Handbook (NEH), Part 628 – Dams, Chapter 52 Field Procedures Guide for the Headcut Erodibility Index*. Available at: <https://directives.sc.egov.usda.gov/OpenNonWebContent.aspx?content=36147.wba>.
- U.S. Department of Agriculture, Natural Resources Conservation Service (NRCS). 2000. *Conservation Practice Standard, Pond, Code 378*. Available at: https://www.nrcs.usda.gov/Internet/FSE_DOCUMENTS/stelprdb1046898.pdf.
- U.S. Department of Agriculture, Natural Resources Conservation Service (NRCS). 2014. *National Engineering Handbook (NEH), Part 628 – Dams, Chapter 50 Earth Spillway Design*. Available at: <https://directives.sc.egov.usda.gov/OpenNonWebContent.aspx?content=35546.wba>.
- U.S. Department of Agriculture, Natural Resources Conservation Service (NRCS). 2014. *Watershed Rehabilitation Program*. Available at: https://www.nrcs.usda.gov/wps/portal/nrcs/detail/ga/programs/planning/wr/?cid=nrcs144p2_021811.
- U.S. Department of Agriculture, U. S. Forest Service. 2012. *Assessing Dams and Impoundments: A Beginner's Guide*. Available at: <https://www.fs.fed.us/eng/dams/olt/index.html#!27-problems>
- U.S. Department of the Interior, Bureau of Reclamation (USBR). 1987. *Design of Small Dams, A Water Resources Technical Publication, Third Edition*. Available at: http://www1.frm.utn.edu.ar/laboratorio_hidraulica/Biblioteca_Virtual/Desing%20of%20small%20dams/SmallDams.pdf.
- U.S. Department of the Interior, Bureau of Reclamation (USBR). 2012(a). *Best Practices for Preparing Concrete Surfaces Prior to Repairs and Overlays, Report No. MERL 12-17*. Available at: https://www.usbr.gov/research/projects/download_product.cfm?id=446.
- U.S. Department of the Interior, Bureau of Reclamation (USBR). 2012(b). *Embankment Dams, Chapter 10: Embankment Construction (Design Standards No. 13 (DS-13(10)-16: Phase 4 - Final))*. Available at: <https://www.usbr.gov/tsc/techreferences/designstandards-datacollectionguides/finalds-pdfs/DS13-10.pdf>.

- U.S. Department of the Interior, Bureau of Reclamation (USBR). 2012(c). *Embankment Dams, Chapter 6: Freeboard* (Design Standards No. 13 (DS-13(6)-2: Phase 4 - Final)). Available at: <https://www.usbr.gov/tsc/techreferences/designstandards-datacollectionguides/finalds-pdfs/DS13-6wMIR.pdf>.
- U.S. Department of the Interior, Bureau of Reclamation (USBR). 2012(d). *Overtopping protection for dams - a technical manual overview, Report Number PAP-1093*. Available at: https://www.usbr.gov/tsc/techreferences/hydraulics_lab/pubs/PAP/PAP-1093.pdf. (Note: Paper giving overview of FEMA P-1015.)
- U.S. Department of the Interior, Bureau of Reclamation (USBR). 2014(a). *Embankment Dams, Chapter 7: Riprap Slope Protection* (Design Standards No. 13 (DS-13(7)-2.1: Phase 4 - Final)). Available at: <https://www.usbr.gov/tsc/techreferences/designstandards-datacollectionguides/finalds-pdfs/DS13-7.pdf>.
- U.S. Department of the Interior, Bureau of Reclamation (USBR). 2014(b). *Embankment Dams, Chapter 16: Cutoff Walls* (Design Standards No. 13 (DS-13(16)-14: Phase 4 - Final)). Available at: <https://www.usbr.gov/tsc/techreferences/designstandards-datacollectionguides/finalds-pdfs/DS13-16.pdf>.
- U.S. Department of the Interior, Bureau of Reclamation (USBR). 2014(c). *Appurtenant Structures for Dams (Spillways and Outlet Works) Design Standard, Chapter 3: General Spillway Design Considerations*. Available at: <https://www.usbr.gov/tsc/techreferences/designstandards-datacollectionguides/finalds-pdfs/DS14-3.pdf>.
- U.S. Department of the Interior, Bureau of Reclamation (USBR). 2015. *Guide to Concrete Repair, Second Edition*. Available at: https://www.usbr.gov/tsc/techreferences/mands/mands-pdfs/Guide2ConcreteRepair2015_Final.pdf.
- U.S. Department of the Interior, Bureau of Reclamation (USBR). 2017. *Design and Construction Considerations for Hydraulic Structures, Roller-Compacted Concrete*. Available at: <https://www.usbr.gov/tsc/techreferences/mands/mands-pdfs/RCCManualFinal09-2017-508.pdf>.
- U.S. Department of the Interior, Fish and Wildlife Service. 2008. *Low Hazard Dams, Standing Operating Procedures*. Available at: <https://damsafety.org/sites/default/files/files/US%20Fish%20And%20Wildlife%20Service%20SOP.pdf>.
- Virginia Department of Conservation and Recreation. 1999. *Virginia Stormwater Management Handbook, Volume 1, First Edition*. Available at: <https://sswm.info/node/4737>
- Virginia Department of Conservation and Recreation. 2013(a). *Bioretention, Stormwater Design Specification No. 9*. Available at: https://www.swbmp.vwrrc.vt.edu/wp-content/uploads/2017/11/BMP-Spec-No-9_BIORETENTION_v1-9_03012011.pdf.
- Virginia Department of Conservation and Recreation. 2013(b). *Constructed Wetlands, Stormwater Design Specification No. 13*. Available at: https://swbmpvwrrc.wp.prod.es.cloud.vt.edu/wp-content/uploads/2018/07/BMP_Spec_No_13_CONSTRUCTED_WETLAND.pdf.
- Virginia Department of Conservation and Recreation. 2013(c). *Dry Swales, Stormwater Design Specification No. 10 Dry Swales*. Available at: http://chesapeakestormwater.net/wp-content/uploads/downloads/2012/02/DCR-BMP-Spec-No-10_DRY-SWALE_Final-Draft_v1-9_03012011.pdf.
- Virginia Department of Conservation and Recreation. 2013(d). *Extended Definition (ED) Pond, Stormwater Design Specification No. 15*. Available at: https://swbmpvwrrc.wp.prod.es.cloud.vt.edu/wp-content/uploads/2017/11/BMP-Spec-No-15_EXT-DETENTION-POND_v1-9_03012011.pdf.

Virginia Department of Environmental Quality (VA DEQ). 2011. *Introduction to the New Virginia Stormwater Design Specifications, Appendix B: Principal Spillway, Version 1.0*. Available at: https://www.swbmp.vwrrc.vt.edu/wp-content/uploads/2017/11/Introduction_App-B_Principal-Spillways_03012011.pdf.

Zhang, H, L. Liu, X. He, and A. Ji. 2018. *Investigation of Wind-Induced Response of Fluid-Solid Coupling System for High Bent-Type Aqueduct*. Available at: http://scientiainica.sharif.edu/article_4531_7483da16edab09fa478789cfb4411c0b.pdf.

Fact Sheet 2.1: Channels, Aqueducts, and Canals

The mitigation objective of this Fact Sheet is to ensure that channels, aqueducts and canals can meet their purpose in flooded conditions and maintain the movement of water for flood protection, drainage, irrigation, and water supply.

Channels and canals are artificial structures that use gravity to convey water for flood protection, drainage, irrigation, water supply or other purposes. Aqueducts are any system of pipes, ditches, canals, tunnels, and other structures used to convey water.

Table 2.1.1 summarizes some common mitigation strategies for reducing the vulnerability of channels, aqueducts and canals to hurricanes and flooding.

Table 2.1.1. Channel, Aqueduct and Canal Mitigation Solution

Solutions and Options	Erosion	Channel incision/migration	Slope issues	Debris damage	Clogging/turbidity/contamination	Washout/movement of structures
Mitigation Solution: Armor Channels and Canals						
Option 1: Armor Channels and Canals	✓	✓	✓			
Mitigation Solution: Stabilize Channels and Canals						
Option 1: Stabilize Channel and Canal Bottoms and Slopes	✓	✓	✓			
Mitigation Solution: Lessen the Energy of Flood Flow						
Option 1: Install Energy Dissipation Features	✓	✓	✓			✓
Option 2: Realign or Widen Channels and Canals	✓	✓	✓			✓



Solutions and Options	Erosion	Channel incision/migration	Slope issues	Debris damage	Clogging/turbidity/contamination	Washout/movement of structures
Mitigation Solution: Prevent Pipe and Tunnel Issues						
Option 1: Plan for and Handle Intake Issues				✓	✓	
Option 2: Consider Distribution Issues					✓	
Option 3: Avoid Structural Issues				✓		✓

Definitions

Bankfull—Conditions where the structure is filled to design capacity during high water or flood events.

Aqueduct—Any system of pipes, ditches, canals, tunnels and other structures used to convey water.

Mitigation Solution: Armor Channels and Canals

Option 1: Armor Channels and Canals with Concrete

Erosion and scour from flood flow can damage earthen channels and canals such as irrigation canals and drainage ditches. Armoring them can protect against this damage. Pumping or spraying cement concrete mixtures (such as shotcrete or gunite) over steel reinforcement are common methods used to armor a channel or canal Figure 2.1.1.

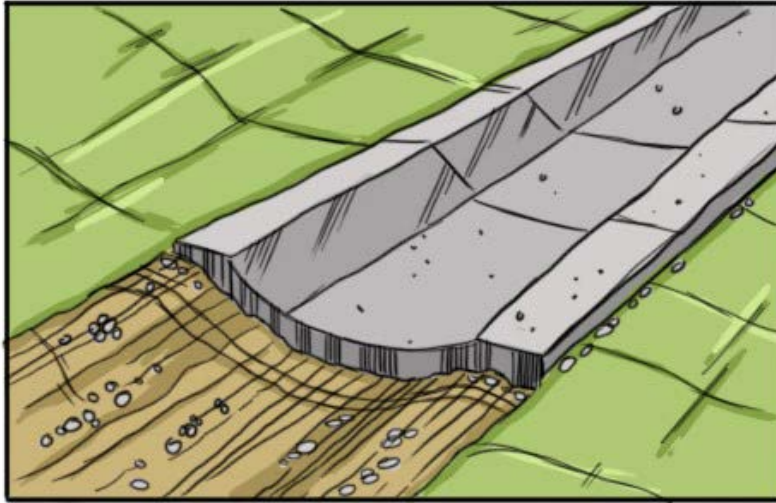

Figure 2.1.1. Concrete lining of a channel.

When evaluating this option, keep these considerations in mind:

- Prevent erosion and scour under the cement slabs by using integrated cutoff walls.
- Lessen the pressure from groundwater underneath lined channels and prevent foundation soil from entering the channel by adding graded filters.

CONSIDERATIONS:



Mitigation Solution: Stabilize Channels and Canals

Option 1: Stabilize Channel and Canal Bottoms and Slopes

Stabilizing channel and canal bottoms and slopes will minimize scour and erosion from flood flows. There are several tools to do this:

- Articulating concrete block (ACB): stabilizes channel and canal bottoms that experience open flow Figure 2.1.2.

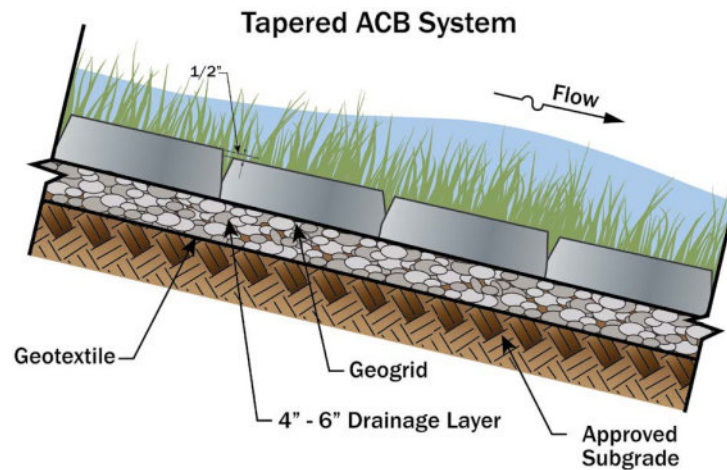

Figure 2.1.2. Typical ACB cross-section.

- Riprap: is used extensively on channel and canal slopes (Figure 2.1.3)

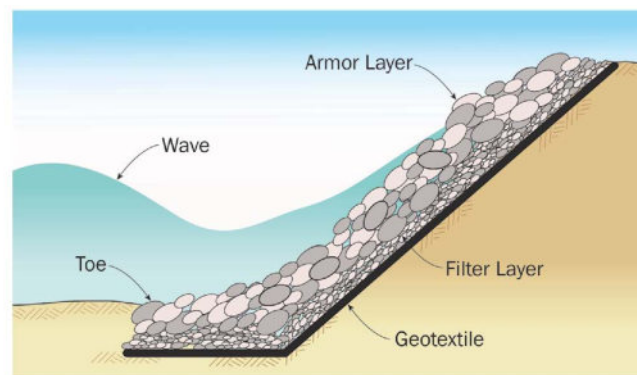

Figure 2.1.3. Typical cross-section of slope protection.

Bioengineered slope and bottom protection: uses vegetation or a combination of vegetation and construction materials such as live fascines, vegetated geogrids, live crib walls, brush mattresses and root wads

CONSIDERATIONS:



Mitigation Solution: Lessen the Energy of Flood Flow

Option 1: Install Energy Dissipation Features

Energy dissipation features, including baffles, stilling basins, drop structures, etc., can slow the movement of flood flow along a channel or canal, which lessens the water's energy and helps minimize scour and erosion (Figure 2.1.4). Supplementary structures such as weirs, tunnels, culverts, siphons, chutes, and sediment or debris basins may be needed to accommodate existing infrastructure (such as roads, bridges, etc.) and maintain ideal flow conditions.



Figure 2.1.4. Energy dissipators such as stone drop structures can help slow the movement of water to decrease erosion and scour.
(NRCS, No Date)

Option 2: Realign or Widen Channels and Canals

To improve flow and minimize erosion and scour, realigning or widening a channel or canal can reduce flood flow's energy and increase capacity to prevent overtopping and erosion. See Fact Sheet 1.3, *Drainage and Culverts*, for additional information about realigning channels and canals to direct flow away from the embankments to reduce erosion.

CONSIDERATIONS:



Mitigation Solution: Prevent Pipe and Tunnel Issues

Option 1: Plan for and Handle Intake Issues

One of the most common issues with structures designed to move water is clogging from silt or debris. Some clogging is from normal wear and tear on the system, but clogging can be an enormous issue after a storm. It can get worse if maintenance of these structures is not done regularly. An operations and maintenance plan should be developed to list inspection and maintenance activities. At a minimum, the plan should include the following activities:

- Inspect the entire length of the channel or canal (including structures and joints)
- Document clogging or debris damage
- Check and unclog sub-drainage systems
- Remove debris
- Repair damaged armoring or stabilization systems

Prevent intake structures from clogging by using screens, barriers or diverters that filter sediment and block or divert debris so these materials cannot cause a clog. Install backflow valves on pipe systems also to ensure that water, sediment and debris do not backflow through the system.

Option 2: Consider Distribution Issues

When large amounts of flood flow hit a channel, canal or aqueduct system, the result can be increased turbidity, which lowers the water quality in the system. Since the purpose of these structures is to distribute water throughout a system, this can create a problem when the water being distributed is poor quality or contaminated.

To handle this problem, consider upsizing the circumference of pipes, channels, canals or culverts in the system to decrease turbidity and maintain better water quality.

Option 3: Avoid Structural Issues

Flood flows can cause structural issues for channel, canal, and aqueduct systems in the following ways:

- Debris impacts
- Tank movement
- Washout of underground piping, accessories, or culverts
- Flooding of pump stations

Anchoring all components that might be subject to movement or washout mitigates structural issues by creating barriers or diverters to protect against debris impact and raising or floodproofing pump stations above flooding.

CONSIDERATIONS:



REFERENCES:

- Federal Emergency Management Agency (FEMA). 2001. *Flood Hazard Mitigation Handbook for Public Facilities*. Available at: <https://www.hSDL.org/?abstract&did=34754>
- Federal Emergency Management Agency (FEMA). 2005. *FEMA 511, Reducing Damage from Localized Flooding*. Available at: <https://www.fema.gov/pdf/fima/FEMA511-complete.pdf>.
- Federal Highway Administration (FHWA). 2006. *Hydraulic Design of Energy Dissipators for Culverts and Channels, Hydraulic Engineering Circular Number 14 (HEC 14), Third Edition*. Available at: <https://www.fhwa.dot.gov/engineering/hydraulics/pubs/06086/heC14.pdf>.
- U.S. Army Corps of Engineers (USACE). 1995. *Engineering and Design Structural Design of Concrete Lined Flood Control Channels (EM 1110-2-2007)*. Available at: <https://www.cedengineering.com/userfiles/Structural%20Design%20of%20Concrete%20Lined%20Flood%20Control%20Channels.pdf>.
- U.S. Department of Agriculture, Natural Resources Conservation Service (NRCS). No Date. *Stream Corridor Restoration Treatment and Practices*. Available at: https://www.nrcs.usda.gov/wps/portal/nrcs/detailfull/?cid=nrcs143_009158
- U.S. Department of the Interior, Bureau of Reclamation (USBR). 1978. *Small Canals*. Available at: <https://www.usbr.gov/tsc/techreferences/mands/mands-pdfs/SmallCanals.pdf>
- Zhang, H, L. Liu, X. He, and A. Ji. 2018. Investigation of Wind-Induced Response of Fluid-Solid Coupling System for High Bent-Type Aqueduct. Available at: http://scientiainica.sharif.edu/article_4531_7483da16edab09fa478789cfb4411c0b.pdf.

Fact Sheet 2.2: Basins

The mitigation objective of this Fact Sheet is to reduce flooding and contamination below stormwater management facilities due to flood conditions.

Basins are generally used to collect stormwater and release it at a controlled rate to prevent flooding and erosion. Some basins can also filter some pollutants out of the water before it enters the storm drain system. Table 2.2.1 summarizes some common mitigation solutions that can improve the performance of these basins.

Table 2.2.1. Basin Mitigation Solutions

Solutions and Options	Stormwater Basins	Bioretention Areas	Dry Swales	Wet Ponds	Extended Detention Ponds
Option 1: Install Riprap	✓		✓	✓	✓
Option 2: Install Screens	✓	✓	✓	✓	✓
Option 3: Add Vegetation	✓	✓	✓	✓	✓
Option 4: Strengthen Riser	✓	✓		✓	✓
Option 5: Increase Capacity				✓	✓

Stormwater Basins

Stormwater basins must remain stable and intact during severe flooding events such as hurricanes and severe storms. These structures typically fail during severe storm events when overwhelmed by flood volumes that exceed the facility's design capacity or by defects or lack of maintenance that result in reduced storage capacity. For these reasons, mitigation for stormwater basins can be a beneficial capital investment.

- Impoundments or excavated areas are usually installed on developed sites for the short-term detention of stormwater runoff from a small watershed.
- Many on-site stormwater storage facilities were built to meet a community's development regulations.



- Determined by design, water is retained for a short period to allow pollutants to settle from the water column to the pond's bottom and then slowly release downstream at or below pre-development flow rates.
- Typical basin structure components are shown in Figure 2.2.1.

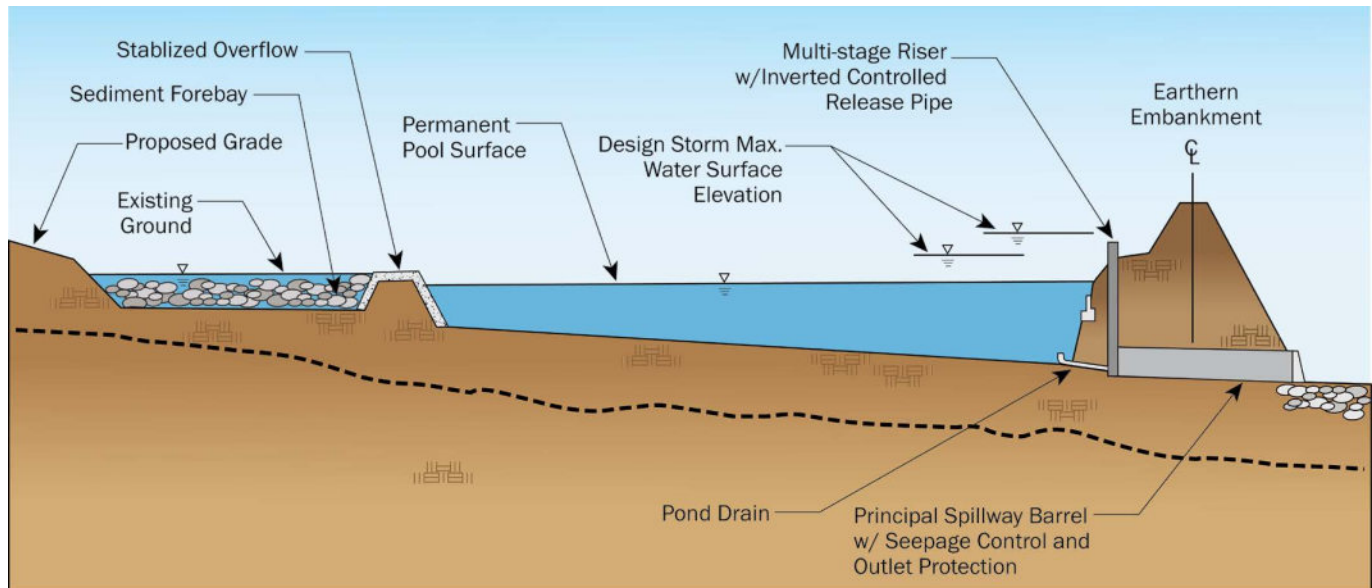

Figure 2.2.1. Typical stormwater basin cut.
(Source: Virginia Department of Conservation and Recreation, 1999)

Rural Stormwater Basins

- Many rural stormwater basins were built during the mid-late twentieth century for rural watershed flood protection and have been poorly maintained due to funding backlog. These stormwater basins are vulnerable to failure during extreme flood volumes due to reduced capacity or failure of equipment or embankment structures.

Bioretention Areas

Bioretention areas are shallow depressions lined with filter materials and topped with mulch and plantings. When functioning properly, water pools above the mulched planting area and quickly drains. Damage can occur when the filter media and underdrains become clogged and cannot properly treat and drain floodwater. Figure 2.2.2 shows a typical bioretention facility.

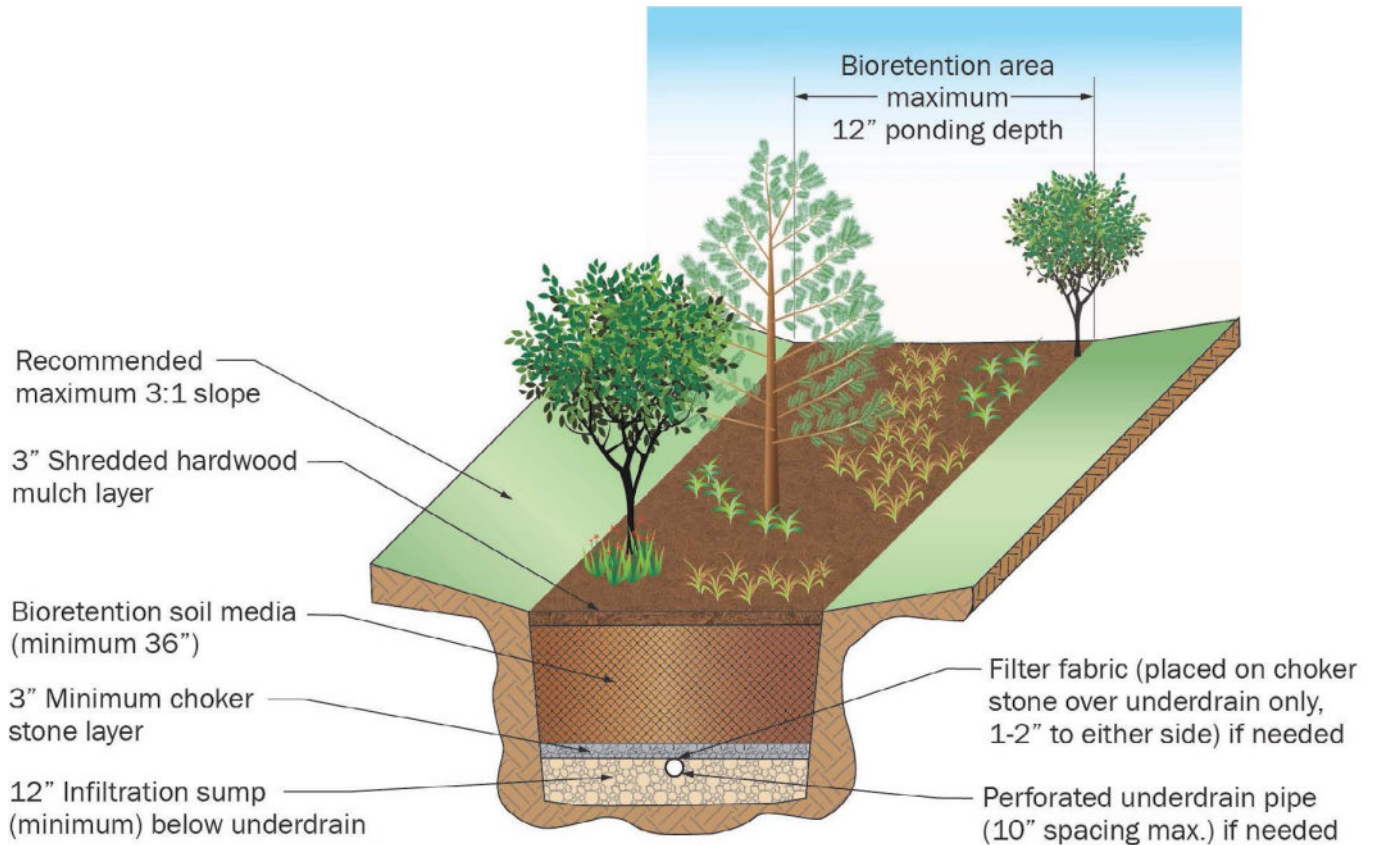

Figure 2.2.2. Typical bioretention facility.
 (Source: Virginia Department of Conservation and Recreation, 2013(a))

Dry Swales

Dry swales are very similar to bioretention facilities but are shallow, linear channels that filter water and convey runoff to specific outfalls. They also feature a soil media filter layer below the channel that directs the water into an underdrain or the underlying soils. Dry swales may include energy dissipating check dams throughout the channel. Dry swale facilities usually treat runoff from areas that are less than five acres. Figure 2.2.3 shows a typical dry swale with check dam profile.

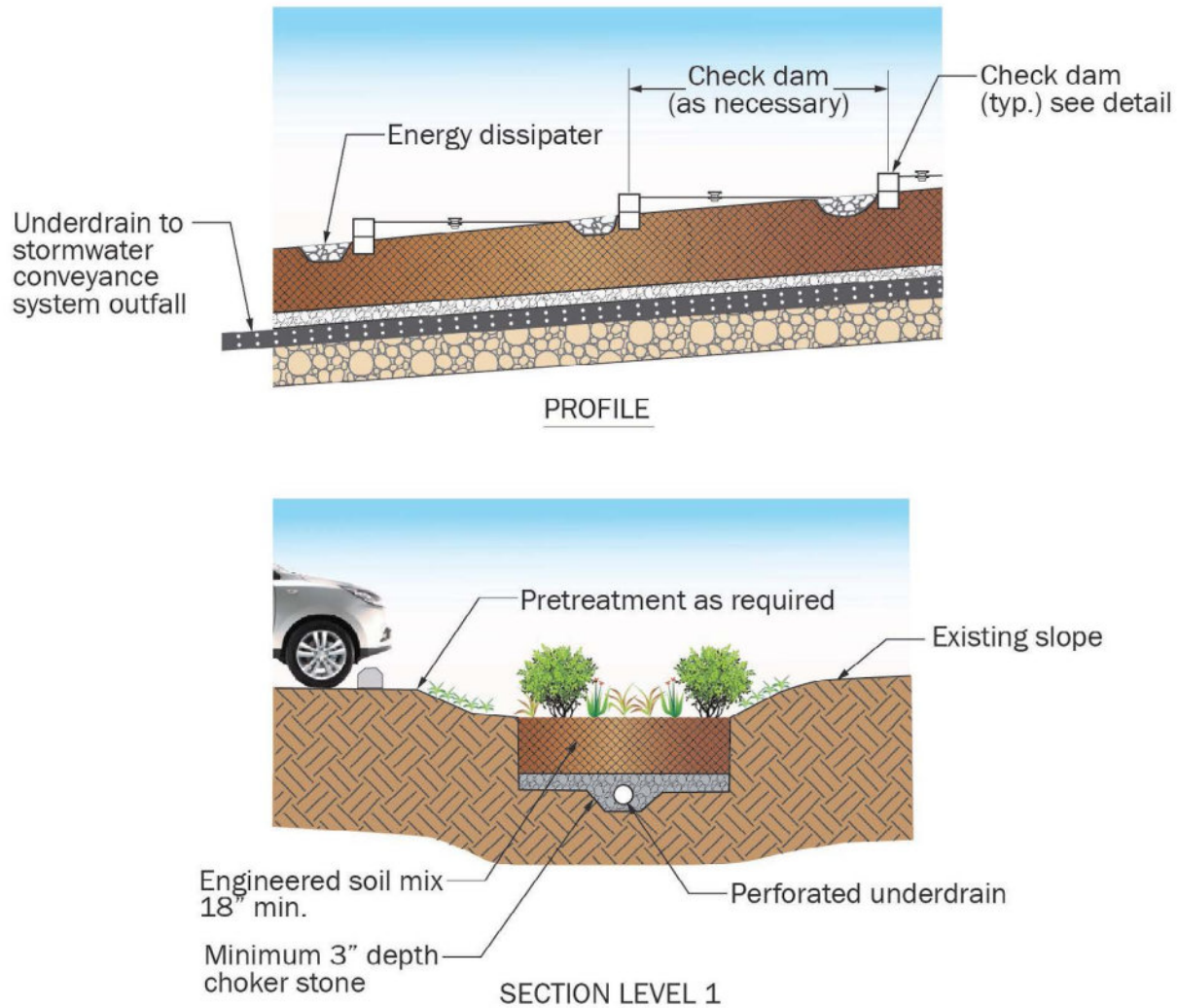

Figure 2.2.3. Typical dry swale with check dams.

Wet Ponds

Wet ponds collect and store stormwater in a permanent, on-site pond or basin which slowly releases that stormwater. Basins treat stormwater by retaining, or “holding”, runoff for a designated period (usually 24 or 48 hours) to allow pollutants like sediments, heavy metals, and nutrients to settle to the pond bottom and petroleum chemicals to be removed by biological action. Wet ponds are designed to have appropriate detention capacity for a stated storm frequency to control storm runoff long enough to mitigate water pollution and reduce the discharge out of the basin. The pond area usually is 1% to 3% of its drainage area and has between 10 to 25 acres draining to it. Figure 2.2.4 shows a typical plan view of a wet pond, and Figure 2.2.5 shows a typical section view.

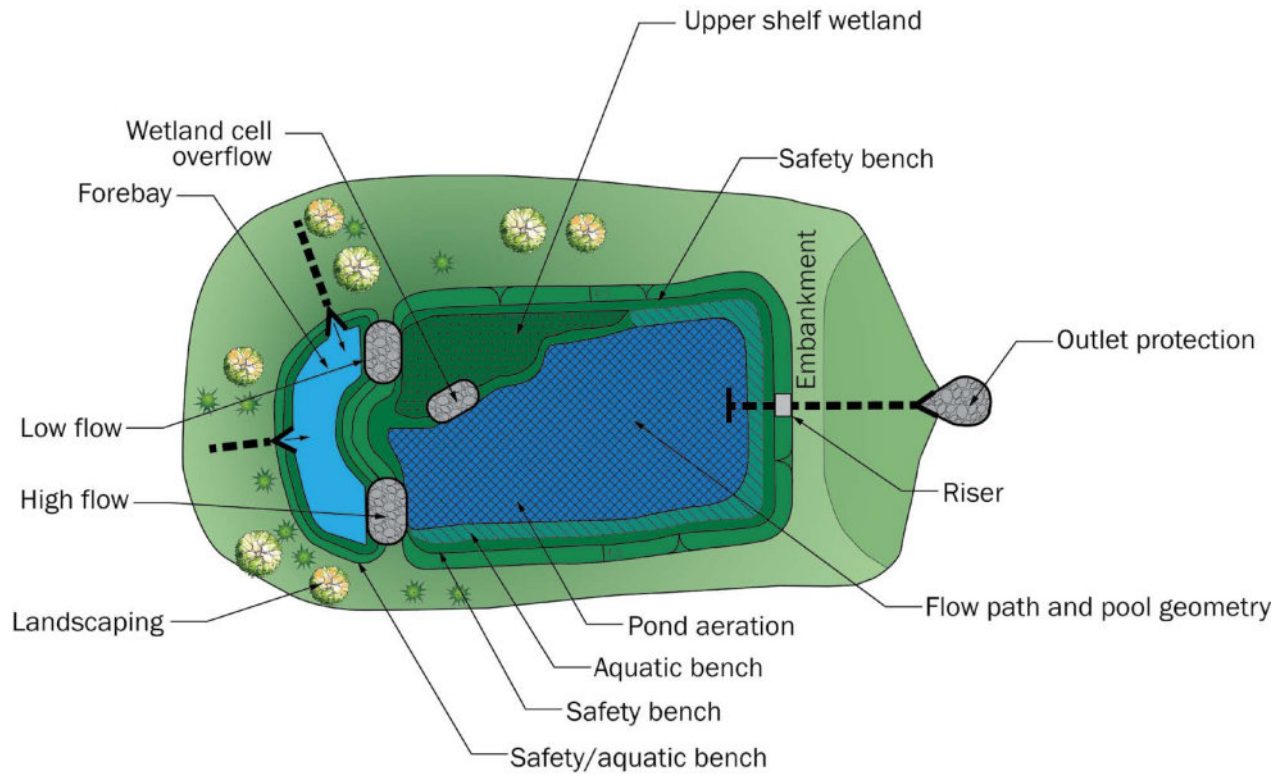

Figure 2.2.4. Wet pond plan view.

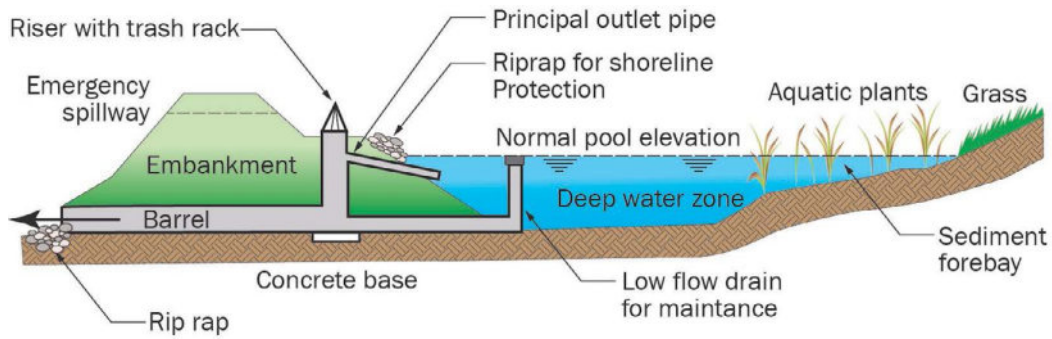

Figure 2.2.5. Wet pond section view.

Extended Detention Ponds

Extended detention ponds are a mix of wet ponds and dry ponds that store water and release it over a 24 to 48-hour period to treat pollutants and minimize downstream flood impacts. Figure 2.2.6 shows a typical plan view of an extended detention pond. These facilities have many of the same potential problems as wet ponds: erosion, sediment control, and damage to the riser. Mitigation measures are similar to Wet Ponds.

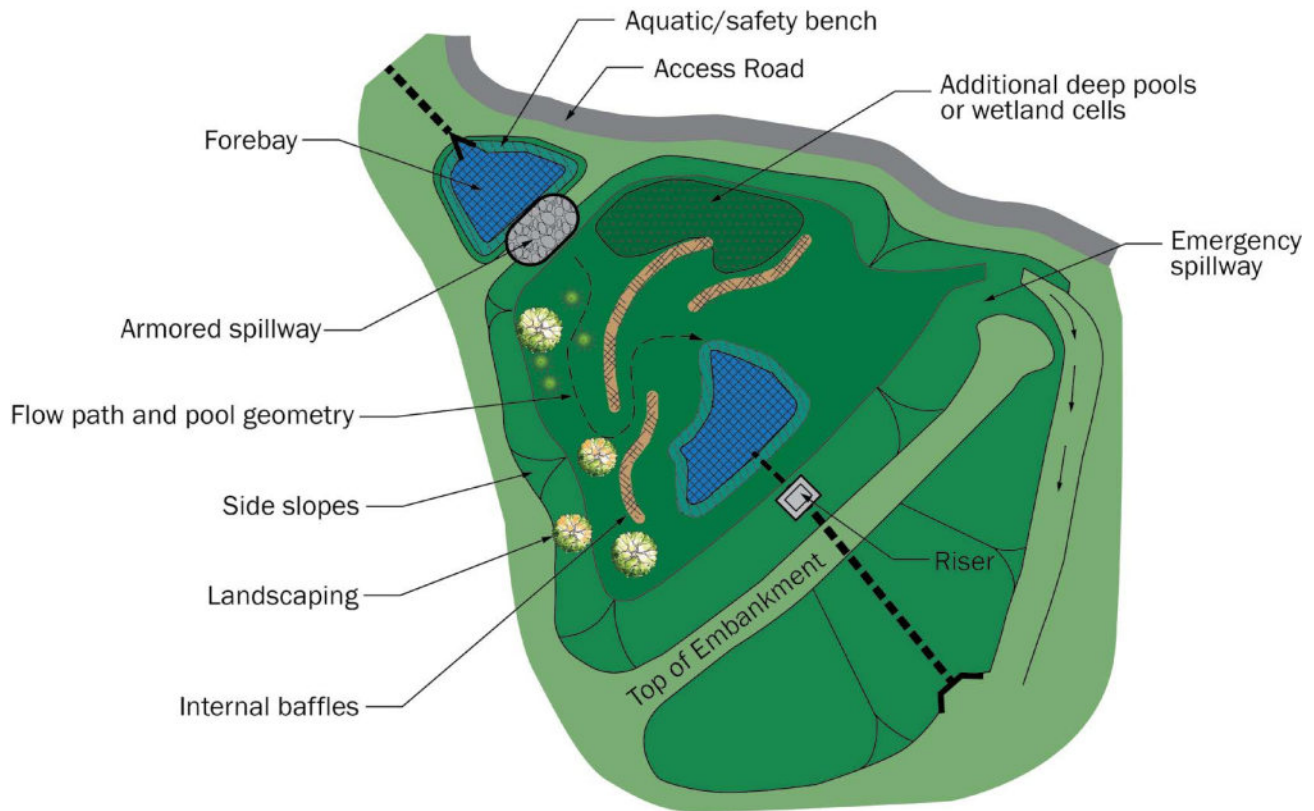

Figure 2.2.6. Extended Detention Pond.

Mitigation Solutions

Option 1: Install Riprap

Basins can be vulnerable to erosion, undercutting and scour which can lead to damage to embankments, side slopes or other components of the basin design. Riprap can be used to reinforce embankments and side slopes, inlets, outlets, overflow spillways and risers. Considerations for riprap installation include:

- Riprap is generally easy to install but may require heavy equipment; determine if site conditions will accommodate the size of equipment needed for installation.
- Riprap should be sized appropriately for the flow conditions. If riprap was present before but did not perform adequately, evaluate the size of the riprap to determine if it should be increased.
- Riprap should be placed to prevent movement of the rock resulting from the velocity and force of water.
- Protection against erosion can be enhanced by installing the riprap over a layer of geotextile fabric.
- Riprap placed immediately upstream of an inlet can help protect against small debris plugging.
- The use of riprap may preclude regrowth of riparian areas. Live stakes and fascines can be placed between riprap to improve effectiveness and foster growth of riparian areas.

CONSIDERATIONS:



Option 2: Install Screens

All basins are vulnerable to the accumulation of sediment, trash, or other debris which can lead to reduced storage or conveyance capacity. To address this issue, removing the accumulated sediment and debris is recommended in combination with installing screens to prevent future accumulation of debris. The following techniques may complement this mitigation strategy:

- Clear the underdrain pipe of clogs and the observation cleanout (if there is one).
- Install debris screens to avoid future clogging.
- These are generally inexpensive and easy to install.
- Screens require regular removal of debris to prevent clogging.
- This option can also keep inlets, outlets, and risers functioning as intended.

CONSIDERATIONS:

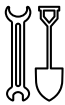

Option 3: Add Vegetation

Basins can be vulnerable to erosion which can lead to damage to embankments, side slopes or other components of the basin design. Adding vegetation can stabilize and reinforce erosion areas. Considerations for adding vegetation include:

- This option can be used alone or together with other stabilization measures.
- Minimize erosion and maintain storage capacity through the addition of vegetation to bench basin embankment areas.
- Carefully selected grasses, shrubs, and other ground cover can be effective in reducing soil erosion. Native species should be used.
- The selection and design of bioengineered embankment protection should consider the steepness of embankment, expected flow rates, and the growing season of the vegetation selected.
- Where flow velocities are of concern, anchor vegetation using stakes to hold it in place while it takes root.

CONSIDERATIONS:



Option 4: Strengthen Riser

Many basins have risers to control water flow, prevent ponding, and release water at a reduced rate. Risers can be vulnerable to spalling, joint failure, corrosion, cracks in the structure, pipe failure or other structural damage which could negatively impact their performance. Considerations when strengthening risers include:

- Repair riser damage immediately after the storm to reduce or prevent leakage.
- Repair spalling and joint damage.
- Apply an interior coating to strengthen the riser structure unless risers are perforated or slotted CMP.

CONSIDERATIONS:

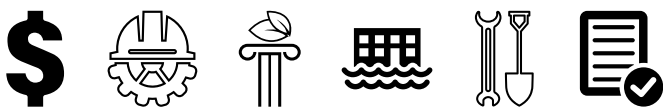

Option 5: Increase Capacity

Over time, sediment can build up in basins, limiting flood storage capacity. Increase capacity by dredging, removing sediment, expanding the footprint of the basin and removing obstructions. Considerations for increasing capacity include:

- This option is appropriate for wet ponds and extended detention ponds.
- After large rainstorms, if the storage capacity of the wet pond has been hindered because of sediment build-up, it may be appropriate to dredge the wet pond to an increased capacity.
- Dredge permanent pool every five to seven years to maintain facility storage capacity.

CONSIDERATIONS:



REFERENCES:

- Clemson Cooperative Extension. 2020. *Stormwater Pond Design, Construction and Sedimentation*. Available at: <https://www.clemson.edu/extension/water/stormwater-ponds/problem-solving/construct-repair-dredge/index.html>
- Federal Emergency Management Agency (FEMA). 2005. *FEMA 511, Reducing Damage from Localized Flooding*. Available at: <https://www.fema.gov/pdf/fima/FEMA511-complete.pdf>.
- Virginia Department of Conservation and Recreation. 1999. *Virginia Stormwater Management Handbook, Volume 1, First Edition*. Available at: https://sswm.info/sites/default/files/reference_attachments/DCR%201999.%20Virginia%20Stormwater%20Management%20Handbook.pdf.
- Virginia Department of Conservation and Recreation. 2013(a). *Bioretention, Stormwater Design Specification No. 9*. Available at: https://www.swbmp.vwrrc.vt.edu/wp-content/uploads/2017/11/BMP-Spec-No-9_BIORETENTION_v1-9_03012011.pdf.
- Virginia Department of Conservation and Recreation. 2013(b). *Constructed Wetlands, Stormwater Design Specification No. 13*. Available at: https://swbmpvwrrc.wp.prod.es.cloud.vt.edu/wp-content/uploads/2018/07/BMP_Spec_No_13_CONSTRUCTED_WETLAND.pdf.
- Virginia Department of Conservation and Recreation. 2013(c). *Dry Swales, Stormwater Design Specification No. 10 Dry Swales*. Available at: http://chesapeakestormwater.net/wp-content/uploads/downloads/2012/02/DCR-BMP-Spec-No-10_DRY-SWALE_Final-Draft_v1-9_03012011.pdf.
- Virginia Department of Conservation and Recreation. 2013(d). *Extended Definition (ED) Pond, Stormwater Design Specification No. 15*. Available at: https://swbmpvwrrc.wp.prod.es.cloud.vt.edu/wp-content/uploads/2017/11/BMP-Spec-No-15_EXT-DETENTION-POND_v1-9_03012011.pdf

Fact Sheet 2.3: Mitigation of Dams and Reservoirs

The mitigation objective of this Fact Sheet is to improve safety and resilience by rehabilitating dams and reservoirs to improve issues with stability, water control and erosion.

- Dams are a critical part of the nation’s infrastructure, providing water supply, hydropower, flood control and other benefits. To lessen potential disastrous effects from floods and hurricanes, having a better understanding of an area’s precipitation conditions and changes in downstream populations over the life of the dam can improve key decision making. Rehabilitating dams to meet the newest technical standards and other factors that may impact dam safety is essential.
- Selection of the best mitigation measures for dams may depend on certain limitations. For example, the availability of land for expansion, availability of materials, and restrictions on downstream release volumes may influence which options are chosen.

Dam Hazard Potential Classifications

It is important to understand a dam’s hazard potential classification before choosing mitigation options. Dams are rated according to their hazard potential, which is “the possible adverse incremental consequences that result from the release of water or stored contents due to failure of the dam or mis-operation of the dam or appurtenances” (FEMA, 2004). Downstream consequences may occur during operation of the dam when floodwater is released through spillways and outlet works or when water is released by partial or complete failure of the dam. Consequences may also occur in the area upstream of the dam because of backwater flooding or the effects of landslides around the reservoir perimeter. Dam hazard potential classifications are important to know because the hazard potential classification may impact the mitigation solution.

Low Hazard Potential: Dams where the failure or mis-operation results in no probable loss of human life and low economic and environmental issues (Figure 2.3.1).

Significant Hazard Potential: Dams where failure or mis-operation results in no probable loss of human life, but it could cause economic loss, environmental damage, disruption of lifeline facilities, or impact other concerns.

High Hazard Potential: Dams whose failure or mis-operation results in probable loss of human life (Figure 2.3.2).





**Figure 2.3.1. This dam is considered low hazard potential because, if it failed, it would only impact the forest around it.
(Source: Library of Congress, Prints & Photographs Division, photograph by Carol M. Highsmith, LC-DIG-highsm-08052)**



**Figure 2.3.2. This dam is considered high hazard potential because its failure would impact the community directly downstream and could result in loss of life and property.
(Source: NRCS, 2014)**

Table 2.3.1 briefly summarizes some common mitigation strategies and briefly describes them in subsequent sections.

Table 2.3.1. Common Mitigation Solutions for Dams and Reservoirs

Solutions and Options	Earth Embankment Dams	Concrete or Masonry Dams	Riser or Conduit Spillways	Mass Concrete Ogee Spillways	Structural or Armored Spillways	Grassed Spillways
Mitigation Solution: Improve Stability						
Option 1: Reduce the Slope Angle	✓					
Option 2: Use Buttressing	✓					
Option 3: Use Anchoring		✓		✓		
Mitigation Solution: Increase Spillway Capacity						
Option 1: Expand Existing Spillway			✓	✓	✓	✓
Option 2: Add New Spillway			✓	✓	✓	✓
Mitigation Solution: Increase Temporary Storage Capacity						
Option 1: Raise the Dam Height	✓	✓				
Mitigation Solution: Control Surface Erosion						
Option 1: Use Armoring	✓					✓
Option 1: Build a Parapet Wall	✓	✓				
Option 2: Build a Cutoff Wall to Address Headcutting	✓					✓

Solutions and Options	Earth Embankment Dams	Concrete or Masonry Dams	Riser or Conduit Spillways	Mass Concrete Ogee Spillways	Structural or Armored Spillways	Grassed Spillways
Mitigation Solution: Reduce Seepage and Internal Erosion						
Option 1: Install a Blanket Drain	✓					
Option 2: Install a Filter Diaphragm	✓		✓			
Option 3: Install a Reverse Filter	✓					✓
Option 4: Install a Seepage Cutoff Wall	✓					✓
Mitigation Solution: Address Foundation Issues						
Option 1: Install a Grout Curtain	✓					
Option 2: Install a Foundation Cutoff Wall	✓					

Non-Structural Mitigation for Safety of Dams and Reservoirs

Resources for non-structural mitigation and resilience measures for dams and reservoirs may be found at the Association of State Dam Safety Officials (ASDSO) website (www.damsafety.org).

Importance of Emergency Planning for Dams

When people live in an area that could be affected by the operation or failure of a dam, there is the potential for a dam safety incident. Development of Emergency Action Plans (EAP) and Emergency Operations Plans (EOP) help dam owners, emergency management officials and other stakeholders work together to protect lives and reduce property damage associated with dam safety incidents.

Dam Safety Incident: An impending or actual sudden uncontrolled release or excessive controlled release of water from an impounding structure occurs.

Option 1: Develop Emergency Action Plan

Each high hazard potential or significant hazard potential dam should have an EAP. An EAP is a formal document that identifies potential emergency conditions at a dam and specifies actions to be followed to minimize loss of life and property damage. The EAP includes:

- Actions the dam owner will take to moderate or alleviate a problem at the dam
- Actions the dam owner will take, and in coordination with emergency management authorities, to respond to incidents or emergencies related to the dam
- Procedures dam owners will follow to issue early warning and notification messages to responsible downstream emergency management authorities
- Inundation maps to help dam owners and emergency management authorities identify critical infrastructure and population-at-risk sites that may require protective measures, warning, and evacuation planning
- Delineation of the responsibilities of all those involved in managing an incident or emergency and how the responsibilities should be coordinated

Specific guidance on Emergency Action Plans is available in FEMA P-64, *Federal Guidelines for Dam Safety: Emergency Action Planning for Dams*.

Option 2: Develop Emergency Operations and Response Plans

Any community that is potentially impacted by dam safety incidents should develop emergency operations plans (EOPs). They should develop, maintain and implement the emergency operations plan in collaboration with community officials; state, local, tribal, and territorial emergency managers; and other key stakeholders who maintain responsibilities during a dam safety emergency.

When evaluating this option, keep these considerations in mind:

- Identify the inundation zone and any other areas that could be impacted by dam operation or a dam safety incident. Also identify impacts to other infrastructure (utilities, transportation networks, etc.) to be able to plan response and recovery activities accordingly.

- Create a chart of key contacts to carry out emergency notification and coordination procedures. As multiple jurisdictions may be impacted by a dam incident, advance coordination of the jurisdictions is highly recommended.
- Address dam incidents in an annex to the emergency operations plan or comprehensive emergency management plan, in an appendix to other base planning products, or in a stand-alone dam incident plan. Emergency managers should choose the option that aligns to their planning architecture.
- Develop procedures for public evacuation that include evacuation routes and emergency shelter locations that meet the needs of the community.
- Encourage dam owners and operators to communicate with residents and businesses whose properties could be impacted by a dam safety incident.

Specific guidance on Emergency Operations Plans is available in FEMA's *Emergency Operations Planning: Dam Incident Planning Guide*, *Dam Safety Collaborative Technical Assistance*.

Mitigation Solution: Improve Stability

A dam must be stable and well maintained. If not, a slope failure or other condition can damage it, making it unreliable to withstand flood conditions. Failing slopes can lead to structure instability and dangerous consequences. Figure 2.3.3 shows an example of a failed slope.



Figure 2.3.3. Example of failed downstream slope.
(Source: U.S. Forest Service, 2012)

Option 1: Reduce the Slope Angle

One way to improve the stability of an earth embankment dam is to reduce (flatten) the unstable slope angle (Figure 2.3.4). The appropriate slope angle should be chosen based on a slope stability analysis using current standards of practice and applying the latest regulations.

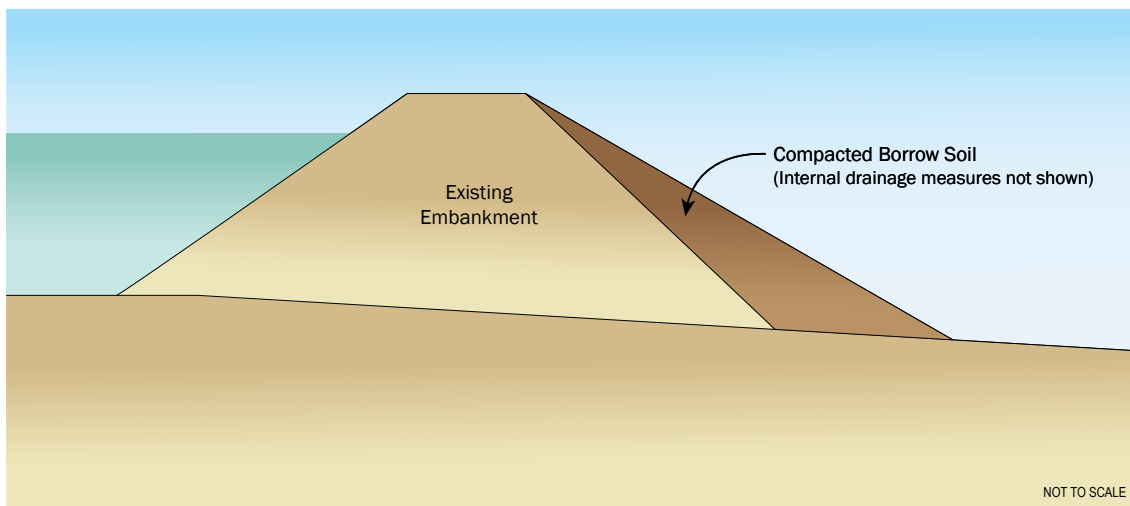

Figure 2.3.4. Use of compacted fill to reduce the downstream slope angle.

When evaluating this option, keep these considerations in mind:

- This option requires additional space downstream of the dam.
- An inclined chimney drain and downstream blanket drain can be added into the design by an engineer to handle seepage.
- There are additional considerations for upstream slope reduction. If downstream land is not available, another option is to drain the reservoir or build a temporary upstream cofferdam to hold the water and allow construction of a flatter slope in the upstream direction. When evaluating this option, keep these considerations in mind:
 - Expanding the embankment in the upstream direction likely would require additional foundation work.
 - This approach also will require a comprehensive plan for dewatering the construction area.
 - How the ends of the new dam configuration tie-in at the abutments may require special attention.

Seepage: The internal movement of water that may take place through the dam, the foundation or the abutments.

CONSIDERATIONS:



Option 2: Use Buttressing

Another way to improve stability of an earth embankment dam is to build a stabilizing fill buttress against the unstable slope (Figure 2.3.5). Adding buttress fill gives counteracting weight and added strength to the embankment to resist slope failure. A stability analysis performed by an engineer is needed to determine the best buttress shape.

When evaluating this option, keep these considerations in mind:

- A rockfill buttress also can be used for stabilizing a concrete or masonry dam.
- This option requires additional land downstream of the dam.
- An inclined chimney drain and downstream blanket drain can be added into the design by an engineer to handle seepage. (See Figure 2.3.17)
- If land downstream is not available, the same considerations apply for working upstream of the dam as discussed in Option 1: Reduce the Slope Angle.

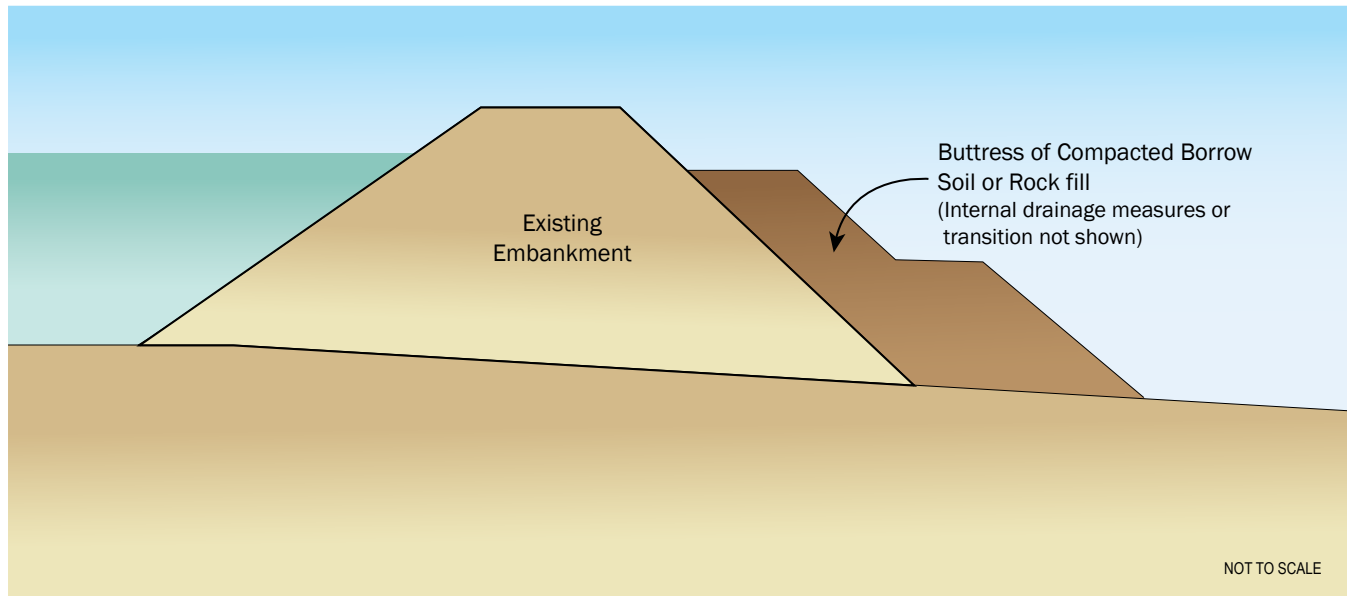

Figure 2.3.5. Buttressing can give additional stability to embankment dams.

CONSIDERATIONS:



Option 3: Use Anchoring

Concrete dams and concrete spillways are at risk for overturning or sliding if the force of the water they contain becomes great enough during or after a flood or hurricane. A common way to stabilize these structures is to use anchors installed into foundation rock. Vertical anchors work to resist overturning and also enhance sliding resistance. Inclined anchors help to resist sliding (Figure 2.3.6). Base the number, size, depth, and capacity of anchors on a stability analysis of the structure performed by an engineer following current practice and regulations.

When evaluating this option, keep these considerations in mind:

- Anchors may also be used to stabilize concrete foundations for risers and other elements.
- Masonry dams may have inside structures that make installing anchors through the dam itself unsuitable; keyed and anchored toe blocks are potential measures for stabilizing masonry dams.

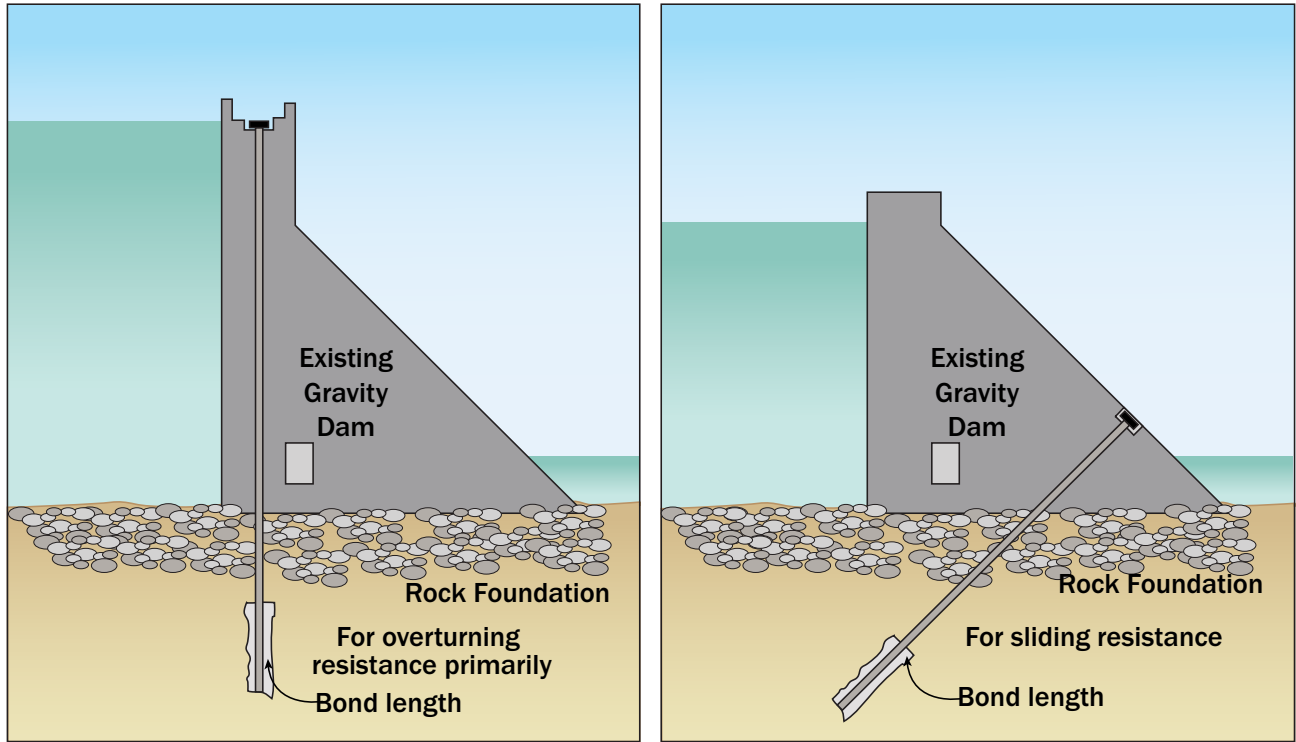
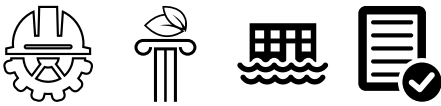

Figure 2.3.6. Anchoring can give resistance to overturning and sliding.

CONSIDERATIONS:



Mitigation Solution: Increase Spillway Capacity

A reservoir (also called an impoundment) is a basin behind a dam designed to store water for a hydropower system, water supply or other purposes. It must be able to store water and safely pass flood flows through a spillway to meet regulations based on the hazard potential classification of the dam.

Due to downstream development in flood zones, adjustments in hazard potential classification have occurred. These changes have left many impoundments without sufficient spillway size or flood storage volume to meet current safety standards.

Option 1: Expand Existing Spillway

One way to increase the size of an existing spillway is to widen it to increase its outflow volume (Figure 2.3.7). A hydrologic and hydraulic (H&H) analysis must be done by an engineer in accordance with current practice and regulations to determine the final design of the expanded spillway.

When evaluating this option, keep these considerations in mind:

- The auxiliary (or emergency) spillway also may be expanded.
- Spillway alteration may cause larger or more frequent releases of water, which could cause flooding in downstream areas, requiring careful planning and permitting.

CONSIDERATIONS:

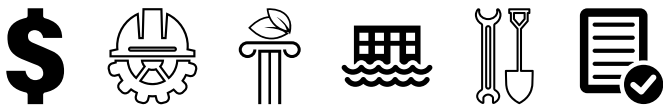

Option 2: Add New Spillway

To meet the total additional capacity needed, it might be necessary to build a new spillway (Figure 2.3.7), in addition to expanding the existing spillway. An H&H analysis must be done by an engineer to determine the final design.

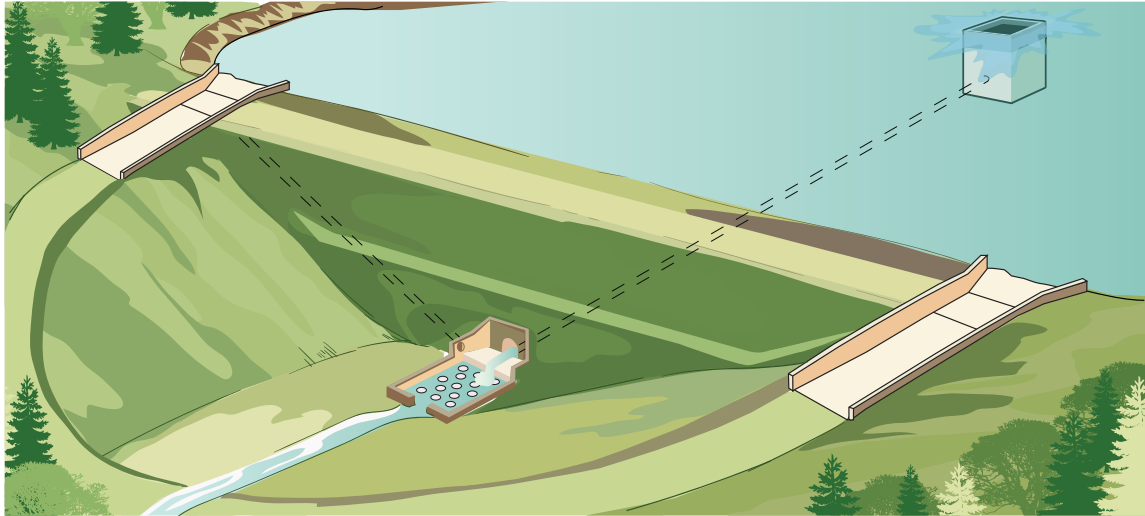

Figure 2.3.7. To increase spillway capacity, widen an existing spillway or build a second spillway.

When evaluating this option, keep these considerations in mind:

- Spillway alteration may cause larger or more frequent releases of water, which could cause flooding in downstream areas requiring careful planning and permitting.
- Expanding an existing auxiliary spillway or adding a new auxiliary spillway usually requires nearby land for development. If land is not available, potential alternatives for increasing spillway volume may include:
 - For impoundments with relatively small drainage areas, replace the existing main spillway with a much larger combined spillway system. Also consider adding the combined spillway while keeping the original main spillway if it is in good operating condition.
 - Build an auxiliary spillway using roller-compacted concrete (RCC), cable-stayed articulated concrete blocks (ACBs), or other suitable armor (see Option 1: Use Armoring, in the Mitigation Solution: Control Erosion and Retrofit for Overtopping Protection below in this Fact Sheet).

CONSIDERATIONS:



Mitigation Solution: Increase Temporary Storage Capacity

Some dams may be high enough to contain the flood pool but have little or no freeboard to give temporary storage capacity for larger than expected floods. Raising the dam height may be necessary to meet freeboard requirements.

Freeboard: An added margin of safety expressed in feet above a specific flood elevation.

Option 1: Raise the Dam Height

Increase temporary flood storage capacity by adding freeboard to the height of the dam (Figure 2.3.8). Some dams may be high enough to contain the flood pool but have little or no freeboard to give temporary storage capacity for floods greater than expected.

Raise an earth embankment dam by expanding it higher in either the downstream direction or in the upstream direction. The dam raise must be engineered to include stable slopes, appropriate internal drainage measures, and external protective measures.

Note

Increasing freeboard to give overtopping protection by increasing temporary flood capacity is a mitigation technique. Increasing normal pool is not a mitigation technique because it raises dam risk by increasing the amount of water stored in the reservoir, thereby increasing the potential inundation area downstream.

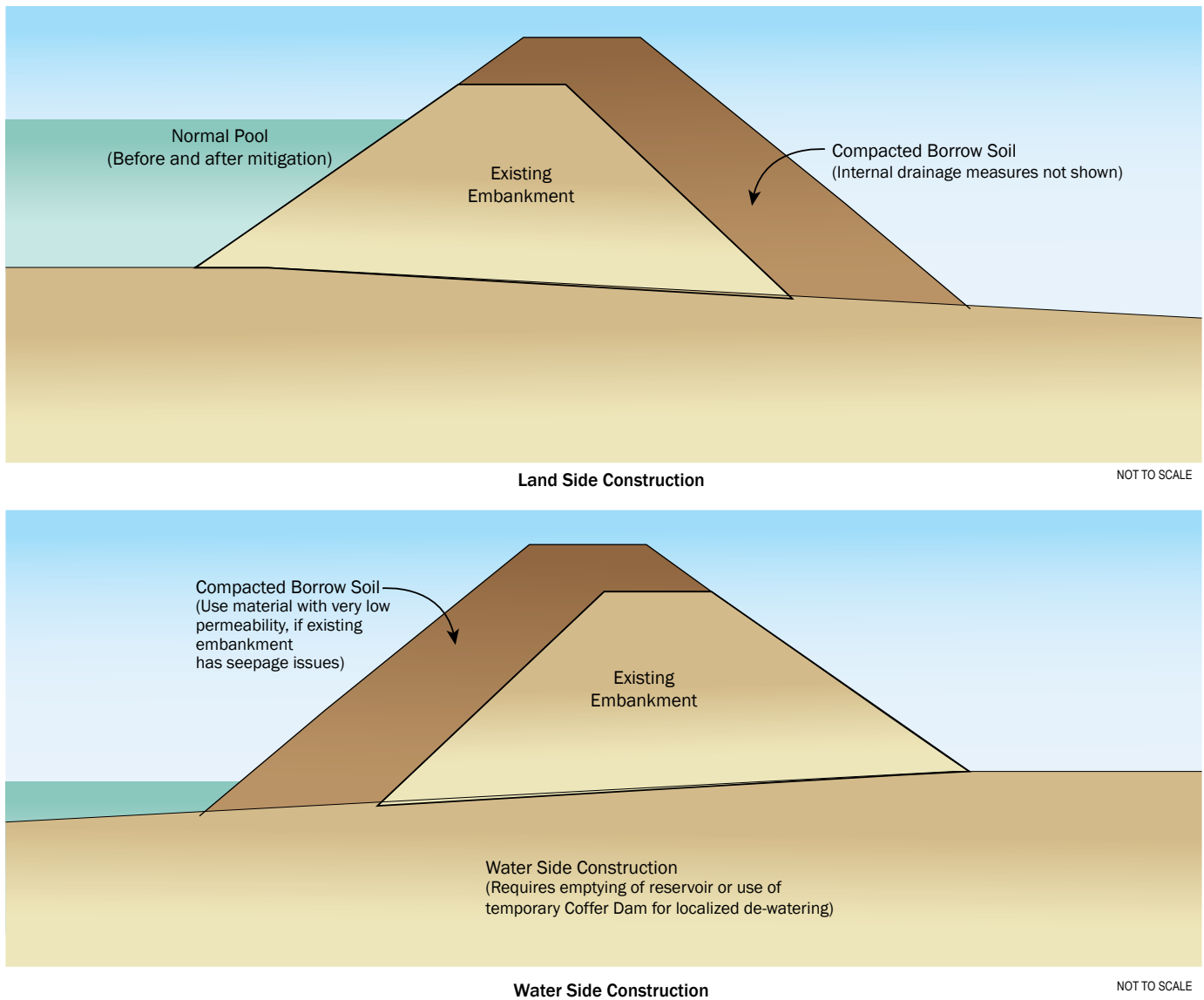

Figure 2.3.8. Raising the height of a dam can increase temporary flood storage capacity.

When evaluating this option, keep these considerations in mind:

- Raising the dam can increase the reservoir storage volume and result in larger flood areas upstream and downstream. Often, when the dam height is raised, the spillway(s) are also altered, which may result in larger releases and flooding in downstream areas. These projects must be designed and engineered carefully.
- If the dam raise embankment section is built using compacted borrow soil, place a filter drainage blanket between the existing embankment soil and new embankment soil on the downstream side.
- Building the outer part of the new embankment section with rockfill will allow a steeper slope (requiring less land downstream). A transition filter between the rockfill and the existing and new embankment soil would be needed.
- Add an inclined chimney drain and downstream blanket drain (Figure 2.3.17) to the design by an engineer to address seepage.

- Expanding downstream is more practical if land is available. If downstream land is not available, the new embankment can be built on the upstream side using the same considerations for working upstream of the dam as discussed earlier in this Fact Sheet.
- If the existing embankment shows signs of seepage on the downstream slope, the upstream embankment that is being raised should be built with compacted low-permeability soil or have an “impervious” blanket built along the upstream slope.
- Using parapet wall sections in combination with raising the dam embankment can lessen the required height of fill being placed.
- Raising the height of an embankment dam without changing the main body of the embankment may be feasible using mechanically stabilized earth (MSE) fill, RCC, or soil-cement.

CONSIDERATIONS:

Mitigation Solution: Control Surface Erosion

Embankment dams can be affected by erosion from wave run-up, overtopping and headcut. Erosion of an unprotected or poorly protected embankment by wave run-up could lead to a dam breach during a major flood (Figure 2.3.9). Overtopping can cause extreme erosion of an embankment dam, which can threaten total breach of the dam and release of the reservoir to the downstream area (Figure 2.3.10). Another serious form of erosion is headcut erosion caused by a major flood. Progressive headcut erosion could lead to release of a major portion of the reservoir to the downstream area, if the headcut advances back to the reservoir (Figure 2.3.11). Even for a dam that has enough freeboard and a wide crest, erosion could become progressively worse and lead to a costlier repair if left uncorrected.

Terminology – Causes of Erosion

Wave run-up: Vertical height above the still water level to which water from a specific wave will run up the face of a structure or embankment

Overtopping: When the reservoir water level exceeds the height of the dam crest and water spills over the top of the dam

Headcut: An erosion process where flow of sufficient energy creates a flaw in the ground surface. Flow then concentrates at the flaw and erosion initiates an abrupt drop in the ground surface.



Figure 2.3.9. Wave action can erode the upstream slope of a dam.
(Source: USFWS, 2008)



Figure 2.3.10. Initial embankment overtopping can lead to a complete overflow.
(Source: USFWS, 2008)



Figure 2.3.11. Headcut erosion could lead to an accidental release from the impoundment.
(Source: NRCS, 2017)

Option 1: Use Armoring

Potential retrofits for erosion control include various types of armoring as described in the sections below.

RIPRAP BLANKETS

Riprap blankets are commonly used to repair upstream embankments damaged by waves (Figure 2.3.12 and Figure 2.3.13). Riprap also is commonly used to repair eroded ditches, dam toes, outlet basins and channels. Riprap blankets must be designed by an engineer to choose the appropriate materials for compatibility with the embankment material to resist wave action.

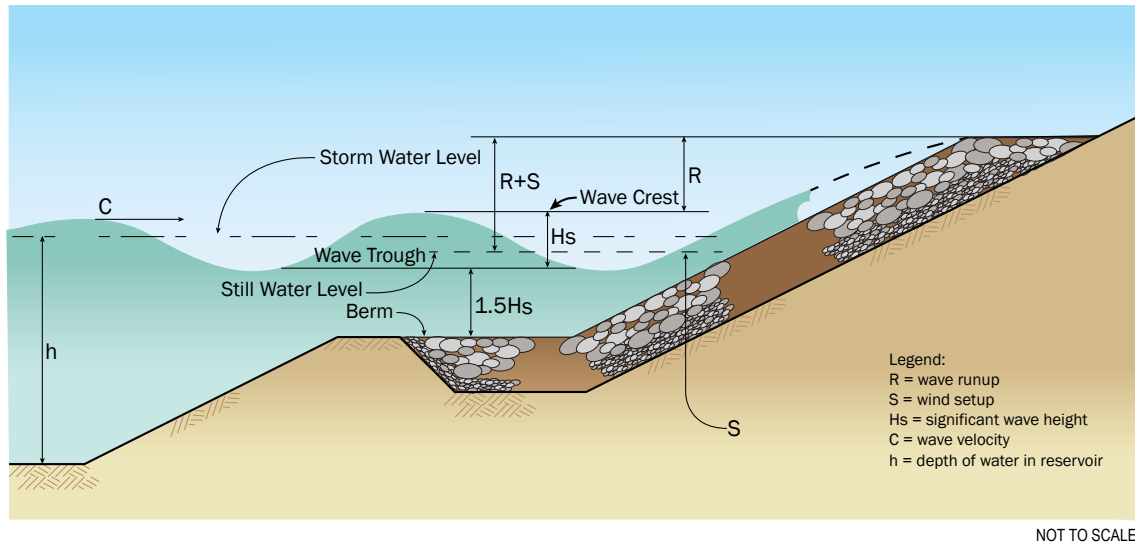

Figure 2.3.12. Riprap layouts can be designed to protect against wave action.(Source: NRCS, 1983)



Figure 2.3.13. Riprap blankets can protect against wave action. (Source: USFWS, 2008)

CONCRETE SLABS AND SOIL CEMENT

To protect against wave erosion, consider reinforced concrete slabs and soil cement. These armoring methods may require more foundation preparation than for riprap in repairing a wave-eroded embankment.

TURF REINFORCEMENT MAT

Turf reinforcement mats work with plant root systems to protect earthen slopes against erosion. They can be designed to reinforce spillways or other earthen areas where calculated flow velocities are within design standards and comply with manufacturer's recommendations.

ARTICULATED CONCRETE BLOCKS AND ROLLER-COMPACTED CONCRETE

Articulated concrete blocks (ACBs) and roller-compacted concrete (RCC) are commonly used to protect embankments from erosion associated with overtopping, particularly when options for increasing spillway capacity are limited or non-existent (Figure 2.3.14). Overtopping protection often is designed to serve as an auxiliary spillway. Tapered wedge blocks also have been used in overtopping retrofits.



Figure 2.3.14. ACBs (left) and RCC (right) can protect spillways from overtopping erosion.

ACBs, RCC and tapered wedge blocks, as well as gabions, riprap and reinforced concrete paving all are potential armoring options for retrofitting existing unarmored auxiliary spillways. The material choice will depend in part on design and constraints.

CONSIDERATIONS:



Option 2: Build a Parapet Wall

A common method to protect against erosion from wave run-up is to install a reinforced concrete parapet wall (Figure 2.3.15). Parapet walls must be engineered for site-specific conditions.

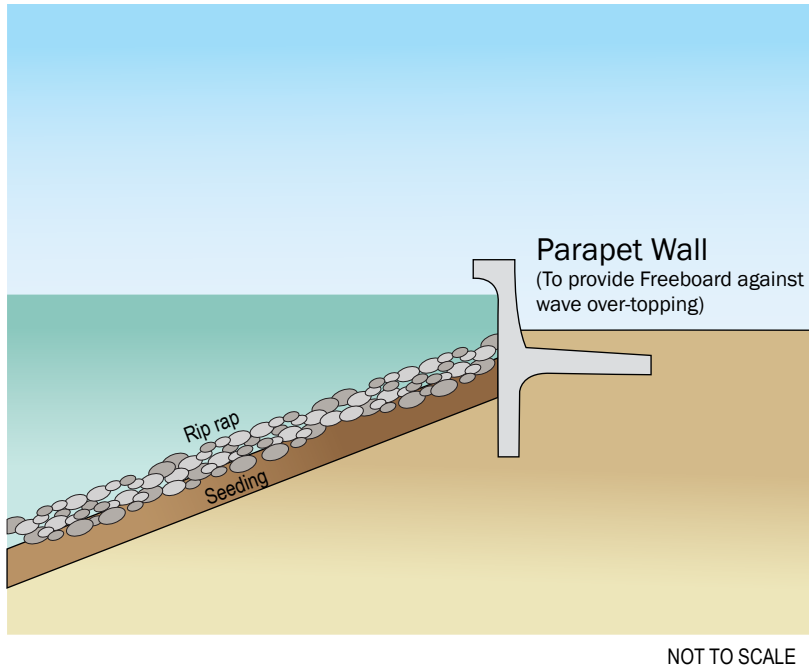

Figure 2.3.15. A parapet wall can give additional freeboard to protect against wave overtopping. (Source: USACE, 2004)

When evaluating this option, keep these considerations in mind:

- Parapet walls are most effective when the upstream slope has an armored facing, such as concrete slab or asphalt, that provides resistance to wave action.
- Design the wall with a curved face to deflect waves more effectively and increase the height of the wall.
- Parapet walls also may be installed on concrete dams (non-overflow sections) to help minimize the required elevation of the crest when raising the dam height.
- Galvanized steel also may be used to build a parapet wall, or the wall can include sheet piles or corrugated steel panels spanning between posts. Steel may be better suited to projects in dry climates or where the soils are not highly corrosive.

CONSIDERATIONS:



Option 3: Build a Cutoff Wall to Address Headcutting

Improve existing unarmored auxiliary spillways with erodible foundations by installing one or more cutoff walls to block the advance of headcut erosion (Figure 2.3.16).

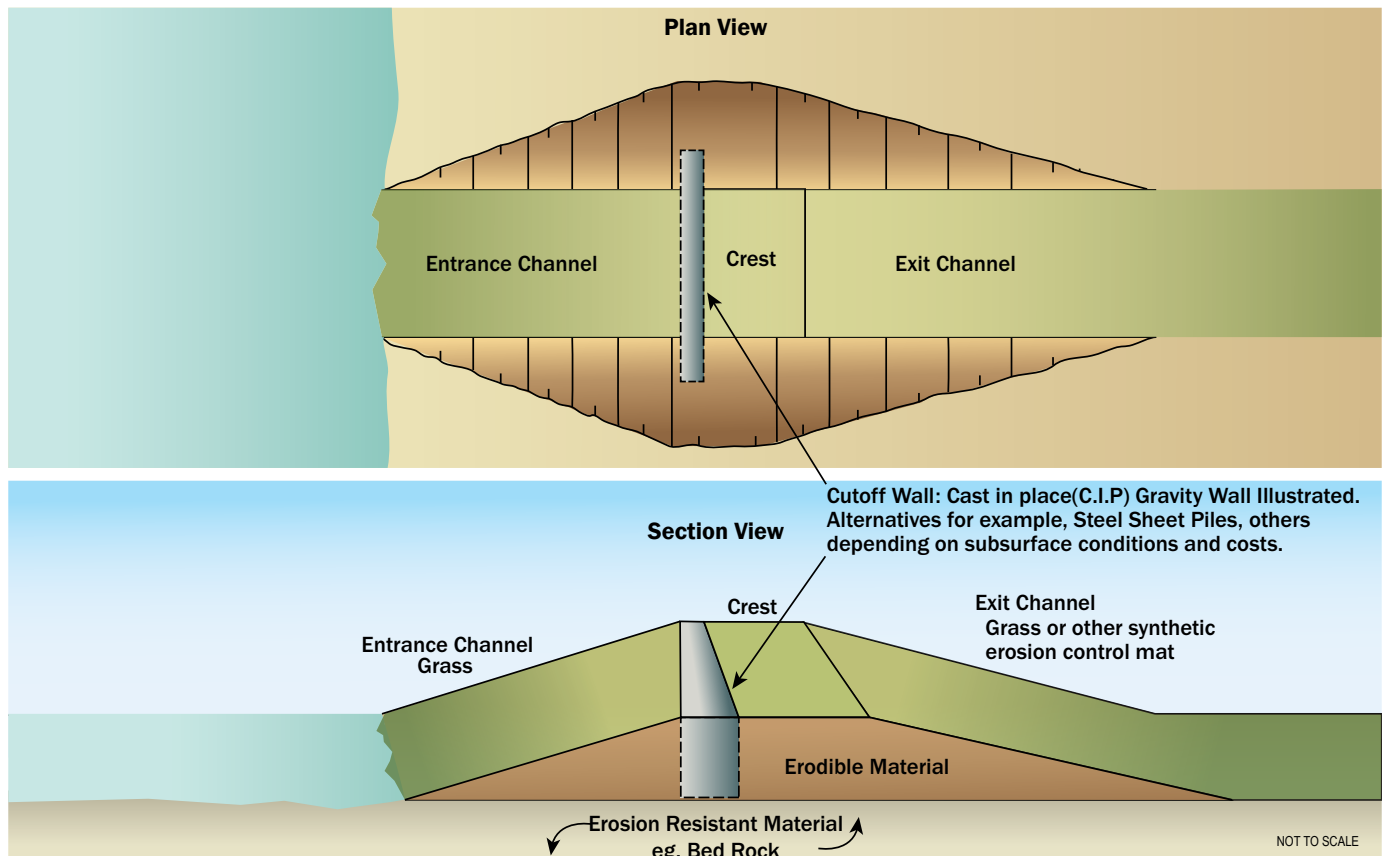

Figure 2.3.16. Cutoff walls can improve the stability of some unarmored auxiliary spillways.

When evaluating this option, keep these considerations in mind:

- This type of retrofit is best for sites with a shallow depth to reach non-erodible material (e.g., bedrock) and infrequent use of the auxiliary spillway.
- Cutoff walls generally are not used at sites where erodible soils extend to great depth.
 - A potential exception occurs if it is determined that flows through the auxiliary spillway have short durations.
 - Engineering analysis should be completed to show that the headcut depth does not extend below the cutoff wall.

CONSIDERATIONS:



Mitigation Solution: Reduce Seepage and Internal Erosion

Option 1: Install a Blanket Drain

Install seepage blanket drains to increase seepage flow paths and reduce the risk of seepage-related piping by retaining embankment soil and conveying the seepage water to a designed exit (Figure 2.3.17).

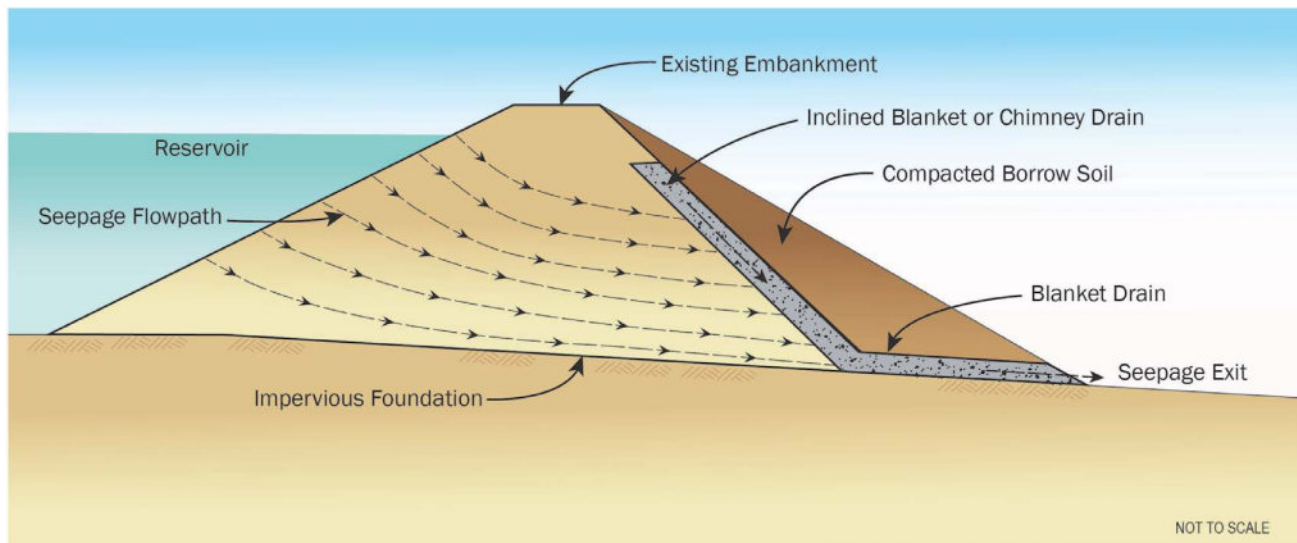

Figure 2.3.17. Blanket drains increase seepage flow paths and reduce the risk of seepage-related piping.

When evaluating this option, keep these considerations in mind:

- Geotechnical analysis of dam materials is required. Base selection of filter materials on compatibility with dam materials.
 - Specific gradation material may be hard to manufacture or find at regular quarry.
 - Use of materials that are not compatible with embankment soils can lead to migration of soils and increased risk of piping.
- This mitigation solution can be combined with reducing the slope angle to increase dam stability.

CONSIDERATIONS:



Option 2: Install a Filter Diaphragm

A filter diaphragm is a designed zone of filter material (usually well-graded, clean sand) built around a conduit to prevent seepage, erosion, and piping through cracks that may occur in compacted fill near conduits or at the interface between the conduit and the surrounding fill. The filter materials are designed to retain embankment soils while allowing seepage water to pass (Figure 2.3.18). Filter diaphragms may be designed in conjunction with internal drainage systems like blanket drains, chimney drains, or transition zones to convey the seepage.

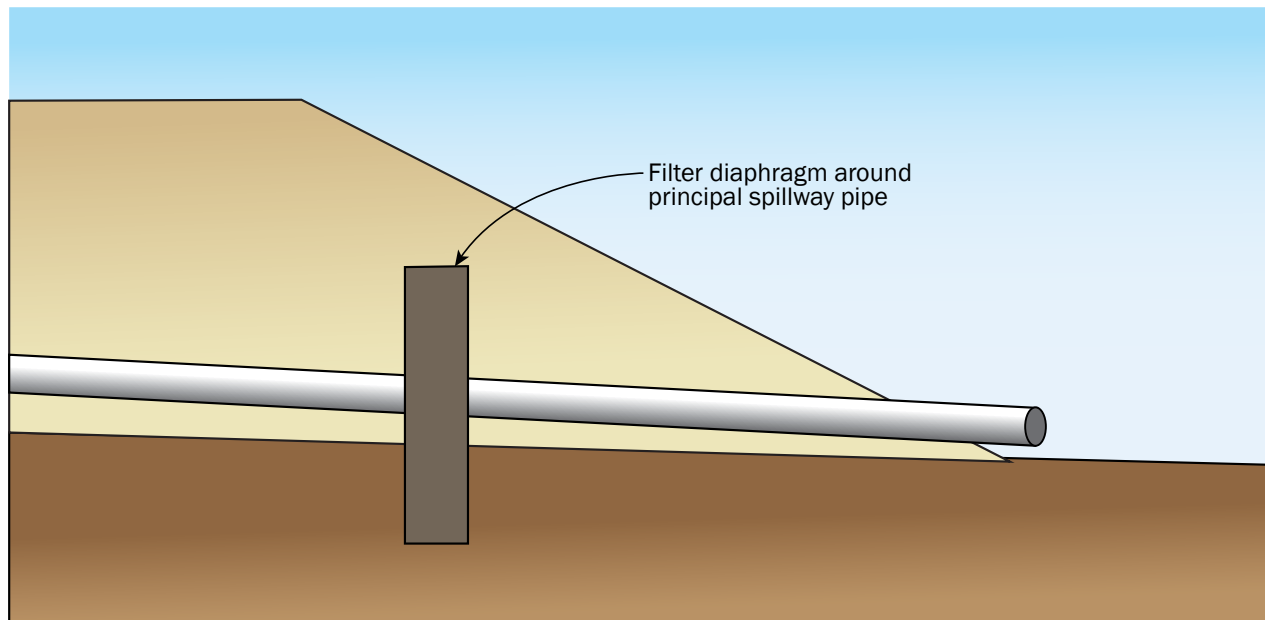
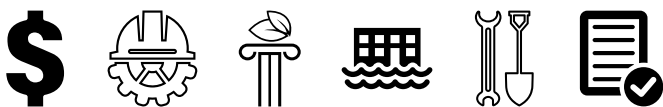

Figure 2.3.18. Filter diaphragms can prevent seepage around conduits.

When evaluating this option, keep these considerations in mind:

- Geotechnical analysis of dam materials is required. Base selection of filter materials on compatibility with dam materials.
 - Specific gradation material may be hard to manufacture or find at regular quarry.
 - Use of materials that are not compatible with embankment soils can lead to migration of soils and increased risk of piping.
- This mitigation solution can be combined with other drainage systems to convey seepage water to a designed exit.

CONSIDERATIONS:



Option 3: Install a Reverse Filter

Reverse filters are designed zones of filter material used to address sinkholes (Figure 2.3.19). The sinkhole throat is plugged with large pieces of concrete rubble or riprap to slow the migration of material into the sinkhole. Layers of finer materials (gravel then sand) are then placed to stop the migration of embankment materials into the voids between the rubble or gravel pieces. Cap the reverse filter with a filter fabric and fine material to bring the area back to desired grade and limit the influence of surface drainage on the area.

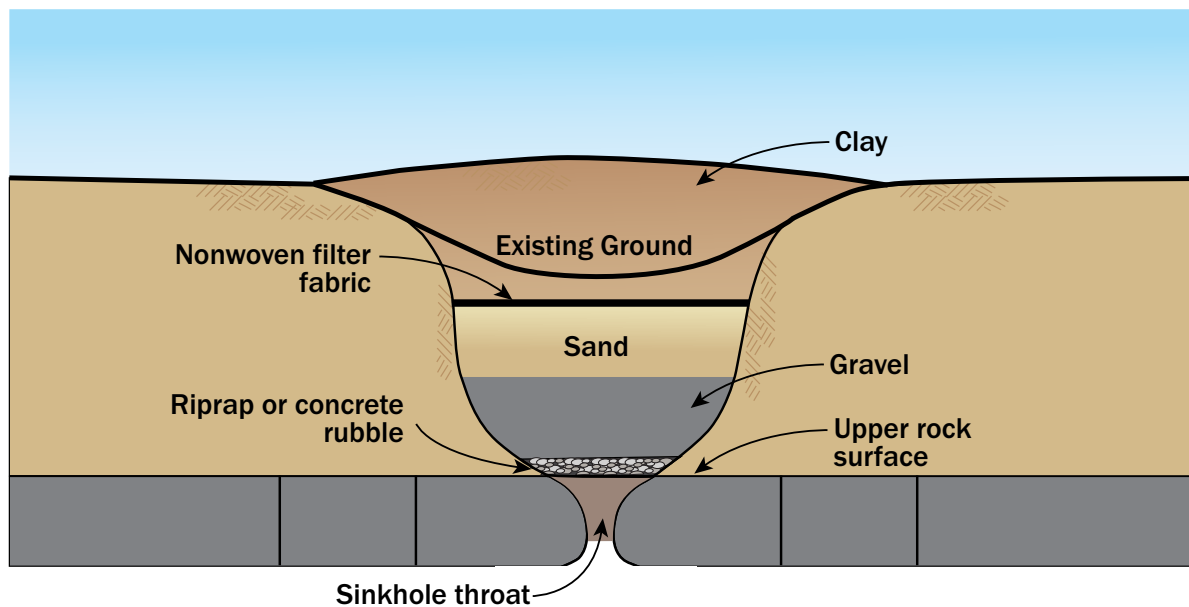

Figure 2.3.19. Reverse filters can be used to address sinkholes.

When evaluating this option, keep these considerations in mind:

- Geotechnical analysis of dam materials is highly recommended. Base selection of filter materials on compatibility with dam materials.
 - Specific gradation material may be hard to manufacture or find at regular quarry.
 - Use of materials that are not compatible with embankment soils can lead to migration of soils and increased risk of piping.
- This mitigation solution can be used as an emergency remedial action. Pay close attention to changing conditions to act in a timely manner. Sinkholes, seepage and piping can evolve quickly, so constant surveillance from a safe vantage point is recommended.

CONSIDERATIONS:



Option 4: Install a Seepage Cutoff Wall

Build seepage cutoff walls to control seepage through an earthen dam. There are various methods for building cutoff walls including:

- Earth-backfilled slurry trench cutoff walls
- Cement-bentonite slurry trench cutoff walls
- Soil-cement-bentonite cutoff walls
- Concrete cutoff walls
- Deep soil mixing cutoff walls
- Secant pile cutoff walls
- Sheet pile cutoff walls
- Jet grouted cutoff walls

When evaluating this option, keep these considerations in mind:

- The reservoir may need to be lowered to facilitate building a cutoff wall.
- Geotechnical analysis of dam foundation materials is required. The type of foundation materials may limit the types of cutoff walls that can be built.
- The required depth of the cutoff wall may limit the type of cutoff wall selected due to limitations in construction equipment reach and depth of excavation capability.
- Depending on the type of cutoff wall, it may be an expensive mitigation measure.

DEEP SOIL MIXING

Deep soil mixing is a method where trenching machines are used to excavate materials along a line, mix the excavated materials with cement or bentonite, and the treated materials are returned to the trench to form a seepage cutoff wall (Figure 2.3.20).

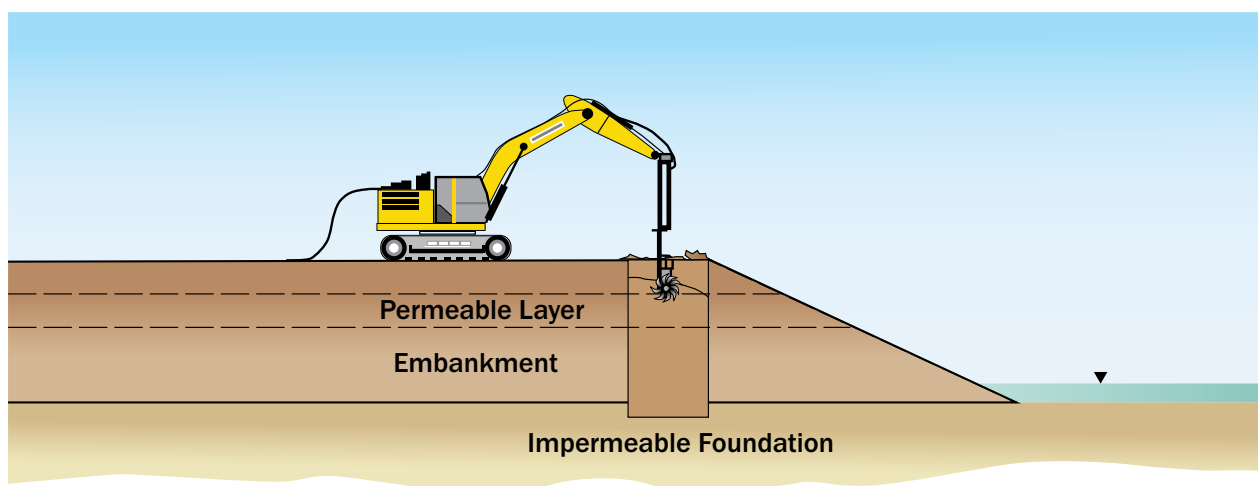

Figure 2.3.20. Seepage cutoff walls can be achieved through deep soil mixing.

SECANT PILE WALL

Secant pile walls are built in a similar way to deep soil mixing (Figure 2.3.21). Instead of a trenched wall, large boreholes are drilled, the excavated materials are mixed with specialized cement or bentonite, and then returned to the borehole to form a reinforced column of soil. Space the boreholes in such a way that the columns overlap and create a reinforced soil wall to address seepage.

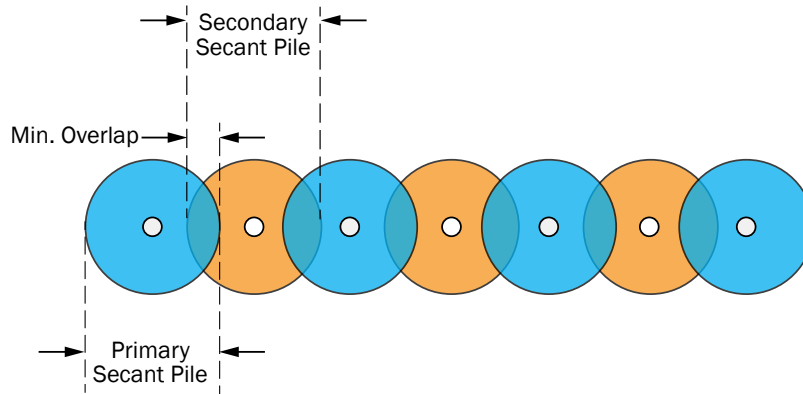
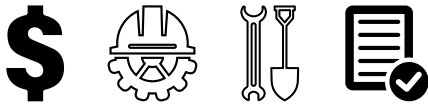

Figure 2.3.21. Plan view of a secant pile wall.

Primary secant piles are installed and given time to cure. The secondary secant piles are installed after the primary secant piles have cured to form a continuous wall.

CONSIDERATIONS:



Mitigation Solution: Address Foundation Issues

Option 1: Install a Grout Curtain

Grout curtains are built by forcing grout under pressure into lines of boreholes that extend to the rock foundation of the dam. The borehole lines are drilled at angles that overlap, creating a curtain (Figure 2.3.22). The grout is pressurized when it is put into the borehole to fill cracks in the foundation of a dam and prevent seepage.

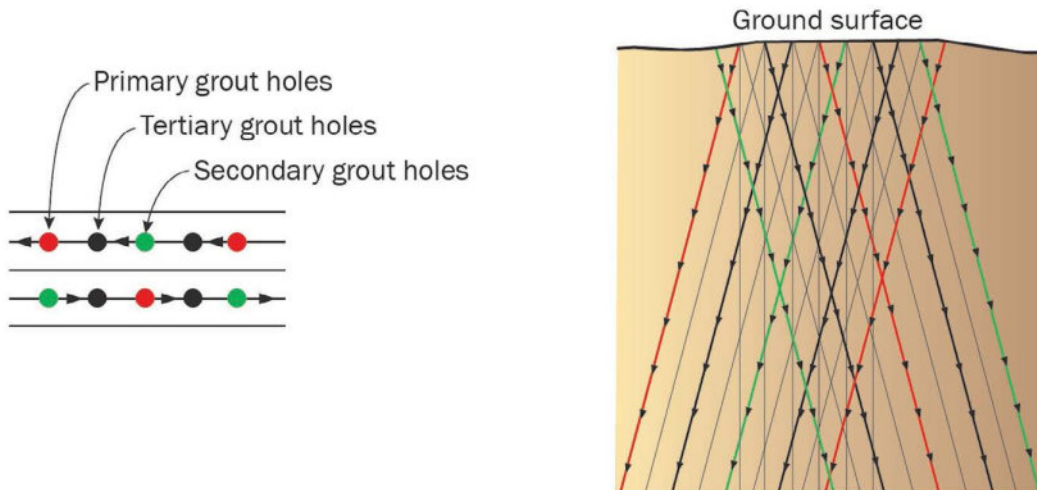
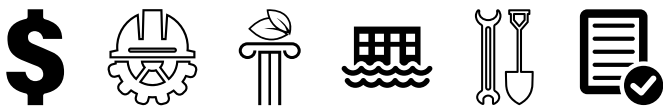

Figure 2.3.22. Plan and profile of a grout curtain design.

When evaluating this option, keep these considerations in mind:

- Geotechnical analysis of dam foundation materials is required.
- Grout pressure must be high enough to fill foundation cracks but not high enough to move embankment materials
- It may be difficult to maintain pressure in the grout boreholes if the seepage path is severe. Installing phased lines of grout in different directions may help address this issue.

CONSIDERATIONS:



Option 2: Install a Foundation Cutoff Wall

Foundation cutoff walls are seepage cutoff walls that are constructed to control seepage through a dam foundation (Figure 2.3.23). The same methods are used to construct foundation cutoff walls:

- Earth-backfilled slurry trench cutoff walls
- Cement-bentonite slurry trench cutoff walls
- Soil-cement-bentonite cutoff walls
- Concrete cutoff walls
- Deep soil mixing cutoff walls
- Secant pile cutoff walls
- Sheet pile cutoff walls
- Jet grouted cutoff walls

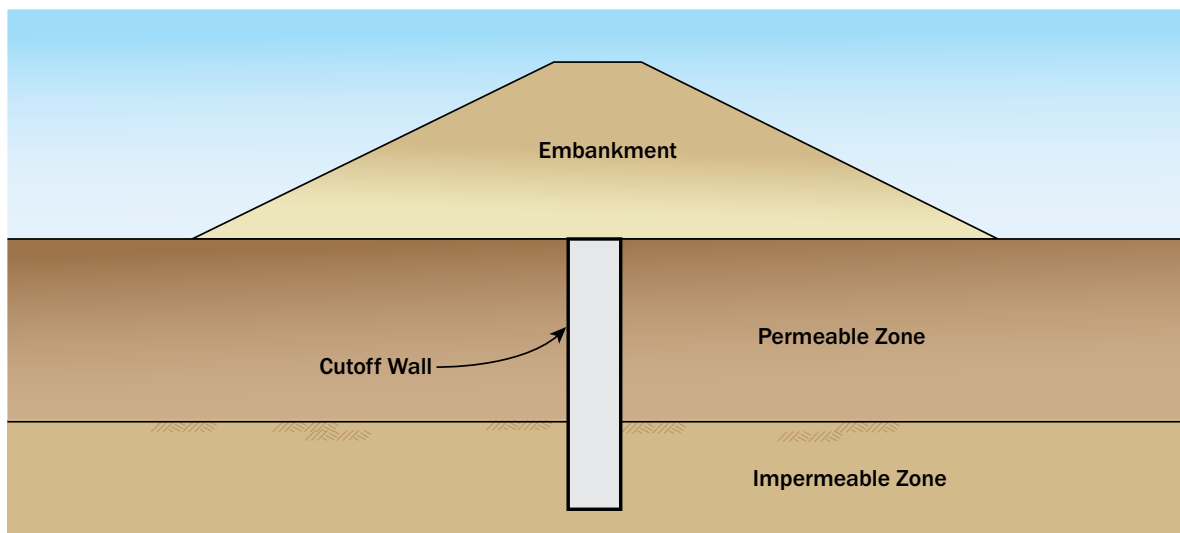

Figure 2.3.23. Foundation cutoff walls can help control seepage through a dam foundation.

When evaluating this option, keep these considerations in mind:

- The reservoir may need to be lowered to facilitate construction of a cutoff wall.
- Geotechnical analysis of dam foundation materials is required. Extent of permeable foundation zones and types of in-situ materials may limit the types of cutoff walls that can be constructed.
- The required depth of the cutoff wall may limit the type of cutoff wall selected due to limitations in construction equipment reach and depth of excavation capability.
- Depending on the type of cutoff wall, it may be an expensive mitigation measure.

CONSIDERATIONS:



REFERENCES:

Useful technical resources for evaluating and developing the retrofits and mitigation strategies touched on in this guide are listed below. These documents may provide ideas about other potential measures to lessen the hazards of flooding on dams and reservoirs and improve their safety and resilience.

- Bryant, S.D., and C.D. Jewell. 1996. "Analysis of Siphon Lake Drain Performance for a Small Earthen Dam," Association of State Dam Safety Officials, 1996 Annual Conference Proceedings.
- Federal Emergency Management Agency (FEMA). Prepared by Interagency Committee on Dam Safety, June 1979. Reprinted April 2004. *Federal Guidelines for Dam Safety (FEMA 93)*. Available at: https://www.fema.gov/sites/default/files/2020-08/fema_dam-safety_P-93.pdf.
- Federal Emergency Management Agency (FEMA). 2001. *Flood Hazard Mitigation Handbook for Public Facilities*. Available at: <https://www.hsd.org/?abstract&did=34754>
- Federal Emergency Management Agency (FEMA). 2005. *FEMA 511, Reducing Damage from Localized Flooding*. Available at: <https://www.fema.gov/pdf/fima/FEMA511-complete.pdf>.
- FEMA. October 2011. *FEMA 10, Filters for Embankment Dams, Best Practices for Design and Construction*. Available at: <https://www.hsd.org/?abstract&did=696738>
- FEMA. July 2012. *FEMA P-919, Summary of Existing Guidelines for Hydrologic Safety of Dams*. Available at: <https://www.fema.gov/media-library/assets/documents/28555>.
- FEMA. August 2013. *FEMA P-94, Selecting and Accommodating Inflow Design Floods for Dams*. Available at: https://www.fema.gov/sites/default/files/2020-08/fema_dam-safety_inflow-designs_P-94.pdf.
- FEMA. May 2014. *FEMA P-1015, Technical Manual: Overtopping Protection for Dams, Best Practices for Design, Construction, Problem Identification and Evaluation, Inspection, Maintenance, Renovation, and Repair*. Available at: <https://www.fema.gov/emergency-managers/risk-management/dam-safety/publications>
- Federal Highway Administration (FHWA). 2006. *Hydraulic Design of Energy Dissipators for Culverts and Channels, Hydraulic Engineering Circular Number 14 (HEC 14), Third Edition*. Available at: <https://www.fhwa.dot.gov/engineering/hydraulics/pubs/06086/hec14.pdf>.
- Miller, C.F., and J.A. Dickerson. 1999. *The Use of Native Warm Season Grasses for Critical Area Stabilization*. Available at: <http://citeseerx.ist.psu.edu/viewdoc/download?doi=10.1.1.631.944&rep=rep1&type=pdf>.
- U.S. Army Corps of Engineers (USACE). 1989. *Retaining and Flood Walls, EM 1110-2-2502*. Available at: https://www.publications.usace.army.mil/portals/76/publications/engineermanuals/em_1110-2-2502.pdf.
- USACE. 1992. *Design, Construction, and Maintenance of Relief Wells, EM 1110-2-1914*. Available at: https://www.publications.usace.army.mil/Portals/76/Publications/EngineerManuals/EM_1110-2-1914.pdf.
- USACE. 1994. *Standard Practice for Concrete for Civil Works Structures, EM 1110-2-2000*. Available at: https://www.publications.usace.army.mil/Portals/76/Publications/EngineerManuals/EM_1110-2-2000.pdf.
- USACE. 1995(a). *Engineering and Design—Structural Design of Concrete Lines Flood Control Channels, EM 1110-2-2007*. Available at: <https://www.cedengineering.com/userfiles/Structural%20Design%20of%20Concrete%20Lined%20Flood%20Control%20Channels.pdf>.
- USACE. 1995(b). *Construction Control for Earth and Rock-fill Dams, EM 1110-2-1911*. Available at: https://www.publications.usace.army.mil/Portals/76/Publications/EngineerManuals/EM_1110-2-1911.pdf.

- USACE. 2004. *Engineering and Design—General Design and Construction Considerations for Earth and Rock-Fill Dams, EM 1110-2-2300*. Available at: https://www.publications.usace.army.mil/Portals/76/Publications/EngineerManuals/EM_1110-2-2300.pdf.
- U.S. Department of Agriculture, Natural Resources Conservation Service (USDA-NRCS). 1997(a). Revised March 2001. *National Engineering Handbook (NEH), Part 628—Dams, Chapter 52, Field Procedures Guide for the Headcut Erodibility Index*. Available at: <https://directives.sc.egov.usda.gov/OpenNonWebContent.aspx?content=36147.wba>.
- USDA-NRCS. 1997(b), Revised March 2001. *Part 628 Dams—National Engineering Handbook (NEH)*. Available at: <https://directives.sc.egov.usda.gov/OpenNonWebContent.aspx?content=36147.wba>
- USDA-NRCS. 2000. *Maryland, Conservation Practice Standard Pond, Code 378*. Available at: <https://directives.sc.egov.usda.gov/OpenNonWebContent.aspx?content=36147.wba>
- USDA-NRCS. 2005. *TR-60 Earth Dams and Reservoirs*. Available at: <https://directives.sc.egov.usda.gov/OpenNonWebContent.aspx?content=24937.wba>
- USDA-NRCS. 2014. *National Engineering Handbook (NEH), Part 628—Dams, Chapter 50, Earth Spillway Design*. Available at: <https://directives.sc.egov.usda.gov/OpenNonWebContent.aspx?content=35546.wba>.
- USDA-NRCS. 2017. *Vegetated Auxiliary Spillways*. Available at: <https://www.ars.usda.gov/plains-area/stillwater-ok/hydraulic-engineering-research/docs/vegetated-auxiliary-spillways/>.
- U.S. Department of the Interior, Bureau of Reclamation (USBR). 1987. *Design of Small Dams, A Water Resources Technical Publication, Third Edition*. Available at: http://www1.frm.utn.edu.ar/laboratorio_hidraulica/Biblioteca_Virtual/Desing%20of%20small%20dams/SmallDams.pdf.
- USBR. 2012(a). Design Standards No. 1: *General Design Standards*. Available at: <https://www.usbr.gov/tsc/techreferences/designstandards-datacollectionguides/finalds-pdfs/DS1-1and2.pdf>
- USBR. 2012(b). *Embankment Dams. Chapter 6: Freeboard (Design Standards No. 13 (DS-13(6)-2: Phase 4—Final)*). Available at: <https://www.usbr.gov/tsc/techreferences/designstandards-datacollectionguides/finalds-pdfs/DS13-6wMIR.pdf>.
- USBR. 2012(c). *Embankment Dams. Chapter 10: Embankment Construction*. Available at: <https://www.usbr.gov/tsc/techreferences/designstandards-datacollectionguides/finalds-pdfs/DS13-10.pdf>
- USBR. 2014(a). Design Standards No. 3: *Water Conveyance Facilities, Fish Facilities, and Roads and Bridges*. Available at: <https://www.usbr.gov/tsc/techreferences/designstandards-datacollectionguides/finalds-pdfs/DS3-4.pdf>
- USBR. 2014(b). Design Standards No. 14: *Appurtenant Structures for Dams (Spillways and Outlet Works). Chapter 3: General Spillway Design Considerations*. Available at: <https://www.usbr.gov/tsc/techreferences/designstandards-datacollectionguides/finalds-pdfs/DS14-3.pdf>
- USBR. 2014(c). *Embankment Dams. Chapter 7: Riprap Slope Protection (Design Standards No. 13 (DS-13(7)-2.1: Phase 4—Final)*). Available at: <https://www.usbr.gov/tsc/techreferences/designstandards-datacollectionguides/finalds-pdfs/DS13-7.pdf>.
- USBR. 2014(d). *Embankment Dams. Chapter 16: Cutoff Walls*. Available at: <https://www.usbr.gov/tsc/techreferences/designstandards-datacollectionguides/finalds-pdfs/DS13-16.pdf>

USBR. 2015. *Guide to Concrete Repair, Second Edition*. Available at: https://www.usbr.gov/tsc/techreferences/mands/mands-pdfs/Guide2ConcreteRepair2015_Final.pdf.

USBR. 2017. *Design and Construction Considerations for Hydraulic Structures, Roller-Compacted Concrete*. Available at: <https://www.usbr.gov/tsc/techreferences/mands/mands-pdfs/RCCManualFinal09-2017-508.pdf>.

U.S. Department of the Interior, Fish and Wildlife Service (USFWS). 2008. *Low Hazard Dams, Standing Operating Procedures*. Available at: <https://damsafety.org/sites/default/files/files/US%20Fish%20And%20Wildlife%20Service%20SOP.pdf>.

Virginia Department of Environmental Quality (VA DEQ). 2011. *Introduction to the New Virginia Stormwater Design Specifications, Appendix B: Principal Spillway, Version 1.0*. Available at: https://www.swbmp.vwrrc.vt.edu/wp-content/uploads/2017/11/Introduction_App-B_Principal-Spillways_03012011.pdf

Fact Sheet 3.0: Buildings, Systems and Equipment

The Fact Sheets in this section present mitigation methods for public buildings and internal systems to make them more resilient to floods and hurricanes so that critical community lifelines can be maintained.

Hurricane and Flood Impacts

Hurricanes and floods can result in damage to public buildings. This loss of building function has the potential to negatively impact communities because some government and public service functions could be reduced temporarily. Ideally, communities will incorporate mitigation elements into renovations of these buildings before disasters occur to decrease impacts that floods and hurricanes could have on providing services to the public. However, if mitigation cannot be done before a disaster impacts a public building it should be incorporated during the repair process to make sure these facilities can withstand disasters in the future to allow communities to be more resilient.

Mitigation Fact Sheets

The Fact Sheets in this series discuss building elements that may be impacted during a flood or hurricane, including building systems, which include mechanical (heating, ventilation, and air conditioning), electrical, and plumbing systems and associated equipment, which includes things like piping, wiring, fixtures and other accessories. There are eight Fact Sheets in this series, covering four topics:

1. **Foundations:** Building foundations help to distribute the weight of the building to the earth below. Foundations generally are classified as shallow or deep and closed or open. Without a proper foundation, a building can suffer damage from erosion, scour or settlement.
2. **Walls and Openings:** The exterior walls of buildings include joints and openings such as doors and windows. These all provide points of entry for wind-driven rain and flood water to pass into the building. They also can be susceptible to damage from wind-borne debris. Implementing mitigation measures can help prevent wind- and flood-related damage.
3. **Roof Systems:** Roof systems generally are classified as sloped or low-sloped, with sloped roofs having a pitch of 1V:4H or greater and low-sloped roofs having a pitch of less than 1V:4H, although this can vary slightly based on the type of roof covering. Roofs can be subject to damage from wind, wind-driven rain and wind-borne debris.



4. **Building Utility Systems:** For these fact sheets, building utility systems include heating, ventilation and air conditioning (HVAC); electrical; plumbing; and conveyance systems. These systems heat and cool buildings, provide water and power, expel wastewater, and move people and equipment between levels of the building. Each of these systems can be susceptible to damage by flood, and exterior components also can be susceptible to wind damage.

Mitigation Solutions

There are many recommended mitigation measures or best practices for small public buildings (Figure 3.0.1) and large public buildings (Figure 3.0.2) in areas prone to floods or hurricanes.

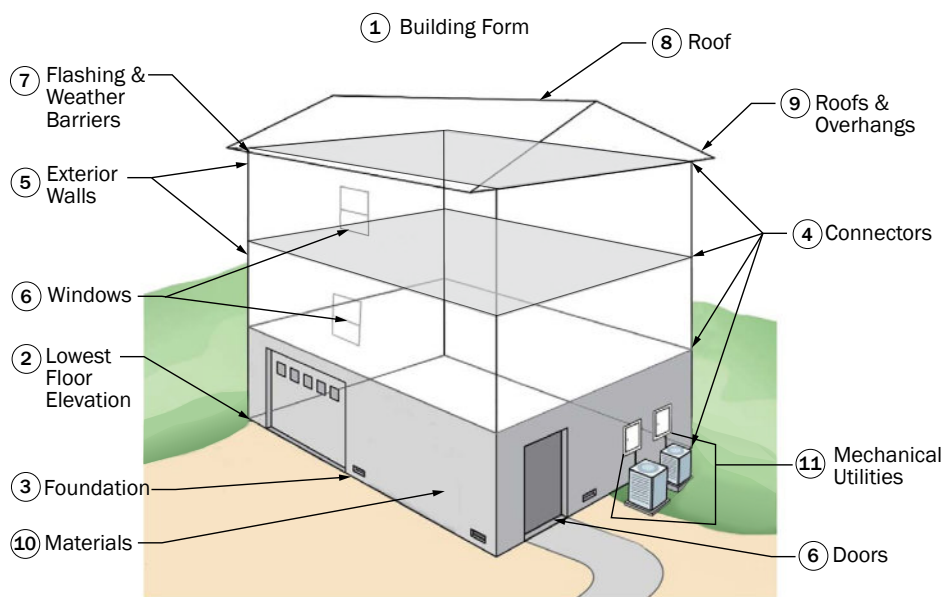

Figure 3.0.1. Small public building elements (before mitigation).

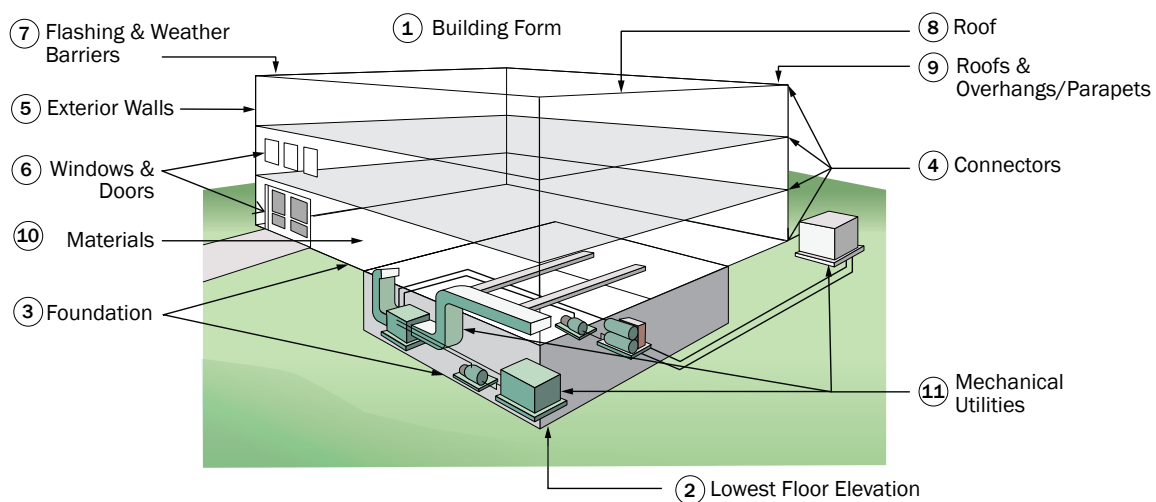

Figure 3.0.2. Large public building elements (before mitigation).

The numbered items below relate to the numbering in Figure 3.0.1 and Figure 3.0.2. They list the recommended mitigation measures for each of the numbered building elements:

- 1. Building Form.** Flat or low-sloped roofs covering open spaces such as porches and carports, overhangs, and gable ends are subject to increased wind pressure in high winds. Buildings that are both tall and narrow are subject to overturning. These problems can be overcome through the design process, but each issue must meet specific design requirements. During the design process, consider moderate-sloped hip roofs with a 4:12 or 6:12 slope.
- 2. Lowest Floor Elevation.** In coastal buildings, elevate the bottom of the lowest horizontal structural member (LHSM) supporting the lowest floor above the Design Flood Elevation (DFE), or highest flood level, in the Coastal A and V Zones. Building foundations in A Zones should be elevated to comply with the local floodplain management ordinance, including codes, specifications and standards such as ASCE 24. Critical public buildings will require more freeboard to reduce damage during the predicted 0.2%-annual-chance (500-year) flood event, which will increase resilience. Lastly, uses for areas that are below the base flood elevation (BFE) are limited to parking, storage, and access and should remain unfinished, using only flood-damage-resistant materials. (See NFIP Technical Bulletin 2, *Flood Damage-Resistant Materials Requirements, for additional information.*)
- 3. Foundation.** Make sure the foundation is deep enough to resist the effects of scour and erosion; strong enough to resist wave, current, flood, and debris forces; and capable of transferring wind forces on upper stories to the ground. A coastal foundation should include piles, piers, or columns and be open to allow the free flow of flood waters and waves. NFIP Technical Bulletin 2, *Flood Damage Resistant Material Requirements*, and NFIP Technical Bulletin 5, *Free of Obstruction Requirements*, provide additional information.
- 4. Connections.** Key connections to ensure a continuous load path from the roof to the foundation include roof sheathing, roof-to-wall, wall-to-wall, and wall-to-foundation connections. Be sure these connections are built according to the design. Bolts, screws and ring-shank nails are common requirements. Define standard connection details and nailing on the plans. Connectors in coastal environments should be corrosion-resistant consistent with NFIP Technical Bulletin 8, *Corrosion Protection of Metal Connectors in Coastal Areas*.
- 5. Exterior Walls.** Use structural sheathing in high-wind areas for increased wall strength. Use tighter than typical nailing schedules for attaching sheathing. Take care not to over-drive pneumatically driven nails. This can result in loss of shear capacity in shear walls. Refer to FEMA P-424, *Design Guide for Improving School Safety*, for more detailed information.
- 6. Windows and Doors.** In high-wind areas, use windows and doors capable of withstanding increased wind pressures. In wind-borne debris areas, use impact-resistant glazing or shutters. Use door shields to prevent water intrusion when used with water-resistant foundation and wall membranes. Refer to Fact Sheet 3.2, *Wall Systems and Openings*, and FEMA P-543, *Design Guide for Improving Critical Facility Safety from Flooding and High Winds*, for additional information.
- 7. Flashing and Weather Barriers.** Use stronger connections and improved flashing for roofs, walls, doors and windows and other openings. Install secondary moisture barriers, such as house wrap or building paper, to reduce water intrusion from wind-driven rain. Refer to FEMA P-424, *Design Guide for Improving School Safety*, for more-detailed information.

8. **Roof.** In high-wind areas, choose appropriate roof coverings and pay attention to detailing. Avoid roof tiles in hurricane-prone areas. Install secondary water barriers to provide extra protection. Secure rooftop equipment to resist design wind loads or place equipment in a rooftop penthouse. Refer to FEMA P-424, *Design Guide for Improving School Safety*, and Hurricanes Irma and Maria in the U.S. Virgin Islands Recovery Advisory 2, *Attachment of Rooftop Equipment in High-Wind Regions*, for additional information.
9. **Porch Roofs and Roof Overhangs.** Design and tie down porch roofs, roof overhangs, and columns to resist uplift forces in accordance with FEMA P-55, *Coastal Construction Manual*.
10. **Materials.** Use flood-resistant materials below the DFE. All exposed materials should be moisture- and decay-resistant. Metals should have enhanced corrosion protection. See NFIP Technical Bulletin 2, *Flood Damage-Resistant Materials Requirements*, and ASCE 24, *Flood Resistant Design and Construction*.
11. **Mechanical and Utilities.** Mechanical, electrical and plumbing (MEP) systems and equipment should be raised to avoid flood damage and strategically located to avoid wind damage. Utility lines should be installed to minimize potential flood damage.

What Should Communities Expect from a Mitigated Building?

A public building can be mitigated successfully if it can resist damage from a variety of natural hazards over time, such as wind, flooding, hurricanes, erosion and scour. This does not mean that a public building will remain undamaged over its intended lifetime. It means that the impacts of a design-level flood, storm, wind, or erosion event (or a series of small events with combined impacts equivalent to a design event) will be limited to the following:

- The building **foundation** should remain intact and functional.
- The **envelope** (walls, openings, roof, and lowest floor) should remain structurally sound and capable of withstanding wind, rain, and debris.
- The **lowest floor elevation** should be sufficient to prevent floodwaters from entering the elevated building envelope during the design event.
- The **utility connections** (e.g., electricity, water, sewer, natural gas) should remain intact or be restored easily.
- The building should be **accessible, habitable, and safe** with minimal repairs following a design-level event.
- Any damage to **enclosures** below the Design Flood Elevation (DFE), or the highest flood level, should not damage the foundation, the utility connections, or the elevated portion of the building.
- Building **contents** will remain safe with minimal damage.

Exceeding Minimum Requirements Can Improve Building Performance

States and communities enforce regulatory requirements that determine where and how buildings may be sited, designed and built under Executive Order 11988, *Floodplain Management*. Federal agencies funding or permitting key public buildings are required to avoid building in areas that are in the 0.2%-annual-chance (or 500-year probability) flood event. See the FEMA fact sheet, *Critical Facilities and Higher Standards*, for additional information.

Designers can help facility owners and communities evaluate their options to make informed decisions about mitigation options. Note that critical facilities, such as hospitals, have their own code requirements. Some buildings have performance standards per ASCE 7, *Minimum Design Loads for Buildings and Other Structures*, or ASCE 24, *Flood Resistant Design and Construction*, for different risk categories based on the building's use or purpose. Hurricane or tornado shelters must be built to ICC 500 Storm Shelter or FEMA Safe Room standards contained in FEMA P-361, *Safe Rooms for Tornadoes and Hurricanes*.

Building Contents, Equipment and Furnishings

Building contents and equipment can be elevated or relocated to protect against flood damage (Figure 3.0.3 and Figure 3.0.4). Finishes can be replaced with materials made to resist flood damage. When advanced notice of a storm allows for it, relocating critical and expensive equipment—for instance, moving fire and rescue equipment away from a fire station that is close to the coast or in a flood-prone area—not only prevents damage but also allows the equipment to be used during critical emergency response operations.

When repairing a non-Substantially Damaged building (i.e., a building for which the total cost of repairs is less than 50% of the structure's market value before the disaster) with significant interior damage, or during a planned renovation, using flood damage-resistant materials for interior elements like flooring, doors, cabinets, etc., can prevent or significantly reduce damage from flooding. Rearranging a building's space—for example, moving critical equipment to a second or third floor above the flood level—can reduce flood damage and allow continued operation.

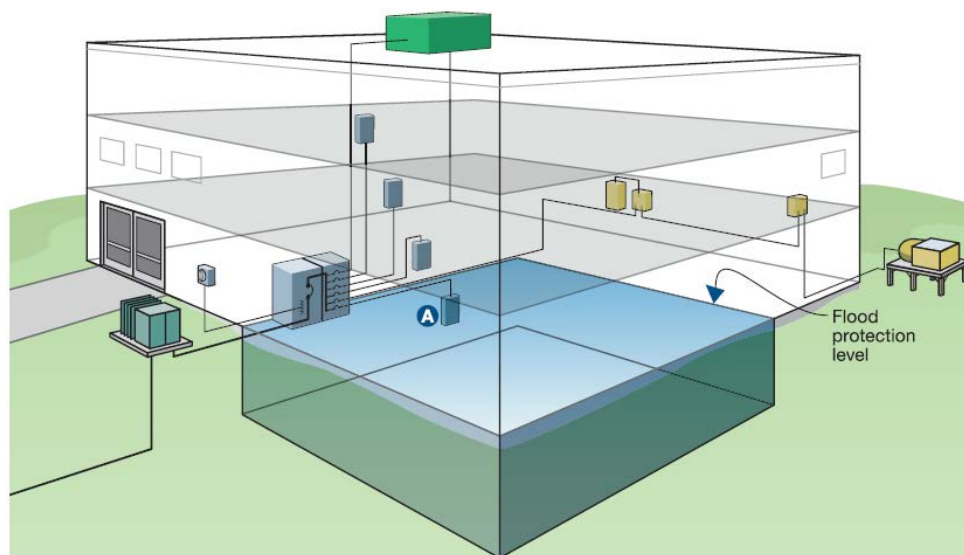

A Note: The basement panel will remain vulnerable to flooding, so it should be electrically isolated from the rest of the electrical system.

Figure 3.0.3. Large public building elements with primary electrical system components mitigated.

Utility Flood Protection Level

FEMA P-348, *Protecting Building Utility Systems from Flood Damage*, defines the flood protection level as “... the elevation required by the NFIP, building codes, or locally adopted regulations. In addition, flood protection level refers to the level selected to provide the desired level of protection when compliance with code or regulation is not required and designers and owners elect to elevate or protect building utility systems.” The flood protection level is the same as the design flood elevation. These may differ from the base flood elevation, which is the elevation to which a flood is expected to rise during the 1%-annual-chance flood, also called the 100-year flood. The flood protection level (or design flood elevation) is generally the base flood elevation plus freeboard.

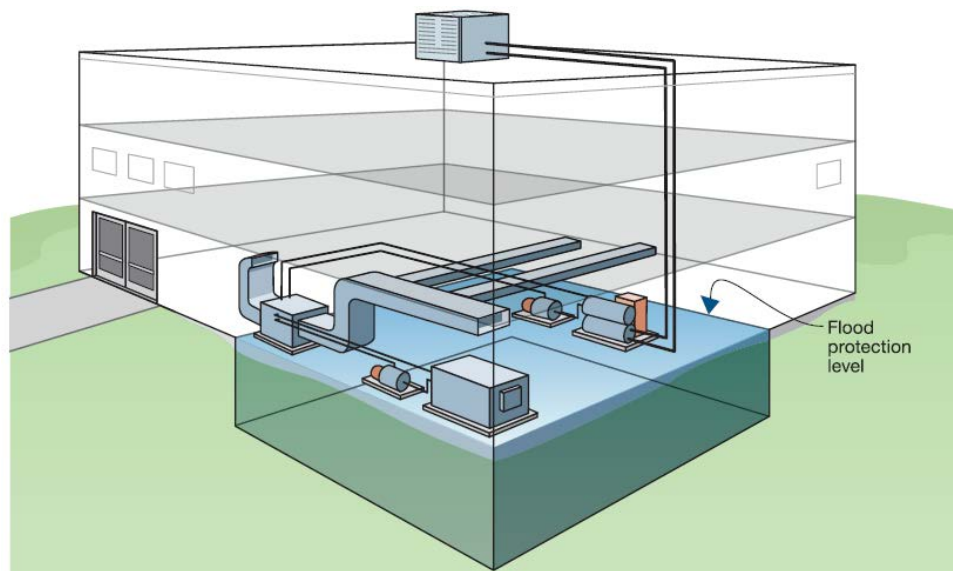







Figure 3.0.4. Flood risk for large public building reduced by relocating primary HVAC components from a subgrade basement level to a higher floor.

Icons

The Fact Sheets include points to consider about developing and implementing each mitigation option. Icons represent these common considerations, which are summarized in Table 3.0.1.

Table 3.0.1. Icons Used to Represent Considerations about Hazard Mitigation Strategies

Icon	Considerations about Hazard Mitigation Strategies
	Cost – The cost to carry out the mitigation option may be high, which could make using the option cost prohibitive.
	Engineering – A qualified engineer would likely need to design the mitigation option.
	Environmental and Historic Preservation – The mitigation option likely will need to comply with local, state and/or federal environmental and historic preservation requirements.
	Floodplain Management – Carrying out the mitigation option might impact the floodplain, triggering compliance with floodplain management requirements.
	Operations and Maintenance – The mitigation option might require additional operations and maintenance activities beyond those currently being performed.
	Permitting – Evaluate the local, state or federal permits required to carry out the mitigation option.

REFERENCES:

Recommended practice and guidance concerning listed topics can be found in the following FEMA publications and trade publications:

- American Society of Civil Engineers (ASCE). 2016. ASCE 24 Flood Resistant Design and Construction. Available at: <https://ascelibrary.org/doi/book/10.1061/asce24>
- Federal Emergency Management Agency (FEMA). 1993a. NFIP Technical Bulletin 3, *Non-Residential Floodproofing—Requirements and Certification*. Available at: <https://www.fema.gov/emergency-managers/risk-management/building-science/national-flood-insurance-technical-bulletins>
- FEMA. 1993b. NFIP Technical Bulletin 7, *Wet Floodproofing Requirements for Structures Located in Special Flood Hazard Areas*. Available at: <https://www.fema.gov/emergency-managers/risk-management/building-science/national-flood-insurance-technical-bulletins>
- FEMA. 2007. FEMA 551, *Selecting Appropriate Mitigation Measures for Floodprone Structures*. Available at: https://www.fema.gov/sites/default/files/2020-08/fema_551.pdf
- FEMA. 2008. NFIP Technical Bulletin 2, *Flood Damage-Resistant Materials Requirements*. Available at: <https://www.fema.gov/emergency-managers/risk-management/building-science/national-flood-insurance-technical-bulletins>
- FEMA. 2009. FEMA P-762, *Local Officials Guide for Coastal Construction* Available at: https://www.fema.gov/sites/default/files/documents/fema_p-762-local-officials-guide-coastal-construction.pdf
- FEMA. 2010. FEMA P-499, *Homebuilder's Guide to Coastal Construction*. Available at: https://www.fema.gov/sites/default/files/2020-08/fema499_2010_edition.pdf
- FEMA. 2011. FEMA P-55, *Coastal Construction Manual: Principles and Practices of Planning, Siting, Designing, Constructing, and Maintaining Residential Buildings in Coastal Areas*. Available at: <https://www.fema.gov/media-library/assets/documents/3293>
- FEMA. 2012. FEMA P-259, *Engineering Principles and Practices for Retrofitting Flood-Prone Residential Structures*. Available at: https://www.fema.gov/sites/default/files/2020-08/fema259_complete_rev.pdf
- FEMA. 2013. FEMA P-936, *Floodproofing Non-Residential Buildings*. Available at: https://www.fema.gov/sites/default/files/2020-07/fema_p-936_floodproofing_non-residential_buiildings_110618pdf.pdf
- FEMA. 2014. FEMA P-312, *Homeowner's Guide to Retrofitting*. Available at: <https://www.fema.gov/media-library/assets/documents/480>
- FEMA. 2015. FEMA P-1037, *Reducing Flood Risk to Residential Buildings That Cannot Be Elevated*. Available at: https://www.fema.gov/sites/default/files/2020-07/fema_P1037_reducing_flood_risk_residential_buildings_cannot_be_elevated_2015.pdf
- FEMA. 2016. FEMA P-787, *Catalog of FEMA Building Science Branch Publications and Training Courses—Fifth Edition*. Available at: https://www.fema.gov/sites/default/files/2020-07/fema_earthquakes_p-787-catalog-of-fema-building-science-branch-publications-and-training-courses-fifth-edition_20161014.pdf
- FEMA. 2019. NFIP Technical Bulletin 8, *Corrosion Protection of Metal Connectors in Coastal Areas* Available at: <https://www.fema.gov/emergency-managers/risk-management/building-science/national-flood-insurance-technical-bulletins>

FEMA. 2020. NFIP Technical Bulletin 5, *Free of Obstruction Requirements* Available at: <https://www.fema.gov/emergency-managers/risk-management/building-science/national-flood-insurance-technical-bulletins>

FEMA. No Date. Fact Sheet, *Critical Facilities and Higher Standards*. Available at: http://data.wvgis.wvu.edu/pub/RA/_resources/CF/FPM_1_Page_CriticalFacilities_and_Higher_Standards.pdf

International Code Council (ICC). 2018. *International Building Codes and I-Codes Summary of Changes to Flood Provisions*.

U.S. Army Corps of Engineers (USACE). 1995. *Flood Proofing Regulations EP 1165-2-314*. Available at: https://www.publications.usace.army.mil/Portals/76/Publications/EngineerPamphlets/EP_1165-2-314.pdf

Fact Sheet 3.1: Foundations

The mitigation objective of this Fact Sheet is to decrease the likelihood of foundation damage or failure from a flood or hurricane that could restrict using the building or parts of the building for extended periods.

Building foundations can be grouped by general characteristics of open, closed/continuous, shallow and deep. Foundations generally have two of these characteristics, e.g., open and deep or continuous and shallow. These characteristics play a large part in how the foundation performs during a flood or hurricane. The text box below provides additional information about foundation characteristics, and Figure 3.1.1 illustrates these foundation characteristics.

Definitions

Closed Foundations—Closed foundations restrict or divert the flow of floodwaters. Closed foundations include basements, crawl spaces where the lowest floor is built above ground, stem walls with soil-supported concrete floor slabs, and soil-supported monolithic slab-on-grade foundations where portions of the slab often are thickened to support the structure above.

Open Foundations—Columns, piers and piles support raised buildings and allow floodwaters to pass underneath the structure. Open foundations are typically less vulnerable to flood damage than closed foundations.

Shallow Foundations—Shallow foundations are supported by soils that are relatively close to the surface of the surrounding grade. Shallow foundations include crawl space foundations, stem walls, monolithic slab-on-grade, discrete pad footings, and mat-style foundations. Column and pier foundations also can be shallow. Shallow foundations are vulnerable to moving floodwaters and can be undermined by scour and erosion.

Deep Foundations—Deep foundations are supported by soils or bedrock that are significantly below the surface of the surrounding grade. Deep foundations include piles, drilled shafts and caissons. Deep foundations naturally resist scour and erosion.



Structure Attributes

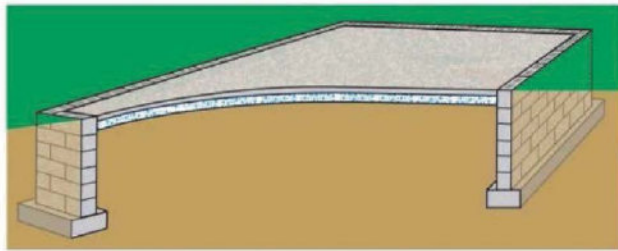

Closed, shallow continuous stem wall with soil supported slab

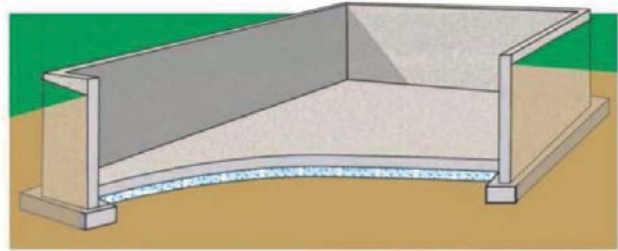

Closed, shallow basement

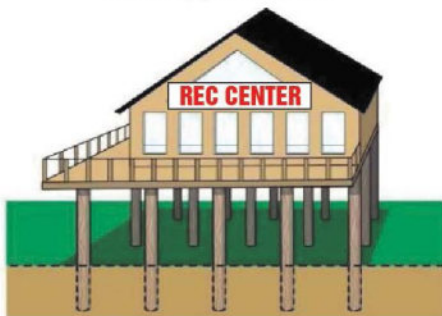

Open, deep foundation on piles

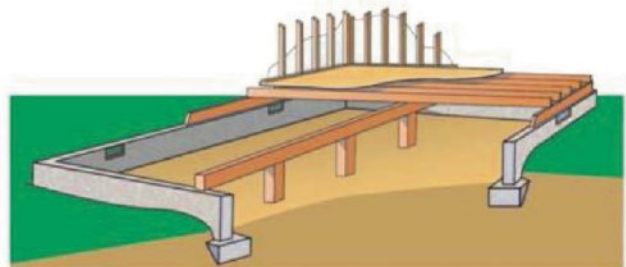

Closed, shallow crawl space

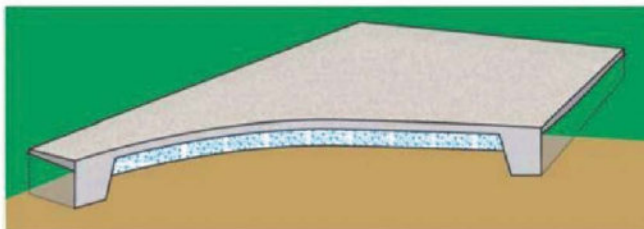

Shallow monolithic slab on grade



Open, shallow foundation on columns/piers/posts

Figure 3.1.1. Foundation characteristics.

Table 3.1.1 summarizes some common mitigation strategies that can improve building foundation performance. These strategies are discussed in the sections that follow.

Table 3.1.1. Common Mitigation Solutions

Solutions and Options	Crawl Space	Stem Wall	Columns/ Piers	Piles	Basement	Slab-on-Grade
Mitigation Solution: Relocate						
Option 1: Relocate the Building	✓	✓	✓	✓	✓	✓
Mitigation Solution: Elevate						
Option 1: Elevate the Foundation (freeboard)	✓		✓	✓		NR*
Option 2: Convert or Abandon the First Floor		✓			✓	✓
Option 3: Raise the Interior Floor	✓	✓			✓	✓
Mitigation Solution: Floodproof						
Option 1: Wet Floodproof	✓				✓	
Option 2: Dry Floodproof		✓			NR*	✓
Mitigation Solution: Retrofit the Structure						
Option 1: Anchor or Brace	✓	✓	✓	✓	✓	✓
Option 2: Improve Connections	✓	✓	✓	✓	✓	✓
Option 3: Underpin Footings	✓	✓			✓	✓

NR* = Not recommended for existing foundation type.

Mitigation Solution: Relocate

Relocation typically involves moving a building out of the hazard area. Due to the challenges of moving buildings over roadways, relocation is typically limited to small non-residential buildings where additional land outside the floodplain is available on the current site or on a nearby site. This mitigation measure can offer the best protection for retrofitting existing buildings from flood and coastal hazards. Still, it is often the most expensive mitigation solution.

Option 1: Relocate the Building

The following steps represent a typical relocation process:

1. Place large steel beams to temporarily support the structure and raise the building off its foundation.
2. Place the raised building on equipment capable of supporting the weight of the building. When relocation involves moving over roads, heavy-duty flatbed trailers often are used (Figure 3.1.2).



Figure 3.1.2. Relocation of a small flood-prone public building.

3. Haul the building to another part of the site or to a new site outside of the hazard area.
4. Lower the building onto a new foundation system.
5. Secure the building to the foundation to resist water and wind forces to which the building may be exposed.

When evaluating relocation as an option, consider the following items:

- Candidate buildings must be thoroughly evaluated for structural soundness.
- All structural members and connections must be strong enough to withstand the stresses of being lifted, transported and placed on a new foundation.
- Small, single-story, wood-frame structures that are supported by open foundations or placed over crawl spaces or basements are often the easiest buildings to relocate.

- Due to size and weight considerations, large, multi-story or heavy buildings like masonry structures are more challenging to relocate.
- Consider relocating critical facilities to an inland site to reduce storm exposure.
- Historic buildings can be susceptible to movement during relocation. If the building is historic, the move should be coordinated with the state historic preservation office.

CONSIDERATIONS:

Mitigation Solution: Elevate

Elevation involves raising a building to reduce its risk of flooding while keeping the building at or near its existing location. For buildings located in a Coastal High Hazard Zone, the lowest floor of a structure or lowest horizontal structural member must be raised to the design flood elevation (DFE). Where possible, provide greater risk reduction by raising the building more than required to reach the DFE. Like relocation, elevation is easiest with smaller or lighter buildings; larger buildings generally are more difficult to raise. Buildings that cannot be relocated may be candidates for elevation.

- Elevation involves most of the same steps as those required for relocation, except for transportation of the building. Elevation does not reduce risk to building foundations, so consider improving the foundation in addition to elevating the building. An example of a foundation improvement is replacing a closed-style foundation with an open-style foundation.
- Some general points to keep in mind when considering elevation as a mitigation strategy include:
 - Shallow foundations, continuous wall foundations and open foundations can fail because of damage caused by erosion and the impact of debris carried by floodwaters.
 - If portions of the original foundation (for example, footings) are used to support any new addition to the building, they must be capable of safely carrying the additional loads imposed by new construction and expected flood and wind forces.
- For Substantially Damaged critical facilities along the coast, choose an inland relocation site to elevate the critical facilities to reduce hazard exposure, so the facilities retain functionality in future hazard events.
- Slab-on-grade buildings are harder to elevate because there is no place to insert the lifting beams. Most grade slabs are not designed to function as raised floor systems. Raising them also can pose a risk to the building. In some cases, the building can be lifted off of and separated from the slab.

Option 1: Elevate the Foundation

This elevation option raises the entire structure of a small public building or portions of a large public building. When evaluating this mitigation strategy, consider the following:

- During the elevation process, most buildings are separated from their foundations, raised on hydraulic jacks, and held by temporary supports (cribbing), while a new or extended foundation is built below. Buildings with basements typically backfill the basement to grade. The new or extended foundation can consist of continuous walls or separate piers, posts, columns or piles.
- Buildings exposed to flooding from rivers or surface water flooding and buildings in NFIP Zone A may be raised on closed, shallow foundations with the top of the lowest floor at or above the DFE, in accordance with Zone A construction requirements.

- Elevation of slab-on-grade buildings is not advised since the slab was never intended to support a raised structure.
- Open, deep foundations using driven piles with the lowest horizontal part of the structure at or above the DFE, in accordance with Zone V construction requirements, as shown in Figure 3.1.3, are the only foundations compliant with coastal zone floodplain management and building code regulations.

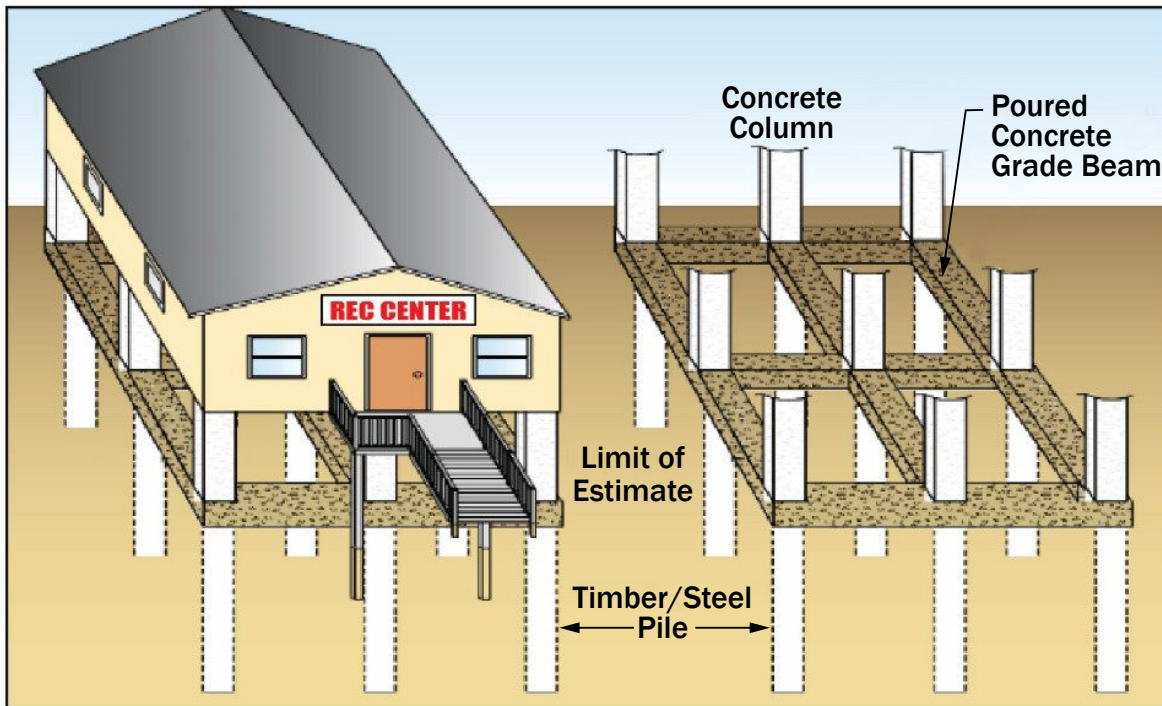

Figure 3.1.3. Elevation of small public building on piles in coastal flood zone.

CONSIDERATIONS:



Option 2: Convert or Abandon the First Floor

For small or large public buildings that are two or more stories high, and where the lowest floor is constructed with flood-resistant materials, elevation can be achieved by vacating the lowest story or converting its use in accordance with the NFIP or local ordinances.

Consider the following when evaluating this option:

- With conversion or abandonment, the building is not raised, but flood risks are reduced.
- Check the base flood elevation (BFE) against the potential for storm surge and design for the higher of the two levels.
- Install flood vents to allow floodwaters to enter the lowest level, equalizing flood levels inside and outside the building and reducing or relieving buoyancy and hydrostatic forces (Figure 3.1.4).

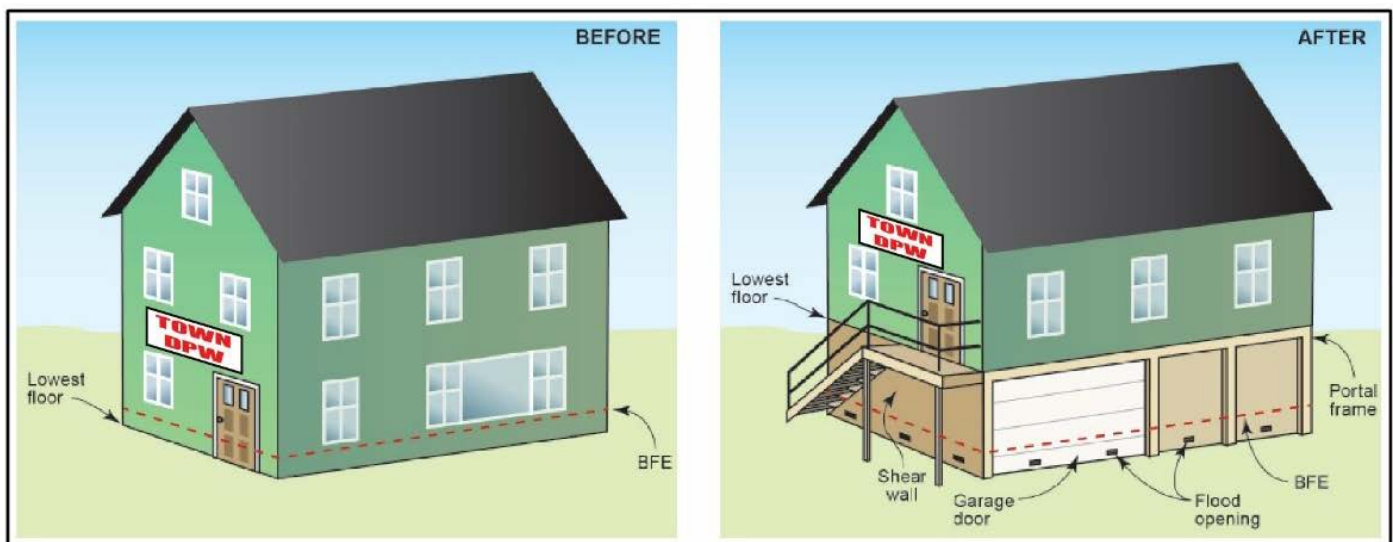

Figure 3.1.4. Abandoning the lowest floor can elevate usable space above the BFE.

- Consider building an additional story to replace a converted or abandoned first floor. This option is only viable for buildings that have the structural capacity to support the added story. The original foundation must safely carry the additional loads imposed by an additional story while also handling flood and wind loads.
- Damage caused by erosion and debris impacts can cause shallow foundations, continuous wall foundations and open foundations to fail.

CONSIDERATIONS:



Option 3: Raise the Interior Floor

For small or large public buildings where the first floor has enough ceiling height, raising the floor can achieve elevation. Basements can be filled to the potential maximum flood level if there is enough first-floor clearance for code compliance and building function, as shown in Figure 3.1.5. This measure is accomplished by constructing a new lowest floor with the bottom of its lowest horizontal structural member at or above the BFE within the existing structure. Any utility systems and associated equipment located below the lowest interior floor must be elevated to protect them from damage or loss of function. The area below the new first floor is filled in with soil or retrofitted with flood openings to allow automatic entry and exit of floodwaters.

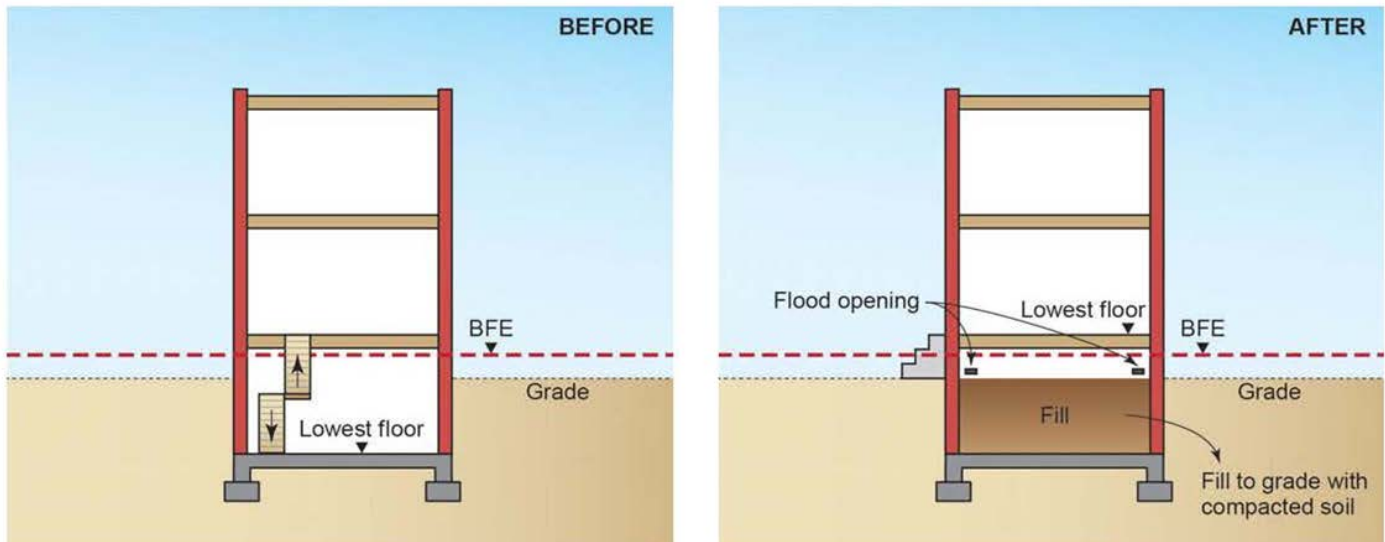

Figure 3.1.5. Constructing a raised floor or filling in a basement can elevate occupied space above the BFE.

CONSIDERATIONS:



Mitigation Solution: Floodproof

FEMA defines floodproofing as “... any combination of structural and non-structural additions, changes, or adjustments to structures which reduce or eliminate flood damage to real estate or improved real property, water and sanitary facilities, structures and their contents.” Floodproofing is done to protect buildings and their contents from water damage caused by flooding.

Option 1: Wet Floodproof

Wet floodproofing involves modifying the unoccupied portions of buildings (such as crawl spaces or unfinished basements) to allow floodwaters to enter and exit, as shown in Figure 3.1.6. Wet floodproofing equalizes pressures exerted by non-moving flood waters on the inside and outside of the building.

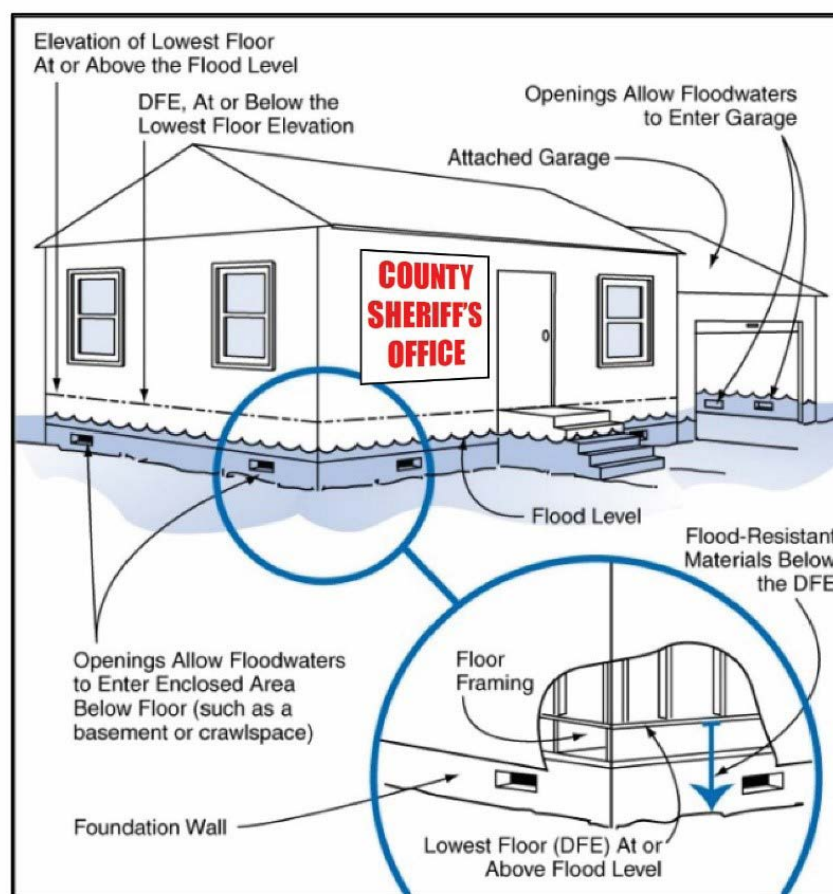

Figure 3.1.6. Wet floodproofing opening retrofit diagram for a small public building.

Crawl space foundation walls below the BFE are retrofitted with flood openings. Flood openings are installed on at least two sides of the foundation. The bottom of the opening is no higher than one foot above ground level. The recommended opening area must be at a ratio of at least one square inch of opening per one square foot of building area (floor space) to allow floodwaters to enter and exit underneath the structure to equalize flood pressure on the foundation walls. See NFIP Technical Bulletin 1, *Requirements for Flood Openings in Foundation Walls and Walls of Enclosures*, for additional information.

Materials that resist damage from water can be used to mitigate inhabited portions of buildings. See the latest editions of NFIP Technical Bulletin 1, *Requirements for Flood Openings in Foundation Walls and Walls of Enclosures* and NFIP Technical Bulletin 2, *Flood Damage-Resistant Materials Requirements*.

CONSIDERATIONS:



Option 2: Dry Floodproof

A dry-floodproofed building is watertight below the design flood elevation as required by ASCE 24 and state or local codes and standards. This mitigation method is designed to prevent floodwater entry and is best applied to small public buildings or sections of large public buildings with slab-on-grade foundations and reinforced masonry or concrete walls. Dry floodproofing can be a good option for all or part of public buildings subject to shallow flooding if building relocation or elevation is not technically feasible or cost-effective, as shown in Figure 3.1.7 and Figure 3.1.8.

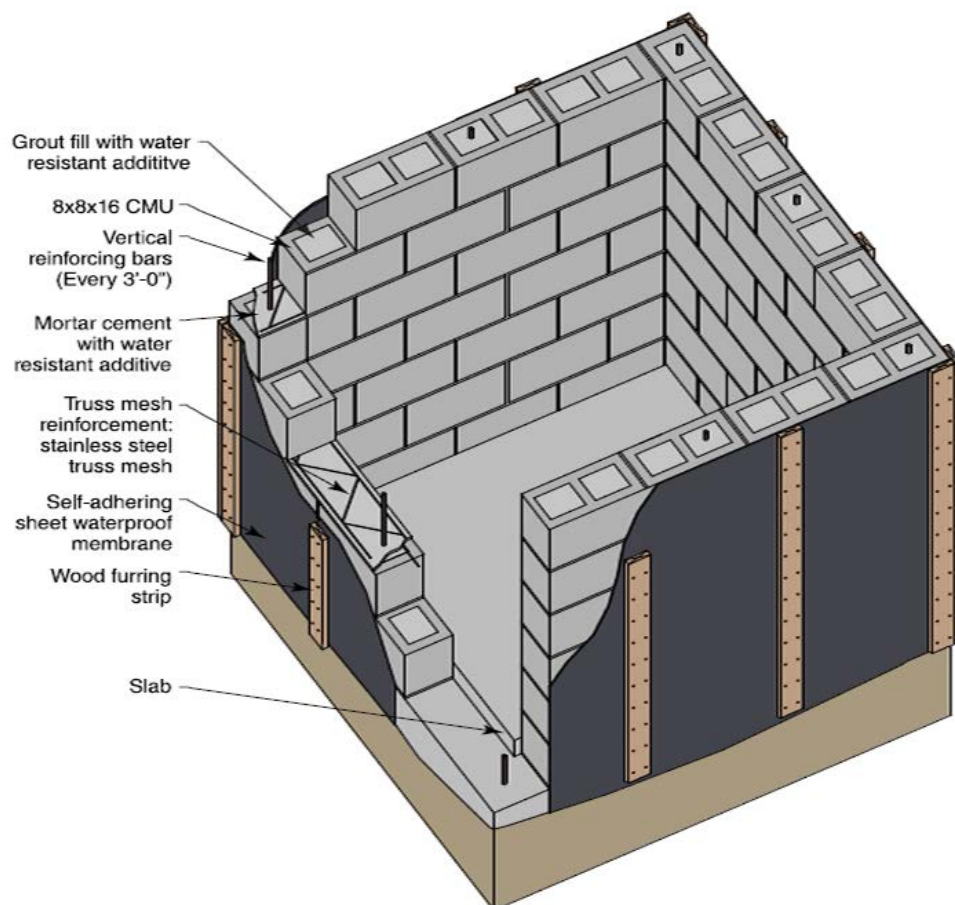

Figure 3.1.7. Dry floodproofing sealants diagram for a portion of a building.

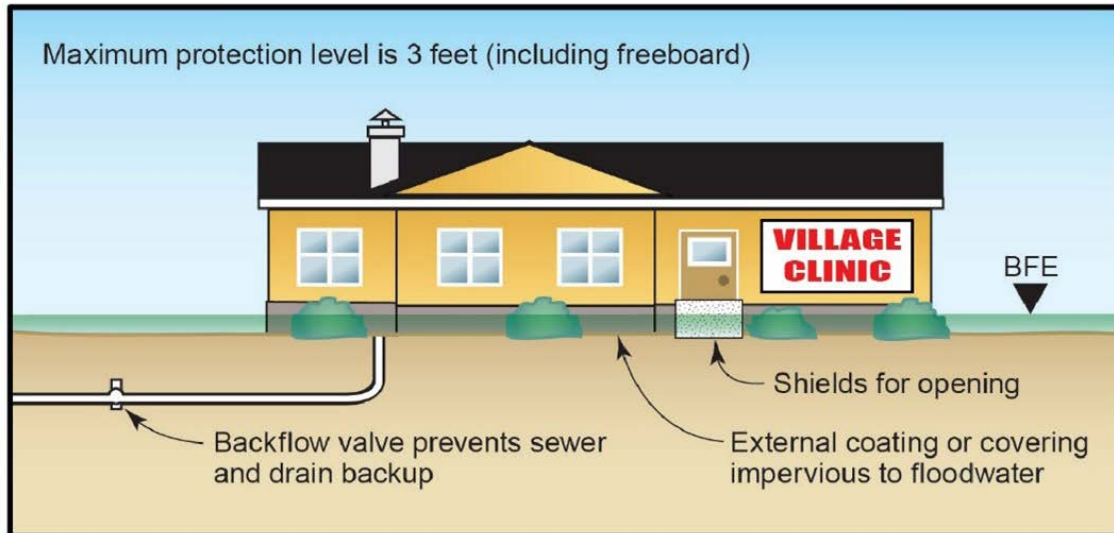

Figure 3.1.8. Dry floodproofing sealants and secondary drainage diagram.

Dry floodproofing mitigation methods may include:

- Construct a flood wall or berm around all or part of the building to protect critical components.
- Seal the building's outside walls using technologies that include waterproof membranes to make the walls impermeable. This approach can potentially strengthen those walls.
- Increase the flood resistance in inside core areas to protect critical components. This approach may be used when dry floodproofing the entire building is either not needed or not feasible.
- Seal openings such as doors, windows, and utility penetrations, and seal walls and slabs to improve flood resistance. These building components are rarely designed to be watertight.
- Install flood shields to prevent water from entering through openings in outside walls.
- Install backflow valves to prevent floodwater flow into the building caused by blockages in the sewage system.
- Install internal drainage systems to remove water that may seep through small fissures and pathways in the protection system.

When evaluating dry floodproofing as a mitigation option, consider the following:

- Elevation or relocation, including elevating or relocating critical equipment, is preferred to floodproofing. However, where elevation or relocation are not possible, proper floodproofing can reduce risk.
- Before dry floodproofing a building, a registered design professional such as a structural engineer should determine if the building is structurally sound and can resist the design flood loads. It should also be confirmed that the dry-floodproofed building can resist other loads such as hydrodynamic loads and debris impacts during the design flood. Extensive structural reinforcement may be needed.

- Dry floodproofing should include passive mitigation that does not require human involvement, such as flood shields that close automatically when triggered by rising floodwater or doors that always seal when closed. It also may include active mitigation that does require human involvement, such as manual installation of door shields or preparation of supplemental drainage.
- Significant warning time (at least 12 hours) is needed to ensure dry floodproofing effectiveness. Flash floods, deep floods, or quickly moving water could prevent the use of dry floodproofing.
- Dry floodproofing the lowest floor of a mixed-use building is permitted if the lowest floor is used for non-residential purposes.

CONSIDERATIONS:

Mitigation Solution: Retrofit the Structure

For public buildings where existing foundations have been damaged but the structure remains intact, foundations can be retrofitted or repaired for improved performance to reduce future damages. When foundation damage is significant, consider replacing the foundation with a type more resistant to flood damage, like an open-style foundation.

Option 1: Anchor or Brace

Anchoring and bracing involve installing ground anchors or lateral bracing systems to improve resistance to horizontal pressures and uplift forces imposed by floods and hurricane winds. When evaluating this option, some considerations include:

- Steel ground anchors, micropiles or helical piles are drilled or bored next to or through the existing foundation (Figure 3.1.9), secured by grouting, and then connected to the existing building.

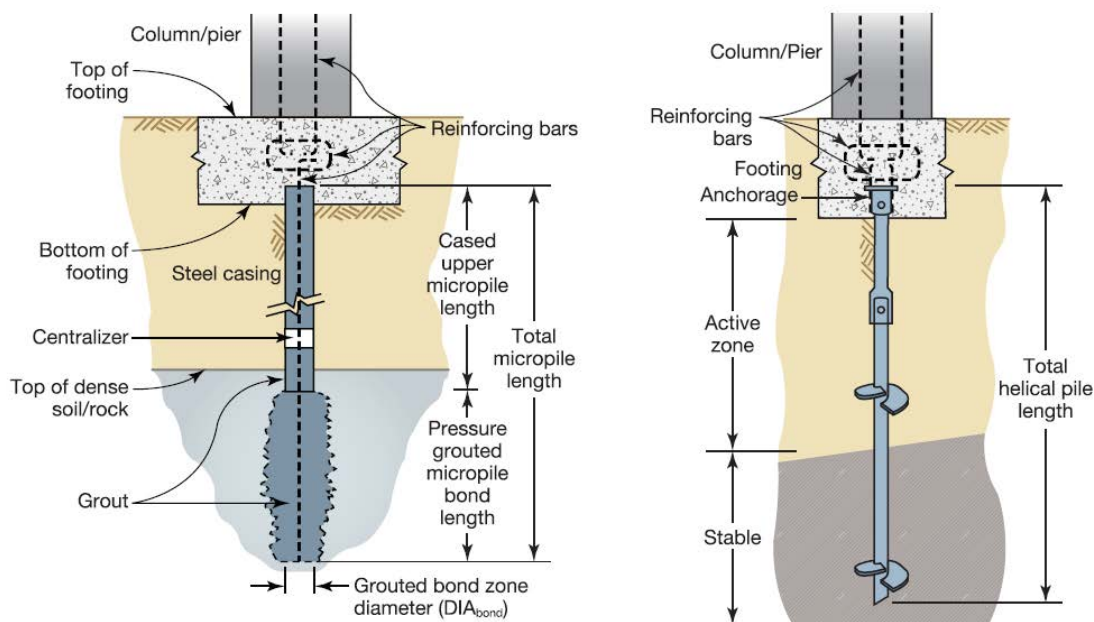

Figure 3.1.9. Grouted micropile (left) and helical pile (right) can strengthen existing building foundations.

- Open foundation bracing can include installation of diagonal cross bracing, knee bracing or grade beams.
- Designers should ensure that foundation bracing does not obstruct water flow or inhibit breakaway wall systems.

CONSIDERATIONS:



Option 2: Improve Connections

This option involves installing enhanced connectors and fasteners to link the foundation to the frame of the building to improve horizontal load resistance. When evaluating this mitigation option, consider the following:

- Use corrosion-resistant techniques to improve wood pile-to-beam connections, including the use of corrosion-resistant connectors and fasteners. Make small notches in piles or add engineered support brackets to handle minor wood pile-to-beam misalignments (Figure 3.1.10).

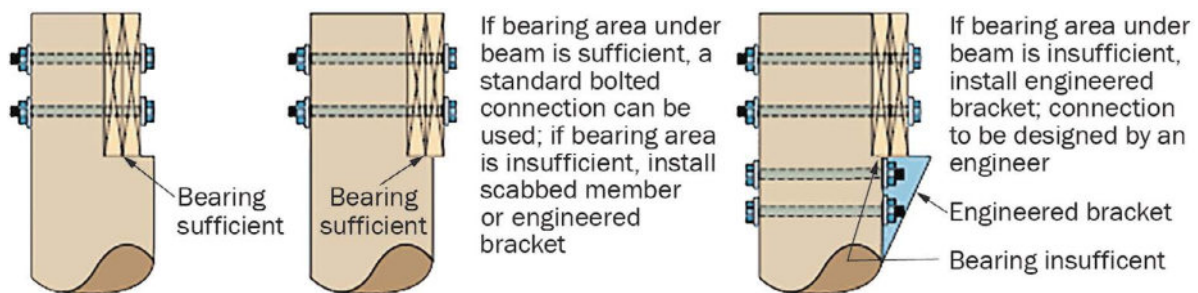

Figure 3.1.10. Improve connections—select approaches to address minor wood pile-to-beam misalignments.

- Install corrosion-resistant connectors and fasteners that are securely grouted to masonry piers or concrete pipes and anchored to the structural frame with enough strength to resist the full combined flood and wind uplift force.
- An engineer should design improved connections. Inspect the installation in the field to prevent the use of inadequate connectors or over-notching existing piles.

CONSIDERATIONS:



Option 3: Underpin Footings

Underpinning extends the foundation depth and/or breadth to rest on stronger soils or distributes the load more evenly across a larger area. Considerations when evaluating this option include:

- Underpin footings to mitigate pier footings or crawl space wall footings that have been undermined by storm-induced erosion and scour.
- Use jacks and temporary supports on either side of the footing to stabilize the structure.
- Restore soil support of the undermined footing by injecting grout, increasing the footing size/depth, or installing micropiles through the footing deep into the underlying soil.
- Consult a geotechnical engineer to determine if stronger soils are present to support the foundation loads. If soil strength is adequate, a structural engineer should design the underpinning system.

CONSIDERATIONS:



REFERENCES:

Detailed technical information on retrofitting and floodproofing methods, considerations and general design practices can be found in these publications. Much of the residential information also applies to non-residential buildings as well.

American Society of Civil Engineers (ASCE). *Highlights of ASCE 24 Flood Resistant Design and Construction*. Available at: https://www.fema.gov/sites/default/files/2020-07/asce24-14_highlights_jan2015.pdf

Federal Emergency Management Agency (FEMA). 1993a. NFIP Technical Bulletin 3, *Non-Residential Floodproofing—Requirements and Certification*. Available at: <https://www.fema.gov/emergency-managers/risk-management/building-science/national-flood-insurance-technical-bulletins>

FEMA. 1993b. NFIP Technical Bulletin 7, *Wet Floodproofing Requirements for Structures Located in Special Flood Hazard Areas*. Available at: <https://www.fema.gov/emergency-managers/risk-management/building-science/national-flood-insurance-technical-bulletins>

FEMA. 2000. FEMA 347, *Above the Flood: Elevating Your Floodprone House*. Available at: https://docs.bryantx.gov/engineering/FEMA-Flooding-Publications/1_fema347_completers.pdf

FEMA. 2007. FEMA 551, *Selecting Appropriate Mitigation Measures for Floodprone Structures*. Available at: https://www.fema.gov/sites/default/files/2020-08/fema_551.pdf

FEMA. 2008. NFIP Technical Bulletin 2, *Flood Damage-Resistant Materials Requirements*. Available at: <https://www.fema.gov/emergency-managers/risk-management/building-science/national-flood-insurance-technical-bulletins>

FEMA. 2009. FEMA P-762, *Local Officials Guide for Coastal Construction*. Available at: https://www.fema.gov/sites/default/files/documents/fema_p-762-local-officials-guide-coastal-construction.pdf

FEMA. 2010. FEMA P-499, *Homebuilder's Guide to Coastal Construction*. Available at: https://www.fema.gov/sites/default/files/2020-08/fema499_2010_edition.pdf

FEMA. 2011. FEMA P-55, *Coastal Construction Manual: Principles and Practices of Planning, Siting, Designing, Constructing, and Maintaining Residential Buildings in Coastal Areas*. Available at: <https://www.fema.gov/media-library/assets/documents/3293>

FEMA. 2012. FEMA P-259, *Engineering Principles and Practices for Retrofitting Flood-Prone Residential Structures*. Available at: https://www.fema.gov/sites/default/files/2020-08/fema259_complete_rev.pdf

FEMA. 2013a. FEMA P-936, *Floodproofing Non-Residential Buildings*. Available at: https://www.fema.gov/sites/default/files/2020-07/fema_p-936_floodproofing_non-residential_buiildings_110618pdf.pdf

FEMA. 2013b. FEMA P-942, *Mitigation Assessment Team Report: Hurricane Sandy in New Jersey and New York*. Available at: <https://www.fema.gov/emergency-managers/risk-management/building-science/mitigation-assessment-team>

FEMA. 2014. FEMA P-312, *Homeowner's Guide to Retrofitting*. Available at: <https://www.fema.gov/media-library/assets/documents/480>

FEMA. 2015. FEMA P-1037, *Reducing Flood Risk to Residential Buildings That Cannot Be Elevated*. Available at: https://www.fema.gov/sites/default/files/2020-07/fema_P1037_reducing_flood_risk_residential_buildings_cannot_be_elevated_2015.pdf

- FEMA. 2019a. FEMA P-2037, *Flood Mitigation Practices for Multi-Family Buildings*. Available at: https://content.govdelivery.com/attachments/USDHSFEMA/2020/06/24/file_attachments/1481529/16-J-0218_Multi-FamilyGuidance_06222020.pdf
- FEMA. 2019b. NFIP Technical Bulletin 8, *Corrosion Protection of Metal Connectors in Coastal Areas*. Available at: <https://www.fema.gov/emergency-managers/risk-management/building-science/national-flood-insurance-technical-bulletins>
- FEMA. 2020. NFIP Technical Bulletin 1, *Requirements for Flood Openings in Foundation Walls and Walls of Enclosures*. Available at: <https://www.fema.gov/emergency-managers/risk-management/building-science/national-flood-insurance-technical-bulletins>.
- International Code Council (ICC). 2018. *International Building Codes and I-Codes Summary of Changes to Flood Provisions*. Available at: https://www.fema.gov/sites/default/files/2020-08/fema_2018-i-code-summary-flood-changes-from-2015.pdf
- U.S. Army Corps of Engineers (USACE). 1995. EP 1165-2-314 *Flood Proofing Regulations*. Available at: https://www.publications.usace.army.mil/Portals/76/Publications/EngineerPamphlets/EP_1165-2-314.pdf

Fact Sheet 3.2: Wall Systems and Openings

The mitigation objective of this Fact Sheet is to decrease the likelihood of building damage or failure from the pressure of floodwaters or wind forces or wind infiltration and wind-driven rain.

Floodwaters and wind can easily enter buildings through joints in wall systems and openings such as doors and windows. Strengthening these points of entry will help improve a building's performance during floods and hurricanes. When considering mitigation options for historic buildings, check with the state historic preservation office to determine which solutions and options meet historic preservation requirements. The text box below provides some additional information about wall systems and openings.

Definitions

Load Path—The route taken by a force as it makes its way through a structure. When a building has a continuous load path, the force is eventually transferred to and resisted by the supporting soils on which the building sits. A continuous load path usually requires the use of metal connectors and fasteners and a strong wall system design.

Framing—Pieces that are fit together to provide structural support for the wall system, which can be built from wood or metal studs, steel, reinforced masonry, reinforced concrete, insulating concrete form (ICF) and common brick.

Connectors and Fasteners—Hardware that links wall framing systems to roof and floor systems, transferring the load from system to system. They include hurricane straps and ties or concrete or grout with steel reinforcing bars.

Sheathing—Plywood or oriented strand board (OSB) wall framing covering that adds strength to wood or metal studs. Gypsum board may be used for metal stud or steel-framed walls.

Exterior Wall Finishes—Covering that protects the wall system from wind pressure, wind-driven rain and debris. Some finishes may even offer some protection from flooding. Finishes include wood, vinyl, aluminum, fiber-cement board siding, brick or stone veneer, stucco or exterior insulation and finish system (EIFS).



A range of mitigation strategies for wall systems and openings for small and large public buildings are shown in Table 3.2.1. These strategies then are discussed in the sections that follow.

Table 3.2.1. Wall Systems and Openings Mitigation Solutions

Solutions and Options	Wind	Wind-Driven Rain	Riverine Flooding	Coastal Flooding
Mitigation Solution: For Wall Systems				
Option 1: Strengthen Framing Materials and Connections	✓		✓	✓
Option 2: Improve Sheathing	✓	✓	✓	✓
Option 3: Upgrade Exterior Wall Finishes	✓	✓	✓	✓
Mitigation Solution: For Door Openings				
Option 1: Prevent Water Intrusion	✓	✓	✓	
Option 2: Upgrade Exterior Doors	✓	✓		
Option 3: Upgrade Garage Doors	✓	✓		
Mitigation Solution: For Window Openings				
Option 1: Strengthen Windows	✓			
Option 2: Retrofit with Impact-Resistant Glazing	✓			
Option 3: Install Storm Shutters	✓	✓		

Mitigation Solution: For Wall Systems

Exterior wall systems help to enclose a building to protect the interior spaces from the environment. According to the *Whole Building Design Guide*, one of the most common threats to the soundness and performance of a building is when rain penetrates the interior. Water penetration can weaken parts of the wall system that are part of the continuous load path, which transfers loads throughout the building from the point where the loads are applied. If there is not a continuous load path in a building, the loads can cause a failure related to the missing connection point. It is important to take steps to prevent water from getting into buildings through wall systems to continue to protect during floods and hurricanes.

Option 1: Strengthen Framing Connections and Materials

Structural failures frequently occur at connections instead of in the framing itself. Especially in coastal areas where the environment is wetter and more humid and buildings are exposed to salt spray, corroded metal connectors and fasteners often fail to transfer loads correctly along the load path. Connectors and fasteners must have enough strength to resist all forces that will act on a building during a hurricane or flood (Figure 3.2.1.)

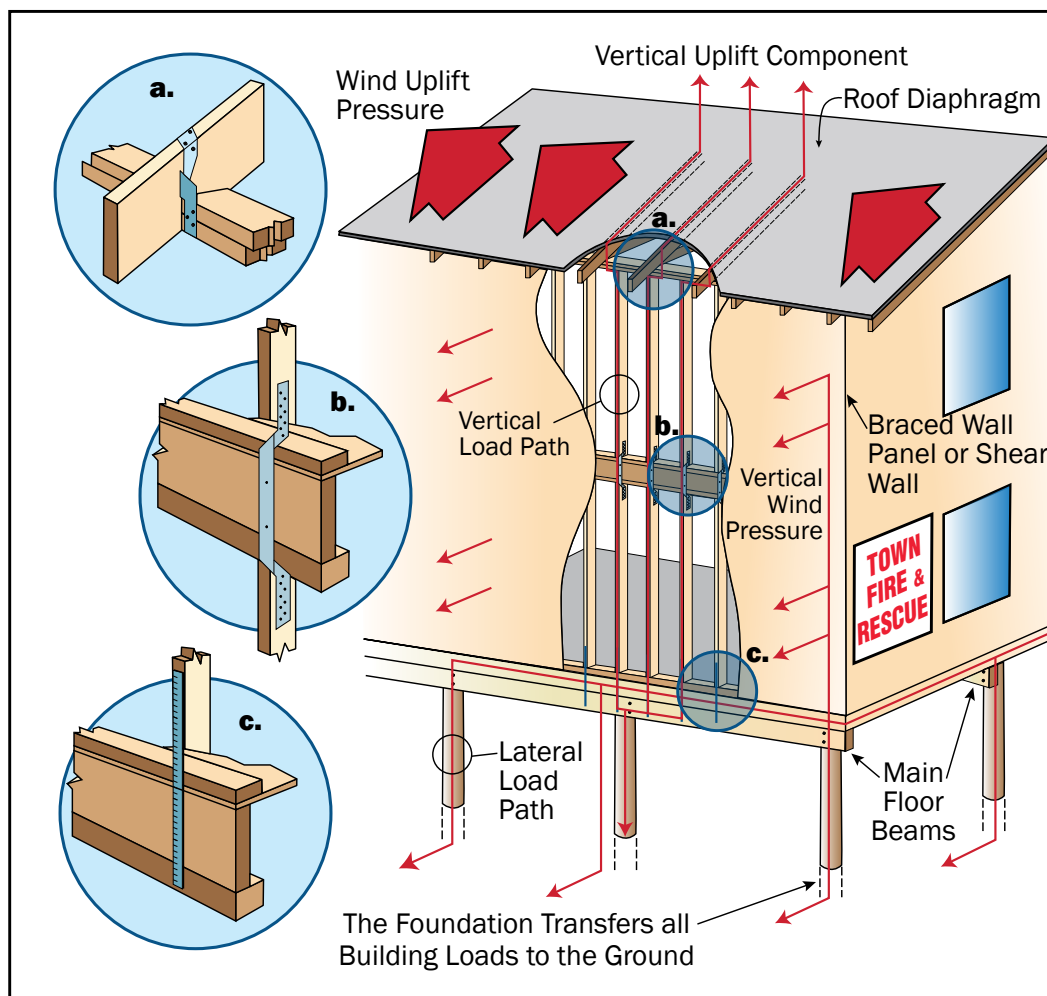

Figure 3.2.1. Connectors help create an adequate building load path.

Strengthen framing connections and materials to establish a continuous load path throughout the wall system to transfer all horizontal, gravity and uplift forces imposed on a building during hurricanes and floods, including:

- Roof framing to wall framing connections
- Wall framing connections and wall-to-wall connections
- Wall framing to foundation connections

When evaluating this option, keep these considerations in mind:

- All framing connectors and fasteners within 3,000 feet of the coastline should be either hot-dipped galvanized or stainless steel.
- Where possible, inspect, maintain, and replace materials as needed to keep a continuous load path.
- Refer to NFIP Technical Bulletin 8, *Corrosion Protection for Metal Connectors and Fasteners in Coastal Areas*.

CONSIDERATIONS:



Option 2: Improve Sheathing

In exterior wall systems, sheathing is the board or panel used to cover the wall frame. Sheathing helps strengthen the wall system and provides a surface to which other materials can be applied. Sheathing material can be chosen that provides some amount of resistance to floods, hurricanes, and other weather-related events.

When evaluating this mitigation option, consider the following:

- Remove flood-damaged sheathing and replace it with thicker, stronger, flood-damage-resistant, exterior-grade sheathing.
- Add a water-resistant barrier between the sheathing and exterior wall finish to provide another layer of protection.
- Replace existing framing and sheathing with reinforced concrete or reinforced masonry. This approach may be desirable in areas subject to high winds with windborne debris, such as island construction in the U.S. territories.
- Refer to NFIP Technical Bulletin 2, *Flood Damage-Resistant Materials Requirements*, for a list of flood-damage-resistant sheathing materials.

CONSIDERATIONS:

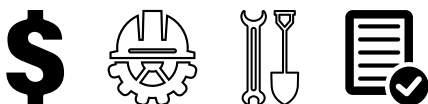

Option 3: Upgrade Exterior Wall Finishes

Exterior wall finishes are materials applied to the outside sheathing on wall systems. They help to protect the building while also providing some decoration. Examples of exterior finishes include, but are not limited to, siding, stucco and masonry veneer.

When evaluating this mitigation option, consider the following:

- Replace existing damaged exterior finishes with materials that are stronger and/or more resistant to wind and water.
- Improve siding connections to enhance wind protection.
- EIFS and vinyl siding are especially at risk to wind and debris damage; replace these materials with fiber cement siding, high-wind-rated vinyl siding or another impact-resistant exterior finish (Figure 3.2.2).

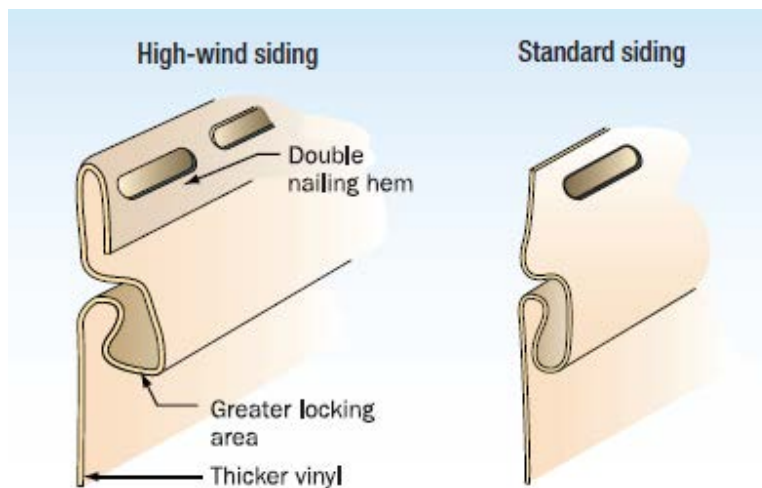

Figure 3.2.2. Features of typical high-wind siding and standard siding.

CONSIDERATIONS:



Mitigation Solution: For Door Openings

Exterior doors are susceptible to damage from hurricanes and floods. Hurricane winds can blow in doors or tear them from their hinges, allowing water to enter the building. Doors and related components such as door frames, connections and hardware can be mitigated to strengthen them and prevent wind and water from entering.

Option 1: Prevent Water Intrusion

Mitigating doors against water entry can protect the building, its interior finishes, and the contents of the building. Some considerations when evaluating this mitigation option include:

- Add weather stripping to the base of the door or drip protection along the top, as shown in Figure 3.2.3.

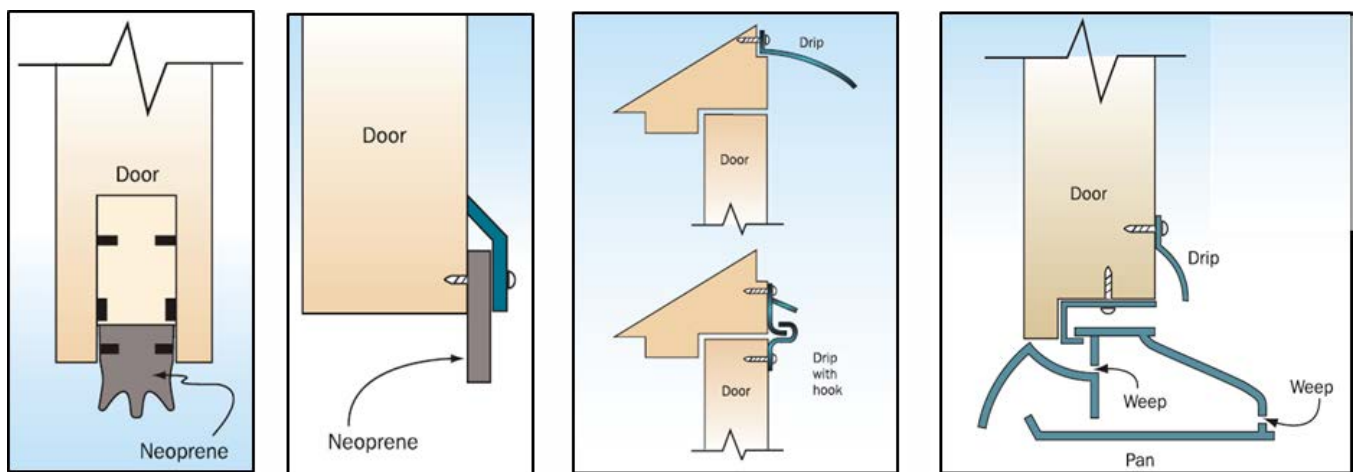

Figure 3.2.3. Examples of weather stripping (far left and center left) and drip protection (center right and far right) to prevent wind-driven rain entry at doors.

- Install flood shields and barriers—a type of dry floodproofing—to prevent floodwater from entering a building through the building exterior. Dry floodproofing should be designed and implemented as a system, as discussed in Fact Sheet 3.1, *Foundations*.
 - All areas of a building that contact floodwaters, including the floor slab, must be considered part of the flood barrier and made strong enough to resist all flood forces and be sealed enough to be substantially impenetrable.
 - Flood barriers should be considered around the exterior of a building, around critical equipment, and around areas that need to provide critical functions.
 - Flood shields with gaskets can provide up to three feet of protection during floods lasting less than 24 hours. This approach works well for concrete or masonry buildings in riverine flood zones. (Figure 3.2.4).
 - Interior door protection can be prioritized to protect areas with critical functions or equipment.

- Some door flood shields or barriers deploy automatically, while others must be placed manually. Manual shield placement is an active mitigation measure that requires a person to place the shield before the event and remove it after the event.
- Replace existing doors with debris-impact-rated doors.
- Make sure any replacement doors are rated for the design wind speed and wind pressure in the area where the building is located.
- Build a vestibule around the entry door to reduce or block water from getting into the interior.
- Residual seepage may occur, requiring drainage, pumping, clean-up, and sanitation. ASCE 24 requires sump pumps to be installed in dry floodproofed buildings.

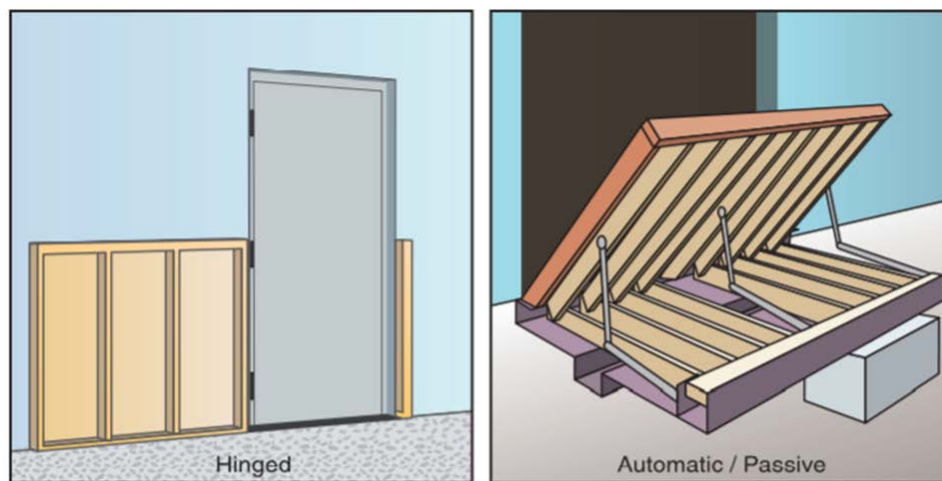

Figure 3.2.4. Examples of hinged (left) and lift out (right) flood shields with gaskets at entry doors. Some flood shields are automatic while others must be placed manually.

CONSIDERATIONS:



Option 2: Upgrade Exterior Doors

Upgrading exterior doors can improve their strength and impact resistance, which can improve the strength of the wall system. When evaluating this mitigation option, consider the following:

- Replace damaged exterior doors, frames, hinges, and hardware with wind-resistant components.
- Replace a hollow-core door with a solid wood door, standard lock and deadbolt lock.
- For protection against high winds and wind-borne debris, install a steel door with multiple hinges and deadbolt locks.
- Replace inward swinging doors with outward swinging doors rated for high wind and debris impacts.
- Replace screws that secure hinges with longer screws that penetrate the wood jamb of the door.

CONSIDERATIONS:



Option 3: Upgrade Garage Doors

Garage doors can be relatively large, making them one of the largest openings in a building. Because of their relative size, garage doors can be vulnerable to the wind blowing them in, pulling them out, or twisting them off their tracks. Refer to Figure 3.2.5 for details on garage door retrofitting techniques.

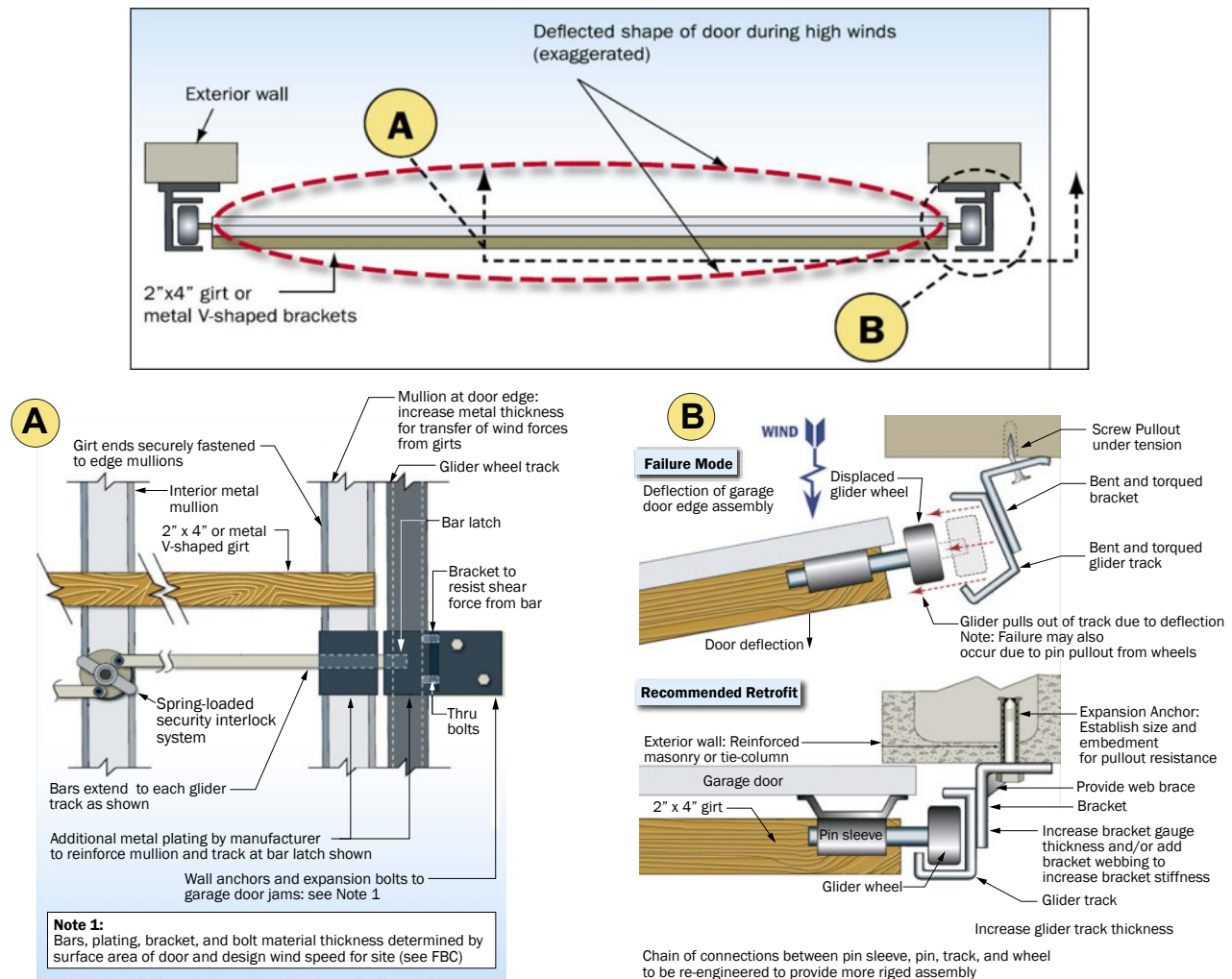

Figure 3.2.5. Recommended details for upgrading garage doors.

When evaluating this option, consider the following:

- Extend latches, add wooden 2" x 4" or steel girts, strengthen glider tracks and wheel axles and improve anchor connection of garage door brackets into the walls of apparatus bays.
- Install a center post brace to the garage door that is anchored into the garage slab and the ceiling framing to reduce the unbraced length of the garage door for additional protection. This approach is active mitigation, requiring a person to install the brace, which prevents the garage door from opening until the brace is removed.
- Install impact-resistant shutters in front of existing garage doors. This is an active mitigation measure, so a person must be available to close and secure the shutters before the event and then open them after the event.

- Replace existing doors with debris-impact-rated doors.
- Make sure any replacement doors are rated for the wind speed and wind pressure in the area where the building is located.
- For added protection, install garage doors that exceed code requirements.
- Design professionals should consider new sectional and rolling door assemblies that comply with wind load testing in accordance with ASTM E1233, *Standard Test Method for Structural Performance of Exterior Windows, Doors, Skylights, and Curtain Walls by Cyclic Air Pressure Differential* or the Door and Access Systems Manufacturers Association International (DASMA) Technical Data Sheet 115, *Standard Method for Testing Garage Doors: Determination of Structural Performance Under Missile Impact and Cyclic Wind Pressure*, respectively.

CONSIDERATIONS:

Mitigation Solutions: For Window Openings

Like exterior doors, windows can allow wind and water to enter buildings, resulting in damage to structural components, inside finishes, and contents. Mitigation solutions can prevent wind and wind-driven rain from entering windows and related components.

Option 1: Strengthen Windows

Wind pressure can blow windows into the building's interior. Windows also can fail when struck by flying debris. To improve window performance during hurricanes and floods, consider the following:

- Install windows in stronger frames and ensure window frames are securely attached to the building wall framing to improve resistance to hurricane wind pressures.
- Where windows are not strong enough to resist the wind pressures, reinforce these frames by installing screws through the window jamb into the house framing.
- Install screw anchors through the window jamb into block walls (Figure 3.2.6). The screw anchors must be long enough to penetrate the window jamb, shim space, and buck strip in addition to penetrating the masonry wall by about 1 ½ inches similar to methods included in Florida Division of Emergency Management, Bureau of Mitigation's *Hurricane Retrofit Guide Openings (Windows and Doors)*. The depth and size of fastener as well as spacing of required fasteners depends on the size of the opening and the design wind requirements at the building site. The design engineer should determine these requirements.

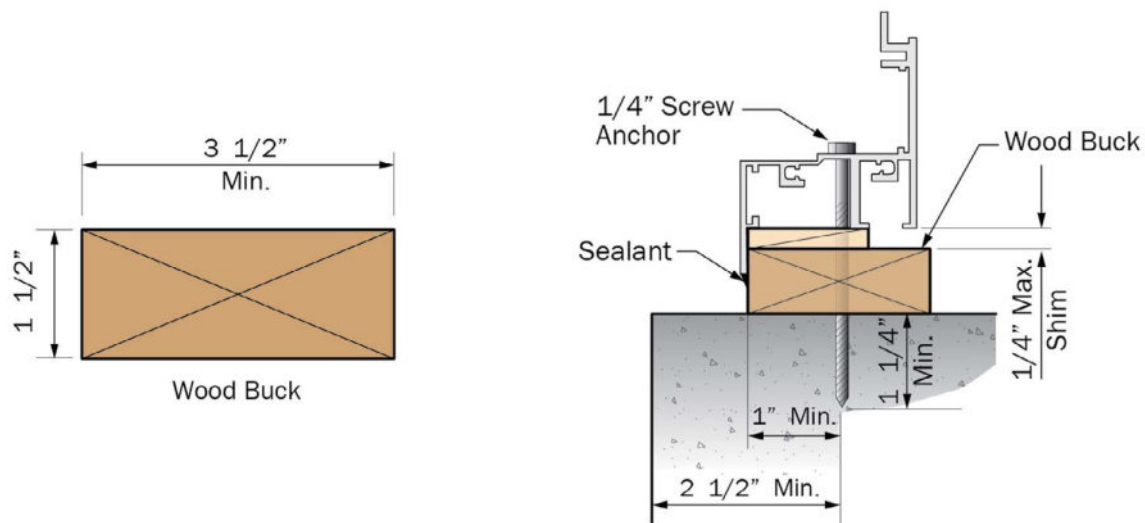

Figure 3.2.6. Use screw anchors to fasten window frames directly to concrete.

- Ensure that wall sheathing and wall framing connections to the window header are strong enough to resist wind uplift and positive and negative horizontal wind pressures, as shown in Figure 3.2.7.

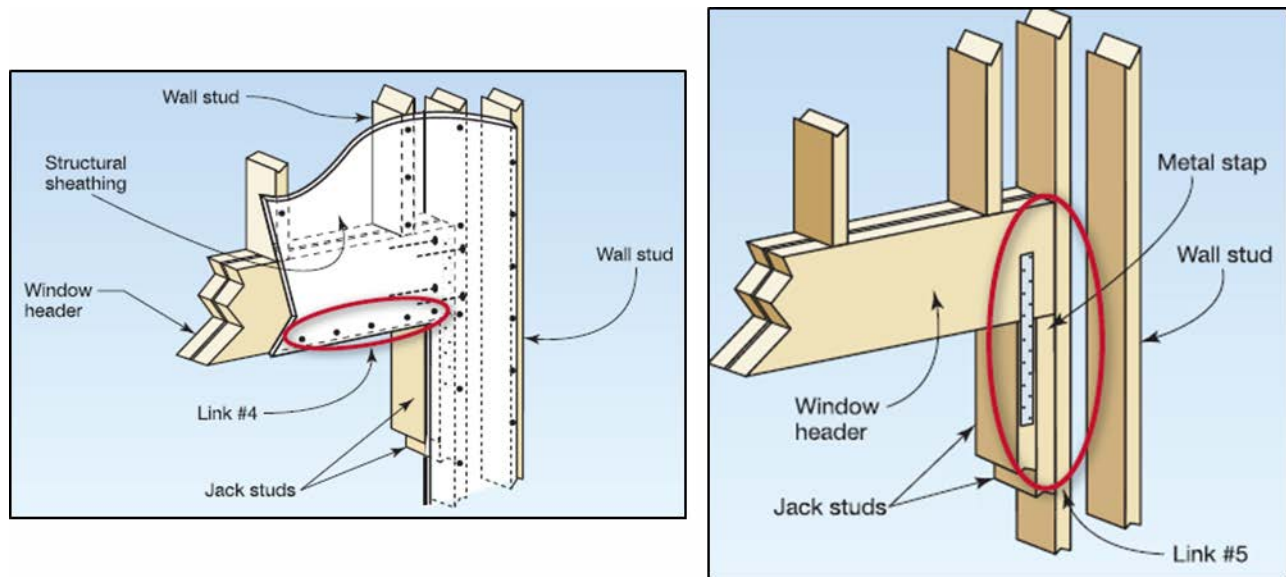

Figure 3.2.7. Connection of wall sheathing to window header (left) and window header to exterior wall (right) as part of a wall framing system.

CONSIDERATIONS:



Option 2: Retrofit with Impact-Resistant Glazing

Wind-borne debris can shatter windows, posing a safety threat to building occupants from flying glass shards and allowing rain, floodwater, and wind to enter the building through the window opening. Impact-resistant glazing can help strengthen windows. Impact-resistant glazing can include laminated glazing systems and polycarbonate systems:

- Laminated glazing systems are made with two or more glass panes and an interlayer of film laminated into the assembly. The glass panes may be broken by wind-borne debris, but the interlayer will remain intact to prevent wind and wind-driven rain entry. Laminated glazing systems also may increase the energy efficiency of the building.
- Polycarbonate systems are plastic resins that are molded into sheets that provide lightweight, clear panels with high impact-resistance qualities. The strength of the polycarbonate sheets can be up to 200 times higher than existing non-laminated glazing.

When evaluating this mitigation option, consider the following:

- Replace existing glass windows with impact-resistant glazing that mitigates hurricane wind pressures and wind-borne debris impact.

CONSIDERATIONS:



Option 3: Install Storm Shutters

Install storm shutters to prevent windows from breaking because of hurricane wind pressure and wind-borne debris impact. Storm shutters must be securely connected to the wall framing. Storm shutter deployment is an active mitigation measure that requires manual installation, so adequate time must be available before the storm to complete the task. It may require equipment in addition to labor to reach the upper levels of buildings. Figure 3.2.8 shows a variety of available shutter types.

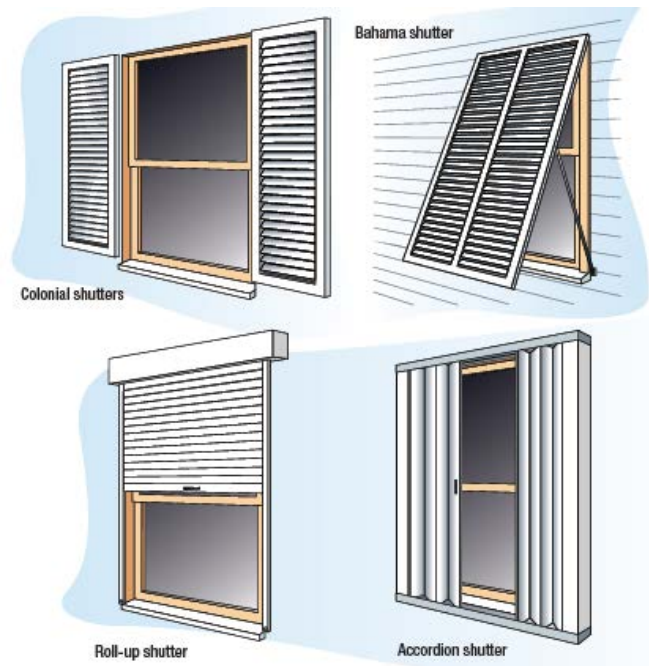

Figure 3.2.8. Examples of storm shutter styles.

Consider the following when evaluating this mitigation option:

- Only install shutters that have a label indicating they have been tested and are building code compliant.
- The Engineered Wood Association's Hurricane Shutter Design (APA T450) provides guidance for building and installing wood panel shutters. If wood panels are installed, it is important to adequately anchor them so that they do not become wind-borne debris. The International Building Code, Section 1609.2, gives guidance regarding panel thickness.
- Detailed information about window installation is provided in Standard Practice for Installation of Exterior Windows, Doors and Skylights (ASTM E2112), which concentrates on detailing and installation procedures to minimize water entry.

CONSIDERATIONS:



REFERENCES:

Detailed technical information on hurricane mitigation of wall systems and openings can be found in these publications. Much of the residential information also applies to non-residential buildings.

- American Society of Civil Engineers (ASCE). 2015. *Highlights of ASCE 24-14 Flood Resistant Design and Construction*. Available at: https://www.fema.gov/sites/default/files/2020-07/asce24-14_highlights_jan2015.pdf
- Federal Emergency Management Agency (FEMA). 2007. FEMA 543, *Design Guide for Improving Critical Facility Safety from Flooding and High Winds*. Available at: https://www.fema.gov/sites/default/files/2020-08/fema543_design_guide_complete.pdf
- FEMA. 2007. FEMA 577, *Design Guide for Improving Hospital Safety in Earthquakes, Floods, and High Winds*. Available at: https://www.fema.gov/sites/default/files/2020-08/fema577_design_guide_improving_hospital_safety_2007.pdf
- FEMA. 2008. NFIP Technical Bulletin 2, *Flood Damage-Resistant Materials Requirements*. Available at: https://www.fema.gov/emergency-managers/risk-management/building-science/publications?name=%22Technical+Bulletin+2%22&field_keywords_target_id=All&field_document_type_target_id=All&field_audience_target_id=All
- FEMA. 2010a. FEMA P-424, *Risk Management Series: Design Guide for Improving School Safety in Earthquakes, Floods, and High Winds*. Available at: https://www.fema.gov/sites/default/files/documents/fema_p-424-design-guide-improving-school-safety.pdf
- FEMA. 2010b. FEMA P-499 *Homebuilder's Guide to Coastal Construction*. Available at: https://www.fema.gov/sites/default/files/2020-08/fema499_2010_edition.pdf
- FEMA. 2010c. FEMA P-804, *Wind Retrofit Guide for Residential Buildings*. Available at: https://www.fema.gov/sites/default/files/2020-08/fema_p804_wind_retrofit_residential_buildings_complete.pdf
- FEMA. 2011. FEMA P-55, *Coastal Construction Manual: Principles and Practices of Planning, Siting, Designing, Constructing, and Maintaining Residential Buildings in Coastal Areas*. Available at: https://www.fema.gov/emergency-managers/risk-management/building-science/publications?name=%22FEMA+P-55%2C+Coastal%22&field_keywords_target_id=All&field_document_type_target_id=All&field_audience_target_id=All
- FEMA. 2013. FEMA P-936, *Floodproofing Non-Residential Buildings* Available at: https://www.fema.gov/emergency-managers/risk-management/building-science/publications?name=%22P-936%22&field_keywords_target_id=All&field_document_type_target_id=All&field_audience_target_id=All
- FEMA. 2019a. FEMA P-2062, *Guidelines for Wind Vulnerability Assessments of Existing Critical Facilities*. Available at: https://www.fema.gov/sites/default/files/2020-07/asce24-14_highlights_jan2015.pdf
- FEMA. 2019b. NFIP Technical Bulletin 8, *Corrosion Protection of Metal Connectors in Coastal Areas*. Available at: https://www.fema.gov/emergency-managers/risk-management/building-science/publications?name=%22Technical+Bulletin+8%22&field_keywords_target_id=All&field_document_type_target_id=All&field_audience_target_id=All
- Florida Division of Emergency Management, Bureau of Mitigation. 2010. *Hurricane Retrofit Guide Openings (Windows and Doors)*. Available at: https://apps.floridadisaster.org/hrg/content/openings/openings_index.asp
- Lemieux, D.J. and Totten, P.E. (2016). "Wall Systems." *Whole Building Design Guide*. Available at: <https://www.wbdg.org/guides-specifications/building-envelope-design-guide/wall-systems>

Fact Sheet 3.3.1: Roof Systems—Sloped Roofs

The mitigation objective of this Fact Sheet is to improve the resilience of sloped roof systems to allow a building to continue to be used or quickly repaired following a hurricane, with an end goal of rapidly returning the building to full use.

Roof systems include all the building elements above the top of the wall system (wall systems are covered in Fact Sheet 3.2, *Walls and Openings*). Roof systems can be classified by roof shape and building size. As shown in Figure 3.3.1.11, gable and hip sloped roof systems include the following elements: framing, connectors and fasteners, sheathing, covering, edges and overhangs, roof vents, roof drainage, and openings, as well as roof-mounted equipment. Other roof shapes exist, including sawtooth roofs, mansard roofs, and round or dome-shaped roofs, and mitigation strategies for gable and hip sloped roof systems also apply to edge systems, rooftop equipment, gutters, etc., for these other roof shapes. Sloped roofs have a pitch of 3 feet vertical to 12 feet horizontal (3:12) or greater.

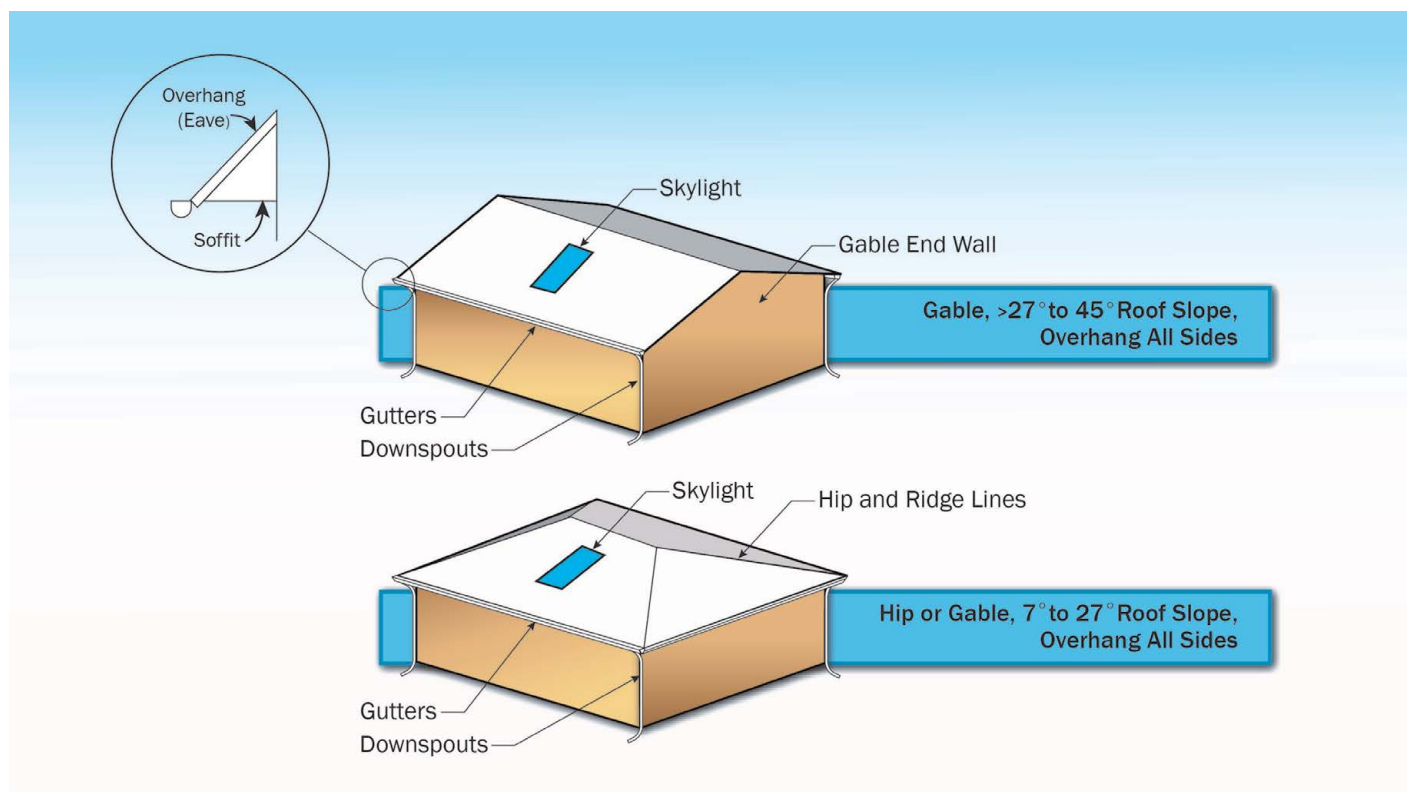

Figure 3.3.1.1. Basic elements of typical sloped roofs featuring gable-end roof system (top) and hip roof system (bottom).



DEFINITIONS

Elements of gable and hip sloped roof systems include the roof deck, roof covering, and edge materials. For this Fact Sheet, mitigation options also are provided for:

Framing—Provides the main structural support for the roof. Sloped-roof framing components include wood or metal trusses, wood rafters, or steel beams that form a gable end or hip roof shape.

Connectors and Fasteners—Link the roof framing to the wall system and hold elements of the roof system together. Sloped-roof connectors and fasteners may include hurricane straps or ties attached with nails or screws.

Sheathing—Covers the roof framing and provides additional structural strength to the wood or metal framing. Sloped-roof sheathing may include plywood, oriented strand board (OSB) or tongue-and-groove planks for wood-framed roofs, and metal decking or panels for steel-framed roofs.

Covering—Protects the roof framing and sheathing from rain, snow, wind and wind-driven rain. Sloped roof coverings may include asphalt or wood shingles, extruded concrete or clay tiles, slate or metal panels.

Edges and Overhangs—The roof border is frequently at risk of damage from wind uplift pressures and wind-driven rain entry than the rest of the roof. Sloped roof border elements typically include wood-framed overhangs (eaves) and soffits enclosed with wood, vinyl or aluminum panels, and fascia panels along roof rake edges (i.e., slanting edge of a gable roof at the end wall of the house). Roof edges also include edge metal systems such as eave flashing and drip edges.

Vents—Provide airflow in attic spaces to vent cooler air in the hotter months and vent warmer air in the cooler months to lower heating and cooling costs. Ventilation elements include soffit vents, ridge vents, gable-end vents, off-ridge vents, gable rake vents, turbines and standpipes.

Drainage—Removes water off the roof and away from the structure. Sloped roof drainage elements include gutters connected to downspouts.

Skylights—Provide an overhead source of natural light. Sloped roof opening elements include glass or clear polymer skylights.

Rooftop Equipment—On sloped roofs, roof-mounted equipment typically includes small equipment vents and fans, communications antennas and satellite dishes, solar panels and lightning rods.

Table 3.3.1.1 summarizes some common mitigation solutions that can improve the performance of sloped-roof systems. These strategies are discussed in the sections that follow.

Table 3.3.1.1. Mitigation Solutions for Sloped-Roof Systems

Solutions and Options	Wind	Wind-Driven Rain	Rain
Mitigation Solution: Strengthen or Improve			
Option 1: Install Gable End Bracing for Gable Roofs	✓		
Option 2: Strengthen Roof Framing and Connections	✓	✓	
Option 3: Upgrade Wood Sheathing	✓	✓	✓
Option 4: Improve Asphalt Shingles and Metal Roofing	✓	✓	✓
Option 5: Upgrade Vinyl and Aluminum Soffits	✓	✓	
Option 6: Improve Gutters and Downspouts	✓	✓	✓
Option 7: Strengthen Skylights	✓	✓	✓
Option 8: Strengthen Roof-Mounted Equipment and Connections	✓	✓	
Mitigation Solution: Add or Increase			
Option 1: Upgrade Underlayment to Shingle Roofs	✓	✓	✓
Option 2: Increase Roof Drainage	✓	✓	✓
Mitigation Solution: Secure or Eliminate			
Option 1: Secure or Eliminate Clay Tile Roofs	✓	✓	✓
Option 2: Secure, Minimize or Eliminate Roof Overhangs	✓	✓	
Option 3: Reduce or Eliminate Soffit Vents	✓	✓	
Option 4: Secure or Replace Ridge Vents and Turbines	✓	✓	✓
Option 5: Protect or Eliminate Gable Vents	✓	✓	✓

In addition to physical mitigation measures, it is important to create and follow a regular roof maintenance schedule. The roof should be inspected at least twice per year, generally in the spring and fall, to evaluate the condition and identify potential repair needs. Inspections also should be done after high wind events to assess if storm-related damage occurred. Needed repairs should be completed quickly after the inspection to help protect the roof.

Mitigation Solution: Strengthen or Improve

Strengthening or improving roofing systems involves upgrading elements of the existing roof system to help improve resistance to wind and wind-driven rain. A few mitigation options use this solution to protect various sloped roof system elements and maintain a continuous load path throughout the roof system.

Option 1: Install Gable End Bracing for Gable Roofs

Gable end walls are at risk for damage in hurricanes because of their shape. Wind pressures can push or pull a gable end wall and cause it to collapse if it is not properly braced. A failed gable end wall can cause serious damage to the roof and allow wind and rain to get inside the building through openings and cracks that result from the failure. Installing gable-end bracing in gable roof shapes that are more than 4 feet tall protects against this problem. This retrofit builds on the Basic Mitigation Package item for strengthening overhangs at gable end walls (see FEMA P-804, *Wind Retrofit Guide for Residential Buildings*).

One way to retrofit gable end walls for mitigation involves:

1. Strengthening vertical framing members of the gable end using retrofit studs.
2. Bracing the top and bottom of the gable end with horizontal braces to transfer horizontal loads to the roof and ceiling.
3. Making connections between horizontal braces and retrofit studs using metal straps and fasteners.
4. Connecting the bottom of the gable end to the wall below using metal bracket connectors. Figure 3.3.1.2 shows a retrofit for a gable end wall without an overhang. Figure 3.3.1.3 shows a retrofit for a gable end wall with an overhang.

CONSIDERATIONS:

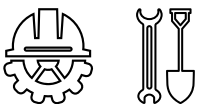

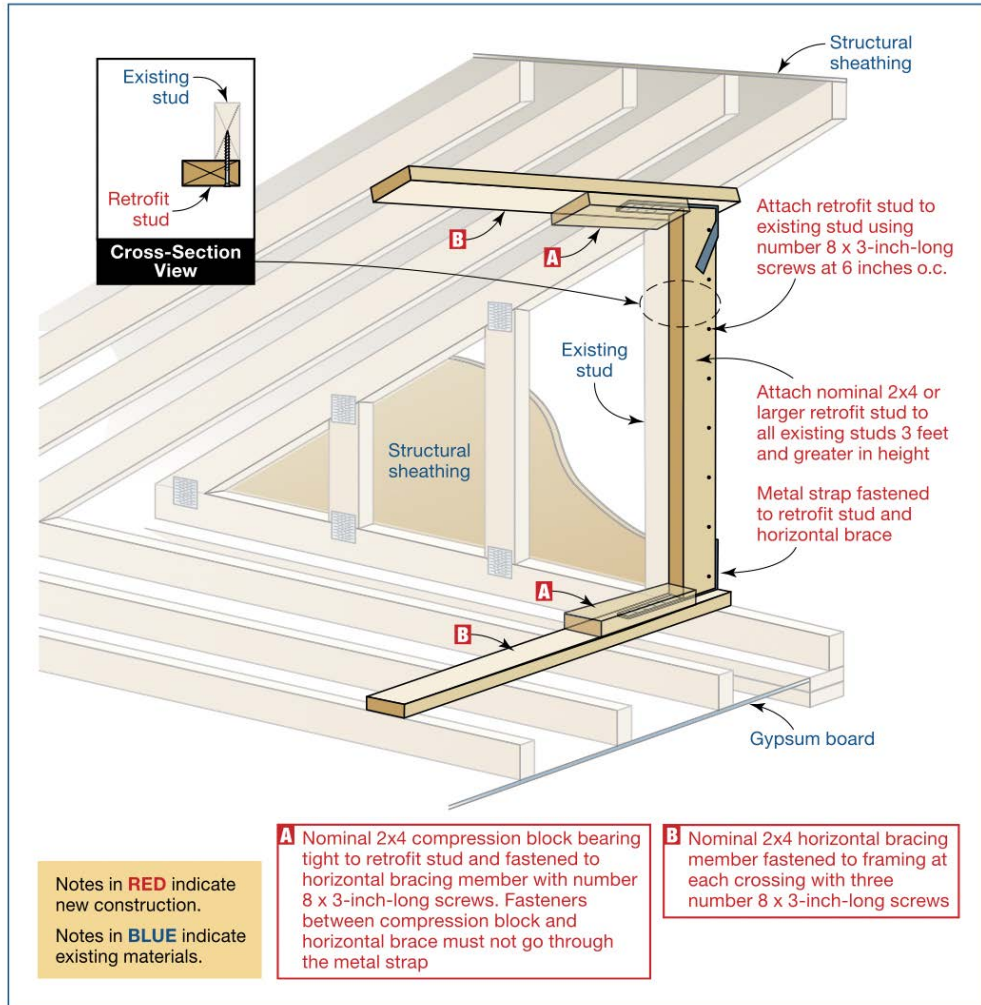

Figure 3.3.1.2. Conceptual gable end retrofit without overhangs.

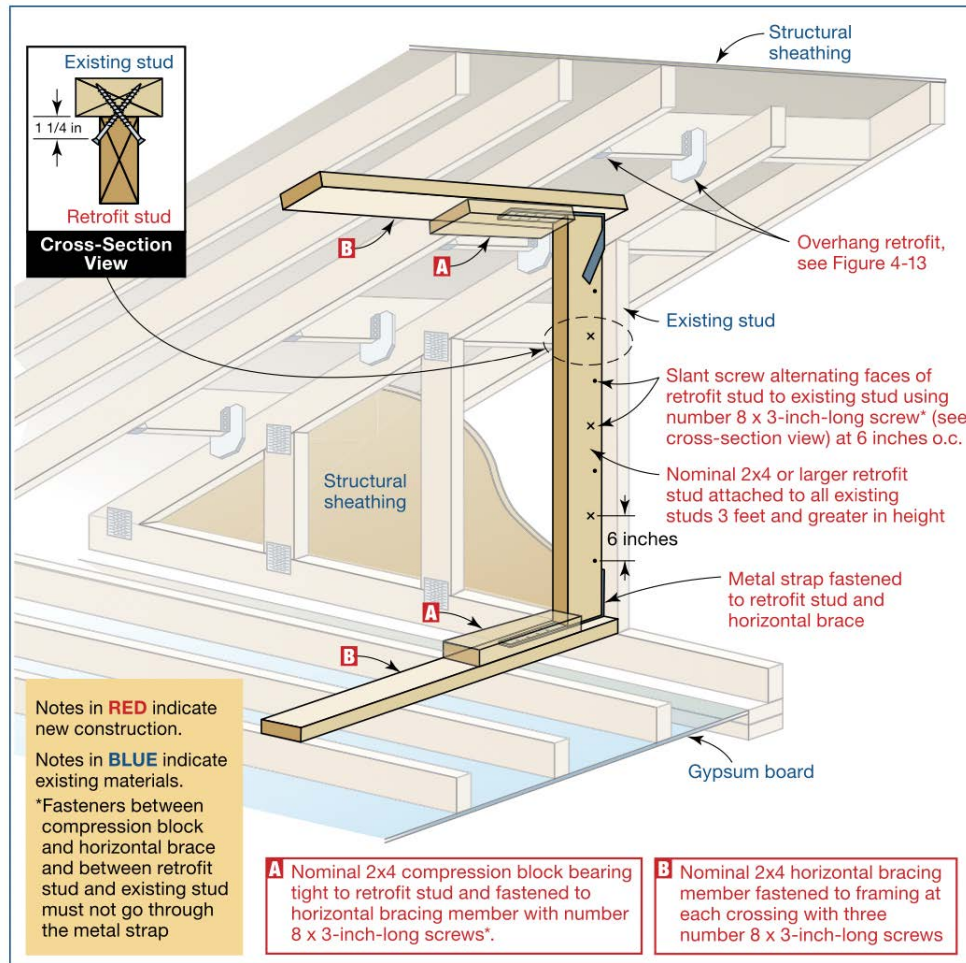

Figure 3.3.1.3. Conceptual gable end retrofit with overhangs.

Option 2: Strengthen Roof Framing and Connections

To make sure the roof framing and the connections between the roof and the wall framing are strong enough to withstand wind forces and wind uplift, use the following techniques to strengthen the roof framing and connections:

- Strengthen roof framing by using stronger or larger roof framing materials, adding ladder framing, and bracing the ends of gable roofs that are at risk of failing in high winds (see Option 1) according to FEMA P-55, *Coastal Construction Manual*.
- Strengthen connections by installing hurricane clips, anchors, straps, connectors and fasteners compatible with the roof system, as shown in Figure 3.3.1.4. As with wall framing connections discussed in Fact Sheet 3.2, *Wall Systems and Openings*, roof connectors and fasteners must be strong enough to resist the hurricane wind forces imposed on them.

Connection Hardware Applications

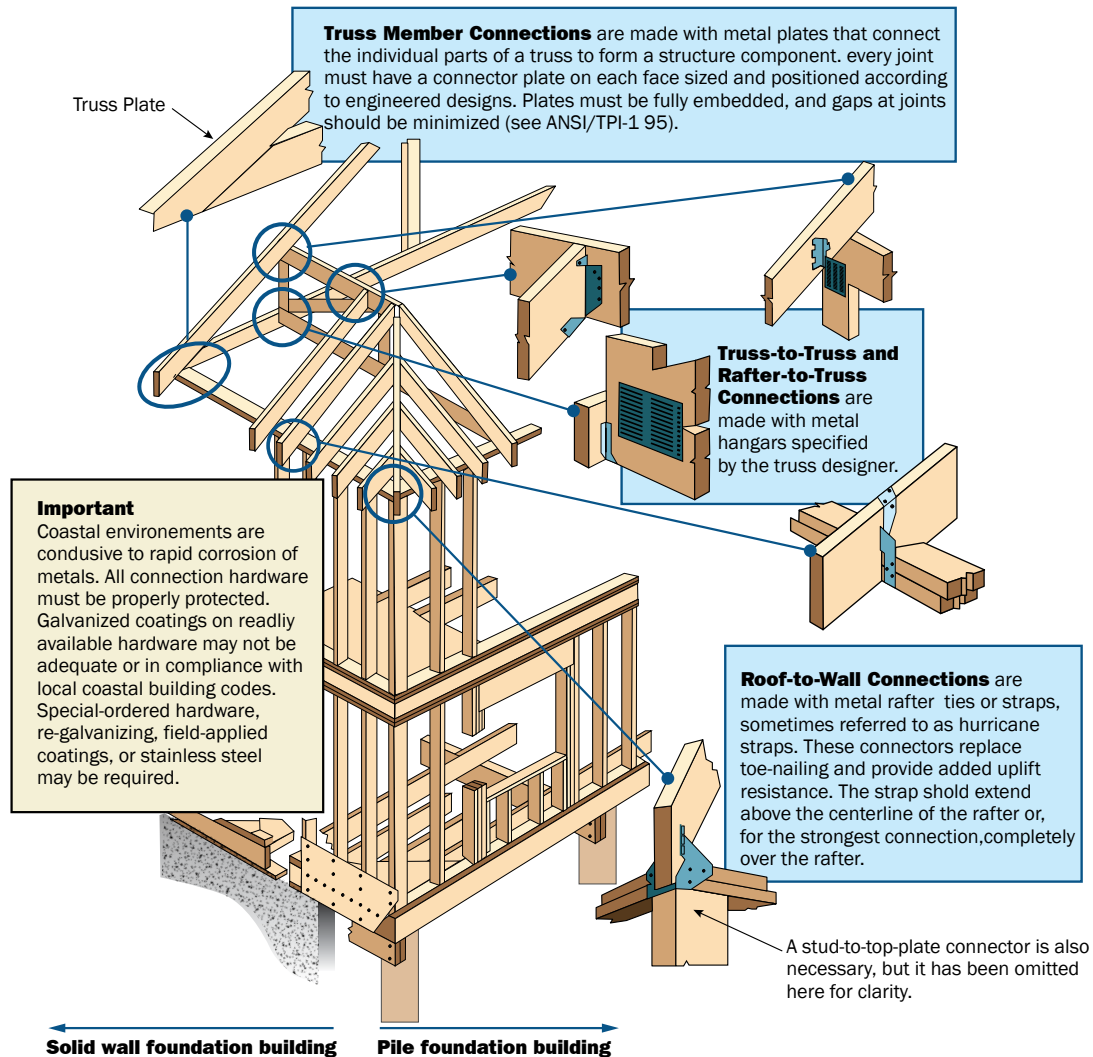
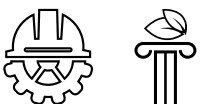

Figure 3.3.1.4. Examples of proper roof connectors and fasteners for a wood-framed truss.

- Connection hardware used in coastal areas must meet building code requirements to resist corrosion. Standard hardware available in local stores may not meet these building code requirements; special-ordered hardware, field-applied coatings, re-galvanizing or stainless steel may be required. As part of these solutions, note that NFIP Technical Bulletin 8, *Corrosion Protection of Metal Connectors in Coastal Areas*, recommends all exposed roof connectors and fasteners within 3,000 feet of the coastline to be either hot-dipped galvanized steel or stainless steel to resist salt spray and corrosion.

CONSIDERATIONS:



Option 3: Upgrade Wood Sheathing

Lightweight wood sheathing can be at risk for wind uplift and damage from wind-borne debris. Upgrading wood roof sheathing can improve its performance during hurricanes. This can be done to replace roof sheathing damaged after a storm or as a retrofit. When evaluating this mitigation option, consider the following:

- Wood sheathing panels made of plywood or OSB are recommended for high wind regions. The panels should be rated for high wind and usually are designated as “Exposure 1” or better. Building codes require more specific materials in the High-Velocity Hurricane Zone (HVHZ) specific to Miami-Dade and Broward Counties in Florida.
- Sheathing layouts for gable-end and hip roofs should be installed to match APA—The Engineered Wood Association recommendations as shown in Figure 3.3.1.5.
- Improved sheathing connections should use full round head deformed-shank nails, ring shank nails or screws; staples should not be used in high-wind areas.
- Decrease nail spacing for sheathing systems that do not meet current wind load requirements.
- Adding closed cell spray foam to connect roof decking to rafters/trusses improves roof performance by strengthening areas where there may not be enough nails between the roof deck and the rafters/trusses.

CONSIDERATIONS:



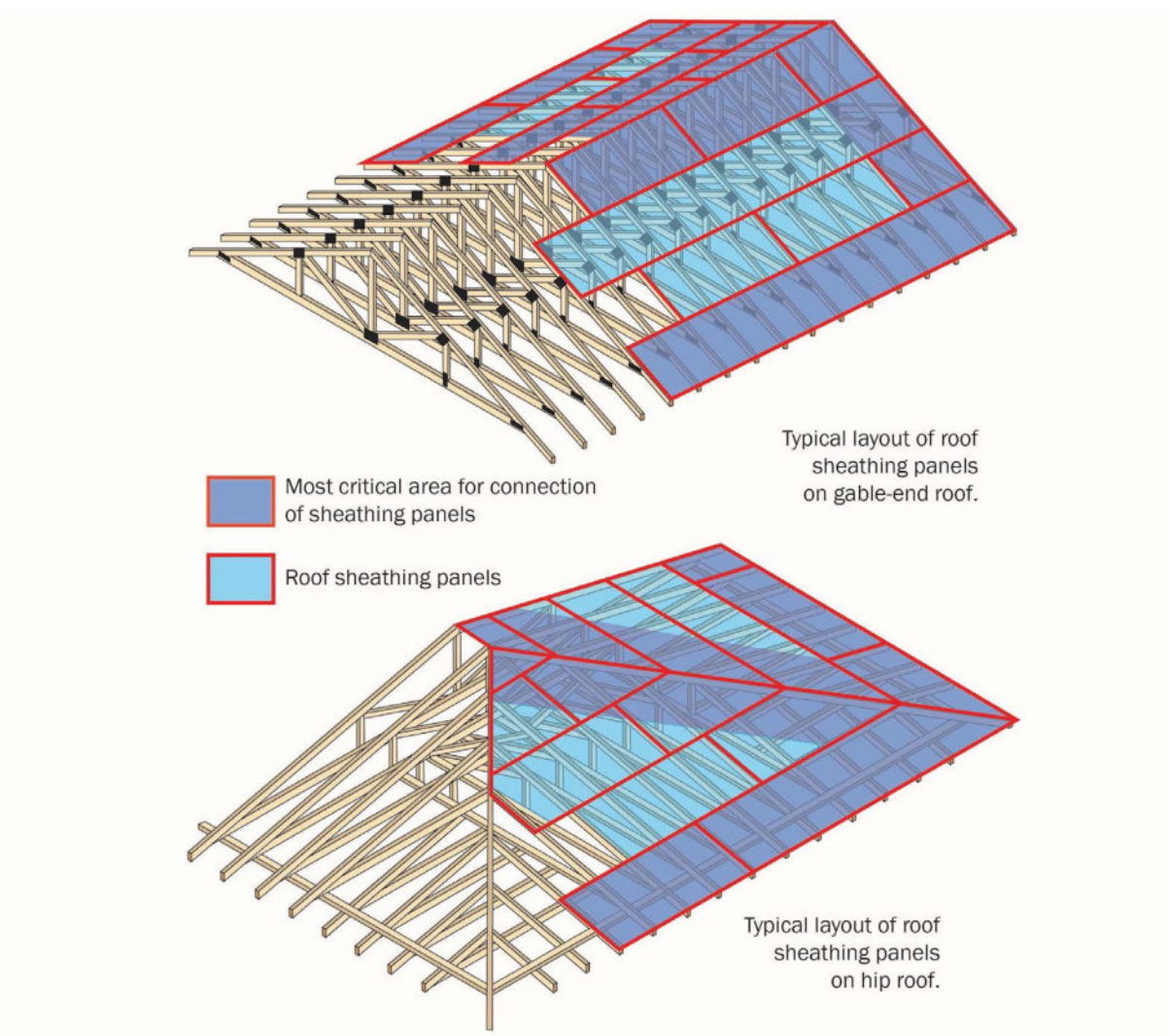

Figure 3.3.1.5. Examples of proper sheathing panel layouts for gable-end roof (top) and hip roofs (bottom)

Option 4: Improve Asphalt Shingles and Metal Roofing

Improve the performance of asphalt shingles and metal roofing by following best practices for materials, installation and connections, as noted below:

- Use ring shank nails for all wood nailing.
- Consider replacing loose or damaged shingles as needed with ASTM-rated shingles that meet the area's local code regulations and wind requirements or International Building Code requirements, whichever is stricter.
- If it is determined the entire roof covering should be removed and replaced, install an upgraded underlayment to the roof sheathing (Figure 3.3.1.6) before installing the new roof covering. The upgraded underlayment provides an additional layer of water resistance to the roof system.

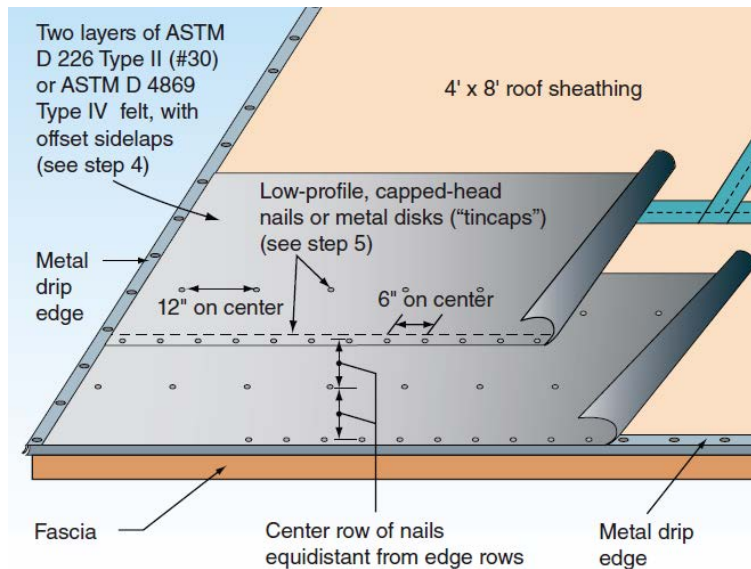

Figure 3.3.1.6. Strong underlayment installation details applied to asphalt shingle roof sheathing in high-wind regions.

- Ensure shingles are attached correctly, as shown in Figure 3.3.1.7. Ensure nails are adequately driven as shown in Figure 3.3.1.8.
- Apply dabs or continuous lines of asphalt roof cement beneath shingles along eaves, rakes, hips and ridges to better attach shingles.
- Make sure flashing is installed correctly around plumbing vents, chimneys, exhaust vent caps, dormers and skylights. Flashing must be integrated with the shingles and roof underlayment to prevent water from entering.
- Consider using metal roof panels that have been tested to meet the local code regulations and wind load requirements of the area and installing them per site-specific analysis requirements.

CONSIDERATIONS:



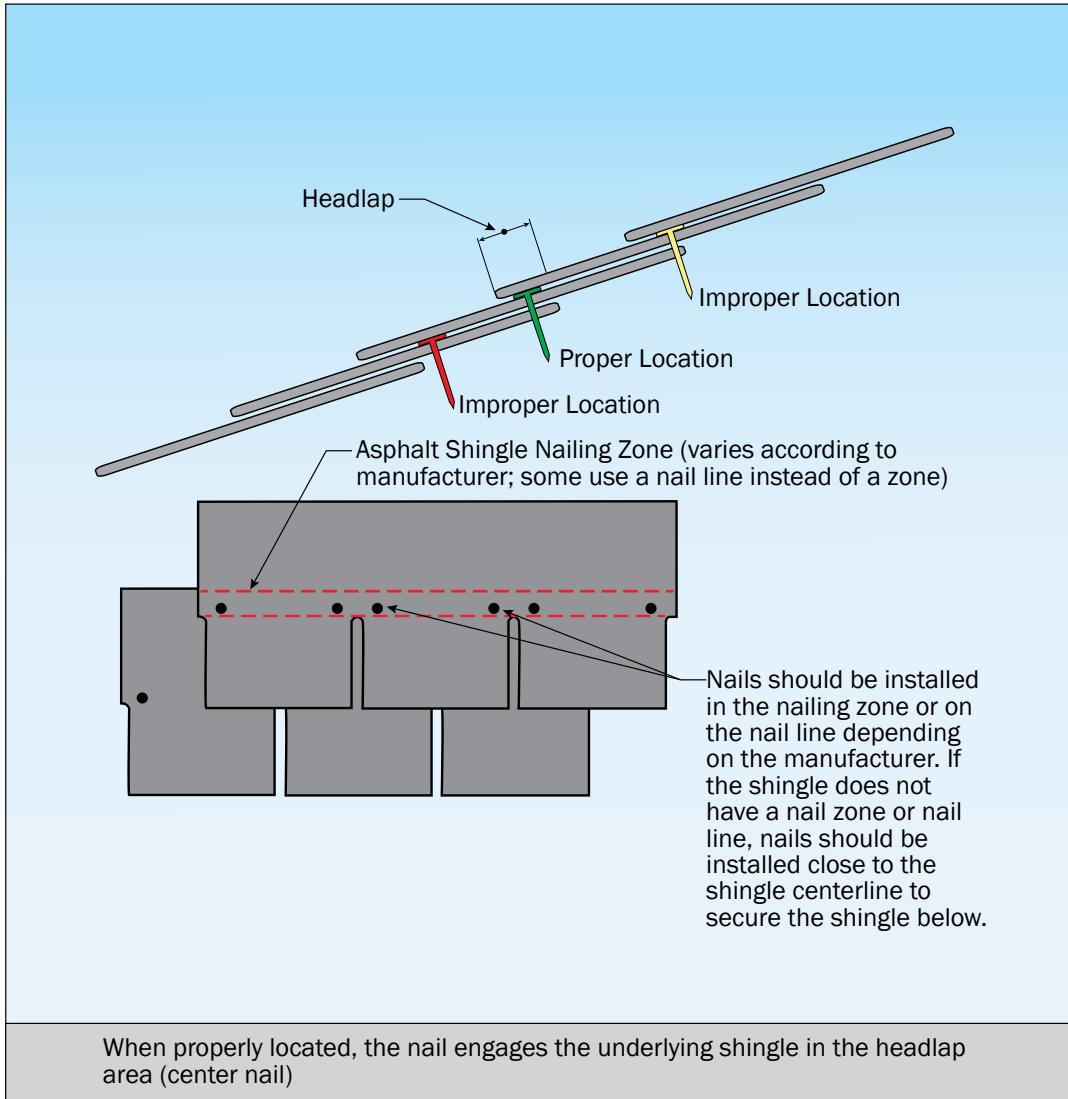

Figure 3.3.1.7. Proper and improper locations of shingle fasteners.

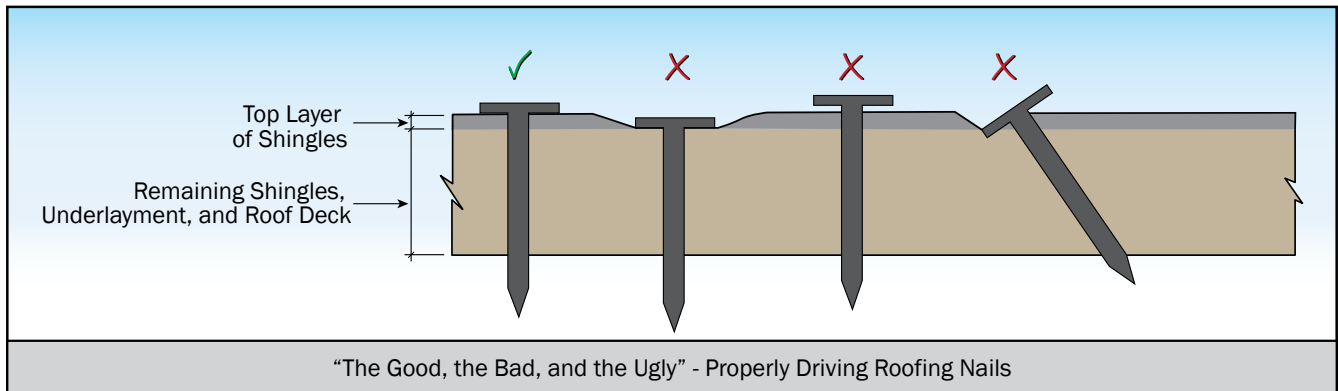

Figure 3.3.1.8. The Dos and Don'ts of driving roof nails through asphalt shingles.

Option 5: Upgrade Vinyl and Aluminum Soffits

Vinyl and aluminum soffit panels that are commonly used to enclose the underside of sloped roof overhangs (eaves) are vulnerable to damage from wind and wind-driven rain. The following upgrades to vinyl and aluminum soffits can address this issue:

- Replace vinyl or aluminum soffits with plywood soffits that tend to be more rigid and well anchored to the wall and roof framing (Figure 3.3.1.9).
- Replace poorly connected tracks with nailing strips and intermediate framing and connections to reduce bending of soffits in roof overhangs greater than 12 inches.
- Seal soffits:
 - Clean the surfaces first to ensure proper bonding.
 - Apply beads of sealant along the bottom edge of the wall channel to adhere it to the wall surface below.
 - Also, apply beads of sealant in indentations between the soffit panels and the wall channel at one end and the fascia flashing at the other end.
 - Install screws to tie the soffit panels to both the fascia flashing and the wall channel.
- Soffit upgrades should be done simultaneously as changes are made to reduce or eliminate soffit vents, as shown in Figure 3.3.1.9.
 - Use soffits designed or tested for the same wind loads as the attached walls.
 - To reduce water intrusion, verify soffit vents are tested for resistance to wind and wind-driven rain.
 - Fasten soffit panels directly at the wall and the fascia rather than in tracks to prevent them from failing in high winds.

CONSIDERATIONS:

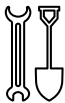

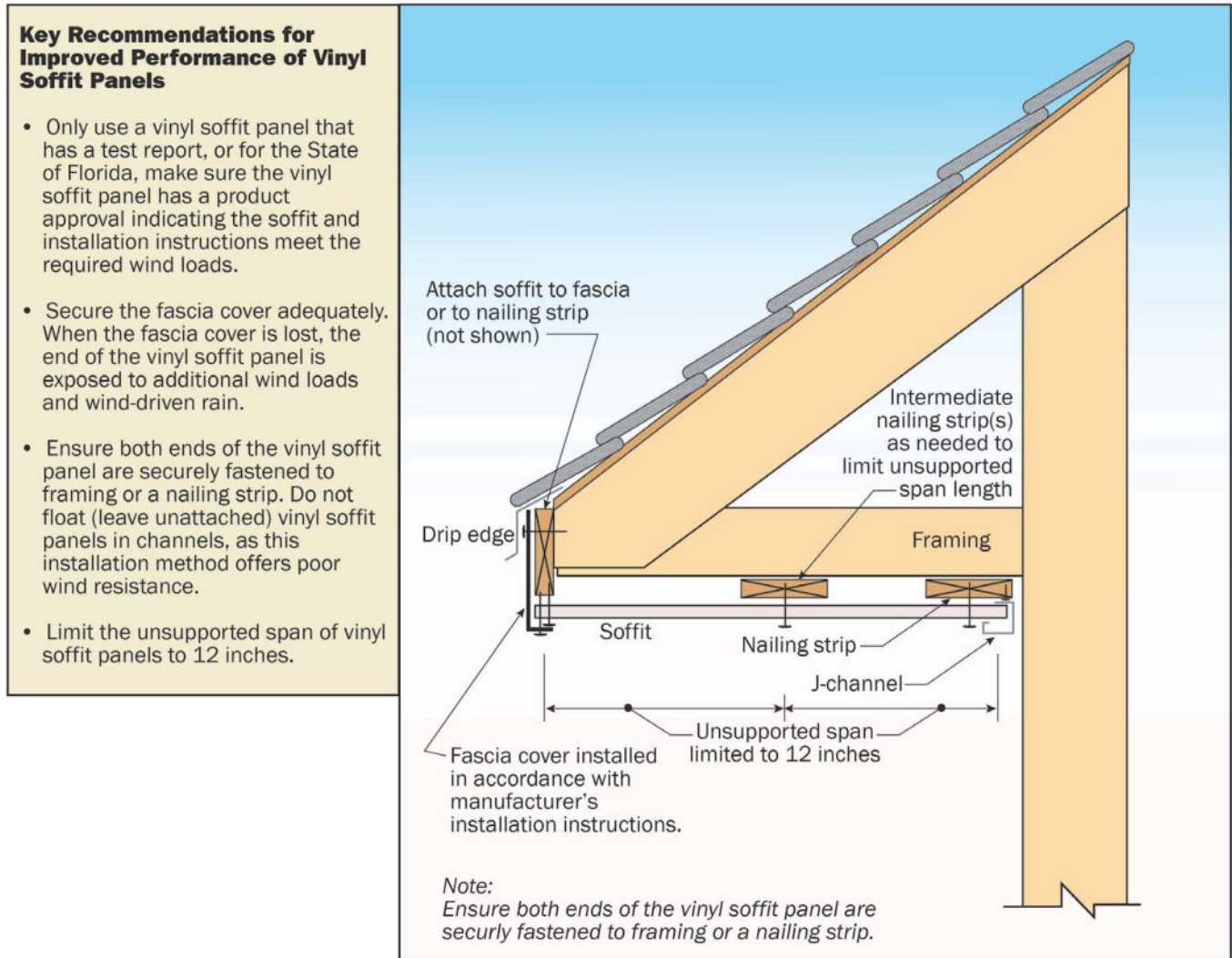

Vinyl Soffit Panel Installation

Figure 3.3.1.9. Improving soffits can decrease wind damage to sloped roofs.

Option 6: Improve Gutters and Downspouts

Gutters and downspouts carry water away from the roof and the building. If they become clogged or damaged, they cannot perform their function and leave the roof exposed to potential wind and water damage. FEMA P-55, *Coastal Construction Manual*, recommends the following measures to protect gutters and downspouts from wind damage and make sure they provide sufficient storm runoff capacity:

- Use gutter materials and connectors designed to resist wind, water and ice loads as per ANSI/SPRI GD-1, *Structural Design Standard for Gutter Systems Used on Low-Sloped Roofs*, for both low- and steep-slope roofs, as shown in Figure 3.3.1.10.



Figure 3.3.1.10. Sheet metal straps (circled) attached to an existing gutter to increase wind uplift resistance.

- Upgrade and lengthen downspouts to direct water farther away from the building to reduce the risk of interior or basement water damage.
- Maintain gutters and downspouts using routine inspections to clean them of vegetation and other debris and to tighten loose connections. Trim back tree limbs surrounding the building, so they do not extend over the rooftops.

CONSIDERATIONS:



Option 7: Strengthen Skylights

While skylights can provide added light to a room, they can also be a point of entry for water and wind if they are not rated for the wind zone in the area where the building is located, or if they are not properly sealed. Consider using skylight systems that have product approval or have been tested using approved methods and meet the site-specific wind requirements for the area. (The online ASCE 7 Hazard Tool and ATC Hazards by Location tool contain information about wind requirements by location.) Strengthen skylights to help reduce damage to the interiors of public buildings as follows:

- Upgrade older plastic skylights with wired glass or other impact-resistant glazing materials with thicker seals and frames.
- Use skylight installation and performance standards found in ASTM E 2112 and ASTM E330.
- Replace hinged skylights with closed skylights to further reduce the risk of wind-driven rain penetration and increase security.

- Install a protection device such as a shutter to protect a skylight from debris impact.
- Ensure the skylight frame is adequately flashed and sealed to prevent water entry.

CONSIDERATIONS:**Option 8: Strengthen Roof-Mounted Equipment and Connections**

Sloped roofs may have heating/ventilation/air conditioning (HVAC) and communication systems mounted on them, including satellite dishes, antennas, solar panels and vents. Mounting HVAC and communications systems components on the roof can make it vulnerable to wind and wind-borne debris damage. Equipment that collapses or is torn off the roof by wind can damage the roof covering and sheathing, allowing rain to enter the building.

Improve the performance of rooftop-mounted equipment by doing the following:

- Follow specific design guidance found in *Calculating Wind Loads and Anchorage Requirements for Rooftop Equipment* published by the American Society for Heating, Refrigeration and Air Conditioning Engineers (ASHRAE); FEMA P-424, *Design Guide for Improving School Safety in Earthquakes, Floods, and High Winds*; and FEMA P-543, *Design Guide for Improving Critical Facility Safety from Flooding and High Winds*.
- Ensure antennas and communications masts are designed for the wind loads in the geographic region where they are located. If they support equipment such as satellite dishes, make sure they are designed for the additional wind load that could be transferred from the equipment.
- Make sure antennas and communications masts are well attached to the roof using mechanical anchors instead of ballast material.
- Make sure the uplift rating of roof-mounted solar panels is enough to handle the potential wind loads during a storm. The uplift rating may be in the manufacturer's specifications for the panels; otherwise, contact the manufacturer for wind uplift rating.
- Evaluate the parts used to make connections between the photovoltaic modules and the framing system, such as mechanical fasteners, panel clips, snap-fit couplings and adhesive. Tighten loose connections and replace corroded or otherwise inadequate parts with corrosion-resistant connectors.

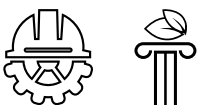
CONSIDERATIONS:

Mitigation Solution: Add or Increase

Roofs can be particularly vulnerable to wind and rain during a hurricane. Adding an element or increasing the size or quantity of an existing roof system component can help protect it from hurricane damage caused by wind, wind-driven rain and rain hazards. This solution can help improve the performance of roof sheathing and roof drainage components.

Option 1: Upgrade Underlayment to Shingle Roofs

Strong winds can blow coverings off roofs and wind-driven rain can get underneath shingles, exposing the underlying roof material and increasing the potential of water and debris damage. Sealing the roof deck by upgrading the underlayment can help protect the roof from rain and debris impacts if the covering is lost or damaged. An upgraded underlayment to the roof sheathing will provide a significant secondary water and impact barrier.

- Ensure the underlayment is rated and labeled according to ASTM standards and matches the wind ratings for the area.
- Ensure the underlayment is securely fastened to the roof deck in accordance with the manufacturer's specifications, through the use of button cap nails or install a fully adhered underlayment.
- Install drip edges at eaves above the underlayment to reduce water entry from wind-driven rain.
- See Figure 3.3.1.6 for more information about installing an underlayment on a shingle roof.

CONSIDERATIONS:

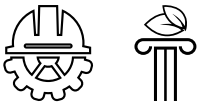

Option 2: Increase Roof Drainage

Gutters and downspouts typically are sized to handle regular rainfall events and often are poorly maintained. As a result, they quickly can become overwhelmed or clogged with vegetation or debris during extreme rainfall events. This increases the risk of water ponding on roofs and on the ground around the building, which can leak in and cause damage. To address these issues:

- Increase the capacity of gutters and downspouts by using larger elements positioned for positive drainage that can collect and carry more rainwater away from the roof and building.
- Larger gutters and downspouts will require stronger connectors and fasteners to attach to roof and wall systems (see Figure 3.3.1.10).

CONSIDERATIONS:

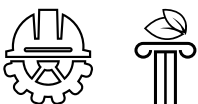

Mitigation Solution: Secure or Eliminate

Secure a vulnerable component or eliminate it from the roof system to reduce or end wind and wind-driven rain damage. In particular, wind pressure can damage roof coverings, overhangs and vents, making them susceptible to wind-driven rain entry.

Option 1: Secure or Eliminate Clay Tile Roofs

Clay tile roofs on public buildings in high wind regions should be attached using a tested and approved assembly based on site-specific analysis for the area. Tile roof attachments should meet local code regulations. When evaluating mitigation of clay tile roofs, consider the following:

- Determine the wind loads for the geographic area and make sure the tiles are rated to withstand those wind loads.
- Install clay tiles as per the most current guidance from the Tile Roofing Institute.
- To improve performance, use the attachment designed for the corner area throughout the entire roof area.
- For roofs within 3,000 feet of the ocean, straps, fasteners and clips should be hot-dipped galvanized or stainless steel to resist corrosion.

CONSIDERATIONS:



Option 2: Secure, Minimize or Eliminate Roof Overhangs

Roof overhangs on sloped roofs (eaves) can become a major source of uplift failure for the roof system, allowing wind-driven rain to damage the building's interior. The following mitigation options can be used to address at-risk overhangs on buildings subject to high winds:

- Use stronger materials, connectors and fasteners to attach moderately sized overhangs (12 inches to 16 inches) to resist uplift forces and wind-driven rain penetration. See the *Wood Frame Construction Manual for additional information*.
- Large overhanging roofs covering porches and other areas connected to the main building should be designed as either a single-roof structure to resist the maximum uplift forces or as a separate roof structure not attached to the main building.
- For new construction or existing buildings with large roof overhangs that are damaged and need to be replaced, consider redesigning the roof system to minimize or strengthen roof covering attachments and strengthen roof-to-wall connections.
- New or reconfigured roofs should be designed by a licensed engineer.

CONSIDERATIONS:**Option 3: Reduce or Eliminate Soffit Vents**

Soffit vents provide ventilation of the attic space from the underside of sloped-roof overhangs (eaves), but they can be a point of failure unless the weak vinyl and aluminum soffit panels that cover most soffit vents are upgraded. Currently, there is no suitable test method to evaluate the potential for wind-driven rain to enter the attic through soffit vents. Designers should consider the following options:

- Reduce the size of existing soffit vents by custom designing a filter fabric (such as those used in HVAC system filters) above the vent openings.
- Eliminate soffit vents by designing a different airflow route into the attic or design for an unvented attic.

CONSIDERATIONS:**Option 4: Secure or Replace Ridge Vents and Turbines**

For public buildings with sloped roofs, ridge vents placed along the crown of the roof and/or off-ridge vents placed along the edges of the roof near the crown can provide air flow into attic spaces. Turbines that use wind power to pull humid air out of attic spaces can be mounted on top of short standpipes and installed on sloped roofs. Ridge vents, off-ridge vents, and turbines often are poorly attached to the roof and can bend or dislodge during hurricanes, allowing entry of wind-driven rain into the building. Consider the following mitigation recommendations:

- For ridge vents, replace ordinary roofing nail connectors with gasketed stainless steel wood screws.
- Consider replacing the existing ridge vents with vents that have passed the Florida Building Code Testing Application Standard (TAS) 100(A), *Test Procedure for Wind and Wind Driven Rain Resistance and/or Increased Windspeed Resistance of Soffit Ventilation Strip and Continuous Intermittent Ventilation System Installed at the Ridge Area*, for wind-driven water.
- For off-ridge vents, check existing connectors and consider adding vent covers that can be installed from inside the attic, but avoid simply adding nails or screws that can damage roof coverings.

- Turbines can be securely anchored to the roof sheathing and framing with straps, and the turbine head should be connected to the standpipe with sheet metal screws. Consider temporarily removing the turbine head before a hurricane and plugging the top of the standpipe to prevent rain entry. Even high wind-rated turbines will rotate at above-design speeds and can be damaged easily by wind-borne debris.

CONSIDERATIONS:**Option 5: Protect or Eliminate Gable Vents**

Gable end vents placed in the center of gable end walls near the roof line create air flow into the attic space of gable roofs. Gable rake vents may use porous soffit panels or screen vents on the bottom surface of gable end roof overhangs bigger than 12 inches and are supported by outriggers (2-inch by 4-inch boards running perpendicular to the gable truss that extend into the gable overhang). Gable end and rake vents are susceptible to wind-driven rain. The following mitigation measures for gable vents, as shown in Figure 3.3.1.11, include:

- Add shutters to gable end vents. This is an active mitigation measure that requires manual installation before a hurricane and removal after a hurricane.
- Plug gable rake vents when not needed using metal flashing or pre-cut pieces of wood that can be anchored to



Figure 3.3.1.11. Protecting gable end vents using shutters (left) and sealing gable rake vents using metal plugs as indicated by red arrows (right).

CONSIDERATIONS:

REFERENCES:

Detailed technical information on hurricane mitigation of sloped roofs can be found in these publications. Much of the residential information also applies to non-residential buildings.

American Society of Civil Engineers (ASCE). 2016. ASCE 7, *Minimum Design Loads and Associated Criteria for Buildings and Other Structures*. Available at: <https://www.asce.org/asce-7/>

American Wood Council. 2018. *Wood Frame Construction Manual*. Available at: <https://awc.org/publications/2018-wfcm/>

Federal Emergency Management Agency (FEMA). 2007a. FEMA 543, *Design Guide for Improving Critical Facility Safety from Flooding and High Winds*. Available at: https://www.fema.gov/sites/default/files/2020-08/fema543_design_guide_complete.pdf

FEMA. 2007b. FEMA 577, *Design Guide for Improving Hospital Safety in Earthquakes, Floods, and High Winds*. Available at: https://www.fema.gov/sites/default/files/2020-08/fema577_design_guide_improving_hospital_safety_2007.pdf

FEMA. 2010a. FEMA P-424, *Risk Management Series: Design Guide for Improving School Safety in Earthquakes, Floods, and High Winds*. Available at: https://www.fema.gov/sites/default/files/documents/fema_p-424-design-guide-improving-school-safety.pdf

FEMA. 2010b. FEMA P-499, *Homebuilder's Guide to Coastal Construction*. Available at: https://www.fema.gov/sites/default/files/2020-08/fema499_2010_edition.pdf

FEMA. 2010c. FEMA P-804, *Wind Retrofit Guide for Residential Buildings*. Available at: https://www.fema.gov/sites/default/files/2020-08/fema_p804_wind_retrofit_residential_buildings_complete.pdf

FEMA. 2011. FEMA P-55, *Coastal Construction Manual: Principles and Practices of Planning, Siting, Designing, Constructing, and Maintaining Residential Buildings in Coastal Areas*. Available at: https://www.fema.gov/emergency-managers/risk-management/building-science/publications?name=%22FEMA+P-55%2C+Coastal%22&field_keywords_target_id=All&field_document_type_target_id=All&field_audience_target_id=All

FEMA. 2018. FEMA P-2021, *Mitigation Assessment Team Report: Hurricanes Irma and Maria in the U.S. Virgin Islands, Recovery Advisories*. Available at: https://www.fema.gov/sites/default/files/2020-07/mat-report_hurricane-irma-maria_virgin-islands.pdf

FEMA. 2019a. FL-RA2, *Best Practices for Minimizing Wind and Water Infiltration Damage*. https://www.fema.gov/sites/default/files/2020-07/minimizing-wind-water-damage_hurricane-michael_florida.pdf

FEMA. 2019b. NFIP Technical Bulletin 8, *Corrosion Protection of Metal Connectors in Coastal Areas*. Available at: https://www.fema.gov/emergency-managers/risk-management/building-science/publications?name=%22Technical+Bulletin+8%22&field_keywords_target_id=All&field_document_type_target_id=All&field_audience_target_id=All

Fact Sheet 3.3.2: Roof Systems— Low-Slope Roofs

The mitigation objective of this Fact Sheet is to improve the resilience of low-slope roof systems to allow a building to continue to be used or quickly repaired following a hurricane, with an end goal of rapidly returning the building to full functionality.

Roof systems include all the building elements above the top of the wall system (addressed in Fact Sheet 3.2, *Wall Systems and Openings*). Roof systems can be classified by roof shape and building size. As shown in Figure 3.3.2.1, low-slope roof systems include the following components: framing, connectors and fasteners, roof deck, insulation, covering, edges and overhangs, parapet walls, roof vents, roof drainage, and openings, as well as roof-mounted equipment. Low-slope roofs have a pitch of fewer than 3 feet vertical to 12 feet horizontal (3:12) for metal roofs, 2.5:12 for clay tile roofs and 2:12 for ballasted roofs).

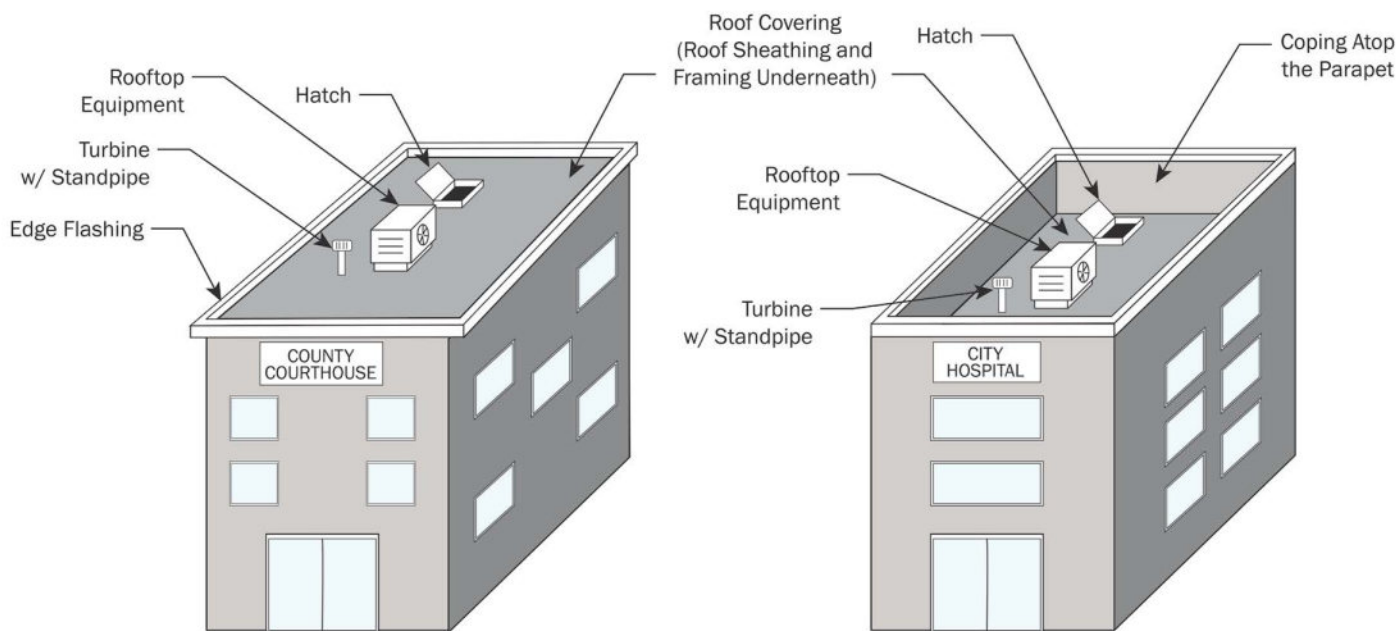

Figure 3.3.2.1. Basic components of typical low-slope roofs featuring overhangs (left) and parapet walls (right).



Definitions

Elements of low-slope roof systems include the roof deck, roof covering, and edge metals. For this Fact Sheet, mitigation options also are provided for:

Framing—Provides the main structural support for the roof. Low-slope roof framing elements may include roof joists, roof slabs and decks, and concrete or steel roof beams.

Connectors and Fasteners—Link the roof framing to the wall system and hold elements of the roof system together. Low-slope roof connectors and fasteners may include hurricane straps or ties secured with nails or screws, steel bolts or welds, and concrete or grout with steel reinforcing bars.

Decking/Sheathing—Covers the roof framing on all framing systems except concrete roof slabs and provides additional structural strength to wood or metal framing. Low-slope roof sheathing may include plywood or oriented strand board (OSB) for wood-framed roofs and metal decking or panels for steel-framed roofs.

Covering—Protects roof framing and sheathing from rain, snow and wind-driven rain. Low-slope roof coverings may include built-up roof (BUR) layers, metal, modified bitumen membrane, ethylene propylene diene terpolymer (EPDM) membrane, single-ply polyvinyl chloride (PVC) or thermoplastic olefin (TPO) membrane.

Edges and Overhangs—The roof border frequently is at more risk of damage from wind uplift forces and wind-driven rain entry than the rest of the roof. Low-slope roof elements typically include either concrete overhangs or masonry parapet walls with metal wall and cap flashing, coping or fascia covers along the edges.

Vents—Provide airflow in attic spaces needed to vent cooler air in the hotter months and vent warmer air in the cooler months to lower heating and cooling costs. Ventilation components may include turbines and standpipes.

Drainage—Removes water off the roof and away from the structure. Low-slope roof drainage components include interior drains, gutters or scuppers connected to downspouts, and secondary or emergency overflow scuppers or drains.

Skylights and Roof Hatches—Provide rooftop access and/or an overhead source of natural light. Low-slope roof opening components include steel or wood-framed hatches and glass or clear polymer skylights.

Rooftop Equipment—On low-slope roofs, rooftop equipment typically may include heating/ventilation/air conditioning (HVAC) equipment, vents and fans, elevator equipment penthouses, antennas and communications towers, solar panels and lightning protection systems.

Table 3.3.2.1 summarizes some common mitigation solutions that can improve the performance of low-slope roof systems common to public buildings. These strategies are then discussed in the sections that follow.

Table 3.3.2.1. Mitigation Solutions for Low Slope Roof Systems

Solutions and Options	Wind	Wind-Driven Rain	Rainfall
Mitigation Solution: Secure or Eliminate			
Option 1: Eliminate or Secure Gravel Ballast Roofs	✓	✓	✓
Option 2: Secure, Minimize or Eliminate Roof Overhangs	✓	✓	
Option 3: Secure or Replace Roof Vent Turbines	✓	✓	✓
Option 4: Secure Access Panels and Hatches	✓	✓	✓
Mitigation Solution: Add or Increase			
Option 1: Add Roof-Mounted Equipment Pedestals or Relocate Inside	✓	✓	✓
Option 2: Add a Secondary Membrane	✓	✓	✓
Mitigation Solution: Strengthen or Improve			
Option 1: Strengthen Roof Framing and Connections	✓	✓	
Option 2: Upgrade Wood Sheathing/Decking	✓	✓	✓
Option 3: Improve Metal Roof Decking	✓	✓	✓
Option 4: Strengthen Edge Flashings, Copings and Fascia Covers	✓	✓	
Option 5: Improve Gutters	✓	✓	✓
Option 6: Strengthen Roof Access Hatches and Skylights	✓	✓	✓
Option 7: Strengthen Roof-Mounted Equipment and Component Connections	✓	✓	
Mitigation Solution: Upgrade			
Option 1: Upgrade Roof Covering with Tested Systems	✓	✓	✓

In addition to physical mitigation measures, it is important to create and follow a regular roof maintenance schedule. The roof should be inspected at least twice per year, ideally in the spring and fall, to evaluate the condition and identify potential repair needs. Inspections also should be done after high wind events to assess if storm-related damage occurred. Needed repairs should be completed quickly after the inspection to ensure additional damage does not occur.

Mitigation Solution: Secure or Eliminate

This solution involves reinforcing low-slope roof elements vulnerable to wind or wind-driven rain damage or removing those elements from the roof system. Mitigation options focus on roof coverings, overhangs and vent components vulnerable to damage or failure from positive or negative wind pressures resulting in wind-driven rain entry.

Option 1: Eliminate or Secure Gravel Ballast Roofs

Gravel ballast sometimes is placed on low-slope roof coverings to protect the covering from sun damage and provide a small amount of resistance to uplift. However, gravel ballast often is loose and frequently becomes a source of wind-borne debris (missiles) that can break windows and other openings on the building and surrounding structures. Consider the following mitigation options:

- Remove loose gravel ballast roof coverings in high-wind regions. Note that the 2009 and later editions of the International Building Code prohibit gravel ballast roof surfacing in hurricane-prone regions. An engineer can recommend other roofing types.
- Consider securing the gravel ballast on roofs for less-severe wind conditions by applying a strong adhesive over the gravel ballast system to keep the gravel from becoming airborne.

CONSIDERATIONS:



Option 2: Secure, Minimize or Eliminate Roof Overhangs

Roof overhangs on low-slope roofs create a major source of uplift failure for the roof system, allowing wind-driven rain to enter, which can damage the building's interior. Consider the following mitigation options to address vulnerable overhangs in buildings:

- Secure moderately sized (12-inch to 16-inch) overhangs with stronger materials, connectors and fasteners to resist uplift forces and protect against wind-driven rain entry. Ensure a registered professional with knowledge of local wind forces reviews the design to confirm the stronger components comply with local codes and regulations.
- Large overhanging roofs covering porches and other open areas connected to the main building should be designed as either a single-roof structure or as a separate-roof structure not attached to the main building.
- For new construction or existing buildings with large roof overhangs that are damaged and need to be replaced, consider redesigning the roof system to minimize or eliminate overhangs.
- A licensed design professional with knowledge of local wind load requirements should design new or reconfigured roofs in accordance with required codes, standards and specifications. The design professional should implement the latest consensus-based codes, standards and specifications and consider code-plus measures in the design, as appropriate.

CONSIDERATIONS:**Option 3: Secure or Replace Roof Vent Turbines**

For large public buildings, turbines that use wind power to pull humid air out of attic spaces can be mounted on top of short or long standpipes and installed on low-slope roofs. Turbines often are poorly fastened and can become bent or dislodged by high winds during hurricanes, creating entry points for wind-driven rain. Consider the following mitigation recommendations:

- Attach roof vent turbines to the roof sheathing or framing with straps and connect the roof vent turbine head to the standpipe with sheet metal screws instead of relying on a simple friction fit with dimple punches.
- Consider temporarily removing turbine heads before hurricanes and plugging the tops of the standpipes to prevent rain infiltration. Even high-wind-rated turbines will rotate at above-design speeds and can be easily damaged by wind-borne debris. To anchor the plug to the standpipe, use a wooden plug that covers the entire hole and has blocks that rest against the walls of the standpipe where screws can be installed.
- Consider installing roof vent turbines that have been tested and evaluated to meet local code regulations and wind force requirements.

CONSIDERATIONS:**Option 4: Secure Access Panels and Hatches**

Strong winds can blow off access panels on rooftop-mounted HVAC equipment. The panels then become wind-borne debris that can puncture and tear roof membranes, allowing rain to enter the building. If the equipment is not specifically manufactured for the panel to resist the local wind forces, consider the following:

- Attach hasps and locking devices like carabiners.
- Modifications to HVAC equipment, such as attaching locking devices to access panels, must be customized. Detailed design may be required.
- The manufacturer should approve modifications to equipment.

CONSIDERATIONS:

Mitigation Solution: Add or Increase

This solution involves adding an element or increasing the size or quantity of an existing roof system component to protect it from damage in future wind, wind-driven rain, and rainfall events. Using this solution can help improve the performance of roof sheathing, drainage, and roof-mounted equipment components.

Option 1: Add Roof-Mounted Equipment Pedestals or Relocate Inside

On low-slope membrane roofs, poorly anchored roof-mounted equipment can be knocked out of place by high winds or wind-borne debris impact. This often leads to tearing and peeling of the roof membrane as the equipment skips across the roof. Consider the following techniques to deal with this issue:

- Add a concrete curb or pedestal on which to mount rooftop equipment to provide a solid connection point without having to break through the surrounding roof membrane. This improvement should be made together with strengthening equipment connections, as described in Mitigation Solution: Strengthen or Improve—Option 7 (see below) and as shown in Figure 3.3.2.2. Pedestal size and weight are design considerations to be addressed by the engineer.

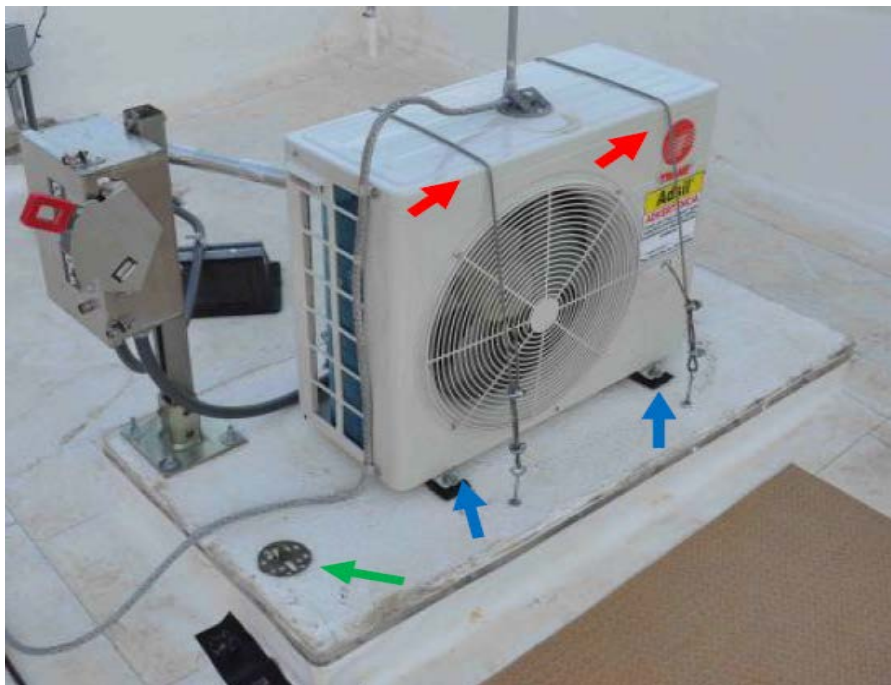
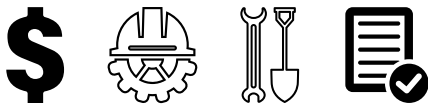

Figure 3.3.2.2. Condenser bolted down to concrete curb (blue arrows) with tie-down cables (red arrows), but the lightning protection system is no longer secured by its connector (green arrow).

- Make sure rooftop equipment supports are either tested to comply with local code regulations or designed by a professional familiar with the wind requirements of the region.
- Lightning protection systems are critical to keeping equipment safe during lightning storms. Ensure such systems are properly secured to equipment.
- In situations where roof-mounted equipment is difficult to anchor or the equipment itself is unlikely to withstand high winds, wind-borne debris impact and wind-driven rain, consider moving the equipment inside the building or move it into a rooftop penthouse to protect it from damage.
 - This approach may require moving existing systems and contents.
 - This approach also may need to meet additional clearance and ventilation requirements to hold the relocated equipment.
 - Penthouses need to be designed and constructed as per ASCE 7 to resist local wind design speeds specified in the most recent building code edition.

CONSIDERATIONS:



Option 2: Add a Secondary Membrane

Installing a secondary membrane over a concrete deck can provide extra protection against damage from debris impacts and wind-driven rain. When evaluating this option, keep these considerations in mind:

- Seal the secondary membrane at the edges, openings and penetrations to prevent water from entering.
- Use a layer thickness that meets requirements for local wind design speeds specified in the most recent building code edition.
- Install insulation over the secondary membrane. The insulation helps absorb energy from debris impacts.
- Install the primary membrane over the insulation. Consider a modified bitumen membrane, which is more resistant to puncture than other membrane systems used for roof coverings.

CONSIDERATIONS:

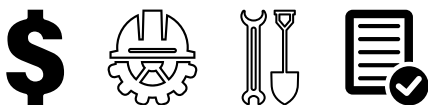

Mitigation Solution: Strengthen or Improve

This solution involves upgrades to one or more of the existing roof system elements to help improve resistance to wind, wind-driven rain and rainfall events. Multiple mitigation options use this solution to protect low-slope roof system components and maintain a continuous load path throughout the roof system.

Option 1: Strengthen Roof Framing and Connections

Use the following techniques to make sure the roof framing and connections between the roof and wall framing are strong enough to withstand both horizontal and uplift wind forces. As part of these solutions, note that NFIP Technical Bulletin 8, *Corrosion Protection for Metal Connectors and Fasteners in Coastal Areas*, recommends all exposed roof connectors and fasteners within 3,000 feet of the coastline should be either hot-dipped galvanized steel or stainless steel to resist salt spray and corrosion.

- Strengthen all low-slope roof-framing types using materials prespecified in FEMA P-55, *Coastal Construction Manual*, and FEMA P-424, *Design Guide for Improving School Safety in Earthquakes, Floods, and High Winds*.
- Strengthen roof connections by installing anchors, straps, reinforcing bars, connectors and fasteners compatible with the roof system. As with wall framing connections discussed in Fact Sheet 3.2, *Wall Systems and Openings*, roof connectors and fasteners must be strong enough to resist hurricane wind forces. See FEMA P-543, *Design Guide for Improving Critical Facility Safety from Flooding and High Winds*, for additional information.

CONSIDERATIONS:



Option 2: Upgrade Wood Sheathing/Decking

Upgrade wood roof sheathing/decking by making the following improvements listed in Technical Fact Sheet 7.1, *Roof Sheathing Installation*, of FEMA P-499, *Home Builder's Guide to Coastal Construction*.

- Install wood sheathing/decking panels for high-wind regions, including plywood or OSB rated as “Exposure 1” or better with a minimum thickness of 15/32-inch (outside of the Florida High-Velocity Hurricane Zone [HVHZ] only).
- Sheathing/decking layouts for low-slope roofs should be installed to match APA—The Engineered Wood Association recommendations.
- Improved sheathing/decking connections should use a minimum of 8d (i.e., 2 ½ inches long), full round-head deformed-shank nails, ring shank nails, or screws; staples are insufficient and should not be used in high-wind areas.
- Increase nailing frequency for sheathing systems that do not meet current wind load requirements.

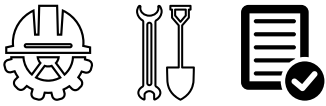
CONSIDERATIONS:**Option 3: Improve Metal Roof Decking**

Improve metal roofing performance using the following for materials, installation details and connections per Technical Fact Sheet 7.6, *Metal Roof Systems in High-Wind Regions*, of FEMA P-499, *Home Builder's Guide to Coastal Construction*; FEMA P-543, *Design Guide for Improving Critical Facility Safety from Flooding and High Winds*, and local building code requirements. When evaluating this option, consider the following:

- When clip or panel fasteners are attached to mailers, note the connection of the nailer to the nailer support.
- When clip or panel fasteners are loaded-in withdrawal (tension), use screws instead of nails.
- Make sure clips are correctly spaced.
- Use the correct clip type for the wind speed and roof panel type.
- Closely space fasteners at hip and ridge flashings. Please refer to the manufacturer's tested assemblies or technical requirements from the Sheet Metal and Air Conditioning Contractors' National Association (SMACNA) for additional information.

CONSIDERATIONS:**Option 4: Strengthen Edge Flashings, Copings and Fascia Covers**

Public buildings with low-slope membrane roofs often fail at the edges of high winds from lifting and peeling metal edge flashings, copings, or fascia covers. FEMA P-543, *Design Guide for Improving Critical Facility Safety in Flooding and High Winds*, recommends the following approaches to strengthen these components:

- Reinforce metal edge flashings, copings and fascia covers with stronger materials and improved connectors. Design these elements to resist wind uplift as per ANSI/SPRI ES-1, *Test Standard for Edge Systems Used with Low Slope Roofing Systems*, referenced in the International Building Code.
- Attach edge flashings, copings and fascia covers with wood or masonry screws and washers instead of cleats, as shown in Figure 3.3.2.3. Also install anti-bridging bars on roof membrane liners.

- If cleats are used to attach the roof membrane, place a peel-stop bar over the roof membrane near the edge flashing or coping. The bar provides secondary protection against membrane lifting and peeling if the flashing or coping fail. The bar should be well anchored to the parapet or deck.



Figure 3.3.2.3. Both vertical faces of coping were attached with exposed fasteners (1/4-inch diameter stainless steel fasteners spaced 12" on center) instead of concealed cleats following Typhoon Paka (1997) in Guam to prevent the flashing from tearing in future storms.

CONSIDERATIONS:

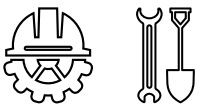

Option 5: Improve Gutters

Storm damage research has shown that—when lifted by wind—gutters cause the edge flashing, which laps the gutter to lift as well, resulting in a progressive peeling of the roof membrane. This leaves the roof exposed to potential water entry and damage. The following measures can be used to protect gutters from wind damage and make sure they provide needed storm runoff volume:

- Use gutter materials and connections designed to resist wind, water and ice loads as per ANSI/SPRI GD-1, *Structural Design Standard for Gutter Systems Used on Low-Sloped Roofs*, for both low-slope and steep-slope roofs using a safety factor of 2.0 as in Figure 3.3.2.4.



Figure 3.3.2.4. Sheet metal straps (circled) attached to an existing gutter to increase wind uplift resistance.

- Gravity-support brackets can be designed to resist uplift loads. In addition to being attached at its top, the bracket should also be attached to the wall at its low end. Bracket spacing will depend on the gravity and uplift loads, the bracket's strength, and the strength of the connections from gutter-to-bracket and bracket-to-wall.
- Use separate sheet metal straps at 45-degree angles to the wall to resist uplift loads. The strap spacing will depend on the gutter uplift and strength of the connections from gutter-to-strap and strap-to-wall.
- Regularly inspect gutters to clean vegetation and other debris that builds up and tighten loose connections. Keep trees surrounding the building trimmed back so they do not extend over the rooftops.

CONSIDERATIONS:



Option 6: Strengthen Roof Access Hatches and Skylights

Roof access hatches and skylights can be a point of entry for water and wind if they are not rated for the wind zone in the area where the building is located or if they are not properly sealed. Strengthen roof access hatches and skylights to help reduce damage to the interiors of public buildings as follows:

- Strengthen roof access hatches using thicker hatch door materials and more robust hatch frames with thicker seals, more durable hinges, and tougher locks compared to non-tested or off-the-shelf roof hatches.
- Upgrade older plastic skylights with wired glass or other impact-resistant glazing materials with thicker seals and frames compared to non-tested or standard seals and frames.
- Use skylight installation and performance standards, including ASTM E2112 and ASTM E330.

- Consider replacing hinged skylights with closed skylights to reduce the risk of wind-driven rain entry and for increased security.

CONSIDERATIONS:

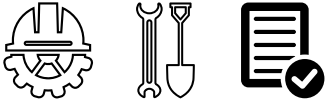

Option 7: Strengthen Roof-Mounted Equipment and Component Connections

Some mechanical and electrical equipment may be located on the roof. If this equipment is not protected in a rooftop penthouse, strong winds can dislodge the components from where they are attached to the roof. Rooftop equipment connections can be strengthened using the following methods:

- Follow specific design guidance such as *Calculating Wind Loads and Anchorage Requirements for Rooftop Equipment*, published by the American Society for Heating, Refrigeration and Air Conditioning Engineers (ASHRAE).
- Where specific design guidance is unavailable, follow the practices outlined in *Recovery Advisory 2, Attachment of Rooftop Equipment in High-Wind Regions* from FEMA P-2021, *Mitigation Assessment Team (MAT): Hurricanes Irma and Maria in the U.S. Virgin Islands*; FEMA P-543, *Design Guide for Improving Critical Facility Safety from Flooding and High Winds*, or similar advisories for details on the number of screws needed to secure select rooftop equipment.
 - Table 1 of the Recovery Advisory provides recommendations on the number of fasteners to use for different types of equipment.
 - The advisory also includes best practices for hold-down connectors, anchors and straps to resist wind uplift pressures, as shown in Figure 3.3.2.5.



Figure 3.3.2.5. Rooftop periodic gas line supports using a steel angle welded to a pipe that was anchored to the roof deck for lateral and uplift resistance (left). Use of intermittent membrane flashing to secure a lightning protection system conductor (center). Cables attached prevent rooftop equipment cowling from blowing off (right).

- Make sure rooftop equipment attachments are designed to meet local code requirements and meet the requirements of ASCE 7.
- For lightning protection systems, conductor connectors should be mechanically secured to the inside face of the parapet nailer and properly sealed to be watertight. On built-up and modified bitumen roofs, attach air terminal base plates with asphalt roof cement. For single-ply membranes, attach the air terminal base plates with pourable sealer.
- Evaluate the strength of roof-mounted antennas as per the latest version of ANSI/TIA-222, *Structural Standard for Antenna Supporting Structures and Antennas and Small Wind Turbine Support Structures*, to determine if additional guy wires, bracing or tower strengthening are required.

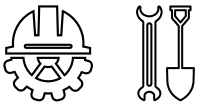
CONSIDERATIONS:

Mitigation Solution: Upgrade

This solution involves removing a roof system that has been destroyed or significantly damaged and replacing it with a stronger roof system that is resistant to wind and wind-driven rain.

Option 1: Upgrade Roof Covering with Tested Systems

For low-slope roofs where the roof framing or structural support system is sufficient to resist wind loads but the roof covering is not, consider removing the existing roof covering and upgrading it with a system that has been tested to meet the local wind requirements. This also presents an opportunity to fix any ponding issues that may occur with the existing roof covering. In hurricane-prone regions, it is recommended that roof coverings with gravel ballast surfacing, lightweight pavers or cementitious-coated insulation boards be replaced to avoid blow-off.

- Storm damage research has shown that sprayed polyurethane foam (SPF) and liquid-applied roof systems are very reliable performers in high winds.
- Built-up roofs and modified bitumen systems have demonstrated good wind performance provided the edge flashing or coping does not fail, which happens frequently.
 - Design flashing and coping to comply with ANSI/SPRI ES-1, Wind Design Standard for Edge Systems Used in Low Slope Roofing Systems.
 - Use exposed fasteners to attach the vertical flanges of copings and edge flashings as they have been found to be a very effective and reliable attachment method.
- Mechanically attached and air-pressure equalized single-ply membrane systems are prone to degradation after debris impact; this roofing system is not recommended for hurricane-prone regions.
- When upgrading a roof covering, remove the old roof covering down to the deck rather than just re-covering the roof. This allows the structural integrity of the roof to be evaluated and problems to be addressed.
- It may be necessary to re-skin the parapet with sheathing before installing new base flashing.

CONSIDERATIONS:



REFERENCES:

Detailed technical information on hurricane mitigation of low-slope roofs can be found in these publications. Much of the residential information also applies to non-residential buildings.

American Society of Civil Engineers (ASCE). 2016. ASCE 7, *Minimum Design Loads and Associated Criteria for Buildings and Other Structures*. Available at: <https://www.asce.org/asce-7/>

Federal Emergency Management Agency (FEMA). 2007a. FEMA 543, *Design Guide for Improving Critical Facility Safety from Flooding and High Winds*. Available at: https://www.fema.gov/sites/default/files/2020-08/fema543_design_guide_complete.pdf

FEMA. 2007b. FEMA 577, *Design Guide for Improving Hospital Safety in Earthquakes, Floods, and High Winds*. Available at: https://www.fema.gov/sites/default/files/2020-08/fema577_design_guide_improving_hospital_safety_2007.pdf

FEMA. 2010a. FEMA P-424, *Risk Management Series: Design Guide for Improving School Safety in Earthquakes, Floods, and High Winds*. Available at: https://www.fema.gov/sites/default/files/documents/fema_p-424-design-guide-improving-school-safety.pdf

FEMA. 2010b. FEMA P-499, *Homebuilder's Guide to Coastal Construction*. Available at: https://www.fema.gov/sites/default/files/2020-08/fema499_2010_edition.pdf

FEMA. 2011. FEMA P-55, *Coastal Construction Manual: Principles and Practices of Planning, Siting, Designing, Constructing, and Maintaining Residential Buildings in Coastal Areas*. Available at: https://www.fema.gov/emergency-managers/risk-management/building-science/publications?name=%22FEMA+P-55%2C+Coastal%22&field_keywords_target_id=All&field_document_type_target_id=All&field_audience_target_id=All

FEMA. 2018. FEMA P-2021, *Mitigation Assessment Team Report: Hurricanes Irma and Maria in the U.S. Virgin Islands, Recovery Advisories*. Available at: https://www.fema.gov/sites/default/files/2020-07/mat-report_hurricane-irma-maria_virgin-islands.pdf

FEMA. 2019a. FEMA P-2062, *Guidelines for Wind Vulnerability Assessments of Existing Critical Facilities*. Available at: <https://www.fema.gov/sites/default/files/2020-07/guidelines-wind-vulnerability.pdf>

FEMA. 2019b. NFIP Technical Bulletin 8, *Corrosion Protection of Metal Connectors in Coastal Areas*. Available at: https://www.fema.gov/emergency-managers/risk-management/building-science/publications?name=%22Technical+Bulletin+8%22&field_keywords_target_id=All&field_document_type_target_id=All&field_audience_target_id=All

Fact Sheet 3.4.1: Building Utility Systems—Heating, Ventilation and Air Conditioning

The mitigation objective of this Fact Sheet is to improve the resilience of the components of heating, ventilation and air conditioning (HVAC) systems to allow a building to retain partial functionality or to be quickly repaired following a flood, with an end goal of rapidly returning the building to full use.

HVAC systems are used to heat and cool indoor spaces. In public buildings, HVAC systems may include chilled water and hot water systems and active ventilation systems for controlling indoor temperatures, humidity levels and indoor air quality. HVAC components generally are not flood resistant, so they will be damaged or destroyed when exposed to flood water. Wind and wind-borne debris can damage or destroy rooftop-mounted equipment. Mitigation actions can be taken to reduce physical damage and functional loss of HVAC system components from floods and hurricanes so public facilities can provide essential community services during and after these disasters.

Wind and wind-related mitigation of HVAC system components and equipment located inside the building or inside rooftop enclosures can be accomplished by making sure the building envelope and enclosures are built to resist wind pressures, wind-borne debris and wind-driven rain. Wind and wind-related mitigation of non-enclosed rooftop HVAC system components and equipment can be accomplished by making sure the equipment is well anchored to resist the design wind forces for the geographic location.

Added protection can result from following best practices, which often go beyond minimum codes and standards. Additional information about measures that can be implemented to mitigate against wind are discussed in Fact Sheet 3.2, *Wall Systems and Openings*; Fact Sheet 3.3.1, *Sloped Roof Systems*; and Fact Sheet 3.3.2, *Low-Slope Roof Systems*. Mitigation of rooftop mechanical equipment to resist high winds and wind-driven rain also is covered in Fact Sheet 3.3.1, *Sloped Roof Systems*; and Fact Sheet 3.3.2, *Low-Slope Roof Systems*. Because other fact sheets cover wind-related hazard mitigation of rooftop-mounted HVAC system components, this fact sheet focuses primarily on flood mitigation.



Key Terms and Definitions

HVAC systems are mechanical systems generally associated with building heating, ventilation and air conditioning that use air, water or other fluids as a thermal transfer medium to heat and cool the structure. The basic components of fluid-based HVAC systems commonly used in large public buildings are shown in Figure 3.4.1.11. The basic components of forced-air HVAC systems common to small public buildings are shown in Figure 3.4.1.2.

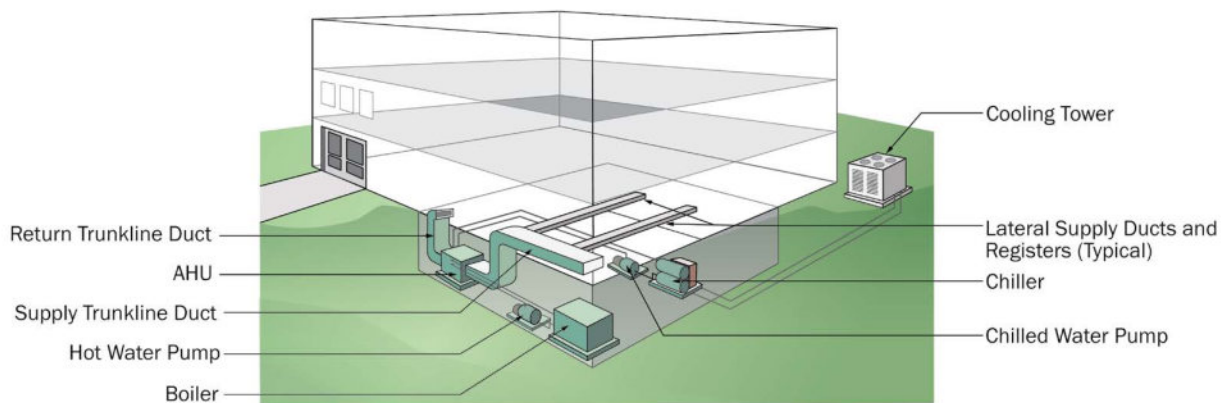

Figure 3.4.1.1. Basic components of a large public building fluid-based HVAC system.
Note HVAC components on upper floors are not shown in this simplified graphic.

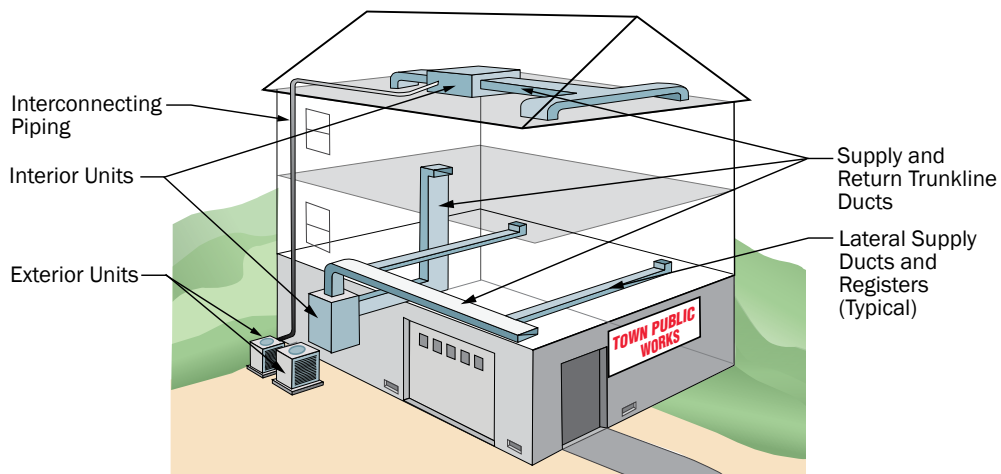

Figure 3.4.1.2. Basic components of a small public building supplied by two forced-air HVAC systems.

HVAC systems are comprised of two types of components:

- **Primary Components**—Components that must work for the system to work. When a primary component does not work, the entire system stops working. Examples of primary components of HVAC systems include air handling units, condenser units, and evaporative coils.
- **Secondary components**—Components that can lose function without causing complete loss of building system operation. When secondary components do not work, the system may not function at its highest level of service or it may cause service interruptions to a portion of the building. Examples of secondary components of HVAC systems include ducts, supply grills and return louvers.

Mitigating existing HVAC systems typically is done by elevating and partially protecting HVAC components, with some in-place component protection also recommended. Refer to FEMA P-348, *Protecting Building Utility Systems from Flood Damage*, for more details. In addition, new construction and substantial improvements for proposed building sites that are in flood-prone areas must comply with the National Flood Insurance Program (NFIP) requirements.

Table 3.4.1.1. summarizes some common mitigation solutions that can improve the performance of building HVAC system components. These strategies then are discussed in the sections that follow.

Table 3.4.1.1. Common HVAC System Mitigation Solutions

<i>Solutions and Options</i>	<i>Coastal Flood</i>	<i>Riverine Flood</i>
Mitigation Solution: Elevate or Relocate		
Option 1: Elevate or Relocate	✓	✓
Mitigation Solution: Dry Floodproof		
Option 1: Dry Floodproof	✓	✓
Mitigation Solution: Wet Floodproof		
Option 1: Wet Floodproof	✓	✓

Mitigation Solution: Elevate or Relocate

Since most HVAC components are not water resistant and can be damaged or destroyed when exposed to floodwater, elevation is the most effective overall solution for mitigating both primary and secondary components.

Option 1: Elevate or Relocate

Specific examples of HVAC mitigation measures that use this strategy include:

- Elevate or raise (in place) outdoor HVAC compressors and interior units onto platforms or pedestals above the flood protection level, as shown in Figure 3.4.1.3.

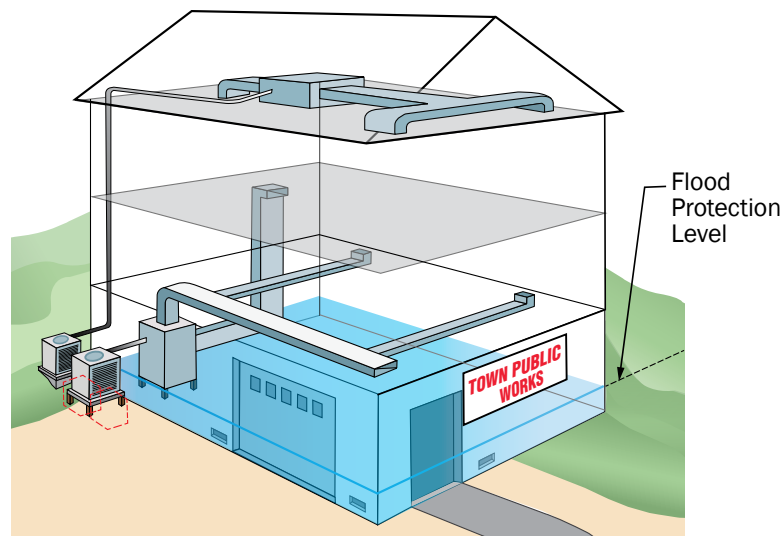

Figure 3.4.1.3. Elevation of indoor and outdoor HVAC components on platforms above flood protection level for small public building.

- In coastal flood zones (Zone V), anchor HVAC equipment to platforms attached to the main structure using corrosion-resistant connectors and fasteners to protect from storm surge and wave action. Platforms and pedestals should be well anchored to withstand being dislodged by flood forces.
 - HVAC equipment placed on these platforms also should be anchored to resist wind forces. The equipment's dimensions will determine its vulnerability to wind forces.
- If primary components shift due to flood and wind forces, their connections to fixed electrical, piping and duct components can be strained or disconnected. Where permissible, install flexible connections such as flexible conduit, cords and cables, piping and ducts with appropriate fittings. Availability of flexible for plumbing systems that operate at high pressures or convey reactive fluids may be limited.
- Elevate interior equipment in place by suspending ducts from the floor framing if that level is high enough to protect the components from flood or consider if the floor framing itself can be raised above the flood protection level.

If elevation in place is not possible, relocate all primary and secondary HVAC components to higher floors above the flood protection level, as shown in Figure 3.4.1.4.

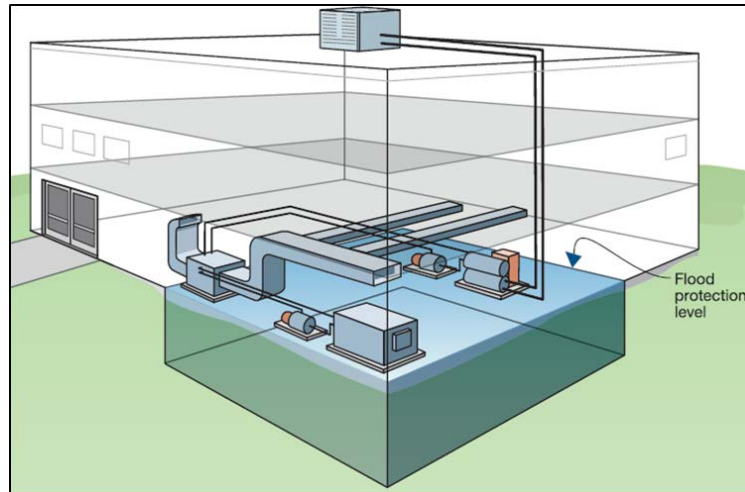

Figure 3.4.1.4. Elevation of indoor HVAC components from basement to first floor above flood protection level for large public building, with outdoor HVAC components relocated to the rooftop.

- Relocating HVAC system components to a higher floor will require having or creating enough space to put the equipment. Space may need to be traded by moving another less-critical function to a lower floor. Relocating system components is likely to require additional design by a licensed engineer.
- Elevating or relocating equipment may cost more than some other mitigation strategies, but these solutions are the most effective approach to mitigating HVAC system components against flood impacts.

CONSIDERATIONS:



Mitigation Solution: Dry Floodproof

When primary HVAC components cannot be elevated, dry floodproofing may be an effective solution to protect equipment in-place.

Option 1: Dry Floodproof

Although options are few given the limited flood resistance of HVAC components, some specific examples of HVAC mitigation measures that can apply this strategy include:

- Protect HVAC equipment in-place with a low wall or step-over curb if the flood protection level is 12 inches or less.
 - Higher protective walls should have a gasketed entrance panel door or other closure type, as shown in Figure 3.4.1.5.
 - A secondary drainage system using a sump pump with backup power is recommended.

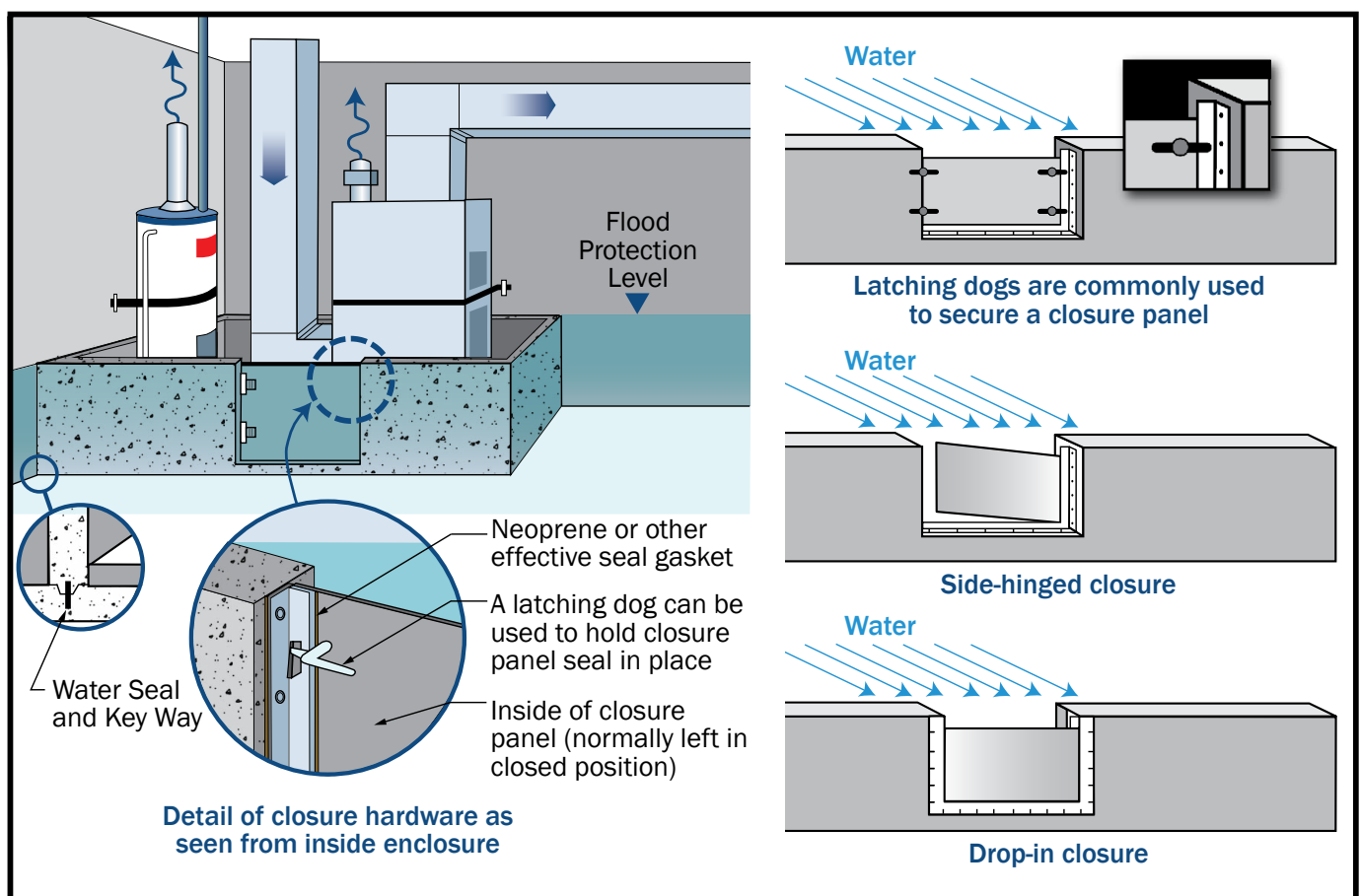

Figure 3.4.1.5. Dry floodproofing with a watertight wall and access gate can be used to protect HVAC and plumbing equipment (left); alternate dry floodproofing protective enclosures for protecting equipment (right).

- Place HVAC components within watertight vaults or protected areas built with reinforced walls and floors strong enough to withstand all flood forces. Make sure there is enough space to build the enclosures.

CONSIDERATIONS:



Mitigation Solution: Wet Floodproof

When piping for water-conveying portions of HVAC systems cannot be elevated above the flood protection level and dry floodproofing is not possible or practical, wet floodproofing can reduce system damage and repair time after a flood, helping to restore service more rapidly.

Option 1: Wet Floodproof

Some wet floodproofing mitigation options include:

- Create transition points between sections of the HVAC system that are above and below the flood protection level.
- Install piping unions above the required flood protection level for chilled- and hot-water systems to allow damaged components to be removed and replaced while minimizing disruption to the undamaged portions of the system.
- Install isolation devices above the required flood protection level, such as valves that control feed portions of piping exposed to floodwater, to make repair or replacement of damaged equipment faster and easier.
 - The valves allow damaged equipment to be isolated from undamaged sections and may allow the undamaged sections to function during repairs.
 - Similarly, dampers can be installed in lateral sections of exposed HVAC ducts that are fed from trunk-line ducts above the floodwater.

CONSIDERATIONS:



REFERENCES:

Detailed information on hurricane mitigation of building HVAC systems can be found in these publications. Much of the residential information applies to non-residential buildings as well.

- American Society of Civil Engineers (ASCE). *Highlights of ASCE 24 Flood Resistant Design and Construction*. Available at: https://www.fema.gov/sites/default/files/2020-07/asce24-14_highlights_jan2015.pdf
- Federal Emergency Management Agency (FEMA). 2007a. FEMA 543, *Design Guide for Improving Critical Facility Safety from Flooding and High Winds*. Available at: https://www.fema.gov/sites/default/files/2020-08/fema543_design_guide_complete.pdf
- FEMA. 2007b. FEMA 577, *Design Guide for Improving Hospital Safety in Earthquakes, Floods, and High Winds*. Available at: https://www.fema.gov/sites/default/files/2020-08/fema577_design_guide_improving_hospital_safety_2007.pdf
- FEMA. 2010. FEMA P-424, *Risk Management Series: Design Guide for Improving School Safety in Earthquakes, Floods, and High Winds*. Available at: https://www.fema.gov/sites/default/files/documents/fema_p-424-design-guide-improving-school-safety.pdf
- FEMA. 2011. FEMA P-55, *Coastal Construction Manual: Principles and Practices of Planning, Siting, Designing, Constructing, and Maintaining Residential Buildings in Coastal Areas*. Available at: https://www.fema.gov/emergency-managers/risk-management/building-science/publications?name=%22FEMA+P-55%2C+Coastal%22&field_keywords_target_id=All&field_document_type_target_id=All&field_audience_target_id=All
- FEMA. 2013. FEMA P-936, *Floodproofing Non-Residential Buildings* Available at: https://www.fema.gov/emergency-managers/risk-management/building-science/publications?name=%22P-936%22&field_keywords_target_id=All&field_document_type_target_id=All&field_audience_target_id=All
- FEMA. 2017. FEMA P-348, *Protecting Building Utility Systems from Flood Damage; Principles and Practices for Design and Construction of Flood Resistant Building Utility Systems*. Available at: https://www.fema.gov/sites/default/files/2020-07/fema_p-348_protecting_building_utility_systems_from_flood_damage_2017.pdf
- FEMA. 2019. NFIP Technical Bulletin 8, *Corrosion Protection of Metal Connectors in Coastal Areas*. Available at: https://www.fema.gov/emergency-managers/risk-management/building-science/publications?name=%22Technical+Bulletin+8%22&field_keywords_target_id=All&field_document_type_target_id=All&field_audience_target_id=All

Fact Sheet 3.4.2: Building Utility Systems—Electrical

The mitigation objective of this Fact Sheet is to improve the resilience of the components of electrical systems to allow a building to continue to be used or quickly repaired following a hurricane, with an end goal of rapidly returning the building to full functionality.

Electrical systems include the electrical wiring and components that supply electricity to devices and equipment within a building. They also include the wiring and components to distribute utility power and, in some buildings, to distribute power from standby power sources or emergency power sources. Standby power sources generally are considered optional systems and are installed to allow a facility to function when utility power is lost, although usually not at full power. Emergency power systems are those required by building codes and standards for life safety, smoke control and fire protection.

Electrical systems are comprised of two types of components:

- **Primary components**—Electrical components that must function for the system to work. When a primary component is damaged, the entire system stops working. Examples of primary electrical system components include pole- or pad-mounted transformers and service drops or laterals, utility meters, service and distribution equipment, motor control centers, branch circuit panelboards and emergency or standby power system components.
- **Secondary components**—Electrical components that can lose function without preventing the complete shutdown of building system operation. When secondary components are damaged, the system may function at a reduced level of service or cause service interruptions to a portion of the building. Examples of secondary electrical system components include branch circuits, convenience outlets and lighting fixtures.

The typical components of main electrical systems and standby or emergency power systems common to small public buildings before mitigation are shown in Figure 3.4.2.1. The typical components of main electrical systems and standby or emergency power systems common to large public buildings before mitigation are shown in Figure 3.4.2.2



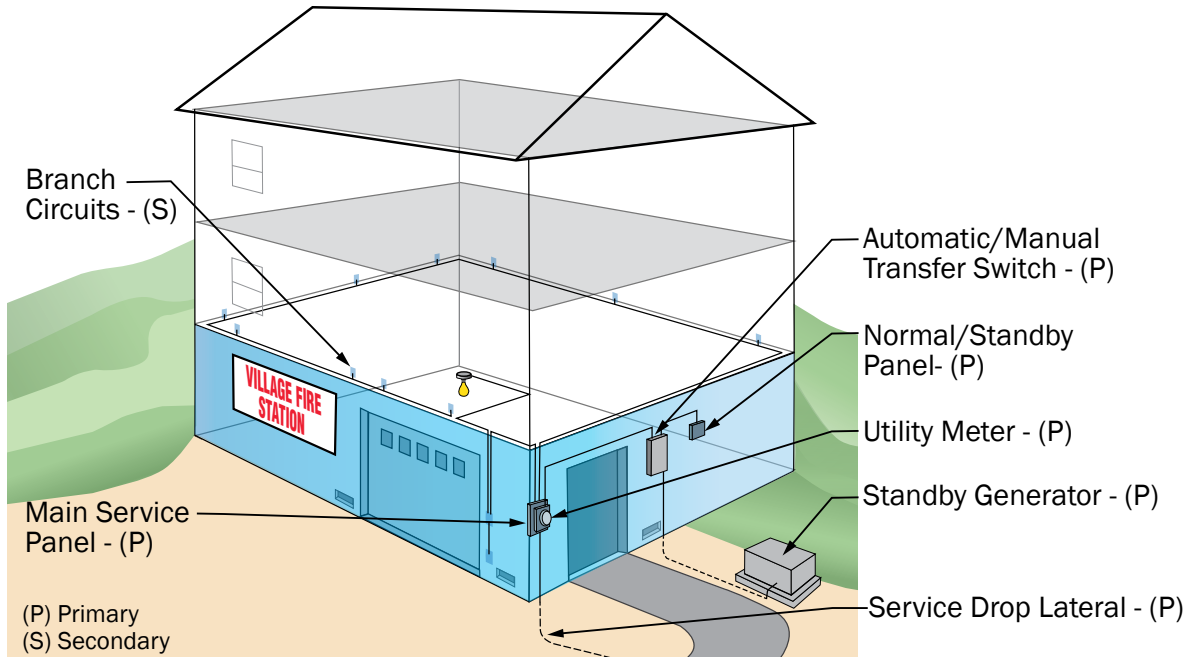

Figure 3.4.2.1. Typical small public building electrical system components with an onsite standby or emergency generator.

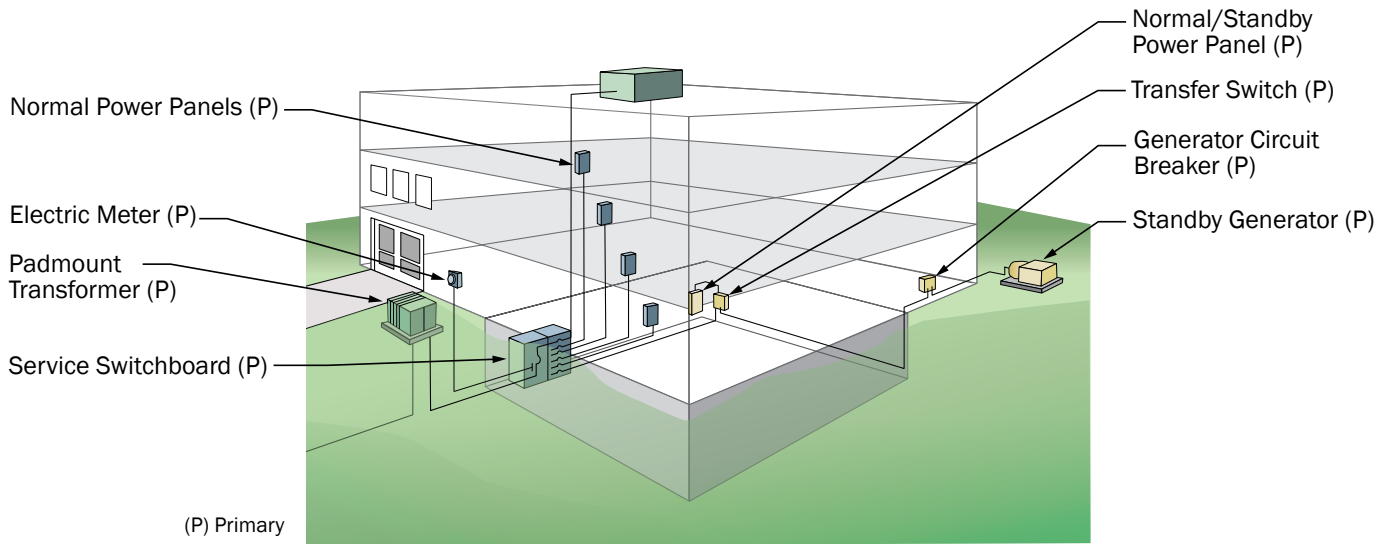

Figure 3.4.2.2. Simplified diagram showing primary components of a large public building electrical system with standby generator (before mitigation).

Mitigation of main and standby power system components typically is best achieved by elevating in place or relocating to an upper floor. If elevation in place or relocation is not practical, dry floodproofing can be considered, but this often is difficult to do and carries its own set of risks. Refer to FEMA P-348, *Protecting Building Utility Systems from Flood Damage*, for additional details.

In addition to main and standby power systems, electrical systems also may include communications systems such as voice communication, information technology (IT), networking, fiber optic, and cable television (CATV). Other electrical systems may include components for security such as alarms and closed-circuit television (CCTV).

Wind and wind-related mitigation measures for electrical system components and equipment located inside the building can be accomplished by making sure that the building envelope is built to resist wind pressures, wind-borne debris and wind-driven rain. Added protection can be accomplished by following best practices, which often go beyond following the minimum codes and standards. Additional information about measures that can be implemented to mitigate against wind are discussed in Fact Sheet 3.2, *Wall Systems and Openings*; Fact Sheet 3.3.1, *Sloped Roof Systems*; and Fact Sheet 3.3.2, *Low-Slope Roof Systems*. Mitigation of rooftop electrical equipment to resist high winds and wind-driven rain is covered in Fact Sheet 3.3.1, *Sloped Roof Systems* and Fact Sheet 3.3.2, *Low-Slope Roof Systems*. Because other fact sheets cover wind-related hazard mitigation of rooftop-mounted electrical system components, this fact sheet focuses primarily on flood mitigation.

Table 3.4.2.1 summarizes some common mitigation solutions that can improve the performance of building electrical system components. These strategies then are discussed in the sections that follow.

Table 3.4.2.1. Common Electrical System Mitigation Solutions

<i>Solutions and Options</i>	<i>Coastal Flood</i>	<i>Riverine Flood</i>
Mitigation Solution: Elevate or Relocate		
Option 1: Elevate or Relocate	✓	✓
Mitigation Solution: Dry Floodproof		
Option 1: Dry Floodproof	✓	✓

Mitigation Solution: Elevate or Relocate

Since most electrical components are not water resistant and can be damaged or destroyed when exposed to floodwater, elevation is the most effective overall solution for mitigating primary and secondary electrical system components in buildings.

Option 1: Elevate or Relocate

Elevate all primary electrical system components and, wherever possible, secondary components of buildings on platforms or pedestals above the flood protection level, as shown in Figure 3.4.2.3. Elevating electrical system components must comply with National Fire Protection Association (NFPA) 70, which presents the National Electrical Code (NEC) requirements for access and minimum working clearance. Additional information about the flood protection level can be found in Fact Sheet 3.0, *Buildings, Systems and Equipment*.

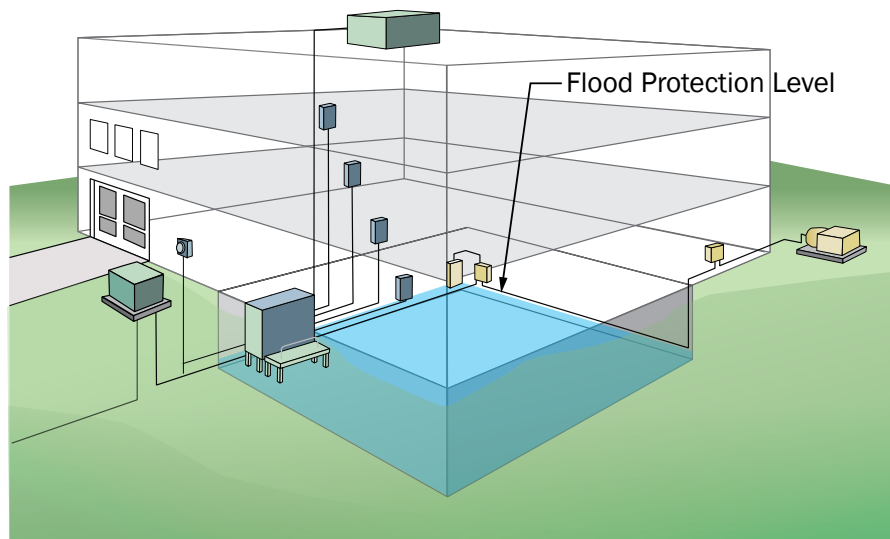

Figure 3.4.2.3. Simplified diagram showing elevation of main and standby power components on elevated platforms above flood protection level for large public building.

If elevation is not practical, relocate all primary and secondary electrical components to higher floors above the flood protection level or move them to the rooftop.

When evaluating these strategies, some things to consider include:

- Transformers need to be located physically close to the building's electrical service equipment. If a transformer is elevated, the service equipment likely will need to be elevated as well.
- In existing buildings, flood mitigation may be more easily included as equipment is replaced at the end of its useful service life, when it becomes obsolete, or during building renovations.
- Secondary components vulnerable to flooding that cannot be elevated or relocated should be designed to be electrically isolated from the rest of the system so that power can be restored before flood-related electrical repairs are completed.

The placement of most utility meters is directed by the utility company based on a maximum height above the ground (typically 6 feet). Placement of meters typically is at a height so meters can be read and, if needed, removed to disconnect power to the building they serve. Consider installing a combination meter socket and circuit breaker service disconnect. This device, as shown in Figure 3.4.2.4

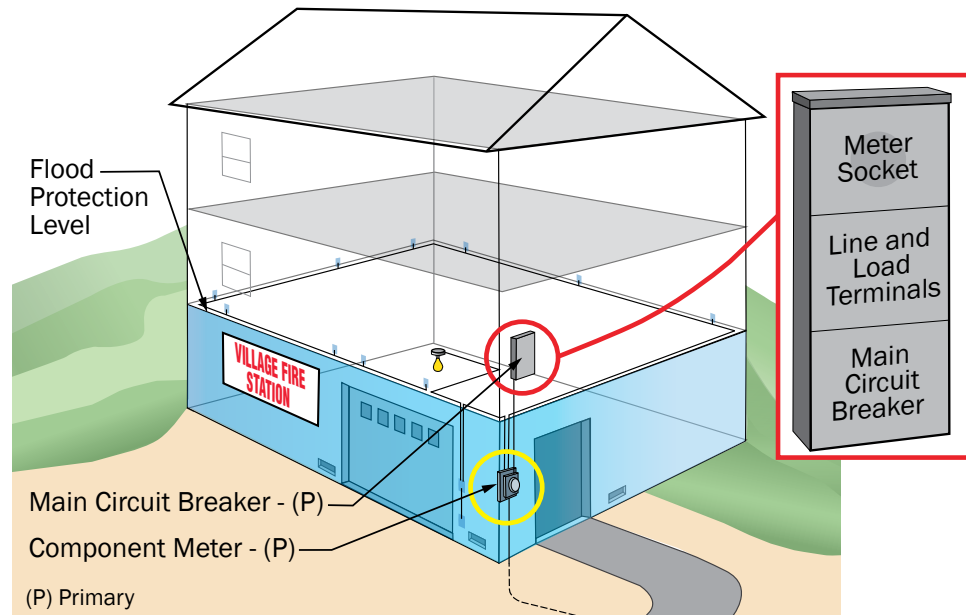

Figure 3.4.2.4. Combination meter socket and circuit breaker service disconnect (circled in red) used to allow the main panel to be elevated and protected from flooding when the meter (circled in yellow) cannot be moved.

When elevation or relocation are not possible, install equipment and wiring below the flood protection level to provide easier access for post-flood repair—for instance, corrosion-resistant conduit systems that allow flood-damaged conductors to be replaced. Where possible, connections, taps and splices that involve removing cable sheaths and conductor insulation should be made above the flood protection level.

CONSIDERATIONS:



Mitigation Solution: Dry Floodproof

When electrical components cannot be elevated above the flood protection level, component protection in place using dry floodproofing may be possible, but effective dry floodproofing often is difficult to achieve and even when it is feasible, residual risks remain. For electrical components, wet floodproofing is not an option since they cannot be operated under submerged conditions.

Option 1: Dry Floodproof

Dry floodproofing for electrical system components is most appropriate and effective when it protects a large portion of the building. Electrical dry floodproofing options should consider the following:

- Because of the sensitive nature of electrical system components in water, including freeboard with any dry floodproofing is recommended to provide additional flood protection.
- Flood walls or flood barriers should be placed to provide access, clearance and working space that meet NEC requirements. When installing temporary flood protection systems, installation of removable components should meet NEC requirements, but since they are typically installed for 90 days or less, NEC requirements for temporary installations as provided in NEC Article 590 may apply if approved by local officials.
- Pump systems are required to remove seepage and rainwater that accumulate inside the protected area.

Do Not Use Wet Floodproofing for Electrical Components

Wet floodproofing should not be used as a flood mitigation solution for electrical components because these components cannot be operated under submerged conditions.

CONSIDERATIONS:



REFERENCES:

Detailed information on hurricane mitigation of building electrical systems can be found in these publications. Much of the residential information applies to non-residential buildings, as well.

American Society of Civil Engineers (ASCE). *Highlights of ASCE 24 Flood Resistant Design and Construction*. Available at: https://www.fema.gov/sites/default/files/2020-07/asce24-14_highlights_jan2015.pdf

Federal Emergency Management Agency (FEMA). 2007a. FEMA 543, *Design Guide for Improving Critical Facility Safety from Flooding and High Winds*. Available at: https://www.fema.gov/sites/default/files/2020-08/fema543_design_guide_complete.pdf

FEMA. 2007b. FEMA 577, *Design Guide for Improving Hospital Safety in Earthquakes, Floods, and High Winds*. Available at: https://www.fema.gov/sites/default/files/2020-08/fema577_design_guide_improving_hospital_safety_2007.pdf

FEMA. 2010. FEMA P-424, *Risk Management Series: Design Guide for Improving School Safety in Earthquakes, Floods, and High Winds*. Available at: https://www.fema.gov/sites/default/files/documents/fema_p-424-design-guide-improving-school-safety.pdf

FEMA. 2011. FEMA P-55, *Coastal Construction Manual: Principles and Practices of Planning, Siting, Designing, Constructing, and Maintaining Residential Buildings in Coastal Areas*. Available at: https://www.fema.gov/emergency-managers/risk-management/building-science/publications?name=%22FEMA+P-55%2C+Coastal%22&field_keywords_target_id=All&field_document_type_target_id=All&field_audience_target_id=All

FEMA. 2014. FEMA P-1019, *Emergency Power Systems for Critical Facilities: A Best Practices Approach to Improving Reliability*. Available at: https://www.fema.gov/sites/default/files/2020-07/fema_p-1019_final_02-06-2015.pdf

FEMA. 2017. FEMA P-348, *Protecting Building Utility Systems from Flood Damage: Principles and Practices for Design and Construction of Flood Resistant Building Utility Systems*. Available at: https://www.fema.gov/sites/default/files/2020-07/fema_p-348_protecting_building_utility_systems_from_flood_damage_2017.pdf

Fact Sheet 3.4.3: Building Utility Systems—Plumbing

The mitigation objective of this Fact Sheet is to improve the resilience of the components of plumbing systems to allow a building to continue to be used or quickly repaired following a hurricane, with an end goal of rapidly returning the building to full functionality.

Plumbing systems generally are associated with a building's drinking water systems that supply white (clean) water and wastewater drain/waste/vent (DWV) systems that remove gray (sink) water and black (toilet) water from the building. Plumbing systems also can be used to deliver propane or natural gas or compressed air. They are comprised of two types of components:

- **Primary components**—Plumbing components that must function for the system to operate. When a primary component is damaged, the entire system stops working. Some examples of primary plumbing system components include:
 - Drinking water systems: water meter, domestic water booster pumps and hot water circulator pumps, domestic water heaters (when there is only one), main piping lines, and valves and fittings within main piping lines
 - DWV piping and equipment: sanitary lift pumps, sanitary sewer lateral service connections, drainage waste and vent piping, and backwater valves
 - Fire suppression: all components are considered primary components for fire suppression systems and include service risers (shut off valves, backflow prevention valves, check valves, test points and gauges), fire pump and jockey pump
- **Secondary components**—Plumbing components that can be damaged without causing a complete loss of building system function. When secondary components are damaged, the system may function at a reduced level of service or cause service interruptions to a portion of the building. Examples of secondary plumbing system components include:
 - Drinking water systems: lateral piping lines, valves and fittings within lateral piping lines, plumbing fixtures
 - DWV piping and equipment: lateral drain lines, fixtures, grease traps

Typical components of drinking water and DWV systems for small public buildings connected to public water and sanitary sewer are shown in Figure 3.4.3.11 and Figure 3.4.3.2, respectively.



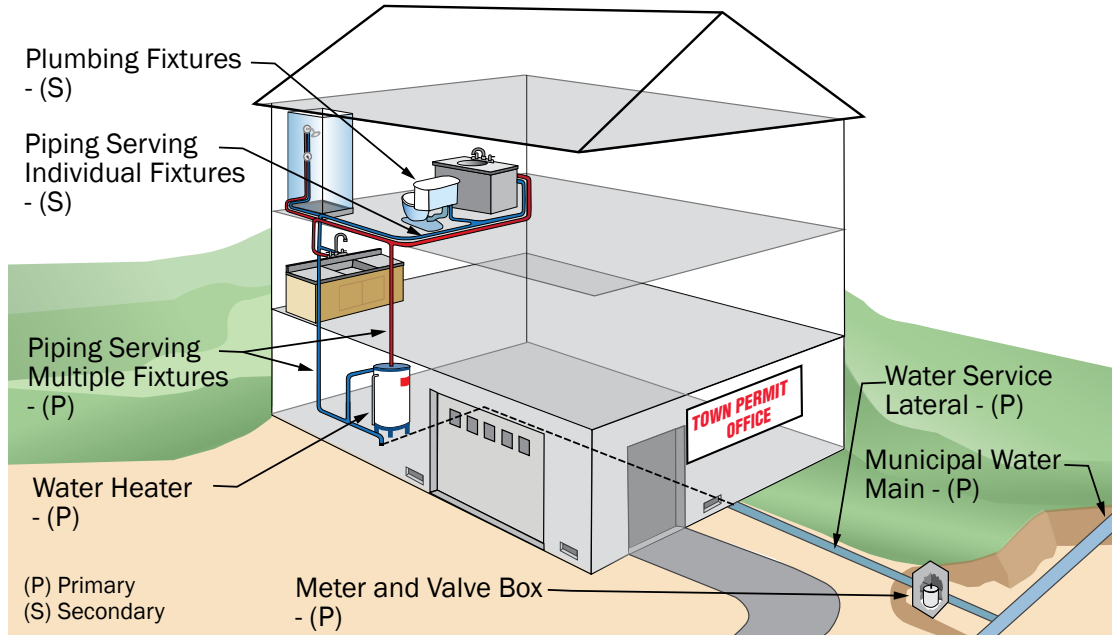

Figure 3.4.3.1. Typical small public building drinking water plumbing system components served by the public water system.

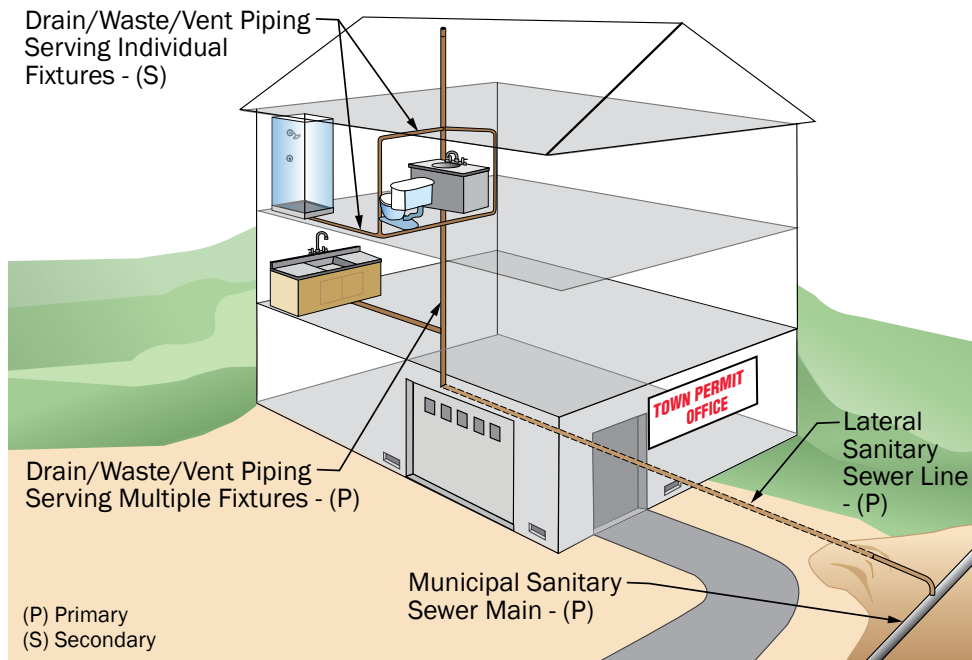

Figure 3.4.3.2. Typical small public building wastewater DWV system components served by the public sanitary sewer system.

Figure 3.4.3.3 and Figure 3.4.3.4, respectively, show alternate components of drinking water and wastewater systems for small public buildings supplied by a well and discharging into an onsite waste disposal (septic) system. Typical components of drinking (domestic) water and wastewater DWV systems for large public buildings connected to public and sanitary sewer, as well as fire suppression systems, are shown in Figure 3.4.3.5.

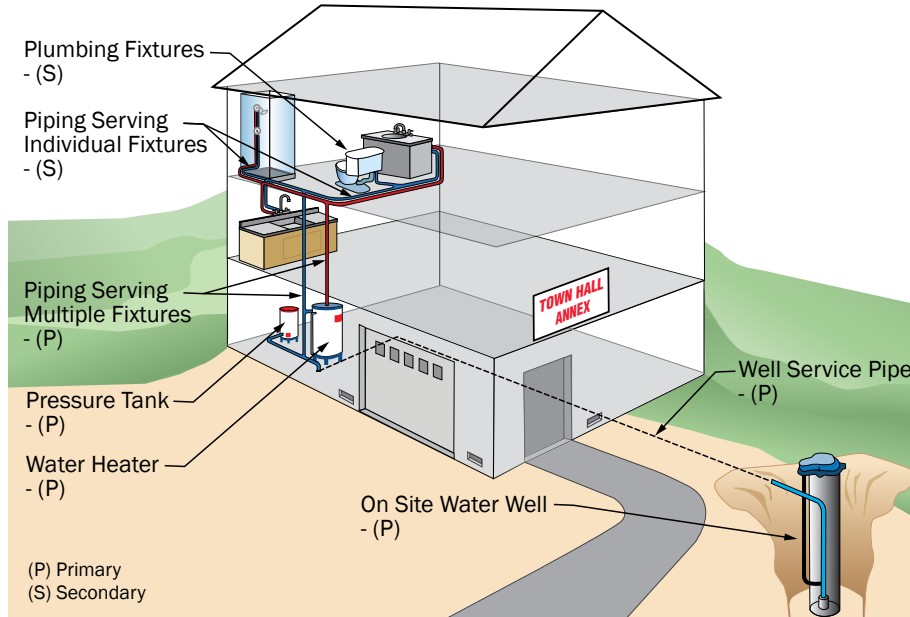

Figure 3.4.3.3. Alternative small public building drinking water plumbing system components supplied by a well.

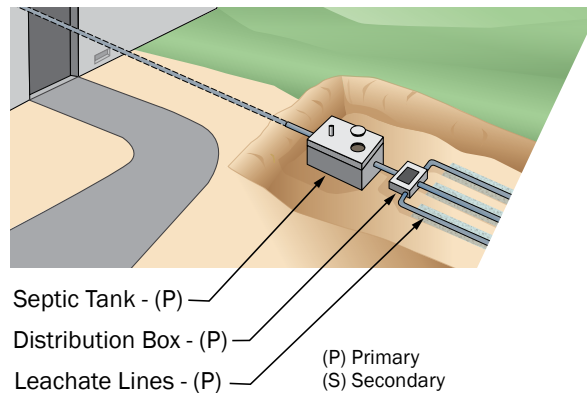

Figure 3.4.3.4. Alternative small public wastewater DWV system components served by onsite waste disposal (septic).

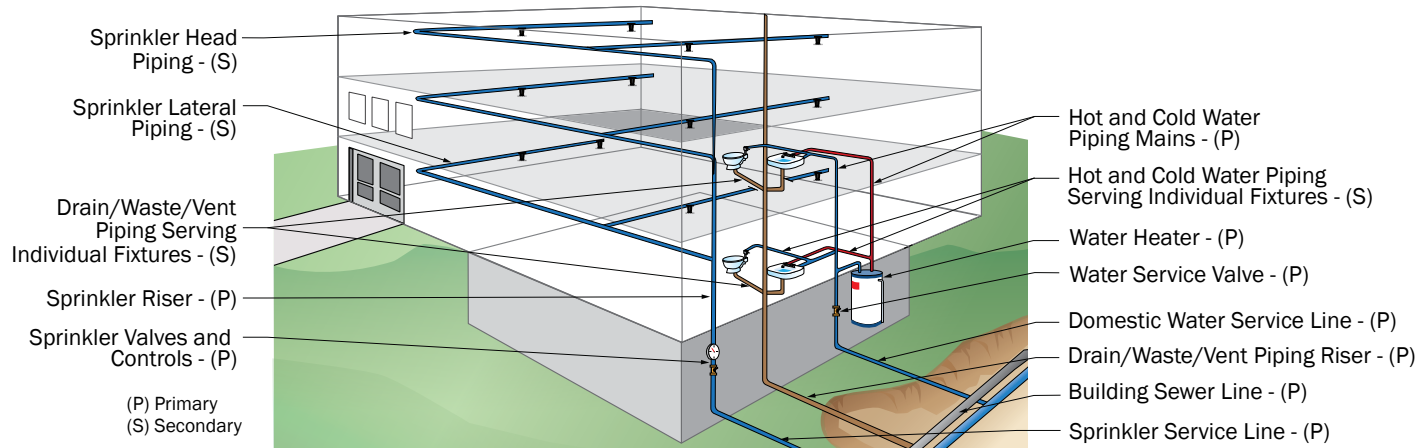

Figure 3.4.3.5. Simplified large public building drinking water plumbing, wastewater DWV, and fire suppression system components with utilities supplied by public water and sanitary sewer.

Typical components of liquid fuel and flammable gas systems, including liquid propane (LP) and natural gas (NG), for small public buildings are shown in Figure 3.4.3.6 and Figure 3.4.3.7, respectively. Typical components of liquid fuel or flammable gas systems for large public buildings are shown in Figure 3.4.3.8.

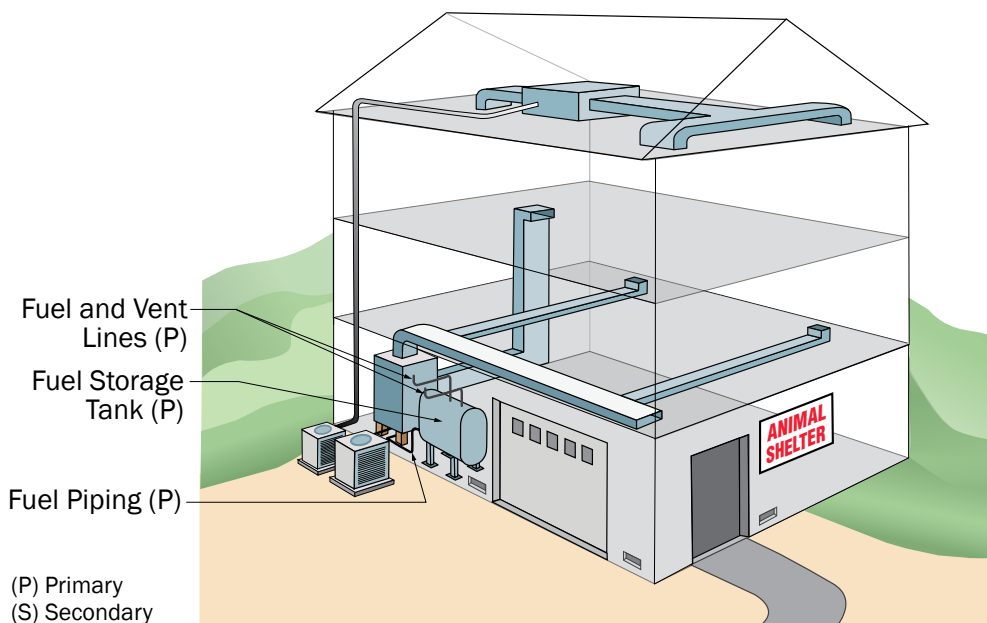

Figure 3.4.3.6. Typical small public building liquid fuel system.

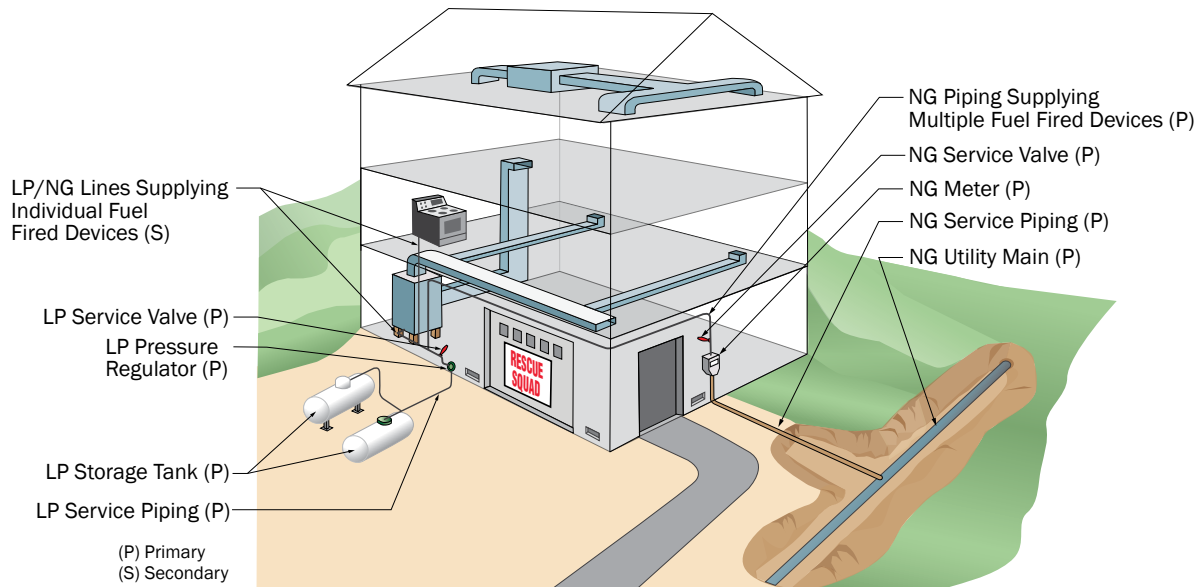

Figure 3.4.3.7. Typical small public building flammable gas system liquid propane (LP) with tank and pressure regulator (left side); natural gas (NG) with meter (right side).

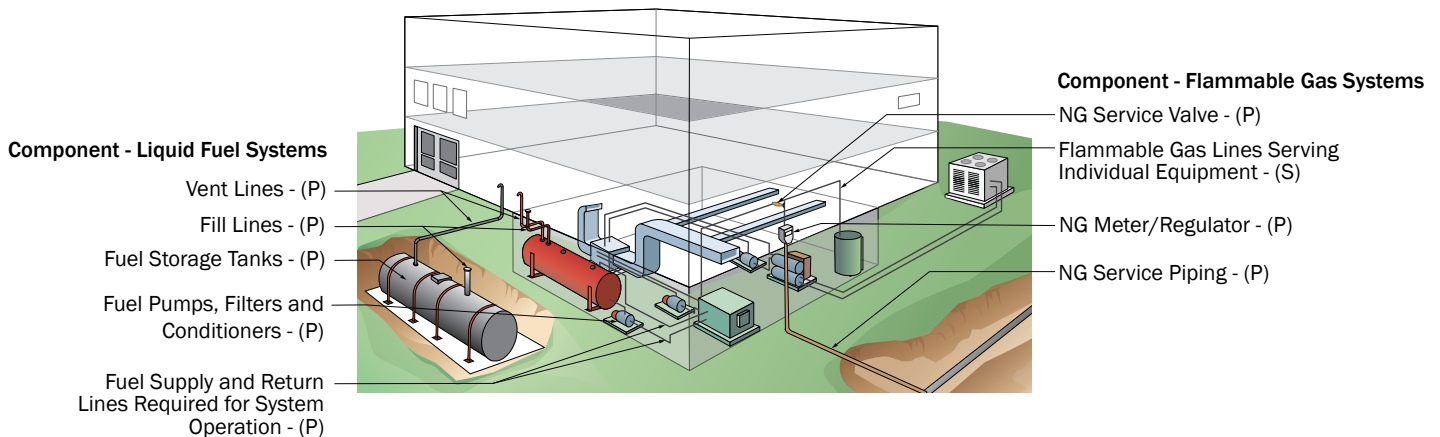

Figure 3.4.3.8. Typical large public building supplied with liquid fuel (LP) or flammable gas (NG) systems.

Although fuel systems and tanks technically include primary components and secondary components, fuel systems usually contain only a few secondary components since nearly all components need to work to supply fuel-burning devices.

The nature of plumbing systems as carriers of fluids makes them resistant to flood damage. Plumbing systems also tend to be less at risk for damage by wind than other building systems. Consequently, the risk to these systems is less than other building systems and the mitigation solutions are fewer. However, water heaters, booster pumps, lift pumps and some valve components and fittings can be damaged by flood. Exposed piping can be damaged by fast-moving flood water, wave action and debris impacts.

A unique risk to drinking water systems comes from the fact that public drinking water systems may not be watertight. Groundwater getting into the system outside the building can result in a loss of water pressure. A loss of water pressure often results in an order to boil water being issued. Plumbing systems inside a building usually are watertight, so infiltration is less likely inside the building even if there is a loss in pressure.

Table 3.4.3.1 summarizes some common mitigation solutions that can improve the performance of building plumbing system components. These strategies then are discussed in the sections that follow.

Table 3.4.3.1. Common Plumbing System Mitigation Solutions

<i>Solutions and Options</i>	<i>Coastal Flood</i>	<i>Riverine Flood</i>
Mitigation Solution: Elevate or Relocate		
Option 1: Elevate or relocate	✓	✓
Mitigation Solution: Seal or Isolate		
Option 1: Seal or Isolate	✓	✓
Mitigation Solution: Secure		
Option 1: Secure	✓	✓
Mitigation Solution: Dry Floodproof		
Option 1: Dry Floodproof		✓

Mitigation of drinking water components typically involves a combination of raising and sealing or isolating. Mitigation of DWV systems is more limited because they must be sloped to drain to the sanitary sewer lateral, but there may be some opportunities to re-route them to reduce flood risk. To mitigate fuel system components, refer to FEMA P-348, *Protecting Building Utility Systems from Flood Damage*, for additional details.

Wind and wind-related hazard mitigation of plumbing system components and equipment located inside the building or in rooftop enclosures can be achieved by ensuring the building envelope or rooftop enclosure is constructed to resist wind pressures, wind-borne debris and wind-driven rain. Additional protection can be gained by following best practices, which often go beyond minimum codes and standards. Additional information about measures that can be implemented to mitigate against wind is discussed in Fact Sheet 3.2, *Wall Systems and Openings*; Fact Sheet 3.3.1, *Sloped Roof Systems*; and Fact Sheet 3.3.2, *Low-Slope Roof Systems*.

Mitigation Solution: Elevate or Relocate

As with other building utilities, elevation is the most effective overall solution for mitigating primary and secondary drinking water system components in buildings. When raising the components is not possible, relocating them may be an option. Elevation of DWV systems generally is not an option because these systems must connect to other plumbing fixtures in the building, as well as the sanitary sewer lateral, and they must be sloped to drain. There may be opportunities to reconfigure the system to reduce flood risk. Because many DWV system components are naturally flood-damage-resistant, their location does not significantly affect overall building flood risk.

Option 1: Elevate or Relocate

For some existing buildings, it may be possible to relocate all primary water system components to an upper floor above the flood protection level, as shown in Figure 3.4.3.9. For existing buildings with many complex components, elevation above the flood protection level often is limited to key water equipment, such as booster pumps, water heaters and main water and wastewater piping within the building.

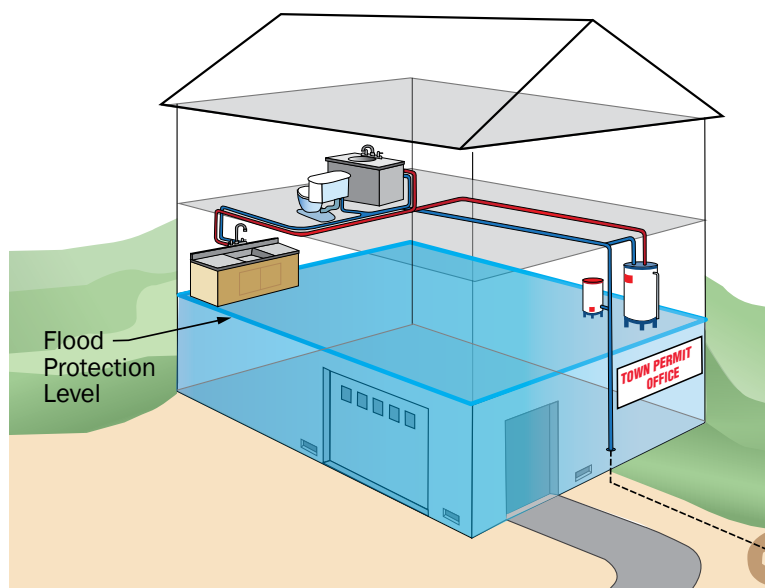

Figure 3.4.3.9. Elevation of primary plumbing system components to the upper floor of an existing small public building.

For some buildings, it may be possible to elevate primary fuel components on pedestals at or above the flood protection level, as shown in Figure 3.4.3.10.

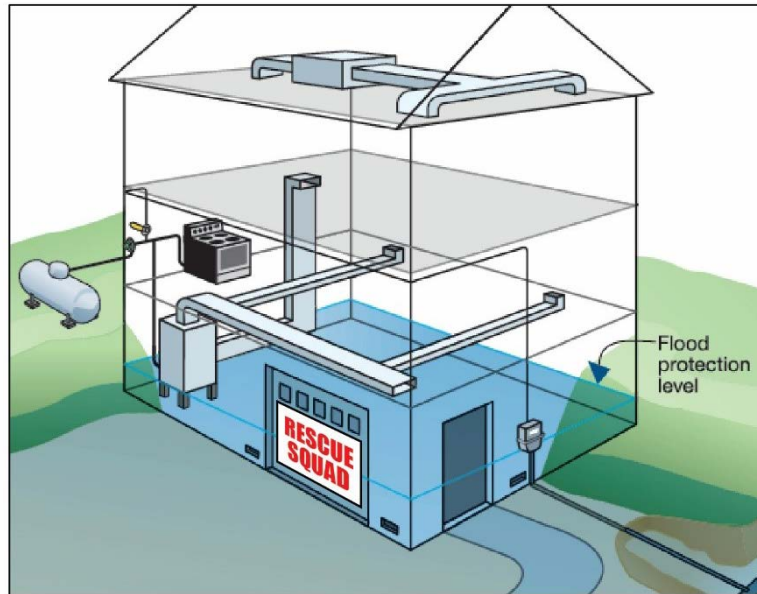

Figure 3.4.3.10. Elevation of primary fuel system components on pedestals for a small public building.

In some situations, raising primary fuel system components is limited to elevating outdoor fuel tanks above the flood protection level using a supporting frame or structural fill, depending on flood conditions, as shown in Figure 3.4.3.11. In coastal areas, be sure to elevate tanks on supporting frames that are designed to resist all coastal flood and wind forces and are built using corrosion-resistant connectors and fasteners in accordance with NFIP Technical Bulletin 8, *Corrosion Protection for Metal Connectors and Fasteners in Coastal Areas*.

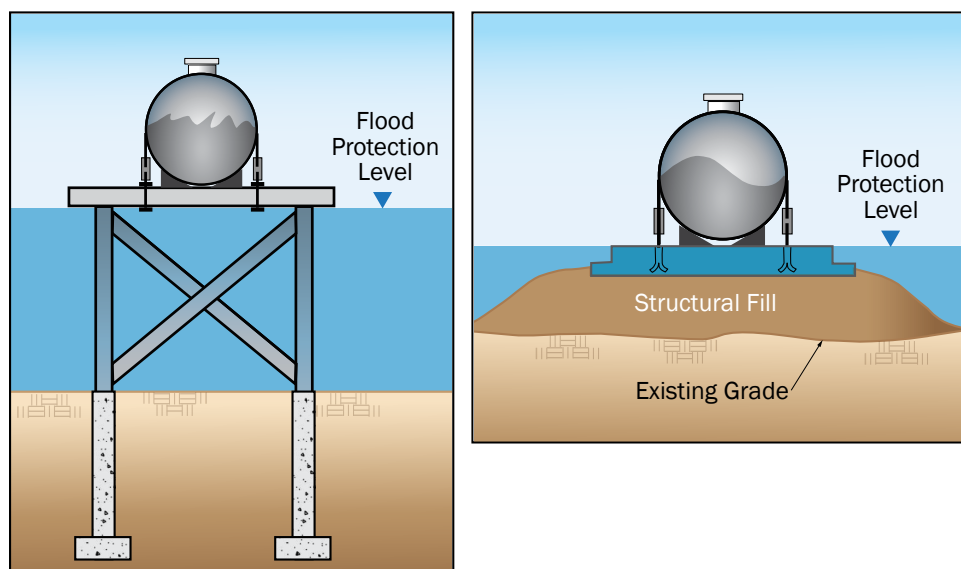
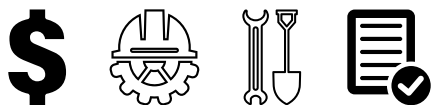

Figure 3.4.3.11. Outdoor fuel tank elevated on supporting frame (left); fuel tank elevated on structural fill (right).

When evaluating this option, also take note of these considerations:

- Fire suppression components, especially fire pumps and controls, should be elevated at or above the flood protection level whenever possible so they will remain undamaged and continue to operate during an emergency. Avoiding contact with floodwaters to reduce the risk of corrosion.
- Pool and spa equipment should be elevated at or above the flood protection level whenever possible.
- Backflow prevention valves located above ground that pose a tripping hazard may be relocated closer to the building. Alternatively, bollards may be placed around the valve for protection.

CONSIDERATIONS:



Mitigation Solution: Seal or Isolate

Since many water and wastewater components are designed to convey water and are connected to underground supply or discharge lines, there are more options to seal primary and secondary building plumbing system components in place or isolate them from the rest of the system. While fuel system components may be more susceptible to flood, in-place protection options can be implemented if elevation is not feasible.

Option 1: Seal or Isolate

For water, DWV, fire suppression and pool and spa system components, consider the following:

- Protect private wells and septic tanks using sealed caps or covers to prevent floodwater infiltration, as shown in Figure 3.4.3.12.

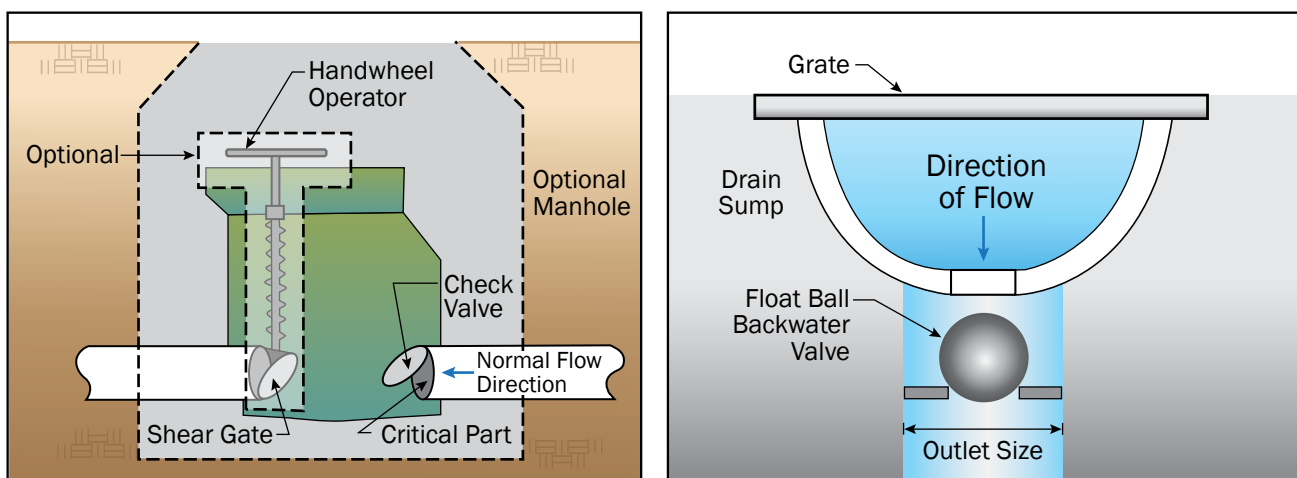

Figure 3.4.3.12. Backflow protection valves including a combination check valve and gate valve (left) and floor drain with ball float valve (right).

- Install check valves in gravity storm drain systems to prevent water from surcharged storm drains from backflowing into the building. Consider installing ejector systems with backflow prevention valves for all drains located below the maximum expected surcharge level.
- For facilities that may need to discharge wastewater during flood events, consider incorporating ejector systems with backflow prevention to serve all fixtures with flood rim elevations that are below the maximum anticipated surcharge of the sewer system that they discharge into.
 - Drain fixtures below the maximum surcharge level into sumps and pump the effluent out to the municipal line or on-site wastewater system.
 - Make sure pipes and ejector pumps are sized for the maximum expected surcharge pressure and the volume of wastewater anticipated.
- Install backflow prevention valves on wastewater lines to prevent floodwater mixed with sewage from entering buildings.

- There are a range of backflow prevention valves, as shown in Figure 3.4.3.13.
 - Check valves can automatically restrict flow to one direction.
 - Gate valves may need to be manually closed and opened.
 - Ball float valves can be used to protect floor drains.

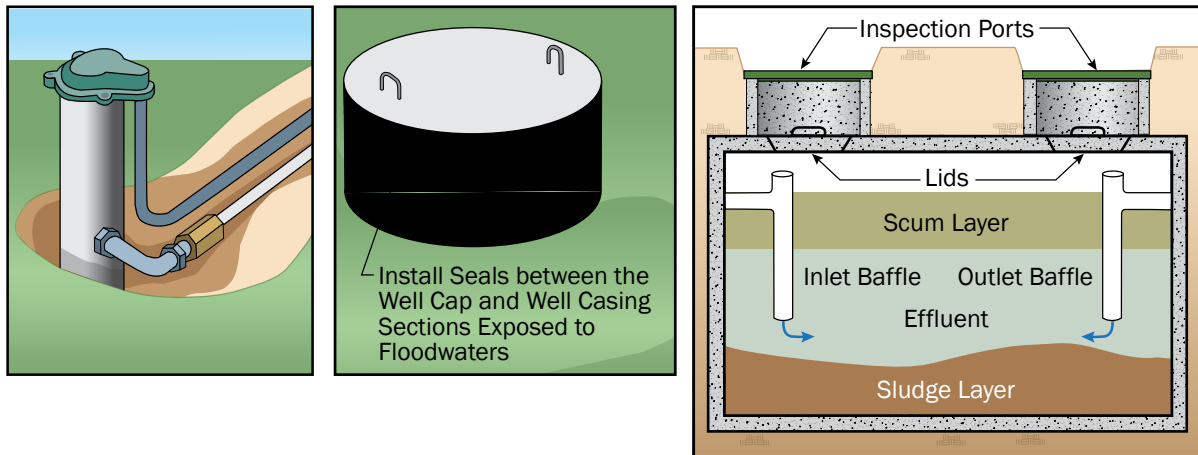
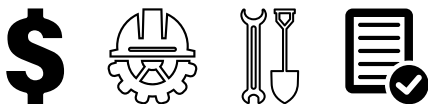

Figure 3.4.3.13. Protection of private well using a sanitary well cap (left) or concrete well cap (middle), and protection of septic tank with lids and gasketed access covers, concrete risers and riser caps (right).

- Note that a combination check valve and gate valve, shown in Figure 3.4.3.12 (on the left side of the figure), provides the most-effective protection against sewage backflow.
- Fire suppression piping that must be installed below the flood protection level can be protected in the same way as water and wastewater piping.
- Tank inlets and vents that extend above the flood protection level must be fitted with covers designed to prevent the inflow of floodwater and the outflow of tank contents.

CONSIDERATIONS:



Mitigation Solution: Secure

Some building plumbing or fuel system components may be subjected to flood, wind, and debris forces. These forces could dislodge them if the components are not properly secured.

Option 1: Secure

When evaluating mitigation options to secure building plumbing and fuel system components, consider the following:

- Service connections such as meters and risers can be attached to the land side (for coastal areas) or downstream side (for river areas) of a vertical structural member such as a pile.
- Outdoor underground fuel tanks can be sealed with a watertight cover to prevent floodwater infiltration and anchored to concrete pads, as shown in Figure 3.4.3.14.

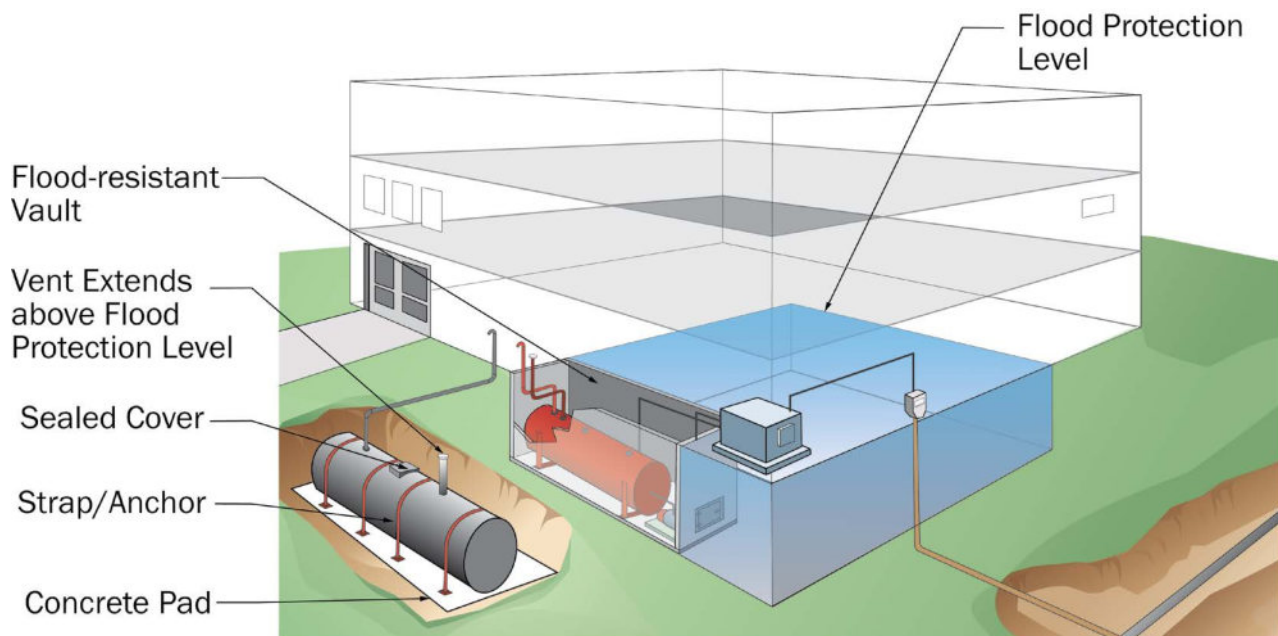
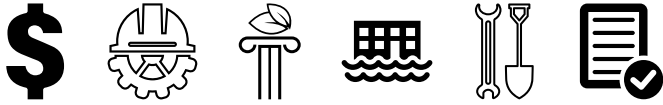

Figure 3.4.3.14. Secure and seal underground tanks to protect them from flood damage.

- Underground fuel tanks, underwater fuel system components and aboveground tanks must be designed to prevent flotation, collapse, or horizontal movement from flood loads.
- Fill and vent piping must be properly attached to prevent horizontal movement from flood forces.
- Underground tanks must be designed to resist crushing forces that act on them as floodwaters get deeper.
- In flood zones subject to moving floodwaters or storm surge, waves, wind, erosion and scour, fuel lines need to be attached to risers, buried well below the expected frost and scour depths, and strapped to the tank and tank supports with additional bracing.

- Fuel lines, straps, anchors, bracing and other connectors and fasteners should be made of corrosion-resistant materials.
- Fuel tanks can be filled to reduce flood forces acting on them. For this to be effective, though, fill and vent piping must reach above the flood protection level. If it does not, there is the potential for floodwaters to enter the tank through this piping and displace the fuel, resulting in a fuel spill.

CONSIDERATIONS:

Mitigation Solution: Dry Floodproof

Option 1: Dry Floodproof

While many components of building plumbing systems have some natural resistance to flood damage, a few components could benefit from dry floodproofing if they cannot be elevated or relocated. Booster pumps, water heaters, fire pumps and controls for fire suppression systems, pool and spa filters and pump equipment and fuel pumps can be at risk for flood damage and should be protected. Current codes that reference ASCE 24, *Flood Resistant Design and Construction*, require fuel system equipment and utilities to be elevated to a specified height or dry floodproofed when placed in areas of buildings that have identified flood risk.

Evaluate these considerations about dry floodproofing:

- Place flood-susceptible plumbing and fuel system components that cannot be elevated in rooms or vaults that are substantially impermeable. These vaults should be built to resist flood forces. An example of a vault is shown in Figure 3.4.3.14, above.
- To dry floodproof, make sure the frames around doors, hatches or other access points are properly sealed as well to prevent water entry.
- For dry floodproofing to be effective, sump pumps connected to emergency power sources should be installed in the protected areas to remove any water that may seep in.

CONSIDERATIONS:



REFERENCES:

Detailed information on hurricane mitigation of building plumbing systems can be found in these publications. Much of the residential information applies to non-residential buildings as well.

- American Society of Civil Engineers (ASCE). *Highlights of ASCE 24 Flood Resistant Design and Construction*. Available at: https://www.fema.gov/sites/default/files/2020-07/asce24-14_highlights_jan2015.pdf
- Federal Emergency Management Agency (FEMA). 2007a. FEMA 543, *Design Guide for Improving Critical Facility Safety from Flooding and High Winds*. Available at: https://www.fema.gov/sites/default/files/2020-08/fema543_design_guide_complete.pdf
- FEMA. 2007b. FEMA 577, *Design Guide for Improving Hospital Safety in Earthquakes, Floods, and High Winds*. Available at: https://www.fema.gov/sites/default/files/2020-08/fema577_design_guide_improving_hospital_safety_2007.pdf
- FEMA. 2010a. FEMA P-424, *Risk Management Series: Design Guide for Improving School Safety in Earthquakes, Floods, and High Winds*. Available at: https://www.fema.gov/sites/default/files/documents/fema_p-424-design-guide-improving-school-safety.pdf
- FEMA. 2010b. FEMA P-499, *Homebuilder's Guide to Coastal Construction*. Available at: https://www.fema.gov/sites/default/files/2020-08/fema499_2010_edition.pdf
- FEMA. 2011. FEMA P-55, *Coastal Construction Manual: Principles and Practices of Planning, Siting, Designing, Constructing, and Maintaining Residential Buildings in Coastal Areas*. Available at: https://www.fema.gov/emergency-managers/risk-management/building-science/publications?name=%22FEMA+P-55%2C+Coastal%22&field_keywords_target_id=All&field_document_type_target_id=All&field_audience_target_id=All
- FEMA. 2017. FEMA P-348, *Protecting Building Utility Systems from Flood Damage; Principles and Practices for Design and Construction of Flood Resistant Building Utility Systems*. Available at: https://www.fema.gov/sites/default/files/2020-07/fema_p-348_protecting_building_utility_systems_from_flood_damage_2017.pdf
- FEMA. 2019. NFIP Technical Bulletin 8, *Corrosion Protection of Metal Connectors in Coastal Areas*. Available at: https://www.fema.gov/emergency-managers/risk-management/building-science/publications?name=%22Technical+Bulletin+8%22&field_keywords_target_id=All&field_document_type_target_id=All&field_audience_target_id=All

Fact Sheet 3.4.4: Building Utility Systems—Conveyances

The mitigation objective of this Fact Sheet is to improve the resilience of building conveyance systems and their components to allow a building to continue to be used or quickly repaired following a hurricane or flood, with an end goal of rapidly returning the building to full functionality.

Conveyance systems include elevators, escalators, lifts and moving walkways. Lifts are more common in small public buildings and may include outside passenger lifts consisting of a cab connected to two or more hoist beams, inside chairlifts to assist those in wheelchairs along a staircase between floors, and vertical platform lifts (VPLs) that can be installed inside or outside the building.

Vertical conveyance systems include elevators, escalators and lifts. The typical components of hydraulic and traction elevators used in small and large public buildings are shown in Figure 3.4.4.1. The typical components of escalators sometimes used in large public buildings are shown in Figure 3.4.4.2.

All components of conveyance systems can be considered primary components, which means that they must all work for the system to work. When a primary component is damaged, the entire system stops working.

Flood is the primary risk to conveyance systems. Walls and openings can be mitigated to protect conveyance systems inside buildings (see Fact Sheet 3.2, *Walls and Openings*.) However, wind and wind-related damage to conveyance systems could result from damage to rooftop-mounted equipment. Mitigation measures for rooftop-mounted conveyance system components and equipment include locating the equipment inside a penthouse built to resist wind pressures, wind-borne debris and wind-driven rain. Extra protection also can be accomplished by following best practices, which often go beyond minimum codes and standards. Additional information about measures to mitigate against wind are discussed in Fact Sheet 3.3.1, *Sloped Roof Systems*, and Fact Sheet 3.3.2, *Low-Slope Roof Systems*.



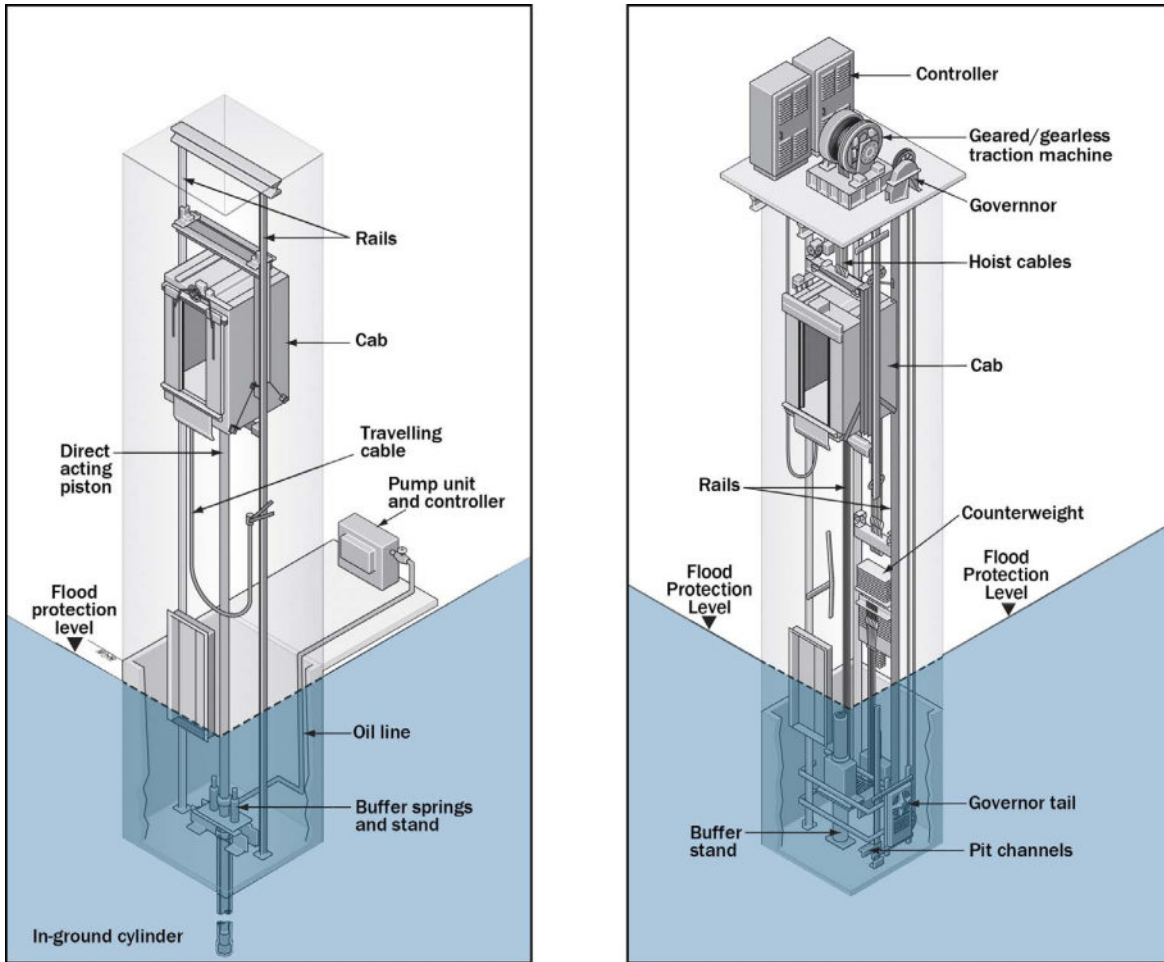

Figure 3.4.4.1. Typical elements of hydraulic elevators common in low-rise construction (left) and traction elevators common in high-rise construction (right). (Source: Otis Elevator Company)

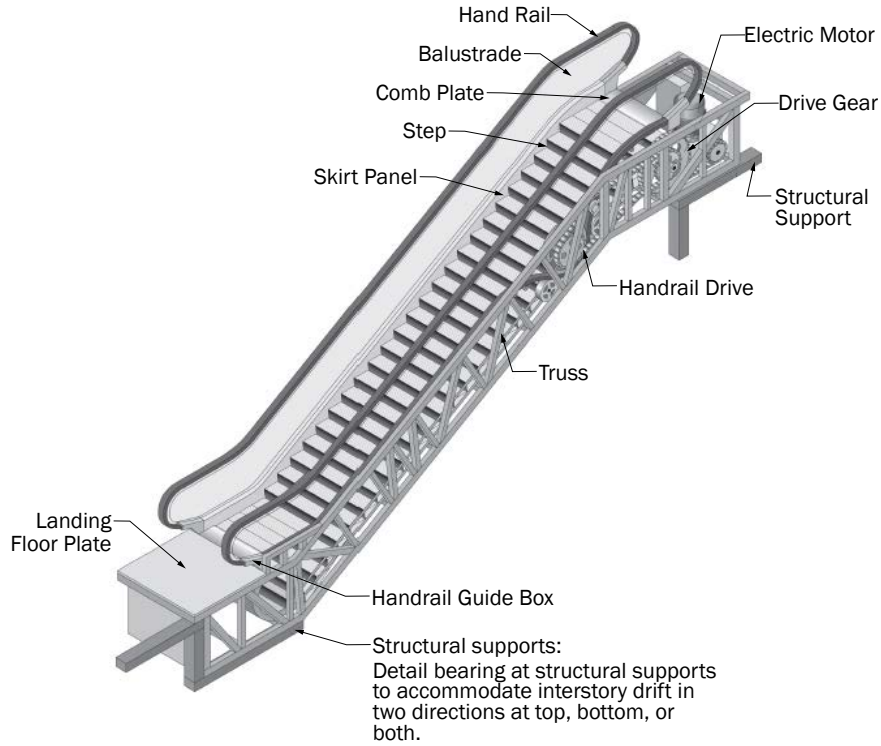

Figure 3.4.4.2. Typical elements of escalators used in some large public buildings. (Source: Otis Elevator Company)

Table 3.4.4.1 summarizes some common mitigation solutions that can improve the performance of building conveyance system components. These strategies then are discussed in the sections that follow.

Table 3.4.4.1. Common Mitigation Solutions for Conveyance Systems

<i>Solutions and Options</i>	<i>Coastal Flood</i>	<i>Riverine Flood</i>
Mitigation Solution: Protect		
Option 1: For Elevators	✓	✓
Option 2: For Escalators and Moving Walkways	✓	✓
Option 3: For Lifts	✓	✓

Mitigation Solution: Protect

Option 1: For Elevators

Some measures can be taken to protect elevators against hurricane and flood damage. When evaluating mitigation measures for elevators, consider the following:

- Design elevator shafts that extend below the flood protection level to resist flood forces. Consider dry floodproofing shafts to make them substantially impermeable and add equipment such as sump pumps to eliminate seepage.
- Raise as many elevator components as possible above the flood protection level.
- For hydraulic elevators, elevate the cab, equipment room, hydraulic pump, hydraulic reservoir and electrical control panel.
- For traction elevators, elevate the cab, equipment room, counterweight and roller guides, hoist cable, limit switches, electric hoist motor and electrical control panel.
- Wherever possible outside of Zone V or Coastal A Zones, protect components below the flood protection level by dry floodproofing in water-resistant enclosures.
- Where elevation and dry floodproofing are not possible, protect components below the flood protection level by using flood-damage-resistant materials or coatings.
- Use stainless steel doors and frames, galvanized hardware and galvanic or rust-preventive paint below the flood protection level.
- Consider raising one or more elevators with dedicated standby power so the landing ends on a higher floor. This will cause the bottom of the pit to be above the flood protection level for large critical facilities such as hospitals, where elevators are essential to support operations.
- Install float switches at the bottoms of elevator shafts to prevent cabs from descending into floodwater as shown in Figure 3.4.4.3.

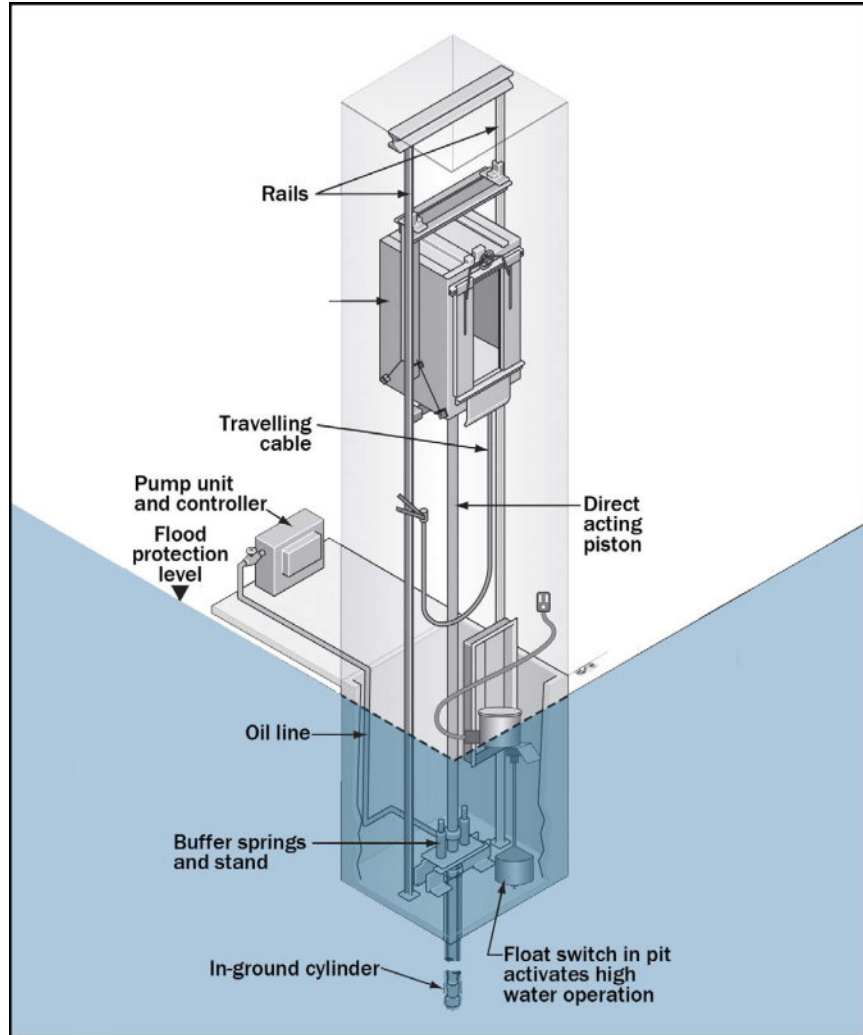
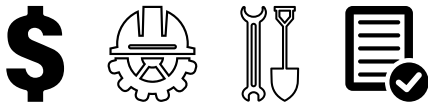

Figure 3.4.4.3. Float switch in pit to stop cab descent. (Source: Otis Elevator Company)

CONSIDERATIONS:



Option 2: For Escalators and Moving Walkways

Mitigation measures can be implemented to help protect escalators and moving walkways from flood damage. While many escalators and moving walkways are located inside buildings, some are partially or fully outside. When evaluating mitigation for escalators and moving walkways, consider the following:

- Mitigation is best achieved by elevating as many components as possible above the flood protection level. Most indoor escalator and moving walkway components can be located at or above the flood protection level. See Fact Sheet 3.2, *Walls and Openings*, for information about protecting indoor systems by mitigating the building envelope. See Fact Sheet 3.4.2, *Building Utility Systems—Electrical*, for additional information about mitigation for electrical system components.
- For outdoor escalator and moving walkway components, use one or more of the following measures to reduce damage:
 - Use flood damage-resistant materials for outdoor escalator components at or above the flood protection level but exposed to weather.
 - Install sump pumps to limit water accumulation at escalator landings.
 - Design and construct escalator components located below the flood protection level like those located in the escalator pit to facilitate post-flood repair and restoration. The escalator pit contains equipment such as an oil/water separator, switches, and an escalator motor.
- To reduce flood risk to escalator pits, consider the following:
 - Elevate vulnerable components as high as practical to reduce flood risks.
 - Consider placing electrical equipment in NEMA 6P-rated (water-resistant) enclosures.
 - Dry floodproof the escalator pit.
 - Install sump pumps in the pit to prevent water buildup from seepage. Size sump pumps and discharge piping to remove the maximum amount of seepage from the total area of the facility that could drain into the escalator pit. When retrofitting existing facilities, make sure that the penetrations into the pit are sealed and the sump discharge piping releases water above the flood protection level. When that is not possible, install check valves to prevent floodwaters from backflowing into the pit.
 - Use corrosion-resistant components or coatings wherever possible for equipment in the pit.
- Place electrical and mechanical equipment in rooftop penthouses designed to resist wind forces for the geographic area.

CONSIDERATIONS:

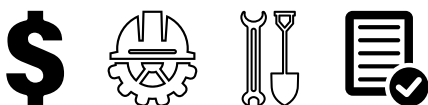

Option 3: For Lifts

Lifts are used to get people from one level to another when it's not possible to install a ramp to move people between floors. Lifts include vertical passenger lifts and inclined stair lifts, as shown in Figure 3.4.4.4. Passenger lifts differ from elevators in that elevators have fully enclosed cabs while passenger lifts typically have open cabs with panels on the sides of the platform. Stair lifts are motorized seats attached to a fixed track located near the stair rail to carry people up and down stairs. VPLs move people in wheelchairs or scooters between levels of a building.

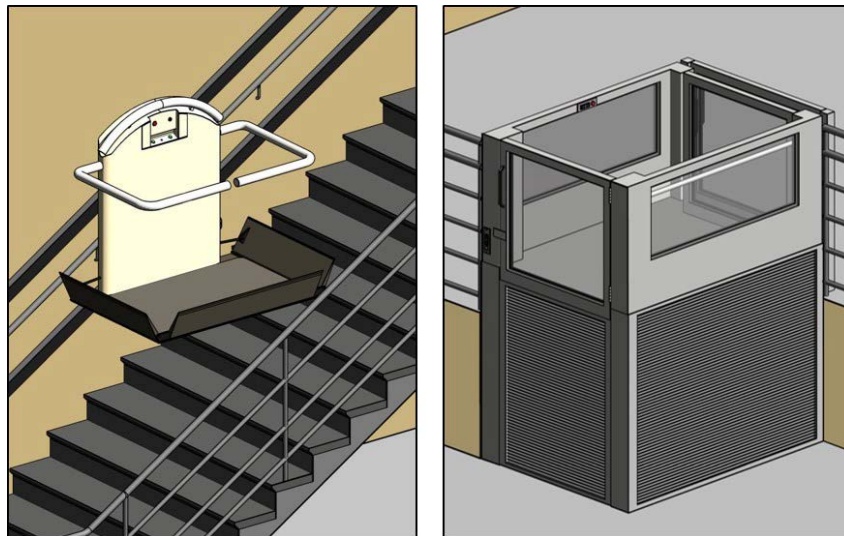

Figure 3.4.4.4. Inclined (left) and vertical (right) platform lifts move people between floors of a building. (U.S. Access Board, 2015)

The most effective lift mitigation is to elevate as many of the components as possible above the flood protection level. See Fact Sheet 3.4.2, *Building Utility Systems—Electrical*, for additional information about mitigation for electrical system components.

- For passenger lifts, place hoist cables and lift controls above the flood protection level and use flood-damage-resistant materials such as aluminum or stainless steel for hoist beams and passenger lift cages.
- Stair lifts typically are inside buildings, so there is little risk from outside elements, such as wind or wind-borne debris. Elevate as many components as possible above the flood protection level.
- Place VPLs inside the building and above the flood protection level whenever possible to protect them from flood damage.

CONSIDERATIONS:



REFERENCES:

Detailed information on hurricane mitigation of building mechanical systems can be found in these publications. Much of the residential information applies to non-residential buildings as well.

American Society of Civil Engineers (ASCE). *Highlights of ASCE 24 Flood Resistant Design and Construction*. Available at: https://www.fema.gov/sites/default/files/2020-07/asce24-14_highlights_jan2015.pdf

Federal Emergency Management Agency (FEMA). 2007a. FEMA 543, *Design Guide for Improving Critical Facility Safety from Flooding and High Winds*. Available at: https://www.fema.gov/sites/default/files/2020-08/fema543_design_guide_complete.pdf

FEMA. 2007b. FEMA 577, *Design Guide for Improving Hospital Safety in Earthquakes, Floods, and High Winds*. Available at: https://www.fema.gov/sites/default/files/2020-08/fema577_design_guide_improving_hospital_safety_2007.pdf

FEMA. 2010. FEMA P-424, *Risk Management Series: Design Guide for Improving School Safety in Earthquakes, Floods, and High Winds*. Available at: https://www.fema.gov/sites/default/files/documents/fema_p-424-design-guide-improving-school-safety.pdf

FEMA. 2017. FEMA P-348, *Protecting Building Utility Systems from Flood Damage; Principles and Practices for Design and Construction of Flood Resistant Building Utility Systems*. Available at: https://www.fema.gov/sites/default/files/2020-07/fema_p-348_protecting_building_utility_systems_from_flood_damage_2017.pdf

FEMA. 2019. NFIP Technical Bulletin 4, *Elevator Installation for Buildings Located in Special Flood Hazard Areas*. Available at: https://www.fema.gov/sites/default/files/documents/fema_elevator-installation-technical-bulletin_06072021.pdf

U.S. Access Board. 2015. *U.S. Access Board Technical Guide Elevators and Platform Lifts*. Available at: <https://www.access-board.gov/files/ada/guides/elevators.pdf>

Fact Sheet 4.0: Public Utilities

The Fact Sheets in this section present mitigation approaches used to maintain or quickly recover from the disruption of drinking water, wastewater, electric power and communications services during and immediately after hurricanes or floods.

Hurricane and Flood Impacts

Public utilities provide essential services such as drinking water, stormwater and wastewater collection and treatment, electric power, and communications. These services contribute to the economic well-being and public health and safety of the communities they serve. Under Presidential Policy Directive 21 (PPD 21), the National Infrastructure Protection Plan (NIPP), they comprise three of sixteen critical infrastructure sectors. Safe drinking water is crucial for public welfare. Nearly every sector requires electric power, so it is a cornerstone upon which all other sectors are built, making it critical to the economy. Effective wastewater collection and treatment help avoid the spread of disease and protect the environment by preventing people and property from being exposed to untreated wastewater. Communication is necessary for emergency responders, governments, other public safety organizations, and businesses to function.

Hurricanes and floods can damage utilities and interrupt critical services. Flooding of system components and facilities can damage them and cause them to stop working. Quickly flowing water can erode soil, putting structures at risk. Floodwaters carrying sediment and debris can clog screens and pumps. Hurricane winds can bring down power lines and cause other structures to collapse. Any of these impacts from hurricanes and floods can disrupt service, negatively impacting emergency management procedures and slowing the recovery process for communities.

Mitigation Fact Sheets

Public utilities are grouped into four Fact Sheets in this Handbook. Some mitigation measures presented, such as building improvements, are relevant to other public facilities and may be referenced in other Fact Sheets in the Handbook. The four Public Utilities Fact Sheets are:

- **Drinking Water Systems**—These systems provide drinking water to users. They also can be called potable water systems.
- **Wastewater Treatment Systems**—These systems collect, carry and treat wastewater to prevent the spread of disease and contamination that results from sewage overflow into the environment.



- **Electric Power Generation, Transmission and Distribution**—These systems provide electricity to public, commercial and residential buildings and support structures.
- **Communication Towers, Masts and Antennas**—These systems provide communications capabilities to essential support functions and critical facilities as well as other public, commercial and residential facilities.

Mitigation Solutions

Public utilities are critical to community resilience. It is vital for the services they provide to remain as stable as possible during hurricanes and floods and to be restored quickly if service is disrupted. These systems' resilience can be improved by protecting them against flooding, providing backup power sources, strengthening structural connections, and retrofitting some system components. The choice of mitigation measures may depend on project restrictions, such as the availability of land and materials and environmental requirements, and on consideration of other hazards so that the selected measure addresses multiple hazards. Many potential mitigation solutions can be used, including:

- Elevate critical equipment and components to a height above the flood protection level.
- Strengthen structures to resist wind and flood forces.
- Create redundancy in electrical distribution systems.
- Install distributed power generation systems, such as solar and wind power, which generate electricity near the location where it will be used.
- Provide on-site standby power supplies for when power is lost.
- Install quick-connects for portable temporary backup power supplies for when power is lost.
- Construct floodwalls, levees or berms around large areas containing critical facilities or critical components that are at risk for flooding but cannot be relocated or elevated.







In addition to structural mitigation measures, non-structural measures also can be implemented and often are essential to the safe and efficient operation of public utilities. Non-structural measures generally are cost-effective compared with structural measures, which may be more expensive to build. Non-structural measures generally are included in a safety program for the facilities and may include:

- Implementing a surveillance and monitoring program
- Preparing and regularly updating an emergency action plan
- Monitoring system status to protect from failure

Icons

The Fact Sheets include points to consider about developing and implementing each mitigation option. Icons represent these common considerations which are summarized in Table 4.0.1 below.

Table 4.0.1. Icons Used to Represent Considerations about Hazard Mitigation Strategies

Icon	Considerations about Hazard Mitigation Strategies
	Cost – The cost to carry out the mitigation option may be high, which could make using the option cost prohibitive.
	Engineering – A qualified engineer would likely need to design the mitigation option.
	Environmental and Historic Preservation – The mitigation option likely will need to comply with local, state and/or federal environmental and historic preservation requirements.
	Floodplain Management – Carrying out the mitigation option might impact the floodplain, triggering compliance with floodplain management requirements.
	Operations and Maintenance – The mitigation option might require additional operations and maintenance activities beyond those currently being performed.
	Permitting – Evaluate the local, state or federal permits required to carry out the mitigation option.

REFERENCES:

- Alaska Department of Environmental Conservation (ADEC). 2012. *Flood Preparation and Recovery for Drinking Water Systems*. Available at: <https://dec.alaska.gov/media/8582/security-9-flood-packet.pdf>
- American Water Works Association (AWWA). AWWA J-100, *Risk Analysis and Management for Critical Asset Protection (RAMCAP®) Standard for Risk and Resilience Management of Water and Wastewater Systems*. Available at: <https://www.awwa.org/Store/AWWA-J100-10R13-Risk-and-Resilience-Management-of-Water-and-Wastewater-Systems-PDF/ProductDetail/37334446>
- Asea Brown Boveri Ltd. (ABB). 2018. “ABB Technology helps weather-proof the US against future storms.” Available at: <https://new.abb.com/news/detail/5748/abb-technology-helps-weather-proof-the-us-against-future-storms>
- Federal Communications Commission (FCC). 2019. *FAA Tower & Antenna Siting*. Available at: <https://www.fcc.gov/wireless/bureau-divisions/competition-infrastructure-policy-division/tower-and-antenna-siting>
- FCC. 2020. *FCC Public Safety & Homeland Security*. Available at: <https://www.fcc.gov/public-safety-and-homeland-security>
- Federal Emergency Management Agency (FEMA). 2006. FEMA 549, *Hurricane Katrina in the Gulf Coast: Mitigation Assessment Team Report, Building Performance Observations, Recommendations, and Technical Guidance*. Available at: <https://www.fema.gov/media-library/assets/documents/4069>
- FEMA. 2007. FEMA 543, *Design Guide for Improving Critical Facility Safety from Flooding and High Winds*. Available at: https://www.fema.gov/media-library-data/20130726-1557-20490-1542/fema543_complete.pdf
- FEMA. 2013. Hurricane Sandy Recovery Advisory RA2, *Reducing Flood Effects in Critical Facilities*. Available at: https://www.fema.gov/media-library-data/1381404651877-881a2cf70a90ac63b9c067100ffcca/SandyRA2CriticalFacilities_508_FINAL2.pdf
- Florida Power and Light (FPL). 2010. *Distribution Engineering Reference Manual (DERM) Section 4 – Overhead Line Design Addendum for Extreme Wind Loading*. Available at: http://www.floridapsc.com/library/filings/2016/07490-2016/Support/SFHHA%2015th%20POD%20Nos%20227,228-DERM%20Section%204%20Addendum%20for%20EWL_Rev%2003-09-2010.pdf
- Lanier, B., et. al. 2017. “Planning Advisory Notice: Classification of Tower Structures per ANSI/TIA-222-G, IBC and ASCE 7.” *Tower Times*. Available at: https://tirap.org/wp-content/uploads/2017/06/PAN_ClassTwrStructures_Jan-Feb_2017.pdf
- Siemens Global. 2015. *How to Make Cities More Resilient*. Available at: <https://new.siemens.com/global/en/company/stories/infrastructure/resilient-cities.html>
- Smart Electric Power Alliance. 2017. *Build Back Better: Reimagining and Strengthening the Power Grid of Puerto Rico*. Available at: <https://sepapower.org/resource/build-back-better-reimagining-and-strengthening-the-power-grid-of-puerto-rico/>
- Telecommunications Industry Association (TIA). 2017. *ANSI/TIA-222 Structural Standard for Antenna Supporting Structures and Antennas*. Available at: https://global.ihs.com/doc_detail.cfm?&rid=IHS&item_s_key=00122271&item_key_date=821231&input_doc_number=TIA%2D222&input_doc_title=
- U.S. Department of Energy (DOE). 2018. “Solar Photovoltaic Systems in Hurricanes and Other Severe Weather.” Available at: https://www.energy.gov/sites/prod/files/2018/08/f55/pv_severe_weather.pdf

U.S. Environmental Protection Agency (EPA). 2009. *Is Your Water or Wastewater System Prepared? What You Need to Know About Generators*, EPA 901-F-09-027. Available at: <https://www3.epa.gov/region1/eco/drinkwater/pdfs/WaterWastewaterSystemGeneratorPreparedness.pdf>

EPA. 2014. *Flood Resilience, A Basic Guide for Water and Wastewater Utilities*. Available at: https://www.epa.gov/sites/production/files/2015-08/documents/flood_resilience_guide.pdf

Fact Sheet 4.1: Drinking Water Systems

The mitigation objective of this Fact Sheet is to identify ways to maintain or quickly restore the operation of drinking water systems impacted by floods and hurricanes to make sure there is safe drinking water for users.

During hurricanes or severe flooding, the system components needed to ensure the ongoing operation of drinking water systems are at high risk for damage. Flooded rivers and lakes can expose source water intake structures to silt and debris clogging or damage. Contaminated or muddy floodwaters can impact treatment plant processes. All floodwaters can expose system components such as storage tanks, unprotected piping, and chlorination and filtration equipment to moving floodwater forces that exert horizontal pressure and the added risk of flotation, increasing the chances of damage. Moving floodwaters also can damage drinking water system components by causing scour and erosion. Floodwaters can submerge wellheads and contaminate well water.

Damage to drinking water systems can result in loss of system pressure, which could allow ground and floodwater to get into the system, resulting in contamination. Following hurricanes and floods, system pressure loss often results in boil water orders until drinking water systems are disinfected. Hurricanes and floods often can cause power outages due to wind damage to power lines, downed trees, and flooding of transformers and transmission facilities. When drinking water pumps lose power, electrical controls and instrumentation, service often is disrupted. Damaged drinking water system components require rapid repair or replacement to bring the system to full operational capacity.

Figure 4.1.1 shows a typical drinking water treatment system.

Note

Refer to Mitigation Fact Sheet 2.3, *Mitigation of Dams and Reservoirs*, Fact Sheet 3.1, *Foundations*, and Fact Sheet 3.2, *Walls and Openings*, for other mitigation ideas that may apply to drinking water systems.



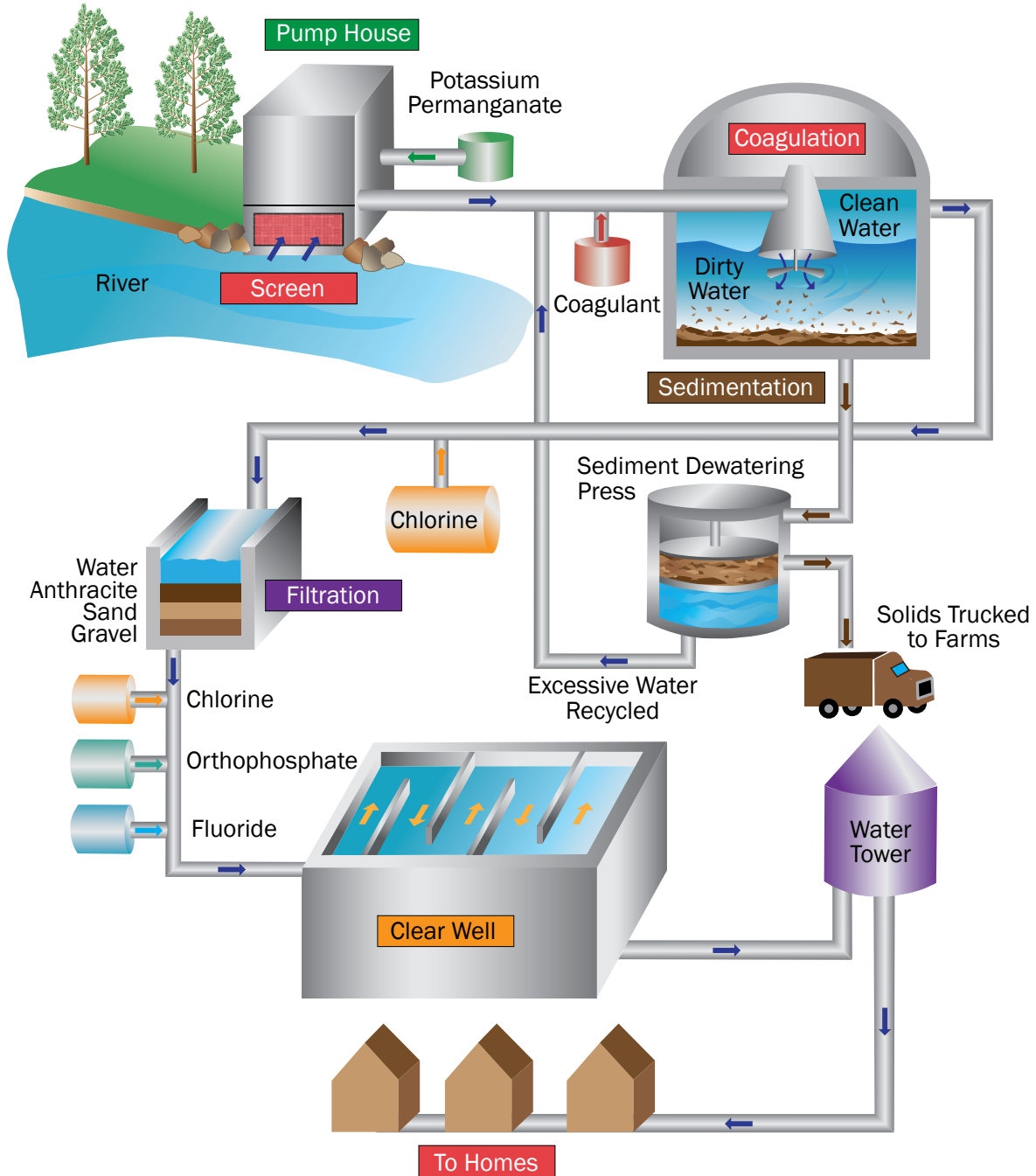

Figure 4.1.1. The typical water treatment process has opportunities for hazard mitigation. (Source: City of Rockville, Maryland, 2012)

Table 4.1.1 summarizes some common mitigation strategies that can improve the resilience of drinking water systems. These strategies are then discussed in the sections that follow.

Table 4.1.1. Common Mitigation Solutions for Drinking Water Systems

Solutions and Options	Wind	Wind-Driven Rain	Flooding
Mitigation Solution: For Water Intake, Distribution and Storage Components			
Option 1: Elevate or Relocate			✓
Option 2: Protect or Divert			✓
Option 3: Floodproof			✓
Option 4: Increase Storage Volume			✓
Mitigation Solution: For Drinking Water Treatment Facilities			
Option 1: Elevate or Relocate			✓
Option 2: Floodproof		✓	✓
Option 3: Provide Redundant Systems	✓	✓	✓
Mitigation Solution: For Booster Stations and Other Pumps			
Option 1: Elevate or Relocate			✓
Option 2: Floodproof		✓	✓
Option 3: Provide Redundant Systems	✓	✓	✓
Mitigation Solution: For Chemical and Fuel Storage Tanks			
Option 1: Elevate or Relocate			✓
Option 2: Floodproof			✓
Option 3: Secure or Anchor	✓		✓
Option 4: Provide Redundant Systems	✓		✓
Mitigation Solution: For Instrumentation and Electrical Controls			
Option 1: Elevate or Relocate			✓
Option 2: Floodproof			✓
Mitigation Solution: For Power Supplies			
Option 1: Elevate or Relocate			✓
Option 2: Floodproof		✓	✓
Option 3: Provide Redundant Systems	✓	✓	✓

Mitigation Solution: For Water Intake, Distribution and Storage

Water intake, distribution and storage components can be at risk for damage from flooding. Intake structures can be clogged by soil and debris; they also can be physically damaged by debris hitting them. Underground distribution pipes can be exposed by fast-flowing floodwaters eroding the soil covering them, making them vulnerable to damage by the flowing water and debris. Well casings and wells can be submerged by floodwaters, which can lead to contamination. Water storage tanks can be moved off their foundations by swiftly flowing floodwater. Steps can be taken to mitigate against this damage and make water intake, distribution and storage components more resilient to floods and hurricanes.

Option 1: Elevate or Relocate

When evaluating this option, consider the following:

- Elevate or relocate pump houses and distribution system elements to at least the 0.2%-annual-chance (500-year) flood elevation to reduce the chance of the structure flooding, which can cause damage or system shutdown.
- Relocate system components if susceptible to flood damage or contamination.
- Bury all distribution lines crossing streams or water bodies to prevent damage from scour or debris.
- Extend well casings above the 0.2%-annual-chance (500-year) flood elevation.

CONSIDERATIONS:



Option 2: Protect or Divert

When evaluating this option, consider the following:

- Install or upgrade intake screens to prevent debris blockages.
- Use jetties or breakwaters to divert debris and silt away from intake structures.
- Grade land to slope away from wells.
- Use stainless steel or PVC piping components.

CONSIDERATIONS:



Option 3: Floodproof

When evaluating this option, consider the following:

- Floodproof or reinforce fire hydrants, valve vaults and other system elements if they are susceptible to flood damage or contamination.
- Retrofit all system pumps vulnerable to floodwaters with submersible pumps with waterproof pump motors.
- Seal tops of well casings.
- Waterproof well caps.

CONSIDERATIONS:



Option 4: Increase Storage Volume

When evaluating this option, consider the following:

- Increase the storage volume of emergency finished water (treated water stored at a drinking water treatment facility ready for distribution), as needed, or set up a different storage location.

CONSIDERATIONS:



Mitigation Solution: For Drinking Water Treatment Facilities

Flooding can damage drinking water system buildings and destroy process equipment, communications controls, data records, and field administrative equipment. Flooding also can wash out treatment plant tanks and filter beds, damage equipment, cause equipment to malfunction, and contaminate the water supply.

Option 1: Elevate or Relocate

When evaluating this option, consider the following:

- Elevate the pads that support process tanks and critical equipment to be above the 0.2%-annual-chance (500-year) flood level.
- Elevate or relocate equipment, control centers and furnishings critical to operations to a higher floor in a building or above the design flood elevation.
- Maintain any generators or critical electrical components above the 0.2%-annual-chance (500-year) flood elevation.

CONSIDERATIONS:



Option 2: Floodproof

When evaluating this option, consider the following:

- Install a floodwall or berm to protect the facility (Figure 4.1.2).
- Install waterproof protection, such as shields, on building entry points, including windows, doors and garages.
- Use flood-damage-resistant building materials below the design flood elevation to prevent water damage.
- Use green infrastructure or stormwater management strategies near the plant to redirect floodwater away from the facility.
- Install pumping systems, channels or culverts that also may redirect floodwater away from treatment facilities.
- Seal all potential wall and floor water entry points.
- Install backflow prevention devices on sewers and drains in buildings that are at risk.



Figure 4.1.2. Constructing a floodwall around a water treatment plant can protect buildings and equipment from flood damage. (Source: U.S. Army Corps of Engineers, 2013)

- Create ways to pump sewage generated within buildings that are at risk.
- Outfit Motor Control Centers (MCCs) with waterproof models.
- Install backflow preventers on low-profile pipes to protect treated water from contamination.
- See Fact Sheet 3.1, *Foundations*, and Fact Sheet 3.2, *Walls and Openings*, for additional information.

CONSIDERATIONS:

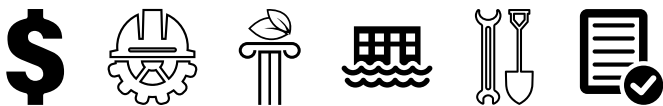

Option 3: Provide Redundant Systems

Installing backup systems and equipment can keep water treatment plants working during a flood (Figure 4.1.3, below). When evaluating this option, consider the following:

- Provide hardwired backup controls that are independent of Supervisory Control and Data Acquisition (SCADA) systems.
- Install wiring to make it possible to use temporary generators if needed.
- Provide redundant systems for the motor control center.



Figure 4.1.3. Installing an emergency backup generator can provide power to help a water treatment plant continue to operate during a flood. (Source: U.S. Environmental Protection Agency [EPA], 2014)

CONSIDERATIONS:

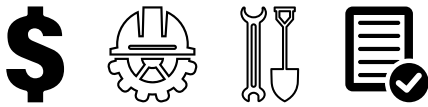

Mitigation Solution: For Booster Stations and Other Pumps

Pumps move water throughout the water treatment system and are an important element of the system. Pumps and control systems, including pump controls, electrical panels, and the Motor Control Center are at risk for flood damage, which may cause the system to shut down. The following options provide mitigation strategies against floods and hurricanes for booster stations, other pumps and associated equipment.

Option 1: Elevate or Relocate

When evaluating this option, consider the following:

- Elevate or relocate instrumentation, computers and records.
- Replace below-ground booster stations with above-ground stations raised to 0.2%-annual-chance (500-year) flood elevation.

CONSIDERATIONS:

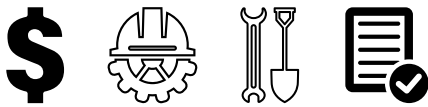

Option 2: Floodproof

When evaluating this option, consider the following:

- Install permanent flood barriers, such as flood walls or berms, around buildings and any important outside equipment.
- Install flood shields on doors and openings (Figure 4.1.4).
- Replace non-submersible pumps with submersible pumps.
- Install sump pumps to remove any leakage in facilities that are below ground level.
- Use electrical panel enclosures rated for submersion.



Figure 4.1.4. Water-tight doors can be used to protect pumps and other equipment in pump houses and booster stations.

CONSIDERATIONS:

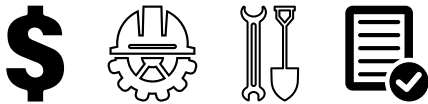

Option 3: Provide Redundant Systems

When evaluating this option, consider the following:

- Install wiring that is compatible with portable generators.
- Invest in energy-efficient equipment that uses less fuel to extend the operating capacity of a backup system during a power outage.
- Explore the possibility of temporarily removing and safely storing critical components in advance of a storm.

CONSIDERATIONS:



Mitigation Solution: For Chemical and Fuel Storage Tanks

If access is blocked or the supply chain fails during or after a flood or hurricane, this can slow down delivery of treatment chemicals and fuel. Without chemicals or fuel, the operation of drinking water systems may be stalled for some time, even if the facilities themselves are not damaged.

Storage tanks are also at risk from damage and rupture, which can cause tanks to leak or float if not properly raised and anchored.

Option 1: Elevate or Relocate

When evaluating this option, consider the following:

- Elevate or relocate tank platforms above the 0.2%-annual-chance (500-year) flood elevation.
- Elevate fill and vent lines above 0.2%-annual-chance (500-year) flood elevation.

CONSIDERATIONS:

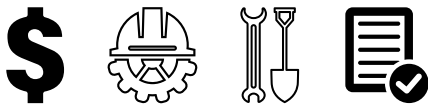

Option 2: Floodproof

When evaluating this option, consider the following:

- Install protective barriers around tanks to keep water and debris out.
- Install sump pumps to pump out water that leaks inside the protective barrier.
- In coastal areas, use saltwater-resistant equipment and storage tanks to avoid corrosion.

CONSIDERATIONS:



Option 3: Secure or Anchor

When evaluating this option, consider the following:

- Fill storage tanks to full volume prior to a storm to increase the tank's weight.
- Anchor tanks to platforms with corrosion-resistant straps to prevent the tank from becoming loose and floating (Figure 4.1.5).



Figure 4.1.5. Secure tanks with non-corrosive straps to prevent flotation.
(Source: U.S. Environmental Protection Agency [EPA], 2014)

CONSIDERATIONS:

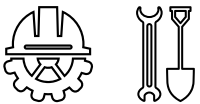

Option 4: Provide Redundant Systems

When evaluating this option, consider the following:

- Install larger-volume tanks or a second tank to ensure adequate treatment chemicals and fuel are available to run the needed systems until the supply chain or access is restored.

CONSIDERATIONS:

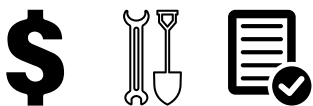

Mitigation Solution: For Instrumentation and Electrical Controls

Instrumentation, electrical controls and electrical wiring are essential components of drinking water systems. Motor control centers or SCADA systems also are vital to system operation. If these elements are damaged or unusable, operations and data collection in operations centers, treatment facilities, remote distribution locations, collection valve chambers and pump stations are at risk.

Option 1: Elevate or Relocate

When evaluating this option, consider the following:

- Relocate motor control centers or SCADA systems to facilities outside of the Special Flood Hazard Area.
- Elevate individual instruments, motor control centers and critical components to above 0.2%-annual-chance (500-year) flood elevation (Figure 4.1.6).



Figure 4.1.6. Elevating instrumentation can protect it from flood damage.
(Source: U.S. Environmental Protection Agency [EPA], 2014)

CONSIDERATIONS:

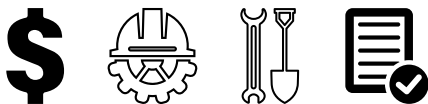

Option 2: Floodproof

When evaluating this option, consider the following:

- Replace enclosures that house instrumentation and controls with water-resistant models.
- Isolate the equipment that is likely to be exposed to floodwaters for rapid removal, repair, replacement and installation.
- Make sure that staff can operate all systems manually.

CONSIDERATIONS:

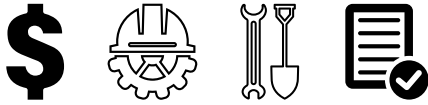

Mitigation Solution: For Power Supplies

Hurricanes and floods often result in power outages caused by wind damage to power lines, downed trees and flooding of transformers and transmission facilities. This can disrupt service and cause public health and safety concerns (for instance, boil water advisories). Improving the resilience of power supplies to drinking water systems can help decrease or even eliminate the amount of time these systems are unavailable.

Option 1: Elevate or Relocate

When evaluating this option, consider the following:

- Raise all critical electrical equipment that might be at risk above the 0.2%-annual-chance (500-year) flood elevation.
- Relocate electrical vaults and relocate or elevate service panels away from the floodplain.

CONSIDERATIONS:

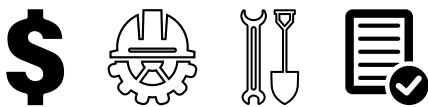

Option 2: Floodproof

When evaluating this option, consider the following:

- Replace or upgrade connections and junction boxes with water-resistant equipment.
- Use submersible pumps in areas at risk for flooding.

CONSIDERATIONS:

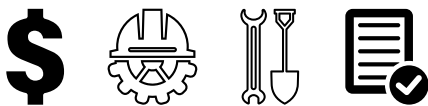

Option 3: Provide Redundant Systems

When evaluating this option, consider the following:

- Install an additional power feed to the drinking water system.
- Create more reliable connections to the power source or a dedicated feeder between the power station and the drinking water treatment plant.

- Install permanent standby generators at locations having priority.
- Wire pump stations and other key equipment with quick-connect capability to work with portable backup generators.
- Consider options for using equipment that can run on more than one type of fuel. This can allow equipment to work even if it becomes difficult to get one fuel type.
- Install larger-volume fuel tanks or a second fuel tank to increase fuel availability.
- Connect to solar panels or wind turbines with battery storage or use combined heat and power plants (CHP) to reduce dependency on the electrical grid.
- Consider the addition of a flood- and wind-resistant microgrid system to power the facility (Figure 4.1.7).

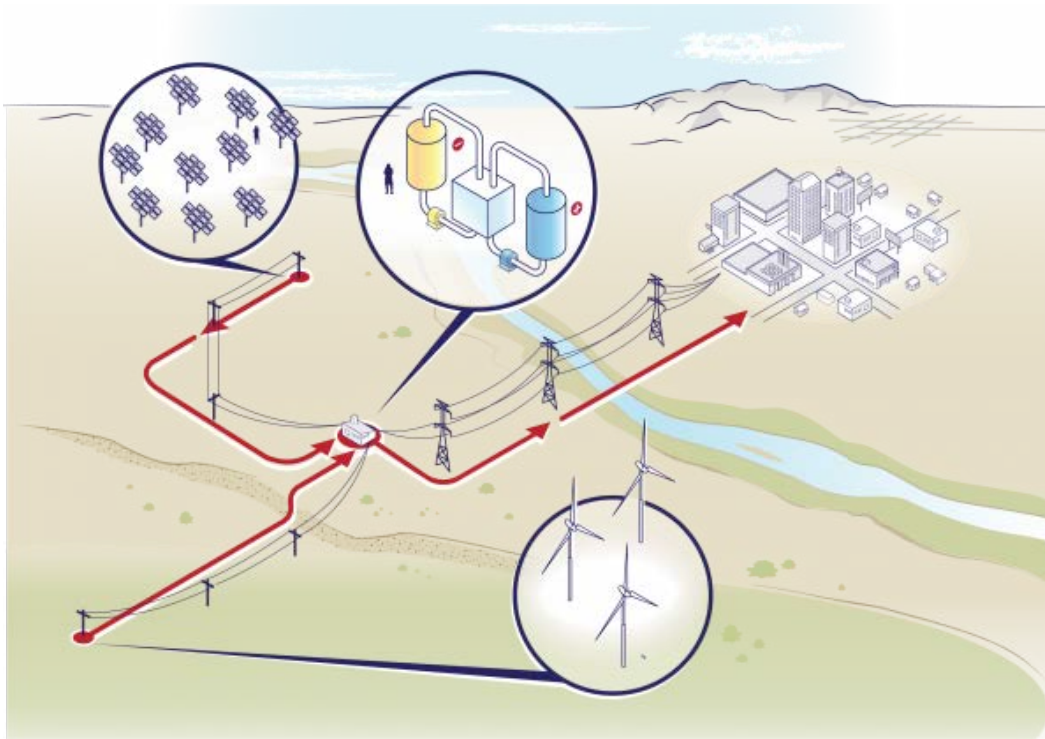

Figure 4.1.7. Microgrids can provide power to a facility to reduce its dependence on the main electrical grid. (Source: Sandia National Laboratories, 2020)

- Store temporary or backup equipment, like replacement pumps, away from areas at moderate to high risk for flooding or limited access.
- See Fact Sheet 4.3, *Electric Power*, for additional information.

CONSIDERATIONS:



REFERENCES:

- Alaska Department of Environmental Conservation. 2012. *Flood Preparation and Recovery for Drinking Water Systems*. Available at: <https://dec.alaska.gov/media/8582/security-9-flood-packet.pdf>
- American Water Works Association (AWWA). 2013. AWWA J-100, *Risk Analysis and Management for Critical Asset Protection (RAMCAP®)*, Standard for Risk and Resilience Management of Water and Wastewater Systems. Available at: <https://www.awwa.org/Store/AWWA-J100-10R13-Risk-and-Resilience-Management-of-Water-and-Wastewater-Systems-PDF/ProductDetail/37334446>
- City of Rockville, Maryland. 2012. "Rockville Drinking Water Treatment." Available at: <https://www.rockvillemd.gov/DocumentCenter/View/898/Drinking-Water-Treatment?bidId=>
- Federal Emergency Management Agency (FEMA). 2013a. FEMA P-936, *Floodproofing Non-Residential Buildings*. Available at: https://www.fema.gov/emergency-managers/risk-management/building-science/publications?name=%22P-936%22&field_keywords_target_id=All&field_document_type_target_id=All&field_audience_target_id=All
- FEMA. 2013b. Hurricane Sandy Recovery Advisory RA2, *Reducing Flood Effects in Critical Facilities*. Available at: https://www.fema.gov/media-library-data/1381404651877-881a2cf70a90ac63b9c067100ffcca/SandyRA2CriticalFacilities_508_FINAL2.pdf
- FEMA. 2014. FEMA P-1019, *Emergency Power Systems for Critical Facilities: A Best Practices Approach to Improving Reliability*. Available at: <https://www.wbdg.org/ffc/dhs/criteria/femap1019>
- FEMA. 2017. FEMA P-348, *Protecting Building Utility Systems from Flood Damage*. Available at: https://www.fema.gov/sites/default/files/2020-07/fema_p-348_protecting_building_utility_systems_from_flood_damage_2017.pdf
- Sandia National Laboratories. 2020. "Advanced Microgrids." Available at: <https://energy.sandia.gov/programs/electric-grid/advanced-microgrids/>
- U.S. Army Corps of Engineers (USACE). 2013. "U.S. Army Corps of Engineers hosts ribbon cutting ceremony." Available at: <https://www.mvr.usace.army.mil/Media/News-Releases/Article/477058/us-army-corps-of-engineers-hosts-ribbon-cutting-ceremony/>
- U.S. Environmental Protection Agency (EPA). 2009. *Is Your Water or Wastewater System Prepared? What You Need to Know About Generators*, EPA 901-F-09-027. Available at: <https://www3.epa.gov/region1/eco/drinkwater/pdfs/WaterWastewaterSystemGeneratorPreparedness.pdf>
- EPA. 2014. *Flood Resilience, A Basic Guide for Water and Wastewater Utilities*. Available at: https://www.epa.gov/sites/production/files/2015-08/documents/flood_resilience_guide.pdf

Fact Sheet 4.2: Wastewater Treatment Systems

The mitigation objective of this Fact Sheet is to identify ways to maintain or quickly restore the operation of wastewater treatment plants impacted by floods and hurricanes to provide services to users and prevent contamination from sewage overflow into the environment.

During hurricanes or flooding, the elements needed to ensure the ongoing operation of wastewater treatment systems are at high risk for damage. After the storm, wastewater treatment system components may need repair or replacement to bring the system back to full operation. It is important to identify these at-risk elements before a severe storm happens so that mitigation strategies can be developed and put into action to avoid or minimize storm damage and quickly restore service.

Table 4.2.1 summarizes some common mitigation strategies that can strengthen wastewater treatment systems and prevent contamination of surrounding areas. These strategies are then discussed in the sections that follow.

Table 4.2.1. Common Wastewater Treatment System Mitigation Solutions

Solutions and Options	Wind	Wind-Driven Rain	Flooding
Mitigation Solution: For Lift Stations			
Option 1: Elevate or Relocate			✓
Option 2: Protect or Divert			✓
Option 3: Floodproof			✓
Option 4: Provide Redundant Systems	✓	✓	✓
Mitigation Solution: For Headworks			
Option 1: Elevate or Relocate			✓
Option 2: Protect or Divert			✓
Option 3: Floodproof		✓	✓
Option 4: Provide Redundant Systems	✓	✓	✓



Solutions and Options	Wind	Wind-Driven Rain	Flooding
Mitigation Solution: For Wastewater Treatment Plants			
Option 1: Elevate or Relocate			✓
Option 2: Protect or Divert			✓
Option 3: Floodproof		✓	✓
Option 4: Provide Redundant Systems	✓	✓	✓
Mitigation Solution: For Chemical and Fuel Supplies			
Option 1: Elevate or Relocate			✓
Option 2: Floodproof			✓
Option 3: Secure or Attach	✓		✓
Option 4: Provide Redundant Systems	✓		✓
Mitigation Solution: For Instrumentation and Electrical Controls			
Option 1: Elevate or Relocate			✓
Option 2: Floodproof			✓
Option 3: Provide Redundant Systems	✓	✓	✓
Mitigation Solution: For Power Supplies			
Option 1: Elevate or Relocate			✓
Option 2: Floodproof		✓	✓
Option 3: Provide Redundant Systems	✓	✓	✓

Mitigation Solution: For Lift Stations

Lift stations move wastewater from a lower level to a higher level. They are usually located at the lowest areas in gravity-fed sewer systems. Because of their locations, they are prone to flooding and power outages. If lift stations lose power, untreated sewage can back up into homes, businesses, and critical facilities and flow into waterways, causing a threat to public health and the environment.

Option 1: Elevate or Relocate

When evaluating this option, consider the following:

- Elevate or relocate electrical components such as motors, switchgears and motor control centers at risk for flood damage to locations above the design flood elevation.
- Extend vent lines above the potential design flood elevation (Figure 4.2.1).

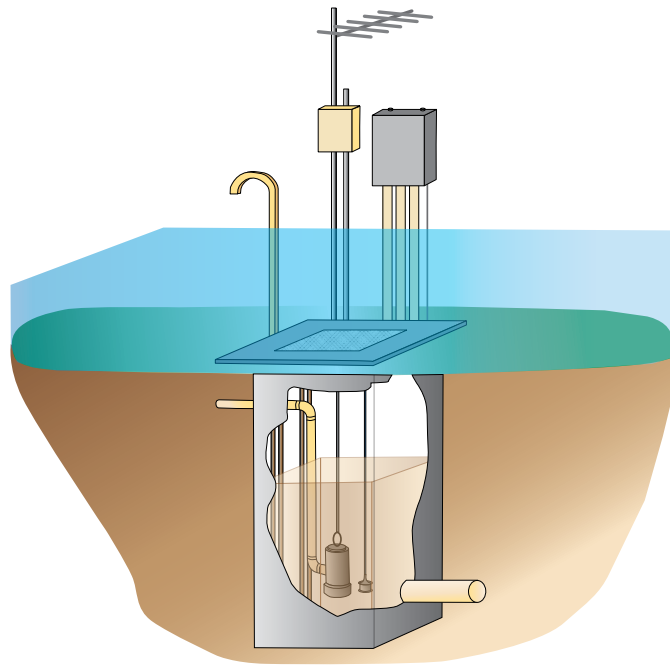

Figure 4.2.1. Extend vent pipes and electrical controls above the flood elevation at lift stations.

- Raise below-ground lift stations either by elevating them in-place or by replacing the lift station to the level of the potential highest flood elevation or higher based on local standards.
- Elevate backup generators above the highest potential flood elevation.

CONSIDERATIONS:



Option 2: Protect or Divert

When evaluating this option, consider the following:

- Install gates on influent and emergency overflow lines at the inflow and overflow locations.
- Divert floodwater and surge away from the lift station using green infrastructure.

CONSIDERATIONS:



Option 3: Floodproof

When evaluating this option, consider the following:

- Use temporary flood barriers for lift stations that are at risk for only minor flooding.
- Install permanent barriers, such as flood walls, berms, levees, or sealed doors, for the most at-risk lift stations.
- Install fully submersible pumps in lift stations.
- Install electrical components, controls and circuitry in water-resistant cabinets in lift stations.
- Install backflow prevention devices such as valves on lines that flow into the lift station and emergency overflow lines.
- Install water-tight manhole covers and vault access hatches in flood-prone areas to limit inflow into the gravity sewer system.

CONSIDERATIONS:



Option 4: Provide Backup Systems

When evaluating this option, consider the following:

- Install standby generators to power critical equipment in a lift station.
- Install quick-connects on equipment to attach to portable generators.
- Use generators that run on more than one type of fuel. This will allow the generators to still be used if it becomes difficult to obtain one fuel type.
- Install a renewable energy supply with a battery system.

CONSIDERATIONS:

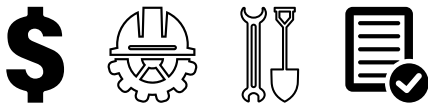

Mitigation Solution: For Headworks

The headworks of a wastewater treatment plant is where wastewater enters a wastewater treatment plant. The headworks screen and remove solids, grit and other debris from the incoming wastewater to avoid clogging other parts of the treatment system. The headworks system is made up of the structures and equipment at the beginning of the wastewater treatment process, including gates and flow controls, metering equipment, pumps, mechanical screens, and grit removal systems. Because of its low elevation, the headworks is at risk for damage from flooding. If the headworks fails without a relief or bypass system in place, it can create a backwater effect on the collections system, which can flood streets, basements and low-lying buildings with untreated sewage.

Option 1: Elevate or Relocate

When evaluating this option, consider the following:

- Before the storm hits, remove and store at-risk, expensive equipment and controls to prevent damage and lessen the time required to bring the system back online.
- Elevate pump and screen motors above the 0.2%-annual-chance (500-year) flood elevation to decrease the risk of flood damage.
- Also, raise electrical system components, instrumentation and other critical systems above the 0.2%-annual-chance (500-year) flood elevation to decrease the risk of flood damage.

CONSIDERATIONS:

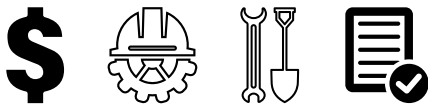

Option 2: Protect or Divert

When evaluating this option, consider the following:

- Upgrade mechanical screens to prevent them from being blocked by debris and to handle sand, grit, trash, and debris potentially entering pumps during and immediately after a flood.

CONSIDERATIONS:

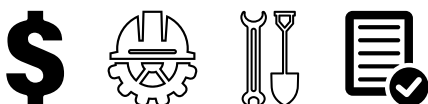

Option 3: Floodproof

When evaluating this option, consider the following:

- Place electrical equipment that is at risk for flood damage in water-resistant cabinets.
- Replace dry well pumps with submersible pumps.

CONSIDERATIONS:

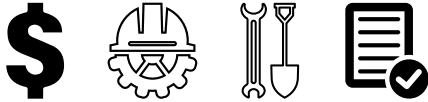

Option 4: Provide Redundant Systems

When evaluating this option, consider the following:

- Install secondary controls, such as float switches for pumps, that are not dependent on Supervisory Control and Data Acquisition (SCADA) systems to allow headworks to resume their function during power outages and interruption to telemetry switches.
- Provide an additional power supply source—either a portable generator with quick-connects on at-risk equipment or a permanent generator with appropriate fuel supply tanks to support continued headworks operation.
- Replace motorized equipment with diesel-driven or dual-option mechanisms. Diesel-driven motors use less fuel than gasoline-powered motors so run longer on the same amount of fuel. They also are relatively easy to maintain and less flammable. Dual fuel motors can run on gasoline or propane, which allows the motor to continue running if one fuel is not available but the other is.
- Increase pump capacity to meet the needs during floods and hurricanes.

CONSIDERATIONS:

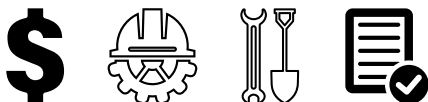

Mitigation Solution: For Wastewater Treatment Plants

Wastewater treatment plants include buildings, system components and equipment needed to treat wastewater. Wastewater treatment system buildings that are key to system operation must be protected from water entry before, during and after a hurricane or flood. Flooding or surge can damage the buildings and destroy process equipment, communications controls, field equipment, and important data records while blocking access to the plant.

Option 1: Elevate or Relocate

When evaluating this option, consider the following:

- Elevate process tank pads to be above the 0.2%-annual-chance (500-year) flood elevation.
- Elevate or relocate individual equipment, instrumentation or controls that are at risk from flooding to be above the 0.2%-annual-chance (500-year) flood elevation.
- Elevate control centers, equipment and furnishings vital to operations or relocate them to a higher floor of the building.
- See Fact Sheet 3.1, *Foundations*, and Fact Sheet 3.4.2, *Building Utility Systems—Electrical*, for additional information.

CONSIDERATIONS:

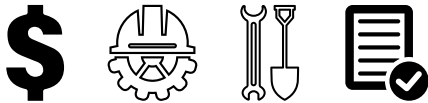

Option 2: Protect or Divert

When evaluating this option, consider the following:

- Anchor any air tanks to prevent them from floating.
- Use green infrastructure to reroute or collect floodwater.
- Install pumping systems or channels and culverts that can collect and drain floodwater effectively.
- Build a combined sewage overflow tunnel or a large collection pond to collect sewage overflow for future treatment. These equalization basins typically hold a volume determined by the highest expected flow. Increasing the volume can help mitigate larger recurrence flood events.
- Install corrosion-resistant equipment in coastal areas.

CONSIDERATIONS:



Option 3: Floodproof

When evaluating this option, consider the following:

- Install barriers such as door shields on building entry points, including windows, doors and garages.
- Seal wall and floor openings using water-resistant sealants.
- Install backflow prevention devices on sewers and drains in at-risk buildings.
- Isolate electrical equipment in water-resistant closets.
- Construct levees, floodwalls or berms to be higher than the 0.2%-annual-chance (500-year) flood elevation around extremely flood-prone facilities (Figure 4.2.2).



Figure 4.2.2. Constructing a flood wall that extends above the 500-year flood elevation can help protect a wastewater treatment plant from flood damage. The blue lines indicate the approximate location of the planned floodwall for this treatment facility. (U.S. Environmental Protection Agency [EPA], 2021)

- See Fact Sheet 3.2, *Walls and Openings*, for additional information about protecting buildings from flood damage.

CONSIDERATIONS:

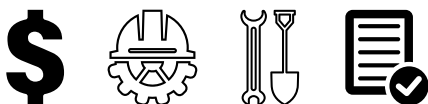

Option 4: Provide Backup Systems

When evaluating this option, consider the following:

- Install a generator at a height that would be above the 0.2%-annual-chance (500-year) flood elevation or install wiring (called a quick-connect) to make it possible to use a temporary backup generator.
- Ensure that generators that use fuel have fuel tanks installed above the 0.2%-annual-chance (500-year) flood elevation and that the fuel tanks are anchored firmly in place.
- Install motorized equipment and generators capable of using more than one fuel type. This will allow them to continue to work when disasters limit the availability of one fuel type.
- Construct a large storage tank to store sewage overflows for future treatment.

CONSIDERATIONS:

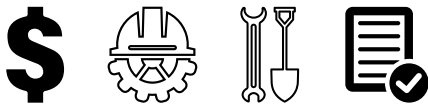

Mitigation Solution: For Chemical and Fuel Supplies

A constant supply of treatment chemicals and fuel is needed to operate a wastewater treatment system, particularly after a flood. Flooding can slow down or completely stop delivery of chemicals or fuel to the facility if access to the treatment plant is blocked or if the availability of these items is impacted.

Option 1: Elevate or Relocate

When evaluating this option, consider the following:

- Elevate tank platforms and tanks above the 0.2%-annual-chance (500-year) flood elevation.
- Raise individual instruments and motor control centers above the 0.2%-annual-chance (500-year) flood elevation or relocate them to facilities away from the flood zone.
- Elevate fill and vent lines above 0.2%-annual-chance (500-year) flood elevation.

CONSIDERATIONS:

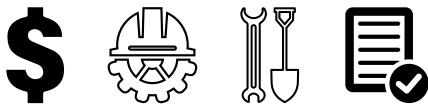

Option 2: Floodproof

When evaluating this option, consider the following:

- Install protective barriers around a tank to a height above the 0.2%-annual-chance (500-year) flood elevation.
- Replace instrumentation enclosures and control boxes with water-resistant models.
- Install submersible pumps to pump out water that accumulates within the protective barrier.
- Install corrosion-resistant equipment, storage tanks and fasteners in coastal areas. Additional information about corrosion-resistant materials in coastal environments can be found in NFIP Technical Bulletin 8, *Corrosion Protection for Metal Connectors and Fasteners in Coastal Areas*.

CONSIDERATIONS:



Option 3: Secure

When evaluating this option, consider the following:

- Fill storage tanks to their maximum volume prior to a storm to prevent floating or backflow.
- Anchor tanks to platforms using non-corrosive strapping (Figure 4.2.3).

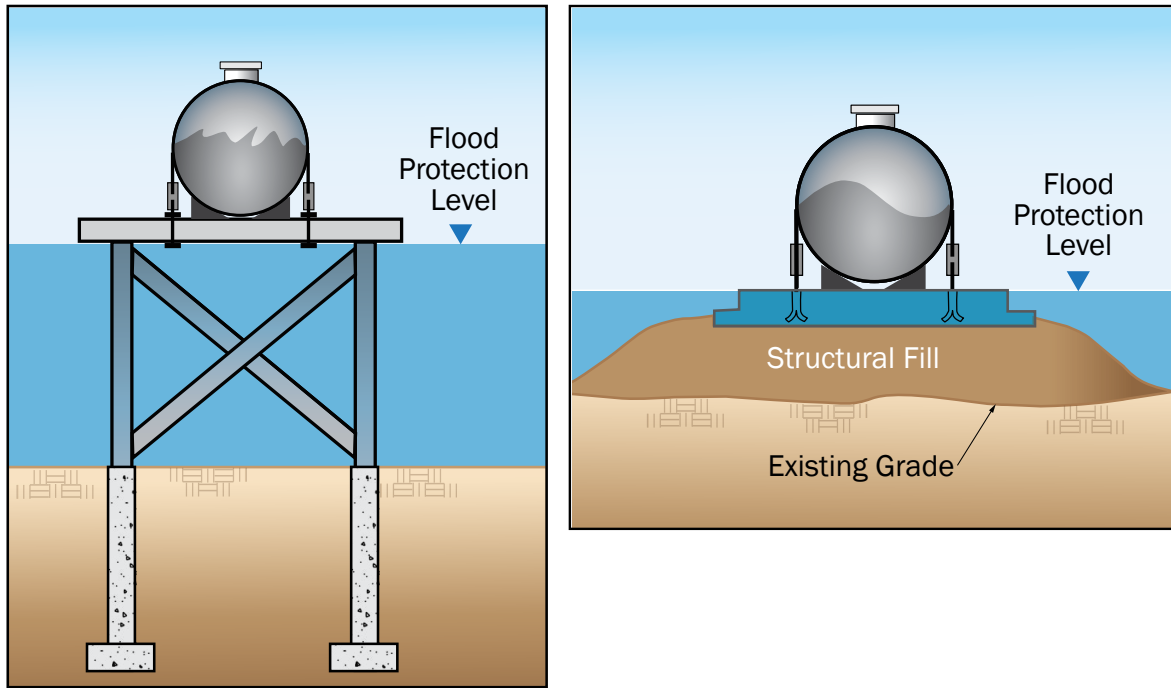
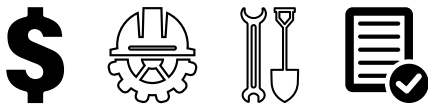

Figure 4.2.3. Raise tanks above the 500-year flood elevation and secure them with non-corrosive hardware to keep them from floating.

CONSIDERATIONS:



Option 4: Provide Redundant Systems

When evaluating this option, consider the following:

- Install larger volume or secondary chemical and fuel tanks to ensure treatment operations remain ongoing until more supplies are available or access is restored.

CONSIDERATIONS:

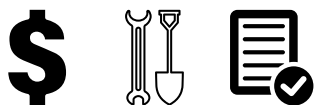

Mitigation Solution: For Instrumentation and Electrical Controls

Instrumentation and controls for wastewater treatment systems are critical equipment for operating these systems. Ensuring that they do not fail during hurricane and flood events or that they can be quickly or easily repaired after a storm will help improve resilience and decrease possible threats to public health and the environment.

Option 1: Elevate or Relocate

When evaluating this option, consider the following:

Raise service panels above the 0.2%-annual-chance flood elevation and relocate electrical vaults outside of the floodplain.

Elevate individual instruments, motor control centers and critical components to heights above 0.2%-annual-chance (500-year) flood elevation (Figure 4.2.4).



Figure 4.2.4. Elevating instrumentation can protect it from damage during flooding. (Source: U.S. EPA, 2014)

CONSIDERATIONS:

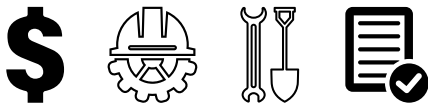

Option 2: Floodproof

When evaluating this option, consider the following:

- Replace or upgrade connections, motor controls and junction boxes with water-resistant versions.
- Use water-resistant electrical components, controls and circuitry.
- Isolate critical components in water-resistant cabinets.
- Replace pumps, flow meters and gate valve operators with submersible models.
- Isolate the equipment that is most likely to be exposed to floodwaters so it can be removed quickly, repaired or replaced. Make sure that staff can operate all systems manually.

CONSIDERATIONS:

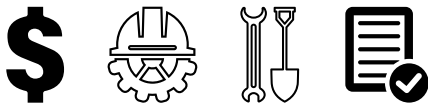

Option 3: Provide Redundant Systems

When evaluating this option, consider the following:

- Provide hardwired backup controls that are separate from the SCADA systems.
- Have secondary controls at another location or remote access capabilities.

CONSIDERATIONS:

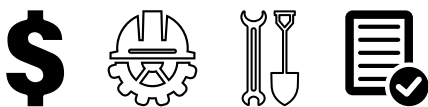

Mitigation Solution: For Power Supplies

Wastewater treatment plants use a large amount of power to complete the treatment processes. If the treatment plant does not have redundant systems for critical parts of the process that depend on power, service may be disrupted during hurricanes or floods. This disruption could result in raw sewage backup or even discharge of raw sewage following hurricanes or floods. Some strategies to mitigate the impacts of a loss of power wastewater treatment facilities are identified below. See Fact Sheet 3.4.2, *Building Utility Systems—Electric*, and Fact Sheet 4.3, *Electric Power*, for additional information about mitigating power supply disruptions.

Option 1: Elevate or Relocate

When evaluating this option, consider the following:

- Elevate all at-risk critical electrical equipment above the 0.2%-annual-chance flood elevation.
- Raise service panels above the 0.2%-annual-chance flood elevation or relocate electrical vaults and service panels away from the floodplain.
- Elevate power substations.

CONSIDERATIONS:

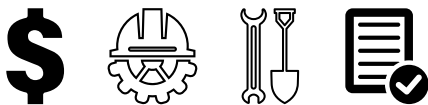

Option 2: Floodproof

When evaluating this option, consider the following:

- Install a floodwall or protective berm around the substations to the 0.2%-annual-chance flood elevation.
- Replace or upgrade connections and junction boxes with water-resistant panels.
- Use submersible pumps in areas at risk for flooding.

CONSIDERATIONS:

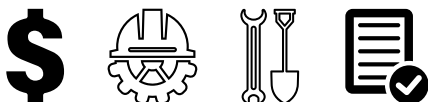

Option 3: Provide Redundant Systems

When evaluating this option, consider the following:

- Install an additional power feed to the treatment plant.
- Establish more reliable connections to the power source or use a dedicated feeder between the power station and the treatment plant.
- Install permanent standby generators at priority locations.
- Wire pump stations with quick-connect capability to use portable backup generators.
- Consider multi-fuel options, allowing equipment to continue to work even if one fuel type is unavailable due to the disaster.
- Consider the addition of a flood- and wind-resistant microgrid system to power the wastewater treatment plant.
- Install solar panels or wind turbines with backup storage batteries to reduce electrical grid dependency (Figure 4.2.5).



Figure 4.2.5. Installing renewable energy resources like solar panels can provide a standby source of power for wastewater treatment facilities. (National Renewable Energy Laboratory [NREL], 2017)

CONSIDERATIONS:



REFERENCES:

- Alaska Department of Environmental Conservation. 2012. *Flood Preparation and Recovery for Drinking Water Systems*. Available at: <https://dec.alaska.gov/media/8582/security-9-flood-packet.pdf>
- American Water Works Association (AWWA). 2013. AWWA J-100, *Risk Analysis and Management for Critical Asset Protection (RAMCAP®) Standard for Risk and Resilience Management of Water and Wastewater Systems*. Available at: <https://www.awwa.org/Store/AWWA-J100-10R13-Risk-and-Resilience-Management-of-Water-and-Wastewater-Systems-PDF/ProductDetail/37334446>
- Federal Emergency Management Agency (FEMA). 2013. Hurricane Sandy Recovery Advisory RA2, *Reducing Flood Effects in Critical Facilities*. Available at: https://www.fema.gov/media-library-data/1381404651877-881a2cf70a90ac63b9c067100ffccace/SandyRA2CriticalFacilities_508_FINAL2.pdf
- FEMA. 2014. FEMA P-1019, *Emergency Power Systems for Critical Facilities: A Best Practices Approach to Improving Reliability*. Available at: <https://www.wbdg.org/ffc/dhs/criteria/femap1019>
- FEMA. 2017. FEMA P-348, *Protecting Building Utility Systems from Flood Damage*. Available at: https://www.fema.gov/sites/default/files/2020-07/fema_p-348_protecting_building_utility_systems_from_flood_damage_2017.pdf
- Ferrell, Lee. *Tennessee Water Wastewater Utility Partnership Aeration Efficiency and Optimization*. Available at: <https://efc.sog.unc.edu/sites/default/files/5EPA%20Region%204%20Blower%20Optimization.pdf>
- National Renewable Energy Laboratory (NREL). 2017. “How Is Solar PV Performing in Hurricane-Struck Locations?” Available at: <https://www.nrel.gov/state-local-tribal/blog/posts/how-is-solar-pv-performing-in-hurricane-struck-locations.html>
- Than, Ker. 2012. “Reclaimed Wastewater for Drinking: Safe but Still a Tough Sell.” *National Geographic*. Available at: <https://www.nationalgeographic.com/news/2012/1/120131-reclaimed-wastewater-for-drinking/>
- U.S. Environmental Protection Agency (EPA). 2009. *Is Your Water or Wastewater System Prepared? What You Need to Know About Generators*, EPA 901-F-09-027. Available at: <https://www3.epa.gov/region1/eco/drinkwater/pdfs/WaterWastewaterSystemGeneratorPreparedness.pdf>
- EPA. 2010. *Evaluation of Energy Conservation Measures*. Available at: <https://www.epa.gov/sites/default/files/2016-01/documents/p1008sbm.pdf>
- EPA. 2014. *Flood Resilience, A Basic Guide for Water and Wastewater Utilities*. Available at: https://www.epa.gov/sites/production/files/2015-08/documents/flood_resilience_guide.pdf
- EPA. 2021. *Water Reuse and Recycling*. Available at: <https://www.epa.gov/waterreuse>
- U.S. Geological Survey (USGS). *Water Science School Reclaimed Wastewater*. Available at: https://www.usgs.gov/special-topic/water-science-school/science/reclaimed-wastewater?qt-science_center_objects=0#qt-science_center_objects
- Wika Instruments. No Date. “Pressure Transmitter Usage in Lift Station Monitoring for Wastewater Management in Water Supply and Wastewater Treatment Applications.” Available at: https://www.wika.us/upload/AN_2211_en_us_37073.pdf

Fact Sheet 4.3: Electric Power Generation, Transmission and Distribution

The mitigation objective of this Fact Sheet is to identify ways to maintain or quickly restore electrical power generation, transmission and distribution systems impacted by floods and hurricanes to provide ongoing service to users.

Electric power is essential for living and functioning in a modern society. The electric power industry generates, transmits and distributes the power that supports people, businesses and other critical infrastructure daily. As such, making electric power reliable and resilient is a fundamental need for national safety and security. Components of electric power generation, transmission and distribution systems are at risk for damage by hurricanes and floods, resulting in large-scale electric service failure lasting days to weeks and affecting hundreds of thousands to millions of people. Mitigation measures can improve the resilience of the systems and lessen the impact of a power outage.

Some mitigation solutions for major components of electric power transmission and distribution (T&D) systems are summarized in Table 4.3.1. These strategies are then discussed in the sections that follow.

Table 4.3.1. Common Mitigation Solutions for Electric Power Systems

<i>Solutions and Options</i>	<i>Wind</i>	<i>Wind-Driven Rain</i>	<i>Flooding</i>
Mitigation Solution: For Transmission and Distribution (T&D)			
Option 1: Upgrade Overhead Conductors	✓		
Option 2: Prevent Conductor Slapping and Galloping	✓		
Option 3: Manage Vegetation	✓		
Option 4: Improve Utility Poles and Cross Arms	✓		✓
Option 5: Convert Radial-Fed Lines to Loop-Fed Lines	✓		✓
Option 6: Replace Overhead T&D Lines with Underground Lines	✓		



<i>Solutions and Options</i>	<i>Wind</i>	<i>Wind-Driven Rain</i>	<i>Flooding</i>
Mitigation Solution: For Substations			
Option 1: Elevate and Strengthen Systems	✓	✓	✓
Option 2: Install Standby Power Systems	✓		✓
Option 3: Convert Switchgears		✓	✓
Mitigation Solution: For Power Plants			
Option 1: Strengthen Buildings and Other Structures	✓	✓	✓
Option 2: Elevate Buildings, Structures and Equipment			✓
Option 3: Use Distributed Generation	✓		✓
Option 4: Diversify Energy Resources	✓	✓	✓
Mitigation Solution: For the Smart Grid			
Option 1: Use Redundant Communications Channels	✓		✓
Option 2: Strengthen Data Collection Gateways	✓	✓	✓

Mitigation Solution: For Transmission and Distribution

Power lines, called conductors, are an essential part of electric systems that provide basic electric service to entire regions, both rural and urban. Typically, they are installed overhead on poles or towers set into the ground or—less commonly—built entirely underground. Damage can happen from high winds, wind-borne debris, flooding, erosion at the base of the poles, or soil covering underground lines.

Option 1: Upgrade Overhead Conductors

In cases where transmission and distribution (T&D) lines were not designed to withstand expected environmental or operational conditions, upgrades might be considered. Figure 4.3.1 shows conductors that may be used as line replacements:

- All Aluminum Conductor (AAC)
- All Aluminum Alloy Conductor (AAAC)
- Aluminum Conductor Steel Reinforced (ACSR)

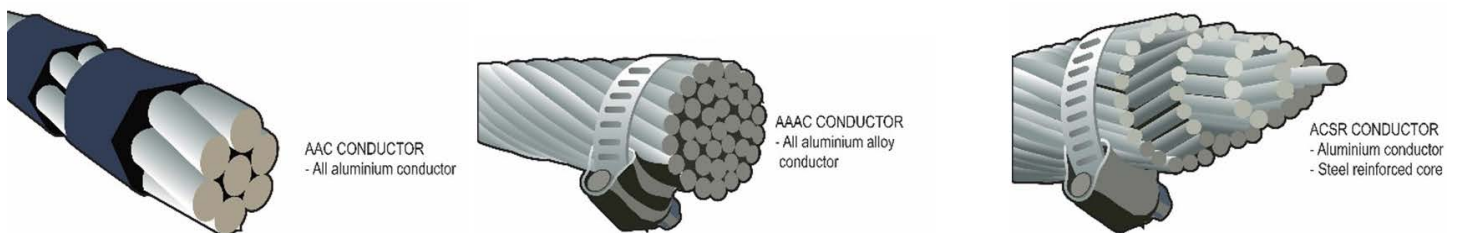

Figure 4.3.1. Cross-section of conductor types.

The following considerations for different types of conductors should be evaluated carefully to determine if upgrading should be considered:

- Cost
- Ampacity (the maximum current, in amperes, that a conductor can carry continuously under the conditions of use without exceeding its temperature rating)
- Compatibility with the existing system
- Environmental resistance
- Sag characteristics
- Strength-to-weight ratio

CONSIDERATIONS:



Option 2: Prevent Conductor Slapping and Galloping

During hurricanes, high winds may cause overhead conductors to vibrate and gallop or slap together, creating power outages. Slapping and galloping can produce electrical arcing, which causes increasing conductor damage, and, in extreme cases, results in broken conductors. Each episode also can throw off electric sparks that might start a fire. Knowing a line's susceptibility to slap or gallop enables the electric company to fix the problem and avoid future damage.

There are several ways to mitigate conductor slap or gallop:

- Install dampers or de-tuners. These devices separate the frequencies of two motions that are close together by de-tuning them (Figure 4.3.2). However, dampers and de-tuners may not be able to reduce the twisting in the lines.

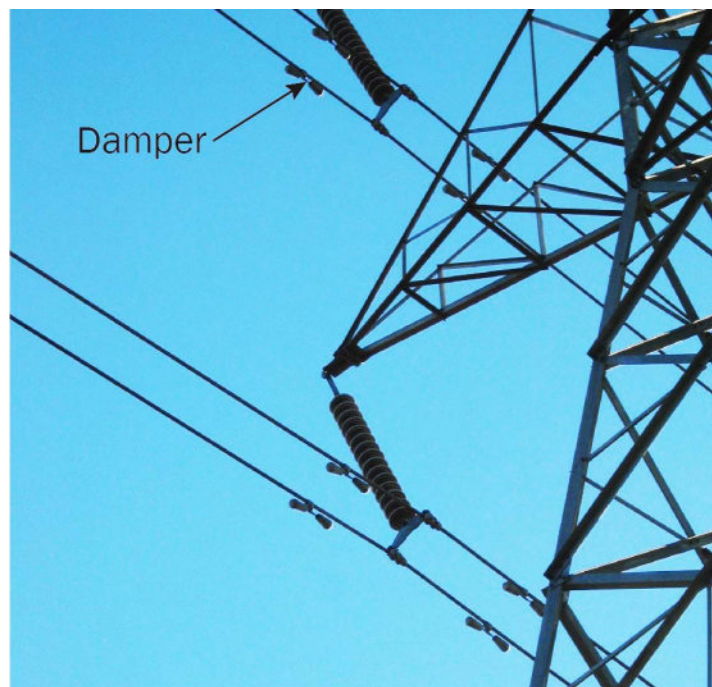

Figure 4.3.2. Dampers and detuners can help mitigate against gallop.

- Use interphase spacers (Figure 4.3.3). The spacers help to maintain phase-to-phase clearances at pre-determined, acceptable limits. They also can help limit the twisting motions of conductors or conductor bundles.
- Increase tension in the line. This approach can be costly and may be difficult after the line has been built.

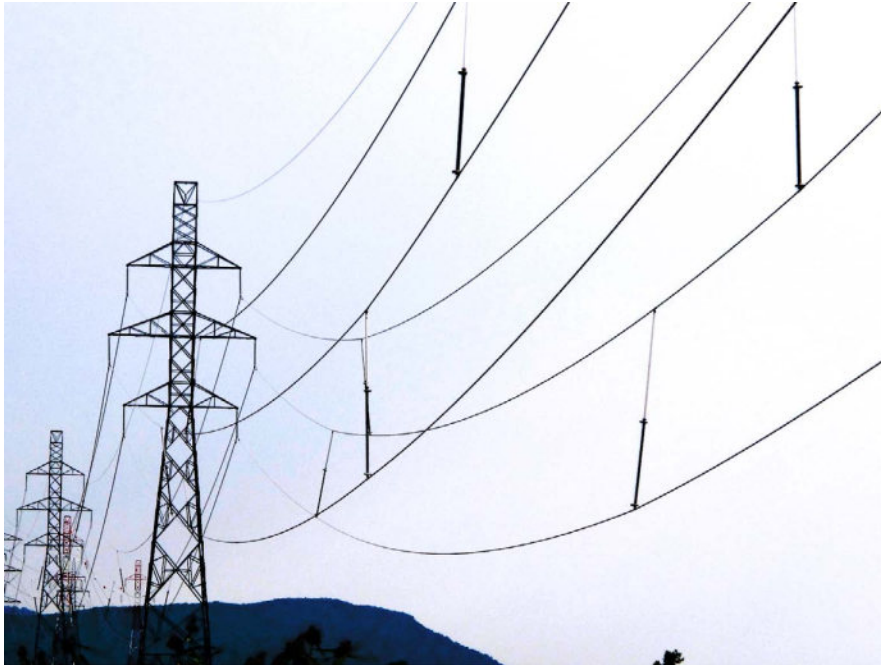

Figure 4.3.3. Interphase spacers can be used to help mitigate conductor gallop. (Source: INMR, 2021)

CONSIDERATIONS:



Option 3: Manage Vegetation

Falling trees and tree limbs are one of the main causes of power outages for electric power companies. Falling trees or limbs can damage transmission and distribution lines, sometimes even causing fires. Developing and carrying out a vegetation management program can help prevent damage to lines, reducing power outages. A vegetation management program may include any or all of the following:

- Pruning or cutting down trees and limbs
- Mowing in the transmission and distribution line right of way
- Inspecting from the air and trimming—Aerial inspection may be done using drones or aircraft. Aerial trimming may be done using helicopters to trim trees in remote areas.
- Managing tree growth—These methods include products and techniques to strengthen trees or control growth
- Applying herbicides—Herbicides used must be registered with and approved by the U.S. Environmental Protection Agency (EPA).

When evaluating which vegetation management methods to use, consider the following (Duke Energy, No Date):

- Line voltage
- Right-of-way width and location
- Type, height and compatibility of the vegetation around the power lines
- Federal and state requirements and other agreements governing vegetation management
- Location relative to environmentally sensitive areas

CONSIDERATIONS:



Option 4: Improve Utility Poles and Cross Arms

The measures listed below can be used to reduce the risk of high wind forces and wind-borne debris impacts on utility poles. All approaches discussed below should be included in the engineering design, and they may be provided by the pole manufacturer given a specific wind force design parameter.

- Reduce the wind forces by moving pole-mounted components to ground level above the highest potential flood elevation.
- Reduce the size of the pole-mounted components.
- Install armless insulators in place of traditional wooden or steel cross arms (Figure 4.3.4).
- Increase pole height and mount lines above trees and other vegetation.

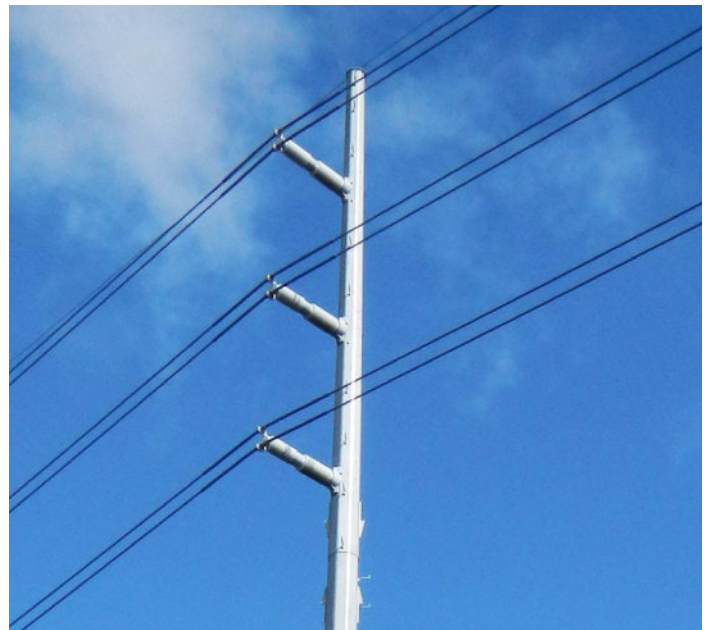

Figure 4.3.4. An armless composite utility pole helps mitigate against wind damage. (Source: Ramon Velasquez, 2013)

- Use higher-strength poles made from stronger materials. Select a pole made from a similar material with a higher class rating or a stronger pole with the same class rating.
 - Round concrete or steel poles have performed better during hurricanes than wood poles or square cast concrete poles of the same pole class.
 - Round composite poles should perform similarly to round concrete poles.
 - Round steel and concrete monopoles often perform better than lattice towers during hurricanes.
- Use storm guy wires with extra anchors (Figure 4.3.5).
 - Guy wires and anchors must be engineered for the specific location of the pole.
 - Use extra guy wires and anchors with increased anchor surface area.
- Improve the pole foundation design (Figure 4.3.6).
 - Concrete, flowable fill, or other special fill materials can improve the strength of the pole foundation.
 - Set the pole deeper. Poles should be set in the ground at approximately 10% of the overall pole length, plus an extra 6 feet to 10 feet deep, depending on the overall pole height.

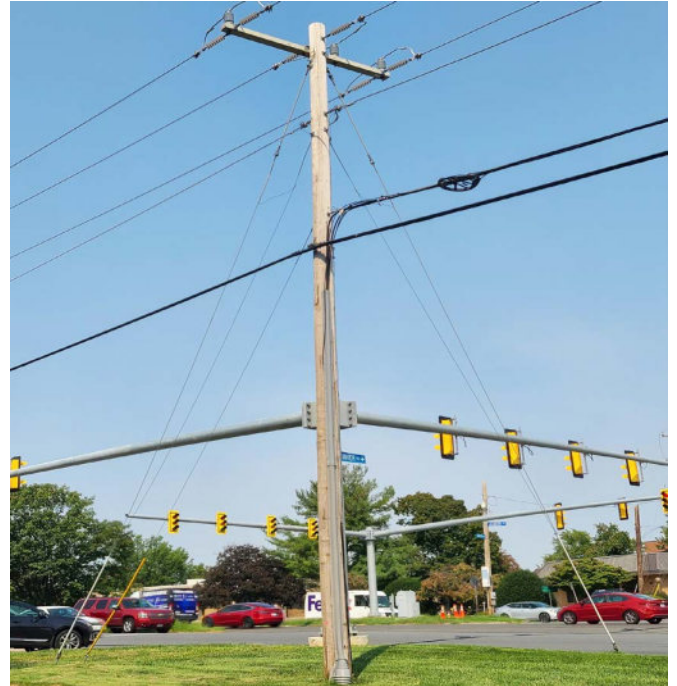

Figure 4.3.5. Typical utility pole with multiple guy wires and anchors.

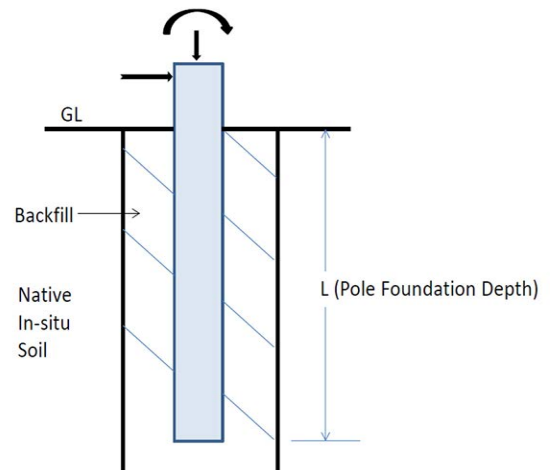

Figure 4.3.6. Poles can be directly embedded in the ground deep enough to help prevent overturning, then backfilled with materials that can help increase foundation stability. (Source: Yenumula et al., 2017)

CONSIDERATIONS:



Option 5: Convert Radial-Fed Lines to Loop-Fed Lines

Many transmission and distribution lines are radially fed, which means that a single set of cables goes out overhead or underground from the substation to the customers or to another substation. Damage to this single set of cables results in all customers beyond the damaged section losing power until the damaged section is repaired. An alternate, more reliable configuration is to have loop-fed lines (Figure 4.3.7).

- Loop-fed lines have two sets of cables originating in the substation and going out into the service area connected in a large loop.
- If a line section is damaged, the damaged section can be isolated, and all customers can be given service from one of the two cable origin points in the substation.
- Loop-fed lines are routinely used with underground service.
- It is becoming more and more common to convert overhead lines to a loop-fed design due to the high reliability and reduced outage time of loop-fed systems.

CONSIDERATIONS:



RING OR LOOP DISTRIBUTION SYSTEM

ADVANTAGES

- Less conductor material is required.
- Less voltage fluctuations.
- More reliable.

- It consists of two or more paths between power sources and the customer.
- The loop circuit starts from the substation bus-bars, makes a loop through the area to be served, and returns to the substation.

DISADVANTAGES

- It is difficult to design as compared to the design of radial system.

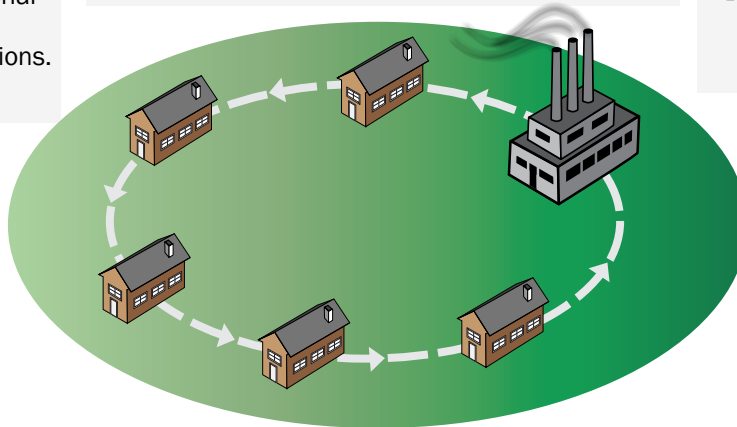

RADIAL DISTRIBUTION SYSTEM

- Separate feeders radiate from a single substation and feed distributors at one end only.
- Only one path is connected between each customer and substation.
- Electrical power flows along a single path.
- If interrupted, results in complete loss of power to the customer.

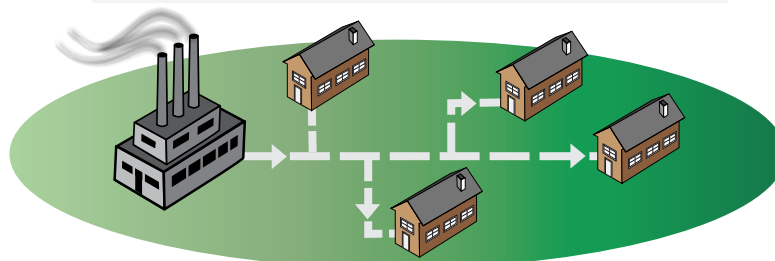

ADVANTAGES

- Low cost.
- Simple planning.

DISADVANTAGES

- The radial system is employed only when power is generated at low voltage and the substation is located at the center of the load.
- Distributor nearer to feeding end is heavily loaded.
- Consumers at far end of feeder would be subjected to serious voltage fluctuations.

Figure 4.3.7. Comparison of loop-fed line versus radial-fed line systems. (Source: Bharti, 2015)

Option 6: Replace Overhead T&D Lines with Underground Lines

If overhead lines fail repeatedly, it may be helpful to move them underground. This strategy completely removes transmission and distribution lines from exposure to wind-borne hurricane damage and has been proven effective in most cases, particularly in urban areas. However, some considerations should be evaluated before proceeding:

- Underground lines can be harder to repair than overhead lines—it can take days or weeks to repair an underground line compared to minutes to hours to repair an overhead line.
- The installation cost for overhead power lines—even storm-hardened lines that can perform well during severe storms—is lower than that the cost to install underground lines.
- Underground lines may be buried in the ground or installed in concrete-encased duct banks with a series of splice vaults that usually are installed underground and allowed to fill with water (Figure 4.3.8). If cables and other equipment are buried in the ground, make sure they are submersible.

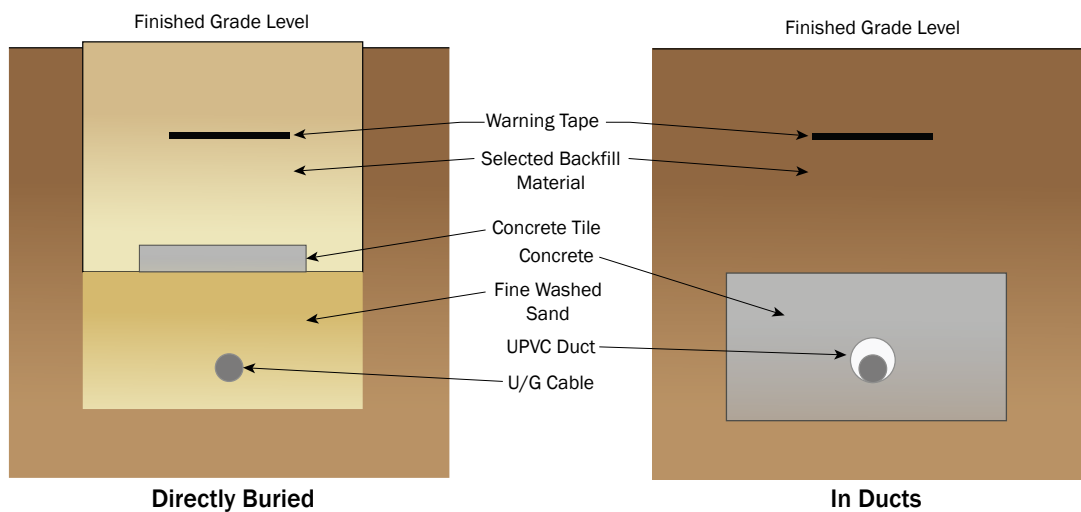

Figure 4.3.8. Installation of underground power lines.

- Underground lines may be damaged by erosion during storms.
- Despite some disadvantages, underground lines may be the best overall solution for coastal areas that are regularly subjected to Category 4 or Category 5 hurricanes. Some urban areas also may find it best to bury lines.

CONSIDERATIONS:



Mitigation Solution: For Substations

Option 1: Elevate and Strengthen Systems

Substations are a key part of electrical power generation, transmission and distribution systems. Flooding can damage substation components, leading to power outages and even fires. In some cases, the substation components are in the open air. In contrast, the temperature control systems, communications equipment and other components are protected in a control house. The substation control house contains sensitive electronic equipment worth hundreds of thousands of dollars for the proper functioning and protection of the entire substation and associated transmission and distribution lines.

To mitigate against the impacts of flood on substations and their components, the following mitigation measures are suggested:

- Elevate the control house building to protect against storm surge and flooding (Figure 4.3.9). Building elevation is discussed further in Fact Sheet 3.1, *Foundations*.



Figure 4.3.9. Elevating a control house in coastal areas can protect it against damage from storm surge and flooding. (Source: Modular Connections, 2020)

- Elevate the substation above the design flood elevation using elevated foundations, platforms or stilts. Make sure there is enough overhead clearance at the site to reach the desired elevation.
- Strengthen the building by designing the outside walls to be reinforced concrete or concrete blocks with a pre-stressed concrete roof.
- Strengthen and seal doors and windows. See Fact Sheet 3.2, *Walls and Openings*, for additional information.
- Install float switches that are connected to the substation's Supervisory Control and Data Acquisition (SCADA) system. The float switches can be monitored remotely and can notify operators about elevated water levels.

CONSIDERATIONS:



Option 2: Install Standby Power Systems

Substations typically have a battery bank that can run the substation controls for hours or days during a power outage. However, the batteries might die, leaving the entire substation inoperable before normal power can be restored. Several approaches can be taken to mitigate this problem:

- Install a standby generator. This approach is best when substation power may be lost for days, weeks or months.
 - The generator should be sized to provide power to the substation battery charger, control equipment, lights and air conditioning system.
 - The generator should be elevated above the storm surge elevation or design flood elevation, whichever is higher.
 - Installing the generator in a concrete building with sealable entrances and louvers to protect it against wind and moisture damage may be a good choice, provided the generator does not run while the building is completely sealed, as it requires ventilation during operation.
- Modify the battery system (Figure 4.3.10).
 - Extend the battery life by installing an additional battery system as a backup to the first battery bank. Or, as an alternative, enlarge the first battery bank to handle the anticipated load for a longer period.
- Install a second outdoor transformer at a different location. This approach will provide power to the substation battery if the existing transformer is damaged. This method requires an automatic transfer switch to switch from one transformer to the other if one fails.



Figure 4.3.10. The existing battery bank can be modified or augmented to provide additional backup power to the substation. (Source: OSHA, No Date)

CONSIDERATIONS:



Option 3: Convert Switchgear

High- and medium-voltage equipment in a substation is located either outside as open-air bus work or indoors in special cabinets called switchgear. If floodwater or wind-driven rain or seawater gets into the control house, indoor switchgears may become contaminated and stop working, requiring repair or replacement. This indoor switchgear can be converted to a Gas-Insulated Switchgear (GIS) (Figure 4.3.11).



Figure 4.3.11. Indoor gas-insulated switchgears can be used in environments where water can penetrate the control house. (Source: Siemens Energy, 2021)

Gas-insulated switchgears are contained in pressurized vessels that are sealed against the environment. They offer benefits in locations where space is limited. They typically are used indoors at 69 kilovolts (kV) and below but can be used outdoors and at higher voltages in some applications.

CONSIDERATIONS:



Mitigation Solution: For Power Plants

Option 1: Strengthen Buildings and Other Structures

Power plant buildings and structures tend to be large and at significant risk for wind damage during hurricanes. They usually are built with large surface areas of sheet metal with a reinforcing steel frame. Methods to strengthen these buildings include:

- Reinforce large wall and roof surfaces with additional steel frame members.
- Add fasteners to increase resistance for large sheets of metal flying loose.
- Retrofit roll-up doors and regular doors with storm-resistant replacements.
- Replace existing ventilation louvers with storm-resistant, sealable and closable louvers.
- Design buildings that are still in the planning and design stages using reinforced concrete or reinforced concrete blocks.
- See Fact Sheet 3.2, *Walls and Openings*, and Fact Sheet 3.4.3, *Building Utility Systems—Plumbing*, for additional information.

Similarly, steps can be taken to decrease the impact of floods and wind on other power-related structures, including renewable energy sources. Wind turbines, for instance, can be mitigated in the following ways:

- Consider using twisted jacket foundations for wind turbines with the substructure having three or four support piles installed in a battered or twisted manner rather than using a monopile substructure.
- Switch to a downwind orientation for wind turbines.

For solar arrays (Figure 4.3.12), follow these Federal Energy Management Program recommendations from the Department of Energy:

- Use wedge-lock washers or something of a similar type for locking hardware.
- Use through-bolting fastener modules with a locking fastener.
- Use 316-grade stainless steel fasteners in corrosive environments.
- Make sure solar modules are rated for “very severe hail” to lessen debris impact damage.
- Use a three-frame rail system for better rigidity and support.
- Consult an engineer to determine what frame elements are strong enough.
- Consider using wind-calming fences along the perimeter of the array to slow damaging winds and lessen the amount of debris that enters the solar array field.
- Install equipment on pads elevated above the design flood elevation.
- If able, tilt the panels, so they protect each other.



Figure 4.3.12. Hurricane Maria severely damaged a solar array in Puerto Rico in 2017.

For other system equipment, consider:

- Installing ventilated maintenance hole covers or installing sensors on existing maintenance hole covers to prevent ejection during an outage by allowing gases to escape.
- Installing additional oil and water separator capacity to help handle accidental spills during floods.
- Expanding the use of breakaway hardware.

CONSIDERATIONS:



Option 2: Elevate Buildings, Structures and Equipment

Elevating buildings, structures and equipment above the design flood elevation can help protect them against flood damage. Fact Sheet 3.1, *Foundations*; Fact Sheet 3.4.1, *Building Utility Systems—HVAC*; Fact Sheet 3.4.2, *Building Utility Systems—Electrical*; and Fact Sheet 3.4.3, *Building Utility Systems—Plumbing*, have additional information about elevating buildings, structures and equipment.

CONSIDERATIONS:



Option 3: Use Distributed Generation

Traditionally, power plants are large generating units built in a single location to serve that specific area, which may be quite large. An outage can affect all the people being serviced in the geographic area. Distributed generation—namely, smaller generating units spread out at multiple sites over the same service area—has proven to be more resilient during and after hurricanes. This approach includes smaller generation sites, including rooftop solar panels or small wind turbines (Figure 4.3.13) and microgrids (Figure 4.3.14).



Figure 4.3.13. Individual building-based solar and wind form the backbone of widely distributed generation. (Source: U.S. Bureau of Labor Statistics, 2021)



**Figure 4.3.14. A solar array on Vandenberg Air Force Base helps power facilities on the base.
(Source: Defense Logistics Agency, photo by Airman First Class Clayton Wear, No Date)**

A similar alternative is multiple medium- or small-sized generating plants distributed over the service area. Damage still can occur, but it is likely to affect a fewer number of customers. This distributed generation approach is well-suited to islands and remote areas with no large power plant or generation grid. This approach should be evaluated for its feasibility and cost-effectiveness.

CONSIDERATIONS:



Option 4: Diversify Energy Resources

Cost, energy availability, and proximity are usually the deciding factors in selecting the energy source for a utility. The more diversified the power sources are, the more resilient the electric utility is likely to be. Geography can play a part in energy diversity, too. For example:

- Mountainous areas with high rainfall lend themselves to the development of dams with reservoirs and hydroelectric power plants.
- Coastal areas generally have more consistent and stronger winds so that wind turbines may be a good resource.
- More days of sunshine in an area may be conducive to the development of solar farms.
- More energy type and source diversity leads to better resilience after hurricanes or floods since the location does not depend on one damaged energy supplier.

CONSIDERATIONS:



Mitigation Solution: For the Smart Grid

Electrical system automation is popular with electric utilities because of the smart grid technology's remote control and data collection capabilities. This not only saves money on employee wages, but it allows for the rapid collection of system-wide data and the control of substations, transmission and distribution lines, and individual customer loads. Some critical components of smart grid systems include:

- Supervisory Control and Data Acquisition (SCADA) system: Power lines and substations are almost universally monitored and controlled remotely using a SCADA system with human operators from a remote command center. These systems collect data from substations and, based on operational parameters, may control the substation and outgoing power lines. SCADA systems are made up of numerous remote terminal units (RTUs) that collect field data and send it back to a master station. The master station displays the data and allows the operator to perform remotely controlled tasks.
- Automatic transmission and distribution line feeder reclosing: Automatic transmission and distribution line feeder reclosing provides the electronic ability to “see” a fault on a transmission or distribution line, disconnect the circuit breaker controlling that line and close back in to restore power in milliseconds (Figure 4.3.15).
- Distance to fault calculation: This software and electronic function measures the distance from the substation to the fault location on a power line. The measurement includes identifying which cable or three-phase line is faulted. This allows repair crews to be dispatched quickly to the location of the faulted line. Some systems automatically dispatch repair crews as soon as the fault is detected. This approach can shorten long power outages.
- Advanced Metering Infrastructure: For efficiency, control and cost savings, traditional meter reading of the home electric meter is being replaced with Advanced Metering Infrastructure (AMI). The benefits of this technology can be divided into two general areas: storm-hardening of multiple communications channels and storm-hardening of collection gateway sites. Because AMI is not considered mission-critical, utilities may lease third-party communication cables.

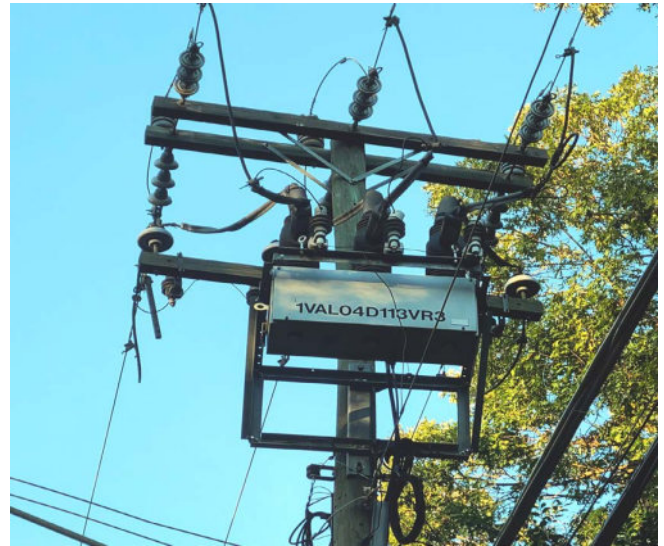

Figure 4.3.15. Pole-mounted automatic transmission and distribution line feeder reclosers can help identify and isolate faults so power can be restored quickly.

Option 1: Use Redundant Communications Channels

Dedicated fiber-optic cables can be embedded in power cables to provide additional communication channels for SCADA systems (Figure 4.3.16). These wires, called optical ground wires (OPGWs), combine the functions of grounding and communications. These cables can be:

- Embedded in overhead power neutral cables
- Properly attached to storm-hardened power poles
- Buried underground cables
- Spread spectrum radio modems (dedicated industrial radio systems) as another communication channel

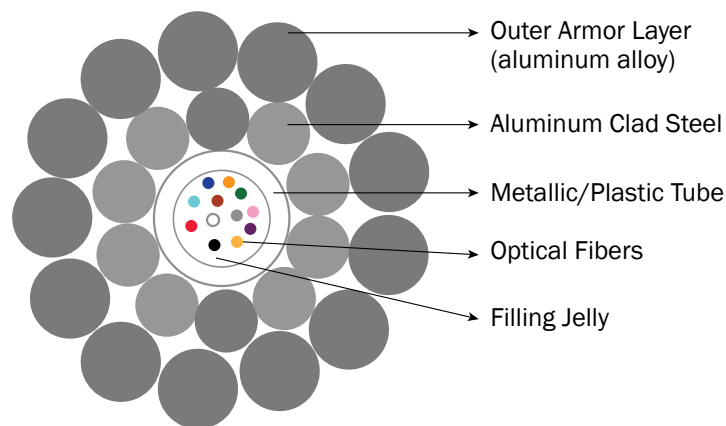
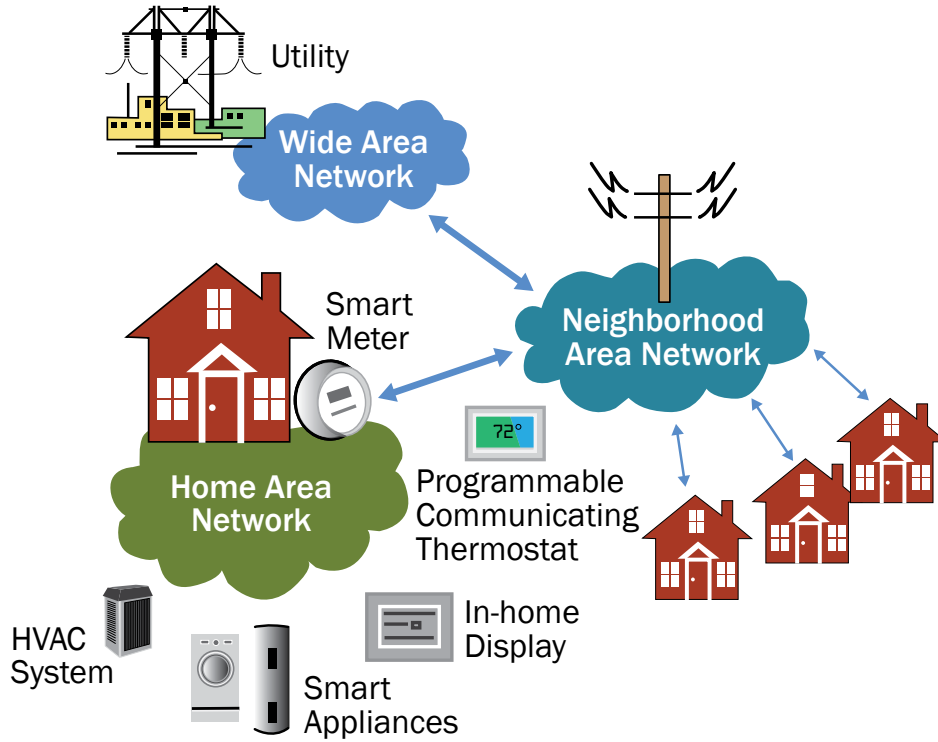

Figure 4.3.16. Dedicated fiber-optic cables embedded in power cables can provide additional communication channels for SCADA systems. (Source: Transmission-line.net, 2010)

The more communications channels that a meter can access, the more resilient the system is to outages. Figure 4.3.17 shows how wireless and wired communications channels are used. When using multiple communications channels, consider the following:

- Attach cables properly to a strengthened utility pole or bury the cables underground.
- Advanced metering infrastructure (AMI) may share cable fiber optic bundles with the SCADA system if the SCADA cable locations allow for easy connection of the AMI system.
- Install multiple communication channels between collection gateways and metering collection servers.



Advanced Metering Infrastructure with Home Area Networking

Figure 4.3.17. Simplified AMI system (Source: Christopher Villareal, 2020)

CONSIDERATIONS:



Option 2: Strengthen Data Collection Gateways

Data collection gateways collect data from sensors, meters and equipment. They are frequently situated in exposed locations like mountain tops because they need to have wireless line-of-sight radio reception from electric meters. Collection gateways should be sealed in storm-resistant cabinets or buildings (Figure 4.3.18) with wind- and flood-resistant doors, reinforced concrete or reinforced concrete block walls, and concrete roofs, and they should be raised above the highest potential flood level.

Antennas for data collection gateways should be fastened to storm-hardened round fiberglass or concrete poles set in the ground at greater-than-recommended depths and guy-wired similarly to utility poles.



Figure 4.3.18. Data collection gateways should be protected against wind by placing them in storm shelters.

CONSIDERATIONS:



REFERENCES:

- Asea Brown Boveri Ltd. (ABB). 2018. "ABB Technology helps weather-proof the US against future storms." Available at: <https://new.abb.com/news/detail/5748/abb-technology-helps-weather-proof-the-us-against-future-storms>
- Anixter. 2020. *Shoring Up: Critical Steps for Substation Flood Control*. Available at: https://www.anixter.com/en_us/resources/literature/utility-powerups/shoring-up-critical-steps-for-substation-flood-control.html
- Bharti, Ankush. 2015. "Building Services II." Available at: https://www.slideshare.net/9anku/electrical-distribution-system-52992371?from_action=save
- Bogges, J.M., G.W. Becker, and M.K. Mitchell. 2014. "IEEE 2014 T&D Conference Paper 14TD0564—Storm & Flood Hardening of Electrical Substations." Available at: <https://www.ieee-pes.org/presentations/td2014/td2014p-000564.pdf>
- Csanyi, Edvard. 2012. "Substation Main Functions and Classification." *Electrical Engineering Portal*. Available at: <https://electrical-engineering-portal.com/substation-main-functions-and-classification>
- Defense Logistics Agency. No Date. *DKA Images Solar Array*. Available at: <https://www.dla.mil/About-DLA/Images/?igsearch=solar%20array>
- Duke Energy. No Date. "How We Manage Trees." Available at: <https://www.duke-energy.com/community/trees-and-rights-of-way/how-we-manage-trees/transmission-lines-vegetation-management?jur=NC01>
- Ellsworth, James and Otto Van Geet. 2020. NREL/TP-7A40-75804. *Solar Photovoltaics in Severe Weather: Cost Considerations for Storm Hardening PV Systems for Resilience*. Golden, CO: National Renewable Energy Laboratory. Available at: <https://www.nrel.gov/docs/fy20osti/75804.pdf>
- Federal Energy Regulatory Commission (FERC). 2020. *Tree Trimming and Vegetation Management*. Available at: <https://www.ferc.gov/industries-data/resources/tree-trimming-and-vegetation-management>
- Florida Power and Light (FPL). 2010. *Distribution Engineering Reference Manual (DERM) Section 4—Overhead Line Design Addendum for Extreme Wind Loading*. Available at: http://www.floridapsc.com/library/filings/2016/07490-2016/Support/SFHHA%2015th%20POD%20Nos%20227,228-DERM%20Section%204%20Addendum%20for%20EWL_Rev%2003-09-2010.pdf
- INMR. 2021. *Applying Interphase Spacers to Control Conductor Galloping*. Available at: <https://www.inmr.com/application-composite-interphase-spacers-prevent-conductor-galloping-2/>
- New Jersey Board of Public Utilities (NJBPU). 2020. *Advanced Metering Infrastructure (AMI) Work Session*. Available at: <https://www.nj.gov/bpu/pdf/publicnotice/Nov%2023%20AMI%20Conference%20FINAL.pdf>
- Novec. 2021. *Vegetation Management*. Available at: <https://www.novec.com/Environment/Vegetation-Management.cfm>
- Occupational Safety and Health Administration (OSHA). No Date. *Electric Power Generation, Transmission, and Distribution eTool*. Available at: <https://www.osha.gov/etools/electric-power/glossary-terms>
- Ouranos. 2016. *Protecting Assets Against an Increasing Risk of Flood*. Available at: <https://www.ouranos.ca/wp-content/uploads/Case-Study-1-AN-final.pdf>
- Siemens Energy. 2015. *How to Make Cities More Resilient*. Available at: <https://new.siemens.com/global/en/company/stories/infrastructure/resilient-cities.html>

Siemens Energy. 2021. "Gas-insulated switchgear." Available at: <https://www.siemens-energy.com/global/en/offerings/power-transmission/portfolio/gas-insulated-switchgear.html>

Smart Electric Power Alliance (SEPA). 2017. *Build Back Better: Reimagining and Strengthening the Power Grid of Puerto Rico*. Available at: <https://sepapower.org/resource/build-back-better-reimagining-and-strengthening-the-power-grid-of-puerto-rico/>

Transmission-line.net. 2010. *OPGW—Optical Ground Wire*. Available at: <http://www.transmission-line.net/2010/11/opgw-optical-ground-wire.html>

U.S. Bureau of Labor Statistics (BLS). 2021. "Solar and wind generation occupations: a look at the next decade." *Beyond the Numbers*. Available at: <https://www.bls.gov/opub/btn/volume-10/solar-and-wind-generation-occupations-a-look-at-the-next-decade.htm>

U.S. Department of Energy (DOE). 2018. *Solar Photovoltaic Systems in Hurricanes and Other Severe Weather*. Available at: https://www.energy.gov/sites/prod/files/2018/08/f55/pv_severe_weather.pdf

DOE. 2020. *Roof Anchor System for Solar Panels*. Available at: <https://basc.pnnl.gov/resource-guides/roof-anchor-system-solar-panels#edit-group-training>

Velasquez, Ramon. 2013. File: Tagaytayjf9771_08.jpg. Available at: https://commons.wikimedia.org/wiki/File:Tagaytayjf9771_08.JPG

Yenumula, P., A. Haldar, and T. Chari. 2017. "Design of Direct Embedment Foundations for Poles Under Moment Loads in Granular Soils." *The Open Civil Engineering Journal*, Vol. 11. Available at: <https://opencivilengineeringjournal.com/VOLUME/11/PAGE/748/FULLTEXT/>.

Fact Sheet 4.4: Communication Towers, Masts and Antennas

The mitigation objective of this Fact Sheet is to improve the resilience of communications towers, masts and antennas that support vital communications functions at critical facilities so they can continue to operate safely.

Communications antennas often are mounted on towers or masts at heights where they can send and receive radio waves. Towers are self-supporting structures or supported on one side, while masts are held up by stays or guy wires. Towers and masts can be ground-based or mounted on rooftops. Hurricane winds can collapse towers and masts that support antennas, damaging roofing systems by puncturing roof membranes (Figure 4.4.1). Falling trees and limbs also can damage communications towers and masts, but this Fact Sheet only addresses direct damage from wind and flood.



Figure 4.4.1. The collapse of a tower with antennas can damage the roof membrane, causing it to peel.



Table 4.4.1 summarizes some standard mitigation solutions for reducing the risk of damage to communication systems from hurricanes and floods. These strategies are discussed in the sections that follow.

Table 4.4.1. Common Mitigation Solutions for Communications Systems

<i>Solutions and Options</i>	<i>Wind</i>	<i>Pluvial Flooding</i>	<i>Riverine (Fluvial) Flooding</i>	<i>Coastal Erosion</i>	<i>Storm Surge</i>
Mitigation Solution: Anchor					
Option 1: Add Bracing and Guy Wires	✓				
Option 2: Replace Gravity Supports with Structural Anchors	✓				
Mitigation Solution: Strengthen					
Option 1: Strengthen the Design	✓	✓	✓	✓	✓
Option 2: Use Appropriate Materials	✓	✓	✓	✓	✓
Option 3: Strengthen the Equipment Shelter	✓	✓	✓	✓	✓
Option 4: Strengthen Poles and Lines	✓	✓	✓	✓	✓
Option 5: Add System Redundancy	✓	✓	✓	✓	✓
Mitigation Solution: Elevate or Relocate					
Option 1: Increase the Equipment Elevation	✓	✓	✓	✓	✓
Option 2: Elevate or Change the Site Grading	✓	✓	✓	✓	✓

Mitigation Solution: Anchor

Option 1: Add Bracing and Guy Wires

In high winds, towers and masts frequently become dislodged from the building or the surface on which they are mounted. Antennas mounted on rooftop towers or masts often use only ballast to hold them in place, which quickly can become dislodged during strong winds. Anchoring using guy wires or bracing can improve the performance of towers and masts during high winds. Some things to consider when evaluating this option include:

- Attach guy wires on the towers or masts in a way that is consistent with structural and manufacturer recommendations.
- Anchor towers and masts to solid structures using corrosion-resistant through-bolts and backing plates below the roof.
- Ensure that mast and guy-wire design can resist the potential wind forces and meet design criteria for the jurisdiction. Building codes require that the antenna supports be designed for wind forces based on location, exposure and other factors.
- Consider the building's primary use, e.g., public safety, when determining the correct design level.
- Replace or modify support structures and connections to towers and masts to increase the design strength of the whole system.
- Evaluate the building or structure to which the mast and guy wires are being attached to ensure that it is structurally capable of supporting the additional loads imposed by the tower or mast.
- Develop and implement a regular tower or mast inspection and maintenance plan. Address deficiencies soon after they are discovered to keep the building and equipment in good condition.

CONSIDERATIONS:



Option 2: Replace Gravity Supports with Structural Anchors

Rooftop equipment that is gravity self-supported is vulnerable to high winds because usually it is not anchored to the structure. Instead, antennas often are mounted on towers or masts using ballast sleds and ballast blocks (mounts that rely on the weight of the blocks to keep the tower or mast in place) (Figure 4.4.2). In high-wind areas, antennas subjected to uplift from wind forces may rotate the tower, knocking ballast off the sled. A ballast sled can be replaced with a structural frame that connects directly to the building (Figure 4.2.3). A structural engineer should evaluate the roof before using structural frames to make sure the roof can provide enough support.



Figure 4.4.2. Rooftop antennas often are mounted using ballast sleds.



Figure 4.4.3. Antennas can be secured to the building structure to improve wind resistance.

When evaluating this option, consider the following items:

- On gravel ballast roofs, the gravel ballast should be removed from under the ballast frame if this approach is used.
- Antennas can be mounted on a tower or mast attached to chimneys, parapets, or other structural parts of the building using straps or anchors (Figure 4.4.3).
 - Anchors and straps should be galvanized or stainless steel to resist corrosion.
 - Anchors require holes to be drilled in the building where the attachment occurs.
 - Straps can be secured to free-standing structural building components, such as chimneys and secured to brackets mounted on the antenna.
 - Chimneys, parapets and other structures must be structurally capable of supporting the forces imposed on them by the antenna as well as their intended functions.

CONSIDERATIONS:



Mitigation Solution: Strengthen

Communications sites can include towers, masts and equipment shelters. Towers and masts can be designed to improve their performance under the forces of wind and flood at the site. Equipment shelters built at the base of large communications towers or masts to house communication equipment (Figure 4.4.4) also can be strengthened to increase the level of protection against damage from floods and hurricanes.



Figure 4.4.4. Exterior and interior of an equipment shelter.

Option 1: Strengthen the Design

Towers, masts, their components and their structural supports should be checked regularly and maintained per code recommendations. Strengthen or replace any of these components if they are not strong enough to withstand the forces of wind or water.

- Evaluate tower or mast strength as part of an assessment.
- Design according to the most recent editions of relevant codes and standards, such as ANSI-TIA-222 and ASCE 7, for expected wind and water forces or even ice loads in the geographic area where the tower is located.
- Design the tower or mast for the appropriate type of use. For example, towers and masts supporting public communications equipment have more strict design requirements than those that support equipment for commercial uses.

- Guy wires and anchors supporting towers should be designed to withstand the wind forces caused by hurricanes. These elements must be properly inspected and maintained through the life cycle of the tower to prevent any section loss from occurring. If the anchor is not strong enough to withstand the wind forces, then additional anchors should be added. These anchors would start within the existing foundation and connect to the tower leg to increase the overall anchorage ability of the tower.
- Evaluate internal bracing within the tower to ensure it can withstand the maximum wind forces for the geographic area. Bracing can be added to improve tower or mast performance in high winds.

Note

ANSI-TIA-222, *Maintenance and Condition Assessment of Telecommunications Towers*, Annex J (Normative), paragraph H outlines a recommended schedule for tower inspections. TIA recommends annual inspections for towers located along the coast subject to corrosive salt air and high winds.

CONSIDERATIONS:



Option 2: Use Appropriate Materials

Use materials suitable for the environment where the tower or mast is located, e.g., galvanized or stainless steel, best resist corrosion in outdoor locations. Metals made of different materials that are in direct contact with each other can result in galvanic corrosion. Ensure that connector metals and the tower or mast structure metals are compatible.

CONSIDERATIONS:

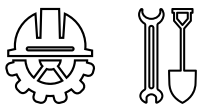

Option 3: Strengthen the Equipment Shelter

Equipment inside a shelter may be mounted to the floor, walls or ceiling via mounting racks. Cables are run through a cable port in the shelter wall and connected to the tower via the underside of a bridging structure known as an ice bridge. Depending on the elevation and location of the equipment shelter, hurricane winds and flooding both may impact the shelter. Improve the equipment shelter's ability to withstand wind and flood damage by implementing the following measures:

- Strengthen the walls and roof of the shelter by using more wind- and flood-resistant materials such as reinforced concrete.
- Improve and seal exterior doors and windows to resist debris impacts and water intrusion.
- See Fact Sheet 3.2, *Walls and Openings*, Fact Sheet 3.3.1, *Sloped Roof Systems*, and Fact Sheet 3.3.2, *Low-Slope Roof Systems*, for additional information.

CONSIDERATIONS:

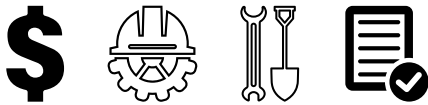

Option 4: Strengthen Poles and Lines

In some cases, antennas are mounted directly on poles rather than on towers or masts. Power and communications lines may be attached directly to the pole. To improve the resilience of communications poles and lines, consider the following:

- Use higher-strength materials for this type of pole. Ensure the pole is structurally able to withstand wind forces in the geographic area, plus the antennas mounted on the poles.
- Use guy wires with extra anchors.
- Improve the pole foundation design by using special fill materials and setting the pole deeper in the ground.
- Evaluate incoming and outgoing communications lines for sufficient strength.
 - Install dampers or de-tuners to dampen some of the vibrations.
 - Install interphase spacers to reduce galloping.
 - Increase tension in the line. This approach can be costly and may be difficult after the line has been constructed.
- See Fact Sheet 4.3, *Electric Power Systems*, for additional information about strengthening lines and poles.

CONSIDERATIONS:



Option 5: Add System Redundancy

Communications systems can stop functioning temporarily when electric power is lost or when data systems go offline. Adding redundancy to power and data systems will help ensure that the communication system continues to function during hurricanes and floods.

Secondary data systems should be in place to back up primary systems if the primary data systems go down. Processes to start the secondary systems should be well-known and practiced in advance of an emergency. Some secondary systems that may be needed include:

- Additional satellite dishes
- Additional microwave dishes
- Additional relay switches

A standby power supply is essential for keeping communications equipment on towers and masts functioning during storms. All standby power supply systems should be elevated out of the floodplain. Communications towers typically have standby generators on-site; however, they must be reachable and maintained regularly to ensure they function when most needed. Below are some key considerations:

- Standby generators must have enough fuel to keep running. Keep fuel tanks filled. If there are concerns about getting to the standby generator because of downed trees or other blockades, consider installing an additional fuel tank.
- Install a quick-connect on the tower or mast to allow a portable backup generator to be used if the primary standby generator fails.
- Consider installing a dual fuel or bi-fuel generator. This will allow continued use of the generator if supplies of one fuel type are temporarily disrupted.
- Add remote monitoring to generators to determine if automatic tests regularly occur and the duration of these tests.
- Communication systems also can use uninterruptable power supply (UPS) systems. These are generally battery systems that can provide 8 to 12 hours of continuous backup to extend connectivity.
- Renewable energy sources such as solar power can be used to provide an additional source of power and may be good options in remote areas that are not easily accessible. They can be connected to UPSs to extend battery life.
- Additional information about backup generators and fuel tanks can be found in Fact Sheet 3.4.2, *Building Utility Systems—Electrical*, and Fact Sheet 3.4.3, *Building Utility Systems—Plumbing*.

CONSIDERATIONS:



Mitigation Solution: Elevate or Relocate

Option 1: Increase the Equipment Elevation

While many towers and masts themselves cannot be elevated, they support and are supported by equipment that is located on or near the tower or mast. This support equipment should be elevated above the design flood elevation to help protect it against flood damage. When evaluating this option, consider the following:

- Design the first-floor elevation of equipment shelters to be above the design flood elevation.
- Mount floor-supported equipment on the walls or ceiling to raise the elevation of the equipment.
- Elevate the equipment shelter itself above the flood protection level (e.g., design flood elevation) to protect it from flooding. Building elevation is discussed in Fact Sheet 3.1, *Foundations*.
- If an equipment shelter is not available, mount equipment on the tower above the design flood elevation.

CONSIDERATIONS:



Option 2: Elevate or Change the Site Grading

Flooding at a tower site can block or close the access road. It also can erode and undermine the foundation, leading to uneven foundation settlement, causing further damages. Some measures that can be implemented to help prevent access road and foundation damage include:

- If a tower or mast is in a floodplain, evaluate options to relocate it outside the floodplain. If relocation is not possible, ensure roads used to access the facility will not be made impassable by floodwaters. This could involve raising the road grade, improving roadside drainage, or a combination of these measures. See Fact Sheet 1.3, *Drainage and Culverts*, for additional information about improving road drainage.
- Site location, grading and access should consider increased quantities of stormwater runoff. Site grading designs should consider how to direct large volumes of stormwater runoff away from towers or masts and access roads.
- Designs should include best practices and align with state and local requirements.

CONSIDERATIONS:

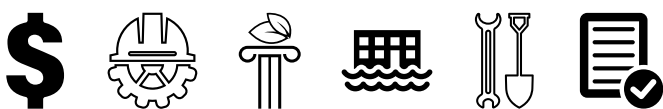

REFERENCES:

- American Society of Civil Engineers (ASCE). 2016. ASCE 7, *Minimum Design Loads for Buildings and Other Structures*. Available at: <https://www.asce.org/asce-7/>
- Federal Communications Commission (FCC). 2019. *FAA Tower & Antenna Siting*. Available at: <https://www.fcc.gov/wireless/bureau-divisions/competition-infrastructure-policy-division/tower-and-antenna-siting>
- FCC. 2020. *FCC Public Safety & Homeland Security*. Available at: <https://www.fcc.gov/public-safety-and-homeland-security>
- Federal Emergency Management Agency (FEMA). 2006. FEMA 549, *Hurricane Katrina in the Gulf Coast: Mitigation Assessment Team Report, Building Performance Observations, Recommendations, and Technical Guidance*. Available at: <https://www.fema.gov/media-library/assets/documents/4069>
- FEMA. 2007. FEMA 543, *Design Guide for Improving Critical Facility Safety from Flooding and High Winds*. Available at: https://www.fema.gov/media-library-data/20130726-1557-20490-1542/fema543_complete.pdf
- INMR. 2021. *Applying Interphase Spacers to Control Conductor Galloping*. Available at: <https://www.inmr.com/application-composite-interphase-spacers-prevent-conductor-galloping-2/>
- International Code Council (ICC). 2018. *International Building Code*. Available at: <https://codes.iccsafe.org/content/IBC2018>
- Lanier, B., et. al. 2017. "Planning Advisory Notice: Classification of Tower Structures per ANSI/TIA-222-G, IBC and ASCE 7." *Tower Times*. Available at: https://tirap.org/wp-content/uploads/2017/06/PAN_ClassTwrStructures_Jan-Feb_2017.pdf
- Telecommunications Industry Association (TIA). 2017. *ANSI/TIA-222 Structural Standard for Antenna Supporting Structures and Antennas*. Available at: https://global.ihs.com/doc_detail.cfm?&rid=IHS&item_s_key=00122271&item_key_date=821231&input_doc_number=TIA%2D222&input_doc_title=
- Yenumula, P., Haldar, A., and Chari, T. 2017. "Design of Direct Embedment Foundations for Poles Under Moment Loads in Granular Soils." *The Open Civil Engineering Journal*, Vol. 11. Available at: <https://opencivilengineeringjournal.com/VOLUME/11/PAGE/748/FULLTEXT/>.

Fact Sheet 5.0: Parks, Recreational and Other Facilities

The mitigation objective of this Fact Sheet is to provide information about mitigation strategies for parks and recreational facilities, public mass transit, earth slopes and shorelines to reduce their vulnerability to floods and hurricanes. These steps will help improve the resilience of the communities in which these facilities are located.

Hurricane and Flood Impacts

Some community facilities are not easily labeled as buildings or infrastructure, yet they are important to community resilience after a natural disaster. Some of these facilities, such as parks and recreational facilities, might be used to provide temporary disaster relief services and/or space for recovery operations to proceed, such as for temporary debris staging and removal.

Mass transit facilities can be important for getting people to place of employment, schools or tourism points of interest, thus helping a community to return to “normal” by advancing its economic recovery. Some communities are located adjacent to steep earth slopes and/or along shorelines. Maintaining these land features and protecting property also can be important to the economic well-being of the community.

Hurricanes and floods can impact these facilities by causing physical and/or environmental damage. Flooding from storm surge and heavy rains can damage buildings, structures, beaches and mass transit tunnels. It also can lead to slope instability, resulting in landslides and mudslides. Erosion and scour from flooding can cause earth instability as well, both on inland slopes and along shorelines. Erosion along shorelines or slopes can damage nearby buildings and infrastructure. Debris created by flooding and hurricanes can cause damage by striking buildings or structures, and it also can block access to roads, bridges, mass transit facilities and utilities, slowing down the recovery process.



Mitigation Fact Sheets

Parks, recreational and other facilities have been grouped into five Fact Sheets in this Handbook. Some mitigation measures presented, such as armoring and drainage, are relevant to other types of public facilities and may be referenced in other Fact Sheets in the Handbook. The five Parks, Recreational and other Facilities Fact Sheets are:

- **Parks and Recreational Facilities.** Parks and recreational facilities can be used to provide temporary disaster relief services such as food and water distribution, debris staging and other recovery services during and after floods and hurricanes. Parks and recreation facilities include buildings and structures, lighting, signs, poles and related structures such as playgrounds, benches, trash cans, fences, turf, trails and hard surfaces.
- **Mass Transit Facilities.** Mass transit support facilities rely on a network of above- and below-ground structures, tunnels and other infrastructure to provide transportation services. They include subways, rail, ferry, and/or bus systems.
- **Earth Slopes.** Earth slopes are unsupported slanting surfaces formed naturally (such as a hill slope) or artificially (such as a railway or highway embankment, an earth dam or a canal bank). They are found in communities nationwide and may have buildings, structures and infrastructure near the slope tops and/or bottoms. Transportation corridors also may be located adjacent to earth slopes. Keeping these slopes stable is important for protecting lives and property, but also for helping facilitate emergency services during and immediately after natural disasters.
- **Shorelines.** Shorelines (the boundary between a body of water and land) can be important to the economic well-being of communities and serve a commercial purpose. Not only do they provide recreational and environmental benefits to society, but ports and harbors assist in the import and export of goods and allow cruise ship access to promote tourism. Protecting shorelines helps protect public and private property, infrastructure and the environment.
- **Coastal Facilities.** Coastal facilities support the many uses of the coastal and ocean waters and waterfront. Exposure of these facilities to severe weather varies, depending primarily on their locations in relation to the shoreline. While facilities located above the high-tide line could be damaged by high winds, flooding from storm surge, wave runup, splash and corrosive air, those located below the high-tide line also could be exposed to coastal waves and currents.

Mitigation Solutions

Employing mitigation solutions for parks, mass transit facilities, earth slopes, shorelines and coastal facilities can decrease the damage from flooding and hurricanes, which in turn helps communities to recover more quickly. The applicable mitigation measures may depend on project limitations, such as availability of land and materials, and on environmental requirements. There are many potential mitigation solutions that can be used, including:

- Strengthening to resist wind and flood forces
- Relocating features to less flood- or hurricane-prone areas
- Raising or elevating components and equipment to keep them dry
- Floodproofing when relocation or elevation is not possible
- Civil engineering improvements, which include:
 - Installing or improving drainage
 - Installing retaining structures
 - Using geosynthetics







In addition to structural mitigation measures, non-structural measures also can be used and often are essential to the success of the structural/physical mitigation measures. Non-structural measures may include:

- Regularly implementing and updating an operations and maintenance program
- Starting a surveillance and monitoring program
- Preparing and regularly updating an emergency action plan

Icons

The Fact Sheets include ideas/points to consider about developing and implementing each option. These common considerations are represented by symbols/icons, which are summarized in Table 5.0.1.

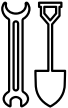
Table 5.0.1. Icons Used to Represent Considerations about Hazard Mitigation Strategies

Icon	Considerations about Hazard Mitigation Strategies
	Cost – The cost to carry out the mitigation option may be high, which could make using the option cost prohibitive.
	Engineering – A qualified engineer would likely need to design the mitigation option.
	Environmental and Historic Preservation – The mitigation option likely will need to comply with local, state and/or federal environmental and historic preservation requirements.
	Floodplain Management – Carrying out the mitigation option might impact the floodplain, triggering compliance with floodplain management requirements.
	Operations and Maintenance – The mitigation option might require additional operations and maintenance activities beyond those currently being performed.
	Permitting – Evaluate the local, state or federal permits required to carry out the mitigation option.

REFERENCES:

Recommended practices and guidance concerning listed topics can be found in the following publications:

- Bruce, D.A. 2000. Report No. FHWA-RD-99-138, *An Introduction to the Deep Soil Mixing Methods as Used in Geotechnical Applications*. Washington, DC: U.S. Department of Transportation, Federal Highway Administration. Available at: <https://www.fhwa.dot.gov/publications/research/infrastructure/pavements/99138/99138.pdf>
- California Coastal Commission. 1994. *Land Form Alteration Policy Guidance, Attachment 3: Overview of Engineering Techniques to Reduce Grading*. Available at: <https://www.coastal.ca.gov/landform/attach3.html>
- Federal Emergency Management Agency (FEMA). 1993. NFIP Technical Bulletin 3, *Non-Residential Floodproofing*. Available at: https://www.fema.gov/emergency-managers/risk-management/building-science/publications?name=%22Technical+Bulletin+3%22&field_keywords_target_id=All&field_document_type_target_id=All&field_audience_target_id=All
- FEMA. 2007. FEMA 551, *Selecting Appropriate Mitigation Measures for Floodprone Structures*. Available at: <https://www.wbdg.org/ffc/dhs/criteria/fema551>
- FEMA. 2009. *Engineering with Nature, Alternative Techniques to Riprap Bank Stabilization*. Available at: https://www.fema.gov/pdf/about/regions/regionx/Engineering_With_Nature_Web.pdf
- FEMA. 2009. FEMA P-762, *Local Officials Guide for Coastal Construction*. Available at: https://www.fema.gov/emergency-managers/risk-management/building-science/publications?name=%22P-762%22&field_keywords_target_id=All&field_document_type_target_id=All&field_audience_target_id=All
- FEMA. 2013. FEMA P-936, *Floodproofing Non-Residential Buildings*. Available at: https://www.fema.gov/emergency-managers/risk-management/building-science/publications?name=%22P-936%22&field_keywords_target_id=All&field_document_type_target_id=All&field_audience_target_id=All
- FEMA. 2013. *Mitigation Ideas, A Resource for Reducing Risk to Natural Hazards*. Available at: https://www.fema.gov/sites/default/files/2020-06/fema-mitigation-ideas_02-13-2013.pdf
- FEMA. 2014. FEMA P-312, *Homeowner's Guide to Retrofitting*. Available at: https://www.fema.gov/emergency-managers/risk-management/building-science/publications?name=%22P-312%22&field_keywords_target_id=All&field_document_type_target_id=All&field_audience_target_id=All
- FEMA. 2018. Job Aid: *Bioengineered Shoreline Stabilization*. Available at: <https://www.mass.gov/doc/bioengineered-shoreline-stabilization-job-aid/download>
- Georgia Environmental Protection Division. 2014. *Greenspace and Flood Protection Guidebook*. Available at: https://epd.georgia.gov/sites/epd.georgia.gov/files/related_files/site_page/EPDGreenspace-Flood-Guidebook.pdf
- Highland, L.M. and P. Bobrowsky. 2008. *The Landslide Handbook—A Guide to Understanding Landslides*. Reston, VA: U.S. Geological Survey, Circular 1325, 129 pp. Available at: <https://pubs.usgs.gov/circ/1325/>
- International Code Commission. 2018. *International Building Code*. (See especially Sections 105 and 1807.)
- Karstunen, M. 2014. Report No. 431, *Ground Improvement for Marginally Stable Slopes*. Norwegian Public Roads Administration. Available at: <https://pdfs.semanticscholar.org/f07c/04610383db46ede672afa4aa1f288b5e1c76.pdf>

- Kenyon, Peter. 2012. "Inflatable protection against inundation." *TunnelTalk*. Available at: <https://www.tunneltalk.com/New-Products-Dec12-Resilient-Tunnel-Plug-for-inflatable-flood-protection.php>
- Kim, Y.J., et al. 2019. "Geosynthetic reinforced steep slopes: Current technology in the United States." *Applied Sciences*, Vol. 9, No. 2008. Available at: <https://www.mdpi.com/2076-3417/9/10/2008/pdf>
- LinkedIn. 2014. *Soil Nailing*. Available at: <https://www.slideshare.net/asertseminar/soil-nailing>
- National Park Service. 2012. *Standard Mitigation Measures*. Available at: https://www.nps.gov/yose/learn/management/upload/Appendix_A_Standard_Mitigation_Measures_508.pdf
- National Wildlife Federation. 2020. *Softening Our Shorelines: Policy and Practice for Living Shorelines Along the Gulf and Atlantic Coasts*. Available at: <https://www.nwf.org/-/media/Documents/PDFs/NWF-Reports/2020/Softening-Our-Shorelines.ashx>
- National Wildlife Federation. 2020. *The Protective Value of Nature: A Review of the Effectiveness of Natural Infrastructure for Hazard Risk Reduction*. Available at: <https://www.nwf.org/-/media/Documents/PDFs/NWF-Reports/2020/The-Protective-Value-of-Nature.ashx?la=en&hash=A75F59611475502BEE58723F8B3C58423417E579>
- New York City Parks Department. 2017. *Design and Planning for Flood Resiliency*. Available at: https://www.nycgovparks.org/pagefiles/128/NYCP-Design-and-Planning-Flood-Zone__5b0f0f5da8144.pdf
- New York State Department of Transportation. 2015. *Geotechnical Design Procedure for Flexible Wall Systems*. Available at: <https://www.dot.ny.gov/divisions/engineering/technical-services/technical-services-repository/GDP-11b.pdf>
- Nicholson, P. 2015. "Objectives and approaches to hydraulic modification." *Soil Improvement and Ground Modification Methods*. Available at: <https://www.sciencedirect.com/book/9780124080768/soil-improvement-and-ground-modification-methods>
- Pohll, G.M., et al. 2013. Report No. WA-RD 787.1, *Design Guidelines for Horizontal Drains used for Slope Stabilization*. Washington State Department of Transportation. Available at: <https://www.wsdot.wa.gov/research/reports/fullreports/787.1.pdf>
- Rogers, J.D. 1992. "Recent developments in landslide mitigation techniques." *Geological Society of America Reviews in Engineering Geology*, v. IX. Available at: https://web.mst.edu/~rogersda/hazard_mitigation_techniques/recent_developments_in_landslide_mitigation_techniques.pdf
- Saftner, D., et al. 2017. *Slope Stabilization and Repair Solutions for Local Government Engineers*. Available at: <http://dot.state.mn.us/research/reports/2017/201717.pdf>
- Sprecher, M.H. 2009. "Find the right fix." *Tennis Industry Magazine*. Available at: http://www.tennisindustrymag.com/articles/2009/03/17_find_the_right_fix.html
- University of Massachusetts Extension. 2016. *Best Management Practices for Lawn and Landscape Turf*. Available at: https://ag.umass.edu/sites/ag.umass.edu/files/pdf-doc-ppt/lawn_bmp_establishment_2016_final.pdf
- U.S. Army Corps of Engineers. 1989. EM 1110-2-1204, *Environmental Engineering for Coastal Shore Protection*. Available at: https://www.publications.usace.army.mil/Portals/76/Publications/EngineerManuals/EM_1110-2-1204.pdf

- U.S. Army Corps of Engineers. 1995. EM 1110-2-1614, *Design of Coastal Revetments, Seawalls, and Bulkheads*. Available at: https://www.delmar.ca.us/DocumentCenter/View/1899/Design-of-Coastal-Revetments-Seawalls-and-Bulkheads_Army-Corps-of-Engineers-1995?bidId=
- U.S. Army Corps of Engineers. No Date *Engineering with Nature*. Available at: <https://ewn.el.erdc.dren.mil/index.html>.
- U.S. Department of Agriculture. 1996. *Engineering Field Handbook—Chapter 16, Streambank and Shoreline Protection*. Available at: https://efotg.sc.egov.usda.gov/references/public/IA/Chapter-16_Streambank_and_Shoreline_Protection.pdf
- U.S. Department of Agriculture. 2007. *Trail Construction and Maintenance Notebook*. Available at: <https://www.fs.fed.us/t-d/pubs/pdfpubs/pdf07232806/pdf07232806dpi72.pdf>
- U.S. Department of Transportation. 2001. FHWA-NHI-00-043, *Mechanically Stabilized Earth Walls and Reinforced Soil Slopes Design & Construction Guidelines*. Available at: <https://soilretention.com/wp-content/uploads/2015/10/0413110450FHWA-NHI-00-043.compressed.pdf>
- U.S. Department of Transportation. 2009. Report Nos. FHWA-NHI-10-24 and FHWA GEC 011-Vol I, *Design of Mechanically Stabilized Earth Walls and Reinforced Soil Slopes—Volume I*. Washington, DC: U.S. Department of Transportation, Federal Highway Administration. Available at: <https://www.fhwa.dot.gov/engineering/geotech/pubs/nhi10024/nhi10024.pdf>
- U.S. Department of Transportation. 2015. *Soil Nail Walls Reference Manual*. Available at: <https://www.fhwa.dot.gov/engineering/geotech/pubs/nhi14007.pdf>
- U.S. Geological Survey. 2004. *Formation, Evolution, and Stability of Coastal Cliffs—Status and Trends*. Available at: <https://pubs.usgs.gov/pp/pp1693/pp1693.pdf>
- Washington Forest Protection Association. 2017. *Deep-Seated and Shallow-Rapid Landslides: Know the Difference*. Available at: <http://www.wfpa.org/news-resources/blog/deep-seated-landslides-shallow-landslides-washington/>
- Wold, R.L. and C.L. Jochim. 1989. FEMA 182, *Landslide Loss Reduction: A Guide for State and Local Government Planning*. Washington, DC: Federal Emergency Management Agency. Available at: <https://www.hsd.org/?abstract&did=234464>

Fact Sheet 5.1: Parks and Recreational Facilities

The mitigation objective of this Fact Sheet is to protect parks and recreational facilities, including picnic facilities, playgrounds, basketball and tennis courts, baseball fields, swimming pools and trails, from damage caused by hurricanes or floods.

This Fact Sheet describes mitigation solutions available for various components that are part of parks and recreational facilities, including:

- Associated structures found at parks and recreational facilities, such as playgrounds, sport fields and courts, swimming pools, benches, trash containers and fences
- Surfaces at these facilities that could be damaged by flooding or high winds, such as turf, trails and hard surfaces

Parks and recreational areas also can have different types of buildings and structures, such as recreation centers, maintenance facilities and picnic shelters. Because parks and recreational facilities can be used to help provide disaster recovery services, it is important to protect these facilities against the impacts of hurricanes and floods so they can serve these important functions. Information about mitigation solutions for buildings and structures are included in Fact Sheet Series 3, *Buildings*, which addresses foundations; walls and openings; roofs; HVAC, plumbing and electrical systems; and conveyances.

Parks and recreational areas also can have lighting, signs and poles to provide information to facility users about the facilities and to make them easier to use. Information about mitigation solutions for lights, signs and poles are included in Fact Sheet 1.5, *Roadways Lights, Poles, and Signage*. While that fact sheet is written in the context of transportation lights, signs and poles, the same mitigation solutions apply to lights, signs and poles in parks and recreational areas.

Some common mitigation solutions for protecting other parks and recreational facilities are summarized in Table 5.1.1.



Table 5.1.1. Common Mitigation Solutions for Parks and Recreational Facilities

Solutions and Options	Strengthen	Anchor or Embed	Add or Modify Drainage	Aerate	Seed	Resurface	Stabilize Stream-banks
Mitigation Solution: For Accessory Structures							
Option 1: Surface Mounts		✓					
Option 2: Chaining		✓					
Option 3: Embedding		✓					
Mitigation Solution: For Sport Courts							
Option 1: Resurfacing	✓					✓	
Mitigation Solution: For Landscaping							
Option 1: Drainage			✓		✓	✓	✓
Option 2: Turf				✓	✓		
Option 3: Trails and Hard Surfaces			✓			✓	✓

Mitigation Solution: For Accessory Structures

Accessory structures within parks and recreational facilities include playground equipment, benches, trash cans, fences, bicycle racks, etc. When not properly supported or anchored, storm surge, floodwaters, and wind can displace or damage these components so that they become water- or wind-borne debris, creating a threat of structural damage. Anchoring these structures can help prevent them from becoming potentially damaging debris.

Option 1: Surface Mounts

Surface mounts consist of clamps or brackets that can be bolted to concrete to help anchor structures in parks (Figure 5.1.1).

When evaluating this option, keep these considerations in mind:

- Place the clamp, bracket or mounting flange over the bottom part of the structure's frame.
- Drill holes into the concrete and use a wedge lock anchor or epoxy to anchor the clamp or bracket to the concrete.
- Hot-dipped galvanized or stainless steel brackets and anchors are recommended for outdoor use to resist corrosion.
- Only use wedge lock anchors in concrete. When drilling into concrete, try to avoid drilling through rebar by obtaining the mesh spacing ahead of time. If rebar is encountered during drilling, it may be possible to angle the hole to miss the rebar and backfill the additional space with epoxy.
- Anchor embedment is a function of anchor diameter. Charts are available to indicate minimum embedment depth for different anchor diameters.



Figure 5.1.1. Bolted brackets or clamps can be used to anchor some structures.

CONSIDERATIONS:

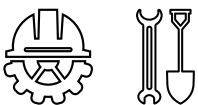

Option 2: Chaining

Attach chains or steel cables to heavy-duty helical ground anchors to help anchor picnic tables, benches, other park furnishings and some appurtenances (Figure 5.1.2).

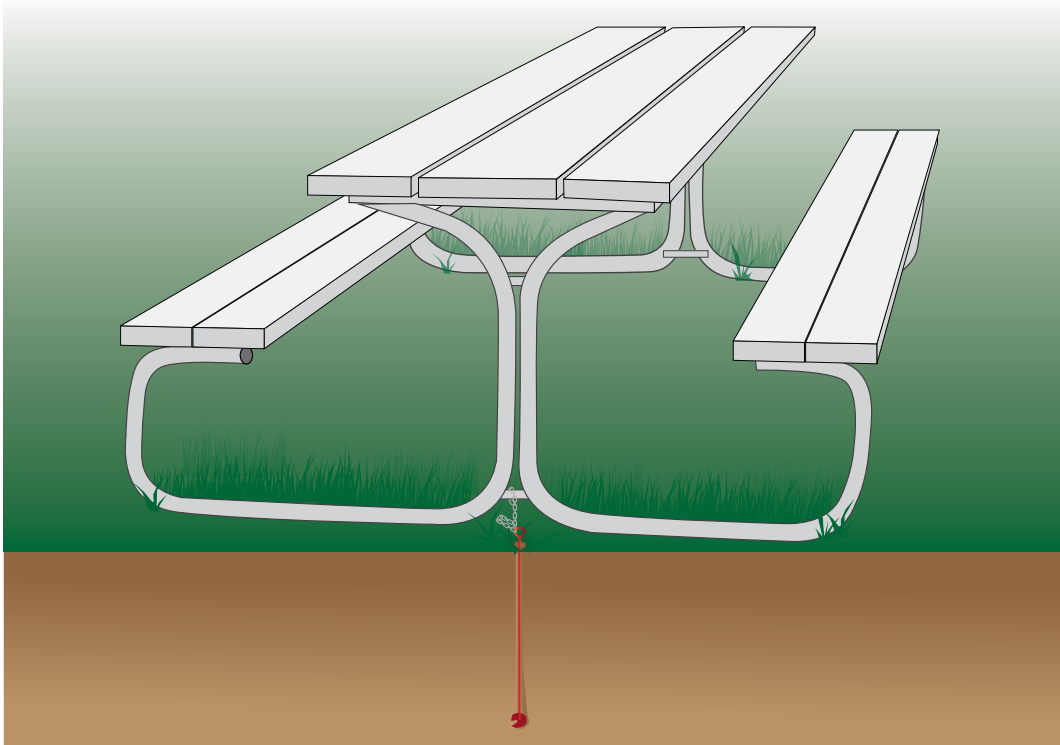
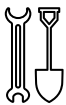

Figure 5.1.2. Chains or steel cables attached to ground anchors can be used to anchor park structures.

When evaluating this option, keep these considerations in mind:

- Install the ground anchor flush with the ground.
- Locate the anchor and chain so that they do not present a tripping hazard.
- Install the anchor deep enough to resist uplift forces.
- The soil must be strong enough to resist the anchor pulling out of the ground.
- The cable or chain should be corrosion resistant.

CONSIDERATIONS:



Option 3: Embedding

Embed the foundations or bottoms of some structures found in parks or recreational facilities deep enough in soil to prevent them from becoming dislodged by flood or wind (Figure 5.1.3). If the soil is not strong enough to support the structure, install it in concrete (Figure 5.1.4).

When evaluating this option, keep these considerations in mind:

- Embed poles and posts deep enough to prevent toppling failures.
- If on-site soils have enough strength, backfilling with soil is likely to be less expensive than backfilling with concrete.
- Place fence posts, bicycle racks, etc., in excavated holes and backfill the holes with concrete to anchor the posts.
- Backfilling posts placed in holes with concrete is recommended for asphalt, decomposed granite or earth surfaces.

CONSIDERATIONS:



Figure 5.1.3. Some park equipment can be embedded deep enough into the ground to improve stability.

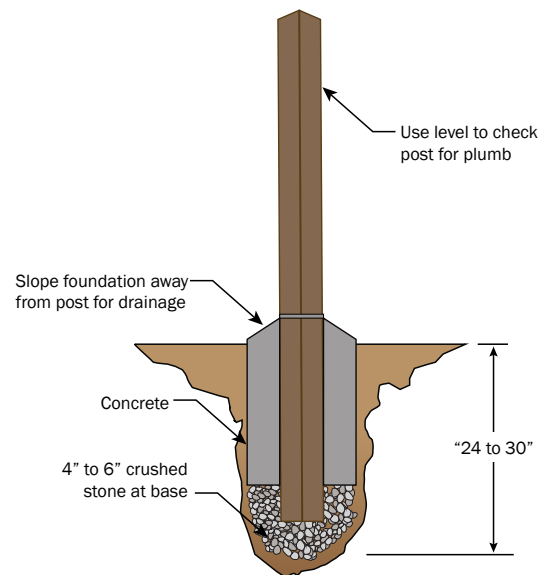

Figure 5.1.4. Poles and posts embedded in concrete can help resist wind.

Mitigation Solution: For Sport Courts

Option 1: Resurfacing

Basketball and tennis courts create areas for water to pond and run off. Depending on the condition of the court, standing water on these surfaces can be lessened.

- Resurface courts in good condition using an acrylic coating over the existing asphalt or porous concrete. This will make the surface more resistant to weather-related damage.
- Cracked courts may benefit from applying a geotextile over the existing court, then adding a layer of freely draining sand or gravel, and then applying new asphalt or concrete and the acrylic finish surface (Sprecher, 2009) (Figure 5.1.5).

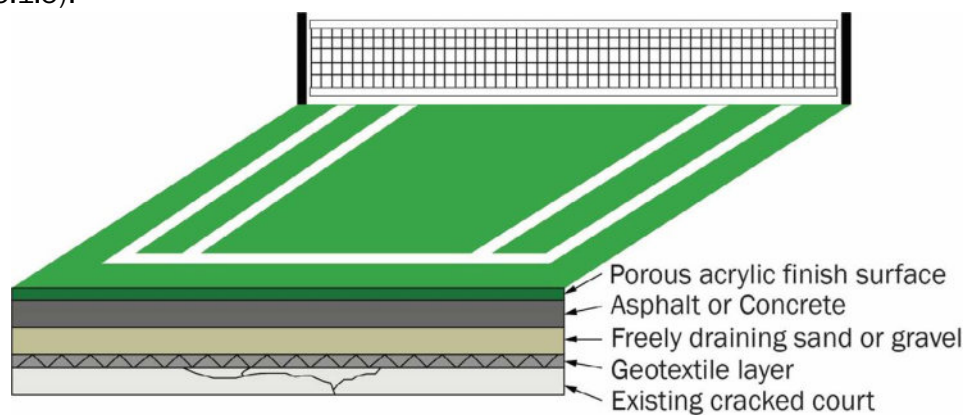

Figure 5.1.5. New courts can be overlaid on existing cracked tennis and basketball courts.

CONSIDERATIONS:



Mitigation Solution: For Landscaping

Option 1: Drainage

Because parks often are near flooding sources or in a flood zone, making the most of drainage is an important mitigation solution. Potential approaches for reducing surface flows and improving drainage include:

- Change the channel of a water body to increase its ability to carry moving floodwaters away from areas where damage could occur. This approach may require permits for working in water.
- Use both nature-based solutions (for example, bioswales) and hardscape principles (for example, installing a culvert) to improve drainage (Figure 5.1.6).

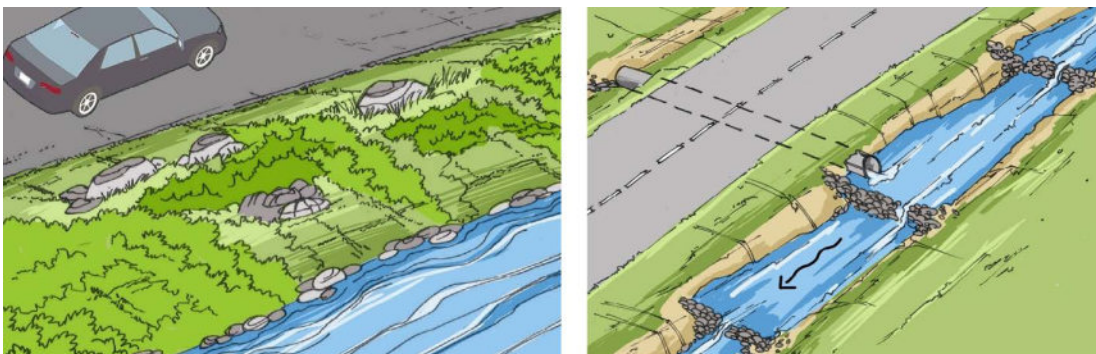

Figure 5.1.6. A bioswale can help retain floodwaters (left), and a culvert pipe can direct flow under a road or trail (right).

- Use native plants for nature-based solutions, as these plants easily adapt to the environment and are more resilient to natural disasters.
- See Fact Sheet 1.3, *Drainage and Culverts*, for additional information about drainage structures.
- See Fact Sheet 5.3, *Earth Slope Stabilization*, for additional information about nature-based solutions.

Drainage improvements may help in one area but create new challenges in another area. For example:

- Whenever drainage improvements are considered as a flood mitigation measure, evaluate the effects upstream and downstream from the proposed improvements using a Hydrology and Hydraulics (H&H) study.
- Other environmental concerns may arise with drainage projects. Consider topography, local and state environmental factors and requirements, U.S. Fish and Wildlife Service (USFWS) requirements, U.S. Army Corps of Engineers (USACE) permit requirements, the potential need for an environmental site assessment (ESA), and other federal environmental requirements when creating the mitigation project.

CONSIDERATIONS:



Option 2: Turf

Well-managed landscape and turf zones in parks and recreational areas help promote drainage and floodwater retention, while also decreasing erosion and sediment movement. Mitigation solutions using turf include:

- Manage vegetation to provide open space for native turfgrass, shrubs and trees to remain healthy.
- Control or eliminate harmful weeds and non-native plants using locally approved methods.
- Reduce soil compaction from foot traffic and machinery. Aerate and de-thatch as necessary to reduce soil compaction.
- Temporarily close off newly seeded areas to allow the grass to grow. Use clean straw or biodegradable fiber rolls to cover and protect seeded areas to help protect new seed.
- Provide underground drainage as appropriate prior to planting.
- Use multiple, short watering cycles to increase water absorption and decrease runoff.

CONSIDERATIONS:

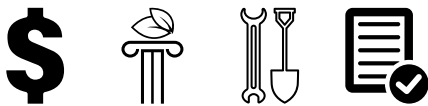

Option 3: Trails and Hard Surfaces

Building and expanding pathways to guide pedestrian/bicycle and vehicle traffic in specific areas, which often are called greenways, helps maintain open space and natural areas (Figure 5.1.7). Erosion caused by flowing water can damage these pathways. Common mitigation solutions include:

- When designing trails, consider slope, width, soil and underground conditions to evaluate the erosion potential and maintenance needs, which will help make decisions about if or how a trail will be paved. Determine which permits will be required, if any.
- Elevate the surface structures above the design flood elevation to allow floodwaters to follow a more natural flow path.
- Stabilize streambanks along trails and hard surfaces to protect walkways from damage without losing the scenic value (Figure 5.1.8). Nature-based solutions can work well for streambank stabilization and provide additional environmental benefits.



Figure 5.1.7. Greenways can help direct and absorb floodwaters.



Figure 5.1.8. Nature-based solutions or hybrid approaches to streambank stabilization (combining hardscapes with nature-based solutions) can protect trails and other park facilities.

CONSIDERATIONS:



REFERENCES:

Detailed technical information on retrofitting and floodproofing methods, considerations, and general design practices can be found in these publications. This list is not exhaustive but provides some information that can be used for decision-making and design.

Federal Emergency Management Agency (FEMA). 2007. FEMA 551, *Selecting Appropriate Mitigation Measures for Floodprone Structures*. Available at: <https://www.wbdg.org/ffc/dhs/criteria/fema551>

FEMA. 2009. FEMA P-762, *Local Officials Guide for Coastal Construction*. Available at: https://www.fema.gov/emergency-managers/risk-management/building-science/publications?name=%22P-762%22&field_keywords_target_id=All&field_document_type_target_id=All&field_audience_target_id=All

FEMA. 2013. FEMA P-936, *Floodproofing Non-Residential Buildings*. Available at: https://www.fema.gov/emergency-managers/risk-management/building-science/publications?name=%22P-936%22&field_keywords_target_id=All&field_document_type_target_id=All&field_audience_target_id=All

Georgia Environmental Protection Division. 2014. *Greenspace and Flood Protection Guidebook*. Available at: https://epd.georgia.gov/sites/epd.georgia.gov/files/related_files/site_page/EPDGreenspace-Flood-Guidebook.pdf

National Parks and Recreation Association. 2019. "FEMA funding for building nature-based resilient communities." *Parks & Recreation Magazine*. Available at: <https://www.nrpa.org/parks-recreation-magazine/2019/april/fema-funding-for-building-nature-based-resilient-communities/>

National Park Service. 2012. *Standard Mitigation Measures*. Available at: https://www.nps.gov/yose/learn/management/upload/Appendix_A_Standard_Mitigation_Measures_508.pdf

New York City Parks Department. 2017. *Design and Planning for Flood Resiliency*. Available at: https://www.nycgovparks.org/pagefiles/128/NYCP-Design-and-Planning-Flood-Zone__5b0f0f5da8144.pdf

Sprecher, M.H. 2009. "Find the Right Fix." *Tennis Industry Magazine*. Available at: http://www.tennisindustrymag.com/articles/2009/03/17_find_the_right_fix.html

University of Massachusetts Extension. 2016. *Best Management Practices for Lawn and Landscape Turf*. Available at: https://ag.umass.edu/sites/ag.umass.edu/files/pdf-doc-ppt/lawn_bmp_establishment_2016_final.pdf

Fact Sheet 5.2: Mass Transit Facilities

The mitigation objective of this Fact Sheet is to protect mass transit facilities, including subway, rail, ferry, and bus systems, from damage caused by hurricanes or floods.

Mass transit systems rely on a network of above- and below-ground components to function. Parts of the network that would be at risk from floods or hurricanes include, but are not limited to:

- Tunnels, entrances and ventilation shafts
- Retaining walls
- Underpasses
- Buildings
- Stations
- Mechanical systems
- Electrical systems
- Drainage systems
- Ventilation systems

Mass transit facilities can be protected from floodwater by:

- Hardening or dry floodproofing entrances and openings
- Elevating equipment and rail structures above the design flood elevation (or as high as possible given their locations)
- Floodproofing equipment that cannot be elevated
- Armoring embankments to protect from erosion
- Protecting drainage systems from debris and other obstructions
- Constructing floodwalls along tracks to protect areas exposed to coastal surge or other extreme flooding

Mitigation strategies for many of these systems are addressed in other fact sheets. Table 5.2.1 identifies where additional information on these system components can be found.



Table 5.2.1. Additional Information on Mass Transit Facility Vulnerabilities and Mitigation Solutions

System Component	Vulnerability	Fact Sheet
Buildings		
Pump Building	<ul style="list-style-type: none"> ■ Flooded equipment fails to operate ■ Flooded electrical systems lose power and may become corroded 	Fact Sheet 3.4.1, <i>Building Utility Systems—HVAC</i> Fact Sheet 3.4.2, <i>Building Utility Systems—Electrical</i> Fact Sheet 3.4.3, <i>Building Utility Systems—Plumbing</i>
Electrical Substation	<ul style="list-style-type: none"> ■ Flooded electrical systems lose power and may become corroded 	Fact Sheet 3.4.2, <i>Building Utility Systems—Electrical</i> Fact Sheet 4.3, <i>Electric Power</i>
Offices and Control Rooms	<ul style="list-style-type: none"> ■ Loss of function of operation centers and equipment 	Fact Sheet 3.2, <i>Walls and Openings</i> Fact Sheet 3.4.1, <i>Building Utility Systems—HVAC</i> Fact Sheet 3.4.2, <i>Building Utility Systems—Electrical</i> Fact Sheet 3.4.3, <i>Building Utility Systems—Plumbing</i>
Stations		
Multimodal Hubs	<ul style="list-style-type: none"> ■ Facility becomes inaccessible to commuters due to flooding ■ Flood damage can cause lengthy transportation delays during repair 	Fact Sheet 1.1, <i>Road and Highway Surfaces</i>
Underground Stations	<ul style="list-style-type: none"> ■ Stormwater can enter the station through entrances, utility accesses, and vent openings, making the station inoperable ■ Flooded electrical systems lose power and may become corroded 	Fact Sheet 3.4.2, <i>Building Utility Systems—Electrical</i>
Subway Entrances	<ul style="list-style-type: none"> ■ Flooding creates high-velocity flow into stations and tunnels 	Fact Sheet 3.2, <i>Walls and Openings</i>
Platforms/Surface-Level Stations	<ul style="list-style-type: none"> ■ Wave action and stormwater flow may weaken concrete platforms through erosion ■ Erosion can occur at stairs and pavement areas 	Fact Sheet 3.1, <i>Foundations</i>

System Component	Vulnerability	Fact Sheet
Parking Lots	<ul style="list-style-type: none"> ■ Moving floodwaters and wave action can cause erosion and scour ■ Saturated soils can cause subsidence 	<p>Fact Sheet 1.1, <i>Road and Highway Surfaces</i></p> <p>Fact Sheet 1.2, <i>Road Shoulders and Embankments</i></p>
Equipment and Access		
Sidewalk Vents and Other Ventilation Structures	<ul style="list-style-type: none"> ■ Flooded electrical systems lose power ■ Stormwater can enter the tunnel through ventilation shafts ■ Flooding may cause stations or tunnels to be impacted by fresh or brackish water 	<p>Fact Sheet 3.2, <i>Walls and Openings</i></p> <p>Fact Sheet 3.4.1, <i>Building Utility Systems—HVAC</i></p> <p>Fact Sheet 3.4.2, <i>Building Utility Systems—Electrical</i></p>
Access and Emergency Hatches	<ul style="list-style-type: none"> ■ Flooding can lead to seepage, which may cause stations or tunnels to be impacted by fresh or brackish water 	Fact Sheet 3.2, <i>Walls and Openings</i>
Manholes	<ul style="list-style-type: none"> ■ Flooding can lead to leaking, which may cause underground utilities to be impacted by fresh or brackish water 	Fact Sheet 3.2, <i>Walls and Openings</i>
Generators	<ul style="list-style-type: none"> ■ Flooding can damage generators or cause them to short out ■ Backup power becomes unavailable 	<p>Fact Sheet 3.4.2, <i>Building Utility Systems—Electrical</i></p> <p>Fact Sheet 4.3, <i>Electric Power</i></p>
Fueling Stations	<ul style="list-style-type: none"> ■ Inability to access fuel disrupts operations ■ Pumps cannot operate due to power loss 	<p>Fact Sheet 1.1, <i>Road and Highway Surfaces</i></p> <p>Fact Sheet 3.4.4, <i>Building Utility Systems—Other</i></p>
Fences and Guardrails	<ul style="list-style-type: none"> ■ Flood-borne and wind-driven debris cause structural damage 	Fact Sheet 1.4, <i>Bridges</i>
Maintenance Facilities		
Maintenance Yard	<ul style="list-style-type: none"> ■ Loss of function of maintenance facility due to flooding can reduce fleet ■ Flooding and wave action can cause erosion ■ Flooded equipment fails to operate ■ Flooded electrical systems lose power and may become corroded 	<p>Fact Sheet 1.1, <i>Road and Highway Surfaces</i></p> <p>Fact Sheet 1.2, <i>Road Shoulders and Embankments</i></p> <p>Fact Sheet 3.4.2, <i>Building Utility Systems—Electrical</i></p>
Specialized Equipment	<ul style="list-style-type: none"> ■ Specialized maintenance equipment, such as cranes, lifts and pits, may become damaged due to flooded electrical systems or may be clogged with sediment 	<p>Fact Sheet 3.4.2, <i>Building Utility Systems—Electrical</i></p> <p>Fact Sheet 3.4.4, <i>Building Utility Systems—Other</i></p>

Table 5.2.2 summarizes common strategies for reducing the vulnerability of mass transit facilities to floods and hurricanes. These strategies are discussed in the sections that follow.

Table 5.2.2. Table 5.2.2. Common Mitigation Solutions for Mass Transit Facilities

<i>Solutions and Options</i>	<i>Flooding</i>	<i>Wind</i>
Mitigation Solution: For Tunnels		
Option 1: Use Inflatable Plugs	✓	
Option 2: Cover Vents and Seal Street-Level Openings	✓	
Option 3: Install Deployable Barriers	✓	
Option 4: Install a Floodwall	✓	
Option 5: Elevate Utilities	✓	
Option 6: Seal Conduits and Openings	✓	
Mitigation Solution: For Railways		
Option 1: Elevate Rail Line and Equipment	✓	
Option 2: Install Backup Power	✓	✓
Mitigation Solution: For Catenary Overhead System		
Option 1: Strengthen the Whole System	✓	✓

Mitigation Solution: For Tunnels

Tunnels—necessary for roads, rail and utilities—are vulnerable to flooding and erosion. Figure 5.2.1 shows a cross section of a typical subway tunnel.

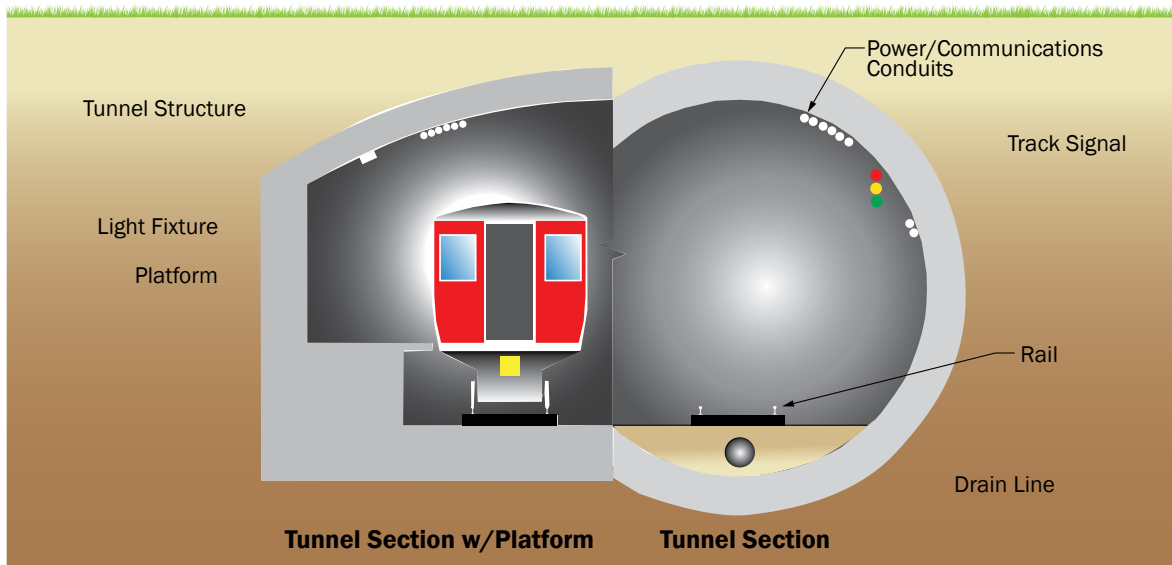

Figure 5.2.1. Subway tunnel cross section.

Flooding can be caused by heavy rainfall, storm surge, increased wave action, or high stream and river flow levels. Flooding occurs when water enters the main tunnel through vent shafts, utility conduits, stairways and other openings. Flooding also happens when water seepage or flows exceed the drainage system capacity or when the storm interrupts the power to drainage system pumps. In addition to flooding and loss of power inside the tunnels, floodwater that enters ventilation shafts also can result in loss of function of the tunnel.

Damage to tunnels can include the following:

- Soils saturated by flooding cause the walls, slopes and embankments around the tunnel to become unstable.
- Tunnel utility conduits that house electrical lines, natural gas pipelines, communications cables (like fiber optics), and water lines can be damaged by saltwater, disrupting utility service.
- Utility conduits and the wall openings through which they pass are seldom watertight, allowing water to enter the utility conduit and the tunnel itself.
- Water-borne material such as soil, vegetation or floating debris can clog drainage inlets, pipes or vents, or it can block or damage fire and life safety systems.

Option 1: Use Inflatable Plugs

Inflatable tunnel plugs are large, cylindrical balloon-like objects made from special fabric that can be used to seal tunnels to protect them against flooding (Figure 5.2.2).



**Figure 5.2.2. Inflatable plugs can prevent flooding in tunnels.
(Source: Department of Homeland Security, 2017)**

When evaluating this option, keep these considerations in mind:

- Use air or water to inflate the plug. The plug can inflate in several minutes and can achieve full internal pressure in about 15 to 20 minutes (Kenyon, 2012).
- The fully inflated plug is approximately 32 feet long.
- The plug is adaptable to different tunnel shapes.
- The deflated plug can be stored relatively easily by laying it flat against the tunnel wall.
- A leakage rate of 200 gallons to 400 gallons per minute requires pumps to remove the water.

CONSIDERATIONS:



Option 2: Cover Vents and Seal Street-Level Openings

Covering ground-level vents and openings prevents floodwater from flowing into underground rooms and shafts. Raise some vent covers above the ground surface to prevent flooding (Figure 5.2.3).

- Automate covers or louvers or allow sufficient time for manual deployment.
- Some systems, such as water-sensitive louvers, are designed to close automatically when water levels rise.
- Installing watertight hatches and lining manhole covers with pans to prevent leaking also can reduce seepage from the street level.



Figure 5.2.3. Elevated vent covers help protect against subway flooding while also acting as public sculptures.
(Source: Jim Henderson, 2009)

CONSIDERATIONS:



Option 3: Install Deployable Barriers

Underground subway stations have multiple access points that are vulnerable to flooding. These include entrance stairwells and elevator shafts. Deployable barriers can include active and passive barriers. Active barriers such as flood gates and flood barriers are protective structures that can be deployed relatively quickly to protect buildings and structures from flooding (Figure 5.2.4 and Figure 5.2.5). Passive barriers (also called self-actuating barriers) gauge the rising water to activate deployment.



Figure 5.2.4. Flood gates and flood barriers can help protect buildings and structures against rising water.



Figure 5.2.5. Recessed passive barriers float into place automatically to protect against flooding.

When evaluating this option, keep these considerations in mind:

- Surround elevators and stairs by a temporary flood barrier to act as a dam and prevent water entry.
- Manual flood gates and barriers that require human deployment may be hinged, drop-in/lift-out, sliding, bolt-on, or modular panels.
- Passive flood gates and barriers may be flip-up or recessed.
- Passive barriers do not require electricity. They will automatically deploy when the water reaches a certain level.
- Products such as stackable flood panels or logs require manual deployment and, therefore, must be installed before flooding occurs.
- Deployable fabric covers and barriers close stair entrances, forming a barrier with only minimal leaking during floods (Figure 5.2.6).
- Depending on the type of barrier used, there might be height and length limitations.
- Flood gates and barriers can be effective against relatively shallow flooding (3 feet to 4 feet deep or less).
- The life cycle costs for flood gates and barriers can be relatively high.

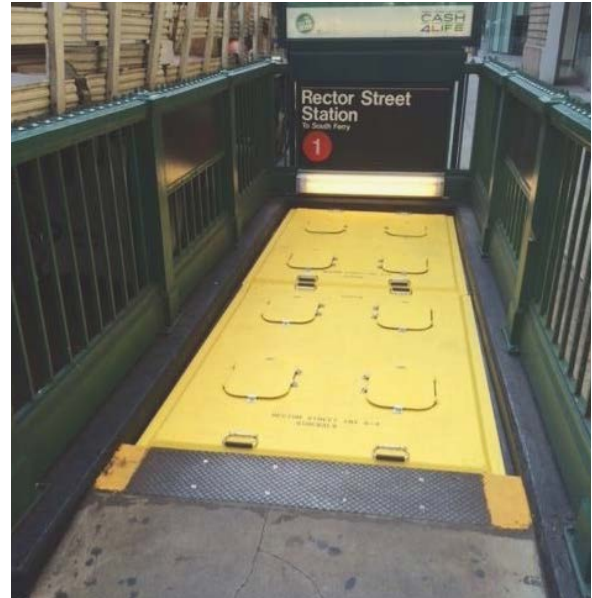

Figure 5.2.6. Deployable covers for subway access stairways can help prevent flooding of underground stations. (Source: Metropolitan Transportation Authority, 2021)

CONSIDERATIONS:



Option 4: Install a Floodwall

Installing a floodwall around entrances to tunnels can help prevent surge or flood flows from running over existing embankments or retaining structures by holding back water (Figure 5.2.7).



Figure 5.2.7. Floodwalls can help protect buildings from being flooded.

When evaluating this option, keep these considerations in mind:

- Floodwalls usually are constructed of reinforced concrete or masonry.
- Floodwalls work best where space is limited or where fast-moving water might cause erosion.
- The height of the floodwall is dependent on local criteria. Verify local building code and zoning requirements to ensure the wall complies.
- Design floodwalls high enough to protect against expected future flood heights.
- Extend the length and height of existing floodwalls to provide greater flood protection and additional freeboard to guard against wave overtopping.
- Design floodwalls to withstand the force of water acting on it. If the wall is in an area that has adopted codes that reference ASCE 7, the wall must be designed to comply with the load combinations included in ASCE 7.
- Soil type may impact floodwall design. Soils such as sands and gravels have a higher chance of seepage. Install drainage at the footing foundation of the wall in locations where soils are susceptible to seepage.
- Design and install sump pumps to remove water that collects behind floodwalls.
- Floodwalls may require extensive annual maintenance.
- Floodwalls can be designed to be aesthetically pleasing.
- Floodwalls typically are cost effective only where flood depths do not exceed 3 feet to 4 feet.

CONSIDERATIONS:



Option 5: Elevate Utilities

Tunnels contain electronic components such as lights, signals and equipment—all of which require power. Attach power systems in tunnels directly to the tunnel wall or install them in conduits (i.e., piping that holds the various types of lines, i.e., electric, fiber optic, communications, etc.). Elevating equipment as high as possible within the tunnel can help protect it against flood damage.

When considering this option, keep these points in mind:

- Where possible, make connections, taps and splices that involve removing cable sheaths and conductor insulation above the flood protection level.
- Evaluate utilities to decide if they need to be anchored to resist floating, water forces, erosion or scour that could free the utility line.
- When elevation or relocation are not possible, install equipment and wiring below flood protection level to facilitate access for post-flood repair, such as corrosion-resistant conduit systems that allow flood-damaged conductors to be replaced.

Option 6: Seal Conduits and Openings

Cables and conduits pass through openings in the tunnel wall to connect the transit system components to the power supply system. Unsealed openings have the potential to allow floodwater through. Floodwater can damage electrical system components, especially if the system is under water. If electrical system components are exposed to saltwater, this creates an additional risk of corrosion, which will impact the system's function. If raising system components is not possible, improving seals around openings could provide some protection.

When evaluating this option, keep these considerations in mind:

- Use a mechanical pipe penetration seal, or grouted seal, to make a watertight seal between the conduit and its wall opening. Expanding foam systems also can be used, but they should be appropriate for the purpose and setting where they are used.
- Make sure sealants can withstand being under water for the total time of the flood.
- Test seals to make sure they are fully watertight.
- Water pressure acting on the seal could damage it and result in leaks.

CONSIDERATIONS:



Mitigation Solution: For Railways

A rail system is made up of rails attached to timber or concrete ties that lay in a bed of graded ballast (equally sized crushed rock) (Figure 5.2.8). Different components of rail systems are described below:

- Trackside equipment, such as switches, are vital to railroad operation. Trackside electronic signaling systems that monitor operation and track condition control most rail systems.
- Heavy rail and subway systems may have a railway electrification system (electric railway) to power the train, also called a “third rail.”
- Power also can be delivered through an overhead line, which is attached to tunnel ceilings, poles, or trackside towers.
- In urban settings, heavy rail may be separated, running in underground tunnels or as a raised system.
- Light railways, trams, trolleys, cable cars and street cars usually are not at a separate elevation and often run along the street.
- Monorails use one rail instead of a two-rail system.

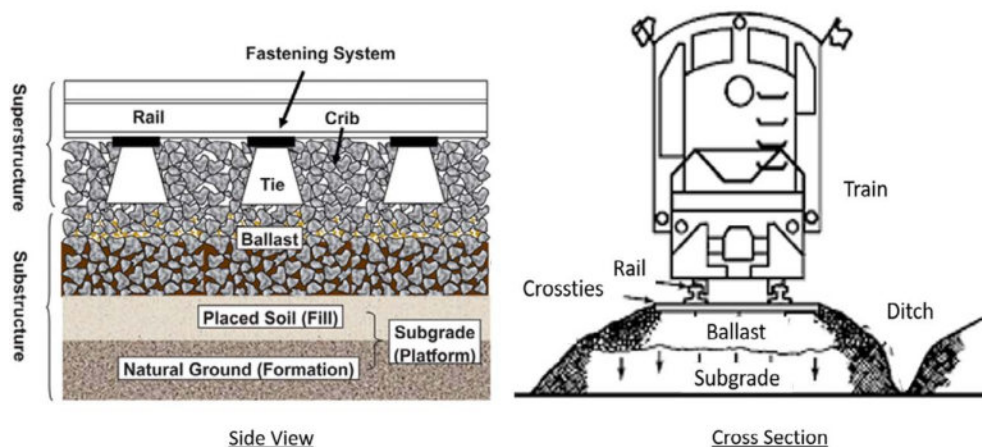

Figure 5.2.8. Rail system components.

Rail is at risk during floods and hurricanes from erosion, corrosion from saltwater, flooding of trackside equipment, wind damage, debris strikes, and debris blocking the track. Electric traction and electronic signaling systems are especially vulnerable to power outages. Railway damage may include track damage, halted rail service, and damaged or destroyed equipment.

Mitigation solutions for rail include:

- Raising track elevation and equipment
- Floodproofing equipment
- Providing backup power
- Improving drainage systems

Option 1: Elevate and Floodproof Rail Line and Equipment

In small areas where there is localized flooding, the best solution may be to elevate the rail lines and trackside equipment if frequent flooding threatens the system or that line of the system. Where equipment cannot be elevated, it should be floodproofed.

When evaluating this option, keep these considerations in mind:

- Elevate the railroad superstructure (see Figure 5.2.8) above the design flood elevation by raising the subgrade. This could require major changes to meet elevation requirements, which may make it a less desirable solution.
- Combine adding elevation with embankment slope protection measures. This approach may require surface drainage improvements.
- Adding fill to a floodplain will require approval from the local or state floodplain management agency since using fill to raise the rail bed may increase upstream flood risk by creating a damming effect.
- Larger embankment slopes and railway footprints can encroach on neighboring property.
- Trackside equipment, such as signals, also might need to be raised.
- As an alternative, install a bridge to raise the rail bed. This solution will be costly and will require a lengthy design and permitting process even if the land is available.
- Anchor ground-level equipment that can be raised on a concrete pedestal or steel post at an elevation above the design flood elevation.
- For equipment that cannot be elevated, consider floodproofing the equipment housing.
- Seal controller cabinets to prevent intrusion of floodwater.

CONSIDERATIONS:



Option 2: Install Redundant Power

Railway switches and signals, tunnel fans, and radio communications systems rely on electric power to operate. Power failure to these components could force the railroad to stop operating temporarily. Alternate sources of power can be independent of utility feeds and provide power temporarily until utility power is restored.

Use a generator to provide backup power to important systems. Where an existing generator is not working or cannot provide enough power, add a portable generator. Make sure the generator is located higher than the design flood level and that sufficient fuel is available to power it.

Consider using an Uninterruptible Power Supply (UPS) to supply shorter-duration power needs or to provide power to enable safe shutdown of equipment or to allow startup of backup generators. Increase the battery storage in a UPS to provide several hours of operation.

When evaluating this option, keep these considerations in mind:

- To help lessen flood damage, use an emergency generator for pumping systems.
- Make sure that the fuel pump used to power a generator is flood-proofed and has a backup source of power.
- Consider solar arrays and backup batteries that can continue to provide power even if the electric grid is down.
- Make sure that enough backup power is available for charging electric fleets.

CONSIDERATIONS:



Option 3: Improve Drainage Systems

Tracks must have working drainage systems to be able to operate. Whether from precipitation or flooding, water that enters the track substructure can decrease the strength of the underlying soils, which can cause the rail line to deform when trains run over it. If the underlying soil gets so wet that it becomes muddy, it can erode the ballast (rock) that supports the tracks and railroad ties. Soils that expand when they get wet and then shrink when they dry out can result in track misalignment.

Approaches to good track drainage include:

- Install open drainage systems that parallel the rails
- Install underground drainage systems

OPEN DRAINAGE SYSTEMS

Open drainage systems are ditches built parallel to the track next to and at the bottom of the sloped ballast. Water runs down the ballast embankment to the ditch.

Several considerations to keep in mind when evaluating this option include:

- Unlined, open drainage systems are inexpensive and easy to construct, but require frequent maintenance.
- Open drainage systems can be lined to reduce the amount of maintenance required.
- Open drainage systems require enough space on both sides of the track to be installed. Open drainage systems constructed too close to the track can cause it to fail.
- Open drainage systems should be sloped to allow water to flow.
- Open drainage systems should be connected to a surface water collection system.
- Open drainage systems can be easily clogged by debris.
- Open drainage systems can attract mosquitoes and other insects.

UNDERGROUND DRAINAGE SYSTEMS

Underground drainage systems can be used to lower the groundwater level and collect surface water. Interceptor trenches, discussed in Fact Sheet 5.3, *Earth Slope Stabilization*, can be used for this purpose.

Some points to keep in mind when evaluating this option include:

- Use underground drainage systems where space along the track is limited.
- Underground drainage systems may cost more to construct than open drainage systems but require less maintenance.
- Connect underground drainage systems to a water collection system.
- Underground drainage systems can become clogged.

Mitigation Solution: For Catenary Overhead System

Catenary is an overhead line that runs continuously above a mass transit route to supply traction power to a mass transit vehicle (Figure 5.2.9). Vehicles powered in this way include:

- Trains
- Streetcars
- Light rail
- Trolleybuses
- Maintenance vehicles and equipment

The overhead line may consist of one or more electrified wires with regularly spaced supports. A messenger wire is strung between support poles, towers or other structures. From the messenger wire, the contact wire may be hung at the appropriate overhead elevation. All systems require two power conductors.

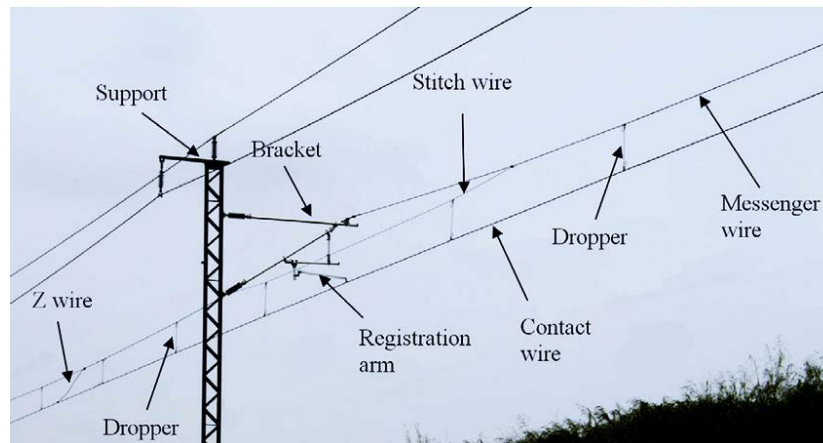

Figure 5.2.9. Catenary system.

Catenary overhead equipment is vulnerable to wind. During hurricanes, coastal storms and severe storms, high winds can weaken anchors and supports. Power interruptions can occur, which can shut down transit.

Option 1: Strengthen the Whole System

For mitigation solutions for support structures, lines, power control systems, and power lines, see Fact Sheet 4.3, *Electrical Power*. In addition, consider the following:

- Replace existing poles supporting catenary wires with poles rated for the design wind speed in the area.
- Use higher conductor tensions to reduce blow-off from wind.
- Vary the lengths of spans to reduce the likelihood of galloping (i.e., high-amplitude, low-frequency vertical vibration).
- Consider converting the overhead catenary system to an in-ground (“catenary-less”) system.

CONSIDERATIONS:



REFERENCES:

- Argonne National Laboratory. 2016. ANL/GSS-16/1, *Onsite and Electric Power Backup Capabilities at Critical Infrastructure Facilities in the United States*. Available at: <https://www.osti.gov/biblio/1260256-onsite-electric-backup-capabilities-critical-infrastructure-facilities-united-states>
- C40 Knowledge. 2019. Policy Brief: *Reducing climate change impacts on mass transit*. Available at: https://www.c40knowledgehub.org/s/article/Reducing-climate-change-impacts-on-mass-transit?language=en_US
- Federal Emergency Management Agency (FEMA). 1993. NFIP Technical Bulletin 3, *Non-Residential Floodproofing*. Available at: https://www.fema.gov/emergency-managers/risk-management/building-science/publications?name=%22Technical+Bulletin+3%22&field_keywords_target_id=All&field_document_type_target_id=All&field_audience_target_id=All
- FEMA. 2007. FEMA P-543, *Design Guide for Improving Critical Facility Safety from Flooding and High Winds*. Available at: https://www.fema.gov/sites/default/files/2020-08/fema543_design_guide_complete.pdf
- FEMA. 2013. FEMA P-936, *Floodproofing Non-Residential Buildings*. Available at: https://www.fema.gov/emergency-managers/risk-management/building-science/publications?name=%22P-936%22&field_keywords_target_id=All&field_document_type_target_id=All&field_audience_target_id=All
- FEMA. 2013. FEMA P-942, *Mitigation Assessment Team Report Hurricane Sandy in New Jersey and New York, Chapter 5*. Available at: https://www.fema.gov/emergency-managers/risk-management/building-science/publications?name=%22P-942%22&field_keywords_target_id=All&field_document_type_target_id=All&field_audience_target_id=All
- Florida Power and Light (FPL). 2010. *Distribution Engineering Reference Manual (DERM) Section 4—Overhead Line Design Addendum for Extreme Wind Loading*. Available at: http://www.floridapsc.com/library/filings/2016/07490-2016/Support/SFHHA%2015th%20POD%20Nos%20227,228-DERM%20Section%204%20Addendum%20for%20EWL_Rev%2003-09-2010.pdf
- Kenyon, Peter. 2012. “Inflatable protection against inundation.” *TunnelTalk*. Available at: <https://www.tunneltalk.com/New-Products-Dec12-Resilient-Tunnel-Plug-for-inflatable-flood-protection.php>
- National Electrical Manufacturers Association. 2020. *Storm Reconstruction Toolkit*. Available at: <https://www.nema.org/storm-disaster-recovery>
- Phythyon, John. 2011. “The future is here: Catenary-less power for light rail.” *Mass Transit*, June 3, 2011. Available at: <https://www.masstransitmag.com/rail/article/10262406/the-future-is-here-catenaryless-power-for-light-rail>
- Wingler, Frank. 2016. *Water the Enemy of the Rail Track*. Available at: <http://www.drwingler.com/wp-content/uploads/2016/09/WATER-THE-ENEMY-OF-THE-RAIL-TRACK.pdf>

Fact Sheet 5.3: Earth Slope Stabilization

The mitigation objective of this Fact Sheet is to decrease the likelihood a landslide or earth movement will occur on a slope by improving slope stability.

Landslides generally are categorized as shallow or deep seated, which can determine their speed and size. Shallow landslides are rooted in the soil layer and often form slumps (depressions) along roadways or fast-moving debris flows down valleys. These types of landslides often are called “mudslides” by the news media. Shallow landslides also occur as flows (such as mudflows, earthflows, and debris flows), slides, or rockfalls and topples.

Deep-seated landslides are rooted in bedrock, often are slow moving, and can cover large areas and devastate infrastructure and housing developments. Deep-seated landslides usually occur as translational slides, rotational slides, or large block slides (see definitions below). Deep-seated landslides typically are much larger than shallow landslides (WA Geological Survey, 2017).

Definitions

Landslide—Movement of a mass of rock, debris or earth down a slope.

Debris Flow—Fast mass movement in which loose soil, rock and organic matter combine with water to form a slurry that flows downslope. Commonly called a “mudslide.”

Earthflow—Generally occurs in fine-grained soil (e.g., silts and clays) when a disturbance causes the soil to lose its shear strength and liquefy. Earthflows can range from very slow (creep) to rapid and catastrophic.

Rotational Landslide—A landslide on which the surface of rupture is curved upward (spoon-shaped) and rotates around a line parallel to the ground surface and diagonal across the slide. (Figure 5.3.1)

Translational Landslide—A landslide in which the soil mass moves downward along a plane with little rotation or backward tilting. (Figure 5.3.1)

Block Landslide—A translational landslide in which the moving mass acts like one unit or several closely related units moving downslope together as one mass. (Figure 5.3.1)

Source: U.S. Geological Survey (USGS)



Slides

Slides are downslope movements of soil surface and can be deep-seated or shallow. The initiation of slides, like flows or rockfalls, is sensitive to steep slopes, the additional weight of water or other loads, and friction along their base.

Translational slides usually fail along geological discontinuities such as faults, joints, bedding surfaces, or the contact between two rock types. They move out or down a planar surface with little tilting and can travel great distances. Translational slides can contain loose sediments or large slabs of bedrock.

Rotational slides (slumps) are landslides that occur along a curved or spoon-shaped surface. Backtilting may occur near the scarp of the landslide and there is often a toe of displaced material. Rotational slides occur because the internal strength of the material is overcome by its own weight. They are usually composed of relatively loose or consolidated material.

Block slides are a particular type of translational slide that occur when large and relatively intact slabs of rock or earth are rapidly transported downslope. These types of landslides can be large and damaging and occur where alternating layers of strong and weak rock slope downhill.

Figure 5.3.1 summarizes some common mitigation strategies that can improve the performance of earth slopes and decrease slide potential. These strategies are discussed in the sections that follow.

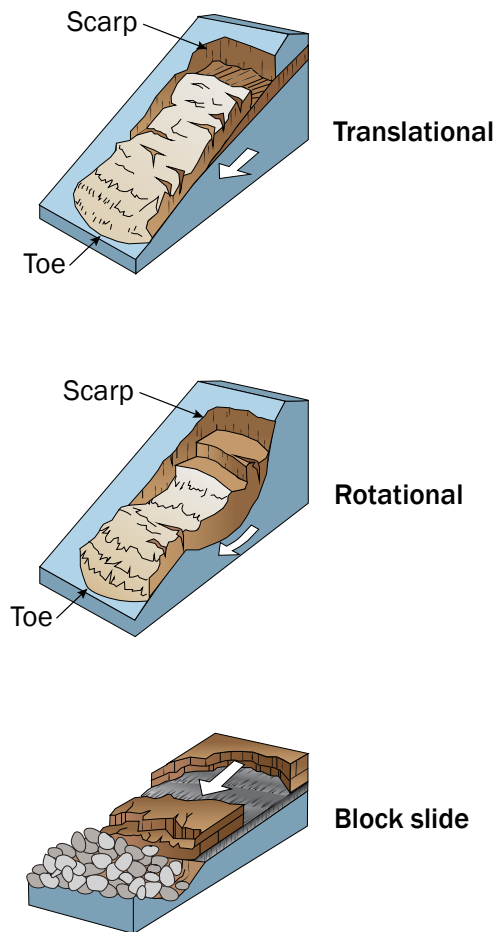

Figure 5.3.1. Examples and description of slides.
(Source: Washington Geological Survey)

Table 5.3.1. Common Mitigation Solutions for Earth Slope Stabilization

Solutions and Options	Shallow Failure	Deep Failure
Mitigation Solution: Excavate		
Option 1: Remove or Replace Material at the Top of the Slope	✓	
Option 2: Build Benches or Terraces	✓	
Option 3: Reduce Slope Angle	✓	
Mitigation Solution: Reinforce or Strengthen		
Option 1: Install Geosynthetics	✓	✓
Option 2: Construct a Toe Buttress or Berm	✓	✓
Option 3: Conduct Deep Soil Mixing		✓
Option 4: Install Soil Nails		✓
Mitigation Solution: Install Drainage		
Option 1: Construct an Interceptor Trench	✓	
Option 2: Install Subsurface Drains	✓	✓
Option 3: Install Check Dams	✓	
Mitigation Solution: Install Retaining Walls		
Option 1: Install a Mechanically Stabilized Earth Wall		✓
Option 2: Install a Timber Pile Wall		✓
Option 3: Construct a Gabion Wall	✓	✓
Option 4: Construct a Crib Wall	✓	✓
Option 5: Construct a Bin Wall		✓
Mitigation Solution: Install Nature-Based Solutions		
Option 1: Use Natural and Hybrid Approaches	✓	

Mitigation Solution: Excavate

Excavation is used to remove material from the slope to lessen the forces that cause sliding. Generally, excavation is appropriate only for small slumps or shallow slides. The excavator should be kept a safe distance from the edge of the slope, so it does not add weight at the top of the slope, leading to slope instability. Do not remove the toe material at the bottom of the slope.

Option 1: Remove or Replace Material at the Top of the Slope

Removing soil from the top of the slope helps to reduce the downward pressure on the slope by reducing the weight of the overlying soil, which helps improve stability (Figure 5.3.2).

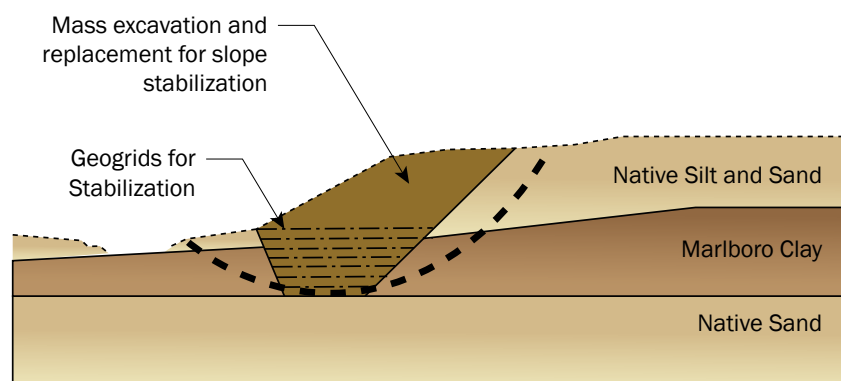
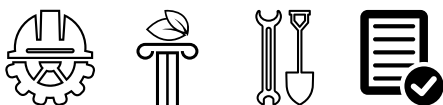

Figure 5.3.2. Removing soil and replacing it with lightweight fill can help decrease loads that drive soil downslope.

When evaluating this option, keep these considerations in mind:

- The soil removed should be placed away from the slope and/or trucked offsite. The removed soil may be replaced with lightweight fill.
- This option may be appropriate for rotational-type landslides, but it should not be used for translational slides or debris-flow landslides (USGS, 2008).

CONSIDERATIONS:



Option 2: Build Benches or Terraces

Benching involves making a series of stair-step cuts into the slope to reduce the slide-driving forces (Figure 5.3.3). It also can be used to cut a large slope into smaller slopes that can be mitigated individually.

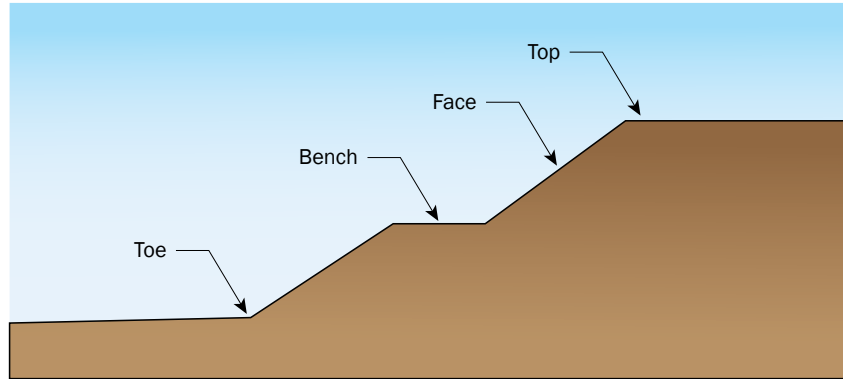
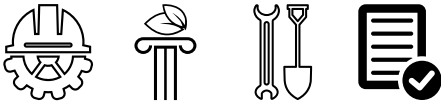

Figure 5.3.3. Benching or terracing can help improve slope stability.

When evaluating this option, keep these considerations in mind:

- The flat surfaces of the benches can be used to control surface drainage or install other structures such as drainage pipes or retaining walls.
- Benching can help address shallow slope failures but is not effective for deeper failure surfaces.

CONSIDERATIONS:



Option 3: Reduce Slope Angle

Steep slopes can have an increased risk of instability (Figure 5.3.4). Reducing the slope angle of the ground surface while also removing some of the driving force can improve slope stability.

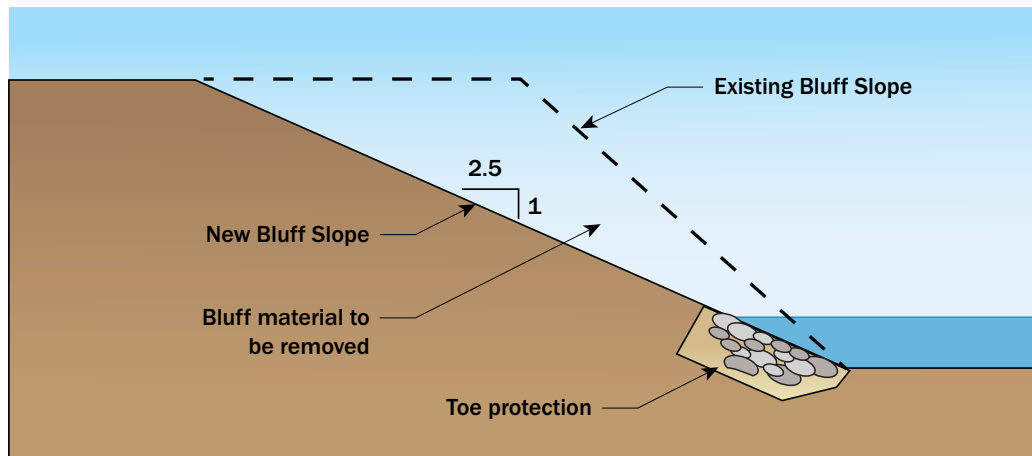
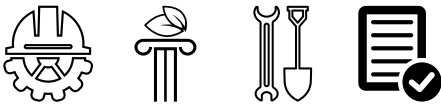

Figure 5.3.4. Reducing the slope angle removes some of the driving forces that can cause instability. (Source: USGS, 2004)

When evaluating this option, keep these considerations in mind:

- Smoothing the slope surface while reducing the slope angle also can help improve surface drainage.
- This approach is effective only for small slumps and shallow slides.

CONSIDERATIONS:



Mitigation Solution: Reinforce or Strengthen

The shear strength of soil, which is a combination of friction and bonding between particles, is what resists downward movement of the soil along a slope. Increasing the shear strength of soil helps it withstand sliding. There are several common methods of strengthening soil to improve sliding resistance.

Option 1: Install Geosynthetics

Geosynthetics generally are flat, manmade materials used to improve the strength of soil and rock through reinforcement. Reinforced soil slopes are constructed by placing alternating layers of a specified thickness of compacted soil and geosynthetic (Figure 5.3.5). Reinforced soil slopes usually are constructed under two conditions: (1) to improve stability during reconstruction of a slope that already has failed, or (2) to improve stability at the edges of a slope.

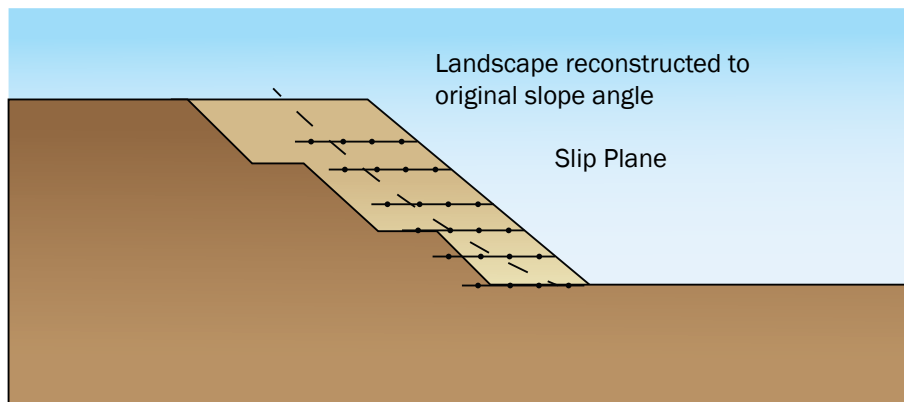
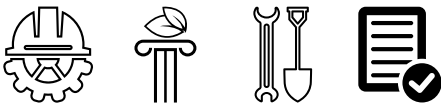

Figure 5.3.5. Geosynthetics can be used to reinforce and strengthen slopes. (Source: FHWA, 2009)

When evaluating this option, keep these considerations in mind:

- Reinforcement allows the slope to be constructed at a steeper angle than would be safe when placing the soil alone. Where space is restricted or to create additional space for road shoulders and lanes, slope angles can be up to 70 degrees.
- Use geosynthetics to help increase drainage within the slope.

CONSIDERATIONS:



Option 2: Construct a Toe Buttress or Berm

Build a toe buttress or berm is built by adding compacted soil along the bottom of the slope to provide extra resistance against material sliding on the slope (Figure 5.3.6).

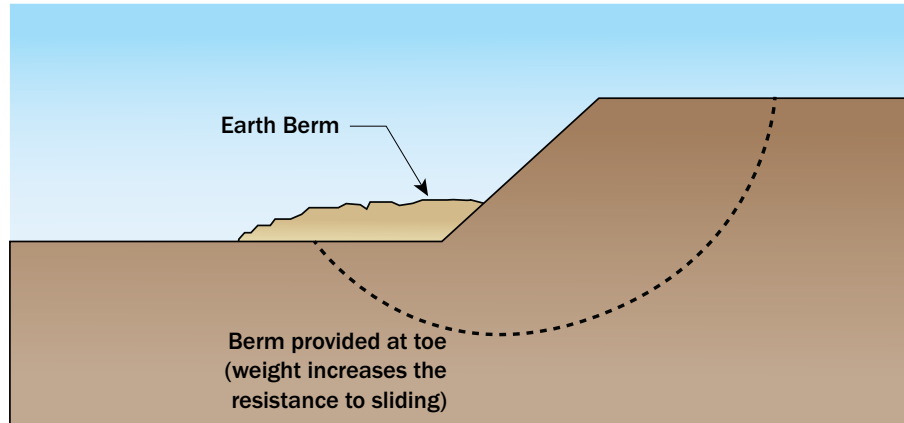
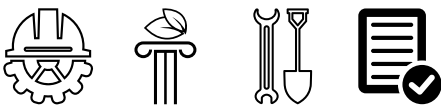

Figure 5.3.6. A toe berm adds resistance to sliding material.

When evaluating this option, keep these considerations in mind:

- While any material can be used to build the berm, freely draining material such as sand allows water to flow and not build up along the slope. Water build-up within the slope can increase the chances of a landslide occurring.
- Use this option for all slide types (shallow and deep).

CONSIDERATIONS:



Option 3: Conduct Deep Soil Mixing

Deep soil mixing (DSM) involves mixing a chemical stabilizer such as cement or lime with soil in place on the slope. Mixing is done using a long tool with a hollow shaft and blades or paddles mounted on a drill rig. Typically, the tool is drilled into the ground to the required depth and then the chemical stabilizer is added as the tool is slowly pulled out (Figure 5.3.7).

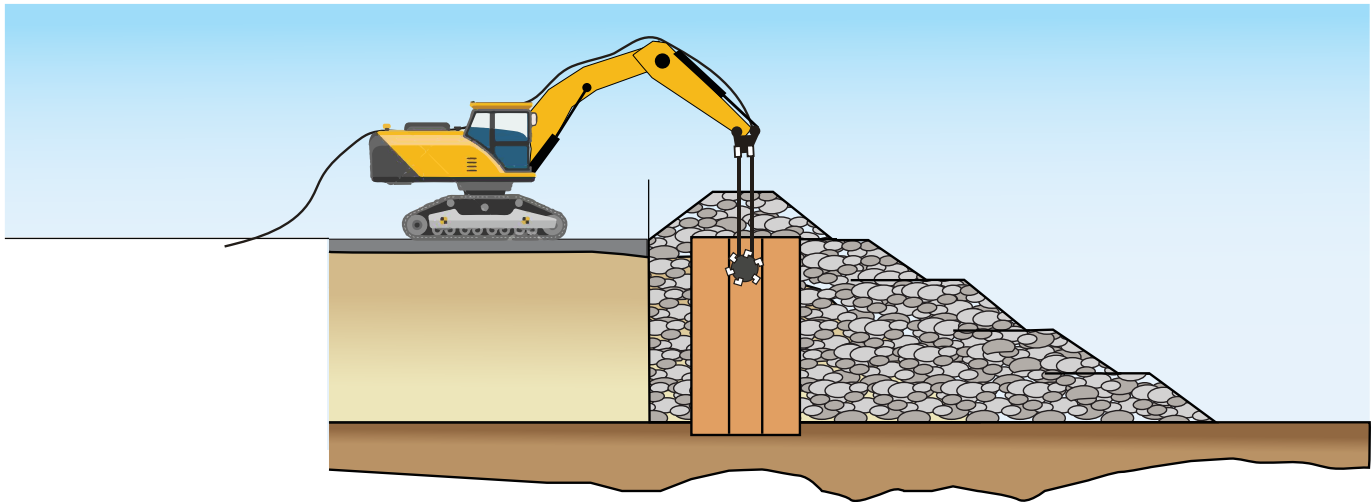

Figure 5.3.7. Deep soil mixing (DSM) creates a soil-concrete column to provide additional stability against sliding.

When evaluating this option, keep these considerations in mind:

- DSM can be wet or dry.
 - Wet DSM involves mixing the soil with a wet slurry to create a soil-concrete column. When using wet mixing, add the slurry through the hollow shaft while the drilling tool is penetrating the soil.
 - Dry DSM involves blending wet soil with a dry binding material to create a soil column.
- Both wet and dry DSM methods result in a soil column that has increased shear strength and stiffness.
- Arrange a series of individual columns to resist the driving forces of the slope.
- Soil mixing typically is used in soft soils for stabilization purposes.
- Use DSM to lessen the potential for deep slides.

CONSIDERATIONS:



Option 4: Soil Nailing

Typically, soil nails are steel rods or bars that are installed with cement grout into a slope at an angle (Figure 5.3.8). Usually, the nails are inserted into pre-drilled holes, but other methods, including driving, self-drilling, launching, and jet-grouting, can be used. A grouting material such as concrete is used to fill the hole around the nail. The grout protects the nail from corrosion while also providing additional resistance to sliding of the surrounding soil.

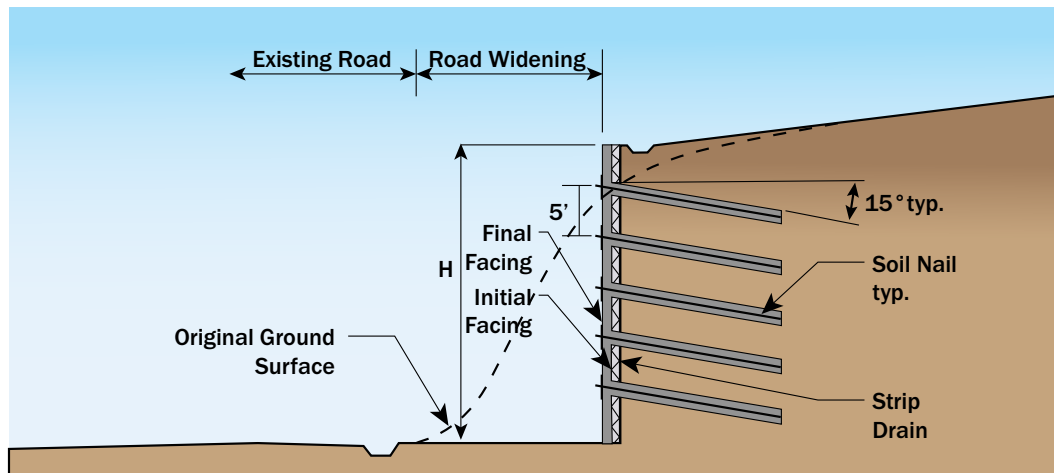

Figure 5.3.8. Soil nailing can allow slope stabilization at steep angles. (Source: FHWA, 2015)

When evaluating this option, keep these considerations in mind:

- Use additional corrosion protection measures, such as galvanization or epoxy coating, to further protect the nails.
- Apply a facing to the surface of the nailed slope to help improve stability of the soil between the nails and provide erosion protection. While reinforced concrete, shotcrete, or precast panels typically are used for the facing of soil nail walls, softer materials such as mesh can be used on slopes so that vegetation can be established (Figure 5.3.9).

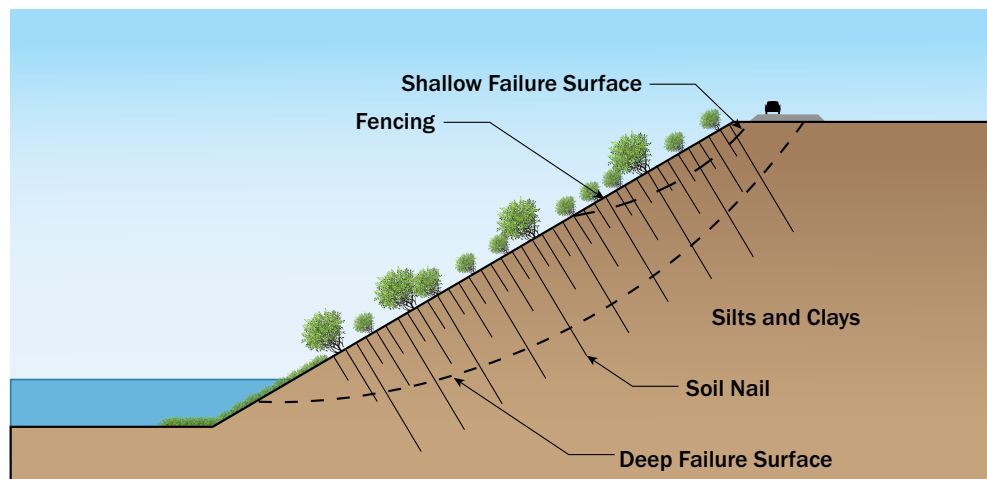
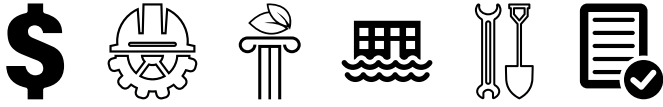

Figure 5.3.9. Soil nailing can be combined with vegetation to improve slope stability and aesthetics for both shallow and deep failure surfaces. (Source: FHWA, 2015)

- Attach a bearing plate to the nail over the surface of the facing, and if concrete facing is being used, apply additional facing to permanently cover the bearing plate and nail head.
- Use soil nailing to lessen the potential for deep slides.

CONSIDERATIONS:



Mitigation Solution: Install Drainage

Water is a key element that contributes to the stability or instability of a slope. The weight of water adds weight to the slope, which increases the forces driving soil down the slope and can decrease stability. Water also can dissolve binding agents that hold soil or sediment particles together, which reduces the bond between particles and can lead to decreased stability. In addition, water can act as a lubricant between an overlying well-drained soil (sand and gravel) and an underlying poorly drained soil (clay and silt). In this situation, the water drains more quickly through the well-drained soil and accumulates along its interface with the poorly drained soil since water cannot enter the poorly drained soil as quickly. Improving drainage within a slope can help to improve slope stability.

Option 1: Construct an Interceptor Trench

An interceptor trench is a drainage system installed near the top of a slope or above the top of a known slide area to collect and direct surface water and subsurface water from within soil layers away from the slope (Figure 5.3.10). Reducing the amount of water on and within a slope helps to decrease the driving weight at the top of the slope and helps to reduce the risk of erosion.

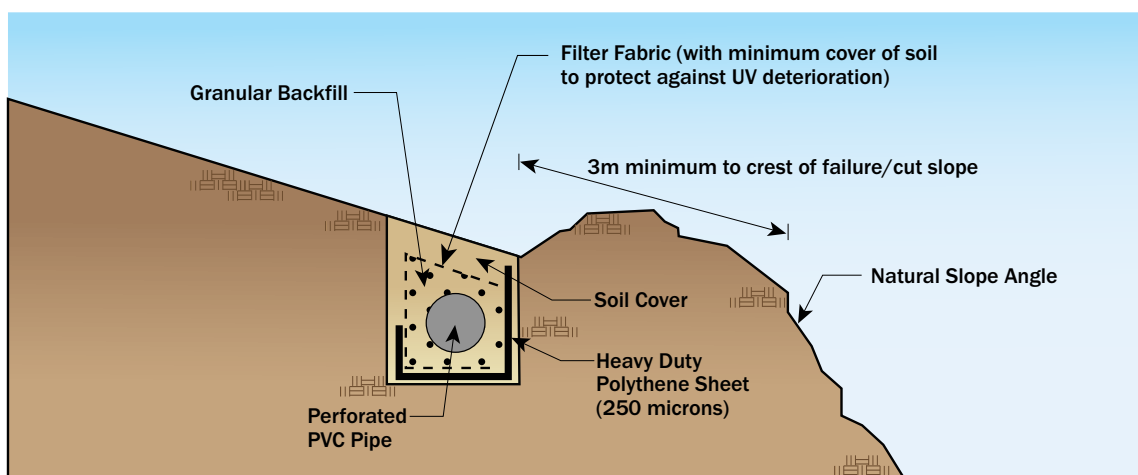

Figure 5.3.10. Interceptor trench drains can be used to direct surface runoff away from slopes.

Some things to consider when evaluating this option include:

- Use freely draining material, usually clean gravel, as backfill to help prevent the perforated pipe from clogging. Add a geotextile filter fabric to further prevent clogging.
- Hydraulically connect the trench to another pipe or to a drainage ditch or spillway to direct the water down the slope at a controlled location.
- Use this approach for slopes with shallow slide potential and on terraced slopes, where a trench drain is installed at the base of each terrace step. Deeper trenches can be constructed but must comply with worker safety requirements.

- Combine this approach with other measures, such as subsurface drains discussed below, to increase effectiveness.

CONSIDERATIONS:

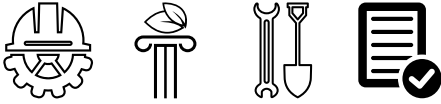

Option 2: Install Subsurface Drains

Subsurface drains are perforated pipes that are inserted into the slope at set elevations and spacings (Figure 5.3.11). The idea is to lower the water table to the level of the lowest pipe, which decreases the driving forces by decreasing the water content of the slope soils.

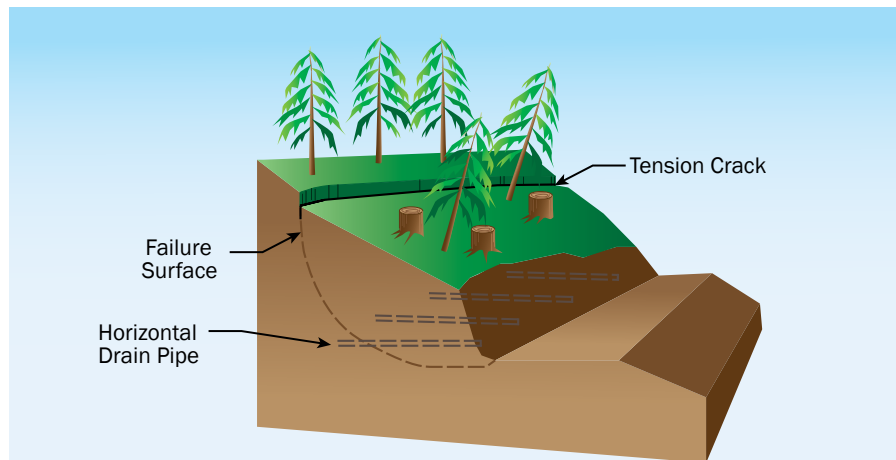
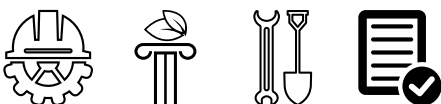

Figure 5.3.11. Horizontal drains help lower the water table, which reduces driving forces by decreasing soil water content. (Source: USGS, 2008)

When evaluating this option, keep these considerations in mind:

- Slightly slope the drains to drain down from the top of the drain inside the slope to the pipe exit above ground.
- If a well-drained soil overlies a poorly drained soil, install the drain to intercept water near the interface of the two layers. This helps reduce the likelihood that water will accumulate at the interface causing the overlying layer to slide along the underlying layer.
- Use subsurface drains to mitigate slopes with both shallow and deep failure surfaces.

CONSIDERATIONS:



Option 3: Construct Check Dams

A check dam is built across a drainage ditch to slow the flow of water and reduce erosion (Figure 5.3.12). Check dams usually are built with rock, but also can be made from wattles, fiber rolls, sand or gravel bags, logs, or manufactured systems.

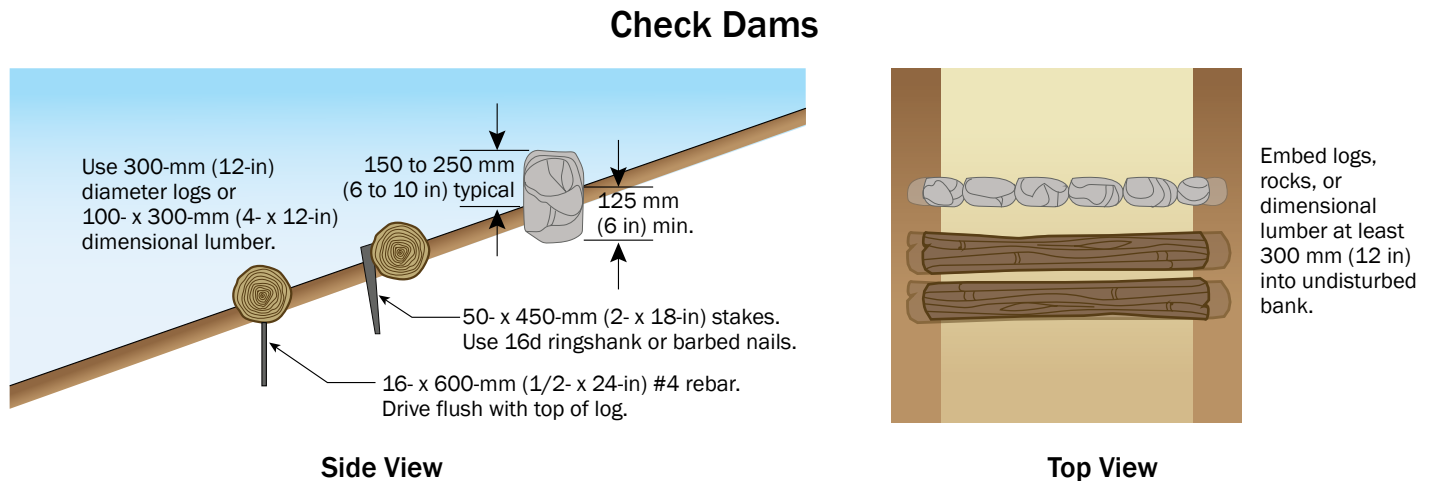
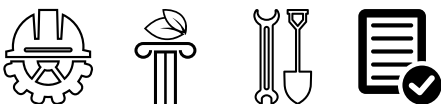

Figure 5.3.12. Check dams can be constructed of logs, rocks, or other materials to slow the flow of water in a channel on a slope. (Source: U.S. Forest Service, 2007)

When evaluating this option, keep these considerations in mind:

- Use check dams with interceptor trenches to direct the flow of water down a slope to a location where the water is collected and/or released.
- A series of check dams can control the flow of water more effectively than a single check dam.
- The check dam should completely span the width of the channel to prevent washout.
- Check dams can be effective for slopes with shallow slide potential.

CONSIDERATIONS:



Mitigation Solution: Install Retaining Walls

Retaining walls are relatively rigid structures that can help strengthen soil and increase resistance to sliding forces in areas where space is limited. They also can be used to create additional space, such as for road shoulders or parking areas. Retaining walls must be designed so they will not overturn, slide, or dislodge from extreme foundation pressure or water uplift. Local zoning, permitting, or code requirements might require a wall to be designed by a licensed Professional Engineer.

Option 1: Install a Mechanically Stabilized Earth Wall

Mechanically stabilized earth (MSE) walls are built using compacted granular soil backfill and geotextiles in alternating layers to make a steep slope that then has a wall facing applied (Figure 5.3.13). The stability of the wall comes from the friction that acts between the compacted soil backfill and the geotextile material. The wall facing is relatively thin; it helps hold the layers in place and allows the wall angle to be steep—usually from about 70 degrees up to even vertical (90 degrees).

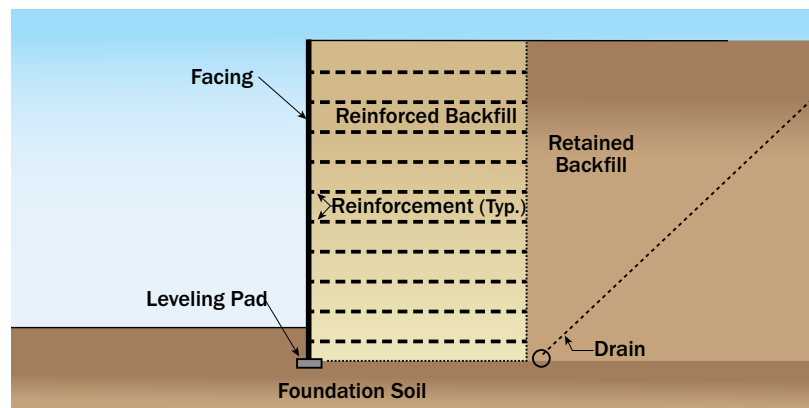

Figure 5.3.13. MSE walls use geotextiles and granular soil backfill to retain slopes. (Source: FHWA, 2009)

When evaluating this option, keep these considerations in mind:

- The facing must be able to withstand erosion and corrosion.
- MSE walls can be built quickly and are resistant to forces such as earthquakes.
- MSE walls also must be a minimum width to provide enough stability.
- Use MSE walls to protect against deep-seated slides.
- MSE walls are used commonly in highway projects for bridge abutments and wing walls, but also can be used for other purposes, such as containment structures around oil and gas tanks.

CONSIDERATIONS:



Option 2: Install a Soldier Pile Wall

Soldier pile walls use a system of steel piles driven vertically at regular intervals (usually every 6 feet to 12 feet) and horizontal planks, called lagging, placed between the piles to retain the soil behind the planks (Figure 5.3.14). Soldier pile walls provide stability by resisting the sideways forces of the soil behind the wall. The piles are usually steel H-piles, but can include precast concrete, micropiles, and conventional pipe sections (Pilebuck, March 2019). The lagging material usually consists of wood planks but also can be metal decking or precast concrete. The piles are installed and then excavating occurs in stages to place the lagging until the design wall height is reached. This type of retaining wall should be designed by a Professional Engineer.

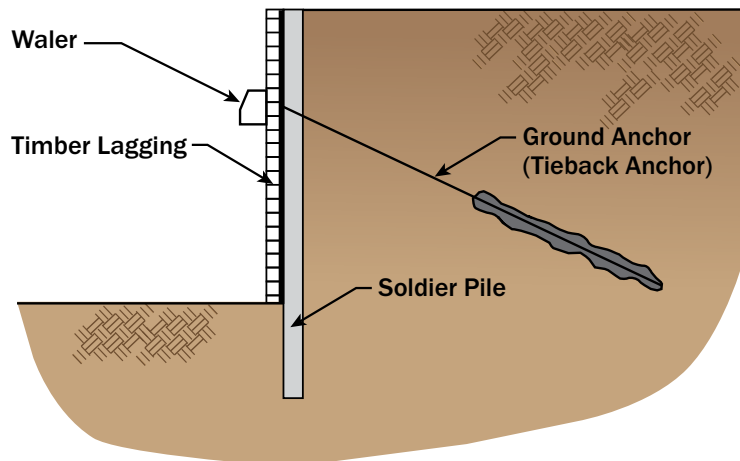

Figure 5.3.14. Soldier pile walls can be used to reinforce failure planes. (Source: FHWA, 1999)

When evaluating this option, keep these considerations in mind:

- The empty space behind the wall lagging is filled with compacted soil. If backfilling is not completed properly, settlement behind the wall can occur.
- Soldier pile walls can be designed as cantilevered walls up to a certain height, above which steel tiebacks can be drilled and grouted into the retained soil as shown in Figure 5.3.14.
- If the retaining wall is permanent, consider applying a shotcrete facing.
- Soldier pile walls are difficult to construct where a high-water table exists; complete dewatering first.
- Installation of soldier pile retaining walls in soft soils can be difficult.
- Use soldier pile walls generally to provide resistance to deep-seated slides.

CONSIDERATIONS:



Option 3: Construct a Gabion Wall

A gabion is a wire cage filled with rocks, concrete pieces, gravel, or bricks (Figure 5.3.15). Gabion walls provide stability by resisting lateral forces behind them. Because gabion walls typically are filled with rocks, they are freely draining and do not allow a buildup of water behind the wall.

Typically, a gabion is shaped like a box or a cylinder. For soil retention purposes, a gabion will be rectangular. For dams or foundation construction, cylinder-shaped gabions typically are used. The wire used to build a gabion basket usually is stainless steel, PVC-coated steel, or galvanized steel. The wire should be corrosion resistant. The filled wire boxes are stacked in rows to create a wall. The rows might have a slight step-back or might be placed directly on top of each other to create a vertical face. The rows are tied together with wire. A bastion is a gabion that is lined with a geotextile and filled with sand.

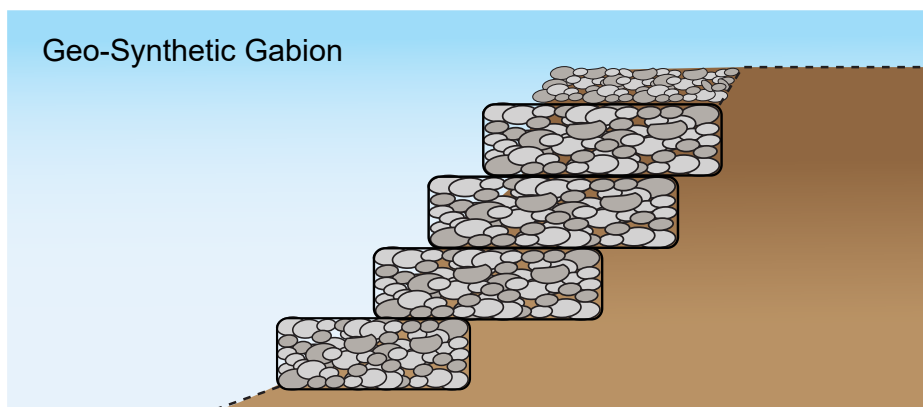
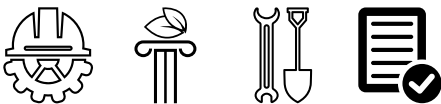

Figure 5.3.15. Gabions can be used to improve slope stability by resisting the sideways forces behind them. (Source: FHWA, 2001)

When evaluating this option, keep these considerations in mind:

- Depending on local zoning, permitting, and code requirements, gabion walls exceeding a certain height might need to be designed by a Professional Engineer.
- Gabions can get clogged by debris and soil, requiring maintenance. They also can become habitats for small animals.
- Gabion walls can protect against shallow or deep failure potential.

CONSIDERATIONS:



Option 4: Construct a Crib Wall

A crib wall is a gravity wall system consisting of stacked elements that are filled with soil or rock (Figure 5.3.16). Typically, precast concrete parts are used to build the walls, although preservative-treated timber also can be used. Crib walls are constructed like log cabins. Elements called headers are set perpendicular to the wall face. Elements called stretchers are interlocked with the headers to form the wall face. Headers and stretchers are stacked alternately to form a gravity retaining wall. Crib wall elements can be stacked vertically but usually are sloped back. The area behind the crib wall is backfilled with freely draining, compacted soil or rock.

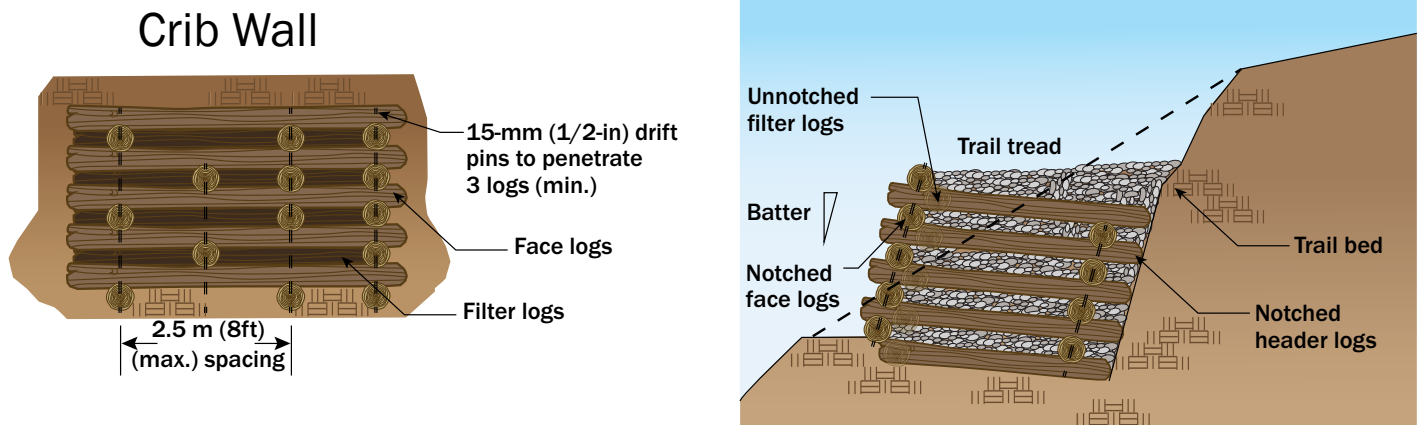
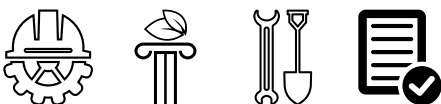

Figure 5.3.16. Crib walls can be constructed easily to retain soil on a slope. (Source: U.S. Forest Service, 2007)

When evaluating this option, keep these considerations in mind:

- Securely attach, bury or anchor the toe of the crib wall for it to be effective; otherwise, the wall can fail.
- Use higher walls by building deeper cribs or by building additional cribs terraced or staggered behind the front crib.
- Crib walls can accommodate curves along roads, parking areas, etc., and can be covered with plant materials to make them more aesthetically pleasing.
- Use crib walls to protect against shallow or deep failure potential.

CONSIDERATIONS:



Option 5: Construct a Bin Wall

Bin walls are gravity wall systems like crib walls, but interlocking bins are stacked on top of each other and backfilled with granular soil. The bins typically are made from steel or concrete and are bolted together.

When evaluating this option, keep these considerations in mind:

- The design of these walls should meet minimum embedment requirements.
- Depending on the environment, metal bin walls may be subject to corrosion.
- Use bin walls to protect against shallow or deep failure potential.

CONSIDERATIONS:

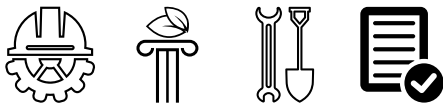

Mitigation Solution: Install Nature-Based Solutions

Option 1: Use Natural and Hybrid Approaches

Using natural materials to protect against soil movement is referred to as nature-based solutions or natural infrastructure. Hybrid approaches, which use a combination of living and non-living materials, can be used to protect slopes against erosion and improve the stability of upland slopes against shallow failures (Figure 5.3.17).

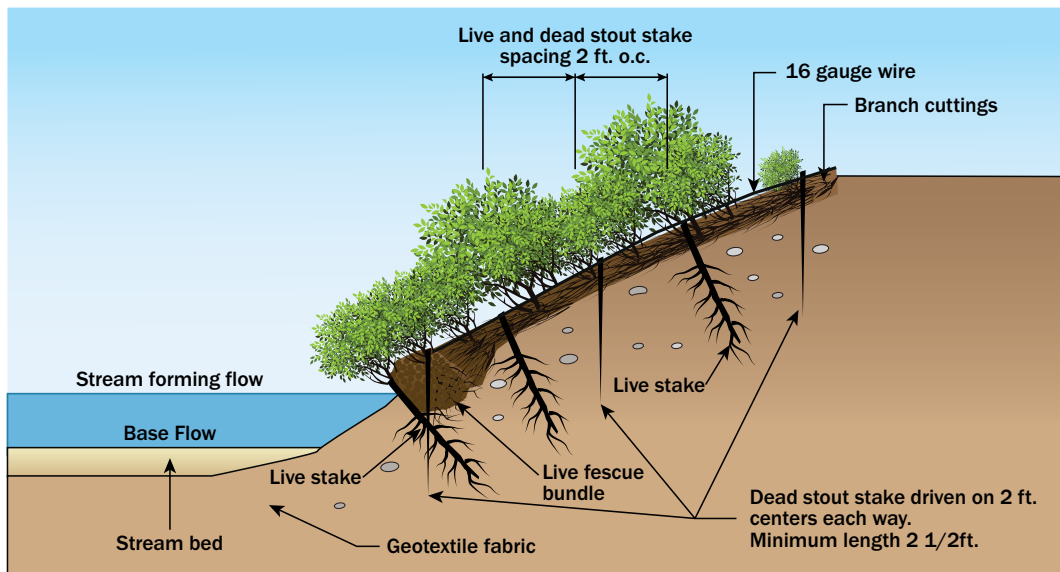

Figure 5.3.17. Using vegetated stakes alone or in combination with a brush mat can help control erosion on slopes. (Source: NRCS, 1996)

When evaluating this option, keep these considerations in mind:

- Use nature-based solutions alone or in conjunction with other slope stabilization methods.
- Use surface coverings, such as seeding, hydroseeding, transplanted vegetation and mulch, to protect against wind and water erosion.
- Use live plantings, alone or in combination with crib walls or gabion walls, to improve slope stability.
- As seen in Figure 5.3.18, live plantings such as stakes and fascines can help to reinforce the soil and withstand soil movement through interconnected root systems. Stout stakes are live but dormant woody cuttings with the branches removed. Fascines or wattles are living branches bundled together to trap sediment and protect against erosion. They are laid horizontally along streambanks to decrease stream velocity and reduce erosion.

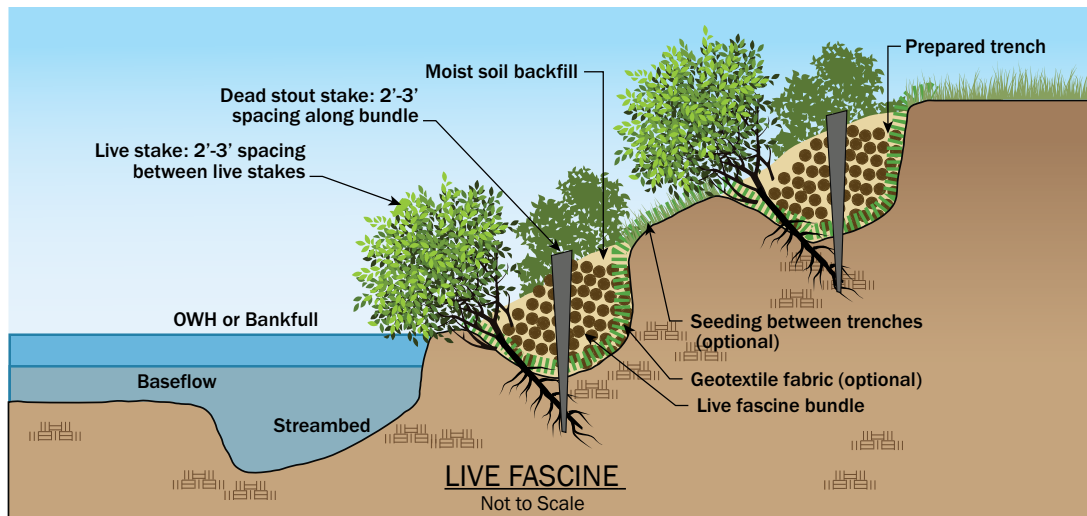

Figure 5.3.18. Live fascine bundles can be used with stakes to help control erosion. (Source: USDA Forest Service, 2006)

- Use stakes in combination with brush mattresses to provide erosion control and improve slope stability.
- Live plantings placed among gabion walls or crib walls can help to reinforce the fill and improve the appearance of those structures.
- Use vegetative plantings in small areas where accessibility is an issue to improve aesthetics (Figure 5.3.19).
- Plantings can be installed only during dormant seasons, and some planting methods can be labor intensive.
- Some plantings require regular maintenance, such as fertilization and watering, until they are well established.

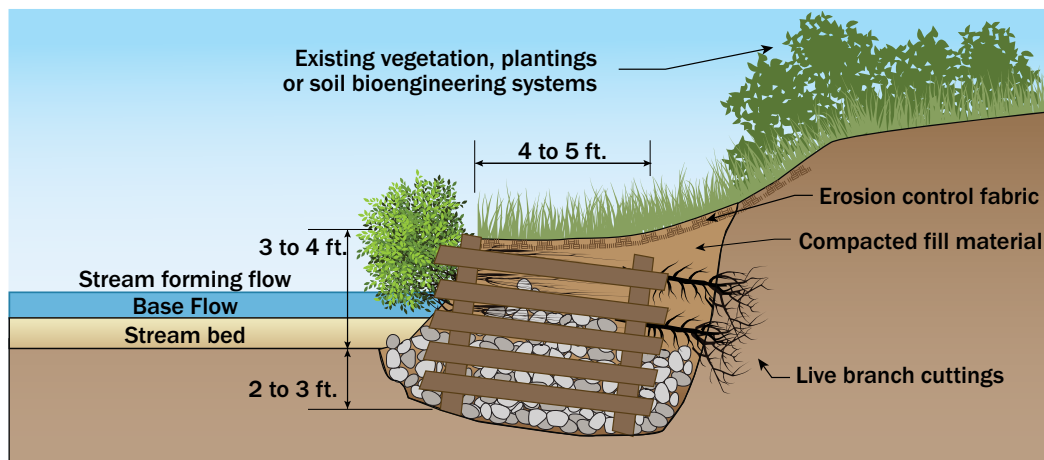

Figure 5.3.19. Live crib walls can provide stability and help control erosion. (Source: NRCS, 1996)

CONSIDERATIONS:



REFERENCES:

More detailed information about landslides, their causes, and potential mitigation strategies can be found in these publications. This list is not exhaustive, but it provides some information that can be used for decision-making and design.

Bruce, D.A. 2000. Report No. FHWA-RD-99-13,8 *An Introduction to the Deep Soil Mixing Methods as Used in Geotechnical Applications*. U.S. Department of Transportation, Federal Highway Administration. Available at: <https://www.fhwa.dot.gov/publications/research/infrastructure/pavements/99138/99138.pdf>

California Coastal Commission. 1994. *Land Form Alteration Policy Guidance Attachment 3: Overview of Engineering Techniques to Reduce Grading*. Available at: <https://www.coastal.ca.gov/landform/attach3.html>

Federal Emergency Management Agency. 2009. *Engineering with Nature: Alternative Techniques to Riprap Bank Stabilization*. Available at: https://www.fema.gov/pdf/about/regions/regionx/Engineering_With_Nature_Web.pdf

Federal Emergency Management Agency. 2013. *Mitigation Ideas: A Resource for Reducing Risk to Natural Hazards*. Available at: https://www.fema.gov/sites/default/files/2020-06/fema-mitigation-ideas_02-13-2013.pdf

Highland, L.M. and P. Bobrowsky. 2008. *The Landslide Handbook—A Guide to Understanding Landslides*. Reston, Virginia: U.S. Geological Survey Circular 1325, 129 pp. Available at: <https://pubs.usgs.gov/circ/1325/>

International Code Commission. 2018. International Building Code. (See especially Sections 105 and 1807.)

Karstunen, M. 2014. Report No. 431, *Ground Improvement for Marginally Stable Slopes*. Norwegian Public Roads Administration. Available at: <https://pdfs.semanticscholar.org/f07c/04610383db46ede672afa4aa1f288b5e1c76.pdf>

Kim, Y.J., et. al. 2019. “Geosynthetic Reinforced Steep Slopes: Current Technology in the United States.” *Applied Sciences*, Vol. 9, No. 2008. Available at: <https://www.mdpi.com/2076-3417/9/10/2008/pdf>

New York State Department of Transportation. 2015. *Geotechnical Design Procedure for Flexible Wall Systems*. Available at: <https://www.dot.ny.gov/divisions/engineering/technical-services/technical-services-repository/GDP-11b.pdf>

Nicholson, P. 2015. “Objectives and Approaches to Hydraulic Modification.” *Soil Improvement and Ground Modification Methods*. Available at: <https://www.sciencedirect.com/book/9780124080768/soil-improvement-and-ground-modification-methods>

Pohll, G.M., et. al. 2013. Report No. WA-RD 787.1, *Design Guidelines for Horizontal Drains Used for Slope Stabilization*. Washington State Department of Transportation. Available at: <https://www.wsdot.wa.gov/research/reports/fullreports/787.1.pdf>

Rogers, J.D. 1992. “Recent developments in landslide mitigation techniques.” *Geological Society of America, Reviews in Engineering Geology*, v. IX. Available at: https://web.mst.edu/~rogersda/hazard_mitigation_techniques/recent_developments_in_landslide_mitigation_techniques.pdf

Saftner, D., et. al. 2017. *Slope Stabilization and Repair Solutions for Local Government Engineers*. Available at: <http://dot.state.mn.us/research/reports/2017/201717.pdf>

U.S. Department of Agriculture. 1996. *Engineering Field Handbook—Chapter 16, Streambank and Shoreline Protection*. Available at: https://efotg.sc.egov.usda.gov/references/public/IA/Chapter-16_Streambank_and_Shoreline_Protection.pdf

- U.S. Department of Agriculture. 2006. *Wilderness and Backcountry Site Restoration Guide*. Available at: https://www.fs.fed.us/rm/pubs_other/rmrs_2006_therrell_I001.pdf
- U.S. Department of Agriculture. 2007. *Trail Construction and Maintenance Notebook*. Available at: <https://www.fs.fed.us/t-d/pubs/pdfpubs/pdf07232806/pdf07232806dpi72.pdf>
- U.S. Department of Transportation. 1999. Report No. FHWA-IF-99-015. *Geotechnical Engineering Circular No. 4 Ground Anchors and Anchored Systems*. Available at: <https://www.fhwa.dot.gov/engineering/geotech/pubs/if99015.pdf>
- U.S. Department of Transportation. 2001. Report No. FHWA-NHI-00-043. *Mechanically Stabilized Earth Walls and Reinforced Soil Slopes, Design & Construction Guidelines*. Available at: <https://soilretention.com/wp-content/uploads/2015/10/0413110450FHWA-NHI-00-043.compressed.pdf>
- U.S. Department of Transportation. 2009. Report Nos. FHWA-NHI-10-24 and FHWA GEC 011-Vol I, *Design of Mechanically Stabilized Earth Walls and Reinforced Soil Slopes—Volume I*. Available at: <https://www.fhwa.dot.gov/engineering/geotech/pubs/nhi10024/nhi10024.pdf>
- U.S. Department of Transportation. 2015. *Soil Nail Walls Reference Manual*. Available at: <https://www.fhwa.dot.gov/engineering/geotech/pubs/nhi14007.pdf>
- U.S. Geological Survey. 2004. *Formation, Evolution, and Stability of Coastal Cliffs—Status and Trends*. Available at: <https://pubs.usgs.gov/pp/pp1693/pp1693.pdf>
- U.S. Geological Survey. 2008. Circular 1325. *Appendix C, Introduction to Landslide Stabilization and Mitigation*. Available at: <https://pubs.usgs.gov/circ/1325/pdf/Sections/AppendixC.pdf>
- Washington Forest Protection Association. 2017. *Deep-Seated and Shallow-Rapid Landslides: Know the Difference*. Available at: <http://www.wfpa.org/news-resources/blog/deep-seated-landslides-shallow-landslides-washington/>
- Washington Geological Survey. 2017. *What Are Landslides and How Do They Occur?* Available at: https://www.dnr.wa.gov/publications/ger_fs_landslide_processes.pdf
- Wold, R.L. and C.L. Jochim. 1989. FEMA 182, *Landslide Loss Reduction: A Guide for State and Local Government Planning*. Federal Emergency Management Agency. Available at: <https://www.hsdl.org/?abstract&did=234464>

Fact Sheet 5.4: Shorelines

The mitigation objective of this Fact Sheet is to protect areas inland from shorelines from coastal erosion and flooding.

Coastal erosion typically is caused by wave action, coastal flooding, currents, water runoff, wind effects, and other impacts of storms. Coastal erosion can damage property and infrastructure, while also impacting beach construction and access. Protecting the shoreline using structural and non-structural stabilization methods can reduce the effects of coastal erosion and flooding. The ability to reduce losses from wave action, erosion and flooding depends on the elevation, configuration, strength and durability of stabilization.

Table 5.4.1 summarizes some common mitigation options for dealing with coastal erosion. The options marked with “O” are for ocean shorelines, the options marked with “S” are for sheltered water shorelines, and those marked with “O, S” are for both ocean and sheltered water shorelines.

Table 5.4.1. Common Shoreline Mitigation Solutions

<i>Solutions and Options</i>	<i>Reduce Wave Risk</i>	<i>Reduce Land Loss</i>	<i>Reduce Flooding</i>
Mitigation Solution: Structurally Stabilize Shorelines			
Option 1: Construct Seawalls	O, S	O, S	O, S
Option 2: Construct Bulkheads	S	S	S
Option 3: Install Revetments	O, S	O, S	O, S
Option 4: Place Detached Breakwaters	O, S	O, S	O, S
Option 5: Build Jetties and Groins	S	S	
Option 6: Reinforce Dunes	O, S	O, S	O, S
Mitigation Solution: Use Non-Structural Stabilization			
Option 1: Nourish Beaches and Restore Dunes	O, S	O, S	O, S
Option 2: Stabilize Using Living Shorelines	S	S	

O = ocean shoreline, **S** = sheltered water shoreline



Mitigation Solution: Structurally Stabilize Shorelines

Mitigation options aim to stabilize coastal areas by building shoreline structures, such as seawalls, bulkheads, revetments, detached breakwaters, groins/jetties, reinforced dunes or coastal levees/dikes.

Seawalls, bulkheads, revetments and detached breakwaters are usually built parallel to the shore or at the base of a bluff. These structures are intended to keep the sediment or soil along the shoreline and to protect against high water levels, waves and erosion. Jetties and groins are built perpendicular to the shore to block the movement of sediment along the shore, hold back currents, protect areas from wave forces, guide sand movement and maintain navigation depth. Reinforced dunes have internal support that is designed to reduce dune loss and lessen flooding on the inland side of dunes.

Evaluate the following considerations when determining which structural shoreline stabilization method is an appropriate mitigation measure:

- The degree of protection these structural methods offer depends on their design, construction and maintenance. Some options may be suitable for ocean shoreline only or sheltered water areas only, while others may be suitable both ocean and sheltered water areas.
- These structural methods may not prevent erosion of the beach on the waterside of the structure and may, in fact, worsen ongoing erosion of the beach.
- Depending on the design, some structures can:
 - Trap sediments on the land that otherwise would erode and nourish the beach
 - Lead to passive erosion (eventual loss of the beach since the structure prevents movement of the beach toward the land)
 - Lead to active erosion (localized scour on the waterside of the structure and on unprotected property beyond the ends of the structure)

Some jurisdictions distinguish between erosion control structures built to protect existing development and those built to create a buildable area on an otherwise unbuildable site. Designers should investigate federal, state and local regulations and requirements for erosion control structures before starting design.

Option 1: Construct Seawalls

Seawalls are built to resist the effects of waves and protect against land loss from erosion, current and wave action. As the term is used here, seawalls are suitable for ocean shorelines and shorelines that receive lower wave energy. Seawalls can be constructed of concrete, steel, large stones or a combination of these materials. They can be built with several different face shapes to deflect wave energy (Figure 5.4.1).

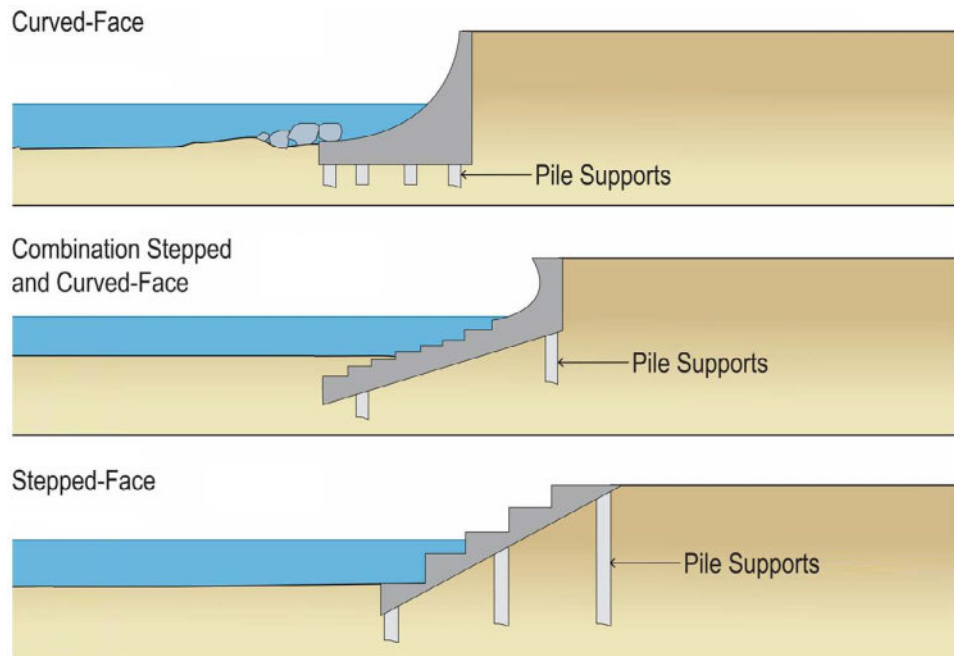

Figure 5.4.1. Example seawall cross-sections.

Drainage and designed filters can help maintain backfill behind seawalls. Void spaces that may develop under the toe of rock or armor-type protection can be resolved by grouting under the wall, depending on the elevation of the footing relative to tide levels. Where seawalls protect docks, wharfs, or piers that are elevated, elevate the top elevation of the seawall to match the dock, wharf, or pier.

When evaluating seawalls as a mitigation option, consider the following:

- Consider future conditions such as sea level rise and post-storm beach profiles in the design of a seawall.
- Vertical seawalls often deflect wave energy instead of dissipating it, which can make the shoreline more subject to erosion.
- Waves and tidal effects of large storms and hurricanes can erode the beach profile and undermine the seawall foundation, leading to failure.
- If the seawall is not constructed high enough, backfill behind seawalls can be lost when waves overtop. When the backfill is lost, structures on land can be undermined and damaged.

- Consider permitting requirements before choosing to use a seawall. Some jurisdictions may prohibit or limit the number of new seawalls. Check with the jurisdiction before selecting this, or any, stabilization option.
- Implement an inspection and maintenance program to maintain the seawall's stability throughout its intended life.

CONSIDERATIONS:



Option 2: Construct Bulkheads

Bulkheads are barriers constructed of wood, steel, stone, vinyl or concrete to prevent sliding or erosion of the land (Figure 5.4.2). The primary purpose of a bulkhead is to keep soil in place and prevent the shoreline from sliding during flooding and wave attack. Protecting the land beyond the bulkhead generally is a secondary consideration. Bulkheads are not as strong as seawalls and are not suitable for ocean shorelines.

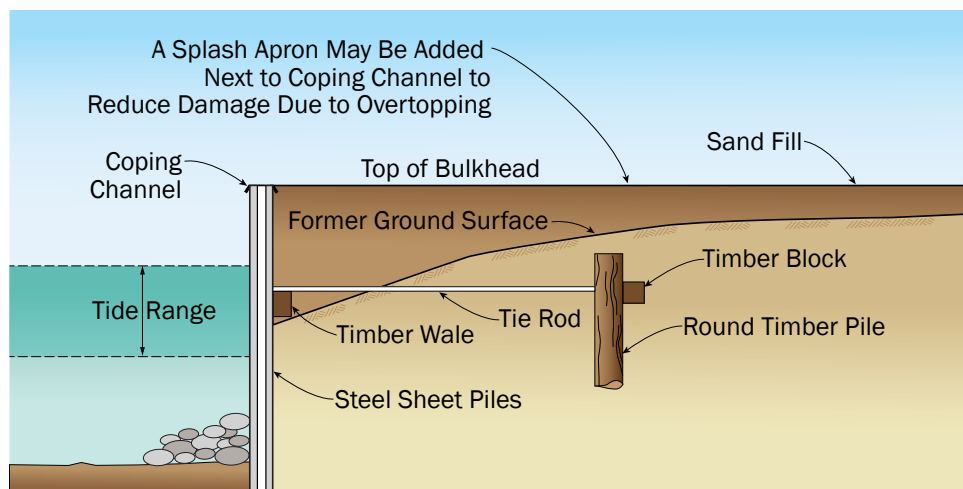

Figure 5.4.2. Example of an anchored sheet-pile bulkhead.

Bulkheads provide protection against low to moderate wave action. They can be used where deep water is needed directly at the shore to navigate or at harbors and marinas. Bulkheads can be cantilevered, anchored or gravity structures (such as rock-filled timber cribs). Piles or caissons can be reinforced by jacketing to provide additional strength. Void spaces that may develop under the toe of rock or armor-type protection can be resolved by grouting under the wall, depending on the elevation of the footing relative to tide levels. If the dock, wharf or pier being protected by a bulkhead is raised, the bulkhead itself also should be raised to match the dock, wharf or pier.

When evaluating bulkheads as a mitigation option, consider the following:

- Structurally, bulkheads do not resist wave action as well as seawalls.

- Consider future conditions, such as sea level rise, when designing the height of the bulkhead to reduce the likelihood of overtopping.
- Carefully consider the location if the bulkhead is built near existing structures since installation may impact existing structures and lead to potential maintenance issues with the bulkhead system.
- Consider permitting requirements before choosing to use a bulkhead. Some jurisdictions may prohibit or limit the installment of bulkheads. Check with the jurisdiction before selecting this, or any, stabilization option.
- Implement an inspection and maintenance program to maintain the bulkhead's stability throughout its intended life.

CONSIDERATIONS:

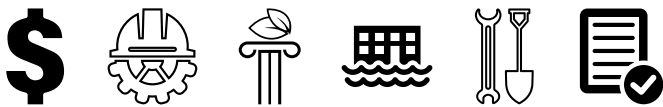

Option 3: Install Revetments

Coastal revetments generally are built of durable stone, concrete or other materials placed on an earthen slope to protect the shoreline from erosion caused by floodwater or wave action. Coastal revetments typically are comprised of an armor layer, filter layer(s), geotextile filter fabric, and toe protection (Figure 5.4.3). Revetments are suitable for ocean shorelines and sheltered water shorelines.

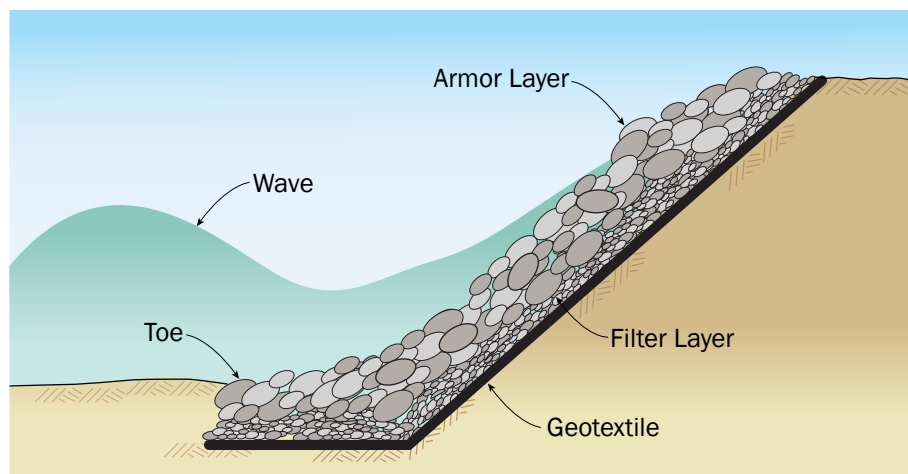

Figure 5.4.3. Typical cross section of an armor stone revetment.

The armor layer may be made from stone, concrete, concrete rubble or other structural elements such as gabions that are heavy enough to resist shifting during wave attack. The wave height and water velocity will determine the type and size of armor needed. The filter layer, also called the bedding layer, promotes drainage and helps seat the armor without damaging the geotextile fabric. Geotextile filter fabric generally is placed between the filter layer and the existing soil layer to prevent movement of soil through the revetment. Movement of the underlying soil can lead to revetment settlement or collapse, losing protection to land areas beyond the revetment. Finally, toe protection

provides stability against undermining at the bottom of the structure. Increasing the size of the stones or armor units in the armor layer can improve revetments' ability to resist damage from larger waves.

When evaluating revetments as a mitigation option, consider the following:

- Consider future conditions, such as sea level rise, and post-storm beach profiles when deciding the revetment's height and slope to reduce the chance of overtopping.
- Consider minimum expected water levels in the design of the armor layer depth at the toe to avoid scour.
- Revetments may not be as strong against wave action as seawalls are.
- Implement an inspection and maintenance program to maintain the revetment's stability throughout its intended life.
- Consider Federal, state and local permitting requirements before choosing to use a revetment. Some jurisdictions may prohibit or limit the installment of revetments. Check with the jurisdiction before selecting this, or any, stabilization option.

CONSIDERATIONS:



Option 4: Place Detached Breakwaters

A detached breakwater is a manmade structure placed offshore to protect land areas beyond the shoreline from high waves, to maintain the structure of the beach, and to create or stabilize wetland areas. Detached breakwaters help disperse wave energy and encourage sediment to deposit along the shoreline in the area protected by the structure. Breakwaters generally are situated parallel to the shore (Figure 5.4.4).

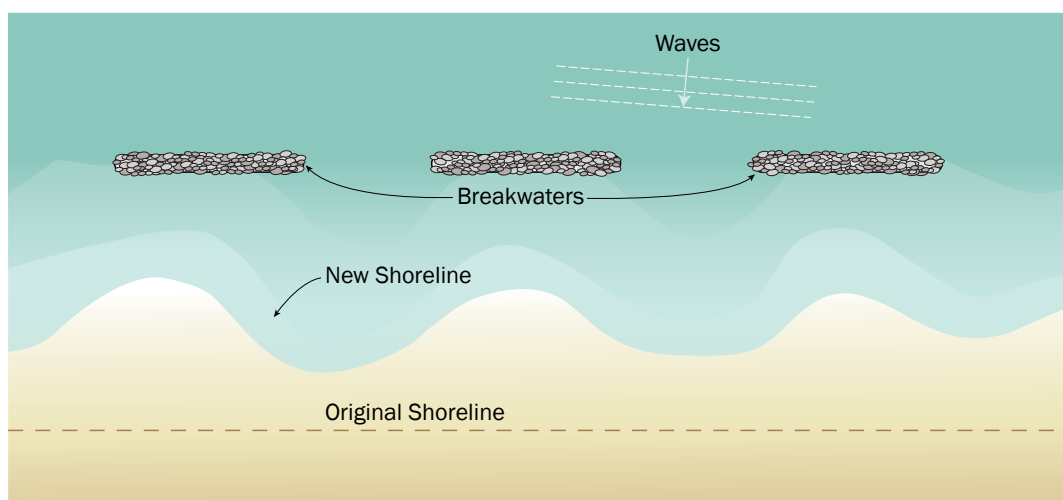

Figure 5.4.4. Typical plan view of a breakwater system.

Detached breakwaters can be high above the water level for maximum wave dispersal, low-crested to reduce construction costs (but these will allow greater wave transmission) or designed as reef-type breakwaters that are under water. Some systems use a combination of shore-connected and detached breakwaters. Most breakwaters in the U.S. are made of rubble-mound construction. The breakwater's crest elevation, width, permeability, slope angles and type of construction can be adjusted based on the desired level of wave energy dispersal and sand buildup.

When considering this mitigation option, evaluate the impact to sediment movement toward downdrift beaches, which may receive less sand deposit after a breakwater is built.

CONSIDERATIONS:



Option 5: Build Jetties and Groins

Jetties and groins are built perpendicular to the shore to slow down sediment transport along the shoreline, control currents, protect areas from wave forces, impact sand movement, and preserve navigation depth (Figure 5.4.5). Jetties usually are built at tidal inlets, river entrances or port or harbor entrances to reduce channel shoaling or stabilize the updrift shoreline. Single jetties can be built on one or both sides of the entrance.

Groins generally are built in larger numbers along a shoreline—there usually are several to many of them, spaced hundreds of feet apart. Jetties and groins can be built on both ocean and sheltered water shorelines. Sometimes a jetty is called a terminal groin (meaning a single groin at the end of a section of land, acting like a jetty).

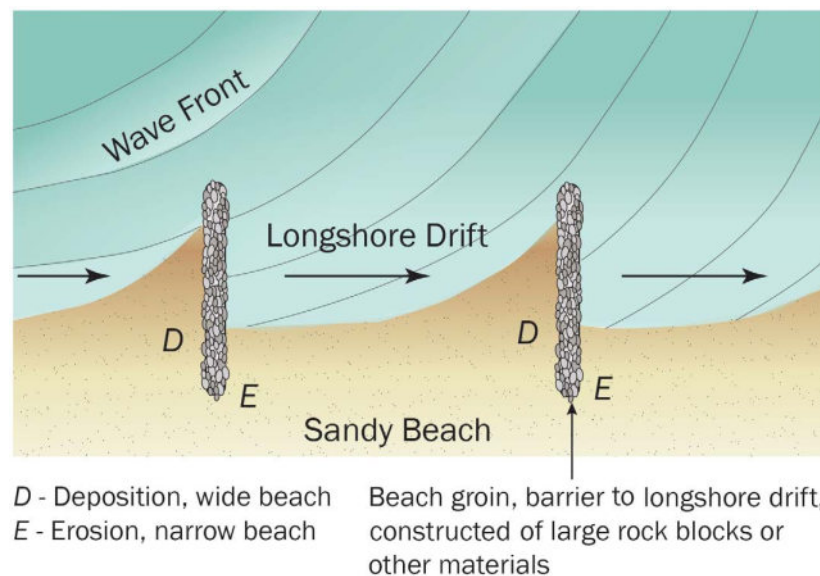

Figure 5.4.5. Example sand accretion and erosion patterns around a groin system.

Jetties and groins typically are built of various stone filter and base layers overlain by large armor stone or concrete armor units. Timber, steel and concrete also can be used in jetty design. Designers should know about coastal processes at the site, such as dominant wave directions and sediment movement along and across the coastline. The design also must consider wave forces, ocean currents and changing tidal patterns. Increasing the size of the stones or armor units in the armor layer can improve the ability of jetties and groins to resist damage from waves.

When evaluating jetties as a mitigation option, consider the following:

- Periodic dredging of the sand that builds up against the jetty or groin may be necessary to repair downdrift shorelines that do not receive sand due to the structure. Dredging to maintain navigation depth also may be necessary.
- Consider future conditions, such as sea level rise, and the expected maximum wave crest when deciding the structure's height to reduce the chance of overtopping.
- Consider impact protection from ships and other vessels in the design.
- Implement an inspection and maintenance program to maintain the jetty or groin throughout its intended life.
- Consider Federal, state and local permitting requirements before choosing to use a jetty or groin. Some jurisdictions may prohibit or limit the installment of jetties and groins. Check with the jurisdiction before selecting this, or any, stabilization option.

CONSIDERATIONS:



Option 6: Reinforce Dunes

Reinforced dunes protect the inland areas behind the dunes from flooding and loss of ecological value. Reinforced dunes are built with solid cores using components such as geotubes, rock revetments and sheet piles to maximize the dune's ability to resist erosion by waves and surge during severe storms. Figure 5.4.6 shows an example of a rock core used to reinforce a dune.

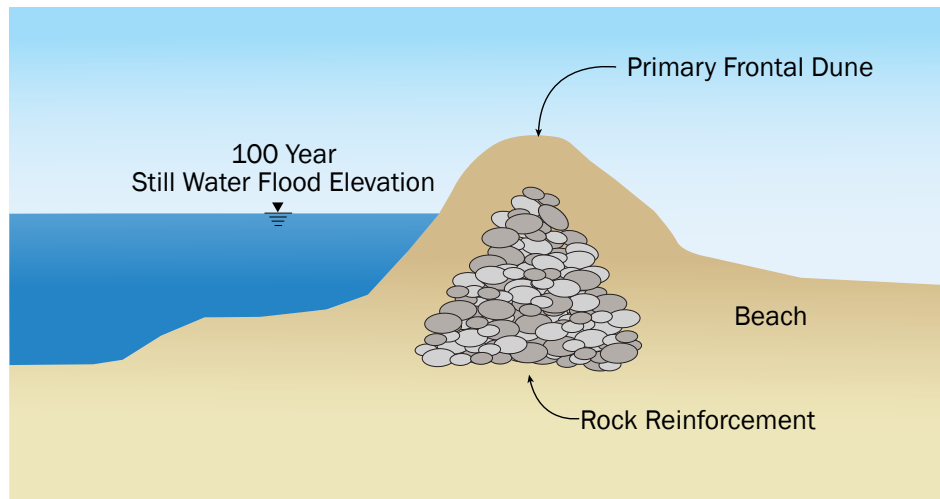
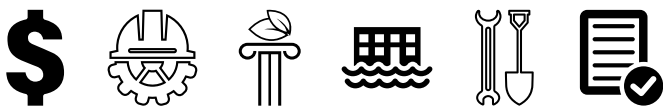

Figure 5.4.6. Rock cores can be used to build dunes that resist erosion from waves and surge.

When evaluating reinforced dunes as a mitigation option, consider the following:

- Raise the crests of reinforced dunes to reduce wave overtopping and landside flooding under extreme storm conditions.
- Grow vegetation on reinforced dunes to mitigate them further. This step is described in the following non-structural stabilization section.
- Design reinforced dunes to preserve the ecological functions of the original dunes.
- Reinforced dunes must comply with permit requirements.

CONSIDERATIONS:



Mitigation Solution: Use Non-Structural Stabilization

There are also non-structural mitigation solutions that can help stabilize the shoreline, including beach nourishment, dune restoration, and living shorelines. Natural or nature-based shoreline stabilization methods use living plants together with natural and synthetic construction materials to reduce coastal erosion, establish vegetation and stabilize shorelines.

Option 1: Nourish Beaches and Restore Dunes

Beach nourishment replaces sand lost through longshore drift or erosion (Figure 5.4.7). Beach nourishment results in a wider beach between the water and the land, which can reduce storm damage and protect the land beyond the beach. Beach nourishment typically is not a one-time fix; it will need to be repeated because the beach is still subject to longshore drift and erosion at the original site.



Figure 5.4.7. Beach nourishment replaces sand lost through longshore drift or erosion and increases resilience. (Source: USACE, 2020).

Dune restoration is accomplished by building or rebuilding dunes, and it often includes planting native dune vegetation to stabilize the dune, trap windblown sand and add coastal habitat. Vegetated dune restoration involves re-establishing native plants and installing fencing to keep sand in place and help dunes grow. Vegetated dunes can help protect against storm surge and provide habitat for many animal species.

Dune restoration or beach nourishment combined with sediment stabilization with plantings and fencing can be used in addition to other stabilization measures to protect the shoreline and nearby structures.

CONSIDERATIONS:



Option 2: Stabilize Using Living Shorelines

Living shoreline stabilization involves using vegetation combined with geogrids, crib walls, brush mattresses, root wads or other bioengineered construction materials. Living shorelines can mitigate erosion in lesser-developed areas that do not experience high velocity waves (Figure 5.4.8).

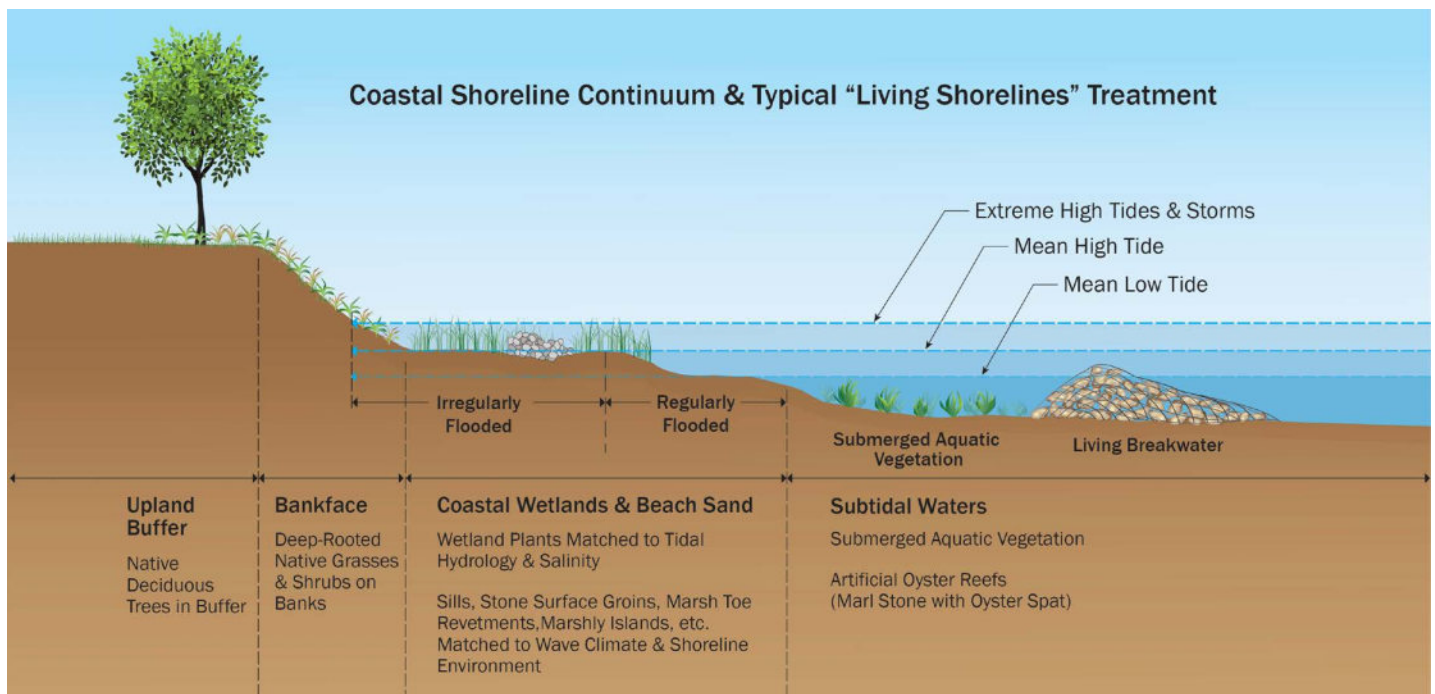

Figure 5.4.8. Nature-based solutions for shoreline stabilization via a "Living Shorelines" approach. (Source: Adapted from NOAA, 2016)

A living breakwater may include, but is not limited to, an oyster reef, seagrasses, mangroves, and vegetated dunes.

- Oyster reefs serve as natural breakwaters, which can calm waves and reduce erosion on the shoreline side of the reef. They also can provide habitat for fish and some invertebrates. Oyster reefs can be constructed of bagged oyster shells placed in the intertidal area. Shell bags may need to be anchored in place, particularly if they are stacked, or waves may overtop the structure.
- Seagrasses typically grow as underwater grass fields in shallow water off coastlines. They help protect the coastline by slowing wave energy and trapping sediment, thus reducing erosion. They also serve as a habitat to many different sea creatures.
- Mangroves are trees or shrubs that grow primarily in shallow tropical water. The dense root systems of mangrove forests help trap sediment, which can help stabilize the coastline and protect reefs and seagrasses from being trapped under sediments. Mangroves also can reduce the impacts of waves, and wide mangrove belts can help reduce wind speed.

Bioengineered shoreline protection can:

- Protect against erosion while augmenting the natural ecosystem and providing habitat for plant and animal species.
- Provide low-maintenance shoreline stability when the vegetation's root system is established and strengthened as it matures.
- Restore many natural ecosystem functions and have ancillary benefits to the human and the ecological communities.

When evaluating living shorelines as a mitigation option, consider the following:

- Designers need to understand the coastal sediment transport system and erosion cycle in the coastal zone in which the project is located.
- Designers should use sound engineering practices and ecological principles to assess, design, construct and maintain living vegetation systems that are blended into the shoreline and the supported coastal ecosystem.
- Living shorelines typically are effective only in low-energy environments and may need to be paired with other mitigation techniques to provide a desired level of protection.
- Projects likely will involve an interdisciplinary effort between scientists, engineers and landscape architects.
- Implement an inspection and maintenance program to maintain a bioengineered shoreline stabilization system throughout its intended life.
- Consider Federal, state and local permitting requirements before choosing to use living shoreline stabilization methods.
- As with structural mitigation methods, heavy storms can damage living shorelines, requiring them to be repaired to provide the same level of protection they did prior to the storm.

CONSIDERATIONS:



REFERENCES:

- FEMA. 2018. Job Aid: *Bioengineered Shoreline Stabilization*. Available at: <https://www.mass.gov/doc/bioengineered-shoreline-stabilization-job-aid/download>
- Florida Department of Environmental Protection (FDEP). Office of Resilience and Coastal Protection Website. Available at: <https://floridadep.gov/rcp>
- National Oceanic and Atmospheric Administration (NOAA). 2016. *Living Shorelines Guidance*. Available at: <https://coast.noaa.gov/data/digitalcoast/pdf/living-shoreline.pdf>
- National Wildlife Federation (NWF). 2020a. *Softening Our Shorelines: Policy and Practice for Living Shorelines Along the Gulf and Atlantic Coasts*. Prepared by Hilke, C., J. Ritter, J. Ryan-Henry, E. Powell, A. Fuller, B. Stein, and B. Watson. Available at: <https://www.nwf.org/-/media/Documents/PDFs/NWF-Reports/2020/Softening-Our-Shorelines.ashx>.
- NWF. 2020b. *The Protective Value of Nature: A Review of the Effectiveness of Natural Infrastructure for Hazard Risk Reduction*. Prepared by Glick, P., E. Powell, S. Schlesinger, J. Ritter, B.A. Stein, and A. Fuller. Available at: <https://www.nwf.org/-/media/Documents/PDFs/NWF-Reports/2020/The-Protective-Value-of-Nature.ashx?la=en&hash=A75F59611475502BEE58723F8B3C58423417E579>.
- U.S. Army Corps of Engineers (USACE). 1981. *Low Cost Shore Protection, A Guide for Local Government Officials*. Available at: <https://apps.dtic.mil/dtic/tr/fulltext/u2/a112641.pdf>
- USACE. 1989. EM 1110-2-1204, *Environmental Engineering for Coastal Shore Protection*. Available at: https://www.publications.usace.army.mil/Portals/76/Publications/EngineerManuals/EM_1110-2-1204.pdf
- USACE. 1995. EM 1110-2-1614, *Coastal Revetments, Seawalls, and Bulkheads*. Available at: https://www.delmar.ca.us/DocumentCenter/View/1899/Design-of-Coastal-Revetments-Seawalls-and-Bulkheads_Army-Corps-of-Engineers-1995?bidl=
- USACE. 2002. EM 1110-2-1100, *Coastal Engineering Manual*. Available at: <https://www.publications.usace.army.mil/USACE-Publications/Engineer-Manuals/u43544q/636F617374616C20656E67696E656572696E67206D616E75616C/>
- USACE. 2004. *Low Cost Shore Protection, A Property Owner's Guide*. Available at: https://books.google.com/books/about/Low_Cost_Shore_Protection.html?id=qNHW6vc42WgC
- USACE. 2012. *Low Cost Shore Protection, A Guide for Engineers and Contractors*. Available at: <https://www.pdhone.com/courses/c223/Low%20Cost%20Shore%20Protection%20Guide.pdf>
- USACE. 2020. "Army Corps awards contract for Absecon Island beach nourishment." Available at: <https://www.usace.army.mil/Media/News-Releases/News-Release-Article-View/Article/2297830/army-corps-awards-contract-for-absecon-island-beach-nourishment/>
- USACE. No Date Engineering with Nature Website. Available at: <https://ewn.el.erdc.dren.mil/index.html>.
- USACE. No Date Systems Approach to Geomorphic Engineering Website. Available at: <http://www.sagecoast.org/index.html>
- U.S. Army Corps of Engineers, Institute for Water Resources. 2021. *Tales of the Coast, Corps and the Coast Navigation Structures*. Available at: <https://www.iwr.usace.army.mil/Missions/Coasts/Tales-of-the-Coast/Corps-and-the-Coast/Navigation/Structures/>

Fact Sheet 5.5: Coastal Facilities

The objective of this Fact Sheet is to mitigate the effects of severe weather to coastal facilities.

Coastal facilities, as defined here, are facilities built to support the many uses of the coastal and ocean water and waterfront. Severe weather can damage or destroy coastal facilities, and their loss will be felt by those who are frequent users as well as the communities that benefit economically from their use. Exposure of these facilities to severe weather varies, depending primarily on their locations relative to the shoreline. While high winds, flooding from storm surge, wave runup, splash, and corrosive air can damage facilities located above the high-tide line, those located below the high-tide line also could be exposed to continual hydrodynamic forces from coastal waves and currents.

In general, a coastal facility is one structure or a complex of structures. Typical waterfront facilities and structures include:

- Piers
- Boardwalks
- Docks
- Wharves
- Floating docks
- Boat launch ramps
- Boat storage facilities
- Beach accesses
- Restrooms
- Lifeguard stations
- Police stations
- Administrative offices
- Educational centers
- Other amenities that support recreational, commercial, ecological and community uses

Mitigating threats from severe weather involves minimizing damage to these structures.

Table 5.5.1 presents four primary mitigation solutions for reducing the likelihood that coastal facilities will sustain damage from severe weather. The options for implementing the solutions, which vary with the types of the structures, are discussed as applicable.

Repair, improvement or mitigation of building structures associated with these facilities may be subject to building code and floodplain management requirements, which vary based on flood zone and building use. Consult the jurisdiction for these requirements.



Table 5.5.1. Common Mitigation Solutions for Damage to Coastal Facilities

Solutions and Options	Piers	Boardwalks	Docks and Wharves	Floating Docks	Boat Launch Ramps	Boat Storage	Beach Accesses	Shoreline Amenities
Mitigation Solution: Monitor, Inspect, Repair								
Option 1: Optimize Maintenance Programs	✓	✓	✓	✓	✓	✓	✓	✓
Mitigation Solution: Retrofit, Reinforce								
Option 1: Retrofit or Reinforce by Structure Type	✓	✓	✓	✓	✓	✓		✓
Mitigation Solution: Elevate								
Option 1: Elevate by Structure Type	✓	✓	✓					✓
Mitigation Solution: Upgrade, Relocate								
Option 1: Upgrade	✓	✓	✓	✓	✓	✓		✓
Option 2: Relocate	✓	✓	✓	✓	✓	✓		✓

Mitigation Solution: Monitor, Inspect, Repair

Monitoring, inspecting and completing repairs of coastal facilities in a timely manner will help maintain their usability and allow them to withstand severe weather better. The solution is to optimize and enhance existing maintenance programs to mitigate severe weather. Therefore, it applies to all structures, including all types of beach accesses.

Option 1: Optimize Maintenance Programs

MONITOR

- Identify key components of the structures that are at risk.
- Identify the baseline conditions of the at-risk components based on as-built or original design drawings.
- Monitor changes from the baseline through on-site observations and assess the need for inspection (1) after storms, (2) at regular intervals, e.g., every two years, and (3) after reports of accidental damage.
- Consider more-intensive monitoring for new or recently rehabilitated structures.

INSPECT

- Inspect structures when causes for concern are found during monitoring.
- Conduct the inspection using:
 - On-site measurement (for accessible structures)
 - Aerial or drone photography or photogrammetry (for large-scale, offshore or rubble mound structures)
 - Underwater inspection for submerged elements
 - Any combinations of these measures

REPAIR

- Repair observed damage, whether major or minor, based on the documentation, data and measurements from the inspection and the as-built or original design drawings.
- Schedule the repair as soon as feasible and, at the latest, before the next storm season to prevent progressive damage.

Overall, this monitor-inspect-repair strategy is relatively inexpensive within the existing maintenance framework and usually can be done within normal maintenance budgets.

CONSIDERATIONS:



Mitigation Solution: Retrofit, Reinforce

Retrofitting and reinforcing coastal structures that are likely to be damaged will improve their ability to withstand severe weather. The types and details of retrofitting and reinforcement vary by structure and are presented that way below.

Option 1: Retrofit or Reinforce by Structure Type

PIERS AND BOARDWALKS

Piers and boardwalks are framed decks on pilings built over water and land. Additionally, some have superstructures that include buildings and amenities. Typically, they serve recreational and commercial uses on the waterfront. Reinforcing piers and boardwalks helps mitigate damage from flood, wind and debris impacts, as described below. In-water work generally requires permits; check with the local permitting agency to learn what permits are required.

- Retrofit or reinforce the supporting piles. The material used for these piles includes wood, steel or reinforced concrete piles, or large columns or pillars placed on pile caps with deep pile foundations.
- Retrofit wooden piles with piling wraps to protect against deterioration caused by marine borers. Figure 5.5.1 shows an example of polyvinyl chloride (PVC)-wrapped piles.



Figure 5.5.1. Piles can be wrapped with PVC to protect them from damage (Source: Marine Fix Supply, 2018).

- As a preventive measure, or for aging timber piles showing decay and concrete piles showing cracking and spalling, retrofit the pile with a jacket encasement. This measure applies a jacket encasement, an internal reinforcing layer, and a grout infill that prevents further weakening and also reinforces the pile. Figure 5.5.2 presents an example of aging piles before and after fitting with a jacket encasement.



Figure 5.5.2. Fit aging piles with jacket encasements to strengthen and protect them (Source: Shoreline Plastics, No Date).

- Replace damaged or deteriorated piles with new piles designed to resist the existing conditions and potential storm conditions.
- If erosion and scour are a concern, install deeper piles. Deeper piles can replace existing damaged or deteriorated piles or be sistered (i.e., installed alongside) to existing piles in good condition.
- Retrofit or reinforce the bottom of piles, called pile toes, with scour protection to shield against soil undermining from storm waves.
- Retrofit or reinforce the deck frame, deck and superstructure against wave uplift, splash, high winds and flooding during severe storms. Figure 5.5.3 shows the replacement of pre-cast concrete pier deck panels with cast-in-place concrete. Grates that relieve uplift pressures might be feasible instead of solid deck panels.



Figure 5.5.3. Improve pier performance during future storms by replacing storm-damaged pre-cast concrete pier deck panels with reinforced cast-in-place concrete (Source: U.S. Army Corps of Engineers, No Date).

- Other mitigation measures can include:
 - Use either splicing or timber or steel cross bracing to retrofit or reinforce the frame
 - Upgrade or replace the frame, deck and superstructure's hardware fittings and joints with materials that have anti-corrosion properties and added strength. Figure 5.5.4 shows an example of reinforced splicing of the structural components of a timber pier.
- Retrofit superstructure buildings using dry or wet floodproofing techniques (see Docks and Wharves, below, and see Fact Sheet 3.1, *Foundations*).
- Retrofit handrails and stairs as needed.



Figure 5.5.4. Reinforce wharves, docks and boardwalks by splicing and reinforcing the structural components of piers and piles (Source: Professional Diving Services, 2020).

DOCKS AND WHARVES

Docks and wharves are most commonly the central waterfront structures of ports, harbors, marinas and urban or industrial waterfronts. Docks are structures that extend from the shoreline into a body of water and often are used for tying up boats. Some docks may be floating on the water. Wharves are docks formed by large bulkheads (i.e., retaining walls) and often are part of large industrial or commercial facilities such as ports and harbors or urban waterfronts. Wharves usually support shipping and transportation and have connections to land-based transportation in addition to water-based transportation. Protecting these structures from damage during severe weather is critical to their use.

- Retrofit or reinforce pilings as described above under Piers and Boardwalks.
- Retrofit or reinforce decks of fixed or floating piers and finger piers, as discussed under Piers and Boardwalks (above) and Floating Docks (below).
- Retrofit dockside buildings with dry or wet floodproofing, i.e., retrofit the portion of the building below the potential flood elevation with:
 - Waterproof wall coatings, membranes and/or added masonry layers
 - Watertight shields at windows and doors to prevent water from entering (dry floodproofing)
 - Damage-resistant wall materials (e.g., concrete, treated plywood)
 - Flood vents
 - Improved in-door drainage to allow water to enter and drain on gravity while equalizing hydrostatic pressures on both sides of the walls to prevent collapse (wet floodproofing); for additional information, see Fact Sheet 3.1, *Foundations*

FLOATING DOCKS, GANGWAYS AND PIERS

Floating docks, gangways and piers are integral parts of marinas, ferry terminals and urban waterfront developments. The dock, which floats over the water, is connected to the shore-based pier by a gangway or ramp. These structures can be reinforced to mitigate damage from flood, wind and debris impacts, as described below.

- Retrofit or reinforce bolting and hinging systems of interconnected walkways, finger docks, pontoons and anchorage, as well as the upper support of gangways. Figure 5.5.5 illustrates a marine terminal dock complex with in-water structural components joined together with shore-based structures.

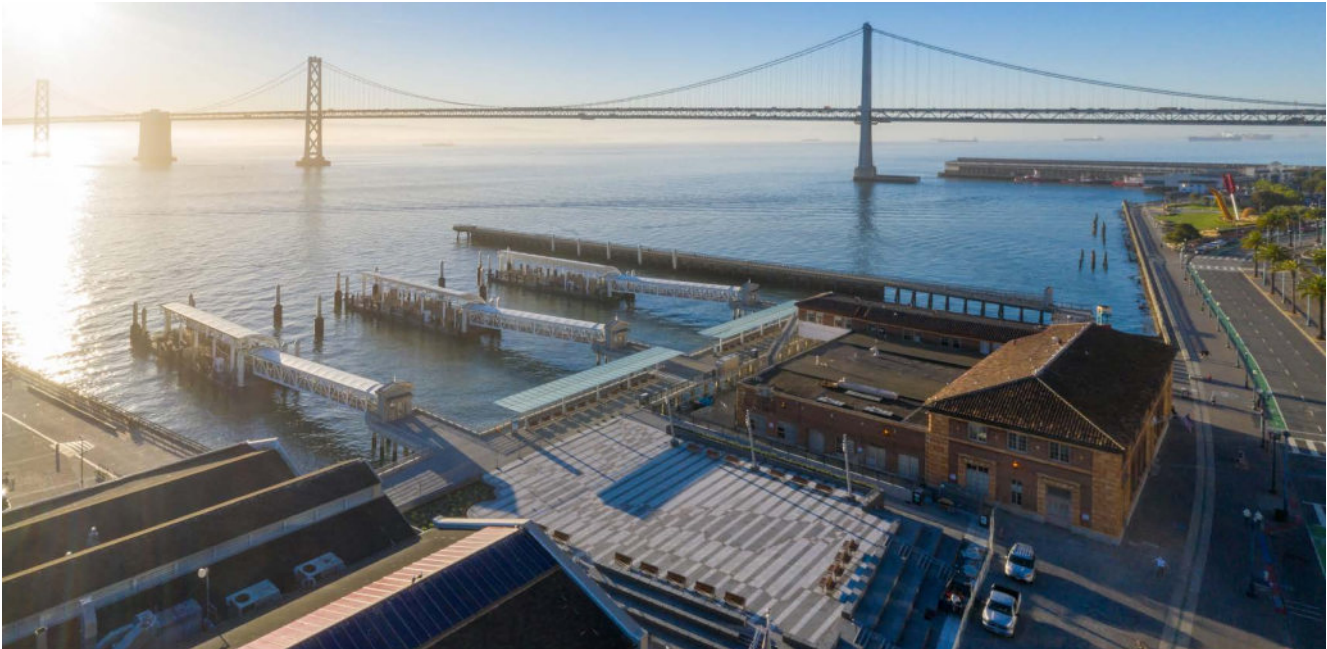

Figure 5.5.5. Rendering of downtown San Francisco Terminal Expansion Project containing a marine terminal dock complex with in-water structural components joined together with shore-based structures (Source: Water Emergency Transportation Authority, 2021).

- Given that inadequate anchorage is a primary reason why floating docks fail during severe weather, consider retrofitting, reinforcing or adjusting pile and cable anchor systems against extreme sideways and up-and-down motion during storms.
- Retrofit or enhance bumpers to mitigate damage from impact and chafing between docks and vessels during severe storms.
- Retrofit with fixed or floating debris booms to prevent excess forces from floating debris during and after storms.
- For marinas and small craft harbors, confirm the security and integrity of weatherproofing measures (e.g., covers, boxes, storages) for utility services, especially potable water, sewage and wastewater holding tanks, pump-out, electrical, fueling, lighting, communication and fire safety.

BOAT LAUNCH RAMPS AND BOARDING FLOATS

Boat launch ramps and boarding floats are among the common core structures that support recreational boating and commercial and sport-fishing activities.

- Retrofit or reinforce pile anchors and hinging of boarding floats (see also Floating Docks) against severe wave, current, wind and vessel impact damage.
- Repair and reinforce revetments along the shoreline near the boat launch ramp. Revetments are retaining walls that help disperse wave energy and protect the floating dock boarding system against extreme wave action during severe weather. Figure 5.5.6 shows an example of revetments surrounding a boat launch ramp system.



Figure 5.5.6. An example of revetments protecting a boat launch ramp system.

BOAT STORAGE

Boat storage facilities are shoreside structures that warehouse boats when not in use. Dry-stack storage facilities lessen in-water storage space requirements and reduce vessel damage from surges and waves during storms. Figure 5.5.7 shows an example of an outdoor dry-stack storage facility. The stack structures also are commonly built indoors for added weatherproofing storage (see Figure 5.5.8). See Fact Sheet 3.3.1, *Sloped Roof Systems*, and Fact Sheet 3.3.2, *Flat Roof Systems*, for roof retrofits.

Since they are relatively high profile, make sure that dry-stack frames and buildings can withstand high wind during a storm.



Figure 5.5.7. An example of an outdoor dry-stack storage facility (Source: Brendan McGinley, 2021).



Figure 5.5.8. An example of an indoor dry-stack facility.

SHORELINE AMENITIES

Shoreline amenities (e.g., bathrooms, information centers, lifeguard or police stations, bike trails and scenic lookouts) provide needed services to beachgoers, tourists and the local community. These services also can have an educational aspect to them. Retrofit shoreline amenity and service buildings by using dry or wet floodproofing. See Fact Sheet 3.1, *Foundations*.

CONSIDERATIONS:



Mitigation Solution: Elevate

In part or in whole, elevating coastal facilities relative to the potential flood level can preserve their functionality against severe weather. The following sections provide additional information about elevation mitigation approaches.

Option 1: Elevate by Structure Type

PIERS, DOCKS, WHARVES AND BOARDWALKS

For new construction, elevate the decks of fixed piers, docks, wharves and boardwalks to protect from damage by severe flooding (Figure 5.5.9).

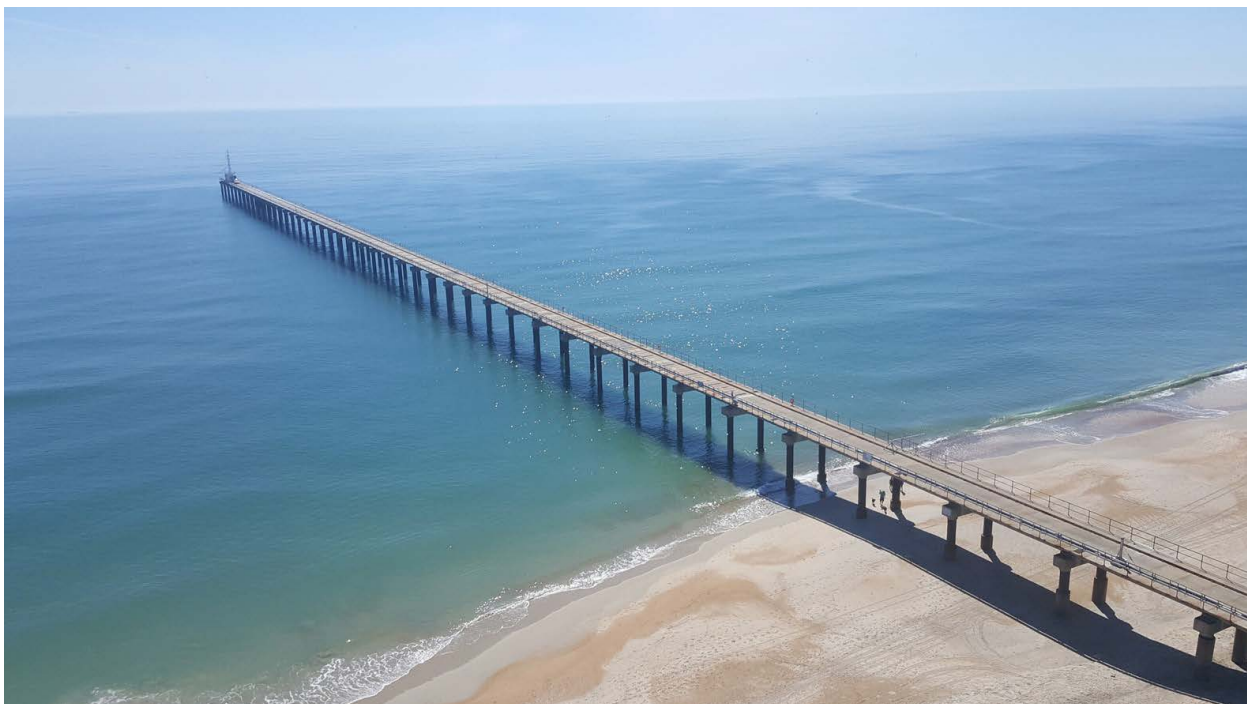

Figure 5.5.9. Elevating piers can help protect them from the impacts of floods (Source: USACE, 2020)

When elevating, some points to consider include:

- For floating piers, make sure that guide piles and anchoring systems can adjust to higher water levels.
- For existing buildings, elevate the lowest indoor floors and convert the lower floors to non-habitable spaces such as offices and storage areas. Alternatively, raise the entire building (see Fact Sheet 3.1, *Foundations*).
- Consider also elevating structures on the landside of coastal facilities, including seawalls, bulkheads, docks and wharves, to provide a smooth transition between land- and water-based structures.
- Ensure that appropriate measures are in place to raise historically important buildings or structures (e.g., disassembling, reassembling, moving).

SHORELINE AMENITIES

Elevate any and all shoreline amenity and service buildings above potential flood elevations. See Fact Sheet 3.1, *Foundations*, for additional information about elevating buildings.

CONSIDERATIONS:

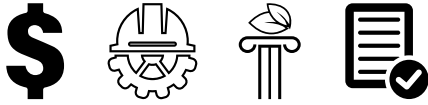

Mitigation Solution: Upgrade, Relocate

In some cases, adapting to changing water levels and tidal conditions through retrofitting, reinforcing, or elevating coastal facilities may not be practical or might be too expensive. Repair may not be feasible if damage is too great, or if the structure has become obsolete. The remaining mitigation option is to upgrade or relocate the coastal facilities in danger.

Option 1: Upgrade

Upgrading, either in the original location or to a new location, may be more cost-effective, satisfy the latest design requirements, and improve operations. Consult the jurisdiction regarding requirements for new construction. Codes and regulations may affect siting, design and use of the structure.

CONSIDERATIONS:

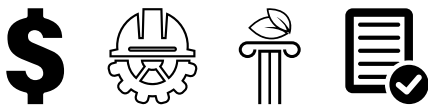

Option 2: Relocate

Relocation to a site in the same general area that is more sheltered from direct waves and less impacted by increases in water levels may be appropriate. When evaluating relocation as a mitigation strategy, consider the following:

- Relocate coastal structures that do not function as shoreline protection. These structures can include piers, boardwalks, docks, wharves, boat launch ramps, boat storage facilities, bike trails and shoreline amenities.
- For onshore structures and facilities, determine the flood zones of potential relocation sites to evaluate whether relocation is feasible.
- For in-water structures, relocating to an entirely new site may be necessary.

CONSIDERATIONS:

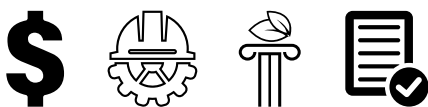

REFERENCES:

Detailed technical information on coastal structure design considerations and practices can be found in these publications:

American Society of Civil Engineers (ASCE). 2012. "Planning and Design Guidelines for Small Craft Harbors." *Manuals and Reports on Engineering Practice No. 50*. 3rd Ed. American Society of Civil Engineers. Available at: <https://ascelibrary.org/doi/book/10.1061/9780784411988>

Federal Emergency Management Agency (FEMA). 2008. *National Flood Insurance Program Technical Bulletin 2, Flood Damage-Resistant Materials*. Available at: https://www.fema.gov/emergency-managers/risk-management/building-science/publications?name=%22Technical+Bulletin+2%22&field_keywords_target_id=All&field_document_type_target_id=All&field_audience_target_id=All

FEMA. 2011a. *Coastal Construction Manual, Volume I*. Available at: https://www.fema.gov/sites/default/files/2020-08/fema55_voli_combined.pdf

FEMA. 2011b. *Coastal Construction Manual, Volume II*. Available at: https://www.fema.gov/sites/default/files/2020-08/fema55_volii_combined_rev.pdf

Marine Fix Supply. 2018. "Pile Wrap." Available at: <https://www.fixmarinesupply.com/pile-wrap>

National Institute of Building Sciences (NIBS). 2012. *Design: Small Craft Berthing Facilities—Unified Facilities Criteria UFC-4-152-07*. Available at: https://www.wbdg.org/FFC/DOD/UFC/ufc_4_152_07_2009_c1.pdf

NIBS. 2017. *Design: Piers and Wharves—Unified Facilities Criteria UFC 4-152-01*. Available at: <https://www.wbdg.org/ffc/dod/unified-facilities-criteria-ufc/ufc-4-152-01>

Professional Diving Services. 2020. "Beacon Cove Pile Repair Works." <https://www.profdivers.com/beacon-cove-pile-repair-works/>

Shoreline Plastics. No Date. "Snap Jacket." <https://shorelineplastics.com/snapjacket/>

U.S. Army Corps of Engineers (USACE). 2002. *Coastal Engineering Manual—EM 1110-2-1100*. Available at: <https://www.publications.usace.army.mil/USACE-Publications/Engineer-Manuals/u43544q/636F617374616C20656E67696E656572696E67/>

USACE. 2020. "The Corps' Field Research Facility unsurpassed for coastal observation and research." Available at: <https://www.erdc.usace.army.mil/Media/News-Stories/Article/2091155/the-corps-field-research-facility-unsurpassed-for-coastal-observation-and-resea/>

USACE. No Date Image Gallery. Available at: <https://www.lrd.usace.army.mil/Media/Images/igphoto/2002312377/>

Water Emergency Transportation Authority. No Date. "The Downtown San Francisco Ferry Terminal Expansion Project." <https://weta.sanfranciscobayferry.com/downtown-san-francisco-ferry-terminal-expansion-project>

Appendices

A: Acronyms

ACB	Articulated Concrete Blocks	LHSM	Lowest horizontal structural member
ACI	American Concrete Institute	LIMWA	Limit of Moderate Wave Action
ADA	Americans with Disabilities Act	LOMC	Letter of Map Change
AF&PA	American Forest & Paper Association	LOMR-F	Letter of Map Revision based on fill
ANSI	American National Standards Institute	MAT	Mitigation Assessment Team
ASCE	American Society of Civil Engineers	mph	Miles per one hour
ASME	American Society of Mechanical Engineers	MRL	Machine room-less traction elevators
ASTM	American Society for Testing and Materials	MSJC	Masonry Standard Joint Committee
ATC	Applied Technology Council	NAVD	North American Vertical Datum
AWC	American Wood Council	NDS	National Design Specification
BFE	Base flood elevation	NEMA	National Electrical Manufacturers Association
CFR	Code of Federal Regulations	NFIP	National Flood Insurance Program
CMU	Concrete masonry unit	NFPA	National Fire Protection Association
DASMA	Door and Access Systems Manufacturers Association International	NGVD	National Geodetic Vertical Datum
DFE	Design flood elevation	NOAA	National Oceanic and Atmospheric Administration
DHS	Department of Homeland Security	NSSA	National Storm Shelter Association
EIFS	Exterior Insulation Finishing System	oz/ft²	Ounces per square foot
FEMA	Federal Emergency Management Agency	PA	Public Assistance
FHBM	Flood Hazard Boundary Map	PAPPG	Public Assistance Program and Policy Guide
FIA	Federal Insurance Administration	PFD	Primary frontal dune
FIMA	Federal Insurance and Mitigation Administration	PWF	Permanent Wood Foundation
FIRM	Flood Insurance Rate Map	RCC	Roller Compacted Concrete
FIS	Flood Insurance Study	SEI	Structural Engineering Institute
HMA	Hazard Mitigation Assistance	SFHA	Special Flood Hazard Area
HVAC	Heating, Ventilation and Air Conditioning	SFIP	Standard Flood Insurance Policy
IBC	International Building Code	SLTT	State, local, tribal and territorial
ICC	International Code Council	SSPC	Society for Protective Coatings
ICC-ES	ICC Evaluation Service	TB	Technical Bulletin
I-Codes	International Codes	USACE	U.S. Army Corps of Engineers
IBC	International Building Code	USFWS	U.S. Fish and Wildlife Service
ICC	International Code Council	USGS	United States Geological Survey
ICC-ES	ICC Evaluation Service	VPL	Vertical Platform Lift
I-Codes	International Codes		
LAG	Lowest adjacent grade		

B: Glossary of Key Terms

The acronyms used in this Handbook are defined in Appendix A.

Quoted material from ASCE 24-14 is used with permission. Definitions of some terms used in this handbook are not the same as those used by the NFIP.

Accessory (or appurtenant) structure: “Structure which is on the same parcel of property as the principal structure to be insured and the use of which is incidental to the use of the principal structure” (44 CFR § 59.1). Detached garages used for parking of vehicles and limited storage and small sheds used for limited storage are considered accessory structures.

Active mitigation measure: A mitigation measure that requires human intervention to start.

Apron: A covering or structure along a streambank or shoreline for protection against erosion.

Aqueduct: Any system of pipes, ditches, canals, tunnels and other structures used to convey water.

Area of special flood hazard: “Land in the flood plain within a community subject to a 1% or greater chance of flooding in any given year. The area may be designated as Zone A on the Flood Hazard Boundary Map (FHBM). After detailed ratemaking has been completed in preparation for publication of the flood insurance rate map, Zone A usually is refined into Zones A, AO, AH, A1-30, AE, A99, AR, AR/A1-30, AR/AE, AR/AO, AR/AH, AR/A, VO, or V1 30, VE, or V. For purposes of these regulations, the term ‘special flood hazard area’ is synonymous in meaning with the phrase ‘area of special flood hazard’” (44 CFR § 59.1).

Baffle structure: A structure that regulates flow or impedes the force or movement of a fluid.

Bankfull: The water level, or stage, at which a stream, river or lake is at the top of its banks and any further rise would result in water moving into the floodplain.

Barb (flow diverter): Rock structures that extend into the stream flow to modify flow patterns and bed topography to protect against erosion.

Base flood: “Flood having a 1% chance of being equaled or exceeded in any given year” (44 CFR § 59.1).

Base flood elevation (BFE): The computed elevation to which floodwater is anticipated to rise during the base flood, including wave height, relative to the datum specified on the Flood Insurance Rate Map. The BFE is shown on the FIRM for Zones AE, AH, A1–A30, AR, AR/A, AR/AE, AR/A1–A30, V1–V30 and VE. For Zones AR/AH and AR/AO, a depth of flooding is given for the 1% annual chance event. SFHAs without BFEs are identified on FIRMs as Zone A or Zone V. When BFEs are not identified, communities must obtain, review, and reasonably use any BFE data available from a federal, state or other source. Additionally, it is the elevation of the base flood relative to the datum specified on a community’s Flood Insurance Rate Map (FIRM) that is crucial. In any given year, there is a 1% chance that the base flood will be equaled or exceeded. The BFE is the NFIP’s minimum elevation used for design and construction of buildings. Areas affected by the base flood are shown as Special Flood Hazard Areas (SFHAs) on FIRMs.

Basement: “Area of the building having its floor subgrade (below ground level) on all sides” (44 CFR § 59.1). NFIP regulations do not allow basements to extend below the BFE except in dry-floodproofed, non-residential buildings.

Bioengineered/Bioengineering: The use of a combination of biological, mechanical and ecological concepts to control erosion and stabilize soil through the sole use of vegetation or a combination of vegetation and construction materials. Includes the use of living and non-living plant materials in combination with natural and synthetic support materials for slope stabilization, erosion reduction, and vegetation establishment.

Bioretention: A technique that uses soil, plants and microbes to treat stormwater before it infiltrates or is discharged.

Breakaway wall: “A wall that is not part of the structural support of the building and is intended through its design and construction to collapse under specific lateral loading forces without causing damage to the elevated portion of the building or supporting foundation system” (44 CFR § 59.1).

Buttress: A structure, usually brick or stone, built to give support or reinforcement.

Catchment: An area for collecting water, especially rainwater.

Closed foundation: Continuous foundations that restrict or divert the flow of floodwater. Closed foundations include basements, crawl spaces where the lowest floor is built above grade, stem walls with soil supported concrete floor slabs and soil supported monolithic slabs-on-grade foundations where portions of the slab are often thickened to support the structure above.

Coastal A Zone: “Area within a special flood hazard area, landward of a V Zone or landward of an open coast without mapped V Zones. In a Coastal A Zone, the principal source of flooding must be astronomical tides, storm surges, seiches, or tsunamis, not riverine flooding. During the base flood conditions, the potential for breaking wave heights shall be greater than or equal to 1.5 feet. The inland limit of the Coastal A Zone is:

1. The Limit of Moderate Wave Action if delineated on a FIRM, or
2. Designated by the authority having jurisdiction” (ASCE 24-14).

Coastal high hazard area: “An area of special flood hazard extending from offshore to the inland limit of a primary frontal dune along an open coast and any other area subject to high velocity wave action from storms or seismic sources” (44 CFR § 59.1). The coastal high hazard area is shown on a FIRM or other flood hazard map as Zone V, VO, VE or V1-V30.

Community: “Any State or area or political subdivision thereof, or any Indian tribe or authorized tribal organization, or Alaska Native village or authorized native organization, which has authority to adopt and enforce flood plain management regulations for the areas within its jurisdiction” (44 CFR § 59.1).

Connector: Hardware that links wall framing to roof and floor systems, holding the building together. Includes hurricane straps/ties or concrete or grout with steel reinforcing bars.

Continuous load path: See Load path.

Dampening/damper: A device that eliminates or diminishes vibrations or oscillations.

Deck: Exterior floor supported on at least two opposing sides by an adjacent structure and/or posts, piers or other independent supports.

Deep foundation: Foundations that are supported by soils that are significantly below the surface of the surrounding grade. Deep foundations include piles, drilled shafts and caissons. Deep foundations are inherently resistant to scour and erosion.

Design flood: “The flood associated with the greater of the following two areas: (1) area within a floodplain subject to a 1% or greater chance of flooding in any year, or (2) area designated as a flood hazard area on a community’s flood hazard map or otherwise legally designated” (ASCE 24-14).

Design flood elevation (DFE): “Elevation of the design flood, including wave height, relative to the datum specified on the community’s flood hazard map” (ASCE 24-14). The DFE is the locally adopted regulatory flood elevation. If a community regulates based on the FIRM, the DFE is identical to the BFE. If a community chooses to regulate based on a different flood hazard map, a lower frequency flood, or adds freeboard, the DFE must be at least as high as the BFE. Additionally, it is the elevation of the design flood relative to the datum specified on a community’s flood hazard map. This elevation is the higher of the base flood or the value designated for a flood hazard area on a community flood map or otherwise designated. Communities may designate another flood elevation to regulate based on a flood of record, to account for future increases in flood levels based on upland development, or to incorporate freeboard.

Detailing: Design practice of using structural and architectural drawings and specifications to arrange, configure and connect structural and nonstructural building components of a building system. Design details convey to the contractor exactly how the structural and nonstructural components of a building should be built.

Development: “Any man-made change to improved or unimproved real estate, including but not limited to buildings or other structures, mining, dredging, filling, grading, paving, excavation or drilling operations, or storage of equipment or materials” (44 CFR § 59.1).

Dry floodproofing: See Floodproofing, dry.

Elevation Certificate: An NFIP administrative tool used to document elevation and other information necessary to determine compliance with a community’s floodplain management requirements, determine proper insurance premium rates, or support requests for Letters of Map Change (LOMCs).

Enclosure or enclosed area: Area below an elevated building and enclosed by walls on all sides. The NFIP does not explicitly define “enclosure,” but it is mentioned in the definition of “lowest floor.” Foundation perimeter walls (crawl space), framed walls, or breakaway walls may form enclosures. Also defined in ASCE 24-14 as the “confined area below the DFE, formed by walls on all sides of the enclosed space.”

Endwall: A retaining wall at the outlet of a drain or culvert.

Erosion: Under the National Flood Insurance Program, the process of the gradual wearing away of land masses.

Existing construction/structures: For the purposes of determining flood insurance rates, structures for which the “start of construction” began before the effective date of the FIRM or before January 1, 1975, for FIRMs effective before that date. “Existing construction” also may be referred to as “existing structures” (44 CFR § 59.1). Also defined in ASCE 24-14 as “any structure for which the start of construction commenced before the effective date of the first floodplain management code, ordinance, or standard adopted by the authority having jurisdiction.”

Exterior wall finish: Covering that protects the wall system from wind pressure and wind-driven rain and debris. Some finishes may offer some protection from flooding. Finishes include wood, vinyl, aluminum, fiber-cement board siding, brick or stone veneer, stucco, or exterior insulation and finish system (EIFS).

Fastener: See Connector.

Filter (filter zone): One or more layers of granular material graded (either naturally or by selection) to allow seepage through or within the layers while preventing the movement of material from nearby zones. (USSD Glossary)

Flood: A general and temporary condition of partial or complete inundation of normally dry land areas from: (1) the overflow of inland or tidal waters, or (2) the unusual and rapid accumulation or runoff of surface waters from any source.

Flood Hazard Boundary Map (FHBM): “Official map of a community, issued by the Federal Insurance Administrator, where the boundaries of the flood, mudslide (i.e., mudflow) related erosion areas having special hazards have been designated as Zones A, M and/or E” (44 CFR § 59.1).

Flood Insurance Rate Map (FIRM): “Official map of a community, on which ... [FEMA] has delineated both the special hazard areas and the risk premium zones applicable to the community” (44 CFR § 59.1).

Flood Insurance Study (FIS) (flood elevation study): “An examination, evaluation and determination of flood hazards and, if appropriate, corresponding water surface elevations, or an examination, evaluation and determination of mudslide (i.e., mudflow) and/or flood-related erosion hazards” (44 CFR § 59.1). The FIS is the official report provided by FEMA that contains the FIRM, the Flood Boundary and Floodway Map (if applicable), the water surface elevations of the base flood, and supporting technical data.

Floodplain or flood-prone area: “Any land area susceptible to being inundated by water from any source” (44 CFR § 59.1).

Floodproofing, dry: “Any combination of structural and non-structural additions, changes, or adjustments to structures which reduce or eliminate flood damage to real estate or improved real property, water and sanitary facilities, structures and their contents” (44 CFR § 59.1). Referred to simply as “flood proofing” in 44 CFR § 59.1. Further defined in ASCE 24-14 as “... a combination of measures that results in a structure, including the attendant utilities and equipment, being watertight, with all elements substantially impermeable and with structural components having the capacity to resist flood loads.”

Floodproofing, wet: “Floodproofing method that relies on the use of flood damage-resistant materials and construction techniques in areas of a structure that are below the elevation required by this standard by intentionally allowing those areas to flood” (ASCE 24-14). The NFIP does not define wet floodproofing. Wet floodproofing measures allow areas to flood in such a way that damage to a structure and its contents is minimized by using specific design, construction, and planning measures outlined in FEMA Technical Bulletin 7, *Wet Floodproofing Requirements for Structures Located in Special Flood Hazard Areas*.

Floodproofing Certificate: An NFIP administrative tool that documents certification by a registered professional engineer or architect that the design and methods of construction of a nonresidential building are in accordance with accepted practices for meeting a community’s floodplain management requirements for floodproofing. Both floodplain management requirements and NFIP flood insurance rating require this documentation.

Flood protection level: The level (elevation) of the flood used in design of buildings, including building utility systems, equipment and equipment components. As used in this publication, the flood protection level refers to the elevation required by the NFIP, building codes, or locally adopted regulations. In addition, flood protection level refers to the level selected to provide the desired level of protection when compliance with a code or regulation is not required and designers and owners elect to elevate or protect building utility systems.

Flow diversion: Change in the course of flood flow when it encounters an object or structure. An increase in the local flood level and/or flood velocity may accompany diversion when the blockage is large relative to the area through which the flow would otherwise pass.

Framing: Structural support for the wall system which can be wood or metal studs, steel framing, reinforced masonry, reinforced concrete, insulating concrete form (ICF) and common brick.

Freeboard: An added margin of safety expressed in feet above a specific flood elevation, usually the BFE. Some states, tribes and many community regulations require freeboard. Freeboard can account for unknown factors, future development and floods higher than the base flood. For example, if a regulation or code requires a 2-foot freeboard, then new construction and substantially improved buildings and their utility systems must include elevation or floodproofing to a minimum of 2 feet above the BFE. The I-Codes and ASCE 24 incorporate additional height into building elevation requirements.

Geosynthetic: A man-made material used to improve soil conditions. It helps separate/confine/distribute loads, reinforce soil, prevent soil movement, or control water pressure by allowing flow in the plane of the material.

Geotextile: Permeable fabric that, when used in association with soil, has the ability to separate, filter, reinforce, protect or drain. Geotextiles come in three basic forms: woven, needle punched and heat-bonded.

Girt: A horizontal structural member in a framed wall that provides lateral support to the wall panel primarily to resist wind loads. Commonly called a sheeting rail.

Headcut: An erosion process where flow of sufficient energy creates a flaw in the ground surface. Flow then concentrates at the flaw and erosion initiates an abrupt vertical drop in the ground surface. If not addressed, headcut erosion can deepen and move upstream.

Headwall: A retaining wall at the inlet of a drain or culvert.

High hazard potential dam: Dam whose failure or mis-operation probably will cause loss of human life.

Hydraulic: Operated, moved or affected by means of water or other liquids.

Hydrodynamic loads: “Loads imposed on an object [such as a building or foundation element] by water flowing against and around it” (ASCE 24-14). Examples are positive frontal pressure against the structure, drag effect along the sides, and negative pressure on the downstream side. The magnitude of hydrodynamic load varies as a function of the square of velocity and other factors.

Hydrologic: The study of the properties, distribution, and effects of water on the Earth’s surface, in the soil and underlying rocks, and in the atmosphere.

Hydrostatic loads: “Loads imposed on an object [or a surface, such as a wall or floor slab] by a standing mass of water” (ASCE 24-14). Slowly moving masses of water can also cause hydrostatic loads. Hydrostatic load increases as water depth increases.

Impoundment: A body of water confined within an enclosure.

Internal erosion: Removal of soil particles from within an embankment dam or its foundation by seepage or leakage (USACE ER 1110-2-11556).

Lateral Force: A force that acts primarily in the direction parallel to the ground and perpendicular to the force of gravity.

Limit of Moderate Wave Action (LiMWA): The inland limit of the area affected by [breaking] waves greater than 1.5 feet. Base flood conditions delineate the LiMWA and can extend farther landward during more extreme events. FEMA began delineating the LiMWA on coastal FIRMs in 2009.

Load path: The route taken by a force as it makes its way through a structure. The force is eventually transferred to and resisted by the ground. A continuous load path usually requires the use of metal connectors and fasteners and a strong wall design.

Low hazard potential dam: Dam where the failure or mis-operation likely results in no loss of human life and causes only low economic and/or environmental issues.

Lowest floor: Lowest floor of the lowest enclosed area of a building, including a basement. An unfinished or flood-resistant enclosure used solely for vehicle parking, building access, or storage in an area other than a basement area is not considered a building's lowest floor if the enclosure is built in compliance with applicable requirements.

Net open area: Permanently open area of a non-engineered flood opening.

New construction/structures: "... For floodplain management purposes, new construction means structures for which the start of construction commenced on or after the effective date of a floodplain management regulation adopted by a community and includes any subsequent improvements to such structures" (44 CFR § 59.1). Further defined in ASCE 24-14 as "structures for which the start of construction commenced on or after the effective date of the first floodplain management code, regulation, ordinance, or standard adopted by the authority having jurisdiction, including any subsequent improvements to such structures. New construction includes work determined to be substantial improvement."

Open foundations: Columns, piers and piles that support buildings and allow floodwater to pass underneath the structure. Open foundations typically are less vulnerable to flood damage than closed foundations.

The NFIP requires the elevation of all new construction and substantially improved buildings in Zone V to or above the BFE on open foundations (pilings, columns and sometimes shear walls) that allow floodwater and waves to pass beneath the elevated structure. The NFIP further requires that areas below elevated structures remain free of obstructions that would prevent the free flow of coastal floodwater and waves during a base flood event. The lowest horizontal structural member must be at least one foot above the BFE (i.e., must include freeboard).

Opening, engineered: Opening used to meet the requirement in 44 CFR § 60.3(c)(5) that is "certified by a registered professional engineer or architect" for meeting the requirement in 44 CFR § 60.3(c)(5) to "be designed to automatically equalize hydrostatic flood forces on exterior walls by allowing for the entry and exit of floodwater."

Opening, non-engineered: Opening used to meet the prescriptive requirement in 44 CFR § 60.3(c)(5) to provide "a total net area of not less than one square inch for every square foot of enclosed area subject to flooding."

Overtopping: When the reservoir water surface elevation exceeds the elevation of the dam or levee crest and water flows into protected areas.

Overtopping flood: The flood described by the probability of exceedance; water surface elevation at which flow occurs over the highway, over the watershed divide or through structure(s) provided for emergency relief.

Parapet wall: A low wall or railing along the edge of a balcony, roof, etc.

Passive mitigation measure: A mitigation measure that does not require human intervention to implement.

Piping: The progressive expansion of internal erosion by seepage.

Pluvial: Conditions resulting from extreme rainfall. Pluvial flooding occurs when the ground and urban drainage systems cannot effectively absorb rainfall or excess runoff.

Primary frontal dune (PFD): “A continuous or nearly continuous mound or ridge of sand with relatively steep seaward and landward slopes immediately landward and adjacent to the beach and subject to erosion and overtopping from high tides and waves during major coastal storms. The inland limit of the primary frontal dune occurs at the point where there is a distinct change from a relatively steep slope to a relatively mild slope” (44 CFR § 59.1).

Registered design professional: A registered or licensed individual practicing his or her design profession (e.g., architect, engineer, land surveyor) as defined by the statutory requirements of the professional registration laws of the state or jurisdiction in which construction of a project occurs.

Riparian areas: Lands adjacent to streams, rivers, lakes and estuarine-marine shorelines. Riparian areas provide a variety of ecological functions and services and help improve or maintain local water quality. The plant species that grow in riparian areas are adapted to tolerate conditions of periodically waterlogged soils.

Riprap: Broken stone, cut stone blocks, or rubble placed on slopes to protect them from erosion or scour caused by floodwater or wave action.

Riser: Any open conduit, shaft, tunnel, pipe, vent, etc., that rises vertically within a building.

Scour: Removal of soil or fill material by the flow of floodwater. Flow moving past a fixed object accelerates, often forming eddies or vortices and scouring loose sediment from the immediate vicinity of the object. The term frequently describes storm-induced, localized conical erosion around pilings and other foundation supports, where the obstruction of flow increases turbulence. See also Erosion.

Seepage. The internal movement of water that may take place through the dam, the foundation or the abutments.

Shallow foundation: Foundations supported by soils that are relatively close to the surface of the surrounding grade. Shallow foundations include crawl space foundations, stem walls, monolithic slabs-on-grade, discrete pad footings and mat-style foundations. Columns and piers foundations can also be shallow. Shallow foundations are vulnerable to moving floodwater and undermining by scour and erosion may occur.

Significant hazard potential dam: Dam where failure or mis-operation results in no probable loss of human life but can cause economic loss, environmental damage, disruption of lifeline facilities or can impact other concerns.

Special Flood Hazard Area (SFHA): Area on a Flood Insurance Rate Map (FIRM) that will be inundated by the flood event having a 1% chance of being equaled or exceeded in any given year. Additional terms used to refer to the 1% annual chance flood include the base flood or 100-year flood. SFHA labels include Zone A, Zone AO, Zone AH, Zones A1-A30, Zone AE, Zone A99, Zone AR, Zone AR/AE, Zone AR/AO, Zone AR/A1-A30, Zone AR/A, Zone V, Zone VE and Zones V1-V30. Moderate flood hazard areas, labeled Zone B or Zone X (shaded), also shown on the FIRM, are the areas between the limits of the base flood and the 0.2%-annual-chance (or 500-year) flood. The areas of minimal flood hazard, labeled Zone C or Zone X (unshaded) (see Figure B-1), are the areas outside the SFHA and higher than the elevation of the 0.2%-annual-chance flood.

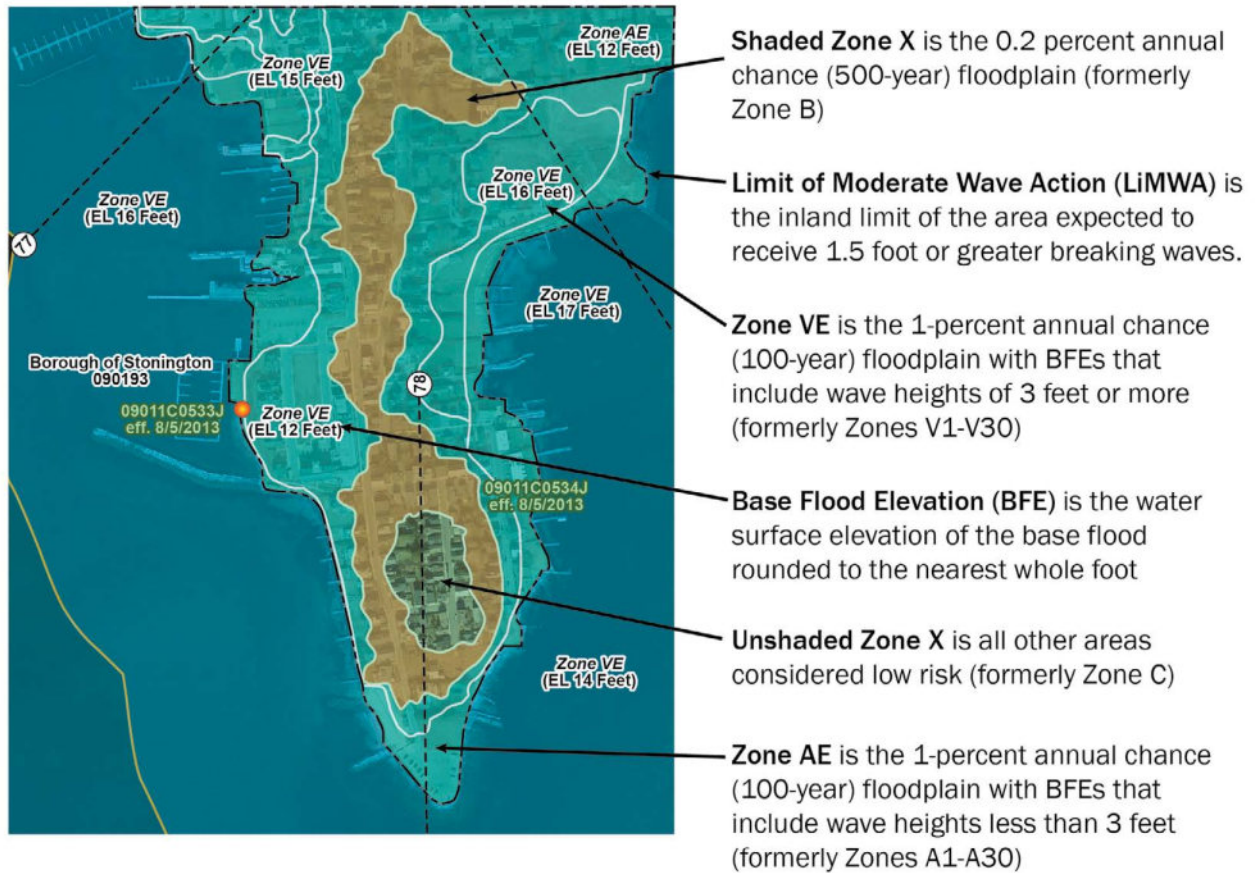

Figure B-1. A Flood Insurance Rate Map (FIRM) shows locations of special flood hazard areas.

Spillway: A passage for surplus water to run over or around an obstruction (such as a dam).

Spur dike: An elongated structure having one end on the bank of a stream and the other end projecting into the current.

Standard residential garage door: A door, typically up to 18 feet wide by up to 8 feet tall, intended for use in a residential garage for vehicular access and normally with an expected operation of less than 1,500 cycles per year.

Structural sheathing: Plywood or oriented strand board (OSB) wall framing covering that adds structural strength to wood or metal studs by resisting in-plane loads. Gypsum board may be used for metal stud or steel-framed walls.

Structure: For floodplain management purposes, "... a walled and roofed building, including a gas or liquid storage tank, that is principally above ground, as well as a manufactured home" (44 CFR § 59.1).

Substantial damage: "Damage of any origin sustained by a structure whereby the cost of restoring the structure to its before damaged condition would equal or exceed 50% of the market value of the structure before the damage occurred" (44 CFR § 59.1). Some communities have adopted a more-restrictive substantial damage definition.

Substantial structural damage: A condition, defined by the International Existing Building Code, in which one or both of the following apply:

1. The vertical elements of the lateral force-resisting system have suffered damage resulting in the reduction of the lateral load-carrying capacity of any story in any horizontal direction by more than 33% from its pre-damage condition.
2. The reduction, by more than 20% from its pre-damage condition and the remaining capacity of such affected elements capacity, of any vertical component carrying gravity load or any group of such components, that supports more than 30% of the total area of the structure's floor(s) and roof(s), with respect to all dead and live loads, is less than 75% of that required by this code for new buildings of similar structure, purpose and location.

If substantial structural damage is present, elements of undamaged components that support damaged components or are part of a system that sustained damage could require certain retrofits. Find details outlining FEMA substantial structural damage compliance requirements in *Public Assistance Job Aid Understanding Substantial Structural Damage in the International Existing Building Code* (<https://www.fema.gov/media-library/assets/documents/130384>).

Substantial improvement: Any reconstruction, rehabilitation, addition or other improvement of a structure, the cost of which equals or exceeds 50% of the market value of the structure before the "start of construction" of the improvement. This term includes structures that have incurred substantial damage, regardless of the actual repair work performed. The term does not, however, include either:

3. Any project for improvement of a structure to correct existing violations of state or local health, sanitary, or safety code specifications identified by the local code enforcement official and which are the minimum necessary to assure safe living conditions, or
4. Any alteration of a "historic structure," given that the alteration will not preclude the structure's continued designation as a "historic structure" (44 CFR § 59.1).

Variance: "Grant of relief by a community from the terms of a flood plain management regulation" (44 CFR § 59.1).

Wave reflection: Return or redirection of a wave striking an object.

Wave runup: “Rush of wave water running up a slope or structure” (ASCE 24-14). “Vertical height above the stillwater level to which water from a specific wave will run up the face of a structure or embankment” (USACE ER 1110-2-11556). Wave runup occurs as waves break and run up beaches, sloping surfaces and vertical surfaces.

Wet floodproofing: See Floodproofing, wet.

Wingwall: A wall that prevents scour and/or soil erosion, retains the embankment adjacent to a culvert or bridge, controls grade elevations, and directs water flow.

C: Codes, Standards, Best Practices and Mitigation

Codes, standards and best practices are an essential part of mitigation. Codes serve as a set of requirements that govern the design, construction and maintenance of buildings and structures to protect the health, safety and welfare of building occupants. Codes must be followed and, to reach the desired end result, they must be enforced effectively. Standards that are referenced by codes become required. Best practices are methods or procedures that offer improved results over the results attained through the adoption of codes and standards alone. The development of best practices often help handle situations where following minimum codes and standards falls short of the desired outcomes, as is often the case with critical or essential facilities. FEMA develops documents and publications that present best practices, many of which result from the observations by FEMA Mitigation Assessment Teams (MATs) of building performance following natural disasters. Using best practices, occasionally referred to as “code plus,” is not mandatory, but could become a requirement to obtain funding under some federal programs. Often, mitigation involves actions that follow best practices.

FEMA PUBLIC ASSISTANCE PROGRAM AND THE I-CODES

Projects receiving FEMA Public Assistance Program funding must comply with the Public Assistance Minimum Standards Policy found in the Public Assistance Program and Policy Guide, Chapter 2, Section VII.B.2., which requires incorporation of the natural hazards-related provisions of the most recent editions of the International Code Council’s International Building Code (IBC), International Existing Building Code (IEBC), and/or International Residential Code (IRC), known collectively as the I-Codes. The policy applies to buildings that have received designations of substantial damage, substantial structural damage, or are eligible for replacement in accordance with 44 CFR Part 206.226(f). Public Assistance Job Aid Understanding Substantial Damage in the International Building Code, International Existing Building Code, or International Residential Code.(<https://www.fema.gov/media-library/assets/documents/130382>).

1. Codes

The development of building codes results from a consensus process with input from interested parties. Architects, engineers, builders, representatives of trade groups, manufacturers and government officials typically are involved in code development, but any interested person can participate. Regular updates to codes occur, typically every three years. Code development is a continual process; the next code development cycle often begins shortly after the publication of a new edition of a code. Developers of codes request input via public proposals and comments, and developers consider all proposals and comments.

FEMA routinely develops and submits code change proposals, many based on best practices, to improve performance and resilience of buildings and structures.

Codes are not mandatory until adopted by state or local governments. During the adoption process, some government agencies modify provisions within the codes and create local amendments. Those modifications often reflect local conditions, but they can lower the requirements of the codes, which can reduce their effectiveness at promoting resilience.

Once adopted, all new construction and all work involving substantial improvements and repairs to substantially damaged buildings must comply with the adopted codes. Repairs to public facilities damaged during hurricanes and floods and mitigated through FEMA's Public Assistance (PA) or Hazard Mitigation Assistance (HMA) programs must use the most recent editions of the building codes and standards, regardless of the adoption status of the codes and standards by the states and communities receiving FEMA grant assistance.

The International Code Council (ICC) develops a widely adopted family of codes. The I-Codes include the International Residential Code (IRC), International Building Code (IBC), International Existing Building Code (IEBC), and other codes that govern the installation of mechanical systems, plumbing, fuel gas service and other aspects of building construction. Provisions in state- and community-adopted building codes can vary from these model codes, so coordination with local building officials is necessary to confirm which requirements apply within a given area.

Where adopted, the IBC applies to all applicable buildings and structures, whereas the scope of the IRC is limited to one- and two-family dwellings and townhomes up to three stories. The IEBC establishes minimum requirements for existing buildings to encourage the use and reuse of existing buildings while requiring reasonable upgrades and improvements. The general flood and wind design requirements of the IBC and IRC include by reference ASCE 7, Minimum Design Loads and Associated Criteria for Buildings and Other Structures, a standard developed by the American Society of Civil Engineers (ASCE). Flood requirements in the IBC and IRC are included by reference to ASCE 24, Flood Resistant Design and Construction. Additionally, the ICC 500, ICC/NSSA Standard for the Design and Construction of Storm Shelters, developed by the ICC and the National Storm Shelter Association (NSSA) contains specific provisions for storm shelters designed for hurricane and tornado wind protection.

FEMA assumes that the latest published editions of the I-Codes meet or exceed NFIP requirements for buildings and structures. Excerpts of the flood requirements of the I-Codes are available on FEMA's Building Code Resource webpage (<http://www.fema.gov/building-code-resources>).

ICC AND FEMA FLOODPLAIN MANAGEMENT RECOMMENDATIONS

The joint ICC and FEMA publication *Reducing Flood Losses through the International Codes: Coordinating Building Codes and Floodplain Management Regulations*, recommends that communities coordinate floodplain management requirements and building codes. Differences in requirements between the regulatory tools can lead to inconsistencies or confusion when managing and enforcing requirements for development in flood-prone areas.

2. Standards

Standards are documents that, when referenced by an adopted code, become requirements. Like codes, standards are developed by a consensus process. Unlike codes, standards generally are more narrowly focused and technical in nature and can be optional when not referenced by an adopted code. Various industries (i.e., concrete, masonry, steel, wood) develop standards. The revision and updating of consensus standards typically occurs every five years.

STAFFORD ACT AND CODES AND STANDARDS

Section 406 of the Robert T. Stafford Disaster Relief and Emergency Assistance Act (Stafford Act) has been amended by Section 1235(b) of the Disaster Recovery Reform Act (DRRA) and now requires FEMA to fund repair, restoration, reconstruction or replacement in conformity with “the latest published editions of relevant consensus-based codes, specifications, and standards that incorporate the latest hazard-resistant design and establish minimum acceptable criteria for the design, construction, and maintenance of residential structures and facilities that may be eligible for assistance under this Act for the purposes of protecting the health, safety and general welfare of a facility’s users against disasters.” Consensus-Based Codes, Specifications and Standards for Public Assistance FEMA Recovery Interim Policy FP- 104-009-11 Version 2.1 outlines this.

NFIP REQUIREMENTS AND HIGHER REGULATORY STANDARDS

State and Local Requirements. State or local requirements that are more stringent than the minimum requirements of the NFIP take priority. The Technical Bulletins and other FEMA publications give guidance on the minimum requirements of the NFIP and describe best practices. Design professionals, builders and property owners should contact local officials to determine whether more-restrictive provisions apply to buildings or sites in question. All other applicable requirements of the state or local building codes also must be met.

Higher Building Elevation Requirements. Some communities require the elevation of buildings above the NFIP minimum requirement. The additional elevation is called freeboard. Design professionals, builders and property owners should check with local officials to determine whether a community has freeboard requirements. References to building elevations in this Technical Bulletin should be construed as references to the community’s elevation requirement in areas where freeboard is required.

3. Best Practices

The NFIP Technical Bulletins, MAT reports, Recovery Advisories, and Building Science guidance documents present best practices that can guide successful mitigation of damaged or destroyed facilities and structures. Factors that are important when it comes to best practices for flood resilience include: flood risk zones, elevation of the lowest floor above the base flood elevation (BFE), the type of building and foundation in Zone V and Coastal A Zones, and the number of floors and whether there is a basement or enclosure below the elevated building. For wind resilience, FEMA guidance focuses on load path continuity, integrity of a building envelope and the building's ability to resist wind pressures, wind-borne debris, and wind-driven rain. For roofs, secondary membranes that provide additional protection if the primary membrane is damaged or pierced are important.

NFIP Technical Bulletins

The NFIP Technical Bulletins are a group of FEMA publications that help guide successful mitigation of buildings and infrastructure for improved flood and wind performance. The Technical Bulletins describe some of the best practices for hurricane- and flood-resistant construction. The Technical Bulletins also offer recommendations for increasing storm resistance in buildings and their utility systems and for reducing the loss of life and property and economic and social hardships. FEMA encourages that these best practices be:

- Implemented by designers, builders, contractors and other stakeholders to reduce risk and improve resilience
- Used to potentially lower NFIP flood insurance or wind insurance premiums
- Incorporated into state or community floodplain management regulations and/or building codes
- Based on field-verified data and include information gathered during decades of post-disaster building performance assessments

The NFIP Technical Bulletins are available online through FEMA's Building Science website: <https://www.fema.gov/emergency-managers/risk-management/building-science/national-flood-insurance-technical-bulletins>.

MAT Reports

For more than 30 years, the MAT Program has used the combined resources of a federal, state, local and private sector partnership. The MAT Program allows FEMA to put together and send out teams of investigators to evaluate the performance of buildings and infrastructure after disasters strike. The teams conduct field investigations at disaster sites; work closely with local and state officials to develop recommendations for improvements in building design and construction; and develop recommendations concerning code development and enforcement and mitigation activities that will lead to better results post-disaster. FEMA publishes the observations and recommendations in MAT reports. The reports are available on FEMA's Mitigation Assessment Team Program website: <https://www.fema.gov/emergency-managers/risk-management/building-science/mitigation-assessment-team>.

Recovery Advisories

One subset of the publications produced by MATs are Recovery Advisories, which present guidance on design, construction and restoration of buildings in areas subject to the effects of a particular disaster. Recovery Advisories have been published for hurricanes, floods and tornadoes based on field observations. Each advisory tends to address a particular issue identified by the MAT. Copies of Recovery Advisories are available online on FEMA's Mitigation Assessment Team Program website: <https://www.fema.gov/emergency-managers/risk-management/building-science/mitigation-assessment-team>.

Building Science Guidance Documents

The FEMA Building Science Branch studies natural disasters and man-made hazard events and takes a lead role in developing state-of-the-art publications, guidance materials, tools, training, technical bulletins and recovery advisories. These publications incorporate the most up-to-date building codes, flood damage-resistant requirements, seismic design guidelines and wind design requirements for new and existing buildings.

Communities can strengthen their ability to reduce loss of life, injuries and property damage by taking advantage of the vast resources available in the FEMA Building Science Library. The information in the library can help communities and interested citizens understand impacts from disasters, determine the right standards for new construction, decide how to best retrofit existing structures to mitigate the risk of damage, and understand the benefits of enhancing or updating building codes to reduce the community's risk. Publications in the library are available online through FEMA's Building Science website: <https://www.fema.gov/emergency-managers/risk-management/building-science>.

4. Mitigation

Mitigation increases resilience, which reduces risk and minimizes the loss of life and damage to property.

Each structure can become more resilient by complying with codes, standards and best practices and by implementing the right mitigation strategies.

Risk Assessment and Risk Reduction

Meeting basic regulatory and code requirements for building design and construction does not guarantee the building will be safe from all high wind and flooding. Winds and floods that are more severe than planned for can and do occur. It is up to designers and building owners to determine the level of acceptable risk and whether to exceed the basic requirements.

Preparing a high-wind and flood-resistant building design—including utility systems and their repair, replacement or upgrade—begins with a risk assessment. Designers and building owners may best achieve meeting the regulatory standards and creating buildings and infrastructure that are more resistant to flooding and hurricanes by successfully identifying and managing those risks.

Risk Assessment. When considering hurricanes and floods, include a review of historical events and the vulnerability of the infrastructure within the community, as shown in Figure C-1. Risk is the potential losses that are associated with any disaster given how likely it is to occur and how vulnerable the building or infrastructure is. The risk assessment is the process of quantifying the total flood and hurricane risk to buildings and infrastructure in an area prone to flooding or hurricanes. Designers and builders should seek information about current storm and risk information and understand how design decisions can mitigate exposures.

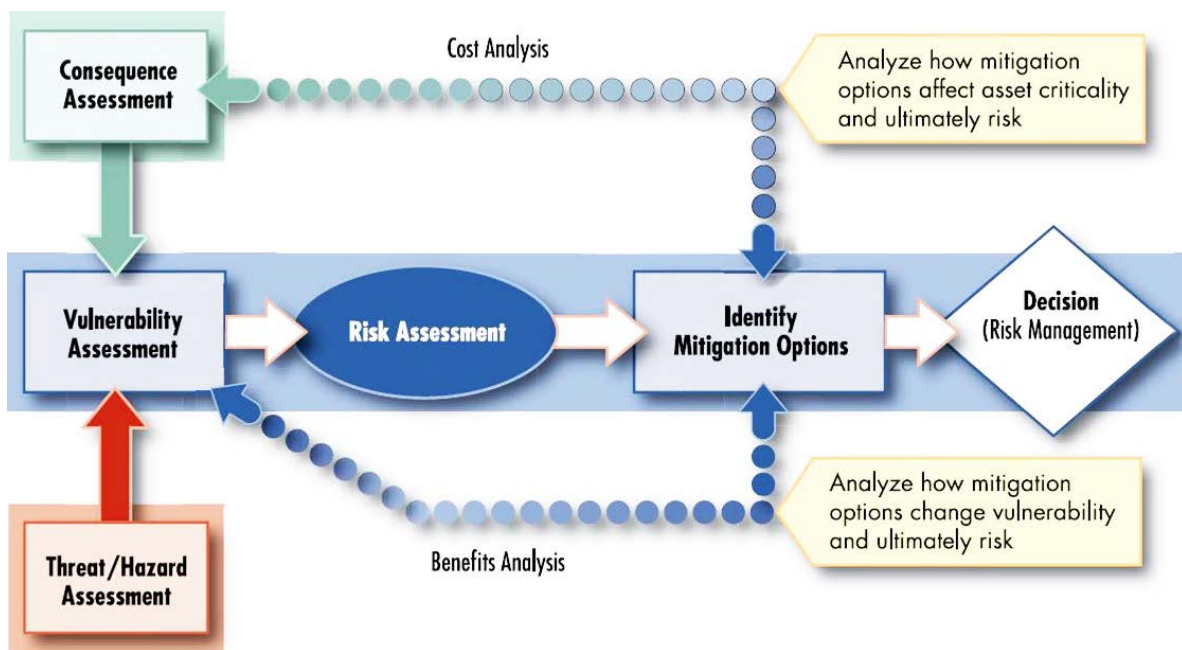

Figure C-1. Conducting a risk assessment can help prioritize mitigation strategies and projects.

Designers and builders should follow these guidelines for areas prone to hurricanes and floods:

- Use the most-current published flood and hurricane wind data to determine site or infrastructure vulnerability. A Flood Insurance Study (FIS) report contains flood information for most communities, although many communities and regional agencies develop studies that include additional information. Reference information from ASCE 7, *Wind Loads: Guide to Wind Load Provisions* for specific wind evaluation and design consideration.
- Conduct a detailed risk assessment or update an existing assessment if site or watershed conditions may have changed significantly since the publication of flood data or if the published flood data do not represent a site's exposure to flooding.
- Consider how site or watershed conditions may change over the expected life of a structure or building, considering future upland development and the size of extreme weather events.
- Review design options that will best mitigate the effects of high winds and flooding for the proposed project. Building owners may find potential damage costs or loss of function unacceptable, leading them to work with designers to determine mitigation options and reduce risk to an acceptable level.

Risk Reduction. After assessment of the risk, the next step is to decide how to best mitigate the identified potential damage. The risk assessment and risk reduction strategies must account for the short- and long-term impacts of each storm, including the potential for impacts from different storms to build on each other over time.

Complying with floodplain management regulations and building codes, applying best practices, and purchasing insurance to provide financial protection for residual risks can reduce the initial, unmitigated risk. Regardless of the levels of protection, property owners must accept residual risks.

D: References

This lists additional resources related to hazard mitigation. Each individual fact sheet also includes references related to the topic addressed in the fact sheet.

Date	Document Number	Title	Website
ASCE (American Society of Civil Engineers)			
2014	ASCE 24-14	Flood Resistant Design and Construction	https://ascelibrary.org/doi/book/10.1061/9780784413791
2016	ASCE/SEI 7	Minimum Design Loads and Associated Criteria for Buildings and Other Structures	https://www.asce.org/publications-and-news/asce-7
Various	—	Flood Insurance Manual	https://www.fema.gov/flood-insurance/work-with-nfip/manuals *As a note, updates occur semi-annually
FEMA (Federal Emergency Management Agency)			
2004	FEMA 467-1	Floodplain Management Bulletin: Elevation Certificate	https://www.fema.gov/sites/default/files/2020-07/fema467-6-10-04.pdf
2009	FEMA P-85	Protecting Manufactured Homes from Floods and Other Hazards	https://www.fema.gov/media-library/assets/documents/2574
2009	FEMA P-550	Recommended Residential Construction for Coastal Areas: Building on Strong and Safe Foundations	https://www.fema.gov/sites/default/files/documents/fema_p550-recommended-residential-construction-coastal-areas_0.pdf
2009	FEMA P-762	Local Officials Guide for Coastal Construction	https://www.fema.gov/emergency-managers/risk-management/building-science/publications?name=P-762&field_keywords_target_id=All&field_document_type_target_id=All&field_audience_target_id=All
2010	FEMA P-499	Home Builder's Guide to Coastal Construction Technical Fact Sheet Series	https://www.fema.gov/emergency-managers/risk-management/building-science/publications?name=FEMA+P-499%2C+Home&field_keywords_target_id=All&field_document_type_target_id=All&field_audience_target_id=All

Date	Document Number	Title	Website
2010	FEMA P-758	Substantial Improvement / Substantial Damage Desk Reference	https://www.fema.gov/sites/default/files/documents/fema_nfip_substantial-improvement-substantial-damage-desk-reference.pdf
2011	FEMA P-55	Coastal Construction Manual: Principles and Practices of Planning, Siting, Designing, Construction, and Maintaining Residential Buildings in Coastal Areas (Fourth Edition)	https://www.fema.gov/emergency-managers/risk-management/building-science/publications?name=FEMA+P-55%2C+Coastal&field_keywords_target_id=All&field_document_type_target_id=All&field_audience_target_id=All
2012	FEMA P-259	Engineering Principles and Practices for Retrofitting Flood- Prone Residential Structures, Third Edition	https://www.fema.gov/sites/default/files/2020-08/fema259_complete_rev.pdf
2013	FEMA P-936	Floodproofing Non-Residential Buildings	https://www.fema.gov/emergency-managers/risk-management/building-science/publications?name=P-936&field_keywords_target_id=All&field_document_type_target_id=All&field_audience_target_id=All
2013	FEMA P- 938	Mitigation Assessment Team Report: Hurricane Isaac in Louisiana	https://www.fema.gov/emergency-managers/risk-management/building-science/publications?name=FEMA+P-938&field_keywords_target_id=All&field_document_type_target_id=All&field_audience_target_id=All
2013	FEMA P-942	Mitigation Assessment Team Report: Hurricane Sandy in New Jersey and New York	https://www.fema.gov/emergency-managers/risk-management/building-science/publications?name=P-942&field_keywords_target_id=All&field_document_type_target_id=All&field_audience_target_id=All
2014	FEMA P-312	Homeowner's Guide to Retrofitting, 3rd Edition	https://www.fema.gov/emergency-managers/risk-management/building-science/publications?name=P-312&field_keywords_target_id=All&field_document_type_target_id=All&field_audience_target_id=All
2014	FEMA P-1019	Emergency Power Systems for Critical Facilities: A Best Practices Approach to Improving Reliability	https://www.fema.gov/emergency-managers/risk-management/building-science/publications?name=FEMA+P-1019&field_keywords_target_id=All&field_document_type_target_id=All&field_audience_target_id=All

Date	Document Number	Title	Website
2015	FEMA P-1037	Reducing Flood Risk to Residential Buildings that Cannot be Elevated	https://www.fema.gov/emergency-managers/risk-management/building-science/publications?name=FEMA+P-1037&field_keywords_target_id=All&field_document_type_target_id=All&field_audience_target_id=All
2016	FEMA P-787	Catalog of FEMA Building Science Branch Publications and Training Courses	https://www.fema.gov/emergency-managers/risk-management/building-science/publications?name=FEMA+P-787&field_keywords_target_id=All&field_document_type_target_id=All&field_audience_target_id=All
2018	FEMA P-2020	Mitigation Assessment Team Report: Hurricanes Irma and Maria in Puerto Rico	https://www.fema.gov/emergency-managers/risk-management/building-science/publications?name=FEMA+P-2020&field_keywords_target_id=All&field_document_type_target_id=All&field_audience_target_id=All
2018	FEMA P-2023	Mitigation Assessment Team Report: Hurricane Irma in Florida	https://www.fema.gov/emergency-managers/risk-management/building-science/publications?name=FEMA+P-2023&field_keywords_target_id=All&field_document_type_target_id=All&field_audience_target_id=All
2019	FEMA P-2021	Mitigation Assessment Team Report: Hurricanes Irma and Maria in the Virginia islands	https://www.fema.gov/emergency-managers/risk-management/building-science/publications?name=FEMA+P-2021&field_keywords_target_id=All&field_document_type_target_id=All&field_audience_target_id=All
2019	FEMA P-2022	Mitigation Assessment Team Report: Hurricane Harvey in Texas	https://www.fema.gov/emergency-managers/risk-management/building-science/publications?name=FEMA+P-2022&field_keywords_target_id=All&field_document_type_target_id=All&field_audience_target_id=All
2019	FEMA P-2054	Mitigation Assessment Team Compendium Report	https://www.fema.gov/emergency-managers/risk-management/building-science/publications?name=FEMA+P-2054&field_keywords_target_id=All&field_document_type_target_id=All&field_audience_target_id=All
2019	FEMA PA 406	Mitigation Brochure	https://www.fema.gov/sites/default/files/2020-06/fema-pa406-mitigation-brochure.pdf

Date	Document Number	Title	Website
2019	NFIP TB 0	User's Guide to Technical Bulletins	https://www.fema.gov/emergency-managers/risk-management/building-science/publications?name=Technical+Bulletin+0&field_keywords_target_id=All&field_document_type_target_id=All&field_audience_target_id=All
2008	NFIP TB 1	Openings in Foundation Walls and Walls of Enclosures Below Elevated Buildings in Special Flood Hazard Areas	https://www.fema.gov/emergency-managers/risk-management/building-science/publications?name=Technical+Bulletin+1&field_keywords_target_id=All&field_document_type_target_id=All&field_audience_target_id=All
2009	NFIP TB 2	Flood Damage-Resistant Materials Requirements for Buildings Located in Special Flood Hazard Areas	https://www.fema.gov/emergency-managers/risk-management/building-science/publications?name=Technical+Bulletin+2&field_keywords_target_id=All&field_document_type_target_id=All&field_audience_target_id=All
1993	NFIP TB 3	Non-Residential Floodproofing – Requirements and Certification for Buildings Located in Special Flood Hazard Areas	https://www.fema.gov/emergency-managers/risk-management/building-science/publications?name=Technical+Bulletin+3&field_keywords_target_id=All&field_document_type_target_id=All&field_audience_target_id=All
2019	NFIP TB 4	Elevator Installation for Buildings Located in Special Flood Hazard Areas	https://www.fema.gov/emergency-managers/risk-management/building-science/publications?name=Technical+Bulletin+4&field_keywords_target_id=All&field_document_type_target_id=All&field_audience_target_id=All
2008	NFIP TB 5	Free-of-Obstruction Requirements for Buildings Located in Coastal High Hazard Areas	https://www.fema.gov/emergency-managers/risk-management/building-science/publications?name=Technical+Bulletin+5&field_keywords_target_id=All&field_document_type_target_id=All&field_audience_target_id=All
1993	NFIP TB 6	Below-Grade Parking Requirements for Buildings Located in Special Flood Hazard Areas	https://www.fema.gov/emergency-managers/risk-management/building-science/publications?name=Technical+Bulletin+6&field_keywords_target_id=All&field_document_type_target_id=All&field_audience_target_id=All

Date	Document Number	Title	Website
1993	NFIP TB 7	Wet Floodproofing Requirements for Structures Located in Special Flood Hazard Areas	https://www.fema.gov/emergency-managers/risk-management/building-science/publications?name=Technical+Bulletin+7&field_keywords_target_id=All&field_document_type_target_id=All&field_audience_target_id=All
1996	NFIP TB 8	Corrosion Protection for Metal Connectors and Fasteners in Coastal Areas	https://www.fema.gov/emergency-managers/risk-management/building-science/publications?name=Technical+Bulletin+8&field_keywords_target_id=All&field_document_type_target_id=All&field_audience_target_id=All
2008	NFIP TB 9	Design and Construction Guidance for Breakaway Walls Below Elevated Buildings in Coastal High Hazard Areas	https://www.fema.gov/emergency-managers/risk-management/building-science/publications?name=Technical+Bulletin+9&field_keywords_target_id=All&field_document_type_target_id=All&field_audience_target_id=All
2001	NFIP TB 10	Ensuring that Structures Built on Fill In or Near Special Flood Hazard Areas are Reasonably Safe From Flooding	https://www.fema.gov/emergency-managers/risk-management/building-science/publications?name=Technical+Bulletin+10&field_keywords_target_id=All&field_document_type_target_id=All&field_audience_target_id=All
2001	NFIP TB 11	Crawlspace Construction for Buildings Located in Special Flood Hazard Areas	https://www.fema.gov/emergency-managers/risk-management/building-science/publications?name=Technical+Bulletin+11&field_keywords_target_id=All&field_document_type_target_id=All&field_audience_target_id=All
2020	FP 104-009-2	Public Assistance Program and Policy Guide	https://www.fema.gov/assistance/public/policy-guidance-fact-sheets#pappg

E: Comment Submission and Contacting FEMA

How to Obtain Hurricane and Flood Mitigation Handbook for Public Facilities

Download the Handbook at no charge from the FEMA website at <https://www.fema.gov/>.

Order the *Hurricane and Flood Mitigation Handbook for Public Facilities* at no charge from the FEMA Publications Warehouse by:

- Calling 1-800-480-2520, Monday through Friday between 8:00 a.m. and 5:00 p.m. Eastern
- Faxing a request to 1-719-948-9724
- Sending an email to FEMApubs@gpo.gov If you need additional information, email FEMA-Buildingsciencehelp@fema.dhs.gov or contact the *Building Science Helpline* at (866) 927-2104

How to Send Comments on the Handbook

FEMA welcomes your comments and recommendations on the Handbook's Fact Sheet series, which may include, for example:

- Requests for clarifications of the guidance in the Fact Sheets
- Requests for additional guidance
- Recommendations for new Fact Sheets

Email comments or questions to the Building Science Helpline at FEMA-buildingsciencehelp@fema.dhs.gov or call 1-866-927-2104.

How to Get More Information

For questions on any of the Fact Sheets, email the Building Science Helpline at FEMA-buildingsciencehelp@fema.dhs.gov or call 1-866-927-2104.