

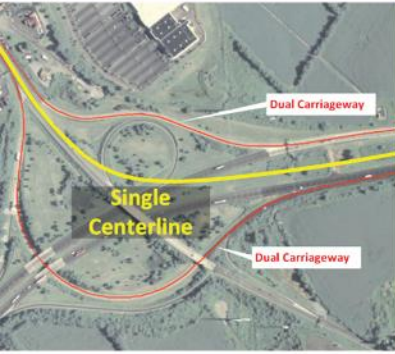

ALL PUBLIC
ROADS GEOSPATIAL
REPRESENTATION STUDY



ALL ROAD NETWORK OF LINEAR REFERENCED DATA
ARNOLD

Reference Manual



Federal Highway Administration
(FHWA)

FOREWORD

On August 7, 2012, FHWA announced that the HPMS is expanding the requirement for State Departments of Transportation (DOTs) to submit their LRS to include all public roads. This requirement will be referred to as the **All Road Network of Linear Referenced Data (ARNOLD)**. Many States will be challenged by this requirement, and as such, FHWA has contracted with Applied Geographics, Inc. under DOT Contract #GS-35F-0001P to produce guidance materials to help State DOTs implement ARNOLD. The project deliverables are listed below, and tasks 2-6 represent the specific guidance that is offered to States:

PROJECT DELIVERABLES

- **Task 1:** Project Schedule, Workplan, Risk Assessment and TFTN crosswalk
- **Task 2:** Local Road Collection Systematic Approach Report
- **Task 3:** LRS Components and Best Practices Report
- **Task 4:** LRS Temporal Maintenance Plan Report
- **Task 5:** LRS Technical Instructions, Rules and Diagrams Report
- **Task 6:** Reference Manual summarizing information gathered from tasks 2-5

PROJECT TEAM

- **US DOT**
 - Joe Hausman (Project Manager)
 - Tom Roff (ARNOLD Lead)
 - Justin Clarke (Team Lead)
- **Contractors**
 - Applied Geographics, Inc. (Prime Contractor)
 - David R. Fletcher (Subcontractor)
 - Michael Baker Jr., Inc. (Subcontractor)
- **Expert Panel**
 - Mark Sarmiento – FHWA Planning
 - Mike Neathery – FHWA Planning
 - Robert Pollack – FHWA Safety
 - Stuart Thompson – FHWA Safety
 - Maria Chau – FHWA NY Division
 - Christopher Chang – FHWA Office of Infrastructure
 - Dave Blackstone – Ohio DOT
 - Frank DeSendi – Pennsylvania DOT
 - Keith Dotson – Kentucky Transportation
 - Sharon Hawkins – Arkansas Highway and Transportation Department
 - James Meyer – Arizona DOT
 - Michele Barnes – University of Michigan
 - Paul O'Rourke – Florida DOT

Table of Contents

EXECUTIVE SUMMARY	1
1 INTRODUCTION	3
1.1 WHY IS AN ALL ROADS OUTLOOK IMPORTANT?	3
1.2 WHY THE U.S. DOT AND FHWA NEED ALL ROADS	4
1.3 WHAT IS THE ALL-ROADS GEOSPATIAL REPRESENTATION STUDY?	4
2 IMPLEMENTATION PLANNING.....	5
2.1 THE OPPORTUNITY TO REVIEW THE AGENCY'S OVERALL NETWORK AND LRS DATA MANAGEMENT	5
2.2 WHAT KIND OF PLANNING DO WE NEED?	6
2.3 IMPLEMENTATION PLANNING BEST PRACTICES	8
3 DATA COLLECTION.....	10
3.1 HOW DO WE COLLECT ALL ROADS ACROSS THE STATE?	10
3.2 WHAT COMPONENTS WILL OUR BASELINE CENTERLINE NETWORK CONTAIN?	15
3.3 DATA COLLECTION RECOMMENDATIONS	16
4 INTEGRATING ALL-ROADS AND CONSTRUCTING THE LRS	18
4.1 HOW DO WE CREATE THE LRS THAT WE NEED?	21
4.2 WHAT TOOLS DO WE NEED TO CONSTRUCT AND MAINTAIN LRS?	26
4.3 RECOMMENDATIONS FOR BUILDING THE LRS	29
5 ONGOING DATA MAINTENANCE	31
5.1 WE'VE SPENT ALL THIS EFFORT BUILDING IT; HOW DO WE KEEP IT CURRENT?	31
5.2 MANAGING TEMPORALITY WITHIN THE LRS	34
5.3 LRS MAINTENANCE RECOMMENDATIONS.....	36
6 CONCLUSIONS AND THE PATH FORWARD	38
TECHNICAL APPENDICES	40
APPENDIX A BASICS OF LRS.....	41
A.1 OVERVIEW OF LINEAR REFERENCING SYSTEMS (LRS)	41
A.2 LINEAR REFERENCING SYSTEM BUSINESS FUNCTIONS	43
A.3 TYPES OF LRMS.....	46
A.4 COMMON BASELINE NETWORK REQUIREMENTS & MATURITY ASSESSMENTS	47

APPENDIX B	ROADWAY GEOMETRY	51
B.1	ROADWAY SEGMENTATION	51
B.2	DUAL CARRIAGEWAYS	53
B.3	TRAFFIC CIRCLES	58
B.4	RAMPS.....	61
B.5	CUL-DE-SACS AND LOOPS	63
APPENDIX C	ROADWAY ATTRIBUTES	66
C.1	ROUTE EVENTS VS. SEGMENTED ATTRIBUTES.....	66
C.2	ARNOLD SCHEMA	67
C.3	ROUTE ID NUMBERING	68
C.4	ROAD NAMING.....	69
C.5	MULTIPLE LINEAR ROUTE MEASURES.....	72
C.6	PUBLIC VS. PRIVATE ROADWAYS	73
C.7	INSTALL DATE AND INSPECTION DATE.....	74
C.8	ADDRESSING	75
APPENDIX D	MAINTENANCE	77
D.1	METADATA STANDARDS FOR GIS AND ROADWAY ASSET DATA	77
D.2	PLANNED, DESTROYED AND DECOMMISSIONED ROADWAYS.....	78
D.3	GEOARCHIVING ROADWAY SEGMENTS	79
D.4	ROADWAY DATA DISTRIBUTION AND CHANGE COMMUNICATION	80
APPENDIX E	CREATING AN INTEGRATED ALL-ROADS NETWORK.....	82
E.1	DATA COLLECTION & CATALOGING.....	83
E.2	DATA EXTRACTION FROM INPUT SOURCES	84
E.3	DATA PROFILING.....	85
E.4	DATA TRANSFORMATION AND LOADING	85
E.5	EDGE-MATCHING AND MATCH POINTS	86
E.6	LRS AND NETWORK TOPOLOGY	89
E.7	OUTPUT DATASETS.....	91
LIST OF ACRONYMS	93

EXECUTIVE SUMMARY

Although a rich body of work covering Linear Referencing Systems (LRS) and Geographic Information Systems for Transportation (GIS-T) has been developed over the past 25 years, there is no national consensus on LRS processes, data, or business rule standards. The Study team's experience is that every Department of Transportation (DOT) maintains a local, internal set of LRS rules, specific to their organization and its business requirements. Moreover, those States that have begun to expand their Geographic Information Systems (GIS) networks to encompass the all-roads requirements have, in many cases, merely extended the LRS approach used on their State route network, which may or may not be appropriate for local roads or multimodal applications. This approach is further complicated by the functionality of various commercial off-the-shelf (COTS) packages, each of which provides a different level of LRS support.

As a consequence of this evolutionary approach, no nationally endorsed or industry-wide LRS standard practices or business rules have been officially and universally embraced. But certainly, there are many existing local approaches to various LRS component-level issues that are satisfactory to meet specific business needs. Therefore, **the ARNOLD¹ Reference Manual is to be used as guidance**, and is not intended as a strict and enforceable standard. Its purpose is to report on the common conventions that can be considered best practices, and to provide guidance for implementation.

This *Reference Manual* covers the four overarching steps for a statewide, all-roads LRS implementation process, including:

- Implementation planning
- Data collection and integration
- Building the LRS
- Ongoing data maintenance

The content in this *Reference Manual* is based on interviews with several State DOTs and local/regional agencies, as well as collaboration and discussion with the project expert panel, and is supplemented by relevant subject matter research, all of which resulted in four individual reports that contain the findings and recommendations of the All Public Roads Geospatial Representation Study.

While the four technical reports are comprehensive and detailed, the main body of this document is synoptic and is aimed at walking a user through the overall process of planning and developing a statewide, all roads network that includes LRS. This document highlights the most important content

¹ All Road Network of Linear Referenced Data (ARNOLD)

from the other four technical reports in the context of an overall implementation process workflow, while also providing *Technical Appendices* that comprise much of the more detailed material that was developed for the individual stand-alone technical reports.

Most importantly, this document provides practical guidance and a handy *Reference Manual* to assist state DOTs in moving forward to meet the new Highway Performance Monitoring System (HPMS) requirements for the submittal of complete, all roads inventories and linear-referenced networks for every State and territory. This requirement is known as *ARNOLD* – the **All Road Network of Linear Referenced Data**. ARNOLD replaces the previous requirement of only collecting Federally Aided Route networks from each State.

OVERVIEW OF RECOMMENDATIONS

Each section in the document contains specific recommendations pertaining to the topic covered in that section (data collection, maintenance, etc.). The following list represents an overview of these recommendations and represents themes that came up repeatedly throughout the Study:

- **Collaborate** with Stakeholders
 - Other States, State agencies, local agencies, non-government entities, etc.
- Move Toward an **Enterprise Approach**
 - Build it once, use for many
- Find **Sustainable Practices**
 - For collection, maintenance, dissemination, etc.
- Expect and **Manage Change**
 - Emphasize flexibility and scalability for data, linear referencing methods, software, etc.
- Build your LRS **Incrementally**
 - Be realistic about current needs, and allow for the system to grow

1 INTRODUCTION

1.1 WHY IS AN ALL ROADS OUTLOOK IMPORTANT?

Geospatial data for transportation is a key data theme within the National Spatial Data Infrastructure (NSDI). The revision to the HPMS data submittal requirements that now require an "all roads network" to be provided to U.S. DOT emanates from the simple fact that given today's technology and transportation challenges, **all roads datasets are needed by both the Federal government and the States**. Indeed, many States had developed and maintained all roads datasets long before this requirement was formalized in 2012. Equally, and as documented in the U.S. DOT's 2011 Transportation for the Nation² strategic plan, both the Federal government and States *are already tracking and managing infrastructure and activity that occur on all roads*, such as bridges and accidents.

In addition, some of the most pressing transportation issues and concerns, such as safety, freight, aging infrastructure and traffic management, demand nationwide data and an all roads outlook. The timing is right for this evolution. This document aims to provide useful guidance on the planning, decisions and approaches that will assist States in successfully meeting the new requirements.

Almost 100 years after the Federal Aid system was put in place through the Federal Aid Road Act of 1916, States and the Federal government are still working together to improve the transportation infrastructure of the country³. In the early years, activity was focused on planning and constructing a physical, national highway system based on the individual, yet coordinated, efforts of the States. In the 21st century, with modern technology and the increased use of data analysis to support planning and management of the physical infrastructure, effort is focused on building a national road network dataset that requires the same kind of coordinated work between the States and Federal government as building the roads required. Indeed, this national road database will be an invaluable tool that will meet current business needs while also paving the way for future advancements that range from Next Generation 911 (NG911) and safety innovation to autonomous vehicles.

² See: [TFTN Strategic Plan](#)

³ Earl Swift, The Big Roads: The Untold Story of the Engineers, Visionaries, and Trailblazers who Created the American Super Highways, Houghton Mifflin Harcourt, Boston, 2011.

1.2 WHY THE U.S. DOT AND FHWA NEED ALL ROADS

Requirements to meet the following business needs are driving the demand for all-roads LRS within the U.S. DOT and FHWA:

- Certified Public Miles
 - All public road centerlines
 - Bureau of Indian Affairs (BIA) and Tribal delineations
- Fiscal Management Information System (FMIS)
 - All public roads, including dual carriageways
 - Highway project locations
 - Bridge project locations
- Fatal and Serious Injury Crashes
 - All public roads, including dual carriageways
 - Link to Model Inventory of Roadway Elements (MIRE) and other safety data
- Freight
 - Dual carriageways
 - Truck network
 - Traffic volumes and vehicle tracking
 - Routing topology
- Performance Measures for Safety
 - Crash locations by Urban Area and Metropolitan Planning Organization (MPO)
 - Vehicle Miles Travelled (VMT) by Urban Area and MPO
- Performance Measures for Pavement
 - Dual carriageways
 - Pavement condition

1.3 WHAT IS THE ALL-ROADS GEOSPATIAL REPRESENTATION STUDY?

Developing and maintaining a statewide, all roads network that includes LRS is a complex, technical endeavor. This *Reference Manual* represents the findings and guidance, both general and technical, of

the full All Roads Geospatial Representation Study. This study included four individual technical reports that cover the activities necessary to realize the ARNOLD vision.

- Local Road Collection Systematic Approach Report
- LRS Components and Best Practices
- LRS Temporal Maintenance Plan Report
- LRS Technical Instructions, Rules and Diagrams Report

The *Reference Manual* is the culmination and compilation of the work done in these four interim reports. In addition to the main body, it contains a set of *Technical Appendices* comprising details of the topics covered throughout the main sections. It is assumed that the reader has a general understanding of LRS, but if this is not the case, a basic introduction to LRS can be found in Appendix Section A.1.

This document is organized around the four key steps of a statewide, all roads LRS implementation process, as follows:



Figure 1: All Roads LRS Implementation Process Diagram ⁴

2 IMPLEMENTATION PLANNING

2.1 THE OPPORTUNITY TO REVIEW THE AGENCY'S OVERALL NETWORK AND LRS DATA MANAGEMENT

It is well understood that the development and maintenance of a statewide, all roads network containing LRS is an involved and complex process. It is also understood that state DOTs may have a variety of existing road networks and LRS that are in current use throughout the agency. In short, there may be an existing and complicated data and LRS environment and adding yet another road network and LRS can be viewed as a chore. At the same time, the new ARNOLD requirements provide an

⁴ Applied Geographics, Inc., 2014

opportunity for the DOT to review the existing data landscape and to have the ARNOLD requirements catalyze a purposeful planning process that may go beyond simply building a new network, and may involve a reconsideration of current practices. Options for approaching ARNOLD development include, but are not limited to:

- Building a new network from scratch
- Adapting or enhancing an existing network
- Consolidating multiple existing networks into a single, multi-purpose enterprise resource

Ultimately, the new ARNOLD requirement can be viewed as an *opportunity* and *reason* for a State to review its overall network and LRS data management approach and to make investments that address what may be a backlog of known issues and challenges.

2.2 WHAT KIND OF PLANNING DO WE NEED?

Planning processes can take a variety of forms, and written plans can be built to cover various levels of detail. For example, a plan to build a new single-purpose ARNOLD network would differ from a plan that involved consolidating multiple existing LRS into a multi-purpose, enterprise dataset that may power a variety of applications. As such, there is no single way that implementation planning should proceed. Rather, the most important point is that ***planning needs to happen***. It will then be up to the DOT to determine the appropriate level of detail and the resources necessary to carry out the planning.

Regardless of the level of detail chosen, the following list presents the most important questions that any planning process should answer:

What are the requirements? Datasets are not constructed for the sake of creating data; rather, the data are created to support business requirements and to support planning and decision making. There are at least two categories of requirements that the ARNOLD data should meet:

- **FHWA HPMS submittal requirements:** The HPMS program requires an annual data submission of an all roads network that, among other things, can be used to validate a State's road mileage figure.
- **Additional business requirements:** As documented in Appendix A.2, LRS are versatile and can be used to support a wide variety of DOT activities and business functions (as seen in Figure 2). These activities range from Transportation Improvement Planning (TIP) to safety management and crash reporting to asset inventory and management. As DOTs plan potential expansions or improvements to the LRS, it is critical to fully catalog and understand all potential uses of the LRS.

- **What roles and responsibilities need to be covered?** Together, a statewide road network and LRS are a complex database that changes over time and requires human resources for management. Additionally, as technology and software continue to evolve there may be a concomitant need for technical evolution of the LRS. As such, planning for the LRS should identify the human resource requirements, the "organizational owners," and other participants in managing and updating the LRS on an ongoing basis.



Figure 2: DOT Business Functions⁵

- **Is there an established change management strategy?** Constructing a statewide network and LRS is not a one-time activity. Indeed, both the network characteristics (e.g., additions and changes in road alignment) and the technologies available for managing, storing, and accessing LRS-based data will change. As such, change management should be part of any implementation planning exercise, with a focus on:
 - Understanding and documenting the **initial changes in current practices** that are necessary to develop the new, enhanced all roads network and LRS
 - **Designing with flexibility** in mind so as to accommodate inevitable technological advancement and change
- **What are the desired outcomes of planning?** The planning process will help the organization to answer key questions and identify the resources that need to be marshaled to complete the work of developing a statewide, all roads network. Several of the key issues that the planning process will answer are highlighted in the succeeding sections of this report:
 - Identify a data collection approach and process, including a repeatable updating process (Section 3)
 - Identify the data structure and underlying software for building and storing the network and LRS (Section 4)
 - Establish sustainable maintenance processes for keeping the data current and useful to all stakeholders (Section 5)

⁵ Applied Geographics, Inc., 2014

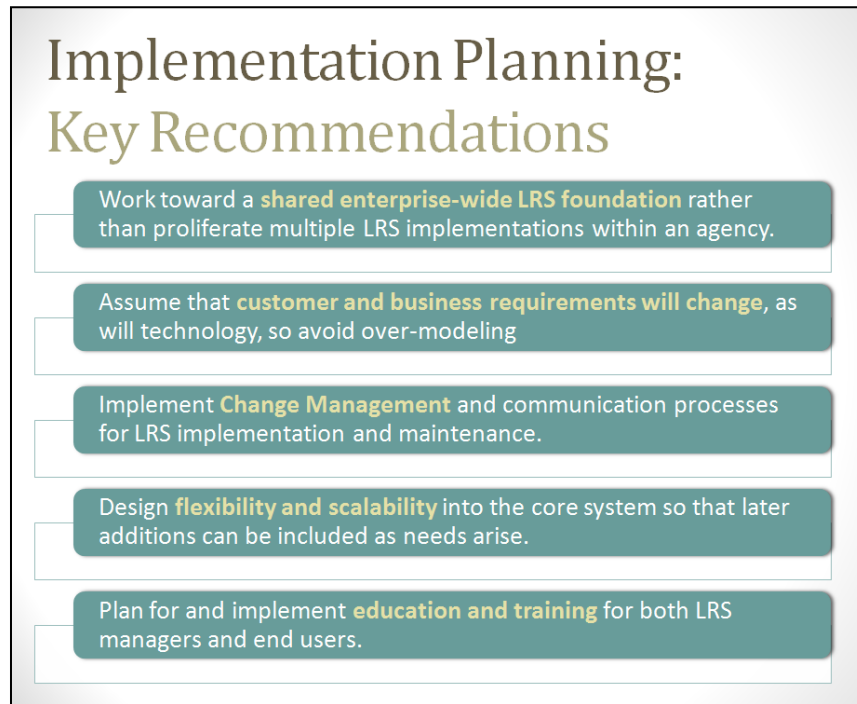

Figure 3: Implementation Planning Key Recommendations⁶

The recommendations below represent a synthesis and encapsulation of the best practices for implementation planning gathered through research, interviews, and analysis.

- **Work toward a shared, enterprise-wide LRS foundation within a State’s DOT.** Rather than the proliferation of different methods of LRS implementation within an agency, the all-roads integration requirement is a rare opportunity to not only expand the roadway geometry under consideration, but also move a DOT towards constructing and utilizing a single, multi-purpose network and LRS across the network. This includes developing an improved institutional, organizational, and procedural context surrounding the all-roads network – including a shared LRS foundation. It should be noted that while moving to a *single* LRS may not be feasible in the short term, minimizing the number of LRS in use is strongly recommended, and a single network and LRS should remain a long-term goal.
- Assume that **customer and business requirements and technology will change**, so avoid over-modeling the enterprise-wide LRS.

⁶ Applied Geographics, Inc., 2014

- Maintain a modern outlook – embrace change and facilitate adoption
- Monitor and control change to an appropriate degree to ensure the smooth operation of interdependent systems (see next recommendation).
- Implement **Change Management** and communication processes for both organizational and technical components of the LRS implementation and maintenance.
 - **Preparing for Change:** Include activities to prepare the organization for the application of change management strategies, to enable sponsors to support the change, and to help architect a high-level change management strategy.
 - **Managing Change:** Include the design of the change management plans and activities, and the implementation of those plans throughout the organization. These plans will be customized based on the characteristics of the change and the unique attributes of the LRS and related organizations.
 - **Reinforcing Change:** Include analysis of the results of the change management activities and implementation of corrective actions. This phase also focuses on celebrating early successes, conducting after-action reviews, and transferring ownership for change management to the organization.
- Design **flexibility and scalability** into the core system so that temporal features can be added as modular extensions of the core system.
 - Employ a data structure that tracks inventory projects and roadway/route changes so that questions regarding data changes can be answered.
 - Recognize that many downstream users and business processes depend on LRS. Any changes to the LRS will cascade down to them and may have unintended effects. Understand these relationships during the design and development stage.
- Plan for **education and training** on LRS concepts, methods, tools and data objects, for both LRS maintainers and end users.
 - Proactively manage the ARNOLD deployment and manage predictable resistance with education, training, and positive reinforcement.
 - Adopt a customer orientation, with awareness and empathy for customer expectations.

3 DATA COLLECTION

The core difference between the previous HPMS road data submittal requirements and the new ARNOLD requirements is that the State road network must now contain **all roads** within the State, not just the Federally Aided routes. Thus, the core challenge for DOTs is identifying mechanisms and repeatable processes for collecting the all roads data. State DOTs are not the only entities that map roads within a State. Other local levels of government, such as counties and cities, are also involved in road data collection and management. In addition, private sector companies collect and sell high-quality road data. As such, there are significant opportunities for DOTs to *partner* with other entities to meet the new requirements. The following sections lay out two key questions that State DOTs need to answer as they embark on developing a statewide, all-roads network.

3.1 HOW DO WE COLLECT ALL ROADS ACROSS THE STATE?

There are four "local roads supply chain" patterns that can effectively deliver the information necessary to build a statewide, all-road network. While each of these supply chains is feasible, they differ in how important potential partnerships are, and also in the level of cash and direct DOT labor that may be involved. The following information provides an overview of each of these supply chain patterns.

1. **Local government supplies roads data to the State DOT:** The DOT collects and assembles centerline data from multiple governmental organizations, typically local and Federal governments that have jurisdictional responsibility over some set of roads. Often, these organizations have their own geospatial capacity and are already using geospatial technology to manage their roads. At the local government level, these organizations typically include municipalities and counties. At the Federal level, agencies such as the U.S. Forest Service, National Park Service, Bureau of Land Management and the Bureau of Indian Affairs have jurisdiction over the local roads in their geographic domains.

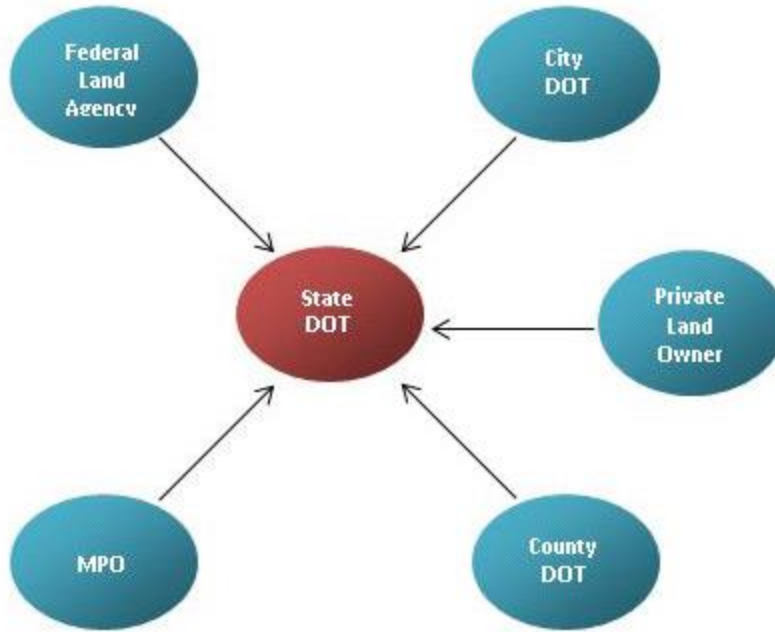

Figure 4: Local Government Supply Chain Pattern⁷

When this pattern is chosen, the core task is to establish outreach, communication and collaboration with various partners. The communication is critical, and non-trivial amounts of effort should be devoted to it so that a regular data exchange between partners occurs. Nevertheless, collecting data on a regular basis is only the start of the process. This pattern also requires that DOTs establish repeatable processes and workflows for assembling a cohesive "whole" from the "parts" that are collected from local and Federal partners. Appendix E provides detailed guidance on **integrating local data** into a statewide resource through techniques such as: data profiling; data extraction, transformation and loading (ETL); edge-matching; and the application of new LRS.

Pros:

- Highest data quality emanates from obtaining data from local sources that know the landscape best

Cons:

- State DOT takes on the burden of data compilation and edge-matching
- Update and maintenance involves many stakeholders

⁷ Applied Geographics, Inc., 2014

- Communication and collaboration with local entities, particularly larger counties and cities, can be difficult
2. **Commercial and third-party road centerline data supporting a State DOT:** The third-party entity collects and aggregates road data from a variety of agencies and makes these data available to the State DOT. This third party may be another government or quasi-government agency (e.g., a regional Metropolitan Planning Organization (MPO), a State GIS clearinghouse, State E911 program) or a commercial data supplier (e.g., HERE, TomTom, or Google). In addition, this third party could be a publicly available data source such as OpenStreetMap⁸ (OSM) or a Federal data source, such as the U.S. Census TIGER⁹ files. In essence, the third party takes on the role of gathering and assembling a statewide dataset from a variety of sources that it chooses.

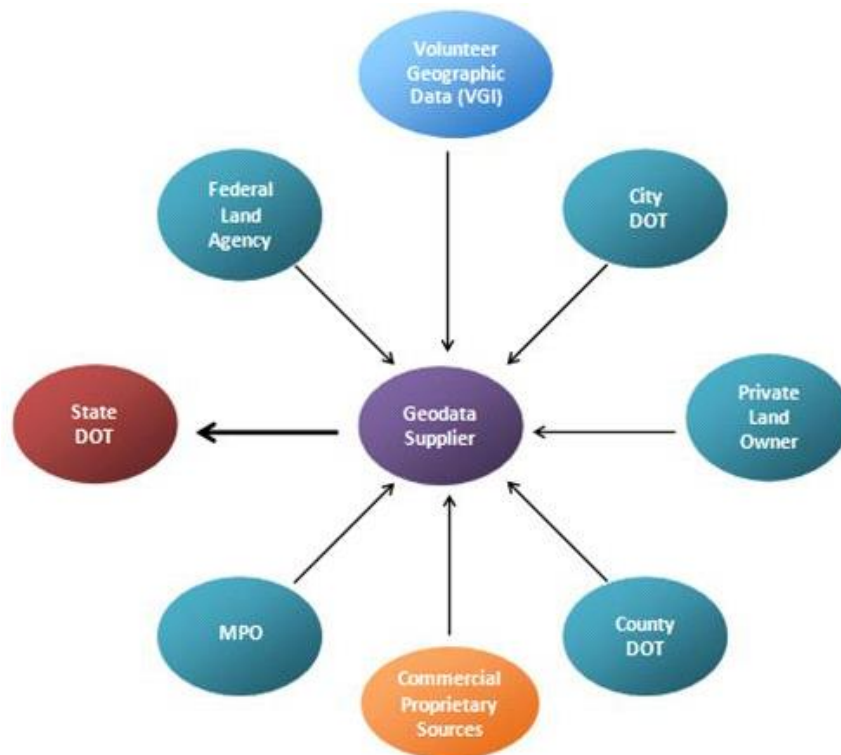

Figure 5: Geodata Supplier Supply Chain Pattern¹⁰

⁸ See: [Open Street Map website](#)

⁹ TIGER stands for Topologically Integrated Geographic Encoding and Referencing. TIGER products are published by the U.S. Census Bureau and contain features such as roads, railroads, and rivers, as well as legal and statistical geographic areas. See [U.S. Census Bureau TIGER Products webpage](#)

¹⁰ Applied Geographics, Inc., 2014

Currently, several States, including Florida, Illinois, New York, and Massachusetts, have developed relationships with commercial road centerline data suppliers. Others, such as California, which uses TIGER, are using publicly available road data as a component of its statewide, all roads networks. In addition, there is precedent for Federal agencies purchasing commercially licensed street data, including the National Geospatial-Intelligence Agency (for the Highway Safety Improvement Program) and the U.S. Geological Survey (for *The National Map*).

Pros:

- The State does not need to carry the full costs and business processes associated with assembling the dataset, as the third party takes these on

Cons:

- State DOT does not have control over the data creation
- When a commercial supplier is involved, licensing restrictions can limit distribution

3. **The State DOT does it all:** As illustrated in Figure 6¹¹, the DOT creates and manages the statewide, all roads data layer on its own, irrespective of whether other agencies are also managing centerline data. The DOT becomes responsible for identifying and accurately mapping all new roads and other road changes (alignments, names, etc.). Because the State is wholly responsible, this method may require considerable resources for original data collection and mapping on top of just managing the technical aspects of the dataset and LRS. In some States, such as Delaware, there is not a choice, as the DOT is administratively responsible for all public roads in the State.

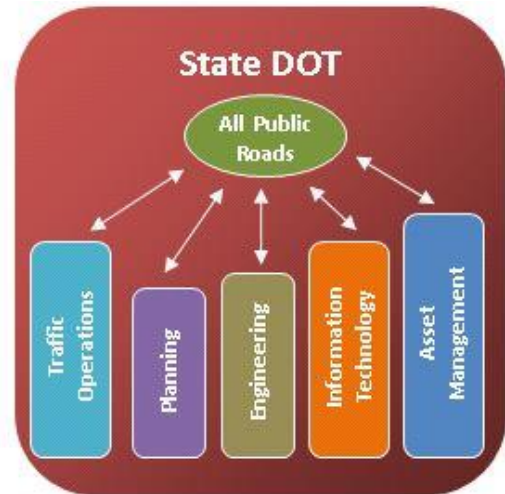

Figure 6: State DOT creates and manages all data¹¹

Pros:

- The DOT is in complete control

Cons:

- Cost can be higher as the DOT takes on more data collection and mapping
- Quality of data can suffer without proper local involvement to review and “ground truth” the data

4. **Hybrid approach:** Given the three other patterns, a variety of hybrid approaches can be pursued. Most typically, the DOT collects as much data as is available and useful from a geodata

¹¹ Applied Geographics, Inc., 2014

supplier (e.g., a regional agency or State GIS clearinghouse) and then fills in gaps as needed through its own efforts and by working directly with local and/or Federal government agencies. In essence, the State DOT can choose one approach whereby it can collect the most data in the best condition, and then uses additional tactics and efforts to fill in gaps or address shortcomings. Other examples may include a State with a strong MPO that provides data for the metropolitan area and then direct outreach to rural counties and Federal agencies for the less developed parts of the State.



Figure 7: Hybrid Supply Chain Pattern¹²

Pros:

- Blends the benefits of getting data from a strong third-party aggregator with having the DOT remain directly involved in data collection from other partners

Cons:

- State DOT takes on the burden of data compilation and edge-matching
- Update and maintenance involves many stakeholders

¹² Applied Geographics, Inc., 2014

3.2 WHAT COMPONENTS WILL OUR BASELINE CENTERLINE NETWORK CONTAIN?

All road centerline datasets are not equal in their content. Indeed, part of the power of the road centerline is its versatility and the ability for it to house a wide variety of related information. As Appendix Section A.4 details, five key classes of information may be present in a statewide, all roads network:

1. **Road centerline geometry**
2. **Basic road attributes (e.g., road names)**
3. **Address ranges¹³**
4. **LRS control**
5. **Network topology to allow routing**

Figure 8 provides details on each of these key classes of information.

Road Centerline Geometry	Basic Road Centerline Attributes	Address Ranges	LRS Control	Network/ Linear Topology
All public and private highways, roads and streets	Persistent road ID number	Right side/left side address ranges	Linear precision: 0.001 miles	Common topology for road network models (e.g. spatial analysis, routing)
Dual carriageway representation	Road/street name	Urban and rural addresses used for E911	Centerline Mileage Begin/ End accuracy: 0.001 miles	
Updated/certified annually	Functional Class			
1:5,000 scale	Year			
WGS 84 Coordinates	State			

Figure 8: Common Baseline Network Requirements¹⁴

¹³ Increasingly, address points are being collected for emergency dispatch and routing applications, since they produce more accurate address-matching and geocoding results. If they are available, they are preferred to address ranges.

¹⁴ Applied Geographics, Inc., 2014

Typically, more basic statewide networks will contain the first three components: geometry, basic attributes and LRS. More advanced statewide networks will contain all five components. States that are just embarking on their statewide, all roads networks may choose to start with a more basic set of three components. Meanwhile, States that have had their own statewide, all roads networks for some time and are contemplating the creation of more enterprise-oriented and multi-purpose networks may choose to pursue all five components. (See Section A.4 for more on assessing network maturity.)

3.3 DATA COLLECTION RECOMMENDATIONS

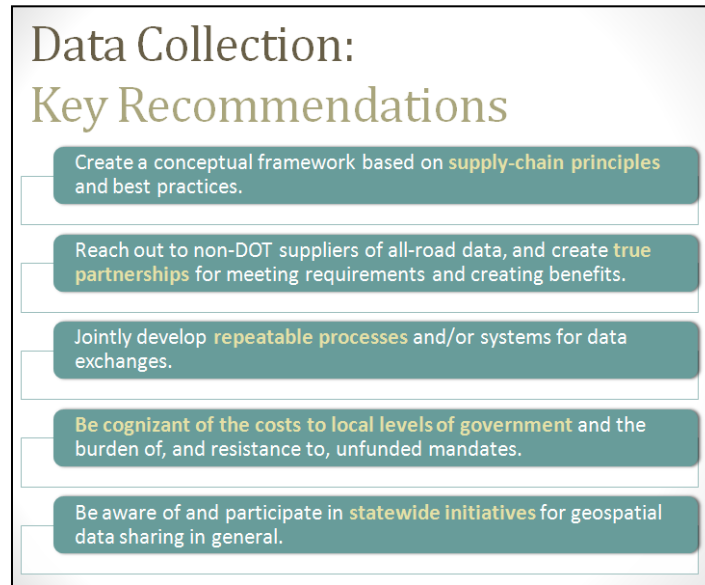

Figure 9: Data Collection Key Recommendations¹⁵

The recommendations below represent a synthesis and encapsulation of the findings on best practices gathered through research, interviews, and analysis. These recommendations provide an overall game plan for effective approaches to collecting and integrating all-roads data into LRS that can be followed by State DOTs and FHWA.

1. Create a conceptual framework based on **supply-chain principles and best practices**.
 - a. Define primary activities related to collecting and integrating all-roads data, and support activities for a sustainable approach as part of the organizational approach.

¹⁵ Applied Geographics, Inc., 2014

- b. Articulate the drivers, facilitators, components, and desired outcomes for the State, as well as for other levels of government and other sectors that may be stakeholders or part of the supply chain.
2. **Reach out to non-DOT suppliers of all roads data**, and treat them as true partners in meeting requirements and creating bilateral benefits.
 - a. Make the effort to understand their capabilities and needs.
 - b. Identify mutually beneficial outcomes.
3. Jointly develop **repeatable processes** and/or systems for data exchange.
 - a. Consider updates more frequently than once per year.
 - b. Leverage the Internet and Web applications.
4. **Be cognizant of the costs to local levels of government** and the burden of, and resistance to, unfunded mandates.
 - a. Unlike State DOTs, not all suppliers of road data are LRS-centric. This is especially true for local governments, and many will not want to change their existing practices, especially if new requirements are unfunded.
 - b. The key to a sustainable supply chain of local road data, flowing from local governments to the State DOT, is to identify the mutually beneficial products of a partnership approach, and to provide funding for activities that are uniquely required to meet HPMS reporting requirements.
 - c. The State DOT also needs to be prepared to add the required value-added elements (edge-matching, the addition of LRS, etc.) as a DOT function.
5. Understand related **statewide initiatives for geospatial data sharing** in general, and participate as appropriate. For example:
 - a. A non-DOT government entity, such as the State GIS Office (or GIO¹⁶), may be coordinating or partnering in the collection and distribution of all-roads data.
 - b. A non-government entity (e.g., commercial data provider) may be working in collaboration with a non-DOT government entity, such as the Department of Public Safety, to collect and maintain all-roads data (public and private).
 - c. Volunteered geographic information (VGI), such as Open Street Map (OSM), may be well regarded in some States as a legitimate source of all-roads data.

¹⁶ Geographic Information Officer

4 INTEGRATING ALL-ROADS AND CONSTRUCTING THE LRS

Linear referencing systems are among the most important and complex datasets within a DOT. Thus, great care needs to be taken in establishing new LRS or enhancing and extending the capabilities of existing LRS.

This section highlights some of the key technical aspects of building LRS. The table below provides summarized guidance for these technical details, along with the page number in the *Technical Appendices* where additional background information, details, and diagrams can be found.

SUMMARIZED GUIDANCE FOR BUILDING LRS		
ROADWAY GEOMETRY SUMMARIZED GUIDANCE		<i>Tech. Appendix</i>
Roadway Segmentation	Implement an enterprise approach allowing multiple business needs to be met. For example, maintain an intersection-based network, and regularly generate the route-based network from it.	pg 51
Dual Carriageways	As defined, and in order to meet ARNOLD requirements, utilize a dual-carriageway representation for divided roadways, ideally with independent mileage calibration ¹⁷ .	pg 53
Traffic Circles	Model each traffic circle on a case-by-case basis, with the goal of minimizing segment overlap and route segmentation.	pg 58
Ramps	Define the start and end of the ramp as the taper from and to the mainline. Define deceleration and acceleration sections as LRS events.	pg 61
Cul-de-Sacs and Loops	These roadway elements often have the same start and end point, which can be problematic for at least one major vendor's GIS software to handle for LRS applications. The DOT will need to establish standards for handling them consistently in the statewide network, taking into account any software limitations.	pg 63

¹⁷ As described in the content in Appendix Section B.2, while the recommendation is for the mileage to be independent, measures on both sides can be related. For example, as a road changes from divided to undivided and back, a relationship between measures may be appropriate.

SUMMARIZED GUIDANCE FOR BUILDING LRS

ROADWAY ATTRIBUTES SUMMARIZED GUIDANCE

Route Events vs. Segmented Attributes	Store a minimum set of “base” attributes on the segment, and save everything else as route events within the LRS.	pg 66
ARNOLD Schema	State DOTs should maintain or be able to generate the key ARNOLD fields to meet submission requirements.	pg 67
Route ID Numbering	Define a standardized route identification convention as the framework for aligning all DOT and local agency roadway asset data.	pg 68
Road Naming	All roadways should include at least one standardized name. Roadway naming should also include roadway aliases, historical names, honorary names, etc.	pg 69
Multiple Linear Route Measures	The GIS network should have the capability to support multiple LRMs, while standardizing to a single LRM (such as driven mileage) as the preferred measure.	pg 72
Public vs. Private Roadways	Although the HPMS only requires the roads that correspond to certified road mileage, State DOTs should include private roads in their network to support emergency response and safety considerations.	pg 73
Installation Date and Inspection/Inventory Date	For maximum data evaluation capability, capture and manage both the construction date and inventory dates.	pg 74
Addressing	For emergency response purposes, discrete address point locations linked to the LRS are preferable to give first responders an exact location.	pg 75
LRS MAINTENANCE SUMMARIZED GUIDANCE		
Metadata Standards for GIS and Roadways Asset Data	All published and distributed datasets should include standardized metadata, ideally at both the layer level and the object level, but at least at the dataset level.	pg 77

SUMMARIZED GUIDANCE FOR BUILDING LRS

LRS MAINTENANCE SUMMARIZED GUIDANCE (Cont.)		<i>Tech. Appendix</i>
Planned, Destroyed and Decommissioned Roadways	Include planned, unbuilt facilities, as well as abandoned or destroyed roadways, in the dataset.	pg 78
Geoarchiving Roadway Segments	Always geoarchive data when significant updates and changes occur.	pg 79
Roadway Data Distribution and Change Communication	Make data readily available to all users via web services, and develop a consistent change communication mechanism.	pg 80
SUMMARIZED GUIDANCE FOR CREATING AN INTEGRATED ALL ROADS NETWORK		
Data Collection and Cataloging	Create a data inventory, including metadata, of all data sources to be integrated.	pg 83
Data Extraction from Input Sources	To streamline data loading and conflation, create a staging dataset as needed for the ETL process, that contains the pertinent subset of features from each source dataset.	pg 84
Data Profiling	Data should be evaluated for consistency and quality using a combination of automated and manual procedures.	pg 85
Data Transformation and Loading	When loading source data, only minor changes should be made (e.g., re-projecting data, fixing obvious errors). Ideally, the source data owner would take responsibility for needed data maintenance.	pg 85
Edge-Matching and Match Points	Match points should be established to allow edge-matching and data alignment between neighboring or overlapping transportation agencies.	pg 86
LRS and Network Topology	Topology rules and Open GIS Consortium (OGC) standards should be applied to and enforced within the roadway network to ensure data quality and stability, as well as to support routing and network analysis.	pg 89
Output Datasets	The network should be built to meet the needs of routing, and then be processed to support the needs of LRS.	pg 91

The following section provides some focused and practical guidance for making the key decisions necessary to build a statewide, all roads network of linear referenced data.

4.1 HOW DO WE CREATE THE LRS THAT WE NEED?

There are several key sets of issues, with attendant decisions that need to be made:

1. Managing both segmented and route-based road data

Traditionally, most GIS road networks are created and maintained in “segmented” form. That is, if two lines intersect, each of those lines is broken at the intersection, or segmented. This is useful since road characteristics can vary from segment to segment (e.g., the number of lanes changes) and the intersection itself may have various characteristics to record (e.g., a “no left turn” restriction). At the same time, most LRS are created and maintained in “route-based” form. That is, each unique street name is stored as a route that has the complete geometry of the entire street, from beginning to end and through all intersections. Typically, within LRS, when two routes intersect, they are not broken into segments.

These two modes of storing road network data have evolved for good reason, based on different use cases and capabilities. For example:

- Segment-based networks support details such as one-way streets and turn restrictions at intersections, and these characteristics are critical in terms of vehicle routing and emergency response.

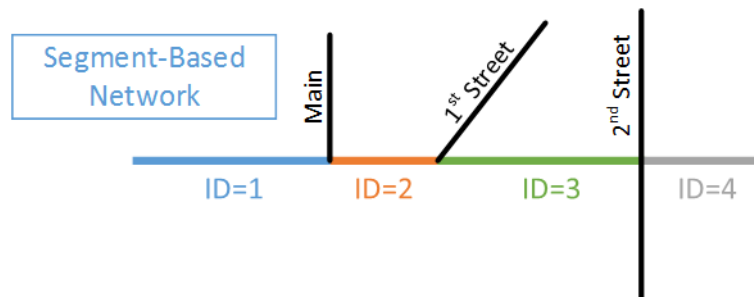

Figure 10: Segment-Based Network Diagram¹⁸

- Route-based networks are more traditional within a DOT’s LRS, as they enable roads to be mileposted, from beginning to end, in a continuous fashion.

¹⁸ Michael Baker Jr., Inc., 2014

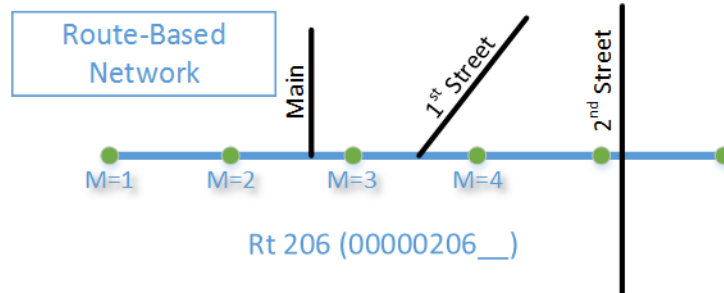

Figure 11: Route-Based Network Diagram¹⁹

Each type of network also uses a different approach for storing attributes. In a segment-based network, attributes are stored as database fields associated with each segment. In a route-based network, attributes are stored as events that are measured along the route (see Appendix Section C.1).

Currently, most DOTs recognize that **both** types of networks are valuable and support different use cases. For example:

- Segment-based networks support vehicle routing and are better for storing some types of attributes, such as one-way streets
- Route-based networks support the storage of attributes such as pavement condition, which may cover only a portion of a segment, and can be used to store point events (e.g., an accident) that occur along a network

Understanding that DOTs need both types of networks, the challenge becomes developing a data maintenance workflow that doesn't involve the need to complete an edit twice (i.e., once in the segment-based network, and again in the route-based network). Thus, the recommended approach is to implement an enterprise road dataset that contains both segment geometry and comprehensive LRS that can meet multiple business needs. One approach for achieving this would involve the following (see Figure 15 as well as Appendix Sections B.1 and E.7):

- Maintain the segment-based network for the base geometry and enter all changes (e.g., new roads, realigned roads, etc.) into the segment based network
- Use geospatial software, ideally automated routines, to regularly generate the route-based network as a derivative of the segment based network

¹⁹ Michael Baker Jr., Inc., 2014

2. What linear referencing method(s) (LRM) will we use? Do we need more than one?

One of the key characteristics of LRS is the ability to store “measures” along the network. A measure allows locations along the network to be described in a unique way. For example, a culvert could be described as existing “4.62 miles from the beginning for Route 495”. This example uses a specific “linear referencing method” (LRM) for identifying the location of the culvert. In this case, the LRM is “the absolute distance from the start of the road”.

There are several different LRM besides “absolute distance” and (Appendix Section A.3 provides details on the most common LRMs in use by DOTs):

- **Absolute:** Distance from the start of the route segment (e.g., 4.62 miles)
- **Relative:** Distance from a reference location (e.g., 292 feet from milepost 101 on Route 495)
- **Interpolative:** Proportional distance from start of segment (e.g., 68.2 percent)
- **Addresses:** Can generally be done in two ways (see Appendix Section C.8 for more details):
 - *Address Range: estimated distance based address range of a segment*
 - *Address Points: location of an actual, measured address location*
- **GPS route:** Measured Global Positioning System (GPS) coordinates are projected onto a segment/route in the network

Ideally, the statewide, all roads network should have the ability to support multiple LRMs, while the DOT standardizes on a single LRM as the preferred, default measure (see Appendix Section C.5). As such, identification of all of the LRMs in use by a DOT, as well as the most frequently used ones should be an important aspect of planning the statewide, all roads network .

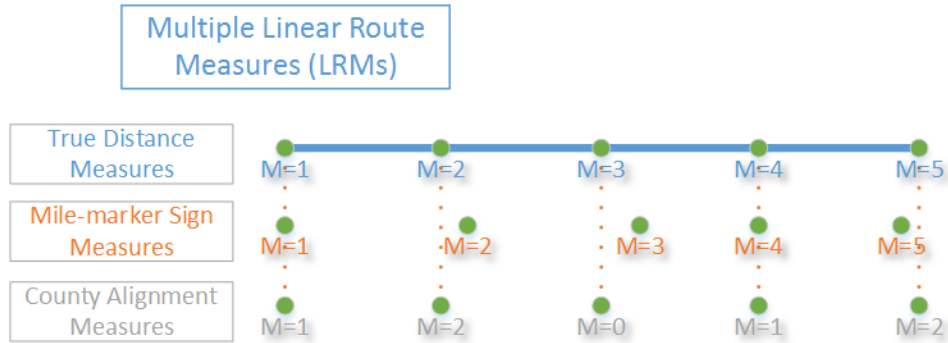

Figure 12: Multiple Linear Route Measures Diagram²⁰

3. How will the LRS handle the most challenging geometric roadway elements?

Roadway networks can be extremely complex, and as highway construction and traffic management techniques continue to evolve they will continue to increase in complexity. Initially, digital representations of roadway networks, particularly those designed to house LRS, were simplified, schematic representations. That is, every road was represented as a single line, and every intersection was depicted as a single point/node where two lines intersected. However, as technology has advanced and as the uses of electronic roadway data have broadened, it has become increasingly important to more accurately depict the layout and alignment of roadway networks.

As more State DOTs perform work on their road networks to meet the new ARNOLD requirements, it may be appropriate to improve and enhance the existing networks to not just contain all roads, but also to include more accurate roadway configurations. As detailed in Sections B.2 – B.5 of the Appendix, the following describes some of the more challenging road configurations that need to be modeled to create the most accurate LRS possible. Properly handling these situations will help DOTs develop the most accurate possible statewide roadway mileage by use of their all roads network.

- **Dual carriageways:** Store divided roadways as two separate segments with each direction having its own measurements²¹ (see Appendix Section B.2).

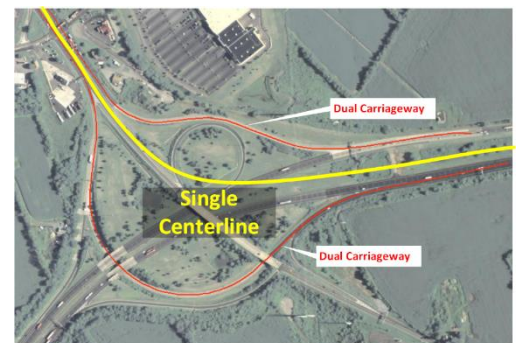

²⁰ Michael Baker Jr., Inc., 2014

²¹ Graphic by Michael Baker Jr., Inc., 2014

- **Traffic circles/rotaries:** Model each traffic circle on a case-by-case basis, with the goal of minimizing segment overlap and route segmentation (see Appendix Section B.3).

- **Ramps:** Model as a special form of intersection containing unnamed segments²² (see Appendix Section B.4).



- **Cul-de-Sacs and Loops:** These features often have the same start/end point, which can be problematic for LRS. The DOT will need to establish standards for handling them consistently in the statewide network (see Appendix Section B.5).

4. Creating a seamless network using edge-matching and match points

Match points (also known as integration points, touch points, smart points, demarcation points, agreement points, snap-to points, join points, etc.) are point locations established within the GIS to mark the connection point between two (or more) geospatial datasets. These points allow datasets to be seamlessly joined together without any overlap or gaps (which is essential to network topology, as described in the section below). In terms of a nationwide ARNOLD, establishing these points between neighboring States will be critical in facilitating the **edge-matching** of data and ultimately stitching together a nationwide roadway dataset.

²² Graphic by Michael Baker Jr., Inc., 2014

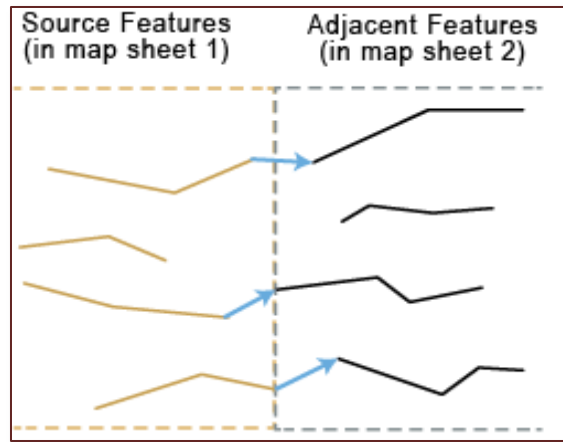

Figure 13: Edge Matching Scenarios²³

If match points to facilitate data integration have been agreed upon at the State or local levels, they should be used. If they do not exist, then a set of recommended points should be presented to the affected jurisdictions for negotiation and agreement. Feedback and adjustments should be allowed for, and incorporated into an agreed-upon Statewide Match Point Layer (see Appendix E.5 for more detail).

4.2 WHAT TOOLS DO WE NEED TO CONSTRUCT AND MAINTAIN LRS?

The geospatial software industry - both for computer-aided design (CAD) and geographic information systems (GIS) - has consistently advanced the toolsets that are available for developing, managing and maintaining both linear networks and LRS. In short, a variety of commercial, off-the-shelf (COTS) software solutions can provide the tools a State DOT needs, and most of these can be extended with customization for particular situations in a given State.

The following list provides an overview of the core software capabilities that are necessary for the construction and maintenance of a statewide, all road network and LRS:

1. Constructing and Maintaining the Centerline

- **Geometric editing of the centerline data:** Having the core capabilities to create and edit data and to maintain network topology ensures that new roads can be added, obsolete

²³ See: Esri, [ArcGIS Resources, About Edgematching](#)

features can be removed (and archived), and network connectivity and attributes can be properly maintained.

- **Data import/export from/to common, standard formats:** These tools are particularly important when the chosen supply chain involves the collection and integration of data from partners and other third parties.
- **Extract, transform, and load (ETL):** These tools are also particularly important in the process of integrating data obtained from multiple sources into a single statewide dataset. The ETL process may involve taking data from one format and running it through conversion routines that prepare it for loading into another dataset, in another format.
- **Conflation:** This feature involves the ability to transfer the geometry and/or attributes from one dataset to another, including edge-matching functionality.
- **Multi-user editing and versioning:** Given the size of statewide networks, it is highly desirable to have a software environment that enables multiple people to edit the same network simultaneously. When this takes place, advanced features such as feature locking and data versioning (i.e., the ability to track and manipulate multiple versions of the same dataset) become increasingly important.

2. Applying and Maintaining the LRS

- **LRM calibration:** The baseline geometry of networks can change over time, or wholesale improvements can occur in response to an event such as a new flyover. When the underlying geometry changes, tools are necessary to re-calibrate the LRM to the new geometry and to allow fixed assets, such as mileposts, to maintain their positions.
- **Applying an LRM:** This capability involves taking a baseline geometric network and applying the LRM so that it can calculate, house, and maintain measure-based values.
- **Storage of, and access to, measure-based information:** Once the LRM is applied, the software needs to be able to house derivative datasets/features that are based on measurements. Typically, these additional features are stored as "events" that reference the LRS. Thus, a user can access and manipulate datasets of "accidents" or "culverts" or "pavement conditions" based on their measured values.

3. Publication and Sharing of LRS Data

- **Ability to publish web services:** Increasingly, routine end user access to data of all types, including LRS and derivative measures, is via web browser-based applications, including access on mobile devices. As such, it is important that the chosen software environment is able to publish the data as web services that can be consumed by browser-based applications, mobile applications, and by many desktop geospatial

environments. For greatest flexibility, the publication environments should support open geospatial standards such as the Web Map Service²⁴ (WMS) from the Open Geospatial Consortium²⁵.

- **Programmatic access to LRS via APIs:** Like web services, Application Programming Interfaces (APIs) are an important tool for making LRS and measure-based data accessible through web browser and mobile applications. Unlike web services, which provide access to raw data, an API can provide tools to manipulate and query the data, thus providing expanded capabilities to application developers.
- **Download of LRS information:** Public availability of road network and LRS data is important, and DOTs should anticipate creating a capability for public download, or adding road centerline and LRS data to existing download capabilities. Broadly speaking, the download capability can be considered an extension of the process of providing the final data products to the HPMS program.

Ultimately, building and maintaining a statewide, all roads network is an involved process. As described above, a variety of tools are required to perform the three core functions of centerline creation and maintenance, application and management of the LRS, and the publication and use of LRS and measure data. While some toolsets may be able to meet all of the requirements of State DOTs, it is feasible and can be beneficial to combine tools to create “best of breed” solutions. For example, some tools are highly specialized for activities such as ETL or high-performance web publication, and other tools are tightly focused on the maintenance and management of LRS and measure data.

²⁴ See [Open Geospatial Consortium, Web Map Service](#)

²⁵ See [Open Geospatial Consortium Standards](#)

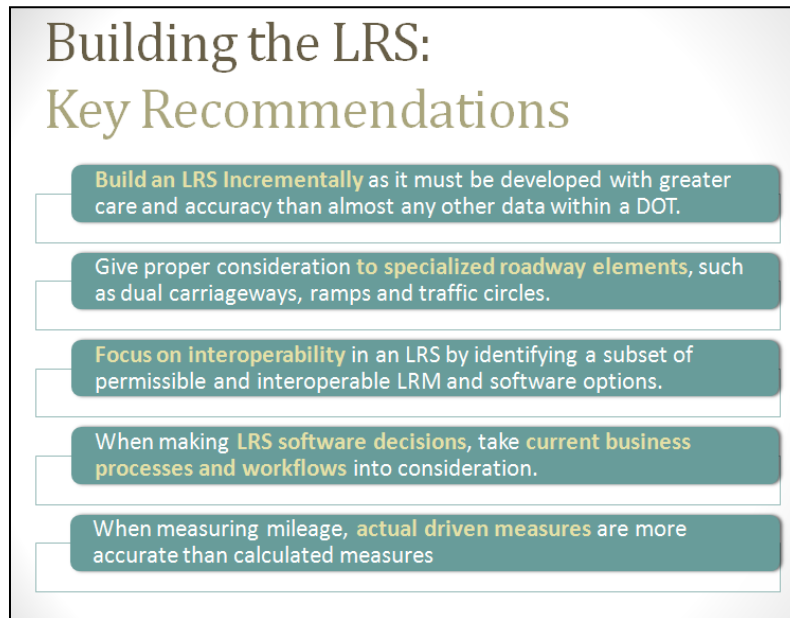

Figure 14: Building the LRS Key Recommendations²⁶

The recommendations below represent a synthesis and encapsulation of the LRS best practices gathered through research, interviews, and analysis.

- **Build LRS incrementally.** Due to its foundational nature, the all-roads LRS must be developed with greater care and accuracy than almost any other data within a DOT. Practically speaking, the magnitude of this effort may be somewhat mitigated using an incremental approach. Ideally, the initial design would outline the ultimate LRS configuration, which would then be incrementally achieved using a series of intermediate projects. Given the all-roads HPMS reporting deadline, an incremental strategy may be a practical necessity.
- **Give proper consideration to specialized roadway elements,** such as dual carriageways, traffic circles, and ramps. For example:
 - **Dual carriageways** necessitate two or more sets of linework to adequately represent the roadway geometry. As defined, and in order to meet ARNOLD requirements, utilize a dual-carriageway representation for divided roadways, ideally with independent mileage calibration.

²⁶ Applied Geographics, Inc., 2014

- **Traffic circles** should be represented in a way that matches their use. The smaller, local road traffic circles are best modeled in a simple way. Larger and more complex traffic circles may require a more detailed linework representation.
- **Defining ramps** can be a challenge due to their ambiguous nature. Define the start and end of the ramp as the taper from and to the mainline. Define deceleration and acceleration sections as LRS events.
- **Focus on interoperability when implementing LRS and LRM.** It is not advisable that State all-roads LRS efforts perpetuate the non-interoperable silos of the past.
 - One way to achieve improved interoperability is to have a smaller number of permissible LRMs.
 - Interoperability is key, in terms of both the LRMs and the software tools.
- **Current business rules are a key driver of LRS software.** LRS software choices within an agency are typically driven by existing practices and workflows.
 - Whenever possible, pursue software and technology choices that match the existing practices of the organization.
 - It can be easier to implement a new technology than to alter an established business practice within a large agency.
- When measuring mileage, **actual driven measures** that account for elevation and other variability in roadways are more accurate than calculated measures. Since mileage is certified for HPMS reporting purposes, this is an important consideration in terms of verification.

5 ONGOING DATA MAINTENANCE

As described above, statewide, all road networks are inherently complex to create and are vital to State DOTs for a wide variety of business purposes. This innate complexity carries over to the maintenance activity, especially since physical roads are in a constant state of change based on new construction and development. Thus, it is critically important that building the statewide, all roads network and LRS *not* be considered a one-time task. Rather, regular maintenance and updates need to be considered a fundamental part of an overall statewide, all roads data program.

5.1 WE'VE SPENT ALL THIS EFFORT BUILDING IT; HOW DO WE KEEP IT CURRENT?

There are at least three components to a statewide, all road network and LRS, and each of these may change; thus, some level of updating attention is required for each component, including:

- The baseline centerline geometry
- Route system topologies that may be derived from the segmented centerline
- Multiple LRS/LRM that are applied to the route system, and measured features derived from the LRS

And, there are four key considerations when planning for or developing a program for LRS maintenance:

1. Identify actions/activities that trigger a need for maintenance

First, *external events* emanating from the DOT or from other road-building authorities in the State may prompt a need for LRS maintenance. These events include:

- New road construction by the DOT or a local authority
- Construction that impacts alignment/roadway geometry
- Roadway name changes
- Other attribute changes (speed limit, number of lanes, etc.)

Second, *internal DOT events* may prompt LRS maintenance, including:

- Improved base map accuracy (e.g., through a new flyover that allows a more accurate representation of the linear geometry)
- Improved geometry (e.g., adding dual-carriageway representation)
- Routine error identification and corrections based on user reports

The external events typically involve "feature by feature" maintenance to make sure individual changes are represented in the network. The internal events may involve wholesale changes that impact the entire dataset or large pieces of it, such as improving the geometry for all divided highways.

2. Establish LRS maintenance best practices

It is strongly recommended that DOTs pursue an **enterprise approach** to their centerline and LRS data development and management. To the extent practical, DOTs are well served by moving to a single (or reduced number of) multi-purpose, enterprise road centerline and LRS. Indeed, it is in the maintenance process where the largest payoff to this approach is realized. If done properly, when roads change, that change will only need to be recorded once in the enterprise road dataset. Otherwise, that change would need to be repeated in each of multiple road centerlines and LRS.

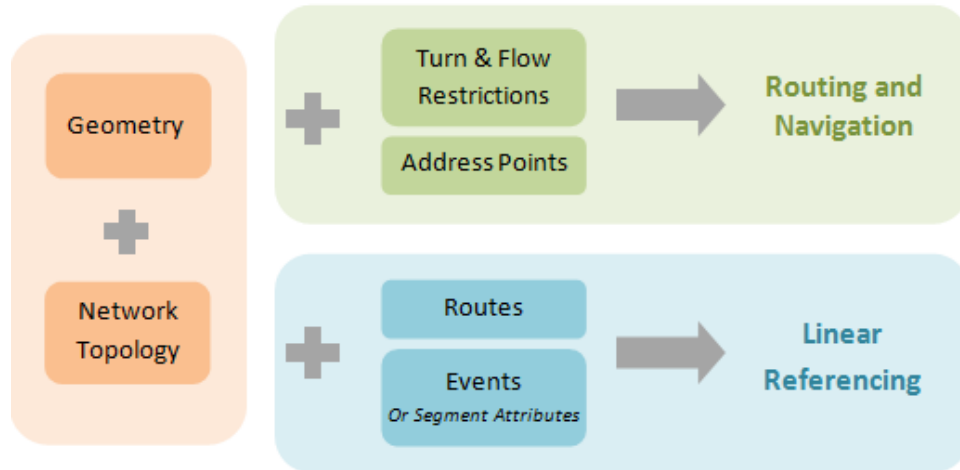

Figure 15: Enterprise LRS Maintenance (base geometry supporting multiple business cases)²⁷

As discussed in Section 4.1 of this document as well as in Sections B.1 and E.7 of the *Technical Appendices*, the ultimate goal is to maintain a single geometry that supports multiple business cases (i.e. navigation/routing, as well as DOT/LRS). As depicted in Figure 15, node and segment geometry are needed for the creation and maintenance of a roadway network (e.g., adding new routes or new alignments). This geometry, along with its network topology, can be combined with turn and flow restrictions and address points to satisfy routing and navigation use cases. Similarly, LRS routes can be derived from the same updated roadway geometry and network

²⁷ Applied Geographics, Inc., 2014

topology. These newly derived routes can satisfy linear referencing use cases when combined with point and line events along the LRS.

Under all maintenance scenarios, it is a best practice to record and maintain metadata that describes the origins and maintenance history of the road network. As described in Appendix D.1, it is optimal if **Metadata Standards** are followed. Best practices imply that all published/distributed datasets should include *standardized* metadata, ideally at both the layer level and the object level (e.g., individual road features within the dataset).

3. Emphasize collaboration with stakeholders and data suppliers

As described throughout this report, there are two key kinds of collaborators:

1. Collaborators who contribute data to the statewide, all roads network as part of the supply chain
2. End-users, both inside and outside of the DOT, that utilize the LRS but may not be directly involved in its development, management and update

It is critical for the first group of "supply chain collaborators," to continue to remain involved in the updating process as part of the supply chain, by providing data on the new and newly aligned roads within their jurisdiction. Achieving this goal will require clear communication and ongoing outreach for data exchanges.

For the second group of "business user collaborators," it needs to be recognized that many downstream users and business processes are dependent on LRS. Many types of changes to the LRS cascade down to them and may have unintended impacts (e.g., calculated measures may need to be re-calculated if alignments are changed). These kinds of relationships need to be well understood, and once again, regular and active communication to the user community must occur when updates are made.

4. Data distribution and change communication

As detailed in Appendix D.4, it is important to make data readily available to all users via web services, and to develop a consistent change communication mechanism. Ultimately, one of the major benefits of web services is that changes are automatically pushed to all users of the service. In other words, the end user does not need to do anything special to access the latest data. While it remains important to support a download capability, one shortcoming is that users *need to remember* to periodically download the latest data that reflects changes.

There are three important best practices for change communication:

1. Establish a readily accessible **change log** to allow users to review and understand the changes that have been made. Users who require download would review the change log to determine when downloading a new copy of the data is beneficial.
2. Establish a means to collect and track **change requests from users**. Ultimately, the regular users of the data are in the best position to detect errors or inaccuracies, and they should be encouraged to report what they find so that those issues can be addressed in future update cycles.
3. Proactively **notify users when changes occur** to enhance awareness.

5.2 MANAGING TEMPORALITY WITHIN THE LRS

Temporality involves notions of time. In the LRS context, this means storing information about roadway characteristics over time as part of the database. State DOTs routinely face questions about roads that involve a time element. Examples of these questions include the following:

- Where are all the accidents within this construction boundary that occurred during the construction period from June 2012 through October 2013?
- Where are the locations of all the accidents that occurred after the construction project was completed in February 2014?
- Where are all the *current* road closures and temporary detours? What roads were closed on December 15, 2012?
- What was the Annual Average Daily Traffic (AADT) for this route in 2010?
- What was the total statewide road mileage in 2012? In 2013?

Unlike Section 5.1, which describes techniques and activities for *managing change within the LRS itself*, such as data updates and accuracy improvements, *temporal LRS* involves techniques for tracking and archiving *changes within the physical road systems* as depicted by the centerline network and LRS. For example, roadways may be **planned**, **under construction**, **in use**, or **demolished** at different points in time. Routes may be **renamed**, **reclassified**, or **transferred** to other jurisdictions over time. Pavement and bridges may have different **condition indices** as they wear-down over time and are refurbished or replaced.

As such, it is key that the planning and development of a statewide, all road network consider how temporal changes can be stored and managed. The following kinds of DOT programs require temporal information:

- Travel demand forecasting
- Highway planning
- Asset tracking and management
- Construction project management
- Right-of-way (ROW) and property acquisition and disposal
- Crash reporting and safety analysis

When planning the LRS, it is important to design flexibility and scalability into the system so that complex data, such as temporally based information, can be added over time and as the LRS matures. As detailed in Appendix Section C.7, the most basic storage of temporal data can involve adding appropriate attribute tables and fields to the segment-based road network; such fields could include:

- Construction date
- Inspection date(s)
- Maintenance date(s)

As detailed in Appendix Sections D.2 and D.3, more advanced incarnations of temporal data storage include:

- Geometric features for **planned** (i.e., “paper streets”), **destroyed**, and **decommissioned roadways** in the statewide, all road network. These features should be readily identifiable through their attributes and could be either included or filtered out, depending on use.
- Development of a “**geoarchive**” of the road network and LRS that would enable users to go back in time to view the entire dataset as it existed previously. Typically, geoarchives are created by taking snapshots of the road geometry and associated LRS on a regular basis (monthly, quarterly, annually, etc.) and then storing and providing access to them. A comprehensive geoarchive over an extended period of time would enable the DOT to build an animation that shows the development and evolution of the entire road network.

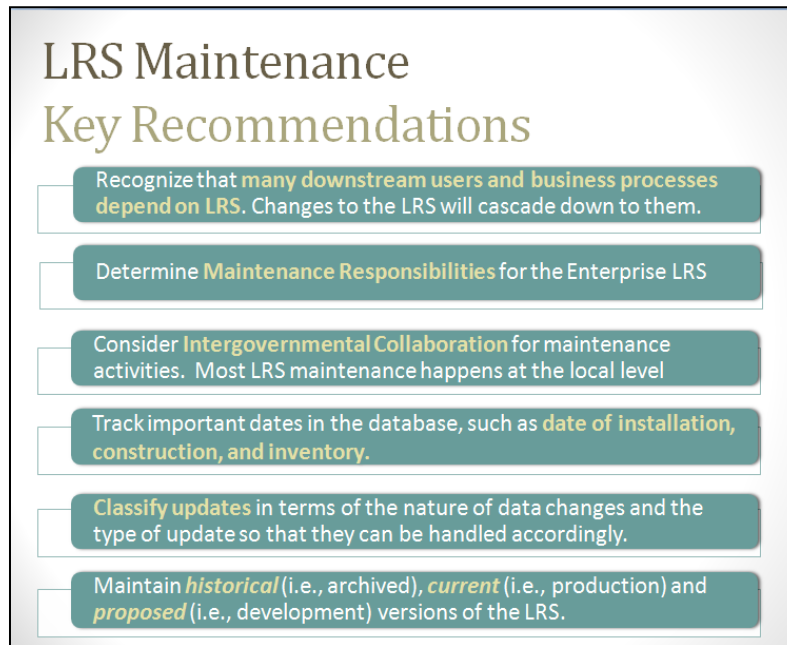

Figure 16: LRS Maintenance Key Recommendations²⁸

The recommendations below represent a synthesis and encapsulation of the LRS maintenance best practices gathered through research, interviews, and analysis.

- Recognize that **many downstream users and business processes depend on LRS**. Any changes to the LRS will cascade down to them and may have unintended effects. Understand these relationships during the design and development stage.
- Determine **maintenance responsibilities** internal to the enterprise. Often, although not always, enterprise LRS maintenance responsibilities are assigned to the group responsible for base mapping maintenance.
- Consider **data sharing and inter-governmental collaboration** on LRS maintenance activities. Although the road system changes every year, the workload for LRS maintenance is not uniform statewide.
 - Almost all LRS maintenance (new or realigned roads) is driven by changes to local roads and minor collectors in the system.

²⁸ Applied Geographics, Inc., 2014

- Since local roads are usually the exclusive responsibility of local governments and are not eligible for Federal aid (i.e., the DOT is not involved with their design or construction), inter-governmental data-sharing relationships may be the most efficient way to perform much of the required LRS maintenance.
- Track and maintain **key dates** at the individual asset level, including the date of installation (or construction) and the date of inventory.
 - The date of installation (or construction) is when the asset was built; this date may become less critical if the data maintenance strategy is a periodic full asset inventory, but it can be important for deterioration modeling and predicting asset lifespans.
 - The date of the inventory is the date of the field observation of the asset or object; when using manual feature extraction from collected roadway photos, the stored date should be the date of the photo capture.
- **Classify updates** in terms of the nature of the data changes (e.g., roadway changes or improving spatial accuracy) and the type of update (e.g., geometry or attributes), so that they can be handled accordingly. In some cases, field verification might be required.
- Maintain **historical** (i.e., archived), **current** (i.e., production) and **proposed** (i.e., development) versions of the LRS. The proposed alignments can go “live” – a real-time update – as soon as the road is open for traffic.
- Establish **procedures for geoarchiving** (i.e., storing snapshots of LRS data) and **geopublishing** (i.e., disseminating LRS data to support various business needs).

6 CONCLUSIONS AND THE PATH FORWARD

The *All-Roads Geospatial Data Representation Study* (the Study) was focused on the challenges faced by State DOTs to gather and integrate all roads data. The Study resulted in a set of individual technical reports and a final *Reference Manual* (this document) that provide guidance and best practices (not strict rules or formal standards) to State DOTs for implementing and maintaining an All Road Network of Linear Referenced Data (ARNOLD).

In terms of timing, the requirement for ARNOLD data submittals as part of the HPMS reporting process preceded the Study. Initial data submittals toward meeting this new requirement began in June 2014, before the ARNOLD Reference Manual was published. Thus, the guidance in this Reference Manual is relevant for the June 2015 HPMS submittal cycle.

While these submittals are for individual States, there is still the national challenge of creating an all-roads network for the nation from these data as the basis for the Transportation data theme for roads as part of the National Spatial Data Infrastructure (NSDI) – i.e., Transportation for the Nation (TFTN). The Study focused on the creation and maintenance of all-roads networks within a State, and not on the challenge of conflating the data from the 50 States and the Territories into a national network; therefore, work is still required in this regard.

Based on feedback from the Expert Panel assembled to provide advice during the Study, the following suggestions for “next steps” were made:

For States:

- Leverage the AASHTO²⁹ GIS-T Survey to self-assess, to determine progress toward meeting the ARNOLD findings and recommendations from the Study, such as:
 - What data collection type (i.e., supply-chain pattern) do you use, and who are your partners?
 - Have you sufficiently collected data for all roads, including local roads?
 - Have you built repeatable processes to update and maintain the statewide all-roads LRS?
 - Have you adequately addressed the technical challenges and requirements of ARNOLD?
 - Have you gone beyond the base requirements to build a robust and sustainable statewide LRS?

²⁹ American Association of State Highway and Transportation Officials

- Based on the State’s self-assessment, begin a planning process for long-term success, for example:
 - Understand what resources (e.g., funding sources), besides the technical guidance, are available to support all-roads implementation effort (e.g., Highway Safety Improvement Program funds)

For FHWA:

- Profile the June 2014 HPMS all-roads submittals to understand the data issues for moving forward with conflating multiple States into a national network
- Provide clear feedback to State DOTs on enhancing their data where needed
- Create a collaborative forum for State DOTs to share their experiences and ideas on ARNOLD implementation
 - For example, build a website where each State has a log-in and can share ideas, input “self-assessment” information, and connect with other States that fall into the same categories (collection pattern, maturity level, etc.).
 - Publish information on available resources (including funding sources) for ARNOLD implementation
- Analyze findings from the individual State DOT self-assessments on the ARNOLD requirements, and perform overall maturity assessments
- Publish aggregated information based on overall findings
- Tighten ARNOLD specifications where appropriate and needed
- Update the ARNOLD guidance based on “day forward” implementation discoveries

TECHNICAL APPENDICES

APPENDIX A	BASICS OF LRS.....	41
APPENDIX B	ROADWAY GEOMETRY	51
APPENDIX C	ROADWAY ATTRIBUTES	66
APPENDIX D	MAINTENANCE	77
APPENDIX E	CREATING AN INTEGRATED ALL-ROADS NETWORK.....	82

A.1 OVERVIEW OF LINEAR REFERENCING SYSTEMS (LRS)

Linear referencing is a method for storing and managing geospatial information along a linear feature, with positional location defined by a distance measure along that linear feature. LRS is most frequently implemented for roads and highways. In LRS, the locations of both data and events are determined according to their distance along a road from some known point (e.g., the beginning of the road, a mile marker, or an intersection). Linear reference measures can also be applied to other types of linear features, such as bus routes, railways, waterways, pipelines, or power lines.

LRS is crucial for managing the vast and varied data collected and maintained by a DOT. As stated by the AASHTO Technology Implementation Group (TIG), “The Linear Reference System (LRS) aligns the linear reference points in all databases so information from crash statistics, pavement management, and other business data can be accurately mapped and data more easily analyzed.”³⁰

The figures below depict first the base centerline geometry, segmented at intersections (see Section B.1 for more on this), and then this same geometry with LRS event data overlaid on it. In Figure A.2, pavement condition data and accident locations are stored as LRS events in tables (also shown), which are displayed on top of the base geometry.

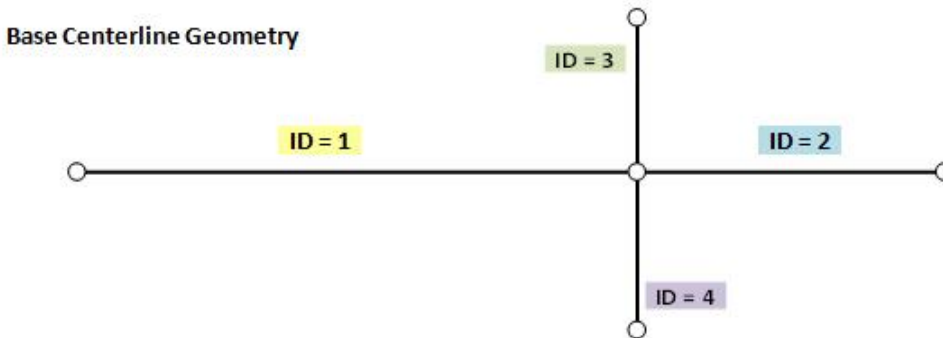

Figure A.1: Example of Base Centerline Geometry³¹

³⁰ See [AASHTO Innovation Initiative - Linear Referencing System](#)

³¹ Applied Geographics, Inc., 2014

Geometry with LRS Event Data (e.g. pavement condition and accident locations)

Pavement Condition

Good

Fair

Poor

Accident Locations

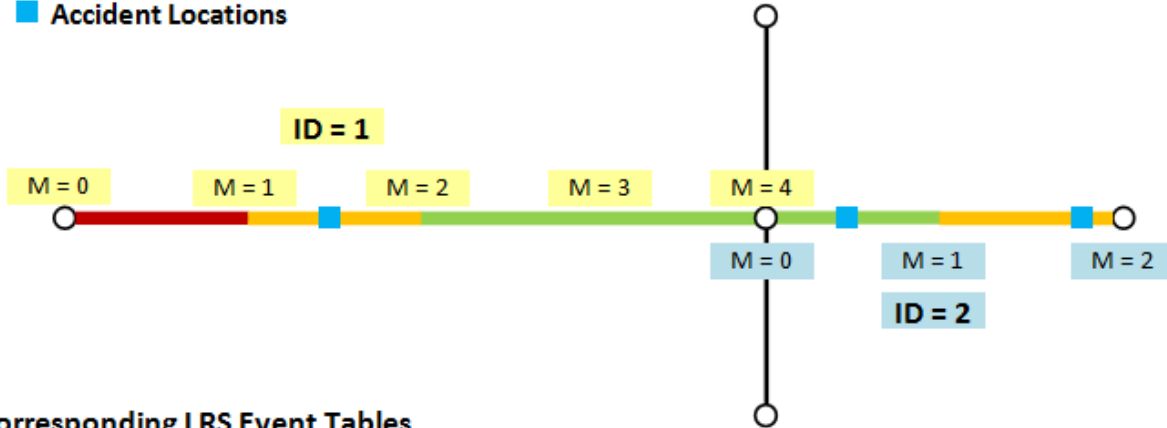

Corresponding LRS Event Tables

RouteID	Mileage_From	Mileage_To	Pavement Condition
1	0	1	Poor
1	1	2	Fair
1	2	4	Good
2	0	1	Good
2	1	2	Fair

RouteID	Accident_Mileage
1	1.5
2	.5
2	1.75

Figure A.2: Example of Base Geometry with LRS Events³²

³² Applied Geographics, Inc., 2014

A.2 LINEAR REFERENCING SYSTEM BUSINESS FUNCTIONS

Long before the widespread use of GIS technology, transportation organizations used linear referencing methods to measure distances, describe routes, and locate objects along transportation routes such as roadways, railways, and waterways. The approaches have been as diverse as using stationing and staking methods during the design and construction of new facilities, to using mile marker signage and straight line diagrams³³ (SLDs) as a framework for road inventory purposes. The large number of linear referencing methods that have been developed over time, such as those described above, are a good indicator of the ubiquity of LRS throughout the transportation industry, particularly in the DOT sector.

Although many classifying taxonomies for LRS use have been developed over time, the simplest and most prevalent can be derived from the commonly understood transportation system life cycle.

³³ Straight Line Diagrams (SLD) are linear depictions of roads and intersecting features (e.g., intersections, fixtures, structures) where the line does not include alignment geometry (i.e., curves). The distances between features may or may not be to scale. The route-based segments discussed in the text generally include scaled alignment geometry.

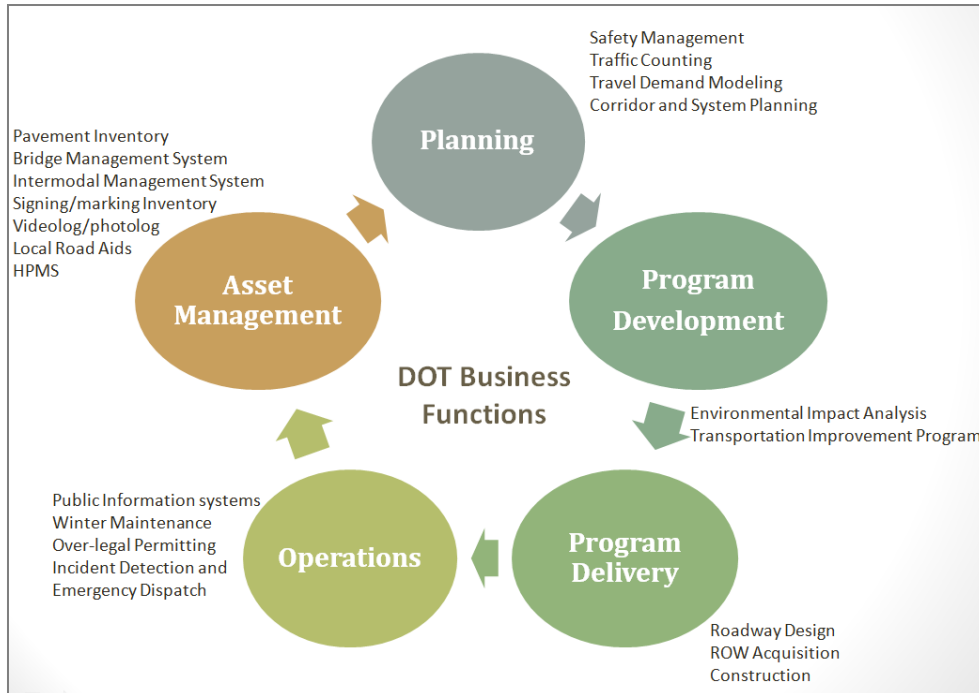

Figure A.3: Transportation System Life Cycle³⁴

Each of these major life-cycle functions is supported by multiple business processes, which use and/or share LRS. The following uses provide a sample of the wide variety and diversity of LRS used in State DOTs today. Several of these, such as crash reporting, bridge inventory, and HPMS, already embody the Federal all-roads requirements. Others, such as public information, over-legal permitting, incident detection, and dispatch systems, commonly encompass an all-roads perspective as well.

BUSINESS FUNCTIONS THAT UTILIZE LRS

Planning

- Safety Management, including crash location and reporting
- Traffic Counting
- Travel Demand Modeling
- Corridor and System Planning

³⁴ This diagram is based on several industry sources, including: Wisconsin DOT Enterprise Information Strategy Plan (1991); Utah (1995) and Idaho (2000) Information Architectures; AASHTO Pooled Study business process model (1993); and the National Cooperative Highway Research Program (NCHRP) 20-27 project.

Program Development

- Environmental Impact Analysis
- Transportation Improvement Program (TIP)

Program Delivery

- Surveys
- Roadway Design (CAD)

Operations

- Winter Maintenance
- Over-Legal Permitting
- Public Information (511) Systems
- Incident Detection and Emergency Dispatch

Asset Management

- Pavement Inventory, including pavement condition surveys
- Bridge Management Systems
- Intermodal Management Systems
- Local Road Aids
- HPMS and other Highway Inventory Systems
- Videolog/Photolog
- Signing/Marking Inventory

In addition to supporting these and other business functions, transportation organizations are using LRS (and related GIS-T³⁵ technology, such as dynamic segmentation) to support enterprise-level data management, data integration, and data fusion initiatives³⁶ – all of which make an all-roads LRS network more valuable.

³⁵ GIS-T is the term used coined by Fletcher and Lewis in a TRB workshop circa 1986 and adopted by the American Association of State Highway and Transportation Officials (AASHTO) circa 1987 to distinguish general-purpose Geographic Information Systems (GIS) from those devoted to Transportation (T).

³⁶ The term “data fusion” simply refers to the merger of different data, often from different sources, into a unified dataset, using a variety of methods, depending on the data.

A.3 TYPES OF LRMS

A Linear Reference Method³⁷ (LRM) defines a specific way in which locations are described (i.e., measured) along linear geographic features such as roads, railroads, and bus routes. While the features themselves do not need to be abstracted as linear geometry, an LRM must support measurements in a one-dimensional linear sense. Over time, the term LRM has come to refer to real-world measurements using various kinds of instruments (e.g., Electronic Distance Measuring, odometers, 5th-wheel sensors) and also refers to measurements taken along cartographic linear features (e.g., polylines, curves, and directed edges) using specialized geospatial software algorithms.

As documented by the International Organization for Standardization (ISO) Standard on Linear Referencing,³⁸ All LRMs can be characterized as belonging to one of three types: **absolute**, **relative**, and **interpolative**.

Absolute methods measure the total distance from the start of the segment to the event. Absolute methods include Mile Point and Project stationing where the start point is location 0.0 and the end value is equal to the total route or project distance.

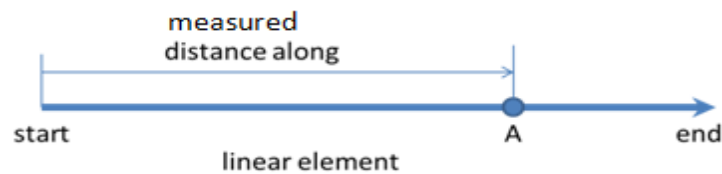

Figure A.4: Absolute LRM³⁹

Relative methods locate events according to their distance from a known reference location. Examples include Mile Post, Reference Post, and Feature-based (i.e., literal description, such as an intersection).

³⁷ The concepts embedded in Linear Reference Methods are not synonymous with Linear Reference Systems, and the terms are not synonymous with the much broader topic of Location Reference Systems. A Linear Reference System typically encompasses multiple methods, plus the office and field procedures necessary to establish, maintain, and use each method, and also includes the knowledge, skills, experience, and technology involved with linear referencing. Location Reference has a still larger scope, encompassing all location issues in all dimensions used within an agency.

³⁸ ISO 19148:2012 - Geographic information -- Linear referencing

³⁹ Adopted from a 2012 GIS-T presentation by Paul Scarponcini, "NCHRP 20-27 to ISO 19148: 18 Years of Progress in Linear Referencing."

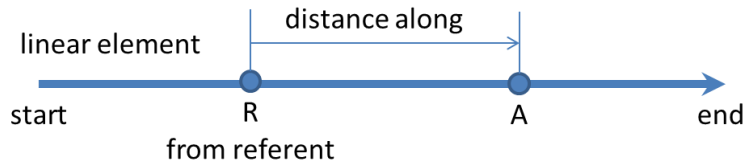

Figure A.5: Relative LRM⁴⁰

Interpolative (i.e., proportional) methods measure distance as a fraction of the entire section distance. Examples include Percentage, Normalized, and M Values.⁴¹

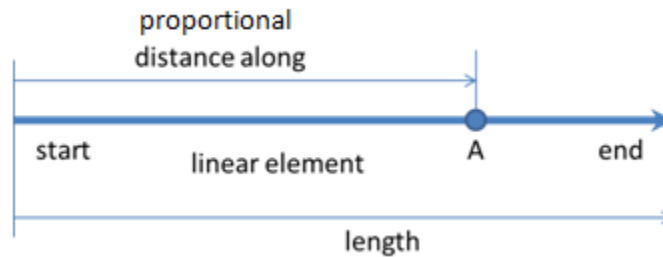

Figure A.6: Interpolative LRM⁴²

A.4 COMMON BASELINE NETWORK REQUIREMENTS & MATURITY ASSESSMENTS

From a DOT perspective, when aligning supplied data with business needs, the level of maturity can be assessed by evaluating the following components of local road data:

- Geometry (completeness, dual carriagemway representation, update cycle, scale, etc)
- Existence of basic attributes
- Existence/type of address information

⁴⁰ Adopted from a 2012 GIS-T presentation by Paul Scarponcini, “NCHRP 20-27 to ISO 19148: 18 Years of Progress in Linear Referencing.”

⁴¹ M values (or local interpolative methods) are a way of moving between map (i.e., page) distances and scale (i.e., real world) distances by interpolating linear measures in either map units or page units along a single polyline. Note that because the scale factor for each polyline may be different, this method is considered a local interpolation.

⁴² Adopted from a 2012 GIS-T presentation by Paul Scarponcini, “NCHRP 20-27 to ISO 19148: 18 Years of Progress in Linear Referencing.”

- LRS accuracy/precision
- Network/linear topology

Figure A.7 details the baseline network requirements used to assess level of maturity. These baseline requirements were derived from the FHWA network specification guidance, with some additions and modifications based on the current recommended best practices. For example, the project team is recommending that the baseline scale requirement be changed from 1:24,000 to 1:5,000 which is in line with the linear precision and accuracy recommendation of 0.001 miles. Moreover, the degree of cartographic generalization that occurs at 1:24,000-scale mapping makes dual-carriageway discrimination problematic and obscures other roadside features.

Road Centerline Geometry	Basic Road Centerline Attributes	Address Ranges	LRS Control	Network/ Linear Topology
All public and private highways, roads and streets	Persistent road ID number	Right side/left side address ranges	Linear precision: 0.001 miles	Common topology for road network models (e.g. spatial analysis, routing)
Dual carriageway representation	Road/street name	Urban and rural addresses used for E911	Centerline Mileage Begin/ End accuracy: 0.001 miles	
Updated/certified annually	Functional Class			
1:5,000 scale	Year			
WGS 84 Coordinates	State			

Figure A.7: Common Baseline Network Requirements⁴³

MATURITY ASSESSMENTS

Common baseline network requirements can be characterized in one of three ways:

- **Needs investment to meet common baseline network requirements** – Local road network is incomplete and will require additional effort before submission to the State DOT
- **Satisfies common baseline network requirements** – Local road network substantially meets the minimal requirements established for the ARNOLD/HPMS national network

⁴³ Applied Geographics, Inc., 2014. Regarding Addresses, address points are preferred when available.

- **Exceeds common baseline network requirements** – Local road network meets all of the minimal requirements for the ARNOLD/HPMS national network plus contains value-added features supporting State-level business processes (e.g., address ranges)

Using the common baseline network requirements, the table below summarizes how different road data components can be classified by their maturity and ability to meet these requirements.

	Needs Investment to meet common baseline network requirements	Satisfies common baseline network requirements	Exceeds common baseline network requirements
Road Centerline Geometry			
Data Inclusion	Some or all local roads, including alleys, NOT included Some or all private roads NOT included Some or all ramps, roundabouts, frontage roads or other highway geometry NOT included	All public and private highways, roads and streets, including ramps and frontage roads	All public and private highways, roads and streets, including ramps and frontage roads + Includes temporary, emergency, construction and/or evacuation roads + Contains historical and future alignments
Dual Carriageway	Single-carriageway representation	Dual-carriageway representation where positive barrier median or median width > 4'	Dual-carriageway representation where positive barrier median or median width > 4'
Scale	Scale smaller than 1:5,000	1:5,000 scale	Scale larger than 1:5,000
Update Cycle	> 1 year	Updated/certified annually	Updated more frequently than annually
Coordinate System		WGS 84	WGS 84
Road Attributes			
Basic	One or more basic road attributes missing	All basic road attribute values exist: <ul style="list-style-type: none"> • Persistent road ID number • Road/street name • Functional class • Year • State 	All basic road attribute values exist + HPMS Section data

	Needs investment to meet common baseline network requirements	Satisfies common baseline network requirements	Exceeds common baseline network requirements
Advanced	No baseline network requirements for advanced road attributes have been established Examples Include: <ul style="list-style-type: none"> • Active vs. Planned; Public or Private; Improved vs. Unimproved • X-section, pavement surface, signing & marking, traffic characteristics • Certified mileage • Political, administrative or census geographies 		
Street addresses⁴⁴			
Right/Left Address ranges	No right side/left side address ranges	Right side/left side address ranges	Right side/left side address ranges
E911	No rural addresses for E911	Urban and rural addresses used for E911	Urban and rural addresses used for E911
Site Address	N/A	N/A	Address points (i.e., actual property locations)
Linear reference control			
Linear precision	> 0.001 mile (e.g., 0.01 mile)	0.001 mile	< 0.001 mile
End-end centerline mileage accuracy	unknown or > 0.001 mile	0.001 mile	< 0.001 mile
Network/Linear Topology			
Topology	Simple segments with no topology	Common topology for road network models (e.g., spatial analysis, buffering)	Local road networks with enhanced network/linear topology for modeling features such as grade separations (i.e., over/underpasses), tunnels, ferry routes, one-way traffic flow, turn restrictions.

⁴⁴ Most often, addresses are expressed as an "address range" (lowest address number to highest address number) for each roadway segment. This allows any distinct address to be interpolated to a specific location along the street. However, due to the inherent uncertainty of interpolation and the fact that addresses are often not evenly distributed along a roadway -- particularly for longer, rural roads -- the interpolated location may not accurately match the true location. This can adversely impact the routing of emergency vehicles to the correct address location during dispatching. Due to these challenges, it is increasingly common for addresses to be mapped as discrete address *points* for each location. When an address point dataset is used as a reference, the addresses of facilities such as hospitals, daycare centers, police and fire stations, etc. can be matched precisely to these discrete, accurate point locations, thereby facilitating routing and improving response time.

B.1 ROADWAY SEGMENTATION

Roadway segmentation (i.e., depicting the physical start, end, and length of each roadway segment) can be accommodated by one or more methods: 1) intersection-based (segmented); or 2) route-based. Ideally, the chosen solution would combine the two methods to meet multiple business needs.

It is important to select and maintain a consistent approach that aligns with the internal business systems of the DOT, as well as with those of external systems that rely on the transportation data. However, it also must be acknowledged that there are many different uses of centerline data, with various business drivers for both segmented and route-based networks (e.g., emergency response and roadway inventory, respectively). Thus, multiple sets of centerline geometry (often at different map scales) are frequently created and maintained to meet various business needs defined by State DOTs. In order to achieve optimal benefits from the LRS, a shared enterprise approach should be considered such that the same solution can be used to support several business needs. For example, the production data maintenance network might be intersection based, where nodes are located at at-grade intersections and ramps (to support segment-level attributes such as address ranges, and to support routing and turn restrictions); and then a derivative product or export from this could be a route-based network to support DOT needs.

Implement an enterprise approach allowing multiple business needs to be met. For example, maintain the intersection-based network, and regularly generate the route-based network from it.

INTERSECTION-BASED SEGMENTATION

Intersection-based or variable-length segmentation approaches are defined by segment endpoints occurring at geometric or physical intersections (i.e. “transportation opportunities”) of two or more road centerlines. Routes are defined by associating segments in a logical from/to node order (see Figure B.1). The main advantage of using a segmented network is that updates to segment geometry are local and limited in their cascading effects. Additionally, intersection-based networks can support details such as one-way streets and turn restrictions at intersections- both of which are critical in terms of vehicle routing and emergency response. A disadvantage of this structure is that segmented networks can become very large and challenging to maintain at the statewide level, especially if one or more LRMs are defined for the network.

Intersection-based networks should be used when details such as one-way streets and turn restrictions at intersections are needed.

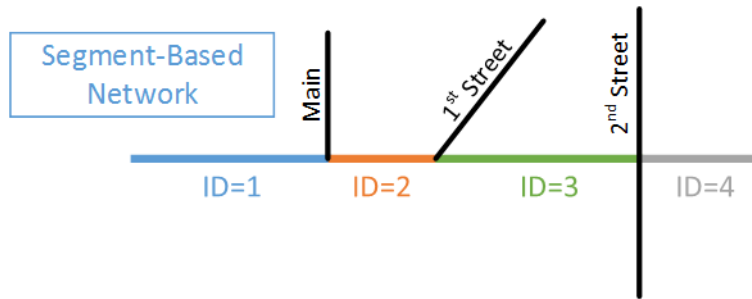

Figure B.1: Segment-Based Network⁴⁵

ROUTE-BASED SEGMENTATION

A common alternative to variable-length segments is to create long polylines representing entire route lengths and indexing various point locations along this line using one or more linear reference methods (see Figure B.1). This approach is adopted from the Straight Line Diagram⁴⁶ (SLD) highway inventory methods used by many DOTs. The advantage of using a route-based network is that it usually aligns with legacy statewide systems and requires far fewer roadway segments in the GIS system to manage. Disadvantages include increased complexity with routing, address ranging, and requiring a well-defined LRM to assign roadway attributes. This approach also requires the underlying database or application software to support some kind of “dynamic segmentation” functionality.

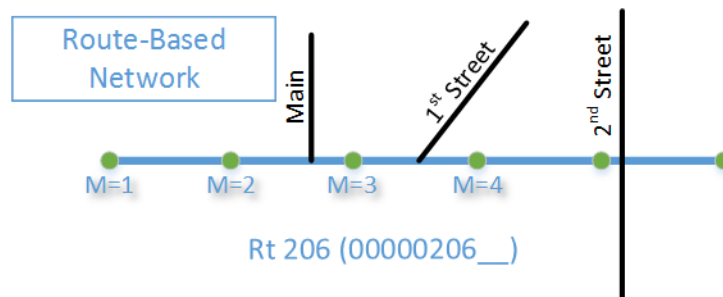

Figure B.2: Route-Based Network⁴⁷

⁴⁵ Michael Baker Jr., Inc., 2014

⁴⁶ Straight Line Diagrams (SLD) are linear depictions of roads and intersecting features (e.g., intersections, fixtures, structures) where the line does not include alignment geometry (i.e., curves). The distances between features may or may not be to scale. The route-based segments discussed in the text generally include scaled alignment geometry.

⁴⁷ Michael Baker Jr., Inc., 2014

A COMBINED ENTERPRISE APPROACH

Recognizing that each alternative has strengths and weaknesses relative to certain business needs, many States have implemented a solution that includes both types. For production data maintenance needs, a segmented centerline model is often used for flexibility, incorporating roadway aliasing, shielding, and multiple Linear Route Measures. Understanding that this large and complex model may not work for many supported agencies and systems, data collaborators can then develop workflows that export the GIS network into different formats (e.g., route-based) using Extract, Transform, and Load (ETL) processes. Using this dual approach for flexible reporting, the needs of various end-users can be met. For example, if the DOT gets a route-based network, and Emergency Response gets a segment-based network for NG911, and the State GIS office gets a network to support the need for cartographically accurate labels – all derived from the same fundamental road geometry – then all use case business needs can be met.⁴⁸

B.2 DUAL CARRIAGEWAYS

Dual Carriageways for a roadway typically involve a physically divided roadway that necessitates two or more lines to adequately model the road when it has become too complex to be represented by a single line. The multi-line representation can also help meet more rigorous business needs and application requirements for real-world fidelity. Increasingly, States are collecting road characteristics on both sides of a divided highway, which is another consideration. A multi-centerline representation of the roadway provides high accuracy in representing the actual roadway elements, but requires additional complexity in processing and managing the roadway data. Figure B.3 depicts the necessity for dual carriageway to accurately reflect the road geometry.

As defined, and to meet ARNOLD requirements, utilize a dual-carriageway representation for divided roadways, ideally with independent mileage calibration.

⁴⁸ For an example on how this has been implemented in New Jersey, please see the New Jersey Geographic Information Network https://njin.state.nj.us/NJ_NJGINExplorer/jviewer.jsp?pg=ROADS

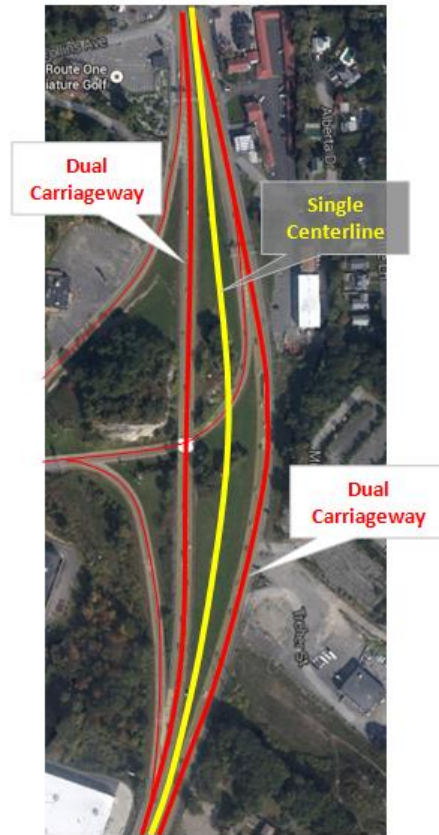

Figure B.3: Single-Centerline vs. Dual-Carriageway representation⁴⁹

DUAL CARRIAGEWAY MILEAGE CALIBRATION

Keeping in mind that roads represented by dual carriageways are still technically the same road, defining LRMs on dual-carriageway centerlines can be done in different ways. The simplest option is to assign the same linear measure to both roadways using the “primary” measure on both roadways. When the lengths of the two roadways are equal (or nearly so), this simple approach may be adequate. However,

For dual carriageways, maintain a separate and independent mileage for each segment, while providing a mileage conversion factor.

in many cases, the differences between the primary and secondary roadway’s geometry result in significant differences in the lengths of the segments. In this case, the preferred method is to maintain a separate and independent linear reference for each segment (see Figure B.4). This allows for the use of true measured mileage when performing roadway

⁴⁹ Michael Baker Jr., Inc., 2014

inventory, which is preferred. Be aware that a potential disadvantage of this approach occurs when using small display or print scales. Distinguishing between the primary and secondary roadways can be visually confusing.

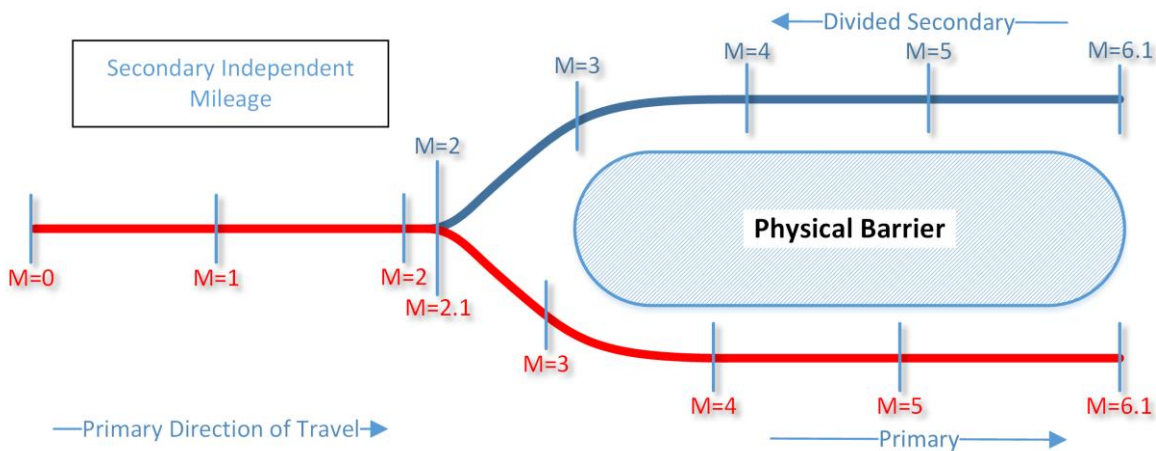

Figure B.4: Secondary Independent Mileage⁵⁰

There are different options for handling measures on the non-cardinal (“secondary”) side of the roadway (i.e., the blue line in Figure B.4). As shown, measures can be assigned in the same direction as the cardinal side, using a similar (but separate) measure structure. Under this scenario, mile point values increase in the direction of travel on primary roadways and decrease in the direction of travel on the secondary side. This approach is used by all Interstate mile posts, and allows for tracking true mileage on both sides of a dual carriageway, but with similar measures on both sides. Alternatively, measures can be assigned in the direction of travel on the non-cardinal side, such that they would run opposite to those of the cardinal side. This approach can help to simplify field inventory (e.g., using a Distance Measuring Instrument, or DMI).

Ultimately, because most dual-roadway routes are on the Federal-Aid System, they will already be included in a State's LRS, and the best approach would be for States to extend whatever business rule that is in place for handling the non-cardinal measures on the Federal-Aid routes to any local dual-carriageway roadways, in order to have a consistent, enterprise approach across the State. As described below, mileage transformations can be used to convert secondary roadway "as-driven" mileages to official mile points in either real-time or post-processing transactions.

⁵⁰ Michael Baker Jr., Inc., 2014.

In many cases, roadway attributes are referenced to the primary (or cardinal) direction of travel for a roadway. As such, it is advisable to create and maintain a mileage conversion process, for translation to and from the LRMs. For this situation, translation from the primary (or cardinal) direction mileage to the secondary (or non-cardinal) direction mileage can be performed as needed. See Figure B.5 for details on the provisions required for the LRM conversion.

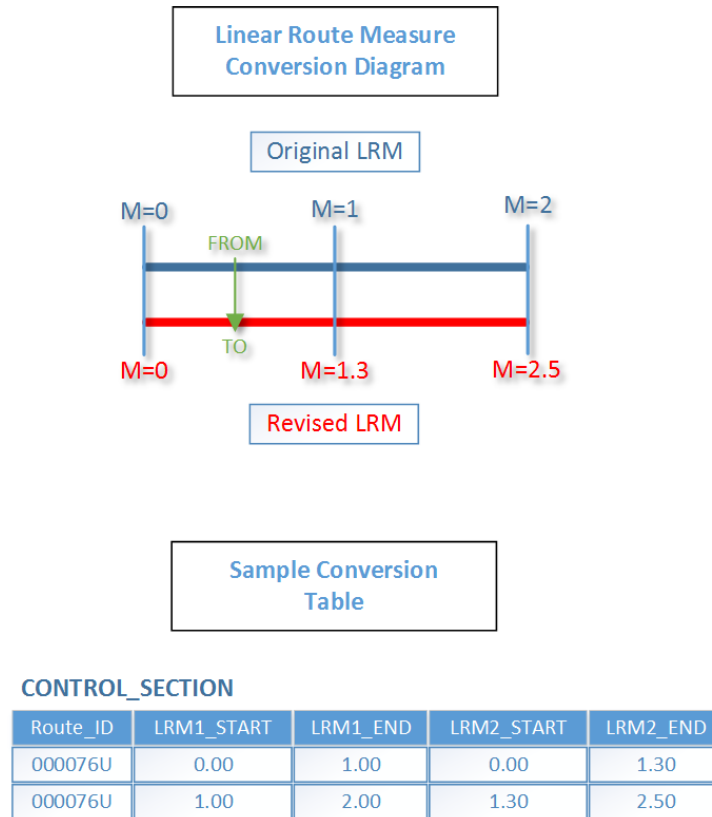

Figure B.5: LRM Conversion Diagram⁵¹

DETERMINING WHEN TO REPRESENT A ROADWAY AS DUAL CARRIAGEWAY

When digitizing a roadway into appropriate carriageways (divided, undivided, express/local lanes, etc.) the challenge is determining when it is most appropriate to model a roadway as divided or undivided. Within the HPMS guidelines, FHWA defines a divided roadway as “A multi-lane facility with a curbed or positive barrier median or a median that is 1.2 meters (4 feet) or

FHWA defines a divided facility as having a median with a positive barrier or a width of 4 feet or greater.

⁵¹ Michael Baker Jr., Inc., 2014

wider.” However, the State DOT may have other business needs (e.g., safety, NG 911, bridge inventory) for representing facilities as dual carriageway differently than the HPMS guidance; the DOT should take into account the predominant function of the roadway.

Situations with complex roadway geometry or areas that may require a more simplified model may warrant alternative models beyond the basic HPMS guidance. For example, a roadway island barrier to delineate left turn lanes for an intersection may not truly require the added complexity of a dual carriageway (see Figure B.6⁵²). Conversely, a roadway model strictly following HPMS guidance should include



Figure B.6: Roadway Island Barrier

separate carriageways for roadways with center striping. However, doing so would imply a discontinuity between each travel-way, and would not accurately depict the ability to cross over to the opposite direction of travel, particularly for emergency vehicle purposes). Ultimately, **defining the overall goal of the roadway data model and predominant function of the section of roadway can help determine the most appropriate dual carriageway solution.** If the goal is to create a topologically detailed and accurate representation of the roadway, regardless of the additional complexities this would introduce, then modeling divided roadways that strictly adhere to the guidelines may make the most sense. In many cases, though, it is recommended that States define a balance between an overly complex model and an overly simplified model. For example, implement a guideline that defines a divided roadway as a continuous 500-foot divided physical barrier or median (greater than 4 feet). This guidance also excludes a physical barrier that exists only for turning channelization. This definition provides a good balance between overly simplified and overly complex models.

*Model a roadway as dual carriageway when there is a divided physical barrier or median greater than 4 feet that **continues for at least 500 feet.***

⁵² Image from <http://nacto.org/usdg/neighborhood-main-street/>

SPECIALIZED LANES

Specialized travel lanes, such as reversible lanes, HOV lanes, express lanes, through lanes, etc., can also be a complicating factor when it comes to dual-carriageway representation. These types of lanes are best handled tabularly, as LRS events.

Store specialized lanes (HOV lanes, reversible lanes, express lanes) as LRS events.



Figure B.7: HOV Lane⁵³

B.3 TRAFFIC CIRCLES

Traffic circles (also known as rotaries and roundabouts)⁵⁴ have proven to be a GIS challenge for transportation agencies. Traffic circles are the intersection of two or more roadways in an uncontrolled at-grade interchange, intended to keep traffic moving through the intersection. Defining this in GIS terms and meeting the requirements of the LRS becomes much more challenging, and smaller traffic circles might best be modeled differently than larger, more complex traffic circles. For small traffic circles, even if the map geometry is generalized, the measured travel distance can be as driven. For large traffic circles, involving higher-order roadways, the fundamental modeling debate becomes centered on how to minimize roadway segmentation, while also minimizing segment overlap.

Model each traffic circle on a case-by-case basis, with the goal of minimizing segment overlap and route segmentation.

Due to the complex nature of how traffic circles interweave different roadways, there are alternative ways of handling various situations, rather than a single “one size fits all” solution. Depending on the individual needs of the system, options for modeling traffic circles include case-by-case segment merging or more simplified configurations.

⁵³ Image from <http://transportationblog.dallasnews.com/2012/09/as-officials-mull-hov-lane-changes-north-texas-toll-filled-future-comes-into-focus.html/>

⁵⁴ The difference between roundabouts and traffic circles is recognized in terms of traffic flow and safety concerns. However, from an LRS modeling perspective, they are handled in a similar fashion.

CASE-BY-CASE SEGMENT MERGING

Since many traffic circles are not perfectly symmetrical in design, each circle can be modeled on a case-by-case basis, with the goals of minimizing segment overlap and route segmentation, minimizing breaks for the highest order route entering/exiting the circle, and defining ramps where needed. Figure B.8 shows an example of this type of complex ramp configuration.

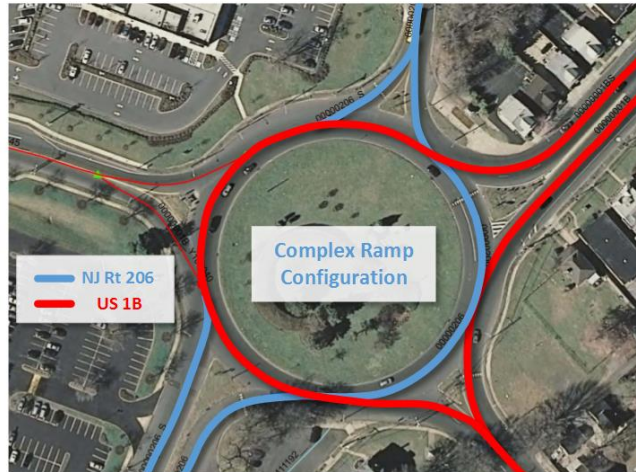

Figure B.8: Complex Traffic Circle Ramp Configuration⁵⁵

Additionally, larger circles can be configured as concurrent routes, where the overlapping roadways share centerline geometry. In these cases, the lower-order route would show a gap in mileage where coincident with the higher-order roadway. Figure B.9 provides an example of this alignment:

⁵⁵ Michael Baker Jr., Inc., 2014

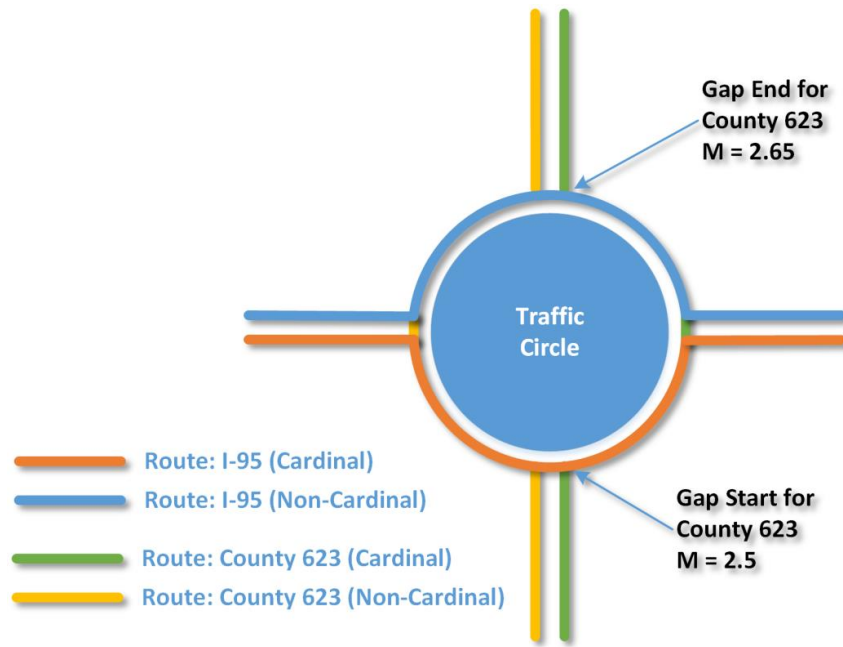

Figure B.9: Coincident Roadway Circle Configuration⁵⁶

SIMPLIFIED TRAFFIC CIRCLE CONFIGURATION

Some States have chosen non-traditional methods for representing smaller traffic circles. For example, New Hampshire treats the circle as its own route, separate from the other participating routes. The other routes show a segment break, but do not have a mileage gap in their LRM. See Figure B.10 for an example of this method.

⁵⁶ Michael Baker Jr., Inc., 2014. In this diagram, the small connecting pieces of Route 623 on either side of the circle would best be modeled as connector ramps between the two divided I-95 segments. This approach would minimize segmentation on the broken route (in this case, 623).

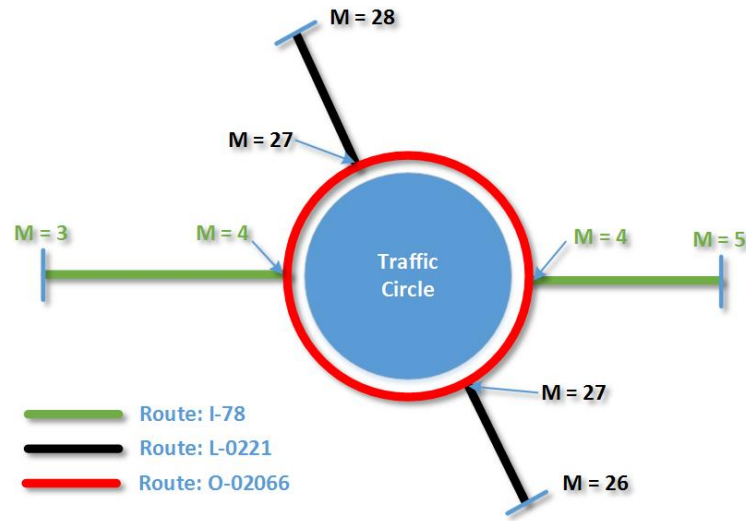

Figure B.10: Simple Traffic Circle Configuration⁵⁷

B.4 RAMPS

Ramps can be defined as connecting roadways that permit traffic to flow from one mainline highway to another without crossing any other traffic stream⁵⁸. The interchanges that use ramps may be grade-separated (i.e., elevated) or at-grade (i.e., same elevation)⁵⁹. At-grade intersections can have a physical barrier to separate the turn lane from the mainline. Depending on the ramp length, these can be considered ramps. Ramps are generally not assigned mainline road names or address ranges, and they typically have a single direction of travel. Defining ramp start and end locations poses a special challenge to transportation GIS networks. When building a GIS network, ramps typically start and end at the point that the ramp tapers from (or to) the mainline route (see Figure B.11).

Define the start and end of the ramp as the taper from and to the mainline. Define deceleration and acceleration sections as LRS events.

⁵⁷ Michael Baker Jr., Inc., 2014

⁵⁸ Features such as “jug handles” are also handled as ramps within the network.

⁵⁹ HPMS only requires that the ramp participates in a grade-separated interchange. However, this discussion of ramps covers general guidance and best practices for both types of ramps, regardless of HPMS requirements.



Figure B.11: Ramp Alignment Diagram⁶⁰

To further clarify the physical sections of a ramp (e.g., if needed for inventory and field work), the deceleration and acceleration lanes should be defined through LRS events on the roadway. The deceleration area of the ramp is between the mainline taper and the start of a physical barrier when entering the ramp. The acceleration area of the ramp is between the end of the physical barrier and the mainline taper when exiting the ramp. See Figure B.12 for details. The ramp mileage would start and end at the mainline taper locations.

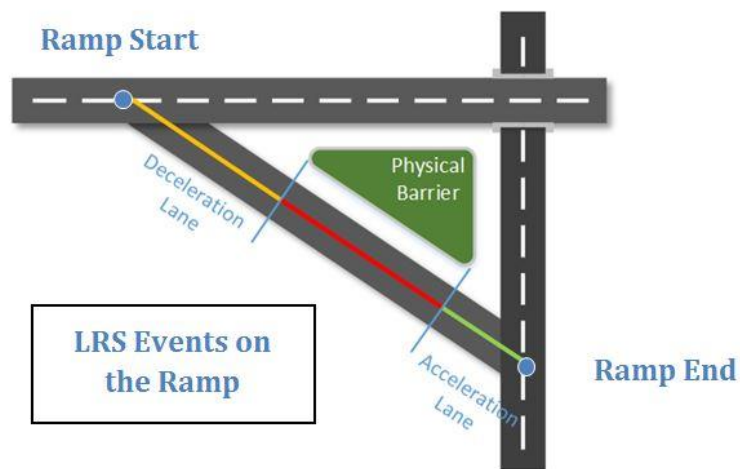

Figure B.12: LRS Events on the Ramp Segment⁶¹

⁶⁰ Michael Baker Jr., Inc., 2014

⁶¹ Michael Baker Jr., Inc., 2014

Additionally, it is recommended that DOTs determine a minimum ramp length for modeling ramps within their roadway network. Without a defined standard on when to create a ramp features (and when not to), a statewide network can become overly complex, with many small and relatively insignificant segments. It is recommended that small connecting ramps of less than 25 feet (excluding deceleration and acceleration sections) do not need to be modeled in the network. These situations can instead be modeled as simple intersections.

Minimum ramp length recommendation: 25 feet

B.5 CUL-DE-SACS AND LOOPS

As State DOTs begin to incorporate local road data into their network, they will likely encounter certain roadway features that do not occur at the State level. Some prime examples of these are *Cul-de-sacs* and *loops*. Cul-de-sacs and loops are generally described as highway segments where one continuous arc starts and ends at the same coordinate (see Figure B.13 for examples). In terms of LRS, having the same start and end point can create issues (e.g., with topology, measures, and mileage calibration) in certain vendor products. As these features are incorporated into a statewide all-roads network, the DOT will need to establish standards of handling them to ensure consistency and data quality. A key aspect of this issue depends on how COTS software products handle these types of situations, and DOTs should understand the limitations of any particular vendor software as they develop standards.

These roadway elements often have the same start/end point, which can be problematic for LRS. The DOT will need to establish standards for handling them consistently in the statewide network, taking into account any software limitations.

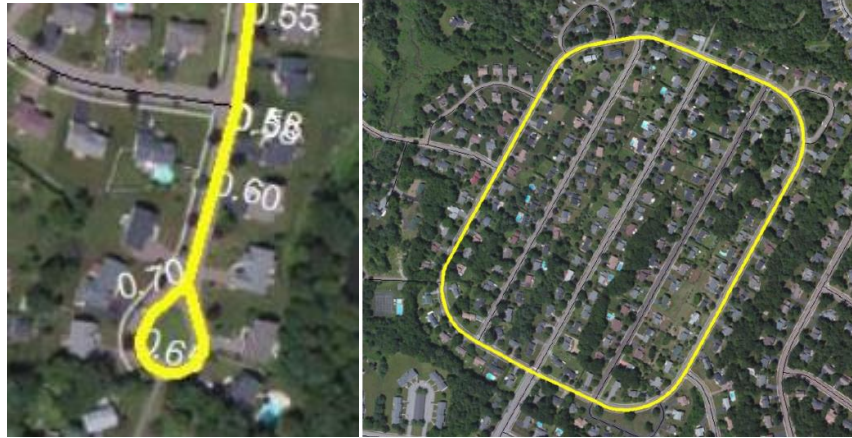

Figure B.13: Cul-de-sacs and Loops⁶²

For certain looped roads (like the one shown in Figure B.13 on the right), the start/end point issue may be unavoidable. However, cul-de-sacs can be modeled in a number of ways, depending on their nature and the specific needs of the agency. A cul-de-sac without an island can terminate straight through to the edge of the pavement, or terminate in the middle of the pavement. Cul-de-sacs with a physical island may include a “lollipop” end (as is shown in Figure B.13 on the left). While “lollipop” ends may be the cartographic preference, they are not recommended for use in LRS because self-connecting segments can cause complications with topology checks, mileage calibration, and physical inventory. Some DOTs have chosen to draw the “lollipop” for aesthetic purposes, but not connect it to the segment (i.e., stop the loop 1 foot before it self-intersects). However, this approach can cause issues with connectivity and network topology, which can inhibit routing and network analysis (see Appendix Section E.6 for further detail). An alternative to the “lollipop” end is to create a separate loop segment around the physical island, which will accommodate applications or uses that can’t handle the self-intersecting segments. If address ranges are being stored, the circle can be made up of two segments, one for each side (as seen in the lower diagram in Figure B.14). Ultimately, the agency will need to determine the appropriate representation to match its specific needs, taking into account any software or application limitations.

The State of Tennessee’s TIPS GIS Modeling Specifications document⁶³ contains some additional useful guidance about modeling cul-de-sacs. Figure B.14 summarizes its recommendations, and distinguishes between cul-de-sacs with and without a physical island.

⁶² VTrans Mapping Unit, 2014

⁶³ [TIPS GIS Modeling Specifications, State of Tennessee, Next Generation 9-1-1](#)

Cul-de-sac without island:

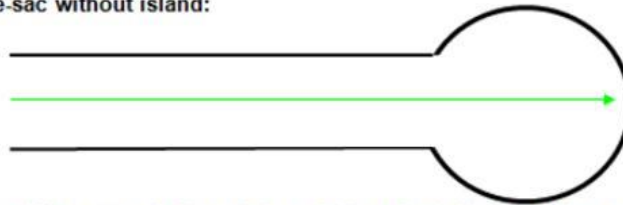

This should be represented by a single centerline extended to edge of pavement. There is no physical barrier to impede access.

Cul-de-sac with island:

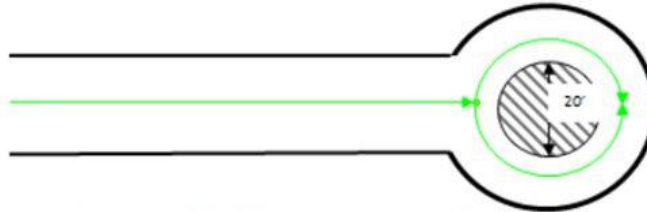

Circle centerline should be centered between edge of pavement and island (20' or wider). Centerline should be broken at the end of cul-de-sac for address range placement.

Figure B.14: Cul-de-sac guidance from the State of Tennessee⁶⁴

⁶⁴ [TIPS GIS Modeling Specifications, State of Tennessee, Next Generation 9-1-1](#)

C.1 ROUTE EVENTS VS. SEGMENTED ATTRIBUTES

When developing a roadway GIS network, creating the network data schema (i.e., how attributes are stored) can be a complex and involved task. One of the most important decisions that must be made early in the design is whether roadway attributes will be related to the segments as route events, or stored within the roadway segments. Route events are related to the segments through Linear Referencing, allowing the flexibility to change extents without changing route segmentation. Segment attributes are related directly to the GIS centerline segment database record. Figure C.1 depicts the distinction between roadway events and segment attributes.

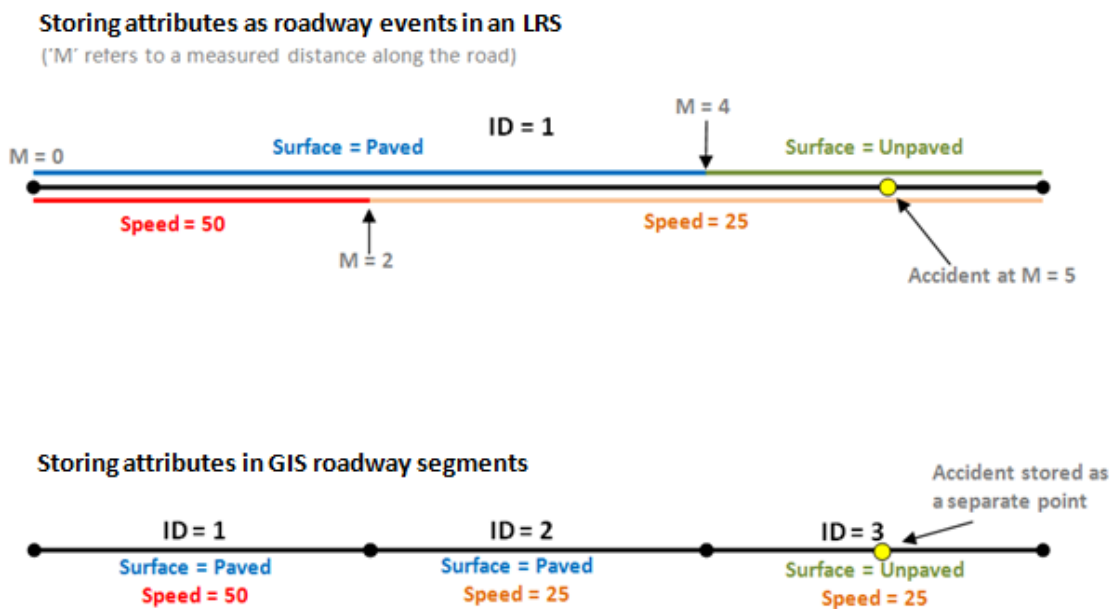

Figure C.1: Storing attributes as Roadway Events vs. Segments⁶⁵

Below is a brief description of each option, and some basic considerations.

Route Events are stored as separate roadway data, referenced to the road segments through Linear Referencing. Any changes that affect the segment’s LRM would also need to be evaluated and changed in the route event tables. **Route events require additional considerations and necessitate well-established, defined, and standardized Linear Reference Systems (LRS).**

⁶⁵ Applied Geographics, Inc., 2014

In **Segment Attribution**, roadway attributes are stored at the segment level of the database model. This means that changes to these attributes would require additional roadway segmentation, which would in turn increase the centerline data maintenance. As more attributes are included in the roadway network, more line-work segmentation and maintenance would be required.

Store a minimum set of “base” attributes on the segment, and everything else as route events within the LRS.

When deciding how to store attributes within a roadway network, and how many to store, the DOT should choose a minimum set of “base” attributes to store within the segment, and then store everything else as route events in the LRS. At a minimum, the base attributes should include the route ID, beginning and end mileage, and data source for the segment.

The DOT may also choose to store other key attributes in the segments, such as route number, road name, facility type, functional classification, ownership, etc. These “base” attributes should be determined in collaboration with key stakeholders (both inside and outside the DOT, such as emergency response), and take into account the ARNOLD schema (see next section). However, the goal should be to minimize the overall number of “base” segment attributes and store the majority of the roadway information (number of lanes, pavement condition, speed limit, etc.) as events. Automated routines can then be created to export and publish centerline datasets that meet the needs of non-LRS users, such as a GIS layer with speed limit information stored within the segments. Storing fewer attributes also results in less costly data collection and maintenance.

Additionally, as DOTs are collecting much of the ARNOLD data from local agencies, the format of the local data will need to be taken into consideration. Local transportation centerline data is typically segment-based and stores attributes directly within the segments. Local streets and roads are, in many cases, non-continuous and non-contiguous, which makes route-based schemes quite complicated. Moreover, routes are often concurrent or coincident, adding to the complexity of route-based approaches. Thus, it is anticipated that most local attributes will be stored within segments, and the DOT will need to accommodate this when creating the ARNOLD dataset. Either way, attributes should be evaluated to determine whether they are more suitable for route-event storage or segment storage.

Local roadway attributes are often stored within the segments; DOTs should keep this in mind when integrating local data into an ARNOLD dataset.

C.2 ARNOLD SCHEMA

As discussed in Section C.1, each State DOT likely stores similar information in its roadway dataset, although in different attribute schemas (i.e., as part of the base, or as route events). This report is not aimed at standardizing attributes across DOTs. Instead, the goal is to communicate the key, common attributes needed for the ARNOLD requirements. As such, the following fields are critical for ARNOLD and will need to be maintained and generated in some manner by the DOT:

- **Route_ID** – unique road ID number
- **Road Name**
- **Functional Classification**
- **Ownership**
- **Facility Type**
- **State Code**
- **Year_Record**
- **Source** – the entity providing the data
- **Geometry**- Well Known Binary (WKB) using (x,y,m) geometry. This should adhere to the OGC specification for Simple Features⁶⁶. The measures will be stored in Miles (with a recommended minimum precision is to the nearest thousandth of a mile.)

State DOTs should maintain or be able to generate the key ARNOLD fields to meet submission requirements.

C.3 ROUTE ID NUMBERING

One of the most vital components of an enterprise GIS Roadway Network is a standardized and common route numbering schema. DOTs should create a common route identification method as the framework with which all units within a State transportation department (safety, traffic, pavement, etc.) and local agencies (counties, municipalities, etc.) can align their respective roadway asset data.

Define a standardized route identification convention as the framework for aligning all DOT and local agency roadway asset data.

Ideally, DOTs will implement a standardized route ID convention⁶⁷ that can be utilized by all jurisdictions (counties, municipalities, etc.) in the State. However, the DOT will need to understand that local government agencies (LGAs) are unlikely to adopt State-mandated standards unless they have had meaningful input. The

benefit for LGAs that choose to adopt such standards is reduced duplicative overlap with other local roadway names and numbers. Alternatively, the State DOT may want to create unique system IDs to share with LGAs.

⁶⁶ FHWA requires that HPMS submissions meet the OGC standard for simple features. See [Open Geospatial Consortium Standards, Simple Feature Access](#)

⁶⁷ DOTs may also want to consider implementing a multi-modal route ID convention that includes other transportation methods (such as Rail and Waterways). Multi-modal data is an important consideration for the future but outside the scope of this Study.

Modern best practices in database management are to use IDs such as GUIDs (Globally Unique Identifiers).

Traditionally, a route ID convention might include information about the route type, county, municipality, route number, and directionality. However, modern best practices in database management are to use identifiers such as GUIDs (Globally Unique Identifiers) rather than IDs comprising descriptive information. Regardless of the ID system chosen, field values should be kept to a **reasonable length** (e.g., less than 30 characters).

C.4 ROAD NAMING

The roadway name is a core attribute for roadway systems. Excluding ramps, all roadways should include at least one standardized name. Roadway naming should also include roadway aliases, historical names, and honorary names (if applicable), ideally following a national standard (such as the FGDC standard⁶⁸). This level of detail is required for proper geo-locating for addressing and emergency services. In addition, route shielding (e.g., I-95) and coincidence (e.g., Route 1 & 9) should also be accommodated for higher functional class roadways. In many cases, roadway names will not align with route designations (or with each other). These situations typically arise from legacy route definitions associated with older State and county route alignments. As shown in Figure C.2, County Route 612 covers multiple road names. Since road names may differ from the route designation, they should not be part of the route definition as a rule, although they may be used as a surrogate when there is no other route designation.

All roadways should include at least one standardized name. Roadway naming should also include roadway aliases, historical names, honorary names, etc.

⁶⁸ The Federal Geographic Data Committee (FGDC) standard is one example of an address standard. (See [FGDC project standards](#).) The National Emergency Number Association (NENA) also has a GIS Data Collection and Maintenance standard with useful information relevant to emergency response data, including addresses and road names. (See [NENA GIS Collection & Maintenance](#).)

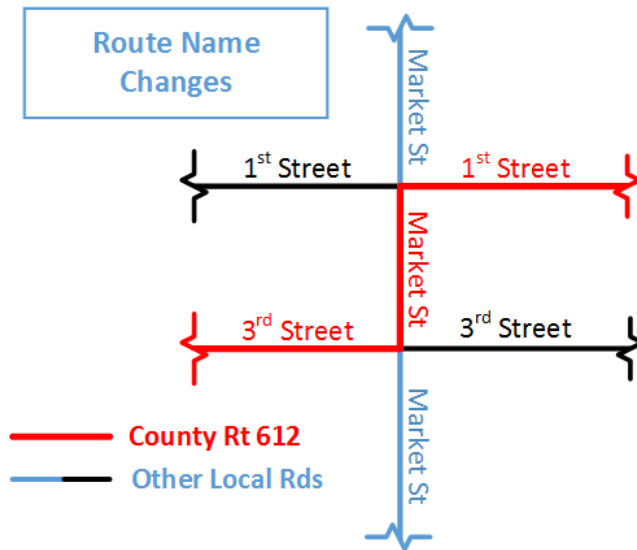

Figure C.2: Route Name Changes Diagram⁶⁹

For segmented roadway networks that are broken at physical or geometric intersections, road names can be stored as attributes of the segments (although a separate database table with a one-to-many relationship could be utilized to accommodate multiple names). For route-based networks, names should be stored as a linear-referenced event.

The LRS database developer needs to be aware of several situations regarding multiple route names associated with the same route segment.

1. Route aliases occur when two or more names are used for the same route segment in the same route system). Route aliases are the simplest case of multiple names. In many cases, aliases are not posted but are still recognized and used by travelers, local governments, or the U.S. Postal Service.
2. Route concurrencies occur when two or more routes in the same route system share the same road segment, as seen in Figure C.3.

⁶⁹ Michael Baker Jr., Inc., 2014



Figure C.3: Route Concurrency⁷⁰

3. Route coincidence occurs when two or more routes from *different* route systems share the same route segment:



Figure C.4: Route Coincidence⁷¹

⁷⁰ Photo from [AARoads Interstate Guide website](#)

⁷¹ Photo from [The New I-26 Virtual Tour Tennessee and North Carolina](#)

C.5 MULTIPLE LINEAR ROUTE MEASURES

As isolated data systems begin to adopt a standardized roadway network, they do not all follow the same standards for route measures (see Figure C.5). For example, it is common for HPMS supporting systems to use driven mileage measures⁷² through a physical Distance Measuring Instrument (DMI), while accident records and State police use mile-markers or intersection offsets.

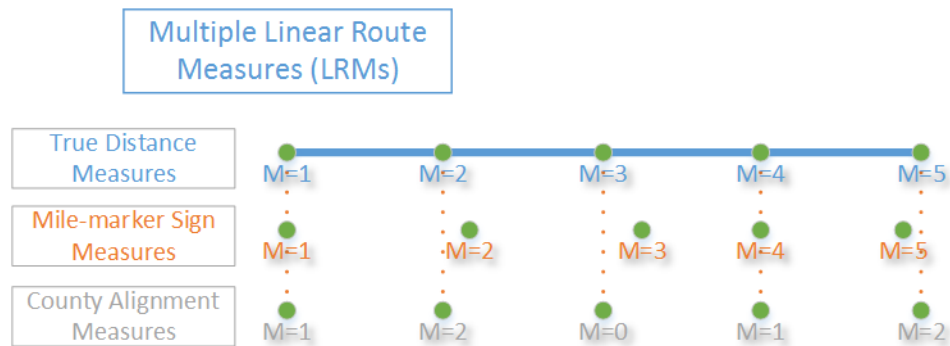

Figure C.5: Multiple Linear Route Measures⁷³

Forcing a standard convention for all dependent systems and business functions can be counterproductive in fostering widespread adoption. Alternatively, multi-linear route measures should be allowable and be utilized to solve the needs of multiple dependent systems, while encouraging a single LRM as the preferred, standardized measure. To support field data collection efforts, it is recommended that driven mileage be used as the standardized measure.

The GIS network should have the capability to support multiple LRMs, while standardizing on a single LRM as the preferred measure (such as driven mileage).

Supporting multi-linear route measures requires calibration points or segments for each linear route measure, as well as functionality to translate between reference systems (e.g., conversion of a driven mile reference to a mile marker reference). Several types of transportation GIS software will automatically support the management and dissemination of data on multi-linear route measures (Intergraph GeoMedia, Esri Roads & Highways, etc.).

⁷² In modern LRS, an as-driven system is a necessity.

⁷³ Michael Baker Jr., Inc., 2014

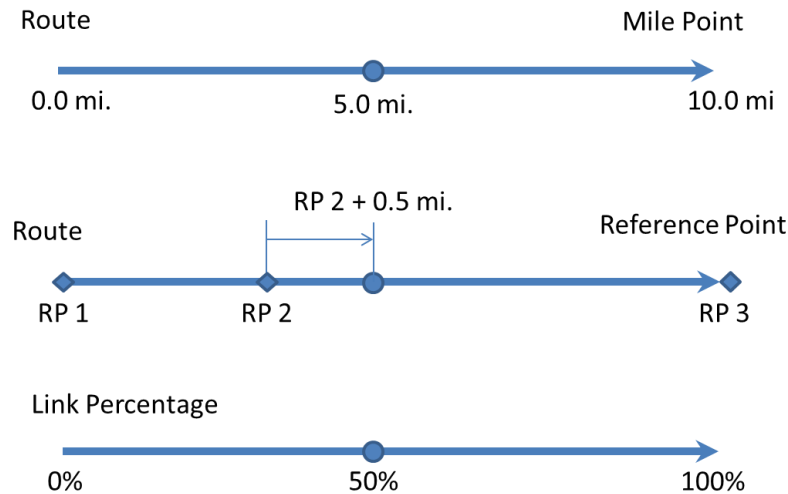

Figure C.6: LRM Transformation⁷⁴

As illustrated in Figure C.6, the location of an event can be described using multiple LRM types with no loss of positional accuracy. A common example occurs when transferring roadway data from construction files indexed by stationing (e.g., format STA XX+yy.yyy') to a GIS-based asset inventory database indexed by a statewide LRM such as Route Milepoint. The common linear element is the new alignment, and the common reference object is usually the project terminus, generally located at a road intersection, administrative boundary, or other geographic feature. The transformation aligns the 00+00.00 station with the corresponding route milepoint value and uses simple arithmetic to calculate the station-to-milepoint conversion of each roadway object of interest.

C.6 PUBLIC VS. PRIVATE ROADWAYS

Statewide roadway networks do not typically include private roadways; thus, State DOTs have not had to manage or track private roadway data. But as the GIS network expands to include all local roads, State DOTs will need to begin to manage the distinction⁷⁵ between public and private roads and store this information in the roadway network. Although private roads are not required in the HPMS submission⁷⁶, Emergency Response is a key driver for including private roads in the network. Therefore,

⁷⁴ Dave Fletcher, 2014

⁷⁵ This distinction expands beyond simply public vs. private road, and can also include other non-public roads such as military roads, Bureau of Land Management (BLM) roads, Forest Service roads, etc.

⁷⁶ HPMS requires that the road geometry submitted correspond to the State-certified mileage, which is signed by the Governor. In other words, if a State decides to include private roads in its certified mileage number, then the

private roads should be properly attributed so that they can be removed from the HPMS submission, if applicable. That said, if a State wants to submit private roads in its HPMS submission, they may be accepted by FHWA.

The distinction between public and private roads is typically defined at the local level, based on who is responsible for maintenance and record keeping. For example, a town/city/county-maintained road would be “public,” while a road maintained by a homeowners association within a gated community would be “private.” Making this distinction between public and private can be very difficult, particularly if the only source is orthophotography. It is critical that this information come from an authoritative source (e.g., the local jurisdiction).

Although HPMS only requires the roads that correspond to certified road mileage, State DOTs may include private roads in their network to support emergency response and safety considerations.

C.7 INSTALL DATE AND INSPECTION DATE

Implementing the ability to analyze transportation data over time (i.e., temporality) starts with the inclusion of effective dates. However, an effective date can be more complex than a simple, single date.

For maximum data evaluation capability, capture and manage both the construction date and inventory dates.

The most obvious date to capture would be the installation or creation date for the roadway. In reality, this information may not be available to the group maintaining the GIS datasets. As such, it may be more realistic to capture the inspection or field inventory date of the roadway.

- **Installation date** (or “Open for Traffic” date) is the date that construction on the new or realigned roadway section was completed.
- **Inspection or Inventory date** is the date that the roadway was inventoried or inspected to collect the newly constructed alignment and attribution.

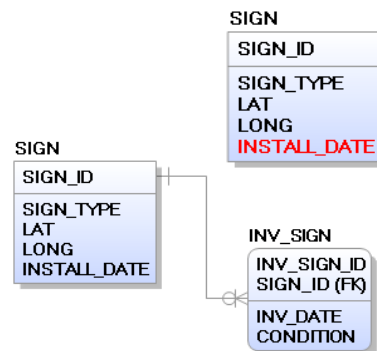

roads should be included in the HPMS geometry. If a State wants to include a private road in its submittal, the facility type must be > 4.

C.8 ADDRESSING

While addressing is not typically a mainstream DOT business function and is not required for HPMS reporting, it is very practical and rational to include addresses with roads, when feasible. There are two main methods of storing address information:

- **Address Range:** Address locations are estimated by proportional relative distances determined by the lowest address on the block (i.e., the “from address” attribute on the segment) to the highest address on the block (i.e., the “to address” attribute on the segment). For example, if the address range on one block of Main Street runs from 100 to 200, then the address of 150 Main Street would be located 50 percent of the distance along the street segment.



Figure C.7: Address Range LRM⁷⁷

- **Address Points:** In this method, address information is stored as distinct locations, represented by a point feature stored at or near the physical address (building centroid, driveway entrance, property centroid, etc.), or as an LRS event.

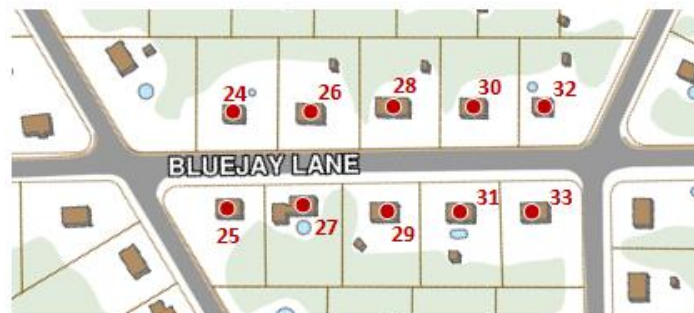

Figure C.8: Address Points LRM⁷⁸

⁷⁷ Applied Geographics, Inc., 2014

⁷⁸ Applied Geographics, Inc., 2014

Either method is workable, but the following issues should be considered:

- For emergency response purposes, address point locations are preferable to give first responders an exact location⁷⁹, rather than an approximated location based on the distance along the segment. Particularly in rural areas, approximated location based on address ranges can be very far off from the exact address due to long stretches of roadway and irregular addresses. Whether using address ranges or points, field verification of house numbers is strongly recommended for address-matching and geocoding applications.
- When address points are used, the location of the placement of these points may vary, depending on local needs and standards. This can cause data conflation issues, depending on where the point is placed (e.g., at the centroid of the parcel, centroid of the structure, front door of the structure, the end of the driveway – all examples used by different localities for placing address points).
- If using an intersection-based network, implementing address ranges is possible as the segments are broken at actual intersections.
- If using a route-based network, it is recommended that address point locations be used; implementing accurate address ranges along the entire length of a route segment would be very difficult without segmentation to accommodate the assignment of address ranges.

For emergency response purposes, discrete address point locations linked to the LRS are preferable to give first responders an exact location.

Coordination between DOT and local E911 agencies is critical in ensuring that emergency responders have access to accurate data.

Although address management is typically not a core DOT function, it is needed for tracking crash and safety information, as well for as several uses outside of the DOT (e.g., emergency response). Address ownership and origination are often outside of the DOT and usually at the local (e.g., city or county) E911 agency. Thus, it is important

for the DOT and local E911 agencies to coordinate to ensure the most accurate data is available to emergency first responders.

⁷⁹ The National Emergency Number Association (NENA) has a GIS Data Collection and Maintenance standard with useful information relevant to emergency response data, including addresses and road names. ([NENA GIS Data Collection](#))

D.1 METADATA STANDARDS FOR GIS AND ROADWAY ASSET DATA

A statewide GIS roadway network and associated data are typically distributed to stakeholders, both internally to State agencies and externally to the public; therefore, having consistent and well-defined metadata (i.e., information that describes the dataset and dataset attributes) for all production data layers is critical to data usability and widespread adoption. While metadata creation is emphasized for GIS data layers, it is important to include some form of metadata with any published datasets, whether or not they are geospatial. End users need the ability to reference important data facts, such as data accuracy, collection methodologies, and data owners. Data aggregators also need to know about such information.

All published or distributed datasets should include standardized metadata, ideally at both the layer level and the object level, but at least at the dataset level.

Ideally, metadata is maintained at both the layer level and at the object level (i.e., for each geometric object within the dataset). At a minimum, metadata is needed at the dataset level, which might contain multiple data layers or themes. Whenever possible, the metadata should adhere to existing standards, such as the Federal Geographic Data Committee (FGDC) Content Standard for Digital Geospatial Metadata, or the Dublin Core Metadata Element Set⁸⁰. States may want to work with their GIS data clearinghouse on metadata standards as well. The metadata should be built into the GIS data layer, without the need for additional data files. Additionally, the ability to export metadata information into a report format is useful in communicating this information when sharing data, and for meeting HPMS metadata reporting requirements.

Metadata should be embedded within the GIS layer whenever possible. At a minimum, complete the ISO metadata sections containing **Identification** and **Metadata Reference**.

It is recommended that all published data follow International Organization for Standardization (ISO) metadata standards, which should be embedded within datasets using standard GIS software. The ISO metadata sections containing **Identification** and **Metadata Reference** elements are suggested to be included at a minimum for all centerline data layers.

⁸⁰ GIS metadata standardization is supported by the FGDC and International Organization for Standardization (ISO). FGDC-endorsed ISO metadata standards can be found at: [FGDC Geospatial Metadata Standards](#). The Dublin Core Metadata Element Set can be found at: [Dublin Core Metadata Element Set, Version 1.1](#).

To document published data where embedding metadata within the dataset is not available (e.g., Excel files, text files), define and mandate metadata standards.

D.2 PLANNED, DESTROYED AND DECOMMISSIONED ROADWAYS

When building and maintaining a roadway GIS network, it is natural to consider only existing facilities and roadways. But in many cases, it is important to be able to manage and reference unbuilt, planned roadways (sometimes called “paper streets”), as well as alignments that have been abandoned or destroyed. Doing this allows DOTs to track and manage infrastructure and assets throughout the entire roadway data lifecycle (see Figure D.1).

Include planned, unbuilt facilities as well as abandoned or destroyed roadways in the dataset.

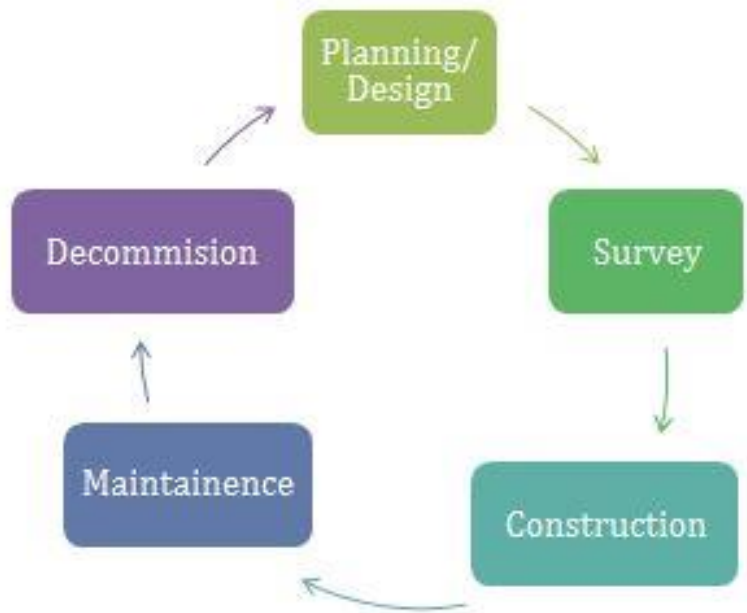

Figure D.1: Roadway Lifecycle Diagram⁸¹

It is recommended that State agencies include planned, unbuilt facilities in their networks, assigning route identifiers and approximate mileage. Likewise, abandoned or destroyed roadways should be properly archived. These features should either be designated as such, or kept in a separate database, to minimize confusion.

⁸¹ Applied Geographics, Inc., 2014

D.3 GEOARCHIVING ROADWAY SEGMENTS

Archiving the road geometry and associated LRS (e.g., a weekly, monthly, quarterly, or annual snapshot of the data) is a process known as “geoarchiving.” The lower the amount of data that is included in the LRS, the easier it is to store snapshots; with more data, different updates might be more appropriate.

Always geoarchive data when significant updates and changes occur.

For incorporating temporal functionality (i.e., the ability to do time-based analysis) into a GIS network, it becomes important to archive data when significant⁸² changes occur to the system.

Geoarchiving allows stakeholders and supporting systems to track changes, details on the changes, and potential impacts to other data. Geoarchiving is also an important consideration for compliance with record retention rules and regulations. Further, because most changes happen at the local level, proper geoarchiving procedures will become even more critical as State DOTs begin incorporating local data.

The recommended means to perform geoarchiving is to have a separate archive data structure reflecting the road geometry table(s). For geoarchiving, a new data column (ex. ARCHIVE_YEAR) should be added to the archive table to track the archive date. See Figure D.2 for an example.

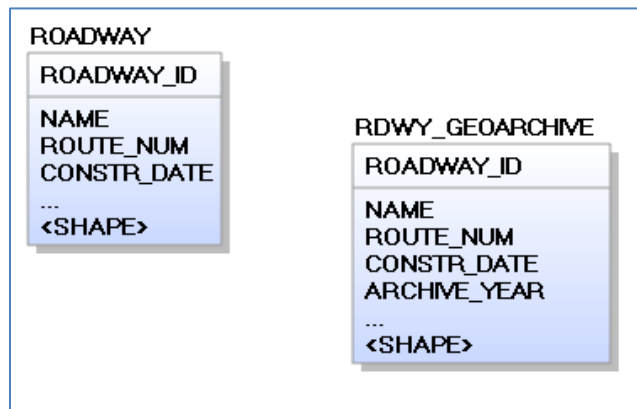

Figure D.2: Geoarchiving data structure⁸³

⁸² In this context, the term significant can be defined as changes that can impact dependent systems directly. For example, a change to an attribute that only affects labeling may not be deemed significant. The meaning of this term needs to be clearly defined and communicated to stakeholders.

⁸³ Michael Baker Jr., Inc., 2014

Data should be copied from the main production road geometry table to the archive table in its entirety on a scheduled basis. Additionally, a data retention policy will need to be defined, which dictates when data should be removed from the archive table. To group changes together, an additional table can be linked to show a logical data transaction. This structure includes the inherit ability to “roll back” a grouped transaction if there was a problem with the update.

Define a data retention policy to dictate how long archived data should be kept.

D.4 ROADWAY DATA DISTRIBUTION AND CHANGE COMMUNICATION

As external systems gain dependence on an enterprise GIS Roadway dataset, the distribution and communication of data with dependent stakeholders becomes vital to a system’s success. As data changes occur within the roadway network, these changes need to be communicated so that dependencies can be reviewed and changed accordingly. This communication should include the

Make data readily available to all users via web services, and develop a consistent change communication mechanism.

updated GIS dataset, as well as a change log that describes all the changes that have been made to the network. Additionally, dependent stakeholders need a means to communicate change requests to the GIS roadway network, to maintain data alignment between the systems.

The drivers and solutions of the three key components of data distribution and change communication are further described below:

- Data Publishing:
 - *Driver:*
 - Dependent systems and users should have a way to directly connect to the most current published version of the GIS network. It should be in a known, fixed location, easily accessible to all users.
 - *Solutions:*
 - Utilize a feature service or map service (i.e., a specialized web service) to distribute the GIS network to end users.
 - Additionally, the agency may choose to distribute the network through a downloadable geospatial data format. This would allow for off-line data use; however, it would put the responsibility on the user to get the “most recent” version as needed. It is advisable that this file format should not be vendor dependent but allow users to view the data using a variety of different GIS tools.

- Change Log:
 - *Driver:*
 - Stakeholders need a way to review a descriptive change log detailing the date and reasons for roadway changes. This allows users to understand roadway changes and determine how the changes affect their particular business needs. For example, a roadway realignment may require additional field inspection of asset installations, pavement conditions, and roadway attribution. In contrast, the addition of a simple traffic signal to augment a non-signalized intersection may not require a full field inspection.
 - *Solution:*
 - A change log and complete metadata should be linked to the map service so that users can view a detailed description of each change.
- Change Requests:
 - *Driver:*
 - Users should have a means to communicate change requests to the GIS network.
 - *Solution:*
 - This can be accomplished through a variety of means. For example a “red-lining” map interface would allow users to identify the area of change, mark a spatial location, and provide details on the requested change to the GIS maintenance group.

APPENDIX E CREATING AN INTEGRATED ALL-ROADS NETWORK

When creating an integrated all-roads network, whether at the State or national level, many of the same processes will need to be completed in order to ensure data alignment and network continuity. This integration of geospatial data is known as conflation. Conflation is the process used to reconcile datasets from multiple sources, optimizing their quality and usability. For road data, the likely sources and partners are described in Report 2 of this Study, on data collection.

Figure E.1 provides an overview of the entire process of integrating road data. The process is described in detail in Sections E.1 through E.7.

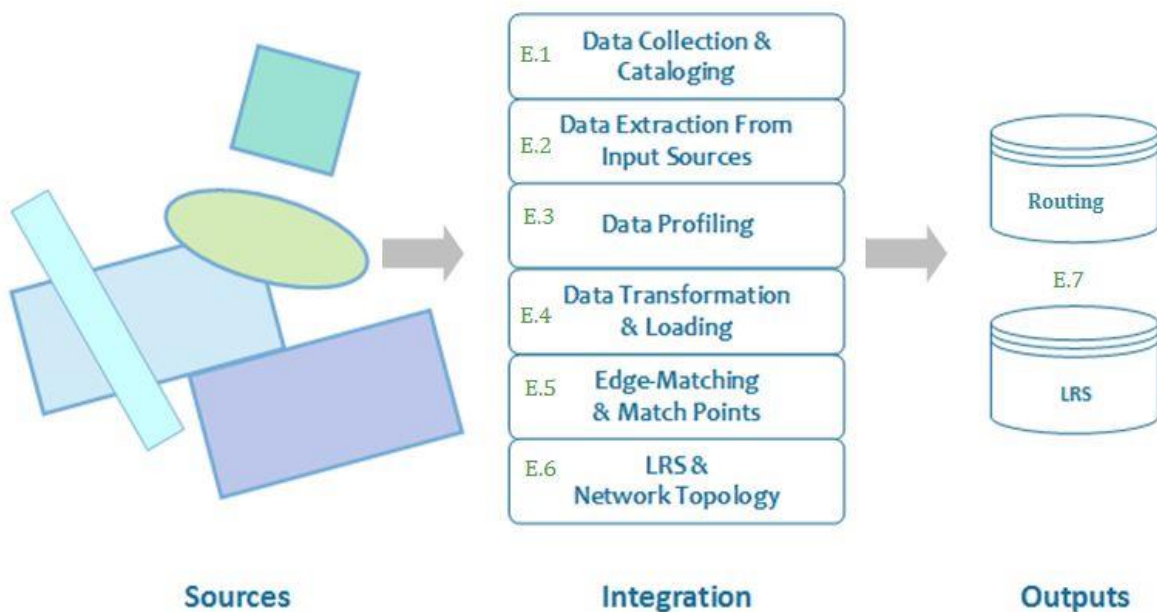

Figure E.1. Overview of Roadway Data Integration⁸⁴

Once data is collected, conflation involves the unification of multiple datasets into a single dataset with combined spatial features and attributes. The datasets may have common and uncommon features and attributes, which require evaluation and reconciliation. There are decisions to be made about feature matching (i.e., identifying corresponding features); feature additions and deletions (i.e., deciding what to include or not include, such as removing obvious duplicates); spatial adjustments (i.e., rubbersheeting, adjusting gaps and overshoots); and attribute transfer (i.e., combining non-spatial

⁸⁴ Applied Geographics, Inc., 2014

descriptive data). The process is a combination of automated and manual steps for transforming and aligning features and includes evaluating and validating changes and adjustments, which are based on business rules about what is allowed. The following sections address the key issues and steps for performing conflation and achieving data integration, which are also laid out in Figure E.2.

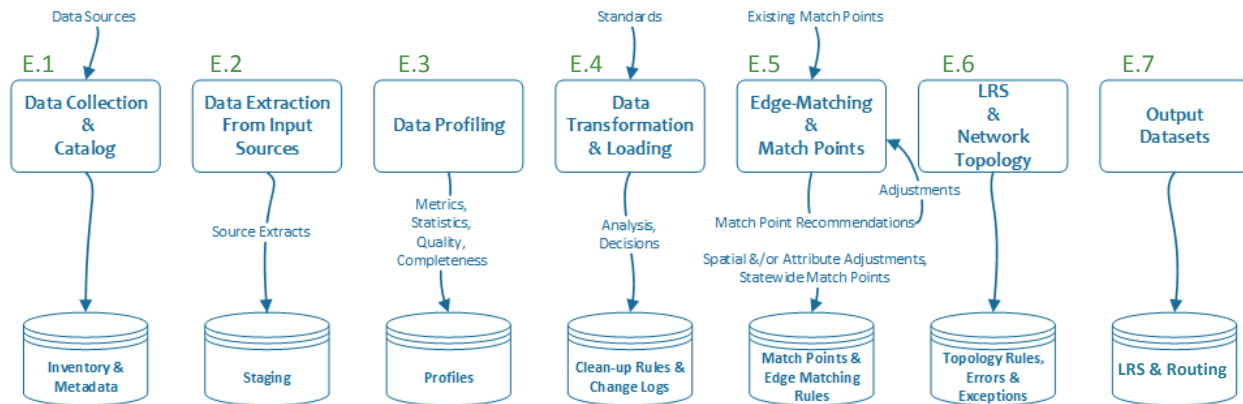

Figure E.2: Steps and Interim Outputs in Data Conflation and Integration Process⁸⁵

E.1 DATA COLLECTION & CATALOGING

Different sources may have different map projections, levels of completeness, currentness, and consistency. A cataloging or data inventory step to document the contents of the datasets, including metadata generation, is important when conflating data from different sources. The source data may be stored as

Create a data inventory, including metadata, for all data sources to be integrated.

transactional data in a schema optimized for performance during data collection operations (e.g., insert, update, delete), but not necessarily optimized for queries. These datasets are typically part of an On-Line Transaction Processing (OLTP)

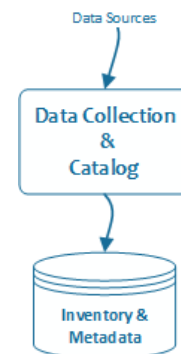

environment. Part of the cataloging step is to document the data schema as well as the actual populated contents of the source datasets. This becomes useful in optimizing any aggregated datasets to support indexing and a faster query response, which is typical of On-Line Analytical Processing (OLAP) environments, such as data warehouses.

⁸⁵ Applied Geographics, Inc., 2014

It is also important during data cataloging to understand and document any known issues or limitations with certain datasets. The inventory and metadata that result from this step will inform the rest of the processes described below.

E.2 DATA EXTRACTION FROM INPUT SOURCES

As described in task 2 of this report, source data can come from a wide variety of agencies including:

- Local Government (e.g., city, town, county)
- Regional Entity (e.g., Regional Planning Agency (RPA) or Metropolitan Planning Organization (MPO))
- State GIS Clearinghouse
- U.S. Census Bureau (TIGER data)
- Federal Agency (e.g., BIA, BLM, USFS, NPS, etc.⁸⁶)
- Commercial Data Provider (e.g., HERE, TomTom, Google)
- Volunteered Geographic Information (e.g., Open Street Map (OSM))

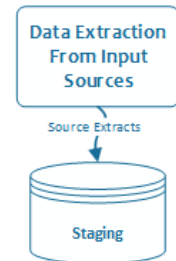

To streamline data loading and conflation, create a staging dataset that contains the pertinent subset of features from each source dataset.

These datasets will all be in varied formats and locations, and they may contain extraneous data and geospatial layers that are not pertinent to the integration project. Thus, it is recommended that a “staging” dataset be created for each source dataset that contains only the pertinent features to be conflated. For example, if the data extends beyond the geographic extent of a State (e.g., TIGER, OSM), it is recommended that the staging dataset be a subset of only the features in the pertinent geographic extent. Or, if the plan is to conflate local roads from the local government data with county roads from county data and State roads from the DOT, each staging dataset might contain only the subset of features that will ultimately be integrated.

⁸⁶ *BIA* = Bureau of Indian Affairs; *BLM* = Bureau of Land Management; *USFS* = United States Forest Service; *NPS* = National Park Service.

E.3 DATA PROFILING

A data profiling step is recommended to evaluate the quality of each dataset, in advance of data transformation and other pre-processing steps. Incoming datasets may not be correct, consistent, or complete. They should be reviewed and evaluated using a combination of automated and interactive procedures.

Data should be evaluated for consistency and quality using a combination of automated and manual procedures.



The following is a sample list of typical items to check for during profiling:

- Database values
 - Dummy default values, such as 99999 for a zip code
 - Missing values, such as no projection parameters
 - Contradicting data values, such as when the road construction date is before the project plan date
- Violation of business rules
 - Multi-purpose fields, such as when the same field is used to store information with different meanings
 - Cryptic data, such as when ad hoc abbreviations or truncated road names are used
 - Inappropriate use of an address line, such as splitting addresses across multiple lines
 - Reused primary keys, such as when an old road and a new road in different places have the same key
 - No unique identifiers, such as when the same road element has several primary keys
 - Interoperability flaws, such as when data is inadvertently related but should not be

E.4 DATA TRANSFORMATION AND LOADING

All datasets are not the same. Loading data into the data integrator’s review and edit environment very often requires transformation. For example, if datasets from local sources are in a different projection than the State DOT data, a common projection needs to be chosen, and the data re-projected as needed. Depending on a State DOT’s workflow procedures and tools, data transformation may be automated as part of the extraction process from the source. Also, depending on the technology being used, this can be an intermediate staging database for performing the edge-matching of features. Edge-matching is explained in a subsequent section.

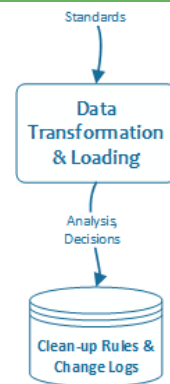

A data cleansing step may also be needed, in accordance with business rules, to assure the integrity of the data. Such data cleansing may include de-duplication, for example, whereby common features and attributes that are obvious duplicates are removed. Generally, only obvious discrepancies should be changed during data cleansing, to assure fidelity to the source data. Ideally, the supplier of the data should make the changes, assuming that they are also the party responsible for data maintenance. Any changes made by someone other than the data-provider should be tracked in a change layer or change report for auditing purposes.

When loading source data, only minor changes should be made (e.g., re-projecting data, fixing obvious errors). Ideally, the source data owner would take responsibility for needed data maintenance.

E.5 EDGE-MATCHING AND MATCH POINTS

Making sure that all road segments are properly edge-matched is a key step in creating an integrated network. Many DOTs have already edge-matched most major roadways, but this data enhancement needs to be extended to local roads as part of the ARNOLD all-roads integration effort, to densify the road network.

Match points should be established to allow edge-matching between neighboring or overlapping transportation agencies.

Match points (also known as integration points, touch points, demarcation points, smart points, agreement points, snap-to points, join points, etc.) are point locations established within the GIS to mark the connection point

between two (or more) geospatial datasets. These points allow datasets to be seamlessly joined together without any overlap or gaps (which is essential to proper topology, as described in Section E.6). In terms of a nationwide ARNOLD, establishing these points between States will be critical in facilitating the edge-matching of data between neighboring States, and ultimately stitching together a nationwide roadway dataset.

It is important to note that in this context, match points are not necessarily indicative of actual jurisdictional boundaries or asset management and maintenance responsibilities. They merely help to delineate where the GIS data management responsibilities start and stop for a particular agency. The essential idea is to locate such points at unambiguous, verifiable locations that bordering jurisdictions can agree upon. The

Match points are not indicative of jurisdictional boundaries or asset management and maintenance responsibilities. They merely help to delineate GIS data management responsibilities.

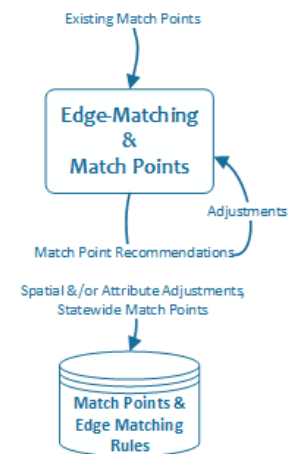

agreement can be between the GIS data managers for the adjacent jurisdictions, and ideally would be endorsed by their respective senior executives.

If match points to facilitate data integration have been agreed upon at the State or local levels, they should be used. If they do not exist, then a set of recommended points should be presented to the affected jurisdictions for negotiation and agreement. Feedback and adjustments should be allowed for, and the points should be incorporated into an agreed-upon Statewide Match Point Layer.

Jurisdictions that have agreed upon match points should be identified during all-roads data collection. Where they don't exist, the State DOT can create these points based on evident criteria, and provide them to Local Government Agencies (LGAs) for review; the LGAs should be given a reasonable amount of time to review and to provide feedback to the DOT. Most DOTs do not have the resources to mediate disputes between counties or cities, so the local jurisdictions will need to work this out between themselves. If the LGAs cannot reach agreement, then the State DOT match points should be used.⁸⁷

While the FHWA has a business rule not to make spatial adjustments to the data received from State DOTs, there are cases where DOTs make spatial adjustments within their State when combining datasets from different sources. Such adjustments can be based on proximity, topology, and continuity analyses and rules, as well as attribute comparisons. One method, commonly referred to as rubbersheeting, adjusts input features to a target, based on rules. Another method involves the automatic correction of gaps and overshoots, based on agreed-upon geometric tolerances. This method may be combined with queued edit scenarios, where gaps and overshoots are presented to a human operator for a decision on whether to make a change. Types of change in this context include: spatial change; attribute change; spatial and attribute change; no change; new update features; and delete feature.

⁸⁷ See: "State of Colorado Unified Road Layer Assessment," September 30, 2012, p. 46.

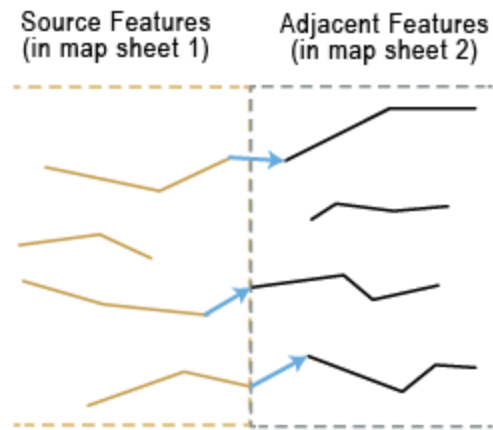

Figure E.3: Edge Matching Scenarios⁸⁸

A number of States and jurisdictions (Arizona, the District of Columbia, Maryland, Washington, and others) are working on using match points to help streamline data integration from multiple sources (State, county, local, tribal, etc.).

Based on the *One Maryland One Centerline* initiative⁸⁹, the following list provides an overview of the **Integration Points Workflow**⁹⁰:

- Determine the road centerline segment recognized to be the authoritative source for the given length of road (e.g., State, county, local)
- Create initial integration points at any intersection of road centerline where the data provider attribute changes
- Intersect with a bridge polygon layer to identify and remove integration points where roads are not intersecting
- Provide integration points to local jurisdictions for review, comment and acceptance
- State and locals edit their respective centerline data to coincide at integration points

⁸⁸ See: [ArcGIS Resources: About Edgematching](#)

⁸⁹ The Maryland State Highway Administration (SHA) is responsible for maintaining a statewide road centerline dataset containing linear referencing route and measure information and an inventory of roadway characteristics. More information can be found at [Maryland iMAP](#).

⁹⁰ From the *One Maryland One Centerline* initiative presentation at GIS-T 2014 by Erin Lesh and Marshall Stevenson, Maryland SHA.

Regardless of the datasets being joined (i.e., those of neighboring States or local and State data), the same basic workflow can be applied.

E.6 LRS AND NETWORK TOPOLOGY

This step is where important decisions need to be made regarding whether the ARNOLD baseline layer will support routing (path) topologies for routing and navigational purposes (e.g., emergency management and traffic modeling) as well as traditional LRS. To support the decision-making process, this section provides a discussion of topology.

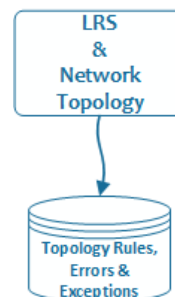

Transportation systems have structure and flow that are commonly represented graphically as a network. Geometrically, a network comprises an arrangement of nodes (a.k.a. vertices or points) and links (a.k.a. edges or lines) between the nodes, which typically represent roads (but also railways, waterways, flight paths, bicycle trails, pedestrian walkways, etc.). A sequence of links that are traveled in the same direction is a path, which is a fundamental attribute for measuring traffic flows and finding navigational routes.

The structural arrangement and connectivity of a network represent its topology. Topology is sometimes referred to as “coordinate-free geometry,” since a topological network can be stretched as if it were a rubber sheet without changing the “from/to” and “left/right” relationships of the nodes and links. More appropriately, it should be described as the study of those geometric concepts that can be defined independent of any coordinate system. Nonetheless, in a transportation context, location, direction, and connectivity are all important.

Topology rules define key spatial relationships between corresponding datasets. Examples of topology rules include:

- Prohibiting disconnected segments
- Disallowing segments missing associated measures
- Not allowing segments to overlap
- Not allowing segments to have gaps

Topology rules and OGC standards should be applied to and enforced within the roadway network in order to ensure data quality and stability, as well as to support routing and network analysis.

The roadway network should allow for the creation and enforcement of topology rules, and should follow the Open Geospatial Consortium (OGC) Standard for Simple Features⁹¹. Violations of topology

⁹¹ FHWA requires that HPMS submissions meet the OGC standard for simple features (See [Open Geospatial Consortium Standards, Simple Feature Access](#)).

rules are stored as errors, but exceptions can be marked accordingly. Network topology can be encoded and its properties measured using graph theory, which is incorporated at a fundamental level in most GIS products. Network analysis based on graph theory is commonly supported in GIS data models. LRS are an extension to GIS, adding dynamic segmentation and allowing State DOTs to measure the location of features and events on the road network, thus handling linear measurements along a road segment. In this GIS-T case, the node geometry of a road network might be dissolved along logically continuous routes. Conversely, in a non-GIS-T case, the road network might be subdivided into a multitude of segments for graphic purposes to support cartographic representation, or geocoding. These approaches, while valid for their own purposes, can adversely impact the topology needed for traffic flow and routing applications. In other words, a dataset that is optimized for linear measurements, or cartographic representation, or geocoding, is less than optimal for traffic flow modeling and routing.

Topology, particularly for connectivity, forms the basis for network analysis and routing. A routable

Routing and navigation applications typically require a node at every legitimate intersection in order to model items such as vehicle turn restrictions and directionality, and for geocoding.

network is key to many GIS applications, such as fleet management, drive-time analysis, and most notably emergency response. Routing allows first responders to determine the quickest route from their location to the dispatch destination. Typically, routing applications require a node at every legitimate intersection where a turn can be made, which may differ from the data

structure of the LRS. For example, to achieve processing efficiencies for non-routing applications, State DOTs have traditionally dissolved segmented networks into non-segmented networks, to reduce the number of nodes and to define numbered routes with the minimum number of essential segments. However, for routing purposes, nodes and related intersections are very important for modeling vehicle restrictions (turns, heights, weights, speeds, direction, stop signs, traffic signals, congestion, construction, detours, etc.); and for geocoding purposes for matching addresses with a location along a street.

Routing applications require a network topology in which the relationships of each node and link with other nodes and links are modeled in terms of constraints and possibilities. Fundamentally, two tables are required to geospatially represent a network data model: 1) a node table, including unique IDs and X and Y coordinates for each node; and 2) a link table, also with unique IDs, as well as the “from” node (the origin or starting point), and the “to” node (the destination or ending point). When these tables are relationally linked, the topological structure of the network can be built, and network analysis based on graph theory can be applied.⁹²

⁹² Rodrigue, Comtois, and Slack. The Geography of Transportation Systems. Taylor & Francis Group: New York, 2009, pp. 76-77.

E.7 OUTPUT DATASETS

To create a road network that supports both routing and linear referencing use cases, as described in Section 2.1, the network should combine roadway geometry with network topology in order to meet the needs of routing and navigation, and then be

The network should be built to meet the needs of routing, and then be processed to support LRS needs.

processed to “thin” the data to suffice for the needs of LRS. If the network is built only to support LRS (without topology), it will be inadequate for routing. **The goal**

to “build once, use many times” can be achieved through this approach: the base geometry and topology support multiple business needs.



Node and segment geometry is needed for the creation and maintenance (e.g., adding new routes or new alignments) of a roadway network. As shown in the diagram below, this geometry, along with its network topology, can be combined with turn and flow restrictions and address points to satisfy routing use cases⁹³. Similarly, the roadway geometry and network topology can be used to create LRS routes. These routes, combined with point and line events, can satisfy linear referencing use cases. Frequently, DOTs are focused on the LRS portion of the diagram (i.e., the bottom output), but through collaboration, both use cases can be met.

⁹³ There are different levels of complexity when it comes to routing and navigation. There are general/casual uses for everyday navigation (e.g., generating directions given “from” and “to” locations), and more complex routing scenarios, such as routing for heavy load purposes. The network should be designed to handle the full spectrum of routing and navigation use cases.

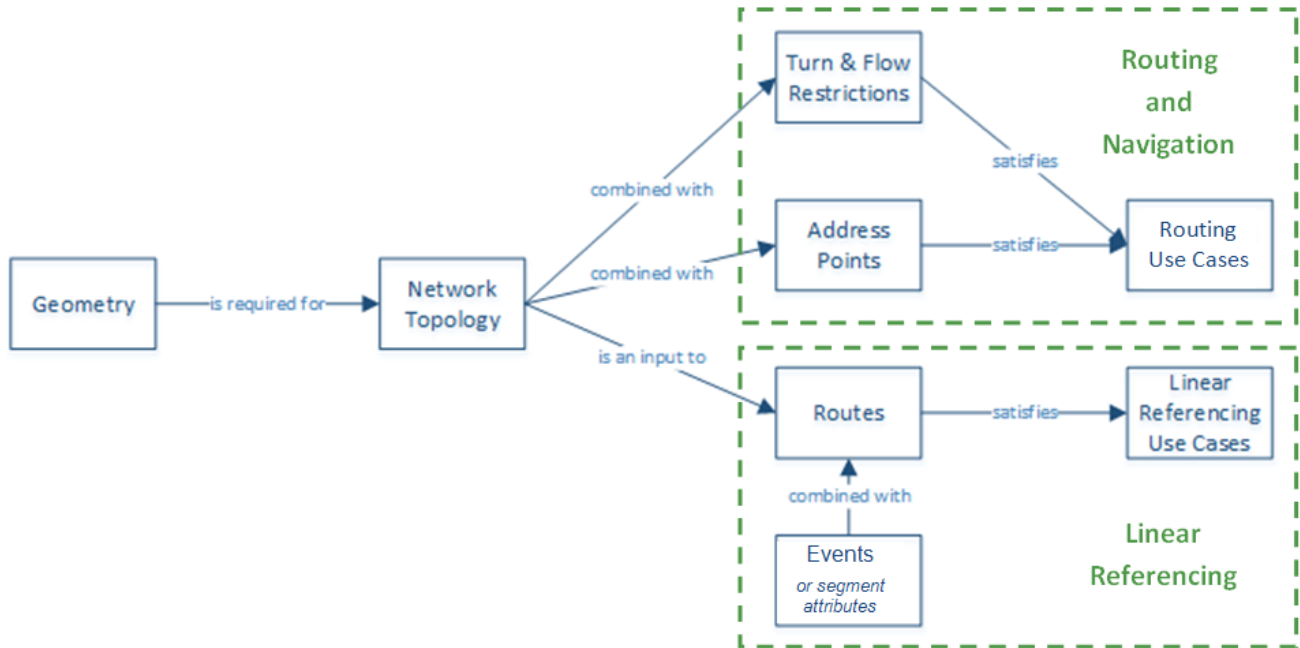

Figure E.4: Routing and LRS Output Datasets.⁹⁴

⁹⁴ Applied Geographics, Inc., 2014

LIST OF ACRONYMS

AADT – Annual Average Daily Traffic

AASHTO – American Association of State Highway and Transportation Officials

API – Application Programming Interface

ARNOLD – All Road Network of Linear Referenced Data

BIA – Bureau of Indian Affairs

BLM – Bureau of Land Management

CAD – Computer-aided design

COTS – Commercial-off-the-shelf

DOT – Department of Transportation

ETL – Extract, Transform and Load

FGDC – Federal Geographic Data Committee

FHWA – Federal Highway Administration

FMIS – Fiscal Management Information System

GIO – Geographic Information Officer

GIS – Geographic Information System

GIS-T – Geographic Information Systems for Transportation

GPS – Global Positioning System

HPMS – Highway Performance Monitoring System

ISO – International Organization for Standardization

LGA – Local Government Agency

LRM – Linear Referencing Method

LRS – Linear Referencing Systems

MIRE – Model Inventory of Roadway Elements

MPO – Metropolitan Planning Organization

NCHRP – National Cooperative Highway Research Program

NENA – National Emergency Number Association

NG911 – Next Generation 911

NPS – National Park Service

NSDI – National Spatial Data Infrastructure

OGC – Open GIS Consortium

OLAP – On-Line Analytical Processing

OLTA – On-Line Transaction Processing

OSM – Open Street Map

ROW – Right-of-way

RPA – Regional Planning Agency

SHA – State Highway Administration

SLD – Straight Line Diagram

TFTN – Transportation for the Nation

TIGER – Topologically Integrated Geographic Encoding and Referencing

TIP – Transportation Improvement Program

USFS – United States Forest Service

VGI – Volunteer Geographic Data

VMT – Vehicle Miles Travelled

WKB – Well Known Binary

WMS – Web Map Service



Federal Highway Administration
(FHWA)