

# Vehicle Occupancy Data, Speed, NPMRDS, Axle Spacing and Body Type for Vehicle Classification

Wenjing Pu

FHWA Highway Information Seminar

October 31, 2018



# Outline

1. Vehicle Occupancy Data
2. Speed
3. National Performance Management Research Data Set (NPMRDS)
4. Axle Spacing and Body Type for Vehicle Classification (Vehicle Inventory)



# Why Is Vehicle Occupancy Important?

- Vehicle occupancy is the number of occupants in a vehicle during a vehicle trip *including the driver*.
- The ultimate goal of transportation is to transport **people** and goods.
- Vehicle occupancy translates vehicle travel to person travel.
- Vehicle occupancy is used in evaluating the effectiveness of certain transportation programs, such as HOV facilities.
- Vehicle occupancy is required in the Transportation Performance Management (TPM).



# Vehicle Occupancy in TPM (now)

- In Transportation Performance Management (TPM), Average Vehicle Occupancy Factors (AVOs) are used in computing (1) Travel Time Reliability Measures and (2) Total Peak Hour Excessive Delay Metrics
- (1) Travel Time Reliability Measures

*Table 1 - Average Vehicle Occupancy Factor for Travel Time Reliability Measures*

Vehicle Type	Average Vehicle Occupancy Factor
All vehicles	1.7

Table 1 is calculated from the National Household Travel Survey (NHTS) 2017 Data.

Source: FHWA, [Average Vehicle Occupancy Factors for Computing Travel Time Reliability Measures and Total Peak Hour Excessive Delay Metrics](#)



# Vehicle Occupancy in TPM (now)

- (2) Peak Hour Excessive Delay (PHED) Metrics

*Table 2 - Annual Average Vehicle Occupancy Factors for Cars, Buses and Trucks for PHED Metrics*

Vehicle Types	Applicable Area	Average Vehicle Occupancy Factors
<b>Cars</b>	All	1.7
<b>Buses</b>	Atlanta, GA	10.3
	Baltimore, MD	15.9
	Boston, MA-NH-RI	12.2
	Charlotte, NC-SC	8.5
	St. Louis, MO-IL	6.9
	Washington, DC-VA-MD	8.9
<b>Trucks</b>	All	1.0

In Table 2: AVO for Cars is from NHTS 2017 Data, AVOs for buses are from FTA's National Transit Database (NTD), and AVO for Trucks is a nominal value.

Source: FHWA, [Average Vehicle Occupancy Factors for Computing Travel Time Reliability Measures and Total Peak Hour Excessive Delay Metrics](#)



# Vehicle Occupancy in TPM (Future)

- For (1) Travel Time Reliability Measures, Vehicle Occupancy will be provided by at least the following categories:
  - Vehicle type: All vehicles (aggregation of passenger cars, buses, and trucks)
  - Geographic resolution: State
  - Road types:
    - Interstate
    - Non-Interstate NHS
  - Time periods:
    - Weekday 6 – 10 am
    - Weekday 10 am – 4 pm
    - Weekday 4 – 8 pm
    - Weekend 6 am – 8 pm



# Vehicle Occupancy in TPM (Future)

- For (2) Peak Hour Excessive Delay (PHED) Metrics, Vehicle Occupancy will be provided by at least the following categories:
  - Vehicle Types:
    - Passenger cars
    - Buses
    - Trucks
  - Geographic resolution: Urbanized Area (population 200,000+ only)
  - Road Type: NHS
  - Time periods:
    - Weekday 6 – 10 am
    - Weekday 4 – 8 pm



# Speed

- Measuring vehicle speed
  - Location-fixed detection: detectors, sensors, etc.
  - Vehicle ID re-matching: toll tags, license plate matching, Bluetooth, etc.
  - Vehicle probes: GPS-enabled vehicles, etc.
- Speeds from multiple sources enable cross-validations
  - NPMRDS v1 vs. TMAS continuous monitoring sites
  - NPMRDS v2 vs. Bluetooth
- Using travel distance, speed can be converted to travel time, which is the most useful information to travelers





# What is NPMRDS?

- A package of vehicle probe data procured by FHWA
  - 1<sup>st</sup> procurement (NPMRDS v1): July 2013
  - 2<sup>nd</sup> procurement (NPMRDS v2): April 2017
- Archived travel time and speed; AADT (if available) is conflated from HPMS
- Resolution: 5-minute intervals on over 400,000 TMC segments
- Coverage: National Highway System, 26 border crossings
- Travel time and speed by vehicle type:
  - Passenger vehicles
  - Trucks
  - All (passenger vehicles and trucks)



# NPMRDS: v1 vs. v2

	V1	V2
Data Vendor	HERE	UMD-INRIX-TTI-KMJ-IDAX
Temporal resolution	5-minute	5-, 10-, 15-, 60-minute
Epoch w/o obs.	Not included in the file	Has the option to include empty (null) values
TMC Path	Combined TMCs	Internal/External TMCs
Path Processing	No	Yes
GIS Shapefile	HERE LinkID TMC Look Up Table	TMC path 15 HPMS Data Items
Data Download	Multi-States/US; large files	Flexible, Customized selection
Temporal coverage	2011 – 1/31/2017	1/1/2017 – ( up to 12/31/2021)



# What's in the NPMRDS v2?

- Access to NPMRDS v2:

<https://npsmrds.ritis.org/analytics/>

1. TMC Shapefile (each state is a separate file)

<https://npsmrds.ritis.org/analytics/shapefiles>

2. TMC Identification table (.csv)

3. Speed/travel time data table (.csv)



# NPMRDS Supports Four PM3 Measures

- Reliability (2)
  - Percent of person-miles traveled on the Interstate that are reliable
  - Percent of person-miles traveled on the non-Interstate NHS that are reliable
- Freight (1)
  - Truck Travel Time Reliability (TTTR) Index
- CMAQ Peak Hour Excessive Delay (PHED)(1)
  - Annual Hours of PHED Per Capita



# The Vehicle Inventory Project

- Develop Vehicle Inventory Pictorial Illustrations
  - Develop Vehicle Axle Spacing Data and Illustrations
  - Develop Vehicle Tire Arrangement Data and Illustrations
  - Review FHWA 13 Vehicle Classes' Empty GVW, GVWR and Curb Weight Data
- 
- Final Report and Presentation:  
[https://www.fhwa.dot.gov/policyinformation/travel\\_monitoring/pubs/pl17016/index.cfm](https://www.fhwa.dot.gov/policyinformation/travel_monitoring/pubs/pl17016/index.cfm)





















# Vehicle Inventory Pictorial Data

- All 13 FHWA vehicle classes
- Minimum 20 vehicles per vehicle class (only 14 motorcycles, however)
- Minimum 650 vehicles
- Nationwide coverage



# FHWA 13 vehicle classes

FHWA Vehicle Classifications				
<p><b>1. Motorcycles</b> 2 axles, 2 or 3 tires</p> 	<p><b>2. Passenger Cars</b> 2 axles, can have 1- or 2-axle trailers</p> 	<p><b>3. Pickups, Panels, Vans</b> 2 axles, 4-tire single units Can have 1 or 2 axle trailers</p> 	<p><b>4. Buses</b> 2 or 3 axles, full length</p> 	
<p><b>5. Single Unit 2-Axle Trucks</b> 2 axles, 6 tires (dual rear tires), single-unit</p> 		<p><b>6. Single Unit 3-Axle Trucks</b> 3 axles, single unit</p> 	<p><b>7. Single Unit 4 or More-Axle Trucks</b> 4 or more axles, single unit</p> 	<p><b>8. Single Trailer 3- or 4-Axle Trucks</b> 3 or 4 axles, single trailer</p> 
<p><b>9. Single Trailer 5-Axle Trucks</b> 5 axles, single trailer</p>  		<p><b>10. Single Trailer 6 or More-Axle Trucks</b> 6 or more axles, single trailer</p>  		  
<p><b>11. Multi-Trailer 5 or Less-Axle Trucks</b> 5 or less axles, multiple trailers</p> 			<p><b>12. Multi-Trailer 6-Axle Trucks</b> 6 axles, multiple trailers</p>  	
<p><b>13. Multi-Trailer 7 or More-Axle Trucks</b> 7 or more axles, multiple trailers</p> 				



# Final Pictorial Count

Category	Total Count	Side Picture Count	Front Picture Count	Rear Picture Count	Dimension Picture Count
Class 1	14	14	2	2	2
Class 2	20	15	0	0	6
Class 3	36	20	0	0	4
Class 4	29	14	2	2	0
Class 5	23	19	1	1	1
Class 6	39	25	3	4	3
Class 7	36	27	1	1	0
Class 8	60	1	1	0	0
Class 9	75	28	2	1	0
Class 10	138	37	2	2	1
Class 11	30	3	9	0	0
Class 12	32	0	4	2	2
Class 13	172	37	4	4	2
<b>TOTAL</b>	<b>704</b>	<b>240</b>	<b>31</b>	<b>19</b>	<b>21</b>





# Class 3 Example

ID 3-2

FHWA Vehicle Class : 3

Mid Size Pickup

3D Model view



Back View

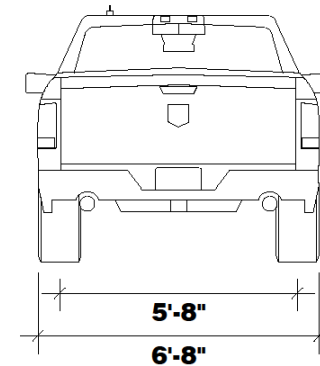

Side View

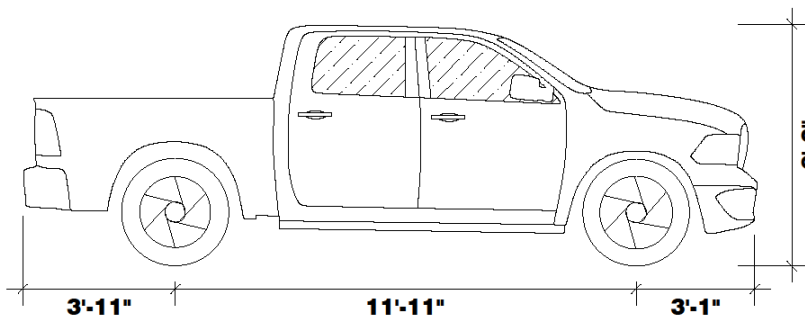

☆ Dimension Details

Vehicle Specification	Measured (Field)	Estimated (Pixel-base)	Variance (%)	Range
Front Overhang		3'-1"		
Interaxle_1		11'-11"		
Rear Overhang		3'-1"		
Overall Height	6'-8"	6'-3"	5.95%	
Overall Width	6'-7"	6'-8"	0.75%	
Rear Track	5'-8"	5'-8"	0.00%	

☆ Pixel dimension is based on rim size. Dimension in ft-in.

Location	No Data Available
Regions Operating	ALL
Main Commodity	No Data Available
Signature	

Dimension shown in figure is an example.

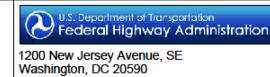

# Class 7 Example

ID 7-36

FHWA Vehicle Class : 7

Dump Truck(1-4)

3D Model view



Back View

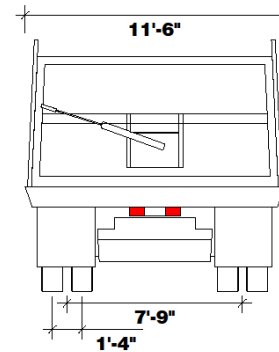

Side View

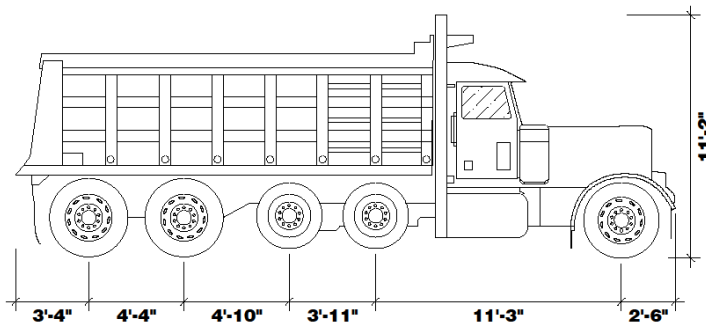

☆ Dimension Details

Vehicle Specification	Measured (Field)	Estimated (Pixel-base)	Variance (%)	Range
Front Overhang		2'-6"		
Interaxle_1		11'-3"		
Interaxle_2		4'-10"		
Interaxle_3		3'-11"		
Interaxle_4		4'-4"		
Rear Overhang		3'-4"		
Overall Height		11'-2"		
Overall Width		11'-6"		
Rear Track		7'-9"		
Twin Wheelbase		12'-4"		

☆ Pixel dimension is based on rim size. Dimension in ft-in.

Location	No data available
Regions Operating	ALL
Main Commodity	No data available
Signature	

Dimension shown in figure is an example.

U.S. Department of Transportation  
Federal Highway Administration  
1200 New Jersey Avenue, SE  
Washington, DC 20590



# Class 12 Example

**ID 12-22**

FHWA Vehicle Class : 12

2-S2-2 (Extended Hitch) Dump Truck

3D Model view



Back View

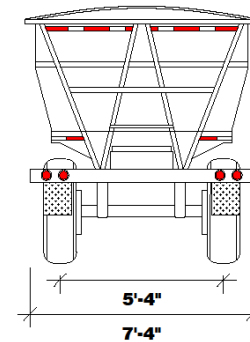

Side View

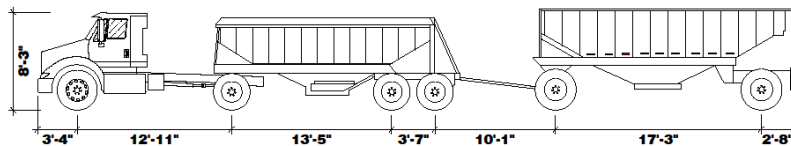

☆ Dimension Details

Vehicle Specification	Measured (Field)	Estimated (Pixel-base)	Variance (%)	Range
Front Overhang		3'-4"		
Interaxle_1		12'-11"		
Interaxle_2		13'-5"		
Interaxle_3		3'-7"		
Interaxle_4		10'-1"		
Interaxle_5		17'-3"		
Rear Overhang		2'-8"		
Overall Height		8'-3"		
Overall Width		7'-4"		
Rear Track		5'-4"		

☆ Pixel dimension is based on rim size. Dimension in ft-in.

Location	NE
Regions Operating	ALL
Main Commodity	No data available
Signature	

Dimension shown in figure is an example.

U.S. Department of Transportation  
Federal Highway Administration  
1200 New Jersey Avenue, SE  
Washington, DC 20590



# How can vehicle inventory data be used

- Freight analysis
- Pavement/bridge design
- Geometric design
- Safety analysis
- Environmental analysis (air/noise)
- Origin-Destination (when coupled with signature data)



# Summary

1. Vehicle Occupancy Data
2. Speed
3. National Performance Management Research Data Set (NPMRDS)
4. Axle Spacing and Body Type for Vehicle Classification (Vehicle Inventory)



# Thanks!

