

Fortify Your Networks with

# The Only Company to Truly Converge Networking and Security

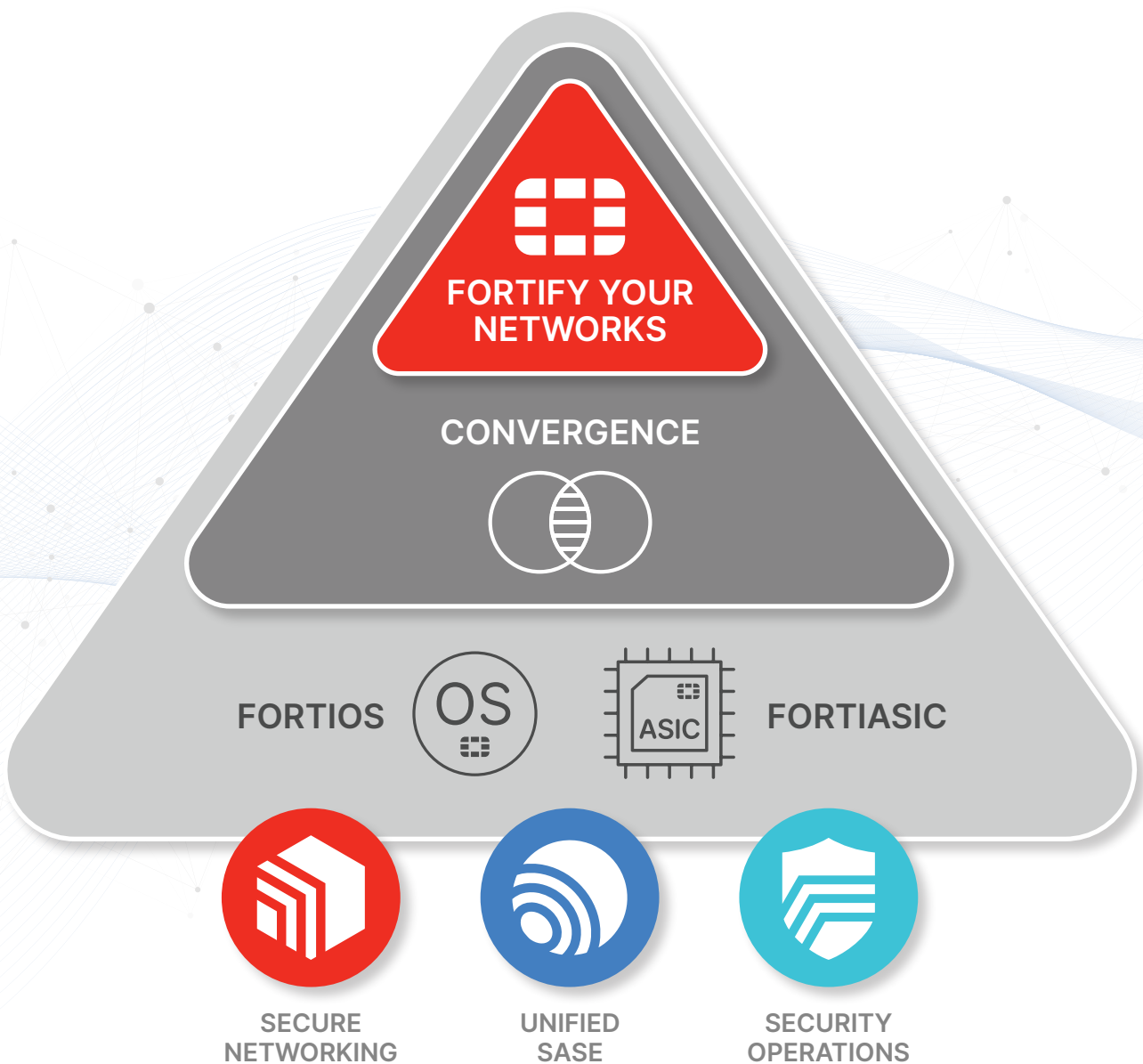

- **Founded:** October 2000
- **Member of:** Dow Jones Sustainability Index
- **Headquarters:** Sunnyvale, CA
- **NASDAQ 100 and S&P 500**
- **Fortinet IPO (FTNT):** November 2009

## FY 2023 Results

**Revenue**  
\$5.305B

**Billings**  
\$6.40B

## Q1 2024 Results

**Revenue**  
\$1.353B

**Billings**  
\$1.407B

**Op. Margin (GAAP)**  
23.7%

**EPS (GAAP)**  
\$0.39/share

**Cash + Investments**  
\$3.023B

**Market Cap**  
\$52.1B  
(AS OF MAR 31, 2024)

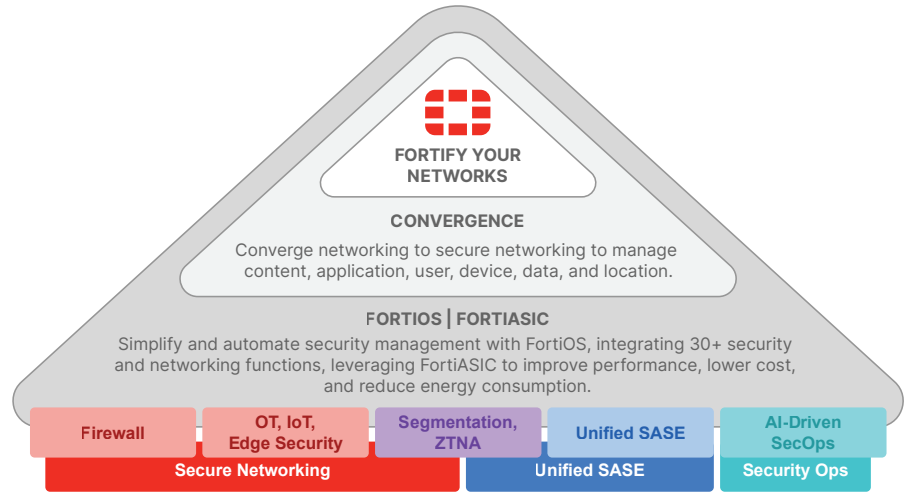

## Customers

755,000+

## Cumulative Units Shipped

12.2+ Million

## Headcount by Region

	U.S.	3,804
AMERICAS	CANADA	2,601
	REST OF AMERICAS	968
	FRANCE	519
EMEA	U.K.	450
	REST OF EMEA	2,455
APAC	INDIA	715
	JAPAN	622
	REST OF APAC	1,388
<b>TOTAL</b>		<b>13,522</b>

ALL INFORMATION AS OF MARCH 31, 2024

## Global Leader in Product Growth with Strong Growth in Annual Billings and Profitability

GAAP profitable every year since IPO

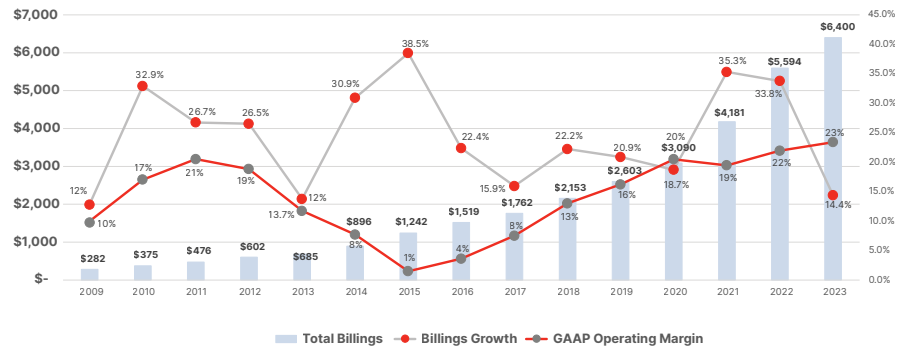

2009-2024 CAGR: 25.0%

## Highly Diversified Across Regions and Segments

Q1 2024  
REVENUE BY REGION

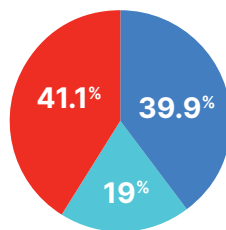

■ AMERICAS ■ EMEA ■ APAC

Q1 2024  
BILLINGS BY SEGMENT

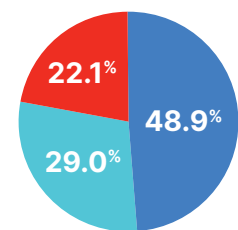

■ HIGH-END ■ MIDRANGE ■ ENTRY-LEVEL

# #1 Network Security Company in the World

## #1 in Enterprise

73% of Fortune 100 and 69% of Global 2000 depend on Fortinet to stay secure.



## #1 in Network Security

"Fortinet is the #1 vendor for firewall shipments globally with more than 50% share."  
-650 Group

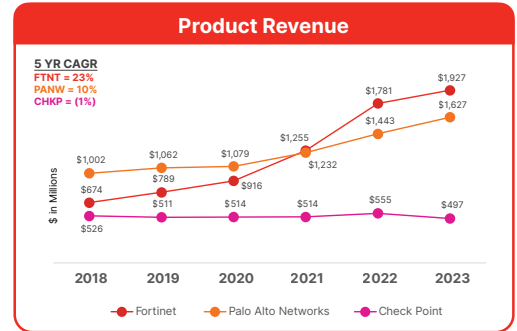
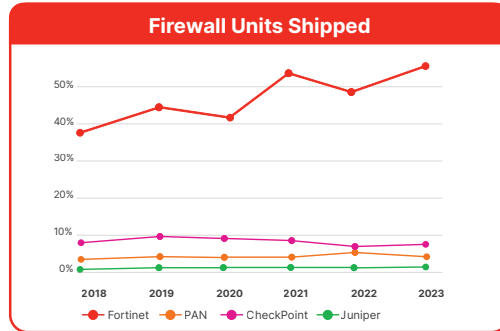

## #1 in Innovation

2x more patents than comparable cybersecurity companies.

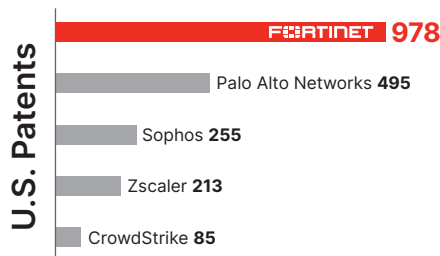

Source: U.S. Patent Office, as of March 31, 2024



**Innovation**  
~\$2.5B

investment in innovation since 2017, with 91% R&D

**Capital Return**  
~\$6.1B

repurchased 219M shares since 2017

## #1 Most Third-Party Validated

Leadership positions in eight Gartner Magic Quadrants.

**100+**  
Enterprise Analyst Reports Validate Fortinet Across Networking and Security

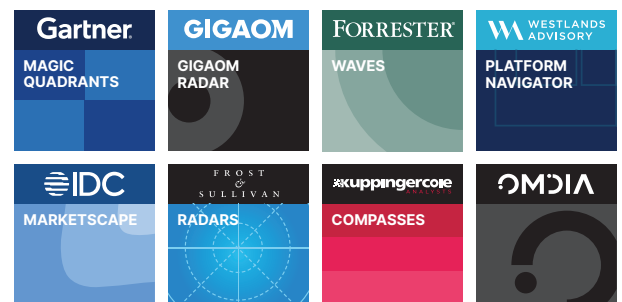

## #1 in Product Energy-Efficiency

Product environmental impacts are central to our sustainability approach.

**Second Consecutive Year**  
Member of  
**Dow Jones Sustainability Indices**

Powered by the S&P Global CSA

## Pledge to Reach Net Zero

By 2030 across scopes 1 and 2 emissions from Fortinet's owned facilities worldwide.



## Lead in Energy-Efficiency

**88%** less power consumption over industry-standard CPU

**66%** average reduction on product energy consumption<sup>1</sup>

<sup>1</sup> Based on new models of 2022 FortiGate F-series (compared to equivalent models from previous generation).

# Security at the Application and Content Layer

The main networking and internet protocols were designed 50 years ago. Its foundation was built on trusting everyone and connecting everything. Many cyberattacks today hide in the application and content layers where networking devices like routers and switches cannot see them. Fortinet Secure Networking is based on a zero-trust strategy, checking every application and its content, data, user, device, and location before making connections.

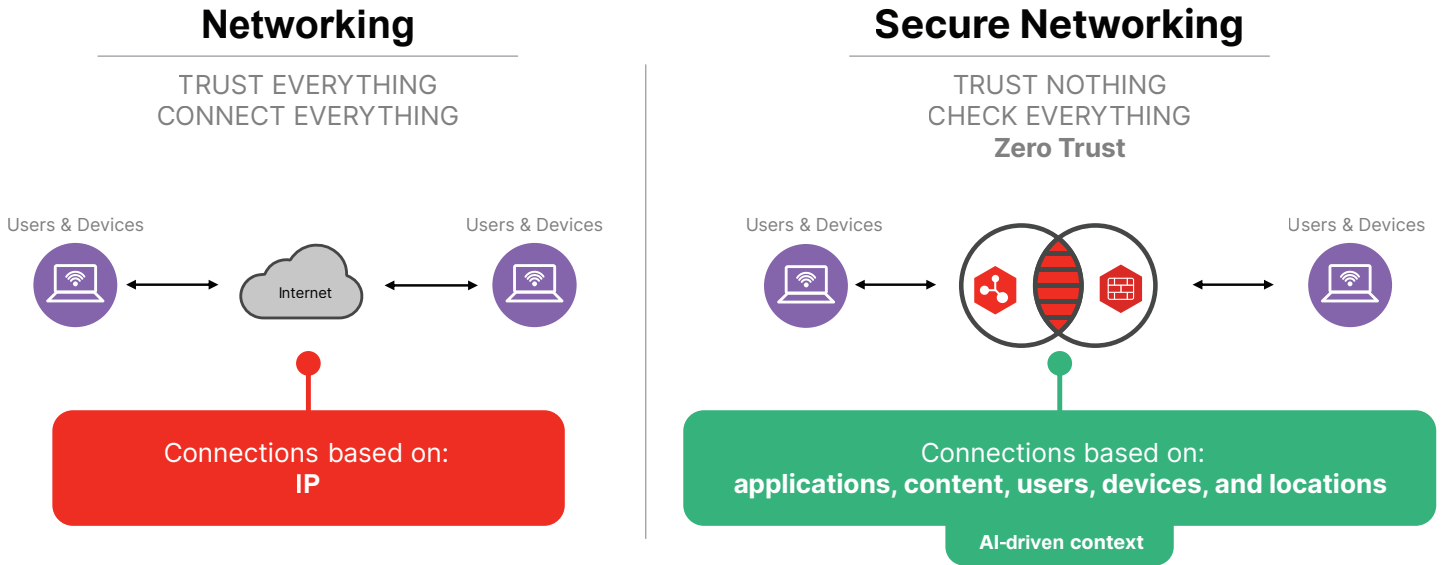

## Total TAM of \$145B in 2024, Growing to \$222B by 2028

Gartner forecasts that secure networking will be larger than connection-only networking by 2030 with secure networking components such as NGFW, Secure SD-WAN, SASE, and ZTNA as top investment priorities for customers today. Secure networking also means that networking and security teams, especially those assigned to the NOC and SOC, must work more closely together.



# The Fortinet Security Fabric: Cybersecurity, Everywhere You Need It

Within our unified platform, three solutions redefine cybersecurity, helping you to respond to an ever-evolving cybersecurity landscape to meet constantly accelerating business needs. The solution to simplifying complex networks, distributed users, and hybrid applications is the convergence and consolidation of security, all with flexible consumption models to make buying easy.

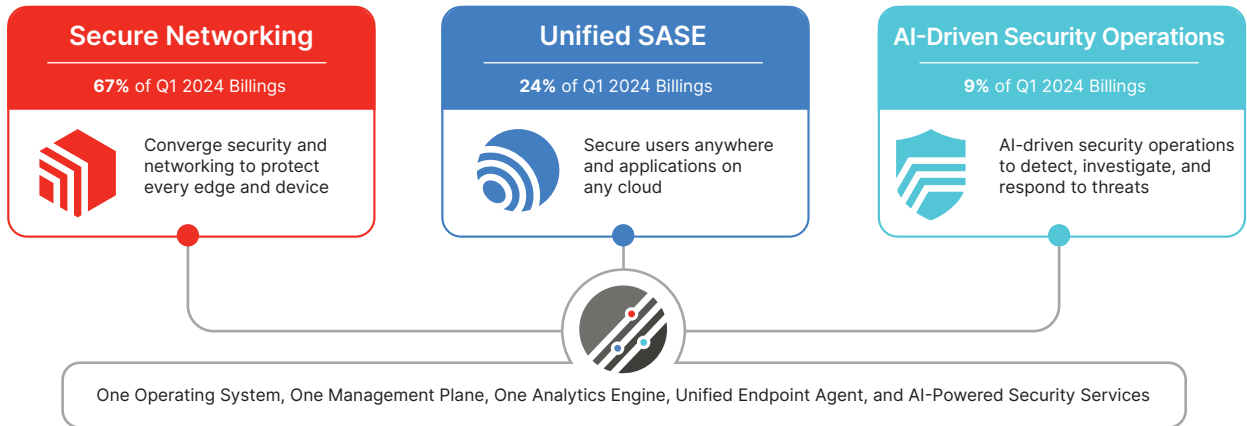

## The Only Purpose-Built Proprietary ASIC

Fortinet's ASIC-based security processing units (SPUs) radically increase the speed, scale, efficiency, and value of Fortinet solutions while greatly improving user experience, reducing footprint and power requirements. From branch and campus to data center solutions, SPU-powered Fortinet appliances deliver superior Security Compute Ratings versus industry alternatives.

### Network Processor 7 NP7



Network processors operate in-line to deliver unmatched performance for network functions and hyperscale for stateful firewall functions.

### Content Processor 9 CP9

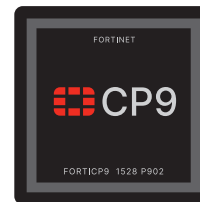

As a co-processor to the main CPU, content processors offload resource-intensive processing and drive content inspection to accelerate security functions.

### Security Processor 5 SP5



The security processor consolidates network and content processing, delivering fast application identification, steering, and overlay performance.

FortiSP5 concurrently supports 2x more applications than the previous generation.

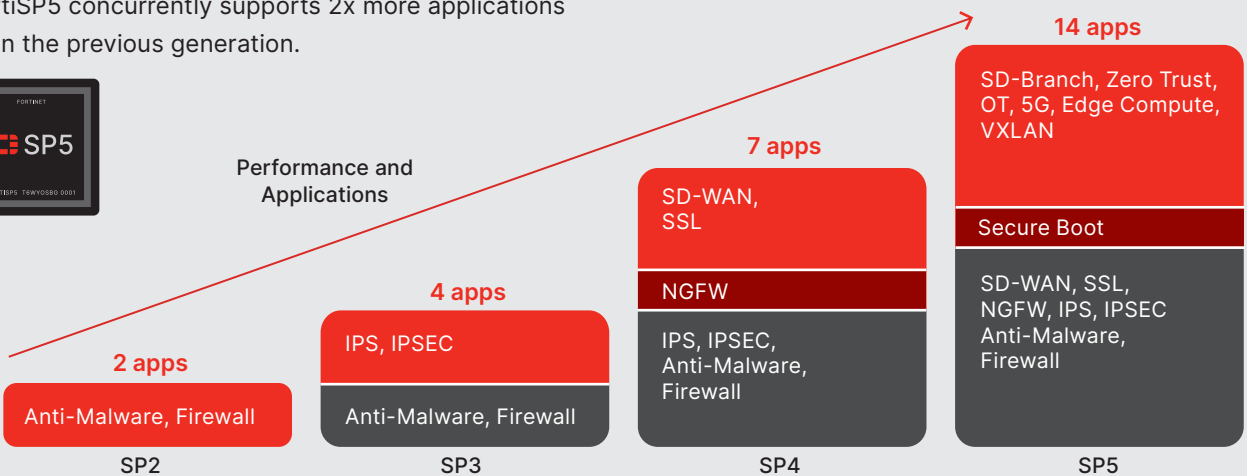



# Technology Advancements Enable Refresh and Replace Opportunities

Firewall appliances need to be refreshed and replaced on average every four to five years for better performance and to support more functions. The Fortinet FortiGate firewalls are, on average, 5–10x times faster than similar competitive firewalls, with many more functions integrated and automated together. With the seamless integration of FortiOS and FortiASIC, they are also 5x more power efficient.

**Better Performance**

Security Compute Rating

**7x** better than the competition

201G Security Compute Rating

**Better Efficiency**

Security Compute Rating - Energy

**29x** better than the competition

90G Security Compute Rating

**Better Security**

FortiGuard Labs

**99.88%** security effectiveness

Competitors: <80% security effectiveness

CyberRatings.org Security Effectiveness Report

Data Center Perimeter Firewall

Core Segmentation Firewall

Distributed Firewall

Firewall-as-a-Service

OT Firewall

Cloud-Native Firewall

Virtual Machine Firewall

Container Firewall

Expand to Hybrid Mesh Firewall

## A New Perimeter Security Approach with the FortiGate 200G

The FortiGate 200G series redefines next-generation firewall (NGFW) performance with the revolutionary SP5 security processing chip. When coupled with FortiGuard AI-Powered Security Services, like the Enterprise Protection Bundle, this powerhouse delivers a significant performance boost in throughput to accelerate intrusion prevention system (IPS) capabilities for faster and more reliable deep packet inspection, including SSL inspection of encrypted traffic.



Energy-efficiency

Cutting-edge SP5 security chip

New standard in network connectivity

Performance numbers taken from external data sheets match as closely as possible. Different testing methodologies may be applied by different vendors.

Specification	FortiGate 201G	Security Compute Rating	Competitive Average	PAN PA-1410	Cisco Firepower 1140	Check Point Quantum 3600	Juniper SRX 380
Firewall (Gbps)	39	<b>7X</b>	5.9	8.5	6	4	5.00
IPsec VPN (Gbps)	35	<b>16X</b>	2.3	4.1	1.2	2.75	0.97
Threat Protection (Gbps)	6.4	<b>2X</b>	2.9	4.2	-	1.5	-
Concurrent Sessions	11,000,000	<b>8X</b>	1,430,000	945,000	400,000	4,000,000	375,000
Connections per Second	390,000	<b>6X</b>	68,750	100,000	100,000	60,000	15,000
<b>Power Consumption</b>		<b>Energy Efficiency</b>					
Watts/Gbps Firewall Throughput	4.5	<b>4X</b>	18	21.18	16.67	10.00	24.40
Watts/Gbps IPsec VPN Throughput	5.0	<b>13X</b>	67	43.90	83.33	14.55	125.77
BTU/hr per Gbps of FW Throughput	15.4	<b>4X</b>	61	72.21	56.83	30.75	84.00

# The Only Way to Secure Agentless Devices Is through Secure Networking

OT/IoT security will remain one of the fastest growing areas. The only way to secure most OT/IoT devices is through secure networking, as most of these devices have very limited computing power to run security software agents, especially given the many different kinds of operating systems on these devices. As the only leader in the OT/IoT security-based Westlands Advisory Platform Navigator, Fortinet offers the broadest range of products designed to address the unique needs within healthcare, manufacturing, utilities, and other sectors.

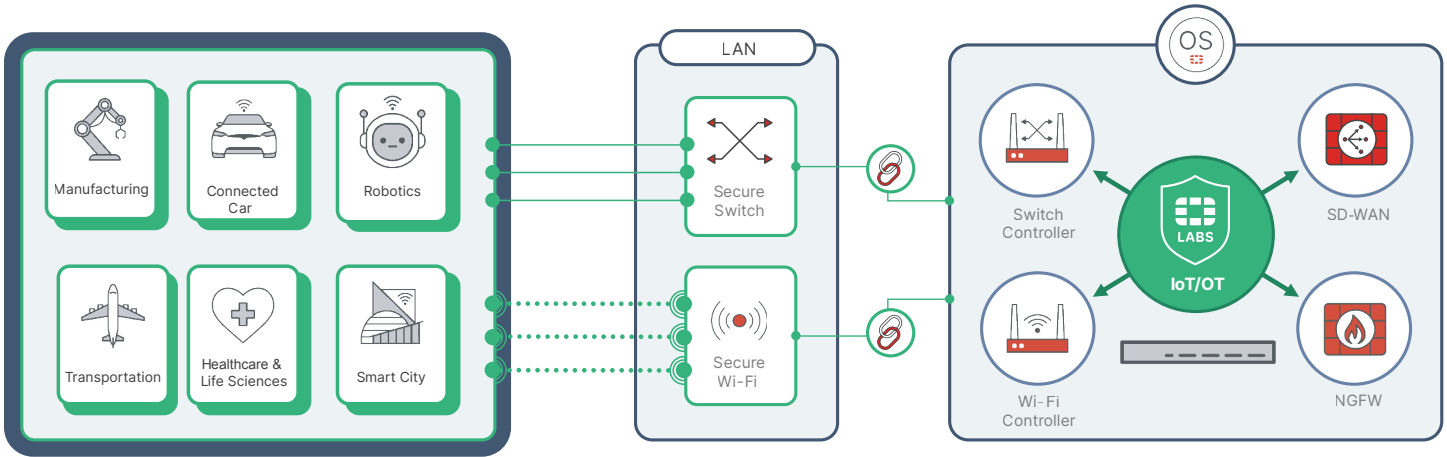

## Detect and Respond to Sophisticated Cyberthreats Faster

Our consolidated security operations solution, built on AI and automation, offers the broadest attack surface coverage and cyber kill chain coverage to accelerate incident detection and containment, as well as investigation and response across your entire infrastructure.

### NIST Cybersecurity Framework

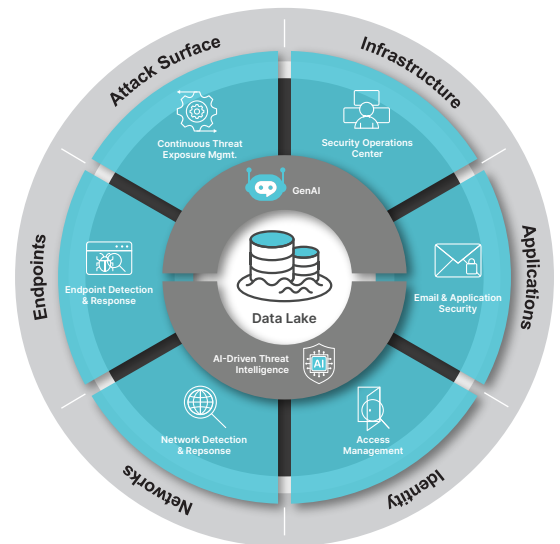
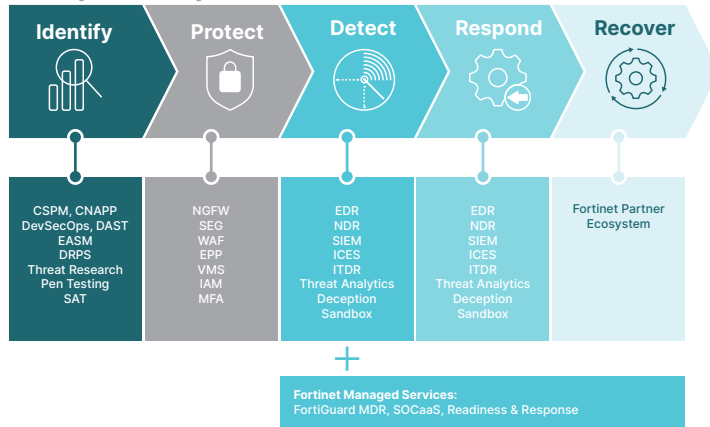



# Single-Vendor SASE Requires a Hybrid Approach

Fortinet's Unified SASE offers two huge advantages over all other competitors. Fortinet is the only company to have built all of the SASE functions directly into the Fortinet operating system, FortiOS, including SD-WAN and all SSE functions. We are also the only company that is able to deploy SASE in both the cloud and locally, with software and hardware agents.

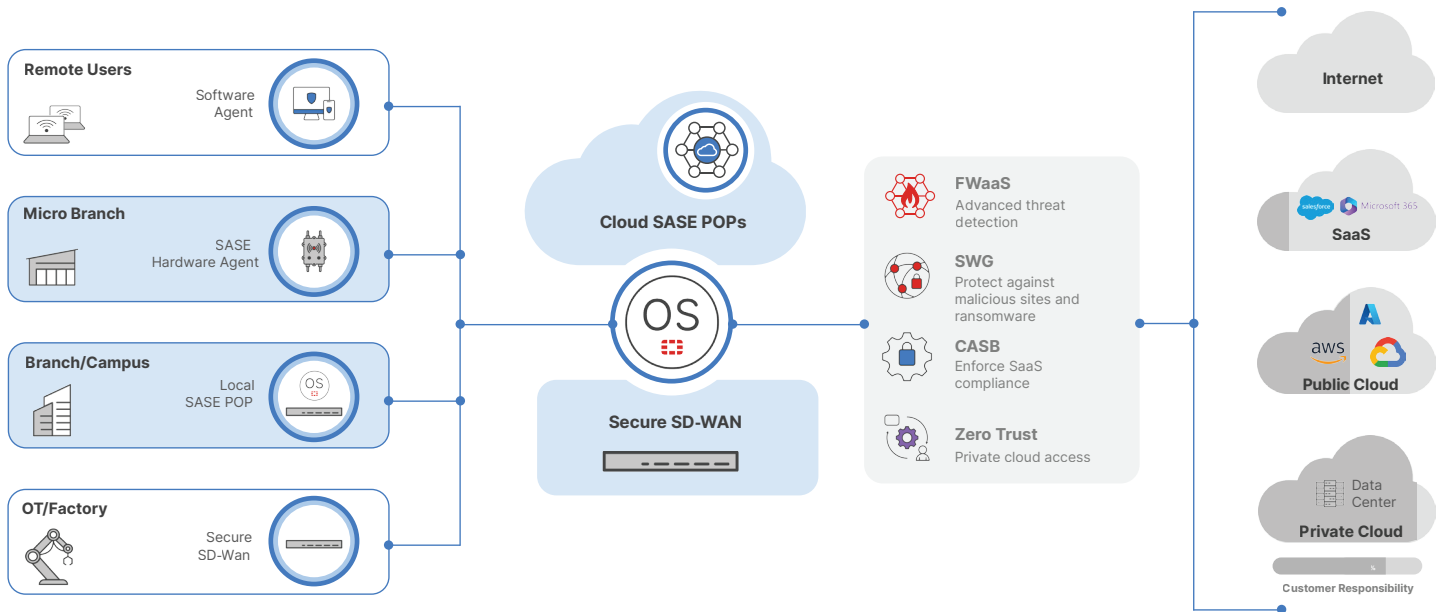

## Organically Built and Fully Integrated

Our Unified SASE solution is the most robust on the market, providing secure internet access, secure corporate access, and secure SaaS access, all in a single integrated solution. This is validated through our leadership and acknowledgement in eight separate Gartner® Magic Quadrant™ reports. Additionally, with the same FortiOS across five distinct markets, customers can better mitigate risk, reduce complexity, and realize a superior user experience.

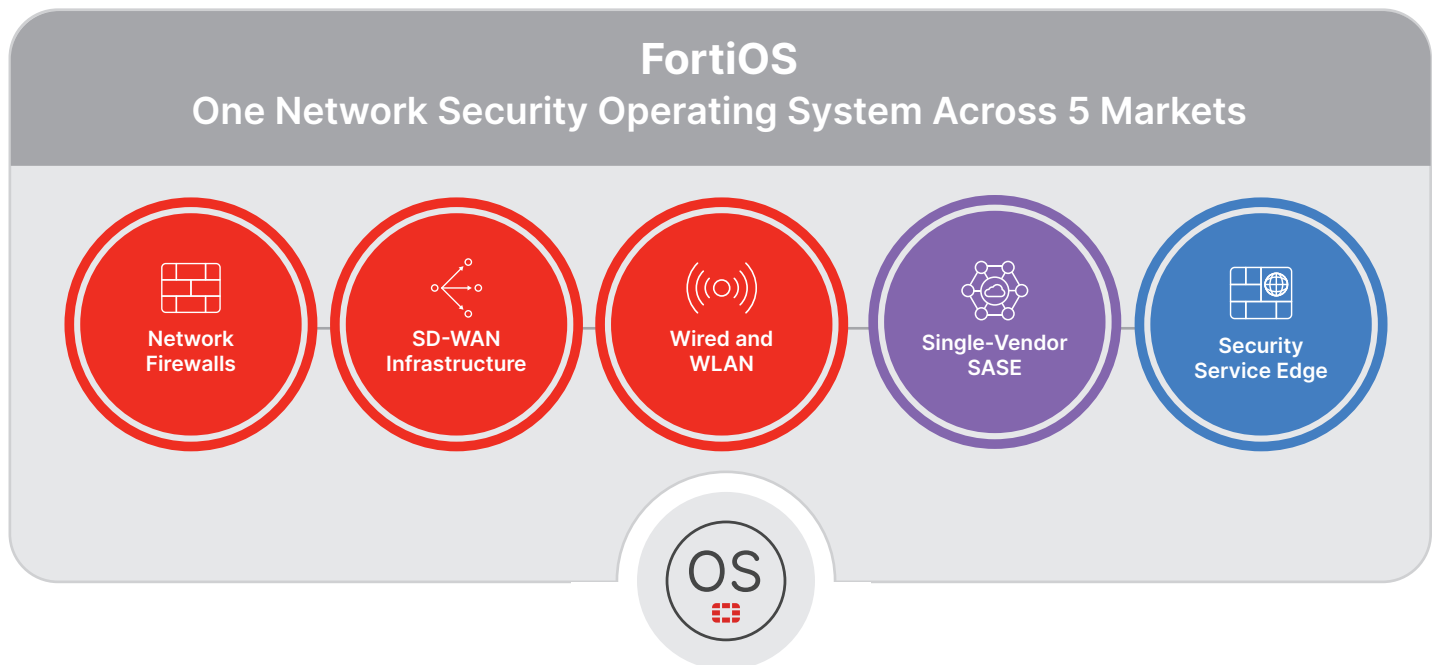





# FortiGuard Labs: The AI Engine Behind Advanced, Proactive Security

Founded in 2002, FortiGuard Labs is Fortinet's elite cybersecurity threat intelligence, and research organization that provides customers with timely and consistently top-rated protection and actionable threat intelligence. It partners with law enforcement, government agencies, and security vendors worldwide to fight emerging security risks. FortiGuard Labs plays a crucial role in powering the Fortinet Security Fabric by creating a proactive, unified, and intelligent defense platform powered by AI/ML.



### Trusted ML and AI

Stop unknown threats faster with a powerful combination of actionable local learning and AI and ML models on large-scale, cloud-driven data lakes.



### Real-Time Threat Intelligence

Achieve a proactive security posture with continuous security updates based on in-house research and collaboration.



### Threat Hunting and Outbreak Alerts

Achieve faster remediation with alerts, analysis and detection, prevention and remediation tools, including outbreaks.

Global Leadership and Collaboration



## FortiGuard AI-Powered Security Services

This rich set of industry-leading security capabilities has been unified into one security framework to deliver coordinated, context-aware policy for hybrid deployments across networks, endpoints, and clouds. These services continually assess risk and automatically adjust prevention to counter known and unknown threats in real time.

### Market-Leading Security-as-a-Service

ML-enabled security, deployed close to the protected assets, powered by FortiGuard Labs.

### Consistent Context-Aware Policy

Centralized detection and prevention delivered from the cloud and built for hybrid environments.

### Coordinated Real-Time Prevention

Continuous risk assessment and automatic response to counter known and unknown threats.

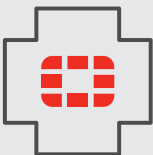

## FortiCare: Expertise at Your Service

Learn more at [fortinet.com/support](https://fortinet.com/support)

FortiCare Services helps thousands of organizations every year to get the most out of their Fortinet Security Fabric solutions. We have over 1,900 experts providing accelerated implementation, reliable assistance, and proactive care through advanced support and professional services to maximize your security and performance.

**1,900+**  
EXPERTS



**24x7**  
TECHNICAL  
SUPPORT



**23**  
GLOBAL SUPPORT  
CENTERS



Whether on-prem, cloud-based, simple or complex hybrid topology adopting new technologies is not a project with a start and a finish. Instead, it is a journey from design and implementation to optimization, operations, and ongoing management of the solution. Fortinet has you covered every step of the way, freeing up your resources to focus on your business needs.

# Our Global Partner Commitment

Fortinet leverages a global network of trusted advisors our customers can rely on to secure digital acceleration and strategically drive business growth.



The Engage Partner Program helps partners build a highly differentiated security practice by leveraging Fortinet solutions to drive customer success. Our global partner program is driven by three concepts:

## Growth through Technology Differentiation

Our broad portfolio is integrated into an automated, high-performance platform that spans endpoints, networks, remote workers, and clouds.



## Business Success with Proven Credibility

Our technology innovation and industry-leading threat intelligence, alongside customer ratings and independent analyst reports, validate and differentiate partner offerings.

## Long-Term, Sustained Growth

The Engage Partner Program provides sales, marketing, and executive support so partners can grow successful relationships. With growth drivers like specializations built into the program, we provide solutions that are driving market demand, ensuring partners are positioned for success.

# FORTINET Training Institute

Fortinet has pledged to train 1 million people by 2026 through our Training Advancement Agenda (TAA) and award-winning Training Institute programs.

## NSE Certification Program

Twelve certifications to assess specific levels of cybersecurity expertise, from foundation to expert. Supported by 119 Authorized Training Centers that deliver technical training in over 150 countries.

## Training and Education Programs

Increase access to Fortinet certifications including students and a diverse population, including women, minorities, veterans, and other underrepresented groups.

## Security Awareness and Training Service

Delivers awareness and training on today's cybersecurity threats and helps IT, security, and compliance leaders build a cyber-aware culture.

An Education Edition, with additional student curriculum, is available at no cost to all K-12 schools in the U.S., U.K., Australia, Canada, and Brazil, with plans to expand to other countries.



**1,500,000+**  
CERTIFICATIONS



**702**  
ACADEMIC  
PARTNERS IN 100  
COUNTRIES



**47**  
EDUCATION OUTREACH  
AND VETERANS  
PROGRAM PARTNERS

# 100+

## Enterprise Analyst Reports Validate Fortinet Across Networking and Security



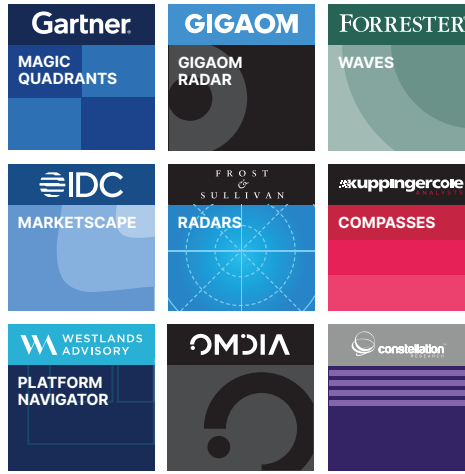





Fortinet is one of the most validated enterprise cybersecurity companies in the world. We continually rank in leadership positions across dozens of analyst reports, highlighting the broad application of the Fortinet Security Fabric.



Learn more at [fortinet.com/solutions/analyst-reports](https://fortinet.com/solutions/analyst-reports)

## Fortinet is recognized in 8 Gartner® Magic Quadrant™ reports based on the Fortinet Security Fabric Platform

Fortinet's network security offerings are uniquely based on one operating system, FortiOS, and seamlessly integrates into the Security Fabric platform, so customers can better mitigate risk, reduce complexity, and realize a superior user experience.

 <b>Network Firewalls</b>	 <b>SD-WAN Infrastructure</b>	 <b>Single-Vendor SASE</b>
 <b>Endpoint Protection Platforms</b>	 <b>Wired and WLAN</b>	 <b>SIEM</b>
 <b>Security Service Edge</b>	 <b>Access Management</b>	

## Third-Party Testing and Certifications

Fortinet submits its products for impartial, third-party performance and effectiveness testing with the most prominent organizations in the industry, with consistent positive results.



Antiphishing approved



100% protection, two years in a row



Highest "VBSpam+" rating



Near perfect score for WAF at 96%

GARTNER and MAGIC QUADRANT are registered trademarks and service marks of Gartner, Inc. and/or its affiliates in the U.S. and internationally and are used herein with permission. All rights reserved. Gartner Peer Insights content consists of the opinions of individual end users based on their own experiences with the vendors listed on the platform, should not be construed as statements of fact, nor do they represent the views of Gartner or its affiliates. Gartner does not endorse any vendor, product or service depicted in this content nor makes any warranties, expressed or implied, with respect to this content, about its accuracy or completeness, including any warranties of merchantability or fitness for a particular purpose.

## CUSTOMER RECOGNITION



Gartner Peer Insights Customers' Choice distinctions are based on the ratings of vendors by verified end-user professionals across a variety of industries and from locations around the world. These distinctions take into account both the number of end-user reviews a vendor receives, along with the overall ratings score a vendor receives from those end-users.

### Fortinet is proud to be named a Gartner Peer Insights Customers' Choice in several critical areas:

- Wired and Wireless LAN
- Network Firewalls
- SD-WAN
- Email Security
- Security Service Edge (SSE)
- Endpoint Protection Platforms (EPP)

See our Gartner Peer Insights reviews and distinctions at [www.gartner.com/reviews](https://www.gartner.com/reviews)

Gartner, Gartner Peer Insights 'Voice of the Customer': Network Firewalls, Peer Contributors, 9 April 2021

Gartner, Gartner Peer Insights 'Voice of the Customer': Wired and Wireless LAN Access Infrastructure, Peer Contributors, 12 May 2021

Gartner, Gartner Peer Insights 'Voice of the Customer': Email Security, Peer Contributors, 5 February 2021

Gartner, Gartner Peer Insights 'Voice of the Customer': WAN Edge Infrastructure, Peer Contributors, 5 February 2021

Gartner, Gartner Peer Insights 'Voice of the Customer': Security Service Edge (SSE), Peer Contributors, 29 September 2023

Gartner, Gartner Peer Insights 'Voice of the Customer': Endpoint Protection Platforms, Peer Contributors, 18 September 2023

The GARTNER PEER INSIGHTS CUSTOMERS' CHOICE badge is a trademark and service mark of Gartner, Inc. and/or its affiliates and is used herein with permission. All rights reserved. Gartner Peer Insights Customers' Choice constitute the subjective opinions of individual end-user reviews, ratings, and data applied against a documented methodology; they neither represent the views of, nor constitute an endorsement by, Gartner or its affiliates.

# Fortinet secures over 755,000 enterprises, service providers, and government organizations around the world.



HOTELS & RESORTS

Global hospitality company with 18 hotel brands and over 6,000 hotels in over 100 countries and more than 1,900 in development.

HQ: EMEA



DP WORLD

Leading men's professional golf tour in Europe, featuring tournaments all over European regions.

HQ: EMEA



Australia's largest private rail freight operator. Operating 24 hours a day, seven days a week, 365 days a year.

HQ: APAC



2,400+ locations nationwide and consistently ranked in the top 10 franchises in America in *Entrepreneur* magazine's annual Franchise 500.

HQ: NAM



Second-largest fast-food chain in the world. India became the 100th country to open over 380 locations.

HQ: APAC



Global leader in high-performance low-code application development of mobile and web enterprise applications.

HQ: US and EMEA



Global industrial leader in technology and aerospace manufacturer and service provider.

HQ: US



Largest automotive services company in North America, with over 4,400 locations across 15 countries servicing over 50 million vehicles annually.

HQ: NAM



The leading enabler of Advanced Air Mobility (AAM), providing the critical link between the ground and the sky.

HQ: EMEA

Visit [fortinet.com/customers](https://fortinet.com/customers) to see how our customers benefit from Fortinet solutions and the Fortinet Security Fabric.



Copyright © 2024 Fortinet, Inc. All rights reserved. Fortinet®, FortiGate®, FortiCare® and FortiGuard®, and certain other marks are registered trademarks of Fortinet, Inc., and other Fortinet names herein may also be registered and/or common law trademarks of Fortinet. All other product or company names may be trademarks of their respective owners. Performance and other metrics contained herein were attained in internal lab tests under ideal conditions, and actual performance and other results may vary. Network variables, different network environments and other conditions may affect performance results. Nothing herein represents any binding commitment by Fortinet, and Fortinet disclaims all warranties, whether express or implied, except to the extent Fortinet enters a binding written contract, signed by Fortinet's General Counsel, with a purchaser that expressly warrants that the identified product will perform according to certain expressly-identified performance metrics and, in such event, only the specific performance metrics expressly identified in such binding written contract shall be binding on Fortinet. For absolute clarity, any such warranty will be limited to performance in the same ideal conditions as in Fortinet's internal lab tests. Fortinet disclaims in full any covenants, representations, and guarantees pursuant hereto, whether express or implied. Certain offerings mentioned herein may not be generally available, and Fortinet reserves the right to change, modify, transfer or otherwise revise this publication without notice, and the most current version of the publication shall be applicable.

Revision: Q4 / 2024 v1 June 3, 2024 1:24 PM