



# Understanding Control Room Solutions for Your Business

Whitepaper

# 01 Control Room Overview

The control room is the space where a system is controlled to monitor an area for situation awareness, and should be structured accordingly. The control room is a mission-critical environment that needs to operate 24 hours a day, 365 days a year. Since reliability and stable operation are required, there are many collateral systems to prevent power or signal failure.

The control room consists of three main components: a visual solution that displays the overall area/situation, a control solution that processes AV signals, and a variety of terminal devices that are monitored and controlled.

The visual solution displays information about the overall situation, mainly through a video wall or DVLED solution.

The control solution consists of controller equipment (a matrix switcher and video wall controller) that controls and processes various video and audio signals. It can be connected to the visual solution to form screens with different layouts.

Terminal devices (CCTV, servers, IP cameras, set-top boxes, etc.) can be connected to the control solution by various means (HDBaseT, HDMI, DP, DVI, etc.) for real-time monitoring and control.

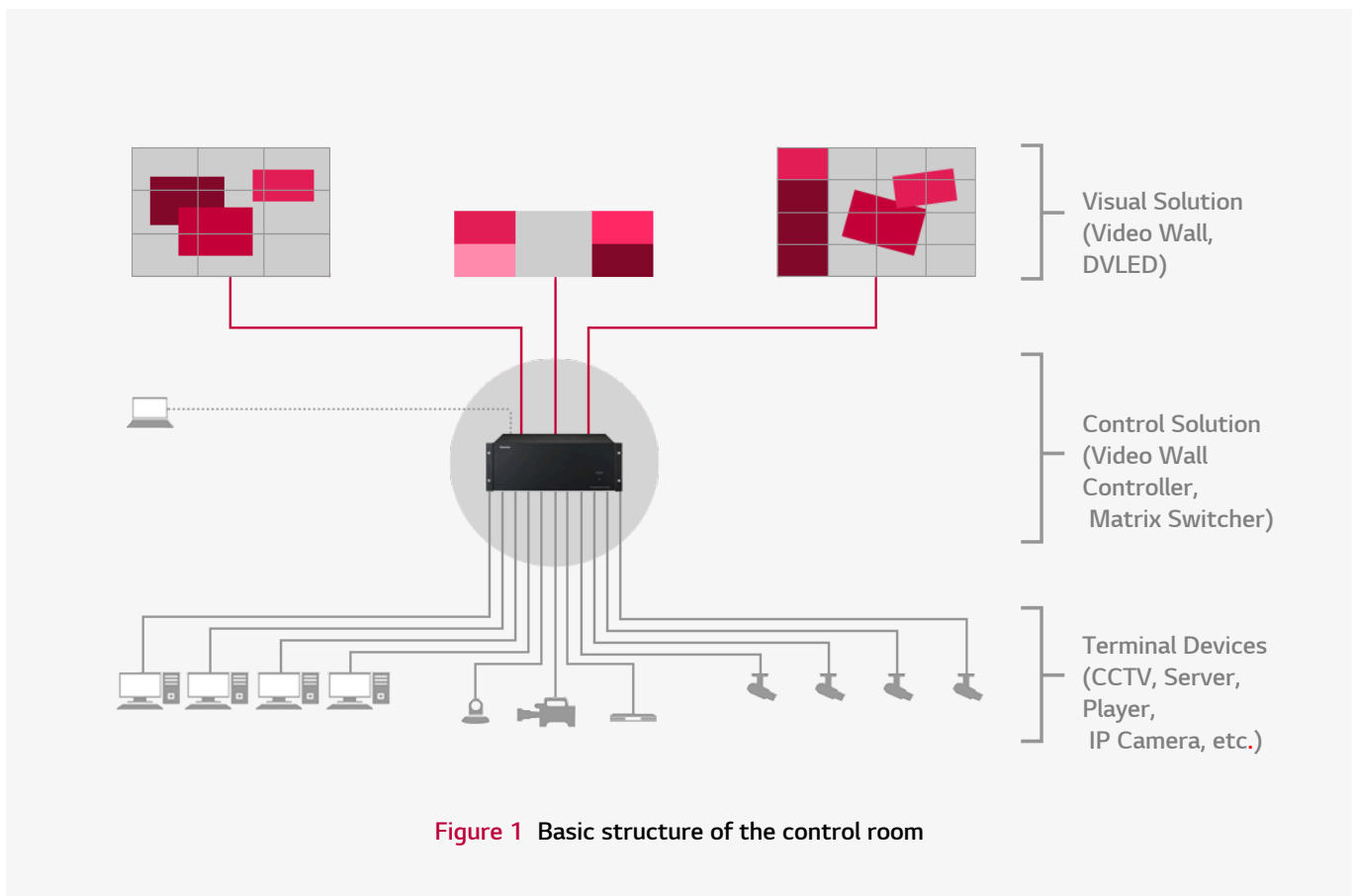

Control rooms are used for traffic monitoring and management, telecommunications and network operation, utilities and power plants, command and control, and security and surveillance.



For traffic monitoring and management, road congestion can potentially be reduced by collecting and analyzing traffic information. By using high-resolution CCTV or IP cameras installed on the road or sidewalk, traffic conditions are monitored in real time. The visual solution suitable for traffic control operates 24 hours a day, and you can use a bezel-less video wall or a fine-pitch DVLED that can display road maps and camera images in high resolution.



**Figure 2** Traffic monitoring and management

For telecommunications and network operation, a variety of real-time information can be shown – such as network transmission, network traffic of base stations, number of simultaneous users, and so on – through central servers for easy identification. The status of the nationwide network and the network availability level can also be displayed.

The visual solution for telecommunications and network operation should be available for 24 hours a day and should not interfere with the configuration of network equipment or displaying traffic information. For example, when showing a network configuration with lines, the bezel can obstruct the image. Therefore, you need a visual solution to meet your visual display requirements.



**Figure 3** Telecommunications and network operation  
(Source: <http://fortune.com/att-global-network-operations-center/>)

For utilities and power plants, control rooms are used for real-time monitoring of power and facility operation status, such as power plant management, electricity distribution, and transmission. A control room is connected to central servers called the Supervisory Control and Data Acquisition (SCADA) system, which lets you diagnose problems and make quick decisions by managing and supervising the facility while viewing the facility configuration diagram. Since the SCADA system shows lines, connection diagrams, and schematic diagrams, the visual solution should have no bezel and the system needs to transmit and show that YCbCr 4:4:4 sampling is being used.



**Figure 4** SCADA system screen for utilities and power plants

In command and control rooms, various real-time videos, sound, and multimedia data are shared and rapid situation response from the battlefield is required to quickly and accurately handle field situations. Source video of the combat scene, combat mission-based databases, detailed and accurate 2D and 3D terrain maps, and height data must be visualized and viewable at a glance.

A visual solution suitable for command and control should operate 24/7 and should be capable of smooth reproduction of the dynamic motion in battlefields, 2D and 3D terrain elevation representation, and high-resolution representation of real terrain through satellite imagery. It should also be able to accurately display the situation in the field with detailed color representation.



**Figure 5** Command and control  
([https://en.wikipedia.org/wiki/North\\_American\\_Aerospace\\_Defense\\_Command](https://en.wikipedia.org/wiki/North_American_Aerospace_Defense_Command))

Security and surveillance control rooms are spaces where immediate decision-making is performed for security issues, accidents, and other field issues. People can use equipment and systems with image processing technology and real-time image acquisition in order to identify criminals through facial recognition from input sources such as IP cameras, or monitor intrusion into certain areas through sensors.

For a visual solution suitable for security and surveillance, you can use a video wall with high resolution and color representation, or DVLED.



Figure 6 Security and surveillance

## 02 Control Room Trends

With the advancement of IT and signal transmission technology, it has become easier to construct a centralized control room that can collect data and signals in one place. And, with the development of remote control and communication technology, the need for centralized control rooms is gradually increasing. In addition, the demand for a small war room with video walls installed, where a small number of top management personnel make major decisions, is also increasing.



In the past, we have produced ultra-large screens for visual solutions in control rooms by tiling a video wall and using displays with a thick bezel (3.5mm or more), or by using a DLP display. Nowadays, however, the LG Video Wall, with a near-seamless 0.44mm bezel, is increasingly being used for big screens in control rooms.

In addition, with the development of DVLED technology and the falling price of LED chips, there has been an increasing use of fine-pitch DVLEDs for the visual solution in control rooms.

As anxiety over terrorism and disaster increases and situation detection technology develops, the control scale is gradually increasing, including the size of the video wall or screen in the control room. Although the size of the space has not changed much, the number of displays in the same space has more than doubled. Additionally, software breakthroughs mean that control technology will also evolve by the use of virtual reality.

As 4K cameras have become more and more popular, 4K signal transmission equipment has developed rapidly, and demands for high-resolution visual solutions are increasing. In addition, since multi-angle pictures can be taken with miniaturized cameras and drones, and the real-time signal transmission of such has become possible, their usage in the field is increasing, for example, with US police drones and personal action cams. This is expected to increase demand for signal transmission equipment and high-definition displays, and to create demand for upgrading the control room in the long term.



# 03 Features According to Control Room Size

Control rooms can be categorized as large, medium, or small, according to the size of their visual solutions. A large control room will have a video wall with an expandable space ratio of  $M \times N$ , in other words, an unlimited number of tiled displays. Medium control rooms have a limited expandable space for their video walls, with a ratio of  $2 \times N$  or  $3 \times N$ , so, two or three displays can be installed vertically, but an unlimited number of displays horizontally. Finally, a small control room will have an expandable space of  $2 \times 2$  or  $3 \times 3$ .

## Large Control Room

LG defines a large control room generally as having a floor-to-ceiling height of at least 5 meters, emphasizing the viewing angle of the visual solution, which should be clearly visible at a distance. In addition to the situation room, there is normally a separate room for briefings. A large telecom network operation center is a typical example of a large control room.,



Figure 7 Large control room

A large control room's ultra-large, attention-grabbing screen can build trust for your VIP customers. The control room should provide flexible installation and layout for the video wall with scalability and mobility of the installed equipment, and necessary management convenience. In addition, it should be possible to expand the screen without limit, and the control room systems should also be expanded accordingly. To show critical and important information on the screen, visibility for the user should be increased by delivering accurate and clear picture quality.

LG's Video Wall products, such as the SVH7E (0.44mm bezel) or VH7E (0.9mm bezel), can be used as the visual solution in a large control room. Alternatively, fine-pitch DVLEDs can be used, such as LG's LAPE series (with 1.5, 2.0, or 2.5mm pixel pitch).

Major features include fast and reliable digital video and audio switching, video signal distribution for a variety of AV sources, and complete modular architecture design for stability and high performance. They can be configured as matrix switchers and video wall controllers with a variety of AV source input processing.

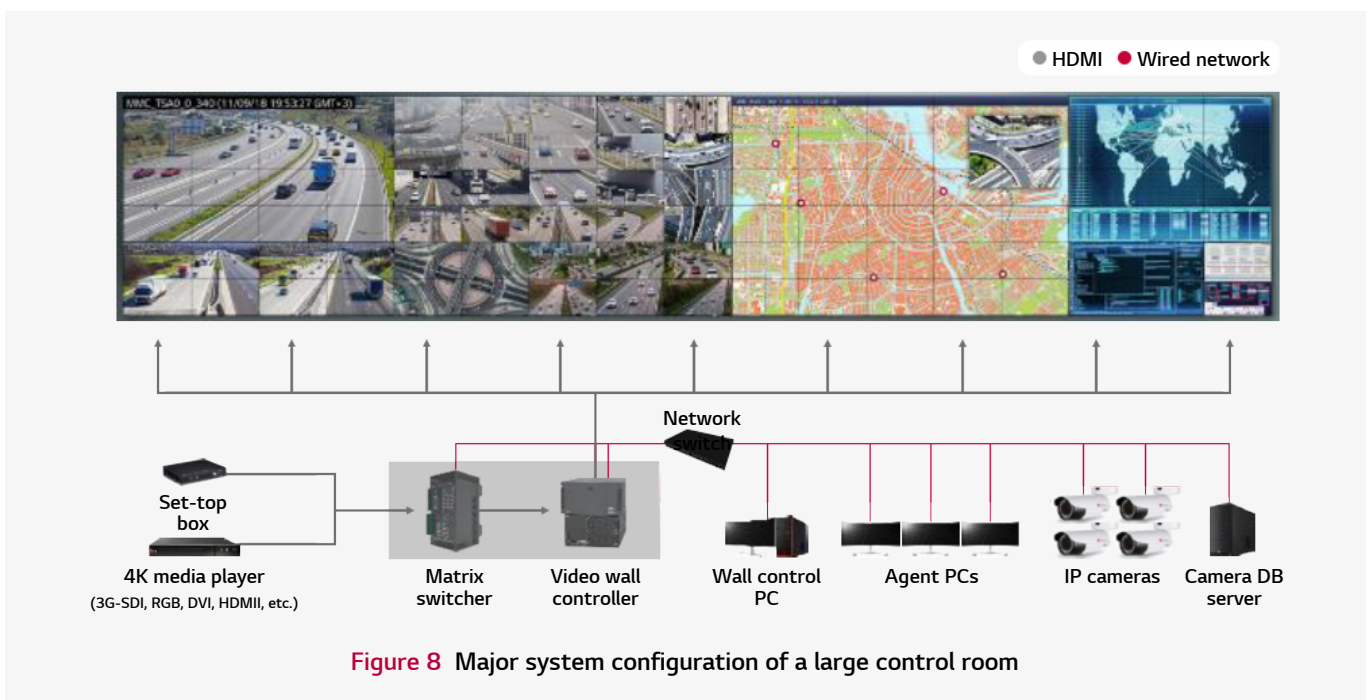

Figure 8 Major system configuration of a large control room

### Medium Control Room

LG defines medium control rooms as those having a floor-to-ceiling height of 2.7–3 meters, with the screen installed higher than 1.5 meters above the floor to be viewed easily when the control personnel are seated. Due to the limited floor-to-ceiling height, the video wall will be at least two, but no more than three displays high. A corporate security control room is an example of a typical medium control room.



Figure 9 Medium control room

For the medium control room, the limited space should be used efficiently by placing displays accordingly. In addition, the visualization of data to be shown on the medium-sized display should be done easily and smoothly, and an integrated environment of AV solutions and IT solutions should also be provided. In an emergency situation, the video wall can also be used as a communication device for quick decision-making based on the information available in the control room, and the current situation should be shown to many people simultaneously.

The 2 × N or 3 × N video wall models proposed by LG are the 55SVH7E (0.44mm bezel) and the 49/55VH7E (0.9mm bezel).

Major features include fast digital video and audio switching similar to the large control room, video signal distribution for a variety of AV sources, and complete modular architecture design for expandability. They also use an integrated hybrid wall controller system based on IP video streaming and video cables.

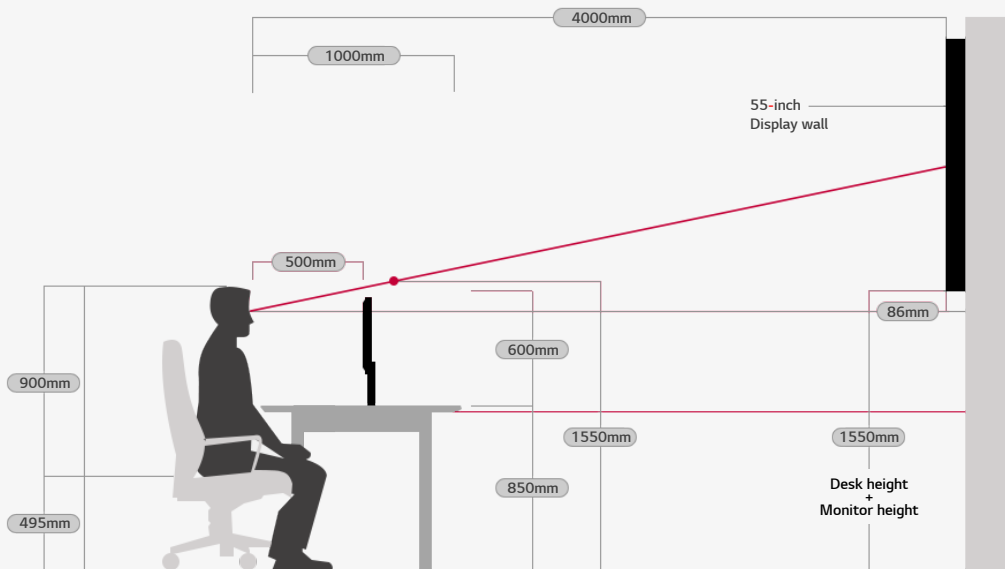

Figure 10 Medium control room display installation height

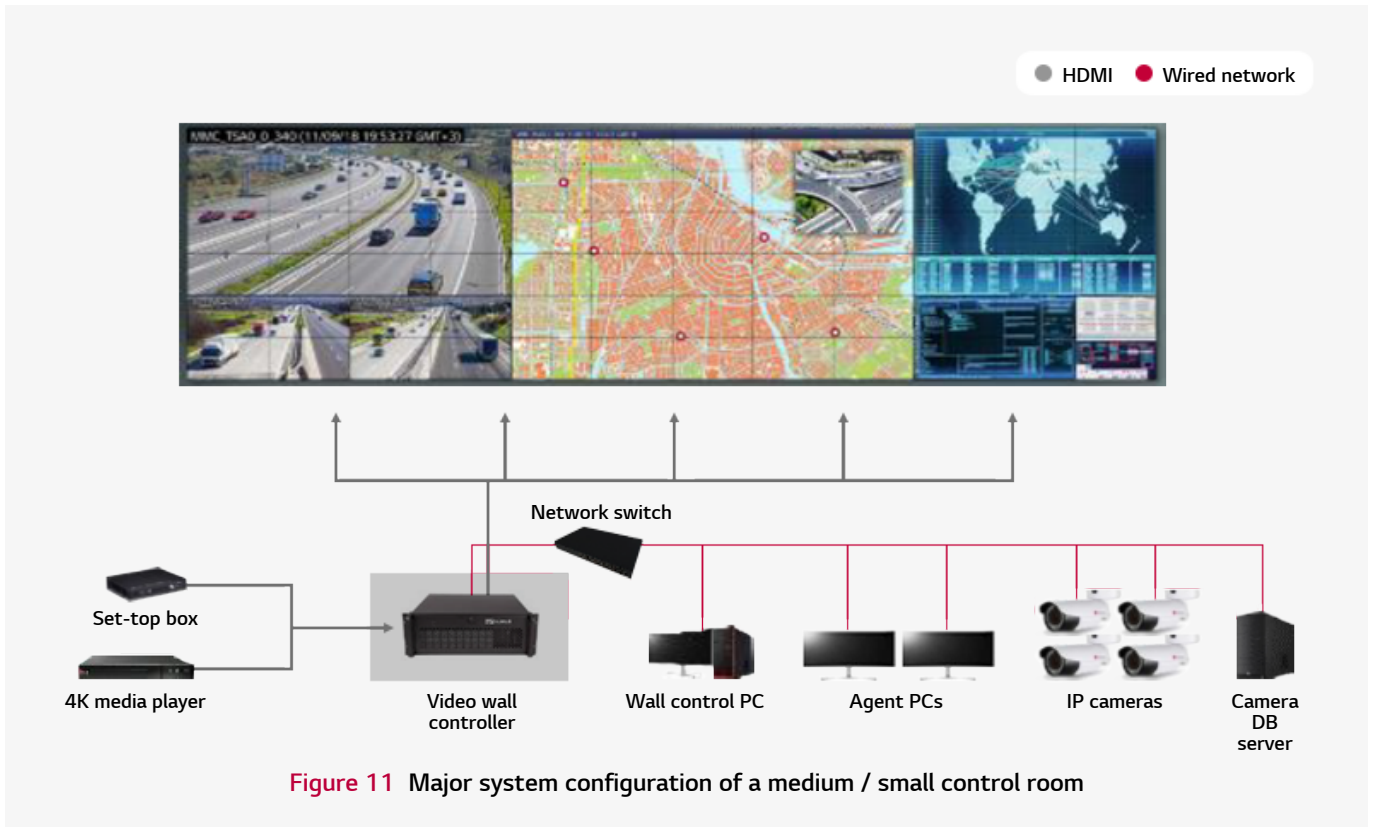

Figure 11 Major system configuration of a medium / small control room

### Small Control Room

In a small control room, a 2 × 2 or 3 × 3 video wall, which is smaller than the medium control room’s, can be installed, or a single 98-inch display.

Small control rooms have relatively little space compared to large and medium rooms, so the space should be maximized by using a more compact display. Typically, a group of people each perform a number of different tasks in small control rooms, so a compact solution and an optimized operating environment should be provided.

By working together closely, a group of people can make decisions through mutual communication in a narrow space. The data visualization screen must be provided seamlessly on the small display.

The 2 × 2 or 3 × 3 video wall models proposed by LG are the 55SVH7E (0.44mm bezel) and 49/55VH7E (0.9mm bezel), as well as the 98UH5E, which is a large, UHD display.

Although stand-alone controllers are compact and can be cost-effective, they are not expandable. However, it must provide cost savings and convenience for users in terms of installation and maintenance. The screen must have a multi-window layout and various configuration functions for showing content.



Figure 12 Small control room

## 04 Key Considerations for Control Rooms

Selecting the optimal solution for the control room requires expert technical knowledge that can simultaneously consider the ergonomics for the staff, convenience for operators, various content, budget and space constraints, use of the visual solution and control system, power and signal redundancy, and reliability.

**First, we will take a look at what to consider when selecting a visual solution.**

You need to decide whether to use a video wall or DVLED according to the content that will be shown on the control room screen. If you need to show a connection diagram of components using lines, such as using SCADA, then a DVLED will be a suitable solution rather than video walls with bezels.

The size of the visual solution should be decided after considering the size of the control room and the possibility of installing the display at least 1.5 meters above the floor.

The brightness of the video wall or DVLED should be 500–1500 nits, depending on the lighting environment. The location of the lighting in the control room should also be considered, and there may be a need for haze option to reduce glare from the display surface.

The pixel pitch of the DVLED must be decided by taking into account the visual distance of the control room screen and the controller. The maximum pixel pitch where individual pixels cannot be visually identified from the observation site must be selected. In general, 1.5mm, 2.0mm, and 2.5mm pitch should be used in the control room, and an appropriate pitch should be proposed according to the amount of space available in the room.

**Second, we will take a look at what to consider when selecting the control system.**

Selecting equipment depends on the purpose of the control room as well as how many devices are coming into the input source. In general, video wall controller equipment that enables various screen layouts should be used. If there are many various input sources, it will be difficult to configure your system with only a video wall controller, so a matrix switcher should be used in that case.

**In addition, if there is a considerable distance between a terminal device and control server, various interfaces must be considered.**

If the distance between an IP camera and the server is 100 meters, signals can be transmitted at high speed without loss by using HDBaseT. Or, if the distance is several kilometers, fiber-optic cable should be considered. Depending on the various types of terminal devices, the optimum solution should be designed considering the performance of the signal transmission equipment and controllers in the control room.

You can choose between a matrix switcher and a video wall controller as your major video control solution in the control room.

A matrix switcher can set the route of multiple AV input devices (media players, cameras, DVD players, etc.) to multiple AV destination devices (LCD displays, LED displays, videoconferencing codecs, projectors, etc.). These input and output devices are connected to matrix switcher inputs and outputs through various standards, such as DisplayPort, HDMI, DVI, RGB, 3G-SDI, HD component, S-video, or composite video signals. Modular expansion (8 inputs × 8 outputs, 16 inputs × 16 outputs, 32 inputs × 32 outputs, etc.) can be used to expand to the required number of inputs and outputs. The matrix switcher switches input signals through one-to-one mapping and connects to other outputs.

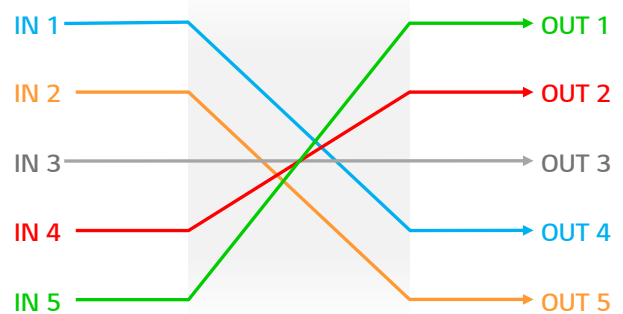

Figure 13 Concept of matrix switcher

Video wall controllers control each display in the video wall. They enable output to multiple displays, and the entire screen can be controlled and adjusted in a variety of layouts and configurations. By using a video wall controller, you can scale images over the whole screen or convert multiple images into PIP (Picture-In-Picture), as well as switch content and use various configurations. In general, administrators can manage the configuration and content of the video wall. General types of video wall controllers can be hardware-based, PC-based, or software-based, and a device called the video wall processor will handle the video content.

The video wall processor is an advanced signaling router that can take several inputs and create or synthesize one image and display it to a synchronized video wall. Note, however, that the border between the video wall controller and the video wall processor has recently become ambiguous, making them compatible with each other within the same equipment. It can also be regarded as having the same function with the video wall controller because the functions are integrated.



# 05 Visual Solutions for Control Rooms

## Video Wall

The video wall product is a basic specification that determines how easily the thickness of the bezel can make a large screen configuration look seamless.

The LG Video Wall can configure a large screen with a combined. 0.88mm bezel-to-bezel (0.44mm bezel for each display), so the gap between displays appears to be a thin line compared to existing video walls. Therefore, it is highly suited as a visual solution for control rooms because it has almost no restriction when showing content across multiple displays.

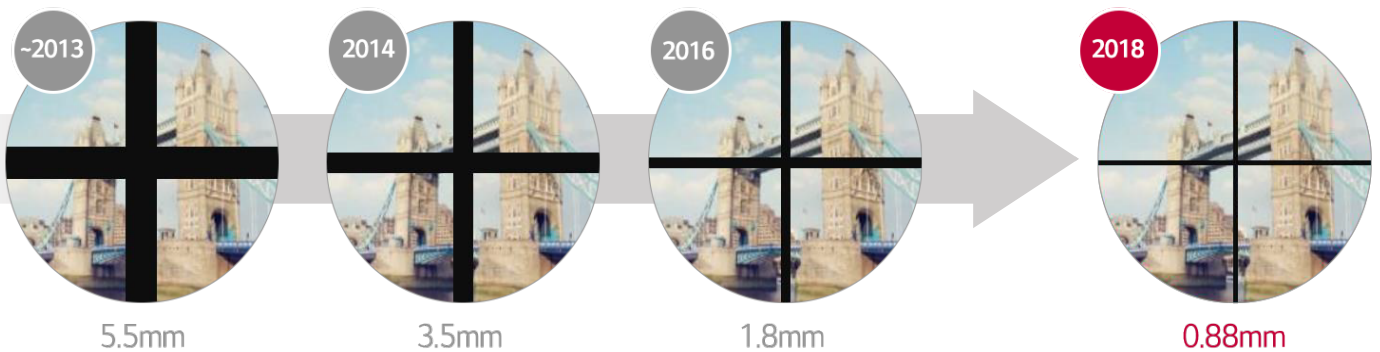

Figure 14 Bezel size comparison - Images are for illustrative purposes only

To use the video wall as a large screen, the uniformity of brightness within a single panel and between multiple panels is extremely important.

By applying the brightness and color adjustment algorithm, LG Video Wall's uniformity within the panel has improved by more than 95%, resulting in more than 95% brightness uniformity in the entire video wall.

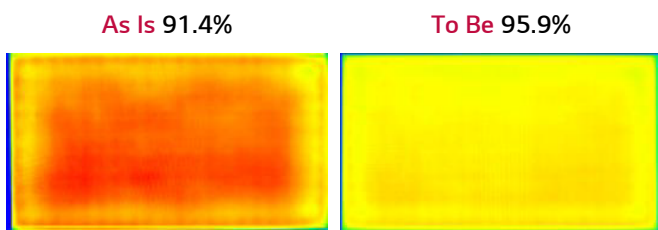

Figure 15 Brightness uniformity – LG model 55SVH7F

To improve the uniformity of brightness between the panels, we have applied the “Smart Calibration” function – an automatic calibration adjustment algorithm between products using the optical data of the panel and the internal illuminance sensor – and improved the adjustment convenience as well as shortened the calibration time.

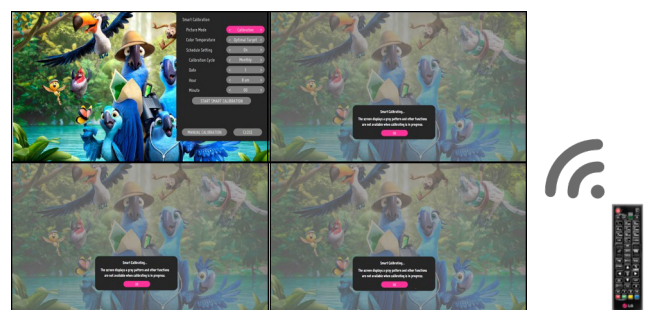

Figure 16 Smart Calibration: Adjusting the brightness uniformity between panels - Images are for illustrative purposes only

The SVH7E series features a 0.44mm bezel, maximizing the visibility of your content. 0.44mm EVEN BEZEL and 0.88mm BEZEL-TO-BEZEL have been verified by Nemko – a global organization that tests and certifies electronic equipment.

In general, large screens are positioned above human eye level, providing uniform brightness and image quality from any angle. The SVH7E series can meet this condition.

When configuring a large screen, low uniformity of brightness close to the video wall's bezel makes the edges of the screen look darker, so brightness uniformity is a very important consideration when selecting a video wall. The SVH7E series' uniformity has been enhanced even at the four corners of the display, creating a vivid, consistent color while maintaining luminance uniformity throughout the screen.

By using the remote control, the color temperature of the display can be adjusted in 100K units. The SVH7E series also features the "Smart Calibration" function, improved adjustment convenience, and shortened calibration time, as mentioned above.

By using a LAN daisy chain, you can update the firmware that executes commands to control and monitor the video wall.

If you sign up for Signage365Care, the optional and supplemental cloud service solution provided by LG, you can handle maintenance quickly and easily. Fault diagnosis and remote control services enable stable operation.

Rear-projection cubes in control rooms have a light source engine sealed in a small box. When the image is created by this engine and is shot as light, it is reflected on the screen through the mirror and becomes visible.

As a rear-projection cube is much thicker than a video wall, you need at least 1 meter of space on the back. Also, a cube cannot be hung on the wall because of its weight, but a video wall is much lighter and is able to be wall-mounted. An advantage of the cube is that you can hardly see the bezel, whereas you can see a very thin bezel on the video wall. On the other hand, cubes require a separate cooling system due to the generation of high temperatures. In terms of consumables, however, a cube costs less than a video wall, so using it saves maintenance costs.

The key buying factors (KBF) of video walls are color calibration, bezel size, screen resolution, serviceability, and power supply.



DVLED

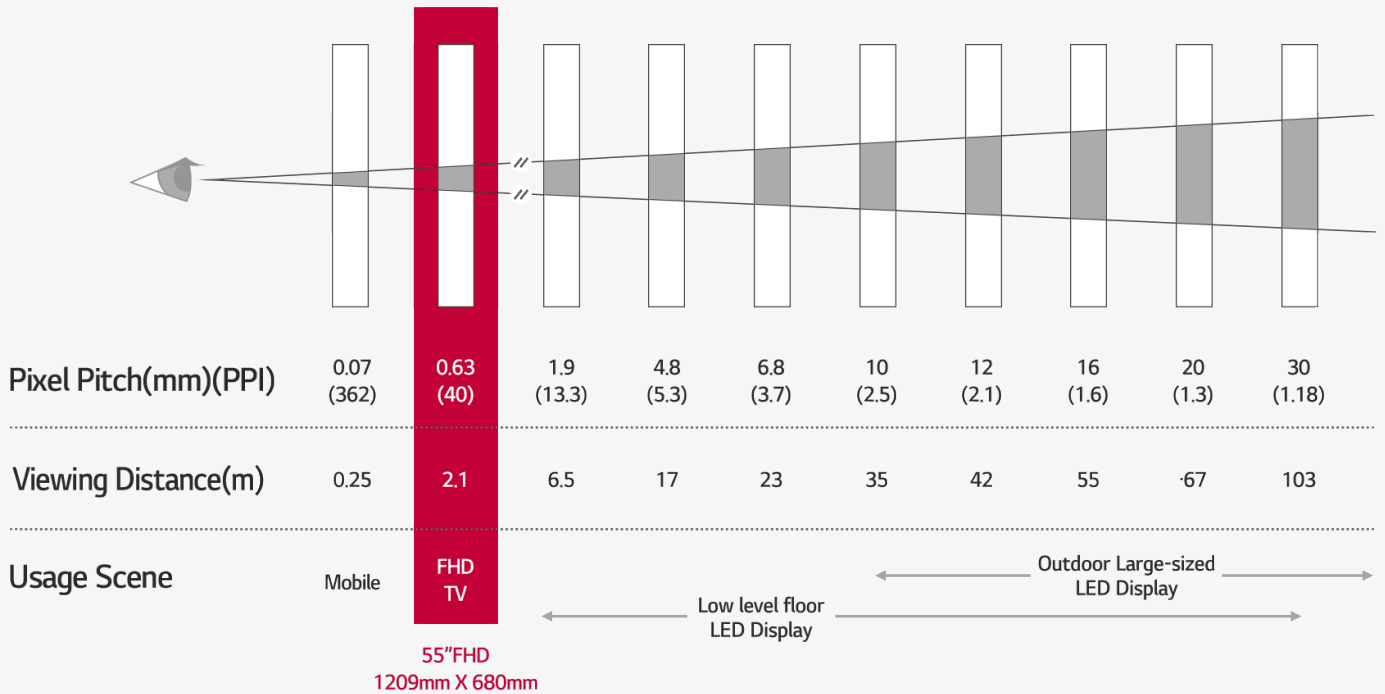

Figure 18 Pixel pitch selection according to the proper viewing distance

The key specifications of DVLED screens in control rooms are pixel pitch, brightness, screen resolution, lifetime, power/signal redundancy, and installation/maintenance convenience.

Pixel pitch is the distance between the center of one pixel and the center of an adjacent pixel. The pixel pitch can be chosen when the distance between the operator in the front control room and the screen itself is such that the operator cannot see the individual pixels.

Control rooms are located within a closed indoor space, so a brightness of 300–1000 nits is sufficient.

The resolution can be determined by analyzing the space of the control room, considering the size of the space and pixel pitch, and that the DVLED screen should be at least 1.5 meters above the floor. Once the dimension of the space where the DVLED to be installed is determined, pixel pitch will be used to determine the resolution.

$$\text{Screen Resolution} = \frac{\text{Width(mm)}}{\text{Pixel Pitch(mm)}} \times \frac{\text{Height(mm)}}{\text{Pixel Pitch(mm)}}$$

Figure 19 Screen resolution

The typical lifetime of a DVLED is usually more than 50,000 hours, so the warranty lasts for almost six years even when it is run 24 hours a day, 365 days a year. This means you can fully refurbish to a new IT system after six years of continuous usage. Nowadays, DVLED products with a lifetime of 100,000 hours are being released, so they can potentially be used for more than 10 years.

Because the control room is a mission-critical environment, power/signal redundancy is very important. Even if there is a problem with the power supply, it should be able to operate using a backup. Moreover, even if there is a problem with the signal supplied on the large screen, you should be able to view the content on the rest of the modules – excluding the LED module with the problem – via a different signal delivery system.

Installation and maintenance convenience are very important factors in selecting DVLEDs. It is not recommended from the perspective of space efficiency to place over 60cm of the cat work space in the wall where the large screen of the control room is to be installed. Therefore, we generally prefer DVLED products that can enable complete installation and maintenance.

LG's DVLED products have an advantage considering the key specs mentioned above and provide DVLEDs that are optimal for the control room.

The LAPE series has a pixel pitch lineup of 1.0mm, 1.5mm, 2.0mm, and 2.5mm, which is optimal for the control room and can be adjusted to optimum brightness depending on the control room environment. With a typical lifetime of over 100,000 hours and a power/signal redundancy system, it can be used with confidence, and the front mounting/maintenance function has enhanced installation convenience.

The specially designed flexible LED display module (LDM) supports true concave and convex curvature of up to 1,000R. This greatly improves design flexibility, giving users the ability to experience a true curved screen. Thanks to LG's unique "Dynamic Contrast Algorithm," the LAPE series offers vivid and unique picture quality through the detailed description of colors. The 16-bit color processing provides a higher grayscale level to display different depths and densities of color naturally with virtually no distortion, therefore providing more realistic and sophisticated content.

Driven by LG's display technology, content is reproduced smoothly with a high refresh rate of 3,840Hz. The flicker-free image prevents black bars while shooting video, as well as fatigue and blurred vision for the control room operator.

The LAPE series comes with a versatile 4K system controller to simplify system configuration on high-resolution canvas platforms. The controller also has a built-in scaler on top of a high-performance media player.

LG's new management control software platform "LED Assistant" provides easy screen management.

If you sign up for Signage 365 Care, LG's optional and supplemental cloud service solution, you can handle maintenance work quickly and easily. For fault diagnosis and remote control services, the LED display status is managed remotely.

On existing large and heavy cabinet-based installations, LED dot defects can occur. In the LAPE series, however, a much smaller and lightweight LDM-based installation is introduced, providing extraordinary, unmatched ease of handling. The unit frame of the LAPE series has been carefully designed to match the flatness of the screen.

Each LDM has 20 Z-axis alignment points for ultra-fine plane alignment. The LAPE series is front-mounted, enabling front service access. As such, the user does not need space for rear access, enabling a sophisticated screen design that maximizes space.

The key buying factors (KBF) of DVLED screens are pixel pitch, brightness, serviceability, size, reduced noise (no fan), and less heat.





# 06 Control System Solutions for Control Rooms

## 6.1 Crestron

### Matrix Switcher – Crestron DM Series

The DM series is a matrix switcher lineup including the DM-MD 32 X 32, 64 X 64, and 128 X 128 models, providing fully modular and expandable DigitalMedia matrix switching and ultra-fast digital video and audio signal switching functions. It performs lossless HD multi-signal distribution on various types of AV sources. It also supports SD, HD, UHD, 2K, 4K, and computer signals with advanced HDCP support as well as EDID resolution management, CEC signal management, and USB signal routing, including integrated Ethernet switch, simultaneous 7.1 and stereo audio, and H.264 streaming.

By using a DM series matrix switcher, you can configure the video/audio system that meets various requirements of your clients in a stable manner. The DM series with its I/O port expandability and high modularity can accommodate a wide variety of digital sources, including 4K60Hz 4:4:4 HDR and analog sources. You can also integrate copper, fiber, and IP streaming in a single chassis.

### Video Wall Controller – Crestron HD-WP-4K-401-C

The HD-WP-4K-401-C model is a 4K multi-window video processor with HDBaseT and HDMI output. Up to four video sources can be shown simultaneously on a single HD, Ultra HD, or 4K display. It supports auto view, quad view, parallel view, PIP (Picture-In-Picture) view, and full screen view, as well as 4 HDMI and 4 USB input connections, with input 1 and input 2 supporting 4K and input 3 and input 4 supporting 2K resolution. It also supports simultaneous Mirrored HDMI® and HDBaseT® outputs, and is HDCP 2.2-compliant.

The HDBaseT output is compatible with DM receivers, switchers, and Crestron RL® 2 and DM-DGE-200-C models.

Parallel HDMI and HDBaseT outputs provide flexible connection to display devices and other equipment, and up to 4K is supported via 4 HDMI inputs. Fully automated, easy-to-use operation can be realized without the control system and integration with the control system can enable more advanced operation and customization.

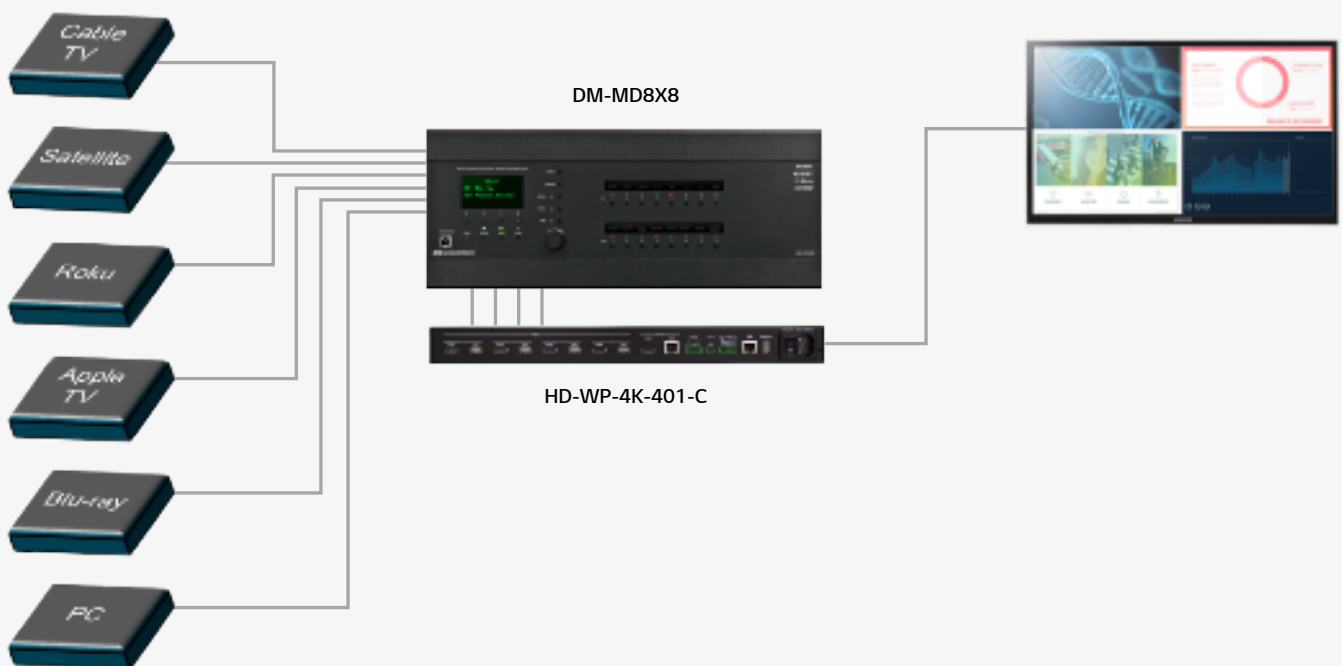

**Figure 20** Major system configuration diagram of the Crestron DM series (DM-MD8X8)

## 6.2 Extron

### Matrix Switcher – Extron XTP II CrossPoint Series

The XTP II CrossPoint series includes the 6400 and 3200 models, which are multi-format matrix switchers with modular designs.

This multi-format refers to various signal types as the XTP II CrossPoint series supports various digital video inputs and outputs such as analog, DVI, HDMI, and SDI. Choosing a model from the XTP II CrossPoint series would be a long-distance solution (over 100 meters), and twisted-pair cable or fiber-optic cable can be used.

The maximum expandable size is 64 × 64 (4 × 4 per card as modular architecture). This equipment is mainly used in the control room.

The XTP II CrossPoint series supports color depths of 4096 × 2160 (60Hz) 4:4:4 16-bit and 3840 × 2160 (60Hz) 4:4:4 16-bit. The 3200 model has eight input and eight output slots, while the 6400 model has 16 of each. The supported video input signals are HDMI, DVI, 3G-SDI, RGBHV, RGBS, RGSB, RsGsBs, YUV, S-video, Composite video, XTP twisted pair, and XTP fiber. The supported video output signals are HDMI, DVI, XTP twisted pair, and XTP fiber.

The XTP II CrossPoint series is an AV platform that supports HDMI 2.1, which can be installed by selecting from among various I/O boards. In addition, end-to-end 4K, HDCP 2.2-compliant twisted pair switching and transmission, and 4K switching and transmission through fiber are provided with user-friendly control software.

### Video Wall Controller – Quantum Ultra

Quantum Ultra video processor models include the Quantum Ultra 610 and 305. Designed to be expandable for a variety of display systems, the Quantum Ultra can also handle 4K60Hz video wall processing. It can be configured with a modular design architecture that accommodates a wide range of input and output devices. It is a processor that can manage multiple video walls with different resolutions and different layouts.

In addition, direct control via RS-232 and Ethernet can be performed. It is designed for mission-critical environments and 24/7 usage. The Quantum Ultra has four input and four output per board. It also supports both landscape and portrait video wall output, with the 610 model supporting a height of up to 6U with 10 slots and the 305 model supporting a height of up to 3U with five slots.





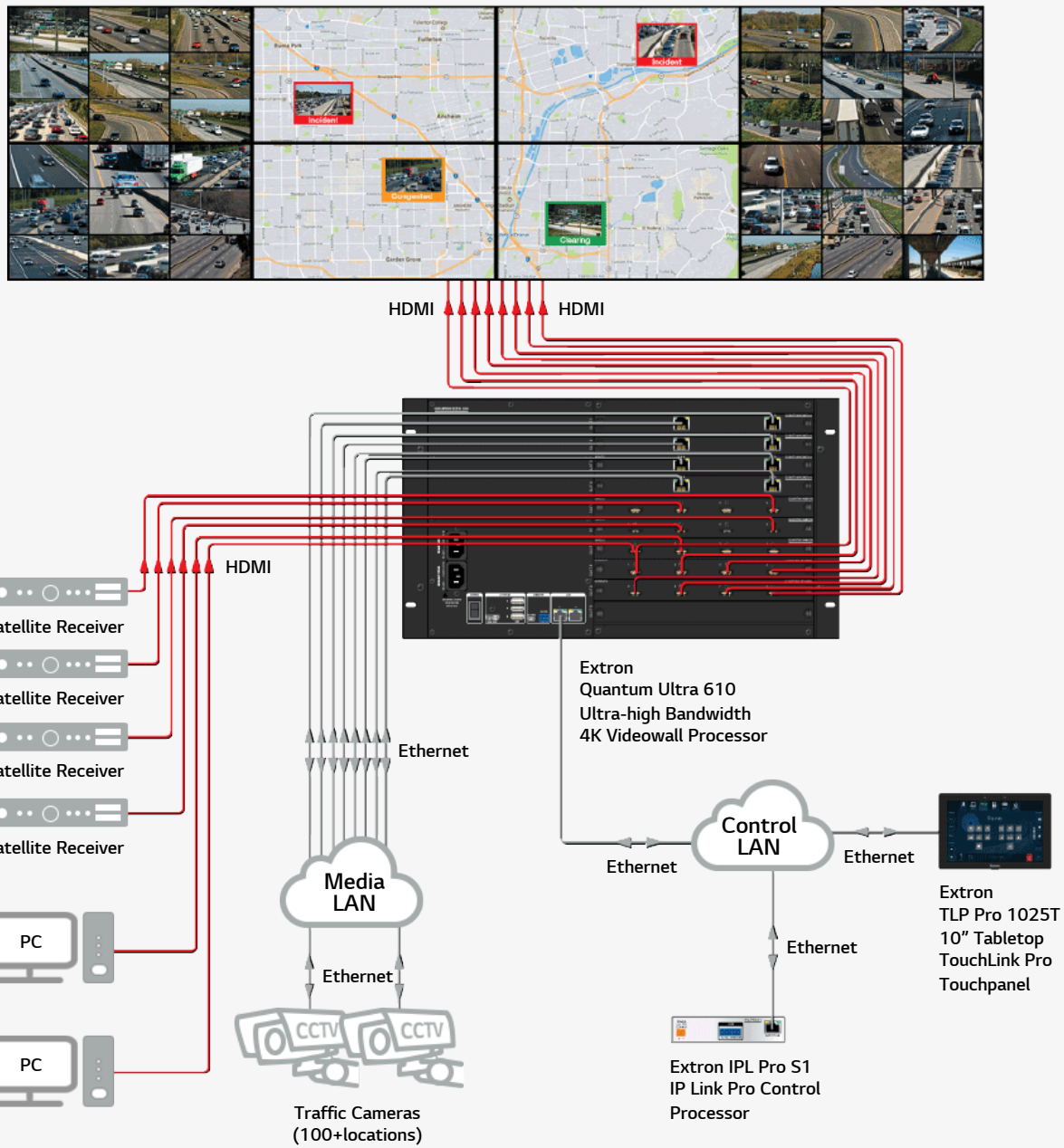

**Figure 21** Major configuration of the Extron Quantum Ultra system

## 6.3 Lightware

### Matrix Switcher – Lightware 25G Hybrid Series

As matrix switchers that support fast processing speeds of 25 gigabits per second, Lightware 25G Hybrid models are designed to provide a future-proof platform for the transmission of existing standard video formats, signal switching, and various signal management. Video, sound, Ethernet, USB KVM, IR, CEC, and RS-232 signals can be controlled simultaneously on a single system.

### Matrix Switcher – Lightware MX or MX2 Series

The MX series matrix switcher is a modular and expandable DVI and HDMI switcher with outstanding performance, offering detailed models of five frame sizes. Moreover, various modular frame sizes from  $9 \times 9$  to a maximum of  $80 \times 80$  can be used for input and output, so you can customize the matrix configuration with your desired number of inputs and outputs.

Unlike the MX series, the MX2 series is a standalone matrix switcher. It supports 4K UHD-based HDMI 2.0, but it is not modular.

## 6.4 VuWall

### Video Wall Controller – VuWall VuScape Series

As shown in the figure below, the VuScape controller located at the center has 12 outputs. Among them, outputs 1–6 are connected to a  $6 \times 4$  video wall with 55" screens, with each HDMI output connected to a  $2 \times 2$  section within the video wall. Outputs 7–10 are each connected to a 65" monitor in a 4-monitor configuration via individual HDMI extensions through the network.

The VuScape controller receives input signals from four mobile devices (see bottom of image) via the network, two direct HDMI connections, three HDMI encoders (see right of image) via the network, and one Internet connection (see top of image) via the network. The VuScape series of video wall controllers includes the VS400, VS560, and VS640 models, which are hybrid wall controllers based on IP video streaming and video cable. 4K video signal and true color image processing are available, and they have various image conversion effects, and the IP decryption module enables IP stream decryption. Also, by supporting standard Windows applications, users can operate the functions with familiarity and can save content that requires playback to an internal storage device.

The VuScape series of controllers features up to 64 inputs and outputs; the ability to configure, and show data from, multiple desktop surfaces; synchronized output of up to 1024 megapixels; universal multi-format input; 24-bit true color image processing at full frame rate; and HDCP support.





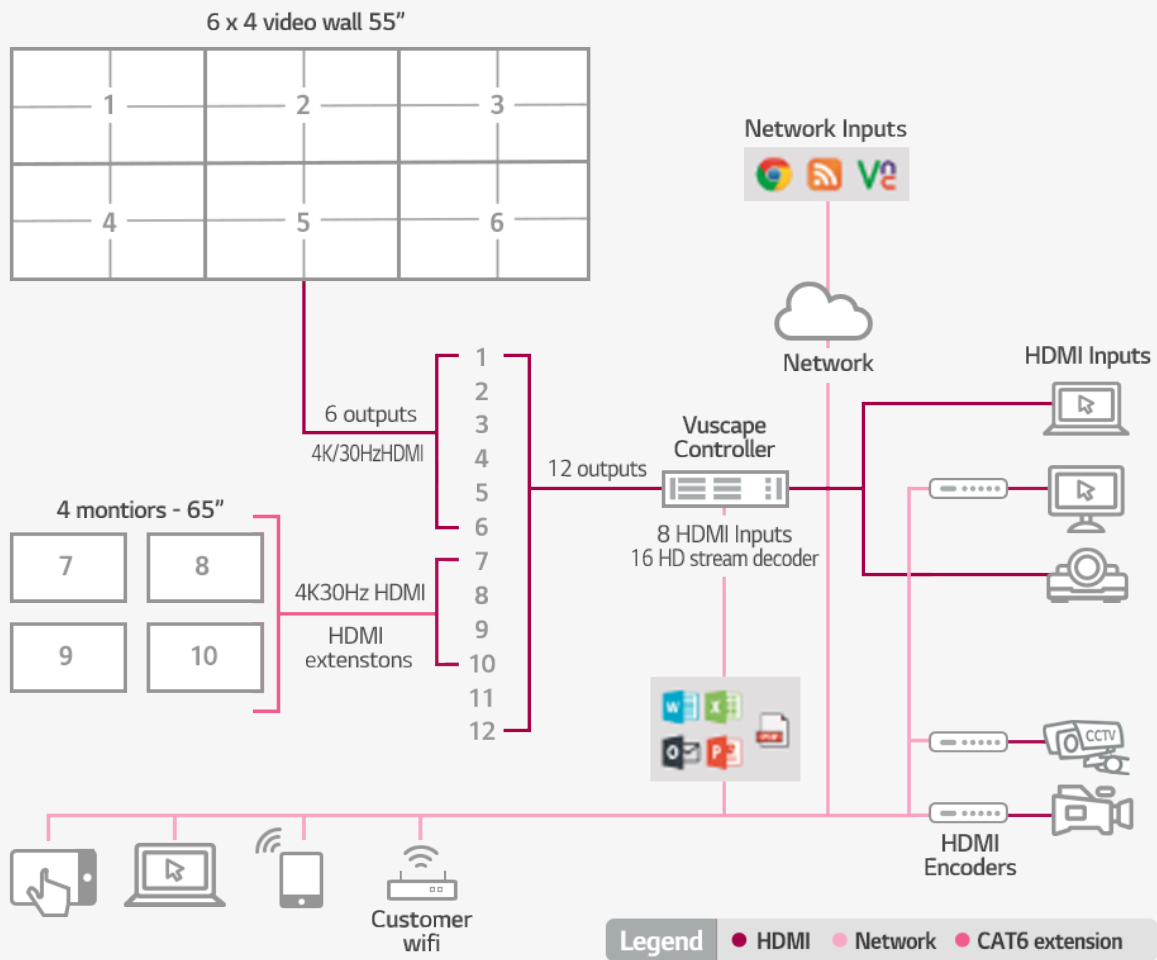

Figure 22 Major configuration of a VuScape controller

Model	VuScape V5120	VuScape V5280	VuScape V5400	VuScape V5560	VuScape V5640
<b>Hardware</b>					
Intel® Xeon E5 / 8GB RAM 240GB SSD Drives with optional RAID Up to two network ports Standard of redundant power supply Windows operating system					
<b>Inputs</b>					
	Up to 12x	Up to 28x	Up to 40x	Up to 56x	Up to 64x
<b>Outputs</b>					
	Up to 12x	Up to 28x	Up to 40x	Up to 56x	Up to 64x
<b>Decoding</b>					
	Up to 100x D1 streams	Up to 250x D1 streams	Up to 1000x D1 streams	Up to 1000x D1 streams	Up to 1000x D1 streams

Figure 23 Major specs by model in the VuScape series

## 6.5 Datapath

### Video Wall Controller – Datapath VSN Series

As shown in Figure 24, Datapath’s video wall controllers can support various source types: physical sources such as desktop captures and video cameras; IP streams such as IP cameras; in-network encoded sources including both desktops and individual application windows; web pages; local applications; and local media.

A single system can support up to 48 FHD60 outputs. Within this range, multiple walls of different configurations can be created. The figure below provides three configuration examples – 4 x 3 and 3 x 2 walls of displays in landscape and a 3 x 1 wall of displays in portrait.

Datapath’s “Wall Control 10” software enables users to easily and flexibly create and switch between various content patterns, and to independently control multiple video walls from a single interface. It also supports command line interface for use with external controllers.

All VSN controllers are standard 4U 19” chassis with dual redundant power supplies as default or optional, designed for large and medium-scale mission-critical environments (Control Rooms). The VSN9 & VSN11 series offer multiple options for system processor and storage, as well as the number of slots available for Datapath’s graphics, video capture, or IP decoder cards. For larger projects, the number of slots available can be increased by connecting VSN900X and VSN1100X expansion chassis. See the product table in Figure 25 below.

All systems are custom built and come with Windows 10 pre-installed. The modular/expandable design allows customers to add further graphics, video capture, or IP decoder cards, or even additional expansion chassis, to increase post-installation system capabilities.

### Video Wall Controller – Datapath VSN400, VSNMicro 600, iolite 600, iolite 12i

With fewer slots, the VSN400 and VSNMicro 600 are designed for smaller mission-critical environments (Control Rooms). The VSN400 is a standard 4U 19” chassis, while the VSNMicro 600 is a compact, quiet chassis that may be placed near operators instead of a separate AV equipment room.

Datapath’s lower-cost iolite 600 and iolite 12i models are most suitable for non-mission-critical environments. The iolite 600 has six slots and can accommodate up to 24 outputs. The small form factor and extreme low noise mean this model is often placed near the video wall, in the same room as operators. While also quiet enough to be placed near users, the iolite 12i is rack mountable for easier installation in AV equipment rooms. Uniquely, the iolite 12i is equipped with integrated graphics outputs: 12 HDMI ports each up to FHD, and three DisplayPort ports each up to 4K. There are two slots available for Datapath video capture or IP decoder cards.



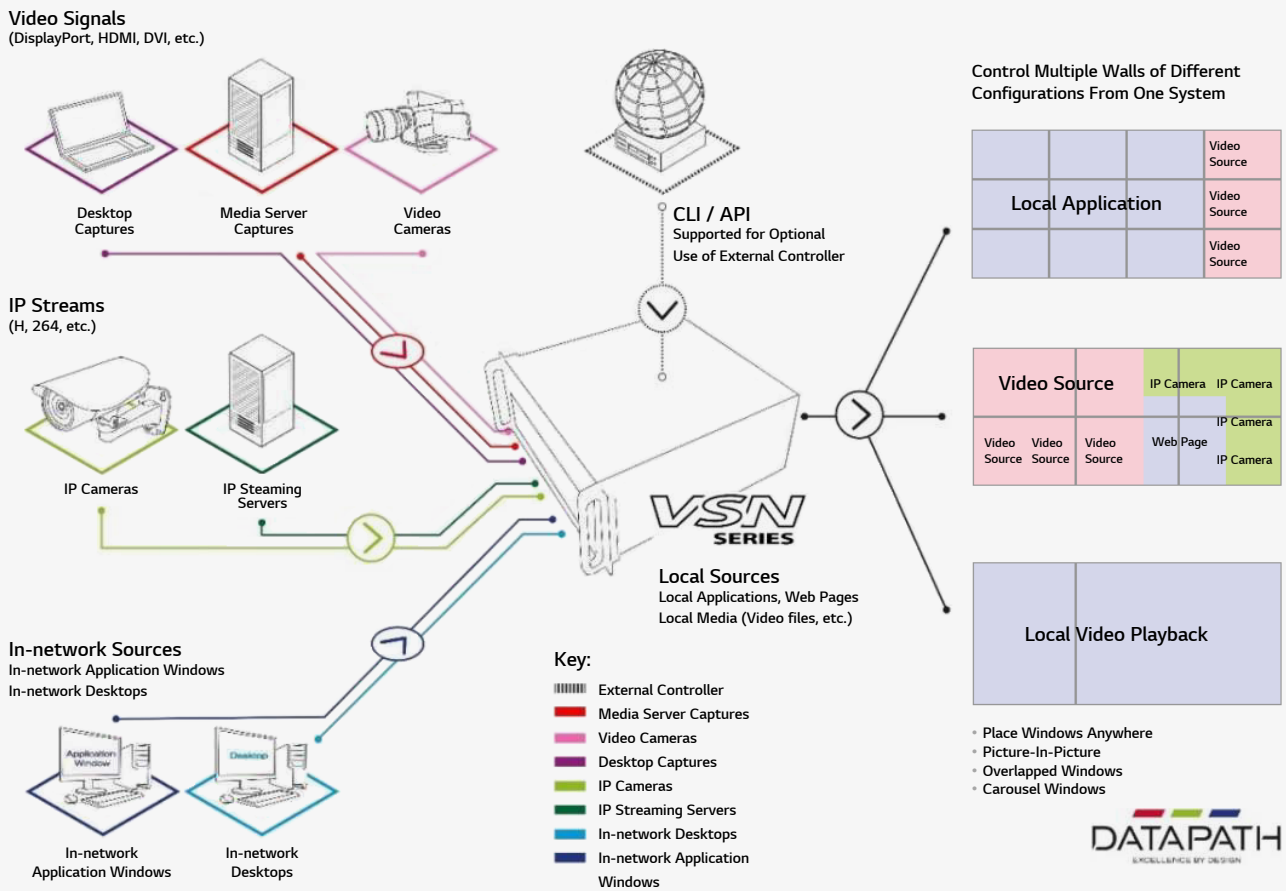

Figure 24 Major configuration of a VSN controller

Standard 19" 4U chassis		Processor		Windows OS	
4-Slot System	4	Intel® Core i5	5	First Gen, Windows 7	0
9-Slot System	9	Intel® Core i3	7	Second Gen, Windows 10 LTSB	2
11-Slot System	11	Intel® E3 Xeon	8		
		Dual Intel® Quad Core Xeon	9		

Product Table

Windows 10 systems with RPSU (redundant power supply) as standard or upgrade option				
Processor	Intel Corei5	Intel Corei7	Single Intel E3 Xeon	Dual Intel E5 Xeon
Compact and powerful chassis				
VSNMicro 600 (6 Slot)	VSNMicro 600 (Corei5 as standard)	VSNMicro 600 (Corei7 upgrade)		
Standard 19" 4U chassis				
VSN400 (4 Slot)	VSN400 (Corei5 as standard)	VSN400 (Corei7 upgrade)		
VSN 9 Series* (9 Slot)		VSN972	VSN982	
VSN 11 Series* (11 Slot)		VSN1172	VSN1182	VSN1192

\* Can increase available slots by using VSN900X and VSN1100X expansion chassis

Figure 25 Major specs of video wall controllers in the VSN series



## 6.6 Useful

### Video Wall Controller – Useful Zero Client

The Zero Client solution from Useful is an IP streaming-based video wall controller solution that is inexpensive, and the UI of the software is convenient and easy to use. It consists of a Zero Client box to attach to each display and a PC server for streaming. It can be configured with two solution methods: cloud and on-premise management. It performs IP video streaming in a gigabit infrastructure environment. The web-based GUI makes it easy to map the video source onto the output video wall and display the various sources on the screen anytime, anywhere.

It supports zone type, multiple-window layout, PIP (Picture-In-Picture), and a preset switching function. It can control the source displayable on the video wall through a web browser and interact with output display accordingly. The model name of the Zero Client solution is N420, and the recommended server models are the HP Prodesk 600 Series, Dell Optiplex XE2, and Acer VM6630G.

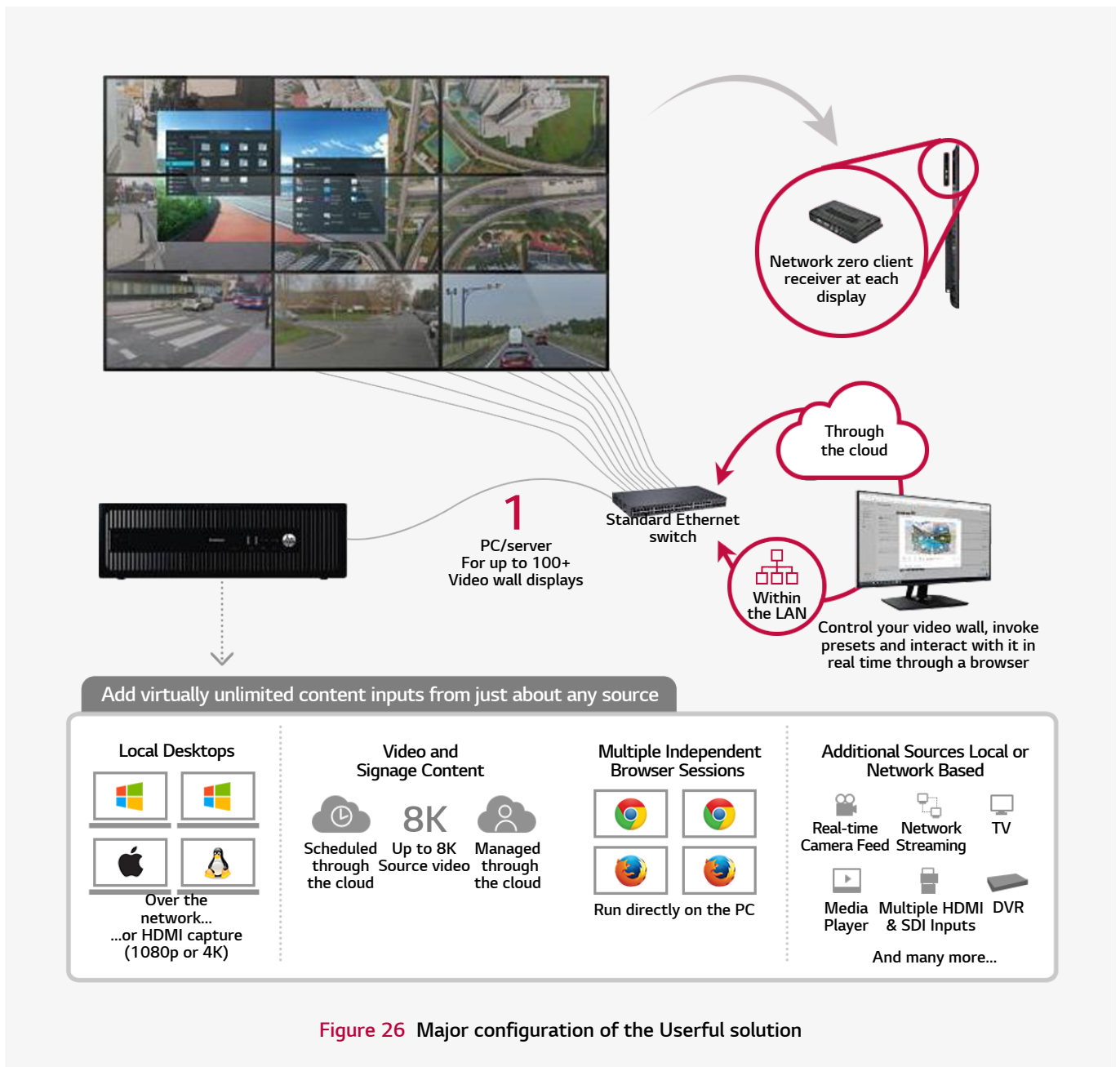

## References:

LG Electronics LSR Lab Fusion Experience Research Team  
ID Business Division Professional Space Vertical GTM Strategy Report

<https://www.barco.com/en/solutions/Control-rooms>

<https://www.mitsubishielectric-displaysolutions.com/markets/broadcast/control-room>

<https://www.extron.com/company/article.aspx?id=selectingmatrixswitchers>

<https://crestron.com/en-US/Products/Featured-Solutions/DigitalMedia-Matrix-Switchers>

<https://www.extron.com/article/xtpiicp6400ad>

<https://www.extron.com/product/quantumultra>

<https://vuwall.com/products/vuscape>

<https://www.datapath.co.uk/datapath-products/vsn-controllers>

<https://lightware.com/product-families/25g-hybrid>

<https://www.userful.com/control-room-video-wall>

<https://www.hiperwall.com/video-wall-solution-competitive-comparison-chart>

<https://www.isemc.com/video-wall-controller-product-comparison-chart>

<https://www.cinemassive.com>

<https://panasonic.net/cns/prodisplays/products/et-mwp100q>

<http://fortune.com/att-global-network-operations-center>

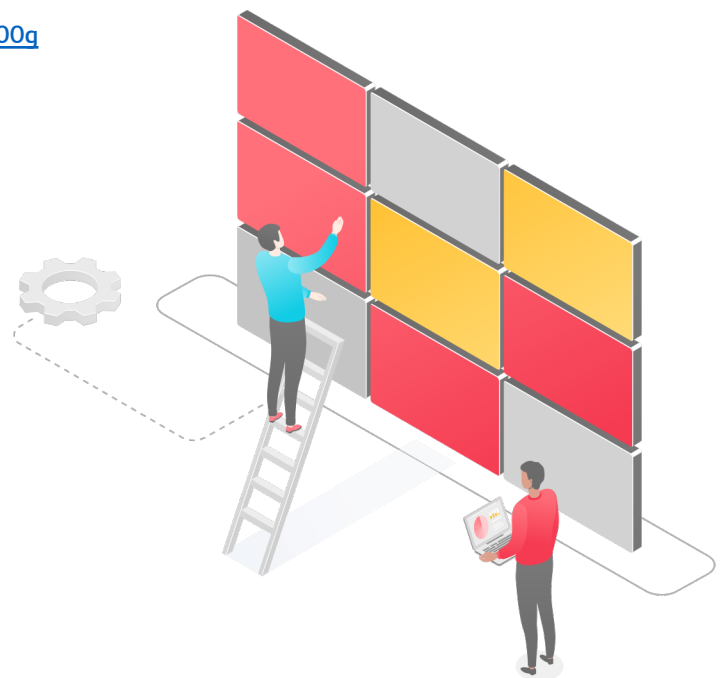

Download  
LG C-Display+  
Mobile App

Google Play Store

[www.lg.com/b2b](http://www.lg.com/b2b)

[www.youtube.com/c/LGCommercialDisplay](https://www.youtube.com/c/LGCommercialDisplay)

[www.facebook.com/LGInformationDisplay](https://www.facebook.com/LGInformationDisplay)

[www.linkedin.com/company/LGInformationDisplay](https://www.linkedin.com/company/LGInformationDisplay)

LG Electronics U.S.A., Inc. | Business Solutions | 2000 Millbrook Drive | Lincolnshire, IL 60069  
All images on screen are simulated. Design, specifications, and features subject to change without notice. © Copyright 2019 LG Electronics USA, Inc. All rights reserved. LG and the LG logo are registered trademarks of LG Corp. WP\_Understanding\_ControlRooms\_012042\_LR