



Video Wall

NEW
COLLECTION

SHOP NOW

Understanding LG Video Wall Solutions for Your Business

Whitepaper

01 Video Wall Overview

Video walls are big screens created by using multiple display products. Display products such as monitor signage made of LCD panels or OLED panels, LED electronic displays, projector screens, and rear-projection cubes are used to compose video walls.

Display products for video walls have a narrow bezel to minimize the video distortion between the screens, provide functions of operating content and controlling monitors for multiple display products (Video/LAN/RS-232C Daisy Chain), and require coupling with CMS (Content Management System) for content operation.

Video walls are used for delivering information or advertising products in places such as control rooms, meeting rooms, broadcast stations, airports, and shops. Cases where giant video walls are installed as landmarks to attract people are increasing.



Figure 1 Control Room



Figure 2 Meeting Room



Figure 3 Open Company Space

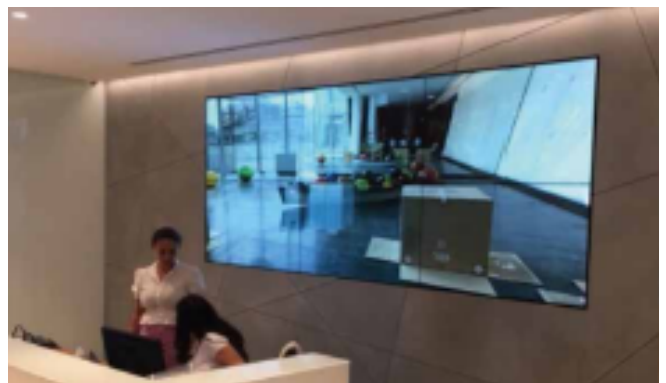

Figure 4 Building Lobby



Figure 5 Broadcasting Station



Figure 6 Store



Figure 7 Department Store



Figure 8 Museum



Figure 9 Airport



Figure 10 Landmark

02 Designing a Video Wall

2.1 Analyzing Customer Requirements and Environment

Video walls differ according to the installation environment (size, structure, surrounding brightness) and targeted content. The types and characteristics of products and CMS must be understood to suggest the optimized solution based on the obtained information. The total funds and operational complexity may greatly differ depending on the type of displays and models chosen for the video solution, so the optimized solution can be suggested only after precisely understanding the customer's needs.

LCD video walls can only be installed for flat structures since they can't be bent, but OLED products or LED products can be bent. If video walls are needed to be installed on curved surfaces, OLED products or LED products may be selected.

The distance to recognize the pixel line for LED products changes, depending on the pixel pitch, so an appropriate pixel pitch product must be chosen according to the viewing distance. If the viewing distance is short, LCD or OLED products could be a better choice than LED products.

It is better to use products with high brightness if the video wall is being installed in a bright environment, and products with high haze for the surface of the products are better for places where the visibility of the content may be disrupted by reflected light. Especially the video walls for broadcasting stations require a product that can change the color temperature according to the surrounding lighting, so knowing what products are available by understanding the light temperature beforehand is necessary.

The content type that is to be used in the video wall must be selected before employing a video wall. It must be known if it will be used for simple videos or images, if there are various external inputs or interactive content displayed, and what the content changing cycle is, to select the best CMS and operate a video wall according to the information. The overall system components and surrounding equipment may differ according to the chosen CMS, so understanding this prior to the installation is necessary.

2.2 Display Selection

An appropriate display type must be chosen according to the installation space and requirements. The following is an example of selecting appropriate products according to the user settings.

Broadcast Station

The cameras in the broadcasting station capture the videos played on the video walls, so the video walls require color temperature calibration (about 4000K) according to the lighting and camera settings. When a product with no options is selected, it may need to be replaced if the color temperature of the screen does not fit. Lighting or reflections of people on the surface of the video walls may disrupt screen visibility, so choosing a product with a high haze may be required to prevent reflection. It is better to use a model with a thin bezel since the viewing distance is short and there shouldn't be any video distortion, but it is necessary to choose a model that fits the customer's budget when designing the system.



Figure 11 Broadcasting Station

Video wall (SVH7F (0.44mm), VH7E (0.9mm)), Fine-pitch DVLED (LAPE 1.5 / 2.0 / 2.5mm pixel pitch) can be used as the broadcasting station's display

Retail Shop

Video walls in retail shops usually play advertisement content for the items sold in the shop, and they must be easily seen by passersby and customers within the shop. Video walls are often used to show the charms of products and emphasize them from a location that can be easily seen from the customer routes.

They can be used to express the true size of the product and advertise a promotion or a product behind the counter. The surrounding lighting of retail shops is usually bright, so it is best to use an indoor product with high brightness. Video walls with high brightness could also be considered for window-facing settings according to the brightness of the sunlight.



Figure 12 Retail Shop

LCD video wall 49/55VL7F, 49/55VH7E, 55SVH7F (700 nit) is available for an indoor product for shops, and 55VX1D (1500 nit) is available for window-facing environments

Big Landmarks

Shopping malls or public facilities sometimes use unique video walls to attract attention. OLED products can be installed on curved surfaces to increase the immersion of the played video content, so they are the best products to maximize the use of landmarks.



Figure 13 LG OLED Landmark

LG is the leading manufacturer that produces OLED products for big landmarks and released the 55EF5E model.

Control Room

Narrow bezels are required for video walls in control rooms to prevent video distortion. The SCADA (Supervisory Control And Data Acquisition) system in particular displays lines, connections, and system diagrams, so it is preferred to use LED electronic displays that don't show the bezel line, rather than video walls that show the bezel line. A product that doesn't show afterimages after displaying a fixed image for 24 hours, 7 days a week must be chosen.



Figure 14 Control Room

Video wall (SVH7F (0.44mm), VH7E (0.9mm)), Fine-pitch DVLED (LAPE 1.5 / 2.0 / 2.5) can be used as control room displays

Airport

Big video walls are used to announce the flight schedule and check-in information to passengers in airports. A product with high brightness that doesn't show afterimages with fixed content must be chosen to increase visibility.

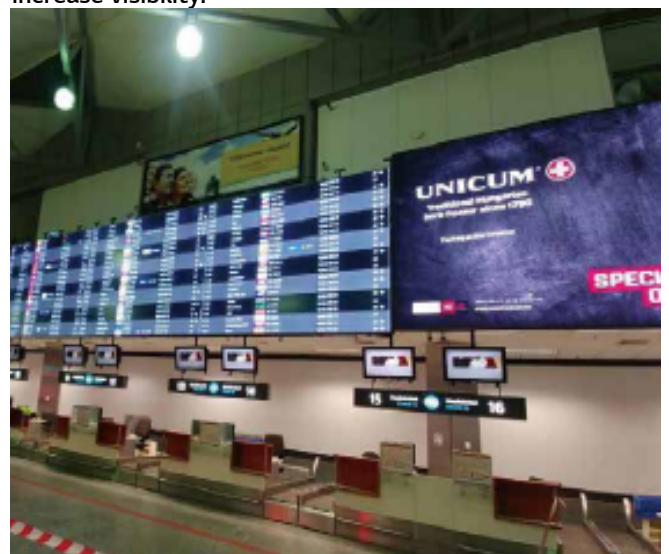

Figure 15 Airport FIDS (Flight Information Display System)

Fine-pitch DVLED (LAPE 1.5 / 2.0 / 2.5) or LCD video wall 49/55VL7F, 49/55VH7E, 55SVH7F (700 nit) can be used as airport displays

2.3 CMS (Content Management System) Selection

CMS operates actions related to creating, editing, distributing, and playing content to manage what is shown on video wall screens. The appropriate CMS should be selected according to the type of content, the size of the video wall, the number of screens operated, and the SoC (System-on-Chip) Play availability of the operated products.

The entire video wall system composition and required devices may differ according to the chosen CMS. The budget required for the system composition may vary greatly, so choosing the appropriate CMS is important.

Content Form	Screen Size	Smart Platform	Video Wall CMS Solution	
Single Video File Single Image File Multiple Video Files Video file (mp4, mov, ts, etc.) Image file (jpeg, png, bmp, etc.)	3x3 or less	webOS	SuperSign CMS	
		Non webOS	Media Player	
	10x10 or less	webOS	SuperSign CMS / webOS	
		Non webOS	Player Sync	
	10x10 or more			Player Sync
Mixed Content (video / image / text)	3x3 or less	webOS	webOS	
		Non webOS	Media Player	
	10x10 or less	webOS	webOS / Wall Controller	
		Non webOS	Media Player Sync / Wall Controller	
Various Sources Simultaneous Input Source External Input IP Streaming Live Feeds Web page (HTML5)	10x10 or more	Media Player Sync / Wall Controller		

Figure 16 CMS Selection

SuperSign CMS

SuperSign CMS is the optional, paid software provided by LG for creating, editing, distributing, and playing of the content shown on the LG signage monitor. It can operate as an SoC player without connecting video signal cables to video wall setups, just to play simple media files. Simplifying the system components can reduce the cost and make installation and operation more convenient.

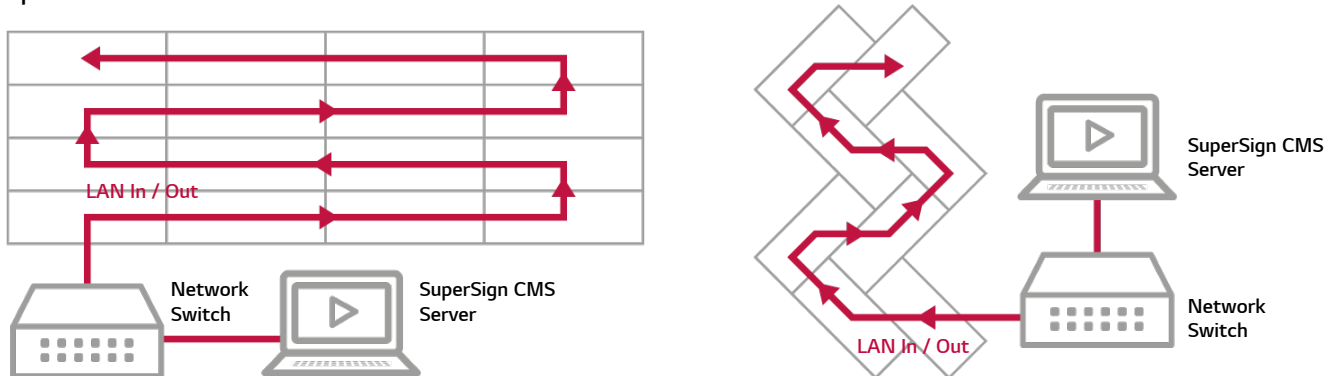

Figure 17 Example of SuperSign CMS System Composition

Main Features

- **Multiple Media Sync:** To form a big screen, the same number of content items and monitors should be prepared so that the content can be distributed only on the designated area on each monitor whose resolution is adjusted to the optimized level in order to set up a high resolution.
- **Simple Media Sync:** This feature distributes one content item to all monitors and plays on only the required area of the monitors. It is good for a 2x2 or 3x3 small video wall without needing to prepare split content.
- **Playlist Sync:** This feature plays multiple content in sequence.
- **Scheduled Play:** This feature plays the video wall content at a desired time.

webOS Partner Solution

webOS is a smart platform from LG that can selectively apply synchronized CMS solutions by partner companies that develop apps based on webOS, so it is able to operate projects in cooperation with a favored local partner company. For example, the uClient solution from a professional video wall solution ecosystem partner, Useful, can be used.

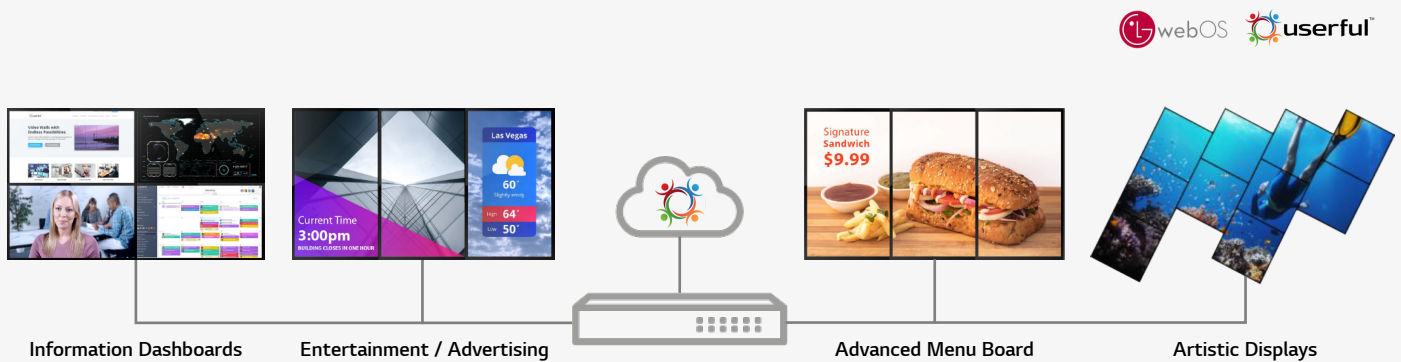

Figure 18 Overview of uClient Cloud Solution by Useful

uClient is a video wall solution with a reasonable price based on LG webOS, and is a video wall controller that easily uses SW UI. It can be used for LG monitor signage webOS 3.2 or higher and operates and manages video wall content via the cloud. Easy video source mapping on the video wall display can be done through GUI. Various sources can be displayed on any location at any time on the video wall, and IP Streaming input support is available. It supports features such as zone type, multiple window layout, and preset switching. Also, managing sources that can be displayed on the video wall and related interactions through web browsers are available. The video wall models available for this are 55SVH7F, 49/55VH7E, 49/55VM5E (webOS 4.0), 55SVH7E, 55VX1D, and 49VL5D (webOS 3.2).



Media Player

Small video walls can operate regardless of the monitor platform when media players are used. It can easily operate by using the DP Daisy Chain feature between one media player and monitor, and there are no specific restrictions on the type of content. However, it is recommended to be used only for small sizes such as 2x2 or 3x3 since the resolution drops when the video wall is large due to resolution degradation. BrightAuthor, a media player and CMS from another ecosystem partner, BrightSign, can be used in content management where creating and editing is required.

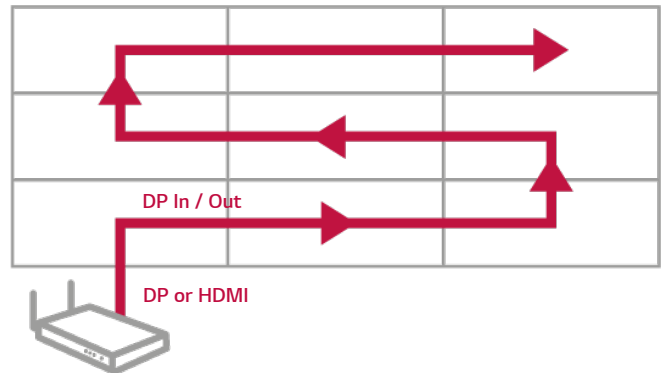

Figure 19 Example of a System Composition Using a Media Player

Media Player Synchronization Solution

The content must be played after synchronization with multiple media players to operate large video walls for a high-resolution video. BrightSign and Dataton (Watchout) are ecosystem partners for this.

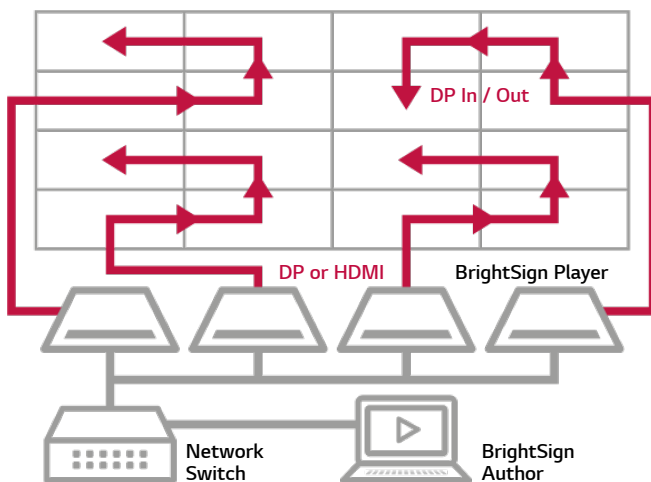

Figure 20 Example of BrightSign System Composition

This is a solution that edits, distributes, and plays content by using BrightSign Media Player and BrightSign Author CMS. It uses a media player based on Linux, and the appropriate model specs can be chosen among the HD / XD / XT series according to the user settings. External input or IP Streaming input support is available, and content schedule setting is also available by using external equipment or events through GPIO. Large video walls can be composed and operated by using multiple media players.

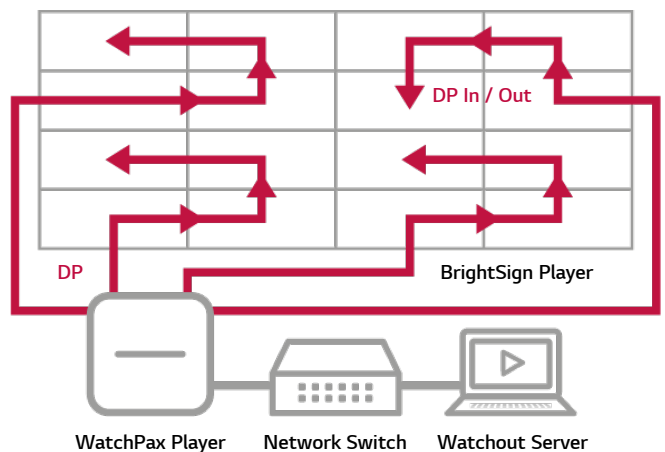

Figure 21 Example of Dataton (Watchout) System Composition

This is a solution that edits, distributes, and plays content by using WatchPax Media Player and Watchout CMS. It uses a media player based on Microsoft Windows, and the appropriate model specs can be chosen according to the user settings. External input and IP Stream input support is available, and the Multi 4K output reduces the number of used media players to compose large video walls. Some models support HW External Sync (Genlock) for stable synchronization. There's a reference for WatchPax Media Player and Watchout on the giant video wall installed in The Dubai Mall's aquarium, which is composed of 820 LG OLED products.

Video Wall Controller Solution

The video wall controller controls each display of the video wall. It enables output to multiple displays that can be controlled and adjusted in a variety of layouts and configurations. By using the video wall controller, either certain images can be scaled over the entire video wall, or multiple images can be converted into PIP (Picture-In-Picture) to employ content switching and various configurations. In general, administrators can manage the configuration or content of the video wall. The general types of video wall controllers are hardware-based, PC-based, or software-based. There are ecosystem partners such as Crestron, Extron, VuWall, Datapath, and RGB Spectrum for video wall controllers, and the appropriate solution may be selected according to the size of the video wall and user settings.

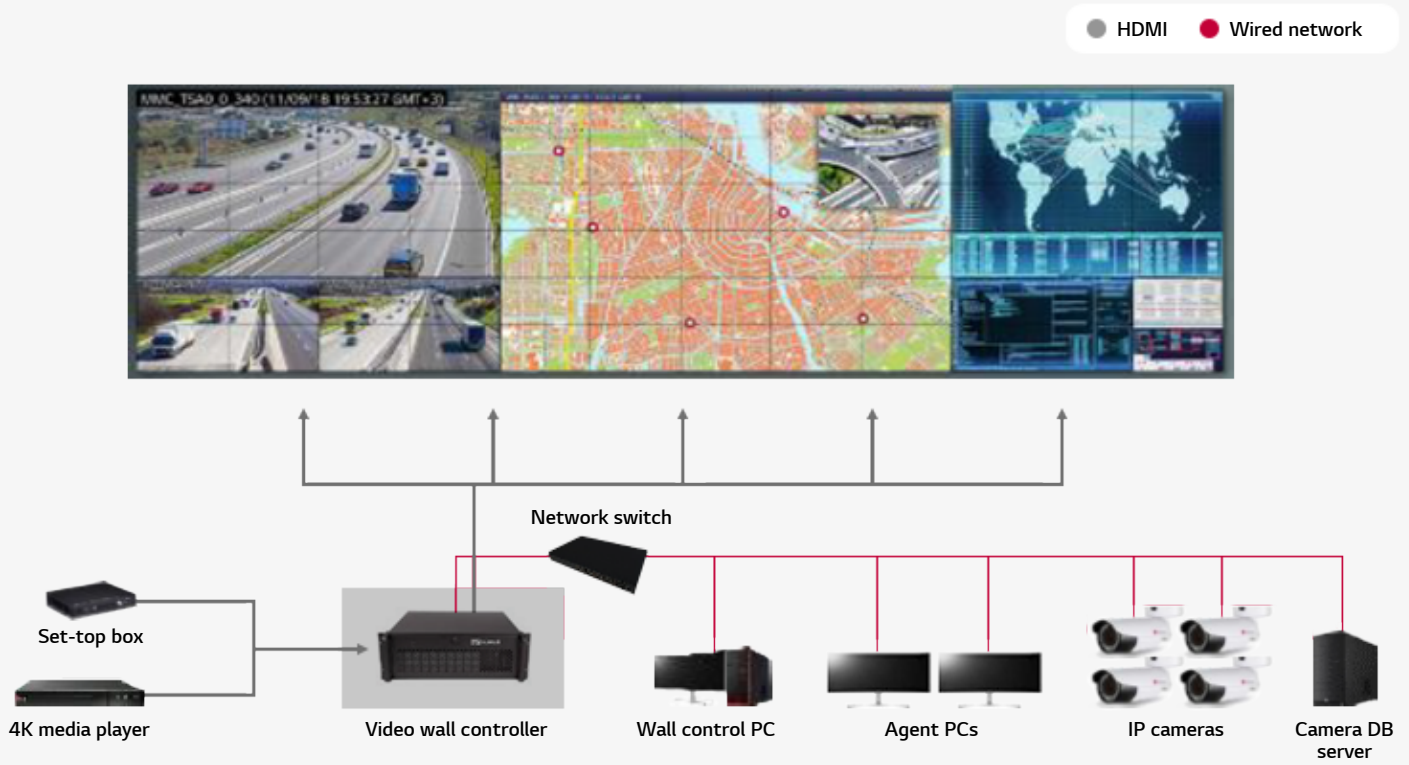

Figure 22 Example of Video Wall Controller Main System Components



03 Why LG Video Walls

Bezel Competitiveness

The thickness of the bezel is a basic spec for video wall products that indicates how seamless the screens look when arranged together. LG video walls use 0.44mm bezels that allow the composition of large screens with a 0.88mm bezel-to-bezel distance, which is seen as a line compared to earlier video walls. This almost doesn't interfere with the content display, so it can be used as the best optimized video wall solution.

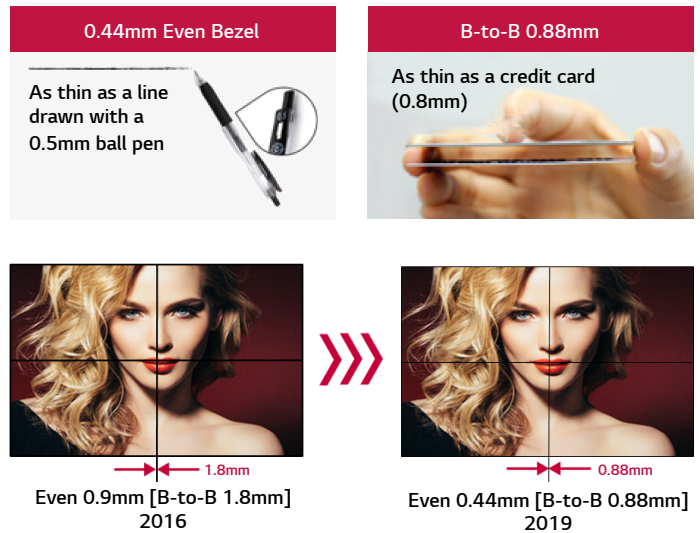

Figure 23 Bezel Size.
Images are for illustrative purposes only.

White Balance Competitiveness

The brightness uniformity within the video wall panel and between panels is important when using video walls as one big screen. LG video walls have improved the panel's brightness uniformity by applying a brightness and color calibration algorithm.

The edges of the panels seem darker for big screens if the brightness uniformity is low near the video wall's bezel thresholds. So this is an important factor in choosing a video wall. The SVH7F series maintains the total brightness uniformity and displays a lively and uniform color by enhancing the uniformity for all four corners as well.

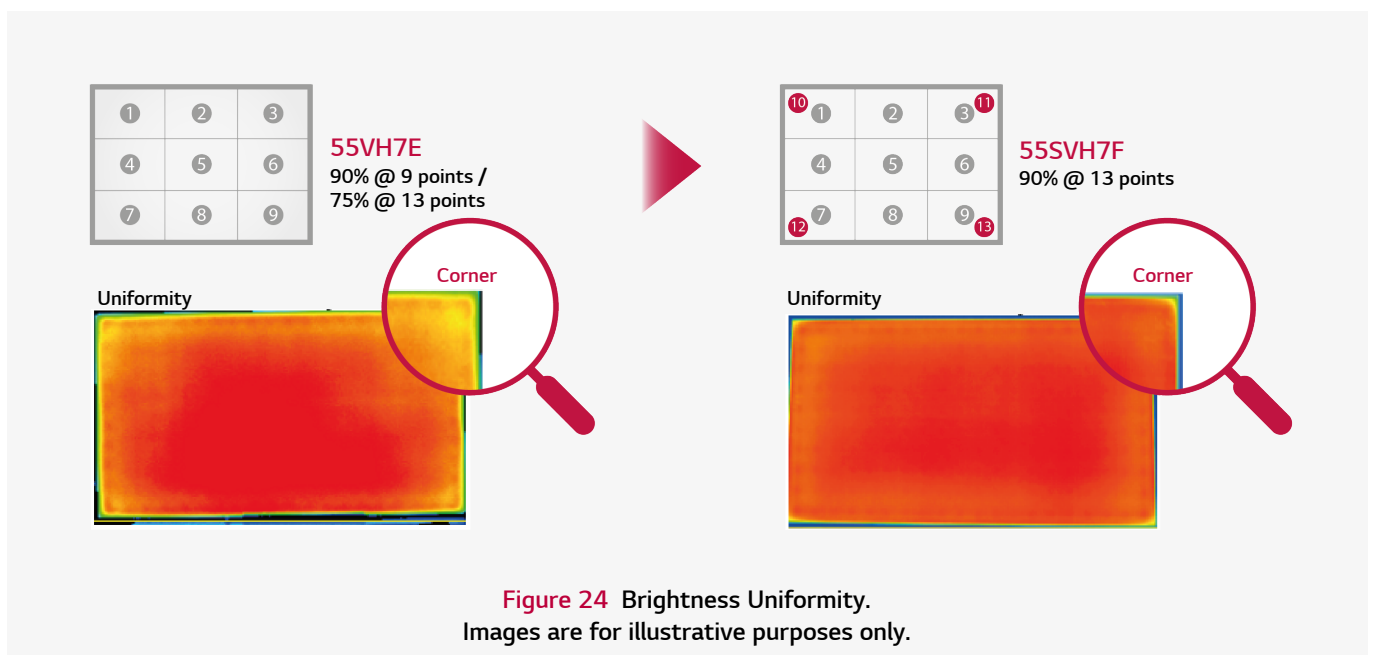

Figure 24 Brightness Uniformity.
Images are for illustrative purposes only.

Video walls are calibrated by the Factory Calibration during the production process, and the Site Calibration after module installation and maintenance at the site. The product's color temperature and brightness is calibrated for the same target through Factory Calibration, but Site Calibration is required because there is a property deviation for LCD modules (Cell Gap, Color Filter, time to stabilize the LED backlight, etc.), and each customer may want different color temperatures. SuperSign WB is provided for calibration, and the calibration can be performed by Color Sensors (i1 Display Pro, Spyder5) or Nikon DSLR cameras. Manual calibration may be required for fine-tuning, and a separate calibration guide is provided for this.

The prior calibration method was inconvenient since it required separate SW and equipment and took a long time to complete. So the "Smart Calibration" feature has been implemented for the new model (55SVH7F). The manufacturers use a camera to collect and save the panel's optical data (144 point) for Smart Calibration, and a uniformity enhancing algorithm is used. Internal illumination intensity sensors are used to automatically calibrate the brightness difference between products. Smart Calibration makes calibration easy for everyone and reduces the required time (roughly three minutes for 3x3 displays) since it can be automatic for products by running the "Smart Calibration" feature through the user's remote control without requiring separate SW, equipment, or controller.

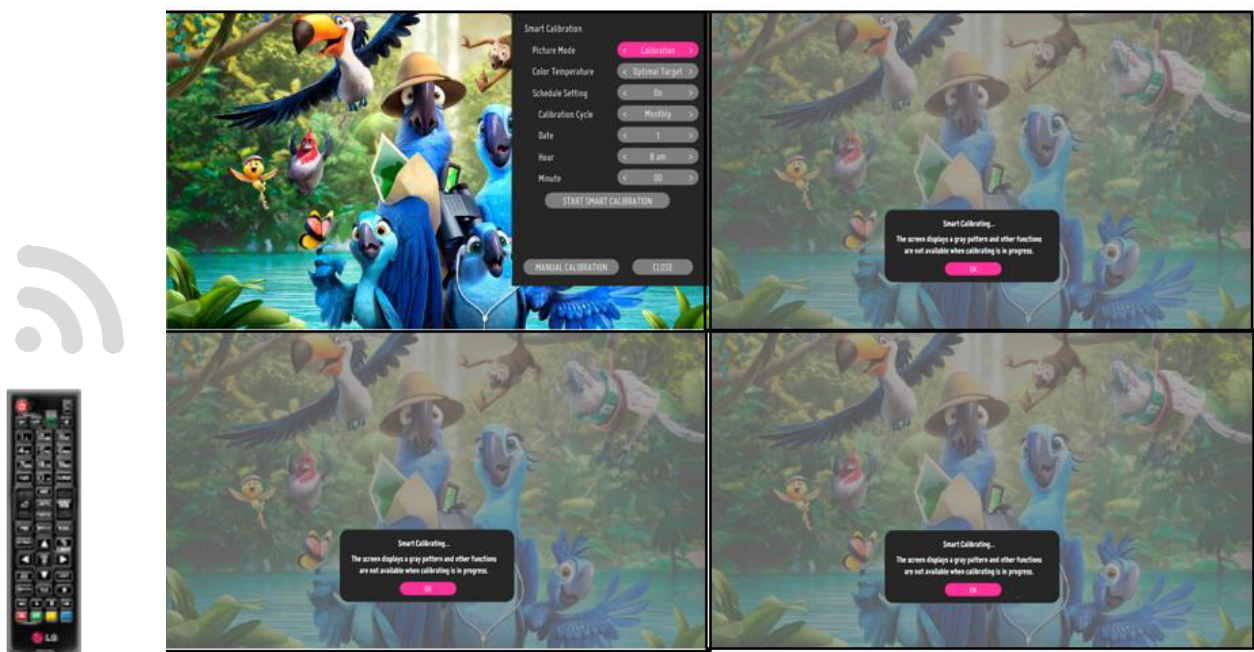

Figure 25 Smart Calibration: Calibrating the Brightness between Panels and Brightness/Color Uniformity in each Panel. Images are for illustrative purposes only.

LED Assistant SW is provided for the product settings of LED fine-pitch LAPE products. The white balance can be manually calibrated through the LED Assistant, and the brightness of the LDM-to-LDM threshold can be controlled through the Edge Calibration feature.

A brightness difference is caused between products according to the displayed content for OLED panels. Depending on the content, it also can be controlled by VLC connection separately from white balance calibration.



Picture Quality Competitiveness

Playing fast-moving videos on the monitor's edge creates a video gap (roughly one frame = 16.7 ms) due to the time difference of video scanning. Using the Scan Inversion feature of our video wall enables playing fast video content with virtually no image gaps. (Image Gap Reduction)

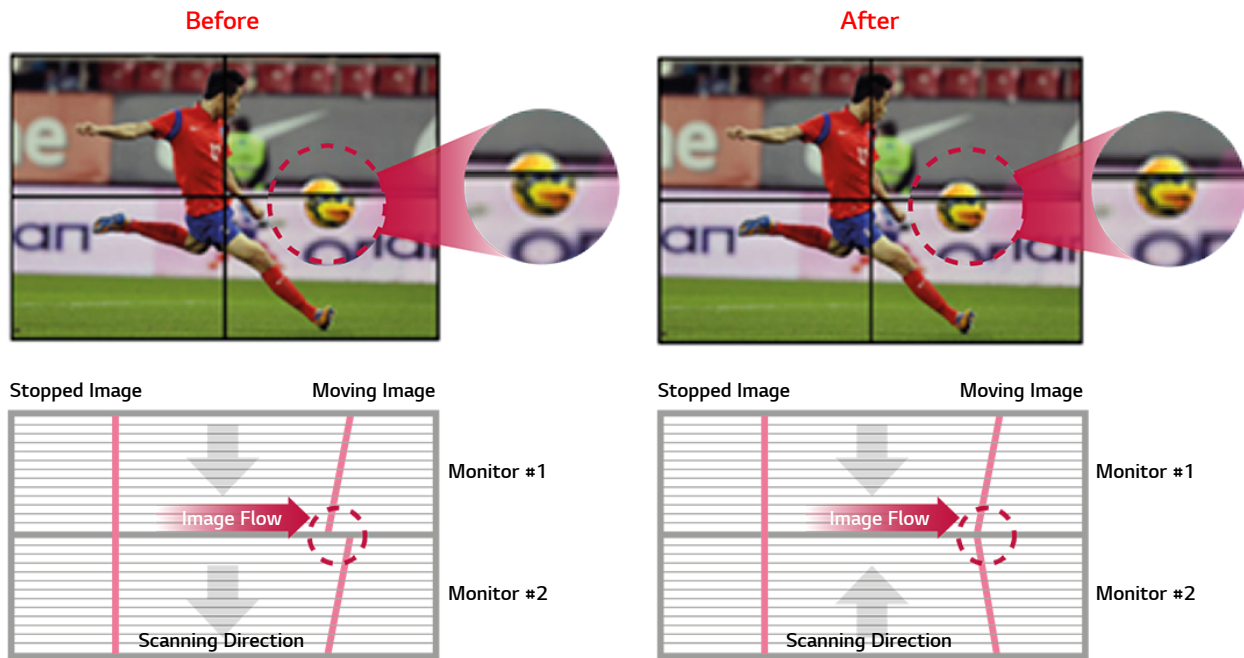

Figure 26 Image Gap Reduction. Images are for illustrative purposes only.

Maintenance Competitiveness

If you sign up for the optional and supplemental cloud service solution Signage 365 Care provided by LG, you can handle maintenance work more easily and quickly. Fault diagnosis and remote control services enable countermeasures before product problems occur and allow quick actions to resolve them. This enables stable operation, as well as reduces costs resulting from display malfunction.

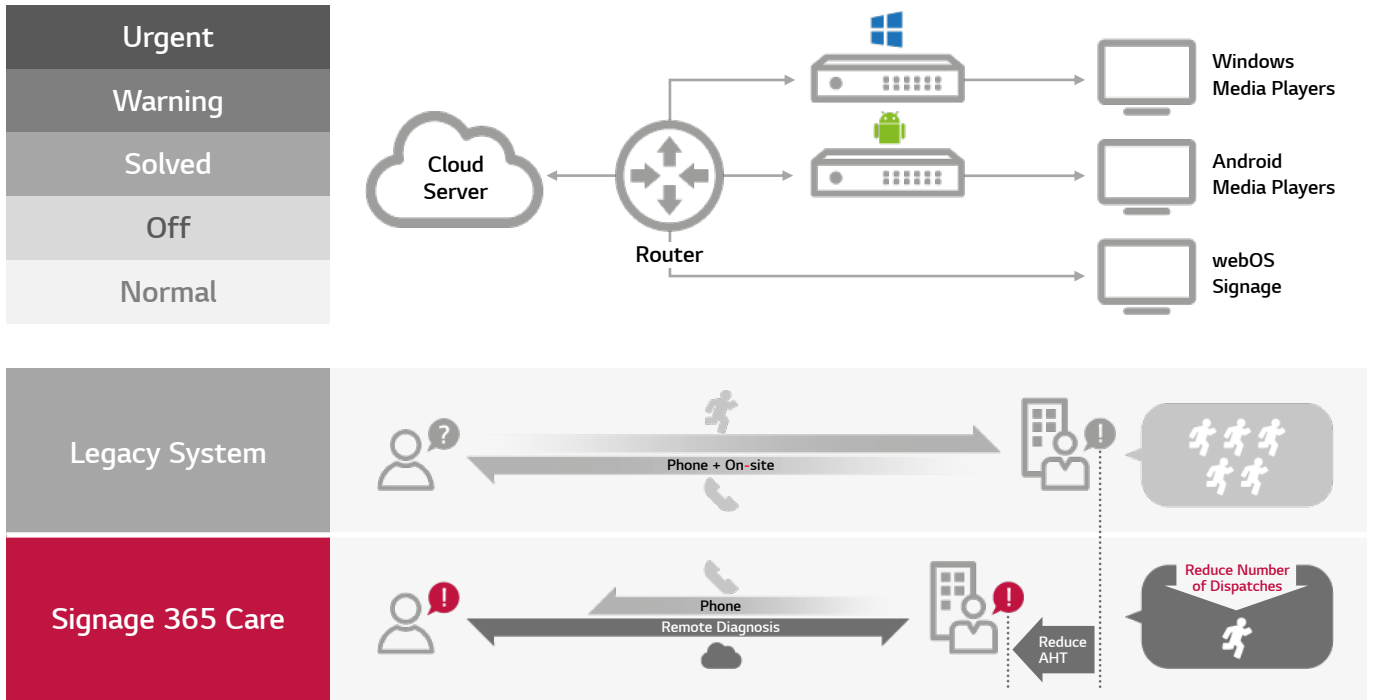

Figure 27 Signage365Care

Power Redundancy (Only 55SVH7PF)

Products with separate power supply enable placement of the display screen and power supply in separate locations (up to 60m available) to gain the effects of stable power management, convenient service, efficient space utilization, and reduced noise and heat.

Products with separate power supply can use the remote power redundancy feature to maintain stable power use for situation rooms that require video walls to operate 24/7. Power modules can be replaced while still maintaining the power supply for the displays, so the situation room screen can still be operating in case of a power module failure.

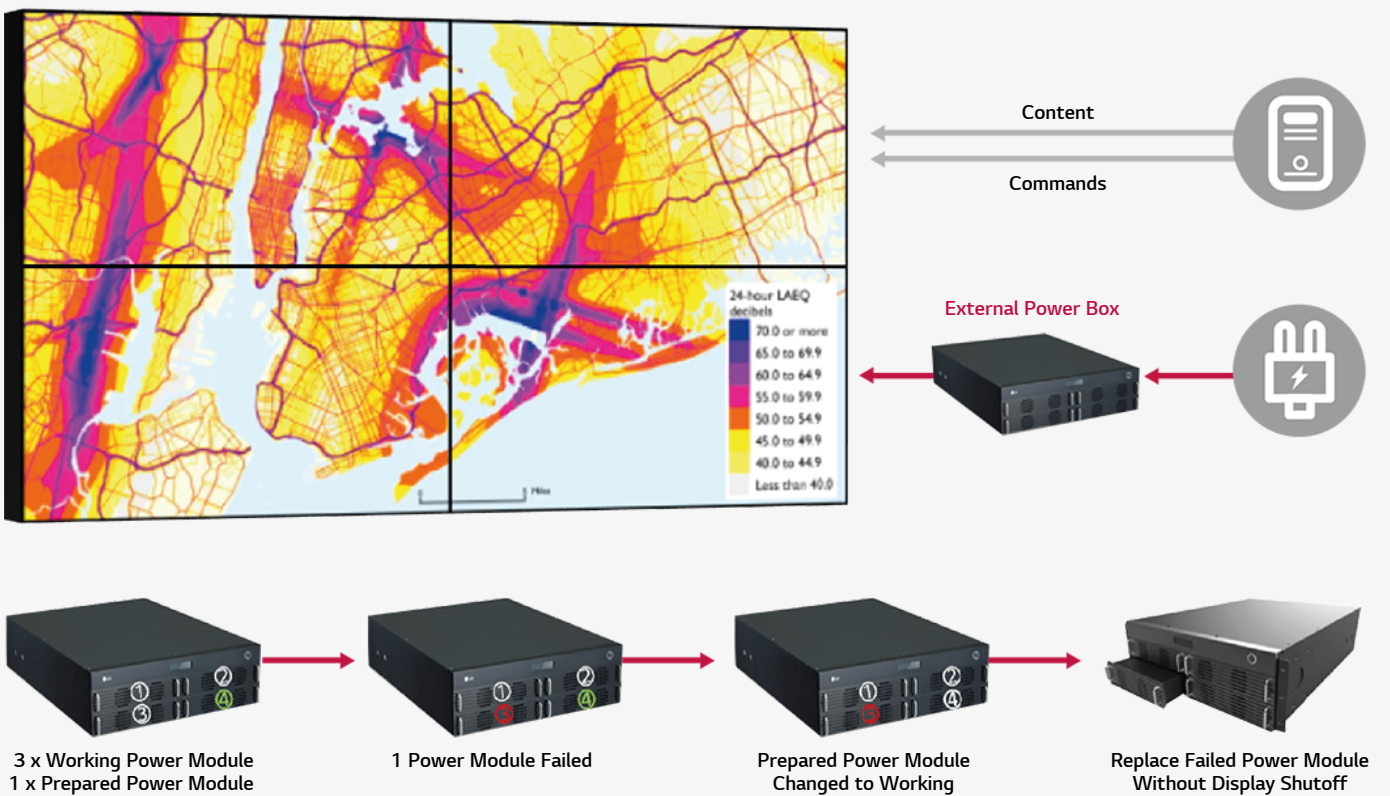

Figure 28 Power Redundancy



Feature Comparison

As there are various model options, choose the best optimized model according to user settings and budgets.

Model Name	55SVH7PF	55SVH7F 55SVH5F	55SVH7E	55VH7E-H	49/55VH7E 49/55VM5E	49/55VL7F 49/55VL5F	55LV77D 55LV75D	55VX1D
Size	55"	55"	55"	55"	49"/55"	49"/55"	55"	55"
Brightness (cd/m2)	700	700 500	700	700	700 500	700 450/500	700 500	1500
Haze	28%	3%	3%	44%	3%	3%	1%/10%	3%
Bezel(mm)	0.44(even)	0.44(even)	0.44(even)	0.9(even)	0.9(even)	3.5(B-to-B)	3.5(B-to-B)	3.5(B-to-B)
Weight(kg)	16.2	16.8	16.8	18.6	17.5/18.6	17.8/23.2	23.2	23.5
webOS	4.0	4.0	3.2	4.0	4.0	No	No	3.2
4K Thru DP Daisy Chain	Yes	Yes	Yes	Yes	Yes	No	No	Yes
Image Gap Reduction	Yes	Yes	Yes	Yes	Yes	No	No	No
Smart Calibration	Yes	Yes	No	No	No	No	No	No
Power (Watt_Typ)	188	210 TBD	170	220	150/220 120/150	130/230 90/160	230 160	250
Signage365 Care	Yes	Yes	Yes	Yes	Yes	No	No	Yes

Table 1 LG Video Wall Specs



Download
LG C-Display+
Mobile App

Google Play Store

- www.lg.com/b2b
- www.youtube.com/c/LGCommercialDisplay
- www.facebook.com/LGInformationDisplay
- www.linkedin.com/company/LGInformationDisplay

LG Electronics U.S.A., Inc. | Business Solutions | 2000 Millbrook Drive | Lincolnshire, IL 60069 All images on screen are simulated. Design, specifications, and features subject to change without notice. © Copyright 2019 LG Electronics USA, Inc. All rights reserved. LG and the LG logo are registered trademarks of LG Corp.
WP_Understanding_Videowalls_012043_LR

<https://www.lg.com/global/business/information-display/digital-signage/video-wall>