

Publication

PISA Vocational Education and Training (VET)

Assessment and analytical framework



PISA Vocational Education and Training (VET)

ASSESSMENT AND ANALYTICAL FRAMEWORK

This work is published under the responsibility of the Secretary-General of the OECD. The opinions expressed and arguments employed herein do not necessarily reflect the official views of the Member countries of the OECD.

This document, as well as any data and map included herein, are without prejudice to the status of or sovereignty over any territory, to the delimitation of international frontiers and boundaries and to the name of any territory, city or area.

Please cite this publication as:

OECD (2024), *PISA Vocational Education and Training (VET): Assessment and Analytical Framework*, PISA, OECD Publishing, Paris, <https://doi.org/10.1787/b0d5aaf9-en>.

ISBN 978-92-64-78251-8 (print)
ISBN 978-92-64-63938-6 (PDF)
ISBN 978-92-64-74940-5 (HTML)
ISBN 978-92-64-39470-4 (epub)

PISA
ISSN 1990-8539 (print)
ISSN 1996-3777 (online)

Revised version, May 2024

Details of revisions available at: https://www.oecd.org/about/publishing/Corrigendum_PISA_Vocational_Education_and_Training_VET.pdf

Photo credits: Cover © NassornSnitwong/Shutterstock.com.

Corrigenda to OECD publications may be found on line at: www.oecd.org/about/publishing/corrigenda.htm.

© OECD 2024

This work is available under the [Creative Commons Attribution-NonCommercial-ShareAlike 3.0 IGO](https://creativecommons.org/licenses/by-nc-sa/3.0/) (CC BY-NC-SA 3.0 IGO). For specific information regarding the scope and terms of the licence as well as possible commercial use of this work or the use of PISA data please consult Terms and Conditions on www.oecd.org.

Foreword

The Programme for International Student Assessment (PISA) Vocational Education and Training (VET) initiative being developed by the OECD is designed to measure the skills of learners who are about to complete their vocational education and training programmes in selected occupational areas. The PISA-VET assessment project supports countries in strengthening their skills systems by developing, piloting and implementing an internationally standardised assessment of outcomes of initial VET programmes, the analysis of the results of which will enhance comparative policy insights on how to improve the relevance, quality, equity and effectiveness of initial VET programmes.

The assessment focuses on five occupational areas: **Automotive Technician**; **Business and Administration**; **Electrician Craft /Industry**; **Health Care**, with a focus on **Healthcare/Nursing Assistants**; and **Tourism and Hospitality**, with a focus on **Employability Skills**. Students' proficiency in a set of Employability Skills is also assessed. These Employability Skills are: **Task performance** as defined by the OECD's **Survey of Social and Emotional Skills (SES)**; **Literacy**, as defined by **the OECD's Survey of Adult Skills (PIAAC)**; **Problem solving**, as included in **the OECD's PIAAC** as "Problem solving in technology rich environments", and/or "Adaptive problem-solving"; and **Collaboration** as defined by **the OECD's Survey of SES**.

The PISA-VET initiative builds on a range of national and industry-specific efforts to measure practice-oriented skills, but it would be the first time to apply these methods at scale and across countries. The initiative has the potential to pay huge dividends in terms of improving the labour-market relevance, quality and social status of vocational education and training. To achieve these benefits, the OECD, international experts, and participating countries must confirm the validity of the metrics and the international comparability of results that will come from this assessment. To address this, the OECD has established a three phased approach to the development of the assessment with multiple opportunities for countries to review progress and decide on subsequent work, and for industry experts to provide inputs.

This publication presents the theory underlying the PISA-VET assessment. It includes frameworks for assessing the five occupational areas selected for the assessment together with frameworks for the employability skills. These chapters outline the content knowledge that learners need to acquire in each occupational area, the processes that learners need to be able to perform, and the contexts in which this knowledge and these skills are applied. The publication also discusses how each occupational area is assessed. The chapter on employability skills outlines how these will be assessed using existing OECD frameworks and instruments. Subsequently, the publication presents the frameworks for the various questionnaires distributed to learners, the leaders of VET training institutions, teachers, and trainers in work-based learning environments. It concludes with the framework for the system level data that will be used to help the interpretation of the assessment and contextual data that will be collected.

This framework publication will act as a roadmap for the assessment. It sets out guidelines for test design and data analysis. The test design builds on the experiences of successful professional skills assessments such as the [ASCOT](#) research programme in Germany and [WorldSkills](#). It also makes the most of recent technological advances in assessment methods, such as the use of digital simulation to assess practice-oriented skills in the workplace.

PISA-VET is the product of a collaborative effort between OECD and the governments of both OECD countries and countries that are participating in the Development Phase of the initiative (Australia, Brazil, Belgium (Flanders), Germany, Greece, Ireland, Mongolia, Netherlands, Portugal, Republic of Türkiye, United Arab Emirates, United Kingdom and United States). The development of PISA-VET is overseen by the OECD's Working Party on International VET Assessment which is chaired by Luís Pereira dos Santos of Portugal. Technical guidance is provided to the OECD on PISA-VET by an Expert Group which is chaired by Erik Hess of Germany. PISA-VET is also the product of the OECD's collaboration with a range of international partner institutions and organisations, including the Trade Union Advisory Committee (TUAC) to the OECD, Business at the OECD (BIAC), WorldSkills, the Technology-based Assessment of Skills and Competences in VET (ASCOT+) initiative of the German Federal Ministry of Education and Research (BMBF), UNESCO, ILO, World Bank, Cedefop (European Centre for the Development of Vocational Training), European Training Foundation (ETF) and several corporations, industries, businesses and enterprises.

The Automotive Technicians framework was developed under the guidance of a sub-group of the Expert Group led by Stephan Abele (Dresden University of Technology, Germany). Other experts who contributed to the Automotive Technicians framework are Tobias Gschwendtner (Country Expert, Germany), Tanja Käser (Expert, Switzerland), Grant Petch (WorldSkills Expert, Australia), Peter Hesse (Country Expert, Germany), Dave Rexhäuser (Country Expert, Germany), Stefan Hartmann (Country Expert, Germany), Johanna Teliëps (Country Expert, Germany), Daniel Santos (Country Expert, Portugal), Veerle Vandepuit (Country Expert, Belgium (Flanders)), Jeferson Leandro Mateucci (Country Expert, Brazil), Cesar Cruz (Country Expert, Brazil), Bruno Assis (Country Expert, Brazil), Matthias von Davier (Expert, USA) and Lucas de Jesus (Country Expert, UAE).

The Electricians framework was developed under the guidance of a sub-group of the Expert Group led by Michael Hourihan (Munster Technological University, Ireland). Other experts who contributed to the Electricians framework are Nico Link (Country Expert, Germany), Gerard Galligan (Country Expert, Ireland), Leo van Waveren (Country Expert, Germany), Veerle Vandepuit (Country Expert, Belgium (Flanders)), Luke Boustridge (WorldSkills Expert, New Zealand), Adelino Santos (WorldSkills Expert, Portugal), Robson dos Santos (Country Expert, Brazil), Gustavo Henrique Moraes (Country Expert, Brazil), Paulo Roberto Wollinger (Country Expert, Brazil), Sally Messenger (WorldSkills Expert, United Kingdom), Robert Smart (Valid-8 Expert, Canada), Gert Zinke (Country Expert, Germany), Fábio Lima de Deus (Country Expert, Brazil), Carlos Junior (Country Expert, UAE).

The Business and Administration framework was developed under the guidance of a sub-group of the Expert Group led by Esther Winther (University of Duisburg-Essen, Germany). Other experts who contributed to the Business and Administration framework are Viola Deutscher (Country Expert, Germany), Jürg Schweri (Expert, Switzerland), Antonio Jorge (Country Expert, Portugal), Annick Denys (Country Expert, Belgium (Flanders)), Hilde Klykens (Country Expert, Belgium (Flanders)), Rosamaria Sobral (Country Expert, Brazil), Inês Filipa Pereira (Country Expert, Brazil), Eduardo São Paulo (Country Expert, Brazil), Joelma Kremer (Country Expert, Brazil), Gabriele Jordanski (Country Expert, Germany), Rami Khamis (Country Expert, UAE).

The Healthcare/Nursing Assistant framework was developed under the guidance of a sub-group of the Expert Group led by Jenny Shackleton (WorldSkills, United Kingdom). Other experts who contributed to the Healthcare/Nursing Assistant framework are Carolina Lopes (Country Expert, Portugal), Sally Messenger (WorldSkills Expert, United Kingdom), Inge Biot (Country Expert, Belgium (Flanders)), Natalia Lohmeyer (Country Expert, Germany), Robert Smart (Valid-8 Expert, Canada), Samuel Greiff (Country Expert, Germany), Sabina DeCurtins (WorldSkills Expert, Switzerland) Eduardo São Paulo (Country Expert, Brazil), Eveline Wittmann (Country Expert, Germany), Chee Nguk Lan (WorldSkills Expert, Singapore), Patrick Rouble (WorldSkills Expert, Canada), Miriam de Paula (Country Expert, UAE).

The Hotel Receptionist framework was developed under the guidance of a sub-group of the Expert Group led by Regina Madruga (School of Hotels and Tourism, Estoril, Portugal). Other experts who contributed to the Hotel Receptionist framework are Susan Relly (Country Expert, Australia), Elisabete Mendes (Country Expert, Portugal), Inês Filipa Pereira (Country Expert, Brazil), Soetkin De Knijf (Country Expert, Belgium (Flanders)), Séverine De Bruyn (Country Expert, Belgium, (Flanders)), Eduardo São Paulo (Country Expert, Brazil), Tânia Denise Ferreira (Country Expert, Portugal), Anita Milolaza (Country Expert, Germany), Raimund Lainer (WorldSkills Expert, Austria), Sarah Elson-Rogers (UNESCO-UNEVOC), Bruno Lanvin (WorldSkills Expert, France), Anita Milolaza (Country Expert, Germany), Hatim Urabi (Country Expert, UAE).

The Employability Skills framework was developed under the guidance of a sub-group of the Expert Group led by Samuel Greiff (University of Luxembourg, Luxembourg). Other experts who contributed to the Hotel Receptionist framework are Francesca Borgonovi (OECD), Dragos Iliescu (Expert, Romania), Haizheng Li (Expert, USA), Martina Lubyova (Expert, UK), Andreas Rausch (Country Expert, Germany), Catharina Gress-Wright (OECD), Claudia Tamassia (OECD), Alexandra Figueiredo (Country Expert, Portugal), Pedro Moreno da Fonseca (ILO), Hugo Nakatani (Country Expert, Brazil), Anna Christina Aun de Azevedo Nascimento (Country Expert, Brazil), Stefanie Velten (Country Expert, Germany), Laura Visan (European Commission-ESCO), Paulo Roberto Wollinger (Country Expert, Brazil), Gustavo Henrique Moraes (Country Expert, Brazil), Robson dos Santos (Country Expert, Brazil), Jennifer Diedrich (Country Expert, Germany), Anabela Serrão (Country Expert, Portugal), Jenny Shackleton (WorldSkills, Expert, United Kingdom), Kinga Szebeni (European Commission), Hiromichi Katayama (UNESCO), Agnes Dietzen (Country Expert, Germany), Stefanie Velten (Country Expert, Germany), Umut Erkin Taş (Country Expert, Türkiye), Ziwen Teuber (Expert, Luxembourg).

The framework for the PISA-VET questionnaires was developed by Lucia Tramonte (University of New Brunswick, Canada) with the guidance of and input from the Expert Group sub-group on questionnaires. This sub-group includes: Francesca Borgonovi (OECD), Alex da Silva Barbosa (Country Expert, Brazil), Viola Deutscher (Country Expert, Germany), Kinga Szebeni (European Commission), Herbert Emery (Expert, Canada), Samuel Greiff (Country Expert, Germany), Hiromichi Katayama (UNESCO), Tamara Kastorff (Country Expert, Germany), Viktoria Kis (OECD), Anthony Mann (OECD), Sally Messenger (WorldSkills Expert, United Kingdom), Mihaylo Milovanovitch (ETF), Hugo Nakatani (Country Expert, Brazil), Inês Filipa Pereira (Country Expert, Brazil), Eduardo São Paulo (Country Expert, Brazil), Annalisa Schnitzler (Country Expert, Germany), Anabela Serrão (Country Expert, Portugal), Jenny Shackleton (WorldSkills Expert, United Kingdom), Umut Erkin Taş (Country Expert, Türkiye), Silvia Taurelli (ETF), Marieke Vandeweyer (OECD), Michael Ward (OECD), Eveline Wittmann (Country Expert, Germany).

The framework for the PISA-VET system level data questionnaire was developed by Viktoria Kis (OECD) with the guidance of and input from the Expert Group sub-group on system level data. This sub-group includes: Marieke Vandeweyer (OECD), Hugo Nakatani (Country Expert, Brazil), Henrik de Moel (Expert, the Netherlands), Eveline Wittmann (Country Expert, Germany), Samuel Greiff (Country Expert, Germany), Anabela Serrão (Country Expert, Portugal), Kinga Szebeni (European Commission), Hiromichi Katayama (UNESCO), Robert Smart (Valid-8 Expert, Canada), Andrew McQueen (Country Expert, UK), Mihaylo Milovanovitch (ETF), Stefan Thomas (ETF), Siria Taurelli (ETF), Cristina Mereuta (ETF), Hugues Moussy (ETF).

The publication was prepared by the OECD Secretariat. Michael Ward and Marieke Vandeweyer coordinated the production of the framework with Isis González Pérez, Duniya Dedeyn, Dongwook Choi, Federico Bolognesi, and contributions from Yuri Belfali, El Iza Mohamedou, Francesco Avvisati and Tiago Fragoso. Charlotte Baer and Della Shin provided communications assistance, and Sasha Ramirez-Hughes provided editorial and administrative support. The report is published under the responsibility of the Secretary General of the OECD.

Table of contents

Foreword	3
Abbreviations and acronyms	11
1 What is PISA-VET?	12
How the initiative was developed	13
Organisation of the framework	14
Purpose of the assessment	15
Guiding principles	16
The scope of the assessment	17
The target population	20
The PISA-VET tests	21
The PISA-VET contextual questionnaires	31
System level data	33
A collaborative project	33
Implementation of PISA-VET	34
References	35
Notes	35
2 Automotive technician	37
Introduction	38
Defining the automotive technician occupational area	39
Organising the domain of automotive technicians	40
Assessing automotive technician learners	48
References	58
Annex 2.A. Systems, subsystems, components, and parts	60
3 Electrician	63
Introduction	64
Defining the Electrician occupational area	64
Organising the domain of electrician for PISA-VET	66
Assessing electrician learners	79
References	85
Annex 3.A. Content topics for guiding the assessment of electrician competence for VET learners	86
Annex 3.B. Further examples of digital simulations and a scenario question for the electrician occupational area	89

4 Business and Administration	96
Introduction	97
Defining the business & administration occupational area	97
Organising the domain of business & administration	99
Assessing Vocational Competency of learners in the business and administration occupational area	109
References	117
5 Healthcare	120
Introduction	121
Defining the healthcare occupational area	121
Organising the domain of healthcare/nursing assistant	123
Assessing healthcare/nursing assistant learners	136
References	142
Annex 5.A. Content topics for guiding the assessment of healthcare assistant competency for VET learners	144
Annex 5.B. Implications of live performance with (on-site) expert markers	149
Annex 5.C. Short versions of scenarios for immersive simulation and/or performance assessment	150
Notes	153
6 Tourism and Hospitality	154
Introduction	155
Defining the tourism and hospitality occupational area	155
Organising the domain of hotel receptionist	156
Assessing hotel receptionist learners	166
References	170
Notes	171
7 Employability Skills	172
Introduction to Employability Skills in PISA-VET	173
Defining Employability Skills	174
Organising the Domains of Employability Skills	175
Assessing Employability Skills in PISA-VET	196
Conclusion	203
References	204
Annex 7.A. Examples of Generic Assessments of Employability Skills in International Large-Scale Assessments	209
Annex 7.B. Examples of Occupationally Embedded Assessments of Employability Skills	212
8 Contextual Questionnaires Framework	218
Introduction	219
The core of contextual assessment in PISA-VET	219
Selection and organization of core content	224
Core content for assessing learners' success in the school and work environment	227
References	234
Notes	238
9 System-level data on VET	239
Introduction	240

Overview of available system-level data	241
Proposals for additional questions	249
References	254
Notes	254
Annex A. Glossary	256
Annex B. Contextual Questionnaires	259
Annex C. Experts contributing to the framework	304

FIGURES

Figure 2.1. Screenshots of the computer simulation to assess investigation capabilities (in German)	52
Figure 2.2. Screenshot of a log file (in German)	54
Figure 2.3. Screenshot of the correct responses to three items relating to the example given in the text (a car that will not start; free text entry; open-ended constructed-response items)	54
Figure 2.4. Screenshot of the 'Tools' menu of the computer simulation	55
Figure 2.5. Screenshot of a testing protocol	56
Figure 2.6. Screenshot of a CBA item utilising video vignettes	57
Figure 2.7. Screenshot of a CBA item utilising video vignettes	58
Figure 3.1. Example item from PISA Science 2006	82
Figure 4.1. Operational value chains and related contexts	101
Figure 4.2. Business and administration processes and the underlying capabilities	103
Figure 4.3. Content knowledge linked to occupational contexts	107
Figure 4.4. Design anchors that bind an authentic test environment to the occupational context	110
Figure 4.5. Model of Competency Dimensions in the business and administration Domain	112
Figure 4.6. The interface of an authentic technology-based test environment	114
Figure 4.7. PCM based on an item	115
Figure 5.1. Bloom's taxonomy: cognitive, psychomotor, and affective domains	127
Figure 5.2. Miller's Pyramid of Competence	137
Figure 5.3. Proposed assessment package	139
Figure 7.1. The Literacy Continuum towards Occupation-Specific Skills	180
Figure 7.2. The Nexus of Task Dimensions, Cognitive and Metacognitive Processes and Proficiency Levels	184
Figure 7.3. Generic and Occupationally Embedded Assessment of Employability Skills	199
Figure 8.1. Assessment approach to equality and equity	223
Figure 9.1. Average age of learners in vocational programmes, by level of education	245
Figure 9.2. Share of upper secondary vocational learners in combined school and work-based programmes (2021)	246
Annex Figure 5.B.1. infrastructure for standardised performance assessment	149
Annex Figure 7.A.1. Example of A PIAAC Literacy Item	209
Annex Figure 7.A.2. Example of A PIAAC Cycle 2 Problem Solving Item	210
Annex Figure 7.B.1. Depictional Item Taken from the Assessment of Functional Reading Competence	213
Annex Figure 7.B.2. Example Item from the assessment of diagnostic skills in automotive technicians	214
Annex Figure 7.B.3. Screenshot of LUCA Office Simulation with Spreadsheet and Calculator	215
Annex Figure 7.B.4. Example Item Taken from the Assessment of Communication Strategies	216
Annex Figure 7.B.5. Screenshot of Embedded Experience Sampling (EES) within the LUCA Office Simulation	217

TABLES

Table 1.1. Narrowing of occupational areas for the assessment	18
Table 1.2. Occupational areas and target populations	20
Table 1.3. Total test material by clusters (two-hour test)	23

Table 1.4. Total test material (forms) by domains (135 minutes test)	24
Table 1.5. Summary descriptions of proposed performance reporting	30
Table 1.6. Modules assessed in PISA-VET	32
Table 2.1. Examples of VET programmes for automotive technicians	39
Table 2.2. Desired distribution of items by context	40
Table 2.3. Desired distribution of items by automotive technicians' processes	46
Table 2.4. Desired distribution of items by content knowledge	48
Table 2.5. Summary description of the levels of investigation proficiency in PISA-VET	51
Table 2.6. Summary description of the levels of rectification proficiency in PISA-VET	51
Table 3.1. ISCO-08 Electrical and Electronics Trades Workers	65
Table 3.2. Examples of VET programmes for electricians	66
Table 3.3. The environments in which Electricians work	67
Table 3.4. Percentage of items by context	69
Table 3.5. Desired distribution of electrician items, by process	72
Table 3.6. Relationship between electrician processes and fundamental capabilities	76
Table 3.7. Percentage of items by content knowledge category	79
Table 3.8. Digital simulation example 1: Fault finding, testing, and reporting	81
Table 3.9. Example of a potential scenario	83
Table 3.10. Descriptors of learning outcomes	84
Table 4.1. Examples of VET programmes in the business and administration occupational area	98
Table 4.2. Operational value chain and occupational scope	100
Table 4.3. Desired distribution of business and administration items, by context category	102
Table 4.4. Business and administration processes and level of complexity/level of capability	104
Table 4.5. Desired distribution of business and administration items, by process category	104
Table 4.6. Relationship between business and administration processes and fundamental capabilities (example)	106
Table 4.7. Desired distribution of business and administration items, by content category	108
Table 4.8. Summary description of the levels of business and administration proficiency in PISA-VET	116
Table 5.1. Main programmes leading to qualified healthcare/nursing assistant status	122
Table 5.2. Percentage of items by context	126
Table 5.3. Desired distribution of healthcare/nursing assistant items, by process	129
Table 5.4. Relationship between healthcare/nursing assistant processes and fundamental capabilities	133
Table 5.5. percentage of items by content category	136
Table 5.6. Scenario template with sample	138
Table 5.7. Descriptors of learning outcomes	140
Table 5.8. Self-management of asthma	141
Table 6.1. Main programmes leading to qualified hotel receptionist (country's participation in the Development Phase)	156
Table 6.2. Desired distribution of hotel receptionist	161
Table 6.3. Relationship between hotel receptionist processes and fundamental hotel receptionist capabilities	163
Table 6.4. Desired distribution of hotel reception items, by content category	165
Table 6.5. Summary description of the levels of hotel receptionist proficiency in PISA-VET	168
Table 7.1. PIAAC Literacy Described Scale	178
Table 7.2. PIAAC Problem Solving Scale on Three Proficiency Levels	184
Table 7.3. Further Skills	193
Table 7.4. Overview for all Employability Skills x Occupational Area combinations	194
Table 7.5. Advantages and Disadvantages of a Generic Assessment	197
Table 7.6. Advantages and Disadvantages of An Occupationally Embedded Assessment	198
Table 8.1. PISA-VET Areas of assessment and questionnaire organization	225
Table 9.1. Types of institutions	251
Annex Table 3.B.1. Digital simulation example 2: Install pumps in a wastewater plant	89
Annex Table 3.B.2. Digital simulation example 3: Produce a circuit design	90
Annex Table 3.B.3. Digital simulation example 4: Quantity survey	90
Annex Table 3.B.4. Example 2 of a scenario	91
Annex Table 7.A.1. Examples Items for Task Performance	211
Annex Table 7.A.2. Example Items for Collaboration	211

BOXES

Box 1.1. Definitions of the domains

24

Box 9.1. Data collections under the INES Working Party

242

Follow OECD Publications on:



<https://twitter.com/OECD>



<https://www.facebook.com/theOECD>



<https://www.linkedin.com/company/organisation-eco-cooperation-development-organisation-cooperation-developpement-eco/>



<https://www.youtube.com/user/OECDiLibrary>



<https://www.oecd.org/newsletters/>

Abbreviations and acronyms

List of abbreviations and acronyms used in the framework document

	Full name
AI	Artificial Intelligence
ASCOT	Technology-based Assessment of Skills and Competences in VET
BIAC	Business at the OECD
CEDEFOP	European Centre for the Development of Vocational Training
CTT	Classic Test Theory
EC	European Commission
EDPC	Education Policy Committee
EG	Expert Group of the PISA-VET
EEG	Extended Expert Group of the PISA-VET
EQF	European Qualifications Framework
ERP	Enterprise Resource Planning
ESCO	European Skills, Competences, Qualifications and Occupations
ESCS	Economic, social and cultural status
EU	European Union
EU-LFS	European Union Labour Force Survey
EU-SILC	European Union Statistics on Income and Living Conditions
ICT	Information and communication technology
INES	Indicators of Education Systems (INES) Working Party
ILO	International Labour Organisation
IRT	Item Response Theory
ISCED	International Standard Classification of Education
ISCO	International Standard Classification of Occupations
LSO	Network on Labour Market, Economic and Social Outcomes of Learning
OECD	Organisation for Economic Co-operation and Development
O*NET	Occupational Information Network
NESLI	Information on Educational Structures, Policies and Practices
PGB	PISA Governing Board
PIAAC	Programme for the International Assessment of Adult Competencies
PISA	Programme for International Student Assessment
SES	Social and Emotional Skills
SSES	Survey on Social and Emotional Skills
STEM	Science, Technology, Engineering and Mathematics
TUAC	Trade Union Advisory Committee to the OECD
UNESCO	United Nations Educational, Scientific and Cultural Organisation
UOE	UNESCO-OECD-Eurostat (UOE) data collection
VET	Vocational Education and Training
VET-LSA	VET Large Scale Assessment
WP	Working Party on International Vocational Education and Training Assessment

1 What is PISA-VET?

This chapter provides an overview of PISA-VET and explains how the initiative was developed in response to interest from several countries. It describes the purpose of the assessment and its scope, the guiding principles, the target population, as well as the test design for assessing professional skills and employability skills across different systems and the policy implications of this. The chapter also highlights the key features of the initiative, describes the collaborative nature of PISA-VET and sets out the timeline for its Development Phase and the preparation of its Pilot Phase.

How the initiative was developed

Interest in vocational education and training (VET) is increasing. It is high on the policy agenda in most OECD countries and the European Union (EU), as a vehicle to engage learners in learning and facilitate effective school-to-work transitions (see Annex A for a glossary that provides definitions of the main concepts and terms used in this document). It can contribute to developing the skills needed for greener and more digital economies and societies, both by equipping young learners in initial VET programmes with the right skills and by providing opportunities for upskilling and reskilling to adults.

The OECD's Education Policy Committee (EDPC) first discussed a proposed PISA (Programme for International Student Assessment)-type assessment focused on vocational skills in 2014 but countries decided to defer work on it since the paper-based assessment formats available at that time were not adequate to the task.

During 2020, in response to interest from several countries and considering advances in assessment technology and methodologies, the OECD PISA Secretariat, in collaboration with the OECD's Centre for Skills (SKC), prepared a new proposal for an international assessment of professional skills of learners undertaking programmes of vocational education and training. The proposal is to leverage recent innovations in assessment technology to assess and compare learners in initial VET programmes (i.e. those programmes offering a first VET qualification, regardless of learner background) in different countries, through the assessment of the professional skills/outcomes of individuals and their learning environments. This will eventually lead to the assessment of the outcomes of VET activities.

The proposal was discussed among interested OECD member countries in a series of meetings during 2021 and into 2022 in which the questions that guided the design of the assessment were formulated. These questions included:

- How to compare achievement in VET across countries and within specific occupations?
- How does achievement in VET relate to differences in the design and delivery of VET programmes (between and within countries)?
- How to relate achievement in VET to per learner expenditures?
- Which VET programmes and occupational areas lend themselves most readily to international comparison?

The OECD Secretariat established a PISA-VET Expert Group (EG) in September 2022 to support the technical work involved in the project. This Group works closely with the OECD on the development of the initiative, including this framework document. The EG is chaired by a representative of Germany and is made up of more than 100 specialists in VET and assessment that are drawn mainly from the participating countries but also includes experts from partner organisations, experts that have been identified by the OECD, together with representatives of employers and trade unions. The OECD formed sub-groups of the EG for each chapter of the framework (see Annex C of this document for details of all the experts that have contributed to the framework) and each of these was led by a lead expert.

A zero draft of the framework was prepared in May 2023, and many VET and assessment experts in the participating countries (known as the Extended Expert Group, or EEG for short) beyond those involved in the EG reviewed and commented on this. At the same time, a wide range of stakeholders, including representatives of employers and trade unions, as well as the OECD's network of VET and skills experts also reviewed and commented on the zero draft.

The OECD and the EG took account of the feedback on the zero draft as they prepared the current version of the framework, this document. This framework will be used as the basis for the instrument development and methodological study scheduled to take place in 2024-2025. This framework will be revised and updated during 2025 in the light of the instrument development and the results of the methodological study,

to clarify any remaining issues regarding the feasibility and manageability of the assessment, test design, learner performance reporting and the likely costs to countries of participating in a large-scale assessment of VET.

Organisation of the framework

This framework is intended to guide the work of the instrument developers, help policymakers understand the purpose and the appropriate use of the assessment results, and inform researchers and educators about methodological choices. It:

- Defines the target occupational areas.
- Specifies the competencies to be tested.
- Provides orientations for task design.
- Indicates appropriate data analysis and reporting approaches, including how to use the proposed proficiency scale.

In line with the recommendations of the OECD's education committees and the Working Party on the PISA-VET (WP) and the EG, the assessment framework follows the design of the PISA assessment and analytical frameworks and is organised as follows:

- **Introductory Chapter (Chapter 1 of this document)** – an overview of PISA-VET and explanation of how the initiative was developed; a description of the purpose of the assessment and its scope, the guiding principles, the target population, as well as the test design for assessing professional skills and employability skills across different systems and the policy implications of this.
- **One chapter on each of the five selected Occupational Areas (Chapters 2-6 of this document)** – a definition of each of the occupational areas and the domains associated with each of these, description of the contexts, processes, underlying capabilities and knowledge content involved in the domains, organising the domains, reference points (such as the occupational profiles of the European Skills, Competences, Qualifications and Occupations (ESCO), the European Qualification Framework (EQF) levels and equivalents from other regions), description of competencies, definitions of the constructs to be measured, assessing the domain, the types of tasks to be used in the assessment, including sample items and task characteristics, how it is proposed that performance in the domain will be measured, including reporting proficiency.
- **Chapter on Employability Skills (Chapter 7 of this document)** - definition of the domains, description of the processes involved in the domains, organising the domains, description of competencies, definitions of the constructs to be measured, assessing the domains, the types of tasks to be used in the assessment, including sample items and task characteristics, how performance in the domains will be measured, reporting proficiency.
- **Chapter on Background Questionnaires (learner, institution, teacher and work-based trainer/employer – Chapter 8 of this document)** – describes the framework and core content for the PISA-VET contextual questionnaires. The Chapter presents the content and the aims of the instruments for learners in the targeted occupational areas. It also describes the teacher, VET institution, and employer/trainer questionnaires that are used for the assessment.
- **Chapter on System Level Data (Chapter 9 of this document)** – description of the contextual variables of VET systems that PISA-VET will use to analyse and interpret the results of the assessment, presentation of the system level questionnaire to be used to collect the data, including highlighting system level data currently collected for the OECD's *Education at a Glance*, description of the data collection methodology.

- **Annexes**
 - Glossary of Terms - **Annex A** of this document
 - Background questionnaires (learner, teacher, institution, and work-based trainer/employer) – **Annex B** of this document
 - Details of experts contributing to the framework - **Annex C** of this document

Purpose of the assessment

Vocational education and training systems vary widely across the world. They have their own government systems and unique frameworks which are in general underpinned by specific legal regulations with often shared ministerial responsibilities, including regional government bodies and diverse funding schemes. They may assign particular roles and responsibilities to relevant stakeholders like companies and social partners and exploit strategic initiatives and programmes to respond to training and labour market developments.

The updated International Standard Classification of Education (ISCED) allocates in a comprehensive approach the different educational programmes and pathways to its hierarchical taxonomy with the aim to globally providing statistical data. In Europe and beyond, the paradigm shift to learning outcomes has become established as a result of the European Qualifications Framework (EQF). The learning outcomes approach basically expresses that the total amount of training hours spent is less important than what VET graduates are able to perform.

PISA-VET does not and could not aim to ultimately produce an international ranking of complex VET systems. It rather targets the cross-border assessment of typical professional skills of VET students the outcomes of which provide VET policy makers and relevant stakeholders on an operational level with meaningful data to inform their national decision-making when seeking to modernise or improve programmes, content, learning settings or concepts according to their national or regional circumstances and objectives. In this regard, the PISA-VET project supports countries in strengthening their skills systems by developing, piloting, and implementing an internationally standardised assessment of outcomes of initial VET programmes.

The aim of the initiative is to enhance comparative policy insights on improving relevance, quality, equity, and effectiveness of initial VET programmes. The initiative will accomplish this by delivering a comprehensive dataset on selected VET learning outcomes and related background factors. This dataset will go beyond participation and employment rates and provide internationally comparable data on the performance of selected VET programmes within systems in key occupational areas in the context of a broader policy environment. In doing so, the initiative will inform decision making, help to further develop the quality of VET provision, provide evidence for competency development of VET learners, facilitate peer learning opportunities between countries, and help to raise the image and promote the profile of VET.

PISA-VET will achieve its aim by collecting and analysing data on learner performance in the tests of professional skills outlined in Chapters 2-6 and the tests of employability skills described in Chapter 7 alongside the collection and analysis of contextual data and system level data presented in Chapters 8 and 9 respectively. Thus, through the collection and analysis of this data PISA-VET will provide policy insights on a range of outcomes and related factors, including:

- Comparative skill levels of learners across countries within specific VET programmes and programme types¹ and differences between learners with distinct characteristics.
- Distinct or similar features of VET programmes in selected occupational areas across and within countries and how they are related to outcomes.

- System-level features, such as resources invested in VET and regulations around VET teachers and trainers, and how these are related to outcomes.

To develop meaningful policy insights from the differences that will be observed between countries and programmes, these variations must be contextualised to account for contrasts in programme design and learner background. PISA-VET will provide the means for this contextualisation through the collection of the necessary background data and system level data.

This assessment for vocational education and training is inspired by PISA and follows the PISA model in respect of its framework and approach to assessment. However, the exercise will reflect the distinctive features of vocational education and training when it comes to developing the test methodology and test items. The test design is meant to cover in a coherent way both domain-specific as well as cross-cutting competencies by focusing on selected professional activities that are typical for the work and business process in the selected occupational areas.

As with PISA, the PISA-VET test is designed to provide an assessment of performance at the system (or country) or programme level. Similarly, it is not designed to produce scores for individual learners, and it is not, therefore, necessary for each learner to receive the same set of test items. Thus, PISA-VET adopts an efficient design in which the full set of test material, covering all aspects of the framework, is distributed over many test forms. This procedure enables the OECD to obtain a much greater coverage of the content at a test length that fosters learner engagement and institutional participation, resulting in higher data quality.

This initiative builds on a range of national and industry-specific efforts to measure professional skills, but it will be the first time to apply these methods at scale and across countries. The initiative has the potential to pay huge dividends in terms of improving the labour market relevance, quality and social status of vocational education and training. To achieve these benefits, the OECD, international experts, and participating countries must confirm the validity of the metrics and measurement and the international comparability of results that will come from this assessment. To address this, the OECD has established a step-by-step approach to the development of the assessment framework and the instruments with multiple opportunities for countries to review progress and decide on subsequent work.

Guiding principles

The purpose of PISA-VET will be achieved ultimately through the continuous and regular administration of the survey following a successful Development Phase and Pilot Phase. PISA-VET will be developed and implemented in accordance with the following principles.

PISA-VET principles for 2023-2030:

- (i) PISA-VET is policy-oriented and meets the needs of educational policy making and implementation for enhancing teaching and learning in selected VET programmes.
- (ii) PISA-VET will be a regularly administered system-level assessment of learning outcomes, well-being and learning environments of learners following selected initial VET programmes.
- (iii) PISA-VET measures knowledge, skills, attitudes and values of learners and their capacity to apply these competencies creatively and effectively in work situations and real life.
- (iv) PISA-VET provides valid, comparable, and reliable data on selected initial VET programmes across a wide range of countries and over time.
- (v) PISA-VET is a collaborative and innovative effort to develop forward-looking assessments.

The scope of the assessment

The purpose of PISA-VET determines its scope, target population and design. With the aim of providing internationally comparative information on the professional skills of learners near the end of their training, the scope of the assessment is sufficient to measure the “yield” of VET programmes, or what skills learners have and can apply in their chosen occupational areas to real-work contexts. The assessment emphasises the mastery of processes, the understanding of concepts, and the application of knowledge and functioning in various work situations and contexts in the selected occupational areas.

The occupational areas and employability skills are treated as domains or subject areas for assessment purposes. The domains covered by the assessment are first defined and then presented and analysed in the chapters of this framework in terms of four inter-related aspects:

- Contexts – the domain specific context or situation in which the tasks and problems arise or are set.
- Processes – the mental strategies, approaches, purposes, concepts, and reasoning that the learners are required to engage with and to employ, formulate or interpret to be successful in the domain.
- Underlying capabilities – the set of fundamental domain specific capabilities that underpins each of the processes.
- Content knowledge – the learners’ knowledge and understanding of the domain content – and the ability to apply that knowledge to contextualised tasks and problems.

The scope and target population for PISA-VET was agreed by the EDPC and PGB, following proposals and recommendations from the PISA-VET Expert Group (EG) and Working Party (WP)².

Occupational areas

Following discussions with VET and assessment experts from OECD countries and beyond, five occupational areas have been selected as the focus of the assessment’s Development Phase, as follows:

- Automotive Technician occupations
- Electrician occupations
- Business and Administration occupations
- Health Care occupations
- Tourism and Hospitality occupations.

Some of these occupational areas are broad in nature, encompassing several types of occupations, while others have a narrow focus on a particular occupation or set of occupations. As such, where needed, the target population within these occupational areas focuses on one or a set of more narrowly defined occupations.

The occupational areas have been narrowed down during the development of this framework and as the target population has been defined (as shown in the relevant sections below). This is particularly the case for Business and Administration, Health Care and Tourism and Hospitality, which cover a broad range of occupations and associated VET programmes. In these three occupational areas the assessment will focus on the occupations illustrated in Table 1.1 below. The focus of the assessment in each of the five occupational areas is summarised in the later sections of this chapter and is elaborated in more detail in the respective chapters for each of the occupational areas.

Table 1.1. Narrowing of occupational areas for the assessment

Occupational Area	Assessment focus
Business and Administration	Business and administration job family in commercial workplaces
Health Care	Healthcare/nursing assistant
Tourism and Hospitality	Hotel receptionist

When deciding on the selection of occupational areas, a set of selection criteria were used. The occupational areas have been chosen because each of them comprises fields that are of significant economic importance now and are likely to remain so well into the future while demanding professional skills that are sufficiently comparable at the international level. In addition, the choice was also guided by the existence of learner cohorts of sufficient size in participating countries to support reliable, valid, and relevant conclusions for the labour market. A further key consideration was whether there are sufficient resources already available to support measurement of competencies within these occupational areas.

Consideration was also given to achieving a balanced mix of types of occupations and the gender of learners. This mix of occupational areas achieves a balance between those occupational areas requiring mostly Science, Technology, Engineering and Mathematics (STEM)-related competencies and those requiring mostly competencies outside of STEM fields. Gender dimensions are a crucial feature of the assessment and, taken together, the five occupational areas selected for the Development Phase represent an acceptable gender balance in terms of learner population. Two of the occupational areas (electrician and automotive technician) are typically male dominated, one of the occupational areas (health care) is female dominated and two (business and administration and tourism and hospitality) represents both male and female learners equally, while the more narrowly focused occupation of hotel receptionist is female dominated. The assessment at the same time integrates a gender equality perspective into all aspects of the assessment material to promote a less gender-stereotyped view of the occupational areas and associated VET programmes.

In addition, the digital and the green transitions are critical dimensions for VET³. The green transition is necessary to mitigate the consequences of climate change and environmental degradation. The digital transition is an ongoing process that continues to transform the way we live. The green and digital transitions together have the potential to further transform dominant practices in the economy and in society. The five selected occupational areas are each impacted by these transitions, albeit at varying degrees. Therefore, the two transitions are treated as crosscutting issues in the framework for each occupational area. They are also reflected in the framework for employability skills and in the background questionnaires.

While each of the occupational areas selected for the assessment are expected to continue and remain important for the economy and for VET over the longer term, it is important to recognise that the assessment is taking place in a rapidly changing world. All the occupational areas selected for the assessment are affected by rapidly changing contexts and technologies. In the case of automotive technicians, for example, there is a move away from petrol and diesel driven engines towards alternative fuels and electric powered vehicles. These changes are reflected in the framework and the instruments in the same way that they are being reflected in the VET systems that are the focus of the assessment.

Employability Skills

Success in the world of work requires transversal competencies in addition to job-specific knowledge and skills. In a changing world of work, employers increasingly seek employees who adapt easily and can apply and transfer their skills and knowledge to new occupational contexts. This is especially the case in the context of the green and digital transformations which are changing the world of work in rapid and profound

ways. It is thus important to supplement the assessment of occupation-specific skills with information on a broader set of cognitive and social and emotional competencies – referred to as employability skills in the contexts of this framework document.

While certain employability skills are important across the occupational areas, others are more relevant and potentially occupation-specific in some areas than in others. The assessment therefore includes a set of “core” or “foundational” employability skills which are considered relevant for all VET learners irrespective of their occupational focus.

Following lengthy consultation with VET and assessment experts, the following “core” employability skills were selected for the Development Phase:

- **Collaboration**, as defined by the OECD’s *Survey of Social and Emotional Skills (SSES)*.
- **Literacy**, as defined by the OECD’s *Survey of Adult Skills (PIAAC)*.
- **Problem Solving**, as included in *the OECD’s PIAAC Cycle 2 (adaptive problem solving)*.
- **Task performance** (responsibility, self-control, and persistence), as defined by the OECD’s SSES.

When deciding on the selection of employability skills, a set of selection criteria were used. Foremost among these criteria was the condition that only employability skills that had existing international frameworks and instruments could be considered for selection. From a shortlist of employability skills that met this fundamental criterion, the EG selected the four “core” employability skills for the assessment based on their clear understanding of what employers are looking for from newly trained professionals in this regard and their analysis of the foundational skills required by learners to participate effectively in the selected occupational areas.

While various other employability skills met the fundamental criteria for selection and can be considered of importance across occupational areas and hence potentially interesting additions to the “core” set of employability skills, the number of abilities to include in the core had to be kept low due to practical constraints (see below). However, the focus on these “core” employability skills has not precluded the possibility of assessing other abilities that are transversal in nature but show different complexity, characteristics, and shape from a certain occupational area to another (e.g. ICT literacy in business and administration, communication in healthcare, numeracy in automotive technician). The framework therefore includes a broader set of employability skills as elaborated in later chapters of this document, in particular Chapter 7.

In addition, the framework allows for assessment of the core employability skills within the occupational contexts in addition to the PIAAC Literacy and PIACC problem solving tests to reflect the specialised nature of these skills for certain occupations (e.g. literacy skills needed to read patient care plans in the case of healthcare assistants). The further work on measuring these occupation-specific employability skills carried out in the Development Phase will aim at establishing a common understanding, especially regarding these other abilities outlined at Table 7.3 in Chapter 7. Indeed, Table 7.3 in Chapter 7 might serve as a basis for such a common understanding. These distinctions between a core set of foundational employability skills measured using existing PIAAC and SSES instruments and the skills that are applied to each of the occupational areas are elaborated further in the remainder of this Chapter and in the respective Occupational Area and Employability Skills Chapters included in this framework document.

Given the target population for PISA-VET of learners close to the end of their initial VET programmes of learning (see below), it will be a challenge to isolate the skills they have acquired from their VET programme from those they had developed before entry to these programmes – and this represents a particular challenge for employability skills, which can be developed over the lifetime through various learning experiences. At this stage, it is not envisaged that there will be an additional assessment of employability skills of VET entrants in the participating countries. As in PISA, PISA-VET will measure the accumulated learning of the participating learners, not just the skills and knowledge they have acquired in their initial VET programmes. The analysis of contextual data will help to identify those factors that are

most closely related to learner performance, for example by taking into account the age of the learners and their pathway into the VET programme. It is therefore possible that the policy implications of certain findings from the assessment may go beyond the VET sector. The two opening phases of the assessment, the Development Phase and the Pilot Phase, will seek to account for differences in these initial conditions when comparing professional skills across countries and to determine the outcomes of VET programmes.

The target population

The target population for the assessment generally are learners nearing the end of initial formal VET programmes in the five occupational areas at the upper-secondary and post-secondary non-tertiary education levels (International Standard Classification of Education (ISCED) Levels 3 and 4). The population of learners enrolled in the sampled VET programmes will be outlined for the assessment based on their programme comparability in terms of learning outcomes (levelled across levels 3-4 of the European Qualifications Framework, EQF, or equivalent for those countries not using EQF). This includes learners in school-based programmes and in programmes that combine school-based and work-based learning (e.g. apprenticeships).

The learners sampled for this programme will be assessed in the last six months of their programmes, as the aim of the assessment is to measure professional skills of learners when they are close to gaining their first VET qualification in readiness to enter their target occupation.

While no age range is specified for the target population, it is likely that most learners sampled for this assessment will have commenced their training programmes at age 16 or 17 and would be aged 18-20 at the time of taking the test. In some countries, however, the learners are likely to be older. The OECD has consulted the participating countries on the target population and these have confirmed the feasibility of targeting these learners and ensuring representativeness and cross-national comparability.

In recognition that for some systems adults are a significant and increasing proportion of the VET student population, adult learners returning to VET after beginning working life, may be included in the assessment, but they will be kept separate for analytical purposes as an additional sample if of interest to participating countries – given their different educational backgrounds, work experiences and life skills.

The precise target population in terms of VET programmes for each occupational area has been narrowed down during the development of the framework. The focus will be on a set of VET programmes or qualifications within the selected occupational areas that are comparable in terms of learning outcomes. The target populations for each of the five occupational areas has been defined as presented in Table 1.2 below.

Table 1.2. Occupational areas and target populations

Occupational Area	Target population
Automotive Technician	Students, apprentices and trainees training to be automotive technicians in the last six months of their initial VET programmes corresponding to ISCED levels 3-4 and EQF levels 3-4, or equivalent
Electrician	Students, apprentices and trainees training to be electricians in the last six months of their initial VET programmes corresponding to ISCED levels 3-4 and EQF levels 3-4, or equivalent.
Business and administration job family	Students, apprentices and trainees training for employment in the business and administration job family in the last six months of their initial VET programmes corresponding to ISCED levels 3-4 and EQF levels 3-4, or equivalent.
Healthcare/nursing assistant	Students, apprentices and trainees training to be healthcare/nursing assistants in the last 6 months of their initial VET programmes corresponding to ISCED levels 3-4 and EQF levels 3-4, or equivalent.
Hotel receptionist	Students, apprentices and trainees training to be hotel receptionists in the last 6 months of their initial VET programmes corresponding to ISCED levels 3-4 and EQF level 4, or equivalent.

The PISA-VET tests

The PISA-VET instrument is a computer-based test designed to be taken by groups of learners on the premises of their VET institution or in their work-based learning environment if this is the main place of training (for example, in the case of apprentices). Given the constraints for the practical implementation of the assessment and the resources likely to be available, the assessment is designed to take place within a three-to-four-hour test window. This window includes time for:

- Introductions, setting up and guidance for the test-takers.
- Approximately 35 minutes for completing the learner background questionnaire discussed later in this chapter (and in more detail in Chapter 8).
- 10 minutes for the non-cognitive skills assessed through a self-report discussed later in this chapter (and in more detail in Chapter 7).
- Between two-three hours for the cognitive test, including any pause time needed for test-takers to adjust to using the simulation environment of the test and time for changing test location, for example, moving from a testing room to a workshop or workplace scenario for demonstration tasks.

The VET assessment experts have found that VET test takers generally endure longer test durations than those participating in classical literacy, numeracy or theoretical tests, such as PISA and PIAAC. Therefore, given the target population for PISA-VET, it could be assumed these test takers are likely to be more motivated and tolerate a longer testing time than PIAAC (one hour) and PISA (two hours) test takers. In addition, the test design envisages more pauses between tasks than is found in PIAAC and PISA to promote student engagement, increase test-taker motivation, reduce test fatigue and increase response rates.

The initial test design presented in this framework allocates two-hours-thirty minutes of the total test window for the cognitive tests, including the cognitive test of core employability skills and occupation-specific skills. However, there is scope to increase the length of time for the cognitive test to, say, three or even four hours depending upon the resources available and confirmation during the Development Phase and Pilot Phase that test taker motivation and test fatigue are not significant challenges.

On the basis of a two-hours-thirty-minute cognitive test window with two pauses, each test form distributed to learners will comprise one 15-minute cluster of test material, one 30-minute cluster of material and one 90-minute cluster of material as follows:

- PIAAC Literacy (15 minutes)
- PIAAC Problem Solving (30 minutes)
- One of the five occupational domains (90 minutes).

It is important to note that if the test time is increased by, say, one hour, then it is most likely that the test forms would comprise two 30-minute clusters of literacy and problem-solving test material from PIAAC and one two-hour cluster of occupation-specific skills material.

The testing material will comprise five kinds of tasks, namely:

- Reading and answering questions on digital texts (e.g. texts containing hypertext and navigation features, such as scrolling or clicking on links) as well as traditional print-based texts (PIAAC literacy).
- Solving scenario-based every day and working-life problems (PIAAC problem solving).
- Scenario-based questions of occupation-specific knowledge and skills.
- Digital simulations of occupation-specific professional skills at the workplace and, where possible,
- Live or recorded demonstrations of occupation-specific professional skills with expert judges⁴.

These types of tasks are most suitable for an assessment in a VET context and also provide a promising testbed for innovation in PISA and other large-scale assessments. The first two of these tasks are well established in PISA and PIAAC as well as other international large-scale assessments. The third task is also well established in international large-scale assessments, but not in respect of occupation-specific knowledge and skills.

PISA-VET will be the first attempt to incorporate digital simulations and live or recorded demonstrations of occupation-specific professional skills with human judges in an international large-scale assessment. These two tasks are summarised as follows:

- A **simulation** is a recreation of a real-world situation or task, which is designed to explore key elements of that situation. Simulations are “interactive events” in which “the environment ... is simulated ... but the behaviour is real.” (Jones, 1995, p. 7^[11]). Simulation offers a simplified representation or imitation of an object or process which may not be directly accessible due to issues of scale, time, risk, or complexity. A controlled set of challenges can be offered, both to train learners, and subsequently to assess their skills. Literature has emerged on the use of technology, recognising both its potential and its limitations (for example in simulating the capacity to address interpersonal challenges). Simulation technology may also facilitate standardisation in assessment, so that candidates face the same, or similar challenges in a final assessment (Nyström and Ahn, 2020, p. 6^[21]). These kinds of tasks have been created most successfully in the VET sector by ASCOT + which is a research and transfer initiative of the German Federal Ministry of Education and Research (BMBF). ASCOT stands for “Technology-based Assessment of Skills and Competences in VET”. The “+” denotes transfer into training and examination practice of the results which emerged from the predecessor initiative ASCOT (ASCOT, 2011–2015). ASCOT + has created computer-based learning and assessment instruments which can be used to promote and measure the competencies of trainees in industrial and technical occupations, commercial occupations and healthcare occupations.
- **Live demonstrations of occupation-specific professional skills with expert judges** have been created and developed by WorldSkills International over a period of sixty years. WorldSkills has built a movement aimed at changing the lives of young people through skills. It has 85 member organisations that have global reach for the purpose of raising the profile and recognition of skilled people, and showing how important skills are in achieving economic growth and personal success. Through competitions, projects, conferences and campaigns WorldSkills has become a global hub for skills excellence and development as well as skills assessment. WorldSkills International has confirmed its willingness to work with the OECD and its Contractor on the development of instruments for PISA-VET that may be based on its demonstration tasks with human judges.

Simulation items have the potential to offer a more engaging experience for learners as they are capable of emulating real-world (and thus more relevant) settings through complex interactions and the use of multiple media, such as animations and sounds. Albeit complex to develop, simulation-based items have the potential to assess skills that are challenging to assess in the abovementioned formats, such as decision-making and situational judgement. Another challenge with simulations is grading – subject matter and assessment experts will be involved in the development of (automatic) marking rubrics and how to collect data on learner strategies to potentialize the reporting of learner outcomes. Experiences with the development of the PISA 2025 innovative domain, which relies on this item format and grading will also be leveraged.

Demonstrations of professional skills assessed by expert judges present even further potential to assess learner skills with even more flexibility, given the possibility of interactions between learners and judges and the nuanced assessment of learner performance. Furthermore, demonstrations can be central for the validity and reception of results as results are directly connected to trained professionals in the field of occupation being assessed. Benefits notwithstanding, demonstrations are challenging to scale in large-scale settings, due to the human resources required, internationally comparable training protocols to be

developed and statistical models to be employed, thus demanding their careful addition to the assessment's test design.

Within the 90 minutes of testing for the occupational areas there will be variation regarding the amount of testing time devoted to scenario-based questions, digital simulations and live or recorded demonstrations. For example, automotive technicians may devote more time to digital simulations, while electricians might spend more time on live or recorded demonstrations with expert judges. The total test material is summarised in the table 1.3 below.

During the Development Phase particular attention will be given to the efficacy of the three types of tasks. In particular, data from the methodological study will be analysed to determine the extent to which learner performance on the knowledge-based tasks and digital simulation tasks are a predictor of performance on the live demonstration tasks. If the first two types of tasks prove to be accurate and strong predictors of performance on the live demonstration tasks the role of the latter in the assessment will be reviewed during the Pilot Phase.

Table 1.3. Total test material by clusters (two-hour test)

Domains	No. of 15-minutes Clusters
PIAAC Literacy	2
Domains	No. of 30-minutes Clusters
PIAAC Problem Solving	2
Domains	No. of 90-minutes Clusters
Automotive Technicians	2
Electricians	2
Business and administration job family	2
Healthcare/nursing assistant	2
Hotel receptionist	2

While in the Development Phase a smaller scale administration of the test is anticipated and will only include the five selected occupational area forms, in the Pilot Phase each test form (employability skills and occupational areas) will be completed by a representative sample of eligible learners from each occupational area to allow for estimations of proficiency on all items by learners in each country/economy and in relevant subgroups within a country/economy, such as males and females, or learners from different social and economic backgrounds.

The test design includes items from each of the domains of literacy, problem solving and the occupational area domains. At this stage, traditional psychometric Classic Test Theory (CTT) and Item Response Theory (IRT) analyses are planned to guide the test design. The test design will feature different test booklets within a rotating block design for each occupational area, including the occupational domain together with literacy and problem solving in order to assure adequate framework coverage. These different test booklets will be designed with common items that work as anchors to build multiple linkages across each domain. In this way, the results from the different booklets will scale together for each domain.

With the initial test design, each booklet allocated to learners comprises one 15-minute cluster of test material and one 30-minute cluster of material for the Employability Skills and one 90-minute cluster for one of the five occupational areas, as illustrated in Table 1.4 below. In total, learners spend 135 minutes on all domains plus two pauses amounting to 15 minutes. Final decisions on test design and analysis will be made in light of findings at the end of the Development Phase and prior to the commencement of the Pilot Phase. In connection with test design, it is important to note that PISA-VET is designed to provide an assessment of performance at the system (or programme) level. Thus, PISA-VET adopts an efficient

design in which the full set of test material, covering all aspects of the framework, is distributed over a number of test forms (2x2x2), see Table 1.4. This procedure enables the OECD to obtain a much greater coverage of the framework within feasible survey operational constraints while fostering learner engagement and school/VET institution/work-based learning environment participation.

Table 1.4. Total test material (forms) by domains (135 minutes test)

Test booklet	No.	Domains (15 minutes each)	Domains (30 minutes each)	Domains (90 minutes each)
Automotive Technicians	8	Literacy	Problem Solving	Automotive Technicians
Electricians	8	Literacy	Problem Solving	Electricians
Business and administration job family	8	Literacy	Problem Solving	Business and administration job family
Healthcare/nursing assistant	8	Literacy	Problem Solving	Healthcare/nursing assistant
Hotel receptionist	8	120 minutes	Literacy Problem Solving	Hotel receptionist

An overview of what is assessed in each domain

Box 1.1. Definitions of the domains

Automotive Technicians: the competencies and content knowledge required to perform the duties of an automotive technician employed in a workshop, including servicing, overhauling and troubleshooting light vehicles (passenger cars, light commercial vehicles) of various manufacturers.

Electricians: the competencies and content knowledge required to perform the tasks of installing, commissioning, and maintaining and adjusting electrical systems and components in accordance with regulations and professional standards in a safe way.

Business and administration job family: the competencies and content knowledge required to perform typical tasks and activities related to the management and organisation of business enterprises, including record, organise, store, compute and retrieve information, clerical duties in connection with money-handling operations, travel arrangements, requests for information, and appointment, financial accounting and transaction matters, selling and buying financial instruments, specialised secretarial tasks, and enforcing or applying relevant government rules.

Healthcare/nursing assistant: the competencies and content knowledge needed to provide direct personal care and assistance with activities of daily living to patients and residents in a variety of healthcare settings, such as hospitals, clinics, and residential nursing care facilities together with the capacity to implement established care plans and practices under the direct supervision of medical, nursing, or other health professionals or associate professionals.

Hotel receptionist: the competencies and content knowledge required to perform the necessary tasks and procedures related to the arrival, entry, stay, and departure of guests and customers at hospitality establishments, including the planning and organising of hotel receptionist activities.

Literacy: The ability to access, understand, evaluate, and reflect on written texts to achieve one's goals, to develop one's knowledge and potential and to participate in society (OECD, 2021^[3]).

Problem Solving: The capacity to achieve one's goals in a dynamic situation, in which a method for solution is not immediately available. It requires engaging in cognitive and metacognitive processes to define the problem, search for information, and apply a solution in a variety of information environments and contexts (OECD, 2021^[3]).

Box 1.1 above presents definitions of the seven domains assessed in PISA-VET, two of which (literacy and problem solving) are the same as in PIAAC. The definitions for the occupational areas all emphasise functional knowledge and skills that allow one to participate fully in the occupations selected for the assessment. Such participation requires more than just being able to carry out tasks imposed externally by, for example, an employer; it also means being able to participate in decision making. The more complex tasks in the assessment require learners to reflect on and evaluate material, not just to answer questions that have one correct answer. A summary of what is assessed in each domain is presented below.

Automotive technicians

Automotive Technicians (Chapter 2) focuses on the two main **capabilities** that constitute the proficiency of automotive technicians, namely:

- **Investigation capability** is defined as an automotive technician's ability to gather information about light vehicles in workshops, to draw conclusions from the information obtained and to justify the actions taken and results achieved.
- **Rectification capability** is defined as the ability to establish or re-establish desired states of light vehicles to remove damage, correct malfunctions, maintain functionality, meet manufacturers' specifications, or fulfil customers' wishes.

PISA-VET assesses learners' performance in the domain of automotive technicians in the workshop **context** and with a focus on the following core **processes** or task areas of automotive technicians that are grouped under the two capabilities of *investigate* and *rectify*.

Investigate includes the following processes:

- Inspect, which are activities to determine if there are any undesired states of vehicles. It comprises (1) gathering information about the vehicle systems, and (2) drawing conclusions from this information.
- Diagnose aims to identify the cause(s) of a vehicle malfunction and suggest actions to eliminate it. Actions to eliminate malfunctions are "(dis)assemble and replace," "rebuild and restore," and "adjust".

Rectifying includes the following processes:

- Replace and (Dis)assemble includes all actions in which some part, component, subsystem, or operating fluid (e.g. engine oil, coolant, etc.) is removed from a vehicle and either reattached or replaced. There are various reasons for such actions.
- Restore and Rebuild refers to corrective actions that reinstate the function and/or specified state of a broken, damaged, malfunctioning, or excessively worn part, component, or subsystem without replacing it.
- Adjust refers to actions in which automotive technicians change the setting of a car's part, component, or subsystem to specified values.

To complete these processes, skills and knowledge in various **content areas** are required. Automotive technicians deal with light vehicles, and these consist of several systems, including drive unit, powertrain, undercarriage, assistance, and chassis. These systems, as well as combinations of these systems, provide the knowledge content for this occupational area. Automotive technicians need to know the relevant facts and concepts regarding light vehicles systems as well as the principles that apply to them.

Electricians

The domain of electricians (Chapter 3) is comprised of the set of competencies and content knowledge required to perform the tasks of installing, commissioning, and maintaining and adjusting electrical systems and components in accordance with regulations and professional standards in a safe way.

PISA-VET assesses learners' performance in the domain of electricians in three **contexts**: commercial and public sector, domestic, and industrial. In these contexts, there is a focus on the following core **processes** or task areas of electricians:

- assess and diagnose
- plan and design
- assemble and install
- repair and maintain
- inspect, commission, test and report.

To complete these processes, skills and knowledge in various **content areas** are required. Electricians require knowledge of electrical theory and fundamentals (including mathematics and science); norms, standards & regulations; materials, components, and tools; electrical systems and applications; configuration and control. Electricians also require underlying **capabilities** related to the processes and content areas, including:

- Identifying and resolving electrical problems - the ability to identify, diagnose and resolve electrical problems in dynamic situations.
- Responding to customers and colleagues - the ability to impart or exchange information with customers and colleagues, both verbally and “in writing.”
- Collaborating on electrical tasks, problems, projects - the ability to work with other professionals on electrical projects and problems.
- Using digital and communications technology for daily electrical tasks and problems - the ability to use digital technology, tools and networks within daily work routines.

Business and administration job family

Business and Administration (Chapter 4) focuses on a core of four **capabilities** that constitute the proficiency required by a family of occupations involved in the management and organisation of business enterprises, namely, the capability to:

- retrieve situationally adequate knowledge stocks: Retrieving business and administration data and other relevant information.
- describe system coherences and to act within them: Drawing conclusions from business and administration data and other relevant information.
- think and act purposefully in specific situations: Making appropriate decisions/proposals for business and administration work products.
- independently control processing procedures: Establishing appropriate, quality-assuring working practices for business and administration workplaces as well as promoting their own professionalism.

PISA-VET assesses learners' performance in the domain of business and administration in the **context** of operational value chains in business and administration. The operational value chain is a framework used to describe the various processes and activities involved in producing and delivering goods and services to customers by business enterprises. Within this contextual framework, the assessment focuses on the following core **processes** or task areas of business and administration:

- identifying and understanding business and administration information
- analysing business and administration information and situations
- applying business and administration knowledge and skills
- evaluating and reflecting on business and administration issues.

To complete these processes, skills and knowledge in various **content areas** are required. These content areas include knowledge of:

- The significance of relevant operational indicators in business administration and how to interpret and present data appropriately.
- Appropriate procedures and tools for correspondence and communication, of cross-cultural differences, and of dealing with diverse customers and stakeholders.
- Methods, forms, and areas of application of project management and of the use of concrete work strategies.

Healthcare/nursing assistant

The domain of healthcare/nursing assistant (Chapter 5) is comprised of the set of competencies and content knowledge required to perform the tasks of providing direct personal care and assistance with activities of daily living to patients and residents in a variety of healthcare settings.

PISA-VET assesses learners' performance in the domain of healthcare/nursing assistant in five **contexts**: hospitals (inpatient or outpatient facilities, specialist or general); clinics for specific purposes and conditions (e.g. psychiatric, geriatric); residential nursing care; hospices for terminal care; clients' and patients' own homes. In these contexts, there is a focus on the following core **processes** or task areas of healthcare/nursing assistant:

- Working in professional teams.
- Identifying needs and collaborate in healthcare planning.
- Supporting and enhancing clients' quality of life.
- Providing and supporting treatment and medical processes.
- Reviewing and evaluating care.

To complete these processes, skills and knowledge in various **content areas** are required. Healthcare/nursing assistants require knowledge of:

- Multi-professional collaboration.
- Communication and relationship building.
- Medical and related sciences.
- Client/patient care, service, and assistance.
- Administrative and legal frameworks.

Healthcare/nursing assistants also require underlying **capabilities** related to the processes and content areas, including: collaboration with others to achieve optimal healthcare; open-mindedness throughout the healthcare process; engagement with others to achieve therapeutic outcomes; communication as a therapeutic instrument; emotional regulation to achieve optimal healthcare; access to and use of evidence and information to support healthcare solutions; management of self, time, tasks, and workspace to optimise health outcomes; coordination of mind, feelings, and movement for dextrous, respectful healthcare; contribution to healthcare solutions; and reflective practice for healthcare.

Hotel receptionist

Hotel receptionists (Chapter 6) focuses on the main **capabilities** that constitute the proficiency of hotel receptionists, namely:

- Hospitality service orientation
- Hotel receptionist interpersonal and communication skills
- Collaboration with other hotel staff
- Problem Solving in the context of hotel reception
- Task performance in the context of hotel reception
- Critical thinking in hospitality service
- Literacy in hospitality service
- ICT Literacy for hotel reception.

PISA-VET assesses learners' performance in the domain of hotel receptionists in the hotel **context** and with a focus on the following core **processes** or task areas:

- check-in and check-out
- reservations
- management of complaints
- touristic information.

To complete these processes, skills and knowledge in various **content areas** are required. Hotel receptionists need to know about:

- hotel reservation procedures
- checking-in procedures
- administration and back-office procedures
- checking-out procedures
- promotion of the local area.

Hotel receptionists need to know the relevant facts and concepts regarding these procedures as well as the principles that apply to them.

Literacy

PIAAC defines literacy (Chapter 7) as the ability to "access, understand, evaluate and reflect on written texts to achieve one's goals, to develop one's knowledge and potential and to participate in society" (OECD, 2021, p. 186^[3]). In this, literacy refers to one's ability to comprehend and use written sign systems. Literacy encompasses a range of skills, from decoding written words and sentences to comprehending, interpreting, and evaluating complex texts.

The definition of literacy in PISA-VET is strongly rooted in the literacy framework of PIAAC. PISA-VET assesses learners' performance in literacy as follows:

- The assessment will include units developed within the PIAAC literacy framework designed to measure foundational skills.
- The assessment will be based on existing and validated PIAAC units, using national versions for participating countries and economies whenever available.
- Three main contexts were defined in PIAAC literacy ("work and occupation," "personal use" and "social and civic contexts"); if feasible, units should be chosen from the context "work and occupation."

- Linking with a domain-embedded assessment within occupations in addition to the core generic assessment of literacy is an option.

Problem-solving

The definition of **problem solving** (Chapter 7) in PISA-VET is strongly rooted in the adaptive problem-solving framework of PIAAC Cycle 2. PIAAC Cycle 2 defines problem solving as “the capacity to achieve one’s goals in a dynamic situation, in which a method for solution is not immediately available. It requires engaging in cognitive and metacognitive processes to define the problem, search for information, and apply a solution in a variety of information environments and contexts” (OECD, 2021^[3]).

PISA-VET assesses learners’ performance in problem solving as follows:

- Their assessment will include units developed within the PIAAC Cycle 2 adaptive problem solving as foundation.
- The assessment will be based on existing and validated PIAAC units, using national versions for participating countries and economies whenever available.
- Three main contexts were defined in PIAAC adaptive problem solving; if feasible, units should be chosen from the context “work”.
- Linking with a domain-embedded assessment within occupations in addition to the core generic assessment of problem solving is an option.

Reporting learner performance in PISA-VET

At this stage, it is proposed that the results from PISA-VET will be reported using numeric scales and proficiency levels. However, modern digital assessments offer a host of other options, and some two-dimensional and multi-dimensional metrics (as discussed in Chapter 3 in particular) may be better suited for the purpose of PISA-VET. These options will be explored during the Development Phase. Based on the PISA experience with a numeric scale, it is envisaged currently that the participating average score for all five occupational area domains will be set at 500 with a standard deviation of 100, which means that two-thirds of learners across participating countries should score between 400 and 600 points. These scores represent degrees of proficiency in a particular domain. The PIAAC literacy scale and the PIAAC problem solving scale will be used for the literacy and problem-solving tests that are based on existing PIAAC items. No link across the PIAAC and occupational scales is planned. Each of the learners taking PISA-VET will therefore receive three separate scores as follows:

- PIAAC Literacy
- PIAAC Problem Solving.
- Occupational area (one of the five occupational areas).

The proposed reporting of performance in PISA-VET in the seven domains (PIAAC literacy, PIAAC problem solving and the five occupational areas) is discussed in each of the occupational area and employability skills chapters. As in PISA, the proficiency levels proposed in each occupational domain are descriptors of learner proficiency constructed through scale anchoring methods. However, as noted above, other options for reporting, such as multi-dimensional metrics, will be considered during the second half of the Development Phase.

Occupational areas

At this stage, the proficiency levels that are anticipated for each occupational area are based on notional cutpoints. In some cases (automotive technicians and electricians), these cutpoints refer to actual standards for performance while in others (business and administration job family, healthcare/nursing assistant and hotel receptionist) the cutpoints refer to a continuum from “novice” to “expert.” Given that

there is no pre-existing definition of proficiency levels in the five domains, the final decisions on reporting, especially the number of cutpoints and the bandwidth for proficiency levels will be determined ex post the Development Phase, based on the reliability of the scale and the number and difficulty of tasks included in the instruments developed for the assessment,

In the meantime, the notional proficiency levels and cutpoints proposed for each occupational area are summarised in Table 1.5.

Table 1.5. Summary descriptions of proposed performance reporting

Occupational area	Components/sub-components scales	Anticipated proficiency levels and cutpoints
Automotive technicians	Domain of automotive technician scale.	Three proficiency levels that will be based on a numeric scale. A common automotive technician's scale will be a real composite (compound) measure made up of the reports on two competencies: investigation and rectification.
Electricians	Domain of professional electrician scale.	Six proficiency levels that are defined based on numeric scale and described in terms of typical task requirements and learners' performance.
Business and administration job family	Domain of business and administration scale.	Five proficiency levels that will be based on a numeric scale. A common business and administration scale will be a real composite (compound) measure made up of the reports on two competencies: occupation-specific and occupation related.
Healthcare/nursing assistant	Domain of professional healthcare/nursing assistant scale	Six proficiency levels that are defined based on numeric scale and described in terms of typical task requirements and learners' performance.
Hotel receptionist	Domain of professional hotel receptionist scale	Six proficiency levels that are defined based on numeric scale and described in terms of typical task requirements and learners' performance.

Literacy

The proficiency scales used to report PIAAC results describe what learners typically know and can do at given levels of proficiency. The numeric scales are divided into proficiency levels that carry a descriptive purpose and aid the interpretation and understanding of the scales. PISA-VET will employ the PIAAC literacy scale as described in the PIAAC reports. As the PIAAC literacy framework was updated for Cycle 2, this scale will be updated before reporting. For information, in PIAAC Cycle 1, there were five proficiency levels leading to six categories: proficiency at level 5, proficiency at level 4, proficiency at level 3, proficiency at level 2, proficiency at level 1, proficiency below level 1. Considering that the assessment time in PISA-VET will be limited, the level of detail might be lower as compared to the original PIAAC scale, for instance, maybe only three levels of proficiency (for instance, low, medium, high) can be distinguished in PISA-VET.

Problem Solving

PISA-VET will employ the PIAAC adaptive problem solving as described in the PIAAC framework. As of now, there is only a general description of different proficiency levels in the PIAAC adaptive problem-solving scale from Cycle 2 (for details, consult PIAAC Cycle 2 assessment framework: (OECD, 2021_[31])). These are based specifically on behavioural descriptions that were offered in the PIAAC Cycle 2 framework for low and for high scorers on the three task dimensions, i.e. when (a) confronted with different problem configurations, (b) confronted with different dynamics in a situation, and (c) confronted with different features of the environment. These might also be used for PISA-VET, but – as for literacy - the level of detail might be lower.

Employability Skills (non-cognitive)

In addition to the reports on learner performance noted above, PISA-VET also covers two employability skills that are non-cognitive, namely: **task performance** and **collaboration** (as described in Chapter 7).

The definitions of task performance and collaboration in PISA-VET are strongly rooted in the OECD's survey on social and emotional skills (SSES) framework. The OECD defines "task performance" as a range of constructs that describe the ability to be self-controlled, responsible to others, hardworking, motivated to achieve, honest, orderly, persistent and rule-abiding. In short, it refers to the skills that enable individuals to get things done, as required and on time. The OECD defines "collaboration" as a range of constructs that describe the ability to understand, feel and express concern for others' well-being, manage interpersonal conflict and maintain positive relationships and beliefs about others (trust). In short, it refers to the skills that enable individuals to have a good relationship with other people and work successfully together in various contexts.

The assessments of task performance and collaboration will be based on self-reports that will be part of the background questionnaire. The assessments will be based on existing and validated items from the OECD-convened SSES; depending on the specific wording of the items, they might need to be adapted to the target population, which will be, on average, older than the SSES population. Linking with a domain-embedded assessment within occupations in addition to the core generic assessments of task performance and collaboration will not be explored during the Development Phase (mainly due to the different formats and the difficulty in assessing task performance within occupational contexts).

Proficiency levels were not developed for task performance and collaboration in SSES, although reporting scales were. For the recently completed Round 1 of SSES data collection, psychometric scales were developed using the assessment items for each skill. The reference value was fixed at 500 and standard deviation set to 100. The scale for each of the two sub-skills of task performance (e.g. persistence, self-control) features two meaningful poles. Taking the "self-control" scale, as an example, respondents towards the highly self-controlled pole, reported themselves as more inclined to be careful with tasks, to think before speaking, and to postpone fun until they are finished with work. Likewise, the scale for each process of collaboration (i.e. empathy, trust, co-operation) included in SSES features two meaningful poles. Taking "empathy," for example, respondents towards the highly empathetic pole, reported themselves as more inclined to consider others' wellbeing and their perspectives.

The PISA-VET contextual questionnaires

The focus of the PISA-VET contextual questionnaires (Chapter 8) is on understanding how measures of performance in initial VET programmes are related to various aspects of VET institution, classroom, and work-based practice as well as other related factors, such as economic, social, and cultural context. The PISA-VET questionnaires include these aspects and cover a set of well-being outcomes.

The contextual framework for PISA-VET

The PISA-VET contextual framework with its four questionnaires (see Annex B) provides policy makers with information on: outcomes that measure holistically learners' success; foundational resources and processes that support learners' outcomes; and learner-level demographic characteristics that allow assessing whether performance of VET systems is obtained at the expense of equality and equity of outcomes for different learner sub-groups.

The framework describes processes and resources that support two major roles of VET: building platforms of skills and competencies for young commencing workers and promoting or enriching skills for established workers. Learners' success is defined as acquired skills and competencies; engagement, persistence in the programme and educational and training attainment; and finally, health and well-being. The framework elects three areas of foundational resources and processes within the VET institution and the work-based learning places that support and promote learners' outcomes. The three areas consistently appear in educational research as directly connected to learners' outcomes. Specifically, a large body of applied research findings identified them as proximal to learners' outcomes; as pervasive in their relationships with

more than one outcome; and as having potent effects on learners' success. The three areas include resources and processes pertaining to effective learning time, in the VET institution and in work-based learning; quality of teaching and instructional/training practices; and quality and suitability of human and material resources for education and training.

These resources and processes, when effectively deployed and fully accessed by learners, support their active participation to formal education and training; they sustain learners' progression through elected VET studies. Finally, they promote the full achievement of the outcomes sought from the training. Additionally, the framework acknowledges the permeability of the VET system to the labour market and describes exchanges between the educational programmes and the social partners, as well as the broader community.

The framework places great emphasis on equality and equity, with equality referring to differences among sub-populations in the distribution of their VET outcomes and equity referring to differences among sub-populations in their access to the resources and VET processes that affect VET outcomes.

The four questionnaires developed under this framework explore 15 modules of content. These modules measure the seven Learner Success Outcomes, the nine Foundations for Success, and the ten demographic factors relevant to assessing equality and equity that are shown in Table 1.6 below. In addition, the questionnaires include several teachers, trainer, VET institution, employer, and system-level background measures that provide context for the Learner Success Outcomes. Chapter 8 presents the PISA-VET contextual framework in detail and the questionnaires are included at Annex B.

Table 1.6. Modules assessed in PISA-VET

VET programme/learning outcomes	Foundations for Success	Demographic factors for assessing equality and equity
Job-specific learning outcomes (the five occupational areas).	Inclusive environments.	Age.
Employability skills (collaboration, literacy, problem solving and task performance).	Quality of instruction: <ul style="list-style-type: none"> Instructor collaboration and mentorship Peer mentorship and support Work-related and general learning tasks Pedagogical methods Learning venue co-operation 	Gender.
Students' educational and work-related progression and plans.		Socio-economic status.
Learner engagement in school and work.		Family structure and living arrangements.
Health and well-being.	Education institution-based and work-based learning time.	Previous education and work career.
Work safety: knowledge on safety and experience of injuries.	Material and human resources.	Language spoken at home and language of instruction.
	Family, friends' and partners' support for learners.	Urban/rural status.
	Social partners' engagement.	Immigrant status.
		Disability.

The questionnaires

The questionnaires for learners, teachers of the occupational areas covered by the assessment, and the principals/leaders of VET institutions, as well as the questionnaire for employers (the establishments responsible for the work-based learning) have been developed in accordance with the contextual framework. These questionnaires take about 35 minutes for the learners to complete, about 30 minutes each for teachers and the institution leaders/principals, and 10-15 minutes for the person most knowledgeable about the respondent's training at the work-based training site. The responses to the questionnaires are analysed with the assessment results to provide at once a broader and more nuanced picture of learner, VET institution, and programme/system performance. These questionnaires seek information about:

- Learners and their family backgrounds, including their economic, social, and cultural capital, and the language they speak at home versus the language of instruction.
- Aspects of learners' lives, such as their level of educational attainment, their health and well-being, and their engagement with school.
- Aspects of learning, including quality of instruction, inclusive environments, learning time, school material resources and family and community support.
- Contexts of learning, including teacher, VET institution, employer, and system-level information as well as impacts of the green and digital transformation.

System level data

The contextual information collected through the learner, institution, teacher, and trainer/employer questionnaires comprises only a part of the information available to PISA-VET. System-level data (Chapter 9) describing various features of VET systems will be used in PISA-VET analysis and reports. This system-level data includes information on the place of VET in national skills systems, pathways into and from VET (e.g. stratification and selection, access to higher levels), the profile of VET learners, the delivery of VET (e.g. provider institutions, the use of work-based learning), skills targeted by VET (e.g. targeted fields of study), teachers and trainers (e.g. teacher training and salaries), finance and employment outcomes. While some of the system-level data may cover the overall VET system, certain elements will focus on the occupational areas or selected programmes within those areas – given that regulations and practices might differ between programmes.

The system-level questionnaire (Chapter 9) is an OECD tool designed to complement existing data, providing further contextual information on VET systems to underpin the interpretation and analysis of the results of PISA-VET. The system-level questionnaire to be used in the PISA-VET implementation consists of a set of worksheets that capture data on system-level features on VET. Available data on all the indicators have been reviewed for the data collection countries, identifying the status of system-level data collection and availability in terms of quality and completeness, in effort to design a system-level questionnaire that focuses on existing data gaps.

A collaborative project

PISA-VET is a highly collaborative effort carried by the OECD Secretariat, twelve participating countries, national experts and experts hired by the OECD together with the support of several institutional partners. From the outset of the project, the OECD has engaged the participation of the key international agencies and programmes concerned with VET learner assessment and improving the quality of VET. These partners include the United Nations Educational, Scientific and Cultural Organisation (UNESCO), the

European Centre for the Development of Vocational Training (CEDEFOP), the European Commission, the European Training Foundation (ETF), International Labour Organisation (ILO), VALID-8 network testing company, World Bank and WorldSkills International. Experts from ASCOT+, a research and transfer initiative of the German Federal Ministry of Education and Research, were also closely involved.⁵ Representatives of these institutions and initiatives have been consulted on all aspects of project design and development and they have also contributed to the preparation of this framework document.

The OECD also sought to have a strong involvement of employers in the design of the initiative, particularly through the auspices of *Business at OECD* (BIAC). Employers are key, as they know the skills the labour market needs so that the offer and content of VET programmes can be closely aligned to those needs. Employers are often also an important provider of VET, especially in countries with a large apprenticeship sector, and research consistently shows that it is the work-based component of VET that makes it effective. Given the essential role of businesses, corporations, and other employers in VET, it is vitally important that the PISA-VET initiative benefits from their inputs and partnership. The initiative is currently in its Development Phase and the employers' understanding of skills needs, their expectations of VET graduates and their experiences of training VET learners will provide crucial information to help the OECD to design a relevant assessment and to ensure the validity and credibility of the assessment. In addition, the OECD has sought the engagement of trade unions in the initiative (mostly representing teachers' unions), particularly through the auspices of the Trade Union Advisory Committee (TUAC) to the OECD.

Implementation of PISA-VET

PISA-VET is being developed and implemented in three phases over the course of 2023 to 2030.

1. The **Development Phase** from 2023-2025 would include the following activities:
 - Draft the assessment framework, including the identification of occupational areas and the skills to be assessed within those areas.
 - Undertake a consultation with the business sector in the field of selected occupational areas to ensure the labour market relevance of the assessment.
 - Select the most suitable target population.
 - Develop a set of measurement instruments (scenario-based units, digital simulations of workplace situations, and/or demonstration tasks).
 - Undertake a methodological study comparing the reliability, validity, and costs of the instruments developed for assessing the five selected occupational areas in four data collection countries (Australia, Germany, Portugal and the United Arab Emirates).
 - Complete an operational document that describes the second phase of instrument development and implementation, including target population, test design, reporting and sampling design, costs of participation and recruit countries to participate in the Pilot Phase.
2. The **Pilot Phase** from 2025-2029, subject to the agreement of the EDPC and PGB and following the successful completion of the Development Phase and the recruitment of a minimum number of countries that can commit resources to undertake further instrument development and data collection, would include the following activities:
 - The further development and validation of the assessment instruments developed during the Development Phase.
 - The implementation of the data collection (occupational areas, employability skills, contextual data and system level data) in participating countries (field trial and main survey).

- The analysis of the data and the preparation of an international report, including confirmation of the feasibility, manageability and affordability of the assessment together with recommendations for the implementation of a large-scale PISA-VET.

At the end of the Pilot Phase, it should be possible to confirm how much of the VET sector can be covered by PISA-VET and the extent to which results can be informative for occupational areas not included in the assessment. It should also be possible at that stage to confirm the limits of the approach and whether there are any VET sectors that cannot be compared internationally.

The **Large-scale Implementation Phase** from 2029-2032, subject to a successful implementation of the Pilot Phase, countries could decide to continue with an international assessment of VET on a regular basis as per PISA to collect timely data on the quality and effectiveness of VET. Such regular data collection would allow observations of trends, which provide a valuable tool for measuring the impact of reforms. If there was sufficient interest and funding, it would also be interesting and help to establish the validity of the assessment to do a follow-up study a few months after the Pilot Phase, to see how the participating learners integrated into the labour market or further education. Future rounds of data collection could also expand the exercise to a wider range of occupation areas and skills, possibly reflecting emerging occupations and skills (e.g. green skills). It would be possible to envisage a rolling survey with several different occupational areas (as prioritised by members) being included in each cycle. It would be important to repeat assessments in occupational areas every few years to enable assessment of change in skills levels. Additional countries could be recruited over time, including emerging economies with a particular interest in expanding or strengthening their VET systems.

References

- Jones, K. (1995), *Simulations: a Handbook for Teachers and Trainers*, Routledge, [1]
<https://doi.org/10.4324/9780203761151>.
- Nyström, S. and S. Ahn (2020), "Simulation-based training in VET through the lens of a sociomaterial perspective", *Nordic Journal of Vocational Education and Training*, Vol. 10/1, [2]
<https://doi.org/10.3384/njvet.2242-458x.201011>.
- OECD (2021), "PIAAC Cycle 2 assessment framework: Adaptive problem solving", in *The Assessment Frameworks for Cycle 2 of the Programme for the International Assessment of Adult Competencies*, OECD Publishing, Paris, <https://doi.org/10.1787/3a14db8b-en>. [3]

Notes

¹ VET can be accomplished through many different programmes, and at varying points in someone's career. The VET programme types that are the focus of PISA-VET include upper secondary and post-secondary VET programmes that are either mostly school-based (i.e. with the training mostly being delivered in VET institutions) or have a large work-based learning component (i.e. with a substantial

proportion of the training taking place on the premises of employers, like for example in apprenticeship programmes).

² See the acronyms and abbreviations section of this document for the explanations of these bodies.

³ Digital transition refers to the economic and societal effects of digitisation and digitalisation. Digitisation is the conversion of analogue data and processes into a machine-readable format. The green transition means a shift towards economically sustainable growth and an economy that is not based on fossil fuels and overconsumption of natural resources. A sustainable economy relies on low-carbon solutions that promote the circular economy and biodiversity.

⁴ The Development Phase will consider whether live or recorded demonstrations of tasks are most suitable for PISA-VET. If live demonstrations are included, it is possible that there will be a heterogeneity of marking (despite instructions) which could impact on the assessment results.

⁵ ASCOT stands for “Technology-based Assessment of Skills and Competences in VET”. The “+” denotes transfer into training and examination practice of the results which emerged from the predecessor initiative ASCOT (2011–2015).

2 Automotive technician

This chapter defines the occupational area of “automotive technician” as assessed by PISA-VET and elaborates the framework for automotive technician that has been designed for the Development Phase of the project, including descriptions of the competencies and constructs to be assessed. It presents and explains the processes, content knowledge, and contexts and provides several sample items with descriptions of task characteristics. The chapter also discusses how performance in the automotive technician occupational area is measured and reported against proficiency levels and scales.

Introduction

This chapter of PISA-VET assessment framework defines the occupational area of “automotive technician.” It has been prepared by a group of experts from a range of countries that are well versed in the training and assessment of automotive technicians. The chapter draws on previous work in assessing automotive technicians, such as the work undertaken as part of the ASCOT (+) initiative and WorldSkills competitions.

There are several reasons for selecting the occupational area of automotive technician for the Development Phase of PISA-VET, including the significance of vehicles for the economy, the international comparability of the occupation and key learning objectives of the associated VET programmes, as well as its role in the green and digital transformations:

- **Economic importance of automotive technology:** In most OECD countries, individual motorised transport is the dominant form of transportation. In the long term (and despite the green transition, see below), it is still a growing market, especially in newly industrialised economies. The automotive industry is in many ways a hub that sets technological and especially digital standards worldwide. It prompts suppliers and vehicle workshops to adapt accordingly. Furthermore, it is a world leader and a major driver of innovation (e.g. future mobility), and accounts for a large number of jobs around the world.
- **International comparability and importance of the occupational area in VET:** In all countries, technicians service, overhaul, and diagnose vehicles. They deal with internationally comparable technologies and so perform similar work tasks in each country. Automotive technicians are typically trained through VET programmes. The complexity of vehicles increases rapidly, changing capability profiles, requiring workers to participate in elaborated VET programmes, and setting new challenges to VET teachers and trainers. Baethge and Arends (2009, p. 33^[1]) examined several countries and concluded that the number of students and trainees of automotive technicians in VET is large enough internationally to draw suitable samples.
- **Green transition:** The transport sector is the second largest emitter of carbon dioxide, accounting for about 20 % of carbon dioxide emissions worldwide. About 75% of these emissions come from road transport (Ritchie, 2020^[2]). If vehicles are not regularly and properly maintained and adjusted, their CO₂ emissions can increase significantly. Consequently, the work of automotive technicians can contribute to environmental and climate protection. Moreover, automotive technology is developing rapidly due to the energy transition that vehicles are currently undergoing. It is important that automotive workshops follow this development to make their contribution.
- **Digital transition:** The occupational area is highly relevant in terms of the digital transformation. Due to the change in thinking towards electric vehicles, the work and service profile of workshops will become more complex than in the past and therefore their impact on employment will continue to be relevant. The electrification and complexity of vehicles require automotive technicians to use different software, computer-based expert systems, and other digital information and communication systems. The transformation to e-mobility creates new environmental challenges due to the materials, infrastructure, and energy needed. For example, future assessments of automotive technicians will need to include high-voltage technology in connection with e-mobility/hybrid vehicle technology as well as the complex area of pollutant reduction in internal combustion engines (especially diesel engines),

Defining the automotive technician occupational area

Occupational definition and associated VET programmes

Automotive technicians are defined as professionals who work in workshops and service, overhaul, and troubleshoot light vehicles (passenger cars, light commercial vehicles). Within the International Standard Classification of Occupations (ISCO-08), automotive technicians are part of the “Motor Vehicle Mechanics and Repairers” occupation (i.e. ISCO-08 code 7231). It is defined as: “Motor vehicle mechanics and repairers fit, install, maintain, service and repair engines and the mechanical and related equipment of passenger cars, delivery trucks, motorcycles, and other motor vehicles. Their tasks include: a) detecting and diagnosing faults in engines and parts; b) fitting, examining, testing and servicing motor vehicle and motorcycle engines; c) replacing engine components or complete engines; d) fitting, examining, adjusting, dismantling, rebuilding and replacing defective parts of motor vehicles; e) installing or adjusting motors and brakes, and adjusting steering or other parts of motor vehicles; f) installing, adjusting, servicing and replacing mechatronics components of motor vehicles; g) performing scheduled maintenance services, such as oil changes, lubrications and engine tune-ups, to achieve smoother running of vehicles and ensure compliance with pollution regulations; and h) reassembling engines and parts after being repaired”. The European Skills, Competences, Qualifications and Occupations (ESCO, 2020^[3]) classification, further breaks this down into ten more narrow occupations, of which that of “vehicle technician” is mostly closely related to the occupation under consideration in this chapter. It is defined as: “Vehicle technicians inspect, test and maintain vehicles, motorcycles, engine tune-ups and tyre replacements. They repair engine failures, lube replacements. Vehicle technicians replace vehicle components and evaluate warranty options.”

The capabilities to perform these tasks are acquired in VET programmes corresponding to ISCED level 3 and EQF level 4 or equivalent. PISA-VET covers learners in the last six months of their vocational training.

Table 2.1. Examples of VET programmes for automotive technicians

Selected programmes in data collection countries of PISA-VET

	Australia	Germany	Portugal	United Arab Emirates
Title	AUR30620 - Certificate III in Light Vehicle Mechanical Technology	Kfz-Mechatroniker/-in	Tecnico de mecatronica automóvel	Certificate 4 in Light Vehicle Service
ISCED level	4	3B	3	3
EQF level	3	4	4	3
Duration (years)	4	3.5	3	2-3

Note: EQF: European Qualifications Framework; ISCED: International Standard Classification of Education; Kfz-Mechatroniker/-in: Motor vehicle mechatronics technician

International comparability of the occupational area

The occupational area of automotive technician is comparable at the international level for the following reasons:

- It has been found that VET programmes for automotive technicians in different countries aim to teach comparable capabilities, although the VET programmes differ internationally (e.g. in terms of the amount of school-based and vocational learning; (Baethge and Arends, 2009, pp. 3-4^[11]).

- As vehicles from different manufacturers are present all over the world, the requirements in this area are similar internationally.
- The tasks and the tools used to fulfil these requirements are highly similar worldwide, as they are closely linked to vehicle technologies. An increasing number of vehicle technologies are based on shared platforms as this helps vehicle manufacturers to reduce costs.
- Due to requirements established by automobile manufacturers, automotive technicians must often use standardised procedures.
- Standardisation increasingly leads to comparable safety, environmental, and climate protection requirements and thus to comparable requirements overall.

Organising the domain of automotive technicians

In this section of the chapter, the domain of automotive technicians is first organised and described by specifying the context, contents, and processes of the domain. While the context refers to both work tasks and the environment in which automotive technicians work, the contents cover the major subjects that automotive technicians deal with in performing their core tasks. The processes refer to activities that are required to fulfil the core tasks of automotive technicians. These specifications are then used to define the key capabilities of automotive technicians, which form the basis for the development of the assessment described in the further sections of this chapter.

Context

Context category: workplace and work orders of automotive technicians

Automotive technicians work in two kinds of workplaces and deal with different types of vehicles.

Regarding the workplace, two context categories can be identified: work in the production of vehicles or in workshops. Following the VET-LSA feasibility study (Baethge and Arends, 2009^[11]) and the 2022 WorldSkills Occupational Standards, automotive technicians working in workshops are selected as the focus for PISA-VET. Sub-categories of workshops can be identified, such as brand workshops, independent workshops, fleet workshops). As automotive technicians in these workshops deal with comparable content (e.g. systems, technologies) and perform comparable tasks, no distinction is made between these subcategories in the remainder of the chapter. In terms of vehicles, the focus is on light vehicles, i.e. passenger cars and light commercial vehicles from various manufacturers, in line with the 2022 WorldSkills Occupational Standards. Other vehicles such as agricultural vehicles, commercial vehicles, motorbikes, or construction vehicles are disregarded.

There are three types of work orders in workshops, each of which is formulated in the form of specific, often combined work orders: service orders, overhaul orders, and troubleshoot orders. Autobody repairers are not included in this framework, as they carry out other work orders.

Desired distribution of items

The items used in the assessment relate to the above context category, i.e. light vehicles in workshops and orders for service, overhaul, and troubleshooting in workshops.

Table 2.2. Desired distribution of items by context

Context category	Percentage of items in the assessment
Workshop	100

Processes and the underlying automotive technician capabilities

As described above, automotive technicians engage in the work orders of servicing, overhauling, and troubleshooting light vehicles. There can be considerable overlap between these: Service includes inspection and may require overhaul. Overhaul includes replacing, restoring, and adjusting parts and components. Troubleshooting is about diagnosing the cause(s) of malfunctions and taking action to correct them by replacing, restoring, or adjusting parts and components.

In PISA-VET however, the processes must be distinct, as each assessment item should be clearly attributable to a single process. Otherwise, the assessment results are either difficult to interpret and do not provide a sound basis for policy recommendations, or they require complex statistical models whose results are difficult to communicate or may lead to misinterpretation. Therefore, the following five separate processes are included in the assessment of automotive technicians based on the three overlapping work orders above: inspect, diagnose, replace, restore, and adjust.

To carry out these processes, automotive technicians need certain fundamental capabilities. Possessing capabilities means that someone can perform a given task. Capabilities are mentally represented in the form of procedural knowledge. Procedural knowledge can represent heuristics and internalised systematic approaches to inspect, diagnose, replace, restore, and adjust parts, components, and subsystems of light vehicle systems. It can also refer to algorithms and internalised rules that clearly define each step to be performed in these processes. Procedural knowledge includes both the capabilities to perform the process and the knowledge needed to describe how to perform the process. Automotive technicians need procedural knowledge for:

- Obtaining information from standardised sources (e.g. access mounting positions or wiring diagrams using repair manuals or digital expert systems).
- Operating measuring instruments (e.g. multimeter, brake tester, wheel aligning system).
- Performing measurements (e.g. measuring voltage on the pins of a connector, measuring the freezing point of engine coolant).
- Adjusting (e.g. adjusting headlights, adjusting the amount of engine oil, tire balancing).
- Restoring or replacing vehicle parts, components, or subsystems (e.g. carrying out a cable repair, replace the cabin filter), etc.

When the automotive technician applies the procedural knowledge, content knowledge can be required (e.g. to justify the steps, sequences, and results of a certain course of action). Content knowledge categories are described in the next section.

For substantive and pragmatic reasons, the five processes are grouped into the following two process categories: *investigate* and *rectify*. The investigate category comprises inspect and diagnose, and the rectify category includes restore, replace, and adjust. The substantive reason for this grouping is that “inspect and diagnose” are about investigating vehicles and drawing conclusions from the information obtained and that “restore,” “replace,” and “adjust” aim to rectify light vehicles, i.e. to establish or re-establish desired states of light vehicles. This grouping also allows to report proficiency on two scales instead of five, which makes it easier to communicate assessment results.

Investigate

“Investigate” includes two sub-processes: inspect and diagnose light vehicles. While “inspect” aims to examine whether vehicles have undesired states, “diagnose” aims to identify the cause(s) of a certain kind of undesired states, namely vehicle malfunctions.

Inspect

“Inspect” includes activities to determine if there are any undesired states of vehicles. It comprises (1) gathering information about the vehicle systems, and (2) drawing conclusions from this information.

1. A standard procedure is used to collect information about the vehicles. In the standard procedure, each step of information collection is clearly defined. The steps typically represent sensory tests of the actual states of operating fluids, parts, components, or subsystems of the vehicle.
2. The information obtained about the vehicle states is compared with target values and used to determine whether undesired states exist and, if so, their specification. Undesired vehicle states can be malfunctions (e.g. light does not work) or parts, components, or subsystems of a vehicle that do not comply with standards (e.g. brake pads that are too thin). Standards are legal requirements or requirements set by automobile manufacturers.¹ Based on the specification of undesired states, the next actions are derived. In case of deviations from the standard, the action following the inspection is “rectify” (see below), in case of malfunctions, it is “diagnose.”

Diagnose

“Diagnose” aims to identify the cause(s) of a vehicle malfunction and suggest actions to eliminate it. Actions to eliminate malfunctions are “(dis)assemble and replace,” “rebuild and restore,” and “adjust” (see below). “Diagnose” refers to a coordination between evidence and hypotheses in which automotive technicians generate hypotheses based on the available evidence and then generate and interpret further evidence to test the respective hypotheses (Abele, 2018^[4]; Klahr and Dunbar, 1988^[5]). “Diagnose” comprises various steps, which in reality do not usually run in a linear fashion: (1) generating evidence to formulate hypotheses about causes of malfunctions and to evaluate these hypotheses, (2) generating hypotheses about causes of malfunctions, and (3) drawing conclusions from this evidence about the cause(s) of the malfunction and the actions to eliminate it.

1. Evidence is information relevant (a) to formulate hypotheses about the causes of undesired states and (b) to evaluate those hypotheses. (a) The evidence needed to formulate hypotheses comes from activities such as reading work orders, collecting information on the vehicle, and investigating its undesired state. (b) To evaluate hypotheses, tests are required. Tests require strategies and can be carried out with equipment (e.g. measurement tools) or without equipment through sensory testing (e.g. visual checks). Measurement strategies can either be self-developed or retrieved from long-term memory or external sources (e.g. computer-based expert system). In addition to measured values, target values for parts, components, and subsystems are needed to evaluate hypotheses. Target values can be obtained from long-term memory or external sources (e.g. technical documents).
2. Hypotheses provide potential explanations (i.e. causes) for undesired states of the vehicle. They are formulated based on the knowledge gained and hypotheses that have already been rejected.
3. To infer the cause(s) of the undesired states, all the evidence and hypotheses obtained must be integrated. The cause(s) can then be specified and described precisely. Causes of undesired states can be, for example, defective parts, components, or sub-subsystems of vehicles. From the description of the cause(s) it can be concluded how to eliminate the undesired state (replacing, rebuilding, or adjusting).

“Diagnose” is a special type of problem solving (Jonassen, 2000^[6]) and meets the main characteristics of problem solving as described in the PIAAC framework: It refers to dynamic situations, as it includes manipulations of vehicles that change their states (e.g. switching off the ignition can change the measured values). In diagnostic situations, methods to identify the cause(s) of undesired states are not immediately available, especially at the third level (see section 3.3.4). Finally, diagnosis involves defining the diagnostic

situation and searching for information (e.g. to obtain evidence) and applying the solution (i.e. the conclusion on the actions to be taken to eliminate the undesired state).

Rectify

This process² includes actions in which automotive technicians actively alter the condition of a vehicle to establish or re-establish a specified condition or desired state. It includes but is not limited to the actions of “replacing and (dis)assembling,” “rebuilding and restoring” and “adjusting.”

Typical reasons for such actions include: restoring functionality after damage or malfunction (i.e. repairing), compensating for wear, maintaining a vehicle's functionality and safety (i.e. preventing future damage, malfunction, or excessive wear), meeting the manufacturer's specifications, upgrading a system, or fulfilling a customer's request.

Replace and (Dis)assemble

The first sub-process “Replace and (Dis)assemble” includes all actions in which some part, component, subsystem, or operating fluid (e.g. engine oil, coolant, etc.) is removed from a vehicle and either reattached or replaced. There are various reasons for such actions. Parts or components are often removed to gain access to other parts or components; in this case, they are later re-attached without replacement. Parts or components are also removed if they need replacement. Such replacement might be technically necessary, e.g. to restore functionality after damage, to maintain functionality in case of ageing or wear, or because of product recalls. A replacement might also be in order at a customer's request without being technically necessary, e.g. if a vehicle owner wishes to upgrade an existing system, or to change the vehicle's appearance according to individual taste.

The replacement parts, components, subsystems, or operating fluids can be of the exact same type as the removed one, or of a different type (e.g. an improved version).

Replacing a part, component, subsystem, or an operating fluid can be an easy task (e.g. replacing a wheel or replacing engine oil) or a complex operation (e.g. replacing the timing belt of an engine or replacing the radial seal of a crankshaft). It might require disassembling subsystems, components and/or parts to gain access to the subsystem(s), component(s), or part(s) to be replaced. Sometimes, existing structures must be torn down or destroyed to remove a subsystem, component, or part and/or to install a replacement subsystem, component, or part, e.g. when an exhaust pipe is cut off to replace a damaged silencer.

Automotive technicians usually begin the (dis)assembling or replacement process by retrieving information about the target or goal of the operation – usually by reading a work order. The next step involves using their expertise to determine the precise location of the part, component, system, or operational fluid, as well as the necessary procedure for (dis)assembling or replacing it. They also consider the required condition of the vehicle, the specific tools and their settings, and any necessary equipment and materials. In case of any missing materials, they ensure that the required materials are ordered or provided promptly. If the technicians' knowledge is not sufficient, they will have to retrieve this information from external sources such as maintenance and repair instructions, exploded view drawings, schematics, or diagrams, which requires literacy and – in case of digital workshop information systems – ICT skills.

Technicians use different tools and equipment to (dis)assemble and replace fluids, parts, and components. Usually, they follow a pre-defined sequence of steps, but under certain circumstances it might also be necessary for them to develop an individual professional solution to the problem. During the procedure, the technicians should monitor their progress frequently. After they completed the operation, they usually conduct a final assessment to ensure success. Sometimes, such assessments involve a systematic examination or comparison of an actual state to a specified state; such actions fall under the core process *investigate*.

Examples include:

- replacing engine oil
- replacing air filter
- replacing brake pads
- replacing spark plugs
- replacing a silencer
- replacing a ball joint
- replacing a timing belt
- replacing a windshield.

Restore and Rebuild

The second sub-process “Restore and Rebuild” refers to corrective actions that reinstate the function and/or specified state of a broken, damaged, malfunctioning, or excessively worn part, component, or subsystem without replacing it.

Rebuilding or restoring a part, component, or subsystem can be an easy task (e.g. fixing a punctured tyre with a tyre repair kit) or a complex operation (e.g. fixing a damaged threaded hole in an oil sump using a threaded insert repair kit). It might require disassembling parts, components, or subsystems to gain access to the part that needs repair. Sometimes, existing structures must be torn down or destroyed to prepare or conduct the rebuilding, e.g. when a stripped bolt head or nut needs to be cut off or drilled out to remove a part. In these cases, (dis)assembly and/or replacement skills are necessary before and after the actual repair task is performed.

Automotive technicians usually begin the rebuilding/restoring process by retrieving information about the target or goal of the operation—usually by reading a work order. In the next step, they access their knowledge about the procedure, required tools, equipment, and material(s). If the technicians' knowledge is not sufficient, they will have to retrieve information from external sources such as service manuals, exploded view drawings, schematics, or diagrams, which requires literacy and – in case of digital media – ICT skills.

Technicians use different tools, equipment, and materials to rebuild or restore fluids, parts, and components. They might follow a pre-defined sequence of steps, but it might also be necessary to develop an individual professional solution to the problem. During the procedure, the technicians should monitor their progress frequently. After they completed the operation, they usually conduct a final assessment to ensure success. Sometimes, such assessments involve comparing an actual state to a specified state; such actions fall under the core process investigate. If a part, component, or subsystem is repaired by simply replacing one of its parts or components, such actions fall under the sub-process “Replace and (Dis)assemble.”

Examples include:

- Fixing a punctured tyre with a tyre repair kit.
- Soldering a cut wire with a soldering connector.
- Restoring a damaged threaded hole in a cylinder head using a threaded insert repair kit.

Adjust

The third sub-process “Adjust” refers to actions in which automotive technicians change the setting of a car's part, component, or subsystem to specified values. Adjusting is only possible if the part, component,

or subsystem in question is adjustable, i.e. the manufacturer provided it with a mechanism, interface, or other option to tamper its settings or calibration.

Adjusting often involves the use of specialised equipment such as wheel alignment systems or headlight adjustment tools. Reasons for adjustments can be:

- Restoring correct settings after replacement, rebuilding or incorrect adjustment.
- Compensating for engineering tolerance.
- Compensating for wear.

The process of adjusting often involves the comparison of an actual state to a specified state; in this regard it is like investigation tasks. It also includes acts of changing a setting to a specified state; in that regard it is like rebuild and replace. However, in contrast to diagnosis, adjusting involves an active change of state or condition. In contrast to the other rectifications processes – which eliminate damage or malfunction – adjustments are taken out on intact parts, components, or subsystems.

Adjustments can be easy tasks (e.g. inflating a tyre to a specified pressure) or complex operations (e.g. adjusting the camber, caster, and toe on a car with a multi-link suspension). Automotive technicians usually begin the adjustment process by retrieving information about the target or goal of the operation – usually by reading a work order. In the next step, they access their knowledge about the procedure, required tools, and equipment. If the technicians' knowledge is not sufficient, they will have to retrieve information from external sources such as service manuals, exploded view drawings, schematics, or diagrams, which requires literacy and – in case of digital media – ICT skills.

Depending on what part, component, or subsystem is adjusted, technicians use different tools and equipment. They usually follow a pre-defined sequence of steps and rarely improvise. During the procedure, the technicians should monitor their progress frequently. After they completed the operation, they usually conduct a final assessment to ensure success. Sometimes, such assessments involve comparing an actual state to a specified state; such actions fall under the core process *investigate*.

Examples include:

- Adjusting the headlights using a headlight adjustment tool.
- Adjusting the camber, caster, and toe of the wheels using a wheel alignment system.
- Adjusting the ground clearance of a car after equipping it with height adjustable springs.
- Calibrating the sensors of a driver assistance system.

Desired distribution of items by automotive technicians' processes

The item distribution by automotive technicians' processes is shown in the following Table. It was extensively discussed and agreed upon by a group of experts from different countries. The item distribution reflects the frequency of processes in the daily work of automotive technicians. "Investigate" (diagnose, inspect) is overall more frequent, because rectification measures (replace and [dis]assemble, restore, and rebuild, adjust) usually involve inspection steps as well (e.g. to monitor progress and to ensure success of the rectification task). The higher percentage of "investigate" compared to "rectify" is also supported by the VET-LSA feasibility study (Baethge and Arends, 2009^[1]) and by the WorldSkills Occupational Standards.

Table 2.3. Desired distribution of items by automotive technicians' processes

Process category		Percentage of items in the assessment
Investigate	Diagnose	50
	Inspect	10
Rectify	Replace and (Dis)assemble	30
	Rebuild and Restore	5
	Adjust	5
Total		100

Within the first process “Investigate,” the sub-processes “Diagnose” and “Inspect” were given a different weight. Even though both sub-processes occur frequently in daily work, inspection tasks are usually much less demanding than diagnostic tasks. As a result, items to assess inspection skills will only cover the lowest part of the ability scale, whereas the “Diagnose” process covers the whole range of item difficulties. Therefore, “Inspect” is represented by much fewer items compared to “Diagnose”.

Within the second process “Rectify,” the sub-processes “Replace and (Dis)assemble” were given a higher weight because in modern workshops it is much more common to replace damaged or defective parts and components instead of rebuilding and restoring them. Also, most rectification tasks include at least some steps of (dis)assembly.

Fundamental capabilities underlying the automotive technician processes

Two broad capabilities and associated sub-capabilities are fundamental and underlying the requirements for the assessment of automotive technician learners: investigation and rectification capability. The learners can achieve different levels of these capabilities.

Investigation capability is defined as an automotive technician’s ability to gather information about light vehicles in workshops, to draw conclusions from the information obtained and to justify the actions taken and results achieved. The investigation capability includes capabilities to (1) inspect vehicles and to (2) diagnose vehicles:

1. To inspect vehicles requires procedural knowledge to investigate the states of the vehicles systems and, in case of undesired states, to conclude whether diagnosis or what type of rectification is needed. This includes justifying the conclusions about the undesired states and the inspection steps taken.
2. To diagnose vehicles requires procedural knowledge to investigate undesired states of vehicle systems, formulate failure hypotheses and to infer the cause(s) of the undesired states and the actions to rectify them. This includes justifying the steps taken to explore the undesired states and the conclusions about the cause(s) of the undesired states as well as the rectification actions proposed.

Rectification capability is defined as the ability to establish or re-establish desired states of light vehicles to remove damage, correct malfunctions, maintain functionality, meet manufacturers' specifications, or fulfil customers' wishes. Rectification capability includes the abilities (1) to (dis)assemble and/or replace, (2) to rebuild and/or restore, and (3) to adjust light vehicles' parts, components, or subsystems. It also includes the associated content and procedural knowledge.

1. To (dis)assemble and/or replace, automotive technicians require procedural knowledge about single steps, required tools, and equipment involved in the process. They should be familiar with sources of technical information such as repair manuals, wiring diagrams and digital expert systems, and should be able to use these sources for information retrieval.
2. To rebuild and restore, automotive technicians require procedural knowledge about single steps, required tools, and equipment involved in the process. They should be familiar with sources of

technical information such as repair manuals, wiring diagrams and digital expert systems, and should be able to use these sources for information retrieval.

3. To adjust, automotive technicians require procedural knowledge about single steps, required tools, and equipment involved in the process. They should be familiar with sources of technical information such as repair manuals, wiring diagrams and digital expert systems, and should be able to use these sources for information retrieval.

Content knowledge for automotive technicians

Content categories

Automotive technicians deal with light vehicles, and these provide the structures of knowledge content for this occupational area. Light vehicles consist of several systems:

- drive unit
- powertrain
- undercarriage
- assistance
- chassis.

Apart from the chassis, these systems are relevant content categories and topics for automotive technicians. The chassis is excluded because in many countries this content and the related activities do not fall within the scope of automotive technicians or their training curriculum, but rather into the occupational area of autobody repairer. Each system has central functions (e.g. to convert other forms of energy into kinetic energy). The systems consist of subsystems (e.g. fuel injection) that are interconnected and made up of components (e.g. common rail injector) which can be also interconnected. Components, in turn, are composed of parts. Parts are elements that cannot be further disassembled (e.g. coil) without destroying them. The functions of the systems are realised through the connections and interactions of the subsystems, components, and parts. Further details about the four systems can be found in the Annex of this chapter.

In modern light vehicles, the four systems can be distinguished according to their functions. They cannot be distinguished by the technical principles (e.g. electrotechnical, mechanical, hydraulic, etc. principles) they use to provide these functions, as they all use a mixture of technical principles. From this principle-based perspective, service, overhaul, and troubleshooting of modern light vehicle systems require some of the same content knowledge. Because of this overlap in knowledge, the four content categories are not considered as empirically distinct dimensions of knowledge. Rather, these categories are used to ensure that the relevant knowledge of automotive technicians is broadly covered in PISA-VET. All principles and related knowledge required to service, overhaul, and troubleshooting vehicles should be included in the assessment. Assessment of abstract knowledge that is not relevant to understanding and performing these activities and to justifying the steps, sequences, and results of these activities should not be assessed.

Content knowledge

To service, overhaul, and troubleshoot light vehicles and their systems, automotive technicians need content knowledge. In this chapter, content knowledge is defined as disciplinary knowledge (see Appendix A for definitions), i.e. the knowledge of concepts of vehicle systems. Following de Jong and Ferguson-Hessler (1996^[7]), concepts represent facts, technical terms, and principles (e.g. function of systems). Content knowledge functions as additional information on the work order at hand, that automotive technicians use to understand and perform the order (De Jong and Ferguson-Hessler, 1996, p. 107^[7]).

Content knowledge is also needed to justify the steps, sequences, and results of a certain course of action. The most relevant content knowledge includes:

- Knowledge of technical terms and facts, such as for example legal requirements, requirements of vehicle manufacturers, types and signs of malfunctions, damage, and wear (e.g. visual appearance of corroded cables), most common designs etc. for the respective system.
- Knowledge of scientific principles (e.g. principles of electronics, fluid mechanics, material science) relevant to the system in question.
- Knowledge of the structure of the subsystems, components, and parts including their interdependences and connection types (e.g. electrical wire, hydraulic lines) for the respective system.
- Knowledge of the functions of each system, the system-related subsystems, and components (e.g. knowing the function of a fuel temperature sensor).

Desired distribution of items by content knowledge

The table below lists the four categories of content knowledge. The items should be evenly distributed among the categories, as they can be considered equally important. It is proposed to develop the content knowledge items by selecting a concrete work order and determining associated process(es). Afterwards, the content knowledge (i.e. the knowledge of the technical terms and facts, the principles, the structure, and the functions) necessary to carry out this process should be determined. Finally, the corresponding items can be designed.

Table 2.4. Desired distribution of items by content knowledge

Content knowledge	Percentage of items in assessment
Content knowledge of the drive unit	25
Content knowledge of the power train	25
Content knowledge of the undercarriage	25
Content knowledge of the assistance system	25
Total	100

Assessing automotive technician learners

In PISA-VET, the capabilities of automotive technician learners to carry out investigation and rectification processes will be assessed. The assessment should provide objective, reliable, and valid results about the learners' capabilities. It should accurately measure the capabilities learners need for the occupational area, and predict their future job performance, while minimising the impact of confounding factors on the results (e.g. local standards and contexts).

To obtain reliable and valid results, the items should authentically and broadly represent the constructs. The number of items and their coverage of the constructs should be as high as possible within the constraints imposed by student fatigue and survey implementation considerations.

Technology-based assessments allow for a cost-effective assessment that is also feasible in international large-scale settings. There is evidence for the domain of automotive technicians that technology-based assessments can provide objective and reliable results in reasonable testing times (Abele et al., 2014), valid interpretations of these results (e.g. Gschwendtner et al., 2009), and objective process data which can be used to increase the informative value of assessments (Abele and von Davier, 2019).

To assess the *investigation* and *rectification* capabilities, technology-based authentic scenarios can be used. The scenarios include authentic work orders, authentic work environments, and where possible and appropriate allow for authentic interactions. They are presented in a computer environment and can use digital simulations and/or videos to imitate relevant features of the automotive technicians' workplace as authentically as possible. An example of such a scenario would be a situation where learners must diagnose the malfunction of a vehicle in a computer simulation that represents a typical work order, (parts of) the light vehicle as well as the work environment and allows typical diagnostic activities.

Authentic scenarios are used for technology-based assessment. Each scenario starts with a work order which is a formal request to carry out a single task (e.g. "Replace the timing belt of the engine") or several tasks (e.g. "Diagnose why the engine does not start, and eliminate the cause of the malfunction"). A task requires test takers to perform actions that fall under one of the five processes (inspect, diagnose, etc.). Within each task of the scenario, test items assess specific aspects of the task. Tasks usually contain more than one item.

For example, a scenario may involve tasks of diagnosing and rectifying a specific vehicle malfunction. The test items may assess the test takers knowledge to:

- identify the cause(s) of the malfunction (e.g. defective component)
- justify their conclusion
- explain how the diagnosed defect causes the symptoms of the malfunction at hand, and
- replace the defective component.

The capabilities are assessed in a two-step procedure: First, the sub-capabilities of each capability are measured. For reporting purposes, the results are then used to build scores for the investigation capability and rectification capability.

To assess the sub-capabilities reliably and validly, at least three tasks per process are required. Consequently, at least fifteen tasks are used in the assessment, as there are five processes. The number of scenarios could be less than 15 as they include work orders and work orders can integrate more than one task (process). The number of items per task depends on the testing time available and the percentages given above. Assuming a total of 150 items and a testing time of 2 minutes per item, this results in a total testing time of 5 hours and, considering test fatigue, a booklet design is needed. Using 150 items as an example, "diagnose" and the content topic "electric and electronic" would each be represented with seventy-five items, "adjust" with eight items (rounded up).

Item formats and scoring

Technology-based assessments can contain simulation items. Simulation items have the potential to offer a more engaging experience for test takers as they are capable of emulating real-world (and thus more relevant) settings through complex interactions and the use of multiple media, such as animations, and sounds. Albeit complex to develop, simulations have the potential to validly assess the investigation and rectification capability as they can authentically represent parts of the work environment.

Another challenge with simulations is grading – subject matter and assessment experts will be involved in the development of (automatic) marking rubrics and how to collect data on test takers' strategies to potentialise the reporting of the outcomes. The next sections provide examples of simulation items and references that show that such items are feasible and can lead to reliable and valid results.

Technology-based items can be open-ended constructed-response items, closed constructed-response items, and selected-response items. They are expected to be combined in the assessment and are selected based on content and difficulty considerations.

The number of open-ended constructed-response items will be kept to a minimum as scoring such items is reliant on dedicated systems and coder training, thus time-consuming and less practical in international large-scale assessments. Additional challenges notwithstanding, open-ended items can be especially useful to assess certain, more complex components of the framework and to infer whether learners can generate responses based on more complex cognition and integrated knowledge. They are beneficial, for example, to assess how and to what quality learners justify the results they have achieved or the actions they have taken. Where such items are needed, algorithms will be explored for automatic scoring to decrease the workload on national counterparties as much as possible, but useful algorithms are difficult to develop and to validate, meaning no definite implementation can be decided now. Closed constructed-response items have a finite number of responses. In these, users manipulate the state by their input but do not have unlimited choices (not free typing or drawing), as they can only pick from a certain number of actions, while they have more choices than in a typical multiple-choice item. Examples are selection and dragging and dropping of objects, drawing graphs with fixed start and endpoints, etc. Such items are also useful to tap more complex knowledge and cognition but are limited in this respect compared to open constructed-response items.

Selected-response items (simple and complex multiple-choice items) are employed, for example, to assess content knowledge such as the knowledge of facts (e.g. components of a system, legal requirements). The development of such items considers measures to reduce rate biases (e.g. a high number of choices) and the risk of assessing superficial thinking and knowledge (e.g. the use of many appropriate and complex distractors).

The items will be scored dichotomously or with partial credits based on expert generated scoring guides to encode test takers' responses. Two response types are used for the item scoring: learners' written responses and process data. The process data results from the learners' interactions with the technology-based interactive task environments and is recorded by the computer, or by data related to student response reported by expert judges. Such data is used to score for example, whether the learners have performed a relevant diagnostic activity (e.g. measuring the resistance of a particular sensor in a computer simulated vehicle). In this case, the natural processes do not have to be interrupted for item scoring purposes. The item scoring can be done afterwards with the help of the process data.

Demonstration tasks could also be used in the assessment. In this case, expert judges, and relevant material (e.g. vehicles) must be present and prepared. Demonstration tasks have the potential to assess learner capabilities with a considerable amount of flexibility, given the possibility of interactions between test takers and judges and the nuanced assessment of learner performance. Demonstrations can be capital for the validity and reception of results as results are directly connected to trained professionals in the field of occupation being assessed. Benefits notwithstanding, demonstrations are challenging to scale in large-scale settings, due to the human and material resources required (e.g. judges, vehicles, measurement devices, computer-based-expert systems) and the preparation effort, internationally comparable training protocols to be developed and statistical models to be employed. Demonstration tasks pose a particular challenge for standardisation as they require identical vehicles, measuring equipment, computerised systems, etc., which is not easy to achieve in a globally conducted assessment.

Reporting proficiency of automotive technician learners

The proficiency of the automotive technician learners may be reported for the investigation and rectification capability or using a single scale. Two scales are preferable but testing time must be considered. The scales cover different levels of capability (see table 2.3.). The lower score limits will be determined with data in the second stage of the Development Phase according to the standard PISA scaling procedure.

The levels of investigation capability are described based on an evidence-based proficiency scale (Nickolaus et al., 2012^[8]). The levels depend on how the information is obtained during the investigation of vehicles: At the first level, it is obtained with sensory checks and without technical aids such as

measurement devices. At the second level, it is generated by measurements with equipment and measurement strategies that are retrieved rather than developed independently. At the third level, the information is obtained by measurements with equipment and the independent development of measurement strategies. The third level refers only to diagnosis, as inspection follows standardised procedures that are either given in external sources or recalled from memory.

Table 2.5. Summary description of the levels of investigation proficiency in PISA-VET

Level	Lower score limit	Descriptor
3	To be confirmed with data	At level 3, learners can diagnose different systems and types of light vehicles in situations where they need to independently develop strategies for obtaining information and use measuring equipment .
2	To be confirmed with data	At level 2, learners can inspect and diagnose various systems and types of light vehicles in situations where information can be obtained by applying standard procedures from memory or external sources and using measurement devices .
1	To be confirmed with data	At level 1, learners can inspect and diagnose various systems and types of light vehicles in situations where information about the vehicle can be obtained by applying standard procedures from memory or external sources and using sensory testing .

The task difficulty of rectification activities is determined by various parameters. One of these parameters is experience: Certain tasks are quite common and are conducted frequently during the training, while other tasks are rare, so that learners lack opportunities to become familiar with them and to develop routines. Experience builds on a continuum starting with very frequent service activities (e.g. oil change, change of brake pads), less frequent service activities (e.g. changing the timing belt of an engine), up to novel, problem-based activities (e.g. overhauling a gearbox). Another parameter that affects task difficulty is the scope of work: The more work steps that either must be retrieved from memory and/or from external information sources, the more complex, difficult, and error-prone the work. Task difficulty is also determined by whether individual action steps must first be organized by content knowledge, e.g. if an adequate solution to a problem must be developed by choosing from possible options, which is often the case with more complex repairs. Finally, difficulty is affected by the tools and equipment involved in the task: Using a screwdriver is easy while using a laser-based wheel alignment system is more difficult.

Against this background, we distinguish three rectification capability levels. At the first level, the learners solve routine tasks (such as frequent service tasks) with a varying amount of pre-defined sequence of steps. At the second level, the learners solve tasks of less routine character (less frequent service tasks), which often involve a larger number of work steps and require content knowledge and specialised tools to be applied successfully. At the third level, the learners solve novel problem-based tasks, resp. fewer routine tasks in a novel context, which is accompanied by a larger number of work steps using specialised tools and more sophisticated content knowledge. Despite their high degree of difficulty, the requirements of the third level are in principle covered by the training contents and can be solved.

Table 2.6. Summary description of the levels of rectification proficiency in PISA-VET

Level	Lower score limit	Descriptor
3	To be confirmed with data	At Level 3, learners can solve problem-based tasks that are rich in complexity and require them to independently develop problem solving and information retrieval strategies and use specialised tools . Following a step-by-step repair manual is not sufficient to solve such tasks.
2	To be confirmed with data	At Level 2, learners can solve tasks of medium complexity that require them to use specialised tools as well as to apply content knowledge . It is possible to successfully perform such tasks by following a step-by-step repair manual.
1	To be confirmed with data	At Level 1, learners can solve routine tasks (such as frequent rectification tasks) that consist of a varying number of standardised steps and require the use of standard tools . It is possible to successfully perform such tasks by simply following a step-by-step repair manual.

Examples of technology-based assessment

Technology-based assessment utilising computer-simulated scenarios

The following technology-based scenario relates to investigation and focuses on diagnosis. The scenario was developed and evaluated as part of the ASCOT+³ initiative of the German Federal Ministry of Education and Research. It involves an authentic work order to diagnose the malfunction of a car. In this case, the scenario represents only one process, namely, “diagnose.” In the scenario, a customer complained about a constantly burning engine control lamp. The malfunction is diagnosed in a computer simulation (Meier et al., 2022[9]). The simulation is made up of authentic drawings, photos, and screenshots of the following parts of the work environment of automotive technicians: (1) a selection of four relevant car systems, (2) a toolbox with various tools, and (3) relevant segments of the computer-based expert system (see Figure 2.1 below).

Figure 2.1. Screenshots of the computer simulation to assess investigation capabilities (in German)

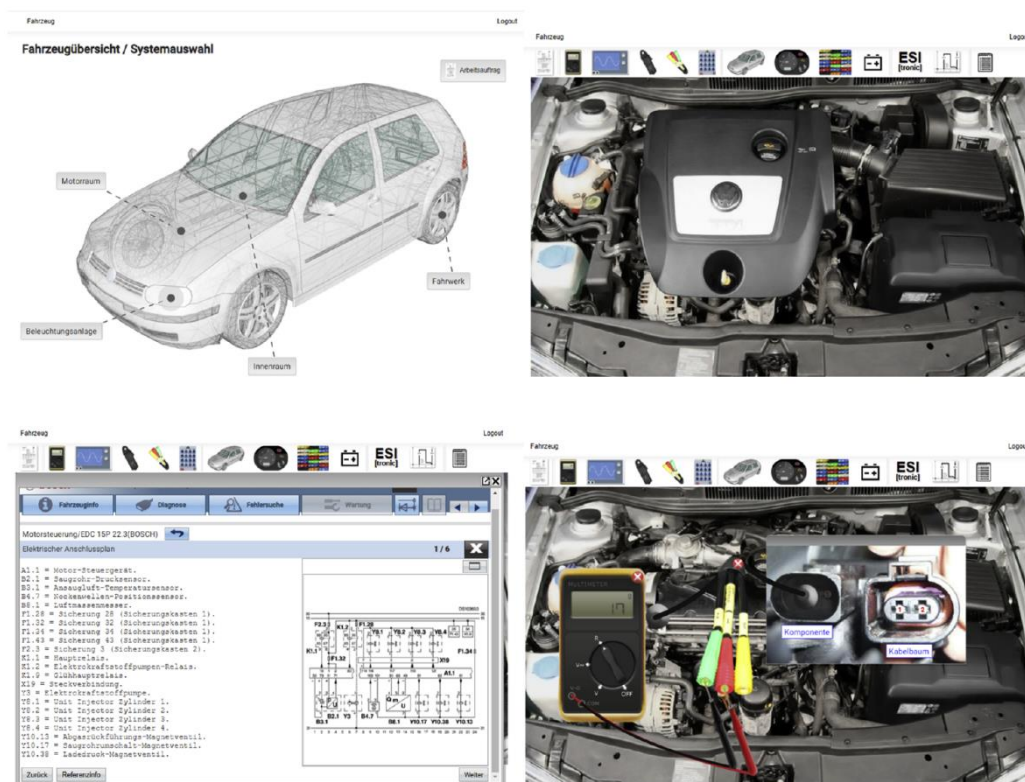

Note: The top left picture shows the starting page of the simulation, giving an overview of the car systems; the top right picture gives an overview of the engine compartment with various tools in the top bar; in the bottom left, the computer-based expert system with a circuit diagram is depicted; the bottom right picture shows the measurement of the resistance of the exhaust gas recirculation valve with a multimeter.

Source: ASCOT+

The car systems are the drive unit (subsystem: engine control unit, access via button “Motorraum”) and the assistance system (subsystems: radio, air conditioning, power window, access via button “Innenraum;” subsystem: lighting unit, access via button “Beleuchtungsanlage”; subsystem: anti-lock-brake unit, access via button “Fahrwerk”). The focus is on malfunctions in the engine control, which are diagnosed in the engine compartment (top-right in Figure 2.1). Numerous components (e.g. sensors, cables, and fuses) are

available for electrotechnical measurements. These components have different numbers of measuring points (e.g. different numbers of plugs or terminals on these plugs). The car can be in four different operating states (ignition off & engine off, ignition on & engine off, ignition on & engine starting, ignition on & engine running). The components and operating states allow for 3840 different measurements of voltages, resistances, and signals.

For these measurements, the test takers have access to various tools. Moreover, the simulation covers relevant segments of the computer-based expert system. It offers a great variety of information such as electrical circuit diagrams, installation plans, descriptions of components, diagnostic instructions, or reference values for electrotechnical measurements. A total of fifty-four malfunction scenarios are available in the computer simulation as realistic work orders on which initial symptoms are listed. When starting a diagnosis in the simulation, a test taker would usually first read the work order and then scan the fault memory of the engine control. Depending on the entry in the fault memory, the learners would then start looking for the cause of the malfunction. Every mouse click made in the simulation is recorded in log-files with a timestamp (Abele and von Davier, 2019_[10]).

Example 1: Simulation items to measure the content and procedural knowledge of malfunction diagnosis.

In the following example the test takers' content and procedural knowledge of malfunction diagnosis are measured. The example refers to an authentic scenario and a situation in which the test takers must identify the cause(s) of a malfunction in the computer simulation and justify their conclusion. To this end, they must conduct a complete diagnostic process (as described in the chapter "Diagnosis"; see p. 9). All necessary information, tools, and corresponding measuring points on the vehicle (such as connector plugs, control units, sensors etc.) are available in the computer simulation. While performing the diagnosis, every action is recorded by the program in a log file (see Figure 2.2 below). Test takers are given both constructed-response items and selected-response items. Their responses are scored according to relevant criteria.

The scenario starts with a work order that refers to a car that will not start (see Figure 2.3 below). The test takers must interact with the computer simulation to identify the cause(s) of this malfunction. They measure the resistance of the coil of the speed sensor and find that the measurement value is different from the reference value according to manufacturer's specifications, for example. They conclude that the sensor is defective (item 1, result of the diagnosis), and justify their conclusion by pointing out the difference between measurement value and reference (item 2, justification). Moreover, they are asked to explain how the defective sensor would cause the engine not to start (item 3, explanation). Test takers' responses are recorded via free text entry (open-ended constructed-response items) or drop-down menus (selected-response items). The identification of the defective sensor (item 1), the justification of the conclusion by giving the relevant measurement value (item 2), and the explanation how this defect causes the malfunction (item 3) are scored. In addition, relevant diagnostic actions (e.g. measurements) can be scored. The log data can be used for this purpose (e.g. by rewarding a correct measurement in the log file with a point). Given that the universe of actions that are logged by the simulation is exceptionally large yet still limited, scoring by log entries refers to closed constructed-response items. To increase reliability and still have an acceptable test time, items could be added to the tasks that do not cover a complete diagnosis but critical diagnostic requirements and require a comparatively short test time (Abele, 2014_[11]). The tasks cover all diagnostic requirements.

Figure 2.2. Screenshot of a log file (in German)

The screenshot displays a log file with the following entries:

id	Value	Timestamp	Score
simulation_log	Arbeitsauftrag geöffnet	05.01.2023 09:47	588603
simulation_log	System geladen: Motorraum	05.01.2023 09:47	588737
simulation_log	cockpit geöffnet	05.01.2023 09:48	628975
simulation_log	Zündung an	05.01.2023 09:48	634795
simulation_log	Motorstart an	05.01.2023 10:01	1430473
simulation_log	Motorstart aus	05.01.2023 10:01	1430475
simulation_log	ESI Seitenwechsel: /esi/s01f56/fehler-suche/auswahl-kapitel	05.01.2023 10:01	1430478
simulation_log	/esi/s01f56/VWW2232/fehlersuche/siscas/motorsteuerung/edc15p223bosch/	05.01.2023 10:01	1430479
simulation_log	steuergerätConnected: true	05.01.2023 10:01	1430475
simulation_log	abgasrückführungs_magnetventilConnected: true	05.01.2023 10:01	1430478
simulation_log	kraftstofftemperatursensorConnected: false	05.01.2023 10:01	1430479
simulation_log	ignitionOn: true	05.01.2023 10:01	1430479
simulation_log	engineStarts: false	05.01.2023 10:01	1430479
simulation_log	engineRuns: false		
simulation_log	Oszilloskop Messung		
simulation_log	kraftstofftemperatursensor.komponente.pin1/kraftstofftemp		
simulation_log	ponente.pin2: ID01 0V		
simulation_log	steuergerätConnected: true		
simulation_log	abgasrückführungs_magnetventilConnected: true		
simulation_log	kraftstofftemperatursensorConnected: false		
simulation_log	ignitionOn: true		
simulation_log	lanvinaStarte: false		

Note: Some log file entries are highlighted and relate to corresponding actions in the computer simulation that can be scored.

Figure 2.3. Screenshot of the correct responses to three items relating to the example given in the text (a car that will not start; free text entry; open-ended constructed-response items)

Diagnosis result

What causes the malfunction?
A defective speed sensor causes the malfunction.

What measurement leads you to this assumption?
A measurement of the electrical resistance between pin 1 and pin 2 on the speed sensor resulted in the value "OL". The target value of the sensor is between 450-550 Ohm. This indicates that the sensor is defective, probably due to an internal defect in the sensor.

How does this defect lead to the present malfunction symptoms?
Due to the defect of the speed sensor, the crankshaft position can no longer be correctly detected and reported to the engine control unit. Without this information, the engine control unit can no longer correctly calculate important parameters, such as the timing of fuel injection and ignition, which results in the engine not starting, as described in the work order.

Example 2: Simulation items to measure the procedural knowledge of tool selection.

The example below (Figure 2.4) is also from the computer simulation and measures procedural knowledge. In several stages of the diagnostic process, it is crucial to select adequate tools. This is realised with a virtual toolbox from which test takers can select a small range of measuring equipment.

For example, at a certain point, the diagnose might require checking an electric signal. To perform this measurement action correctly, test takers must pick the oscilloscope and adapter cable from the list of available tools. Which tools they select is logged by the simulation. Again, the corresponding action from the log file represents a selected-response item. The selection of the correct tool(s) is used for scoring.

Such virtual toolboxes can be integrated in a variety of digital assessment tools (video-based, simulation-based, text-and-picture based etc.).

The same item principle can also be used to measure if automotive technicians would select the correct parts for a replacement (e.g. from an electronic parts catalogue or a virtual storage shelf) or the correct materials (such as oil, lube, thermal grease, or anti-squeal paste from a virtual tool cart or trolley).

Figure 2.4. Screenshot of the 'Tools' menu of the computer simulation

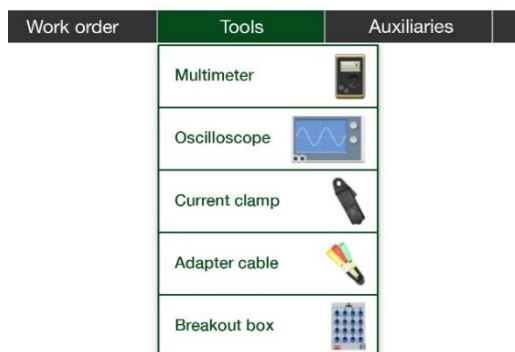

Note: Test takers can freely pick one or more tools in order to perform a certain task. The simulation recognises which tool(s) they use.

Technology-based assessment utilising scenarios

A second type of technology-based assessment involves scenarios rather than simulations. In such scenarios, an authentic work order and necessary information about the initial situation are provided as text. Furthermore, the test takers are granted access to necessary sources of information (e.g. circuit diagrams, testing instructions).

Example 3: Testing protocol to measure the content and procedural knowledge of generating and testing malfunction hypotheses.

The following example (see Figure 2.5 below) measures the test takers' content knowledge and procedural knowledge of diagnosis and more specifically, of generating fault hypotheses and planning how to test them. Based on the information provided in the scenario, the task of the test takers is to formulate reasonable hypotheses about the cause(s) of the described malfunction (the assumed defect) and specify how to evaluate these hypotheses. The test takers type their responses to a standardised testing protocol.

In each row of the protocol (representing one hypothesis and associated diagnostic strategy), the test takers name the appropriate testing instruments, measurement ranges, measuring points, and target values. In some cases, all information can be obtained from a manual; in other cases, test takers must develop their own diagnostic strategy.

Correct answers are determined in advance based on pilot studies and expert solutions. To fill out the cells of the testing protocol, both open-ended constructed-response items (free text entry; see Figure 2.5: measuring points) and selected-response items (single choice, e.g. via drop-down menus; see Figure 2.5: measuring device) are feasible. To score the items, the number of appropriate hypotheses and correct tests could be evaluated, for example.

Figure 2.5 shows a work order in which a customer's vehicle has engine trouble such as rough idle and reduced performance. A reasonable hypothesis about the cause of the malfunction that could be derived from the available information is an interruption of the voltage supply between the engine control unit and

a fuel injector, caused by a broken cable. The test takers could further conclude that a reasonable measurement to test this hypothesis is a voltage test on the plug at the injector side of the cable. For this, they would select the multimeter as the testing instrument and identify pin one and pin two on the injector as the measurement points. They would read the target value of 12 volts from the available testing instructions. They enter all this information into the testing protocol. Afterwards, they can enter further hypotheses and corresponding tests until they cannot think of any more or until the test time is over.

To arrive at such results, the test takers must a) read and understand the description of the malfunction and the context, b) use available electrical circuit diagrams and testing instructions to obtain necessary information, c) combine a, b, and their content knowledge to derive reasonable hypotheses about the assumed defect, and d) derive and plan the necessary tests for the hypotheses using available information. The hypotheses about the cause of the malfunction and relevant measurements must be stated in the testing protocol. To score the items, the number of appropriate hypotheses and correct tests could be evaluated, for example.

Figure 2.5. Screenshot of a testing protocol

The screenshot shows a testing protocol interface. At the top, it says "Testing protocol I Question 1 of 1" and has a "Next" button. Below that is the "Work order:" section with a text description of a customer's complaint and a fault code. Underneath is a table with columns: No., Assumed defect, Testing instrument, Measurement range, Measuring points, and Target value. The table contains two rows of data. To the right of the table are two thumbnails: "Electrical circuit diagrams" and "Testing instructions".

No.	Assumed defect	Testing instrument	Measurement range	Measuring points	Target value
1	Cable interruption between injector and control unit - no power supply	Multimeter	Voltage (V)	Injector cylinder 2 – Pin 1 and Pin 2	12V
2	Defective Injector cylinder 2 – internal resistance too High	Multimeter Oscilloscope - voltage Oscilloscope - current clamp Oiler Visual inspection without test device			

Technology-based assessment utilising video vignettes

Another potential format to assess automotive technicians' work-related capabilities are video-based assessments (Gschwendtner et al., 2017_[12]). Hartmann, Güzel, and Gschwendtner (2023_[13]) measured rectification knowledge with an instrument that uses scripted video vignettes. The instrument was developed and evaluated as part of the ASCOT+ initiative of the German Federal Ministry of Education and Research. The instrument consists of a series of short video clips showing a technician (played by an actor) who performs rectification tasks on a car. The videos and related test items cover the entire replacement process, starting with the presentation of a work order and ending with the final checks after the work is completed.

Some of the actions in these clips are correct whereas in others the actor intentionally makes mistakes which are known to be common for automotive technician learners. Each video clip is followed by one or more selected-response items which refer to the actions shown in the videos. The items are presented on the computer screen.

The distractors are based on empirical studies of learners' pre-concepts regarding the action addressed by the items. It is assumed that learners can only differentiate between correct and incorrect rectification actions in the videos if they know how these actions are adequately performed. Therefore, their responses

can be interpreted as an indicator of their rectification-related knowledge. Evidence from validation studies suggests that even though there are limitations, this format is capable of measuring rectification-related capabilities. The instrument is currently used in the practical exams of automotive technician learners in the Stuttgart Region (Germany) (Hartmann and Gschwendtner, 2022^[14]). A comparison of exam scores indicates that the video-based assessment generates results like those of 'classical' hands-on exams.

Example 4: Video-based item to measure the content and procedural knowledge of replacing the timing belt.

The item example below (Figure 2.6) is from the video-based instrument and measures content and procedural knowledge. The instrument utilises a series of video clips in which an automotive technician replaces the timing belt of an engine. The task in the shown item is the replacement of the timing belt itself. It consists of a series of actions. Among those actions, the technician removes and later reattaches a special tool that holds the camshaft wheels in position, which is the correct procedure for this replacement task. He should also replace a tension pulley but skips the replacement. After the video has stopped, the test takers are presented with two statements (Option A and Option B) that refer to these two aspects of the replacement task. If they judge the statements correctly, they must conclude that Option A is incorrect, and Option B is correct. Therefore, the correct response is answer 2: "Only option B is correct".

The selected-response item is complemented with several documents including a repair manual. It is expected that to solve the item correctly, technicians must either be familiar with the task or be able to extract the essential information from the repair manual.

Figure 2.6. Screenshot of a CBA item utilising video vignettes

Note: To solve this item, test takers must judge an action presented in a video clip.

Example 5: Text- and image-based item to measure the content knowledge about the structure and function of the timing belt

The item example below (Figure 2.7) is from the same video-based instrument and measures content knowledge. Again, the item is part of a series of items that represent the complete task of replacing a timing belt.

To measure knowledge of the structure and function of the engine timing subsystem, test takers are presented with a damage of a pulley. They are then asked what consequences this defect would have on

the related (sub)system. To solve the selected-response item, test takers must know how the damaged component is integrated in the subsystem and in which ways it contributes to the subsystem's function. The pulley in question regulates the tension of the timing belt. It is not connected to the drive belt. Therefore, Option A is incorrect, and Option B is correct. The correct response would be answer 2 ("Only option B is correct").

In order to make the test format even more authentic with even more varied realistic decision processes, it would be conceivable to rework the instrument in such a way that it allows greater freedom with regard to, for example, the selection and setting of tools (e.g. supplemented by menu windows which - similar to a toolbox - allow a selection of the most varied tools) and the like.

Figure 2.7. Screenshot of a CBA item utilising video vignettes

Timing belt | Question 7 of 24

What could be the consequence(s) of the shown damage to the pulley?

Option A: The drive belt (V-ribbed belt) may tear.

Option B: The synchronization between crankshaft and camshaft could be lost.

Only option A is correct.
 Only option B is correct.
 Both options, A and B are correct.
 Neither option A nor option B is correct.

Available materials:

Note: To solve this item, test takers must (a) recognise which component of the engine is damaged in the video, (b) know how that component is integrated in the engine's timing subsystem, and (c) combine a and b with their conceptual knowledge of the subsystem in order to deduce potential consequences of the shown damage.

References

- Abele, S. (2018), "Diagnostic Problem-Solving Process in Professional Contexts: Theory and Empirical Investigation in the Context of Car Mechatronics Using Computer-Generated Log-Files", *Vocations and Learning*, Vol. 11/1, <https://doi.org/10.1007/s12186-017-9183-x>. [4]
- Abele, S. (2014), *Modellierung und Entwicklung berufsfachlicher Kompetenz in der gewerblich-technischen Ausbildung*, <https://doi.org/10.25162/9783515107556>. [11]
- Abele, S. and M. von Davier (2019), "CDMs in Vocational Education: Assessment and Usage of Diagnostic Problem-Solving Strategies in Car Mechatronics", in *Methodology of Educational Measurement and Assessment*, https://doi.org/10.1007/978-3-030-05584-4_22. [10]
- Baethge, M. and L. Arends (2009), "Feasibility study VET-LSA: A comparative analysis of occupational profiles and VET programmes in 8 European countries - international report". [1]

- De Jong, T. and M. Ferguson-Hessler (1996), "Types and qualities of knowledge", *Educational Psychologist*, Vol. 31/2, https://doi.org/10.1207/s15326985ep3102_2. [7]
- ESCO (2020), *European classification of Skills/Competences, Qualifications and Occupations*, <https://esco.ec.europa.eu> (accessed on 16 December 2022). [3]
- Gschwendtner, T., S. Abele and R. Nickolaus (2009), "Computersimulierte Arbeitsproben: Eine Validierungsstudie am Beispiel der Fehlerdiagnoseleistungen von Kfz-Mechatronikern", *Zeitschrift für Berufs- und Wirtschaftspädagogik*, Vol. 105/4, <https://doi.org/10.25162/zbw-2009-0038>. [15]
- Gschwendtner, T. et al. (2017), "Multidimensional Competency Assessments and Structures in VET", in *Methodology of Educational Measurement and Assessment*, https://doi.org/10.1007/978-3-319-50030-0_12. [12]
- Hartmann, S. and T. Gschwendtner (2022), "Premiere für digitale Prüfungsstationen in der praktischen Kfz-Gesellenprüfung". [14]
- Hartmann, S., E. Güzel and T. Gschwendtner (2023), "Digital measurement of hands-on performance? Ecological validation of a computer-based assessment of automotive repair skills", *Empirical Research in Vocational Education and Training*, Vol. 1. [13]
- Jonassen, D. (2000), "Toward a design theory of problem solving", *Educational Technology Research and Development*, Vol. 48/4, <https://doi.org/10.1007/BF02300500>. [6]
- Klahr, D. and K. Dunbar (1988), "Dual space search during scientific reasoning", *Cognitive Science*, Vol. 12/1, [https://doi.org/10.1016/0364-0213\(88\)90007-9](https://doi.org/10.1016/0364-0213(88)90007-9). [5]
- Meier, J. et al. (2022), "Promoting car mechatronics apprentices' diagnostic strategy with modeling examples: Development and evaluation of a simulation-based learning environment", *Studies in Educational Evaluation*, Vol. 72, <https://doi.org/10.1016/j.stueduc.2021.101117>. [9]
- Nickolaus, R. et al. (2012), "Fachspezifische Problemlösefähigkeit in gewerblich-technischen Ausbildungsberufen – Modellierung, erreichte Niveaus und relevante Einflussfaktoren", *Zeitschrift für Berufs- und Wirtschaftspädagogik*, Vol. 108/2, <https://doi.org/10.25162/zbw-2012-0016>. [8]
- Ritchie, H. (2020), "Cars, planes, trains: where do CO2 emissions from transport come from?", *Biofuels, Bioproducts and Biorefining*, Vol. 9/5. [2]

Further reading

Abele, S., Walker, F. and Nickolaus, R. (2014), *Zeitökonomische und reliable Diagnostik beruflicher Problemlösekompetenzen bei Auszubildenden zum Kfz-Mechatroniker [Time-Saving and Reliable Diagnostics in Measuring Professional Problem-Solving Competence in the Domain of Car Mechatronics]*, *Zeitschrift für Pädagogische Psychologie*, Vol. 28/4, pp. 167-179, <https://doi.org/10.1024/1010-0652/a000138>.

Annex 2.A. Systems, subsystems, components, and parts

Each content category for the automotive technician occupational area is described by specifying the topics, i.e. the basic functions of the respective system and naming subsystems, components, and parts. Given the complexity of vehicle systems, it is not the intention to describe the systems exhaustively, but rather to use typical and representative examples to define them.

Drive unit

The central functions of the drive unit are to convert other forms of energy into kinetic energy, to provide the energy to the other systems of the motor vehicle and to store the energy (e.g. fuel tanks or batteries). In the case of the charging subsystem, the direction of energy conversion is reversed. The (still) most widespread drive units are internal combustion engines. These generate motion through controlled, combustion processes of fuels (e.g. diesel, gasoline, or gas). Other engine types such as electric motor drives are becoming increasingly important. There are also mixed forms of these different engine types, so-called hybrids, which are being used more frequently.

It is composed of the following subsystems, components, and parts:

- **Subsystems:** air subsystem (air intake and exhaust, e.g. exhaust gas recirculation systems, exhaust gas aftertreatment systems), fuel injection subsystem (e.g. pumps, fuel metering systems, fuel tank), ignition subsystem (e.g. spark plugs, rotating high voltage distribution, ignition coils), engine management subsystem (e.g. engine control unit, emission control, timing belt), starting and charging subsystem (e.g. starter, generator, battery), etc.
- **Components:** engine control unit, sensors (e.g. temperature sensors, speed sensors, mass airflow sensor), actuators (e.g. starter motor, fuel pump, injection valves), transmission components (e.g. cable harnesses, battery), etc.
- **Parts:** High-pressure rail, coils, intake and exhaust valves, pistons, camshaft, crankshaft, permanent magnets, etc.

Powertrain

A central function of the powertrain is to transmit the engine power (rotation and torque) of the drive unit to the vehicle's drive wheels with as little energy loss, friction, vibration, and noise as possible. In principle, engine power can be transmitted to one (front-wheel or rear-wheel drive) or to all vehicle axles (all-wheel drive). This is the transmission function of the powertrain. At the same time, the powertrain also has a transformation function, i.e. speeds and torques of the driveline can be – if necessary and technically possible – specifically transformed into different peripheral speed and torque at the vehicle wheels. Associated with the transformation function is the compensatory function in that different rotational speed and torque at the vehicle's axles and/or individual drive wheels can be permitted (by means of a differential gear) or purposefully changed (by means of a transfer gearbox, or torque vectoring through a clutch system).

It is composed of the following subsystems, components, and parts:

- **Subsystems:** powertrain management systems, non-shiftable and shiftable mechanical, automated and automatic transmissions (including planetary gear), non-shiftable and shiftable clutch systems (e.g. cam clutches, multiplate clutches, viscous clutches, hydrodynamic torque converters), shaft systems, etc.
- **Components:** powertrain control unit (which can be either a separate unit or integrated in the engine control unit), sensors (e.g. RPM or temperature sensors), actuators (e.g. electro-hydraulic actuators, gear oil pump), complex dynamic seals (e.g. simmering), rolling bearings (e.g. needle bearing), synchronisation device, flange couplings, multiple-disc clutches, park locks, drive/axle shafts, housings, etc.
- **Parts:** shafts, plain bearings, static gaskets, gearwheels, shift sleeves, synchronous body, synchronizer ring, springs, etc.

Undercarriage

The central function of the undercarriage is to provide the vehicle with a load-bearing framework that allows relative motion between the vehicle and the underground, a controlled change of direction, and a reduction of speed up to a full stop in a controlled manner.

Modern undercarriage systems are combined of mechanical, hydraulic, and electric/electronic parts and components:

- **Subsystems:** suspension, steering, brake system, electronic stability control (ESC), etc.
- **Components:** wheel, MacPherson strut, brake calliper, angular rate sensors (ARS), steering mechanism, tie rod, etc.
- **Parts:** tyre, spring, stem (of a shock absorber), brake piston, tone wheel, ball and socket (of a ball joint), etc.

Assistance

The central functions of the assistance system are to support the passengers' well-being and to facilitate the vehicle operation. It protects against hazards (e.g. accident risk and consequences) and enables a pleasant use of the vehicle. They are designed to intervene (semi-)autonomously in other systems and/or warn the driver shortly before and/or in critical situations through suitable instruments. The functions of the assistance system are provided by the following subsystems, components, and parts:

- **Subsystems:** lighting systems, airbag (e.g. driver airbag, head airbag, pedestrian airbag), driver assistance systems (e.g. park assistance system, brake assistant system, driving dynamic systems), ventilation and air conditioning (HVAC; e.g. parking heater, circulation air system), multi-media systems (e.g. radio, head-up display, headrest monitors), interior comfort systems (e.g. electrically adjustable steering wheel, massage seats, noise insulation), data bus systems (e.g. CAN, LIN, FLEXRAY, MOST), etc.
- **Components:** sensors (e.g. temperature sensors, air quality sensors), actuator (e.g. servomotors, electrical valves), control units (e.g. air conditioner control unit, anti-lock-brake control unit), transmission components (e.g. cable harnesses, plug connectors), interior climate compressor, seatbelts, airbags, etc.
- **Parts:** cabin filter, coils, rotors, capacitor plates, wires, cable sheathing, permanent magnets, speaker, etc.

Notes

¹ Besides such global standards, there are also local standards. Compared to the global standards, the local standards are much less relevant and must not be included in the assessment for reasons of comparability.

² This process is often referred to as “repair” in common speech. However, vehicles are often repaired by simply replacing a broken part; the broken part itself is not repaired. Other actions that in common speech fall under the term “repair” also often do not meet the definition of a repair in a strict sense, e.g. when undamaged parts are replaced at customer’s request or in order to maintain functionality before a part has worn beyond the limits specified by the manufacturer. Therefore, we named the process “rectify”, which by definition involves different kinds of corrective actions such as repairs, replacements, adjustments, etc.

³ ASCOT stands for “Technology-based Assessment of Skills and Competences in VET” and the “+” for the transfer of results from the predecessor initiative ASCOT (2011-2015) into training and examination practice.

3 Electrician

This chapter defines “electrician” as assessed by PISA-VET and elaborates the framework for electrician that has been designed for the Development Phase of the project, including descriptions of the competencies and constructs to be assessed. It presents and explains the processes, content knowledge and contexts and provides several sample items with descriptions of task characteristics. The chapter also discusses how performance in the electrician area is measured and reported against proficiency levels and scales.

Introduction

This chapter defines the role of the “electrician” for the purpose of assessment by the PISA-VET project. The chapter elaborates the assessment framework for an electrician that has been designed for the Development Phase of the project, including descriptions of the competencies and constructs to be assessed. It presents and explains the processes, knowledge, skills, competencies, and contexts reflected in PISA-VET’s electrician tasks and provides several sample items with descriptions of task characteristics. The chapter also discusses how performance in the occupational area of electrician can be measured and reported against proficiency levels and scales.

The rationale for the inclusion of the occupation of electrician in this Development Phase is strong because of its continued economic importance and international comparability. Electric power is responsible for running every aspect of society including industry, business, entertainment, and domestic life. The role is in global demand and is dynamic – it is constantly affected by advances in technology and the sustainability (UN Department of Economic and Social Affairs, 2022^[1]). For example, there is increasing demand for efficient equipment and machinery plus renewable energy.

Another reason for selecting electrician for PISA-VET is that it is a highly regulated occupation with international standards that are universally recognised. In most countries, electrical installations comply with a set of regulations, issued by National Authorities or by recognised private bodies. The International Electrotechnical Commission (IEC) is the global organisation that prepares and publishes International Standards for all electrical, electronic, and related technologies which are often adopted by countries or regions to become national or regional standards. For example, approximately eighty per cent of European electrical and electronic standards are IEC International Standards. It should be noted that due consideration will be given to regional norms and standards in the design of the assessments to ensure recognition of differences and fairness.

This chapter represents the views of a group of global experts, including experienced electricians.

Defining the Electrician occupational area

Occupational definition and associated VET programmes

The purpose of the PISA-VET framework is to “encompass VET learners on a trajectory to become skilled professionals able to make well-rounded judgements and decisions”, as electricians in this instance (OECD, 2022a^[2]). Therefore, the aim of this section of the chapter is to precisely define electrician for the purpose of PISA-VET by:

- a) using the available global classifications to help define the electrician as an occupation
- b) identifying the trajectory through which learners may become skilled professional electricians, together with their intermediate destinations and milestones, while
- c) building on the lessons of recent years regarding the opportunities for and challenges of international comparative assessments and judgements.

While the classifications are occupational, as a minimum they indicate the extent of learning required to fulfil each role. The literature search and analysis that follows discusses electrician qualifications and their relationship with the necessary occupational requirements in the context of this project.

This chapter makes use of the International Standard Classification of Occupations (ISCO) to define the occupation of electrician.

Within ISCO-08, the sub-major Group 74” Electrical and Electronics Trades Workers” is the one most closely related to the electrician occupational area. Separate minor groups are provided for electrical (741)

and for electronics (742) equipment installers and repairers. The unit groups, shown in Table 3.1, reflect the growing convergence between computer and telecommunications technologies and aim to provide a clear distinction between those working with high tension, and low tension, equipment. ESCO further details these ISCO occupations, including electrician roles in different environments, such as “domestic electrician” (7411.1.1.1) and “industrial electrician” (7411.1.1.2).¹

Table 3.1. ISCO-08 Electrical and Electronics Trades Workers

ISCO-08 code		ISCO-08 title
74		Electrical and Electrical Trades Workers
	741	Electrical Equipment Installers and Repairers
	7411	Building and Related Electricians
	7412	Electrical Mechanics and Fitters
	7413	Electrical Line Installers and Repairers
	742	Electronics and Telecommunications Installers and Repairers
	7421	Electronics Mechanics and Servicers
	7422	Information and Communications Technology Installers and Servicers

In accordance with the ISCO-08 classification, the occupation of electrician comprises skilled professionals, trained to install, fit, and maintain electrical wiring systems and machinery and other electrical apparatus, electrical transmission and supply lines and cables, and electronic and telecommunications equipment and systems. As such, the professionals select material, components, and tools regarding their appropriateness to meet applying regulations and standards. Electricians engage with activities ranging from the more abstract planning in accordance with customer requests to their repair and maintenance, including the diagnoses of malfunctioning electronic devices with adequate documentation. Often specialising in either craft or industrial sub-domains, electricians require a broad content knowledge to keep systems and equipment operating within (regulatory) requirements and to prevent potential issues or hazards. In summary electrician is a very responsible role which involves much complexity and requires the ability to transfer knowledge and skills across a wide variety of environments and situations some of which are emergencies. Whilst the Electrician is normally responsible for the management of their own workload, they may work within a team.

Discussions within the group have identified that, globally, individuals undertaking initial training to be an electrician embark on a three-to-four-year VET programme which is broadly based and provides a strong foundation. The programmes will be broadly aligned to Levels 3 and 4 of the European Qualifications Framework (EQF) and will have a wide range of titles including “electrician”, “electrical installer”, electrical maintenance technician”, electrical systems installer, “electrical installation technology”, “electronics technician”, “electrical engineering”, “electrical fitter”, “home appliance maintenance and repair technician”, “electronic worker”, and “industrial automation worker”, with or without the addition of either “trade/craft sector” or “industry sector”. After successful completion of the programmes individuals normally follow a particular career pathway, with “domestic/commercial (craft)” and “industrial” being very common. Thus, it has been agreed that in developing the PISA-VET framework the focus should be on both pathways referred to by the 2009 Feasibility Study as “craft” and “industry” electricians, particularly as the Study recommended that the two pathways should be included in subsequent research (Baethge and Arends, 2009, p. 91^[3]).

Table 3.2. Examples of VET programmes for electricians

Selected programmes in data collection countries of PISA-VET

	Australia	Germany	Portugal	United Arab Emirates
Title	Apprenticeship: Systems Electrician Certificate Level 3 (Australian Qualification Framework)	Apprenticeships: Electronics Technician- FR Energy and Building Technology (Craft) Electronics Technician for Building Technology (Craft) Electronics Technician for Industrial Engineering (Industry)		Certificate 4 in Electrical Engineering Technology
ISCED level	4	3		3
EQF level	5	4		3
Duration (years)	3 - 4	3.5		2-3

International comparability of the occupational area

The VET-LSA Feasibility Study (Baethge and Arends, 2009^[3]) was designed to learn if there was a common basis for comparing four selected vocational programmes in each of eight participating European countries. The comparison was focused on a “medium level of proficiency, that is, initial VET programmes at ISCED level 3 and corresponding to occupations requiring medium or considerable vocational preparation” (Baethge and Arends, 2009, p. 7^[3]). As one of the four programmes, the electrician occupation was divided into craft and industry, and both were analysed.

WorldSkills International (WSI, 2022^[4]) similarly divides the area into electrical installation and industrial control and presents two occupational standards at mastery level. Since 2012 each WorldSkills competition has an associated WorldSkills Occupational Standard (WSOS). The WSOSs for “Electrical Installations” and “Industrial Control” have been updated biennially since that time (WorldSkills International, 2022). The WSOSs comprise the knowledge, skills, and competencies that represent occupational mastery, globally. As such, they draw competitors from diverse initial vocational education and training (IVET) programmes and qualifications across WSI’s global membership.

At the time of the Feasibility Study, ESCO V1 had not been published. Another limitation was the use of O*NET as a reference point, given the distinct nature of the North American labour market for the role of electricians. As can be seen from the table above, the European, Skills, Competences and Occupations (ESCO, 2020^[5]) classifications presents “electrician” with a set of more specific roles including “domestic” and “industrial”, while O*NET On-Line includes one occupation specification, noting that electricians can have a specific focus such as “industrial”.

As noted above, the electrician occupation is a highly regulated occupation with international standards that are universally recognised. This contributes to the international comparability of the occupation area.

Organising the domain of electrician for PISA-VET

This section sets out the contexts, processes, capabilities, and content knowledge required to perform the tasks of safely installing, maintaining and adjusting electrical systems and components in accordance with regulations and professional standards. This includes the reasoning and understanding necessary to select appropriate materials, components, and tools to achieve a desirable solution to a commercial or domestic challenge (e.g. based on a customer’s requirements). The domain consists of applying electrical theory and underlying fundamental concepts to electrical systems and applications. Professionals from this domain can use their expertise to implement programs for controlling motors, valves, and other devices used in industrial control. The professionals provide solutions by configuring systems and correcting detected faults.

Context

The choice of appropriate Electrician strategies and representations is often dependent on the context in which a problem arises. For PISA-VET, it is important that a variety of contexts are used for each occupational area. This offers the possibility of connecting with the broadest possible range of individual interests and with the range of situations in which Electricians operate in the 21st century.

Electricians work broadly in three contexts: commercial and public sector, domestic, and industrial (see Table 3.3). The contexts have been selected in the light of the relevance to the demands that will be placed upon electrician students as they enter the world of work as skilled workers. The three context categories are equally demanding. The range of environments an electrician may work in, on successfully completing their initial training, is varied but there are two broad branches: “craft” and “industrial”. It should be noted that the following list of environments is not exhaustive as countries/regions will have additional specialisms (e.g., agriculture in Ireland).

Table 3.3. The environments in which Electricians work

Commercial and public sector	Domestic (Residential)	Industrial
Education/libraries	Houses	Factories
Museums/art galleries	Flats/apartments	Manufacturing plants
Offices	Bungalows	Warehouses
Hospitality establishments		Shipyards
Leisure/fitness		Mines
Shops		Hospitals
Entertainment venues		Water treatment facilities
Data centres		Construction sites
Server rooms		Power generation stations
Back-up generators		Solar energy production
Power Supplies		Industrial control panels
Government buildings		
Traffic and infrastructure systems		

Description of contexts

Commercial and public sector

Electricians in the commercial sector often work in a busy public environment. They work with high voltage generators, electrical systems, appliances, traffic, transport, e.g. railway and infrastructure systems as well as heating and air conditioning units. Most Commercial Electricians work with three-phase systems, which use conductors having voltages between 120 volts and 480 volts. They also work with aerial lift operators, thus ‘working at heights’ is an integral part of the role.

There is a lot of pressure on the Commercial Electrician to be creative and quick to adapt to new challenges, in essence to work at speed. This is to prevent the client/organisation from suffering a reduction in customers/sales revenue due to ‘downtime’.

Domestic (Residential)

Domestic Electricians may work for small independent businesses or for providers of homes and residential services such as local authorities and housing associations, housing construction companies, care homes, electric utility companies and other companies providing electrotechnical services to the residential market. Domestic Electricians carry out electrical work mostly inside residential flats/apartments, houses and bungalows.

A Domestic Electrician will be responsible for completing their own work to specification, with minimal, if any, supervision, ensuring they meet set deadlines. The role is for people who like to work independently most of the time, but it also involves interacting with customers, colleagues, and others.

With the rising popularity of electric vehicles, the domestic electricians may install residential vehicle charging points as part of their service. Domestic Electricians typically work with single-phase voltage systems ranging from 120 volts to 240 volts.

Industrial

An Industrial Electrician may work, for example, in steel production, manufacturing, and electrical power companies. Electricians in the industrial sector work in large organisations which are characterised by complex equipment and heavy machinery which requires specialist knowledge. For example, an Industrial Electrician working at a mine will need to be familiar with mining equipment, such as draglines and hydraulic shovels. Industrial projects will include large-scale plants, generators, and building environment systems.

Typical work includes installing electrical power and systems, telecommunications, fire, security systems, electronic controls, installing wires, servicing, and installing equipment. Alternative areas where an Electrician's service is required are solar and wind power generation sites where installation work is continuously undertaken. They may be employed in one plant and install and maintain production equipment; or they may be employed by a sub-contractor and work in several industrial settings.

The working environment is likely to be one that is potentially very dangerous and hazardous. The industrial control practitioner proactively promotes best practices in health and safety and rigorously adheres to health and safety legislation. The individual is exposed to wires, conduits and other parts that carry live electricity. Some Industrial Electricians work outside in the cold or scorching heat, especially when the power is out due to inclement weather. Other Electricians work indoors in heated or air-conditioned buildings. Sometimes they stand, crouch or kneel for long periods. They also work at height if the job is inside a multi-story building.

Most Industrial Electricians work in factories and manufacturing plants, and their colleagues include building services engineers, electrical engineering technicians and security systems installers. They also work with electrical engineers, field engineers, technicians, and facility managers, as well as other specialists that could include project engineers, factory managers, project managers and cost estimators.

Companies never know when they will need an Industrial Electrician. Sometimes, they schedule an equipment repair or installation ahead of time, but if their system goes down, they need repairs immediately. For this reason, Industrial Electricians work nights, weekends and holidays. Since emergencies often occur, they frequently work longer than eight hours at a time. Most companies have part-time and short-term contracts for Industrial Electricians.

Desired distribution of items by context category

This subsection provides the desired distribution of assessments selected for the Electrician domain across the context categories shown in Table 3.4. As commercial, public sector and domestic are normally clustered within "craft" no single context dominates and a balanced approach to item distribution is proposed.

Table 3.4. Percentage of items by context

Context category	% of items in Assessment
Commercial and public sector	30
Domestic	30
Industrial	40
Total	100

Electrician processes and the underlying occupational capabilities

The literature review and discussions with practising electricians and teachers/trainers of electricians have identified the following five internationally recognised processes which provide the framework within which the Electricians undertake their tasks:

- assess and diagnose
- plan and design
- assemble and install
- repair and maintain
- inspect, commission, test and report.

The underlying capabilities for the electrician occupation that have been identified for PISA-VET include three of the employability skills presented in Chapter 7 of this framework document and five others. The details regarding each of these underlying capabilities are provided in a later section of this chapter. In summary, the nine underlying capabilities for Electrician:

- Identifying and resolving electrical problems - the ability to identify, diagnose and resolve electrical problems in dynamic situations.
- Responding to customers and colleagues - the ability to impart or exchange information with customers and colleagues, both verbally and “in writing”.
- Collaborating on electrical tasks, problems, projects - the ability to work with other professionals on electrical projects and problems.
- Using digital and communications technology for daily electrical tasks and problems - the ability to use digital technology, tools and networks within daily work routines.
- Professional personal management skills for the electrician - the ability to regulate behaviours, thoughts, and emotions in the workplace in a productive way.
- Critically assessing electrical situations – the ability to engage in reflection and independent reasoning, rigorously questioning ideas, and assumptions.
- Safety consciousness in electrical situations – the ability to be constantly aware of hazards and to be alert to electrical dangers.
- Reading electrical documentation and preparing reports - the ability to read manufacturer’s instructions, interpret electrical diagrams, write, speak and listen effectively.
- Using mathematics and numeracy in daily electrical tasks and projects – the ability to deal with calculations and equations e.g. Ohm’s Law, and trigonometry.

Processes

Process 1: Assess and diagnose

One of the most important processes that an Electrician engages in is to check customers/clients' requests/requirements and identify problems in electrical systems. Before they begin any work, the electricians must review any documents used such as a customer order or a specification sheet, assess the situation generally and apply safety precautions. The diagnostic skills of electricians are critical for new tasks or for troubleshooting electrical and electronic systems. They use specialised instruments (e.g. multimeters, diagnostic devices, tools and software, and occasionally oscilloscopes) in the diagnostic process to measure, check and compare electrical quantities and further information. Often the electrical quantity does not directly correspond to the measuring device, so calculations must be performed and values checked for their plausibility. Electricians can analyse complex circuits and systems and identify and correct problems. They use their knowledge of electrical and electronic components and circuits to isolate the fault and find the exact source of the problem. They frequently disassemble the circuit or device into individual components to identify and correct the fault. Overall, the assessment and diagnostic activities of electricians are critical to the smooth operation of electrical and electronic systems. They are essential for identifying and resolving problems quickly and accurately to minimise downtime and costs.

Process 2: Plan and design

The Electrician will be involved in the process of planning and designing electrical projects (small to large, and straightforward to complex) independently, or as part of a team. This will involve in most cases the use of information technology. The overall electrical plan includes specifications, instructions, electrical layout drawings and wiring diagrams. The technical drawings and diagrams deliver visual representations of the requirements, and they consist of electrical symbols (global and national) and lines that outline the electrical design requirements. Furthermore, they detail the positions of the electrical apparatus. The specification describes in detail the overall requirements.

To plan and design a project effectively, electricians start by discussing and analysing customer/other professionals' needs e.g. architects, engineers etc. Providing excellent 'customer service' is a very important part of this process and thus a high level of interpersonal skills is required. Communication and collaboration are fundamental integrated skills for an electrician when planning and designing. Communication, for example, may include providing technical and functional information about electrotechnical systems and equipment to a customer or colleague. Collaboration (teamwork) is important to maintain positive relations with other professions and minimise any potential conflict which may impact on the timing and ultimately the success of the project. Electricians may also lead a team and be responsible for manpower planning, work organisation and co-ordination, plus securing materials and tools and collaborating with other crafts during the work processes.

Planning and design processes are highly dependent on interpreting and understanding requirements, accessing information/facts from several sources (including the use of the internet), reading (e.g. manuals), understanding (e.g. recognising industry symbols), following safety requirements and instructions/procedures, international standards, national industry rules and regulations, calculating and quantifying requirements (numeracy and maths).

Process 3: Assemble and install

The Electrician is responsible for the process of installation and assembly of containment systems (individually and as part of a team) to build cabling networks within an electrical installation. This involves following technical and manufacturers' specifications. Using accessories and appropriate fixings, aligned and located in specified locations, is also part of this process.

Integral to the process is the installation and assembly of single phase and three phase distribution boards /enclosures, fittings, protective devices, isolation devices and associated electrical equipment. Distinguishing and selecting the correct equipment for a safe installation is very important.

The Electrician is also responsible for the termination of supply and load cables using organisation skills to mark and identify cabling and electrical equipment. In addition, Electricians are responsible for the installation and termination of circuits and sub-circuits, using various types of cables and accessories. Electricians install assemblies and electrical equipment located in specific locations, using appropriate fixings. In addition, Electricians select and install the cables and accessories required for an earthing system (main or local) to comply with wiring rules and standards.

Installation and assembly of light fittings, sockets and power outlets within manufacturers' recommendations, incorporating overcurrent and residual current device (RCD) protection where necessary, is also undertaken by the Electrician. They install, wire and assemble motor control and power circuits utilising panel wiring accessories, protective devices and indicator devices. They also install, align, couple, connect, and test run electric motors.

Electricians also install, wire, assemble and program programmable logic controller (PLC) systems and smart/ automated systems, and interpret basic and advanced logical operations/functions. The installation and assembly of fire and intruder alarm control equipment, detecting devices, signalling devices and circuitry is also included in this process. The Electrician identifies efficiency savings in materials during the installation and assembly of equipment, minimising cost and waste to protect the environment.

The assembly and installation process are highly dependent on the Electrician understanding and checking requirements from reading plans/diagrams/sketches and collaborating and communicating with other professionals/the customer, to confirming the next steps. Following industry established safety procedures and manufacturers' instructions, from memory and reading, are fundamental to the process.

Process 4: Repair and maintain

The Electrician undertakes the repair and maintenance of industrial electrical systems, complying with legislation, norms, standards and technical requirements for quality, health, safety and the environment. As part of this process, the Electricians identify:

- the types of components, circuits and their positions in the updated design of the building electrical installation
- preventive maintenance deadlines depending on the components of the building electrical system
- the sequence of activities according to the type of maintenance to be performed on the building electrical system
- the technical specifications of inputs, devices, machines, equipment and tools in the manufacturer's manuals and catalogues in accordance with building electrical maintenance
- the technical maintenance procedures in a building electrical system depending on the component to be repaired or replaced
- the causes and malfunctions of the building electrical system based on good maintenance practices
- the technical and safety criteria applied to the maintenance of the building electrical system to be carried out based on the relevant standards.

In addition, the Electrician interprets the information provided by the customer regarding failures and the operating history of the building electrical system and selects the tools and equipment necessary for its maintenance. They apply verification tests and tests to ensure the functioning and safety of a building's electrical system, and repair malfunctions based on good maintenance practices.

Repairing and maintaining electrical systems require the Electrician to gather information to solve operating problems and undertake preventative maintenance. The process involves communicating with customers/clients and other professionals to identify and confirm the work required. This can involve negotiation. Strong adherence to industry procedures and rules, particularly for safety, is very important.

Process 5: Inspect, commission, test, and report

Electrical inspection, testing, reporting, and commissioning are critical processes in ensuring that electrical systems and equipment are safe, reliable, and functional. The inspection process involves a comprehensive examination of electrical systems and equipment to identify any potential issues or hazards. Testing is then carried out to verify that the systems and equipment are operating within acceptable parameters and meet regulatory requirements. Once the inspection and testing are complete, a detailed report is prepared, (using the appropriate documentation) that includes all findings, recommendations, and any necessary corrective actions. Finally, commissioning involves the final testing and verification of the electrical systems and equipment before they are put into service.

Effective communication and collaboration are essential during these processes, as they involve working closely with other professionals such as engineers, contractors, and project managers. Additionally, a high level of technical expertise, attention to detail, and adherence to safety regulations and industry standards are required to ensure that the inspection, testing, reporting, and commissioning processes are carried out successfully. The process is completed with the handover to the customer, with operating guidance and instructions.

Desired distribution of items by electrician process

The goal in constructing the assessment is to achieve a balance in the weighting that reflects the primary focus of the processes described above. The following distribution of items is proposed:

Table 3.5. Desired distribution of electrician items, by process

Process category	% of items in the assessment
Assess and diagnose	20
Plan and design	20
Assemble and install	20
Repair and maintain	20
Inspect, commission, test, and report	20
Total	100

Fundamental electrician capabilities underlying the electrician processes

As has been indicated in the review of the five key processes, electricians are dependent on a range of capabilities which enable them to undertake their role. These are as follows:

Identifying and resolving electrical problems

A fundamental function of the Electrician is to identify, diagnose and resolve electrical problems for customers/clients in a domestic/commercial or industrial setting. The Electrician is responsible for identifying the root cause of issues and finding working solutions/offering guidance. For this reason, strong problem-solving skills are vital. When working individually they cannot rely on others for assistance, thus they must be confident in their abilities and self-reliant. Alternatively, the Electrician may be working as part of a professional team and will, therefore, be contributing to the problem-solving process. The possession of problem-solving abilities helps the Electrician to appraise diverse circumstances and

develop solutions via the use of technical knowledge and critical thinking. As part of this process, the Electrician will require analytical abilities to compare potential solutions.

All five processes require problem solving skills. For example, when ‘assessing and diagnosing’ a boiler breakdown the Electrician will determine the facts through discussion with the customer/client and professional colleagues such as the plumbing and heating engineer, inspect the boiler and its connections, and work through potential solutions.

When reading ‘plans and designs’ produced, for example, by an architect, the Electrician is focussed on identifying and anticipating potential problems and making recommendations for amendments/alternatives to avoid difficulties at the implementation stage. During the ‘assembly and installation’ phase the Electrician may encounter problems linked to lack of equipment, incorrect materials, conditions, or the work of other professions; in this way they can respond quickly to changing circumstances and keep customers/clients informed as necessary. The situation is similar when the Electrician is involved in a ‘repair or maintenance’ activity because a task can unfold to reveal a more complex situation which can lead to problems such as securing parts for an old system. The ‘inspection, commissioning, testing and reporting’ process is the culmination of the work of the Electrician and this is the final opportunity to confirm there are no problems, or if need be, rectify them, and check that the system is fully operational.

Responding to customers and colleagues

Strong verbal communication and interpersonal skills are core attributes for an Electrician because, before any electrical task is performed, they must understand how to respond to customer/client requests and concerns. Electricians must be patient as they are often dealing with people who do not have a working knowledge of electrical systems. They must be able to listen, ask the right questions, and then communicate with the customer/client and/or their professional colleagues, as necessary, to chart a course of action.

The Electrician must have a positive ‘can do’ attitude and be able to give the customer/client confidence that their electrical work will be undertaken to the right standard and be cost-effective. Building trust through effective communication is an important part of an Electrician’s job.

Clear and careful communication is a significant element of the ‘assess and diagnose’ process as the customer/client is likely to be anxious for a variety of reasons such as the time required to resolve an electrical breakdown and the impact that will have on the operation of their business. When interpreting ‘plans and designs’ the Electrician may need to raise queries and offer suggestions to professional colleagues either verbally or in writing e.g. emails and texts. As part of this process the Electrician must understand the needs/constraints of professional colleagues.

When ‘repairing and maintaining’ electrical systems the Electrician, as with the ‘assess and diagnose’ process, needs to discuss the situation with the customer/client and, as in the ‘installation’ process, research and check catalogues to order new parts and read instructions, and check rules and regulations. At the end of the ‘inspect, commission, test and report’ process the Electrician will give verbal or written feedback to the customer/client to advise of any issues that need further work and to outline the proposed solution.

Collaborating on electrical tasks, problems and projects

Collaboration will often be necessary during each of the five processes, depending on the type of electrical work required. When ‘assessing and diagnosing,’ the situation may require the Electrician to work closely with, for example, a heating and ventilation engineer to agree the work required and when it should be undertaken, together with an estimate of the time and cost.

For the 'plan and design' process an example would be a construction project where the client or building owner, general contractor and subcontractors, and design team, work together to make the project happen to everyone's satisfaction. Electrical considerations may include everything from wiring for security systems installed in doorways or concealed in floors to speakers, fire alarms, and building management systems that enable heat, air conditioning, lighting and other building systems to be controlled from a central headquarters. Without effective project collaboration there may be many on-going changes, cost overruns, and deadlines missed. At worst, poor project collaboration may lead to the loss of a contract and repeat business.

When undertaking an 'installation', it may be necessary to discuss requirements with professional colleagues. For example, enabling smart power infrastructure is vital as we move into an increasingly all-electric era. This is only possible by propelling forward electrical innovation and efficiency – and this requires effective collaboration. Electrical contractors and panel builders must meet and exceed the growing levels of speed, reach and agility that the power industry requires. To achieve this, open partnerships must be created for digital transformation to happen. Since electrical contractors and panel builders often work together for low- and medium-voltage projects, it is vital for them to collaborate easily and respond to emerging customer demands for more digital and sustainable solutions. Deadlines are shrinking, and projects require multiple stakeholders, so connectivity and collaboration is simply good for business. Being able to think digitally and sustainably is now a requirement for success, and organisations need to have easy access to relevant expertise and shared resources to future-proof operations.

In a 'repair/maintain' situation the Electrician may need to collaborate with professional colleagues when the work they are planning will impact on several parts of the infrastructure/business operation. For example, an aircraft may experience an electrical failure resulting from a break in the connection between aircraft systems. A problem in one system may lead to a bus bar failure, causing a complete or partial failure of an airplane's avionics system. This could lead to the crew needing to turn off non-critical electrical items and/or diverting the aeroplane to the nearest suitable airport.

'Commissioning' within a large project is a collaborative, quality-driven, systematic process that focuses on verifying and documenting that a building and all its systems are planned, installed, inspected, tested, operated and managed as designed. Unforeseen issues develop during all projects. Early identification and prompt resolution may be the most important component of a successful commissioning process. From the moment commissioning begins through project completion, issues are identified, documented, communicated and tracked until they are officially resolved. The commissioning team participates in the resolution of most issue associated with their scope of work. They communicate with other team members, including the owner, designers and contractors, provide supporting documentation or research, and track the issues until they are resolved. The commissioning provider and the project management team strive for proactive issue resolution.

Using digital and communications technology for daily electrical tasks and problems

Digital technology and communication tools are fully integrated into the five electrician processes. The Electrician is constantly adapting to the impact of new technology for the products and systems they install, e.g. retrofitting efficient smart lighting systems to support customers in controlling their energy consumption. Using digital tools and equipment is intrinsic to the Electrician's role. For example, they use thermal imaging to detect infrared energy emitted from an electrical object and use a digital clamp meter to test a plant or piece of machinery. Problem solving in a technology-rich environment also involves the use of digital technology, communication tools and networks to acquire and evaluate information, communicate with others and perform practical tasks.

Electricians may use a range of analytical or scientific software, computer aided design (CAD), and industrial control procedures. They may also use customer and business management and administration

applications and create information and digital content. Linked to this, the Electrician needs to understand and apply on-line security measures.

Professional personal management skills for the electrician

Electricians may work independently (self-employed) or be employed by an organisation/business. Whatever their employment status, Electricians often have sole responsibility for their tasks and are, therefore, self-reliant.

Self-management is the ability to regulate behaviours, thoughts, and emotions in a productive way. Aspects of self-management are adaptability, motivation, goal setting, decision-making, stress and time management, plus personal development. An Electrician with strong self-management skills knows what to do and how to act in different situations. For instance, they know how to control their frustration when suppliers change delivery dates.

Self-management has its roots in emotional intelligence where this capability may also be referred to as self-regulation. Self-regulation is supported by the capacity for self-awareness which helps individuals to create conscious access to thoughts, and feelings.

Critically assessing electrical situations

Critical thinking is the ability to think clearly and rationally, understanding the logical connection between ideas. It is the ability to engage in reflective and independent thinking and to reason. For the Electrician it is about being an active listener rather than a passive recipient of information, for example, from a customer. The Electrician rigorously questions ideas and assumptions rather than accepting them at face value. They seek to determine the ideas, arguments and findings that represent the total situation and are open to finding that they do not. They will identify their own assumptions, beliefs and values. The skills the Electrician uses to think critically when undertaking each process include observation, analysis, interpretation, reflection, evaluation, inference, explanation, and decision making. For example, in assessing and diagnosing a malfunctioning piece of equipment in a factory, the Electrician will follow a sequence of questioning designed to identify the cause and the potential solution(s). The most important aspect of critical thinking is for the Electrician to know the purpose of their involvement, and to apply a consistent routine.

Safety consciousness in electrical situations

Safety consciousness is critical for an Electrician, they must be committed to keeping the areas they work in and the equipment (powered and non-powered) they work with as safe as possible for themselves, colleagues and customers. They work in high-risk situations; thus, they need to undertake risk assessments as a regular part of their daily work. Where an area is not safe the electrician needs to know the action to take to remedy the situation. This requires a knowledge of specific electrical safety regulations.

It is important to understand the legal responsibilities of employers and employees and the role of enforcing authorities. Electricians also need to understand emergency and first aid arrangements, environmental requirements, safe storage and marking, waste control hierarchies and emergency planning. The Electrician also needs to understand the general personal health risks from workplace activities, including musculoskeletal problems and the effects of noise and stress.

Reading electrical documentation and preparing reports

Trainee Electricians must be proficient readers to understand technical documents and technical terms, regulations and rules appropriate to the situations they may encounter. When 'assembling and installing' new products the Electrician must read and closely follow detailed written (technical) instructions produced

by the manufacturer and check written industry rules and regulations, which may be in English. Electricians need to read and interpret wiring diagrams and operating instructions when assessing and diagnosing, assembling/installing, repairing/maintaining, inspecting, testing, commissioning, and reporting. Reading and understanding data generated by testing equipment and interpreting associated reports is also critical as is understanding inspection and commissioning procedures. Electricians must be able to read business related documentation such as invoices, accounts, emails from customers and suppliers etc.

Using mathematics and numeracy in daily electrical tasks and projects

A certain level of numeracy (or mathematical literacy) is a necessary condition of being an Electrician. Mathematically related proficiencies such as number sense, familiarity with multiple representations of numbers, and skills in mental calculation, estimation, and the assessment of reasonableness of results are intrinsic to some aspects of the Electrician's role. For example, Electricians need to perform routine measurements and calculations such as working out room dimensions, wiring lengths, converting watts to kilowatts, and calculating loads.

Mastering Ohm's Law (an equation used to study electrical circuits, calculate voltage, current and resistance) is a fundamental capability for Electricians. Ohm's Law is a good example of the kind of logical thinking, problem solving, and practical mathematical skills an electrician needs. Trigonometry is used by Electricians when, for example, they are calculating the correct angle to bend a section of a conduit which is used to protect and route electrical wire when wiring a building or structure.

Table 3.6. Relationship between electrician processes and fundamental capabilities

Capabilities	Processes				
	Assess/ diagnose	Plan/ design	Assemble/ install	Repair/ maintain	Inspect/commission/ test/report
Identifying and resolving electrical problems	√	√	√	√	√
Responding to customers and colleagues	√	√	√	√	√
Collaborating on electrical tasks, problems and projects	√	√	√	√	√
Using digital and communications technology for daily electrical tasks and problems	√	√	√	√	√
Professional personal management skills for the electrician	√	√	√	√	√
Critically assessing electrical situations	√	√	√	√	√
Safety consciousness in electrical situations	√	√	√	√	√
Reading electrical documentation and preparing reports	√	√	√	√	√
Using mathematics and numeracy in daily electrical tasks and projects	√	√	√	√	√

Electrician content knowledge

In addition to the capabilities needed to carry out the processes that are relevant for the electrician occupational area, electricians also need to build on content knowledge to effectively perform their tasks.

The content knowledge for Electrician presented here is deemed to be relevant for trainees nearing the end of their IVET programme. For the structure of the corresponding content knowledge, common and shared areas have been placed in the centre of the five process areas. These are used here to reflect on how the curriculum is structured and to guide the item development at later stages of this project. While national VET programmes vary, the occupation of Electrician can be understood to consist of two large branches – the more domestically and commercially oriented application, often referred to as ‘craft’, and those employed in the more industrial-orientated activities, as outlined earlier.

In addition to national studies, WorldSkills Occupational Standards and occupational profiles in the classification of European Skills, Competences, Qualifications and Occupations (ESCO, 2020^[5]) have been used to outline the required content knowledge. The five categories of knowledge are:

- electrical theory and fundamentals (including mathematics and science)
- norms, standards & regulations
- materials, components, and tools
- electrical systems and applications
- configuration and control.

More details about the content topics underlying these knowledge categories are provided in the annex of this chapter.

Content knowledge categories

Electrical theory and fundamentals

At the end of their vocational training, trainees must have acquired the underlying principles of electrical theory and their fundamentals and apply them to calculate parameters in each equation. They recall the definitions and units (e.g. current, voltage and resistance). They understand technical drawings, layouts of installations and control panels, circuit diagrams, and flow charts. They can explain the mathematical relationships of voltage, current and resistance by using formulas. They apply their knowledge to design electrical circuits and systems, and to solve elementary problems involving electrical principles like Ohm’s and Kirchhoff’s laws. They identify and analyse equivalent circuits and determine the characteristics of complex AC circuits such as impedance and phase angle. The trainees use criteria such as cost, performance, reliability, safety, and environmental impact to compare different solutions for electrical problems. They assess the advantages and disadvantages of different types of electricity such as AC vs DC, single-phase vs three-phase, low-voltage vs high-voltage.

Underpinning a knowledge of electrical theory and fundamentals the trainee needs to have a deep understanding of arithmetic, algebra, geometry, calculus, statistics, and their applications (as also reflected in the capabilities which include numeracy and mathematics, see previous section).

Norms, standards, and regulations

Trainees acquire factual knowledge related to norms that apply to their field of work. They gain knowledge of safety rules and precautions for working with electricity and which codes and standards apply to different electrical installations. They understand building codes and regulations specific to their region and trade. They understand the safety standards for working with electrical equipment and systems, such as lockout/tagout procedures, personal protective equipment (PPE), and hazard identification. Trainees can explain the meaning and purpose of norms, standards, and regulations for electrical work. They understand how safety rules and precautions protect them from electrical hazards. They evaluate given approaches regarding compliance and create solutions themselves that adhere to regulations and standards. Trainees can draw inferences from norms, standards and regulations regarding a given situation and identify inconsistencies.

Materials, components and tools

At the end of their vocational training, trainees must have acquired in-depth understanding of the characteristics of materials, components, and tools used in electrical work. These include wire, conduit, boxes, connectors, switches, receptacles, circuit breakers, fuses, meters, as well as hand and power tools. Trainees can evaluate the appropriateness of selecting a given material or component based on its properties and/or in comparison to a given list of requirements. Trainees understand differences in requirements depending on the environment regarding electric lighting and heating systems. They have the required knowledge to understand the limitations and appropriateness of different materials and installation techniques in different environments. Trainees can evaluate the quality of electrical materials and components and suggest improvements under consideration of external factors (e.g. economic and/or ecological points of view).

Electrical systems and applications

Trainees understand the basic principles of electrical power generation and distribution. They are familiar with variable speed drive (VSD) technology and associated systems. They understand the difference between AC and DC systems, the characteristics of various types of electrical loads such as resistive, capacitive, and inductive. Trainees remember the terminology and symbols used in technical specifications and diagrams. They are familiar with the principles of technical drawings, circuit diagrams, layouts and function descriptions and remember different types of electric lighting, switchboards and wiring systems for usage in different fields of application and can create electrical schematics. Trainees understand structured cabling systems, remember different types of cabling, and can identify installations for specific environments. They can apply their knowledge to derive solutions that take interrelationships between different components into account.

Configuration and control

Trainees apply their knowledge to set up and configure systems to monitor different processes in buildings. They apply tools and software for parameterization and programming. They can implement programs for controlling motors, valves, and other devices used in industrial control. Trainees remember the different types of measuring instruments and understand their respective use. They understand the importance of delivering correct and proper documentation and can fill out existing forms. Trainees apply their knowledge to check parameters for electric and electronical devices, and interpreting results from fault finding procedures (e.g. using a multi-meter, PLC diagnostics). They analyse the outcome of given configurations (e.g. when monitoring systems) and develop suitable adjustments based on results of taken measurements. Trainees evaluate the functionality of a system compared to a given specification and use reports and records for verification purposes.

Desired distribution by content knowledge category

All the content knowledge categories are deemed equally important for success thus there is a balanced distribution.

Table 3.7. Percentage of items by content knowledge category

Content category	% of items in Assessment
Electrical theory and fundamentals (including mathematics and science)	20
Norms, standards and regulations	20
Materials, components and tools	20
Electrical systems and application	20
Configuration and control	20
Total	100

Assessing electrician learners

In this part of the chapter the focus is on the most appropriate methods to assess trainee electricians.

As described in Chapter 1, for the Development Phase of the Project the assessment will likely take the form of:

- Scenario-based questions of technical and practical knowledge.
- Digital simulations of professional problem solving at the workplace, and where possible.
- Live or recorded demonstrations of professional skills with expert judges.

Based on a proposed 90-minute assessment of occupation-specific skills and knowledge, the first two methods of assessment are deemed most appropriate and feasible, with a suggested 60-minute allocation for the digital simulations - as they are the closest alternative to 'a live practical test'. It was also noted that the trainees will need time to adjust to using the simulation technology.

However, if resources and testing time allows the inclusion of a live or recorded practical test would be recommended, as the best evidence of competence is gained from observing an individual undertaking task(s) in a live workplace situation. Performance tasks enable trainees to demonstrate their mastery of skills. Electricians normally undertake practical sessions as part of their learning programmes and as part of their formative and summative assessments. Generally, trainee Electricians, within their national systems, undergo a live practical 'end test', which is usually extensive/complex and therefore takes several hours to complete. The test is normally an important stage in the qualification/licensing process of electricians. For example, in Belgium 'Electro Brain' is the sectoral competence test. The trainee has six hours to complete the assembly of an electrical installation. In New Zealand trainee Electricians must undergo a practical assessment and a final computer-based examination. The practical assessment is undertaken in a decentralised way by different training providers, with results submitted to the Electrical Workers Registration Board for approval. The final examination for an electrician involves a multiple choice, computer-based test undertaken in an examination centre.

Assessment types

Digital simulations of professional problem solving at the workplace

Digital simulations can be used for learning and assessment purposes. One example (for learning) is the USA skills training platform [Transfr](#) which has a package of simulations that harness the power of virtual reality (VR) and augmented reality to help educators and trainers create pathways to careers in electrical construction. Electrical Construction - Transfr Inc provides a video introduction to an electrical construction.

Simulations offer performance-based assessment which can be used to evaluate across all learning dimensions: cognitive, behavioural and affective depending upon the intended learning outcomes to be measured and the nature of the simulation developed. They lend themselves especially well to assessing professional competencies, application of knowledge, and decision-making.

The simulations will present the trainees with situations that replicate real-work challenges, giving them the same practical experiences, they face in the workplace (real, or simulated within an education and training organisation). Digital simulations are particularly suited to professions which work in high-risk/safety performance environments, such as those experienced by electricians.

The digital simulations will need to be realistic in terms of script and simulation environments and immersion will need to be high. Immersion refers to the extent to which the trainees lose their sense of being involved in a digital simulation and perceive the events in the situation as like their everyday work experience (Psołka, 1995^[6]). The higher the immersion, the more likely the response from the trainee will be similar to that displayed in their usual work conditions (Psołka, 1995^[6]). Hagiwara et al (2016^[7]) state that the design of a digital simulation should consider the events and dynamics which could hinder immersion e.g. technology challenges.

The effectiveness of the digital simulation will be dependent on clear objectives and a strong understanding of the tasks usually performed in the workplace. The situation must be precisely defined with a tight script drawing on a team of expert practising Electricians, trainers, digital simulation designers and assessment experts. In discussing the format of the digital simulations, the group advised that visuals should be used as much as possible to aid communication across the global cohort of students, taking into consideration the sophistication/robustness of the technology available to the trainees. Finally, it was recommended that the text included should be as succinct as possible.

Below is one example of a digital simulation for proficiency level 1 (see below for further details about the proficiency levels), followed, in the annex, by more complex examples.

Table 3.8. Digital simulation example 1: Fault finding, testing, and reporting**Proficiency level 1**

At level 1 the trainee can work safely, apply basic knowledge and skills in the performance of a range of normally routine, simple and predictable tasks. They work under close supervision in structured work environments.

This task requires the trainee to undertake the identification of basic faults, which is regular, standard practice.

Time required for the task: 10 minutes

The task: the trainee is required to:

- do a visual check of the test board and identify any faults
- identify if a polarity test was completed correctly and confirm if the results are within required electrical parameters
- identify if an Insulation Resistance test was completed correctly and confirm if the results are within required electrical parameters.

The test circuit designs may include the following circuits:

- lighting
- socket
- power such as a heater or a cooker)
- control (such as a pump).

Two of the following four installation testing faults must be included:

- one high earth resistance
- one low insulation resistance
- one incorrect polarity
- one incorrect visual.

Additional types of installation testing faults that may also be included are:

- incorrect overload settings
- short circuit faults
- open circuit faults
- high resistance joint
- interconnection
- incorrect timer settings.

The processes involved in this task are:

- assess and diagnose
- inspect, commission, test and report.

The capabilities involved in the task are:

- problem solving
- communication
- task performance
- ICT literacy
- critical thinking
- safety practice.

The knowledge categories involved in the task are:

- electrical theory and fundamentals, including maths and science
- norms, standards and regulations.

The context is: domestic.

The assessment criteria for the task: the required number of faults are correctly identified following the correct process:

- collect and analyse the evidence
- investigate and locate the fault(s)
- determine and remove the cause
- rectify the fault
- test the system is working.

Note: the task must reflect the IEC standards

Video: The video provides an example of what is included in electrical testing and fault finding [Lecture 7: Electrical Testing and Fault Finding - YouTube](#)

Scenario-based questions of technical and practical knowledge

Scenario-based assessments allow the trainees to apply their theoretical knowledge to the real-life workplace. They are powerful learning tools requiring students to draw from their own experiences and skills to analyse and respond to a situation. By using scenarios, teachers and trainers aim to develop student reasoning, problem solving and decision-making skills (Tunny, Papinczak and Young, 2010^[8]; Bloomfield and Magney, 2009^[9]). They can assess higher cognitive skills including application, analysis and evaluation.

In terms of structure, scenarios are typically short and could be described as mini-case studies which can be developed to provide different degrees of complexity. In designing the scenarios, consideration will need to be given to the level of the trainees, appropriateness of the content, and ability to gain engagement. They need to be easily understood and focused. Clearly written scenarios with a high level of visuals for the trainees are required. As part of PISA-VET in the electrician occupation area one or two scenarios could be provided (with more than one question allocated to each) to reduce the time for reading, thus maximising the time available to the trainee for answering the questions. The following is an example of a scenario question which was taken from the PISA science items released in December 2006.

Figure 3.1. Example item from PISA Science 2006

Scenario: Wind Farms



Many people believe that wind should replace oil and coal as a source of energy for producing electricity. The structures in the picture are windmills with blades that are rotated by the wind. These rotations cause electricity to be produced by generators that are turned by the windmills.

Question 1 (selected response format)

The higher the altitude the more slowly windmills rotate at the same wind speed. Which one of the following is the best reason why the blades of windmills rotate more slowly in higher places at the same wind speed?

- A. The air is less dense as altitude increases.
- B. The temperature is lower as altitude increases.
- C. Gravity becomes less as altitude increases.
- D. It rains more often as altitude increases.

Question 2 (constructed response format)

Describe one specific advantage, and one specific disadvantage, of using wind to generate electricity compared with using fossil fuels like coal and oil.

Below is one example of a short scenario for proficiency level 1 (see below for more details about the proficiency levels), followed, in the annex, by a more complex scenario with sample questions spanning proficiency levels 1 to 5. Constructed response questions have been developed but some could be presented as selected responses, to provide a mix.

Table 3.9. Example of a potential scenario

<p>Scenario: Rewiring an office</p> <p>Hanna, the Electrician has visited a customer in their new offices. She assesses the electrical installation and advises the customer the wiring is not safe – it needs to be replaced, as it is very old.</p> <p>The office contains an entrance lobby, open plan office, private office and toilet. The customer has agreed the following details:</p> <ul style="list-style-type: none"> • The entrance lobby has 1 light fitting and switch and 1 socket outlet. • The open plan office has 1 switch, 3 light fittings and 10 double socket outlets on dado trunking. • The private office has 1 switch, 1 light fitting, 3 double sockets. • The toilet has 1 switch, 1 light fitting and 1 extractor/ventilation fan.
<p>Proficiency level: Sample questions have been set for level 1</p>
<p>Time allowed: 10 minutes, but the number of questions would need to be decided</p>
<p>Context: Commercial</p>
<p>The knowledge categories included:</p> <ul style="list-style-type: none"> • electrical theory • standards and regulations • materials, components and tools • systems and applications.
<p>Sample questions:</p> <p>Q.1 List 3 points that need to be considered before any work should begin.</p> <p>Q.2 Briefly outline 4 problem(s) that could occur.</p> <p>Q.3 State the equipment and materials that will be required.</p> <p>Q.4 List the type of earth fault and overload protection that should be installed in the socket circuits.</p> <p>Q.5 List the tests (in order) that must take place on the completed installation.</p> <p>Q.6. Draw the circuit diagram of the electrical installation in the bathroom/toilet in coherent representation.</p>

Response format & item scoring

For both the digital simulations and the scenarios a combination of response formats is recommended. Selected-response items (questions) require trainees to select the correct answer from a list of options included in the item. Examples of selected response items include matching, true/false and multiple choice. Multiple-choice questions are common, but they do not suit all types of knowledge. They are often used to test factual recall, levels of understanding, and ability to apply learning (analysing and evaluating). For example, multiple-choice questions may be appropriate for assessing principles of electricity, basic electrical circuits, electromagnetism, basic mechanics, Star/Delta configurations, electrical equipment and A.C. circuits.

Constructed-response items ask trainees to write, or “construct,” the correct answer. Answer keys can be used to mark simple constructed-response items, such as “fill-in-the-blank”. The main challenge when setting constructed-response items is the marking process. It is more complex, requiring more time and effort from human markers. It is recommended that constructed-response items should only require the trainees to provide short answers. Technology is now supporting the process to provide automated marking. One factor to consider is the extent to which the assessment software allows for misspellings.

In summary there are many variations of question types which could be considered to support the scenarios and digital simulations. It is recommended that the assessment for the trainees includes both selected-response items and constructed-response items. This is to enable the most appropriate method to be selected for the content which is being assessed. A wider variety of item types is also potentially more engaging for the trainee. Whilst the number of female electricians in the industry is not high, as

mentioned in the introduction, global efforts are being made to encourage females into the profession. This could have implications, going forward, for the item response format as research indicates that girls can be less engaged with multiple-choice questions as they tend to prefer questions which require more analysis and varied solutions (Griselda, 2020^[10]).

Moreover, it is recommended that most of the items should be dichotomously marked (that is, answers should be awarded either credit or no credit), and the open constructed-response items should sometimes involve partial credit scoring, allowing answers to be assigned credit according to the differing degrees of “correctness” of the answers. The aim is to give the trainee as much opportunity as possible to demonstrate their skills and knowledge.

Reporting proficiency

Descriptions of the degree of Electrician competence typical of trainees for each proficiency level have been developed below. The lower score limits will be determined with data in the second stage of the Development Phase according to the standard PISA scaling procedure.

Table 3.10. Descriptors of learning outcomes

Level	Lower score limit	Descriptor
6	To be confirmed with data	At level 6 the trainee can work safely, has advanced knowledge and skills demonstrating the mastery and innovation required to solve challenging and significant unpredictable problems. They can deal with complex activities, organise work and make decisions in uncertain and changing situations. They can evaluate, introduce improvements, and take the initiative. They can lead others and collaborate with colleagues and teams. <i>Key learning outcome verbs: assemble, compile, design, create, reorganise, articulate, synthesize, naturalise, value</i>
5	To be confirmed with data	At level 5 the trainee can work safely. They have comprehensive, specialised, factual and theoretical knowledge. They can develop solutions to challenging problems and are able to work within an environment of uncertainty and change. They can develop their own work schedules, can manage others, and contribute to teams. <i>Key learning outcome verbs: appraise, consider, critique, evaluate, rate, formulate, recommend, present, test, revise, redesign, estimate.</i>
4	To be confirmed with data	At level 4 the trainee can work safely apply knowledge and skills in a broad range of complex, technical work activities, and problems which are mainly non-routine, adapting actions as required, and reflecting upon own performance. They can collaborate with colleagues and teams. <i>Key learning outcome verbs: analyse, differentiate, classify, calculate, test, organise, examine, adjust, empathise, structure</i>
3	To be confirmed with data	At level 3 the trainee can work safely and apply knowledge and skills in a broad range of varied routine and non-routine work activities, some of which may be complex. They can solve both routine and non-routine problems and take responsibility for the completion of tasks. They can collaborate with others through, for example, being a member of a team. <i>Key learning outcome verbs: interpret, carry out, use, calculate, illustrate, complete, generalise, interpret, modify, predict.</i>
2	To be confirmed with data	At level 2 the trainee can work safely and apply knowledge and skills in a range of normally varied work activities. They solve mainly routine problems although some tasks may be non-routine. They have some individual responsibility or autonomy. They work under supervision in a range of work environments. <i>Key learning outcome verbs: arrange, associate, exemplify, compare, explain, predict, estimate, demonstrate, operate.</i>
1	To be confirmed with data	At level 1 the trainee can work safely and apply basic knowledge and skills in the performance of a range of normally routine, simple, and predictable work tasks. They work under close supervision in structured work environments. <i>Key learning outcome verbs: remember, understand, reproduce, outline, explain, identify, apply, discuss, review, report.</i>

References

- Baethge, M. and L. Arends (2009), “Feasibility study VET-LSA: A comparative analysis of occupational profiles and VET programmes in 8 European countries - international report”. [3]
- Bloomfield, L. and A. Magney (2009), “Does Facilitator Expertise Matter?: A Perspective from Scenario-based Learning on an Old Problem-based Learning Question”, *Focus on Health Professional Education: A Multi-disciplinary Journal*, Vol. 10/3. [9]
- Cairns, L. (1997), “Defining Capability for Education, Training and Industry, Discussion Paper No. 1”, *Capable Organisations Research Project*. [12]
- ESCO (2020), *European classification of Skills/Competences, Qualifications and Occupations*, <https://esco.ec.europa.eu> (accessed on 16 December 2022). [5]
- Griselda, S. (2020), “Different Questions, Different Gender Gap: Can the Format of Questions Explain the Gender Gap in Mathematics?”, *2020 Papers pgr710*, Vol. Job Market Papers. [10]
- Hagiwara, M. et al. (2016), “Measuring participants’ immersion in healthcare simulation: the development of an instrument”, *Advances in Simulation*, Vol. 1/1, <https://doi.org/10.1186/s41077-016-0018-x>. [7]
- Miller, G. (1990), *The assessment of clinical skills/competence/performance*, <https://doi.org/10.1097/00001888-199009000-00045>. [11]
- OECD (2022a), “International VET Assessment Framework”. [2]
- Psootka, J. (1995), “Immersive training systems: Virtual reality and education and training”, *Instructional Science*, Vol. 23/5-6, <https://doi.org/10.1007/BF00896880>. [6]
- Tunny, T., T. Papinczak and L. Young (2010), “Student perceptions of PBL tutor performance: A longitudinal cohort study”, *Focus on Health Professional Education: A Multi-disciplinary Journal*, Vol. 11/3, pp. 74-84. [8]
- UN Department of Economic and Social Affairs (2022), *United Nations Sustainable Development Goals Report 2022*, Global Sustainable Development Report 2022. [1]
- WSI (2022), *Social and Personal Services, Health and Social Care*, <https://api.worldskills.org/resources/download/12384/14943/15871?l=en>. [4]

Further reading

- Jones, K. (1995). *Simulations: A Handbook for Teachers and Trainers*. 3rd ed., Routledge, London, <https://doi.org/10.4324/9780203761151>.
- ILO (2012), International Standard Classification of Occupations: ISCO-08. Vol. 1/Structure, Group Definitions and Correspondence Tables. International Labour Office, Geneva, https://www.ilo.org/wcmsp5/groups/public/---dgreports/---dcomm/---publ/documents/publication/wcms_172572.pdf.
- Nyström, S. and S. Ahn (2020), “Simulation-based training in VET through the lens of a sociomaterial perspective”, *Nordic Journal of Vocational Education and Training*, Vol. 10/1, <https://doi.org/10.3384/njvet.2242-458x.201011>.
- O*NET OnLine, National Center for O*NET Development, www.onetonline.org.

Annex 3.A. Content topics for guiding the assessment of electrician competence for VET learners

To effectively understand and solve contextualised problems involving the content categories requires drawing upon a variety of Electrician concepts, procedures, facts, and tools at an appropriate level of depth and sophistication. As an assessment of Electrician competence, PISA-VET strives to assess the levels and types of professional skills in the occupational area of Electrician that are appropriate for VET learners on a trajectory to become skilled professionals able to make well-founded judgments and decisions. It is also the case that PISA-VET, while not designed or intended to be a curriculum-driven assessment, strives to reflect the Electrician knowledge and skills that learners have likely had the opportunity to develop by the time they are approaching the end of their initial VET programmes.

This annex explains how the content categories serve as the foundation for identifying this range of content. It describes how the content is intended to reflect the centrality of the Electrician concepts to all the content categories and reinforce the coherence of Electrician as a discipline.

The main content topics are listed below – these are illustrative of the content topics that will be included in PISA-VET rather than an exhaustive listing.

Electrical theory and fundamentals (including mathematics and science)

- Basic electrical quantities, numbers/prefixes (mikro, milli) and units
- Ohm's law
- Kirchhoff's laws I and II
- Basic variables in the electrical circuit / Direct current, DC
- Alternating current, AC
- Three-phase AC current
- Power generation
- Energy transmission
- Power calculation (Direct current, alternating current, three-phase current)
- Efficiency and effectiveness
- Digital technology (bits and byte, Data formats, Data transmission etc.,)
- Analog, binary, digital data processing
- Basic Circuits.

Norms, standards and regulations

- Overview of electrical safety standards and regulations
- Understanding National Electrical Code requirements
- Compliance with Occupational Safety and Health regulations

- International Electrical Code (IEC) standards for electrical safety
- Electrical safety in hazardous locations
- Guidelines for the safe use of electrical equipment
- Best practices for electrical system maintenance and inspections
- Electrical safety training for workers and contractors
- Electrical safety requirements for new construction and renovations
- Safe installation and use of electrical grounding systems
- Requirements for electrical arc flash protection
- Electrical safety for power generation and distribution systems
- Guidelines for safe electrical work in confined spaces
- Electrical safety in the workplace and personal protective equipment (PPE)
- Regulatory requirements for electrical equipment testing and certification.

Materials, components and tools

- Scientific calculator, pens, pencils, set squares etc.
- PPE / Safety wear
- Wiring Regulations / Guidelines
- Test equipment
- Hand tools: Snips, Pliers, Screwdrivers, Saws, Crimpers, Knife etc.
- Motors (AC and DC)
- Control Equipment
- Transformers
- Contactors / Relays
- PC & Software
- Conduit, trunking, ladder & glands
- Cables and structured cabling
- Switchgear & Protective Devices
- Electrical & Electronic components (sockets, switches etc.)
- PLC's.

Electrical systems and applications

- Generation
- Transmission
- Distribution
- Renewables
- DC Systems
- AC Systems
- Single Phase Circuits
- Three Phase Circuits
- Transformers

- Power Factor Correction
- Wiring Systems
- Power Cables
- Structured Cables
- Power Circuits
- Control Circuits
- Renewable systems (Wind, Solar PV)
- EV Charging systems.

Configuration and control

- Inputs and outputs of a control system.
- Digital and Analog Signal Acquisition and processing.
- Home/building automation systems – control of lighting circuits and power loads.
- Home automation equipment programming.
- Interconnection of home automation equipment with multi-brand ISO/IEC open systems.
- Home automation systems, maintenance, diagnostic and remote diagnoses.
- Controllers used on industrial control and/or processing.
- Programmable Logic Relay.
- PLC (Programmable Logic Controllers).
- HMI Human Machine Interface
- Scada Software.
- Industrial communication networks.
- Programming based on IEC 61131.
- Soft Starters and Variable speed devices to control electrical motors.
- Test and commissioning, supervision and control.

Annex 3.B. Further examples of digital simulations and a scenario question for the electrician occupational area

The following are further examples of digital simulations and a scenario question.

Annex Table 3.B.1. Digital simulation example 2: Install pumps in a wastewater plant

Proficiency level 5

This task is at proficiency level 5 because the trainee will need to apply specialised knowledge and skills in a complex, changing environment.

Time required for the task: 20 minutes

The task:

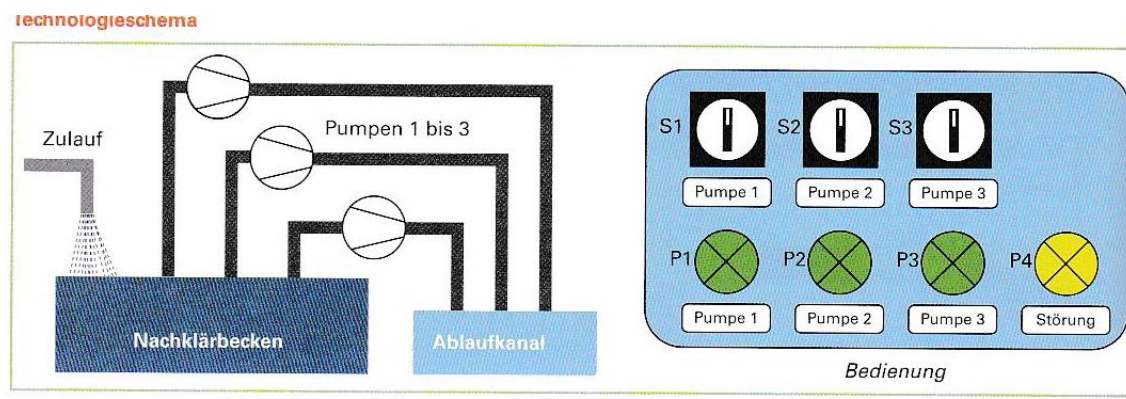

The trainee is required to install three pumps in a wastewater plant to empty the contents of the secondary clarifier. Two pumps will be sufficient to dispose of the resulting sewage and the third pump will be available as a reserve. Within the simulation the trainee will require:

- a programmable logic controller
- sensors
- switches
- valves
- actuators (motor for a pump)
- control panel
- different tanks.

The processes involved in the task are:

- assess and diagnose
- plan and design
- assemble and install.

The capabilities involved in the task are:

- problem solving
- safety practice
- task performance
- ICT literacy
- critical thinking
- self-management
- literacy.

The knowledge categories involved in the task are:

- materials, components and tools
- electrical systems and application
- configuration and control.

The context is: industrial and commercial/public sector

The assessment criteria for the task:

- assesses the situation and advises the customer
- takes health and safety precautions and follows safety rules for self, others, machinery and materials etc.
- selects the correct type of motor for pump or stirrer for the situation e.g. mechanical power, efficiency
- installs new sensor and assesses via a function check
- plc program is correct (all functions are possible)
- risk evaluation is performed (performance graph)
- faulty cable connections detected, (potential fire hazards)
- faulty cable.

Note: the task must reflect the IEC standards

Video: The video provides an example of the environment. There are technical differences with the requirements set in the simulated task. [Pumps, Systems & Services for the Wastewater Treatment Process - YouTube](#)

Annex Table 3.B.2. Digital simulation example 3: Produce a circuit design

Proficiency level 3

This task is at proficiency level 3 because it is a routine complex task, and the trainee is expected to be sufficiently skilled and confident to complete the activity without advice or guidance.

Time required for the task: 45 minutes

The task:

The trainee is required to produce a circuit design. They will receive a layout diagram accompanied by a function list in statement form and a materials list indicating any relevant information e.g. what contacts are available in the contactors.

The process involved in the task:

- plan and design

The capabilities involved in the task are:

- problem solving
- critical thinking
- safety consciousness
- self-management
- literacy
- numeracy and mathematics.

The knowledge categories involved in the task are:

- electrical theory and fundamentals including maths and science
- norms, standards and regulations
- materials, components, and tools
- electrical systems and application.

The context is: commercial/domestic

The assessment criteria for the task:

- the key function requirements will be achieved
- safe practice will be observed throughout the task.

Note: the task must reflect the IEC standards

Video: provides an example of what is involved in [Electrical Circuit Design - YouTube](#)

Annex Table 3.B.3. Digital simulation example 4: Quantity survey

Proficiency level 3

This task is at proficiency level 3 because it is a routine complex task, and the trainee is expected to be sufficiently skilled and confident to complete the activity without advice or guidance.

Time required for the task: 30 minutes

The task:

The trainee is required to provide a detailed survey of all the materials needed to complete a job including the labour component and an estimated timeframe.

The trainee will receive a circuit layout diagram with dimensions to calculate cable runs and cable support system lengths.

Included with the layout diagram, will be the criteria that must be met when considering material selection.

The process involved in the task:

- plan and design.

The capabilities involved in the task are:

- problem solving
- critical thinking
- safety consciousness
- self-management
- literacy.

The knowledge categories involved in the task are:

- electrical theory and fundamentals including maths and science
- norms, standards and regulations
- materials, components, and tools
- electrical systems and application.

The context is:

- commercial/domestic.

The assessment criteria for the task:

- the list of materials required will be correct
- safety regulations and standards will be followed as part of the selection process
- the labour component will have a minimum and maximum permitted outcome.

Note: the task must reflect the IEC standards

Video: provides an example

Annex Table 3.B.4. Example 2 of a scenario

Scenario: Modernising a freight elevator

Proficiency levels: Sample questions have been set for levels 1, 2, 3, 4 and 5

Time allowed: 30 minutes but the number of questions is to be decided

Context: Commercial

The knowledge categories included:

- Electrical theory
- Standards and regulations
- Materials, components and tools
- Systems and applications
- Configuration and control.

Peter the electrician, from 'Electrical Solutions', received a call from a customer to inform him that the freight elevator in a commercial building had failed. He travelled to the building and inspected the installation. The problem has been discussed with the customer and the decision has been taken that the complete electrical installation within the building should be modernised. Peter has emailed the customer to confirm the work that will need to be undertaken. This is listed below:

1. A new three phase main distribution board will be designed and installed to facilitate all three phase and single-phase loads.
2. The main distribution board will supply all the electrical needs within the building including lighting, power circuits and it will also supply a new sub-distribution board for the freight elevator.

- The sub distribution board will house the overcurrent and earth fault protection devices for the freight elevator as well as all the control equipment including the PLC.



- New main, sub-main and final circuit cabling will be installed as well as all structured cabling as required.
- New lighting and power outlets will be installed throughout the building as well as new emergency lighting and fire detection systems.
- All materials required to complete the project will be specified and ordered.
- All work conducted will satisfy relevant national rules and regulations.



Electrical Theory

Q1. The induction motor driving the freight elevator is connected in delta to a line voltage of 400V. The current in each phase is 48A at a power factor of 0.9 lagging. Calculate the total power of the motor. (Prof level 5).

Q2. The 2-pole induction motor driving the freight elevator runs at 2800RPM. If the supply frequency is 50Hz determine the percentage slip of the motor. (Prof level 4).

Q3. Explain why the three-phase power circuit for the freight elevator motor will not necessarily include a neutral conductor. (Prof level 2).

Q4. The freight elevator motor can be considered an inductive load which will operate at a particular power factor which may need to be calculated. Calculate the power factor of a circuit having a resistance of 220Ω

and an inductance of 0.5H both connected in series across a 230V 50Hz supply and state whether it is leading or lagging. (Prof level 3).

Q5. The freight elevator is connected to an existing three phase supply. Determine the neutral current within the three-phase system supplying the complete freight elevator installation if the currents for each phase are as follows - L1 = 80 A, L2 = 60 A and L3 = 40 A. (Prof level 4).

Standards & Regulations

Q1. With reference to wiring rules what type of cables are recognised by CENELEC? What is the colour code for cables and cords for the circuits associated with the freight elevator? (Prof level 2).

Q2. With reference to wiring rules what determines the current carrying capacity of the cable supplying the freight elevator installation. List four considerations that must be taken into consideration. (Prof level 3).

Q3. Explain the purpose of carrying out an Insulation Resistance Test on the completed freight elevator installation. (Prof level 3).

Q4. Explain where, within the freight elevator installation, surge protective devices may be required. (Prof level 2).

Q5. Name one type of earthing systems commonly used in the freight elevator electrical installation (Prof level 1).

Materials, Components, Tools

Q1. Describe three factors that may affect lamp life of any type of luminaire in the building with the freight elevator. (Prof level 2).

Q2. The diagram below shows a single-phase motor circuit which is used to drive a ventilation fan in the freight elevator. Explain the sequence of events that take place from the moment the motor is started until it reaches full load speed. (Prof level 5).

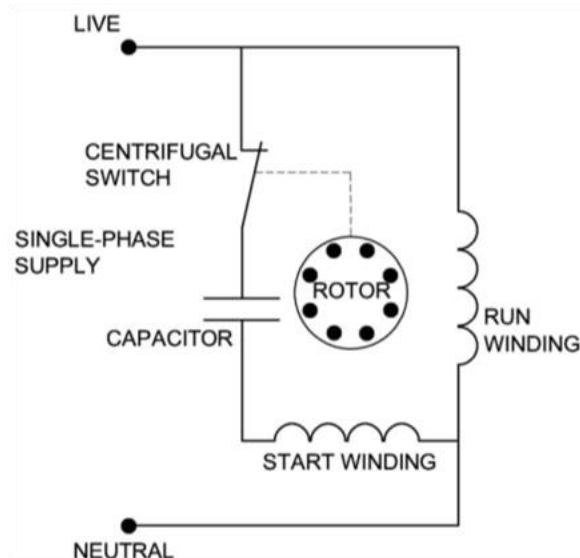

Q3. When connecting up existing single-phase loads to a new three phase Distribution board what is the main point to consider? (Prof level 4).

Q4. Name two types of Fire alarm sounders that could be used in the building with the freight elevator. (Prof level 2).

Q5. List three different devices that could be used to provide overcurrent protection for the freight elevator circuits. (Prof level 3).

Q6. List three considerations that need to be considered regarding the materials, given on a material schedule, before they are obtained and installed for the upgrading of the freight elevator installation.

Systems and Applications

Q1. List three methods of generating renewable energy that could be installed during the upgrading of the freight elevator electrical system. (Prof level 2)

Q2. Give one reason why AC is used in preference to DC for most electrical distribution systems, including the distribution system for the freight elevator. (Prof level 3)

Q3. The diagram below shows a section of a distribution system in the building with the freight elevator. The circuit breakers shown represent a miniature circuit breaker, an air circuit breaker, and a moulded case circuit breaker.

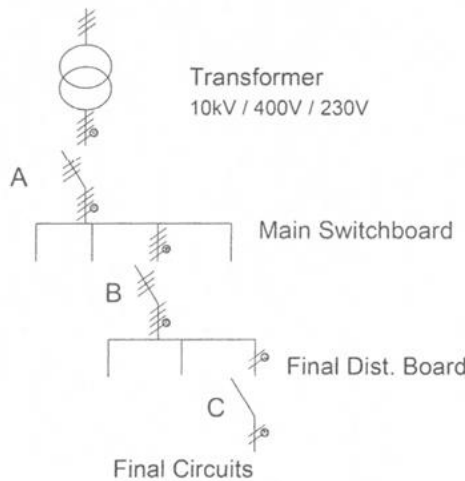

State where each circuit breaker would be located relative to positions A, B and C. Identify the circuit breaker which doesn't have an adjustable overload setting facility. (Prof level 5).

Q4. The control of the freight elevator requires the installation of structured cabling. The termination of Cat5. 5e and 6 for structured cabling is completed to two standards T-568A and T-568B, see figure below. Explain why both the termination standards must not be used in the one installation. (Prof level 3).

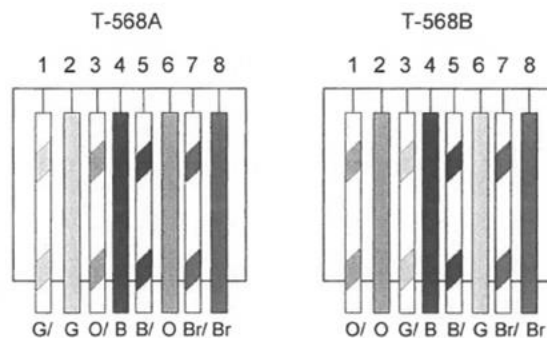

Configuration and Control

Q1. Draw a schematic diagram showing the control wiring for a direct-on-line motor starter which is required for the ventilation fan in the freight elevator. (Prof level 5).

Q2. Draw the truth table for the logic gate below. (Prof level 2).

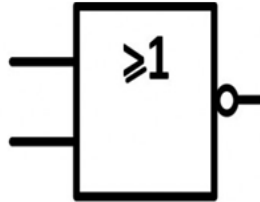

Q3. List two type of input devices that may be found connected to an office/home automation system. (Prof level 2).

Q4. The figure below shows an electronic circuit controlling a lamp. Identify from the list below a suitable switching combination that will turn on the lamp. (Prof level 4).

- a) S1 is closed and S2 is open
- b) S2 is closed and S1 is open
- c) S1 is closed and S2 is closed
- d) S1 and S2 are both open

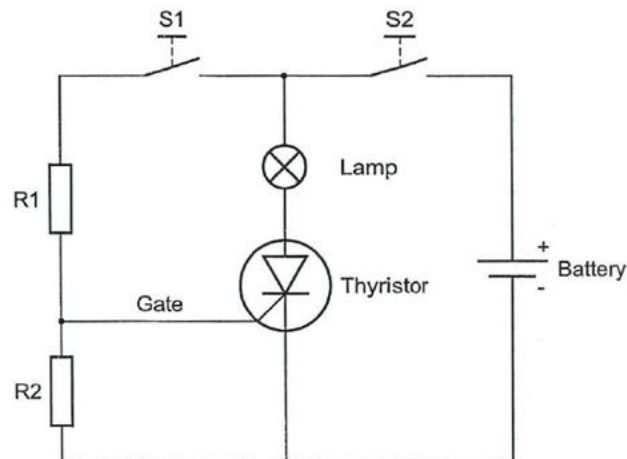

Notes

¹ The electrician occupational area can also be identified in other occupational classifications. The Standard Occupational Classification (SOC), used mostly in the United States, includes “industrial electrician” (47-2111.00). The ‘home appliance repairers’ is also relevant for the electrical parts only (49-9031.00).

4 Business and Administration

This chapter defines “business and administration” as assessed by PISA-VET and elaborates on the framework for business and administration that has been designed for the Development Phase of the project, including descriptions of the competencies and constructs to be assessed. It presents and explains the processes, content knowledge and contexts and provides several sample items with descriptions of task characteristics. The chapter also discusses how performance in the business and administration area is measured and reported against proficiency levels and scales.

Introduction

Vocational education and training for business and administration occupations is a critical success factor for national economies: business and administration is an important cluster (and often the hub) in the business world and is present in every sector, region/country (Dummert, 2021^[1]; Hoidn and Šťastný, 2021^[2]). Many professions in this cluster are high in demand and short in supply. Overall, there are three main reasons for selecting this occupational area for PISA-VET related to the important role of the business and administration domain in the economy and the VET landscape, namely:

- a. The domain is critical to the still ongoing trend toward a service economy.
- b. Commercial clerks are trained and in demand all over the world; in some countries, commercial training is the most chosen training option in VET.
- c. The occupational field is at the centre of several developments: automation (including artificial intelligence) and the digital transition, new forms of work, outsourcing/offshoring.

The corporate world can be seen as both the driver and the driven of digitalisation. On the one hand, it drives digitalisation processes to optimise corporate and work processes and achieve competitive advantages. On the other hand, the sometimes-disruptive developments of digitalisation present companies with major challenges in adapting their business models. The domain of business and administration can be regarded as one of the disciplines that are intensively dealing with the digitalisation of the working world and often assumes a pioneering role here. For example, companies are increasingly relying on digital work processes and tools such as collaboration tools, cloud software and artificial intelligence to optimize their workflows and make them more efficient. The use of big data and business analytics is also becoming increasingly important to make decisions based on data.

Defining the business & administration occupational area

The domain of business and administration encompasses a wide range of activities related to the management and organisation of business enterprises. Therefore, the variety of occupations within the occupational area is huge. Specifically, the business and administration occupational area covers more narrow subareas such as Accounting and Finance, Marketing and Sales, Human Resources, Operations and Strategic Management and Information Technology. Rather than choosing to focus on one subarea, it is proposed to look at the entire area of business and administration but focus on core cross-cutting aspects.

In the International Standard Classification of Occupations (ISCO-08), the occupational area of business and administration covers major group 4 “Clerical support workers”, as well as group 33 “Business and administration associate professionals”. Clerical support workers record, organise, store, compute and retrieve information, and perform a number of clerical duties in connection with money-handling operations, travel arrangements, requests for information, and appointments. Business and administration associate professionals perform mostly technical tasks connected with the practical application of knowledge relating to financial accounting and transaction matters, mathematical calculations, human resource development, selling and buying financial instruments, specialised secretarial tasks, and enforcing or applying relevant government rules. Also included are workers who provide business services such as customs clearance, conference planning, job placements, buying and selling real estate or bulk commodities, and serving as agents for performers such as athletes and artists.

The proposed approach focuses on what young adults can do in their chosen occupational fields of business and administration near the end of their training programmes, not just what they know. Most countries focus on one of up to four VET programmes in the field of business and administration - the target sample will be able to be drawn from students participating in these programmes. Almost all the

training programmes are located at ISCED level 3 and consist mostly of a combination of training on the job or practical training, and training in a VET institution (e.g. PISA-VET: A Feasibility-Study) (Baethge, 2006^[3]). For the measurement of competency in the occupational field of business and administration, this chapter, therefore, focuses on **ISCED level 3** (OECD/Eurostat/UNESCO Institute for Statistics, 2015^[4]): upper secondary vocational education. With this in mind, the target population must meet the requirement of having already completed at least an ISCED level 2 qualification. Due to changes in educational biographies, heterogeneity can be observed when entering initial vocational training regarding the various commercial occupational fields, so an age group between 16 and 19 years can be assumed. With regard to the entry qualification at the start of initial training, differences can also be expected with regard to different occupational fields so that a qualification level EQF3 and EQF4 must be assumed. In terms of the EQF, the focus is primarily on **level 4**.

Table 4.1. Examples of VET programmes in the business and administration occupational area

Selected programmes in data collection countries of PISA-VET

	Australia	Germany	Portugal	United Arab Emirates
ISCED level 3	Advanced vocational courses for recognised trades, technicians and other skilled professions, 1-2 years (Certificate III)	Occupations requiring training for 2 years	General programmes, 3 years	Certificate 4 in Business Administration and Certificate 4 in Customer Service
ISCED level 4	Advanced vocational courses for recognised trades, technicians and other skilled professions, with an advanced skills and theoretical training component., 1-2 years (Certificate IV)	Occupations requiring training for 3 or 3,5 years	Professional programmes or apprenticeship programmes 3 years	Diploma in Business Administration
ISCED level 5	Professional vocational courses at the diploma level, 1-2 years (VET diploma)	Master craftsman training (very short preparation courses only that last less than 880 hours)	Higher professional technical programmes, 2 years	Advanced Diploma in Business Administration

The possibilities of international comparability have already been examined within the framework of a feasibility study (Baethge and Arends, 2009^[5]). For this purpose, selected test contents were subjected to international validation to check whether they can be transferred within and between different countries: It turns out that there are a variety of occupational tasks that are relevant in different countries. For the economic field, for example, a high degree of agreement can be found in the preparation of invoices, reports and annual financial statements.

Based on different international VET standards, legal and economic systems, it is of particular relevance to identify connected domain-specific elements and to narrow down the scope of the domain. To establish international comparability, the focus of an international VET-assessment must therefore be on the typical work situations of the trainees and their domain-specific requirements.

The chapter is based on the following key aspects, which are differentiated in the business and administration area as follows:

- A PISA-VET must be based on a common understanding of the goals of VET in a specific occupational area. For the area of business and administration three central goals are defined: (1) to ensure individual mobility within the professional field, (2) to expand human resources in a

society, and (3) to foster social participation. These goals are reference points for the definition of competencies in business and administration; they make it clear that professional competencies are the starting point for employability and integration.

- A PISA-VET does not claim to be representative of all facets of a specific occupational field; in business and administration, the focus is on measuring competencies in specific fields of action in workplaces that can be considered typical for a broad professional area.
- A PISA-VET records the competencies required for successful participation in the world of work in the 21st century. Against this background, in business and administration, professional competencies and employability are not discrete constructs, but measurable constructs on a continuum between occupation-related or cross-occupational and occupation-specific competencies to act appropriately in the workplace (Winther, 2010^[6]). Occupation-specific competencies denote young adults' abilities to successfully apply their knowledge and experience to authentic occupational situations in selected contexts that characterize the area of business and administration; occupation-related competencies refer to young adults' abilities to be successful in the broader professional field and to develop professional identities (Klotz, 2015^[7]; Winther and Klotz, 2016^[8]).

Organising the domain of business & administration

In vocational education and training, the measurement of competencies is primarily discussed in terms of the domain-specific and domain-related content to which competencies relate (Winther, 2010^[6]). A widespread opinion is that competencies should be derived from the description of concrete occupational activities. This would mean that the instruments of competency measurement would be oriented to and developed from the professional activity. In this case, the test items would be taken from a specific occupational context of action, which shows the characteristics of a domain (Wigdor and Green Jr., 1991^[9]). This section, therefore, outlines the contexts in which learners of business and administration will be employed, the processes they will engage in and the underlying capabilities and knowledge content they will acquire in their training and apply in these contexts.

Context: Operational Value Chains in business and administration

To be able to make statements about competency in the occupational area of business and administration, the focus of this chapter is not on a specific occupation, but on specific occupational activities, typically performed in administrative as well as business workplaces or other types of organisations with administrative areas. The work activities in business and administration are widespread but each can be affiliated at some stage of the operational value chain. The operational value chain is a framework used to describe the various processes and activities involved in producing and delivering goods and services to customers. It is a model that helps organisations understand how different parts of their operations are interconnected and how they contribute to creating value for customers (Porter, 1985^[10]). Therefore, activities are categorised along operational value chains: (Porter, 1985^[10]; Rüegg-Stürm and Grand, 2020^[11])

- Management activities – knowledge and action strategies regarding operational and management and the day-to-day operations; used to prepare decision-making aids for management.
- Business activities – knowledge and action strategies regarding customer processes, production processes, and the distribution of goods; cover the quantifiable process of service creation and its marketing.

- Support activities – knowledge and action strategies regarding business principles, business communication, and the preparation and presentation of relevant business information; address issues of corporate management and organization.

Operational value chains can be defined both in terms of internal company relationships (e.g. coordination between departments) and in terms of their market-oriented external image (e.g. relationships with customers, suppliers, and lenders). Specific occupational scopes of activity can be assigned, see Table 4.2. Occupational scopes of activities in this context can be defined as a range of activities that are affiliated with the same category in the operational value chain. By means of the occupational scopes, the occupational area of business and administration can be operationalised as a job family rather than a specific occupation. Within the job family approach, the focus is on such competencies that are necessary to be able to perform similar activities in different occupations of the area of business and administration. This implies basic competencies in the occupational field as well as their professional-content-related intersection with more specific occupations.

Table 4.2. Operational value chain and occupational scope

Operational value chain	Occupational Scope of activities
Management activities capture procedures and methods of corporate management. These processes are based on operating data and are services in the sense of decision-making aids for management.	Record market-oriented business processes / present accounting as a means of recording, controlling and monitoring value creation.
Business activities capture the process of service creation as well as its marketing against the background of a company's target system. Value creation can be measured via procurement, production and sales processes.	Order processing with procurement, production and distribution logistics.
Support activities capture values and structures that cannot be directly allocated to corporate value creation. These include legal and structural issues of management and organization.	Performing human resources management, business administration and organizational development tasks.

In particular, the megatrends of digitalization and the ecological transformation of the economy have the potential to significantly change (commercial) professions. Based on the megatrend of digitalisation, a change in work contexts can be expected in the future. The use of artificial intelligence and the automation of activities will mean that simple routine and administrative activities will become less important in day-to-day work (Frey and Osbourne, 2017). In view of the increasing importance of the use of big data in the operational work context, the handling of large volumes of data and their adequate processing will gain significance. Depending on the occupational field within the domain, it can be expected that support in decision-making processes and increased work on projects in agile team settings will become more important (Jordanski, 2019^[12]; Seeber and Seifried, 2019^[13]). With regard to the increasing implementation of environmental, social, and corporate governance (ESG), it can be expected that decisions for investments such as the establishment of new production and supply chains as well as corporate reporting will experience a change in values regarding the inclusion of sustainability-related assessment standards. In this way, the sustainability of products will become an important advertising and image factor that can make a significant contribution to a company's success (Williams et al., 2017^[14]).

Orientation to operational value chains provides a good approach to this because changes in the economy are very quickly reflected in the value chains. In addition, the value chains can be used to identify contexts that can be considered relevant for education and training in the domain. The cognitive processes for mastering the context-related challenges as well as the content knowledge required for this can be defined.

Context Categories

The occupational scope of activities can be modelled via contexts. The contexts differentiate challenges at the workplaces and delimit relevant activities in different occupational situations from one another. When

modelling contexts, two aspects are particularly crucial. First, the contexts describe specific occupational activities that can be summarised categorically. Three contexts are distinguished (see Figure 4.1):

1. Working with (business) data – This category describes occupational situations that relate to working with relevant operational indicators or finding and presenting appropriate representations of data.
2. Working with and through communication – This category describes occupational situations that focus on appropriate correspondence or customer-facing skills.
3. Working in and for administrative projects – This category describes occupational situations that can be related to operational project management and administrative work practices.

Figure 4.1. Operational value chains and related contexts



Source: author's own representation

The linking element of the three contexts is working in a digital working environment. This refers to the use of digital tools for data preparation, communication, project administration and project management. An increasingly digital work environment represents a key contextual factor for a variety of professions within the domain. This can include cloud-based tools for storing, sharing, and collaborating on documents and files, communication tools such as instant messaging, video conferencing, and email to facilitate communication and collaboration among employees and project management tools to help teams track tasks, deadlines, and progress. The extent to which work environments are digitalised depends to a large extent on the industry under consideration and the size of the company. Nevertheless, the complete disappearance of face-to-face workplaces is not in the cards, so face-to-face communication with both colleagues and customers will continue to be important.

Desired distribution of items by context category

The three context categories – working with (business) data, working with and through communication, and working in and for administrative projects – are almost evenly contained in the test design (as shown in Table 4.2). This nearly balanced distribution allows no single context type to dominate so that learners are given tasks that cover a wide range of situations they expect to encounter in their work. The goal is to simulate workplace conditions that are as authentic as possible. At commercial workplaces, communicative and administrative tasks are increasing. Responsible for this are changed business models in which collaboration becomes necessary. In this context, commercial employees are often mediators between the

individual departments. Due to the digitalisation of business and work processes, the relevance of dealing with big data is steadily growing and will continue to gain importance in the future. Therefore, the stronger focus on the items in this context area is forward-looking.

Table 4.3. Desired distribution of business and administration items, by context category

Context category	Percentage of items in Assessment
Working with (business) data	40
Working with and through communication	30
Working in and for administrative projects	30
Total	100

Business and administration processes and the underlying capabilities

Business and administration processes

At the centre of an assessment construction for vocational education and training in the field of business and administration are competencies at business and administrative workplaces. That includes knowledge and skills as well as characteristic ways of acting in occupation-specific as well as occupation-related situations. Business and administrative competencies should be understood as learnable and thus measurable constructs, which are demonstrated by the fact that professional challenges can be mastered through the adequate and understanding-guided use of knowledge and skills. Therefore, business and administrative competencies include both the ability and potential to perform typical tasks in administrative and business workplaces based on a systemic understanding of operational and administrative sub-processes. An individual's competency includes occupation-specific and occupation-related competency dimensions. Occupation-specific competencies include recognising, analysing, using, and evaluating business principles, data, and processes to successfully apply individuals' knowledge and experience to authentic occupational situations and contexts; occupation-related competencies refer to individuals' abilities to succeed in the broader occupational field by using transversal competencies like numeracy and digital and ICT literacy skills appropriate to an business and administration occupational situation (OECD, 1996_[15]; 2012_[16]; 2015_[17]; 2019_[18]). This implies a mature approach to business communication and to working tools and techniques for generating general templates, organising professional collaboration, and creating value, for themselves, for the company and for the community. Both occupation-specific and occupation-related competencies help individuals make informed judgments and decisions in the occupational domain (Greiff et al., 2014).

In the following, the question must be answered which cognitive processes and resources are necessary to cope with an occupational situation. In the context of the construct representation, the cognitive processes and resources are chosen as the starting point for the description of occupational situations. Hypotheses about the solution process are consequently translated into hypotheses about the contents of the demanding situations and their difficulty parameters to arrive at a detailed description of the measurement construct (Pellegrino, Chudowsky and Glaser, 2001_[19]). For this purpose, a sufficiently precise idea must be developed about which processes take place during the processing and solving of occupational situations. Therefore, the process category describes the underlying cognitive processes required to complete the assessment. The cognitive processes describe the abilities of professionals to recognise, understand, apply, analyse, and evaluate occupation-relevant concepts of the business domain.

For the business and administration area, four process categories are often differentiated (see Figure 4.2; e.g. (Rausch et al., 2021_[20])):

Figure 4.2. Business and administration processes and the underlying capabilities

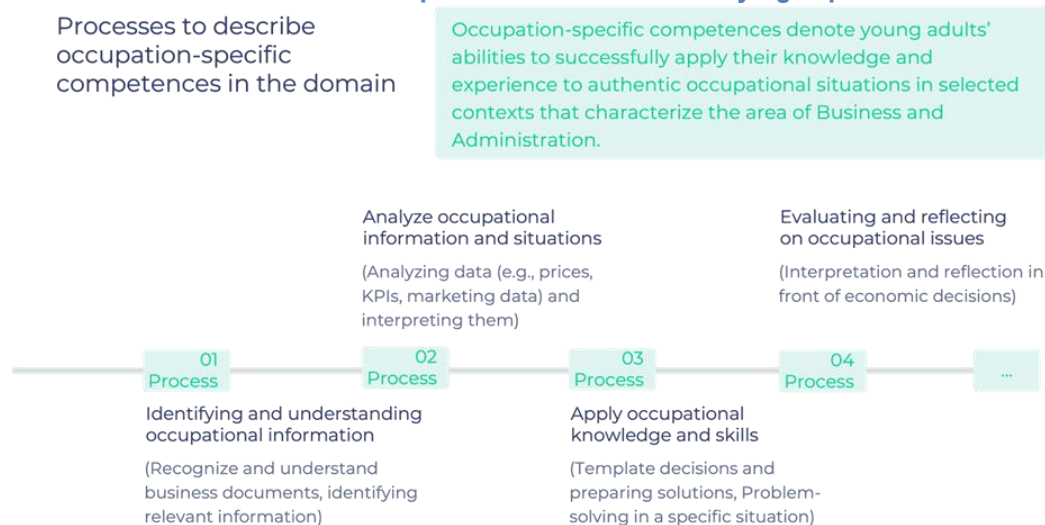

Source: author's own representation

1. Identifying and understanding business and administration information – This process addresses the search for workplace-related information and the recognition of its relevance. Information in the business domain is mainly presented in text form, such as emails from customers or supervisors, business letters, invoices, or presentations from Enterprise Resource Planning (ERP) systems. The process category also includes the recognition and understanding of technical terms and different types and sources of information within the domain.
2. Analysing business and administration information and situations – This process describes the ability to analyse information and recognise relationships between different professional contexts in relation to a specific problem situation. This includes, for example, criterion-supported analysis and interpretation of key performance indicators in relation to different professional contexts, analysing the impact of pricing strategies, or analysing marketing metrics and interpreting them in relation to product sales. The process of analysis also includes understanding the underlying analytical assumptions and their implications.
3. Applying business and administration knowledge and skills – This process focuses on acting in professional situations by applying professional conceptual knowledge in conjunction with professional action knowledge. The testee realises a typical work product. This can include, for example, communicating and corresponding adequately in one's own mother tongue or in a foreign language to finalize a contract conclusion or to inform different stakeholders appropriately. A more complex use case could be the development of a solution or the formulation of recommendations for action for a job-specific problem that requires the use of mathematical and linguistic skills and/or the use of digital work tools such as Office/ERP/CRM.
4. Evaluating and reflecting on business and administration issues – This process refers to the use of knowledge and skills that goes beyond a specific professional situation. This may involve critically evaluating the pros and cons of a career decision both in terms of one's own point of view and in relation to third parties. It includes cognitive skills such as reasoning, evaluating, and generalising. It also includes critical reflection on one's own professional behaviour during the work process and work outcomes and formulating changes in behaviour.

The operationalisation of the process category is based on the taxonomy of Marzano and Kendall (Marzano, Kendall, 2007^[21]) without assuming a hierarchy. The order of the processes rather reflects a typical sequencing for processing an occupational action situation. It is considered that in professional

actions an interaction of the described processes can take place. Regarding assessment, tasks are evaluated according to which process category is most important for solving the task. Therefore, the process category is used as a tool to characterise workplace requirements and to show what competencies an apprentice/trainee should have regarding an occupational situation to be able to cope with this situation.

With recourse to cognitive models, the four identified subcategories of the cognitive system represent differentiable processing and action processes that can be assigned to different levels of complexity: (1) the activation and situation-specific retrieval of knowledge and skills, (2) the elaboration of knowledge and skills and thus the representation of comprehension processes, (3) the inferential interpretation of knowledge and skills with regard to the plausibility of a situation-specific solution, and (4) the utilisation of knowledge and skills, for example, in the context of transfer tasks.

Table 4.4. Business and administration processes and level of complexity/level of capability

Processes	Example for the domain	Level of complexity / level of capabilities
Identifying and understanding business and administration information – the process refers to recognizing and understanding occupational content.	Recognise and understand business documents, identifying relevant information.	Activation and situation-specific retrieval of knowledge / Capability to retrieve situationally adequate knowledge stocks.
Analysing business and administration information and situations – the process refers to the elaboration of knowledge and requires the representation of understanding processes.	Analysing data (e.g. prices, KPIs, marketing data) and interpreting them.	Elaboration of knowledge and the representation of comprehension processes / Capability to describe system coherences and to act within them.
Applying business and administration knowledge and skills – the process refers to the preparation of decisions and the offering of concrete proposals for solutions.	Template decisions and preparing solutions, work products for specific situation.	Inferential interpretation of knowledge regarding the plausibility of a situation-specific solution / Capability to think and act purposefully in specific situations.
Evaluating and reflecting on business and administration issues – the process refers to the use of knowledge that goes beyond a concrete occupational situation.	Interpretation and reflection in front of economic decisions that consider the market environment and company development.	Utilization of knowledge and transfer beyond a concrete situation / Capability to independently control processing procedures.

Desired distribution of items by business and administration processes

Even though recent studies show that the process categories in the test items are not determinants of difficulty, a distribution is aimed that places an emphasis on the processes of analysis and application. This considers the fact that at workplaces in the field of business and administration, these processes also dominate. The same applies to the corresponding skills of the trainees. The ability to act within system contexts and that of goal-oriented action in concrete situations predominate in practice over those of isolated knowledge acquisition and independent further processing.

Table 4.5. Desired distribution of business and administration items, by process category

Process category	Percentage of items in the assessment
Identifying and understanding occupational information.	20
Analysing occupational information and situations.	30
Apply occupational knowledge and skills.	30
Evaluating and reflecting on occupational issues.	20
Total	100

The distribution proposed here provides the plan for selecting items based on practical relevance and on the importance to the workplace. Item selection is based on item characteristics related to a range of framework aspects - including the process and context categories described. In summary, this is reflected in the underlying definition of vocational competency in the domain of business and administration:

*Vocational competency is the potential to act adequately in occupational situations; it is expressed in the capability to cope with variously challenging situations at **administrative as well as business workplaces** by incorporating both **occupation-specific as well as occupation-related knowledge, skills and strategies**.*

Fundamental business and administration capabilities underlying the business and administration processes

Regarding the requirement profile, occupational situations can vary, so a situation-specific explication of the higher-level capability of coping with differently complex and challenging occupational situations is necessary. The situation-specific explication is carried out via business and administration processes and capabilities which are typically in the focus of action in a situation-specific manner. Accordingly, four fundamental business and administration capabilities underlying the cognitive processes can be usefully identified:

1. The capability to retrieve situationally adequate knowledge stocks: Retrieving business and administration data and other relevant information.
2. The capability to describe system coherences and to act within them: Drawing conclusions from business and administration data and other relevant information.
3. The capability to think and act purposefully in specific situations: Making appropriate decisions/proposals for business and administration work products.
4. The capability to independently control processing procedures: Establishing appropriate, quality-assuring working practices for business and administration workplaces as well as promoting their own professionalism.

These four capabilities must be integrated to cope with various challenging situations at administrative as well as business workplaces. Processes and capabilities meet in the test situations. The processes describe the requirements of the situation; the abilities describe the possibilities of the person. The interaction of process and capability is consequently based on what is considered a typical situation in administrative as well as business workplaces. Consider for example the following occupational situation. This situation is an authentic and typical work situation; it integrates all four business and administration capabilities:

You are employed as an assistant to the head of the sales department of a household appliance manufacturer. Due to geopolitical events, there are difficulties in prospecting the future revenues of our newly released product, a smart vacuum cleaner robot. We want to sell our product nationally as well as in the United States. Our sales department calculated that with the revenues of both markets, our product should have a positive cash flow within three years. Your supervisor asks you to evaluate the cash flow calculation based on recent events and to develop a justified proposal when we can expect a positive cash flow at the earliest and should we release our product on both markets?

This occupational situation refers specifically to the context: working with business data. How this occupational situation can be differentiated via the processes and which capabilities underlie it is shown in the following table. The table should be read as follows: The complex occupational situation is divided into process categories - these are the last four columns of the table. It becomes clear that each occupational situation - if it is authentic and complex - addresses several process categories (identify,

analyze, apply, evaluate). The process categories describe the cognitive requirements that lie in complex, occupational situations and thus in individual processes. These requirements are empirically well separable construction criteria for test task. The last four rows of the table indicate which capabilities are needed to master the process categories of an authentic and complex occupational situation. The capabilities must meet the requirements at the process level to be able to deal appropriately with the challenges of the occupational situation. In this table, the two aspects of competence measurement come together: the demand of the situation and the ability of the person.

Table 4.6. Relationship between business and administration processes and fundamental capabilities (example)

	Process one – Identifying and understanding business and administration information	Process two – Analysing business and administration information and situations	Process three – Applying business and administration knowledge and skills	Process four – Evaluating and reflecting on business and administration issues
Coping with various challenging situations at administrative as well as business workplaces by incorporating both occupation-specific as well as occupation-related skills and strategies.	In an internal paper, the difficulties in sales are described. The trainee can identify the connection between geopolitical changes and internal company measures and recognize the interrelationships within them; primarily occupation-related skills are used for this purpose.	Based on graphs showing the expected development of the market-specific demand for household goods as well as the expected consumer climate index in general a trend analysis is to be made. The trainee must be able to read the data, analyse the impact and prepare the information required for the decision in context. Again, this is primarily occupation-related knowledge.	Initial cash flow calculation is available. The trainee must calculate the now expected revenue stream for both markets and compare it with the initial calculation. Occupation-specific knowledge is used for this purpose and learned algorithms for cash flow calculation are applied.	For operational monitoring, it is necessary to evaluate the development of market developments. For this purpose, data are available which contain statements about the market-specific demand and other relevant trends (consumer climate index, development in sales figures of the industry and your own company). The trainees are asked to form a key figure from this data and to explain it. They are to make a judgment as to whether the current plan product release plan should be maintained as it is or to adopt it. In this task, both occupation-specific and occupation-related skills are activated.
Capability to retrieve situationally adequate knowledge stocks			The capability focus is here (Retrieving business and administration data for cash flow calculation).	
Capability to describe system coherences and to act within them	The capability focus is here (Drawing conclusions based on information given in an internal paper).			
Capability to think and act purposefully in specific situations		The capability focus is here (Preparing appropriate decisions based on a trend analysis)		
Capability to independently control processing procedures				The capability focus is here (Promoting professionalism; formulating a key figure goes beyond the daily work requirement).
Main context: Working with (business) data.				

Business and administration content knowledge

Content knowledge is interpreted in a broad sense as action-relevant knowledge which is necessary to be able to decide, against the background of occupational complexity, how to deal with the authentic occupational situation, considering operational main and side effects (e.g. being able to name which information is necessary for an economic decision, such as the selection of a supplier). Content knowledge is the flagship of the test instrument; it determines the breadth and depth of the construct being measured.

The following content knowledge categories are suggested:

1. Content knowledge of the significance of relevant operational indicators in business administration and how to interpret and present data appropriately – this content knowledge is linked to the occupational context 1: working with business data.
2. Content knowledge of appropriate procedures and tools for correspondence and communication, of cross-cultural differences, and of dealing with diverse customers and stakeholders – this content knowledge is linked to the occupational context 2: working with and through communication.
3. Content knowledge of methods, forms, and areas of application of project management and of the use of concrete work strategies – this content knowledge is linked to the occupational context 3: working in and for administrative projects.

Each of these content knowledge categories incorporates knowledge of how and when to use digital work tools, what information-seeking strategies are useful, and how to manage data.

Figure 4.3. Content knowledge linked to occupational contexts

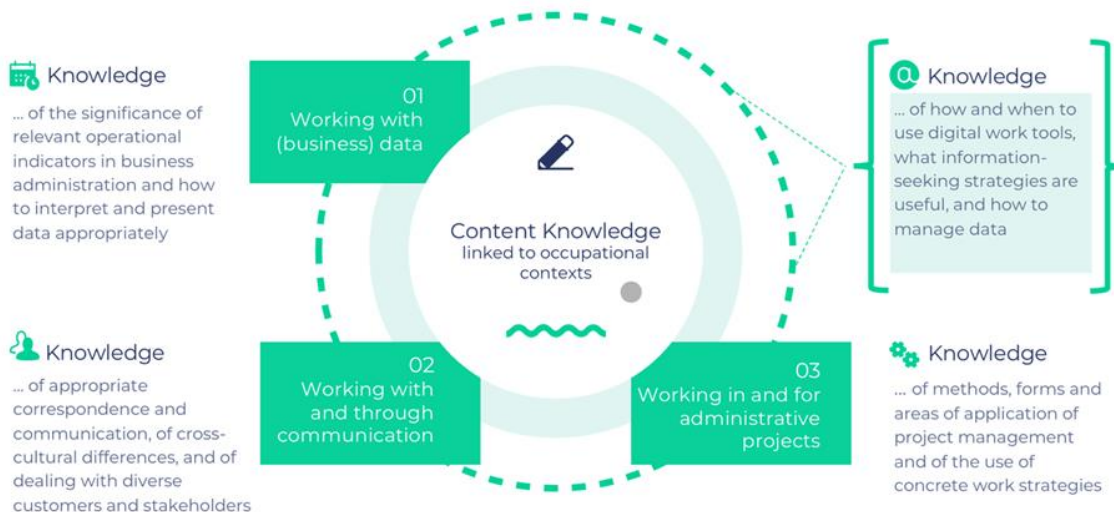

Source: author's own representation

Regarding the measurement of vocational competency, it is demanded that the contents of the measurement be as complex as possible to capture an understanding of the dynamics of economic reality. Against this background, static linearised views of business realities are abandoned, and the system-oriented approach of business and administration is pursued. System orientation means emphasizing the interrelationships between individual topics, concepts, and instruments to integrate the individual content knowledge into a meaningful whole that can depict specific, dynamic relationships.

The system perspective of business administration is to be supplemented by process orientation: All value-added activities of a company and the necessary organisational and administrative work are performed in

processes that can be characterised by a certain factual and temporal logic in the execution of specific tasks. Consequently, cross-functional business processes ask about the sequence, the temporal course, the priorities of subtasks as well as the use of people, material goods and the use of information (operational process organization).

Desired distribution of items by content category

An almost balanced distribution of content knowledge categories is sought in the assessment. Analogous to the distribution of context categories, we consider a stronger content focus on the adequate handling of data for analysis and decision-making to be forward-looking in view of the increasing digitization of corporate and work processes. Mapping the system perspective requires a well-balanced distribution of items across content categories.

Table 4.7. Desired distribution of business and administration items, by content category

Content Category	Percentage of items in Assessment
Content knowledge of the significance of relevant operational indicators in business administration and how to interpret and present data appropriately	40
Content knowledge of appropriate tools and procedure for correspondence and communication, of cross-cultural differences and of dealing with diverse customers and stakeholders	30
Content knowledge of methods, forms and areas of application of project management and of the use of concrete work strategies – this content knowledge is mostly linked to the occupational context 3	30
Total	100

Content topics for guiding the assessment of business and administration competency for VET learners

To effectively understand and solve contextualised problems involving the content categories requires drawing upon a variety of business and administration concepts, procedures, facts, and tools at an appropriate level of depth and sophistication. As an assessment of vocational competency in the field of business and administration, PISA-VET strives to assess the levels and types of professional skills in the domain that are appropriate for VET learners on a trajectory to become skilled professionals able to make well-founded judgments and decisions at the workplace (Winther et al., 2016). It is also the case that PISA-VET, while not designed or intended to be a curriculum-driven assessment, strives to reflect the business and administration area that students have likely had the opportunity to learn by the time they are approaching the end of their initial VET programmes.

The field of business and administration is primarily characterised by its service orientation and the provision of services. The proposed occupational contexts as well as the associated content-related knowledge categories explicitly take this into account. It is recommended that the focus of an international comparison be placed on occupational tasks that deal in different ways with aspects of service provision and are based on different work processes (Holtsch et al., 2016^[22]). Therefore, all knowledge categories are based on real work and business processes. Knowledge must be activated to master occupational challenges in authentic situations. The idea behind using authentic challenges as an assessment style is to observe authentic behaviour in authentic test environments as key indicators of vocational competency in real-life settings (Sangmeister et al., 2018^[23]). In addition, and consistently geared to the requirements of working life in the business and administration area, content knowledge categories are highlighted that stimulate adequate work in corporate domains with their specific economic contexts. Items in this category are referred to as occupation-specific challenges. Each occupation-specific challenge refers to a systemic view of business data and processes regarding economic decision-making processes.

Assessing Vocational Competency of learners in the business and administration occupational area

General assumptions

The focus of the assessment is on knowledge stocks and skills that can be assumed to be needed for an individual's participation in working life. The requirements for graduates of vocational education and training are primarily oriented toward the workplace and, beyond that, the labour market. This implicitly includes personal development, as this is the only way to ensure that graduates can adapt to changing working and living conditions.

Consequently, the following questions are central to the assessment: (1) How can vocational competency be defined, and which operationalisations are useful? Two aspects are of central importance here: on the one hand, the domain and thus both the contexts and the associated contents of professional competency. On the other hand, the person is a characteristic carrier of professional competency. Unlike comparable international large-scale assessments (Third International Mathematics and Science Study (TIMSS); cf. (Baumert, Bos and Lehmann, 2000^[24]) the focus is not on curricular congruence but on functional aspects of education. Closely related to this are (2) the questions of what radius of action, what scope for action and decision-making graduates of vocational education have at their workplaces and on the labour market, and thus of typical contexts of requirements by means of which "competent" behaviour is demonstrated, as well as (3) the question of test situations and test items that adequately depict vocational behaviour and thus make it accessible to a competency measurement. (4) The evaluation and analysis are linked back to the requirement profiles of the occupations and the labour market and thus along the action parameters of the employees.

In the preceding chapters, questions (1) and (2) were answered. Based on the value chains and the associated occupational scopes, the context, the processes, and the content for the domain have been identified (**job family approach**). The domain as well as the occupational actions have thus been comprehensively described and explained. Questions (3) and (4) are addressed below.

Question (3) clarifies which options are available for recording vocational competency in relation to workplace activities. In general, two procedures can be distinguished in this context, which can have different characteristics (cf. (Rauner et al., 2009^[25])):

- The external and/or self-assessment of work behaviour by questionnaire-based or rater-based procedures as well as.
- Simulation-based procedures in which work behaviour can be observed and diagnosed through knowledge and performance measurements.

The feasibility study on the implementation of an international comparative large-scale assessment in vocational education and training (Baethge, 2006^[3]) relies on simulation-based procedures and thus follows the current findings and recommendations of major international comparative studies. Procedures of external and self-assessment can usefully complement simulation-based assessments, especially for validation.

A simulation-based method of vocational competency measurement is proposed for an international assessment in the field of business and administration. Simulations can be used to visualise value chains and the associated professional scopes of action and contexts. Simulation-based test platforms can be used to represent the authentic occupational tasks to be mastered by trainees, including the action and communication processes required to master them. Computer simulation ensures that:

1. concrete processes can be observed in typical contexts, and
2. content knowledge can be tied to work products that are available as standardized results for analysing trainees' capabilities.

A simulation-based approach to a vocational assessment should be modelled in an occupationally authentic setting to represent occupational reality. Authenticity is an essential prerequisite for measuring occupational competency (Deutscher and Winther, 2018^[26]). Authentic contexts serve to shape the space of action (e.g. working with and through communication, such as formulating apologies for delivery difficulties), which can be characterised by various artefacts of professional action:

1. Requirements and tools of work (e.g. office software, ERP) that determine the scope of professional action.
2. Patterns of work (e.g. professional reasoning strategies) to determine the value of a professional action.
3. Ways of working (e.g. communication, judgment) to describe the importance of cross-cutting competencies within a professional action.

The artefacts are design anchors for constructing an authentic context. They determine how well professional activities as well as values and attitudes are represented in the test design (Figure 4.6). Furthermore, authentic situations consider the situational nature of competencies and thus increase test validity. Artefacts are used to construct multi-channel and interactive test stimuli given by videos, animations, or authentic tools.

Design anchor's structure occupation complexity. They help construct authentic test environments that address both the action aspect and the value aspect of occupational competencies. The starting point for this is an accurate and authentic description of the workplace and the tasks that an employee/worker must perform. The action aspect concerns concrete professional challenges that must be dealt with and solved in such a way that an economically sensible decision can be made (e.g. handling purchasing and sales, data preparation, and invoicing). Values and attitudes describe transversally how employees/workers behave in the professional context (e.g. professional reasoning strategies, professional communication, and judgment).

Figure 4.4. Design anchors that bind an authentic test environment to the occupational context

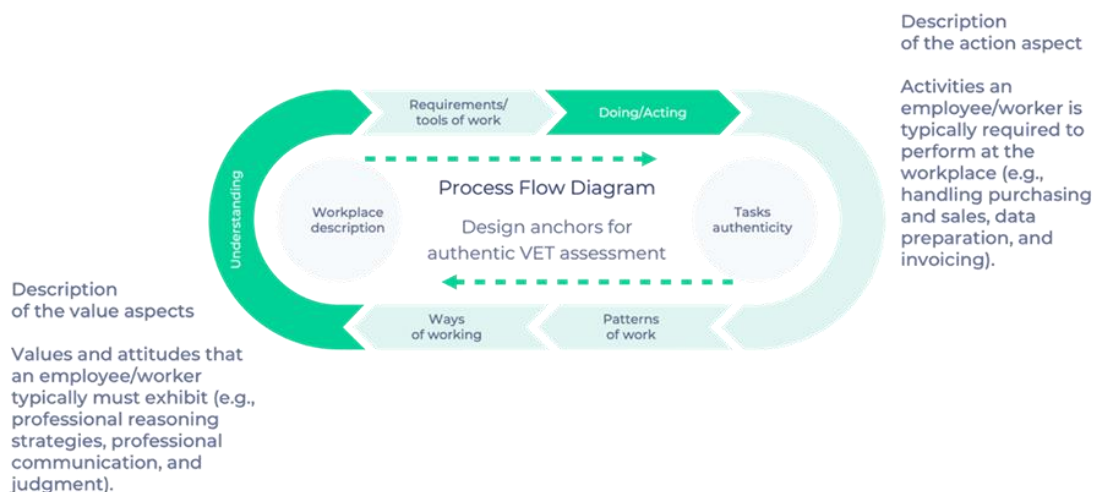

Source: author's own representation

Actions and value attitudes depend on how understanding-guided professional tasks can be processed and which concrete possibilities of doing/acting exist in the process of the action itself. Together with the artefacts (requirements and tools of working, patterns of work, and ways of working) sufficient information with workplace relevance is available in this way. This provides the basis for an authentic test environment.

Considering the job family approach, an authentic test environment consists of several test units: Test units with which those competencies can be assessed that are necessary to be able to perform similar activities in different occupations in the field of business and administration and test units that relate to sector specifics. The design anchors make it very easy to link sector-specific content to the basic vocational competencies.

The simulation-based approach using digital test platforms will be complemented with elements from more traditional knowledge-based tests. Moreover, due consideration should be given to the potential benefits of integrating a live demonstration (or video recorded) in the assessment. Given the nature of the business and administration occupational area and its processes, the value added of such live demonstrations are likely to be limited compared to what can be done using digital test platforms.

Test construction based on competency modelling

Vocational competency in the domain of business and administration is defined as primarily activity-related competency in situations of occupational demand, which can be described in terms of mastering a typical work process. Based on a specific work process, it is thus possible to include many aspects of vocational competency – to the extent that they are necessary for mastering the work process – without having to assume that the dimensions are empirically separable. For the international assessment, vocational competencies are measured as occupation-specific competency across occupational contexts and, by definition, this includes occupation-related competency as well.

Vocational competency in the business and administration domain refers to the interplay of occupation-related and occupation-specific dimensions of competency, based on which trainees have the capability to make entrepreneurial and broader administrative decisions in authentic occupational situations and to validate these decisions to expand their own knowledge and action potential. The distinction between occupation-specific and occupation-related competency is based on a differentiated structure of vocational competency that can be related both to the occupational contexts and to the various cognitive processes with which typical occupational content is mastered (see Figure 4.5).

This considers the fact that competency in a domain is (1) both context-based as well as content-related and (2) not a one-dimensional cognitive disposition and that, consequently, it is not sufficient for competency acquisition and development to focus only on one cognitive structure (Kilpatrick, Swafford, and Findell, 2001^[27]). This model assumption allows the competency areas to be analysed separately without violating the structure of the model.

Figure 4.5. Model of Competency Dimensions in the business and administration Domain



Source: author's own representation

For test development, the competency structure model of vocational competency has the following implications:

- The starting point for test development are authentic occupational contexts that are based on the reality of workplaces. In these contexts, professional action takes place and professional content knowledge is used to master the occupational challenge.
- The degree of demand of the occupational contexts is to be selected in such a way that their processing is differently challenging and addresses different processes.
- The contexts are to be constructed in such a way that two different competency structures can be mapped with them: occupation-specific and occupation-related competency.

Test and response formats

Assumptions are to be formulated as to what effects a chosen test format has on the response behaviour of the trainees in the test and to what extent conclusions can be drawn about competency structures and capabilities via the response behaviour shown. When choosing a simulation-based test format, it is implicitly assumed that by simulating authentic work contexts and processes, work actions and professional behaviour can be depicted better than would be possible with test formats on paper and pencil (criterion of authenticity). This is supported above all by the fact that the use of simulations eliminates the need for a verbal description of the processing steps in an authentic occupational situation and that both the "handling of concepts" and the "handling of technical equipment" can be measured simultaneously in the complexity typical of real work processes. The aim is to develop occupational contexts in such a way that it becomes possible to relate the tasks to be processed to the underlying work processes and, at the same time, to obtain information about the cognitive processing steps during the solution process (criterion of activity-specific validity). In other words: The design steps enable the modelling of tasks that represent occupational contexts and at the same time allow statements about the cognitive requirements during their processing as psychometrics.

- Criterion of authenticity: It must be ensured that the test formats used to present the items can be considered "authentic". Following Doyle (2000^[28]), the following dimensions of authenticity are considered in the test formats:
 - Content authenticity: it involves real data, instruments, and procedures of a particular field/occupation.
 - Situational authenticity: This refers to identification in the test through a high degree of proximity to the workplace and around experiencing a "community of practice".
- Criterion of activity-specific validity: Internationally, there are different cuts for occupations for which activity clusters can be identified in an international comparison, which can be used as an activity-related validity criterion. This makes it possible to identify a workplace and concrete work contexts and tasks. Value chains and occupational scopes can thus be recorded in a valid manner.

For the test format, this means that an authentic description and recording of the action execution in the contexts must be possible. It must therefore be possible to assess the following via the respective test format:

- authentic work processes (e.g. negotiations, work distribution)
- authentic work orders (e.g. the concrete processing of an order), and
- authentic work results (e.g. determination of a delivery date).

Therefore, the test uses different types of response formats that can be implemented in simulations: e.g. open constructed-response, closed constructed-response and selected-response tasks (simple and complex multiple-choice tasks).

Examples of items for addressing the business and administration framework

Simulations can be used to depict the authentic occupational contexts to be worked on by the trainees, including the action and communication processes required for processing, as well as the content knowledge to be used. In the following, a fictitious user interface and individual test items are used to illustrate how simulations can be used to measure vocational competencies in the business and administration domain. It is shown how the criterion of authenticity and the criterion of activity-related validity are met. The development of a simulation-based test environment requires modelling steps that translate notions of reality with respect to the ideas and goals of testing (criteria of authenticity and validity). The following construction and design criteria are characteristic (see Figure 4.6)

Figure 4.6. The interface of an authentic technology-based test environment

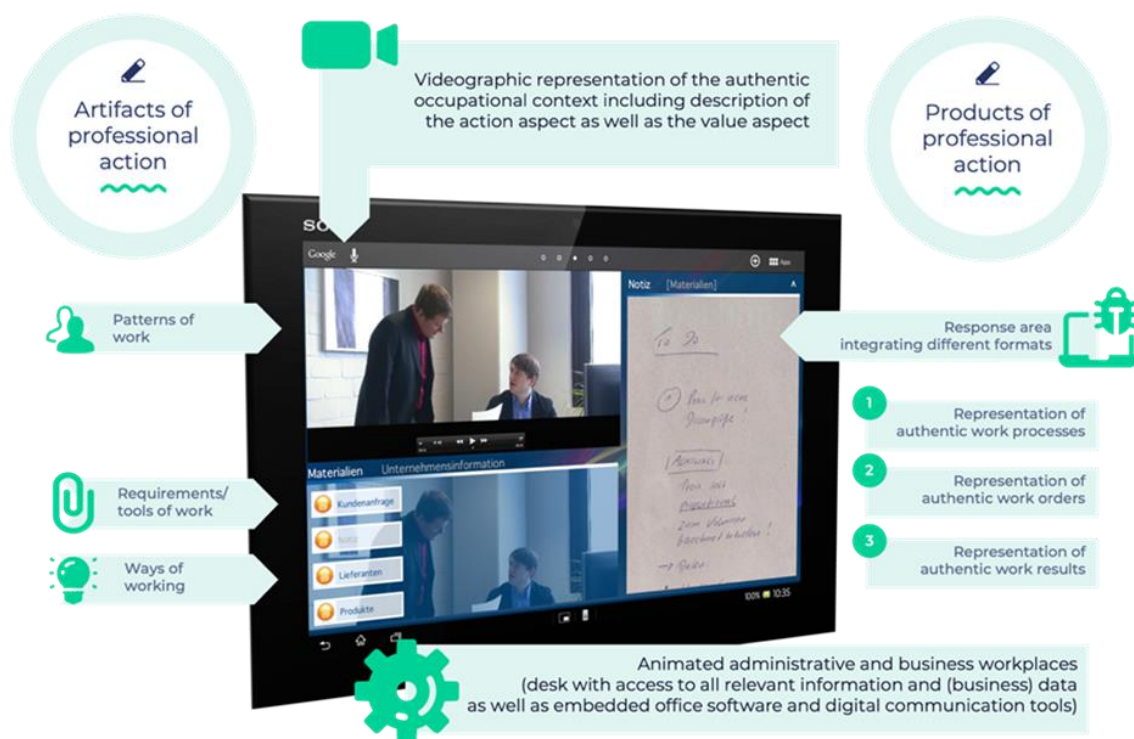

Note: Videographic representations of authentic occupational contexts are currently only available in German. Short stimuli are given to increase identification with the task at hand. Two perspectives are provided: perspective 1 describes interactions between colleagues; perspective 2 involves the trainee directly (for example, by means of video conferencing).

Source: author's own representation

- Workplace simulations contain general introductions to the company structure (including the company history) as well as all-general compilations on the company's business situation (text-based and graphical analyses of business figures as well as presentations of the balance sheet, income statement and cash flow statement). This information can be used to classify the value chains and the associated occupational scopes.
- The test situation itself is linked to animated administrative and business workplaces (desk with access to all relevant information and (business) data as well as embedded office software and digital communication tools). This allows the various authentic occupational contexts to be modelled.
- Videographic representation of the authentic professional context including the description of the action aspect as well as the value aspect define the item stem (stimulus).
- Both artefacts of professional activities as well as products of professional action ensure authenticity. The artefacts in the context of stimulus presentation and the products as authentic outcomes of task/item completion.

Using the example of the occupational context "working with business data", example test items are presented below. The occupational contexts are constructed in such a way that they could each be used as an independent test environment.

- *Initial situation presented by video:* Even in difficult market situations, a customer-oriented company tries to pass on price advantages directly to customers. To this end, individual price lists are drawn up for the most important customers. This approach has proved successful to date; in some cases, customers have increased their order quantities in response to price reductions, and

customer satisfaction has improved. The price lists were published last week. First orders are to be processed.

- *Assess to the following tools of work:* The trainees are provided with a simulated ERP system and additional information on the company's customers and products as well as on warehousing and production planning. This information is necessary to fully confirm the sales order.
- *Products/results requested to assess vocational competency:* A complex work order is simulated that contains the following requirements, which can be formulated into six test items:
 - Create the order confirmation using the information available from the ERP system.
 - Determine the valid price for the sales order and determine its deviation from the list price.
 - Notify production that there will be delivery delays. Communicate this to the customer via e-mail.
 - Based on the information from production, determine the expected production and shipping times.
 - Give a reasoned judgment. Are the delivery delays within the normal range or do they deviate significantly?
 - What measures can be taken to reduce delivery delays? Draft a justified proposal.

The six items illustrate that both occupation-specific and occupation-related skills are required to answer them. The items also show that different processes are addressed by them and that they refer to different content knowledge. To assess the capability to cope with differently challenging situations in administrative and business workplaces, these and other similar sequences must be solved.

Item scoring

The model most intuitively applicable to vocational competency measurement is the Partial Credit Model (PCM) (Masters, 1982^[29]). The term partial credit refers to the fact that it is possible not to receive full credit on an item, but to receive partial credit. The PCM has the advantage over other item response theory (IRT) models in that the distance between the points awarded can vary. This advantage is countered by a demanding coding. It will have to be examined whether a suitable modelling of complex simulation-based test designs is also possible on the basis of the generalised partial credit model (GPCM).

One way of scoring is to evaluate the quality and the reference area of an economic decision. The following figure shows an example of this.

Figure 4.7. PCM based on an item

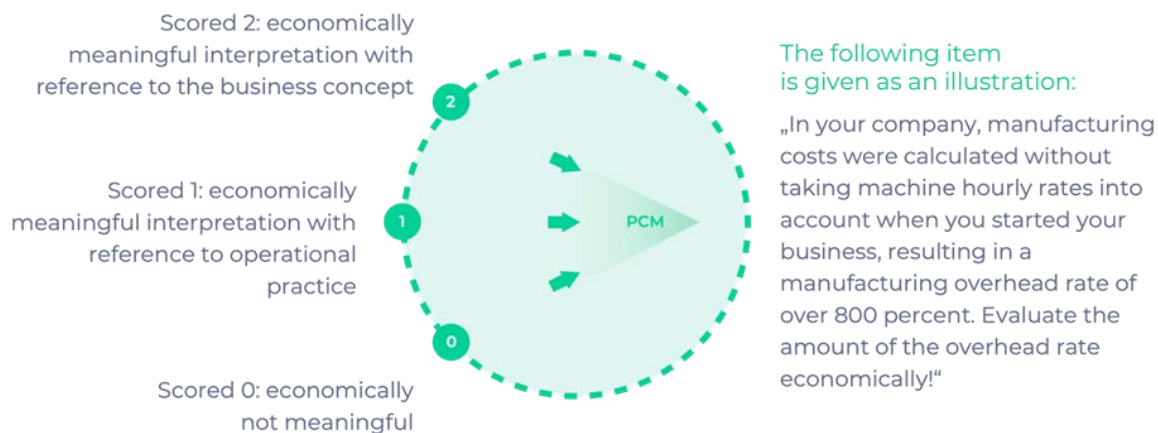

Source: author's own representation

For international comparison, the assessment is constructed based on a competency structure model. It has a two-dimensional structure. The test contains items regarding a between-item multidimensionality and some item constellations that represent the interaction between occupation-specific and occupation-related competency in terms of within-item multidimensionality. Therefore, confirmatory multidimensional IRT models are used for the analysis.

Reporting proficiency in business and administration

PISA generally works with one-dimensional scales that are subdivided into grades/levels of competency. However, a VET assessment in the domain of business and administration is intended to record professional behaviour in authentic occupational contexts, which conceptually and empirically entails occupation-specific skills and task performance, on the one hand, and occupation-related skills and working methods on the other hand. Against this background, it is suggested to use **a two-dimensional model** for the development of tasks and the empirical modelling of competency scores. Both scales can be divided into different competency levels. This grading makes it possible to relate well the task difficulties and the competency levels of the study participants in an international comparison.

The competency dimensions are empirically distinguishable but highly correlated. Reporting on a common scale is possible; the focus of reporting will be on the different levels of proficiency. How many proficiency levels can be differentiated is an empirical question and depends on the test design and the breadth of test content. It is proposed to construct the test along coherent causal relationships between workplace requirements (occupation-specific), labour market requirements (occupation-related), and cognitive psychological assumptions to heuristically locate the test items on a one-dimensional scale (Wilson and Draney, 2004^[30]). Five levels of proficiency (0 to 4) are proposed, which can be interpreted well in terms of content. Level 0 (off-task) describes a missing answer and/or provides no evidence for the economic decision made. Level 4 (advanced), on the other hand, goes significantly beyond the daily work routine, e.g. by providing additional evidence or suggesting solutions that reveal complex economic contextual knowledge.

Table 4.8. Summary description of the levels of business and administration proficiency in PISA-VET

Level	Lower score limit	Descriptor
4	Has to be determined empirically	Level 4 describes the learner going well beyond the daily work routine, e.g. providing additional evidence or proposing solutions that reveal complex economic background knowledge.
3		Level 3 describes a correct approach to the occupational situation. The learner weighs decisions in an economically sensible manner and consistently cites objective reasons for decisions supported by relevant and accurate evidence.
2		Level 2 describes basic understanding while omitting technicality. The learner argues partially objectively using some relevant evidence, but reasons are incomplete and/or some evidence is missing.
1		Level 1 describes the basic recognition of terms and concepts without being able to use them. Learners argue mainly subjectively and/or based on inaccurate or irrelevant evidence.
0		Level 0 describes a missing answer and/or provides no evidence for the economic decision made.

The levels of competency described are deliberately kept very general. To what extent they emerge via the measurement model is an empirical question. Existing studies confirm the graduation proposals - here then with a specific look at the underlying measurement construct and with a stronger differentiation regarding the field of economics and administration (Deutscher and Winther, 2018^[26]).

References

- Baethge, M. (2006), *PISA-VET: A Feasibility-Study*, Franz Steiner Verlag. [3]
- Baethge, M. and L. Arends (2009), “Die Machbarkeit eines internationalen Large- Scale-Assessment in der beruflichen Bildung: Feasibility Study VET-LSA. Eine komparative Analyse von Ausbildungsinhalten und Berufsprofilen in acht Europäischen Ländern.”, *Zeitschrift für Berufs- und Wirtschaftspädagogik*, Vol. 105/4, pp. 492-520, <https://doi.org/10.25162/zbw-2009-0036>. [5]
- Baumert, Bos and Lehmann (2000), *TIMSS/III: Dritte Internationale Mathematik- und Naturwissenschaftsstudie — Mathematische und naturwissenschaftliche Bildung am Ende der Schullaufbahn*, Leske u. Budrich, <https://doi.org/10.1007/978-3-322-83411-9>. [24]
- Deutscher, V. and E. Winther (2018), “Instructional sensitivity in vocational education”, *Learning and Instruction*, Vol. 53, pp. 21-33, <https://doi.org/10.1016/j.learninstruc.2017.07.004>. [26]
- Doyle, W. (2000), *Authenticity*, Paper presented at the annual meeting of the American Educational Research Association (AERA), New Orleans. [28]
- Dummert, S. (2021), “Employment prospects after completing vocational training in Germany from 2008-2014: a comprehensive analysis”, *Journal of Vocational Education & Training*, Vol. 73/3, pp. 367-391, <https://doi.org/10.1080/13636820.2020.1715467>. [1]
- Hoidn, S. and V. Šťastný (2021), “Labour Market Success of Initial Vocational Education and Training Graduates: A Comparative Study of Three Education Systems in Central Europe”, *Journal of Vocational Education & Training*, Vol. 75/4, pp. 629-653, <https://doi.org/10.1080/13636820.2021.1931946>. [2]
- Holtsch, D. et al. (2016), “Challenges of a cross-national computer-based test adaptation”, *Empirical Research in Vocational Education and Training*, Vol. 8/1, <https://doi.org/10.1186/s40461-016-0043-y>. [22]
- Jordanski, G. (2019), “Kompetenzen für die digitalisierte Arbeit von morgen – Industriekaufleute”, *In K. Wilbers (Hrsg.), Digitale Transformation kaufmännischer Bildung: Ausbildung in Industrie und Handel hinterfragt*, pp. (S. 119–146) epubli GmbH, Berlin. [12]
- Jürgen Baumert, W. (ed.) (2000), *TIMSS/III Dritte Internationale Mathematik- und Naturwissenschaftsstudie — Mathematische und naturwissenschaftliche Bildung am Ende der Schullaufbahn*, VS Verlag für Sozialwissenschaften Wiesbaden, <https://doi.org/10.1007/978-3-322-83411-9>. [31]
- Kilpatrick, J., J. Swafford. and B. Findell (eds.) (2001), *Adding It Up: Helping Children Learn Mathematics*, Mathematics Learning Study Committee, National Research Council, Washington, D.C., <https://doi.org/10.17226/9822>. [27]
- Klotz, V. (2015), *Diagnostik beruflicher Kompetenzentwicklung: Eine wirtschaftsdidaktische Modellierung für die kaufmännische Domäne*, Springer Fachmedien Wiesbaden; Springer Gabler. [7]
- Marzano, Kendall (2007), *The new taxonomy of educational objectives (2nd ed.)*, Corwin Press, California. [21]

- Masters, G. (1982), "A rasch model for partial credit scoring", *Psychometrika*, Vol. 47/2, pp. 149-174, <https://doi.org/10.1007/bf02296272>. [29]
- OECD (2019), *The Survey of Adult Skills : Reader's Companion, Third Edition*, OECD Skills Studies, OECD Publishing, Paris, <https://doi.org/10.1787/f70238c7-en>. [18]
- OECD (2015), *Adults, Computers and Problem Solving: What's the Problem?*, OECD Skills Studies, OECD Publishing, Paris, <https://doi.org/10.1787/9789264236844-en>. [17]
- OECD (2012), *Literacy, Numeracy and Problem Solving in Technology-Rich Environments: Framework for the OECD Survey of Adult Skills*, OECD Publishing, Paris, <https://doi.org/10.1787/9789264128859-en>. [16]
- OECD (1996), *Literacy, Economy and Society: Results of the First International Adult Literacy Survey*, OECD Publishing, Paris, https://www.digizeitschriften.de/de/dms/met/?ppn=ppn509215866_0049&dmdid=dmdlog61. [15]
- OECD/Eurostat/UNESCO Institute for Statistics (2015), *ISCED 2011 Operational Manual: Guidelines for Classifying National Education Programmes and Related Qualifications*, OECD Publishing, Paris, <https://doi.org/10.1787/9789264228368-en>. [4]
- Pellegrino, J., N. Chudowsky and R. Glaser (2001), *Knowing What Students Know*, National Academies Press, Washington, D.C., <https://doi.org/10.17226/10019>. [19]
- Porter, M. (1985), *Competitive Advantage: Creating and Sustaining Superior Performance*, Free Press. [10]
- Rauner, F. et al. (2009), *Messen beruflicher Kompetenzen: Band I: Grundlagen und Konzeption des KOMET-Projektes*, LIT Verlag. [25]
- Rausch, A. et al. (2021), "Die web-basierte Bürosimulation LUCA – Funktionen, Einsatzmöglichkeiten und Forschungsausblick", *Zeitschrift für Berufs- und Wirtschaftspädagogik*, Vol. 117/3, pp. 372-394, <https://doi.org/10.25162/zbw-2021-0017>. [20]
- Rüegg-Stürm, J. and S. Grand (2020), *Das St. Galler Management-Modell: Management in einer komplexen Welt (2., überarbeitete Auflage)*, Haupt Verlag, <https://doi.org/10.36198/9783838554990>. [11]
- Sangmeister, J. et al. (2018), "Designing Competence Assessment in VET for a Digital Future", in Ifenthaler, D. (ed.), *Digital Workplace Learning (S. 65–92)*, Springer International Publishing, Cham, https://doi.org/10.1007/978-3-319-46215-8_5. [23]
- Seeber, S. and J. Seifried (2019), "Herausforderungen und Entwicklungsperspektiven der beruflichen Bildung unter veränderten Rahmenbedingungen, Challenges and development prospects for vocational education and training in times of changing socioeconomic and technological conditions", *Zeitschrift für Erziehungswissenschaft*, Vol. 22/3, pp. 485-508, <https://doi.org/10.1007/s11618-019-00876-2>. [13]
- Wigdor, A. and B. Green Jr. (1991), *Performance Assessment for the Workplace. Technical issues, 1(2)*, National Academies Press, Washington, D.C., <https://doi.org/10.17226/1862>. [9]
- Williams, A. et al. (2017), "Systems thinking: A review of sustainability management research", *Journal of Cleaner Production*, Vol. 148, pp. 866-881, <https://doi.org/10.1016/j.jclepro.2017.02.002>. [14]

- Wilson, M. and K. Draney (2004), “Some Links Between Large-Scale and Classroom Assessments: The Case of the BEAR Assessment System”, *Yearbook of the National Society for the Study of Education*, Vol. 103/2, pp. 132-154, <https://doi.org/10.1111/j.1744-7984.2004.tb00051.x>. [30]
- Winther, E. (2010), *Kompetenzmessung in der beruflichen Bildung*, wbv Publikation, Bielefeld, <https://doi.org/10.3278/6004148w>. [6]
- Winther, E. and V. Klotz (2016), “Berufliche Kompetenzniveau modellierung : Eine Blaupause für die kaufmännische Domäne”, *Unterrichtswissenschaft*, Vol. 44/2, pp. 131-146. [8]

Further reading

- Klotz, V., Winther, E. and Festner, D. (2015), “Modeling the Development of Vocational Competence: A Psychometric Model for Economic Domains”, *Vocations and Learning*, Vol. 8(3), pp. 247–268, <https://doi.org/10.1007/s12186-015-9139-y>.
- Baumert, J., Bos, W. and Lehmann, R (2000), *TIMSS/III – Dritte Internationale Mathematik und Naturwissenschaftsstudie – Mathematische und naturwissenschaftliche Bildung am Ende der Schullaufbahn; Band 1: Mathematische und naturwissenschaftliche Grundbildung am Ende der Pflichtschulzeit; Band 2: Mathematische und physikalische Kompetenzen am Ende der gymnasialen Oberstufe*. Opladen: Leske + Budrich. [Rezension], in *Tertium comparationis* 6 (2000) 2, pp. 198-205, <https://doi.org/10.25656/01:3366>.
- Wiggins, G. (1990), *The Case for Authentic Assessment*, <https://doi.org/10.7275/ffb1-mm19>.
- Wilbers, K. (2019), “Kaufmännische Digitalkompetenzen als Ausgangspunkt der digitalen Transformation beruflicher Bildung”, in K. Wilbers (eds), *Digitale Transformation kaufmännischer Bildung. Ausbildung in Industrie und Handel hinterfragt*, pp. 11–72, epubli GmbH.

5 Healthcare

This chapter defines healthcare as assessed by PISA-VET and elaborates the framework for this occupational area that has been designed for the Development Phase of the project, including descriptions of the competencies and constructs to be assessed. It presents and explains the processes, content knowledge and contexts and provides several sample items with descriptions of task characteristics. The chapter also discusses how performance in healthcare is measured and reported against proficiency levels and scales.

Introduction

This chapter identifies and defines a medium-skill occupation within the broad “healthcare” occupational area for the purpose of assessment by the PISA-VET project. It elaborates the framework for the occupation for the Development Phase of the PISA-VET project, including descriptions of the competencies and constructs to be assessed. It presents and explains the processes, knowledge, and contexts reflected in the occupation and provides several sample items with descriptions of task characteristics. The chapter also discusses how performance in initial VET healthcare programmes can be measured and reported against proficiency levels and scales.

The rationale for the inclusion of a healthcare occupation in this Development Phase is strong considering its large economic and societal importance and its continued relevance in ageing societies. As a sector, healthcare is in widespread demand, with a large student population in formal VET programmes worldwide (Bjornavold and Chakroun, 2017^[1]). While the scope of healthcare provision varies in national and regional cultures and settings, there is also a significant common core of competencies across the world (WSI, 2022^[2]). Highlighted as the third UN Sustainable Development Goal (ensure healthy lives and promote well-being for all at all ages), demand and need for good healthcare will require constant evolution in the partnership between the healthcare provider, the circumstances, and the technologies to hand (UN Department of Economic and Social Affairs, 2022^[3]).

Defining the healthcare occupational area

The purpose of the PISA-VET framework is to encompass VET learners on a trajectory to become skilled professionals able to make well-rounded judgements and decisions, in healthcare in this instance (OECD, 2023, p. 6^[4]). Therefore, the aim of this section of the chapter is to:

- a) Use the availability of global and international classifications to help define healthcare as an occupation and in this instance the equivalent of the healthcare domain.
- b) Identify the trajectory through which learners may become skilled professionals, together with their intermediate destinations and milestones.
- c) Build on the lessons of the last 15 years regarding the opportunities for and challenges of international comparative assessments and judgements in healthcare occupations.

While the classifications are occupational, as a minimum they indicate the extent of learning required to fulfil each role. The literature search and analysis that follows discusses qualifications and their relationship with occupational requirements as required in the context of this project.

Healthcare occupational area definitions

The healthcare occupational area comprises many different types of occupations at various levels of qualification requirements. Given that the focus of PISA-VET is on VET programmes at ISCED levels 3 to 5, healthcare occupations that typically require bachelor’s, master’s or doctorate qualifications are excluded, and the focus is instead on medium-skill healthcare occupations. Within the 2008 International Standard Classification of Occupations (ISCO-08) medium-skill healthcare occupations most closely fall within Unit Group 5321 “Healthcare Assistant”. Unit Group 5322 “Home Based Care Assistant”, is also partially relevant since a Healthcare Assistant may work in the home as well as other settings.¹ Health care assistants are defined as providing direct personal care and assistance with activities of daily living to patients and residents in a variety of health care settings such as hospitals, clinics and residential nursing care facilities. They generally work in implementation of established care plans and practices, and under the direct supervision of medical, nursing or other health professionals or associate professionals. Home-based personal care workers provide routine personal care and assistance with activities of daily living to

persons who are in need of such care due to effects of ageing, illness, injury, or other physical or mental condition in private homes and other independent residential settings.

Based on international occupational classifications, there appears to be a broad role, referred to as healthcare assistant, and a role of nursing assistant which may be more specifically focused on nursing rather than nursing and caring. Since both roles sit within the pathway to registered nursing occupations, and in some instances nursing assistant is regarded as a subset of healthcare assistant, it is appropriate to embrace both within the definition of the occupation. As a result, the term ‘healthcare/nursing assistant’ will be used from this point onwards where it relates directly to the focus of the occupation for OECD’s PISA-VET.

The role of the healthcare/nursing assistant, which is classified as a service worker, is accessed by certification or recognition following structured preparation of different types and lengths. Table 5.2 provides an overview of the main VET qualifications for these roles in several countries. Through the length and quality of the preparation, some national systems extend their entry arrangements to incorporate preparation for healthcare associate professional roles. This is particularly the case where there is mixed mode (work and study) delivery. Therefore, given the purpose of the PISA-VET framework, while focusing on initial entry programmes associated with ISCO 5321, account has been taken of the fluidity of the relationship with associate professional roles (ISCO 3221 – Nursing Associate Professionals) in the scoping of this domain.

Table 5.1. Main programmes leading to qualified healthcare/nursing assistant status

Information	Australia	Germany	Portugal	United Arab Emirates
Title of qualification	HLT54121 Diploma of Nursing	State Certified Nursing Assistant		Certificate 4 in Health Care Science Diploma in Health Care Assistant
Programme duration	18-24 months	Up to 36 months	Up to 36 months	24-36 months
Qualification level	AQF 4	EQF 4	EQF 3 and 4	QF Emirates 4,5
ISCED level	3, 4	3, 4	3, 4	3, 4

International comparability of the occupational area

The VET-LSA Feasibility Study (Baethge and Arends, 2009) was designed to learn if there was a common basis for comparing four selected vocational programmes in each of eight participating European countries. The comparison was focused on a “medium level of proficiency, that is, initial VET programmes at ISCED level 3 and corresponding to occupations requiring medium or considerable vocational preparation” (Baethge and Arends, 2009: 7). As one of the four programmes, social and healthcare programmes were found to have distinct characteristics within each country “due to differing political, historical, and cultural backgrounds” (Baethge and Arends, 2009: 85). The relationship of each programme to health on the one hand, and society on the other, was an identifiable factor. Although the Study initially excluded social care and “half-nursing,” ultimately it derived a frame of reference from several O*NET occupational profiles, including social care. The “work object” featured in the Study as “a person in a situation needing help” may indicate the greater breadth of the programmes studied, relative to this chapter’s remit (Baethge and Arends, 2009: 85), which is understood to relate to health needs rather than needs more generally. Notwithstanding variations across the selected vocational programmes, the LSA-VET expert group identified five core areas of commonality, amenable to evaluation across the eight participating European countries (Baethge and Arends, 2009, p. 120^[5]).

WorldSkills International (WSI) has a WorldSkills Occupational Standard for “Health and Social Care” that has been updated biennially since 2012 (WSI, 2022^[2]), and seeks to comprise the competencies that represent medium-level occupational mastery across its membership of 85 nations and regions.

Between 2015 and 2017, a project led by Cedefop and UNESCO analysed and documented the use of learning outcomes from the perspectives of the education and training sector and labour market stakeholders (a) within the European Union (Auzinger, Broek and Luomi-Messerer, 2017^[6]), and (b) worldwide (Bjornavold and Chakroun, 2017^[11]). Ten VET qualifications were reviewed in 10 EU countries, and four were reviewed in 26 countries worldwide, looking at the existence, content and comparability of the qualifications – including medium-level healthcare qualifications. Findings included that healthcare qualifications were newer than qualifications in other occupational areas covered by the analysis and not always present; that relevant qualifications were rated at ISCED 3; and that the relationship between healthcare qualifications and the skills included in the European Skills, Competences, Qualifications and Occupations (ESCO, 2020^[7]) classification was relatively weak.

These findings were supported by an overview of healthcare assistants in EU Member States (Kroezen et al., 2018^[8]), which noted:

“It is shown that most learning outcomes for healthcare assistants across Europe are defined in terms of knowledge and skills, often at a basic instead of more specialized level, and much less so in terms of competences. While there are many differences between member states, there also appears to be a common, core set of knowledge and skills-related learning outcomes which almost all healthcare assistants across Europe possess.”

To conclude: the evidence for a common core of knowledge, skills, and competences relating to the domain of healthcare/nursing assistant is well supported by the literature. The diversity that exists for historical and cultural reasons does not undermine this evidence; it does, however, call for continuing awareness of factors that may have a bearing on assessment. Attitudes to pain, the family, women, the rights of particular social or ethnic groups, and cultural norms, all vary across the world, and may impact on teaching, learning, and practice. Awareness of this will therefore be essential when making comparative judgements.

Organising the domain of healthcare/nursing assistant

Given the diverse understanding and practice of medium-skill healthcare occupations across the world (Bjornavold and Chakroun, 2017^[11]), to organise the domain for international comparative assessment, the contexts, processes, and knowledge are required to be:

- universally recognised as core
- amenable to interpretation, assessment as well as evaluation at several levels
- culturally neutral.

Using the above principles for selection, this section deals with processes, content knowledge, and contexts. Considerable material exists to draw upon and retain, while excluding material that is specialist, culturally or historically determined.

Contexts

Context categories

The choice of healthcare strategies, plans, and interventions is highly dependent on context, which is wide-ranging. To discuss context, five aspects or categories are considered, each of which is relevant to the role of healthcare/nursing assistant.

- The place or location.
- The client or patient.

- The illness, injury, and disability.
- The situation in which care and treatment are needed.
- Regulatory and organisational requirements.

Each of these has a lesser or greater importance in determining the healthcare/nursing assistant's actions; they may also impact on one or more of the others. When under instruction, for example in a hospital, the range of choice may be very limited; in other circumstances, a client's home, in normal circumstances the range of choice may be considerable.

The place or location

While there is a top-level distinction between a hospital and a home-like environment, in practice, there is a complex web of settings, the number and purpose of each depending on each nation's and region's healthcare system and history. The menu of settings is wide:

- Hospitals: inpatient or outpatient facilities, specialist or general.
- Clinics for specific purposes and conditions (e.g. psychiatric, geriatric).
- Residential nursing care.
- Hospices for terminal care.
- Clients' and patients' own homes.

For the healthcare/nursing assistant, there is a gradient of formal care plans and supervision from established and high for inpatient care to more diverse and open in clients' own homes. This reflects the reason for the client or patient being in a particular place or setting.

The client or patient

Within this chapter both 'client' and 'patient' are used to denote the person using healthcare services. According to context, 'client' is used in relation to wellbeing and preventative services, and 'patient' is used in relation to medical services and treatments.

Numerically, the population most in need of the healthcare/nursing assistant's role will be the elderly. However, depending on context, a health need may occur at any point from before birth to after death. Across the lifespan, needs associated with specific ages and stages may lead to specialisation, for example in the needs of the child, or the elderly. For international comparative assessment, while care of the elderly is generally seen as a core part of the role, care of the child lies outside this role's compass.

The age range is therefore proposed to be:

- adolescence
- adulthood
- old age.

Illness, injury, and disability

A healthcare/nursing assistant may encounter patients/clients with a range of temporary, permanent, or deteriorating conditions, separately or in combination. Their response will depend upon the purpose of their visit, within the care or treatment plan, and the regulatory framework in place. The conditions can be grouped in illnesses, injuries, surgeries, and disabilities.

Situations

There are multiple dimensions to the situations. A situation may be planned or unplanned from the outset, as with responding to a fall at home by a frail client. A routine visit may give rise to unexpected challenges during treatment: for example, a client refuses care.

There are many planned transitions in the care and nursing cycle for the healthcare/nursing assistant to respond to, as the client or patient recovers, or stabilises, or deteriorates. For a number of these, for example, arranging transport for a patient moving to hospice care, the role of the healthcare/nursing assistant may be administrative and logistical as much as directly supportive of the client or patient.

Situations also entail a range of people representing both the client or patient, and the web of professions that represent the healthcare sector.

Regulatory and administrative requirements

Legal, regulatory, and administrative requirements are a constant feature of healthcare assistance. Healthcare is a regulated profession at all levels, included intermediate roles. This feeds into its administration, which is the foreground of regulation. Regulation normally includes a framework for audit and quality: compliance, acceptable practice, and improvement.

The healthcare/nursing assistant has a personal responsibility to know and work within their national legal framework and operational regulations. This ranges from ensuring the health and safety of clients, patients and themselves, to striving for best professional practice in life enhancement. In line with operational standards, they manage consumables and agreed medicines, and keep apparatus and furniture operational. They use resources with purpose, efficiency, and environmental consciousness, and dispose of materials according to legal, organisational, and ecological good practice. They are expected to stay up to date with the law and regulations, and to raise non-compliant incidents and practice without hesitation.

Desired distribution of items by context category

Maintaining the focus on the client or patient, and their illness, injury, or disability, which are inseparable, items most closely focused on these should have the highest proportion of items, followed by the situation, which is closely associated to the person and their health need. Place and formal requirements are significant determinants of actions; however, since these are not the purpose of the actions, they rate lower.

Table 5.2. Percentage of items by context

Context category	Sub-categories	Weighting across each sub-category
The place or location	Hospital	4
	Day care	4
	Residential Care	4
	Home care	4
	Hospice	4
	Total	20
The client or patient	Adolescence	4
	Adulthood	7
	Old age	9
	Total	20
Illness, injury, and disability	Illness	5
	Injuries	5
	Surgeries	5
	Disability	5
	Total	20
Situations/incidents	Accident	5
	Falls	5
	Burns	5
	Cardiac arrest	5
	Total	20
Regulatory, professional, and administrative requirements	Health care	7
	Professional standards	7
	Administrative requirements	6
	Total	20

Healthcare/nursing assistant processes and the underlying occupational capabilities

Five occupational processes have been identified that meet the criteria for international comparison, are balanced in their significance to the role and, when taken together, require all the capabilities looked for following initial vocational education and training to equip individuals for roles as healthcare/nursing assistants. The five proposed occupational processes are:

- Work in professional teams.
- Identify needs and collaborate in healthcare planning.
- Support and enhance clients' quality of life.
- Provide and support treatment and medical processes.
- Review and evaluate care.

While other taxonomies exist, for the scope of determining occupational capabilities related to these processes, Cedefop's discussion of universal descriptors, drawn from the Educational Research Institute (Cedefop, 2022, p. 25^[9]), is used. Bloom's taxonomy for cognitive, psychomotor, and affective domains, as set out in Cedefop (2022, p. 62^[9]), offers more detail and creates a link with level descriptors for ISCED purposes (see Figure 5.1).

Figure 5.1. Bloom's taxonomy: cognitive, psychomotor, and affective domains

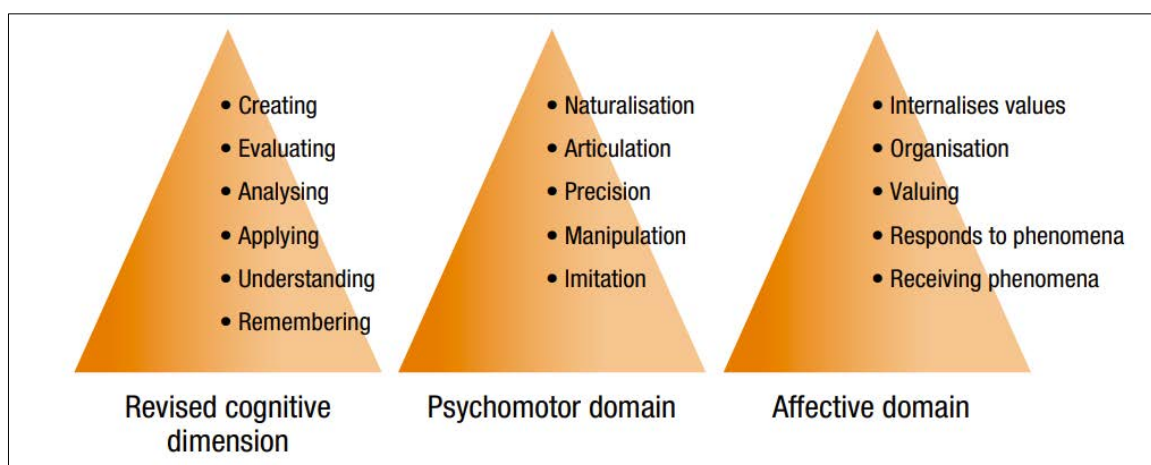

Source: Cedefop (2022: 62)

The following ten capabilities resonate with the five processes and Bloom's taxonomy:

- collaboration with others to achieve optimal healthcare
- open mindedness throughout the healthcare process
- engagement with others for therapeutic relationships
- communication as a therapeutic instrument
- emotional regulation to achieve optimal healthcare
- access to and use of evidence and information to support healthcare solutions
- management of self, time, tasks and workspace to optimise healthcare solutions
- coordination of mind, feelings, and movement for dextrous, respectful healthcare
- contribution to healthcare solutions
- reflective practice for healthcare.

The five processes and underlying ten capabilities are described in detail below.

Processes

Work in professional teams

Healthcare is a purposeful social undertaking, requiring teams of similar and different contributors drawn from many disciplines, cultures, and groups. The healthcare/nursing assistant has therefore both to present and maintain a professional demeanour and recognise and respect difference and diversity. According to their role, status, and specialisms, the healthcare/nursing assistant must contribute to the healthcare team formally and informally. Formally they receive, gather, provide, and retain information, fulfil their obligations, and meet deadlines. They understand interdependencies, follow instructions, raise concerns promptly, and act as advocates when needed. Informally they earn respect and trust through their foresight and insight, discretion, and consideration. When issues and conflict arise, the healthcare/nursing assistant responds openly but with discretion, calmly, and rationally, notwithstanding the pressure on them and others.

Identify needs and collaborate in healthcare planning

Healthcare/nursing assistants contribute to the nursing process – which is managed mostly by qualified nurses- by identifying changes and needs and adapting measures in collaboration with the nurses. According to the status of the healthcare/nursing assistant, and the context, aspects of planning may be delegated, under the supervision of the nurse, who retains this responsibility.

Support and enhance clients' quality of life

Healthcare is about the care of people with health-related needs and covers wellbeing and life enhancement. The healthcare/nursing assistant will support the health and wellbeing needs of individuals of all ages and with a wide range of challenges for health reasons and which are closely associated with the medical profession. Owing to the nature of the needs, and the situation of each client, the range of needs, individuals, and settings will be very wide-ranging. Within those settings, the healthcare/nursing assistant manages health, physical, and psychosocial well-being, supports growth and development, caring and rehabilitation. The support provided follows a planned and reflective process, always taking full account of the nature and limitations of the environment to ensure the safety of the client and others, to avoid the risk of infection, and promote good hygiene. Great care is taken in the transportation, use, storage, and disposal of material and equipment.

The healthcare/nursing assistant takes a strong interest in the client in order to develop a deep understanding of their biography, character, and medical condition, and to win their trust. They respect clients' autonomy, beliefs, norms, and right to refuse care. They use therapeutic communication techniques to establish rapport and communicate with clients who have disabilities in communication and understanding. They use coaching techniques to enable clients to develop or restore life skills and establish positive relations with clients' families and other supporters. Maintaining a realistically open and positive outlook, they will organise educational and rehabilitative activities in an age- and culturally- appropriate way.

Provide and support treatment and medical processes

In hospitals and other healthcare settings where professional nursing roles are required, the healthcare/nursing assistant may have a significant support role during clinical investigations, interventions, and treatment.

Here they perform quality nursing care within the scope of their permitted practice, such as hygiene care, first aid, wound care, and breathing exercises. They monitor and report on different health parameters, such as blood pressure, temperature, pulse, respiration, blood sugar, pain score, and weight. They take precautions to avoid common risks for sick patients, such as infection, pressure ulcers, falls, pneumonia, and contractures. They record and update patients' medical information and identify and report on problems that require referral. They collaborate with patients, families, nursing colleagues, other healthcare professionals, and the community to ensure continuity of care.

They may be expected to prepare rooms, sterilise instruments, provide equipment or supplies, and ensure that the stock of supplies is maintained. They provide a safe environment for patients and staff including implementing infection control procedures.

Healthcare/nursing assistants help to optimise patients' conditions by encouraging their independence through mobilisation, use of mobility devices and nutritional wellbeing. They may advise patients on the administration and storage of common drugs and medication, and their potential side effects. Within the limits of their authority, they plan and schedule their assigned tasks to avoid rushing patients or disrespecting their needs. In hazardous and potentially hazardous settings, the healthcare/nursing assistant uses resources efficiently and effectively and discards waste safely and ecologically.

Review and evaluate care

Review and evaluation are a recurrent, almost continuous, process, at a basic level, and for the healthcare/nursing assistant are most complex in formal settings. Reviews must be grounded in a context and purpose because what is “worth doing” may vary from providing palliative care, through to recuperation and discharge, or the maintenance and enhancement of a life limited for health reasons. Ongoing review may be as simple as continuously encouraging feedback from clients through careful discussion, to enhance the therapeutic relationship. In some settings, the healthcare/nursing assistant may seek feedback from clients’ families and other supporters, and from their own colleagues and related professionals. In these instances, the outcome may be continuous improvement through small changes.

More formal reviews and evaluation will be information- and data-led, which underscores the need to good record keeping and storage. Given the organic nature of healthcare, review and evaluation may be 360° in nature, entailing critical self-review for the healthcare/nursing assistant. Irrespective of the formal requirement, they are expected to be reflective practitioners who seek and act on feedback from a range of trusted sources. This carries with it the responsibility to maintain and update their knowledge, understanding, practice, and compliance with new regulations. For the reflective healthcare/nursing assistant, review and evaluation is the opportunity for innovation and creative solutions in a complex service occupation.

Desired distribution of items by healthcare processes

The goal in constructing the assessment is to achieve a balance in the weighting that reflects the primary focus of the processes described above. The distribution in Table 5.3 reflects the prime focus on the client and patient that runs through this chapter. They represent the core purpose of the role, which the other three processes serve and enable.

Table 5.3. Desired distribution of healthcare/nursing assistant items, by process

Process category	% of items in the assessment
Work in professional teams	15%
Identify needs and collaborate in healthcare planning	15%
Support and enhance clients' quality of life	30%
Provide and support treatment and medical processes	30%
Review and evaluate care	10%
Total	100%

Fundamental healthcare capabilities underlying healthcare processes

The role of healthcare/nursing assistant is holistic as well as diverse. The provision of care to clients and patients is based on a mutual understanding of their physical, psychological, emotional, and spiritual dimensions. To varying extents, the formation of healthcare/nursing assistants is a process of professional socialisation, particularly where the learning contains a work-based element.

Nominally, a number of underlying capabilities for healthcare/nursing assistants resemble the OECD’s Survey for Social and Emotional Skills. Where this is the case, the essential differences between the SSES and the underlying capabilities for the healthcare/nursing assistant are in context, application, and extent, as befits a professional healthcare role. Healthcare/nursing assistants deal with clients and patients who depend upon them, whether they are temporarily or continuously impaired, and when, for whatever reason, their ability to communicate is likely to be restricted or lacking. Often, healthcare/nursing assistants are in situations the client’s or patient’s condition cannot improve. At the same time, they must articulate

themselves in a professional medical and health environment, using appropriate terminology and structures, while generally being at the lower end of the professional hierarchy.

Collaboration with others to achieve optimal healthcare

The purpose of collaboration is to expand the available resources to overcome a problem. Given the complexity of human health, collaboration is a defining feature of healthcare. At its most basic, there must be collaboration between the provider of healthcare and the recipient, who for therapeutic reasons is better regarded as a partner in their recovery or stabilisation. In the community, collaboration may also embrace family and friends. When healthcare needs become more complex, collaboration may be more planned and structured, involving new resources and agencies. The healthcare/nursing assistant is an essential member of larger professional teams, with a support role in the immediate or midterm service of clients and patients.

In their professional role, the healthcare/nursing assistant must keep in mind the purpose of the collaboration, and their position within it. Irrespective of the need, they must demonstrate trustworthiness, dependability, and empathy, while at the same time maintaining their professionalism, which requires objectivity, emotional regulation, and discretion. These attributes will serve them well when complexities arise, as they normally will. As part of the collaborative team the healthcare/nursing assistant should have the ability to give and take feedback, acknowledge the experience, ideas, and contributions of others, and take account of their feelings, concerns, and opinions.

Open mindedness throughout the healthcare process

The management and treatment of ill health is complex. Health needs take many forms and may impact on people at all and any points in life. Clients and patients vary by age, gender, ethnicity, culture, lifestyle, and other factors, united solely through a need for professional support for health reasons. The natural material world, with which healthcare interacts, is in constant flux, often defying certainties and requiring open mindedness in response. A further complexity is the diversity of values which requires an objective awareness of context, norms, relativities, and absolutes.

The healthcare/nursing assistant requires an informed understanding of, and respect for, human diversity, especially where a health need creates vulnerability for the client or patient. Notwithstanding that vulnerability, the client or patient is a partner in their recovery or sustainability, to the extent that their personal agency may be the key to their recovery or wellbeing. This provides an opportunity to explore new approaches, advance, adapt, or delay certain treatments in consultation with others or under the authority of the healthcare /nursing assistant, who may be a partner, mediator, advocate, or restraint, drawing on their underpinning knowledge and understanding to maintain or restore the client's or patient's equilibrium.

In the healthcare context, the term “open mindedness” refers to learned professional behaviours, which are explored under “communication” and “emotional regulation”. It connects with open mindedness as a generic social and emotional skill, but occupationally is realised through specific professional capabilities.

Engagement with others for therapeutic relationships

Where there is a client or patient, healthcare is inherently social. The healthcare/nursing assistant requires a sociable disposition which is mediated through their professional attributes and behaviours. The ability to engage with the patient or client, to respect them and empathise with their situation and condition, is a positive attribute for recovery and wellbeing. A therapeutic relationship needs to be established with all contributors to health, including the client or patient. However, the healthcare/nursing assistant has a distinct role with its own agency in the healthcare process, and the exercise of that agency by taking initiative, injecting energy and optimism, is a significant contribution to healthcare. The healthcare/nursing

assistant may be the most regular or frequent contact for the client, and in some instances the most approachable. Therefore, a consistently sociable demeanour, requiring in some circumstances considerable resilience, is a key attribute of the healthcare/nursing assistant.

Communication as a therapeutic instrument

Ill health and/or disability make a client/patient vulnerable. This both restricts their ability to communicate effectively and increases their need for effective communication by the healthcare team. Outside the hospital environment, the healthcare/nursing assistant may be the individual upon whom the client/patient most depends, to inform, interpret, and explain their health need and situation. The inability to communicate and be understood may cause deep distress and worsen health conditions.

Where due to age or infirmity the client/patient is unable to initiate, respond, or understand verbal communication. The healthcare/nursing assistant must show empathetic perception, by using each of their own senses, and communicate empathetically. They must seek or create alternative forms of communication to the spoken or written word, potentially using facial expression, signs and gestures, pictures, and/or assistive technology. They may require imagination and creativity in order to listen, interpret, anticipate, encourage and reassure the client/patient.

Emotional regulation to achieve optimal healthcare

The healthcare/nursing assistant is the person who retains control of their emotions in order professionally to support others in emotional and stressful situations. The healthcare/nursing assistant works in emotionally charged situations, with clients, patients, their family and friends who have cause for distress and will respond in diverse ways. Their role is to provide supportive environments for the expression of grief or distress; to keep distressed people safe; and make referrals as required. This constitutes emotional labour for which high levels of stress resistance need to be developed, together with the ability to recognise when they should or must seek help. Self-monitoring helps the healthcare/nursing assistant to understand the causes of their own concern and distress, their personal emotional capabilities, and the need to sustain their own wellbeing.

Access to and use of evidence and information to support healthcare solutions

At an intermediate level, the healthcare/nursing assistant constantly monitors, assesses, and makes small and nuanced decisions generally regarding recovery and wellbeing, but also terminal care. They must be alert to clients' and patients' conditions such as distress and pain, recognise or infer causes, report on and alert others to clients' and patients' conditions. Their role is rooted in the natural material world, for which they need to understand scientific concepts and theories and have a working knowledge of scientific procedures and practices. These are the foundation on which their expertise is built. Since measurement and estimation are constant elements of client and patient care, the role also requires an equivalent grounding in mathematics and the natural sciences. Linked to this is the ability to use equipment correctly, record, and interpret data. Since digitalisation and automation has an increasing presence in healthcare, the healthcare/nursing assistant must have ICT skills and be a conscious, discriminating user of ICT and social media.

Healthcare requires human decision-making, in which context, emotion, bias, and capacity are factors. With the welfare of the client and patient at stake, healthcare/nursing assistants need to know and understand what is normal, and what is within and outside given ranges. Data rationality is a vital learned professional skill irrespective of circumstances and pressures.

Management of self, time, tasks, and workspace to optimise healthcare solutions

Healthcare requires effective management of self, time, tasks, other people and workspace to optimise health outcomes. The role of healthcare/nursing assistant is complex in these respects. In many circumstances quality of care may clash with priorities and pressures of time. With a caseload of clients and patients, the calls upon underlying knowledge and experience may be far-reaching. Limitations of the environment and access arrangements may distract or worse. To manage these factors requires an unerringly methodical approach, with a high level of awareness of self, clients/patients, and settings, such as a hospital ward.

Health and safety considerations are constant features of task performance, with many factors at play relating to the client/patient, the environment, equipment, and materials. Risk assessments, plans, and reports are regulatory requirements and essential for both the client/patient's and the healthcare/nursing assistant's safety and wellbeing.

Coordination of the mind, feelings, and movement for dextrous, respectful healthcare.

Psychomotor skills epitomise the professional client/patient relationship in action. Often referred to as "head, heart, and hands", the ideal healthcare/nursing assistant's movements combine cognition, empathy, and dexterity, for example in respectful touching. Coordination, grace, strength, delicacy, and speed are learned behaviours that engender trust and confidence in clients/ patients, ease discomfort and pain, and aid recovery. Psychomotor skills are muscular actions based on mental processes, which develop from imitation and ultimately become naturalised. As an underlying capability, they epitomise the client/patient-facing core of the healthcare/nursing assistant role.

Contribution to healthcare solutions

The purpose of being a healthcare/nursing assistant is to respond to a health-related need or problem within a regulated and managed organisation or structure. In their intermediate role they may have limited autonomy to solve problems, their role being to implement their share of a solution, such as to support the post-operative recovery of a patient in hospital. In other settings, such as a care home, they may have greater autonomy and responsibility to identify and define problems, come up with possible solutions, evaluate the options, choose and implement the solution, and evaluate the outcome. Depending on the problem, the solution may be found through collaboration, referral, or individual creativity and initiative. Examples of problem solving in the home or care environment may include identifying and reporting a pattern of concerning behaviour suggesting deterioration, organising with others a series of recreational activities, or acquiring and setting up a bird table outside an immobile client's window.

Underpinning problem solving are several other capabilities, including data rationality, empathy, and well-founded achievement orientation.

Reflective practice for healthcare

The purpose of the healthcare/nursing assistant's role is to have a positive bearing on individuals' and groups' health, according to their conditions and situations. Given the nature of the natural world and human beings' interactions with it and inside it, the way in which their role is fulfilled is bound to keep changing. This requires reflective practice as a learned habit within the larger review and evaluation systems to which their role is accountable. The focus of review and evaluation includes the client or patient, for whom report structures and systems are normally provided, the context, which may or may not be included in formal reports, and themselves. Self-reflection and learning are essential attributes, and an underlying capability. It underpins self-efficacy, which for the role of healthcare/nursing assistant must include self-care.

Table 5.4. Relationship between healthcare/nursing assistant processes and fundamental capabilities

Capabilities	Processes				
	Work in professional teams	Identify needs and collaborate in healthcare planning	Support and enhance clients' quality of life	Provide and support treatment and interventions	Review and evaluate care
Collaboration with others to achieve optimal healthcare	√	√	√	√	
Open-mindedness throughout the healthcare process	√	√	√	√	√
Engagement with others to achieve therapeutic outcomes	√	√	√	√	√
Communication as a therapeutic instrument	√	√	√	√	
Emotional regulation to achieve optimal healthcare	√		√	√	√
Access to and use of evidence and information to support healthcare solutions	√	√	√	√	√
Management of self, time, tasks, and workspace to optimise health outcomes	√	√	√	√	√
Coordination of mind, feelings, and movement for dextrous, respectful healthcare			√	√	
Contribution to healthcare solutions	√	√	√	√	√
Reflective practice for healthcare	√	√	√	√	√

Healthcare/nursing assistant content knowledge

Content knowledge categories

Across the world, wherever there is a distinct healthcare/nursing assistant role, its core purpose is to help meet the health and care needs of clients or patients, who are living organisms with personal health needs, circumstances, and rights. Beyond this, there is considerable diversity in the scope and limits of the role, and the preparation of young people and adults to fulfil it. As noted above, each nation's and region's healthcare system are a historical, cultural, social, and economic artefact, as are the VET arrangements designed to serve it (Bjornavold and Chakroun, 2017^[1]). To accommodate this, this chapter focusses on the competencies that are (a) universally recognised as “core” to the occupation, (b) amenable to interpretation, assessment, and evaluation at several levels, and (c) culturally neutral. To add to these, effective role execution by a healthcare/nursing assistant requires a blend of social, emotional, physical, mental, and intellectual maturity.

At the heart of PISA-VET is the acknowledgement that an understanding of healthcare content, and the ability to apply that knowledge to the solution of meaningful contextualised problems is fundamental for

success in the healthcare occupation. That is to solve problems and interpret situations in occupational contexts, there is a need to draw upon certain healthcare knowledge.

The five content categories selected reflect the categories explored by the literature discussed above and cross-referenced to international skills classifications like ESCO and O*NET. The categories are:

- Multi-professional collaboration.
- Communication and relationship building.
- Medical and related sciences.
- Client/patient care, service, and assistance.
- Administrative and legal frameworks.

In an experiential, iterative and holistic learning model, each knowledge category contains its own hierarchy, with curricular and pedagogical choices, or opportunism, determining its position and prominence at any one time within a VET programme. In keeping with this, and based on Maggioni and Alexander (2010_[10]), Cedefop (2017_[11]), and the OECD's definitions of learning (OECD, 2019_[12]), the span of each knowledge category is set out as an introduction to 16 cross-cutting knowledge clusters which vary according to their knowledge type: in OECD terms (OECD, 2019_[12]) disciplinary, interdisciplinary, epistemic, and procedural. This is to make a bridge between the more disciplinary origins associated with PISA and the distinctive conceptualisation of knowledge in VET. To reflect the specific nature and demands of healthcare, strategic and conditional knowledge are also considered to be essential knowledge types. Details about the 16 cross-cutting knowledge clusters are provided in the Annex to this chapter.

Multi-professional collaboration

Healthcare is a collaborative process in which the healthcare/nursing assistant combines their expertise with others in multi-professional teams. While each member of the team brings a different perspective and expertise, they must also have inter-disciplinary knowledge and understanding, to apply and combine the contributions of each specialism to resolve given problems. Depending on context, collaboration in providing services will have a prominent role. Within the formal and informal boundaries set nationally and locally, administration and legal frameworks are also determinants for collaboration, as are formal and informal norms, hierarchies, and networks. To fulfil their own role in multi-professional teams, the healthcare/nursing assistant needs to be both literate and numerate to find, absorb, interpret, and work with technical information, both textual and numerical. Tacit knowledge is also essential both to provide good service and to create and sustain mutual trust and confidence with and across teams.

Communication and relationship building

Communication is at the heart of the healthcare/nursing assistant's role and is intrinsic to all their learning and knowledge requirements. It is both a focus for disciplinary knowledge, and a means of unlocking and using other forms of knowledge. There is an extensive new vocabulary to understand and apply, while (re)conceptualising communication as a mode of behaviour and being. Communication is core to the transfer of information, support, and treatment in a therapeutic context, and to the socialisation of intending healthcare/nursing assistants into their professional role. Communication can show respect, create trust, and form a therapeutic relationship upon which recovery or sustainment may be based, both with clients/patients, and colleagues. Where, for whatever reason, the client/patient is unable to initiate, respond, or understand verbal communication, the healthcare/nursing assistant must know and use create alternative forms of communication, potentially using facial expression, signs and gestures, pictures, and/or assistive technology. In patient care, the registered nurse may be the healthcare/nursing assistant's closest colleague, mentor, and role model, from whom most epistemic knowledge is gained. Beyond inpatient care, the client's or patient's relationship with the healthcare/nursing assistant may be the most important factor in preserving their sense of identity and agency.

Medical and related sciences

Medical science covers many subjects which try to explain how the human body works. Starting with basic biology it is generally divided into areas of specialisation, such as anatomy, physiology and pathology with some biochemistry, microbiology, molecular biology and genetics. For an intermediate role, such as healthcare/nursing assistant, the extent to which medical sciences are taught, may vary widely, often determined by the status afforded to the role itself, and where the programme sits in the hierarchy of qualifications and career paths. Good practice suggests that a minimum of anatomy, physiology, and pathology would form an irreducible part of the healthcare/nursing assistant's knowledge and understanding, both for immediate use, and as a foundation for continuing learning. This knowledge is largely disciplinary and relates most directly to client care, service, and assistance. It also influences the quality of communication, relationship building and collaboration.

Client/patient care, service, and assistance

Being mindful of the diversity of VET for healthcare/nursing assistants, which reflects the diversity of the occupation itself, the knowledge in this category is largely epistemic and procedural. The disciplinary knowledge underpinning this category may be regarded as the essentials of the role, irrespective of other divergences. These include (the principles of) person-centred care, health and safety, hygiene, nutrition, first aid, and information handling. This category is quintessential: it is the place where, in various combinations, the healthcare/nursing assistant's grasp of the other content categories is tested.

Administrative and legal frameworks

To a greater or lesser extent worldwide, healthcare is a regulated sector with strict norms and administrative requirements. In their intermediate role, the healthcare/nursing assistant is more personally accountable for what they do than in many equivalent occupations, because the consequences of error and neglect may be severe. This category comprises largely disciplinary content, which needs to be embedded into practice from the start of professional formation.

Content knowledge topics

The 16 cross-cutting content topics that are presented in Annex 5.A vary in their relationship with the three types of knowledge: disciplinary, procedural, and epistemic, required for the role. While the order of the topics broadly relates to the sequence of the five content categories above, each has a different relationship with practice, as befits VET with its distinctive heuristics and significant reliance on conditional knowledge. In broad terms, 12 topics have a strong disciplinary content, and four stress procedural and epistemic knowledge. In keeping with its frequent conditionality, across these topics the knowledge requirement may be presented as applied.

Although most healthcare programmes include healthcare for babies and children, pragmatically the care of individuals below the age of 16 years has been excluded from this framework, due to the complexities of assessment for international comparison. For the same reason, mental illness other than that associated with ageing and the secondary effects of other illness has also been excluded.

Desired distribution by content knowledge category

The table below presents the desired distribution of items in the assessment over the five content knowledge categories. The rationale for this distribution is the same as for the healthcare processes (Table 5.3), namely the primacy of the client or patient, and what most directly serves their needs.

Table 5.5. percentage of items by content category

Content category	Percentage of items in assessment
Multi-professional collaboration	10
Communication and relationship building	20
Medical and related sciences	30
Client/nursing care, service, and assistance	30
Administrative and legal frameworks	10
Total	100

Assessing healthcare/nursing assistant learners

This section of the chapter outlines the approach taken to apply the elements of the framework described in previous sections to PISA-VET. This includes the response formats, item scoring, and the proposed reporting healthcare proficiency. This section also includes examples of test items.

Assessment types and response formats

The assessment model for healthcare

Though related here to medical practitioners,

Figure 5.2 is applicable to and valid across the entire work spectrum. While knowledge and understanding are vital, they cannot replicate or replace the evidence gained from actual performance in real or simulated work settings. To “know about” is different from “can.” For VET assessment, each are essential. A key objective for this section is therefore to propose an approach which includes each layer of

Figure 5.2’s pyramid of performance. For national purposes, summative assessment for VET generally comprises live tests of practice plus tests of knowledge and theory. In so doing it covers actual performance while indicating the extent to which that performance is underpinned, generalised, and built upon through disciplinary, procedural, conditional, and epistemic knowledge and understanding.

The case for live performance assessment within the mix of assessment types is strong, and particularly so for testing procedural knowledge. However, for comparative assessment, testing conditional knowledge will be challenging. The scope and limitations of live performance testing for PISA-VET are worthwhile topics to explore during this development stage of PISA-VET. As explained in Chapter One, limited time is available to assess the employability and occupation-specific skill. For validity at scale, the model developed should be viable for the facilities in which VET programmes have been offered.

Figure 5.2. Miller's Pyramid of Competence

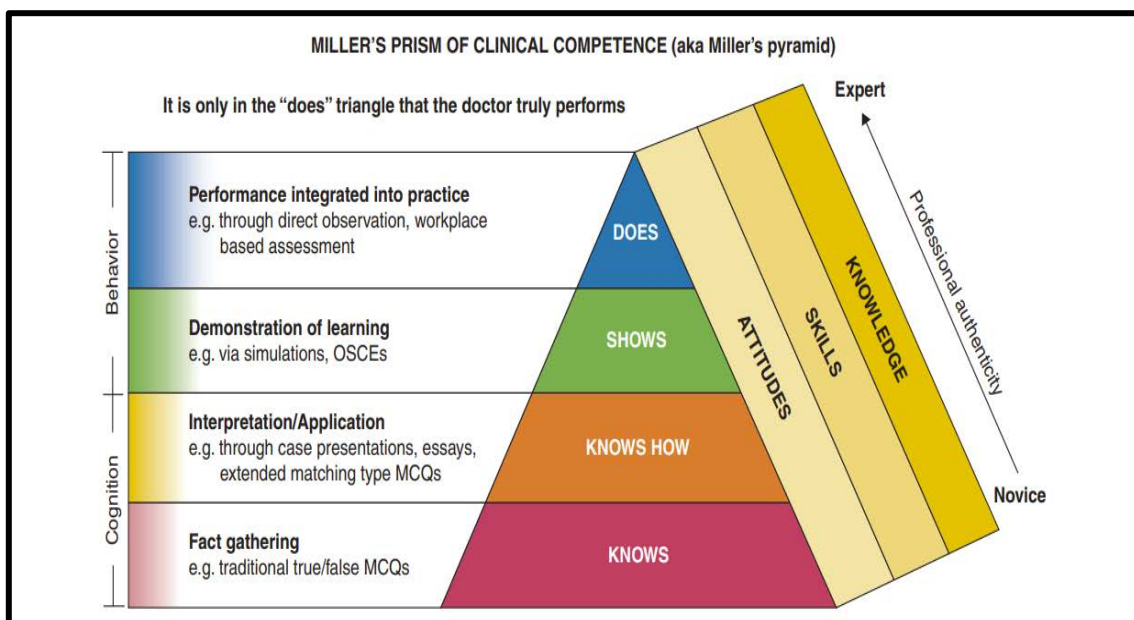

Source: (Miller, 1990^[13])

Scenarios

The main purpose of the healthcare/nursing assistant's role is to serve the client or patient within a therapeutic framework. Due to the holistic nature of the healthcare/nursing assistant's role, a focus on the client or patient also draws on teamwork, planning, frameworks, and review, each of which are means to an end. In keeping with many national assessment systems' practice, the focus on the client and patient leads to scenarios as the starting point and enabler of "knows, knows how, shows, does." These are the hook on which to hang processes, underpinning capabilities, knowledge, and context. To position scenarios for assessment, a template has been created; see Table 5.6.

For two of three assessment types, scenarios should be developed either as a "highly immersive" basis for digitally simulated assessment tasks, as for example the assessments from the ASCOT+ initiative, or for actual live (or video recorded) performance assessment followed or preceded by additional assessment tasks. The aim is to create a menu of scenarios to enable a pair of assessments, one for immersive questioning, and one incorporating live performance, to be used for each assessment cycle. The below template shows a scenario which may be developed further for either immersive questioning, or live performance with live judges, followed by questions.

Table 5.6. Scenario template with sample

Mr. Peterson has had a bad fall		Live or Simulation
Process(es)/ Competencies	Work in professional teams.	
Underpinning capabilities	<ul style="list-style-type: none"> • Open mindedness • Communication • Emotional regulation • Data rationality 	<ul style="list-style-type: none"> • Task performance • Psychomotor skills • Problem solving • Evaluation
Content knowledge	<ul style="list-style-type: none"> • Multi-professional collaboration • Communication and relationship building • Medical and related sciences • Geriatric care 	<ul style="list-style-type: none"> • Chronic disease care • Nursing interventions • Managing information and data
Context	<ul style="list-style-type: none"> • Small nursing home care • Elderly male (87 years old) • Hypertension and coronary disease and disorders • Unplanned situation 	
Situation	You have a day shift. At 11:00 you hear a bang coming from a client room. On closer inspection, an elderly client (Mr. Peterson, 87 years old) appears to have fallen badly. He has a bleeding head wound and his right arm is in an unnatural position. Mr. Peterson is conscious, but anxious.	
Tasks	<ul style="list-style-type: none"> • Ease and comfort the client • Take vital signs • Call the doctor with: <ul style="list-style-type: none"> ○ a clear briefing of the facts ○ the actions already performed and ○ background information in relation to the situation. • Carry out doctor's instructions • Write report/brief colleagues 	
Assessment criteria	<ul style="list-style-type: none"> • Relevance (uses correct competencies) • Effectiveness (each action properly executed) • Efficiency (time management as well as fluency) • sustainability (risk management of environment, energy conserved) • impact (good practice modelled, calm restored, situation ameliorated) 	
Assessment method(s)	If live: observation against a checklist with detailed descriptors, followed by reflective questions. If simulated: what, when, why, how, what if questions?	
Proficiency range tested (1-6: EQF 3-4)	1-6 from disorientated to timely, calm, seamless actions. 3+ Bloom descriptors to denote each level.	
Employability skills: literacy	Underpinning skill; inferred only	
Employability skills: problem solving	Yes	

Note: A list of additional scenarios, with their potential for assessment and achievement range is given in the Annex of this chapter.

Based on practical experience elsewhere (WSI, 2022^[2]), effective assessment of live performance takes around 30 minutes. Two scenarios, each incorporating 25-30 scores, possibly one based on immersive questioning and one live performance, would each comprise one third of the available assessment time (if the proposed 90-minute assessment of occupational-specific skills is maintained, see Chapter 1). There would also be opportunity for additional questions that may not flow naturally from the scenarios: for example, mathematics used for medication and testing. The package would therefore look like this.

Figure 5.3. Proposed assessment package



Ideally, these three assessments would form a coherent package, which flows easily for the candidate. One means of achieving this would be to limit the basis of material to one client and one patient, with different health conditions: that is, to have fewer clients/patients, with more complexities.

Package design would require coordination, the immersive questioning and live performance being designed in tandem, and the separate Q&A testing then designed to achieve completeness and balance, relative to the needs of the work role. The assessment methods depend on the types and purposes of the competency being assessed:

- Immersive questioning would assess disciplinary and procedural knowledge and understanding, using open and closed constructed responses, and selected responses, to cover know, know how, and to a limited extent, show.
- Live demonstrations would both measure and judge performance against assessment criteria with detailed descriptors. These would be recorded as yes/no or 0-2/3 scales by moderated live markers. Reflective questions would mainly use open constructed responses.
- Q&A testing would mainly use multiple choice and/or constructed response items.

The following questions lend themselves to multiple choice:

- Key factors influencing dignity/rights/privacy/confidentiality of patients/colleagues (e.g. age, gender, beliefs) (tick all that apply).
- The rights of patients regarding giving informed consent for treatment when required.
- Which of the following blood pressure readings would cause concern regarding a woman who is 60 years old and without known health issues?
- Before using a sterile package what should you do? (Tick all that apply).
- The functioning of protection equipment (surgical mask, protective respirator). Tick correct answers.

Item scoring

Assessment will be by measurement and judgement, the former mainly being dichotomously scored, and the latter graded according to correctness or quality. The ratio of dichotomous scoring to grading is expected to be around 2:1. Taking the meaning of “item” to be an individual mark or score, however derived, it is known at live performance over 30 minutes would generate 25 to 30 items. It is surmised that immersive scenarios would generate items at a broadly similar rate. Supplementary questions may generate items more quickly. Therefore, over 90 minutes, 90 to 100 items may be expected.

Reporting proficiency

The standard formats of learning outcomes, Bloom (Figure 5.1), and the available vocabulary banks for determining levels of achievement have been referenced to guide assessment criteria. This scale is derived from EQF and ISCED level descriptors across levels 3 and 4. It is expressed as situated learning outcomes, derived from knowledge and skill combined to create competence and capability graded against levels of autonomy, responsibility, and complexity. The essential knowledge and capabilities listed are simply examples. For the design of assessment, a fuller, detailed tabulation is required. The lower score limits will be determined with data in the second stage of the Development Phase according to the standard PISA scaling procedure.

Table 5.7. Descriptors of learning outcomes

Scale for role	Lower score limit	Descriptor
6	To be confirmed with data	<p>Within the limits of the role can organise own workload and support less experienced others. Takes control in critical situations, evaluates services, proposes improvements, and takes well-considered initiatives. May have wider budgetary and decision-making rights.</p> <p><i>Key learning outcome verbs: assemble, compile, design, create, reorganise, articulate, synthesise, naturalise, value.</i></p> <p>Examples of essential knowledge: research and evaluation, nursing interventions, cancer and palliative care.</p> <p>Examples of capabilities: collaboration, open-mindedness, emotional regulation.</p>
5	To be confirmed with data	<p>Can organise own workload and act as a team leader; works with more complex and distressing cases and situations, including conflicts within the boundaries of the role. Contributes to multi-professional teams.</p> <p><i>Key learning outcome verbs: appraise, consider, critique, evaluate, rate, formulate, recommend, present, test, revise, redesign, estimate.</i></p> <p>Examples of essential knowledge: chronic disease care, administrative and legal frameworks, nursing interventions.</p> <p>Examples of capabilities: contribution to solutions, access and use of information, management of self, time, etc.</p>
4	To be confirmed with data	<p>Can work across a wide range of healthcare needs and settings, using and adapting actions as required, reflecting upon own performance. Can undertake a broad range of complex, technical, or professional work activities performed in a wide variety of contexts and with a substantial degree of personal responsibility and autonomy.</p> <p><i>Key learning outcome verbs: analyse, differentiate, classify, calculate, test, organise, examine, adjust, empathise, structure.</i></p> <p>Examples of essential knowledge: regulations, biological and behavioural sciences, interdisciplinary knowledge.</p> <p>Examples of capabilities: reflective practice, communication, multi-professional collaboration.</p>
3	To be confirmed with data	<p>Can take responsibility for routine and non-routine work within the occupation's accepted scope, adapting their actions within the boundaries of their role. Collaboration with others, perhaps through membership of a work group or team, may often be required.</p> <p><i>Key learning outcome verbs: interpret, carry out, use, calculate, illustrate, complete, generalise, interpret, modify, predict.</i></p> <p>Examples of essential knowledge: interdisciplinary working, mathematics, behavioural sciences.</p> <p>Examples of capabilities: engagement, access and use of information, contribution to solutions.</p>
2	To be confirmed with data	<p>Can take responsibility for a caseload of clients and patients with basic nursing and housekeeping needs, recognizes and reports on care and nursing. Some of the activities are complex or non-routine, and there is some individual responsibility or autonomy.</p>

Scale for role	Lower score limit	Descriptor
		<p><i>Key learning outcome verbs: arrange, associate, exemplify, compare, explain, predict, estimate, demonstrate, operate.</i></p> <p><i>Examples of essential knowledge: regulations, basic nursing care, biological sciences</i></p> <p><i>Examples of capabilities: coordination; task performance; collaboration.</i></p>
1	To be confirmed with data	<p>Can take responsibility for a range of work activities that are routine and predictable, in a variety of contexts. Seeks help when faces changes and unfamiliar situations.</p> <p><i>Key learning outcome verbs: remember, understand, reproduce, outline, explain, identify, apply, discuss, review, report.</i></p> <p>Examples of essential knowledge: basic nursing care; hygiene and nutrition; health and safety.</p> <p>Examples of capabilities: engagement with others, communication, access and use of information.</p>

Examples of items for addressing the Healthcare Framework

For the design of assessment, account can be taken of the “natural” limits and scope of each scenario, which can then be adapted and selected or not, to ensure coverage of the full achievement range. As an illustration, the scenario Mr Peterson has had a bad fall (Table 5.6) enables achievement at the upper half of achievement but may be limiting for the lower half. The scenario concerning Mrs Garcia (Annex 5.C) may favour the lower half but limit differentiation.

The scenario in Table 5.6 shows planned differentiation. It covers a routine visit to help a client self-medicate for a new health condition. There are 23 items, each of which is individually well within what a healthcare/nursing assistant should know at EQF equivalent level 3. This scenario assesses the assimilation and naturalisation of competencies, in addition to each competency category individually. This live performance reflects a visit scheduled and is budgeted for 30 minutes.

Table 5.8. Self-management of asthma

Scenario: Jane, a 20-year-old student, is active in sports and has recently found a part time job in a pet shop. Since she started work at the pet shop, she has been having trouble in breathing with flu-like symptoms. She is diagnosed with asthma.

Tasks:

- Assist and guide Jane on the techniques of the use of metered dose inhaler.
- Educate Jane on the avoidance of asthma triggers.
- Educate on the usage of the peak flow meter

Required steps (unseen by the student/trainee)	Assessment criteria to guide markers (unseen by the student/trainee)	
Dress professionally	Be dressed professionally: No jewelry, hair tied up if long.	y/n
Establish rapport with client	Maintain eye contact, sits at the same height as client. Use encouraging words when client gives an answer. Ensure client understands what is said: asks: do you understand?	y/n
Professional ethics	Obtain consent before implementing any intervention for client	
Assess client's knowledge and understanding of disease	Minimum one open question. E.g. ask: what do you know about asthma?	y/n
Obtain history of current attack (ask about last attack)	Minimum 1 open question to history, Example: Have you had an asthma attack lately?	y/n
Ask questions on risk factors and allergies	Minimum one open question about risk factors and allergies, E.g. In which situations you will trigger asthma episodes? In which situations do you have asthma?	scale
Check client's prior knowledge about the use of metered dose inhalator and number of puffs	Minimum 1 open question. E.g. Do you know how to use the metered dose inhaler? Do you know how many puffs you must do?	scale

Provide education on asthma	Educates about asthma. Minimum 2 aspects. E.g. Asthma makes the airway smaller, gives you breathing problems; caused by allergies, or activity	scale
Provide information on action of prescribed medication	Minimum 1 explanation. E.g. Bronchodilator makes the airway wider	
Support client in the use and storage of their medication within the scope of practice and regulations	Check drug name, dosage, process and time of administration (looking at the package and explaining). Check medication expiry date.	scale
Check identity before medication, or earlier	Check client's identity with least 2 identifiers (e.g. name, date of birth)	scale
Teach and demonstrate on the use of metered dose inhalator	Explain how to fit canister into inhaler. Client to sit upright. Remove the mouthpiece cover, shake inhaler well (5 to 6 shakes). Place mouthpiece in mouth, close lips tightly around it. Instruct client to inhale deeply and slowly through the mouth while depressing the medication canister fully at the same time. Hold breath for 10 seconds. Exhale slowly through pursed lips.	scale
Encourage the client to administer at least one puff by herself	Minimum one encouragement example: says to client that she should try for herself.	y/n
Instruct to rinse the mouth after cortisone	Precaution for mucosa lesions	y/n
Provide positive encouragement when client uses inhaler correctly		y/n
Teach client to remove canister and wash inhaler and mouthpiece cover	Wash inhaler and mouthpiece cover, warm water or soap, rinsed and dried well.	y/n
Educate on avoidance of asthma triggers	Minimum 3 triggers. For example: cold air, pet hair, dust, pollen, strong smelling things, Chemical, allergy, hay, smoke	scale
Ask client about her plan for part- time work at the pet shop	example: will you still work at the pet shop?	y/n
Advise client on modifications in the household environment, such as tobacco smoke and pet dog	3 aspects at least: for example: smoking, environment, carpets, flowers, dust, pets, chemicals	y/n
Educate on the usage of the peak flow meter	Client sits down upright or stands up. red gauge to the bottom scale, inhales slowly and deeply to the full lung's capacity, blows in the meter as fast and deep she can, checks the number that is indicated by the red gauge on the numbered scale, repeats this procedure twice more consecutively. Client records the highest score.	scale
Teaches client how to interpret the results according to the zone monitoring system	The general principles of the zone monitoring system are: GREEN zone: your medication is working, go ahead with your normal activities. YELLOW zone: Use caution in your activities, refer to your treatment plan for actions to be taken, RED zone: Medical alert, you should get immediate medical attention, to be defined by the doctor. Healthcare/nursing assistant shows the text of all the Zones and explains them. Answers patient's questions.	scale
Ask if there is anything else client needs before leaving		y/n

References

- Auzinger, Broek and Luomi-Messerer (2017), "Learning outcomes and the labour market. The role of learning outcomes in supporting dialogue between the labour market and education and training; the case of vocational education and training", *3s Business Consulting GmbH*. [6]
- Baethge, M. and L. Arends (2009), "Feasibility study VET-LSA: A comparative analysis of occupational profiles and VET programmes in 8 European countries - international report". [5]
- Bjornavold, J. and B. Chakroun (2017), *Using learning outcomes to compare the profile of vocational education and training qualifications – a global approach*, Cedefop. [1]
- Cedefop (2022), *Defining, writing and applying learning outcomes: a European handbook*, <https://doi.org/10.2801/703079>. [9]

- Cedefop (2017), "The changing nature and role of vocational education and training in Europe. Volume 2", *Cedefop research paper*, Vol. 2/No 64. [11]
- ESCO (2020), *European classification of Skills/Competences, Qualifications and Occupations*, <https://esco.ec.europa.eu> (accessed on 16 December 2022). [7]
- Kroezen, M. et al. (2018), "Healthcare assistants in EU Member States: An overview", *Health Policy*, Vol. 122/10, <https://doi.org/10.1016/j.healthpol.2018.07.004>. [8]
- Maggioni and Alexander (2010), "Knowledge Domains and Domain Learning", *International Encyclopedia of Education*, Vol. Elsevier Science, pp. 255-264. [10]
- Miller, G. (1990), "Miller's Pyramid of Competence. Based on work by Miller, G. E., (1990). The assessment of clinical skills/competence/performance", *Academic Medicine*, Adapted by Drs. R. Mehay and R. Burns, pp. 63-67. [13]
- OECD (2023), *International Vocational Education and Training Assessment (PISA-VET)*, <https://www.oecd.org/pisa/vet.htm>. [4]
- OECD (2019), *Conceptual learning framework*, https://www.oecd.org/education/2030-project/teaching-and-learning/learning/skills/Skills_for_2030_concept_note.pdf. [12]
- UN Department of Economic and Social Affairs (2022), *United Nations Sustainable Development Goals Report 2022*, Global Sustainable Development Report 2022. [3]
- WSI (2022), *Social and Personal Services, Health and Social Care*, <https://api.worldskills.org/resources/download/12384/14943/15871?l=en>. [2]

Further reading

- Cedefop (2021), Review and renewal of qualifications: towards methodologies for analysing and comparing learning outcomes, Luxembourg: Publications Office, Cedefop research paper, No. 82, <http://data.europa.eu/doi/10.2801/615021>.
- Cedefop (2022), Comparing vocational education and training qualifications: towards methodologies for analysing and comparing learning outcomes, Luxembourg: Publications Office, No. 121, <http://data.europa.eu/doi/10.2801/939766>.
- Hase, S., Cairns, L., Malloch, M. (1999), "Capability and vocational education and training", *Graduate College of Management Papers*, https://www.researchgate.net/publication/37358998_Capability_and_vocational_education_and_training.
- ILO (2012). *International Standard Classification of Occupations: ISCO-08*, Vol. 1: Structure, Group Definitions, and Correspondence Tables, International Labour Office, Geneva, [International Standard Classification of Occupations \(ISCO\)](https://www.ilo.org/public/standards/isc08/).
- Kolb, D. (1984), *Experiential Learning Experience as The Sources of Learning and Development*, Prentice-Hall, Englewood Cliffs, <http://www.learningfromexperience.com/images/uploads/process-of-experiential-learning.pdf>.
- O*NET OnLine, National Center for O*NET Development, www.onetonline.org (accessed 16 December 2022).
- OdASanté (2022), Educational plan Health Specialist: EFZ, Zurich.

Annex 5.A. Content topics for guiding the assessment of healthcare assistant competency for VET learners

As noted in Chapter 5, the 16 cross-cutting content topics that follow vary in their relationship with the three types of knowledge: disciplinary, procedural, and epistemic, required for the role. While the order of the topics broadly relates to the sequence of the five content categories above, each has a different relationship with practice, as befits VET with its distinctive heuristics and significant reliance on conditional knowledge. In broad terms, 12 topics have a strong disciplinary content, and four stress procedural and epistemic knowledge. In keeping with its frequent conditionality, across these topics the knowledge requirement may be presented as applied.

Although most healthcare programmes include healthcare for babies and children, pragmatically the care of individuals below the age of 16 years has been excluded from this framework, due to the complexities of assessment for international comparison. For the same reason, mental illness other than that associated with ageing and the secondary effects of other illness has also been excluded.

Multi-professional collaboration

Although the healthcare/nursing assistant's professional relationships will generally be with nurses, they should understand the scope and boundaries of their and others' roles more widely, and the conventions for acknowledging and addressing others in mixed professional settings. Their interdisciplinary knowledge should be sufficient to enable them to understand the perspectives, boundaries, and terminology used by allied professions, and to check their understanding and its relevance to their role if they are uncertain. They should know and adhere to the conventions for presenting, informing, and recording information, together with the distinctions between formal and informal speech and writing. They should recognise and clarify as necessary the explicit and tacit expectations of their role, including individual and collective ethics, accountabilities, and protocols.

Interdisciplinary working

As an adjunct to multi-professional collaboration: whichever setting the healthcare/nursing assistant is in, it is fundamental to know and apply set procedures for record-keeping, handovers, and emergency responses. According to the context, the healthcare/nursing assistant may work alone or in a team. If working in clients' homes, they may be the only link between the client and healthcare services, thus being depended upon to transmit information and advice both ways, and to raise concerns if the client's health or circumstances deteriorate. In nursing homes and clinical settings, they will be part of a larger team with set timetables and routines which they must be fully aware of.

Communication and relationship building with clients and patients

The ability to communicate is a vital attribute of the healthcare/nursing assistant, requiring an advanced understanding of what communication comprises, and its role in creating and maintaining a therapeutic relationship. The healthcare/nursing assistant must learn and correctly employ an extensive new technical vocabulary, and several new speech registers. Thoughtful speaking and listening are important transmitters of information, emotion, and empathy. However, in many instances the client's or patient's

communication skills (speaking and/or hearing) may be impaired, thus requiring alternative forms of communication, some of which may be based in new technologies. Culture and diversity also have a bearing on the extent to which communication can be verbal and oral. In these situations, body language needs to convey meaning, including showing insight and respect. Each of these abilities is a learned skill based on principles of practice.

Mathematics

The healthcare/nursing assistant should know and be able to use measurement, estimation and calculation, proportions, and formulae. They should be able to recognise and work with different numbering systems common to healthcare. They should be able to read, understand and use data in different formats, and communicate using mathematics. They should understand and be able to interpret basic patterns, trends, and risk, and know how to check for validity and accuracy.

Biological sciences

The healthcare/nursing assistant should be able to identify and describe the various parts and functions of the systems of the human body. They should recognise the major physical and physiological changes of the human body as the individual grows and develops across a lifespan. They should understand the importance of appropriate nutrition. They should know the effects of pathological micro-organisms on the human body, and the use of common pharmacological products in healthcare settings. They should understand the healthcare needs of clients with alterations of various body systems requiring different methods of treatment.

Behavioural sciences

The healthcare/nursing assistant requires a sufficient understanding of human actions to be able to anticipate and manage people's behaviour, including their own. Behavioural science relevant to their role may be sociological, cultural, economic, psychological, and biological. The more the healthcare/nursing assistant can understand and objectify their clients' and patients' behaviours, the better they will be able to support them, because behaviour has both a direct and indirect impact on personal health. For the safety of both clients or patients, and themselves, the healthcare/nursing assistant must be able to recognise actual and potentially unsafe behaviours in a timely manner and be able to act accordingly.

Research and evaluation /evidence-based practice

Science underpins the role of the healthcare/nursing assistant. While demonstrating compassion and empathy for clients and patients, their support and interventions must be rationally driven. This requires an evidence-led approach, for which the principles of currency (up-datedness and completeness), relevance (significance), authority (dependability), and accuracy, are key. However brief, research should underpin each of preparation and planning, support and interventions, reflection, and reporting. It is the basis of critical thinking.

Hygiene and nutrition

A healthcare need is associated with a potential or actual decline in a person's ability and/or motivation to care for themselves and their surroundings. Hygiene and good nutrition may be at risk, often exacerbated by reduced mobility. The healthcare/nursing assistant must understand the importance of good nutrition

and hygiene to wellbeing and recovery, and actively ensure the continuation of both through advice and coaching, performing housekeeping duties, advising on positive lifestyle changes, monitoring, and referral to other support services for dietary support and practical aids.

Basic nursing care

Basic nursing care comprises support with a client's/patient's health-related needs, including help with medication, nutrition, and supervision to ensure their safety. It also includes support for personal daily activities such as washing, dressing, eating, moving, and hygiene. It is associated with regularly recurring care services that are distinct from treatment care. Basic nursing care has a role at each stage of ill-health and infirmity: preventative, remedial, palliative, and restorative. It is unique in each case, with the client or patient ideally being a partner in their own recovery or maintenance. The healthcare/nursing assistant may be just one of the wider care networks, including friends and family. While referred to as "basic," this branch of care is complex in its contextual diversity, including its physical setting, wider environment, support network, and the personal capacity, resources, and response of the client or patient. It may become very close to social care. The knowledge to guide actions from an early stage in healthcare/nursing assistants' development will comprise guiding principles, planning models and methods, professional planning (time, resources, processes), rights and obligations, reflection, and reporting.

Nursing interventions

The healthcare/nursing assistant may need to participate in medical-diagnostic and therapeutic tasks, including in emergencies which, in healthcare, may and will happen, in such situations they need to know how to respond, quickly, and in what order. They must know where and how material, fluids, medication, and tests are stored for use in emergencies, and which tests to administer to ascertain the patient's condition and assist in procedures. They must know which tests to administer to ascertain the person's condition, and which immediate treatments are called for as a result. They should know how to treat and/or stabilise the person and their immediate situation, while detecting and reporting on observable effects or reactions. Under instruction they may need to collect additional medical data. They may need to perform simple first aid or wound care, to provide support aids, and therapeutically to reposition the person. Throughout this process the healthcare/nursing assistant may be both taking and giving instructions and guidance, from a superior professional on the one hand, and to family and friends on the other. This requires the confident application of a range of knowledge types

Health and safety

From principles to planning, actions, and reporting, health and safety is likely to be the first and most continuous topic in the healthcare/nursing assistant's formal preparation and learned daily awareness. A healthcare need makes a person vulnerable to a multitude of risks and harm in addition to those directly relating to their disability or illness. If in the home, a previously safe space may become hazardous. If in hospital, risk is still present, from cross-infection to malfunctioning equipment. The client's or patient's dependency on others creates further risks, from the actions of friends, family, and strangers, to substandard care from healthcare/nursing professions. The healthcare/nursing assistant has safeguarding and other health and safety duties throughout the healthcare cycle, including the requirement to draft, conform to, and/or update risk assessments, depending on the care setting. When incidents and emergencies arise, they are also often the first responder, with the requirement for expert urgent action.

Managing information and data

Information and data are key to safe and effective care. The healthcare/nursing assistant must work with standardised care assessment instruments and risk scales. They must be data-rational, knowing how to check and calibrate instruments, read, and interpret findings, and report them in an accurate and timely way. They should be confident users of the organisation's information systems, purposes, and formats. Within the rules for data protection, they should collect and record relevant information regarding activities, habits, sensory perceptions, participation, and circumstances, likewise their response to medication. They should participate in continuous observation, monitoring, and updating.

Geriatric care

Geriatric care is a large and growing part of the healthcare/nursing assistant's role. The manifestations of a healthcare need may include fractures, delirium, dementia, incontinence, poor mobility, and frailty. Whether in hospital, residential care, or the client's home, the healthcare/nursing assistant will form part of a multidisciplinary team, having a sufficient understanding of acute illnesses, chronic diseases, disabilities, and frailty, and the relevant medication and treatments, to fulfil their role. Where this is to assist rehabilitation, they may need to know what adaptations and aids are available, and how to arrange and support transfer between care settings. A knowledge of palliative and end of life care, and the associated legal and ethical issues relating to extreme dependency, is relevant.

Cancer and palliative care

Palliative care is given to improve the quality of life of patients with a serious or life-threatening disease, such as cancer. It addresses the whole person, not just their disease. It aims to prevent or treat, as early as possible, the symptoms and side effects of the disease and to address any related psychological, social, and spiritual problems. In a range of settings, the healthcare/nursing assistant must have sufficient knowledge of cancer or other diseases to follow instructions while fulfilling the spirit of palliative care, practically, and with other care givers such as family members.

Chronic disease care

In addition to cancer, other chronic diseases include diabetes, heart disease, obesity, stroke, and arthritis. They are conditions that normally last for at least one year, and require ongoing medical attention, or limit daily life, or both. Diabetes, cancer, and heart disease are leading causes of death in developed countries. Chronic diseases feature most in the health care of older adults. They are strongly associated with lifestyle habits such as lack of exercise, smoking, and excessive consumption of unhealthy food. On this account, the healthcare/nursing assistant's caseload will be heavily associated with these chronic diseases: their prevention and mitigation. As with the immediately preceding topics, beyond the extent of disciplinary knowledge that characterises the occupation, deeper knowledge will go in tandem with caseloads and specialisation, for which the healthcare/nursing assistant requires self-learning skills and agency,

Administrative and legal frameworks

Administrative and legal frameworks differ across countries, settings, and organisations. For international comparative assessment is therefore on what matters irrespective of the administrative and legal arrangements in place. This comprises procedural and conditional knowledge: the healthcare/nursing assistant's knowledge and understanding of their relationship with rules, procedures, and guidance, and

their ability to respond appropriately. However, advanced a healthcare system may be, healthcare/nursing assistants are commonly expected to undertake tasks that are not within their role or that they have not been trained for. They must therefore know how to respond constructively to undue pressures exerted on them, for whatever cause or reason.

Four factors set the boundaries for a healthcare/nursing assistant's role: the legal framework, professional requirements, organisational requirements, and their own role description and capacities. They must therefore know and understand the legal conditions under which they act, and the consequences of violations. They must also know and internalise the relevant codes of principles and ethics; recognise ethical dilemmas and conflicts and know when and how to refer these for advice and guidance. They must understand, support, and encourage self-determination, and respect the client or patient's right to refuse care and treatment, and withhold consent. They should understand and respect the expectations of clients, patients, friends, and family. They should appreciate that within the law different organisations have different boundaries and procedures, not all of which may be compatible with professional standards. In such instances they need to check their understanding and seek advice.

Annex 5.B. Implications of live performance with (on-site) expert markers

This annex adds brief mention of the operational factors for on-site assessment of live demonstrations, referred to in this chapter as “performance assessment.” Though differing from OECD’s online infrastructure and superstructure for PISA, there exists a large-scale tested infrastructure for global performance assessment that might be adapted, applied, and connected at various points to PISA’s current arrangements.

Annex Figure 5.B.1. infrastructure for standardised performance assessment

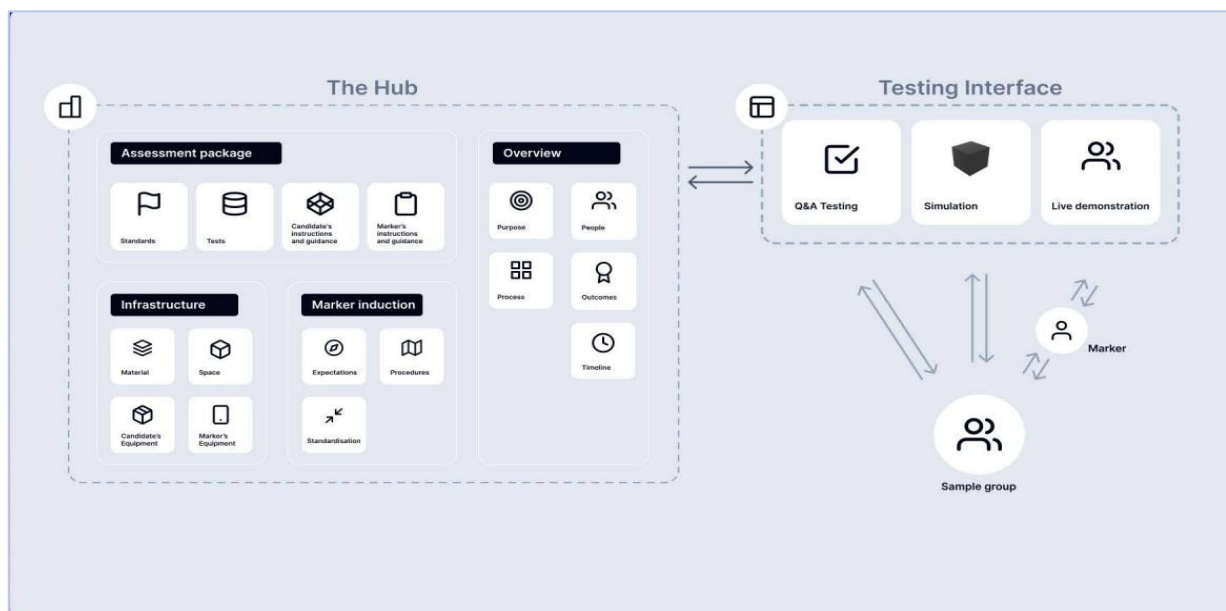

Annex 5.C. Short versions of scenarios for immersive simulation and/or performance assessment

Scenarios from the VET-LSA study

These scenarios taken from the LSA-VET study (Baethge and Arends, 2009^[5]) have the potential for a range of assessment types. Their correspondence to the chapter's five processes is shown in brackets beside the titles.

CORE AREA 1: Client care, service, and assistance within the care process (equivalent to processes 3 and 4)

Case	Content	Task
Frida Peterßen (Denmark)	Is about an elderly woman, waiting to move into a sheltered accommodation; focuses on certain clinical symptoms (dementia, constipation, broken wrist) and the treatment and medication.	Case study with focus on medical aspects; subtasks referring e.g. to pathophysiology.
Mother has changed (Germany)	Deals with the physical and mental changes of an elderly woman, leading to problems in her social life; particularly, the planning, conduction, documentation and evaluation of an eldercare process are assessed.	Case analysis about physical and mental changes and resources; derivation of life skill strategies with reference to the theoretical analysis.
Client's home (Finland)	Concerns the life situation of an old widower suffering from coronary artery disease, adult-onset diabetes and restrictions in movement; the medication is presented; emergency situation: nurse finds him lying on the floor.	Evaluation and discussion of the situation; applied tasks like informing the home care team.
Erik (Sweden)	Is about a 52-years old retired carpenter with Multiple Sclerosis; he sits in a wheelchair and gets support from a home care nurse; emergency situation: nurse finds him without consciousness.	Description of Erik's state to the emergency call centre and of accounted and founded action.

CORE AREA 2: Communication and building relationships (as in processes 1, 3 and 4)

Case	Content	Task
Serhart, 56 (Denmark)	Is about a Turkish immigrant suffering from right-sided brain apoplexy	Selection and examination of problems using culture and activity theory and methods
Mr. Tebbe needs help (Germany)	Deals with the topic of moving into a retirement home, the change of habits and problems with integration into the new situation; focuses on social aspects.	Specification of expectations concerning his behaviour and the resulting problems.
Mrs. Johansson (Sweden)	Deals with an elderly woman, who is hard of hearing	Description of encounter and features of a good dialogue.
Having conversations (Switzerland)	A mentally retarded adult man is not able to express himself; he gets only fragments of verbal demands; the student accompanies him while he is having a shower.	Description of alternatives of supportive communication; explanation of supportive communication.

CORE AREA 3: (Multi)professional cooperation (equivalent to process 1)

Case	Content	Task
Ingeborg Sørensen (Denmark)	Complex case of an elderly woman, regarding her social life in present and past, her physical and mental condition as well as aspects of care and medication in detail; in addition, descriptions of the underlying philosophy, goals and organisation of care in the institution are given.	Discussion and presentation of thoughts concerning work planning and cooperation; defining one's own professional role in the case.
School for young students (Finland)	Deals with students with special needs in an upper grade and process of planning music and physical activity lessons in the multi-professional care team.	Discussion of the case; several applied tasks concerning aspects of organisation.

CORE AREA 4: Health and Safety (as in processes 3,4, and 5)

Case	Content	Task
Elderly people ward (Finland)	Is about an elderly woman suffering from paraplegia; she is bedridden and has problems with the use of her wheelchair.	Several applied tasks surrounding the safe use of a wheelchair
Using protection equipment (Slovenia)	Statements concerning the functioning of protection equipment (surgical mask, protective respirator).	Multiple choice task ('Circle the appropriate answers').

CORE AREA 5: Administration and legal framework (equivalent to process 5)

Case	Content	Task
Mother has changed (Germany)	Deals with the physical and mental changes of an elderly woman, leading to problems in her social life; particularly, the planning, conduction, documentation and evaluation of an eldercare process are assessed.	Discussion of pros and cons of ambulatory/outpatient care in the case
Anna and Edvin Svensson (Sweden)	Is about a married couple; refers to their domestic and social situation as well as Edvin's physical condition after a stroke.	Assessment of possibilities for governmental support.
Quality and efficiency (Switzerland)	Describes the combination of high quality and high efficiency as the main goal of any company.	Explanation of 'efficiency;' description of potential consequences of the primacy of efficiency for the field of care.
Data protection (Switzerland)	Deals with the obligatory bound to data protection and professional discretion.	Exemplification of data handling.

Additional scenarios

Although the focus is on processes 3 and 4, below, each touch on other processes, knowledge, and contexts.

Process	The situation	Tasks
3, 4	Salvador Costa, aged 79, lives with his daughter Luana 32. He attends the day centre twice a week. He has Parkinson's Disease and a heart disease since last year. He takes diuretics and heart medication. He has a hearing impairment since he was a young adult. He gets out of breath when he walks. He takes his heart medication at home by himself but sometimes gets confused. He had oedema on the feet the last time he was here. He is very weak especially while doing activities in the household at home.	<p>Weigh Mr. Salvador Costa. Measure blood pressure. Find out if the patient has taken the medication. Administer new compression stockings. Show him suitable aids and devices.</p>
4	Mr Ong, 69 years old is having lunch at the Residential Care Centre. Suddenly, he stands up from his chair, clutching his neck and attempting to cough. Nursing Assistant Lily runs towards him to see what has happened.	<p>Identify signs of choking. Call for help. Perform steps to relieve foreign body airway obstruction (FBAO) in a conscious adult. Perform steps to relieve FBAO for Mr Ong when He became unconscious.</p>
3, 4	Mrs Lim, 45 years old is admitted to the hospital for dengue fever. She fell in the ward this morning and sprained her right ankle. it is red, swollen and painful. She also sustained an abrasion on her right elbow. The doctor has ordered dressing to the abrasion on the right elbow, pressure bandage and ice pack to the right ankle.	<p>Monitor temperature, pulse, respiration and blood pressure. Assess the pain score and check if pain medication is needed. Elevate right leg on pillows, apply pressure bandage and ice pack to right ankle. apply simple dressing to abrasion on right elbow Advise on fall precaution. Advise on management of her condition after discharge from hospital.</p>
3, 4	Mr Tan, 63 years old, is admitted to the hospital for treatment of stroke. He has right sided weakness and is depressed as he needs help in his daily activities: bathing, mouth care, feeding, transfer from bed to wheelchair and wheelchair to bed. The doctor has referred him to the physiotherapy, occupational therapy and speech therapy. He uses a quad walking stick. You are assigned to take care of Mr Tan.	<p>Monitor temperature, pulse, respiration and blood pressure. Transfer Mr Tan from bed to wheelchair with the help of another nurse. Assist Mr Tan to brush his teeth and wash his face. Assist Mr Tan with body care. Assist and show Mr Tan how to remove and put on his clothing. Show Mr Tan some assistive aids to assist him with his breakfast. Encourage Mr Tan to continue with physiotherapy, occupational therapy, and speech therapy.</p>
	Mrs Garcia is a client in homecare. She is overweight, lives with her elderly husband, has dementia, and is no longer capable of looking after herself. You visit Mrs Garcia on your twice-weekly visit. You note that she is losing strength in her legs and uses the walls and furniture for support while walking around the apartment. She is getting more dependent on others and is no longer able to get up from chairs or get out of bed without help. The risk of a fall is increasing.	<p>Reassess the new needs this client presents. Rearrange the plan for home care assistance. Assess for the need to add medical movement aids. Rearrange furniture to accommodate a less mobile client. Assess the need for extra visits to mobilise the client.</p>
	Health Assistant Jessica works in the chemotherapy unit. She knows Mr Lopes from her hometown and now he is receiving treatment for cancer of the colon. He has many questions that he was too embarrassed to ask the doctor and the nurses. He now needs help to change the colostomy bag and asks you to do it and to teach him how it do it himself.	<p>Maintain a professional relationship, despite the external relationship. Protect Mr Lopes' privacy from his family and acquaintances. Answer Mr Lopes' questions and refer them to the nurses or doctors if beyond your knowledge gather all necessary materials. Explain the procedure as you do it and ask the patient to help you. Ask Mr Lopes to repeat each step for the patients help throughout. Give feedback and reassurance. Finish the session and remove materials.</p>
	Jane is 34 years of age and a patient in the rehabilitation clinic where you work. She has had a car accident and needs physiotherapy to rehabilitate. She has been here before, but today	<p>Greet Jane and ask questions about her condition and pain. Evaluate her pain level using a pain scale. Provide a resting area and start to use non-pharmacological</p>

Process	The situation	Tasks
	you notice she looks sad and is very unsteady when walking. You ask her about this, and she explains that she is in more pain.	techniques. Reassess her pain level. Explain your next steps to Jane. Report your findings and actions to the physiotherapist or doctor.
	An unconscious male patient is being brought into the Emergency Room. Without knowing anything about the patient, the nurses and Health assistants start to make room for the stretcher to be brought inside and laid down for him to be offered professional care. You are new to this kind of situation, but you can listen to the cues and instructions of the nurses and your more experienced peers. As a healthcare/nursing assistant, what do you need to know and do in future?	Transfer the patient to a stretcher with the help of a nurse. Remove the patient's clothes to expose the body while preserving privacy with curtains or appropriate alternatives. Monitor temperature, pulse, respiration, and blood pressure. Anticipate the main techniques and treatments and gather the necessary materials. Identify all materials by name and understand their purpose and effect.

Notes

¹ In the Standard Occupational Classification (SOC), which is mostly used in the United States, the medium-level healthcare occupations are “Home Help Aides” (31-1121), “Nursing Assistants” (31-1131), and “Personal Care Aides” (31-1141).

6 **Tourism and Hospitality**

This chapter defines “Tourism and Hospitality” as assessed by PISA-VET and elaborates the framework for hotel receptionist that has been designed for the Development Phase of the project, including descriptions of the competencies and constructs to be assessed. It presents and explains the processes, content knowledge and contexts and provides several sample items with descriptions of task characteristics. The chapter also discusses how performance in the hotel reception professional skills assessment is measured and reported against proficiency levels and scales.

Introduction

The purpose of this chapter is to define and elaborate the assessment framework for the Tourism and Hospitality occupational area for the Development Phase of PISA-VET.

There are several reasons for selecting the occupational area of Tourism and Hospitality for the Development Phase of PISA-VET, including the rapid growth of the sector in recent decades and its increasing economic importance globally. In the last six decades, the tourism sector has become one of the most dynamic and fastest-growing economic sectors in the world, being considered a driving force for job creation and for local economic development in many countries (OECD, 2018^[1]). Hospitality and personal services accounted for 15% of the EU labour market in 2020 (noting that “personal services” include various services outside the scope of tourism and hospitality). While the occupation was heavily affected by the pandemic in 2020 and 2021, many restaurants, hotels and other hospitality businesses have successfully reopened and resumed activities. Globalisation, social and demographic changes, and the growth in transport, especially air travel, are decisive factors in driving a rapid growth in the tourism industry. According to the World Travel & Tourism Council (WTTC), despite still being below historical lows owing to the impacts of recent health crises, the global hospitality market is expected to grow over the next decade by at least 15%. Hospitality and personal services programmes are important in VET, accounting for at least 10% of initial VET enrolment in most OECD countries (with the caveat that personal services cover also fields outside of tourism). The tourism sector has also been increasingly recognised as a fundamental pillar for sustainable development.

As discussed in the next section, this chapter will focus on one occupation within the broader tourism and hospitality occupational area, namely that of hotel receptionist. Various reasons underly this selection, including its international comparability, gender balance for the assessment (70% of hotel receptionists globally are female) and its importance in the overall tourism and hospitality area. Enrolment in VET programmes preparing for hotel receptionist occupations is high and the demand is growing. The gender ratio among hotel receptionists favours females with, on average, more than two thirds of hotel receptionist positions occupied by females globally (Doherty L., Manfredi S., 2001^[2]) The role of hotel receptionist is changing and will continue to change with transformation, such as for example shift towards self-check in and contactless hotels, but it is expected to maintain its position at the centre of hotel and accommodation establishments. The occupational area will also be affected by the green transition and environmental sustainability will be a key consideration for the industry. The tourism sector is highly vulnerable to climate change and at the same time contributes to the emission of greenhouse gases (GHG), which cause global warming. Accelerating climate action in tourism is therefore of utmost importance for the resilience of the sector.

Defining the tourism and hospitality occupational area

Narrowing down the occupational area

The Tourism and Hospitality occupational area contains many different occupations. For the purpose of PISA-VET, it has been necessary to narrow the focus within Tourism and Hospitality to a single occupation. Following extensive discussion with experts and review of available evidence and resources, the choice was made to focus on the occupation of hotel receptionist in the Development Phase of PISA-VET.

In the International Standard Classification of Occupations (ISCO-08) the hotel receptionist falls within the unit Group 4224 – Hotel receptionist. According to the ISCO definition, hotel receptionists welcome and register guests in hotels and other establishments that provide accommodation services. They assign rooms, issue keys, provide information concerning the services provided, make room

reservations, keep a record of rooms available for occupancy, present statements of charges to departing guests and receive payment^{xi}.

The competencies needed to perform hotel receptionist tasks are typically acquired in VET programmes at ISCED Levels 3-4 with learning outcomes at EQF level 4, or equivalent.

Table 6.1. Main programmes leading to qualified hotel receptionist (country's participation in the Development Phase)

	Australia	Germany	Portugal
Title	Certificate 3 or 4 in hospitality or business	Specialists in the hotel business	Hotel accommodation technician
ISCED level	3	3	3
EQF level	3 or 4	4	4
Duration (years)	1-2 years	3 years	3 years

International comparability of the occupational area

A study conducted by Cedefop with ETF and UNESCO in 2017 (Cedefop, 2017^[3]), compared the learning outcomes of national VET qualifications in hotel reception across 26 countries worldwide. This study found that the knowledge, skills and competencies for hotel receptionist profile was comparable in almost every programme/qualification studied and covered ISCED levels 2, 3, 4 and 5. Moreover, WorldSkills has developed and applied international occupational standards for hotel reception, which specifies the knowledge, understanding and specific skills that underpin international best practice in technical and vocational performance. It is also important to note the international nature of the hotel reception occupation, the presence of large multinationals in the sector and the linkages to large international hotel booking platforms which all have an impact on "standardisation" in the occupation).

Organising the domain of hotel receptionist

The approach in PISA-VET is to follow the PISA model and in accordance with this the definition of hotel receptionist is analysed in terms of three inter-related aspects:

- The processes involved in the practice of the occupational area that describe what hotel receptionists do to connect the context of the problem or task they are faced with in a work situation with their professional competencies and thus solve the problem or complete the task, and the capabilities that underlie those processes.
- The hotel reception knowledge content that is targeted for use in the assessment items.
- The contexts in which the assessment items are located, such as a situation in a hotel reception.

The following sections elaborate these aspects in the following order: contexts, processes and content knowledge.

Hotel receptionist contexts

The choice of appropriate hotel receptionist strategies and representations is often dependent on the context in which a problem arises in the field of hotel reception.

Context category

Hotel receptionists work mainly in the reception area of hotels. The hotel reception is the core of the hotel and creates the first impression of the kind of service that the guest will have during their stay. The hotel reception is the centre of operations and the point of support for all the guest, operations and services.

Hotels of many types, sizes and ownership are an essential part of the tourism and hospitality industry, providing accommodation and associated services to guests from across the globe. They may be part of international hotel chains which market their services on consistency and familiarity for the frequent or regular guest. Alternatively, they may promote distinct characteristics based on their locality, history, architecture, and targeted clientele. Some may focus on tourists, while others may have more of a business traveller clientele. While such differences in types, sizes, ownership and target clientele can have important implications for the organisation and operations of hotels, they do not imply substantially different roles or context for the hotel receptionist. Therefore, within this framework for hotel receptionist one unique context will be considered, i.e. that of the hotel reception. Consequently, all of the items in the assessment will be allocated to that single context category.

Hotel reception processes and the underlying hotel receptionist capabilities

The hotel receptionist receives and serves different guests and other clients and individuals, with technical competence and knowledge, autonomy, creativity, and as an individual and as part of a team. The hotel receptionist receives and welcomes and communicates with these different guests and clients through various communication channels; carries out reception procedures to promote guest and client satisfaction; and ensures quality and excellence in service. The hotel receptionist must be able to work effectively in a team, interact with employees from other sectors, and contribute to guests' satisfaction and to win their loyalty. They must maintain posture and presentation in accordance with professional etiquette and the establishment's standards; meet the guests' needs, respecting current procedures and legislation; provide updated information on services and products offered by the establishment they are working in and the locality; receive and transmit messages to guests, ensuring confidentiality of information and preserving the guest's privacy; market tourism services and support services according to the guests profile and demand, and mediate conflicts, resolving guests incidents and managing complaints, following the establishment's rules. Communication is a key skill for hotel receptionists and must be carried out in the local official language and, whenever possible, in the guest's language or in English or other commonly spoken languages.

Hotel reception processes

According to their relevance in the role of the hotel receptionist, four main processes are identified:

1. check-in and check-out
2. reservations
3. management of complaints
4. touristic information.

Check-in and check-out

Two of the most important and frequent processes that a hotel receptionist engages in are those related to checking-in and checking-out hotel guests. Checking in and checking out guests includes welcoming and greeting guests, informing guests of hotel rates and services, ensuring proper room allocation, registering and checking guests in to the hotel, confirming relevant guest information, verifying guests' payment method, verifying credit cards for authorization, issuing room keys and directing guests to their

rooms, maintaining clear and accurate records of guest room bookings, computing all guest billings, accurately posting charges to guest rooms and house accounts, receiving and transmitting messages for guests, retrieving mail, packages and documents, closing guest accounts and checking guests out, reviewing accounts and charges with guests during the check-out process, processing accurate payment of guest accounts, completing procedures for dealing with guests luggage, belongings, and carparking, and informing housekeeping when rooms have been vacated and are ready for cleaning.

For checking in guests, the hotel receptionist applies guest recognition, greets the guests in a language they understand, interprets regulations and procedures related to the documentary registration of national and foreign guests, performs registration using specific software for the front office, records room assignment and delivery, receipt, and control of room keys, presents the services and schedules of the hotel, ensures the guest's accompaniment or guidance to the reserved room, advises guests on the acquisition of products and services and maintains a neat and orderly front desk and reception area. The hotel receptionist also communicates the arrival and the departure of the guest to the internal services of the hotel and communicates between services to fulfil guests' orders.

For checking out guests, the hotel receptionist uses the features of the computer application for billing and closing accounts, checks expenses, consumption of hotel goods, statements of accounts, issuance of invoices and closing of accounts. The hotel receptionist also manages the transport of luggage and measures the degree of guests' satisfaction during the farewell.

More specifically, in the case of check-in processes, the hotel receptionist engages in the following tasks:

- Ensure that the reception area is well presented in terms of appearance, signage and cleanliness.
- Check in guests according to hotels' policies and procedures.
- Maintain all necessary documentation and information relating to guests.
- Issue room keys to guests.
- Provide directions to allocated rooms and information about hotel services and facilities.
- Request and take instructions for additional services and sales.
- Ensure payment to prepare for smooth check-outs.
- Advise on transferring guests' luggage to rooms and organise transfers according to hotels' policies.
- Prepare and deal efficiently with arrivals of groups.
- Handle efficiently overbooking and book-out situations.

In the case of check-out processes, the hotel receptionist should be able to:

- Check-out guests according to hotels' policies and procedures.
- Manage express check-outs and late check-outs.
- Manage check-outs for large groups or parties.
- Receive payments.
- Account for advance deposits received by hotels and any refunds due to guests.
- Apply sales taxation and all legislation relating to the sale and service of goods and services appropriately.

Reservations

The processes involved in making reservations for guests include answering and directing incoming calls or emails, informing guests of hotel rates and services, making and confirming reservations for

guests, ensuring proper room allocation, and maintaining clear and accurate records of guest room bookings.

In the reservations process, hotel receptionists interpret the reservation requests and data related to the occupancy rates of the hotel, check the availability and occupancy rate of the accommodation to make reservations, and inform guests about availabilities and booking conditions such as prices of different types of services/accommodation, promotions, payment terms, collect and interpret statistical information regarding commercial plans of products and services of the hotel establishment. Depending on the guests, the hotel receptionist adapts the communication for the context of attendance, face-to-face, online, or telephone.

In addition, the hotel receptionists often need to make changes in the tariff according to the price indicators, analyse the contractual conditions, write reports on occupations and other indicators of the reservation system (rooming list, availability reports, reservation plan, others) manage availability and rates on booking platforms/commercial partners.

This process involves communicating with guests and other professionals, interpreting and applying hotels' policies regarding reservations and documentation used within hotels relating to reservations and applying software systems used to record hotel reservations.

More concretely, when it comes to reservations processes, the hotel receptionist engages in the following tasks:

- Take individual reservations in person, over the telephone, by e-mail, booking platforms or letters.
- Take group reservations by telephone, e-mail, booking platforms or letters.
- Take reservations via approved agents or brokers and record appropriately.
- Accept walk-in bookings based on room availability, agreeing tariff and payment according to hotels' policies.
- Request and take deposits according to hotels' policies.
- Allocate rooms according to hotels' policies and procedures.
- Record requests for additional services or sales to ensure delivery and appropriate charging.

While the growth of reservation platforms has significantly altered the reservation process and led to significant automation, the reservation process is still a core process of the occupation of hotel receptionist and is very important to understand the scope of the profession.

Manage complaints

In the complaints process, hotel receptionists communicate with different types of guests and must demonstrate an understanding of customer complaints and expectations, select and use complaint management strategies and procedures, apply general and internal complaint management procedures, demonstrate the ability to solve problems arising from customer requests and complaints within the constraints of hotel procedures and apply hotel complaints procedures when completing records of the services performed.

Hotel receptionists must also demonstrate basic techniques for investigation and analysis of complaints and be able to interpret hotel complaint procedures to identify options and solutions for guests, with conformity to the procedures. Hotel receptionists must apply hotel complaints procedures as appropriate to the situation and have scope for flexibility and understand when to conform to hotel procedures. They must also understand the limits of their personal authority and know when to refer matters to their line managers. A good understanding of principles underlying conflict management is also essential for hotel receptionists.

In the case of managing complaints processes, the hotel receptionist engages in the following concrete tasks:

- Anticipate potential problems and complaints.
- Put complainants at ease, including moving to appropriate locations as required.
- Listen to complaints attentively, taking notes as required.
- Ask questions objectively and sensitively.
- Organise the notes taken, distinguishing between fact, opinion, or assumption.
- Refer to hotels' procedures in order to identify options and solutions.
- Apply hotels' procedures as appropriate to the situation.
- Refer matters to line managers where they go beyond their personal authority.
- Check satisfaction after the recovery of service.

Touristic information

Hotel receptionists provide touristic information to guests and clients about the local area surrounding the hotel. The process involved in providing touristic information to guests and clients includes communicating information on places of interest, tourist activities, and external services in the field of tourism, providing support to guests and clients for making contacts with the providers of touristic activities and cultural attractions, making reservations and scheduling with entities outside the hotel on behalf of guests.

In this process the hotel receptionist selects the relevant information about public services and tour operators to be made available to the guest and identifies activities and existing offers in the vicinity of the geographical location in which the unit is located, according to the guests' age group, profile, needs, expectations and interests. The hotel receptionist is also expected to make travel appointments, arrange excursions and sightseeing tours, rent vehicles and/or purchase tickets for shows, visits, among others on behalf of guests. Hotel receptionists often use the computer and digital means at their disposal to satisfy guests' preferences.

More concretely, with regard to touristic information, the hotel receptionist engages in the following tasks:

- Promote destinations through storytelling, experiences, and guidance.
- Plan trips, book tickets and make reservations on behalf of guests.
- Anticipate guests' needs and promote destinations accordingly.
- Assist in transportation.
- Research, obtain and keep information up to date.
- Collect feedback on guests' experiences.

Desired distribution of items by hotel reception process

The below table provides the proposed distribution of items over the four processes. The item distribution reflects the frequency of processes in the daily work of hotel receptionists. It was extensively discussed and agreed upon by a group of experts from different countries. The check-in/out process receives a higher percentage of items as it is a core part of the hotel receptionist occupation and involves many interrelated tasks. The reservation process has a lower percentage of items in the assessment, due to the growth of reservation platforms that has led to many parts of the process now being automatised. The higher percentage of "check-in and check-out" compared to "reservations" is also aligned with the WorldSkills Occupational Standard for the occupation.

Table 6.2. Desired distribution of hotel receptionist

Process category	Percentage of items in the assessment
Check-in and check out	40
Reservations	15
Manage complaints	20
Touristic information	25
Total	100

Fundamental hotel receptionist capabilities underlying the hotel reception processes

This subsection describes each of the fundamental Hotel Receptionist capabilities that underpin the reported processes in practice. It defines and describes the fundamental Hotel Receptionist capabilities to be used in the framework, including service orientation, interpersonal and communication skills, collaboration, task performance, critical thinking, literacy and ICT literacy. At the end of the sub-section, the relationship between the hotel receptionist capabilities and the processes is provided.

Hospitality service orientation

A hotel receptionist with a service orientation prioritises the needs of the customers as more important than anything else. Hotel receptionists are taught and empowered to listen to guests and customers and to come up with the best solution to meet customer and guest needs. Service orientation is the ability to respond appropriately to diverse customers and guests, provide and satisfy the guests' needs, improve reception productivity and guest loyalty. It is also the capability to respond appropriately to diverse customers and guests, satisfying their needs and providing the best hospitality service. Hotel receptionists must have the capability to quickly adapt to any situation and know the guests and their needs, provide assistance and support guests and costumers before, during, and after they stay in the hotel. It can include everything from providing helpful information about a service or a product to resolving customer complaints.

Hotel receptionist interpersonal and communication skills

Interpersonal skills are the skills hotel receptionists use to communicate and interact with colleagues, guests and customers both verbally (in different languages) and non-verbally, through gestures, body language and their personal appearance. Communication skills are particularly important for a hotel receptionist and are the abilities they use when giving and receiving different kinds of information. Some examples include communicating new ideas to colleagues, providing guidance to guests or even showing a customer a programme for an event. Communication skills involve listening, speaking, observing and empathising. It is also essential for hotel receptionists to understand the differences in how to communicate through face-to-face interactions, phone conversations and digital communications like email and social media. Increasingly important for hotel receptionists are 'inter-cultural communication skills' when dealing with the diversity of tourism market segments and countries of origin.

Collaboration with other hotel staff

The hotel receptionist works closely with other staff members of the hotel. For example, as part of the check-in and check-out process, the hotel receptionist communicates the arrival and the departure of the guest to the internal services of the hotel and communicates between services to fulfil guests' orders. Collaboration capabilities are therefore crucial for this occupation. As discussed in Chapter One

and Chapter Seven of this framework document, the definition of collaboration in PISA-VET is strongly rooted in the SSES framework. The OECD defines “collaboration” as a range of constructs that describe the ability to understand, feel and express concern for others’ well-being, manage interpersonal conflict and maintain positive relationships and beliefs about others (trust) (Kankaraš and Suarez-Alvarez, 2019^[4]; Soto and John, 2016^[5]). In short, it refers to the skills that enable individuals to get along with other people and work successfully together in various contexts.

Problem Solving in the context of hotel reception

In their professional role, hotel receptionists must demonstrate foresight in anticipating potential problems and complaints and respond to problematic situations. In a complaint situation, hotel receptionists must be able to listen to complaints attentively, put guests at ease, including moving to appropriate locations as required, showing consideration and empathy while maintaining objectivity, asking questions objectively and sensitively, taking notes as required, distinguishing between fact, opinion, or assumption, referring to hotel procedures to identify options and solutions, apply appropriate hotel procedures and refer matters, according to hotel policies

As discussed in Chapter One and Chapter Seven of this framework document, the definition of problem solving (Chapter 7) in PISA-VET is strongly rooted in the adaptive problem-solving framework of PIAAC Cycle 2. PIAAC Cycle 2 defines problem solving as “the capacity to achieve one’s goals in a dynamic situation, in which a method for solution is not immediately available. It requires engaging in cognitive and metacognitive processes to define the problem, search for information, and apply a solution in a variety of information environments and contexts” (OECD, 2021^[6]).

Task performance in the context of hotel reception

Hotel receptionists must be able to act reflectively and responsibly, accept feedback, adapt to change and deal effectively with guest-related unexpected situations, to ensure service quality, according to the hotel procedures.

As discussed in Chapter One and Chapter Seven of this framework document, the definition of task performance in PISA-VET is strongly rooted in the OECD’s survey on social and emotional skills (SSES) framework. The OECD defines “task performance” as a range of constructs that describe the ability to be self-controlled, responsible to others, hardworking, motivated to achieve, honest, orderly, persistent and rule-abiding (Roberts, B. et al., 2009^[7]; Kankaraš and Suarez-Alvarez, 2019^[4]). In short, it refers to the skills that enable individuals to get things done, as required and on time.

Critical thinking in hospitality service

In their professional role, hotel receptionists must be able to evaluate and use information of different kinds to plan activities, achieve goals, solve problems, deal with issues and perform complex tasks in routine and new ways.

Critical thinking mainly aims at assessing the strength and appropriateness of a statement, theory, or idea through a questioning and perspective-taking process, which may or may not in turn result in a possibly novel statement or theory. Critical thinking need not lead to an original position to a problem. The most conventional one may be the most appropriate. However, it typically involves the examination and evaluation of different possible positions. The cognitive processes or sub-skills involved in critical thinking are: inquiring, imagining, doing, and reflecting.

Literacy in hospitality service

Hotel receptionist must be able to read and understand different documentation, evaluate, and reflect on written texts to give the correct and expected response to guests, staff, and other clients' demands.

As discussed in Chapter One and Chapter Seven of this framework document, PIAAC defines **literacy** as the ability to “access, understand, evaluate and reflect on written texts to achieve one’s goals, to develop one’s knowledge and potential and to participate in society” (OECD, 2021). In this, literacy refers to one’s ability to comprehend and use written sign systems. Literacy encompasses a range of skills, from decoding written words and sentences to comprehending, interpreting, and evaluating complex texts.

ICT Literacy for hotel reception

Hotel receptionists have to deal with different ICT applications used in the occupational area and the hotels they work at. For example, they may use standard office software as well as highly specialised software systems for managing hotel reservations, including customer relationship management (CRM) software. They therefore need solid ICT literacy, which is defined as encompassing a variety of skills ranging from the capability to use ICT for learning purposes, in professional settings and in everyday life, e.g. to access digital services.

When it comes to the relationship between hotel receptionist processes and underlying capabilities, Table 6.3 below shows that all of the processes require some combination of the hotel receptionists underlying capabilities to complete successfully.

Table 6.3. Relationship between hotel receptionist processes and fundamental hotel receptionist capabilities

	Check-in and check out	Reservations	Manage complaints	Touristic information
Service orientation	X	X	X	X
Interpersonal and communication skills	X	X	X	X
Collaboration	X	X	X	X
Problem solving	X	X	X	X
Task performance	X	X	X	X
Critical thinking	X	X	X	X
Literacy	X	X	X	X
ICT literacy	X	X	X	X

Hotel receptionist content knowledge

The content knowledge for hotel receptionist presented here is deemed to be relevant for trainees nearing the end of their IVET programme. For the structure of the corresponding content knowledge, common and shared areas have been placed in the centre of the four process areas. These are used here to reflect on how the curriculum is structured and to guide the item development at later stages of this project.

In addition to national studies, WorldSkills Occupational Standards and ESCO occupational profiles have been used to outline the required knowledge. An understanding of hotel receptionist content – and the ability to apply that knowledge to the solution of meaningful contextualised problems – is fundamental for success in this occupation. That is, to solve problems and interpret situations in

occupational contexts, there is a need to draw upon certain hotel reception knowledge, understandings and, most importantly, procedures.

Content categories

The hotel receptionist domain is organised in content categories in a way that ensures a spread of items across the domain and focuses on important hotel receptionist tasks and processes. It also describes the content knowledge that characterise each of the content categories chosen for the assessment.

The five categories of content knowledge are:

- hotel reservation procedures
- checking-in procedures
- administration and back-office procedures
- checking-out procedures
- promotion of the local area.

These five categories are further detailed below. These elements provided by category are illustrative of the content topics that will be included in PISA-VET rather than an exhaustive list.

Hotel reservation procedures

Hotel receptionists require knowledge related to reservation procedures and policies:

- Room allocation procedures, including the use of density charts, conventional charts, software solutions.
- Understanding of the place of central reservations within a hotel chain; the status of provisional, confirmed, and guaranteed bookings; the types and range of tariffs.
- Software systems used to record hotel reservations.
- Hotel policies regarding deposits and procedures for taking a deposit at the point of booking; release times for rooms; overbooking; yield management; and the use of agents or brokers.

Checking-in procedures

Hotel receptionists require knowledge related to check-in requirements, protocols and procedures:

- Legal requirements regarding documentation and records for national and international hotel guests.
- Electronic and manual systems for checking in guests; automated check-in procedures; group check-in procedures; registration requirements; the functioning and updating of guests' historic records.
- Procedures and protocols for issuing keys; different types of traditional and electronic room keys.
- Procedures for dealing with guest requests such as early morning calls, newspapers, breakfast, room service; handling of guests' luggage, belongings, and car parking.
- Concepts and principles related to customer service and reception in hospitality.
- Customer service and communication techniques.

Administration and back-office procedures

Hotel receptionists require knowledge of administration and back-office procedures related to guests' stays:

- General office and administrative procedures and processes including filing, word processing, databases, photocopying, and maintenance of records.
- Various types of guest recording and accounting systems including manual (tabular ledger) and computerized systems; posting charges to the guests' bills such as restaurant charges, room service, bar, paid outs; procedures for registration and reporting of complaints; booking management procedures.
- Credit control systems, bad debts and how hotels manage them; the importance and means of security relating to handling and recording cash and cash equivalents.
- Procedures for negotiating prices online and through conventional channels.

Checking-out procedures

Hotel receptionists require knowledge related to check-out requirements, protocols and procedures:

- Check-out times; express check-out procedures; late check-out procedures and policy; check-outs for large groups and parties.
- Billing procedures on guests' departure; Various types of payment methods; refund procedures; procedure for accounting for advance deposits when preparing guests' bills and receiving payment.
- Sales taxes and how they apply to hotel bills.

Promotion of the local area

Hotel receptionists require knowledge related to the local area:

- Cultural, historical and tourist information for the local area; options of public transportation and procedures for renting cars and booking events tickets.
- Know how to obtain new information fast by using the internet.

Desired distribution of items by content category

The desired distribution of items selected for hotel receptionist in PISA-VET across the content categories are shown in Table 6.4. The goal in constructing the survey is a balanced distribution of items with respect to content category since all of these domains are important for success in hotel receptionist.

Table 6.4. Desired distribution of hotel reception items, by content category

Content category	Percentage of items in Assessment
Hotel reservation procedures	20
Checking-in procedures	20
Administration and back-office procedures	20
Checking out procedures	20
Promotion of local area	20
Total	100

Assessing hotel receptionist learners

This section outlines the approach taken to apply the elements of the framework for hotel receptionist described in previous sections to PISA-VET. This includes the response formats, item scoring, and reporting hotel receptionist proficiency. It also includes examples of items.

In the International Vocational Education and Training Assessment, the knowledge and competence of hotel receptionist learners are assessed in accordance with the processes, underlying capabilities, content and contexts described in the earlier sections of this chapter. The assessment should provide objective, reliable, and valid results about the learners' competencies. It should accurately measure the competencies learners need for the occupation of hotel receptionist, and predict their future job performance, while minimizing the impact of confounding factors on the results (e.g. country specifics).

Assessment types and response formats

To obtain valid results, the assessment should broadly and authentically represent the domain of hotel receptionists. The domain is defined by requirements and the knowledge and skills needed for these requirements. In terms of domain requirements, the assessment covers the context, content topics, and processes described above. In this regard, it also reflects occupation-specific standards, namely that hotel receptionists should not only be able to perform processes but to justify their actions and results. In terms of knowledge, the assessment covers the strategic and procedural knowledge required to carry out the processes. Further, it represents the conceptual knowledge of the content topics required to understand the processes, apply the strategic and procedural knowledge, and justify actions and outcomes. To achieve reliable results, the number of items should be as high as possible, but test fatigue and economic arguments must be considered.

Technology-based assessments allow for an economical assessment and are feasible in large-scale assessments. To assess several of the hotel receptionist competencies, technology-based authentic scenarios can be used. The scenarios should include authentic simulations of tasks and problems, authentic work environments and where possible and appropriate allow for authentic interactions between the hotel receptionist and guests. They can be presented in a computer environment and can use simulations and/or videos to imitate relevant features of the hotel receptionists' workplace as authentically as possible. An example of such a scenario would be a situation where learners must deal with a hotel guest's complaint about the quality of the hotel's service or accommodation. Examples of scenarios are provided at the end of this section.

Such technology-based simulations can be complemented with live (or video recorded) demonstrations if these provide value added and fit within the logistical and budgetary limitations of PISA-VET. Moreover, traditional knowledge-based tests can be used to assess certain elements.

The competencies are assessed in a two-step procedure: First, the sub-competencies of each competency are measured. For reporting purposes, the results are then used to build scores for the competency. Hotel receptionist competencies are assessed at two levels, similar to how PISA assesses a domain of interest at a given cycle (its "major" domain). At a more granular level, sub-competences reflecting specific capabilities, knowledges, and contexts can be assessed. Overall competence, encompassing all that has been defined for the domain above can also be derived from the domain-specific items and reported. While the latter is a natural output of a coherent and valid test built around the hotel receptionist construct, the feasibility of sub-scales will be investigated during the Development Phase of the assessment.

For the hotel receptionist profession 5 types of response formats can be considered:

- Selected response (simple and complex multiple-choice) items.
- Closed constructed-response items.

- Open-ended constructed-response items closed constructed-response items and selected-response items are expected to be combined in the assessment and are selected based on content and difficulty considerations.
- Final state and performance response from process files (i.e. “process” or “log” data) from digital simulation items.
- Ratings provided by expert judges from live demonstrations.

The number of open-ended constructed-response items is kept to a minimum as scoring such items is reliant on dedicated systems and coder training, thus time-consuming and less practical in international large-scale assessments. Additional challenges notwithstanding, open-ended items can be very useful to assess certain, more complex components of the framework and to infer whether learners can generate responses based on more complex cognition and integrated knowledge. They are beneficial, for example, to assess how and to what quality learners justify the results they have achieved or the actions they have taken.

Closed constructed-response items have a finite number of states encoding responses. In these, users manipulate the state by their input but do not have unlimited choices (not free typing or drawing), as they can only pick from a certain number of actions, while they have more choices than in a multiple-choice item. Examples are selection and dragging and dropping of objects, etc. Such items are also useful to tap more complex knowledge and cognition but are limited in this respect compared to open constructed-response items. Closed constructed-response items are used to assess, for example, whether hotel receptionist learners can identify a mistake in a reservation or a bill and the appropriate actions to correct it.

Selected-response items (simple and complex multiple-choice items) are employed, for example, to assess conceptual knowledge such as the knowledge of hotel regulations and procedures (e.g. technical terms, legal requirements). The development of such items considers measures to reduce rate biases (e.g. a high number of choices) and the risk of assessing superficial thinking and knowledge (e.g. the use of many appropriate and complex distractors).

The assessment will include the use of digital simulations, for instance a simulation of booking software. The final state (a correct booking with guest, date information etc.) would be more of a state for the item than a test item as commonly understood. The assessment will also include live or recorded demonstrations of tasks assessed by human judges.

Simulation items have the potential to offer a more engaging experience for learners as they are capable of emulating real-world (and thus more relevant) settings through complex interactions and the use of multiple media, such as animations and sounds. Albeit complex to develop, simulation-based items have the potential to assess skills that are challenging to assess in the abovementioned formats, such as decision-making and situational judgement. Another challenge with simulations is grading – subject matter and assessment experts will be involved in the development of (automatic) marking rubrics and how to collect data on learner strategies to potentialize the reporting of learner outcomes. Experiences with the development of the PISA 2025 innovative domain, Learning in a Digital World, which heavily relies on automated grading of this item format will also be leveraged.

Demonstrations of professional skills assessed by expert judges present even further potential to assess learner skills with even more flexibility, given the possibility of interactions between learners and judges and the nuanced assessment of learner performance. Furthermore, demonstrations can be critical for the validity and reception of results as results are directly connected to trained professionals in the field of occupation being assessed. Benefits notwithstanding, demonstrations are challenging to scale in large-scale settings, due to the human resources required, internationally comparable training protocols to be developed and statistical models to be employed, thus demanding their careful addition to the assessment’s test design.

Item scoring

The items are scored dichotomously or with partial credits based on expert generated scoring guides to encode student responses, or student responses per expert judge in the case of demonstrations. Three response types are used for the item scoring: learners' written responses, expert judges' grades, and process data. The process data results from the learners' interactions with the technology-based interactive task environments or expert judges' task metadata (e.g. time per task) and are recorded by computer.

Such data is used to score for example, whether the learners have performed a relevant problem-solving activity (e.g. a guest's complaint about room service), to add statistical corrections as needed (for instance when using population modelling as done in PISA), or to perform quality control and investigation of student experience and of the collected assessment data. As no adaptive design is foreseen, student progress through the test do not have to be interrupted for item scoring purposes. The item scoring can be done afterwards also leveraging the collected process data.

Reporting proficiency in hotel receptionist

The following are initial proposals for reporting proficiency in hotel receptionist. Once all the developed items have been coded and background questionnaire information collected, and psychometric quality assurance has been performed on the test items, proficiency measures can be estimated taking student background information and statistical uncertainty into account. Extensions of this process, which is also aimed to draw from the experience with PISA results, will also be explored for the more complex demonstration and simulation data during the Development Phase. The lower score limits will be determined with data in the second stage of the Development Phase according to the standard PISA scaling procedure.

The assessment measures learners' ability to perform typical hotel receptionist tasks in hotels and accommodation establishments based on a systemic understanding of hospitality processes and sub-processes. This domain will report what learners in the domain of hotel receptionist typically know and can do at given levels of proficiency or, alternatively, this will be described in a numerical manner.

The focus of reporting will be on the different proficiency levels. There are 6 proficiency levels leading to 7 categories: proficiency at level 6 – representing an organized trainee with advanced knowledge, resourcefulness, and leadership - proficiency at level 5, 4, 3, 2, and 1– the latter representing a “bare minimum” level of routine, predictable, and simple tasks, with intermediate levels representing profiles in between. Results will represent the performance regarding key tasks, typically performed in the reception areas of hotels and accommodation establishments.

Table 6.5. Summary description of the levels of hotel receptionist proficiency in PISA-VET

Level	Lower score limit	Descriptor
6	To be confirmed with data	At level 6, trainees have advanced knowledge and skills demonstrating the mastery and innovation required to solve challenging problems. They can deal with complex activities, organise work and make decisions in uncertain and changing situations. They can evaluate, introduce improvements, and take the initiative. In this level, trainees can lead others and collaborate with colleagues and teams using their ability to problem solve. <i>Key learning outcomes verbs: create, reorganize, compile, design, assemble, articulate, value.</i>
5	To be confirmed with data	At level 5, trainees have comprehensive, specialised, factual and theoretical knowledge. They can develop solutions to unexpected problems and are able to work within an environment of uncertainty and change. In this level, trainees can manage others and contribute with the teams.

Level	Lower score limit	Descriptor
		<i>Key learning outcomes verbs: develop, problem solve, manage, contribute</i>
4	To be confirmed with data	At level 4, trainees can apply knowledge and skills in a broad range of complex, technical work activities, and problems which are mainly non-routine, adapting actions as required. In this level, trainee can collaborate with colleagues and teams. <i>Key learning outcomes verbs: apply, adapt, collaborate</i>
3	To be confirmed with data	At level 3, trainees can apply knowledge and skills in a broad range of routine and non-routine work activities, some of which maybe complex. They can solve routine and non-routine problems and have autonomy for the completion of tasks. In this level trainees can collaborate with a team. <i>Key learning outcomes verbs: interpret, modify, predict, illustrate, calculate, generalise, complete.</i>
2	To be confirmed with data	At level 2, trainees apply basic knowledge and skills in a range of normally varied work activities. At this level, trainees have some autonomy but still need supervision in a range of task and operations. <i>Key learning outcomes verbs: compare, exemplify, explain, associate, demonstrate, predict, arrange.</i>
1	To be confirmed with data	At level 1, trainees can apply minimum knowledge and skills in a range of normally routine, simple, and predictable work tasks, according to the hotel procedures. At this level the trainees have no autonomy and works with supervision. <i>Key learning outcome verbs: understand, remember, outline, explain, identify, review, report, apply.</i>

Examples of items for addressing the hotel receptionist framework

Scenarios using digital simulations

As an example, in one item the trainee will have access to a check-in video role play, where he/she will be evaluated by identifying all the right procedures and it's correct order of performance, in a limited time.

The trainee should register if in the video simulation, the hotel receptionist:

1. greets and welcomes the guest
2. assigns the correct room for that reservation
3. verifies guest identity
4. verifies guest credit, etc.

At a second stage of the assessment, the trainee will receive a Guest Complaint and must demonstrate several skills, such as, autonomous judgment, problem solving, empathy, communication, positive attitude, and guest orientation, etc. The learner should also respond in a limited time. The evaluation will be measured, with the verification of the trainee performance and the time spent in both responses, i.e. the ability to perform work under pressure, which is in the role of Hotel Receptionist a constant challenge.

The material needed for this assessment will be a computer-based simulation – videos and photos and writing materials.

Standard scenarios

Q1: Situation Description: While doing the check in, the hotel receptionist interacts with the guest with a positive attitude, explains all the hotel services and indicates the room number. Why does the hotel receptionist not inform verbally the hotel room number to the guest? Choose the right answer:

- a) For security reasons
- b) Because it is not necessary
- c) Because the hotel receptionist should not speak too much while doing the check-in
- d) Because it should be the Housekeeping Manager to inform the guest

Q2: Situation description: A guest is complaining about a strange and strong odour in the room, which didn't allow him to sleep the night before. Rank the below procedures from most to least suitable:

1. Call the Housekeeping Manager to verify the room.
2. Make an upgrade to another room if the guest wishes.
3. If the guest doesn't want to change room, offer something complementary (brunch, massage, voucher to the bar, etc).
4. Report the situation to supervisor.
5. Apologize to the guest and assure that you will take care of the situation personally.
6. Inform the guest that when you have a solution you will inform the guest.

References

- Cedefop (2017), *Global inventory of regional and national qualifications frameworks 2017*, [3]
<https://doi.org/10.2801/238>.
- Doherty L., Manfredi S. (2001), "Women's employment in Italian and UK hotels", *International Journal of Hospitality Management*, Vol. 20/1, pp. 61-76, [https://doi.org/10.1016/S0278-4319\(00\)00040-2](https://doi.org/10.1016/S0278-4319(00)00040-2). [2]
- ESCO (2020), *European classification of Skills/Competences, Qualifications and Occupations*, [8]
<https://esco.ec.europa.eu>.
- Kankaraš, M. and J. Suarez-Alvarez (2019), "Assessment framework of the OECD Study on Social and Emotional Skills", *OECD Education Working Papers*, No. 207, OECD Publishing, Paris, [4]
<https://doi.org/10.1787/5007adef-en>.
- Leary, M. (ed.) (2009), *Conscientiousness*, The Guilford Press), 369–381. [7]
- OECD (2021), *The Assessment Frameworks for Cycle 2 of the Programme for the International Assessment of Adult Competencies*, OECD Skills Studies, OECD Publishing, Paris, [6]
<https://doi.org/10.1787/4bc2342d-en>.
- OECD (2018), *OECD Tourism Trends and Policies 2018*, OECD Publishing, Paris, [1]
<https://doi.org/10.1787/tour-2018-en>.

Soto, C. and O. John (2016), "The Next Big Five Inventory (BFI-2): Developing and Assessing a Hierarchical Model With 15 Facets to Enhance Bandwidth, Fidelity, and Predictive Power", *Journal of Personality and Social Psychology*, Vol. 113/1, pp. 117-143, <https://doi.org/10.1037/pspp0000096>.

[5]

Further reading

CEDEFOP (2021), *Vocational education and training in Portugal: short description*, Luxembourg: Publications Office of the European Union, Luxembourg, <http://data.europa.eu/doi/10.2801/251891>.

ESCO (2020), *European classification of Skills/Competences, Qualifications and Occupations*, <https://esco.ec.europa.eu>.

ILO (2012). *International Standard Classification of Occupations: ISCO-08*, Vol. 1: Structure, Group Definitions, and Correspondence Tables, International Labour Office, Geneva, [International Standard Classification of Occupations \(ISCO\)](#).

OECD (2020), *OECD Tourism Trends and Policies 2020*, OECD Publishing, Paris, <https://doi.org/10.1787/6b47b985-en>.

WSI (2021), Hotel reception, Social and Personal Services, <https://api.worldskills.org/resources/download/12397/14958/15886?l=en>

Notes

¹ In the Standard Occupational Classification (SOC), mostly used in the United States, hotel receptionists are classified under "Hotel, motel and resort desk clerks" (42.4081).

7 Employability Skills

This chapter defines employability skills as assessed by PISA-VET and elaborates the framework for employability skills that has been designed for the Development Phase of the project, including descriptions of the competencies and constructs to be assessed. It presents and explains the dimensions reflected in PISA-VET's employability skills domains and how these will be assessed and provides several sample items with descriptions of task characteristics. The chapter also discusses how student performance in the employability skills is measured and reported against proficiency levels and scales.

Introduction to Employability Skills in PISA-VET

PISA-VET must reflect today's workplaces in their complexity and dynamic nature. As mentioned in Chapter 1, the changing world of work in the 21st century is being profoundly shaped by several megatrends, including the Fourth Industrial Revolution, the advent of Artificial Intelligence, and the green and digital transformation. These trends are fundamentally alerting the nature of work and employment and shifting the global economy, society as well as consumer and employee demands (Frey and Osborne, 2017^[1]; McClelland, 2020^[2]; World Bank, 2018^[3]). Therefore, labour markets are constantly evolving, requiring individuals to engage in lifelong learning and master new situations within their occupation or even across different occupations. The prerequisite for achieving this mastery, even in job market situations that we may not yet know will exist a decade from now, is through possessing so-called employability, i.e. a set of transversal and foundational skills that are fundamental for success in the workplace and for navigating a changing labour market. The significance of such employability skills is paramount for the workplace but extends even further: they are equally valuable for leading a successful and fulfilling social and civic life.

The topic of employability skills needed for the future of work has been of interest to policy makers and practitioners alike for several years, and the role of employability skills for students and adults in successful participation in modern society has been receiving increasing attention in several international surveys. PISA is one such study that has looked at the importance of employability skills in student populations. The most recent PISA report (OECD, 2019^[4]) found that students who possess strong employability skills, such as problem solving, critical thinking, and communication, are more likely to perform well in all three subject areas and exhibit higher levels of well-being. PIAAC is another OECD study that has examined the importance of employability skills in the context of the working adult population. PIAAC assesses the proficiency of adults in key areas, such as literacy, numeracy, and problem solving in technology-rich environments. The most recent PIAAC report (OECD, 2019^[5]) found that adults with stronger employability skills are more likely to have higher levels of employment, earn higher wages, and have better health outcomes. Furthermore, the OECD's Study on Social and Emotional Skills (SSES) (OECD, 2021^[6]) identified five key employability skills that help individuals to be successful in the workplace, namely task performance, emotional regulation, collaboration, open-mindedness, and engaging with others. Overall, these studies not only emphasise the relevance of employability skills for academic and career achievements but also highlight the individual benefits for personal growth and overall well-being associated with these skills in both student and adult populations.

PISA-VET includes employability skills derived from these OECD frameworks. These employability skills can be defined as a broad set of skills and abilities that are essential for success in any occupational field (a more detailed definition can be found in the next section). Without a strong foundation in these skills, individuals may struggle to acquire specialised skills or adapt to changing job requirements and will, thus, not be well-prepared to master the workplaces of the future. Therefore, developing employability skills through VET programmes and integrating them nationwide across occupational areas is critical for ensuring employability and success in the modern workforce as well as individual well-being. The assessment of employability skills in PISA-VET strives to provide valuable insights into their development within VET programmes, predict future employability, and facilitate comparisons both within specific occupations and across diverse contexts.

The purpose of this chapter is to define employability skills as understood by PISA-VET and highlight their relevance in the modern workforce. It also aims to elaborate the framework for employability skills that has been designed for the Development Phase of the project and explain the selected domains and the proficiency levels of employability skills in PISA-VET. Finally, a mode for the assessment of employability skills is proposed.

Defining Employability Skills

Employability skills are a set of competencies that are relevant across occupational areas for success in the workforce and beyond. Employability skills are characterised by the following hallmarks: a) they are necessary for an individual's full integration and participation in the labour market, education, and training, as well as in social and civic life; b) they are highly transferable to other contexts; and c) they are learnable, and thus subject to the influence of policy (OECD, 2019^[4]). In other words, these skills enable individuals to adapt to new technologies and rapidly changing workplaces (OECD, 2019^[5]) and prepare individuals for future learning and help them master situations at work that may not even be relevant today but will be in the future. They are crucial for individuals to navigate the rapidly changing labour market and succeed in an increasingly complex and dynamic world of work. Numerous studies have demonstrated the importance of employability skills in education and the workforce. For instance, PISA and PIAAC have shown that individuals who possess strong employability skills are more likely to perform well academically, have better job prospects, and earn higher wages. Research studies have also found that employability skills are positively associated with job performance, job satisfaction, and career advancement (OECD, 2013^[7]; 2019^[4]; 2019^[5]), which in turn contribute to individuals' integration into society, resilience, personal growth, and well-being (Vanhercke, De Cuyper and De Witte, 2016^[8]).

There are many different terminologies in use for what this chapter calls “employability” skills, and the term “employability skills” has been used synonymously to foundational skills, transversal skills, transferable skills, cross-domain skills, generic skills, core skills, key competencies, soft skills, and 21st-century skills. For example, PISA defines key competencies as the set of knowledge, skills, attitudes, and values needed for individuals to succeed in the 21st century. Similarly, PIAAC emphasises the importance of transferable skills for success in a constantly evolving labour market. Albeit in slightly different terminology, the OECD's PISA (OECD, 2019^[4]) and PIAAC (OECD, 2013^[7]) studies regard employability skills as a combination of cognitive and non-cognitive skills, including problem solving, critical thinking, communication, collaboration, literacy, numeracy, information and communication technology (ICT) literacy, and more. These skills are not limited to specific school subjects, occupations, or industries and can be applied across a variety of contexts. In their report “Enhancing Employability” for the G20 Employment Working Group, the OECD, the ILO (International Labour Organization), and the World Bank (OECD, ILO and The World Bank, 2016, p. 3^[9]) define transferable skills as “skills that can be used in most occupations – e.g. problem solving, team working, etc. – including core skills such as literacy and numeracy, which are essential in all occupations and required for learning new skills.” Furthermore, these ‘skills that are relevant to labour market needs and transferable to different sectors and technologies’ (p. 7) are also referred to as adaptability and are supposed to enhance the employability of employees and job seekers. Like the report “Enhancing Employability”, the focus of PISA-VET is the improvement of individuals' employability and their capacity to successfully seek and maintain employment in the future. The term “employability skills” is chosen to best reflect the context of PISA-VET, and essentially includes skills that are not occupation-specific but relevant across occupations and sectors (albeit at different levels/intensity).

For success in the workforce, employability skills are essential, both by themselves and in close interplay with occupation-specific skills. However, a key question is whether these employability skills should be regarded as domain-general (i.e. independent of occupation-specific knowledge and competencies) or domain-embedded (i.e. including occupation-specific knowledge and competencies). One main advantage of the understanding of employability skills as domain-general is that it not only enables comparability across different occupations but also allows for the measurement of a general capacity to navigate even in workplaces that do not yet exist. However, completing work tasks and solving complex problems in a particular domain always require domain-specific knowledge and skills. Therefore, employability skills are always, at least to some extent, intertwined with occupation-specific skills (Humburg and Velden, 2013^[10]). PISA-VET considers both considerations and includes a generic

assessment part of employability skills and a domain-embedded assessment part to capture the full breadth of both the generic and the domain-nature of employability skills as will be outlined in more specific terms throughout this chapter. While there are highly domain-specific approaches that are represented within the context of occupational skills, the primary emphasis here deliberately focuses on the overarching, non-occupation-specific aspects of employability skills and their integration within occupation-specific contexts.

The topic of employability skills is not only limited to whether they are domain-general or domain-embedded. An associated aspect under discussion is the time frame for defining these skills, which can be either short-term (aimed at being employable now) or long-term (aimed at becoming or staying employable). However, on the basis of responses from more than 900 employers in nine different European countries, Humburg et al. (2013_[10]) conclude that “the skills that are needed to ensure short-term employability are no different from the skills that are needed to increase employability in the long run.”

The core employability skills selected for PISA-VET cut across occupational areas and are essential for all the selected occupations, while also enabling international comparability. As such, four core employability skills are identified for PISA-VET: literacy, problem solving, task performance, and collaboration. Other employability skills may also be important for certain occupations, such as communication skills in healthcare and tourism and hospitality, and numeracy skills for electricians, and these have been integrated within the frameworks for the occupational area assessments (see previous chapters). The four core employability skills were identified as the most relevant by policy makers and stakeholders from participating countries, based on extensive existing knowledge of their relevance from research and policy making (as discussed in Chapter 1). Moreover, test constraints were considered when selecting the employability skills to be included in PISA-VET, as only a small core of the most relevant employability skills could be assessed in the time available. The selected employability skills represent a diverse set of skills that tap into both cognitive and non-cognitive aspects. They are closely aligned with existing well-validated scales from PISA, PIAAC, and SSES. Detailed definitions of these skills will be presented in the section on assessment.

Organising the Domains of Employability Skills

The four employability skills chosen for PISA-VET, literacy, problem solving, task performance, and collaboration, have been extensively studied in previous OECD assessments. PISA-VET therefore benefits from the in-depth conceptual work already completed on these assessments. To this end, the approach taken towards the employability skills included in PISA-VET is to use the existing OECD frameworks for organising the selected domains. This involves PIAAC Cycle 1 (and Cycle 2) for literacy, PIAAC Cycle 2 for problem solving, and the SSES for both task performance and collaboration.

PISA-VET will utilise these existing frameworks and adapt them to the VET context to provide the conceptual background of the four core employability skills. In the sections below information on each of the four core employability skills is presented, including their definition, relevance to VET, (sub-)processes involved in the employability skill, proficiency levels, relations to other relevant frameworks, and its occupation-specific modulation. Acknowledging that employability skills beyond literacy, problem solving, task performance, and collaboration can also be of paramount importance for specific occupations, a later section of this chapter will briefly discuss a set of further skills that are not included as direct assessments in PISA-VET. These further skills were discussed for potential inclusion in assessment but had to be excluded, mainly due to concerns related to testing time and potential low data validity from test taker fatigue.

Literacy

This section aims at summarising the literacy framework, as defined by PIAAC and its relevance to the area of VET as a foundational employability skill. It is based to a large extent on the PIAAC Cycle 2 Literacy Framework (OECD, 2021^[6]) that was developed by the members of the PIAAC Cycle 2 Literacy Expert Group. Literacy skills are fundamental for individuals to participate fully in society, access opportunities, pursue education and employment, communicate effectively, and continue learning and growing throughout their lives. Literacy serves as a gateway to knowledge, empowerment, and personal development, contributing to both individual success and societal progress.

Definition of Literacy

PIAAC defines literacy as the ability to "access, understand, evaluate and reflect on written texts to achieve one's goals, to develop one's knowledge and potential and to participate in society" (OECD, 2021^[6]). In its most literal sense, literacy refers to one's ability to comprehend and use written sign systems. Literacy encompasses a range of skills, from decoding written words and sentences to comprehending, interpreting, and evaluating complex texts. However, it does not involve the production of text (writing). Information on the skills of adults with low proficiency levels is provided by assessing reading components that cover text vocabulary, sentence comprehension, and passage fluency.

Relevance of Literacy to VET

PIAAC views key competencies as "general" in the sense of being relevant to all members of the working population and across all fields of economic and social activity (OECD, 2021^[6]). It further recognises that "while the economic and social importance of 'specific' competencies (skills related to specific rather than general-use technologies, discipline-specific or occupation-specific skills) is not denied, they are intentionally defined to be outside the scope of key competency frameworks" and thus not included in the PIAAC literacy framework (in PISA-VET, both aspects are considered for the assessment as outlined in a later section of this chapter).

Literacy provides the foundation for effective participation in society and literate individuals can make use of a broad diversity of written materials in the service of a wide range of activities and are knowledgeable of the cultural standards of their communities of practice. Thus, literacy is a necessary, but not sufficient, skill for performance in occupational areas where written communication dominates education and training and continuing education. As an employability skill in the PISA-VET framework, it allows individuals to progress towards applying literacy within their occupational areas of interest.

For instance, an automotive technician will need to read through technical manuals and understand the requirements and processes in the maintenance or repair of a car. An electrician will need to read and understand installation requirements, wiring diagrams, and operating instructions. Business and administration professionals will need to comprehend written information and graphical representations, such as evaluating delivery conditions based on international standards. Healthcare workers will habitually engage in reading scientific publications or medical procedures to stay updated on relevant topics and unfamiliar diseases. In tourism and hospitality, literacy is also a strong requirement, as employees will need to both converse with customers in oral and written form, and understand documentation, procedures or regulations that are applicable – for example, reading and understanding documentation relating to checking-out procedures and guest's departure. This intimate relationship between literacy as an employability skill and its role in the various occupational areas is further illustrated below.

In addition to being directly relevant for their target occupations, literacy skills are also crucial to VET learners to adapt to the constant change that they experience at the workplace. As highlighted above, literacy skills are important prerequisites for engaging in further learning. Evidence shows that adults

who hold a VET qualification are strongly exposed to automation in their jobs and are therefore likely to need to adapt and update their skills (OECD, 2020_[11]). Without solid literacy skills they risk not being able to adjust to new working methods and technologies or not being flexible enough to change sectors or occupation – creating a risk that they leave the labour market or end up in low-quality jobs.

It needs to be acknowledged that literacy skills, as with the other employability skills, are not only developed through the VET programmes that the learner participates in. As mentioned in Chapter 1, employability skills are developed in a variety of settings - including settings outside of the education and training system - and are accumulated over the life course. In particular for literacy skills, early stages of education are important. The literacy skills of the learners targeted by PISA-VET are likely to reflect to a large extent the skills they developed even before entering their VET programme. As such, the assessment will not derive conclusions about how well VET does in equipping learners with literacy skills, but rather about how well VET together with the earlier stages of education is at ensuring that all learners have the literacy foundations needed in today's labour market.

Processes, content and contexts involved in Literacy

The literacy domain in PIAAC encompasses cognitive processes, content, and social context. These dimensions are also helpful in defining the proficiency levels for literacy.

- *Cognitive processes* involve accessing text, understanding its meaning, and evaluating its quality. Accessing text includes identifying relevant texts and locating information within them. Understanding involves comprehending written words, integrating text information with prior knowledge, and handling multiple texts with inconsistent or conflicting information. Evaluating entails critically assessing the accuracy, soundness, and task relevance of the information, considering both the content and the source.
- *Content* refers to the texts, tools, knowledge, and cognitive challenges that authors use to convey ideas. It includes different *text types* (description, narration, exposition, etc.), *text formats* (continuous or non-continuous), *text organization* (amount of information and density), and *text sources* (single or multiple texts).
- *Social contexts* represent situations where reading activities are normally situated and may serve various purposes, from personal to professional and civic with professional contexts being the one that PISA-VET will be looking at. These refer to the different situations in which individuals must read: i) work and occupation, ii) personal use, and iii) social and civic context. For PISA-VET, the focus will be on situations in work and occupation.

Proficiency Levels of Literacy

Proficiency scales, also known as reporting scales, are important components of large-scale international assessments, enabling comparisons across countries and providing insights into student performance. In addition to defining the numerical range of the proficiency scale, it is also possible to define the scale by describing the competencies typical of students at points along the scale. Thus, the described proficiency scales describe what students typically know and can do at given levels of proficiency.

Table 7.1 shows the PIAAC literacy described scale from Cycle 1. Across the 32 participating Cycle 1 OECD countries, the average literacy score was 266.2 (Proficiency Level 2) with a standard deviation of 47 points. As the PIAAC literacy framework was updated for Cycle 2, this scale will be updated for reporting. Thus, the scale below is shown for reference only and PISA-VET will rely on Cycle 2.

Table 7.1. PIAAC Literacy Described Scale

Proficiency Levels	Score Range	Types of tasks completed successfully in each level of proficiency
5	Equal or higher than 376 points	At this level, tasks involve searching, integrating, and synthesizing information from multiple dense texts. Respondents are expected to evaluate arguments based on evidence and apply logical and conceptual models. They need to assess the reliability of sources and select pertinent information. Tasks may also require understanding subtle cues, making advanced inferences, and applying specialized knowledge.
4	326 to less than 376 points	At this level, tasks involve integrating and synthesizing information from complex texts, including continuous, non-continuous, mixed, or multiple types. Respondents must perform multiple-step operations and make complex inferences using background knowledge. Understanding specific non-central ideas and interpreting subtle evidence or persuasive relationships are often required. Respondents must consider conditional information and navigate competing information in these tasks.
3	276 to less than 326 points	Texts at this level are dense or lengthy, including continuous, non-continuous, mixed, or multiple pages. Understanding text and rhetorical structures is crucial, particularly in navigating complex digital texts. Tasks involve identifying, interpreting, and evaluating information, often requiring different levels of inference. Respondents must construct meaning from larger portions of text and perform multi-step operations to formulate accurate responses. Filtering out irrelevant content is often necessary. While competing information may be present, it is not more prominent than the correct information.
2	226 to less than 276 points	At this level, texts can be digital or printed, including continuous, non-continuous, or mixed types. Tasks involve matching information in the text, sometimes requiring paraphrasing or basic inferences. There may be competing information to consider. Some tasks require the respondent to: <ul style="list-style-type: none"> • cycle through or integrate two or more pieces of information based on criteria • compare and contrast or reason about information requested in the question • navigate within digital texts to access and identify information from various parts of a document.
1	176 to less than 226 points	Tasks at this level involve reading short digital or print texts, including continuous, non-continuous, or mixed formats, to find a specific matching or synonymous piece of information mentioned in the question or directive. Some tasks may require entering personal information on a document. There is minimal or no competing information. Simple cycling through multiple pieces of information may be needed for certain tasks. Basic vocabulary recognition, sentence comprehension, and paragraph reading skills are expected.
Below Level 1	Below 176 points	Tasks at this level involve reading short texts on familiar topics to find specific information. There is usually no competing information, and the requested information is identical to what is mentioned in the question or directive. The respondent may need to locate information in short continuous texts, but it can be treated as non-continuous for locating purposes. Basic vocabulary knowledge is sufficient, and understanding sentence or paragraph structure is not required. Tasks below Level 1 do not involve specific features of digital texts.

Source: PIAAC Cycle 1 assessment framework; (OECD, 2012_[12]).

Related Frameworks pertinent to Literacy

The PIAAC Cycle 2 Literacy Framework (OECD, 2021_[6]) represents an evolution of the role of literacy in the adult population (16–65 year-olds) that started with the International Adult Literacy Study (IALS; 1994-1998). The framework has undergone several iterations, including the Adult Literacy and Life Skills Survey (ALL; 2003-2008), the Survey of Adult Skills Cycle 1 (PIAAC; 2008-2018), and the ongoing implementation of the Survey of Adult Skills Cycle 2. The PIAAC Cycle 2 framework summarises and organises the evolution of the literacy construct in four areas (p. 24):

- *A reduction of the number of separate domains of literacy assessed:* IALS (OECD/Statistics Canada, 2000_[13]) measured literacy through separated scales of prose, document, and qualitative literacy. This aspect remained in ALL (Murray, Clermont and Binkley, 2005_[14]) when quantitative literacy was replaced by numeracy. Quantitative literacy in IALS had a sole focus on functional, arithmetic calculation embedded in printed materials. In comparison, numeracy is a broader measure, covering a wider breadth of mathematical skills, purposes, and content. Furthermore, it depends less heavily on reading skills (Tout, 2020_[15]). PIAAC Cycle 1 (OECD, 2012_[12]) introduced literacy as a single, global construct, which remained in PIAAC Cycle 2 (OECD, 2021_[6]).

- *An expansion of the range of text types covered in the assessment:* PIAAC eliminated the differentiation between the reading of prose and document texts and expanded the range of text to include digital and electronic texts.
- *An increasing emphasis placed on evaluation and evaluating metacognition as cognitive strategies required for effective reading:* IALS/ALL emphasised "matching" strategies (locating, integrating, and generating understanding) with PIAAC Cycle 1, expanding it towards evaluation and reflection and PIAAC Cycle 2 expanding evaluation further into the evaluation of the accuracy, soundness, and task relevance of a text concerning both its source and content.
- *The disentangling of the description and specification of cognitive strategies from questions of task difficulty:* IALS/ALL frameworks combined cognitive strategies and the factors affecting task difficulty, while PIAAC views these independently. It conceived task difficulty as being driven by the stimulus text(s) features, the formulation of the question/task description and the interaction of the text and question/task description.

Additionally, there has been an increasing interest in providing more detailed information about adults with poor literacy skills. In response, PIAAC Cycle 1 introduced the assessment of reading components – the basic set of decoding skills essential for extracting meaning from written texts: knowledge of vocabulary (word recognition), the ability to process meaning at the level of the sentence, and fluency in reading passages of text – with PIAAC Cycle 2 assessing only the sentence meaning and passage fluency dimensions (OECD, 2021^[6]).

Occupation-Specific Modulation of Literacy

The previous section mentioned that the PIAAC framework recognises 'specific' competencies but intentionally leaves them out of the key competency frameworks. This aligns with the proposed PISA-VET theoretical skills continuum (Figure 7.1). In this continuum, employability skills function as a prerequisite for individuals as they proceed from securing foundational level competency towards applying literacy in one of PISA-VET's five occupational areas and then onwards to demonstrate occupation-specific skills in one of these occupational areas. A key issue for PISA-VET is the point along this continuum at which the skills being measured are no longer the application of employability skills in the occupational area but are rather their direct application as an occupation-specific skill. This aspect and how a generic assessment of literacy as done in PIAAC as well as an extension of this as literacy applied in occupational domains within PISA-VET is discussed further in a later section of this chapter.

Both as a generic employability skill and as a skill that is occupationally embedded, literacy is related to the five vocational domains covered in PISA-VET. The diagnostic skill of automotive technicians cannot be separated from their abilities to understand what the client wants and to consult the relevant technical repository, in order to understand how a specific technical ensemble is diagnosed, repaired, or maintained. An automotive technician needs to diagnose (which is impossible without understanding the target of the diagnosis, i.e. being able to read through the relevant technical documentation), repair (which is not possible without continuously consulting technical documentation, especially in non-routine cases), maintain or inspect (e.g. write off for service) mechanical parts or vehicles. All these processes and activities require literacy, especially related to technical literature.

Figure 7.1. The Literacy Continuum towards Occupation-Specific Skills

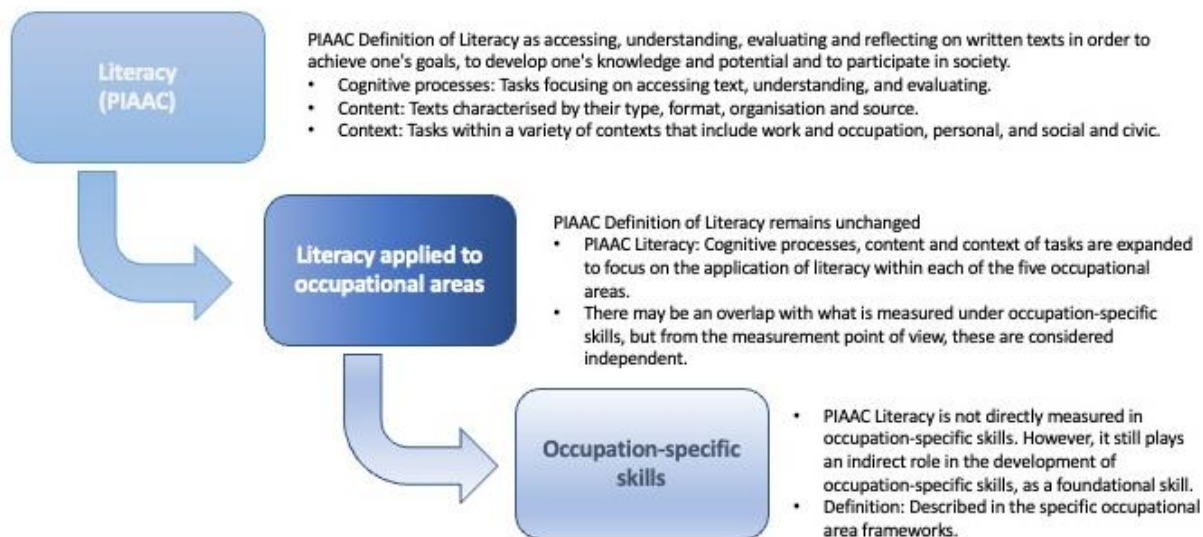

Electricians may need to assess and diagnose technical equipment - for which they need to read and understand installation requirements and technical guidance documents, as well as wiring diagrams and operating instructions. They also need to assemble and install and to inspect, test and maintain electrical equipment - for which they need to read and understand data generated by testing equipment, and need to interpret associated reports, as well as read and understand inspection and commissioning procedures. In general, to perform these activities, electricians need to read and understand manufacturer's instructions, wiring diagrams and layout drawings, to read and understand outputs of the various instruments they work with, and to read and understand (in order to follow them) industry procedures, regulations, or rules with respect to functionality and safety.

Employees working in business and administration need to use literacy in identifying needs for action (e.g. identifying the requirements for a new supplier by processing written information from internal and external business communication and retrieving information from databases), process quantitative and qualitative data (e.g. applying algorithms such as calculating bid prices and interpreting written information and graphical representations regarding delivery conditions based on the comparison with international standards), and communicate with internal and external stakeholders (e.g. understanding and evaluating written and oral communication from a customer).

Employees working in health care need literacy in activities and processes such as assessing needs and plan healthcare (e.g. documentation of past illness and related to planning intervention for a specific illness need to be consulted), supporting and enhancing clients' quality of life (e.g. clients may need to be counselled and supported, and understanding their written case history, as well as their specific personal circumstances will require literacy), providing and supporting treatment and interventions (e.g. preparing for a case conference to assist the assessment of patients' needs).

Finally, literacy will come into play in tourism and hospitality settings, including in activities such as checking in (e.g. reading a reservation document and understanding hotel's policy and procedure for issue room keys to guests and providing directions to allocated rooms and information about hotel services and facilities) or checking out (e.g. reading and understanding documentation relating to checking-out procedures and guest's departure) a customer. Table 7.4. presents examples of occupation-specific modulations of literacy to highlight the relevance of this employability skill within the five occupational areas under consideration in PISA-VET.

Summary

Literacy, as defined by the PIAAC framework, is a foundational or employability skill essential for participation in all aspects of society. More importantly, it serves as the basis for developing additional skills within occupational areas. In the context of PISA-VET, higher literacy levels are most likely linked with better use of these skills within occupational settings and more successful engagement in upskilling or reskilling.

Problem Solving

This section aims at defining problem solving, based on existing assessment frameworks: PIAAC Cycles 1 (“problem solving in technology rich environments”; (OECD, 2009^[16])) and 2 (“adaptive problem solving”; (OECD, 2021^[6]); PISA 2003 (“mathematical problem solving”; (OECD, 2003^[17])) and 2012 (“creative problem solving”; (OECD, 2013^[18])). Most of this summary is driven by the latest conceptualisation of problem solving, i.e. “adaptive problem solving”, as defined by the PIAAC Cycle 2 (OECD, 2021^[6]). This broad inclusion of problem solving across several large-scale assessments is driven by the notion that problem solving skills are essential in the personal, social, and professional lives of adults. They enable individuals to approach complex situations with confidence, creativity, and resilience, allowing them to overcome obstacles and achieve desired outcomes in both personal and professional domains. This section explains the relevance of the concept to the area of VET as an employability skill.

Definition of Problem Solving

PIAAC Cycle 2 defines problem solving as “the capacity to achieve one’s goals in a dynamic situation, in which a method for solution is not immediately available. It requires engaging in cognitive and metacognitive processes to define the problem, search for information, and apply a solution in a variety of information environments and contexts” (OECD, 2021^[6]). In its most basic sense, problem solving is centered around contexts that demand non-routine solutions, and some difficulties for the one facing them, irrespective of any content-specific domain and across occupations.

The latest PIAAC Cycle 2 approach emphasises the following components of this definition:

- **Capacity:** Problem solving is a complex proficiency, and its application to a problem is a goal-directed activity that may result in various degrees of success or performance in handling the problem.
- **Adaptivity:** Problem solving takes place in complex environments that force the process to be a dynamic and not a static sequence of pre-set steps, thus forcing problem solvers to remain open, to monitor the problem environment, and to adapt their approach constantly.
- **Cognition and metacognition:** Problem solving involves cognitive performance to organize and integrate information into a mental model, as well as metacognition for self-monitoring and self-reflection on progress. These two components are interconnected and challenging to separate.
- **Process:** Problem solving is a three-stage process containing problem identification (i.e. “problem finding”), actions to bridge the gap between the initial point to the desired goal (i.e. “problem shaping”), and the actual performance of actions until a satisfactory outcome is achieved. These stages can occur in different orders or even simultaneously.
- **Environment:** Problem solving is typically embedded in information-rich physical, social, and digital environments, emphasizing the particular importance of digital literacy. Digital environments especially are critical in this respect. PIAAC Cycle 1 has already recognized problem solving in technology-rich environments, highlighting the integration of digital skills in

today's problem solving scenarios. Consequently, competent problem solvers are expected to be able to deal with problem solving situations that are digitally embedded.

Relevance of Problem Solving to VET

Problem solving skills are essential in the personal, social, and professional lives of adults. Problem solving has been linked with positive individual-level and societal level outcomes, as it describes at its core “the ability to quickly and flexibly adapt to new circumstances, learn throughout life, and turn knowledge into action” (OECD, 2021^[6]). Problem solving skills have been found in modern economies to be most important for a worker to be successful (OECD, 2015^[19]).

PIAAC views problem solving as a general key competency, i.e. it emphasises the empirically underscored assumption that this competency is relevant to all members of the working population and across all fields of economic and social activity (OECD, 2021^[6]). Problem solving is thus ostensibly defined in contrast (and opposition) with specific competencies, i.e. skills that are discipline-specific or occupation-specific. The importance of such specific competencies is not denied, but on the contrary emphasised; however, they were not included in the PIAAC framework: they are intentionally defined to be outside the scope of key competency frameworks (OECD, 2021^[6]). This fundamental notion of how problem solving is defined is rooted in its pivotal role in current and future employability across diverse contexts. In PISA-VET, both generic and occupationally embedded aspects of problem solving are considered for the assessment as outlined in a later section of this chapter. In this, problem solving is considered to be foundational and essential for effective participation in society and the labour market but is not sufficient for performance in specific professional settings. In such specific professional settings, aside from more specialised skills, problem solving itself may be challenged by the context: Specialized information may mark the problem environment, and specialised reasoning may mark the stages of the problem solving process.

Some examples of how problem solving is inherently bound into the focal occupational areas follow here. An automotive technician may need to identify the causes of automotive malfunction and derive appropriate repair actions, such as removing a rusted bolt with a snapped-off head. An electrician will need to identify and diagnose electrical breakdowns and make informed recommendations to customers or clients. For employees in business and administration roles, typical office work will encompass significant non-routine problems, exceptions, errors, and innovative tasks that include problem solving, especially now that many routine work processes have been automated or outsourced. In healthcare, the essence of intervention is that the problem needs to be understood beforehand – diagnosing the situation and deciding on the appropriate course of action may often be literally the difference between life and death. In tourism and hospitality, adhering to established procedures while adapting services to specific situations and customer needs defines excellency. This relationship between problem solving as an employability skill and success in occupational areas is further illustrated in the section on occupation-specific modulation.

In fact, in a labour market that is exposed to digitalisation and automation, including in the five occupational areas under consideration in PISA-VET, problem solving skills become increasingly important. Complex problem solving is identified as one of the skills that are least exposed to automation (Lassébie and Quintini, 2022^[20]) that is, with a low probability that technology will be able to replace humans in carrying out tasks that require extensive problem solving skills. As such, problem solving skills are key for VET learners who are or will be working in an increasingly digital labour market.

Processes, content and contexts involved in Problem Solving

The problem solving domain in PIAAC is organised along a set of task dimensions (problem configuration, dynamics of the situation, features of the environment, information environment, and

problem contexts) and two large groups of processes: cognitive and meta-cognitive. This section focuses on these two overarching processes and describes the specific processes in each domain.

Cognitive processes are those that individuals must bring into play in order to construct a mental model of the state of affairs described in the problem and then to apply that mental model in real life. These cognitive processes are applied to the three stages of the problem solving process:

1. *Defining (Problem definition: Mental model construction)*
 - Selecting, organising, and integrating information into the mental model: Constructing a mental representation of the problem space (initial state, goal state, operators).
 - Retrieving relevant background information: Accessing memory to retrieve background knowledge (note: assessment tasks should be designed to avoid necessity of this process).
 - Externalising internal problem representation: Creating an external representation (e.g. drawing, table) that illustrates the problem solver's mental model of the problem.
2. *Searching (Search solution: Identifying effective operators)*
 - Searching for operators in the mind and environment: Locating information about available action options that might be suited to solve the problem.
 - Evaluating operators based on problem constraints: Determining which of the action options will be best to reach the goal while considering all possible constraints.
3. *Application (Apply solution: Applying plans and executing operators)*
 - Applying plans and executing operators: Implementing the selected operator(s) to solve the problem.

Metacognitive processes are those that become more important to the extent that problems are more complex and difficult to comprehend, that the problems change, and that progress towards the solution becomes more difficult. The metacognitive processes are also applied to the three stages of the problem solving process:

1. *Defining (Problem definition: Mental model construction)*
 - Goal setting: Deciding upon what the to-be-achieved state is about (cannot be considered in large-scale assessments because allowing problem solvers to set their own goals would yield too many degrees of freedom).
 - Monitoring problem comprehension: Supervising whether one's mental model of the problem matches the current state of affairs.
2. *Searching (Search solution: Identifying effective operators)*
 - Evaluating operators based on executability: Determining which of the action options will be best to reach the goal while considering all possible constraints.
3. *Application (Apply solution: Applying plans and executing operators)*
 - Monitoring progress: Determining whether executing operators achieves the desired outcome.
 - Regulating application of operators: Modifying the selection of operators in case the problem configuration has changed (cf. monitoring problem comprehension) or impasses have been noted (cf. monitoring progress).
 - Reflection: Deliberating about one's own capabilities to solve problems with the goal of abstracting knowledge from it that can be applied in the future (cannot be considered in a large-scale assessment context because it requires repeated confrontation with similar problem solving instances).

Proficiency Levels of Problem Solving

Table 7.2 shows the general descriptions in the PIAAC adaptive problem solving scale from Cycle 2. These are based specifically on behavioural descriptions that were offered in the PIAAC Cycle 2 framework for low and for high scorers on the three task dimensions, that is, when confronted with different (a) problem configurations, (b) dynamics in a situation, and (c) features of the environment. Table 7.2 illustrates the nexus of task dimensions, cognitive, and metacognitive processes, and proficiency levels.

Table 7.2. PIAAC Problem Solving Scale on Three Proficiency Levels

Proficiency level	General statement
1	At Level 1, problem solvers successfully solve simple problems in contexts with minor, slow, discrete, and predictable change. They may also be able to solve static (and not dynamic) problems, or only tasks that are part of a static or dynamic problem.
2	At Level 2, problem solvers successfully solve problems of average complexity in contexts where change has an average impact, pace, and randomness.
3	At Level 3, problem solvers successfully solve problems in highly complex and dynamic (continuous change) problem contexts. They solve complex problems with multiple constraints in the problem configuration and with complex features of the problem environment and adapt their problem solving process well to highly dynamic changes in these problems.

Source: PIAAC Cycle 2 assessment framework; (OECD, 2021^[21]), p. 186.

Figure 7.2. The Nexus of Task Dimensions, Cognitive and Metacognitive Processes and Proficiency Levels

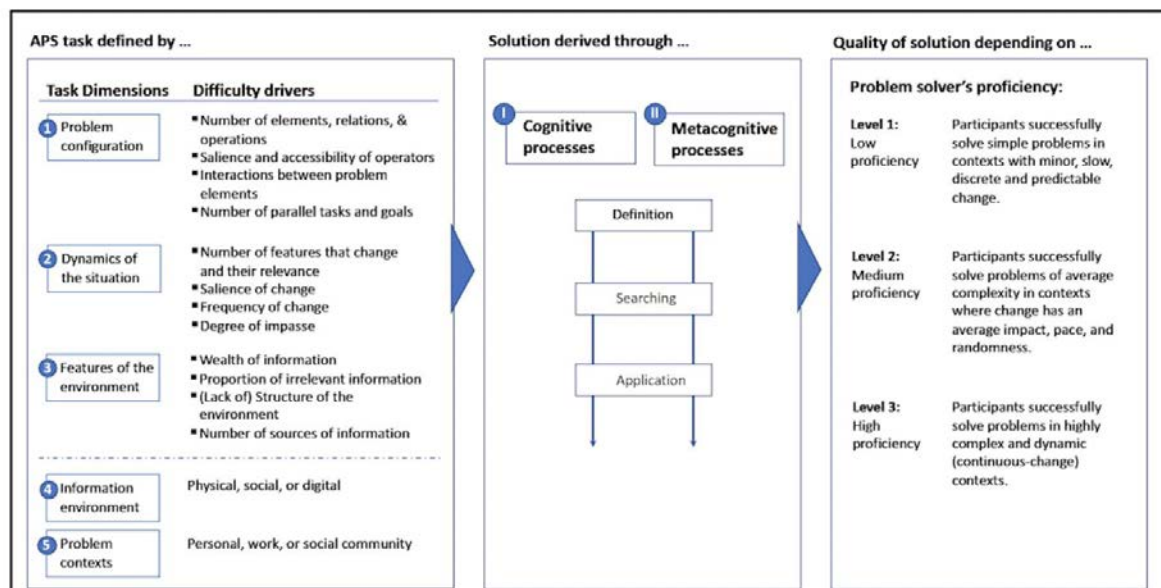

Figure 4.2

Table 4.1

Note: APS is Adaptive Problem Solving.

Source: PIAAC Cycle 2 assessment framework; (OECD, 2021^[21]): 167.

Related Frameworks pertinent to Problem Solving

Different frameworks have given slightly different definitions to problem solving, emphasising one or another component. The first paradigm was analytical problem solving in an earlier version of PISA

(OECD, 2003^[17]). PISA 2012 (OECD, 2013^[18]) linked problem solving to creativity, emphasising creative and critical thinking abilities. PIAAC Cycle 1 (OECD, 2009^[16]) focused on problem solving in technology-rich environments, considering the complexity introduced by technology. The fourth and current approach, championed by PIAAC Cycle 2 (OECD, 2021^[6]), is central to understanding problem solving in PISA-VET. It introduces innovations such as the adaptive component (the problem changes during the process and an adaptive reaction to this is needed) and includes both metacognitive and cognitive skills in its definition. PIAAC Cycle 2 includes problem solving items in various activity contexts, with the "work" context being particularly relevant for the current endeavour. When selecting items from existing assessments, the focus will be on sampling PIAAC items from the work context owing to this compatibility.

Occupation-Specific Modulation of Problem Solving

The previous section mentioned that the PIAAC frameworks of both Cycle 1 and Cycle 2 recognise the importance of distinct competencies (some of which are associated with specific professional contexts) but intentionally leaves them out of the key competency framework. This approach is aligned with the proposed PISA-VET continuum of employability skills, in which these skills are considered transversal skills that function as prerequisites for individuals as they proceed from foundational level competency towards more sophisticated and profession-specific competency that are manifested and demonstrated as occupational-specific skills in one of the occupational areas of PISA-VET. Research regarding the five occupational domains covered by this project (see previous chapters) is overwhelming in terms of acknowledging the importance of problem solving as a prerequisite of job performance and of staying competitive on the job market throughout life.

For automotive technicians, their diagnostic skills have been closely linked to their problems solving skills and are a central point in the selection, training, and appraisal of mechanics (Abele, 2018). An automotive technician needs to diagnose (e.g. a faulty engine performance), repair (e.g. outdated equipment with no spare parts), or inspect (e.g. write off for service) mechanical parts or vehicles. Likewise, electricians, like all STEM-related professions, are deeply in need of problem solving skills, often for even routine and daily operations (Neubert et al., 2016^[22]). They need to assess and diagnose (e.g. the breakdown of a large piece of electrical equipment in a factory), they need to assemble and install (e.g. a 'new to the market' piece of electrical equipment) and to inspect, test and report (e.g. a newly installed new piece of electrical equipment that shows a malfunction) technical equipment.

In business and administration, problem solving has been central both as managerial competency (van Aken and Berends, 2018^[23]) and implicitly as well as explicitly as it is sometimes associated with Ackoff's formulation of the central concept of "problem mess" (1981^[24]), becoming part of the "problem solving cycle" as an approach to management. Similarly, Jonassen (2000^[25]) points out that problems in real life are usually "meta problems" which consist of a bundle of nested problems of various kinds. An employee in such a role may need to identify needs for action (e.g. identify information gaps), process quantitative and qualitative data (e.g. apply the calculation scheme of manufacturing costs), or communicate effectively with internal or external stakeholders in loaded situations (e.g. recognise potential or actual conflicts and work towards their resolution; (Rausch and Wuttke, 2016^[26])).

In health care, the importance of problem solving has been acknowledged very early on, and continues to be considered crucial for specialist performance and inclusion in modern approaches to the design of healthcare systems and physician training (Lorusso, Lee and Worden, 2021^[27]). Employees in the health care industry may need to assess the needs of clients (e.g. analyse the physical and mental changes of a patient), plan a healthcare process (e.g. propose new coping strategies for a client in a therapeutic context), or monitor treatment and interventions (e.g. monitor the vital signs of a person who has undergone a difficult operation and who is still in a critical phase).

In tourism and hospitality, problem solving is considered a critical core skill by both experienced managers and students in hospitality (Dimmock, Breen and Walo, 2003_[28]). Employees working in the hospitality industry may need to understand the personal needs of customers (e.g. converse with customers that are not fluent in your language and understand specific dietary requirements that they have), or manage complaints (e.g. understand and solve effectively complaints about the lodging arrangements of a customer, that have not been communicated in advance and for which the hotel is not prepared). To demonstrate the relevance of problem solving in a specific occupation, Table 7.4. displays examples of occupation-specific modulations of this employability skill across the occupational areas.

Summary

Problem solving, as defined in the PIAAC Cycle 2 framework, is an employability skill that is foundational for participation in all aspects of work. While an essentially general skill, it may have job-specific components that are saturated in knowledge, reasoning, and decision-making typical for specific job domains or environments as acknowledged in an earlier section of this chapter. Thus, it may both contain and, more importantly, serve as the basis for developing additional occupation-specific skills within occupational areas. In the context of PISA-VET, higher levels on problem solving may be linked to better proficiency in the use of problem solving skills in specific professional settings, and in easier development of other skills.

Task Performance

This section aims at summarising the task performance framework, as defined by the OECD's SSES and its relevance to the area of VET as a sub-set of employability skills. Developing and nurturing task performance skills supports individuals in leading fulfilling lives, forming meaningful connections, and thriving in various personal and professional contexts. This section on task performance was primarily extracted from the SSES Assessment Framework and Conceptual Framework (Kankaraš and Suarez-Alvarez, 2019_[29]; Roberts et al., 2009_[30]), which were developed by members of the SSES team. It derives from the international report on SSES Round 1 results (OECD, 2021_[21]).

Definition of Task Performance

In SSES, task performance was derived from the Big Five model of personality. Task performance corresponds to the dimension of conscientiousness. It is defined as a set of social and emotional skills, which are “individual capacities that can be manifested in consistent patterns of thoughts, feelings, and behaviours” (OECD, 2021_[6]). These skills enable individuals to effectively manage and develop their emotions, thoughts, tasks, and relationships. Task performance refers to a range of constructs that describe the ability to be self-controlled, responsible to others, hardworking, motivated to achieve, honest, orderly, persistent and rule-abiding (Kankaraš and Suarez-Alvarez, 2019_[29]). In short, it refers to the skills that enable individuals to get things done, as required and on time.

Relevance of Task Performance to VET

The skills that are part of the SSES, including task performance and its dimensions, were chosen for their relevance to individuals across all aspects of life, whether professional, personal, or social. Empirical evidence supports the hypothesis that task performance is highly relevant across different work-related criteria such as job performance and trainings proficiency and across different occupations (Barrick and Mount, 1991_[31]). Dudley et al. (2006_[32]) found that responsibility, understood as one's ability to honour commitments and be reliable, was significantly linked to several job performance criteria. It was positively linked to task performance (contributing to production of good or service) and organisational citizenship (pro-social workplace behaviour) and inversely linked to counter-productivity.

Consequently, task performance is relevant to the future of work as well as its demands today because it encompasses personal characteristics like being playful, careful, and hard working. Technology is replacing routine jobs, but, at the same time, is creating new opportunities that require individuals who can manage complex social interactions and non-routine tasks (OECD, 2019^[5]). In fact, the capability to focus one's attention on the task at hand is crucial in a lot of occupations and work settings, including scenarios like remote work, which has been accelerated adoption during and post the COVID-19 pandemic. For example, as an automotive technician, conscientiously working through a service checklist, despite high time pressure, noise, and other distractions is important to ensure a car's repair and maintenance. Similarly, management assistants need to concentrate on the current task avoiding distractions from other activities when dealing with information-rich problems (Rausch and Wuttke, 2016^[26]). For a peripatetic healthcare assistant, who provides support and assistance to patients in various healthcare settings, it is important to carefully plan the next week's route for visits taking on responsibility towards the clients' needs, but also on medical needs, logistical issues, and own role-associated boundaries. Well-rounded VET learners should therefore have solid task performance skills to be effective in their target occupation – in line with employers' expectations. Research also suggests that these skills are malleable and susceptible to interventions (Durlak et al., 2011^[33]; Sklad et al., 2012^[34]; Taylor et al., 2017^[35]), and can therefore be developed through education and training – including VET. Social and emotional skills are also more malleable at later stages in life than cognitive skills, which is especially relevant to VET programmes, as they typically cater to older populations, as opposed to general education (Cunha, Heckman and Schennach, 2010^[36]; Cunha and Heckman, 2007^[37]).

Processes, content and contexts involved in Task Performance

As aforementioned, the SSES domain of task performance derives from the domain of conscientiousness from the Big Five model of personality and skills. SSES adapted the general Big Five framework to create a framework of skills, which are individual capacities that are learnable and malleable and thus, susceptible to program and policy interventions (OECD, 2021^[21]). In SSES, task performance is divided into four dimensions, which compose more contextualised manifestations of broad domains. These narrower skills are more descriptive, specific, and accurate, and thus easier to measure:

- **Self-control:** The ability to resist distractions, delay gratification and maintain concentration. Someone with high self-control postpones fun activities until important tasks are completed and thinks before they act, such as finishing notes before chatting to colleagues. Someone with low self-control is prone to say things before thinking and engages in impulsive behaviour, such as an employee who blurts out opinions in a meeting.
- **Responsibility:** The ability to honour commitments and be punctual and reliable. Someone with high responsibility arrives on time for appointments and gets tasks done promptly, such as ensuring all emails are addressed before going home. Someone with low levels of responsibility, for example, does not follow through on agreements.
- **Persistence:** The ability to persevere in tasks and activities until completion. Someone who is highly persistent finishes projects or work once started. Someone who has low persistence gives up easily when confronted with obstacles. This dimension is often assessed differently by age. In adult inventories of the Big Five, being persistent in the face of challenges is sometimes included under achievement motivation.
- **Achievement motivation:** The drive to set high standards for oneself and work hard to meet them. Someone with high achievement motivation enjoys reaching a high level of mastery in some activity, is highly productive and aspires to excellence, such as an entrepreneur who works long hours and perseveres against setbacks to make their business profitable. Someone

with low motivation lacks interest in reaching mastery in any activity, including professional competencies.

Proficiency Levels of Task Performance

Proficiency levels were not developed for SSES, although reporting scales were. For Round 1 of SSES (the only completed round to date), psychometric scales were developed using the assessment items for each skill. The reference was value fixed at 500 representing a centre of the scale characterized by individuals with either only mid-point or perfectly balanced responses (i.e. not leaning on one direction or another towards the poles defined below) and standard deviation set to 100.

The scale for each dimension (i.e. self-control, responsibility, persistence, and achievement motivation) features two meaningful poles. Individuals placed at one end of the scale have more of the attributes and qualities that define the pole to which they are closest and fewer of the attributes defining the pole from which they are farthest. Taking self-control out of the four dimensions of task performance, for example, respondents towards the highly self-controlled pole, reported themselves as more inclined to be careful with tasks, think before speaking, and postpone fun until they are finished with work. Respondents at the opposite end of the spectrum (uninhibited, less self-control) more often reported acting impulsively or speaking without thinking (SSES uses exclusively self-reports to assess skills).

Utilising proficiency levels is particularly beneficial when applied to performance-based measures since they enhance clarity and consistency by offering a clear and standardized framework for assessment and interpretation. However, there are several reasons for avoiding proficiency levels in social and emotional skills such as task performance. In fact, “proficiency levels” for social and emotional skills create problematic, universally normative measures for context-embedded and culturally relative capacities by implying an order, or hierarchy, to assessed behavioural patterns. Additionally, skills that may be useful in one context (e.g. high levels of self-control in fixing a delicate mechanical device or administering medication), may be less useful in others (e.g. coming up with new business ventures or taking creative risks may benefit from less restraint). This aspect of context-embedding is elaborated in the section below on the occupation-specific embedding of task performance. Measures of task performance provide countries and stakeholders with important insights into how test takers manifest task performance dimensions and how these link to contextual factors and outcomes. However, assigning universal proficiency levels may obscure the complexity and context-specific value of these skills.

Related Frameworks pertinent to Task Performance

The SSES task-performance dimensions were derived from a range of existing child and adult taxonomies of the Big Five domains and facets. Task performance in general corresponds to the domain of conscientiousness. However, there are many different conceptualisations of its narrower dimensions. For SSES, taxonomies that were consistently identified and cross-culturally replicated were considered for possible inclusion. Seven dimension-level taxonomies for children and adolescents were used, along dimension scales from several well-known adult personality inventories. These seven taxonomies were examined for conceptual overlaps, similarities and differences and then served as a starting point of the development of a common framework. In addition to this, PISA 2021 Context Questionnaire Framework (OECD, 2019^[38]) can be utilised as an additional point of reference for item adaptation. Within the PISA framework, task-performance items related to SSES were adapted, featuring extended item numbers across several task performance dimensions. These adapted items were seamlessly integrated into the background questionnaire and demonstrated strong psychometric properties.

In addition to these, task performance relates to other OECD frameworks on non-academic skills, such as PISA’s innovative domains and Education 2030’s Concept Notes. Outside the OECD, task performance overlaps with domains of many skills frameworks, including for social and emotional

learning and employability. For example, achievement motivation and persistence both relate to Duckworth's (Duckworth, 2007) much-used construct of Grit, describing sustained interest and perseverance toward long-term goals. The ExploreSEL platform created by the Ecological Approaches to Social and Emotional Learning (EASEL) Lab at Harvard identifies six common domains across 43 different frameworks for non-academic skills, including SSES. Task performance overlaps with all 42 other frameworks in certain dimensions of Cognitive, Values, Social and Identity (EASEL Lab., 2021^[39]).

Occupation-Specific Modulation of Task Performance

Task performance is a central skill to successfully perform at the workplace. All four facets of self-control, responsibility, persistence, and achievement motivation play an important role in different occupational settings. Concentrating on complex tasks, e.g. performing calculations while being frequently interrupted by phone calls or colleagues' questions is challenging. Staying focused and handling those distractions reflects a strong degree of self-control.

In a working situation, for instance, when a colleague has not yet successfully solved a specific problem or an error is detected in an order, taking responsibility means not to ignore the problem or trying to delegate it to someone else. In contrast, a responsible person stays calm and remains focused on the relevant problem searching for additional information to solve it. Similarly, continuing with a task although unexpected challenges like a delivery of incorrect materials has occurred, reflects a high level of persistence. To demonstrate the relevance of task performance and the other three core employability skills in a specific occupation, Table 7.4. displays examples of occupation-specific modulations of the four employability skills.

Summary

Task performance is a social and emotional skill with high relevance for the workplace across occupations consisting of the subdimensions self-control, persistence, responsibility, and achievement motivation. It has been included in previous OECD-led international assessments and describes an important employability skill in PISA-VET.

Collaboration

This section summarises the Collaboration framework, as defined by the OECD's SSES and its relevance to the area of VET as a sub-set of employability skills. Collaboration skills facilitate effective teamwork, innovation, problem solving, and communication. They contribute to personal growth, enhance relationships, and improve outcomes in various contexts, ultimately leading to individual and collective success. This section was extracted from the SSES Assessment Framework and Conceptual Framework (Kankaraš and Suarez-Alvarez, 2019^[29]), which were developed by members of the SSES team. It derives from the international report on SSES Round 1 results (OECD, 2021^[21]).

Definition of Collaboration

In SSES, collaboration was derived from the Big Five model of personality. Collaboration corresponds to the dimension of agreeableness. It is defined as a set of social and emotional skills, which are "individual capacities that can be manifested in consistent patterns of thoughts, feelings, and behaviours" (OECD, 2021^[21]). These skills enable individuals to effectively manage and develop their emotions, thoughts, tasks and relationships (as already outlined in the previous section). Collaboration refers to a range of constructs that describe the ability to understand, feel, and express concern for others well-being, manage interpersonal conflict, and maintain positive relationships and beliefs about others (trust) (Kankaraš and Suarez-Alvarez, 2019^[29]; Soto and John, 2017^[40]). In short, it refers to the

skills that enable individuals to get along with other people and work successfully together in various contexts and situational settings.

Relevance of Collaboration to VET

In SSES, collaboration was chosen for its relevance to school children and individuals across all aspects of life, whether professional, personal, or social. Collaboration is also particularly relevant for VET due to its links to job performance outcomes, especially how individuals relate to colleagues in the workplace. Sackett and Walmsley’s meta-analysis found that agreeableness (the corollary to collaboration) predicted levels of organisational citizenship—pro-social workplace behaviours like supporting co-workers—and inversely predicted counter-productivity, such as absenteeism (Sackett and Walmsley, 2014^[41]). Research also suggests that social and emotional skills such as collaboration are malleable and susceptible to interventions (Durlak et al., 2011^[33]; Sklad et al., 2012^[34]; Taylor et al., 2017^[35]). Importantly, these skills are also more malleable at later stages in life than cognitive skills, which is especially relevant to VET programmes, as they typically cater to older populations, as opposed to general education (Cunha, Heckman and Schennach, 2010^[36]; Cunha and Heckman, 2007^[37]).

Developing the ability to collaborate is essential for VET learners, as many VET jobs – and the labour market more broadly – involve tasks that require workers to work and interact with others. Many typical VET jobs involve collaborating with workers in other roles and at different levels in a workplace hierarchy, as well as with clients/users. For example, healthcare/nursing assistants typically work closely with other healthcare professionals, while also interacting closely with patients to anticipate and understand (empathising) their needs. Electricians on construction sites will need to discuss with the client to understand wishes and constraints and need to work in tandem with architects and other construction workers. As such, collaboration capabilities are key, and VET learners can develop those in school settings as well as during work placements. Collaboration is relevant in many ways to today’s changing economies and societies. Diversifying societies, automation and the decline of traditional social networks are creating new pressures but also opportunities for those who can manage complex social interactions and non-routine tasks (OECD, 2019^[5]). Strong collaboration and interpersonal skills, such as empathising and managing conflict, are increasingly key capacities for the future of work.

Processes, content and contexts involved in Collaboration

The SSES domain of collaboration derives from the domain of agreeableness from the Big Five model of personality and skills (Chernyshenko, Kankaraš and Drasgow, 2018^[42]). SSES adapted this framework to create its skills framework, focusing on capacities that are learnable and malleable and thus, susceptible to program and policy interventions (OECD, 2021^[21]). In SSES, collaboration is divided into three dimensions:

- **Empathy:** The ability to understand and care about others and their well-being. In VET contexts, someone with high empathy might be a nurse who knows how to console an upset patient or a manager who sympathizes with the needs of her employees. Someone with low empathy tends to misinterpret or disregard others’ feelings, such as a manager who ignores his employees’ wellbeing at work.
- **Trust:** The ability to assume that others generally have good intentions and forgive those who have done wrong. Someone with high trust tends to lend things to others and avoids being judgmental or harsh, such as trusting the good intentions of an inexperienced colleague who makes mistakes. Someone with low levels of trust is secretive and suspicious in relation to other people, such as a manager who does not delegate tasks because they do not think their colleagues can handle them.
- **Co-operation:** The ability to live in harmony with others, compromise, and value group cohesion. Someone with high levels of co-operation finds it easy to get along with people and respects

group decisions, such as an engineer who can compromise on their plans when their teammates propose an alternative vision. Someone with low levels is prone to arguments or conflicts and does not tend to compromise, such as a mechanic who finds fault with suggestions from co-workers and gets into arguments over projects.

Proficiency Levels of Collaboration

As mentioned above in the section on task performance, proficiency levels were not developed for SSES, although reporting scales were developed. For Round 1 of SSES (the only completed round to date), psychometric scales were developed using the assessment items for each skill. The reference value was fixed at 500 representing a centre of the scale characterised by individuals with either only mid-point or perfectly balanced responses (i.e. not leaning on one direction or another towards the poles defined below) and standard deviation set to 100.

The scale for each process of collaboration (i.e. empathy, trust, and co-operation) included in SSES features two meaningful poles. Individuals placed at one end of the scale have more of the attributes and qualities that define the pole to which they are closest and fewer of the attributes defining the pole from which they are farthest. Taking “empathy”, for example, respondents towards the highly empathetic pole, reported themselves as more inclined to consider others’ wellbeing and their perspectives. Respondents at the opposite end of the spectrum (less empathetic) more often reported disregarding others’ feelings when making decisions.

As discussed in the earlier section on task performance, there are several reasons for avoiding proficiency levels in social and emotional skills such as collaboration. “Proficiency levels” for social and emotional skills create potentially problematic measures for context-embedded and culturally relative capacities. Skills that may be useful in one context (e.g. high levels of co-operation in healthcare where one often coordinates between healthcare assistants, nursing professionals, and medical doctors) may be less useful in others (e.g. a manager who must make tough but necessary staffing decisions despite short-term employee disapproval). This aspect of context-embedding is elaborated on in the occupation-specific embedding of collaboration.

Related Frameworks pertinent to Collaboration

The SSES collaboration dimensions were derived from existing taxonomies of the Big Five domains and facets. Collaboration in general corresponds to the domain of agreeableness. However, there are many different conceptualisations of its narrower dimensions. For SSES, taxonomies that were consistently identified and cross-culturally replicated were considered for possible inclusion.

Collaboration relates to other OECD frameworks on non-academic skills, such as the PISA’s collaborative problem solving assessment in 2015 (OECD, 2017^[43]; 2017^[44]), the PIAAC Cycle 2 and the PISA 2022 and 2025 questionnaires. In the PIAAC Cycle 2, the assessment of Social and Emotional Skills is based on an extra short 15-item version of the Big Five Inventory BFI-2-XS (Soto and John, 2017^[40]), an instrument based on self-reports composed of three items per domain. Countries had the option of administering a 30-item version (BFI-2-S) with six items per domain. The assessment distinguishes five broad skill domains: conscientiousness (i.e. task performance), emotional stability, extraversion, agreeableness (i.e. collaboration), and openness to experience. The inclusion of this module helps analysts understand the interaction between cognitive and social-emotional skills.

Also related to collaboration is the concept of collaborative problem solving as defined in PISA 2015: “the capacity of an individual to effectively engage in a process whereby two or more agents attempt to solve a problem by sharing the understanding and effort required to come to a solution, and pooling their knowledge, skills and efforts to reach that solution” (OECD, 2017^[43]): 47). The framework encompasses four problem solving processes and three collaboration processes, ensuring

comprehensive coverage of the underlying theoretical concept (OECD, 2017^[44]; 2017^[43]). The PISA 2022 and 2025 questionnaires expanded the assessment to include additional aspects such as co-operation, perseverance, self-control, curiosity, empathy, trust, perspective taking, assertiveness, stress resistance, and emotional control, using self-reported instruments. More specifically, within the PISA 2021 Context Questionnaire Framework (OECD, 2019^[38]), collaboration items related to SSES were adapted, featuring extended item numbers across several dimensions of collaboration. These adapted items were seamlessly integrated into the background questionnaire and demonstrated strong psychometric properties. Thus, this PISA-VET framework can serve as an additional point of reference for item adaptation.

Outside OECD-conveyed studies, collaboration overlaps with domains of many skills frameworks, including for social and emotional learning and employability. The ExploreSEL platform created by the Ecological Approaches to Social and Emotional Learning (EASEL) Lab at Harvard identifies six common domains across 43 different frameworks for non-academic skills, including SSES (EASEL Lab, 2021). Collaboration overlaps with 41 other frameworks in the domains of Social, Emotion and Values.

Occupation-Specific Modulation of Collaboration

Collaboration and its sub-domains are relevant to almost all occupational areas in VET, at multiple levels. Collaboration in VET contexts involves working with others within one's own team, within an organisation, or with clients/users. In many situations, all three aspects are used simultaneously. For example, in tourism and hospitality, a hotel receptionist is at the core of communication between different operations of the hotel. They must not only cooperate with various departments but doing so well involves understanding their role, procedures, and limitations to optimise workflow and trusting their abilities. In business and administration, a member of a sales department must be able to cooperate with internal teams, trust them to manage their responsibilities, but also empathise with customers to anticipate needs and develop opportunities. Further examples of the specific modulation of collaboration across occupational areas is found in Table 7.4.

Summary

Collaboration refers to a range of constructs that describe the ability to understand, feel and express concern for others, manage interpersonal conflict and maintain positive relationships and trust. It is essential for VET learners, as many VET jobs and the labour market generally involve tasks that require workers to interact with others and work together to achieve shared goals. Derived from the OECD's SSES, collaboration has three dimensions: empathy, trust, and co-operation. Collaboration is based on the domain of agreeableness in the Big Five model of personality. It directly relates to the PIAAC assessment of Social and Emotional Skills and overlaps with PISA's domain of "Collaborative problem solving."

Further Skills

Upon entering the labour market, individuals graduating from a VET programme need a set of skills to find and retain a suitable job. In this endeavour, the four employability skills outlined in previous sections of this chapter, cover a broad array of these skills, but they do not account for the full set of employability skills. Further cognitive and social and emotional skills such as numeracy, ICT literacy, and financial literacy skills, along with social and emotional proficiencies like emotional regulation, self-efficacy, and communication skills, contribute to a comprehensive skill set necessary for a successful transition from formal education to the workplace.

Table 7.3 presents definitions and references to existing frameworks of some further relevant employability skills such as numeracy. Numeracy is traditionally regarded as a key cognitive skill in

addition to literacy for succeeding in the labour market. Furthermore, ICT literacy plays an increasingly important role in professional and private life. Recently, financial literacy skills have emerged as a new construct, reflecting the demands of global trends in modern society. Emotional regulation, self-efficacy, and communication skills are social-emotional proficiencies complementing cognitive skills. Emotional regulation and self-efficacy are both important when dealing with uncertainty and challenging situations.

Given time constraints and potential test taker fatigue, it is not feasible to include all relevant employability skills in PISA-VET, and the selected employability skills will provide unique and comprehensive insights into key employability skills in the VET population. In fact, adding additional employability skills to PISA-VET might yield limited new information. Taking numeracy as an illustrative example, findings from the PIAAC suggest a strong correlation between literacy and numeracy skills, potentially limiting the incremental value gained from assessing both skills concurrently (Hanushek et al., 2015). Therefore, it might suffice to incorporate numeracy assessments within occupational domains (e.g. for electricians) where its significance can be directly acknowledged within the assessment of occupation-specific skills. Considering all these factors, the set of four employability skills is likely to be the upper limit for inclusion in PISA-VET. Although the skills presented in Table 7.3 are unlikely to be included as separate scales in the Development Phase of PISA-VET, they do exhibit relevance from a conceptual perspective and are listed here also under the consideration of their relevance within selected occupations.

Table 7.3. Further Skills

Skills	Definition	Reference
Numeracy	Accessing, using and reasoning critically with mathematical content, information and ideas represented in multiple ways to engage in and manage the mathematical demands of a range of situations in adult life	PIAAC Cycle 2 ; (OECD, 2021 ^[21])
ICT Literacy	The interest, attitude, and ability of individuals to appropriately use digital technology and communication tools to access, manage, integrate, and evaluate information, construct new knowledge, and communicate with others to participate effectively in society.	PISA 2022; OECD, unpublished
Financial Literacy	Knowledge and understanding of financial concepts and risks, as well as the skills and attitudes to apply such knowledge and understanding to make effective decisions across a range of financial contexts, to improve the financial well-being of individuals and society, and to enable participation in economic life.	PISA 2021 financial literacy framework; (OECD, 2019 ^[38])
Emotional Regulation (also Emotional Stability/ Neuroticism)	The capabilities to handle one's emotions and negative emotional experiences.	(Petrides and Furnham, 2001 ^[45])
Self-efficacy	The belief in one's skills and competences.	(OECD, 2021 ^[6])
Communication skills	Skills in processing and interpreting both verbal and nonverbal information from others to respond appropriately.	National Research Council (2012 ^[46])

^{xi} In the Standard Occupational Classification (SOC), mostly used in the United States, hotel receptionists are classified under "Hotel, motel and resort desk clerks" (42.4081).

Table 7.4. Overview for all Employability Skills x Occupational Area combinations

ES Occupation	Task performance	Literacy	Problem solving	ICT literacy	Collaboration
Automotive Technicians	<p>Conscientiously working through a service checklist, despite high time pressure, noise, and other distractions.</p> <p>Tire balancing – setting the balance-weights precisely.</p> <p>(F: +, C: +)</p>	<p>Reading and understanding a work order written by the service desk staff.</p> <p>(F: +++, C: +++)</p>	<p>Identifying causes of automotive malfunction and derive appropriate repair actions.</p> <p>Removing a rusted bolt with a snapped-off head.</p> <p>(F: +, C: ++)</p>	<p>Reading OBD (on-board diagnostic) error code(s) with the help of an expert system. A system-guided troubleshooting process is then started based on the error code(s).</p> <p>(F: ++, C: +++)</p>	<p>Joint processing of a difficult fault diagnosis between an automotive mechatronics technician and the manufacturer's service hotline, aiming at a joint identification of the cause of the malfunction.</p> <p>(F: + C: ++)</p>
Electrician	<p>Dealing with multiple demands from customers in an emergency e.g. power failure.</p> <p>Responding logically and positively to a changing situation and remaining professional and efficient throughout.</p> <p>(F: ++, C: ++)</p>	<p>Reading and understanding manufacturer's instructions, wiring diagrams and layout drawings when assembling and installing products, following industry procedures/regulations/ rules with respect to functionality and safety.</p> <p>(F: +++, C: +++)</p>	<p>Identifying symptoms and causes of electrical breakdowns and deciding/recommending the best course of action (with the customer/client) for the circumstances.</p> <p>(F: +++, C: +++)</p>	<p>Using digital tools to calculate the cost of maintenance and support contracts, replacement schedules and the estimated remaining life of a system compared to the power consumption, longevity, and replacement costs of upgrading to newer technologies.</p> <p>(F: ++, C: ++)</p>	<p>Identifying and solving short-term project challenges with other professionals in the same project team.</p> <p>(F: ++, C: +++)</p>
Business and administration	<p>Resisting distractions from other activities and resisting the delegation of the task, while being confronted with information-rich problems under time pressure.</p> <p>(F: ++, C: +++)</p>	<p>Processing and creating a variety of written information ranging from business communication with external persons, e.g. legally binding offer letters to sales-promoting presentations.</p> <p>(F: +++, C: ++)</p>	<p>Solving non-routine problems, exceptions, and errors, and handling innovative tasks.</p> <p>(F: ++, C: +++)</p>	<p>Using standard office software and highly specialized software systems, e.g. enterprise resource planning (ERP) systems or customer relationship management (CRM) software.</p> <p>(F: +++, C: ++)</p>	<p>Communicating with customers or suppliers in a respectful and sensible manner, even if interests may conflict or problems exist.</p> <p>(F: ++, C: ++)</p>
Health care	<p>Planning weekly visit schedule based on clients' needs, data, logistics, and the boundaries inherent to the specific healthcare role.</p> <p>(F: +++, C: +++)</p>	<p>Reading clients' medical history and identifying their problems and support needs.</p> <p>(F: ++, C: +++)</p>	<p>Assisting patients with their daily routines during daily visits, identifying and addressing emergency situations.</p> <p>(F: +, C: +++)</p>	<p>Using and adjusting electronic measuring equipment.</p> <p>(F: +, C: +++)</p>	<p>Coordinating arrangements with other healthcare staff</p> <p>(F: ++, C: ++)</p>

ES Occupation	Task performance	Literacy	Problem solving	ICT literacy	Collaboration
Tourism and hospitality	Knowing and understanding the structure, role, and requirements of front office operations within the hotel industry. (F: +++, C: +++)	Reading reservation documents, understanding hotel's policy and procedure for issue room keys to guests, and providing directions to allocated room and information about hotel services and facilities. (F: +++, C: +++)	Applying the hotel's procedures as appropriate to the situation. (F: +, C: +++)	Applying the hotel's reservation procedures on the software systems used to record hotel reservations. (F: +++, C: +++)	Knowing and understanding the links between the hotel reception and other departments and the role of reception as the hub for communications between departments. (F: +++, C: +++)

Note: F = Frequency: how often this ES is encountered; C = criticality: how essential this ES is; +++ = high relevance, ++ = middle relevance, + = low relevance.

Assessing Employability Skills in PISA-VET

This section outlines the approach taken to apply the elements of the frameworks described in previous sub-sections to PISA-VET. Utilising the existing frameworks discussed earlier in this chapter, the first sub-section of this section elaborates on the role of generic and occupationally embedded assessments within PISA-VET and how they might be combined. Later sub-sections outline the specific strategies for documenting and measuring students' competencies in each of the four domains selected for the core employability skills.

Generic and Occupationally Embedded Assessment of Employability Skills

The assessment of employability skills within PISA-VET should serve the purpose of predicting future employability and facilitating within-occupation and cross-context comparisons, including comparisons across occupations and different international VET systems. In addition, it should allow for comparisons with existing international educational large-scale studies such as PISA and PIAAC. In doing so, a two-pillar framework for the assessment of employability skills, as illustrated in Figure 7.3, is proposed to capture the full breadth of both the generic and the domain-nature of employability skills. More specifically, a generic assessment is independent of occupational knowledge and competencies as outlined in the frameworks in the previous section, whereas an occupationally embedded assessment includes knowledge and competencies of the respective occupational field. On the one hand, it is argued that due to the increasingly rapid technological development, specific knowledge becomes outdated quickly and hence must be acquired at the time of demand. A generic understanding of employability skills as depicted in an earlier section of this chapter are then beneficial prerequisites for the efficient acquisition and successful application of knowledge within concrete work tasks in the occupational domains. On the other hand, it is argued that the requirements for the successful completion of any work task differ between professional domains. As a result, employability skills are, to some extent, modulated differently across occupational fields as conceptually outlined throughout this chapter. An occupationally embedded assessment of employability skills respects these differences by including domain knowledge from the respective professional fields in the assessment. Thus, it is recommended to employ an assessment of employability skills within PISA-VET that accounts for both components. This approach will be outlined and justified in this section and is displayed in Figure 7.3.

Within existing OECD studies, skills are usually defined in a generic manner and targeted broadly towards '... effective functioning in everyday life' and '... to participate in society' (Schleicher and Tamassia, 2000^[47]). Accordingly, in the existing PISA and PIAAC instruments, the influence of domain knowledge has been largely excluded to achieve generic and broadly applicable assessments. Effects of prior knowledge would be considered as a confounding variable. A generic assessment of employability skills entails the following advantages and disadvantages: One obvious advantage is the possibility to use existing assessment instruments, which reduces the development effort required and allows relying on well-validated scales. It facilitates a more nuanced contextualisation of assessment findings, a noteworthy strength that synergistically reinforces both aspects. Furthermore, the results are more generalisable and directly comparable to the results of existing international studies such as PISA and PIAAC contributing a straightforward and natural link to international policy making. Consistent assessment across occupations allows for comparing these occupational groups within PISA-VET. Finally, interpreting generic skills as outcomes of formal education and using these skills as predictors of occupation-specific skills is another advantage. However, it can be argued that this approach may not be as relevant for actual employability as domain knowledge and skills. Furthermore, a less context-dependent assessment of generic skills may be less relevant – and thus less engaging – for test-takers, potentially resulting in lower test motivation and, in consequence, lower validity of the data. Nonetheless, the insights gained from test motivation in PISA, PIAAC, and SSES may be useful, and various studies based on data from these assessments show

that data is valid and allows for meaningful conclusions. As an additional measure, it may be worth exploring the evaluation of generic employability skills before delving into occupation-specific skills, when test engagement remains particularly high. Some advantages and disadvantages of a generic assessment of employability skills are depicted in Table 7.5.

Table 7.5. Advantages and Disadvantages of a Generic Assessment

Advantages of measuring ES generically	Disadvantages of measuring ES generically
<ul style="list-style-type: none"> • Possibility of using existing assessment instruments. • Results are more generalisable and comparable. • Allows for comparing occupational groups within PISA-VET. • Comparison with existing international studies such as PIAAC. 	<ul style="list-style-type: none"> • Generic employability skills may not be as relevant for employability as occupationally embedded employability skills. • Random-context assessment may lead to lower engagement and test motivation. • De-contextualised assessments can be challenging and confusing for test takers.

Assessment of employability skills as a set of occupationally-embedded skills (Winther and Achtenhagen, 2009^[48]; Klotz, Winther and Festner, 2015^[49]) can be considered a “bridge” between occupation-specific skills that build on domain knowledge and experience and generic employability skills that are not specifically linked to a professional context. These occupationally modulated employability skills (see later section) offer basic approaches to solving fewer specific tasks in the professional field and they facilitate the acquisition of more specific professional skills at later stages. Accordingly, an occupationally embedded assessment of employability skills requires some basic knowledge of and experience in the occupational field. For instance, problem solving can be defined as a generic skill and assessed based on tasks in which context matters little. On the other hand, problem solving can be seen as domain-linked and accordingly assessed with tasks embedded into a professional field, not only in terms of context but also in terms of the occupation-specific skills that are needed in addition to problem solving. The latter approach acknowledges that, for example, a competent problem solver in automotive technicians is not necessarily a good problem solver in health care, and vice versa.

An occupationally embedded assessment of employability skills entails the following advantages and disadvantages: One of the advantages is a high level of construct and face validity because the construct is closer to what makes people employable in a specific field. Candidates are familiar with the context reflecting real life situations, which could lead to higher test motivation. Additionally, it is possible to develop the occupational simulation tasks first and identify the employability skills within them, providing a more practical approach to the assessment. However, one of the disadvantages is that the results are not comparable across occupational fields. Furthermore, a fully embedded assessment is challenging with regard to psychometrics and requires high costs for developing and/or adapting measurement instruments. Also, occupationally embedded assessments of employability skills are limited to currently available contexts and situations and may say little about future employability, which is at the core of PISA-VET. To ensure that the occupation-specific nature of employability skills and the unique way that they work in concert is adequately represented in the measurement, it is imperative that the development of occupationally embedded employability skills incorporates a clear and well-defined reference to the frameworks of employability skills and occupation-specific skills taken into account the respective frameworks corroborated throughout this volume and as displayed in Figure 7.3. Some advantages and disadvantages of an occupationally embedded assessment of employability skills are depicted in Table 7.6.

Table 7.6. Advantages and Disadvantages of An Occupationally Embedded Assessment

Advantages of measuring ES occupationally embedded	Disadvantages of measuring ES occupationally embedded
<ul style="list-style-type: none"> • High level of construct validity. • Candidates are familiar with the context, leading to good test motivation. • Provides a more practice-oriented approach to assessment. • Identifies employability skills within occupational simulation tasks. 	<ul style="list-style-type: none"> • Results not comparable across occupational fields. • Challenging with regard to psychometrics. • High costs for developing/adapting measurement instruments specific for each occupation. • Restricted to known situations and contexts; little value for future employability.

The assessment of employability skills is of fundamental importance for PISA-VET, and an optimal balance between generic and occupationally embedded is key for a valid interpretation of employability skills. After contrasting a generic and an occupationally embedded assessment of employability skills, it is recommended to combine the two approaches, in particular for literacy and problem solving, which have, in addition to their established generic component, an occupationally embedded dimension to them. The approach that is recommended is depicted in Figure 7.3. It is recommended for all four employability skills to implement a stand-alone generic assessment on the backdrop of existing frameworks and items: Literacy on the basis of PIAAC Cycle 2, problem solving on the basis of PIAAC Cycle 2, and task performance and collaboration on the basis of SSES (and with additional consideration of PISA). In addition to this, an occupationally embedded assessment with simulations that combine the respective occupation-specific skill and the employability skill (Figure 7.3) is recommended for the two performance assessments of literacy and problem solving. Such an approach might be less relevant for task performance and collaboration as they are considered trait-like characteristics with little variation across contexts and situations. For them, the occupationally embedded assessment is considered optional, and the core will be the generic assessment across contexts and situations.

Thus, two mutually complementing pillars are recommended for PISA-VET for the assessment of employability skills: Pillar 1 with a generic and stand-alone assessment of four employability skills and Pillar 2 with an occupationally embedded assessment of employability skills with a focus on literacy and problem solving. PISA-VET is completed by a third pillar that is composed of the occupation-specific skills assessment as outlined in Chapters 2 to 6 without or with only minimal involvement of employability skills (not depicted in Figure 7.3). Further information on the specific assessment of each employability skill is provided in the next section.

Figure 7.3. Generic and Occupationally Embedded Assessment of Employability Skills

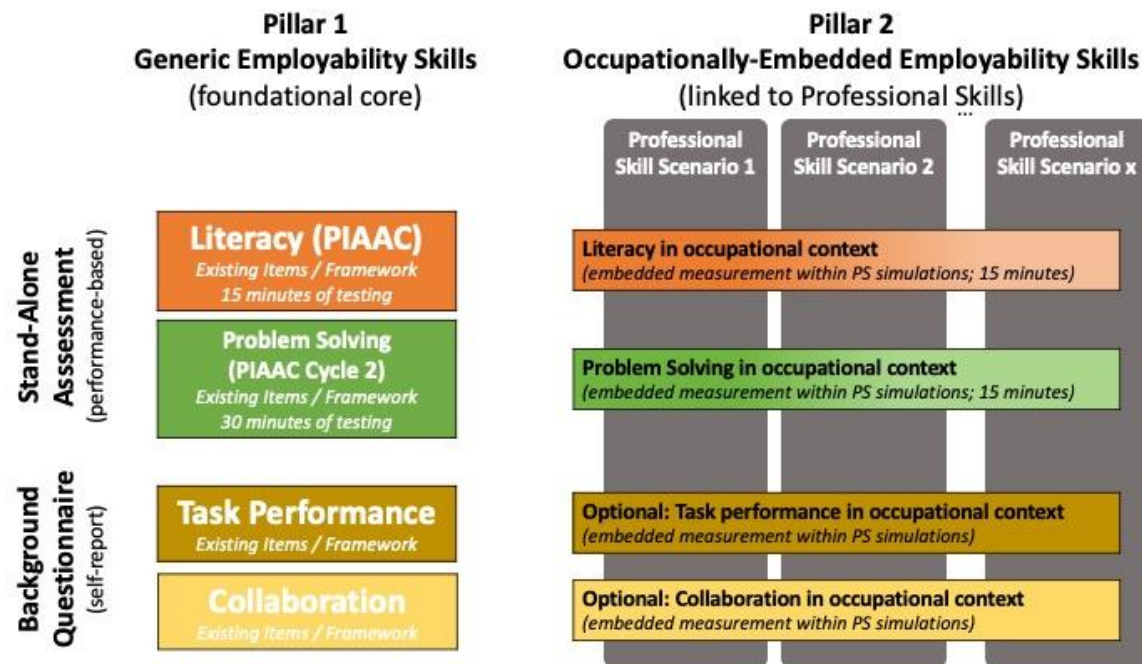

Strategy for measuring Employability Skills

This section summarises the strategy for measuring the four different employability skills that will be part of PISA-VET: literacy, problem solving, task performance, and collaboration. Both, the generic (Pillar 1) and the occupationally embedded component (Pillar 2) are considered.

Literacy

The OECD had led on the development of assessments of literacy among both schooled and adult populations in the context of the PISA and PIAAC assessments. Building on such experience, the VET assessment of literacy will be rooted in the conceptual framework of PIAAC that is outlined in an earlier section of this chapter. The assessment of literacy in PISA-VET will contain a generic and an occupationally embedded component as outlined earlier in this chapter and displayed in Figure 7.3. This reflects the fact that literacy has both a generic component as a transversal skill applicable across vocational contexts and, at the same time, an occupation-specific modulation, for instance, due to the specific nature of the type of texts encountered in a particular occupation.

The generic component of the literacy assessment in PISA-VET will be composed of items from the existing PIAAC literacy assessment within general professional contexts (as defined in PIAAC) and without specific occupational embedding (Pillar 1 in Figure 7.3). To ensure a meaningful assessment within the given time constraints and to reduce the burden for individual respondents, it is recommended to implement a scoping assessment of literacy with a minimum testing time of 15 minutes derived from existing PIAAC items. This will allow normative comparisons across different groups of respondents, but the criterion-referenced comparisons will not be as detailed as in the original PIAAC study. There, the scale contained six proficiency levels (see earlier section of this chapter). For PISA-VET with reduced testing time, a shorter assessment that allows separation into three proficiency levels (e.g. low, medium, and high) is a likely and feasible option. That is, estimates of overall levels of literacy will be obtained for sampled students in each participating country, and proficiency levels are defined in accordance with the PIAAC framework albeit at

a lower level of granularity. Nevertheless, it will be worthwhile to explore the feasibility of employing a 30-minute testing duration for this performance-based assessment in a later phase (e.g. the Piloting Phase) of PISA-VET. An example of a generic literacy item from PIAAC is described and displayed in the Appendix of this chapter.

An occupationally-embedded component of the literacy assessment in PISA-VET might be composed of newly developed items and would account for occupation-specific modulations of literacy, for instance through embedding literacy items in a context of health care or by presenting a certain type of occupationally-relevant text that would not be part of a generic assessment such as a manual for automotive technicians (Table 7.4). Thus, this component combines literacy as generic employability skill with occupation-specific skills (Pillar 2 in Figure 7.3). An assessment time of approx. 15 minutes for the occupationally embedded literacy assessment is recommended. Importantly, this embedded assessment improves content validity, but does not allow for comparisons across occupations as items will be developed in an occupation-specific manner. To ensure the validity of the measure and enhance the interpretability of the results, the development of occupationally embedded literacy items necessitates a clear and precise alignment with the assessment frameworks of both employability skills (this chapter) and occupation-specific skills (Chapters 2 to 6). Achieving a high level of proficiency in occupationally embedded literacy skills demands not only robust generic literacy skills but also profound knowledge and skills within specific occupations. In terms of scaling, it is expected that literacy items in Pillar 2 should load on both employability skills (that are generically assessed in Pillar 1) and occupation-specific skills (that are generically assessed in Pillar 3). Scores derived from this assessment component will not contribute to a separate scale, but they might contribute to both the generic literacy scale and the occupation-specific skills scale in terms of better content coverage and better psychometric quality. Thus, the aim of the occupationally embedded component is to increase the validity of both the generic literacy assessment (complemented through occupationally embedded literacy) and the occupation-specific skill assessment (complemented through literacy within occupation-specific modulations). An example of an occupationally embedded item related to literacy (in the example: functional reading) is described and displayed in the Appendix.

Problem Solving

The most relevant existing assessment of problem solving for the VET context is that of adaptive problem solving as proposed for PIAAC Cycle 2. Adaptive problem solving in PIAAC Cycle 2 underlines the relevance of both cognitive and metacognitive processes when facing new problems and stresses the digital information context of problem solving closely aligned with 21st century workplaces. Utilising this extensive experience, the VET assessment of problem solving will be rooted in the conceptual framework of adaptive problem solving proposed for PIAAC Cycle 2. This framework is outlined both in general terms and with its VET-specific modulation as described earlier in this chapter. Comparable to literacy, the assessment of problem solving in PISA-VET will contain a generic and an occupationally embedded component as outlined previously and displayed in Figure 7.3. This demonstrates that, just as other employability skills, problem solving exhibits a component that pertains across all vocational contexts, but, at the same time, exposes occupation-specific modulations, for instance, due to the specific tools that might be available for problem solving within a specific occupation.

The generic component of the problem solving assessment in PISA-VET will be composed of items from the existing PIAAC Cycle 2 problem solving assessment selecting items mainly from the work context and across different information environments. Accounting for the digital nature of most problem solving activities, the focus should be digital information contexts. For the generic component, there will be no occupation-specific embedding (Pillar 1 in Figure 7.3). Considering the juxtaposition of time constraints in PISA-VET and the paramount role of problem solving in digital information environments for current and future employability, an assessment of problem solving with a testing time of approx. 30 minutes derived from existing PIAAC Cycle 2 items is recommended. This will allow normative and criterion-based

comparisons across different groups of respondents even though the level of measurement precision will be somewhat lower as compared to PIAAC Cycle 2, where more testing time is allocated to problem solving. A separation into four proficiency levels (below level 1, level 1, level 2 and level 3) as outlined earlier in this chapter is proposed. However, it is important to emphasise that the suggested testing duration of 30 minutes should be viewed as a minimum requirement because problem solving often entails intricate scenarios, and it is essential to encompass the digital aspects within these assessments. Both components necessitate a test duration of at least 30 minutes. An example of a generic problem solving item from PIAAC Cycle 2 is described and displayed in the Appendix.

The occupationally embedded component of the problem solving assessment in PISA-VET that is recommended will be composed of newly developed items and will account for occupation-specific modulations of problem solving, which can be manifold and will need to be elaborated alongside the occupation-specific skills frameworks. Such modulations might include identifying the reasons for and repairing an electrical breakdown for electricians or dealing with a previously not encountered medical emergency in health care. Thus, the occupation-specific component embeds problem solving as generic employability skill in occupation-specific skills (Pillar 2 in Figure 7.3). An assessment time of approx. 15 minutes for the occupationally embedded problem solving assessment is recommended. Just like for literacy, this embedded assessment of problem solving is expected to improve content validity, but it will not allow for comparisons across occupations as items will be developed in an occupation-specific manner. To ensure the validity of the measure and enhance the interpretability of the results, the development of occupationally embedded problem solving items necessitates a clear and precise alignment with the assessment frameworks of employability skills (this chapter) and occupation-specific skills (Chapters 2 to 6). Achieving a high level of proficiency in occupationally embedded problem solving skills demands not only robust generic problem solving skills but also profound knowledge and skills within specific occupations. In terms of scaling, it is expected that problem solving items in Pillar 2 should load on both employability skills (that are generically assessed in Pillar 1) and occupation-specific skills (that are generically assessed in Pillar 3). Scores derived from this assessment component will not contribute to a separate scale, but they will contribute to both the problem solving scale and the occupation-specific skills scale in terms of better content coverage and better psychometric quality. Thus, these items might have, psychometrically speaking, a loading on the generic problem solving skill scale and the occupation-specific skill scale. Two examples of an occupationally embedded item related to problem solving (in the examples complex reception competence and problem solving in business and administration in the form of an office simulation) are described in the Appendix.

Task Performance & Collaboration

The OECD has overseen the development of several international assessments of social and emotional skills, most notably in SSES (as an additional note and as outlined above: PISA can be considered as a relevant source of information in addition to SSES), where, amongst others, task performance and collaboration were the focus of the international assessment. Building on this strong level of experience, the assessment of task performance and collaboration in PISA-VET will be constructed around the conceptual framework for task performance and collaboration developed in SSES outlined earlier in this chapter.

Unlike the cognitively focused assessments of literacy and problem solving, the need for developing a modulation of task performance and collaboration across occupational areas is low. While social and emotional skills always show themselves in specific situations, they are generally considered trait-like characteristics that are largely stable across domains. In addition to this, task performance and collaboration are usually assessed via self-reports, which can lead to bias but is a highly efficient way of measuring complex skills. Thus, the assessment of task performance and collaboration in PISA-VET will mainly be composed of self-report items and a generic component in line with the approach taken in SSES and as displayed in Figure 7.3.

The generic assessment of task performance and collaboration in PISA-VET will be composed of items from the existing SSES assessment. Given the efficiency and brevity of the SSES scales, it is recommended that the full self-report scales from SSES are included in the background questionnaire of PISA-VET. This will include sub-scales of self-control, responsibility, persistence, and achievement motivation for task performance and sub-scales of empathy, trust, and co-operation for collaboration. Of note, some adaptations in the wording might be necessary to make the item content sufficiently relevant for the target population in the VET context but these changes should be kept to an absolute minimum. In SSES (Kankaraš and Suarez-Alvarez, 2019^[29]), eight items were used to assess each sub-scale of task performance and collaboration, with each sub-scale taking approximately 1 minute to complete. Therefore, it is expected that approx.7 minutes will be required in total for task performance and collaboration. It is further recommended maintaining the established 5-point Likert scale that was employed in SSES. Proficiency levels were not developed for SSES, although reporting scales were. We recommend the same approach for PISA-VET allowing for comparisons across different groups of respondents, but without defining a distinct set of qualitatively different proficiency levels. An example of a self-report item of task performance and collaboration is given in the Appendix. PISA 2021 Context Questionnaire Framework (OECD, 2019^[38]) has taken a comparable approach by incorporating SSES task-performance and collaboration items into its background questionnaire. Nevertheless, the results indicate that certain scales (e.g. self-control, a facet of task performance; trust, a facet of collaboration in PISA) did not exhibit satisfactory psychometric properties across diverse countries. In contrast, scales with a more extensive items (e.g. persistence/perseverance, a facet of task performance; cooperation and empathy, facets of collaboration in PISA) displayed sound psychometric properties. Hence, it is prudent to consider the international PISA experience when incorporating SSES items into PISA-VET.

While the generic assessment of task performance and collaboration is deemed sufficient in the PISA-VET context, there might be compelling reasons to complement the assessment with additional measures of task performance and collaboration that are occupationally embedded. For instance, when in a specific health care situation, a particular way of teamwork is essential for patient care and the relevant aspects of collaboration are not sufficiently represented in the generic assessment of collaboration. Assuming this kind of compelling reason for expanding the assessment of task performance and collaboration, a similar approach as described for literacy and problem solving could be viable to account for the occupation-specific modulation of social and emotional skills. In this case, new self-report items will need to be developed. A separate mode of assessment for these skills is not recommended (e.g. there are performance-based assessments of collaboration, but we do not recommend switching the mode of assessment away from self-reports). However, different response formats are acceptable, for instance when the assessment of task performance and collaboration is embedded within an occupation-specific skill assessment. Similar constraints as for literacy and problem solving apply in the sense that the occupationally embedded component will not be reported as a separate scale but will complement the generic scale of task performance and collaboration as well as the occupation-specific skill scale. Along these lines, occupationally embedded self-report items of task performance and collaboration can be either included in the background questionnaire or in the occupation-specific skill assessment of PISA-VET. Two examples of occupationally embedded self-report items related to collaboration and task performance (in the examples communication strategies and self-efficacy) are described and displayed in the Appendix.

Conclusion

Employability skills are not only vital for success in the workplace but also for personal growth, well-being, and mental health of the entire VET student. These skills enable them to navigate the challenges and opportunities of 21st century labour markets and lead fulfilling lives. In the context of PISA-VET, four core employability skills that are all foundational in their nature and that are considered vital for the selected occupational areas have been selected for inclusion in PISA-VET: literacy, problem solving, task performance, and collaboration. They cover a broad array of cognitive competencies and social and emotion skills and have previously been included in international assessments such as PISA and PIAAC.

Drawing on this experience, a dedicated three-pillar assessment framework is proposed (Figure 7.3). This framework includes a generic and standalone assessment of each of the four employability skills (Pillar 1), an occupationally embedded assessment of employability skills that primarily focuses on literacy and problem solving (Pillar 2), and an occupation-specific skills assessment that only minimally (or not at all) taps into employability skills (Pillar 3). This way, the assessment accounts for both the generic (i.e. foundational) nature and the occupation-specific modulation of employability skills, allowing for cross-occupation and international comparisons and, at the same time, acknowledging of and allowing for occupational specifics.

On a technical level, the proposed assessment framework allows for both norm-referenced (i.e. comparisons across occupations, across countries, and across other groups of respondents) and criterion-referenced (i.e. through the development of dedicated proficiency levels) assessments. Complex item formats embedded into computer-delivered simulations can facilitate detailed process examination beyond final performance data, enhancing the accuracy and reliability of the results. The use of realistic assessment environments with real-world contexts further facilitates face validity and relevance of PISA-VET. While not explicitly addressed in this chapter, emerging methodologies such as artificial intelligence and machine learning may hold the potential to assist in data analysis and to provide insights on the underlying processes of how VET students engage, utilise, and develop their employability skills.

Overall, the proposed assessment of employability skills is essential for understanding whether individuals are equipped with the necessary competencies to succeed in the labour market, both as we know it today but also as labour markets continue to evolve into the future. By assessing employability skills through a comprehensive and multi-pillar framework, PISA-VET will provide valuable insights into the strengths and weaknesses of education and training systems on an international level, supporting policy and practice in a rapidly evolving global economy.

References

- Abele, S. (2017), "Diagnostic Problem-Solving Process in Professional Contexts: Theory and Empirical Investigation in the Context of Car Mechatronics Using Computer-Generated Log-Files", *Vocations and Learning*, Vol. 11/1, pp. 133-159, <https://doi.org/10.1007/s12186-017-9183-x>. [53]
- Ackoff, R. (1981), "On the use of models in corporate planning", *Strategic Management Journal*, Vol. 2/4, pp. 353-359, <https://doi.org/10.1002/smj.4250020404>. [24]
- Balkenhol, A. (2016), *Lesen in beruflichen Handlungskontexten: Anforderungen, Prozesse und Diagnostik*, Technische Universität Darmstadt, <https://tuprints.ulb.tu-darmstadt.de/id/eprint/5209>. [51]
- Barrick, M. and M. Mount (1991), "THE BIG FIVE PERSONALITY DIMENSIONS AND JOB PERFORMANCE: A META-ANALYSIS", *Personnel Psychology*, Vol. 44/1, pp. 1-26, <https://doi.org/10.1111/j.1744-6570.1991.tb00688.x>. [31]
- Bennett, E. et al. (2003), "Assessing Complex Problem Solving Performances", *Assessment in Education: Principles, Policy & Practice*, Vol. 10/3, pp. 347-359, <https://doi.org/10.1080/0969594032000148181>. [56]
- Chernyshenko, O., M. Kankaraš and F. Drasgow (2018), "Social and emotional skills for student success and well-being: Conceptual framework for the OECD study on social and emotional skills", *OECD Education Working Papers*, No. 173, OECD Publishing, Paris, <https://doi.org/10.1787/db1d8e59-en>. [42]
- Cunha, F. and J. Heckman (2007), "The Technology of Skill Formation", *American Economic Review*, Vol. 97/2, pp. 31-47, <https://doi.org/10.1257/aer.97.2.31>. [37]
- Cunha, F., J. Heckman and S. Schennach (2010), "Estimating the Technology of Cognitive and Noncognitive Skill Formation", *Econometrica*, Vol. 78/3, pp. 883-931, <https://doi.org/10.3982/ecta6551>. [36]
- Dimmock, K., H. Breen and M. Walo (2003), "Management Competencies: An Australian Assessment of Tourism and Hospitality Students", *Journal of Management & Organization*, Vol. 9/1, pp. 12-26, <https://doi.org/10.5172/jmo.2003.9.1.12>. [28]
- Drechsel, B., C. Carstensen and M. Prenzel (2011), "The Role of Content and Context in PISA Interest Scales: A study of the embedded interest items in the PISA 2006 science assessment", *International Journal of Science Education*, Vol. 33/1, pp. 73-95, <https://doi.org/10.1080/09500693.2010.518646>. [62]
- Dudley, N. et al. (2006), "A meta-analytic investigation of conscientiousness in the prediction of job performance: Examining the intercorrelations and the incremental validity of narrow traits.", *Journal of Applied Psychology*, Vol. 91/1, pp. 40-57, <https://doi.org/10.1037/0021-9010.91.1.40>. [32]
- Durlak, J. et al. (2011), "The Impact of Enhancing Students' Social and Emotional Learning: A Meta-Analysis of School-Based Universal Interventions", *Child Development*, Vol. 82/1, pp. 405-432, <https://doi.org/10.1111/j.1467-8624.2010.01564.x>. [33]

- EASEL Lab. (2021), *Explore SEL*, <http://exploresel.gse.harvard.edu/compare-terms/> (accessed on 26 January 2024). [39]
- Frey, C. and M. Osborne (2017), "The future of employment: How susceptible are jobs to computerisation?", *Technological Forecasting and Social Change*, Vol. 114, pp. 254-280, <https://doi.org/10.1016/j.techfore.2016.08.019>. [1]
- Humburg, M. and R. Velden (2013), *The Employability of Higher Education Graduates: The Employers' Perspective*, European Commission, <https://data.europa.eu/doi/10.2766/54258>. [10]
- Jonassen, D. (2000), "Toward a design theory of problem solving", *Educational Technology Research and Development*, Vol. 48/4, pp. 63-85, <https://doi.org/10.1007/bf02300500>. [25]
- Kankaraš, M. and J. Suarez-Alvarez (2019), "Assessment framework of the OECD Study on Social and Emotional Skills", *OECD Education Working Papers*, No. 207, OECD Publishing, Paris, <https://doi.org/10.1787/5007adef-en>. [29]
- Klotz, V., E. Winther and D. Festner (2015), "Modeling the Development of Vocational Competence: a Psychometric Model for Economic Domains", *Vocations and Learning*, Vol. 8/3, pp. 247-268, <https://doi.org/10.1007/S12186-015-9139-Y/FIGURES/3>. [49]
- Lassébie, J. and G. Quintini (2022), "What skills and abilities can automation technologies replicate and what does it mean for workers? New evidence", *OECD Social, Employment and Migration Working Papers* 282. [20]
- Lorusso, L., J. Lee and E. Worden (2021), "Design Thinking for Healthcare: Transliterating the Creative Problem-Solving Method Into Architectural Practice", *HERD: Health Environments Research & Design Journal*, Vol. 14/2, pp. 16-29, <https://doi.org/10.1177/1937586721994228>. [27]
- McClelland, C. (2020), *The impact of artificial intelligence—widespread job losses*, IoT for all, <https://www.iotforall.com/impact-of-artificial-intelligence-job-losses>. [2]
- Monnier, M. et al. (2016), "Occupation-specific social competences in vocational education and training (VET): the example of a technology-based assessment", *Empirical Research in Vocational Education and Training* 8, pp. 1-18, <https://doi.org/10.1186/s40461-016-0036-x>. [58]
- Murray, T., Y. Clermont and M. Binkley (2005), *Measuring Adult Literacy and Life Skills: New Frameworks for Assessment*, Statistics Canada. [14]
- National Research Council (2012), *Education for Life and Work: Developing Transferable Knowledge and Skills in the 21st Century*, National Academies Press, Washington, D.C., <https://doi.org/10.17226/13398>. [46]
- Neubert, J. et al. (2016), "Complex Problem-Solving in a Changing World: Bridging Domain-Specific and Transversal Competence Demands in Vocational Education", in Mulder, M. (ed.), *Competence-based Vocational and Professional Education*, Springer International Publishing, Cham, https://doi.org/10.1007/978-3-319-41713-4_44. [22]
- Norwig, K. et al. (2021), "Tools to tap into the content of human minds", *Zeitschrift für Berufs- und Wirtschaftspädagogik*, Vol. 117/4, pp. 658-693, <https://doi.org/10.25162/zbw-2021-0025>. [52]
- OECD (2021), *Beyond Academic Learning: First Results from the Survey of Social and Emotional Skills*, OECD Publishing, Paris, <https://doi.org/10.1787/92a11084-en>. [21]

- OECD (2021), *The Assessment Frameworks for Cycle 2 of the Programme for the International Assessment of Adult Competencies*, OECD Skills Studies, OECD Publishing, Paris, <https://doi.org/10.1787/4bc2342d-en>. [6]
- OECD (2020), *OECD Employment Outlook 2020: Worker Security and the COVID-19 Crisis*, OECD Publishing, Paris, <https://doi.org/10.1787/1686c758-en>. [11]
- OECD (2019), *PISA 2018 Results (Volume II): Where All Students Can Succeed*, PISA, OECD Publishing, Paris, <https://doi.org/10.1787/b5fd1b8f-en>. [4]
- OECD (2019), *PISA 2021 financial literacy analytical and assessment framework*, OECD Publishing, Paris, <https://www.oecd.org/pisa/sitedocument/PISA-2021-Financial-Literacy-Framework.pdf>. [38]
- OECD (2019), *Skills Matter: Additional Results from the Survey of Adult Skills*, OECD Skills Studies, OECD Publishing, Paris, <https://doi.org/10.1787/1f029d8f-en>. [5]
- OECD (2017), *PISA 2015 Assessment and Analytical Framework: Science, Reading, Mathematic, Financial Literacy and Collaborative Problem Solving*, PISA, OECD Publishing, Paris, <https://doi.org/10.1787/9789264281820-en>. [43]
- OECD (2017), *PISA 2015 Results (Volume V): Collaborative Problem Solving*, PISA, OECD Publishing, Paris, <https://doi.org/10.1787/9789264285521-en>. [44]
- OECD (2015), *Education at a Glance 2015: OECD Indicators*, OECD Publishing, Paris, <https://doi.org/10.1787/eag-2015-en>. [19]
- OECD (2013), *OECD Skills Outlook 2013: First Results from the Survey of Adult Skills*, OECD Publishing, Paris, <https://doi.org/10.1787/9789264204256-en>. [7]
- OECD (2013), *PISA 2012 Assessment and Analytical Framework: Mathematics, Reading, Science, Problem Solving and Financial Literacy*, PISA, OECD Publishing, Paris, <https://doi.org/10.1787/9789264190511-en>. [18]
- OECD (2012), *Literacy, Numeracy and Problem Solving in Technology-Rich Environments: Framework for the OECD Survey of Adult Skills*, OECD Publishing, Paris, <https://doi.org/10.1787/9789264128859-en>. [12]
- OECD (2009), “PIAAC Problem Solving in Technology-Rich Environments: A Conceptual Framework”, *OECD Education Working Papers*, No. 36, OECD Publishing, Paris, <https://doi.org/10.1787/220262483674>. [16]
- OECD (2003), *The Pisa 2003 Assessment Framework: Mathematics, Reading, Science and Problem Solving Knowledge and Skills*, OECD Publishing, Paris. [17]
- OECD, ILO and The World Bank (2016), *Enhancing employability: Report prepared for the G20 Employment Working Group*, <https://www.oecd.org/employment/emp/Enhancing-Employability-G20-Report-2016.pdf>. [9]
- OECD/Statistics Canada (2000), *Literacy in the Information Age: Final Report of the International Adult Literacy Survey*, OECD Publishing, Paris, <https://doi.org/10.1787/9789264181762-en>. [13]

- Petrides, K. and A. Furnham (2001), "Trait emotional intelligence: psychometric investigation with reference to established trait taxonomies", *European Journal of Personality*, Vol. 15/6, pp. 425-448, <https://doi.org/10.1002/per.416>. [45]
- Rausch, A. et al. (2021), "Die web-basierte Bürosimulation LUCA – Funktionen, Einsatzmöglichkeiten und Forschungsausblick", *Zeitschrift für Berufs- und Wirtschaftspädagogik*, Vol. 117/3, pp. 372-394, <https://doi.org/10.25162/zbw-2021-0017>. [55]
- Rausch, A., K. Kögler and J. Seifried (2019), "Validation of Embedded Experience Sampling (EES) for Measuring Non-cognitive Facets of Problem-Solving Competence in Scenario-Based Assessments", *Frontiers in Psychology*, Vol. 10, <https://doi.org/10.3389/fpsyg.2019.01200>. [61]
- Rausch, A. et al. (2016), "Reliability and validity of a computer-based assessment of cognitive and non-cognitive facets of problem-solving competence in the business domain", *Empirical Research in Vocational Education and Training*, Vol. 8/1, <https://doi.org/10.1186/s40461-016-0035-y>. [54]
- Rausch, A. and E. Wuttke (2016), "Development of a Multi-Faceted Model of Domain-Specific Problem-Solving Competence and its Acceptance by Different Stakeholders in the Business Domain", *Unterrichtswissenschaft*, Vol. 44/2, pp. 164-189, https://www.researchgate.net/publication/299746973_Development_of_a_Multi-Faceted_Model_of_Domain-Specific_Problem-Solving_Competence_and_its_Acceptance_by_Different_Stakeholders_in_the_Business_Domain (accessed on 11 February 2024). [26]
- Roberts, B. et al. (2009), *Conscientiousness, Handbook of Individual Differences in Social Behavior*, pp. 369–381, The Guilford Press. [30]
- Rosenberg, M. (2010), *Gewaltfreie Kommunikation: Aufrichtig und einfühlsam miteinander sprechen; neue Wege in der Mediation und im Umgang mit Konflikten*, Junfermann Verlag. [60]
- Sackett, P. and P. Walmsley (2014), "Which Personality Attributes Are Most Important in the Workplace?", *Perspectives on Psychological Science*, Vol. 9/5, pp. 538-551, <https://doi.org/10.1177/1745691614543972>. [41]
- Schleicher, A. and C. Tamassia (2000), *Measuring Student Knowledge and Skills: The PISA 2000 Assessment of Reading, Mathematical and Scientific Literacy*, Education and Skills, ERIC. [47]
- Schulz von Thun, F. (2019), *Klarkommen mit sich selbst und anderen: Kommunikation und soziale Kompetenz: Reden, Aufsätze, Dialoge (6. Auflage)*, Rowohlt-Taschenbuch-Verlag. [59]
- Seifried, J. et al. (2020), *The computer-based assessment of domain-specific problem-solving competence—A three-step scoring procedure*, Informa UK Limited, <https://doi.org/10.1080/2331186x.2020.1719571>. [57]
- Sklad, M. et al. (2012), "Effectiveness of school-based universal social, emotional, and behavioral programs: Do they enhance students' development in the area of skill, behavior, and adjustment?", *Psychology in the Schools*, Vol. 49/9, pp. 892-909, <https://doi.org/10.1002/pits.21641>. [34]

- Soto, C. and O. John (2017), “The next Big Five Inventory (BFI-2): Developing and assessing a hierarchical model with 15 facets to enhance bandwidth, fidelity, and predictive power.”, *Journal of Personality and Social Psychology*, Vol. 113/1, pp. 117-143, <https://doi.org/10.1037/pspp0000096>. [40]
- Taylor, R. et al. (2017), “Promoting Positive Youth Development Through School-Based Social and Emotional Learning Interventions: A Meta-Analysis of Follow-Up Effects”, *Child Development*, Vol. 88/4, pp. 1156-1171, <https://doi.org/10.1111/cdev.12864>. [35]
- Tout, D. (2020), “Evolution of adult numeracy from quantitative literacy to numeracy: Lessons learned from international assessments”, *International Review of Education*, Vol. 66/2-3, pp. 183-209, <https://doi.org/10.1007/s11159-020-09831-4>. [15]
- van Aken, J. and H. Berends (2018), *Problem Solving in Organizations*, Cambridge University Press, <https://doi.org/10.1017/9781108236164>. [23]
- Vanhercke, D., N. De Cuyper and H. De Witte (2016), “Perceived employability and well-being: An overview”, *Psihologija Resurseelor Umane*, Vol. 14/1, pp. 8–18. [8]
- Winther, E. and F. Achtenhagen (2009), “Measurement of vocational competencies - A contribution to an international large-scale assessment on vocational education and training”, *Empirical Research in Vocational Education and Training*, Vol. 1/1, <https://doi.org/10.1007/bf03546481>. [48]
- World Bank (2018), *World Development Report 2019: The Changing Nature of Work*, Washington, DC: World Bank, <https://doi.org/10.1596/978-1-4648-1328-3>. [3]
- Ziegler, B. et al. (2012), “Diagnostik „funktionaler Lesekompetenz “”, *Bwp@ Berufs-Und Wirtschaftspädagogik-Online*, Vol. 22, pp. 1–19, https://www.bwpat.de/ausgabe22/ziegler_et al_bwpat22.pdf. [50]

Further reading

- Greiff, S., & Borgonovi, F. (2022). Teaching of 21st century skills needs to be informed by psychological research. *Nature Reviews Psychology*, 1(6), 314–315.
- Lassébie, J. and G. Quintini (2022), “What skills and abilities can automation technologies replicate and what does it mean for workers?: New evidence”, OECD Social, Employment and Migration Working Papers, No. 282, OECD Publishing, Paris, <https://doi.org/10.1787/646aad77-en>.
- OECD (2020). OECD Employment Outlook 2020: Worker Security and the COVID-19 Crisis, <https://doi.org/10.1787/1686c758-en>.

Annex 7.A. Examples of Generic Assessments of Employability Skills in International Large-Scale Assessments

This annex presents examples of published items from existing employability skill assessments that can be employed as generic assessments (Pillar 1 in Figure 7.3) along the lines of the recommendations contained in the chapter. One example each of a literacy item from PIAAC, of a PIAAC Cycle 2 problem solving item, of a task performance item a collaboration item from SSES is presented.

Literacy

Only three literacy sample tasks were publicly released from PIAAC Cycle 1, and all three tasks were from the personal context. The example presented below, “Preschool Rules”, is of an average difficulty literacy task representing the following aspects of the literacy domain: i) cognitive processes: access and identify, ii) context: personal, and iii) medium: print-based text. There are also tasks available from a professional context, but these have not been released to the public, and may be a better choice for inclusion in PISA-VET. Tasks are delivered through computer-based assessment, with respondents being asked to highlight words and phrases that contain the answer to the task.

The difficulty of literacy tasks depends on three sets of factors, namely a) characteristics of the text(s); b) characteristics of the question; and c) the specific interaction between a question and a text (or set of texts). In addition, some of these factors affect the difficulty of the task regardless of the specific cognitive demands involved, whereas other factors are specific to a certain type of task demand (OECD, 2021^[6]).

Annex Figure 7.A.1. Example of A PIAAC Literacy Item

OECD PIAAC	
<p>Look at the list of preschool rules. Highlight information in the list to answer the question below.</p> <p>What is the latest time that children should arrive at preschool?</p>	<h3 style="text-align: center;">Preschool Rules</h3> <p>Welcome to our Preschool! We are looking forward to a great year of fun, learning and getting to know each other. Please take a moment to review our preschool rules.</p> <ul style="list-style-type: none"> • Please have your child here by 9:00 am. • Bring a small blanket or pillow and/or a small soft toy for naptime. • Dress your child comfortably and bring a change of clothing. • Please no jewelry or candy. If your child has a birthday please talk to your child's teacher about a special snack for the children. • Please bring your child fully dressed, no pajamas. • Please sign in with your full signature. This is a licensing regulation. Thank you. • Breakfast will be served until 7:30 am. • Medications have to be in original, labeled containers and must be signed into the medication sheet located in each classroom. • If you have any questions, please talk to your classroom teacher or to Ms. Marlene or Ms. Tree.

Source: PIAAC Cycle 1 assessment framework; (OECD, 2012^[12]).

Problem Solving

The item in the figure below is an example task presented in the PIAAC Cycle 2 in the Adaptive Problem Solving framework (OECD, 2021^[6]). In this item, test takers are provided with a stock market simulation, in which they begin with initial stock in five companies, and a small disposable sum of cash that they can invest. They can sell stock for cash or buy new stock with cash. Stock prices vary on a day-by-day basis. A new “day” comes on screen every 60 seconds, with new information about the evolution of the five companies. A short history, i.e. the last few days in each company’s evolution are displayed on the screen. The pattern of change for some of the companies is transparent, i.e. future change is predictable. In this first item, problem solvers need to decide, based on the past evolution history of each company, where to invest their money. They need to sell the stock they do not need, and buy stock in the more promising companies, to maximise the value of their portfolio.

This item assesses the overall level of adaptive problem solving (it necessarily requests from the test-taker to go through all the phases of the problem solving process, and to use both cognitive and meta-cognitive skills). It is an example of a criterion- and norm-referenced, objective, digital and adaptive assessment, focusing on final outcomes for adaptive problem solving that is considered an important employability skill in PISA-VET.

Annex Figure 7.A.2. Example of A PIAAC Cycle 2 Problem Solving Item

PIAAC
?
◀ ▶

Stock Market - Question 1 / 2

Look at the information about your investments and performance of companies in which you own stock. Tap on “+” or “-” in the table to answer the question below.

Based on the information provided, which shares should you buy or sell in order to maximize your chance for higher profits next day?

Tap on “+” to buy or “-” to sell shares in one or more of the companies in the table below.

	Shares owned now	buy	sell	Shares owned after invest
Company 1	20	+	-	23
Company 2	4	+	-	6
Company 3	6	+	-	3
Company 4	15	+	-	10
Company 5	10	+	-	8

Your Stock Portfolio			
	Shares held	Current price per share	Total in stock
Company 1	20	2.50 Zeds	50.00
Company 2	4	3.00 Zeds	12.00
Company 3	6	6.00 Zeds	36.00
Company 4	15	1.25 Zeds	18.75
Company 5	10	3.00 Zeds	30.00
Total in Stock			146.75

Your Investments		
Total money to invest	Total money in stocks	Disposable cash to invest
200	146.75	= 53.25

Stock Performance over the Past Five Days

	today	day-1	day-2	day-3	day-4
Company 1	+2.00%	-2.20%	-1.25%	+6.00%	-0.55%
Company 2	+0.10%	+0.10%	+0.10%	+0.10%	+0.10%
Company 3	+0.10%	-0.25%	+0.50%	+0.00%	+0.05%
Company 4	-0.50%	-1.25%	-0.75%	-1.50%	-1.25%
Company 5	+0.50%	-1.50%	-0.25%	+0.10%	-1.15%

Source: PIAAC Cycle 2 assessment framework; OECD, 2021.

Task Performance

Task performance derives from the SSES, where it is divided into four sub-domains that are each assessed separately: self-control, responsibility, persistence, and achievement motivation. Examples of items for each sub-domain are provided below in Table A1. These examples all come from SSES Round 1, except for “achievement motivation”, which comes from Round 2, because in Round 2 it was assessed as a separate rather than composite skill as in Round 1.

SSES uses generic, self-report assessments that focus on processes and behavioural patterns and use a norm-referenced perspective. Students are asked about their general tendencies and their observable behaviours or reactions. These items were developed for both computer-based and paper-pencil-based administration.

Annex Table 7.A.1. Examples Items for Task Performance

Sub-domain	Definition	Example item	Response format
Self-control	ability to avoid distractions, delay gratification and maintain concentration	“I avoid mistakes by working carefully.”	5-point Likert-type format with 0 = strongly disagree, 1 = disagree, 2 = neither agree nor disagree, 3 = agree, 4 = strongly agree
Responsibility	ability to honour commitments and be punctual and reliable	“I keep my promises.”	
Persistence	ability to persevere in tasks and activities until they get done	“I finish what I start.”	
Achievement motivation	ability to set high standards for oneself and work hard to meet them	“I always try to improve.”	

Source: SSES assessment framework; (Kankaraš and Suarez-Alvarez, 2019^[29]; OECD, 2021^[6]).

Collaboration

Collaboration derives from the SSES, where it is divided into three sub-domains that are each assessed separately: empathy, co-operation, and trust. Examples of items for each sub-domain are provided below in Table A2. These examples all come from SSES Round 1. SSES uses generic, self-report assessments that focus on processes and behavioural patterns and use a norm-referenced perspective. Students are asked about their general tendencies and their observable behaviours or reactions. These items were developed for both computer-based and paper-pencil-based administration.

Annex Table 7.A.2. Example Items for Collaboration

Sub-domain	Definition	Example item	Response format
Empathy	ability to understand and care about others and their well-being.	“I get upset if bad things happen to other people.”	5-point Likert-type format with 0 = strongly disagree, 1 = disagree, 2 = neither agree nor disagree, 3 = agree, 4 = strongly agree
Co-operation	ability to live in harmony with others, compromise and value group cohesion.	“I enjoy cooperating with my classmates.”	
Trust	ability to assume that others generally have good intentions and to forgive those who have done wrong.	“I believe most people are kind.”	

Source: SSES assessment framework; (Kankaraš and Suarez-Alvarez, 2019^[29]; OECD, 2021^[6]).

Annex 7.B. Examples of Occupationally Embedded Assessments of Employability Skills

In this annex, examples of occupationally embedded assessments of employability skills are presented. They pertain to slightly different skills as those that will be included in PISA-VET but are supposed to give an impression of the combination of a transversal employability skill and a specific occupational context (pillar 2 in Figure 7.3): Occupationally embedded assessments related to literacy, occupationally embedded assessments related to problem solving, and occupationally embedded assessments related to social and emotional skills.

Occupationally embedded assessments related to Literacy

Functional reading competence was defined and measured within the context of the German “Technology-oriented measurement of competences in vocational education” (ASCOT) programme funded by the German Ministry of Education and Research (BMBF). Ziegler et al. (2012^[50]) developed an assessment of “functional reading competence”, which is defined as reading with the purpose of completing a vocational or a daily task and therefore translating the reading content into an action. Functional reading implies searching for specific information, for example in instruction leaflets, information brochures, (legal) regulations, tables, registers, charts etc., to take an action. It is closely related to the concept of literacy as understood in PISA-VET but embedded into an occupational context and requires occupation-specific skills.

In fact, depending on their prior knowledge, individuals sometimes only must select the relevant information from the given text, e.g. the application rate of a medication. In less familiar contexts, individuals first have to construct a mental model from the information. This means they must develop a concrete idea of the relevant process or task or adjust their knowledge based on new information. The construct of functional reading competence comprises descriptive representations (continuous texts), depictional representations (lists, tables, charts, forms etc.) and mixed representations. Further, the assessment differentiates three cognitive demands: identifying single information, integrating different information, and generating a mental model. The assessment aimed at measuring reading competence in an occupationally embedded context, but simultaneously aimed at being suitable for the assessment across different occupational areas addressed in the ASCOT initiative (car mechatronics, electricians, health care and business and administration). An example item is illustrated below (Balkenhol, 2016^[51]). The participant is required to interpret the chart displaying the evolution of revenues and order numbers of North America, Europe, and Asia from the first quarter of 2003 to the second quarter of 2004. It is crucial to note that the diagram depicts two distinct aspects within the same coordinate system. Correctly associating the lines and bars with their respective statements is essential. The diagram allows for multiple statements about regional development, some of which lack detail.

To keep testing time to a minimum, the assessment is constructed as a computer-based adaptive test with multiple-choice items. Some of the items are taken or adapted from Programme for International Student Assessment (PISA), International Adult Literacy Study (IALS), or Adult Literacy and Life Skills Survey (ALL) that rather follow the generic assessment approach. However, most items were newly developed displaying vocational situations (e.g. order for office supplies, sales, job announcements). The construct of functional reading competence is derived using a one-dimensional Rasch model. In addition, Balkenhol distinguishes between four proficiency levels (Balkenhol, 2016^[51]).

Annex Figure 7.B.1. Depictional Item Taken from the Assessment of Functional Reading Competence

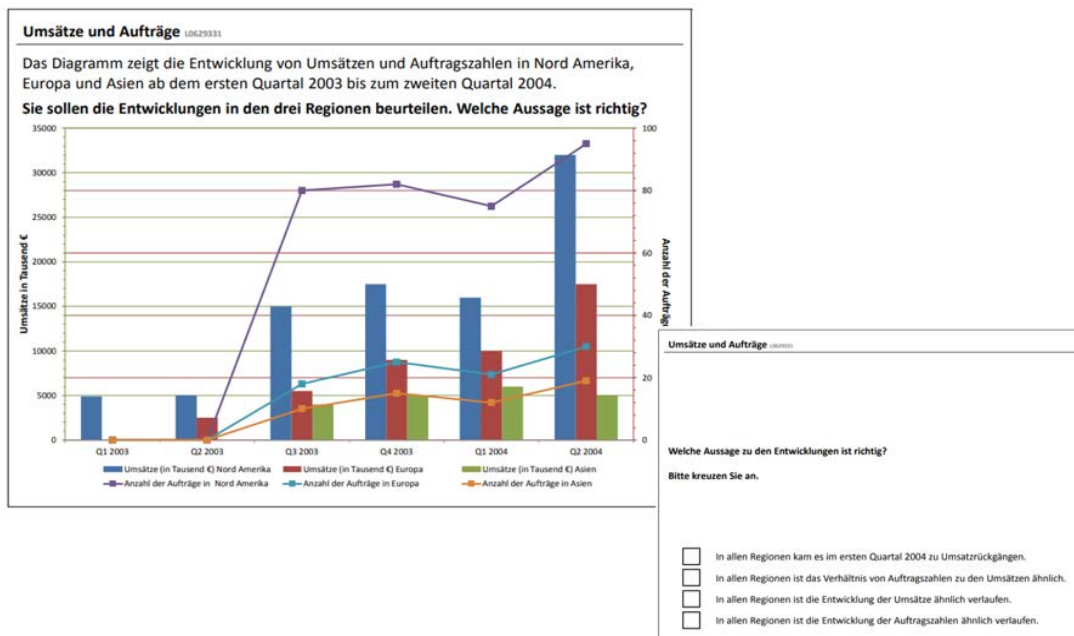

Source: Balkenhol, 2016.

Occupationally embedded assessments related to Problem Solving

Diagnostic skill in car mechatronics, which is closely related to the concept of problem solving, was defined and measured within the research programme ASCOT+ (the successor of the above-mentioned programme ASCOT) by Norwig et al. (2021^[52]). Generally, the competence to diagnose car malfunctions is key in the occupation of car mechatronics (or automotive technicians) although research reveals that a huge proportion of students are not able to perform car-related problem solving tasks appropriately. Abele (2017^[53]) distinguishes four subprocesses in the context of diagnosing car-related malfunctions: First, information regarding the car is collected. Second, hypotheses considering the cause of the malfunction are generated. Third, ideas how to test these hypotheses are derived and carried out. Finally, the results of the testing are evaluated. In this, the measured competence is closely related to the concept of problem solving but is strongly embedded into the field of car mechatronics and requires occupation-specific skills.

Since detecting malfunctions in motor vehicles is a complex task, electronic assistant systems are applied to help employees to identify those malfunctions. The electronic system provides information on how to proceed and suggestions on possible hypotheses and measurements. The output contains short texts loaded with technical terms, technical diagrams, and figures like electronic circuit diagrams (see Figure A4). Consequently, VET students need to learn how to deal with the available information, how to connect them with their domain-specific knowledge, how to build up a mental model and how to proceed in problem solving (this corresponds to the functional reading competence described by (Ziegler et al., 2012^[50]). The authors regard this diagnostic skill as a specific form of problem solving and expect this competence to be crucial for detecting malfunctions in motor vehicles.

Annex Figure 7.B.2. Example Item from the assessment of diagnostic skills in automotive technicians

Aufgabe 6

al Man kann mit nur einer Messung sicher ausschließen, dass die Plusleitung des Kraftstoff-Temperaturensors unterbrochen ist. An welchen Pins müsste man hierzu mit dem Multimeter messen? Klicken Sie die beiden Pins unten an.
Der unten dargestellte Messaufbau besteht aus den Pins des Motorsteuergeräts (links) und dem offenen Steckanschluss der Komponente Kraftstoff-Temperaturensor (rechts).
Beachten Sie bitte auch den Stromlaufplan (rechts abgebildet).

Um Aufgabenteil b) zu bearbeiten, müssen Sie runterscrollen.

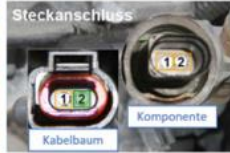
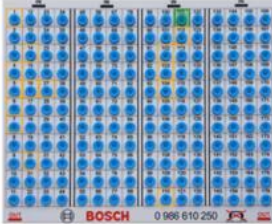

ES[tronic] 2.0

VW (VOLKSWAGEN)/ Golf DV 1.9 TDE Variant / 115 / 1.9 / 74.0 kW / 95/2001 / 96/2001 / 438

Fahrzeuginfo Diagnose Fehlersuche Wartung Schaltpläne Ausrüstung

Motorsteuerung/TDC 13P 22.3/55-Fehlersucheinstellung

Elektronischer Anschlussplan

A1.1 = Motor-Steuergerät.
A2.1 = ABS-Steuergerät.
A3.0 = Automatikgetriebe-Steuergerät.
A4.1 = Airbag-Steuergerät.
A7.1 = Kombiinstrument.
B3.2 = Kühlmittel-Temperatursensor.
B3.8 = Kraftstoff-Temperatursensor.
B6 = Drehzahl-/Bezugsmarkensensor.
B9.1 = Fahrgeschwindigkeits-Sensor.
F1.5 = Sicherung 5 (Sicherungskasten 1).
F1.7 = Sicherung 7 (Sicherungskasten 1).
F1.12 = Sicherung 12 (Sicherungskasten 1).
F2.3 = Sicherung 3 (Sicherungskasten 2).
X9.2 = Diagnoseanschluss (OBD).

Source: Güzel et al., in preparation

As another example from problem solving, domain-specific problem solving in the context of business administration was measured within office simulations that were also developed within the ASCOT initiative (Rausch et al., 2016^[54]). Rausch and Wuttke distinguish four subprocesses of the cognitive dimension of problem solving: identifying needs for action and information gaps, processing information, coming to well-founded decisions, and communicating decisions appropriately (Rausch and Wuttke, 2016^[26]). Test takers must process complex and authentic business-related scenarios within an office simulation. The latest version, LUCA Office Simulation, is a browser-based learning and assessment platform available in German and English (<https://luca-office.de>). The LUCA Office Simulation provides test takers with typical software tools such as a document viewer, an e-mail client, a spreadsheet software, an enterprise resource planning software and so forth (see below screenshot). Within this open-ended environment, test takers have to solve authentic work scenarios over periods of 20 to 40 minutes. LUCA Office Simulation comes with additional modules to create and modify scenarios, administer assessments, and score results based on customizable scoring rubrics (Rausch et al., 2021^[55]). Competence scores for the above subprocesses of problem solving are ideally derived in a three-step process according to Bennett et al. (2003^[56]): (1) fine-grained scoring of problem solving behaviour, (2) aggregating the resulting behavioural patterns into partial credits, and (3) and calibrating a multidimensional Item Response Theory (IRT) model (Seifried et al., 2020^[57]).

Annex Figure 7.B.3. Screenshot of LUCA Office Simulation with Spreadsheet and Calculator

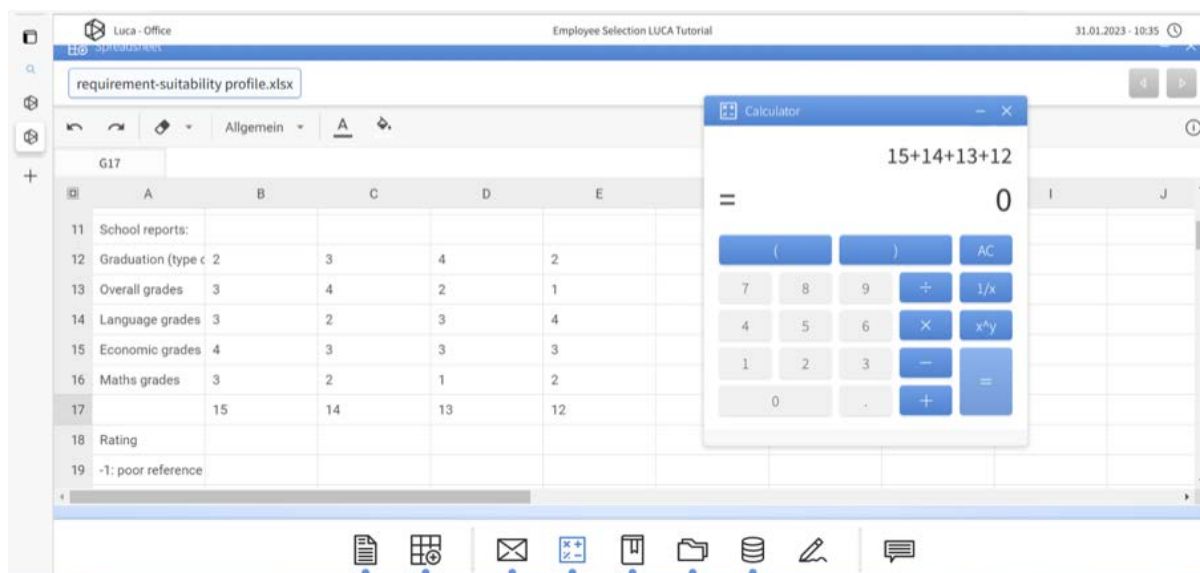

Source: (Rausch et al., 2021^[55]).

Occupationally embedded assessments related to Social and Emotional Skills

A set of social and emotional skills were addressed and measured with a situational judgment test within the ASCOT initiative by Monnier et al. (2016^[58]) for prospective medical assistants. The project aimed at measuring social competences particularly for this occupation considering occupation-specific situations and demands. The three key social and emotional competences of communication strategies, emotional regulation and perspective coordination were addressed due to a requirement analysis based on curriculum analyses and expert interviews. Those are related to task performance and collaboration, which will be included in PISA-VET, but present a somewhat different focus. They are included here to show how social and emotional skills could be assessed in an occupationally embedded way.

More specifically, competent communication strategies are important for medical assistants to handle complex communication with clients/patients balancing their needs as well as other restrictions (e.g. needs of an emergency patient) towards a good solution for both parties. Communication models like Schulz von Thun's communication square (Schulz von Thun, 2019^[59]) and Rosenberg's Nonviolent Communication (Rosenberg, 2010^[60]) were considered as a basis for appropriate communication. For example, establishing a common understanding by repeating what happened and which possibilities exist (sharing one's knowledge) is a useful strategy.

The below figure provides a screenshot of a video presenting a typical scenario from the computer-based situational judgment test in which a client/patient is angry. Based on this video students must read a couple of (mostly) multiple-choice items and select how they would behave in this situation.

Annex Figure 7.B.4. Example Item Taken from the Assessment of Communication Strategies

Currently the doctor is treating an urgent emergency patient.
This leads to delays of the other patients' appointments.



Excuse me, Miss,
I'm already waiting for
OVER ONE HOUR!
Are you kidding me?!
I have an important
meeting coming up
later and I want to see
the doctor
IMMEDIATELY!!!

Source: Monnier et al., 2014

More directly related to the employability skills considered for PISA-VET, task performance could also be measured using Embedded Experience Sampling (EES), which was developed and validated as an occupationally-embedded assessment in the field of business administration (Rausch, Kögler and Seifried, 2019^[61]). EES allows for an integrated measurement of non-cognitive facets of competences within simulation-based assessments. Test-takers are requested to pause their work on business-related scenarios at certain times and spontaneously answer short items (EES items) regarding their actual experience of the scenario. A similar approach was applied in PISA 2006 as an 'embedded science interest assessment' (Drechsel, Carstensen and Prenzel, 2011^[62]). However, EES items are embedded in an EES event that resembles typical social interactions with non-player characters and hence, are part of authentic problem scenarios (Rausch, Kögler and Seifried, 2019^[61]). The figure below shows screenshots of the LUCA Office Simulation. The items refer to situational interest and situational self-efficacy, but further items related to other social and emotional skills could easily be developed and implemented.

Annex Figure 7.B.5. Screenshot of Embedded Experience Sampling (EES) within the LUCA Office Simulation

The screenshot displays the LUCA Office Simulation interface. At the top, the browser address bar shows "luca - Editor" and the user "rausch@uni-mannheim.de". The main window is titled "Scenario preview: Supplier selection (Master thesis)".

An "Event" window is overlaid on the spreadsheet, titled "Chat message from a nice colleague (EES1 - English)". The message reads: "Your nice colleague Mary writes to you in the company chat and asks how things are going: 'I heard you just got a pretty challenging task!'".

Below the message are two questions, both labeled "Single choice":

Question 1
How do you usually cope with such challenges?
Please enter only one answer:

- I usually have a very hard time with this kind of task.
- I can usually manage this type of task to some extent.
- I can usually handle this type of task quite well.
- I can usually handle this kind of task really well.

Question 2
Do you find this topic interesting in general?
Please enter only one answer:

- No, I don't find this general topic interesting at all.
- Well, I find this general topic somewhat interesting.
- Yes, I find this general topic pretty interesting.

At the bottom of the event window, it shows "0 from 2 questions answered" and a "Complete event" button.

The background shows a spreadsheet with a "Price calculation.xlsx" file open. The spreadsheet contains a table with columns A, B, and C, and rows 1 through 26. The table includes items like "Price Calculation", "Total demand", "List purchase price", "Discount", "Target purchase price", "Supply costs", "Purchase price (original currency)", "Purchase price (in \$)", and "Total price for total demand (in \$)".

A calculator window is also visible, showing the calculation "368.21/1.19" resulting in "0".

Source: (Rausch, Kögler and Seifried, 2019^[61]).

8

Contextual Questionnaires Framework

This chapter describes the framework and core content for the PISA-VET contextual questionnaires. The chapter presents the content and the aims of the instruments for learners in the targeted occupational areas. It also describes the teacher, VET institution, and employer/trainer questionnaires that are used for the assessment.

Introduction

As noted in Chapter 1, the focus of the PISA-VET contextual questionnaires is on understanding how measures of student performance at the end of their initial VET programmes relate to practices of educational institution-based learning and work-based learning as well as to other factors from learners' economic, social, and cultural contexts. The questionnaires of PISA-VET include these aspects; they also cover a broader set of well-being outcomes and of risk and protective factors, accounting for differences in life experiences of the participants in the study. Four questionnaires are proposed: one for the learner, one for the teacher, one for the VET institution, and one for the work-based learning provider.

This chapter begins with a presentation of the core elements of the contextual framework for PISA-VET. It introduces the principles of educational prosperity and life course, and discusses them in the context of VET, with a focus on quality, equality and equity, and inclusion. It also explains how the PISA-VET contextual assessment extends or reinterprets these principles.

In subsequent sections, the chapter presents the structure and organisation of core and additional contents of the PISA-VET contextual instruments. The key informants are introduced, and the chapter explains the approach taken for triangulation of information. The chapter also addresses the rationale for single informants on some aspects of VET.

Finally, the chapter elaborates on how the contextual framework of PISA-VET allows for analysing equity and equality with the information obtained from the four questionnaires.

The chapter also provides guidance to prepare the questionnaires for future development or for pilot testing. The questionnaires are included at Annex B of this framework document.

The core of contextual assessment in PISA-VET

PISA-VET aims at conducting a comparative international study of learners near the end of their initial VET programmes at the upper-secondary, post-secondary non-tertiary education level, and/or short-cycle tertiary education level (ISCED levels 3, 4, and 5). Across countries and occupational areas, students are in programmes that are predominantly institution-based, as well as in programmes that have a large work-based learning component. Student age varies, both because programmes are provided at different education levels and because, in some countries, they attract not only young learners but also adults - which is an important departure from PISA and from its age-cohort approach.

PISA-VET has a broader range of measurable learner outcomes than PISA, a more diverse student population, and two distinct places to learn and to develop personal and occupational identity: the educational institution, as well as the workplace, (also referred to as the training company¹). In line with the PISA framework, three questionnaires are addressed to students, to the principals or administrators of the VET institution, and to teachers in the selected occupational areas respectively. A short questionnaire was designed for the trainer or the person most knowledgeable about the student's training in the work-based learning environment.

The questionnaires describe students and their learning experience in context, in their physical and social spaces of work and study. The questionnaires establish a connection between the student occupational-specific skills and the employability skills, and the core features of VET institution-based and work-based environments. These core features are: material and human resources, teaching and training practices, the prevalent climate and beliefs, the social interactions, and the organizational processes. The contextual questionnaires allow an extensive data collection on student outcomes by tracing students' previous education and life experiences

that promoted participation, progression, and outcomes in their current VET programme. The questionnaires also include measures of students' health and well-being, safety, and cognitive and personal engagement.

The framework of the International VET contextual assessment incorporates core and unique elements of the Educational Prosperity model (Willms, 2015^[1]) developed for the 2018-19 PISA for Development (PISA-D). To orient the focus of PISA-VET towards the green transition and green skills, the contextual assessment refers to the PISA 2025 Science Framework (OECDa, 2023^[2]) particularly in recognizing the greater agency of learners in the face of climate change and knowledge acquisition to respond to it. To orient the focus of PISA-VET towards the digital transition and digital skills, the contextual assessment refers to the PISA 2025 ***Learning in the Digital World assessment framework*** (OECDb, 2023^[3]). Additionally, the assessment framework borrows and reflects on lessons from international studies on VET and from national assessments and research studies conducted in the participating countries or in the targeted occupational areas.

The framework of the International VET contextual assessment builds on PISA 2022 and especially on the main components of the Questionnaire Framework for PISA 2022 (ETS/OECD, 2019^[4]). It shares the same key areas of assessments of students' outcomes and personal background, of school-based teaching and learning processes, and of school policies and educational governance. Along with these code dimensions, new areas were included in the PISA-VET framework to capture the unique features of work-based learning and training and of the additional stakeholders involved in training and teaching VET students.

Core of contextual assessment in PISA-VET

The PISA-VET's overarching framework tasks the contextual assessment's instruments, or questionnaires, to inform policy makers on how to track and to promote the success of all learners. These instruments measure holistically the success of learners with multiple outcomes. They collect data on the foundational resources and processes that support them, and detailed information on learner-level demographic characteristics. More detail on the diversity of VET systems will be captured through the system-level questionnaire presented in Chapter 9.

The data collected with the contextual instruments can help assess whether good performance of educational systems is obtained at the expense of equality and equity of outcomes for different learner sub-groups.

Success over the life course: ideas and terminology

The framework of the PISA-VET contextual assessment aims at embedding the experience of studying and working in initial VET programmes within a broader description of learners' life trajectories and their skill development for employment in the labour market.

The framework of the contextual assessment of PISA-VET therefore adopts a life-course approach to assessing learners' outcomes, and it draws on the Educational Prosperity model (Willms, 2015^[1]), which guided the construction of the PISA for Development (PISA-D) contextual assessment. The PISA-D contextual framework was designed to better describe a more diverse population of young adults and their complex lives, in and out-of-school. Several measures introduced in the PISA 2022 questionnaire have embraced the principals and the approaches pioneered in PISA-D. The term "prosperity" used by Willms (2015^[1]) and adopted in the framework documents of PISA-D, refers to the condition of experiencing success or thriving. Educational systems and society are committed to deploy key resources and processes to ensure the full

development of young people’s cognitive skills, employability skills, and well-being. Educational prosperity indicates the achievement of this goal.

Participation, progression, and academic outcomes at all levels of education build on past educational tracks and depend on successful personal transitions. (Ainsworth and Roscigno, 2005^[5]; Alba and Lavin, 1981^[6]; Bozick and DeLuca, 2005^[7]; Dougherty, 1987^[8]; Entwisle and Alexander, 1993^[9]). This means that youth enter, progress, and achieve academic and personal goals in secondary and post-secondary education according to stratification mechanisms, by building on prior achievement, resulting from the sifting and sorting processes embedded in educational, work, and social institutions. Health and socioeconomic advantage experienced early in the life course continue to impact youth development, with ripple effects on their outcomes at various ages, from childhood to adulthood. Cumulative advantage and institutional selective mechanisms impact students’ access to quality of education, to acquisition of skills and maintenance of well-being and engagement.

A life course approach explains the yield of learning as well as the timely entry in postsecondary or its premature dropout (NCES, 2005). The interplay of personal transitions, educational and social resources, and institutional mechanisms leads to the construction and negotiation of educational careers that extend into midlife (Astone et al., 2000^[10]; Boudett, Murnane and Willett, 2000^[11]).

As described in Chapter 9, VET programmes serve different purposes. Most VET programmes target the development of medium-level vocational skills that are immediately relevant for the labour market but can also serve as pathways into further learning. Some programmes equip learners with higher-level vocational skills and lead to postsecondary or tertiary qualifications, supporting entrepreneurial activities, and functioning as innovation hubs for companies. Other programmes focus on lower-level vocational skills and provide job-relevant skills to students at risk of dropping out of school or to those who have already dropped out. These different purposes of VET programmes produce great variability in programme characteristics as well as in student characteristics. One of the main challenges for PISA-VET is portraying while comparing how vocational programmes are organised and delivered across and within countries, and by occupational areas.

To embrace this diversity and to establish some terms of comparison, the contextual framework of PISA-VET focuses on the collection of information on learners’ educational and occupational trajectories and on their personal characteristics to describe learners’ success outcomes, including participation, progression, and personal and educational achievements. The framework guides the collection of data on these outcomes and relates them to the structure of VET programmes, the organisation and the main practices in the venues for learning, and to the resources for learning available and used by teachers, trainers, and learners.

Learner success outcomes

The framework of PISA-VET defines learner success as both a holistic and a cumulative concept. The success of learners enrolled in VET comprises of job-specific learning and skills, employability skills, learners’ health and well-being including work safety, progression and engagement in the programme, aspirations and attitudes towards VET and development of occupational and organisational identity. These outcomes vary by sociodemographic characteristics and by educational and work background. The success outcomes are also associated with learners’ previous experiences, and with current practices, interactions, and resources available in their social, educational, and occupations environments.

The PISA-VET questionnaires collect answers from learners, teachers, workplace trainers, and educational administrators (largely VET institution leaders or principals, or programme administrators) to understand presence, availability and access of key resources and processes that constitute foundations for success.

Following the Educational Prosperity approach of PISA-D, four criteria guided the selection of foundational resources, relationships and processes measured by the PISA-VET questionnaires (OECD, 2018^[12]). Foundational resources must be universal; in early learning stages as in the current time of assessment, these foundational factors have been found to be necessary conditions for youth to thrive. Additionally, to be selected, foundational resources must be potent, proximal, and pervasive factors. A potent factor has a strong correlation with a success outcome; quality of instruction, for example, is the single most potent driver of learning. A proximal factor is directly connected to an outcome and related to it. For instance, quality of instruction is also proximal, as it is directly connected to one or more learning outcomes, including attendance and academic achievement, as well as cognitive engagement. But teachers' opportunity for professional development, which is often looked at as a key driver of learning, is not proximal: in fact, it can be mediated by other "closer" factors, like teaching skills and effective training practices. Finally, a pervasive factor is a driver of several success outcomes. Again, quality of instruction is strongly and directly related to learning, it promotes greater engagement and protects from absenteeism or dropout.

Questionnaire respondents (referred to also as "informants") are selected to provide a mix of unique perspectives and combined views of outcomes, processes, and resources. The term "triangulation" is used to describe the approach of combining data collection on the same general area of assessment from different informants, using different instruments. For example, learners are the direct and only informants on their educational and work career, but they offer information on training arrangements and school processes that is combined with the view of workplace trainers and teachers. Again, learners describe the relationships and the experiences of inclusion at school and in the workplace, while institution leaders add information on policies and school-wide approaches to support inclusion and safety for all learners.

Learners' demographic characteristics to study equality and equity.

Following OECD's Education at a Glance (2011^[13]) and the PISA-D contextual framework (2018), the PISA-VET contextual framework defines equality and equity as separate concepts and measures them with a consistent approach.

Inequality is shown by differences among sub-populations in the distribution of their educational outcomes. The measure of equity involves an assessment of fairness based on the observed differences among sub-populations in their access to the resources, relationships and processes that affect learners' outcomes (OECD, 2011^[13]; Willms, 2011^[14]). Equality is therefore measured by the differences among groups in the distribution of learners' success outcomes, which in the case of PISA-VET are the following: occupational specific learning outcomes, employability skills, learners' educational planned path and educational aspirations; engagement in work and learning; occupational and organisational identity, health and well-being, and work safety.

Equity refers to the possibility for all groups of VET learners to experience success in the form of these outcomes, by having fair access to the foundational resources, relationships, and processes for success. These are the quality of instruction and of training in the school and workplace; inclusive environments, effective usage of institution-based and work-based time; the family's and the parents' or the friends' support; material and human resources; the community support; and a fluid collaboration and effective coordination between VET institution and workplace. Unfair access to the foundational factors increases inequalities in outcomes. For example, for VET

learners to use obsolete equipment can impact several success outcomes, including gaining up-to-date and relevant occupational skills and learn and work safely.

Equity is a normative concept; the PISA-VET contextual framework assesses it in relative terms – by comparing the levels of inequality in outcomes and in access to the foundations of success to those achieved by other countries, in comparable circumstances (OECD, 2018_[12]).

Figure 8.1. Assessment approach to equality and equity

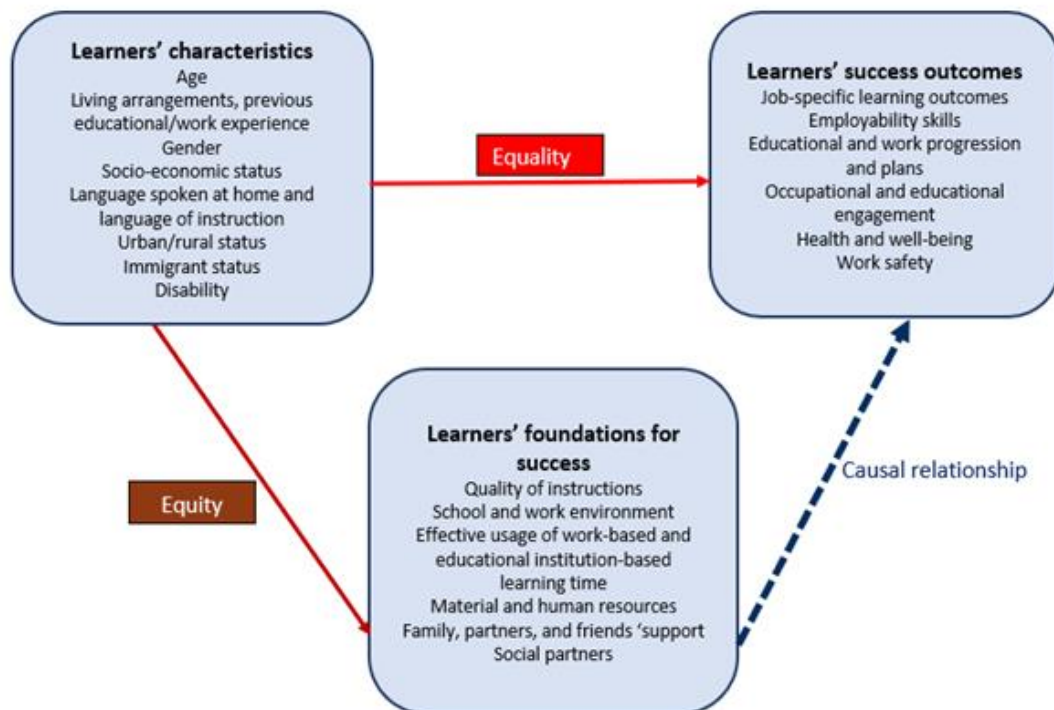

Source: Modified from (OECD, 2018_[15]) based on (Willms et al., 2012_[16]).

Equality in occupational-specific learning outcomes for learners from different socioeconomic backgrounds is assessed by examining the relationship between their performance in occupational-specific tasks and their socioeconomic status (SES), while equity in the same outcomes is assessed by also examining the relationship between SES and the foundation factors that support and promote job-specific learning and skills.

With reference to Bowman (2004_[17]), equity in VET can be effectively assessed and ensured by focusing on policy-specific “priority groups” and by monitoring when and where they experience barriers in the training cycle, from participating in training, progressing through elected VET studies, to achieving the outcomes sought from the training.

The life-course approach at the core of PISA-VET’s instruments guided the construction of questions to nuance the definition of priority groups, to assess accurately equality and equity, and to inform on specific policy changes and interventions that can alleviate or resolve inequities.

The equity priority groups may differ slightly by country and occupational areas, but existing research and national reports point consistently to five types of students to prioritise, identify and to monitor in their access, progression, and acquisition of skills. Those are women, of various age

groups; students from lower socioeconomic background; students whose first language is not the language of the country of assessment; migrants; learners with lower levels of proficiency in literacy and numeracy and with a history of school dropout; and students with disability.

Selection and organization of core content

The instruments

The instruments are self-completed questionnaires. These questionnaires may be completed at the time of the testing of the sampled students or at a later date on-line. They include: a student questionnaire; a teacher questionnaire, administered to most of the teachers in the selected occupational areas in each school (or college or programme); and a VET institution questionnaire, administered to the VET institution leader/principal. The VET institution questionnaire can, where necessary, include programme-specific items for each of the occupational areas. Its function is to collect data on the institution as a whole as well as on the specific VET programmes in the selected occupational areas administered in and by the institution.

The questionnaires targeted to the institutions and the teachers will address questions at three different administrative and contextual levels. Some questions will be specific to different occupational area programmes within an institution. Other questions will be about the general institutional context. Finally, questions will be about the context and the activity of the single programmes. As an additional source of data, trainers in the work-based learning environment that are most knowledgeable about the participating learner's training receive from the learner in training a one-page questionnaire to fill out and return by pre-stamped mail or scanned attachment to an email. The trainer/employer questionnaire will only be administered in countries and programmes that have a substantial work-based component.

Figure 2 maps out the distribution of questions by respondent, for each of the constructs and areas defined by the contextual framework. A dot represents a question. The questions can be drawn from OECD studies; they can be new questions for PISA-VET, or they can be adaptations from questions in other international or national assessments. Several core measures are created with questions drawn directly from various cycles of PISA, including PISA-D, and from PIAAC. The new questions are crafted originally, based on the findings from national and international research studies.

Table 8.1. PISA-VET Areas of assessment and questionnaire organization

	Learner	Teacher	VET institution	Trainer/ employer
Demographic factors to assess equality and equity				
Age	•			
Gender	•			
Socioeconomic status	••••••••••			
Family structure and living arrangements	••••			
Immigrant status	•••			
Language	•••	••		
Previous educational and work career	•••••••••• ••••••••			
Disability	•			
Urban vs rural			•	
Learner success outcomes				
Educational and work progression and plans	••••			
Occupational and educational engagement	•••••	••		
Health and well-being	•••	•		
Work safety	••			
Foundations for Success	Student	Teacher	VET educational institution	Trainer
Quality of instruction: support and mentorship from teachers and trainers	••	•		
Quality of instruction: pedagogical methods	••	••	•	•••
Quality of instruction: learning venue cooperation	••	••••	••	
School and work environment: climate, inclusiveness, relationships, and connections	••••	•••	•••	
Effective usage of school-based learning (SBL) time	•••	•	••	
Effective access and usage of work-based learning (WBL) time	••••			••
Material resources: infrastructural and didactic resources	•	•••••••	•	•
Human resources: teachers and trainers experience and qualification	•	•••••••••• •••	••••	•••••
Family, partners', and friends' support for learners	•			
Social partners			•••	
Context factors	•••••	••••	•••••••••• ••••	•••

The criteria followed for selecting questions and for developing new items included:

- a) Relevance for the VET system and coherence with the goals of the system, which are:
 - the development of the individual's potential occupational mobility, self-regulation, and autonomy
 - the safeguarding of human resources in a society
 - the warranty of social participation and equal opportunity.
- b) Balanced representation of the institutional and individual context factors that are recognised by the international literature and research studies as fundamental for individuals' competence development.
- c) Parsimonious and country-invariant systemic and instructional characteristics and their influences on the development and use of competencies as well as in the promotion of learners' success.
- d) Pervasive in their ability to capture interactions between individual and social factors.
- e) When relevant, traditionally and successfully used in other International Large-Scale Assessments, like PISA and PIAAC.

Proposed approach for instruments administration

In their initial form, pre-Pilot Phase, the questionnaires are inclusive and comprehensive. Annex B presents them in draft form. The questionnaires are structured along a provisional sequence of relevant topics and related questions. The questions and items presented are an attempt to operationalise the conceptual framework, irrespective of specific occupational areas or a country's unique features. Because they are very broadly worded, the questions are formatted to accommodate additional items or for conducting adaptations of terminology by country and by occupational area. The questionnaires in Annex B of this document include adaptable terms contained between the symbols < >, as well as blank items for <occupational specific> or <country specific> new items. Further adaptation, specific to programmes within educational institutions will apply to terms like "classroom", "lessons", and even "teachers".

In the Pilot Phase, the learner questionnaire's content could be tested by designing alternative forms or questionnaire booklets. Each form or booklet would have a common core of questions, and a unique subset of questions. A rotated design in the administration of these forms or booklets contains the length of the questionnaire and the time of response while still allows collecting information on the effectiveness and responses to all the questions drafted in the pre-Pilot Phase version. As noted above, the Pilot Phase would explore the options for students to complete the questionnaire on-line in order to manage the length of the actual assessment time.

VET institution, trainer, and teacher questionnaires are shorter than the learner questionnaire; also, the respondents may be given more time to fill them out. Hence, they could be administered as they are. The Pilot Phase testing may still involve the design and comparison of different layouts and sequences of the same questions.

For the Pilot Phase, and prior to their administration, questionnaires should be finalised by PISA-VET contractors, in collaboration with the OECD and national project managers. To maintain comparability between countries and occupational areas, coordination and adaptation are symbiotic, and instrumental for effective pilot testing. National project managers should coordinate with the PISA-VET contractor and the OECD on the national adaptation of the questions of all the questionnaires. Adaptation involves translation and contextualisation, but also customisation of the country-specific and occupation-specific items that are offered for some of the questions.

The contractors of PISA-VET, with feedback from national project managers, will develop pivots and filters to conduct an initial screening of students and teachers and optimise the sequence of questions that they will answer. The VET institution questionnaire can follow the same approach, if deemed necessary.

The Pilot Phase will also provide the opportunity to ascertain the response rate for the trainer/employer one-page questionnaire, which is designed for an agile and quick completion by the trainer in the work-based learning environment most knowledgeable about the learner. It is necessary to specify further the guidelines for the choice of the person most knowledgeable in the work-based learning environment.

In the PISA study, the student questionnaire begins strategically with questions on students' demographic and socioeconomic characteristics. This information is instrumental for the construction of the plausible values of the test scores. In the PISA-VET study, if plausible values were to be constructed for VET learner, structuring the flow of questions in the learner questionnaire to ensure full and effective collection of their sociodemographic profile would be necessary.

Core content for assessing learners' success in the school and work environment

The PISA-VET contextual framework includes the measurement of learners' characteristics and background, their success outcomes, the foundational factors that support their success, and additional contextual elements that describe the features of the VET institution and the workplace. The content of these elements is discussed below.

Assessing learner success

Learner success includes job-specific learning outcomes and employability skills, as described in Chapters 2-6 and Chapter 7 of this framework document respectively and assessed by the cognitive instruments. The contextual assessment focuses on learners' educational and work-related progression and plans, occupational and educational engagement, health and well-being, and work safety.

Job-specific learning outcomes and employability skills

The framework and the measures for job-specific learning outcomes and employability skills are described in Chapters 2-6 and Chapter 7 of this framework document, respectively.

Students' educational and work-related progression and plans

The PISA-VET framework adopts a life course approach to measure and examine educational attainment and work-related expectations. The life course perspective offers a long view of lives (Elder, 1994^[18]), and helps positioning orientations and attainment at the time of data collection as embedded in ongoing trajectories. The learners' trajectories are shaped by systems of resources and promotion as well as by social stratification's mechanisms that impact their lives. The combination of responsibilities and resources at various stages of learners' lives affect their plans, especially school and work decisions, which depend on the costs of attending, the perceived probability of success, and the utility of completing a degree (Astone et al., 2000^[10]; Johnson and Reynolds, 2013^[19]).

Learners' motives for enrolling in VET are typically diverse and their expectations much wider than just gaining job-related skills. VET is also seen as a pathway to further study, either in the VET or academic sector. The learner questionnaire collects detailed information on the trajectories of the learners and allows matching them with learners' current experience and progress in their VET programmes. The learner questionnaire informs on learners' intentions and plans to continue and complete the programme, as well as on occupational expectations and plans for education and employment. All the other questionnaires,

with exception of the trainer/employer questionnaire, collect additional information on learner absenteeism and truancy.

Learner engagement in school and at work

The PISA studies have examined for more than two decades students' interest and motivation in reading, mathematics and science, and their engagement in activities related to these subjects. PISA has also considered engagement more broadly, as students' attitudes towards schooling and their participation in school activities (Willms, 2003_[20]). Student engagement is more than a predictor of students' achievement, both in their school setting and in the workplace.

Student engagement is an outcome that leads to lifelong learning and the likelihood of becoming a productive member of society (OECD, 2018_[12]). Like PISA, the PISA-VET learner questionnaire includes measures of institutional engagement, providing information on general attitudes towards VET institution, workplace and learning outcomes, as well as attitudes towards learning activities, both in the educational institution and in the workplace.

Health and well-being

The concept of well-being refers to the quality of people's life. Diener (2006_[21]) defines subjective well-being as "an umbrella term for the different valuations people make regarding their lives, the events happening to them, their bodies and minds, and the circumstances in which they live". Previous cycles of PISA defined well-being beyond students' subjective appraisal of their life quality: "Students' well-being refers to the psychological, cognitive, social and physical functioning and capabilities that students need to live a happy and fulfilling life" (OECD, 2018_[12]).

Students' well-being incorporates five domains: emotional, physical, social, cognitive, and spiritual well-being. The health and well-being module of PISA-VET focuses on the first two of these domains, while social and cognitive well-being are included in other areas of assessment. Spiritual well-being is not included in the framework. As in PISA, the PISA-VET learner questionnaire asks about general life satisfaction and includes a non-clinical measure of anxiety and depression. Additionally, it asks learners questions about their overall physical health during the past year.

Social well-being pertains to learners' sense of belonging and their connectedness to others. In PISA-VET, it is measured by questions on attitudes towards VET institutions and the workplace, on learning and inclusive environments focusing, and on connectedness to others, including peers, teachers and trainers or mentors. The development of VET identity can also be seen as key indicator of learners' well-being.

Work safety

Health and safety are key components within the programmes delivered by the VET sector, particularly given that competent application of work-specific skills and knowledge includes applying them in a safe manner.

The learner questionnaire of PISA-VET collects information from the learners about the risks and exposure to hazards in the workplace, and the frequency of such exposure. Additionally, the questionnaire includes a question on learners' awareness of occupational health and safety (e.g. hazards, the rights and responsibilities of both employees and employers).

Assessing the foundations of learner success

As discussed earlier in this chapter, the foundations for learners' success are necessary conditions for success at each stage of the learners' educational and occupational trajectory. A large body of research

provides evidence of the effects of each factor on student outcomes. The foundations selected in PISA-VET are inclusive environments, quality instruction, work-based and school-based learning time, human and material resources, family, partners and friends' support, and social partner engagement.

Inclusive environments

Inclusion is a “process of addressing and responding to the diversity of needs of all learners through increasing participation in learning, cultures and communities, and reducing exclusion within and from education” (UNESCO, 2005^[22]). Inclusion involves modifications in content, approaches, structures, and strategies, with a shared vision that a system must provide quality learning to all students. UNESCO's policy guidelines (2009^[23]) provide a schema for measuring aspects of inclusion relevant to teachers', trainers' and institution leaders' attitudes and values. Inclusive environments are places in which learners across the categorical boundaries of disability, social class, gender, age, ethnicity, national origin, sexual orientation, and religion can succeed.

Inclusive learning and work environments guarantee and promote a complete learning and training experience, including opportunities to learn, engage in the social life of the programme or the workplace, and feel accepted by their peers, mentors, trainers, and teachers.

PISA-VET collects information on inclusion from learners, teachers, trainers, and VET institution leaders. As in PISA, PISA-VET asks learners to report on their sense of belonging at school. It explores the climate in the VET institution with questions about the safety of their VET institution and in their work-based learning environment, whether they feel safe, accepted, and supported. In the teacher questionnaire, PISA-VET asks teachers about their attitudes and practices towards teaching learners with low literacy levels. Like in PISA, in the PISA-VET institution leaders report on institutional or programme specific policies concerning admission and management of instruction for learners with different skills and proficiency. Additionally, leaders or administrators report on the degree of diversity of the educational environment.

Quality instruction

Quality of instruction is the most important driver of student's learning, both in the educational environment and in the workplace. The literature on general education stresses that effective teachers are goal-oriented, and this is evident in virtually all the contemporary models of effective instruction (Coe et al., 2014^[24]).

Theoretical studies in vocational institutions and practical training at workplaces should be considered complementary; they provide different kinds of opportunities for learning (Aarkrog, 2005^[25]). Close collaboration between vocational institutions and workplaces creates the ideal setting to provide workplace learning for VET students. Learners require opportunities to recontextualise their theoretical and practical knowledge in new contexts to create new knowledge and practices (Griffiths and Guile, 2003). Collaboration between learners, workplaces, and vocational institutions benefits learning (Savoie-Zajc. and Dolbec, 2003^[26]; Virtanen and Tynjälä, 2008^[27]; Virtanen, Tynjälä and Eteläpelto, 2014^[28]).

PISA-VET recognises that the provision of guidance and quality of instruction is the responsibility of several stakeholders that constitute the educational and-work based community. All four questionnaires designed in PISA-VET involve questions on support and mentorship by teachers and trainers; pedagogical methods; and learning venue cooperation. Quality instruction manifests in learning sessions the educational programme and in continuous learning in the work-based learning or training place.

Guidance is described as a process during which more experienced workers, or trainers and teachers, and novice learners work together. Working together involves experts monitoring, providing help if needed. It also involves providing explanations or information, categorisation, and transferring of explicit and tacit knowledge. Finally, guidance manifests as reflection, through conversations, discussions, and feedback. Additional practices in the training and workplace involve scaffolding and fading; observation and

demonstration; and independent work and experimentation (Evanciew and Rojewski, 1999^[29]; Filliettaz, 2011^[30]; Koskela and Palukka, 2011^[31]; Onnismaa, 2008^[32]; Tanggaard, 2005^[33]).

Following Billett (2002^[34]; 2002^[35]), PISA-VET definition of quality of instruction incorporates school-based and work-based pedagogical practices on three interdependent areas of guided engagement with work activities. The first area includes everyday participation and the organising of access to knowledge through observing and listening, but also by engaging in tasks of increasing responsibility, accountability and understanding the goals of the required performance. The second area comprises direct guidance and intentional learning strategies that are directed towards developing and promoting values, procedures, and understandings. Guided learning, especially at work, includes the use of modelling, coaching, and scaffolding as well as other techniques to develop understanding and to engage learners in learning for themselves. The third area of guided learning focuses on extending the adaptability of learners' knowledge to new situations and circumstances. The use of questioning, problem solving, dialogues and group discussions aim at assisting learners to assess the scope and the limits of their knowledge and the possibilities of its transfer to new situations.

The process of guidance clearly involves teachers and trainers, especially in planning and evaluating learners' workplace learning periods. Discussions between learners and teachers are vital pedagogical elements of workplace learning that help to integrate school learning and workplace learning. Disconnects between goals and didactical practices in school and in the workplace lead to conflicts and learning loss.

These elements are collected from the learner, the teacher, and the trainer/employer questionnaires, with attention to complementarity and triangulation of information from the three sources of information and stakeholders.

Educational institution-based and work-based learning time

Learner related or work-related factors can hinder the frequency and the intensity of access to quality of instruction. Time for learning and time management, in their educational institution and in the workplace are foundations for students' success.

The PISA-VET questionnaires involve questions on schedule disruption, on learning sessions interruptions and on aspects of classroom management. Additionally, questions on learners' and teachers' voluntary or unplanned absenteeism combined with questions on flaws in the management of work-based learning opportunities and effective educational-institution and work-based learning time can help evaluate the actual and effective learning time available, in the VET institution and in the workplace.

Material and human resources

Drawing from the approach implemented in PISA-D, the PISA-VET teacher, trainer/employer and VET institution questionnaires adopt a schema set out by Murillo and Roman (2011^[36]), which distinguishes between basic services, didactic facilities, and didactic resources:

- Basic services at the VET institution include minimal and more advanced physical infrastructure, resources, and services such as potable water, water fountains, bathrooms, electricity, heating and cooling systems, and other infrastructural features.
- Didactic facilities refer to places other than the classroom for teaching and learning. These include, for example, training rooms and laboratories/workshops, equipment rooms, simulation rooms, computer rooms, libraries, study rooms and other facilities dedicated to teaching and studying.
- Didactic resources can include from very basic materials, such as textbooks, manuals, or whiteboards, through to computers or tablets in the VET institution, laptop computers for learners and teachers, and tools like virtual reality, simulators and other advanced equipment.

Whereas PISA asks principals about their perceptions of school resources (lack of or inadequate physical infrastructure and educational material) and collects information on the availability of information and communication technology resources and internet connectivity, PISA-VET, following PISA-D, designed questions for the VET institution leaders that focus on the availability and conditions of specific elements of school infrastructure and facilities as well as the availability of some basic didactic resources.

Moreover, teachers from the five selected occupational areas respond in their questionnaire to questions on the availability of didactic facilities and resources and on their use of didactic facilities and resources in daily pedagogical practices. Trainers from the work-based learning environment are also asked whether in their workplace they can access dedicated spaces, resources, and equipment to support them in their practice with VET learners.

Human resources are assessed primarily by the teacher and the VET institution questionnaires, which collect information on staffing and qualification as well as occupational specific experience of teachers and staff in the school. Questions on teachers' sociodemographic characteristics help picturing the teaching body in the educational institution and in the programmes (see "context factors" in the item map). Likewise, the trainer/employer questionnaire offers additional information on the occupational profile of the trainer.

Family, friends', and partners' support for learners

The learner questionnaire for PISA-VET collects information on learners' family structure and living arrangements, and inquires specifically about the support, approval, and expectations that family members offer them during their education and work. Perseverance and investment in a VET programme can also depend on the resources and the emotional support as well as on the approval that learners perceive and effectively receive from their family members.

Social partner engagement

Social partnership is a working relationship between trade unions and employers, aiming at improving the prosperity of the company and its employees. Employers and trade unions shape VET and adult learning policies by informing and intervening on training needs, priorities, and delivery of effective training (OECD, 2019_[37]). The engagement of social partners ensures that the skillsets embodied in vocational qualifications reflect occupational needs, that the mix of training provision between different occupations matches the mix of demand for jobs of different types, that programmes reflect the broader needs of workers, and that opportunities for work-based learning are of high quality (OECD, 2023_[38]). The involvement of employers and worker representatives is relevant at multiple levels in VET: the national, sectoral, regional, local as well as the individual VET institution level. The influence of social partners can be just consultative, or alternatively can involve full decision-making (OECD, 2023_[38]). Typically, social partners' role is stronger in apprenticeships than in school-based VET.

PISA-VET asks questions on engagement with social partners to the VET institution leader. It also relies on the system-level data collection for evaluating the involvement of social partners in VET systems at a more aggregate level.

Learner-level demographic factors for assessing equality and equity

PISA-VET focuses on the following measures pertaining to learners' backgrounds that are particularly relevant to identify subgroups for equality and equity analyses: age, gender, socio-economic status, living arrangements, the language spoken at home and the language of instruction in the VET institution and at work, urban/rural status, the previous educational and work experience, their immigrant status, and disability.

Age

Differently from PISA, where all students are age 15 at the time of assessment, PISA-VET assesses learners of different ages, from age 16 up to adulthood, enrolled in various levels of vocational education across secondary and tertiary education.

Gender

Like in some national versions of the PISA student questionnaire, the PISA-VET questionnaire captures data about gender identity. As discussed in Chapter 1, the selected occupational areas for PISA-VET cover programmes that have predominantly male learners, some that have mostly female learners, and some that have a more mixed gender enrolment pattern. More and better data on outcomes by gender could contribute to breaking gender stereotypes in VET.

Socio-economic status

Socio-economic status (SES) refers to the position of a person or family in a hierarchical social structure, based on their access to, or control over, wealth, prestige, and power (Dutton and Levine, 1989^[39]; Mueller and Parcel, 1981^[40]).

Research studies repeatedly show the presence of a socioeconomic gradient that predicts people's life outcomes, especially health, education, and future occupation and revenues. Drawing on a life course perspective, PISA-VET recognises the role of SES in enabling learners to maintain career and educational expectations (e.g. (Alexander, Bozick and Entwisle, 2008^[41]); Bozick et al, 2010). Socioeconomic status differentiates other aspects of the life course pathways of young people, especially the earlier timing and transitioning into adult roles. Youth from lower socioeconomic status marry, become parents and work full-time at earlier ages than their more advantaged counterparts (Dariotis et al., 2011^[42]; Sandefur, Eggerling-Beck and Park, 2005^[43]). Lower socioeconomic status young adults may hold more volatile expectations or more frequently drop their plans through assuming adult roles that may conflict with that of students. To measure individual socioeconomic status, PISA-VET uses the measure of SES in PISA, called the index of economic, social, and cultural status (ESCS). The ESCS provides a measure of SES by aggregating information on household possessions (e.g. a room to study, books or electronic devices), and parental predictors for SES such as parental instruction and occupation, combined into an internationally comparable measure.

PISA 2022 has also introduced a question about food security, which PISA-VET maintained.

Family structure and living arrangements.

The PISA-VET student questionnaire collects information on learners' family structure, allowing to distinguish between those who live withing their parental social unit and those who have formed their family or live alone.

Previous education and work career

Life course transitions are increasingly demographically dense (Rindfuss, 1991^[44]), with multiple transitions occurring in a short amount of time. Employment is the most common social role combined with schooling, and many young adults participate in the two realms simultaneously (Cooksey and Rindfuss, 2001^[45]). PISA-VET captures the density and variability of VET learners' life course trajectories by collecting detailed information on previous educational and occupational experiences. Combined with family and adulthood roles, these can explain how and how successfully learners pursue further educational and career steps.

PISA-VET also asks learners when previous education and occupational experiences took place, and what barriers or personal factors motivated them to change their paths.

Language spoken at home and language of instruction

Learners' first language, which often is the language still spoken at home or with the family and close friends, may differ from the language of instruction in the VET institution or the language used in the workplace.

Researchers have identified that there is a complex array of factors that impact on the education and training experience of students from a non-country language speaking background, with language proficiency the most important one. VET learners who are born in non-country language speaking countries or who speak a language other than the language of instruction at home can come from a wide range of economic and social backgrounds.

Despite the recognition of this intragroup heterogeneity and the variability of resources and support that the students can access, learners with lower levels of proficiency in the language of instruction and literacy more generally are more likely to experience poor outcomes from training programmes and reduced access to higher-level courses (Robertson and Barrera, 1999^[46]). Inadequate basic skills, which referred to both inadequate country language proficiency and insufficient previous education and training, challenge the day-to-day learning progress in the education institution and workplace setting.

Combined with the immigrant experience and lack of local work-experience, low language proficiency is also associated with greater struggles to finding a training venue or job. Low levels of language proficiency have been found to limit awareness of training opportunities, such as apprenticeships and traineeships in non-country language speaking background communities, leaving careers advice programmes in education institutions as the main avenue for distribution of information about and promotion of interest in vocational education and training, and specifically apprenticeships and traineeships (O'Loughlin and Watson, 1997^[47]; Robertson and Barrera, 1999^[46]; Watson and Pope, 2000^[48]).

PISA-VET therefore asks learners "What language do you speak at home most of the time?", "When did you begin learning the language of instruction?" and "What language did your first learn to read?"

In addition, teachers are asked about their usage of other languages to interact with learners who have low proficiency in the language of instruction.

Urban/rural status

The school questionnaire includes a variable pertaining to the size of the community, which can be used to determine the VET institution's rural status. Living in a rural area versus a larger community is sometimes confounded with other student level demographic factors and the analyses will enable to discern this.

Immigrant status

The common factors for all migrants are those related to the actual act of migration, of moving countries, separation from family and friends and the task of establishing themselves in a new country. The length of time a VET learner born in another country has been living in the country of assessment has an impact on language proficiency, development of community support networks, stress levels associated with the migration experience, awareness of VET options and potential outcomes, and confidence in accessing support services offered by various providers. Residential location will also have an impact.

The measure of immigrant status follows a long-standing approach used in PISA which is based on questions to students about where they and their parents were born. PISA-VET asks learners if their parents live outside of the country for more than six months of the year.

Disability

PISA-VET includes a self-reported measure pertaining to disability. Students indicate the nature of their disability, and specifically whether they have impairment, disabilities, or difficulties concerning vision, mobility, behaviours, or learning.

Context factors

The VET institution and teacher context questionnaires gather data on other teacher, VET institution and system-level background variables that are expected to help explain student outcomes but are not included in any of the previously mentioned modules.

Like PISA, PISA-VET asks teachers about their age and sex, qualification, employment status, educational background, years of experience and professional development activities. Additionally, it asks teachers about their experience and training in the occupational area assessed, on their multiple teaching jobs or on their work in other jobs, related or not to the occupational area. Like in PISA, in PISA-VET teachers are asked about their job satisfaction.

The teacher questionnaire collects information on pre-service training, SES, and health and well-being. To meet policy requests directly, PISA-VET also needs to address issues related to governance at the system level. Principals of VET institutions in PISA-VET are asked numerous questions on resources and management, including type of school (public vs. private, distinguishing between types of private schools), number of students, average class or programme size, VET institution management and funding, as well as how many full- and part-time teachers work at their VET institution or in the programme. Unique to PISA-VET is a module of questions in the VET institution questionnaire that investigates the relationship with the industry and the workplace, including aspects of coordination, collaboration, and governance. A small number of questions in the VET institution questionnaire capture the efforts to comply with the principles of the green transition, in both the school management and the teaching of students (ETF, 2022^[49]).

References

- Aarkrog, V. (2005), “Learning in the workplace and the significance of school-based education: a study of learning in a Danish vocational education and training programme”, *International Journal of Lifelong Education*, Vol. 24/2, pp. 137-147, <https://doi.org/10.1080/02601370500056268>. [25]
- Ainsworth, J. and V. Roscigno (2005), “Stratification, School-Work Linkages and Vocational Education”, *Social Forces*, Vol. 84/1, pp. 257-284, <https://doi.org/10.1353/sof.2005.0087>. [5]
- Alba, R. and D. Lavin (1981), “Community Colleges and Tracking in Higher Education”, *Sociology of Education*, Vol. 54/4, pp. 223-37. [6]
- Alexander, K., R. Bozick and D. Entwisle (2008), “Warming Up, Cooling Out, or Holding Steady? Persistence and Change in Educational Expectations After High School”, *Sociology of Education*, Vol. 81/4, pp. 371-396, <https://doi.org/10.1177/003804070808100403>. [41]
- Astone, N. et al. (2000), “School Reentry in Early Adulthood: The Case of Inner-City African Americans”, *Sociology of Education*, Vol. 73/3, pp. 133-154, <https://doi.org/10.2307/2673213>. [10]
- Billett, S. (2002), “Toward a Workplace Pedagogy: Guidance, Participation, and Engagement”, *Adult Education Quarterly*, Vol. 53/1, pp. 27-43, <https://doi.org/10.1177/074171302237202>. [34]

- Billett, S. (2002), "Workplace pedagogic practices: co-participation and learning", *British Journal of Educational Studies*, Vol. 50/4, pp. 457–481. [35]
- Boudett, K., R. Murnane and J. Willett (2000), "'Second-Chance' Strategies for Women Who Drop Out of School", *"Second-Chance" Strategies for Women Who Drop Out of School*. [11]
- Bowman, K. (2004), *Equity in Vocational Education and Training. Research Readings*, National Centre for Vocational Education Research (NCVER), Adelaide, <https://files.eric.ed.gov/fulltext/ED493980.pdf>. [17]
- Bozick, R. and S. DeLuca (2005), "Better Late Than Never? Delayed Enrollment in the High School to College Transition", *Social Forces*, Vol. 84/1, pp. 531-554, <https://doi.org/10.1353/sof.2005.0089>. [7]
- Bunker, J., D. Gomby and B. Kehrer (eds.) (1989), *Overview, methodological critique, and reformulation*, The Henry J. Kaiser Family Foundation, Menlo Park, CA. [39]
- Coe, R. et al. (2014), *What Makes Great Teaching? Review of the Underpinning Research*, Centre for Evaluation and Monitoring, Durham University, Durham. [24]
- Cooksey, E. and R. Rindfuss (2001), "Patterns of work and schooling in young adulthood", *Sociological Forum*, Vol. 16/4, pp. 731-755, <https://doi.org/10.1023/A:1012842230505/METRICS>. [45]
- Dariotis, J. et al. (2011), "Pathways of Early Fatherhood, Marriage, and Employment: A Latent Class Growth Analysis", *Demography*, Vol. 48/2, pp. 593-623, <https://doi.org/10.1007/s13524-011-0022-7>. [42]
- Diener, E. (2006), "Guidelines for national indicators of subjective well-being and ill-being", *Applied Research in Quality of Life*, Vol. 1, pp. 151-157, Springer, New York. [21]
- Dougherty, K. (1987), "The Effects of Community Colleges: Aid or Hindrance to Socioeconomic Attainment?", *Sociology of Education*, Vol. 60/1, pp. 86-103. [8]
- Elder, G. (1994), "Time, Human Agency, and Social Change: Perspectives on the Life Course", *Social Psychology Quarterly*, Vol. 57/1, pp. 4-15, <https://doi.org/10.2307/2786971>. [18]
- Entwisle, D. and K. Alexander (1993), "Entry into school: The beginning school transition and educational stratification in the United States", *Annual Review of Sociology*, Vol. 19, pp. 401–423. [9]
- ETF (2022), *ENESAT22 - ETF Self-assessment Tool for Excellence..* [49]
- ETS/OECD (2019), *PISA 2021 Context Questionnaires Framework (SECOND DRAFT, Preliminary Version for Sr. Advisors)*. [4]
- Evanciew, C. and J. Rojewski (1999), "Skill and knowledge acquisition in the workplace: a case study of mentor-apprentice relationships in youth apprenticeship programs", *Journal of Independent Teacher Education*, Vol. 36/2, pp. 24–53. [29]
- Filliettaz, L. (2011), "Collective guidance at work: a resource for apprentices?", *Journal of Vocational Education & Training*, Vol. 63/3, pp. 485-504, <https://doi.org/10.1080/13636820.2011.580359>. [30]

- Johnson, M. and J. Reynolds (2013), "Educational expectation trajectories and attainment in the transition to adulthood", *Social Science Research*, Vol. 42/3, pp. 818-835, <https://doi.org/10.1016/j.ssresearch.2012.12.003>. [19]
- Koskela, I. and H. Palukka (2011), "Trainer interventions as instructional strategies in air traffic control training", *Journal of Workplace Learning*, Vol. 23/5, pp. 293-314, <https://doi.org/10.1108/13665621111141902>. [31]
- Mueller, C. and T. Parcel (1981), "Measures of Socioeconomic Status: Alternatives and Recommendations", *Child Development*, Vol. 52/1, pp. 13-30, <https://doi.org/10.2307/1129211>. [40]
- Murillo, F. and M. Román (2011), "School infrastructure and resources do matter: analysis of the incidence of school resources on the performance of Latin American students", *School Effectiveness and School Improvement*, Vol. 22/1, pp. 29-50, <https://doi.org/10.1080/09243453.2010.543538>. [36]
- O'Loughlin, T. and I. Watson (1997), *Loyalty is a one-way street: NESB immigrants and long-term unemployment*, Australian Centre for Industrial Relations, Research and Training, Sydney. [47]
- OECD (2023), *Building Future-Ready Vocational Education and Training Systems*, OECD Reviews of Vocational Education and Training, OECD Publishing, Paris, <https://doi.org/10.1787/28551a79-en>. [38]
- OECD (2019), *Getting Skills Right: Making adult learning work in social partnership*, OECD, <https://www.oecd.org/employment/emp/adult-learning-work-in-social-partnership-2019.pdf>. [37]
- OECD (2018), *PISA for Development Assessment and Analytical Framework: Reading, Mathematics and Science*, OECD Publishing, Paris. [15]
- OECD (2018), *PISA for Development Assessment and Analytical Framework: Reading, Mathematics and Science*, OECD, <http://doi.org/10.1787/9789264305274-en>. [12]
- OECD (2011), *Education at a Glance 2011: OECD Indicators*, OECD Publishing, Paris. [13]
- OECDa (2023), *PISA 2025 SCIENCE FRAMEWORK (DRAFT)*, OECD, https://pisa-framework.oecd.org/science-2025/assets/docs/PISA_2025_Science_Framework.pdf. [2]
- OECDb (2023), *PISA 2025 LEARNING IN THE DIGITAL WORLD FRAMEWORK (SECOND DRAFT)*, <https://www.oecd.org/media/oecdorg/satellitesites/pisa/PISA%202025%20Learning%20in%20the%20Digital%20World%20Assessment%20Framework%20-%20Second%20Draft.pdf>. [3]
- Onnismaa, J. (2008), "Age, experience, and learning on the job: crossing the boundaries between training and workplace", *Journal of Employment Counseling*, Vol. 45/2, pp. 79–90. [32]
- Rindfuss, R. (1991), "The Young Adult Years: Diversity, Structural Change, and Fertility", *Demography*, Vol. 28/4, pp. 493-512, <https://doi.org/10.2307/2061419>. [44]
- Robertson, R. and S. Barrera (1999), "Workable solutions: final report for Australian National Training Authority", pp. 55, ANTA, Brisbane. [46]

- Sandefur, G., J. Eggerling-Beck and H. Park (2005), “Off to a Good Start? Postsecondary education and early adult life”, in Settersten, R., F. Furstenberg and R. Rumbaut (eds.), *On the Frontier of Adulthood: Theory, Research, and Public Policy*, University of Chicago Press, <https://doi.org/10.7208/chicago/9780226748924.003.0009>. [43]
- Savoie-Zajc., L. and A. Dolbec (2003), “Co-operative education in the pulp and paper sector in Quebec”, *Journal of Workplace Learning*, Vol. 15/3, pp. 114–122. [26]
- Tanggaard, L. (2005), “Collaborative teaching and learning in the workplace”, *Journal of Vocational Education & Training*, Vol. 57/1, pp. 109-122, <https://doi.org/10.1080/13636820500200278>. [33]
- UNESCO (2009), *Policy Guidelines on Inclusion in Education*, UNESCO, Paris. [23]
- UNESCO (2005), *Guidelines for Inclusion: Ensuring Access to Education for All*, UNESCO, Paris. [22]
- Virtanen, A. and P. Tynjälä (2008), “Students’ experiences of workplace learning in Finnish VET”, *European Journal of Vocational Training*, Vol. 44/2, pp. 200–213. [27]
- Virtanen, A., P. Tynjälä and A. Eteläpelto (2014), “Factors promoting vocational students’ learning at work: study on student experiences”, *Journal of Education and Work*, Vol. 27/1, pp. 43–70. [28]
- Watson, L. and B. Pope (2000), “Equity in Australian education and training: An examination of access and outcomes data across the sectors”, *paper presented at the Australian Vocational Education and Training Research Association Conference, March 23–24, Canberra*. [48]
- Willms, J. (2015), *Educational Prosperity*, The Learning Bar Inc., Fredericton, Canada. [1]
- Willms, J. (2011), “An analysis plan on educational equality and equity: Recommendations for the OECD Education at a Glance”, *paper prepared for the OECD NESLI INES Network for the collection and adjudication of system-level descriptive information on educational structures, policies, and practices (NESLI), UNB-CRISP, Fredericton*. [14]
- Willms, J. (2003), *Student Engagement at School: A Sense of Belonging and Participation: Results from PISA 2000*, PISA, OECD Publishing, Paris, <https://doi.org/10.1787/9789264018938-en>. [20]
- Willms, J. et al. (2012), *Assessing Educational Equality and Equity with Large-Scale Assessment Data: Brazil as a Case Study*, Inter-American Development Bank, Washington, DC. [16]

Further reading

Bergseng, B., E. Degler and S. Lüthi (2019), *Overview: Unlocking the potential of migrants through vocational education and training in Germany*, OECD Publishing, Paris.

Jeon, S. (2019), “Vocational Education and Training in Sweden”, *OECD Reviews of Vocational Education and Training*, OECD Publishing, Paris.

Kis, V. (2020), “Improving evidence on VET: Comparative data and indicators”, *OECD Social, Employment and Migration Working Papers 250*, OECD Publishing, Paris.

OECD (2019), *Getting Skills Right: Making adult learning work in social partnership*, OECD Publishing, Paris.

Notes

¹ In some countries, VET learners also spend significant time in intercompany training centres – a setting that could be considered as sitting between the VET institution and the workplace/employer. These types of training centres fall outside of the scope of the Development Phase of PISA-VET. However, the use of such facilities will be explored in the system-level data collection.

9 System-level data on VET

This chapter reviews the existing collection, availability and quality of VET system-level data and sets out how system-level data for the PISA-VET Assessment differ from those used in the context of PISA. The chapter proposes an approach to using system-level data in the PISA-VET Assessment, drawing on existing data collections and a new system-level questionnaire to complement existing data.

Introduction

The purpose of system-level data in the context of the PISA-VET Assessment is to help the interpretation of the assessment and contextual data that will be collected. System-level data provide contextual information on national VET systems and allow for analysis of the relationship between results in the PISA-VET Assessment and various features of the design and delivery of VET in different countries.

From PISA to the PISA-VET Assessment

The system-level questionnaire for PISA consists of a set of worksheets referring to the structure of national programmes, national assessments and examinations, instruction time, teacher training and salaries, educational finance (including enrolment), national accounts and population data. Not all countries participating in PISA complete this questionnaire; only those that are not already part of a joint data collection project led by UNESCO, the OECD and Eurostat, which collects the same information through annual surveys (see Box 9.1).

Many issues addressed by the system-level questionnaire in PISA are relevant for the PISA-VET Assessment. At the same time, there are differences, which mean adaptations to the collection and use of system-level data are needed to allow for meaningful international comparisons. In this regard, this section highlights three main differences between PISA and the PISA-VET Assessment: the target population, the prior education of learners, and learning providers.

First, the target population of the PISA-VET Assessment is different from that of PISA. For PISA the target population is 15-year-old students – more specifically, students between 15 years and 3 (completed) months and 16 years and 2 (completed) months at the beginning of the testing period, attending educational institutions located within the country, and in grade 7 or higher (OECD, 2019^[1]). In practice, this includes mostly students in the early stages of upper secondary education and as well as some at the final stages of lower secondary education.

By contrast, the target population for the PISA-VET Assessment is not defined by age, but by a specific level of targeted learning outcomes: EQF 3-5 (or equivalent), or ISCED levels 3, 4 and 5. This translates into a broader age range and may cover more levels of education than PISA, depending on the ages and stages of education at which the targeted learning outcomes are provided. More specifically, the PISA-VET Assessment focuses on learners in initial VET who are close to completing an occupationally focused programme of study (both school-based programmes and those with substantial work-based learning). Therefore system-level data are needed to describe the profile of learners targeted by the PISA-VET Assessment in each country (e.g. age, level of currently pursued education) to help the interpretation of results and allow for meaningful comparisons.

At age 15 (i.e. in the PISA sample) enrolment in education is near-universal across OECD countries (and the extent to which it is not universal can be captured by a single indicator, such as the share of 15-year-olds in formal education). By contrast, participation in VET is not universal and there is no single age range or education level that could be defined as “the one” associated with VET. It is therefore useful to include system-level data that capture the use of vocational education and training at different ages and at different levels of education across OECD countries.

Second, the prior education of VET learners targeted by the PISA-VET Assessment is variable in a way that is more complex than in the case of PISA. Typically, 15-year-old students who are in upper secondary education have lower secondary education as their prior education, while those in lower secondary education will have primary education as their background. In the case of the PISA-VET Assessment there are two sources of heterogeneity in the prior education of VET learners. One source is that the targeted learning outcomes may be delivered at distinct levels of education. If automotive technicians are trained at upper secondary level in one country, most learners are expected to hold a lower secondary qualification

as prior education. In another country training for automotive technicians may be delivered in short-cycle tertiary programmes, so that learners will have already completed (general or vocational) upper secondary education prior to starting their occupationally oriented programme. An additional source of heterogeneity in prior education is that even a specific level of education may be pursued by learners with different educational backgrounds – with variation within an individual country and/or between countries. For example, in Germany vocational ISCED level 3 programmes (dual system) target to a large extent young people who have recently completed lower secondary education, as well as an increasing share of graduates of upper secondary education (general programmes). In Australia, on the other hand, vocational programmes at this level (Certificate III) are delivered after the completion of initial schooling, so that many learners already hold an upper secondary qualification, and the average age of students is around 30. An additional complication is the enrolment of adult learners in VET, who come with a distinct education and work experience background.

Third, learning providers are more diverse for vocational programmes than they are in the case of programmes serving 15-year-olds. At age 15 instruction takes place predominantly in schools, except for the youngest participants in vocational programmes with work-based learning, who represent a small share of the target population overall. By contrast, vocational programmes targeted by the PISA-VET Assessment may be delivered in different educational institutions, such as upper secondary schools, training providers that are not viewed as part of initial schooling (e.g. TAFE-s in Australia) or tertiary education institutions (e.g. when vocational programmes are provided at short-cycle tertiary level), as well as workplaces. For the PISA-VET Assessment, it is therefore important to consider system-level data on where vocational programmes are delivered, including information on the use of work-based learning.

In addition to these three factors, various system-level features related to the occupational nature of VET programmes need to be added, as those are of course not addressed by PISA.

The proposed approach to system-level data on VET

Much information on VET is available through existing data collections within the OECD. These are publicly available online and/or are included as indicators published in the annual OECD Education at a Glance report. In the light of the wide range of system-level data that might be used to underpin the interpretation and analysis of the PISA-VET Assessment, this chapter proposes a slightly different approach to the PISA system-level questionnaire. Rather than selecting a set of indicators and including them in a pre-filled questionnaire, the proposal is to provide an overview of the available system-level data for two reasons. First, the comparative data mentioned in this chapter go through a thorough validation process and are publicly available online and/or published in Education at a Glance. Including them in a pre-filled questionnaire for countries to check is therefore not necessary. Second, the specific indicators that are relevant and most helpful for comparative analysis depend on the question in focus and countries to be compared. So, it is better to map out data on system-level features and allow users at later stages to select those most suited to the analysis.

Overview of available system-level data

This section provides an overview of currently available system-level data and metadata collected under the Indicators of Education Systems (INES) Working Party and its networks, in particular the UNESCO-OECD-Eurostat (UOE) data collection, the Network on Labour Market, Economic and Social Outcomes of Learning (LSO) and the Network for the Collection and Adjudication of System-Level Descriptive Information on Educational Structures, Policies and Practices (NESLI) (see Box 9.1). In addition, household surveys, such as the European Union Labour Force Survey (EU-LFS) and the European Union Statistics on Income and Living Conditions (EU-SILC) in EU countries, and individual-level surveys, such

as the OECD Survey of Adult Skills (PIAAC) collect information on the educational background of participants and provide insights on VET.

Box 9.1. Data collections under the INES Working Party

Several annual data collections provide insights on VET and ad-hoc data collections (which may be one-off or cyclical surveys) focus on specific topics (e.g. VET systems, completion rates in upper secondary or tertiary education, VET finance). The regular data collections include:

- UNESCO-OECD-Eurostat (UOE): The annual UOE questionnaires collect data on the enrolment of students, new entrants, graduates in various levels of education, educational personnel, class size, educational finance, and other aspects of education.
- Network on Labour Market, Economic and Social Outcomes of Learning (LSO): The work of the LSO Network, mainly through labour force survey data, focuses on various outcomes of education, including educational attainment; school-to-work transitions; adult learning; employment, unemployment and earnings; educational and social intergenerational mobility; and social outcomes, such as health, trust in public institutions, participation in the political process and volunteering.
- Network for the Collection and Adjudication of System-Level Descriptive Information on Educational Structures, Policies and Practices (NESLI): The Network for the collection and adjudication of system-level descriptive information on educational systems, policies and practices develops indicators for collection of system-level data.

The place of VET in national skills systems

The issue

Data on participation in VET shed light on the position of VET within national skills systems. In many countries in continental Europe, Latin America and Asia, VET is one of the options at upper secondary level (ISCED level 3). By contrast, in some other countries (e.g. Canada, United States), upper secondary education is predominantly general (though students may choose vocational courses usually as a small part of the curriculum) and VET is mostly offered at postsecondary level. This means that preparation for the same occupation might be offered at a different level of education in different countries. For example, electricians are trained in upper secondary level apprenticeships in Switzerland with off-the-job training delivered in vocational schools (SDBB, 2023^[2]), while in Canada a common route to becoming an electrician includes a one-year postsecondary certificate programme followed by an apprenticeship or a two or three-year college programme (OCAS, 2023^[3]). In many countries, provision is developed at both upper secondary and higher levels. Vocational postsecondary and professional tertiary programmes (mostly at ISCED levels 5 and 6, but also some at level 7) offer avenues of progression for graduates of the upper secondary VET system, as well as serving general upper secondary graduates (OECD, 2022^[4]). Data on participation also help gauge the size of the VET system at a given level of education and across different levels. Entrance and enrolment rates in VET and their evolution over time, are also viewed sometimes as indicators of the attractiveness of VET systems (Cedefop, 2014^[5]) – although it is important to keep in mind how decisions about vocational or general enrolment are made (see below).

Existing comparative data

The UOE data collection provides data on entrants, enrolment (i.e. current students) and graduates by ISCED level and programme orientation. The three measures provide a different picture and need to be interpreted differently. While entrants and graduates measure the number of students at the start and at

the end of programmes, enrolment data provide a different picture as they are shaped also by the duration of programmes.

Data are available for all countries, where vocational programmes exist at those levels, for all three levels targeted by the PISA-VET Assessment (ISCED 3, 4 and 5). Data can be broken down by a range of variables, such as gender, age, field of study, part-time or full-time mode of study. Complementing the picture, data are available on the highest qualification held by individuals in the workforce through the LSO data collection (with various breakdowns, such as gender, age and outcomes).

Pathways into and from VET

The issue

The educational pathways that lead to vocational programmes and the mechanisms for selection and/or self-selection vary greatly across countries. In some systems (e.g. Austria, Germany, Switzerland) tracking occurs at the entry to lower-secondary education, based on academic achievement. In most OECD countries, differentiation occurs at upper secondary level, based on different mixes of choice, selection and self-selection. In a few OECD countries (e.g. Canada, United States), upper secondary education is predominantly general, with vocational programmes being one of the postsecondary or tertiary options on offer. In Australia upper secondary level vocational programmes serve mostly young adults who have already left the school system, rather than being one of the routes within initial schooling.

The opportunities for higher level studies open to VET graduates and the extent to which they are pursued also vary considerably between countries (and sometimes within between different vocational tracks within a country). Some vocational programmes have a strong emphasis on preparation for higher level studies, sometimes connected to the field of study targeted by VET (e.g. progression from one of the vocational tracks in Netherlands to universities of applied sciences). By contrast, in some countries, progression from upper secondary VET to higher levels is a mere theoretical option, with few people choosing to pursue higher levels of education and many falling by the wayside. Finally, some vocational programmes do not allow graduates to enter higher level programmes directly, although there are typically bridging programmes that allow for such progression.

Existing comparative data

Various data sources are available on different aspects on the routes that lead into vocational programmes and progression opportunities after VET. These include:

- **Stratification and selection into VET:** ISCED mappings provide data on the age of first selection. Qualitative data on the transition to upper secondary education and pathways from upper secondary VET to higher levels were collected in the context of the INES ad-hoc survey of upper secondary completion rates (2020 and 2023 cycles).
- **Completion:** Data on completion rates are collected through cyclical INES ad-hoc surveys at upper secondary and tertiary level, separately identifying ISCED 5 programmes (which are predominantly vocational). Completion rates measure the percentage of new entrants to a specific level of education who complete their programme (in these surveys reporting completion within the theoretical duration of the programme and within theoretical duration plus two years).
- **Transitions to higher levels of education:** ISCED mappings describe higher level programmes to which each programme provides direct access. This allows to identify potential entry routes into vocational programmes, as well as pathways from vocational upper secondary programmes to bridging programmes, postsecondary and tertiary education. In addition, data are collected on an annual basis on the share of students in upper secondary vocational education who pursue programmes that provide direct access to tertiary education. On the use of progression pathways,

several data sources are available. The LSO data collection yields data on the highest qualification held by current tertiary students. The cyclical INES ad-hoc survey on tertiary completion rates collects data on the orientation of the upper secondary qualification held by first-time entrants to tertiary education, as well as data on the share of students who took at least a gap year between these two levels. Finally, the 2023 INES ad-hoc survey on upper secondary completion rates collected data on the education programmes pursued by VET graduates one year after graduation.

Profile of VET participants

The issue

Data on the profile of learners (and graduates) provide a picture of the population served by vocational programmes. Data on gender and socio-economic background are useful to identify challenges related to equity and measure changes over time. The age of participants signals the target population (and different mixes of profiles) served by vocational programmes – teenagers, young people with some labour market experience or older adults. Even within a specific level of education, there may be much variation across countries in the average age of participants (e.g. the average age of first-time upper secondary VET graduates is 18 in Korea and 29 in Ireland (OECD, 2022^[6])). The profile of learners may also evolve over time – in Germany for example, the average age of apprentices has been increasing since 1993, as upper secondary vocational programmes increasingly enrol learners who already hold an upper secondary qualification (BIBB, 2021^[7]).

Data on other aspects of the profile of learners are also important in terms of equity, in particular on socio-economic background and gender. Effective VET systems need to offer high-quality learning options to students from all backgrounds and avoid being a vehicle for segregation in education and training. In many countries, enrolment in VET is influenced by academic achievement, which in turn is correlated with socio-economic background (OECD, 2016^[8]). The challenge is to ensure that learners enrol in VET because it suits their interests and abilities, and not because of their personal circumstances, which they cannot influence (OECD, 2016^[9]). Similarly, VET systems need to offer equal opportunities to men and women. Gender imbalances in particular fields or types of programmes, for example, can raise equity issues – in an apprenticeship system dominated by the construction sector, the benefits yielded by apprenticeships fall disproportionately on men. Policies typically aim to address this in two ways: widening the coverage of programmes (e.g. expanding apprenticeships into traditionally female occupations) and encouraging entry into non-traditional occupations (e.g. encouraging women to train as electricians).

Existing comparative data

Various regular data collections (UOE, LSO) provide comparative data that can be broken down by age and gender. These include data on entrants, currently enrolled students and graduates in educational programmes at various levels. It is possible to identify, for example the average age of participants or graduates, the share of learners above a particular age etc. Figure 9.1, for example, shows the average age of learners in upper secondary, post-secondary non-tertiary vocational programmes, as well as in short-cycle tertiary education, illustrating the different functions of vocational programmes across different countries. Additional breakdowns are also available, such as gender by field of study, which is relevant in the context of VET. Comparative data on the socio-economic background of VET learners are patchy. The system-level questionnaire will seek to fill this gap.

Figure 9.1. Average age of learners in vocational programmes, by level of education

In years

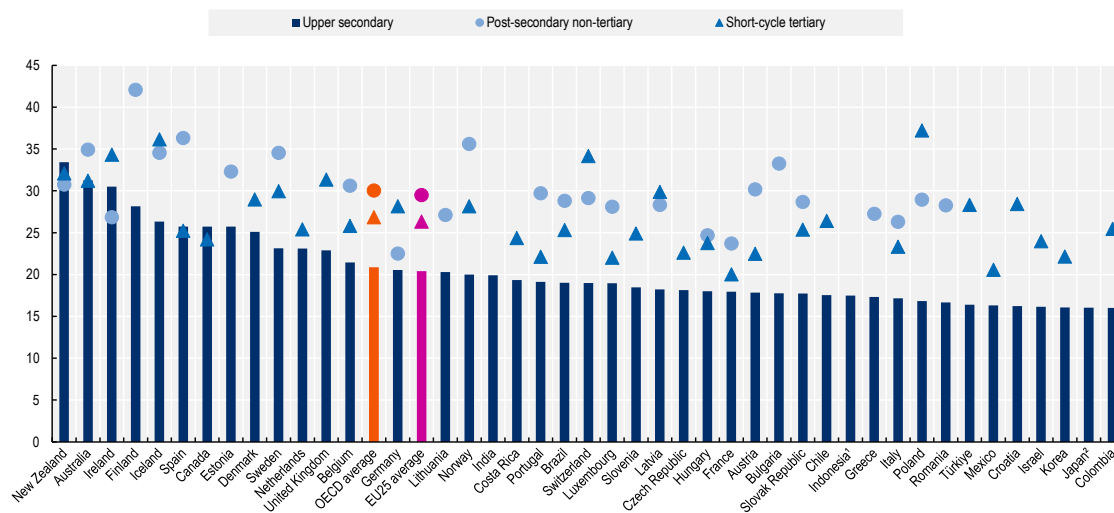

Source: OECD (2023_[10]) Figure B1.3

The delivery of VET

The issue

Vocational programmes may be delivered in various types of VET institutions (such as schools, colleges, or technical institutes) and workplaces (e.g. in the context of apprenticeships or internships).

How institutions that deliver vocational programmes are organised is an important part of the national context. In some countries a range of provider types exist, in others one type of institution delivers programmes at a specific level (OECD, 2022_[11]). The function of institutions also varies, as some are specialised institutions focusing on vocational programmes only (including sometimes a focus on a specific field of study) while others deliver both general and vocational programmes.

How much and in what ways work-based learning is used also varies considerably across countries. Strong VET systems need to exploit the many benefits of work-based learning – using workplaces as a learning environment for the acquisition of both soft and hard skills, motivating learners to learn by helping them connect what is taught at the VET institution to real work contexts and saving on costly equipment in workshops of VET institutions. The extensive use of work-based learning can also help relieve teacher shortages, while the availability of work placements sends a signal of employer needs in an occupation, helping to shape the mix of provision.

In addition, some specific venues are also used in some countries, such as inter-company training centres and replicates of workplaces. Inter-company training centres managed by employers typically involve classroom-like settings for theoretical instruction and/or workshops for the development of practical skills. They typically complement school-based and work-based learning. Replicates of real workplaces in VET institutions allow learners to reap some but not all the benefits of work-based learning. For example, in a restaurant run by a catering school, students cook and serve real customers, though they may not face the same pressures and expectations as in regular restaurants and they do not gain useful connections with potential employers.

Existing comparative data

Currently data are available on whether institutions are public or private, including indicators of participation within different types of institution. Data are also regularly collected on the share of part-time and full-time students. Additional questions in the system-level questionnaire will provide further information on the institutions that provide vocational programmes (e.g. types of provider institutions, whether they deliver general programmes or vocational programmes in different fields).

Information is collected on an annual basis on the share of VET learners in combined school- and work-based programmes (i.e. those involving work-based learning that accounts for 25-90% of programme duration). Data are available for upper secondary VET programmes in most countries – Figure 9.2 shows how the use of work-based learning varies across countries. Additional information on the type of work-based learning within different vocational programmes is collected since 2022 through ISCED mappings (distinguishing between apprenticeships, long internships, short internships, optional work-based learning, or none).

Figure 9.2. Share of upper secondary vocational learners in combined school and work-based programmes (2021)

In per cent

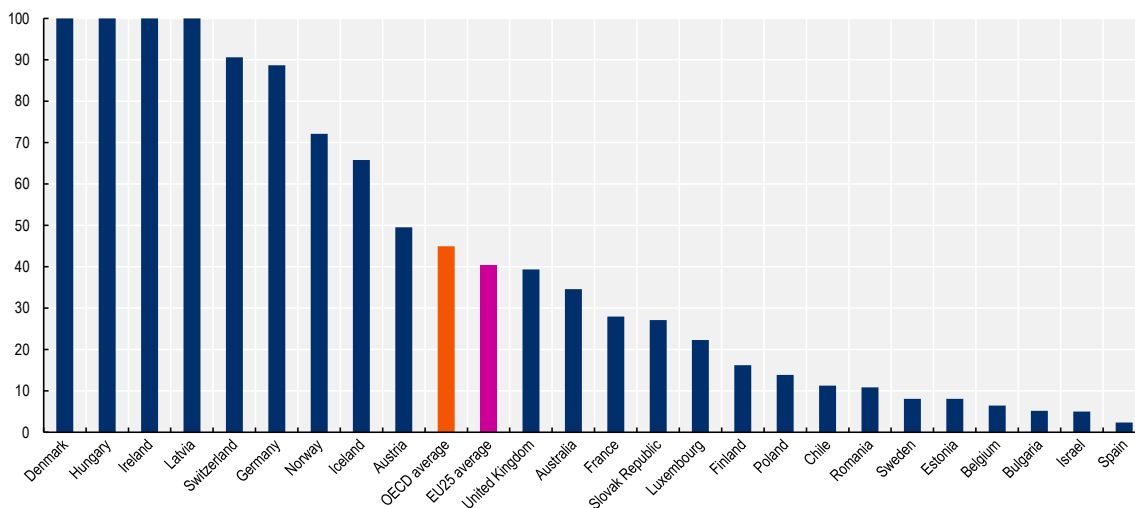

Note: Combined school- and work-based programmes involve work-based learning that accounts for 25-90% of programme duration.

Source: OECD (2023_[10]) Figure B1.5

Skills targeted by VET

The issue

There is much variation across countries in the mix of skills targeted by VET. Some VET systems remain dominated by traditional trades and crafts, often in construction and manufacturing, while others have successfully expanded into non-traditional areas, such as banking or ICT. While the PISA-VET Assessment will directly assess occupational skills in a selected set of occupations, data on fields of study targeted by VET can help situate the targeted programmes in a broader context.

The employability skills measured by the PISA-VET Assessment include literacy as one of the core generic skills needed by VET graduates (see Chapter 7). General skills like literacy, numeracy and digital skills are

crucial in allowing transitions into tertiary education and more broadly, supporting lifelong learning. There is increasing awareness among policy makers, in the context of the green and digital transition driving greater need for worker reskilling and upskilling, that vocational programmes must prepare not just for a first job, but also for further learning. Yet too many people leave the education system, including VET programmes, with weak general skills. Measuring to what extent vocational programmes target general knowledge and skills (or general subjects, like mathematics more broadly) is important to gauge the attention to general vs. vocational skills across countries and programmes. In practice, all vocational programmes contain a mix of general and vocational content, but in varying proportions. Some programmes put strong emphasis on general skills – typically those that prepare graduates for entering tertiary level programmes (e.g. universities of applied sciences). Others have strong focus on occupational skills and include a small element of general education. The attention dedicated to general subjects also depends on the education background of the target population. Some programmes serve partly or predominantly learners who already hold an upper secondary qualification (often a general qualification). Information on the time dedicated to general subjects should therefore be interpreted together with data on other features of the VET system, including the profile of participants.

Existing comparative data

Data are available on graduates by field of study, although the breakdowns include relatively broad categories (1 or sometimes 2-digit ISCED-F categories). Further details are not collected on the content of vocational programmes (e.g. balance between general and vocational content), so this issue will be addressed in the system-level questionnaire for the PISA-VET Assessment.

Teachers and trainers

The issue

As in general education, the quality of the teacher and trainer workforce is critical to effective learning in vocational programmes. Many countries are facing a wave of retirements among teachers or expect have one soon. Recruiting new teachers is often hard, as schools/colleges struggle to compete with salaries in the private sector. The challenge is particularly great in occupations where skilled workers (and therefore potential teachers) are in high demand and therefore offer the best career prospects. The second challenge is to ensure that VET teachers have a combination of up-to-date technical skills and pedagogical skills. Full-time teachers in VET institutions often lack industry experience and opportunities to update their technical skills, while those recruited from industry often lack pedagogical skills. In the workplace, trainers who supervise VET learners play a key role. When a substantial part of the programme is delivered in a workplace (e.g. apprenticeships), the learning experience at work is crucial and several countries offer mandatory or optional targeted training for trainers (OECD, 2022_[12]).

The challenges of adequate supply and quality are interrelated, with policies often having implications for both. For example, strict pedagogical requirements designed to ensure quality can discourage entrants into the teacher profession (OECD, 2022_[12]). To avoid this, some countries offer flexible ways of acquiring pedagogical skills.

Existing comparative data

Data on teachers are regularly collected through the UOE data collection, including breakdowns by age and gender. In addition, the NESLI data collection provides data on different types of teachers in vocational programmes (focusing on upper secondary education). Data on the profile of teachers (e.g. age distribution) provide information on the supply of teachers and extent of the recruitment challenge across countries. Data on qualification requirements for different types of teachers can shed light on how countries use entry and continuing professional development requirements to ensure the right competences among

teachers. In addition, in the 2024 cycle of TALIS eight countries will survey teachers and school leaders in upper secondary schools, covering also vocational programmes. Further information is available from Cedefop in 29 thematic perspective reports from European Union member states, plus Iceland and Norway regarding VET teachers and trainers (Cedefop, 2023^[13]). To fill gaps, the PISA-VET Assessment's system-level questionnaire will include questions on teacher qualification requirements aligned with the NESLI data collection. Additional questions will explore requirements and training opportunities for in-company trainers, which are currently not covered by most of the international data collections. When the TALIS 2024 questionnaires are finalised, the system-level questionnaire may be updated to exploit synergies with TALIS.

Finance

The issue

As for all education and training programmes, financial resources are key in steering the system. Financial resources can encourage institutions to offer some programmes rather than others and steer the number of places offered in each occupation. This is essential to ensure the mix of provision is responsive to labour market needs. Funding arrangements need to consider the targeted field of study, recognising that some programmes are cheaper to deliver than others – one challenge is that the high costs of starting new programmes (e.g. new equipment, staff recruitment) encourages the continuation of existing programmes and discourages the introduction of new programmes. Financial tools are also commonly used to encourage employers to offer work-based learning – for example in the form of tax breaks to training companies and subsidies to employers to take on an apprentice.

Comparative data can shed light on how much and in what ways governments, households and employers invest in VET. This can help compare the cost-effectiveness of different VET systems and approaches to delivery. For example, the effective use of work-based learning can reduce the costs of delivering programmes at the same time as promoting quality. When students can learn practice-oriented skills on equipment available in workplaces, school workshops typically need to provide only basic equipment to develop basic practice-oriented skills. Various financial flows between the public budget, employers and individuals are specific to VET – such as subsidies to employers that offer apprenticeships, or employer funded training levies. Data on transfer schemes and number of transfers are essential to enable meaningful international comparisons of expenditure.

Existing comparative data

The UOE data collection on education finance is built around three dimensions: sources of funds, the location where spending occurs and the type of expenditure. First, sources of funds include the public sector, international agencies, and private entities (households and other private entities, such as companies). Second, the location of service providers refers to the location where spending occurs. Spending on educational institutions includes spending on schools and universities, as well as non-teaching institutions (e.g. education ministries). Spending outside education institutions includes purchased books, computers, fees for private tutoring and student living costs. The third dimension refers to type of expenditure. Goods and services purchased include expenditure on educational core goods and services directly related to instruction and education (e.g. teachers, teaching materials, building maintenance, administration). Peripheral goods and services include ancillary services (e.g. meals, transport), and R&D. This dimension also breaks down current and capital expenditure and identifies financial transfers between the public and private sectors and between different levels of government within the public sector.

Available indicators include, for example, expenditure per full-time equivalent student in vocational vs. general upper secondary education, expenditure on staff per full-time equivalent student, or the share of

expenditure on upper secondary VET institutions coming from households. Data are also available on various measures of expenditure as a percentage of GDP. In addition, information is available on transfers, including a qualitative data collection conducted in 2023 designed to improve information on financial flows in the context of VET (e.g. subsidies to companies that provide work-based learning). These are not yet published but will be included in the system-level data used for the PISA-VET Assessment.

Outcomes

The issue

Measures of different outcomes (including economic and social outcomes, as well as direct measures of skills) associated with vocational programmes, in comparison with other educational options, provide a key indicator of the effectiveness of VET. It is particularly useful to analyse data by various features of VET programmes (e.g. field-of-study, use of work-based learning) to explore which features are associated with the best outcomes. When interpreting data, it is also important to keep in mind the pathways that lead to vocational programmes and those pursued afterwards. For example, a vocational programme may enrol primarily graduates of general upper secondary education and focus on occupational skills, so the literacy and numeracy skills of graduates will reflect to a large extent their learning outcomes from general upper secondary education. Similarly, if a vocational programme leads primarily to higher level studies (e.g. higher vocational programmes or universities of applied sciences), looking simply at the economic and social outcomes and skills of those holding VET as their highest qualification will provide only a partial picture of the effectiveness of the programme (as in those cases many VET graduates may have moved on to and completed tertiary education and are therefore not part of the group of individuals holding a VET qualification as their highest qualification).

Existing comparative data

Data on economic and social outcomes are regularly collected through the LSO data collection, which allow to compare outcomes from VET with those associated with lower and higher levels of education, as well as general programmes. Economic outcomes systematically include employment, unemployment, and inactivity rates, as well as earnings. Breakdowns are available by age group and transition from school to work receives particular emphasis. In addition, data are available for European countries (through the European Labour Force Survey) on outcomes from VET depending on whether a person participated in some form of work-based learning during their last educational programme. In addition, the Survey of Adult Skills (PIAAC) collects data on literacy, numeracy, and problem-solving skills. Currently available data focus on the highest qualification of individuals, but soon data will be available on the second highest or upper secondary level qualification of individuals in PIAAC and the European Labour Force Survey respectively.

Proposals for additional questions

To complement the available data described above, the PISA-VET Assessment will include a dedicated system-level questionnaire for countries to complete to fill the most important data gaps.

As general guidance, respondents will be asked the following:

- If the response varies across programme types (e.g. different for 3-year programmes and 4 year-programmes at the same level) or across specific programmes/occupational areas (e.g. different for automotive technicians and for hotel receptionists), please provide separate responses as appropriate.
- Please provide additional details in comments, if needed.

Choice and selection in VET

1. For upper secondary programmes, which factors constrain student choices of the type of programme?¹

This question only applies to upper secondary programmes. It focuses on factors that constrain student choice regarding the type of upper secondary programme to be pursued – for example factors that determine, in addition to student choice, whether a student will pursue general or vocational upper secondary education, or whether they will pursue a 3-year vocational programme rather than a 2-year vocational programme.

Please select all that apply.

- External examination (e.g. admission into certain upper secondary programmes requires passing an external examination or depends on results obtained at an external examination.)
- School performance (e.g. entering programme A requires better grades in maths, while students with weaker grades may enter programme B – either because of a competitive admission system or because minimum thresholds beyond passing grades are set for certain programmes.)
- Teacher / education institution recommendation
- Type of lower secondary programme pursued (e.g. systems with early selection, when certain types of lower secondary programmes yield access only to vocational programmes)
- Subject choices at lower secondary level (e.g. certain upper secondary programmes require the completion of the subject "higher mathematics" at lower levels)
- For vocational programmes: availability of work-based learning (e.g. students who have not secured an apprenticeship contract with an employer cannot start a particular vocational programme and may need to pursue another type of programme)
- Other (please specify below)
- None

2. Which factors constrain student choices of the specific programme (focused on a given field of study or occupation)?

This question focuses on factors that are considered, beyond the choice of students, regarding the field of study or occupation targeted by the vocational programme.

Please select all that apply.

- External examination (e.g. admission into certain upper secondary programmes requires passing an external examination or depends on results obtained at an external examination.)
- School performance in specific subject areas (e.g. certain level of maths required for entry into a programme for electricians)
- Teacher / school recommendation
- Type of lower secondary programme pursued (e.g. systems with early selection, when certain types of lower secondary programmes yield access only to certain types of vocational programmes)
- Subject choices at lower secondary level (e.g. certain upper secondary programmes require the completion of specific subjects at lower levels)
- Availability of work-based learning (e.g. need to secure an apprenticeship contract prior to enrolment)
- Other indicators of labour market relevance (e.g. skills forecasts)
- Other (please specify below)

3. **Are there any incentives designed to guide student choice towards certain occupations? Please describe relevant initiatives.**

The profile of VET learners

4. **Socio-economic background of VET vs. general education learners**

Please provide data on the characteristics of VET vs. general education learners enrolled at <Level targeted by assessment>:

- % of students with at least one tertiary-educated parent
- % of foreign-born students
- % of students with two foreign-born parents
- % of students whose mother tongue is different from the language of instruction
- Other (relevant to country context)

The delivery of VET

5. **Where are programmes at <Level targeted by assessment> typically delivered?**

Please indicate the share of programme duration delivered in each type of setting (shares need to sum up to 100).

- School-based or college-based learning (.... %)
- Work-based learning (.... %)
- Inter-company training centres (.... %)
- Other (please specify) (.... %)

School-based or college-based learning includes learning in classrooms as well as practical training spaces, such as workshops, in schools, colleges or similar types of VET institutions.

Work-based learning refers to some combination of observing, undertaking, and reflecting on productive work in real workplaces. This excludes simulated work environments, such as school workshops or practice companies.

Inter-company training centres exist in some countries. They are owned collectively by employers (e.g. a sectoral organisation) and typically involve classroom-like settings for theoretical instruction and/or workshops for the development of practical skills.

6. **Which types of institutions provide vocational programmes at <Level targeted by assessment> in your country?**

Please describe all institution types.

Table 9.1. Types of institutions

Institution type	Share of students enrolled	Delivery of general programmes	Delivery of vocational programmes in multiple broad fields	Delivery of vocational programme at multiple ISCED levels
	...%	Yes / Often / Rarely / No	Yes / Often / Rarely / No	Yes / Often / Rarely / No
	...%	Yes / Often / Rarely / No	Yes / Often / Rarely / No	Yes / Often / Rarely / No
	...%	Yes / Often / Rarely / No	Yes / Often / Rarely / No	Yes / Often / Rarely / No

For each institution type, please specify:

- % of students enrolled (i.e. VET students enrolled in this institution type / total number of students enrolled in vocational programmes at this level)
- If this institution type also delivers general programmes at the same level
- If this institution type delivers vocational programmes within one broad field or targets multiple broad fields. Broad fields of study are understood here as 2-digit categories in the [ISCED-F framework](#).
- If this institution type delivers vocational programmes at multiple levels. If the answer is “yes” or “often,” please specify which ISCED levels are typically covered.

Skills targeted by VET

7. Please describe at which level the learning outcomes targeted by a specific programme (e.g. electricians at <Level targeted by assessment>) are determined in your country.

- National level
- Sub-national level (please specify:)
- A combination of national and sub-national level (please provide additional details)

Sub-national level may refer to regional or local level, groups of providers, or individual providers. If a combination of national and sub-national level applies, please specify details (e.g. providers can adapt 20% of the curriculum to local needs).

8. What the share of instruction time within VET institution-based settings is dedicated to general subjects?

- <25%
- 25-49%
- 50-75%
- >75%

Distinguishing between general and vocational subjects:

- *General subjects are not specific to a particular profession or field and may be the same as those taught in general programmes. Examples include mathematics, language, history, chemistry, or physics.*
- *Vocational subjects focus on developing knowledge and skills that are specific to a particular profession or field. Examples include sales techniques or electronics.*
- *General subjects with an explicit vocational focus (e.g. physics specifically designed for electricians) should be counted as half vocational and half general (e.g. if 10% of instruction time is dedicated to physics for electricians, 5% should be included in instruction time dedicated to general subjects and 5% in instruction time dedicated to vocational subjects).*

Teachers and trainers

9. What are the qualification requirements for teachers in VET in your country?²

Please specify the minimum level of qualification to be a fully qualified VET teacher, as relevant:

- Level and type of formal education required
- Relevant work experience (outside teaching), if appropriate (e.g. industry experience)
- Other (please specify).

Please distinguish between different categories of teachers as appropriate in your country context: Teachers of general subjects in VET programmes; Teachers of vocational theory only; Teachers of vocational practice only; Teachers of vocational theory and practice. If there are various pathways to the teaching profession with different minimum requirements, please refer to the main pathway (or select two major pathways and describe them separately).

The **minimum level of qualification** of teachers refers to the requirements to become a fully qualified teacher (i.e. formal qualifications and attainment level, specific training or practical experience, competitive examinations, the successful completion of a probation period or induction programmes). For any of these characteristics to be considered as part of this level of qualification of teachers, they must be part of the core requirements to practice the teaching profession, and mandatory for all teachers (for example, competitive examinations or professional development activities that apply to all teachers without exception). Please describe pedagogical and occupational/field-specific requirements of applicable.

Fully qualified teacher means that a teacher has fulfilled all the training requirements for teaching (a certain subject) and meets all other administrative requirements according to the formal policy in a country.

For the purposes of this data collection, the category of VET teachers excludes in-company trainers responsible for work-based learning in VET.

10. What requirements must companies satisfy to provide work-based learning to students as part of a vocational programme?

Please specify requirements, which may include for example relevant vocational qualifications of staff in the company (in particular in-company trainers), the establishment of a training plan with clearly defined learning outcomes, and any other requirements regarding the company.

11. What types of “training the trainers” initiatives are available to in-company trainers in your country in the context of work-based learning for VET students?

In-company trainers are individuals within companies who are responsible for training vocational students during the work-based learning part of the programme.

- Mandatory training and/or qualification (e.g. mandatory training in pedagogical skills). (Please specify duration)
- Optional training. (Please specify duration)
- No targeted training available.

Governance

12. Which ministries are responsible for VET at <Level targeted by assessment>?

Please describe which ministries (and dedicated agencies, if relevant) take responsibility for VET (and for which aspects/parts).

13. How are social partners engaged in VET at <Level targeted by assessment>?

Please describe how social partners are involved in the design and delivery of VET in your country and their particular role. You may describe involvement at national, regional, sectoral, local, and institutional level separately, as appropriate.

References

- BIBB (2021), *Datenreport zum Berufsbildungsbericht 2021*, Bundesinstitut für Berufsbildung, Bonn, <https://www.bibb.de/dokumente/pdf/bibb-datenreport-2021.pdf> (accessed on 6 January 2022). [7]
- Cedefop (2023), *Teachers and trainers in a changing world*, <https://www.cedefop.europa.eu/en/country-reports/teachers-and-trainers-in-a-changing-world> (accessed on 13 July 2023). [13]
- Cedefop (2014), “Attractiveness of initial vocational education and training: identifying what matters”, *Research Paper*, No. 39, European Centre for the Development of Vocational Training, Luxembourg, https://www.cedefop.europa.eu/files/5539_en.pdf. [5]
- OCAS (2023), *Electrician / Electrical - Ontario Colleges*, <https://www.ontariocolleges.ca/en/programs/professions-and-trades/electrician-electrical> (accessed on 3 May 2023). [3]
- OECD (2023), *Education at a Glance 2023: OECD Indicators*, OECD Publishing, Paris, <https://doi.org/10.1787/e13bef63-en>. [10]
- OECD (2022), *Education at a Glance 2022: OECD Indicators*, OECD Publishing, Paris. [6]
- OECD (2022), *Pathways to Professions: Understanding Higher Vocational and Professional Tertiary Education Systems*, OECD Publishing, Paris. [4]
- OECD (2022), *Preparing Vocational Teachers and Trainers: Case Studies on Entry Requirements and Initial Training*, OECD Reviews of Vocational Education and Training, OECD Publishing, Paris, <https://doi.org/10.1787/c44f2715-en>. [12]
- OECD (2022), *The Landscape of Providers of Vocational Education and Training*, OECD Reviews of Vocational Education and Training, OECD Publishing, Paris, <https://www.oecd.org/publications/the-landscape-of-providers-of-vocational-education-and-training-a3641ff3-en.htm>. [11]
- OECD (2019), *PISA 2018 Results (Volume II): Where All Students Can Succeed*, OECD, <https://doi.org/10.1787/b5fd1b8f-en>. [1]
- OECD (2016), *PISA 2015 Results (Volume I): Excellence and Equity in Education*, PISA, OECD Publishing, Paris, <https://doi.org/10.1787/9789264266490-en>. [8]
- OECD (2016), *PISA 2015 Results (Volume II): Policies and Practices for Successful Schools*, PISA, OECD Publishing, Paris, <https://doi.org/10.1787/9789264267510-en>. [9]
- SDBB (2023), *Berufsberatung*, <https://www.berufsberatung.ch/> (accessed on 3 May 2023). [2]

Notes

¹ Question aligned with 2023 INES survey on upper secondary completion rates.

² Question aligned with relevant NESLI data collection. Answers may be pre-filled if data are available through NESLI, which focuses on ISCED 3).

Annex A. Glossary

This glossary provides definitions of the main concepts used in this framework document. They are substantively compatible with the glossaries of UNESCO and the EU (Cedefop):

- [Glossary | CEDEFOP \(europa.eu\)](#)
- <https://unevoc.unesco.org/home/TVETipedia+Glossary/lang=en/show=char/char=C#start>

Competency and competencies

Each of these two terms refer to the ability to do something.

A **competency** is more than just knowledge and skills. It involves the ability to meet complex demands, by drawing on and mobilising psychosocial resources in a particular context. For example, the ability to communicate effectively is a competency that may draw on an individual's knowledge of language, practical IT skills and understanding of those with whom he or she is communicating. <https://www.oecd.org/pisa/definition-selection-key-competencies-summary.pdf>.

Competencies are the plural of competency and are the combination of abilities, knowledge and skills that may be occupation specific, non-occupation specific, professional or transversal.

Educational institutions

Educational institutions are defined as entities that provide either core or peripheral educational goods and services to individuals and other educational institutions.

Knowledge and content knowledge

Knowledge includes theoretical concepts and ideas related to a domain in addition to practical understanding based on the experience of having performed certain tasks in the domain. The OECD Learning Compass 2030 recognises four types of knowledge: disciplinary, interdisciplinary, epistemic & procedural, <https://www.oecd.org/education/2030-project/teaching-and-learning/learning/knowledge/>:

- Disciplinary knowledge (or content knowledge) includes subject-specific concepts and detailed content, such as that learned in the study of business and administration, for example.
- Interdisciplinary knowledge involves relating the concepts and content of one discipline/subject to the concepts and content of other disciplines/subjects.
- Epistemic knowledge is the understanding of how expert practitioners of disciplines work and think. This knowledge helps students find the purpose of learning, understand the application of learning and extend their disciplinary knowledge.
- Procedural knowledge is the understanding of how something is done, the series of steps or actions taken to accomplish a goal. Some procedural knowledge is domain-specific, some is transferable across domains. The OECD Learning Compass 2030 highlights transferable procedural

knowledge, which is knowledge that students can use across different contexts and situations to identify solutions to problems.

Learning outcomes

Learning outcomes are statements of what a learner knows, understands and is able to do on completion of a learning process, defined in terms of knowledge, skills and competences. Education and training institutions can describe their qualifications in terms of learning outcomes.

Occupational areas

An occupational area refers to one or a group of related occupations in the labour market. These occupational areas can be linked to fields of study and qualifications. For example, the occupational area “electricians” includes a broad range of specialised electrician occupations. Various VET programmes within the broad field of “engineering, manufacturing and construction” can prepare students for work in this occupational area.

Occupation-specific competencies

Skills and knowledge that are specific to the occupation or occupational area that the education and training programme prepares for. These occupation-specific competencies can be practice-oriented competencies and employability skills (see below).

Professional competencies

Are occupation-specific and transversal competencies (see below) that include:

Practice-oriented professional competencies: Practice-oriented knowledge and skills refer to applied competences needed to carry out certain professional tasks. They are also referred to as technical competencies.

Employability skills: Skills related to an individual’s ability to function in a professional setting are referred to as employability skills. Most of these skills are transversal skills, but they may have an occupation-specific element reflecting the different working environments and tasks of occupations (e.g. communicating with patients in health-related occupations is different from communicating with clients in sales-related occupations).

School-based VET programmes

In school-based VET programmes instruction takes place predominantly in educational institutions. These include training centres for vocational education run by public or private entities (e.g. schools, colleges, technical institutes). These programmes can have a small on-the-job training component, i.e. a component of some practical experience at the workplace, but this does not exceed 25% of the curriculum (covering the whole educational programme).

Social partners

Social partners are representatives of employers and workers, usually employer organisations and trade unions.

Transversal competencies

Transversal competencies are those knowledge areas and skills that are not specific to one particular occupation or occupational area but can be applied across many different types of occupations. They include cognitive competences (e.g. problem solving, critical and creative thinking, ICT literacy, numeracy) and socio-emotional competences (e.g. perseverance, communication and collaboration skills). Many of these transversal competencies can be considered employability skills, as they are often crucial for individuals to function in a professional environment.

Underlying or fundamental capabilities

Underlying or fundamental capabilities are the set of domain specific capabilities that underpins each of the processes included in the framework. These include the ability to execute a specified course of action or to achieve certain outcomes related to the processes identified in the framework in each of the selected occupational areas.

Vocational education and training

Vocational education and training (VET) programmes are designed for learners to acquire the competencies specific to a particular occupation, trade, or class of occupations or trades, in addition to more general knowledge and transversal competencies. Such programmes may have work-based components (e.g. apprenticeships or dual-system education programmes). Successful completion of such programmes leads to labour market-relevant, vocational qualifications acknowledged as occupationally oriented by the relevant national authorities and/or the labour market. The PISA-VET Assessment only concerns formal VET programmes, i.e. leading to formal recognised qualifications. Moreover, the PISA-VET Assessment focuses on initial VET programmes, i.e. excluding those that are purely designed for the upskilling and reskilling of adults.

Work-based learning

VET programmes often include a work-based component, i.e. part of the curriculum is delivered in a real work environment. These programmes are classified as combined school-and-work-based programmes if less than 75% of the curriculum is presented in the school environment or through distance education. Such programmes include, for example, apprenticeships and dual VET programmes as well as “traineeships and internships” and “on-the-job training” as stated in the joint IAG leaflet “Investing in Work-Based Learning”: https://www.ilo.org/wcmsp5/groups/public/---ed_emp/---ifp_skills/documents/publication/wcms_565923.pdf.

Annex B. Contextual Questionnaires

Educational institution Questionnaire

Introduction

The wording of questions and response options is susceptible of adaptation to both country specificities and occupational areas: the symbol < > indicates that the terms within angle brackets should be adapted to national or occupational contexts. Similarly, the questionnaire used the ISCED classification to refer to educational levels. The ISCED level is indicated within <...>. The national project managers implementing the study, in collaboration with the contractors are responsible for replacing the ISCED levels with the corresponding national levels or degrees.

The final sequence of the questions should be established considering screening questions, filters, and pivots. Testing and field trial of the items in the educational institution questionnaire will lead to determine the optional sequence and question flow. The following questions and response option should be considered as preliminary and in need of further refinement to improve their effectiveness.

Sources for questions (directly drawn from, or modified from)

ETF (2022), ENESAT22-ETF Self-assessment Tool for Excellence, ENESAT 2022_EN.pdf.

OECD (2017), PISA 2015 Assessment and Analytical Framework: Science, Reading, Mathematic, Financial Literacy and Collaborative Problem Solving, PISA, OECD Publishing, Paris, <https://doi.org/10.1787/9789264281820-en>.

OECD (2019), PISA 2018 Assessment and Analytical Framework, PISA, OECD Publishing, Paris, <https://doi.org/10.1787/b25efab8-en>.

OECD (2023), PISA 2022 Assessment and Analytical Framework, PISA, OECD Publishing, Paris, <https://doi.org/10.1787/dfe0bf9c-en>.

OECD (2018), PISA for Development Assessment and Analytical Framework: Reading, Mathematics and Science, PISA, OECD Publishing, Paris, <https://doi.org/10.1787/9789264305274-en>.

PIAAC Background questionnaires, Cycle 1 and Cycle 2, [The background questionnaire of the Survey of Adult Skills \(PIAAC\)](#).

Tanggaard, L. (2005), “Collaborative teaching and learning in the workplace”, *Journal of Vocational Education & Training*, Vol. 57(1), pp. 109-122, <https://doi.org/10.1080/13636820500200278>.

Virtanen A., Tynjala, P. (2008), “Students’ Experiences of Workplace Learning in Finnish VET”, *European Journal of Vocational Training*, Vol. 44(2), pp. 200–213.

Virtanen A., Tynjala P. and Eteläpelto A. (2014), “Factors promoting vocational students’ learning at work: study on student experiences”, *Journal of Education and Work*, Vol. 27(1), pp. 43–70.

Section on educational institutions and programme characteristics.

Q1	What is the total number of students in your educational institution?
	Overall number of students
	Number of VET students

Q2	What is the average size of a <VET class> in this < VET programme>?
	15 students or fewer <input type="checkbox"/>
	16-20 students <input type="checkbox"/>
	21-25 students <input type="checkbox"/>
	26-30 students <input type="checkbox"/>
	31-35 students <input type="checkbox"/>
	36-40 students <input type="checkbox"/>
	41-45 students <input type="checkbox"/>
	46-50 students <input type="checkbox"/>
	More than 50 students <input type="checkbox"/>

Q3	Is yours a public or a private educational institution?
	A public institution (This is an educational institution managed directly or indirectly by a public education authority, government agency, or governing board appointed by government or elected by public franchise.) <input type="checkbox"/>
	A private institution (This is an educational institution managed directly or indirectly by a non-government organisation, e.g. a church, trade union, business, or other private institution.) <input type="checkbox"/>

Q4	What kind of organisation runs your educational institution?
	The government <input type="checkbox"/>
	A for-profit organization <input type="checkbox"/>
	A not-for-profit organization <input type="checkbox"/>
	A church or another religious organization <input type="checkbox"/>
	A <trade union> operated institution <input type="checkbox"/>
	<country specific> <input type="checkbox"/>

Q5	About what percentage of your total funding for a typical school year comes from the following sources?
	(Please write a number on each line. Write "0" (zero) if no funding comes from that source.)
	Government (includes departments, local, regional, state, and national) _____ %
	Student fees or school charges paid by parents/students _____
	Benefactors, donations, bequests, sponsorships, parent fundraising _____
	<Country specific> _____
	Total 100%

Q6	Which of the following definitions best describes the community in which your educational institution is located?
	A village, hamlet or rural area (fewer than 3 000 people) <input type="checkbox"/>
	A small town (3 000 to about 15 000 people) <input type="checkbox"/>
	A town (15 000 to about 100 000 people) <input type="checkbox"/>
	A city (100 000 to about 1 000 000 people) <input type="checkbox"/>
	A large city (with over 1 000 000 people) <input type="checkbox"/>
	A megacity (with over 10 000 000 people) <input type="checkbox"/>

Q7	As of <date>, what was the total <VET programmes> enrolment (number of students)?	
	Males	_____
	Females	_____
	<For countries that adopt questions on non-binary identity: students who did not identify with being male or female >	_____
	Total	_____

Q8	Which of the following levels of education does your educational institution provide? Consider all programmes provided by your educational institution, including VET. (Please select all that apply.)	
	<ISCED2>	<input type="checkbox"/>
	<ISCED 34>	<input type="checkbox"/>
	<ISCED 35>	<input type="checkbox"/>
	<ISCED 4>	<input type="checkbox"/>
	<ISCED 5>	<input type="checkbox"/>

Q9	How many <VET> fields of study (or programmes) your educational institution offers?	
	Number of fields of study (or programmes)	_____
	Number of sectors	_____

Q10	In which of the following <type of building> is your educational institution located? Please tick only one box	
	A school / college building	<input type="checkbox"/>
	A university campus	<input type="checkbox"/>
	A university building	<input type="checkbox"/>
	Rooms of a government building	<input type="checkbox"/>
	Rooms of an NGO	<input type="checkbox"/>
	A private donor's building	<input type="checkbox"/>
	Rooms of a multi-purpose building	<input type="checkbox"/>
	Rooms of a <company>	<input type="checkbox"/>
	A hospital	<input type="checkbox"/>

Q11	What is the average size of <specific type or general> classes in in your educational institution?	
	15 students or fewer	<input type="checkbox"/>
	16-20 students	<input type="checkbox"/>
	21-25 students	<input type="checkbox"/>
	26-30 students	<input type="checkbox"/>
	31-35 students	<input type="checkbox"/>
	36-40 students	<input type="checkbox"/>
	41-45 students	<input type="checkbox"/>
	46-50 students	<input type="checkbox"/>
	More than 50 students	<input type="checkbox"/>

Section on human resources, teachers, and staff

Q12	How many full-time and part-time teachers are on the staff of your educational institution? <i>(Please write a number in each space provided. Write "0" (zero) if there are none.)</i>		
	<i>A full-time teacher is employed at least 90% of the time as a teacher for the full school year. All other teachers should be considered part-time.</i>		
		Full time	Part time
	Males	_____	_____
	Females	_____	_____
	<Optional, if collected: teachers who do not identify with being male or female>	_____	_____
	Total	_____	_____

Q13	What percentage of part-time teachers at your educational institution holds a job in a relevant industry?	
	%:	_____

Q14	Over the past two years, have you faced difficulties to recruit fully qualified staff (i.e. staff complying with all qualification requirements for the given position) to the following positions?		
		Yes	No
	Teachers of general subjects	<input type="checkbox"/>	<input type="checkbox"/>
	Teachers of <vocational theory>	<input type="checkbox"/>	<input type="checkbox"/>
	Teachers of <vocational practice>	<input type="checkbox"/>	<input type="checkbox"/>

Q15	During the last month of school, how often was the <VET programme> confronted with the following issues concerning teachers and staff's behaviour?			
		Never	Once or twice	Every week
	Arriving late at school	<input type="checkbox"/>	<input type="checkbox"/>	<input type="checkbox"/>
	Absenteeism (i.e., unjustified absence)	<input type="checkbox"/>	<input type="checkbox"/>	<input type="checkbox"/>
	Unjustified cancellation of sessions	<input type="checkbox"/>	<input type="checkbox"/>	<input type="checkbox"/>
	Intimidation or verbal aggression of students	<input type="checkbox"/>	<input type="checkbox"/>	<input type="checkbox"/>
	Sexual harassment of colleagues or students	<input type="checkbox"/>	<input type="checkbox"/>	<input type="checkbox"/>
	Sexual harassment of students	<input type="checkbox"/>	<input type="checkbox"/>	<input type="checkbox"/>
	Drug or alcohol use during working hours	<input type="checkbox"/>	<input type="checkbox"/>	<input type="checkbox"/>
	Physical aggression against colleagues	<input type="checkbox"/>	<input type="checkbox"/>	<input type="checkbox"/>
	Physical aggression against students	<input type="checkbox"/>	<input type="checkbox"/>	<input type="checkbox"/>
	<Occupation or country specific>	<input type="checkbox"/>	<input type="checkbox"/>	<input type="checkbox"/>
	<Occupation or country specific>	<input type="checkbox"/>	<input type="checkbox"/>	<input type="checkbox"/>

Section on time allocation and disruptions

Q16	How many hours per year in this programme are dedicated to the following subjects? <i>If the number of hours is different in different years of the programme, please describe the average.</i>	
	<Test language>	Number of hours: _____
	Mathematics	Number of hours: _____

Q17	For approximately how many instructional days in the last 12 months your educational institution closed or deviated from the regular curriculum for the following reasons?	Number of days
	Vacations and holidays	_____
	National or local elections	_____
	Teacher conferences or professional development activities	_____
	Educational institution-based events and activities (e.g. workshops, presentations from industry partners, or <specific>)	_____
	Regional or local problems, such as weather issues (e.g. storm, heat) or hazards (e. g. epidemics, fire, floods, or landslides)	_____
	Regional or local demonstrations such as manifestations, strikes, riots, protests, or aggressive conflicts	_____
	Safety concerns related to infrastructural issues	_____
	Safety concerns related to behaviour of staff, teachers, or students in the programme or in the institution	_____
	Training <companies> and educational institution joint venues	_____
	Recruitment events	_____
	<Occupation or country specific>	_____
	<Occupation or country specific>	_____

Section on policies for inclusion and practices to support students who struggle in their programme

Q18	Which of the following measures are implemented in your educational institution to support students at risk of academic failure?	Yes	No
	Our educational institution provides <u>mandatory</u> <remedial courses> to students who perform poorly in their programme	<input type="checkbox"/>	<input type="checkbox"/>
	Our educational institution offers <u>optional</u> <remedial courses> to students who perform poorly in their programme	<input type="checkbox"/>	<input type="checkbox"/>
	Our educational institution offers professional counselling to students who feel that they struggle in the programme	<input type="checkbox"/>	<input type="checkbox"/>
	Our educational institution assigns <guide teachers> to students considered to be at risk of academic failure	<input type="checkbox"/>	<input type="checkbox"/>
	<Occupation or country specific>	<input type="checkbox"/>	<input type="checkbox"/>
	<Occupation or country specific>	<input type="checkbox"/>	<input type="checkbox"/>

Q19	How often are the following factors considered when students are admitted in a VET programme at your educational institution?	Never	Sometimes	Often
	Student record of academic performance (placement tests)	<input type="checkbox"/>	<input type="checkbox"/>	<input type="checkbox"/>
	Student's expression of interest in the VET programme (in a letter or in an interview)	<input type="checkbox"/>	<input type="checkbox"/>	<input type="checkbox"/>
	Recommendation of feeder educational institutions	<input type="checkbox"/>	<input type="checkbox"/>	<input type="checkbox"/>
	Student or family endorsement of instructional or religious philosophy of the educational institution	<input type="checkbox"/>	<input type="checkbox"/>	<input type="checkbox"/>
	Whether the student speaks the official language/s of your country>	<input type="checkbox"/>	<input type="checkbox"/>	<input type="checkbox"/>
	Whether the student requires (or is interested in) a special programme in your educational institution	<input type="checkbox"/>	<input type="checkbox"/>	<input type="checkbox"/>
	Student's geographical area of residence	<input type="checkbox"/>	<input type="checkbox"/>	<input type="checkbox"/>
	Student's disciplinary record	<input type="checkbox"/>	<input type="checkbox"/>	<input type="checkbox"/>
	Student's relevant work experience	<input type="checkbox"/>	<input type="checkbox"/>	<input type="checkbox"/>
	Student's established contract with an employer for work-based learning	<input type="checkbox"/>	<input type="checkbox"/>	<input type="checkbox"/>
	Student's parental status or pregnancy	<input type="checkbox"/>	<input type="checkbox"/>	<input type="checkbox"/>
	Student's cultural or ethnical background	<input type="checkbox"/>	<input type="checkbox"/>	<input type="checkbox"/>
	<Occupation or country specific>	<input type="checkbox"/>	<input type="checkbox"/>	<input type="checkbox"/>

Q20	Please estimate the percentage of students in your educational institution who have the following characteristics. Note that the same student can belong to more than one group.	Less than 1 %	1 to 5%	6 to 10%	10 to 20%	20 to 30%	30 % or more
		Students whose first language is different from <country official language/s >	<input type="checkbox"/>	<input type="checkbox"/>	<input type="checkbox"/>	<input type="checkbox"/>	<input type="checkbox"/>
Students from socio-economically disadvantaged homes	<input type="checkbox"/>	<input type="checkbox"/>	<input type="checkbox"/>	<input type="checkbox"/>	<input type="checkbox"/>	<input type="checkbox"/>	<input type="checkbox"/>
Students who are refugees	<input type="checkbox"/>	<input type="checkbox"/>	<input type="checkbox"/>	<input type="checkbox"/>	<input type="checkbox"/>	<input type="checkbox"/>	<input type="checkbox"/>
Students who are new immigrants (1 to 5 years since first arrival) to your country	<input type="checkbox"/>	<input type="checkbox"/>	<input type="checkbox"/>	<input type="checkbox"/>	<input type="checkbox"/>	<input type="checkbox"/>	<input type="checkbox"/>
Students who have been in <prison or correctional facilities>	<input type="checkbox"/>	<input type="checkbox"/>	<input type="checkbox"/>	<input type="checkbox"/>	<input type="checkbox"/>	<input type="checkbox"/>	<input type="checkbox"/>
Students who have children	<input type="checkbox"/>	<input type="checkbox"/>	<input type="checkbox"/>	<input type="checkbox"/>	<input type="checkbox"/>	<input type="checkbox"/>	<input type="checkbox"/>
Students who dropped out of <ISCED 2>	<input type="checkbox"/>	<input type="checkbox"/>	<input type="checkbox"/>	<input type="checkbox"/>	<input type="checkbox"/>	<input type="checkbox"/>	<input type="checkbox"/>
Students who were full-time employed in a company and decided to return education to re-skill	<input type="checkbox"/>	<input type="checkbox"/>	<input type="checkbox"/>	<input type="checkbox"/>	<input type="checkbox"/>	<input type="checkbox"/>	<input type="checkbox"/>
Students who were unemployed for more than one year and were enrolled in education to re-skills	<input type="checkbox"/>	<input type="checkbox"/>	<input type="checkbox"/>	<input type="checkbox"/>	<input type="checkbox"/>	<input type="checkbox"/>	<input type="checkbox"/>
Students with special learning needs	<input type="checkbox"/>	<input type="checkbox"/>	<input type="checkbox"/>	<input type="checkbox"/>	<input type="checkbox"/>	<input type="checkbox"/>	<input type="checkbox"/>
Students with physical disabilities	<input type="checkbox"/>	<input type="checkbox"/>	<input type="checkbox"/>	<input type="checkbox"/>	<input type="checkbox"/>	<input type="checkbox"/>	<input type="checkbox"/>
Students who pursue (or have pursued) work-based learning, with a duration of at least 25% of the duration of the programme	<input type="checkbox"/>	<input type="checkbox"/>	<input type="checkbox"/>	<input type="checkbox"/>	<input type="checkbox"/>	<input type="checkbox"/>	<input type="checkbox"/>

Section on infrastructure and on material resources

Q21	In what conditions are the following features of your educational institution? Please, tick one box in each row	No, not available	Yes, but in poor conditions	Yes, but in need of minor repairs	Yes, in good conditions
		Roof	<input type="checkbox"/>	<input type="checkbox"/>	<input type="checkbox"/>
Walls	<input type="checkbox"/>	<input type="checkbox"/>	<input type="checkbox"/>	<input type="checkbox"/>	
Floors	<input type="checkbox"/>	<input type="checkbox"/>	<input type="checkbox"/>	<input type="checkbox"/>	
Building entrances	<input type="checkbox"/>	<input type="checkbox"/>	<input type="checkbox"/>	<input type="checkbox"/>	
Doors	<input type="checkbox"/>	<input type="checkbox"/>	<input type="checkbox"/>	<input type="checkbox"/>	
Windows	<input type="checkbox"/>	<input type="checkbox"/>	<input type="checkbox"/>	<input type="checkbox"/>	
Hallways	<input type="checkbox"/>	<input type="checkbox"/>	<input type="checkbox"/>	<input type="checkbox"/>	
Classrooms	<input type="checkbox"/>	<input type="checkbox"/>	<input type="checkbox"/>	<input type="checkbox"/>	
Flush toilets	<input type="checkbox"/>	<input type="checkbox"/>	<input type="checkbox"/>	<input type="checkbox"/>	
Other types of toilets	<input type="checkbox"/>	<input type="checkbox"/>	<input type="checkbox"/>	<input type="checkbox"/>	
<Cafeteria>	<input type="checkbox"/>	<input type="checkbox"/>	<input type="checkbox"/>	<input type="checkbox"/>	
<Water fountains>	<input type="checkbox"/>	<input type="checkbox"/>	<input type="checkbox"/>	<input type="checkbox"/>	
Running water	<input type="checkbox"/>	<input type="checkbox"/>	<input type="checkbox"/>	<input type="checkbox"/>	
Electricity	<input type="checkbox"/>	<input type="checkbox"/>	<input type="checkbox"/>	<input type="checkbox"/>	
Indoor plumbing	<input type="checkbox"/>	<input type="checkbox"/>	<input type="checkbox"/>	<input type="checkbox"/>	
First aid room	<input type="checkbox"/>	<input type="checkbox"/>	<input type="checkbox"/>	<input type="checkbox"/>	
Recreational grounds	<input type="checkbox"/>	<input type="checkbox"/>	<input type="checkbox"/>	<input type="checkbox"/>	
Fence or edge	<input type="checkbox"/>	<input type="checkbox"/>	<input type="checkbox"/>	<input type="checkbox"/>	
Access ramps	<input type="checkbox"/>	<input type="checkbox"/>	<input type="checkbox"/>	<input type="checkbox"/>	

Lighting	<input type="checkbox"/>	<input type="checkbox"/>	<input type="checkbox"/>	<input type="checkbox"/>
Fans	<input type="checkbox"/>	<input type="checkbox"/>	<input type="checkbox"/>	<input type="checkbox"/>
Air conditioning or cooling system	<input type="checkbox"/>	<input type="checkbox"/>	<input type="checkbox"/>	<input type="checkbox"/>
Heating system	<input type="checkbox"/>	<input type="checkbox"/>	<input type="checkbox"/>	<input type="checkbox"/>
<occupation specific> lab	<input type="checkbox"/>	<input type="checkbox"/>	<input type="checkbox"/>	<input type="checkbox"/>
<occupation specific> lab or facility	<input type="checkbox"/>	<input type="checkbox"/>	<input type="checkbox"/>	<input type="checkbox"/>
Training rooms	<input type="checkbox"/>	<input type="checkbox"/>	<input type="checkbox"/>	<input type="checkbox"/>
Workshops	<input type="checkbox"/>	<input type="checkbox"/>	<input type="checkbox"/>	<input type="checkbox"/>
Storage rooms	<input type="checkbox"/>	<input type="checkbox"/>	<input type="checkbox"/>	<input type="checkbox"/>
<Room with power tools>	<input type="checkbox"/>	<input type="checkbox"/>	<input type="checkbox"/>	<input type="checkbox"/>
<occupation or country specific>	<input type="checkbox"/>	<input type="checkbox"/>	<input type="checkbox"/>	<input type="checkbox"/>
<occupation or country specific>	<input type="checkbox"/>	<input type="checkbox"/>	<input type="checkbox"/>	<input type="checkbox"/>
<occupation or country specific>	<input type="checkbox"/>	<input type="checkbox"/>	<input type="checkbox"/>	<input type="checkbox"/>

Section on organizational processes and on collaboration between learning venues.

Q22	The following statements present various processes and relationships that typically take place between your educational institution and the workplace. For every statement, select the option that best describes the situation in your educational institution.			
		Yes	Yes, to some degree	No
	Representatives from companies or employers are formally involved in school governance (e.g. members of education board).	<input type="checkbox"/>	<input type="checkbox"/>	<input type="checkbox"/>
	Representatives from companies or employers are consulted by the educational institution in relation to curriculum design.	<input type="checkbox"/>	<input type="checkbox"/>	<input type="checkbox"/>
	The educational institution cooperates with representatives from companies or employers to organise work placements for students.	<input type="checkbox"/>	<input type="checkbox"/>	<input type="checkbox"/>
	The educational institution cooperates with representatives from companies or employers to update its training programmes for both initial and continuing vocational training.	<input type="checkbox"/>	<input type="checkbox"/>	<input type="checkbox"/>
	Companies or employers contribute to infrastructure, equipment, or other costs of the educational institution	<input type="checkbox"/>	<input type="checkbox"/>	<input type="checkbox"/>
	The educational institution cooperates with other educational institutions to organise training for teachers in the workplace.	<input type="checkbox"/>	<input type="checkbox"/>	<input type="checkbox"/>

Q23	Where do students enrolled in your educational institution receive practical training? If there is variation among students, please describe the most common pattern.		
		[tick the box if applies to your students]	% of overall programme duration spent in setting
	Training workshop at the educational institution	<input type="checkbox"/>	_____
	Training workshop outside the educational institution owned by employers (e.g. inter-company training centre)	<input type="checkbox"/>	_____
	Training workshop outside the educational institution owned by the public sector (e.g. regional training centre)	<input type="checkbox"/>	_____
	Work-based learning in a company	<input type="checkbox"/>	_____
	Work-based learning in a practice company (e.g. restaurant owned by the educational institution; health clinic managed by the educational institution)	<input type="checkbox"/>	_____
	Other (please specify: -----)	<input type="checkbox"/>	_____

Section on pedagogical practices and teacher training

Q24	The following statements present different services or processes related to teachers' and instructors' training that may be going on in the educational institution where you work. For every statement, select the option that best describes the situation in your educational institution.		
		Yes	No
	There is a pedagogical coordinator or lead teacher in charge of professional development.	<input type="checkbox"/>	<input type="checkbox"/>
	Most teachers attended minimum one in-service training event (e.g., a seminar or workshop) in the last 12 months.	<input type="checkbox"/>	<input type="checkbox"/>
	Every year the educational institution identifies training needs for all its staff through interviews or surveys.	<input type="checkbox"/>	<input type="checkbox"/>
	The educational institution uses data from student assessment to evaluate its own performance.	<input type="checkbox"/>	<input type="checkbox"/>
	Senior managers, the principal, or a pedagogical coordinator at least once a year observe and evaluate teaching practices	<input type="checkbox"/>	<input type="checkbox"/>
	The educational institution offers in-service training events at least three times a year.	<input type="checkbox"/>	<input type="checkbox"/>
	All teachers and trainers have relevant (because of years or number of job positions) work experience obtained outside of teaching.	<input type="checkbox"/>	<input type="checkbox"/>
	Teachers regularly participate in in-service training to update their occupational skills.	<input type="checkbox"/>	<input type="checkbox"/>
	The educational institution has a budget to develop and provide in-service training.	<input type="checkbox"/>	<input type="checkbox"/>

Q25	During the last 12 months, what percentage of teaching staff in this programme has attended training for professional development?			
		Yes	To some degree	No
	All teaching staff	<input type="checkbox"/>	<input type="checkbox"/>	<input type="checkbox"/>
	Staff who teach general subjects	<input type="checkbox"/>	<input type="checkbox"/>	<input type="checkbox"/>
	Staff who teach vocational subjects	<input type="checkbox"/>	<input type="checkbox"/>	<input type="checkbox"/>

Q26	Which of the following types of professional development exists for teachers of vocational subjects in this programme?			
		Yes	To some degree	No
	Training focused on occupation-specific skills	<input type="checkbox"/>	<input type="checkbox"/>	<input type="checkbox"/>
	Placement in industry as part of in-service training	<input type="checkbox"/>	<input type="checkbox"/>	<input type="checkbox"/>
	<country or occupation specific>	<input type="checkbox"/>	<input type="checkbox"/>	<input type="checkbox"/>
	<country or occupation specific>	<input type="checkbox"/>	<input type="checkbox"/>	<input type="checkbox"/>

Section on development of skills for a green and sustainable economy.

Q27	Please, select the option that best describes the situation in your educational institution.				
		Yes, fully	Yes, to some extent	No	Addressed at national, regional, or sectoral level
	In our educational institution we have annual campaigns to reduce or carefully manage waste	<input type="checkbox"/>	<input type="checkbox"/>	<input type="checkbox"/>	<input type="checkbox"/>
	Our learning programs incorporate competencies that are relevant to making the economy sustainable	<input type="checkbox"/>	<input type="checkbox"/>	<input type="checkbox"/>	<input type="checkbox"/>
	The programmes at our educational institution address the science of climate change	<input type="checkbox"/>	<input type="checkbox"/>	<input type="checkbox"/>	<input type="checkbox"/>
	When pertinent, the teachers in our educational institution teach contents or skills in green technologies.	<input type="checkbox"/>	<input type="checkbox"/>	<input type="checkbox"/>	<input type="checkbox"/>

Section on digitalization.

Q28	Please, select the option that best describes the situation in your educational institution.	Yes, regularly	Yes, occasionally	No
	Digital and on-line instruction is used in our educational institution as a mode of teaching and learning	<input type="checkbox"/>	<input type="checkbox"/>	<input type="checkbox"/>
	Digital and on-line learning is used to train students in work-related learning situations (e.g. video simulations, business games, videos of workplace, or VR).	<input type="checkbox"/>	<input type="checkbox"/>	<input type="checkbox"/>
	The educational institution provides distance learning to its students.	<input type="checkbox"/>	<input type="checkbox"/>	<input type="checkbox"/>
	The educational institution uses Open Educational Resources.	<input type="checkbox"/>	<input type="checkbox"/>	<input type="checkbox"/>
	The educational institution ensures safety, privacy, and a responsible behaviour in its digital environments.	<input type="checkbox"/>	<input type="checkbox"/>	<input type="checkbox"/>
	Teachers and students use digital learning environments or systems for learning and assessment (e.g. Moodle or Microsoft 365).	<input type="checkbox"/>	<input type="checkbox"/>	<input type="checkbox"/>
	The educational institution follows a plan to develop its digital infrastructure that meets the needs of pedagogy, curriculum, and industrial current practices.	<input type="checkbox"/>	<input type="checkbox"/>	<input type="checkbox"/>
	The educational institution connects and collaborates digitally with other skills providers through online platforms.	<input type="checkbox"/>	<input type="checkbox"/>	<input type="checkbox"/>

Section on institutional autonomy

Q29	The following statements refer to the different degrees of autonomy that your educational institution may have in managing both internal and external processes. For every statement, select the option that best describes the situation in your educational institution.	Yes	No	Addressed at national, regional, or sectoral level
	The educational institution has an independent Board of Governors with some elected members.	<input type="checkbox"/>	<input type="checkbox"/>	<input type="checkbox"/>
	The Board of Governors includes companies' representatives.	<input type="checkbox"/>	<input type="checkbox"/>	<input type="checkbox"/>
	The educational institution defines its own mission and institutional development plan.	<input type="checkbox"/>	<input type="checkbox"/>	<input type="checkbox"/>
	The educational institution can earn and retain income.	<input type="checkbox"/>	<input type="checkbox"/>	<input type="checkbox"/>
	The educational institution can make changes to nationally defined curriculum frameworks or profiles to adapt the curriculum to local needs.	<input type="checkbox"/>	<input type="checkbox"/>	<input type="checkbox"/>
	The educational institution's Board of Governors has the authority to appoint and dismiss the <school principal>.	<input type="checkbox"/>	<input type="checkbox"/>	<input type="checkbox"/>
	The educational institution has the authority to hire or fire staff (temporary and permanent).	<input type="checkbox"/>	<input type="checkbox"/>	<input type="checkbox"/>
	The educational institution has budget autonomy.	<input type="checkbox"/>	<input type="checkbox"/>	<input type="checkbox"/>
	The educational institution has the authority to launch new programmes or terminate existing ones.	<input type="checkbox"/>	<input type="checkbox"/>	<input type="checkbox"/>

Section on student assessment

Q30	Generally, how are students assessed in occupational skills at the end of the programme or at various stages of the programme to yield results on a final assessment? Please select one response in each row. Note that <standardised tests> are consistent in design, content, administration, and scoring. Results from standardized tests can be compared across students and schools.				
		Please tick the box if applicable	Please tick the box if the test has the following feature:		
			Includes direct demonstration of practical skills (e.g. use a tool to execute a task)	Includes a written test (e.g. paper and pencil test to check theoretical content)	The assessment panel includes employer(s)
	Test standardised at national level	<input type="checkbox"/>	<input type="checkbox"/>	<input type="checkbox"/>	<input type="checkbox"/>
	Test standardised at sub-national level (e.g. different standards exist, the school may choose)	<input type="checkbox"/>	<input type="checkbox"/>	<input type="checkbox"/>	<input type="checkbox"/>
	Test developed by the educational institution or teacher	<input type="checkbox"/>	<input type="checkbox"/>	<input type="checkbox"/>	<input type="checkbox"/>

Section on tripartite social dialogue between government and companies or employer and employee representatives, and its relationships with the educational institution.

Q31	In your <country or region>, social dialogue applies to VET.	
	No	<input type="checkbox"/>
	Yes	<input type="checkbox"/>

Q32	In your educational institution, social dialogue influences the following processes:		
		Yes	No
	Decisions on which sectors are priority	<input type="checkbox"/>	<input type="checkbox"/>
	Conducting skills identification and anticipation	<input type="checkbox"/>	<input type="checkbox"/>
	Occupational standards	<input type="checkbox"/>	<input type="checkbox"/>
	Education, qualification, or assessment standards	<input type="checkbox"/>	<input type="checkbox"/>
	Continuing training for the employed	<input type="checkbox"/>	<input type="checkbox"/>
	Continuing training for the unemployed	<input type="checkbox"/>	<input type="checkbox"/>
	Youth transition to employment	<input type="checkbox"/>	<input type="checkbox"/>
	Teaching and learning	<input type="checkbox"/>	<input type="checkbox"/>
	Work-based learning	<input type="checkbox"/>	<input type="checkbox"/>
	School management	<input type="checkbox"/>	<input type="checkbox"/>

Q33	Besides national or regional agreements, does your educational institution have specific agreements with <social partners>?	
	No	<input type="checkbox"/>
	Yes - go to Q34	<input type="checkbox"/>

Q34	If yes, do the specific agreements relate to?	Yes	No
	Skills identification and anticipation for the local economy	<input type="checkbox"/>	<input type="checkbox"/>
	Teaching and learning	<input type="checkbox"/>	<input type="checkbox"/>
	School-enterprise staff exchange	<input type="checkbox"/>	<input type="checkbox"/>
	Work-based learning	<input type="checkbox"/>	<input type="checkbox"/>
	Continuing training	<input type="checkbox"/>	<input type="checkbox"/>
	School management	<input type="checkbox"/>	<input type="checkbox"/>

Thank you for your collaboration.

Student Questionnaire

Introduction

The wording of questions and response options is susceptible of adaptation to both country specificities and occupational areas: the symbol < > indicates that the terms within angle brackets should be adapted to national or occupational contexts. Similarly, the questionnaire used the ISCED classification to refer to educational levels. The ISCED level is also indicated within <...>. The national project managers implementing the study, in collaboration with the contractors are responsible for replacing the ISCED levels with the corresponding national levels or degrees.

Response options vary by questions, as students are asked to report on the frequency of different events or behaviours, on their attitudes, and on factual elements. The final sequence of the questions should be established considering screening questions, filters, and pivots. Additionally, full information on sociodemographic characteristics may be needed for the estimation of plausible values for test scores. This could affect the position of sociodemographic questions in the questionnaire.

Testing and field trial of the items in the student questionnaire will lead to determine the optional sequence and question flow. The following questions and response option should be considered as preliminary, pending further refinement to improve their effectiveness.

Sources for questions (directly drawn from, or modified from)

ETF (2022), ENESAT22-ETF Self-assessment Tool for Excellence, ENESAT 2022_EN.pdf.

OECD (2017), PISA 2015 Assessment and Analytical Framework: Science, Reading, Mathematic, Financial Literacy and Collaborative Problem Solving, PISA, OECD Publishing, Paris, <https://doi.org/10.1787/9789264281820-en>.

OECD (2019), PISA 2018 Assessment and Analytical Framework, PISA, OECD Publishing, Paris, <https://doi.org/10.1787/b25efab8-en>.

OECD (2023), PISA 2022 Assessment and Analytical Framework, PISA, OECD Publishing, Paris, <https://doi.org/10.1787/dfe0bf9c-en>.

OECD (2018), PISA for Development Assessment and Analytical Framework: Reading, Mathematics and Science, PISA, OECD Publishing, Paris, <https://doi.org/10.1787/9789264305274-en>.

PIAAC Background questionnaires, Cycle 1 and Cycle 2, [The background questionnaire of the Survey of Adult Skills \(PIAAC\)](#).

Tanggaard, L. (2005), “Collaborative teaching and learning in the workplace”, Journal of Vocational Education & Training, Vol. 57(1), pp. 109-122, <https://doi.org/10.1080/13636820500200278>.

Virtanen A., Tynjala, P. (2008), “Students’ Experiences of Workplace Learning in Finnish VET”, European Journal of Vocational Training, Vol. 44(2), pp. 200–213.

Virtanen A., Tynjala P. and Eteläpelto A. (2014), “Factors promoting vocational students’ learning at work: study on student experiences”, Journal of Education and Work, Vol. 27(1), pp. 43–70.

Section on student demographic characteristics, living arrangement and family structure, and socioeconomic status.

Q1	On what date were you born?	
	Day	_____
	Month	_____
	Year	_____

Q2	How do you identify yourself? (Please select one response option)	
	Female	<input type="checkbox"/>
	Male	<input type="checkbox"/>
	<country option: non -binary gender classification: I identify myself another way>	<input type="checkbox"/>
	I prefer not to say.	<input type="checkbox"/>

Q3	In what country were you and your parents born? (Please tick only one box in each column.)		
	You	Your mother	Your father
	<input type="checkbox"/> <Country A>	<input type="checkbox"/> <Country A>	<input type="checkbox"/> <Country A>
	<input type="checkbox"/> <Country B>	<input type="checkbox"/> <Country B>	<input type="checkbox"/> <Country B>
	<input type="checkbox"/> <Country C>	<input type="checkbox"/> <Country C>	<input type="checkbox"/> <Country C>
	<input type="checkbox"/> Other country	<input type="checkbox"/> Other country	<input type="checkbox"/> Other country

Q4	If you were NOT born in <this country>, how old were you when you arrived in <this country>.? (If you were less than 12-month-old, please write zero (0).)	
	Years	_____

Q5	Does your mother or father live outside of <this country> for more than six months of the year	
	Your mother	Your father
	<input type="checkbox"/> Yes	<input type="checkbox"/> Yes
	<input type="checkbox"/> No	<input type="checkbox"/> No

Q6	Who do you live at home with? (Check all those who apply)	
	Your mother	<input type="checkbox"/>
	Your father	<input type="checkbox"/>
	Your siblings	<input type="checkbox"/>
	Your partner (boyfriend, girlfriend, spouse)	<input type="checkbox"/>
	Yours or your partner's children	<input type="checkbox"/>
	Your friends	<input type="checkbox"/>
	Other relatives (e.g. grandparents, uncles, aunts)	<input type="checkbox"/>
	Nobody, you live alone	<input type="checkbox"/>
	You live in a <boarding school or hostel>	<input type="checkbox"/>

Q7	Do you have children, including your partner's children?	
	<input type="checkbox"/> Yes	
	<input type="checkbox"/> No	Go to Q10

Q8	How many children do you have?	
	Number of children	_____

Q9	How old is the youngest child?	
	Age	_____

Q10	What is the <highest level of schooling> completed by your mother? (Please select one only)	
	<ISCED level 34>	<input type="checkbox"/>
	<ISCED level 35>	<input type="checkbox"/>
	<ISCED level 2>	<input type="checkbox"/>
	<ISCED level 1>	<input type="checkbox"/>
	She did not complete <ISCED level 1>	<input type="checkbox"/>

Q11	Does your mother have any of the following qualifications? (Please check all that apply)	
	<ISCED level 8>	<input type="checkbox"/>
	<ISCED level 7>	<input type="checkbox"/>
	<ISCED level 6>	<input type="checkbox"/>
	<ISCED level 5>	<input type="checkbox"/>
	<ISCED level 4>	<input type="checkbox"/>
	<ISCED 35>	<input type="checkbox"/>

Q12	What is the <highest level of schooling> completed by your father? (Please select one only)	
	<ISCED level 34>	<input type="checkbox"/>
	<ISCED level 35>	<input type="checkbox"/>
	<ISCED level 2>	<input type="checkbox"/>
	<ISCED level 1>	<input type="checkbox"/>
	She did not complete <ISCED level 1>	<input type="checkbox"/>

Q13	Does your father have any of the following qualifications? (Please check all that apply)	
	<ISCED level 8>	<input type="checkbox"/>
	<ISCED level 7>	<input type="checkbox"/>
	<ISCED level 6>	<input type="checkbox"/>
	<ISCED level 5>	<input type="checkbox"/>
	<ISCED level 4>	<input type="checkbox"/>
	<ISCED 35>	<input type="checkbox"/>

Q14	The following concern your home. [Please think about the home where you spend most of your time, and where you have your main possessions and resources] Which of the following are in your home?		
		Yes	No
	A bedroom for you/a room for you and your <partner>	<input type="checkbox"/>	<input type="checkbox"/>
	One or more bedrooms for your children	<input type="checkbox"/>	<input type="checkbox"/>
	A computer that can be used for schoolwork	<input type="checkbox"/>	<input type="checkbox"/>
	Your cell phone	<input type="checkbox"/>	<input type="checkbox"/>
	Internet access	<input type="checkbox"/>	<input type="checkbox"/>

Q15	How many items are there in your home?				
		None	1	2	3 or more
	Cars (vans trucks)	<input type="checkbox"/>	<input type="checkbox"/>	<input type="checkbox"/>	<input type="checkbox"/>
	Motorcycles	<input type="checkbox"/>	<input type="checkbox"/>	<input type="checkbox"/>	<input type="checkbox"/>
	Rooms with bath or shower	<input type="checkbox"/>	<input type="checkbox"/>	<input type="checkbox"/>	<input type="checkbox"/>
	Musical instruments	<input type="checkbox"/>	<input type="checkbox"/>	<input type="checkbox"/>	<input type="checkbox"/>
	Works of art	<input type="checkbox"/>	<input type="checkbox"/>	<input type="checkbox"/>	<input type="checkbox"/>
	Digital devices with screens (excluding cell phones)	<input type="checkbox"/>	<input type="checkbox"/>	<input type="checkbox"/>	<input type="checkbox"/>

Q16	How many books are in your home? Please tick only one box	
	None	<input type="checkbox"/>
	1-10	<input type="checkbox"/>
	11-25	<input type="checkbox"/>
	26-100	<input type="checkbox"/>
	101-200	<input type="checkbox"/>
	201-500	<input type="checkbox"/>
	More than 500	<input type="checkbox"/>

Q17	The following two questions concern your mother's job:	
a	What is your mother's main job?	_____
b	What does your mother do in her main job?	_____ _____ _____

Q18	The following two questions concern your father's job:	
a	What is your father's main job?	_____
b	What does your father do in his main job?	_____ _____ _____

Q19	In the past 30 days, how often did you not eat because there was not enough money to buy food (<i>Please select one response.</i>)	
	Never or almost never	<input type="checkbox"/>
	About once a week	<input type="checkbox"/>
	2 to 3 times a week	<input type="checkbox"/>
	4 to 5 times a week	<input type="checkbox"/>
	Every day or almost every day	<input type="checkbox"/>

Q20	This question concerns you and your body. For each of the following, please indicate if it applies to you or not.	Yes	No
	Visual <impairment>	<input type="checkbox"/>	<input type="checkbox"/>
	Hearing <impairment>	<input type="checkbox"/>	<input type="checkbox"/>
	<Disability> affecting mobility	<input type="checkbox"/>	<input type="checkbox"/>
	Other physical <disability>	<input type="checkbox"/>	<input type="checkbox"/>
	A medical condition like epilepsy, asthma, or diabetes	<input type="checkbox"/>	<input type="checkbox"/>
	Emotional/behavioural difficulties	<input type="checkbox"/>	<input type="checkbox"/>
	Mental illness	<input type="checkbox"/>	<input type="checkbox"/>
	Temporary disability after accident/injury	<input type="checkbox"/>	<input type="checkbox"/>
	Moderate learning difficulty	<input type="checkbox"/>	<input type="checkbox"/>
	Severe learning difficulty	<input type="checkbox"/>	<input type="checkbox"/>
	Dyslexia	<input type="checkbox"/>	<input type="checkbox"/>
	Dyscalculia	<input type="checkbox"/>	<input type="checkbox"/>
	Other specific learning difficulty	<input type="checkbox"/>	<input type="checkbox"/>

Q21	What language do you speak at home most of the time? (Please tick only one box)	
	<language 1>	<input type="checkbox"/>
	<language 2>	<input type="checkbox"/>
	<language 3>	<input type="checkbox"/>
	<...etc.>	<input type="checkbox"/>
	Other language	<input type="checkbox"/>

Q22	When did you begin learning <language of instruction>? Please tick only one box	
	At home before I ever started school, when I was a young child	<input type="checkbox"/>
	In <ISCED 0>	<input type="checkbox"/>
	When I started <ISCED 1>	<input type="checkbox"/>
	When I started <ISCED 2>	<input type="checkbox"/>
	When I started <this VET program>	<input type="checkbox"/>

Q23	Which language did you first learn to read? Please tick only one box	
	<language 1>	<input type="checkbox"/>
	<language 2>	<input type="checkbox"/>
	<language 3>	<input type="checkbox"/>
	<...etc.>	<input type="checkbox"/>
	Other language	<input type="checkbox"/>

Section on educational and work-related previous experiences.

Q24	Which of the qualifications is the highest you have obtained?	
	No formal qualification or below <ISCED 1>	Go to Q28
	<ISCED 1>	Go to Q28
	<ISCED 2>	Go to Q28
	<ISCED 34>	Go to Q28
	<ISCED 35>	Go to Q28
	<ISCED 36>	Go to Q28
	<ISCED 44>	Go to Q28
	<ISCED 45>	Go to Q28
	<ISCED 46>	Go to Q28
	<ISCED 54>	Go to Q28

<ISCED 55>	Go to Q28
<ISCED 56>	Go to Q28
<ISCED 6>	Go to Q28
Foreign qualification	Go to Q25

Q25_filtered	What is the name of this qualification?	
	Name: _____	Go to Q25

Q26_filtered	In which country did you gain this qualification?	
	<country 1>	Go to Q27
	<country 2>	Go to Q27
	<country >	Go to Q27

Q27_filtered	Can you indicate which level in our national education system corresponds most closely with the level of this qualification? Please tick only one box	
	No formal qualification or below <ISCED 1>	<input type="checkbox"/>
	<ISCED 1>	<input type="checkbox"/>
	<ISCED 2>	<input type="checkbox"/>
	<ISCED 34>	<input type="checkbox"/>
	<ISCED 35>	<input type="checkbox"/>
	<ISCED 36>	<input type="checkbox"/>
	<ISCED 44>	<input type="checkbox"/>
	<ISCED 45>	<input type="checkbox"/>
	<ISCED 46>	<input type="checkbox"/>
	<ISCED 54>	<input type="checkbox"/>
	<ISCED 55>	<input type="checkbox"/>
	<ISCED 56>	<input type="checkbox"/>
	<ISCED 6>	<input type="checkbox"/>

Q28 (follows Q24 for unfiltered)	What was the area of study, emphasis or major for your highest level of qualification? If there was more than one, please choose the one you consider most important. Please tick only one box	
	General programmes	<input type="checkbox"/>
	Teacher training and education science	<input type="checkbox"/>
	Humanities, languages and arts	<input type="checkbox"/>
	Social sciences, business and law	<input type="checkbox"/>
	Science, mathematics and computing	<input type="checkbox"/>
	Engineering, manufacturing and construction	<input type="checkbox"/>
	Agriculture and veterinary	<input type="checkbox"/>
	Health and welfare	<input type="checkbox"/>
	Services	<input type="checkbox"/>
	General programmes	<input type="checkbox"/>

Q29	When you completed this qualification, how old were you, or what year was it?	
	Age _____	Year: _____
		Month: _____

Q30	Did you ever start studying for any formal qualification, but you left before completing it?	
	Yes	<input type="checkbox"/> Go to Q31
	No	<input type="checkbox"/> Go to Q34

Q31	What was the level of the qualification you started studying for? If there was more than one, please report the one with the highest level. Please tick only one box	
	<ISCED 1>	<input type="checkbox"/>
	<ISCED 2>	<input type="checkbox"/>
	<ISCED 34>	<input type="checkbox"/>
	<ISCED 35>	<input type="checkbox"/>
	<ISCED 36>	<input type="checkbox"/>
	<ISCED 44>	<input type="checkbox"/>
	<ISCED 45>	<input type="checkbox"/>
	<ISCED 46>	<input type="checkbox"/>
	<ISCED 54>	<input type="checkbox"/>
	<ISCED 55>	<input type="checkbox"/>
	<ISCED 56>	<input type="checkbox"/>
	<ISCED 6>	<input type="checkbox"/>

Q32	When you stopped studying for this qualification, how old were you or what year was it?	
	Age _____	Year _____
		Month _____

Q33	Which of the following reasons prevented you from participating in education and training? Please indicate the most important reason.		
		Yes	No
	My grades were too low to be admitted	<input type="checkbox"/>	<input type="checkbox"/>
	I did not have the educational prerequisites	<input type="checkbox"/>	<input type="checkbox"/>
	Education or training was too expensive/I could not afford it	<input type="checkbox"/>	<input type="checkbox"/>
	Lack of employer's support	<input type="checkbox"/>	<input type="checkbox"/>
	I was too busy at work	<input type="checkbox"/>	<input type="checkbox"/>
	The course or programme was offered at an inconvenient time or place	<input type="checkbox"/>	<input type="checkbox"/>
	I did not have time because of childcare or family responsibilities	<input type="checkbox"/>	<input type="checkbox"/>
	Something unexpected came up that prevented me from taking education or training	<input type="checkbox"/>	<input type="checkbox"/>

Q34	Have you ever had paid work? Please include self-employment but exclude allowances from summer jobs, student jobs, and training programs that were part of your <VET>.	
	Yes	<input type="checkbox"/>
	No	<input type="checkbox"/>

Q35	During the last 12 months, that is since <Month/Year>, did you have any paid work? Please include self-employment but exclude allowances from summer jobs, student jobs, and training programs that were part of your <VET>.	
	Yes	<input type="checkbox"/>
	No	<input type="checkbox"/>

Q36	When you stopped working in your last paid job, how old were you or what year was it?	
	Age: -----	Year: -----
		Month: _____

Q37	In the last 5 years, for how many different firms or organisations did you work? Include your own business or businesses in the case of self-employment, but exclude summer jobs, student jobs, and training programs that were part of your <VET>.	
	Number of firms or organizations	_____

Q38	The following two questions concern your occupation in your last job.	
a	What was your main job	_____
b	What did you do in your main job	_____ _____ _____

Section on choice of the programme.

Q39	Is your current programme mainly (more than half your time) [please select one].	
	Based in the workplace (e.g., an apprenticeship)	<input type="checkbox"/>
	Based in school/college (e.g., a school/college programme which may include direct external work experience)	<input type="checkbox"/>

Q40	What is your status during your programme? [Please select one.]	
	Employee with salary	<input type="checkbox"/>
	Trainee <or apprentice>, not employed but with a salary or grant	<input type="checkbox"/>
	Unpaid trainee <or apprentice> or student	<input type="checkbox"/>
	Student with part-time work not part of your programme	<input type="checkbox"/>

Q41	At what stage of life and career were you when you decided to enrol in this program?		
		Yes	No
	Enrolled in previous educational degrees <upper secondary>, leading to VET	<input type="checkbox"/>	<input type="checkbox"/>
	Enrolled in a different VET programme but wanting to change	<input type="checkbox"/>	<input type="checkbox"/>
	Working, with intention to build it into a career	<input type="checkbox"/>	<input type="checkbox"/>
	Working and wanting to change for a career in the <subject matter> of this VET programme	<input type="checkbox"/>	<input type="checkbox"/>
	School leaver, I dropped out of school without graduating from <lower secondary>	<input type="checkbox"/>	<input type="checkbox"/>
	School leaver, I dropped out of school without graduating from <upper secondary>	<input type="checkbox"/>	<input type="checkbox"/>
	In university and wanting to change career	<input type="checkbox"/>	<input type="checkbox"/>
	In school but I was obtaining poor grades	<input type="checkbox"/>	<input type="checkbox"/>
	Unemployed	<input type="checkbox"/>	<input type="checkbox"/>
	Not in the workforce, wanting a career in the <subject matter> of this VET programme	<input type="checkbox"/>	<input type="checkbox"/>
	Not in the workforce, I was studying for personal reasons	<input type="checkbox"/>	<input type="checkbox"/>

Q42	Why did you decide to undertake a <vocational programme>? (Choose the main reason)
------------	---

	I have been advised by a career counsellor to pursue vocational education	<input type="checkbox"/>
	I have been advised <or I have read that > VET programmes have good reputation	<input type="checkbox"/>
	I have been advised <or I have read that > VET programmes lead to secure employment	<input type="checkbox"/>
	Because of my prior school results	<input type="checkbox"/>
	Because of my interest in this specific occupation or work sector	<input type="checkbox"/>
	Because of my passion and skills	<input type="checkbox"/>
	For the prospect of gaining entry to a skilled job upon completion	<input type="checkbox"/>
	For the prospect of gaining entry to higher level studies through this vocational programme	<input type="checkbox"/>

Q43	Why did you choose your specific <area or subject matter>? (Choose the main reason)	
	I enjoy <this subject matter>	<input type="checkbox"/>
	I have always dreamed to work in this <subject matter>	<input type="checkbox"/>
	It is my passion	<input type="checkbox"/>
	I have been advised by a career counsellor to pursue this <subject matter>	<input type="checkbox"/>
	My parents or family suggested <this subject matter>	<input type="checkbox"/>
	My parents or family work in a related field	<input type="checkbox"/>
	Some of my friends also chose to study <this subject matter>	<input type="checkbox"/>
	To be able to enter my first job	<input type="checkbox"/>
	To benefit from better wages or benefits	<input type="checkbox"/>
	To move from my previous job to a new career	<input type="checkbox"/>
	To gain entry to <further study>	<input type="checkbox"/>
	To gain skills for <community/voluntary activities>	<input type="checkbox"/>
	To gain skills for personal reasons	<input type="checkbox"/>
	I wasn't sure what I wanted to do, and it seemed interesting	<input type="checkbox"/>
	Where I live, there wasn't much choice	<input type="checkbox"/>
	Where I live, the <subject matter> is expanding and flourishing as a work or business opportunity	<input type="checkbox"/>
	Where I live, there are several companies hiring in this <subject matter>	<input type="checkbox"/>

Section on satisfaction with current VET programme and expectations for completion.

Q44	On a scale from 0 to 10, where 0 indicates completely dissatisfied and 10 indicates completely satisfied, how satisfied are you with	
	<the current VET programme> overall	0-1-2-3-4-5-6-7-8-9-10
	With the teaching of this <VET Programme>	0-1-2-3-4-5-6-7-8-9-10
	With the work-based learning component of this <VET programme>	0-1-2-3-4-5-6-7-8-9-10

Q45	In the last five years, have you volunteered in a place of employment or undertaken a work placement related to the current <VET programme of study>? Please choose one only	
	No, never	<input type="checkbox"/>
	Yes, once	<input type="checkbox"/>
	Yes, twice	<input type="checkbox"/>
	Yes, three times or more	<input type="checkbox"/>

Q46	Do you see yourself completing this programme <or graduate>?	
	<input type="checkbox"/> Certainly	Go to Q47
	<input type="checkbox"/> Likely	Go to Q48
	<input type="checkbox"/> No	Go to Q48

Q47	What do you envisage doing upon completion of this programme? (Choose the main reason)	
	Get a job in <this subject matter>	<input type="checkbox"/>
	Get a job in a related <subject matter>	<input type="checkbox"/>
	Get a job in a different < subject matter>	<input type="checkbox"/>
	Open my own business	<input type="checkbox"/>
	Pursue higher level studies immediately upon completion (i.e. starting in the next academic year)	<input type="checkbox"/>
	Get a job and pursue higher level studies after some years of work experience	<input type="checkbox"/>
	Not work or study (e.g. gap year)	<input type="checkbox"/>
	Start a family	<input type="checkbox"/>

Q48	Do you think that one or several of these barriers may prevent you from completing this VET programme? (Please choose all that apply)		
		Yes	No
	Personal motivation	<input type="checkbox"/>	<input type="checkbox"/>
	Personal engagement	<input type="checkbox"/>	<input type="checkbox"/>
	Lack of quality of instructions from teachers in this programme	<input type="checkbox"/>	<input type="checkbox"/>
	Lack of quality of training in the workplace during the <internship or apprenticeship>	<input type="checkbox"/>	<input type="checkbox"/>
	My inadequate skills to complete the programme	<input type="checkbox"/>	<input type="checkbox"/>
	Poor grades in the courses attended so far	<input type="checkbox"/>	<input type="checkbox"/>
	Language challenges	<input type="checkbox"/>	<input type="checkbox"/>
	Money	<input type="checkbox"/>	<input type="checkbox"/>
	Family responsibility	<input type="checkbox"/>	<input type="checkbox"/>
	Pregnancy	<input type="checkbox"/>	<input type="checkbox"/>
	Parental role	<input type="checkbox"/>	<input type="checkbox"/>
	Limited jobs available	<input type="checkbox"/>	<input type="checkbox"/>
	Another work opportunity	<input type="checkbox"/>	<input type="checkbox"/>
	Another educational opportunity	<input type="checkbox"/>	<input type="checkbox"/>

Section on student health and well-being.

Q49	Think about feelings you may experience in your everyday life, while studying, at home, or at your training <company>. For each statement below, please indicate how often you feel this way				
		Never or almost never	About once a week	2 to 3 times a week	Almost every day
	I am fearful, nervous, or on edge.				
	I have trouble relaxing				
	I become easily irritable or annoyed				
	I am afraid that something terrible may happen to me.				
	I worry about everything.				
	I move very slowly or way too fast, fidgeting.				
	I feel lonely.				
	I have poor appetite, or I binge uncontrollably				
	I feel sad or depressed.				
	I have trouble falling asleep, or I sleep too much				
	I feel that my life has no purpose				
	I feel that I am a failure				
	I think that I would be better off dead				
	I feel calm and at peace				
	I feel energized				
	I feel that I have my life under control				
	I feel that I can focus on things that I read or watch				

Q50	In general, would you say your health is									
	0	1	2	3	4	5	6	7	8	9
	Poor		Fair		Good		Very good		Excellent	

Q51	During the past year, have you had any of the following health problems (Tick yes or No in each row)		
		Yes	No
	A chronic disease (e.g., heart disease, cancer, diabetes, lung's or other respiratory problems)	<input type="checkbox"/>	<input type="checkbox"/>
	An infectious disease (e.g. hepatitis A, hepatitis B, hepatitis C, measles)	<input type="checkbox"/>	<input type="checkbox"/>
	Gastrointestinal problems (e.g., heartburn, stomach pain, irritable bowel syndrome)	<input type="checkbox"/>	<input type="checkbox"/>
	A cold or flu	<input type="checkbox"/>	<input type="checkbox"/>
	Long COVID	<input type="checkbox"/>	<input type="checkbox"/>
	An injury that needed treatment	<input type="checkbox"/>	<input type="checkbox"/>
	Pain that was long-lasting or recurring	<input type="checkbox"/>	<input type="checkbox"/>
	Depression	<input type="checkbox"/>	<input type="checkbox"/>
	Panic and anxiety attacks	<input type="checkbox"/>	<input type="checkbox"/>
	Insomnia	<input type="checkbox"/>	<input type="checkbox"/>
	Fatigue that was long-lasting or recurring	<input type="checkbox"/>	<input type="checkbox"/>

Section on the learning environment.

Note: two terms need adaptation and possibly an explanation for students in the body of the questionnaire. They are <school/college> and <lesson>. The term <lesson> should be adapted to refer to a block of variable amount of time that cover a specific section of the curriculum and reoccurs daily or weekly.

The questions below concern the learning environment and programme practices of the <current VET programme> you are enrolled in. The term <lesson> refers to a block of variable amount of time that cover a specific section of the curriculum, and that reoccurs daily or weekly.

Q52	How often do these things happen in your <XXXXX> lessons?	Every lesson	Most lessons	Some lessons	Never or almost never
	Students do not listen to what the lesson's instructor said.	<input type="checkbox"/>	<input type="checkbox"/>	<input type="checkbox"/>	<input type="checkbox"/>
	There is noise and disorder.	<input type="checkbox"/>	<input type="checkbox"/>	<input type="checkbox"/>	<input type="checkbox"/>
	The lesson's instructor has to wait a long time for students to quiet down.	<input type="checkbox"/>	<input type="checkbox"/>	<input type="checkbox"/>	<input type="checkbox"/>
	Students cannot work well.	<input type="checkbox"/>	<input type="checkbox"/>	<input type="checkbox"/>	<input type="checkbox"/>
	Students do not start working for a long time after the lesson begins.	<input type="checkbox"/>	<input type="checkbox"/>	<input type="checkbox"/>	<input type="checkbox"/>
	Students get distracted by using <digital resources> (e.g. smartphones, websites, apps).	<input type="checkbox"/>	<input type="checkbox"/>	<input type="checkbox"/>	<input type="checkbox"/>
	Students get distracted by other students who are using <digital resources> (e.g. smartphones, websites, apps).	<input type="checkbox"/>	<input type="checkbox"/>	<input type="checkbox"/>	<input type="checkbox"/>

Q53	In the last two full weeks of this VET programme, how often did the following things occur? (Please select one response in each row.)	Never	1-2 times	3-4 times	5 times or more
	I <skipped> a whole day	<input type="checkbox"/>	<input type="checkbox"/>	<input type="checkbox"/>	<input type="checkbox"/>
	I <skipped> some <lessons>.	<input type="checkbox"/>	<input type="checkbox"/>	<input type="checkbox"/>	<input type="checkbox"/>
	I arrived late <for my first lesson>.	<input type="checkbox"/>	<input type="checkbox"/>	<input type="checkbox"/>	<input type="checkbox"/>
	I arrived late at the <training company>	<input type="checkbox"/>	<input type="checkbox"/>	<input type="checkbox"/>	<input type="checkbox"/>
	I <called in sick> at the training company while in fact I was fine	<input type="checkbox"/>	<input type="checkbox"/>	<input type="checkbox"/>	<input type="checkbox"/>

Q54	During the past four weeks, did any of the following events occur at the educational institution?	Yes	No
	Buildings, labs, or technical equipment were vandalised.	<input type="checkbox"/>	<input type="checkbox"/>
	Our building had structural issues (heating, cooling problems; pipes bursting...)	<input type="checkbox"/>	<input type="checkbox"/>
	There were altercations or fights that escalated violently.	<input type="checkbox"/>	<input type="checkbox"/>
	Some learning material was stolen	<input type="checkbox"/>	<input type="checkbox"/>
	Students lamented to be threatened or hurt by other students.	<input type="checkbox"/>	<input type="checkbox"/>
	Students saw other students carrying a gun or knife	<input type="checkbox"/>	<input type="checkbox"/>

Q55	The <instructors/teachers> in this VET programme....	Never	Occasionally	Most of the time	Always
	Are respectful towards me	<input type="checkbox"/>	<input type="checkbox"/>	<input type="checkbox"/>	<input type="checkbox"/>
	Are approachable if I have questions about their disciplinary area	<input type="checkbox"/>	<input type="checkbox"/>	<input type="checkbox"/>	<input type="checkbox"/>
	Are passionate about their subject	<input type="checkbox"/>	<input type="checkbox"/>	<input type="checkbox"/>	<input type="checkbox"/>
	Are well prepared in their lessons	<input type="checkbox"/>	<input type="checkbox"/>	<input type="checkbox"/>	<input type="checkbox"/>
	Are absent or arrive late to work	<input type="checkbox"/>	<input type="checkbox"/>	<input type="checkbox"/>	<input type="checkbox"/>
	Are collaborative with their peers	<input type="checkbox"/>	<input type="checkbox"/>	<input type="checkbox"/>	<input type="checkbox"/>
	Are up to date on technology	<input type="checkbox"/>	<input type="checkbox"/>	<input type="checkbox"/>	<input type="checkbox"/>
	Are up to date on the labour market	<input type="checkbox"/>	<input type="checkbox"/>	<input type="checkbox"/>	<input type="checkbox"/>
	Are well organized	<input type="checkbox"/>	<input type="checkbox"/>	<input type="checkbox"/>	<input type="checkbox"/>

Section on teaching practices.

Q56	Thinking about your <XXX lessons>, how often the following things happen in a typical month?	Never	Occasionally	Most of the time	Always
	The most important points of the previous lesson are summarized again at the beginning of the next	<input type="checkbox"/>	<input type="checkbox"/>	<input type="checkbox"/>	<input type="checkbox"/>
	The lessons are highly structured	<input type="checkbox"/>	<input type="checkbox"/>	<input type="checkbox"/>	<input type="checkbox"/>
	The lessons are highly theoretical	<input type="checkbox"/>	<input type="checkbox"/>	<input type="checkbox"/>	<input type="checkbox"/>
	The lessons run late because they are packed with content	<input type="checkbox"/>	<input type="checkbox"/>	<input type="checkbox"/>	<input type="checkbox"/>
	The lessons include job-specific applications	<input type="checkbox"/>	<input type="checkbox"/>	<input type="checkbox"/>	<input type="checkbox"/>
	The lessons mirror tasks in our practical training	<input type="checkbox"/>	<input type="checkbox"/>	<input type="checkbox"/>	<input type="checkbox"/>
	The teachers alternate rounds of explanation to clarify for the most complex things.	<input type="checkbox"/>	<input type="checkbox"/>	<input type="checkbox"/>	<input type="checkbox"/>
	Teachers make explicit the steps that we must follow to complete the <assignments / graded projects>.	<input type="checkbox"/>	<input type="checkbox"/>	<input type="checkbox"/>	<input type="checkbox"/>
	Each set of lessons has related exercises to practice	<input type="checkbox"/>	<input type="checkbox"/>	<input type="checkbox"/>	<input type="checkbox"/>

	We do exercises that can show us and the instructors if we have understood something.	<input type="checkbox"/>	<input type="checkbox"/>	<input type="checkbox"/>	<input type="checkbox"/>
	We apply what we have learned to new problems or situations.	<input type="checkbox"/>	<input type="checkbox"/>	<input type="checkbox"/>	<input type="checkbox"/>
	The teachers let us keep going with our work until we realize ourselves that something is wrong.	<input type="checkbox"/>	<input type="checkbox"/>	<input type="checkbox"/>	<input type="checkbox"/>
	The teachers provide detailed feedback to our <assignments/graded projects>	<input type="checkbox"/>	<input type="checkbox"/>	<input type="checkbox"/>	<input type="checkbox"/>
	The teachers require us to incorporate their feedback in further work or in the revisions of submitted work	<input type="checkbox"/>	<input type="checkbox"/>	<input type="checkbox"/>	<input type="checkbox"/>
	The teachers connect the skills we are developing with actual use in workplaces	<input type="checkbox"/>	<input type="checkbox"/>	<input type="checkbox"/>	<input type="checkbox"/>

Section on peer relationships and peer support.

Q57	The following statements refer to your <peer cohort/classmates>. Please indicate whether they apply to you	Yes	No
	My <classmates> get on well with most of the teachers	<input type="checkbox"/>	<input type="checkbox"/>
	My <classmates> expect me to complete my <vocational training> successfully	<input type="checkbox"/>	<input type="checkbox"/>
	If I have problems in class, I can ask my classmates for help.	<input type="checkbox"/>	<input type="checkbox"/>
	My classmates and I work together to study for tests or exams	<input type="checkbox"/>	<input type="checkbox"/>

Section on availability and access to training in the workplace.

Q58	Does your <vocational educational programme> also offer specific, practical training in your field?	Yes	No
	In its own teaching workshop	<input type="checkbox"/>	<input type="checkbox"/>
	In a teaching office	<input type="checkbox"/>	<input type="checkbox"/>
	In a practice <company>	<input type="checkbox"/>	<input type="checkbox"/> Go to Q 59
	In a training workshop with the <company>	<input type="checkbox"/>	<input type="checkbox"/> Go to Q 59

Q59	Why didn't you train with a company? Select only one option	
	It was not an option	<input type="checkbox"/>
	It was optional, but I did not want to	<input type="checkbox"/>
	It was optional, but I did not find a suitable company	<input type="checkbox"/>
	There were organizational problems to making it happen	<input type="checkbox"/>

Section on the environment, the relationships, and the practices in the workplace.

Q60	This and the following questions ask about your <training/work/apprenticeship > environment, where you are currently complementing your educational institution-based learning. If you have recently changed training <company> and are new to the place, please answer by thinking about the training <company> where you have spent the longest period of your <VET training> programme.
	How much time did you spend in the <company> training during your <VET program>?
	Number of months _____
	Number of weeks _____

Q61	How did you find your <training company>?	
	It was assigned to me by the <VET programme>	<input type="checkbox"/>
	I had an internship there before and I just reached out	<input type="checkbox"/>
	I applied directly to an <internship offer> by the company	<input type="checkbox"/>
	A teacher helped me find this option	<input type="checkbox"/>
	Family or friends facilitated my introduction to the <company>	<input type="checkbox"/>
	I used an <employment agency>	<input type="checkbox"/>
	<Country specific>	<input type="checkbox"/>
	<Country specific>	<input type="checkbox"/>

Q62	Who is the person mainly responsible (or directly involved) in your training? Please select one response	
	A full-time trainer	<input type="checkbox"/>
	My boss or supervisor	<input type="checkbox"/>
	A colleague who also has other tasks besides training	<input type="checkbox"/>
	Another apprentice	<input type="checkbox"/>

Q63	How many employees does your company have at the site where your training so far has been taking place? Please include yourself and other apprentices. (You can approximate to the closest match)	
	1-4	<input type="checkbox"/>
	5-9	<input type="checkbox"/>
	10-49	<input type="checkbox"/>
	50-249	<input type="checkbox"/>
	250-499	<input type="checkbox"/>
	500-999	<input type="checkbox"/>
	1000 or more employees	<input type="checkbox"/>

Q64	How many apprentices does your training company have at the site where your training so far has been taking place most of the time?	
	approximate number of apprentices in your training occupation (all years of training taken together)	-----
	There are no other apprentices other than me	<input type="checkbox"/>

Q65	Thinking about your current training experience in this <company>, please reply yes or no each to each of these statements.		
		Yes	No
	I am satisfied with this training company (or training placement)	<input type="checkbox"/>	<input type="checkbox"/>
	I want to quit it to study at university	<input type="checkbox"/>	<input type="checkbox"/>
	I want to quit this <training company> for a better one	<input type="checkbox"/>	<input type="checkbox"/>
	My company and me match very well	<input type="checkbox"/>	<input type="checkbox"/>
	I think I will be asked by my <training company> to stay and be hired	<input type="checkbox"/>	<input type="checkbox"/>
	I am proud to work for my <training company>	<input type="checkbox"/>	<input type="checkbox"/>
	My training <company> is a place like home for me	<input type="checkbox"/>	<input type="checkbox"/>
	I like to tell others about my training <company>	<input type="checkbox"/>	<input type="checkbox"/>
	After finishing my training, I would like to work in this <training company>	<input type="checkbox"/>	<input type="checkbox"/>

Q66	On a scale from 0 (never) to 6 (daily), rate the frequency of occurrence of the following statements about your training <company>	
	The training is carefully planned by the trainer and their supervisors	0 (never) , 1 , 2 , 3 , 4 , 5 , 6 (daily)
	The training activities align with what I study in my educational programme	0 (never) , 1 , 2 , 3 , 4 , 5 , 6 (daily)
	The trainer is present	0 (never) , 1 , 2 , 3 , 4 , 5 , 6 (daily)

	The trainer masters the training content and activities	0 (never) , 1 , 2 , 3 , 4 , 5 , 6 (daily)
	The trainer is up to date on current norms of safety	0 (never) , 1 , 2 , 3 , 4 , 5 , 6 (daily)
	The trainer is up to date with the newest technology	0 (never) , 1 , 2 , 3 , 4 , 5 , 6 (daily)
	The trainer gives clear working instruction	0 (never) , 1 , 2 , 3 , 4 , 5 , 6 (daily)
	The trainer delegates others to teach me	0 (never) , 1 , 2 , 3 , 4 , 5 , 6 (daily)
	The trainer promotes a collegial environment	0 (never) , 1 , 2 , 3 , 4 , 5 , 6 (daily)
	The trainer simulates the tasks that I replicate	0 (never) , 1 , 2 , 3 , 4 , 5 , 6 (daily)
	The trainer explains clearly how to do the tasks and activities	0 (never) , 1 , 2 , 3 , 4 , 5 , 6 (daily)
	The trainer takes the time to debrief a work task after I finished it	0 (never) , 1 , 2 , 3 , 4 , 5 , 6 (daily)
	The trainer offers detailed feedback	0 (never) , 1 , 2 , 3 , 4 , 5 , 6 (daily)
	The trainer offers constructive feedback	0 (never) , 1 , 2 , 3 , 4 , 5 , 6 (daily)
	The trainer treats me with respect	0 (never) , 1 , 2 , 3 , 4 , 5 , 6 (daily)

Q67	On a scale from 0 (never) to 6 (daily), rate the frequency of occurrence of the following statements about your training <company>			
	Experienced employees in my group ridicule others when they use techniques they learn in training.	0 (never) , 1 , 2 , 3 , 4 , 5 , 6 (daily)		
	My co-workers listen to others' views before speaking	0 (never) , 1 , 2 , 3 , 4 , 5 , 6 (daily)		
	My co-workers spend time building trust with each other	0 (never) , 1 , 2 , 3 , 4 , 5 , 6 (daily)		
	There is racism in my training <company>	0 (never) , 1 , 2 , 3 , 4 , 5 , 6 (daily)		
	I experience racism from my co-workers	0 (never) , 1 , 2 , 3 , 4 , 5 , 6 (daily)		
	There is gender discrimination in my training <company>	0 (never) , 1 , 2 , 3 , 4 , 5 , 6 (daily)		
	I experience gender discrimination from my co-workers	0 (never) , 1 , 2 , 3 , 4 , 5 , 6 (daily)		
	I experience harassment from my co-workers	0 (never) , 1 , 2 , 3 , 4 , 5 , 6 (daily)		
	I experience harassment from my trainer	0 (never) , 1 , 2 , 3 , 4 , 5 , 6 (daily)		
	In the training company, employees steal tools/materials	0 (never) , 1 , 2 , 3 , 4 , 5 , 6 (daily)		

Q68	Thinking about your training <company>. Please indicate to what extent do you agree with the following statements				
		Strongly agree	Agree	Disagree	Strongly disagree
	Working and learning at the workplace gives me confidence	<input type="checkbox"/>	<input type="checkbox"/>	<input type="checkbox"/>	<input type="checkbox"/>
	What I learn at the workplace will be useful for my future career	<input type="checkbox"/>	<input type="checkbox"/>	<input type="checkbox"/>	<input type="checkbox"/>
	I can get to know different areas of work in the company	<input type="checkbox"/>	<input type="checkbox"/>	<input type="checkbox"/>	<input type="checkbox"/>
	My trainer and most of my co-workers listen to what I have to say	<input type="checkbox"/>	<input type="checkbox"/>	<input type="checkbox"/>	<input type="checkbox"/>
	My trainer is a mentor	<input type="checkbox"/>	<input type="checkbox"/>	<input type="checkbox"/>	<input type="checkbox"/>
	My trainer and my co-workers treat me fairly	<input type="checkbox"/>	<input type="checkbox"/>	<input type="checkbox"/>	<input type="checkbox"/>
	I feel safe at the workplace	<input type="checkbox"/>	<input type="checkbox"/>	<input type="checkbox"/>	<input type="checkbox"/>
	My individual needs (e.g., disability) are considered at the workplace	<input type="checkbox"/>	<input type="checkbox"/>	<input type="checkbox"/>	<input type="checkbox"/>
	I feel awkward and out of place in my company	<input type="checkbox"/>	<input type="checkbox"/>	<input type="checkbox"/>	<input type="checkbox"/>

Q69	Thinking about your <training company/workplace>. Please indicate the frequency of occurrence of the following statements				
		Every day	Most days	Some days	Never or hardly ever
	Work tasks are challenging and complex	<input type="checkbox"/>	<input type="checkbox"/>	<input type="checkbox"/>	<input type="checkbox"/>

My work tasks are varied	<input type="checkbox"/>	<input type="checkbox"/>	<input type="checkbox"/>	<input type="checkbox"/>
My work tasks match my level of expertise	<input type="checkbox"/>	<input type="checkbox"/>	<input type="checkbox"/>	<input type="checkbox"/>
My trainer or colleagues are available to offer clear answers to my questions	<input type="checkbox"/>	<input type="checkbox"/>	<input type="checkbox"/>	<input type="checkbox"/>
I do work tasks from start to finish	<input type="checkbox"/>	<input type="checkbox"/>	<input type="checkbox"/>	<input type="checkbox"/>
I participate in group tasks with unclear deadlines	<input type="checkbox"/>	<input type="checkbox"/>	<input type="checkbox"/>	<input type="checkbox"/>
My trainer or colleagues show me how to troubleshoot a problem	<input type="checkbox"/>	<input type="checkbox"/>	<input type="checkbox"/>	<input type="checkbox"/>
I can choose my own work tasks	<input type="checkbox"/>	<input type="checkbox"/>	<input type="checkbox"/>	<input type="checkbox"/>
Other colleagues rely on the results of my work	<input type="checkbox"/>	<input type="checkbox"/>	<input type="checkbox"/>	<input type="checkbox"/>
I document my learning experiences at the workplace in a diary	<input type="checkbox"/>	<input type="checkbox"/>	<input type="checkbox"/>	<input type="checkbox"/>
I end up doing too many things at the same time	<input type="checkbox"/>	<input type="checkbox"/>	<input type="checkbox"/>	<input type="checkbox"/>
There is chaos and disorder at the workplace	<input type="checkbox"/>	<input type="checkbox"/>	<input type="checkbox"/>	<input type="checkbox"/>
I do telework	<input type="checkbox"/>	<input type="checkbox"/>	<input type="checkbox"/>	<input type="checkbox"/>

Q70	Thinking about your training company, how often do you use the following resources at work?	Every day	Most days	Some days	Never or hardly ever
		<input type="checkbox"/>	<input type="checkbox"/>	<input type="checkbox"/>	<input type="checkbox"/>
	Computer or tablet	<input type="checkbox"/>	<input type="checkbox"/>	<input type="checkbox"/>	<input type="checkbox"/>
	Internet	<input type="checkbox"/>	<input type="checkbox"/>	<input type="checkbox"/>	<input type="checkbox"/>
	Occupation-specific software	<input type="checkbox"/>	<input type="checkbox"/>	<input type="checkbox"/>	<input type="checkbox"/>
	Tools to communicate with colleagues and clients	<input type="checkbox"/>	<input type="checkbox"/>	<input type="checkbox"/>	<input type="checkbox"/>
	Programmable tools and machines	<input type="checkbox"/>	<input type="checkbox"/>	<input type="checkbox"/>	<input type="checkbox"/>
	Artificial intelligence	<input type="checkbox"/>	<input type="checkbox"/>	<input type="checkbox"/>	<input type="checkbox"/>
	Virtual reality	<input type="checkbox"/>	<input type="checkbox"/>	<input type="checkbox"/>	<input type="checkbox"/>

Section on effective relationships between educational institution-based and work-based learning.

Q71	Think about your <VET programme>, the educational institution, and the relationships established with the <company/workplace>. To what extent do you agree with the following statements?	Strongly agree	Agree	Disagree	Strongly disagree
		<input type="checkbox"/>	<input type="checkbox"/>	<input type="checkbox"/>	<input type="checkbox"/>
	The educational institution- based portion of the programme prepares me well for the practical phases in the <company/workplace>	<input type="checkbox"/>	<input type="checkbox"/>	<input type="checkbox"/>	<input type="checkbox"/>
	What I learn in the school-based portion of this programme and what I learn at work complement each other	<input type="checkbox"/>	<input type="checkbox"/>	<input type="checkbox"/>	<input type="checkbox"/>
	In this programme, the rotation between the phases in <the company/training company/workplace> and in the educational institution is well organised	<input type="checkbox"/>	<input type="checkbox"/>	<input type="checkbox"/>	<input type="checkbox"/>
	The responsibilities between educational institution and <company/training company/workplace> are clearly regulated	<input type="checkbox"/>	<input type="checkbox"/>	<input type="checkbox"/>	<input type="checkbox"/>
	My teachers in the educational institution and my trainer in the <company/workplace> exchange information about me on a regular basis	<input type="checkbox"/>	<input type="checkbox"/>	<input type="checkbox"/>	<input type="checkbox"/>
	In the educational institution, I can talk about my experiences in the <company/workplace> with my teachers	<input type="checkbox"/>	<input type="checkbox"/>	<input type="checkbox"/>	<input type="checkbox"/>
	The educational institution is always available to troubleshoots problems with the training team or with the trainer in the <company/workplace>	<input type="checkbox"/>	<input type="checkbox"/>	<input type="checkbox"/>	<input type="checkbox"/>

Q72	How long does it take you approximately to get from your home to the training <company>? Please select one response	
	Less than 15 minutes	<input type="checkbox"/>
	15-30 minutes	<input type="checkbox"/>
	31-60 minutes	<input type="checkbox"/>
	61-90 minutes	<input type="checkbox"/>
	More than 90 minutes	<input type="checkbox"/>

Q73	How long does it take you approximately to get from your home to the educational institution? Please select one response	
	Less than 15 minutes	<input type="checkbox"/>
	15-30 minutes	<input type="checkbox"/>
	31-60 minutes	<input type="checkbox"/>
	61-90 minutes	<input type="checkbox"/>
	More than 90 minutes	<input type="checkbox"/>

Section on work safety

Q74	In your training <company>, how often do you?	Never	Once a year	Every 6 months	Every 3 months	Every week	Every day	NA
	Manually lift, carry or push items heavier than 20 kg at least 10 times during the day	<input type="checkbox"/>	<input type="checkbox"/>	<input type="checkbox"/>	<input type="checkbox"/>	<input type="checkbox"/>	<input type="checkbox"/>	<input type="checkbox"/>
	Do repetitive movements with your hands or wrists (packing, sorting, assembling, cleaning, pulling, pushing, typing) for at least 3 hours during the day	<input type="checkbox"/>	<input type="checkbox"/>	<input type="checkbox"/>	<input type="checkbox"/>	<input type="checkbox"/>	<input type="checkbox"/>	<input type="checkbox"/>
	Perform work tasks, or use work methods, that you are not familiar with	<input type="checkbox"/>	<input type="checkbox"/>	<input type="checkbox"/>	<input type="checkbox"/>	<input type="checkbox"/>	<input type="checkbox"/>	<input type="checkbox"/>
	Interact with hazardous substances such as chemicals, flammable liquids, and gases	<input type="checkbox"/>	<input type="checkbox"/>	<input type="checkbox"/>	<input type="checkbox"/>	<input type="checkbox"/>	<input type="checkbox"/>	<input type="checkbox"/>
	Work in a bent, twisted, or awkward work posture	<input type="checkbox"/>	<input type="checkbox"/>	<input type="checkbox"/>	<input type="checkbox"/>	<input type="checkbox"/>	<input type="checkbox"/>	<input type="checkbox"/>
	Work in an environment with too bright or insufficient lighting	<input type="checkbox"/>	<input type="checkbox"/>	<input type="checkbox"/>	<input type="checkbox"/>	<input type="checkbox"/>	<input type="checkbox"/>	<input type="checkbox"/>
	Work at a height that is 2 metres or more above the ground or floor	<input type="checkbox"/>	<input type="checkbox"/>	<input type="checkbox"/>	<input type="checkbox"/>	<input type="checkbox"/>	<input type="checkbox"/>	<input type="checkbox"/>
	Work in noise levels that are so high that you must raise your voice when talking to people less than one metre away	<input type="checkbox"/>	<input type="checkbox"/>	<input type="checkbox"/>	<input type="checkbox"/>	<input type="checkbox"/>	<input type="checkbox"/>	<input type="checkbox"/>
	Experience being bullied or harassed at work	<input type="checkbox"/>	<input type="checkbox"/>	<input type="checkbox"/>	<input type="checkbox"/>	<input type="checkbox"/>	<input type="checkbox"/>	<input type="checkbox"/>
	Stand for more than two hours in a row	<input type="checkbox"/>	<input type="checkbox"/>	<input type="checkbox"/>	<input type="checkbox"/>	<input type="checkbox"/>	<input type="checkbox"/>	<input type="checkbox"/>
	Work over hours when nobody is around	<input type="checkbox"/>	<input type="checkbox"/>	<input type="checkbox"/>	<input type="checkbox"/>	<input type="checkbox"/>	<input type="checkbox"/>	<input type="checkbox"/>

Q75	This section explores your awareness of occupational health and safety (e.g. hazards, the rights and responsibilities of both employees and employers). At your training <company>:	Strongly Disagree	Disagree	Agree	Strongly Agree	NA
	I am clear about my rights and responsibilities in relation to workplace health and safety	<input type="checkbox"/>	<input type="checkbox"/>	<input type="checkbox"/>	<input type="checkbox"/>	<input type="checkbox"/>
	I am clear about my employers' rights and responsibilities in relation to workplace health and safety	<input type="checkbox"/>	<input type="checkbox"/>	<input type="checkbox"/>	<input type="checkbox"/>	<input type="checkbox"/>
	I know how to perform my job in a safe manner	<input type="checkbox"/>	<input type="checkbox"/>	<input type="checkbox"/>	<input type="checkbox"/>	<input type="checkbox"/>
	If I became aware of a health or safety hazard at my workplace, I know who (at my workplace) I would report it to	<input type="checkbox"/>	<input type="checkbox"/>	<input type="checkbox"/>	<input type="checkbox"/>	<input type="checkbox"/>

	I have the knowledge to assist in responding to any health and safety concerns at my workplace	<input type="checkbox"/>	<input type="checkbox"/>	<input type="checkbox"/>	<input type="checkbox"/>	<input type="checkbox"/>
	I know what the necessary precautions are that I should take while doing my job	<input type="checkbox"/>	<input type="checkbox"/>	<input type="checkbox"/>	<input type="checkbox"/>	<input type="checkbox"/>

Section on partner or family support

Q76	These statements refer to conversations and exchanges that you may have had with your family, concerning your plans to enrol in the current <VET program>, to complete it, and to decide for your future. Please, select all that apply		
		Yes	No
	In my family, other people work in this same <occupational area>	<input type="checkbox"/>	<input type="checkbox"/>
	My <spouse/partner> works in this <occupational area>	<input type="checkbox"/>	<input type="checkbox"/>
	Friends of mine work in this <occupational area>	<input type="checkbox"/>	<input type="checkbox"/>
	In my family, VET is greatly valued	<input type="checkbox"/>	<input type="checkbox"/>
	In my family, only <ISCED5-6> is valued	<input type="checkbox"/>	<input type="checkbox"/>
	My <spouse/partner> and I discuss about what I am learning in this programme	<input type="checkbox"/>	<input type="checkbox"/>
	My parents and I discuss about what I am learning in this programme	<input type="checkbox"/>	<input type="checkbox"/>
	My friends find this <VET program> to be a good fit for me	<input type="checkbox"/>	<input type="checkbox"/>
	I upset my family by choosing this <VET program>	<input type="checkbox"/>	<input type="checkbox"/>
	Family and friends offer a good network to find a job	<input type="checkbox"/>	<input type="checkbox"/>
	My parents helped me economically to enrol in this <VET program>	<input type="checkbox"/>	<input type="checkbox"/>
	My parents want me to successfully complete this <VET program>	<input type="checkbox"/>	<input type="checkbox"/>
	My parents buy me learning material	<input type="checkbox"/>	<input type="checkbox"/>
	My parents make sure that I prepare well for tests and assignments	<input type="checkbox"/>	<input type="checkbox"/>
	In my free time I like to occupy myself with <contents> related to my skilled occupation.	<input type="checkbox"/>	<input type="checkbox"/>

Section on VET identity

Q77	These statements refer to your vocational education's identity. Please indicate your level of agreement or disagreement to each of these statements.					
		1	2	3	4	5
		I completely disagree	I somewhat disagree	I neither disagree nor agree	I somewhat agree	I completely agree
	I am proud of my vocation	<input type="checkbox"/>	<input type="checkbox"/>	<input type="checkbox"/>	<input type="checkbox"/>	<input type="checkbox"/>
	I deeply enjoy my vocation	<input type="checkbox"/>	<input type="checkbox"/>	<input type="checkbox"/>	<input type="checkbox"/>	<input type="checkbox"/>
	My vocation fits me	<input type="checkbox"/>	<input type="checkbox"/>	<input type="checkbox"/>	<input type="checkbox"/>	<input type="checkbox"/>
	My vocation is an integral part of who I am	<input type="checkbox"/>	<input type="checkbox"/>	<input type="checkbox"/>	<input type="checkbox"/>	<input type="checkbox"/>
	I am highly devoted to my vocation	<input type="checkbox"/>	<input type="checkbox"/>	<input type="checkbox"/>	<input type="checkbox"/>	<input type="checkbox"/>
	My skilled occupation is part of my personality	<input type="checkbox"/>	<input type="checkbox"/>	<input type="checkbox"/>	<input type="checkbox"/>	<input type="checkbox"/>
	Being a <name of the VET profession> is part of my personality	<input type="checkbox"/>	<input type="checkbox"/>	<input type="checkbox"/>	<input type="checkbox"/>	<input type="checkbox"/>

Thank you for your collaboration.

Teacher Questionnaire

Introduction

The wording of questions and response options is susceptible of adaptation to both country specificities and occupational areas. The symbol < > indicates that the terms within angle brackets should be adapted to national or occupational contexts. Similarly, the questionnaire used the ISCED classification to refer to educational levels. The ISCED level is indicated within <...>. The national project managers implementing the study, in collaboration with the contractors, are responsible for replacing the ISCED levels with the corresponding national levels or degrees.

The final sequence of the questions should be established considering screening questions, filters, and pivots. Testing and field trial of the items in the teacher questionnaire will lead to determine the optional sequence and question flow. The following questions and response option should be considered as preliminary and in need of further refinement to improve their effectiveness.

Sources for questions (directly drawn from, or modified from)

ETF (2022), ENESAT22-ETF Self-assessment Tool for Excellence, ENESAT 2022_EN.pdf.

OECD (2017), PISA 2015 Assessment and Analytical Framework: Science, Reading, Mathematic, Financial Literacy and Collaborative Problem Solving, PISA, OECD Publishing, Paris, <https://doi.org/10.1787/9789264281820-en>.

OECD (2019), PISA 2018 Assessment and Analytical Framework, PISA, OECD Publishing, Paris, <https://doi.org/10.1787/b25efab8-en>.

OECD (2023), PISA 2022 Assessment and Analytical Framework, PISA, OECD Publishing, Paris, <https://doi.org/10.1787/dfe0bf9c-en>.

OECD (2018), PISA for Development Assessment and Analytical Framework: Reading, Mathematics and Science, PISA, OECD Publishing, Paris, <https://doi.org/10.1787/9789264305274-en>.

PIAAC Background questionnaires, Cycle 1 and Cycle 2, [The background questionnaire of the Survey of Adult Skills \(PIAAC\)](#).

Tanggaard, L. (2005), “Collaborative teaching and learning in the workplace”, Journal of Vocational Education & Training, Vol. 57(1), pp. 109-122, <https://doi.org/10.1080/13636820500200278>.

Virtanen A., Tynjala, P. (2008), “Students’ Experiences of Workplace Learning in Finnish VET”, European Journal of Vocational Training, Vol. 44(2), pp. 200–213.

Virtanen A., Tynjala P. and Eteläpelto A. (2014), “Factors promoting vocational students’ learning at work: study on student experiences”, Journal of Education and Work, Vol. 27(1), pp. 43–70.

Section on teacher's demographic characteristics

Q1	On what date were you born?	
	Day	_____
	Month	_____
	Year	_____

Q2	How do you identify yourself? Please select one response	
	Female	<input type="checkbox"/>
	Male	<input type="checkbox"/>
	(For countries allowing nonbinary definitions of gender: <I identify myself another way>	<input type="checkbox"/>
	I prefer not to say.	<input type="checkbox"/>

Q3	In what country were you born? Please select one response	
	<This country>	<input type="checkbox"/> Go to Q5
	<Country A>	<input type="checkbox"/> Go to Q4
	<Country B>	<input type="checkbox"/> Go to Q4
	<Country C>	<input type="checkbox"/> Go to Q4
	Other country (indicate country name)	_____ Go to Q4

Q4	If you were NOT born in <This country>, how old were you when you arrived in <This country>.? (If you were less than 12-month-old, please write zero (0)).	
	Years	_____

Section on teacher health

Q5	During the past 12 months, have you had any of the following health problems? Please tick one box in each row		
		Yes	No
	A chronic disease (e.g., heart disease, diabetes, cancer, lung, or other respiratory problems)	<input type="checkbox"/>	<input type="checkbox"/>
	An infectious disease (e.g., Covid-19, long-Covid, influenza, salmonellosis)	<input type="checkbox"/>	<input type="checkbox"/>
	Gastrointestinal problems (e.g., heartburn, stomach pain, digestive issues)	<input type="checkbox"/>	<input type="checkbox"/>
	Recurring cold	<input type="checkbox"/>	<input type="checkbox"/>
	An injury that needed treatment	<input type="checkbox"/>	<input type="checkbox"/>
	Long-lasting or recurring pain	<input type="checkbox"/>	<input type="checkbox"/>
	Depression	<input type="checkbox"/>	<input type="checkbox"/>
	Panic and anxiety attacks	<input type="checkbox"/>	<input type="checkbox"/>
	Insomnia	<input type="checkbox"/>	<input type="checkbox"/>

Section on teachers' qualification and on educational and occupational background

Q6	What levels of formal education you have completed? Please select all that apply	
	<ISCED level 8>	<input type="checkbox"/>
	<ISCED level 7>	<input type="checkbox"/>
	<ISCED level 6>	<input type="checkbox"/>
	<ISCED level 5>	<input type="checkbox"/>

<ISCED level 4>	<input type="checkbox"/>
<ISCED level 34>	<input type="checkbox"/>
<ISCED level 35>	<input type="checkbox"/>
<ISCED level 36>	<input type="checkbox"/>
<ISCED level 2>	<input type="checkbox"/>
<teaching diploma to teach ISCED 2>	<input type="checkbox"/>
<teaching diploma to teach ISCED 34>	<input type="checkbox"/>
<teaching diploma to teach ISCED 4>	<input type="checkbox"/>
Else (indicate level of education)	_____

Q7	Were any of the following included in your teacher education, training programme, or other professional qualification? Are they part of your <job experience> and do you teach them to <PISA-VET Assessment> students in the current school year? <i>(Because this is an international survey, we had to categorise many of the actual subjects taught in programmes into broad categories. If the exact name of one of your subjects is not listed, please mark the category you think best fits the subject.)</i> Please select all that apply.				
		I teach it this year in this <VET programme>	It was my main discipline of training	It is part of my job experience	It was included in my teacher education or training program
	Reading, writing and literature	<input type="checkbox"/>	<input type="checkbox"/>	<input type="checkbox"/>	<input type="checkbox"/>
	Mathematics	<input type="checkbox"/>	<input type="checkbox"/>	<input type="checkbox"/>	<input type="checkbox"/>
	Science	<input type="checkbox"/>	<input type="checkbox"/>	<input type="checkbox"/>	<input type="checkbox"/>
	Technology	<input type="checkbox"/>	<input type="checkbox"/>	<input type="checkbox"/>	<input type="checkbox"/>
	Social studies	<input type="checkbox"/>	<input type="checkbox"/>	<input type="checkbox"/>	<input type="checkbox"/>
	Modern foreign languages	<input type="checkbox"/>	<input type="checkbox"/>	<input type="checkbox"/>	<input type="checkbox"/>
	<Occupational or country specific>	<input type="checkbox"/>	<input type="checkbox"/>	<input type="checkbox"/>	<input type="checkbox"/>
	<Occupational or country specific>	<input type="checkbox"/>	<input type="checkbox"/>	<input type="checkbox"/>	<input type="checkbox"/>
	<Occupational or country specific>	<input type="checkbox"/>	<input type="checkbox"/>	<input type="checkbox"/>	<input type="checkbox"/>

Q8	How many years of work experience do you have? <i>(Please round up to whole years no matter whether you worked part-time or full-time and write the appropriate number of years on each line. If any option does not apply to you write "0" (zero).)</i>	
	Year(s) working as a teacher <u>at this educational institution</u>	Years:
	Year(s) working as a teacher <u>in total</u>	Years:
	Year(s) working in other education roles (e.g., <curriculum developer>, <pedagogical leader>, or <...>)	Years:
	Years working as a teacher or as a <principal> of a <VET programme>.	Years:
	Years working as a teacher or as a <principal> of <general education> programme>	
	Years working in other jobs unrelated to the occupational areas of this <VET programme>	Years:
	Years working in jobs related to the occupational areas of this <VET programme>	Years:

Q9	Did you complete any pre-teaching service training in <VET programmes>? Please select one response	
	No	<input type="checkbox"/>
	Yes, up to a 1 year	<input type="checkbox"/>
	Yes, for 1 year	<input type="checkbox"/>
	Yes, for 2 years	<input type="checkbox"/>
	Yes, for 3 years or more	<input type="checkbox"/>

Q10	Did you complete any pre-teaching service training in one or more <companies> for the occupational specific skills that you currently teach? Please select one response	
	No	<input type="checkbox"/>
	Yes, up to a 1 year	<input type="checkbox"/>
	Yes, for 1 year	<input type="checkbox"/>
	Yes, for 2 years	<input type="checkbox"/>
	Yes, for 3 years or more	<input type="checkbox"/>

Section on teacher's role, other occupations, and teaching load in the current VET programme

Q11	What <subjects> do you teach at this <VET programme>? Please, select all that apply	
	AAAA	<input type="checkbox"/>
	BBBB	<input type="checkbox"/>
	CCCC	<input type="checkbox"/>
	DDDD	<input type="checkbox"/>
	EEEE	<input type="checkbox"/>
	<occupation or country specific>	<input type="checkbox"/>
	<occupation or country specific>	<input type="checkbox"/>

Q12	In this <VET programme>, do you specifically teach:		
		Yes	No
	Vocational theory	<input type="checkbox"/>	<input type="checkbox"/>
	Vocational practice	<input type="checkbox"/>	<input type="checkbox"/>

Q13	Are you a <permanent> or <non-permanent> teacher? Please select only one response	
	<Permanent> teacher who is paid by the government (<permanent> and pensionable, paid by public institutions, such as <local or regional governments or national government>).	<input type="checkbox"/>
	<Permanent> teacher who is not paid by the government (<permanent> and pensionable, paid by private institutions such as <churches, private companies and organisations, or NGOs>).	<input type="checkbox"/>
	<Non-permanent> teacher (temporary, contract, or student teacher) who is paid by the government.	<input type="checkbox"/>
	<Non-permanent> teacher (temporary, contract, or student teacher) who is not paid by the government.	<input type="checkbox"/>

Q14	In how many educational institutions do you currently teach? Please select only one response	
	In this educational institution only	<input type="checkbox"/>
	In this educational institution and in one other educational institution	<input type="checkbox"/>
	In this educational institution and in two other educational institutions	<input type="checkbox"/>
	In this educational institution and in more than two other educational institutions	<input type="checkbox"/>

Q15	Do you have another or more jobs that are not related to teaching?		
	Yes	<input type="checkbox"/>	Go to Q16
	No	<input type="checkbox"/>	Go to Q18

Q16	Are these jobs related to the occupational area that you teach in this <VET programme>?	
	Yes	<input type="checkbox"/>
	No	<input type="checkbox"/>

Q17	In addition to teaching in this <VET programme>, how many hours per week do you work in the other jobs that is not related to teaching?
	Hours _____

Section on teacher's training needs and desire for professional development.

Q18	Please state your own need for advanced training in the following areas. Indicate the level of need in each area	Indicate the level of need in each area		
		No need	Average need	Great need
	Educational standards in your subject matters	<input type="checkbox"/>	<input type="checkbox"/>	<input type="checkbox"/>
	Assessment methods	<input type="checkbox"/>	<input type="checkbox"/>	<input type="checkbox"/>
	Classroom management	<input type="checkbox"/>	<input type="checkbox"/>	<input type="checkbox"/>
	Expert knowledge in the occupational area	<input type="checkbox"/>	<input type="checkbox"/>	<input type="checkbox"/>
	Planning and implementing online teaching	<input type="checkbox"/>	<input type="checkbox"/>	<input type="checkbox"/>
	Teaching with simulation software	<input type="checkbox"/>	<input type="checkbox"/>	<input type="checkbox"/>
	Teaching of students with special learning needs	<input type="checkbox"/>	<input type="checkbox"/>	<input type="checkbox"/>
	Teaching of students with < Your country language> as a second language	<input type="checkbox"/>	<input type="checkbox"/>	<input type="checkbox"/>
	Handling disciplinary and behavioural problems	<input type="checkbox"/>	<input type="checkbox"/>	<input type="checkbox"/>
	Interaction with educational institution board and administration	<input type="checkbox"/>	<input type="checkbox"/>	<input type="checkbox"/>
	Teaching in a multicultural environment	<input type="checkbox"/>	<input type="checkbox"/>	<input type="checkbox"/>
	Counselling of students	<input type="checkbox"/>	<input type="checkbox"/>	<input type="checkbox"/>
	Integrative teaching (for e.g., individualization and differentiation in inclusive educational opportunities)	<input type="checkbox"/>	<input type="checkbox"/>	<input type="checkbox"/>

Q19	Have you participated in the following training activities during the past 12 months?	Indicate your response	
		Yes	No
	Courses or workshops on pedagogical practices	<input type="checkbox"/>	<input type="checkbox"/>
	Courses or workshops to update <vocational> skills and competencies	<input type="checkbox"/>	<input type="checkbox"/>
	Educational conferences or seminars (during which teachers and/or researchers present research results and discuss education-related issues)	<input type="checkbox"/>	<input type="checkbox"/>
	Qualification programs (e.g. higher education courses)	<input type="checkbox"/>	<input type="checkbox"/>
	Sitting in on classes at other educational institutions	<input type="checkbox"/>	<input type="checkbox"/>
	Sitting in on classes in <company training>	<input type="checkbox"/>	<input type="checkbox"/>
	Participation in a working group specially designed for the professional development of teachers (e.g. projects, model tests)	<input type="checkbox"/>	<input type="checkbox"/>
	Individual or joint research work on a topic which is of professional interest to you as a teacher	<input type="checkbox"/>	<input type="checkbox"/>
	Mentor programs, "peer observation" or training programs (as part of a formal agreement)	<input type="checkbox"/>	<input type="checkbox"/>

Section on infrastructural and didactic resources.

Note for questionnaire design: these questions are lengthy and may lead to acquiescent response set. Further editing and field trial will help trimming them. The questions could also be split down further and distributed in the questionnaire.

Q20	The following questions refer to infrastructural and didactic resources in your educational institution. If you teach in multiple educational institutions or buildings, think about the place where you spend the most time. Do you have the following resources in your educational institution, and if so, in what condition are they? Please, tick one box in each row	No, not available	Yes, but in poor conditions	Yes, but in need of minor repairs	Yes, in good conditions
	Chairs for students	<input type="checkbox"/>	<input type="checkbox"/>	<input type="checkbox"/>	<input type="checkbox"/>
	Desks for students	<input type="checkbox"/>	<input type="checkbox"/>	<input type="checkbox"/>	<input type="checkbox"/>
	Writing board (black, white, green)	<input type="checkbox"/>	<input type="checkbox"/>	<input type="checkbox"/>	<input type="checkbox"/>
	Electronic board	<input type="checkbox"/>	<input type="checkbox"/>	<input type="checkbox"/>	<input type="checkbox"/>
	Screen	<input type="checkbox"/>	<input type="checkbox"/>	<input type="checkbox"/>	<input type="checkbox"/>
	Digital projector connected to instructor's computer	<input type="checkbox"/>	<input type="checkbox"/>	<input type="checkbox"/>	<input type="checkbox"/>
	Workbooks	<input type="checkbox"/>	<input type="checkbox"/>	<input type="checkbox"/>	<input type="checkbox"/>
	Work sheets	<input type="checkbox"/>	<input type="checkbox"/>	<input type="checkbox"/>	<input type="checkbox"/>
	Dictionary	<input type="checkbox"/>	<input type="checkbox"/>	<input type="checkbox"/>	<input type="checkbox"/>
	Reading, mathematics, or science textbooks	<input type="checkbox"/>	<input type="checkbox"/>	<input type="checkbox"/>	<input type="checkbox"/>
	<occupation specific> textbooks	<input type="checkbox"/>	<input type="checkbox"/>	<input type="checkbox"/>	<input type="checkbox"/>
	Online textbooks	<input type="checkbox"/>	<input type="checkbox"/>	<input type="checkbox"/>	<input type="checkbox"/>
	Online manuals	<input type="checkbox"/>	<input type="checkbox"/>	<input type="checkbox"/>	<input type="checkbox"/>
	Reference books for teachers	<input type="checkbox"/>	<input type="checkbox"/>	<input type="checkbox"/>	<input type="checkbox"/>
	Teacher's guide	<input type="checkbox"/>	<input type="checkbox"/>	<input type="checkbox"/>	<input type="checkbox"/>
	Workshop	<input type="checkbox"/>	<input type="checkbox"/>	<input type="checkbox"/>	<input type="checkbox"/>
	School library	<input type="checkbox"/>	<input type="checkbox"/>	<input type="checkbox"/>	<input type="checkbox"/>
	<Training room linked to the subject of study>	<input type="checkbox"/>	<input type="checkbox"/>	<input type="checkbox"/>	<input type="checkbox"/>
	<simulation room>	<input type="checkbox"/>	<input type="checkbox"/>	<input type="checkbox"/>	<input type="checkbox"/>
	Gym	<input type="checkbox"/>	<input type="checkbox"/>	<input type="checkbox"/>	<input type="checkbox"/>
	Teacher table and chair	<input type="checkbox"/>	<input type="checkbox"/>	<input type="checkbox"/>	<input type="checkbox"/>
	Room for student guidance or counselling	<input type="checkbox"/>	<input type="checkbox"/>	<input type="checkbox"/>	<input type="checkbox"/>
	Student study room	<input type="checkbox"/>	<input type="checkbox"/>	<input type="checkbox"/>	<input type="checkbox"/>
	<Education resource centre>	<input type="checkbox"/>	<input type="checkbox"/>	<input type="checkbox"/>	<input type="checkbox"/>
	<Area for productive projects>	<input type="checkbox"/>	<input type="checkbox"/>	<input type="checkbox"/>	<input type="checkbox"/>
	<Occupation specific>	<input type="checkbox"/>	<input type="checkbox"/>	<input type="checkbox"/>	<input type="checkbox"/>

Q21	How often do you use the following resources in your lessons? Please tick one box in each row	<i>I have never used it</i>	<i>About one to three times a year</i>	<i>About once or twice a month</i>	<i>About once or twice a week</i>	<i>Daily</i>
	Writing board (black, white, green)	<input type="checkbox"/>	<input type="checkbox"/>	<input type="checkbox"/>	<input type="checkbox"/>	<input type="checkbox"/>
	Electronic board	<input type="checkbox"/>	<input type="checkbox"/>	<input type="checkbox"/>	<input type="checkbox"/>	<input type="checkbox"/>
	Screen	<input type="checkbox"/>	<input type="checkbox"/>	<input type="checkbox"/>	<input type="checkbox"/>	<input type="checkbox"/>
	Digital projector connected to instructor's computer	<input type="checkbox"/>	<input type="checkbox"/>	<input type="checkbox"/>	<input type="checkbox"/>	<input type="checkbox"/>
	Workbooks	<input type="checkbox"/>	<input type="checkbox"/>	<input type="checkbox"/>	<input type="checkbox"/>	<input type="checkbox"/>
	Work sheets	<input type="checkbox"/>	<input type="checkbox"/>	<input type="checkbox"/>	<input type="checkbox"/>	<input type="checkbox"/>
	Dictionary	<input type="checkbox"/>	<input type="checkbox"/>	<input type="checkbox"/>	<input type="checkbox"/>	<input type="checkbox"/>
	Reading, mathematics, or science textbooks	<input type="checkbox"/>	<input type="checkbox"/>	<input type="checkbox"/>	<input type="checkbox"/>	<input type="checkbox"/>

	<occupation specific> textbooks	<input type="checkbox"/>	<input type="checkbox"/>	<input type="checkbox"/>	<input type="checkbox"/>	<input type="checkbox"/>
	Online textbooks	<input type="checkbox"/>	<input type="checkbox"/>	<input type="checkbox"/>	<input type="checkbox"/>	<input type="checkbox"/>
	Online manuals	<input type="checkbox"/>	<input type="checkbox"/>	<input type="checkbox"/>	<input type="checkbox"/>	<input type="checkbox"/>
	Reference books for teachers	<input type="checkbox"/>	<input type="checkbox"/>	<input type="checkbox"/>	<input type="checkbox"/>	<input type="checkbox"/>
	Teacher's guide	<input type="checkbox"/>	<input type="checkbox"/>	<input type="checkbox"/>	<input type="checkbox"/>	<input type="checkbox"/>
	Workshop	<input type="checkbox"/>	<input type="checkbox"/>	<input type="checkbox"/>	<input type="checkbox"/>	<input type="checkbox"/>
	School library	<input type="checkbox"/>	<input type="checkbox"/>	<input type="checkbox"/>	<input type="checkbox"/>	<input type="checkbox"/>
	<Training room>	<input type="checkbox"/>	<input type="checkbox"/>	<input type="checkbox"/>	<input type="checkbox"/>	<input type="checkbox"/>
	<Simulation room>	<input type="checkbox"/>	<input type="checkbox"/>	<input type="checkbox"/>	<input type="checkbox"/>	<input type="checkbox"/>
	Gym	<input type="checkbox"/>	<input type="checkbox"/>	<input type="checkbox"/>	<input type="checkbox"/>	<input type="checkbox"/>
	Teacher table and chair	<input type="checkbox"/>	<input type="checkbox"/>	<input type="checkbox"/>	<input type="checkbox"/>	<input type="checkbox"/>
	Room for student guidance or counselling	<input type="checkbox"/>	<input type="checkbox"/>	<input type="checkbox"/>	<input type="checkbox"/>	<input type="checkbox"/>
	Student study room	<input type="checkbox"/>	<input type="checkbox"/>	<input type="checkbox"/>	<input type="checkbox"/>	<input type="checkbox"/>
	<Education resource centre>	<input type="checkbox"/>	<input type="checkbox"/>	<input type="checkbox"/>	<input type="checkbox"/>	<input type="checkbox"/>
	<Area for productive projects>	<input type="checkbox"/>	<input type="checkbox"/>	<input type="checkbox"/>	<input type="checkbox"/>	<input type="checkbox"/>
	Teacher table and chair	<input type="checkbox"/>	<input type="checkbox"/>	<input type="checkbox"/>	<input type="checkbox"/>	<input type="checkbox"/>
	<Occupation specific>	<input type="checkbox"/>	<input type="checkbox"/>	<input type="checkbox"/>	<input type="checkbox"/>	<input type="checkbox"/>

Q22	Do you have the following resources in this educational institution, and if so, in what condition are they?				
		<i>No, not available</i>	<i>Yes, but in poor condition</i>	<i>Yes, but in need of minor repairs</i>	<i>Yes, in good condition</i>
	Computers for students	<input type="checkbox"/>	<input type="checkbox"/>	<input type="checkbox"/>	<input type="checkbox"/>
	Internet connection for students	<input type="checkbox"/>	<input type="checkbox"/>	<input type="checkbox"/>	<input type="checkbox"/>
	Computers for teachers	<input type="checkbox"/>	<input type="checkbox"/>	<input type="checkbox"/>	<input type="checkbox"/>
	Internet connection for teachers	<input type="checkbox"/>	<input type="checkbox"/>	<input type="checkbox"/>	<input type="checkbox"/>
	Computers for administrative use	<input type="checkbox"/>	<input type="checkbox"/>	<input type="checkbox"/>	<input type="checkbox"/>
	Computer room	<input type="checkbox"/>	<input type="checkbox"/>	<input type="checkbox"/>	<input type="checkbox"/>
	Workshop	<input type="checkbox"/>	<input type="checkbox"/>	<input type="checkbox"/>	<input type="checkbox"/>
	Science lab	<input type="checkbox"/>	<input type="checkbox"/>	<input type="checkbox"/>	<input type="checkbox"/>
	<Occupation specific lab>	<input type="checkbox"/>	<input type="checkbox"/>	<input type="checkbox"/>	<input type="checkbox"/>
	Photocopier	<input type="checkbox"/>	<input type="checkbox"/>	<input type="checkbox"/>	<input type="checkbox"/>
	Digital projector	<input type="checkbox"/>	<input type="checkbox"/>	<input type="checkbox"/>	<input type="checkbox"/>
	Audio or video players (e.g., CD, DVD, or VCD)	<input type="checkbox"/>	<input type="checkbox"/>	<input type="checkbox"/>	<input type="checkbox"/>
	Radio	<input type="checkbox"/>	<input type="checkbox"/>	<input type="checkbox"/>	<input type="checkbox"/>
	TV or screens	<input type="checkbox"/>	<input type="checkbox"/>	<input type="checkbox"/>	<input type="checkbox"/>
	Teacher staff room	<input type="checkbox"/>	<input type="checkbox"/>	<input type="checkbox"/>	<input type="checkbox"/>
	School administrative office	<input type="checkbox"/>	<input type="checkbox"/>	<input type="checkbox"/>	<input type="checkbox"/>
	Storage room	<input type="checkbox"/>	<input type="checkbox"/>	<input type="checkbox"/>	<input type="checkbox"/>
	<Education resource centre>	<input type="checkbox"/>	<input type="checkbox"/>	<input type="checkbox"/>	<input type="checkbox"/>
	<Occupation specific machines/tools>	<input type="checkbox"/>	<input type="checkbox"/>	<input type="checkbox"/>	<input type="checkbox"/>
	<Occupation specific simulators>	<input type="checkbox"/>	<input type="checkbox"/>	<input type="checkbox"/>	<input type="checkbox"/>
	<Occupation or country specific>	<input type="checkbox"/>	<input type="checkbox"/>	<input type="checkbox"/>	<input type="checkbox"/>
	<Occupation or country specific>	<input type="checkbox"/>	<input type="checkbox"/>	<input type="checkbox"/>	<input type="checkbox"/>

Q23	Do students in your educational institution have [digital] textbooks or manuals for instruction in <XXXXXXX>? Tick only one box	
	Yes, every student has at least one.	<input type="checkbox"/>
	Yes, but not enough. Sometimes two students need to share a textbook.	<input type="checkbox"/>
	Yes, but so few that sometimes more than two students need to share a textbook.	<input type="checkbox"/>
	No, there are no textbooks.	<input type="checkbox"/>

Q24	How often do you use the following resources in your lessons?					
		<i>I have never used it</i>	<i>About one to three times a year</i>	<i>About once or twice a month</i>	<i>About once or twice a week</i>	<i>Daily</i>
	Computers for students	<input type="checkbox"/>	<input type="checkbox"/>	<input type="checkbox"/>	<input type="checkbox"/>	<input type="checkbox"/>
	Internet connection for students	<input type="checkbox"/>	<input type="checkbox"/>	<input type="checkbox"/>	<input type="checkbox"/>	<input type="checkbox"/>
	Computers for teachers	<input type="checkbox"/>	<input type="checkbox"/>	<input type="checkbox"/>	<input type="checkbox"/>	<input type="checkbox"/>
	Internet connection for teachers	<input type="checkbox"/>	<input type="checkbox"/>	<input type="checkbox"/>	<input type="checkbox"/>	<input type="checkbox"/>
	Photocopier	<input type="checkbox"/>	<input type="checkbox"/>	<input type="checkbox"/>	<input type="checkbox"/>	<input type="checkbox"/>
	Overhead or slide projector	<input type="checkbox"/>	<input type="checkbox"/>	<input type="checkbox"/>	<input type="checkbox"/>	<input type="checkbox"/>
	Audio and video disk players (e.g., CD, DVD, or VCD)	<input type="checkbox"/>	<input type="checkbox"/>	<input type="checkbox"/>	<input type="checkbox"/>	<input type="checkbox"/>
	Radio	<input type="checkbox"/>	<input type="checkbox"/>	<input type="checkbox"/>	<input type="checkbox"/>	<input type="checkbox"/>
	TV or screens	<input type="checkbox"/>	<input type="checkbox"/>	<input type="checkbox"/>	<input type="checkbox"/>	<input type="checkbox"/>
	Computer room	<input type="checkbox"/>	<input type="checkbox"/>	<input type="checkbox"/>	<input type="checkbox"/>	<input type="checkbox"/>
	<Area for productive projects>	<input type="checkbox"/>	<input type="checkbox"/>	<input type="checkbox"/>	<input type="checkbox"/>	<input type="checkbox"/>
	<Virtual reality headsets>	<input type="checkbox"/>	<input type="checkbox"/>	<input type="checkbox"/>	<input type="checkbox"/>	<input type="checkbox"/>
	<Machines>	<input type="checkbox"/>	<input type="checkbox"/>	<input type="checkbox"/>	<input type="checkbox"/>	<input type="checkbox"/>
	<Domain specific simulators>	<input type="checkbox"/>	<input type="checkbox"/>	<input type="checkbox"/>	<input type="checkbox"/>	<input type="checkbox"/>
	<Domain specific>	<input type="checkbox"/>	<input type="checkbox"/>	<input type="checkbox"/>	<input type="checkbox"/>	<input type="checkbox"/>

Section on language used for teaching.

Q25	Think about your teaching practices. In case you teach at different educational institutions or in different programs, please respond thinking about the college or the <VET programme> where you work the most. What language do you use when teaching your students? Please selected one only		
			<input type="checkbox"/>
	Only <language of instruction>		<input type="checkbox"/>
	Mostly <language of instruction> but sometimes their <home language or native language>		<input type="checkbox"/>
	Sometimes <language of instruction> and sometimes their <home language or native language >		<input type="checkbox"/>
	Mostly their <home language or native language >		<input type="checkbox"/>
	Always their <home language or native language >		<input type="checkbox"/>

Q26	When the < language of instruction> is not the <home language or native language> of some of your students, how often do you speak [or ask support from a cultural mediator/student peer?] with them using their <home language or native language>?			
		Never	Sometimes	Most of the time
	When students are new to the educational institution	<input type="checkbox"/>	<input type="checkbox"/>	<input type="checkbox"/>
	When students are new immigrants to the country.	<input type="checkbox"/>	<input type="checkbox"/>	<input type="checkbox"/>
	When I explain complex concepts.	<input type="checkbox"/>	<input type="checkbox"/>	<input type="checkbox"/>
	When I try to engage them in a discussion.	<input type="checkbox"/>	<input type="checkbox"/>	<input type="checkbox"/>
	When I want them to feel appreciated.	<input type="checkbox"/>	<input type="checkbox"/>	<input type="checkbox"/>
	When they struggle learning the curriculum.	<input type="checkbox"/>	<input type="checkbox"/>	<input type="checkbox"/>

Section on inclusion.

Q27	Think of a typical <class> that you teach. What proportion of your students lack the numeracy skills required to learn the curriculum? Please select only one option		
			<input type="checkbox"/>
	Only a small proportion (less than 10%)		<input type="checkbox"/>
	About one-quarter of the class (25%)		<input type="checkbox"/>
	About one-half of the class (50%)		<input type="checkbox"/>
	About three-quarters of the class (75%)		<input type="checkbox"/>
	Most or all the students in the class (more than 90%)		<input type="checkbox"/>

Q28	Think of a typical <class> that you teach. What proportion of your students lack the reading skills required to learn the curriculum? Please select only one option	
	Only a small proportion (less than 10%)	<input type="checkbox"/>
	About one quarter of the class (25%)	<input type="checkbox"/>
	About one-half of the class (50%)	<input type="checkbox"/>
	About three quarters of the class (75%)	<input type="checkbox"/>
	Most or all the students in the class (more than 90%)	<input type="checkbox"/>

Q29	To what extent do you agree with the following statements? Please tick a box in each row				
		Strongly disagree	Disagree	Agree	Strongly agree
	The students who are behind are the grade repeaters	<input type="checkbox"/>	<input type="checkbox"/>	<input type="checkbox"/>	<input type="checkbox"/>
	Teachers and instructors should try to teach the curriculum, even to those students who do not have the basics reading and numeracy skills	<input type="checkbox"/>	<input type="checkbox"/>	<input type="checkbox"/>	<input type="checkbox"/>
	Students with disabilities should be taught in separate <special schools>	<input type="checkbox"/>	<input type="checkbox"/>	<input type="checkbox"/>	<input type="checkbox"/>
	It takes too much out of teachers and instructors to teach students with disabilities	<input type="checkbox"/>	<input type="checkbox"/>	<input type="checkbox"/>	<input type="checkbox"/>
	Teachers waste their time trying to support students who don't have a vocation for this <VET programme>	<input type="checkbox"/>	<input type="checkbox"/>	<input type="checkbox"/>	<input type="checkbox"/>
	Students are either talented for this <VET programme> or they are not	<input type="checkbox"/>	<input type="checkbox"/>	<input type="checkbox"/>	<input type="checkbox"/>
	Teachers should adjust the curriculum to the cultural diversity of their <classrooms>	<input type="checkbox"/>	<input type="checkbox"/>	<input type="checkbox"/>	<input type="checkbox"/>
	Students who lag behind should be given a probationary period and then be told out of the programme	<input type="checkbox"/>	<input type="checkbox"/>	<input type="checkbox"/>	<input type="checkbox"/>
	Students who are absent or drop out are a drain resources from the system	<input type="checkbox"/>	<input type="checkbox"/>	<input type="checkbox"/>	<input type="checkbox"/>
	Teachers struggle to teach classes with gender minorities	<input type="checkbox"/>	<input type="checkbox"/>	<input type="checkbox"/>	<input type="checkbox"/>
	Teachers struggle to teach classes with ethnic minorities	<input type="checkbox"/>	<input type="checkbox"/>	<input type="checkbox"/>	<input type="checkbox"/>

Q30	In your <classes>, what strategies do you and your colleagues typically use for teaching students who lack the basic skills, including numeracy or literacy skills, to learn the curriculum?		
		Yes	No
	We offer separate <lessons>	<input type="checkbox"/>	<input type="checkbox"/>
	We occasionally meet with students outside of <class> hours to give them extra help	<input type="checkbox"/>	<input type="checkbox"/>
	We set up lower achievement goals for them	<input type="checkbox"/>	<input type="checkbox"/>
	We teach the rest of the <class> while they work on specific remedial exercises	<input type="checkbox"/>	<input type="checkbox"/>
	We pair them with stronger students to do group activities or projects	<input type="checkbox"/>	<input type="checkbox"/>
	We work with teaching support staff to come to our <classes> and work with them	<input type="checkbox"/>	<input type="checkbox"/>
	We vary the learning activities so that all students can learn	<input type="checkbox"/>	<input type="checkbox"/>
	We advise students to take <remedial classes> outside of regular school hours	<input type="checkbox"/>	<input type="checkbox"/>
	We require students to do extra homework by increasing their workload	<input type="checkbox"/>	<input type="checkbox"/>
	We suggest them to find a <private tutor>	<input type="checkbox"/>	<input type="checkbox"/>
	We sit them beside stronger students who can help them	<input type="checkbox"/>	<input type="checkbox"/>
	We sit them with other students who struggle and let them work on simpler tasks	<input type="checkbox"/>	<input type="checkbox"/>

Section on effective learning time and teachers' absenteeism.

Q31	During the last month, did any of the following situations prevent you from going to work?			
		Yes	If yes, how many working days	No
	I experienced a physical illness	<input type="checkbox"/>	___	<input type="checkbox"/>
	I experienced emotional or mental health problems	<input type="checkbox"/>	___	<input type="checkbox"/>
	Someone in my family was sick	<input type="checkbox"/>	___	<input type="checkbox"/>
	Someone in my family needed care	<input type="checkbox"/>	___	<input type="checkbox"/>
	I had to run errands	<input type="checkbox"/>	___	<input type="checkbox"/>
	I had an appointment with a doctor or dentist	<input type="checkbox"/>	___	<input type="checkbox"/>
	I was hospitalised	<input type="checkbox"/>	___	<input type="checkbox"/>
	There was a death in my family	<input type="checkbox"/>	___	<input type="checkbox"/>
	I had a conflict with the educational institution principal	<input type="checkbox"/>	___	<input type="checkbox"/>
	I had a conflict with the educational institution colleagues	<input type="checkbox"/>	___	<input type="checkbox"/>
	There was violence in the educational institution	<input type="checkbox"/>	___	<input type="checkbox"/>
	There was a strike	<input type="checkbox"/>	___	<input type="checkbox"/>
	There was no public transportation to reach the educational institution	<input type="checkbox"/>	___	<input type="checkbox"/>
	I did not have my own mean of transportation to reach the educational institution	<input type="checkbox"/>	___	<input type="checkbox"/>
	There was extreme weather or a hazard (e.g., heavy rain, fire)	<input type="checkbox"/>	___	<input type="checkbox"/>

Section on teaching approach, mindset, and teaching practices.

Q32	Please indicate whether the following statements apply to the teachers and instructors at your educational institution.		
		Yes	No
	Teachers resist to making changes at our educational institution.	<input type="checkbox"/>	<input type="checkbox"/>
	Teachers are accustomed to being evaluated in their teaching methods based on student's achievement results.	<input type="checkbox"/>	<input type="checkbox"/>
	Teachers in our educational institution want to learn new teaching methods.	<input type="checkbox"/>	<input type="checkbox"/>
	Teachers in our educational institution experiment on new teaching approaches in class.	<input type="checkbox"/>	<input type="checkbox"/>
	Teachers and the principal at our educational institution collaborate to develop the educational institution 's unique pedagogical concept.	<input type="checkbox"/>	<input type="checkbox"/>
	Our educational institution is actively trying to grow and develop.	<input type="checkbox"/>	<input type="checkbox"/>
	Our educational institution struggles to recruit staff with appropriate academic and vocational skills to teach students	<input type="checkbox"/>	<input type="checkbox"/>

Q33	How often do you participate in the following activities at your educational institution?				
		Never	Less than once a year	Once a year	Three to four times a year
	Teachers and principal plenary meetings and discussions regarding the programme's perspectives and mission	<input type="checkbox"/>	<input type="checkbox"/>	<input type="checkbox"/>	<input type="checkbox"/>
	Teachers' group sessions to developing parts of or the full curriculum	<input type="checkbox"/>	<input type="checkbox"/>	<input type="checkbox"/>	<input type="checkbox"/>
	Disciplinary-based group discussions on teaching media (e.g. textbooks, workbooks, manuals)	<input type="checkbox"/>	<input type="checkbox"/>	<input type="checkbox"/>	<input type="checkbox"/>
	Informal exchanging of teaching materials with colleagues	<input type="checkbox"/>	<input type="checkbox"/>	<input type="checkbox"/>	<input type="checkbox"/>
	Teachers' formal discussions that focus on specific groups of students (e.g. focus on non-native language speakers on younger age group, or on students with disability)	<input type="checkbox"/>	<input type="checkbox"/>	<input type="checkbox"/>	<input type="checkbox"/>

	Teachers-parents discussions on the learning progress of individual students	<input type="checkbox"/>	<input type="checkbox"/>	<input type="checkbox"/>	<input type="checkbox"/>
	Teachers-student discussions on the learning progress of individual students	<input type="checkbox"/>	<input type="checkbox"/>	<input type="checkbox"/>	<input type="checkbox"/>
	Team teaching session as part of a course	<input type="checkbox"/>	<input type="checkbox"/>	<input type="checkbox"/>	<input type="checkbox"/>
	Professional learning activities (e.g. team supervision)	<input type="checkbox"/>	<input type="checkbox"/>	<input type="checkbox"/>	<input type="checkbox"/>
	Observation sessions in other colleagues' classes or in other programmes (including giving feedback)	<input type="checkbox"/>	<input type="checkbox"/>	<input type="checkbox"/>	<input type="checkbox"/>
	Multi-level projects, like joining activities across different levels and age groups	<input type="checkbox"/>	<input type="checkbox"/>	<input type="checkbox"/>	<input type="checkbox"/>
	Invited visits in the classroom of someone with industrial experience	<input type="checkbox"/>	<input type="checkbox"/>	<input type="checkbox"/>	<input type="checkbox"/>

Section on teaching approach, mindset, and teaching practices focusing on student advising and guidance.

Q34	How do you and your colleagues at your educational institution ensure that students are well placed to enter <skilled employment / good jobs> at the end of their programmes?		
		Yes	No
	We advise students to meet with career guidance counsellors	<input type="checkbox"/>	<input type="checkbox"/>
	We require students to speak with career guidance counsellors	<input type="checkbox"/>	<input type="checkbox"/>
	We organize programmes of career talks with guest speakers	<input type="checkbox"/>	<input type="checkbox"/>
	We share online resources	<input type="checkbox"/>	<input type="checkbox"/>
	We organize introductions to potential employers	<input type="checkbox"/>	<input type="checkbox"/>
	We offer workshops for development of application and interview skills	<input type="checkbox"/>	<input type="checkbox"/>

Q35	How does your educational institution ensure that students are appropriately recruited onto the programmes you teach?		
		Yes	No
	The educational institution organizes Open Days	<input type="checkbox"/>	<input type="checkbox"/>
	The educational institution asks us teachers to give presentations at feeder educational institutions	<input type="checkbox"/>	<input type="checkbox"/>
	The educational institution offers online resources	<input type="checkbox"/>	<input type="checkbox"/>
	The educational institution involves people who work in professions linked to the programme to engage with potential students	<input type="checkbox"/>	<input type="checkbox"/>
	<country specific>	<input type="checkbox"/>	<input type="checkbox"/>

Section on learning venues and coordination between educational institution, programmes, and the workplace.

Q36	How often do teachers in your <VET programme> meet with the <company/training company/workplace> liaisons and trainers to do the following?				
		Never	Less than once a year	Once a year	Three to four times a year
	Collaborate on an interdisciplinary level with a focus on joint themes for school and <company> learning	<input type="checkbox"/>	<input type="checkbox"/>	<input type="checkbox"/>	<input type="checkbox"/>
	Coordinate students' schedule for alternate schoolwork	<input type="checkbox"/>	<input type="checkbox"/>	<input type="checkbox"/>	<input type="checkbox"/>
	Integrate the educational and the training components of the curriculum	<input type="checkbox"/>	<input type="checkbox"/>	<input type="checkbox"/>	<input type="checkbox"/>
	Develop an assessment approach	<input type="checkbox"/>	<input type="checkbox"/>	<input type="checkbox"/>	<input type="checkbox"/>

	Bring in industry professionals to the classroom to teach certain parts of the curriculum	<input type="checkbox"/>	<input type="checkbox"/>	<input type="checkbox"/>	<input type="checkbox"/>
	Coordinate with the <company> to bring in industry professionals to the classroom	<input type="checkbox"/>	<input type="checkbox"/>	<input type="checkbox"/>	<input type="checkbox"/>
	Schedule alternance between learning and assessments, in the educational institution and on the workplace	<input type="checkbox"/>	<input type="checkbox"/>	<input type="checkbox"/>	<input type="checkbox"/>
	Discuss the progress of students	<input type="checkbox"/>	<input type="checkbox"/>	<input type="checkbox"/>	<input type="checkbox"/>
	Discuss specific student cases	<input type="checkbox"/>	<input type="checkbox"/>	<input type="checkbox"/>	<input type="checkbox"/>
	Plan exercises and practices	<input type="checkbox"/>	<input type="checkbox"/>	<input type="checkbox"/>	<input type="checkbox"/>
	Visit workplaces to assess the progress of students in work-based learning	<input type="checkbox"/>	<input type="checkbox"/>	<input type="checkbox"/>	<input type="checkbox"/>
	<occupational areas specific>	<input type="checkbox"/>	<input type="checkbox"/>	<input type="checkbox"/>	<input type="checkbox"/>
	<occupational areas specific>	<input type="checkbox"/>	<input type="checkbox"/>	<input type="checkbox"/>	<input type="checkbox"/>
	<occupational areas specific>	<input type="checkbox"/>	<input type="checkbox"/>	<input type="checkbox"/>	<input type="checkbox"/>

Section on teacher job satisfaction

Q37	We would like to know how you generally feel about your job. To what extent do you agree with the following statements?				
		Strongly disagree	Disagree	Agree	Strongly Agree
	The advantages of being a teacher clearly outweigh the disadvantages	<input type="checkbox"/>	<input type="checkbox"/>	<input type="checkbox"/>	<input type="checkbox"/>
	If I could decide again, I would still choose to work as a teacher	<input type="checkbox"/>	<input type="checkbox"/>	<input type="checkbox"/>	<input type="checkbox"/>
	I regret that I decided to become a teacher	<input type="checkbox"/>	<input type="checkbox"/>	<input type="checkbox"/>	<input type="checkbox"/>
	I enjoy working at this educational institution	<input type="checkbox"/>	<input type="checkbox"/>	<input type="checkbox"/>	<input type="checkbox"/>
	I wonder whether it would have been better to choose another profession	<input type="checkbox"/>	<input type="checkbox"/>	<input type="checkbox"/>	<input type="checkbox"/>
	I would recommend my educational institution as a good place to work	<input type="checkbox"/>	<input type="checkbox"/>	<input type="checkbox"/>	<input type="checkbox"/>
	I am satisfied with my performance in this educational institution	<input type="checkbox"/>	<input type="checkbox"/>	<input type="checkbox"/>	<input type="checkbox"/>
	All in all, I am satisfied with my job	<input type="checkbox"/>	<input type="checkbox"/>	<input type="checkbox"/>	<input type="checkbox"/>

Q38	We would like to know more about your satisfaction with specific aspects of your job. To what extent do you agree with the following statements?				
		Strongly disagree	Disagree	Agree	Strongly Agree
	The salary that I receive is fair	<input type="checkbox"/>	<input type="checkbox"/>	<input type="checkbox"/>	<input type="checkbox"/>
	For the amount of time that I work every day, the pay is too low	<input type="checkbox"/>	<input type="checkbox"/>	<input type="checkbox"/>	<input type="checkbox"/>
	The employment benefits that I receive as a teacher meet my expectations	<input type="checkbox"/>	<input type="checkbox"/>	<input type="checkbox"/>	<input type="checkbox"/>
	The working conditions and longer holidays make up for the fact that teachers are not very well paid	<input type="checkbox"/>	<input type="checkbox"/>	<input type="checkbox"/>	<input type="checkbox"/>
	The <VET education> is a better work environment than the <companies/private sector/industry>	<input type="checkbox"/>	<input type="checkbox"/>	<input type="checkbox"/>	<input type="checkbox"/>
	The <VET education> is a safer place to work than the <companies/private sector/industry>	<input type="checkbox"/>	<input type="checkbox"/>	<input type="checkbox"/>	<input type="checkbox"/>
	<specific>	<input type="checkbox"/>	<input type="checkbox"/>	<input type="checkbox"/>	<input type="checkbox"/>

Thank you for your collaboration.

Person Most Knowledgeable (PMK) about the student in the work-based learning environment

Introduction

The wording of questions and response options is susceptible of adaptation to both country specificities and occupational areas. The symbol < > indicates that the terms within angle brackets should be adapted to national or occupational contexts. Similarly, the questionnaire used the ISCED classification to refer to educational levels. The ISCED level is indicated within <...>. The national project managers implementing the study, in collaboration with the contractors, are responsible for replacing the ISCED levels with the corresponding national levels or degrees.

The final sequence of the questions should be established considering screening questions, filters, and pivots. Testing and field trial of the items in the trainer questionnaire will lead to determine the optional sequence and question flow. The following questions and response option should be considered as preliminary and in need of further refinement to improve their effectiveness.

Additional items can be added for specific occupational areas. Moreover, new questions, occupational specific but coherent with the assessment framework, can be added.

The response options vary by questions, as trainers are asked to report on the frequency of different events or behaviours, on their attitudes, and on factual elements.

Additional considerations should be made after the field trial-data analysis to ensure that full response rates are achieved with the paper-handled version of this questionnaire. Viable alternatives could be emailed questionnaire or short in-person interview.

Sources for questions (directly drawn from, or modified from)

ETF (2022), ENESAT22-ETF Self-assessment Tool for Excellence, ENESAT 2022_EN.pdf.

OECD (2017), PISA 2015 Assessment and Analytical Framework: Science, Reading, Mathematic, Financial Literacy and Collaborative Problem Solving, PISA, OECD Publishing, Paris, <https://doi.org/10.1787/9789264281820-en>.

OECD (2019), PISA 2018 Assessment and Analytical Framework, PISA, OECD Publishing, Paris, <https://doi.org/10.1787/b25efab8-en>.

OECD (2023), PISA 2022 Assessment and Analytical Framework, PISA, OECD Publishing, Paris, <https://doi.org/10.1787/dfe0bf9c-en>.

OECD (2018), PISA for Development Assessment and Analytical Framework: Reading, Mathematics and Science, PISA, OECD Publishing, Paris, <https://doi.org/10.1787/9789264305274-en>.

PIAAC Background questionnaires, Cycle 1 and Cycle 2, [The background questionnaire of the Survey of Adult Skills \(PIAAC\)](#).

Tanggaard, L. (2005), "Collaborative teaching and learning in the workplace", Journal of Vocational Education & Training, Vol. 57(1), pp. 109-122, <https://doi.org/10.1080/13636820500200278>.

Virtanen A., Tynjala, P. (2008), "Students' Experiences of Workplace Learning in Finnish VET", European Journal of Vocational Training, Vol. 44(2), pp. 200–213.

Virtanen A., Tynjala P. and Eteläpelto A. (2014), "Factors promoting vocational students' learning at work: study on student experiences", Journal of Education and Work, Vol. 27(1), pp. 43–70.

Q1	How do you identify yourself? (Please select only one response)	
	Female	<input type="checkbox"/>
	Male	<input type="checkbox"/>
	<for countries with non-binary definition of gender: I define myself in another way>	<input type="checkbox"/>
	I prefer not to say	<input type="checkbox"/>

Q2	For how many years have you been working in this <company>?	
	Years	_____

Q3	For how many years have you been working in <this occupational sector>?	
	Years	_____

Q4	What levels of formal education you have completed? (Please select all that apply)	
	<ISCED level 8>	<input type="checkbox"/>
	<ISCED level 7>	<input type="checkbox"/>
	<ISCED level 6>	<input type="checkbox"/>
	<ISCED level 5>	<input type="checkbox"/>
	<ISCED level 4>	<input type="checkbox"/>
	<ISCED level 34>	<input type="checkbox"/>
	<ISCED level 35>	<input type="checkbox"/>
	<ISCED level 36>	<input type="checkbox"/>
	<ISCED level 2>	<input type="checkbox"/>
	<ISCED level 1>	<input type="checkbox"/>
	<below ISCED 1>	<input type="checkbox"/>
	<teaching diploma to teach ECEC or ISCED 0>	<input type="checkbox"/>
	<teaching diploma to teach ISCED 1>	<input type="checkbox"/>
	<teaching diploma to teach ISCED 2>	<input type="checkbox"/>
	<teaching diploma to teach ISCED 34>	<input type="checkbox"/>
	<teaching diploma to teach ISCED 4>	<input type="checkbox"/>

Q5	How many employees does your company have at the site where you offer training most of the time? Please include yourself and the trainees that you are <teaching or supervising>. (Choose one option only; you can approximate to the closest match)	
	1-4	<input type="checkbox"/>
	5-9	<input type="checkbox"/>
	10-49	<input type="checkbox"/>
	50-249	<input type="checkbox"/>
	250-499	<input type="checkbox"/>
	500-999	<input type="checkbox"/>
	1000 or more employees	<input type="checkbox"/>

Q6	In the last year, did you participate in any of these activities for continuous professional development?		
		No	Yes
	Training programmes organized by your <company> or by a <consortium>	<input type="checkbox"/>	<input type="checkbox"/>
	Training programmes organized by <VET schools>	<input type="checkbox"/>	<input type="checkbox"/>
	Seminars organized in your <company> or in <consortia	<input type="checkbox"/>	<input type="checkbox"/>

	Workshops organized by your <company>	<input type="checkbox"/>	<input type="checkbox"/>
	Workshops organized by <VET schools>	<input type="checkbox"/>	<input type="checkbox"/>
	Validation of <VET students> assessments	<input type="checkbox"/>	<input type="checkbox"/>
	Short courses or online courses paid by <your company>	<input type="checkbox"/>	<input type="checkbox"/>
	Short courses or online courses paid by <VET schools>	<input type="checkbox"/>	<input type="checkbox"/>
	Evening or weekend offers promoted by <your company>	<input type="checkbox"/>	<input type="checkbox"/>
	Evening or weekend offers promoted by <VET school>	<input type="checkbox"/>	<input type="checkbox"/>
	Traineeships for trainers	<input type="checkbox"/>	<input type="checkbox"/>
	Supervision and mentorship offered by more experienced colleagues	<input type="checkbox"/>	<input type="checkbox"/>
	Peer learning in group activities	<input type="checkbox"/>	<input type="checkbox"/>
	Study visits in other <companies>	<input type="checkbox"/>	<input type="checkbox"/>

Q7	Do you use any of the following while you work with your <trainees>?		
		No	Yes
	Training manual and guidelines provided by <your company>	<input type="checkbox"/>	<input type="checkbox"/>
	Training manual and guidelines provided by <VET school>	<input type="checkbox"/>	<input type="checkbox"/>
	Other training material	<input type="checkbox"/>	<input type="checkbox"/>
	<occupation specific>	<input type="checkbox"/>	<input type="checkbox"/>

Q8	How many <VET students> do you typically train in a <year> (Please tick only one box)		
	I am supervising my first trainee	<input type="checkbox"/>	
	<1-3>	<input type="checkbox"/>	
	<3-5>	<input type="checkbox"/>	
	<5-10>	<input type="checkbox"/>	
	<more than 10>	<input type="checkbox"/>	

Q9	Indicate what support you receive in the company to offer training to <trainees or apprentices>?		
		No	Yes
	Dedicated time as part of my workload	<input type="checkbox"/>	<input type="checkbox"/>
	A dedicated teaching space to meet with the trainees	<input type="checkbox"/>	<input type="checkbox"/>
	Adequate material and infrastructure for training purposes	<input type="checkbox"/>	<input type="checkbox"/>
	An office or dedicated meeting space	<input type="checkbox"/>	<input type="checkbox"/>
	<occupational specific material resources>	<input type="checkbox"/>	<input type="checkbox"/>
	<occupational specific material resources>	<input type="checkbox"/>	<input type="checkbox"/>
	Administrative support	<input type="checkbox"/>	<input type="checkbox"/>
	Grants or funding for professional development	<input type="checkbox"/>	<input type="checkbox"/>
	Personal leave or time release	<input type="checkbox"/>	<input type="checkbox"/>
	Additional pay	<input type="checkbox"/>	<input type="checkbox"/>

Q10	How many hours a week do the <trainee> spends in work-based training at this <company>? (Choose one option only; you can approximate to the closest match)		
	<occupational specific time 0-1>	<input type="checkbox"/>	
	< occupational specific time1-2>	<input type="checkbox"/>	
	< occupational specific time 2-3>	<input type="checkbox"/>	
	< occupational specific time 3-4>	<input type="checkbox"/>	

Q11	How many hours a week do the <trainee> spends in <study time> at this <company>? (Choose one option only; you can approximate to the closest match)	
	< occupational specific time 0-1>	<input type="checkbox"/>
	< occupational specific time1-2>	<input type="checkbox"/>
	< occupational specific time 2-3>	<input type="checkbox"/>
	< occupational specific time 3-4>	<input type="checkbox"/>

Q12	What of the following training approaches do you adopt on a regular basis while training the <trainee>	Never	2-3 times a week	Daily
	Trainee's initial assessment and adaptive training based on the trainee's skills and knowledge	<input type="checkbox"/>	<input type="checkbox"/>	<input type="checkbox"/>
	Standard practices for all trainees	<input type="checkbox"/>	<input type="checkbox"/>	<input type="checkbox"/>
	"Watch me doing it"	<input type="checkbox"/>	<input type="checkbox"/>	<input type="checkbox"/>
	Simulations	<input type="checkbox"/>	<input type="checkbox"/>	<input type="checkbox"/>
	Real-life case studies	<input type="checkbox"/>	<input type="checkbox"/>	<input type="checkbox"/>
	Rote learning for basic skills set	<input type="checkbox"/>	<input type="checkbox"/>	<input type="checkbox"/>
	Memorization of tasks	<input type="checkbox"/>	<input type="checkbox"/>	<input type="checkbox"/>
	<XXXXX>	<input type="checkbox"/>	<input type="checkbox"/>	<input type="checkbox"/>
	<XXXXX>	<input type="checkbox"/>	<input type="checkbox"/>	<input type="checkbox"/>
	<XXXXX>	<input type="checkbox"/>	<input type="checkbox"/>	<input type="checkbox"/>

Q13	Indicate whether you use the following tools or approaches to evaluate the <trainee's> progresses	Never	2-3 times a week	Daily
	Tests	<input type="checkbox"/>	<input type="checkbox"/>	<input type="checkbox"/>
	Quizzes	<input type="checkbox"/>	<input type="checkbox"/>	<input type="checkbox"/>
	Problem solving	<input type="checkbox"/>	<input type="checkbox"/>	<input type="checkbox"/>
	Simulation of real-life scenarios	<input type="checkbox"/>	<input type="checkbox"/>	<input type="checkbox"/>
	Observation and debriefing on direct practice	<input type="checkbox"/>	<input type="checkbox"/>	<input type="checkbox"/>
	<occupational specific>	<input type="checkbox"/>	<input type="checkbox"/>	<input type="checkbox"/>

Q14	How often is your work as a trainer evaluated by the following?	Never	Once per <term>	<At the end of the trainee's internship project>
	By the <Company>	<input type="checkbox"/>	<input type="checkbox"/>	<input type="checkbox"/>
	By the <training team> within the company	<input type="checkbox"/>	<input type="checkbox"/>	<input type="checkbox"/>
	By the <VET programme> or educational institution	<input type="checkbox"/>	<input type="checkbox"/>	<input type="checkbox"/>
	By the <VET student> or <trainee>	<input type="checkbox"/>	<input type="checkbox"/>	<input type="checkbox"/>
	By the <occupational specific association/board>	<input type="checkbox"/>	<input type="checkbox"/>	<input type="checkbox"/>

Thank you for your collaboration.

Annex C. Experts contributing to the framework

Chapter 1: What is PISA-VET?

Michael Ward

OECD – **Organiser and lead expert**

Luís Pereira dos Santos

Chair Working Party (Portugal)

Erik Hess

Chair Expert Group (Germany)

Marieke Vandeweyer

OECD - **Organiser**



Chapter 2: Automotive Technician Expert Sub-group

Stephan Abele

Country Expert, Germany – **lead expert**

Tobias Gschwendtner

Country Expert, Germany

Tanja Käser

Expert, Switzerland

Grant Petch

WorldSkills Expert, Australia

Peter Hesse
Country Expert, Germany

Dave Rexhäuser
Country Expert, Germany

Stefan Hartmann
Country Expert, Germany

Johanna Teliëps
Country Expert, Germany

Daniel Santos
Country Expert, Portugal

Veerle Vandepuut
Country Expert, Belgium (Flanders)

Jeferson Leandro Mateucci
Country Expert, Brazil

Cesar Cruz
Country Expert, Brazil

Bruno Assis
Country Expert, Brazil

Matthias von Davier
Expert, USA

Lucas de Jesus
Country Expert, UAE



Chapter 3: Electrician Expert Sub-group

Michael Hourihan

WorldSkills Expert, Ireland – *lead expert*

Nico Link

Country Expert, Germany

Gerard Galligan

Country Expert, Ireland

Leo van Waveren

Country Expert, Germany

Veerle Vandeput

Country Expert, Belgium (Flanders)

Luke Boustridge

WorldSkills Expert, New Zealand

Adelino Santos

WorldSkills Expert, Portugal

Robson dos Santos

Country Expert, Brazil

Gustavo Henrique Moraes

Country Expert, Brazil

Paulo Roberto Wollinger

Country Expert, Brazil

Sally Messenger

WorldSkills Expert, United Kingdom

Robert Smart
Valid-8 Expert, Canada

Gert Zinke
Country Expert, Germany

Fábio Lima de Deus
Country Expert, Brazil

Carlos Junior
Country Expert, UAE



Chapter 4: Business and Administration Expert Sub-group

Esther Winther
Country Expert, Germany – *lead expert*

Viola Deutscher
Country Expert, Germany

Jürg Schweri
Expert, Switzerland

Antonio Jorge
Country Expert, Portugal

Denys Annick
Country Expert, Belgium (Flanders)

Hilde Klykens
Country Expert, Belgium (Flanders)

Rosamaria Sobral
Country Expert, Brazil

Inês Filipa Pereira
Country Expert, Brazil

Eduardo São Paulo
Country Expert, Brazil

Joelma Kremer
Country Expert, Brazil

Gabriele Jordanski
Country Expert, Germany

Rami Khamis
Country Expert, UAE



Chapter 5: Health Care Expert Sub-group

Jenny Shackleton
WorldSkills Expert, United Kingdom – **lead expert**

Carolina Lopes
Country Expert, Portugal

Sally Messenger
WorldSkills Expert, United Kingdom

Inge Biot
Country Expert, Belgium (Flanders)

Natalia Lohmeyer
Country Expert, Germany

Robert Smart
Valid-8 Expert, Canada

Samuel Greiff
Country Expert, Germany

Sabina DeCurtins
WorldSkills Expert, Switzerland

Eduardo São Paulo
Country Expert, Brazil

Eveline Wittmann
Country Expert, Germany

Chee Nguk Lan
WorldSkills Expert, Singapore

Patrick Rouble
WorldSkills Expert, Canada

Miriam de Paula
Country Expert, UAE

Acknowledgements

The healthcare subgroup is grateful for its access to the healthcare/nursing assistant's curricula of Austria, Germany, and Singapore.



Chapter 6: Tourism and Hospitality Expert Sub-group

Regina Madruga

Country Expert, Portugal – *lead expert*

Susan Relly

Country Expert, Australia

Elisabete Mendes

Country Expert, Portugal

Inês Filipa Pereira

Country Expert, Brazil

Soetkin De Knijf

Country Expert, Belgium (Flanders)

Séverine De Bruyn

Country Expert, Belgium, (Flanders)

Eduardo São Paulo

Country Expert, Brazil

Tânia Denise Ferreira

Country Expert, Portugal

Anita Milolaza

Country Expert, Germany

Raimund Lainer

WorldSkills Expert, Austria

Sarah Elson-Rogers

UNESCO-UNEVOC

Bruno Lanvin
WorldSkills Expert, France

Anita Milolaza
Country Expert, Germany

Hatim Urabi
Country Expert, UAE



Chapter 7: Employability Skills Expert Sub-group

Samuel Greiff
Country Expert, Germany – *lead expert*

Francesca Borgonovi
OECD

Dragos Iliescu
Expert, Romania

Haizheng Li
Expert, USA

Martina Lubyova
Expert, UK

Andreas Rausch
Country Expert, Germany

Catharina Gress-Wright
OECD

Claudia Tamassia
OECD

Alexandra Figueiredo
Country Expert, Portugal

Pedro Moreno da Fonseca
ILO

Hugo Nakatani
Country Expert, Brazil

Anna Christina Aun de Azevedo Nascimento
Country Expert, Brazil

Stefanie Velten
Country Expert, Germany

Laura Visan
EC-ESCO

Paulo Roberto Wollinger
Country Expert, Brazil

Gustavo Henrique Moraes
Country Expert, Brazil

Robson dos Santos
Country Expert, Brazil

Jennifer Diedrich
Country Expert, Germany

Anabela Serrão
Country Expert, Portugal

Jenny Shackleton
WorldSkills Expert, United Kingdom

Kinga Szebeni
European Commission

Hiromichi Katayama
UNESCO

Agnes Dietzen
Country Expert, Germany

Stefanie Velten
Country Expert, Germany

Umut Erkin Taş
Country Expert, Türkiye

Ziwen Teuber
Expert, Luxembourg



Chapter 8: Background Questionnaires Expert Sub-group

Lucia Tramonte
Country Expert, Canada – **lead expert**

Francesca Borgonovi
OECD

Alex da Silva Barbosa
Country Expert, Brazil

Viola Deutscher
Country Expert, Germany

Kinga Szebeni
European Commission

Herbert Emery
Expert, Canada

Samuel Greiff
Country Expert, Germany

Hikomichi Katayama
UNESCO

Tamara Kastorff
Country Expert, Germany

Viktoria Kis
OECD

Anthony Mann
OECD

Sally Messenger
WorldSkills Expert, United Kingdom

Mihaylo Milovanovitch
ETF

Hugo Nakatani
Country Expert, Brazil

Inês Filipa Pereira
Country Expert, Brazil

Eduardo São Paulo
Country Expert, Brazil

Annalisa Schnitzler
Country Expert, Germany

Anabela Serrão
Country Expert, Portugal

Jenny Shackleton
WorldSkills Expert, United Kingdom

Umut Erkin Taş
Country Expert, Türkiye

Silvia Taurelli
ETF

Marieke Vandeweyer
OECD

Michael Ward
OECD

Eveline Wittmann
Country Expert, Germany



Chapter 9: System, Level Data Expert Sub-group

Viktoria Kis
OECD – lead expert

Marieke Vandeweyer
OECD – Organiser

Hugo Nakatani
Country Expert, Brazil

Henrik de Moel
Expert, the Netherlands

Eveline Wittmann
Country Expert, Germany

Samuel Greiff
Country Expert, Germany

Anabela Serrão
Country Expert, Portugal

Kinga Szebeni
European Commission

Hikomichi Katayama
UNESCO

Robert Smart
Valid-8 Expert, Canada

Andrew McQueen
Country Expert, UK

Mihaylo Milovanovitch
ETF

Stefan Thomas
ETF

Siria Taurelli

ETF

Cristina Mereuta

ETF

Hugues Moussy

ETF



PISA Vocational Education and Training (VET)

ASSESSMENT AND ANALYTICAL FRAMEWORK

This report presents the conceptual foundations of the OECD Programme for International Student Assessment (PISA) Vocational Education and Training (VET), currently in the Development Phase of implementation which aims to provide a comprehensive and rigorous international survey of student knowledge and skills that are essential for success in selected occupational areas. The PISA-VET assessment covers professional knowledge and skills in five occupational areas (automotive technician, business and administration, electrician, nursing/healthcare assistant and hotel receptionist), plus an evaluation of learners' employability skills, including literacy, problem solving, task performance (conscientiousness) and collaboration with others. This publication includes the frameworks for assessing all the knowledge and skills included in the assessment. These chapters outline the content knowledge and skills that learners need to acquire in each domain, how each domain is assessed, and the contexts in which this knowledge and these skills are applied. The publication also presents the frameworks for the various questionnaires distributed to students, principals of VET institutions, teachers and trainers, including a questionnaire for trainers in work-based learning environments and a system level data questionnaire for participating countries. The questionnaires are also included as an annex to the publication.

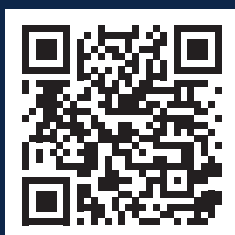

PRINT ISBN 978-92-64-78251-8
PDF ISBN 978-92-64-63938-6

