

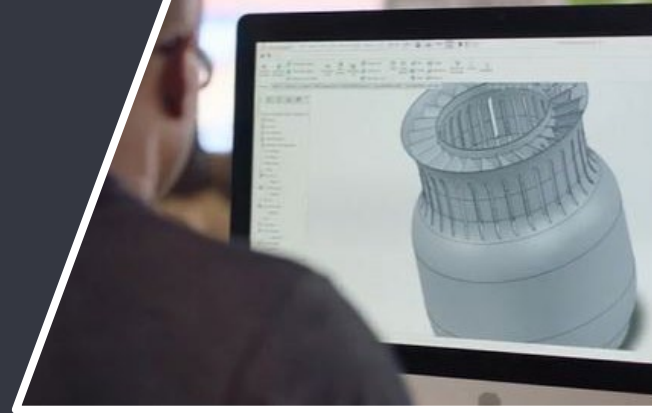

Definitive Guide to 3D Printing

Explore Technologies, Part Design, Materials,
and More for Additive Manufacturing



Contents

03 The History of Additive Manufacturing

06 Comparing Printing Processes

11 Design for Additive

13 Large-Format Parts

16 Materials Comparison

18 Mistakes to Avoid

23 Post-Processing Options

26 Cutting Costs

29 3D Printing and Injection Molding

31 Why Protolabs for 3D Printing?



Get an instant 3D printing quote
with interactive pricing and lead times
based on material, resolution, and finish.

Introduction

It's impossible to have a conversation about the current state of manufacturing without mentioning 3D printing, an additive process that uses digital CAD models to build physical, real-life objects, layer by layer. While additive manufacturing has existed for more than 30 years, it wasn't until the last decade or so that 3D printing, led by increased accessibility and material advancements, became the poster child for progressive technology within the industry. Every day there are new headlines describing cutting-edge applications: NASA prints telescope! Fashion designer prints [haute couture dress](#)! Scientists bio-print human organs!

This guide offers a comprehensive look at industrial 3D printing, from prototype to production. Also, it offers design dos and don'ts and lists materials you'll want know more about to help you create the best parts.





Printing History

Let's start with a clarification. When you hear about additive manufacturing, that's 3D printing, but at a more industrial, production level. While hobbyists have had access to desktop 3D printing for around 15 years, this access has mostly benefited early stage prototypers. For industrial purposes, you need repeatability, precision, and speed all at once. In other words, you need reliability.

Equally important, you need access to engineering-grade materials. Today's additive manufacturers are creating incredibly strong parts—from high-resolution to large-format sizes—with highly complex geometries.

3D Printing: In the Beginning...

Technically, 3D printing refers to the process of building layered objects with an actual inkjet printer head. Z Corporation cleverly trademarked its process in the early 1990s and logically called it 3D printing (3DP). In their process, a printer head solidifies powder layers with a liquid binder. This binder jetting process inherently kept users stuck in a “3D printing is just for prototypes” mentality. Today, binder jet is touted as a production process.

But if you go back about one decade earlier, engineer Chuck Hull was granted the first stereolithography (SLA) patent. SLA—which stands for stereolithographic apparatus—uses lasers to solidify layers of liquid thermoset resin. That invention marked the true start of today’s additive manufacturing.

1984: First complete SLA patent submitted by Chuck Hull

1988: First SLS patent filed by Carl Deckard

1989: EOS founded, dominates SLS printer market

1995: EOS produces first commercial DMLS printers

2009: Original FDM patents expire, prices plummet

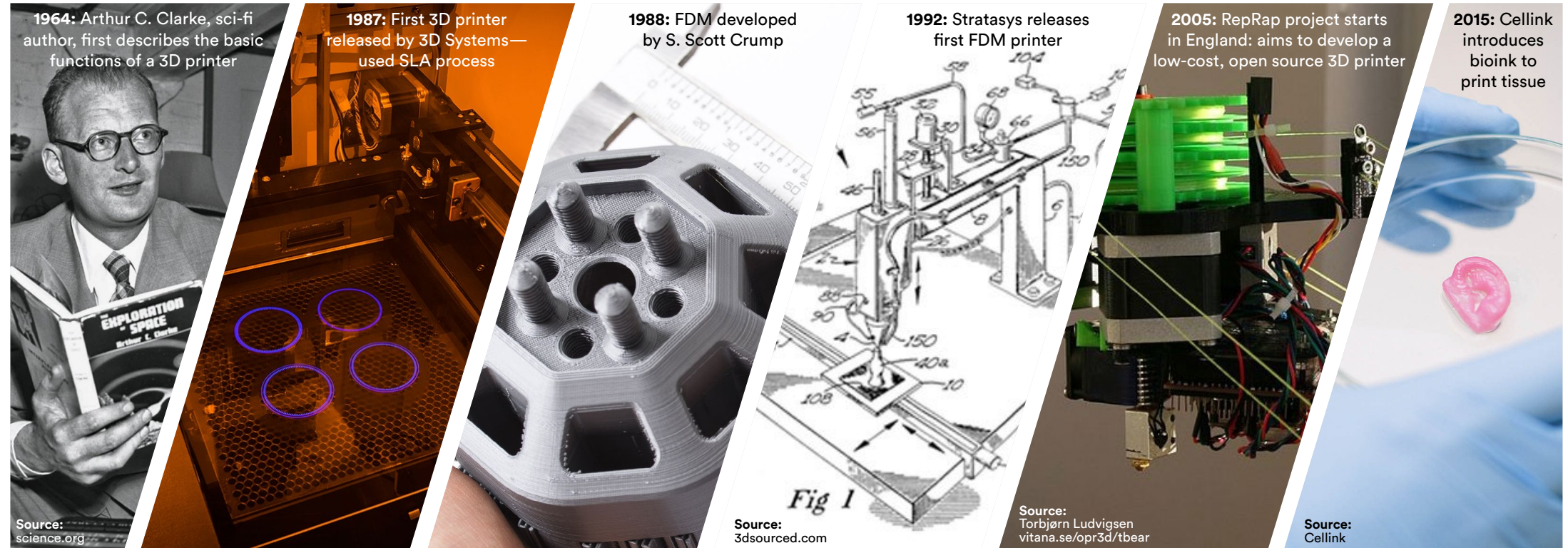

Legal Layers

An early, but noisy, additive boom came with the 2009 expiration of Stratasys' Fused Deposition Modeling (FDM) patent, giving rise to a wave of 3D desktop printer startups, many of which took to crowdfunding sites to launch their companies. At the start of 2014, a key stereolithography patent issued to 3D Systems lapsed and two more important laser sintering patents expired in January and June 2014. From there, the race was on to monetize 3D printing on a large scale.



The Maker Movement

The rapid rise of 3D printing is due in part to the growing consumer-level DIY culture known as the maker movement—individual inventors and entrepreneurs who have affordable desktop 3D printers at their fingertips. At one point, 3D printer Stratasys even formed a partnership with Home Depot to sell its MakerBot printers. These used an FDM process—more on that later. Most desktop 3D printers are paired with a simple design program, but of course, all accept uploaded CAD files. That means it certainly helps to be well-versed in a 3D CAD program such as SolidWorks, AutoCAD, Onshape, or Creo, a potential obstacle for novices of computer-aided design.

Material Changes

While early 3D printing processes relied on plastics such as nylon, ABS, and polypropylene, companies soon developed printers to manufacture metal objects. Processes like direct metal laser sintering (DMLS) have allowed for an impressive list of metals to be built with additive manufacturing. At Protolabs, our DMLS materials are a good snapshot of what's available industry-wide: aluminum, cobalt chrome, copper, Inconel 718, two kinds of stainless steel, and titanium. Final metal parts are often 99.5 percent dense. In fact, using GE Additive's Concept Laser X Line 2000R, we can [print truly enormous parts](#). More about large-format printing later.

What's Ahead?

The future looks bright because 3D printers are getting speedier and more capable of creating a broader offering in production-grade, low-volume manufacturing opportunities, especially for customized parts. Scalability for industrial production is inevitable and automated processing is the key. At the same time, material options are increasing, as are micro-resolution options and larger build volumes. Combining all of these suggests an optimistic outlook for 3D printing.





Comparing 3D Printing Processes

There isn't necessarily a preferred additive process. The challenge is finding the best one to use that serves your final application. Variables when comparing additive methods include:

- ▶ Speed
- ▶ Cost
- ▶ Appearance
- ▶ Supported materials
- ▶ Necessary functional characteristics for your part

In some cases, all you need is something you can hold in your hand; in others, assessing fit with other components is vital, and sometimes, an end-use production application is top of mind. Here's a quick chart to help guide you choose the right process for your parts.

3D Printing Processes

Printing Process	Details	Pros	Cons
Fused Deposition Modeling (FDM)	Melts and re-solidifies thermoplastic resin, such as ABS or polycarbonate, in fused layers; requires support structures	<ul style="list-style-type: none">▶ Can build with desktop equipment▶ Rapid prototyping solution▶ Moderate strength	<ul style="list-style-type: none">▶ Rippled surface texture▶ Limited suitability for functional testing▶ Diminished strength along the Z axis
Stereolithography (SLA)	Uses laser to draw part layers in a pool of photopolymer resin; as each layer is drawn, the part lowers into the pool, allowing the next layer of liquid to solidify; requires support structures	<ul style="list-style-type: none">▶ Smooth surface finish▶ Detailed feature resolution▶ Materials with high heat deflection	<ul style="list-style-type: none">▶ Colors and materials can weaken over time with UV exposure▶ Limited suitability for functional testing▶ Diminished strength along the Z axis



3D Printing Processes

Printing Process	Details	Pros	Cons
Selective Laser Sintering (SLS)	Uses CO2 laser to fuse layers of powdered material such as nylon from the bottom up; does not require support structures	<ul style="list-style-type: none"> ▶ Stiff and durable parts ▶ Isotropic mechanical properties ▶ Materials with chemical resistance 	<ul style="list-style-type: none"> ▶ Textured surface finish ▶ Wider tolerances ▶ Warpage potential on large parts
Multi Jet Fusion (MJF)	Print heads selectively apply fusing and detailing agents across a bed of nylon powder that is heated and fused resulting in a solid part; does not require support structures	<ul style="list-style-type: none"> ▶ Stiff and durable parts ▶ Economical ▶ Materials with heat deflection properties 	<ul style="list-style-type: none"> ▶ Textured surface finish ▶ Inconsistent salt and pepper appearance when undyed ▶ Warpage potential



3D Printing Processes

Printing Process	Details	Pros	Cons
Digital Light Processing (DLP) / Carbon DLS	DLP chip projects part layers onto the surface of a liquid photopolymer bath; projected light hardens each incremental layer of the liquid polymer resting on a build plate that shifts down in small increments; remaining liquid polymer is drained, leaving the solid model and required support structures	<ul style="list-style-type: none">▶ Fast build process▶ Durable parts	<ul style="list-style-type: none">▶ Thickness and warpage limitations▶ Smaller platform▶ Two part materials require additional heat treatment steps
PolyJet (PJET)	Print head sprays thin layers of photopolymer resin that cure with UV light; part is supported with material that requires removal	<ul style="list-style-type: none">▶ Moderate price▶ Prototype overmolded parts▶ Range of durometer options	<ul style="list-style-type: none">▶ Limited suitability for functional testing▶ Limited strength▶ Colors and materials can weaken over time with UV exposure



3D Printing Processes

Printing Process	Details	Pros	Cons
------------------	---------	------	------

Direct Metal Laser Sintering
(DMLS)

Lasers micro-weld cross-sections of metallic powder onto the support structures that are micro-welded to the the build platform; the platform shifts down and a recoater blade moves across the platform to deposit the next layer of powder into an inert build chamber; the process is repeated layer by layer until the build is complete

- ▶ Suitable for end-use applications
- ▶ High resolution parts
- ▶ Create complex geometries with high performance metals
- ▶ Often requires extensive post processing and heat treatments
- ▶ Slower build process
- ▶ Expensive process

Protolabs offers all of the above processes. Hubs, A Protolabs Company, offers [desktop and industrial FDM printing](#) with part sizes up to 19.68 in. x 19.68 in. x 19.68 in. (500mm x 500mm x 500mm). Some of the most important specifications for each process are listed in the next table.



Get an instant 3D printing quote
with interactive pricing and lead times based on material, resolution, and finish.



Design Guidelines for Additive Manufacturing

Know the capabilities of your manufacturer so you can get the highest quality parts for your application.

So many process choices, eh? Let's help you along with some design guidelines for each of them. Note that the material you choose can affect the final part and how you design it.

MicroFine™ SLA

To accommodate for a range of part geometries, we offer **stereolithography (SLA)** 3D printing in three resolutions: normal, high, and micro. Most parts can be built in normal resolution, but for parts with fine features around 0.005 in. (0.127mm), high resolution may be required.

For the times when feature size is extremely small, such as 0.0025 in. (0.0635mm), we offer micro-resolution. We can achieve these ultrafine features with our exclusive material, **MicroFine**. This thermoset resin builds parts in 25 micron layers. The max. part size is 5 in. x 5 in. x 2.5 in. (127mm x 127mm x 63.5mm), and it offers extremely tight tolerances. Most ideal parts built in MicroFine are no more than 1 in. x 1 in. x 1 in. (25.4mm x 25.4mm x 25.4mm)

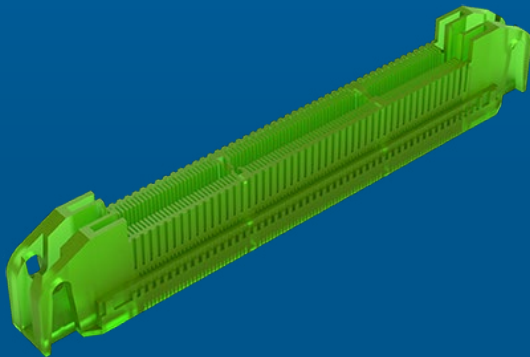

Process	Materials	Layer Thickness	Minimum Feature Size	Tolerances
DMLS	<ul style="list-style-type: none"> ▶ Aluminum ▶ Stainless Steel (17-4, 316L) ▶ Titanium ▶ Inconel ▶ Cobalt Chrome ▶ Copper 	0.00079 - 0.00263 in. (20-60 microns)	0.006 in. (0.153mm)	±0.003 in. (±0.076mm)
SLA	<ul style="list-style-type: none"> ▶ ABS-like ▶ Polycarbonate-like ▶ Polypropylene-like 	Normal: 0.004 in. (100 microns)	0.0025 in. (0.0635mm)	±0.002 in. (±0.05mm)
SLS	<ul style="list-style-type: none"> ▶ Nylons ▶ Filled Nylons ▶ Polypropylene ▶ TPU 	0.004 in. (100 microns)	0.030 in. (0.762mm)	±0.010 in. (± 0.254mm)
MJF	<ul style="list-style-type: none"> ▶ Nylon ▶ Filled Nylon 	0.00315 in. (80 microns)	0.020 in. (0.508mm)	±0.012 in. (±0.305mm)
PolyJet	<ul style="list-style-type: none"> ▶ Elastomers (30A to 95A) ▶ Overmolded Elastomers 	0.00118 in. (30 microns)	0.012 in. (0.305mm)	±0.005 in. (±0.127mm)
FDM: Industrial	<ul style="list-style-type: none"> ▶ Nylon ▶ PEI ▶ Stratasys ASA ▶ ABS 	0.004- 0.012 in. (100-300 microns)	0.00787 in. (0.2mm)	± 0.25% with a lower limit: ± 0.010 in. (± 0.25mm)
FDM: Desktop	<ul style="list-style-type: none"> ▶ PLA ▶ PETG ▶ ASA ▶ ABS ▶ TPU <p>(All of above are prototype quality)</p>	0.004- 0.012 in. (100-300 microns)	0.00787 in. (0.2mm)	± 0.5% with a lower limit of ± 0.020 in. (± 0.5mm)
Carbon DLS	<ul style="list-style-type: none"> ▶ ABS-like ▶ Polypropylene-like 	0.004 in. (100 microns)	0.020 in. (0.508mm)	±0.010 in. (±0.254mm)



Large-Format Parts

Large-format 3D printing is used for large, complex geometries and reducing multipart assemblies into a single design. We can 3D printed metal parts as large as 31.5 in. x 15.7 in. x 19.7 in. and plastic parts as large as 29 in. x 25 in. x 21 in. One of the great things about 3D printing is that your part size is only limited by the build volume of the printer you're using. That can entirely change the way you look at your product design.

Maximum Part Sizes for Large-Format 3D Printing

	Material	Build Size	
Metal	Inconel 718	31.5 in. x 15.7 in. x 19.7 in.	800mm x 400mm x 500mm
	Aluminum (AlSi10Mg)		
Plastic	ABS-Like White	29 in. x 25 in. x 21 in.	736mm x 635mm x 533mm
	ABS-Like Gray		
	ABS-Like Translucent/Clear		
	PC-Like Translucent/Clear		
	PA 12	19 in. x 19 in. 17 in.	482mm x 482mm x 431mm
	FDM	19.7 in. x 19.7 in. x 19.7 in.	(500mm x 500mm x 500mm)

Large SLA parts are built on 3D System iPros, which provide large build volume, while still producing detailed parts. For large SLS parts built in PA 12, we use sPro140 machines.



Combining existing part assemblies into a single part is a prime benefit of additive manufacturing, as shown in this exploded view. This part-assembly consolidation resulted in 30% weight reduction, and 60% cost reduction.

Source: GE Additive

Monster Metal Part Production

What weighs 10 tons (9,500kg) and can print parts the size of six basketballs? The **Concept Laser X Line 2000R** is “the largest metal laser melting machine” on the planet, according to its maker, **GE Additive**. It’s equipped with a pair of 1,000-watt fiber lasers, has an enormous 31.5 in. x 15.7 in. x 19.7 in. (800mm x 400mm x 500mm) build volume, and it’s very well-suited for aerospace, automotive, energy, and industrial components the size of, say, a V8 sportscar engine or two aerospace engine casings. We have two of these massive printing beasts, one printing in Inconel 718 and the other in Aluminum (AlSi10Mg).



Better 3D Printing Builds for Large Parts

You might wonder if large-format 3D-printed parts come with a different design playbook. Well, not as much changes as you might think. Design for Additive Manufacturing (DfAM) guidelines tell us that the thick, bulky parts with which traditional manufacturers are familiar should be optimized for 3D printing. Eliminate heavy cross-sections and excess material in favor of internal honeycombs and lattice structures. Avoid unsupported horizontal planes wherever possible—if not, additional post-processing will be needed to remove build supports, driving up costs.

Regarding build volume, with all additive manufacturing, look for opportunities for part consolidation. This last bit of advice is especially true with large-format parts, where what was once a multi-piece assembly containing perhaps dozens of individual components and fasteners can be printed as a single part. The potential cost and lead-time savings are enormous, as is the advantage of shortening the supply chain.

Bonding for Large Plastic Parts

Need a part that exceeds our machine's build volume? Part cutting and bonding is available for SLA, SLS, and MJF to achieve even larger part sizes.

Wall thickness needs to be sufficient for a good cut. For large geometries we need a minimum of a 0.1 in. (2.54mm) or 0.12 in. (3mm) thick wall to get a decent cut. Keep in mind, the thicker the better to achieve the best cut. If a part is too large to print in one piece then you will likely want to have thick walls regardless to overcome potential part warpage.

Be aware that the cutting and bonding process will leave stark visible seams at the cut and bond interface. These can be unsightly but may be allowable if you are using the part for function only. If the part is meant to be aesthetic, custom finishing can be performed to smooth, fill, prime, and paint the bond interface seams. Note, this is difficult to achieve with functionally clear parts.





Materials Comparison

With around 30 plastics, metals, and elastomers, you have a lot of material choices for your parts. Of course, materials must be well-suited for the application to achieve design goals. The properties of any material become increasingly important as your product progresses from concept and functional prototyping to production.

Remember that material properties must be evaluated in conjunction with the manufacturing process. That combination, plus post-processing, dictates the final characteristics.

Plastic

Attributes	SLA	SLS	MJF	Carbon DLS	PJET
Transparency	<ul style="list-style-type: none"> ▶ PC-Like Translucent/Clear (Accura 60)* ▶ ABS-Like Translucent/Clear (WaterShed XC 11122)* ▶ PP-Like Translucent White (Somos 9120) ▶ PC-Like Advanced High Temp (Accura 5530) – no thermal cure application <small>*requires custom finishing for functional clarity</small>				▶ Digital Clear**
Gray	<ul style="list-style-type: none"> ▶ ABS-Like Gray (Accura Xtreme Gray) ▶ MicroFine Gray™ 	<ul style="list-style-type: none"> ▶ PA12 Mineral-Filled (PA620-MF)*** ▶ PA12 40% Glass-Filled (PA614-GS)*** <small>***very light gray</small>			
Black	<ul style="list-style-type: none"> ▶ ABS-Like Black (RenShape SL7820) 	<ul style="list-style-type: none"> ▶ PA 11 Black 	<ul style="list-style-type: none"> ▶ PA 12 Black ▶ PA 12 40% Glass-Filled Black 	<ul style="list-style-type: none"> ▶ FPU 50 ▶ RPU 70 	▶ Digital Black
Off-White	<ul style="list-style-type: none"> ▶ ABS-Like White (Accura Xtreme White 200) ▶ Ceramic-Like Advanced HighTemp (PerFORM) ▶ PP-Like Translucent White (Somos 9120) 	<ul style="list-style-type: none"> ▶ PA12 White ▶ Polypropylene Natural ▶ TPU-70A 			▶ Digital White
Metal Plated Base Material	<ul style="list-style-type: none"> ▶ Ceramic-Like Advanced HighTemp (PerFORM) 				
Micro Resolution (Ultra Fine Feature Detail)	<ul style="list-style-type: none"> ▶ MicroFine Green™ ▶ MicroFine Gray™ 				
Strength	<ul style="list-style-type: none"> ▶ PC-Like Translucent/Clear (Accura 60) ▶ Ceramic-Like Advanced HighTemp (PerFORM) 				
Impact Resistance/Durability		<ul style="list-style-type: none"> ▶ PA 11 Black (PA 850) ▶ PA 12 White (PA 650) ▶ PA 12 40% Glass-Filled (PA614-GS) ▶ PA 12 Mineral-Filled (PA620-MF) ▶ TPU 70-A 	<ul style="list-style-type: none"> ▶ PA 12 Black ▶ PA 12 40% Glass-Filled Black 	<ul style="list-style-type: none"> ▶ FPU 50 ▶ RPU 70 	
Stiffness	<ul style="list-style-type: none"> ▶ Ceramic-Like Advanced HighTemp (PerFORM) ▶ PC-Like Advanced High Temp (Accura 5530) 	<ul style="list-style-type: none"> ▶ PA 12 Mineral-Filled (PA620-MF) ▶ PA 12 40% Glass-Filled (PA 614-GS) 	<ul style="list-style-type: none"> ▶ PA 12 40% Glass-Filled Black 		
Flexibility	<ul style="list-style-type: none"> ▶ PP-Like Translucent White (Somos 9120) 	<ul style="list-style-type: none"> ▶ Polypropylene Natural ▶ TPU 70-A ▶ PA 11 Black (PA 850) 		<ul style="list-style-type: none"> ▶ FPU 50 ▶ RPU 70 	▶ Digital Clear, White, Black
Temperature Resistance	<ul style="list-style-type: none"> ▶ Ceramic-Like Advanced HighTemp (PerFORM) ▶ PC-Like Advanced High Temp (Accura 5530) 	<ul style="list-style-type: none"> ▶ PA 11 Black (PA 850) ▶ PA 12 Mineral-Filled (PA620-MF) 			
Water Resistance	<ul style="list-style-type: none"> ▶ ABS-Like Translucent/Clear (WaterShed XC 11122) ▶ PC-Like Advanced High Temp (Accura 5530) 			<ul style="list-style-type: none"> ▶ FPU 50 ▶ RPU 70 	
Chemical Resistance		<ul style="list-style-type: none"> ▶ Polypropylene Natural 		<ul style="list-style-type: none"> ▶ FPU 50 ▶ RPU 70 	
UV Resistance				<ul style="list-style-type: none"> ▶ FPU 50 ▶ RPU 70 	
UL Flammability Rating		<ul style="list-style-type: none"> ▶ PA 11 Black 	<ul style="list-style-type: none"> ▶ PA 12 Black ▶ PA 12 40% Glass-Filled Black 	<ul style="list-style-type: none"> ▶ RPU 70 	

Metal

Attributes	DMLS	MP
Strength	<ul style="list-style-type: none"> ▶ Stainless Steels 17-4 PH and 316L ▶ Inconel 718 ▶ Titanium (Ti6Al4V) ▶ Cobalt Chrome (Co28Cr6Mo) 	
Lightweight	<ul style="list-style-type: none"> ▶ Aluminum (AlSi10Mg) ▶ Titanium (Ti6Al4V) 	▶ Metal Plating
Temperature Resistance	<ul style="list-style-type: none"> ▶ Inconel 718 ▶ Titanium (Ti6Al4V) 	
Corrosion Resistance	<ul style="list-style-type: none"> ▶ Stainless Steels 17-4 PH and 316L ▶ Inconel 718 ▶ Titanium (Ti6Al4V) 	
Electrical/Thermal Conductivity	<ul style="list-style-type: none"> ▶ Aluminum (AlSi10Mg) ▶ Copper (CuNi2SiCr) 	▶ Metal Plating (surface conductivity)
Strength-to-Weight	<ul style="list-style-type: none"> ▶ Aluminum (AlSi10Mg) 	



Get an instant 3D printing quote with interactive pricing and lead times based on material, resolution, and finish.



Mistakes to Avoid

Designers and engineers are increasingly turning to industrial-grade 3D printing for high-quality prototypes and end-use production parts. Here are seven common mistakes to avoid that can help you improve the manufacturability of your printed designs and shorten production times.

1 Understand Process Impact on Dimensional Accuracy Before Selecting a Technology

This is a prime issue, which you'll see emerge across several additive methods. Keep in mind that there are some geometries that will allow for exceptions so feel free to consult with one of our applications engineers with questions.

DMLS

Wall thicknesses in metal 3D printing can be tricky and differ depending on metal material selection, orientation, and resolution. Copper and aluminum, for example, require a much higher minimum feature size than other metal materials. Generally, for copper and aluminum, specify at least 0.030 in. – 0.040 in. (0.762mm – 1.016mm) for wall thicknesses because both are harder to sinter.

For other metals, the absolute minimum feature size (for positive features—those that are solid or dense) for high-resolution (HR) is 0.006 in. (0.1524mm), and 0.012 in. (0.3048mm) for normal resolution (NR). This is the minimum feature size the laser will draw. This does not mean that every feature designed at this thickness will form or survive post-processing. This minimum applies to well-designed features that fall in the draw plane (x, y) such as walls or features that are vertical. Horizontal or angled walls have higher minimum feature size of 0.015 in. (0.381mm) for HR and 0.030 in. (0.762mm) for NR.

This is due to these features failing in the build direction (z). The added thickness helps avoid conflicts with laser penetration or supported surfaces that need finishing.

Hole-size capabilities depend on the depth of the hole and resolution. Typically, holes less than 0.025 in. (0.635mm) will be susceptible to sealing shut or becoming smaller than designed. If you've designed holes that small, you should consider switching to high resolution.

SLA

SLA's dimensional accuracy and high surface quality make it a reliable choice for high-fidelity projects. However, orientation will play a role with feature formation. Knowing these minimums based on build orientation will help you better design parts for additive.

Holes with a diameter less than 0.020 in. (0.508mm) will be susceptible to sealing shut during build. Internal channels should be at least 0.025 in. (0.635mm) and slots should be at least 0.015 in. (0.381mm). If a model requires holes less than 0.020 in. (0.5mm), or a slot less than 0.015 in. (0.381mm), consider our Micro Resolution material, offered in MicroFine™ Green and Gray. In SLA, we offer three resolutions: normal, high, and micro (MR).

SLA technology provides one of the best feature resolutions in the industry. Features as small as 0.0025 in. (0.0635mm) in MR, 0.005 in. (0.127mm) in HR, and 0.010 in. (0.254mm) in NR can form.

This feature resolution can only be obtained in the draw plane (x, y) so features like supported walls, inset, and embossed features (think 3D-printed micro molds). The wall thicknesses are different in the build direction where the minimum feature size is 0.016 in. (0.4064mm) in both NR and HR and 0.008 in. (0.2032mm) in MR. Keep in mind the longer/taller the thin features are, the more thickness it will require to survive.

Carbon DLS

When designing parts for Carbon DLS, it is important to have wall thicknesses of at least 0.040 in. - 0.125 in. (1.016mm by 3.175mm). Anything less than the 0.040 in. value will result in features not fully forming, or severely warping.

Sometimes these thin walls can result in the parts being easily broken in post-processing. On the opposite end of this we sometimes see walls that are too thick, which can result in stress cracking or dimensional inaccuracy. It is important to try and keep most walls in the 0.040 in.-0.125 in. range.

While structural walls need to be at least 0.040 in. (1.016mm), Carbon has excellent positive feature resolution. The minimum positive feature size is 0.020 in. (0.508mm). This applies to features like small text, inset, and embossed features.

For negative spaces, we recommend that the minimum hole, channel, or gap size be at least 0.025 in. (0.635mm) due to how viscous the resin is—anything less than this would be at risk of sealing shut during build.

3D-Printed Nylons (SLS and MJF)

For 3D-printed nylon parts via SLS and MJF technologies, there are three important issues we often see on those parts that need to be addressed in the CAD model. Common geometries that can be problematic include blind holes, threads, and areas where internal diameters and tapers are near exterior walls.

A. Wall Thickness: This refers to the thickness in any direction on part walls or geometries. The minimum allowable wall thickness is 0.030 in. (0.762mm) in SLS and 0.020 in. (0.508mm) in MJF.

B. Channel Gaps: This refers to the distance between two features. Channel gaps are important to consider when designing for 3D-printed nylons because the sintering process can fuse two features together that do not account for channel gaps. We recommend minimum channel gap sizes of 0.030 in. (0.762mm) for both SLS and MJF.

C. Knife Edging: Consider designs that have an inset feature, such as a counter-bored hole. Your dimension may drop below the minimum feature size at the distal end of the hole. This could result in a shortened or round feature that does not properly form.



Channels dimensioned below 0.030 in. had a difficult time forming this PA12 40% glass-filled part.

2 Avoid Low-Resolution STL Files

In some cases, we receive STL files that are low resolution, which results in coarse faceting (surfaces like a gemstone). Low-resolution files with coarse faceting will not prevent us from manufacturing the part, but it could impact its aesthetics. Most CAD modeling software allows you to adjust your STL resolution in your export settings. Reducing tolerance usually has the greatest effect and improves resolution. We recommend that you ensure your STLs are high resolution (not so large that they can't be uploaded or manipulated to be 100MB or less) or submit a STP/STEP file that we can convert to STL on our end.

We Accept the Following CAD Files for 3D Printing:

- ▶ MESH (.stl)
- ▶ STEP (.stp/.step)
- ▶ SOLIDWORKS (.sldprt)
- ▶ IGES (.igs/.iges)
- ▶ .zip files

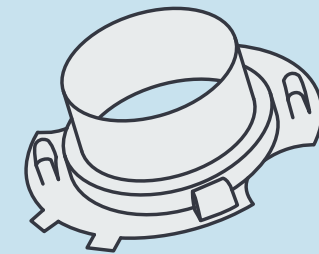

3 Prevent Part Warpage in SLS and MJF Parts

Powder-based printing processes like SLS and MJF use heat to sinter powder together into a solid part. The heat that builds the parts can also lead to undesirable part warpage.

Again, part size and overall thickness has the largest effect on part warping potential. The larger the part—7 in. (177.8mm) and above being particularly difficult—the more likely the part is to warp. The thinner a part is and the closer it is overall to the minimum feature size, the more likely it is to warp.

We recommend four options if you are concerned warpage may be an issue for your design:

- A.** Make the part close to the uniform thickness of 0.125 in. (3.175mm) to help ensure stability.
- B.** Opt for a glass-filled or mineral-filled nylon, like PA 12 40% glass-filled or PA 12 25% mineral-filled (SLS materials).
- C.** If your part is larger than 7 in. (177.8mm) and you are concerned about warpage, another option is to run an unfilled nylon material in our large-frame SLS machine with build extents of 17.6 in. x 17.6 in. x 17 in. (447.04mm x 447.04mm x 431.8mm).
- D.** A final option is to print the part in our larger-format SLA machines, which have build extents as large as 29 in. x 25 in. x 21 in. (736.6mm x 635mm x 533.4mm).

4 Avoid Differential Shrink in SLS, MJF

As with part warpage, differential shrink can occur when a part has unequal distribution of material. When one side of the part is exceptionally thick compared to the rest of the part, this causes the part to thermally cool at different rates. The thicker parts will cool much slower than the thin areas, and this can lead to undesired part shrink.

If a thick feature is required on the part, we recommend hollowing the feature to a shell of approximately 0.100 in. (2.54mm) to 0.125 in. (3.175mm). If possible, match the overall thickness of your part to the large feature's shell thickness.



Be wary of warpage, as seen in this MJF example. The thinner a part is and the closer it is overall to the minimum feature size, the more likely it is to warp.



5 Avoid Large Overhangs for DMLS Parts

Metal 3D printing has its own set of design issues, yet one common item that often emerges involves overhangs. Different from self-supporting angles that offer a smooth slope to a part design, overhangs are abrupt changes in a part's geometry. DMLS is fairly limited in its support of overhangs when compared to other 3D printing technologies like SLA and SLS. Any overhang greater than 0.020 in. (0.5mm) should have additional support to prevent damage to the part. When designing overhangs, it is wise to not push the limits as large ones can lead to reduction in a part's detail and worse, lead to the whole build crashing. Check out this [design tip](#) on metal 3D-printed parts that offers more guidance on how DMLS can create complex, durable, lightweight metal parts.



6 Don't Choose the Wrong Material for SLA Parts

Today's SLA machines use a range of thermoplastic-like materials, and several options are available to mimic polypropylene, ABS, and polycarbonate. However, please note the term "thermoplastic-like." This is an important distinction in that the mechanical properties of SLA materials only mimic those of their molded counterparts. SLA parts do not provide the same strength and durability as parts that are sintered, cast, machined, or molded. That said, SLA is still an excellent choice for quality prototype parts where validation of form and fit—but not necessarily function—is the most important factor. You can find more guidance in our design tip that focuses on [SLA materials](#) and in our [3D printing materials selection guide](#). And if you need some help, our applications engineers can help guide you during material and manufacturing process selection.

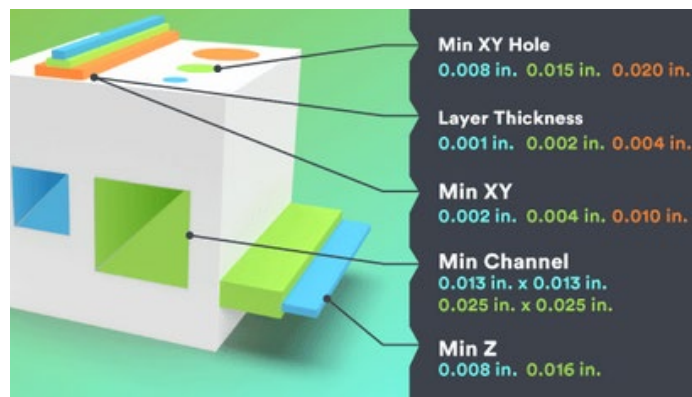

Consider these guidelines when designing for SLA.

7 Ensure 3D-Printed Elastomeric Parts are Suitable for Overmolding

Caution is advised around elastomers for 3D printing if you are considering overmolding as a final production method. PolyJet, uses a special type of "sprayable" liquid photopolymer with a hardness that can be tweaked on the fly and in the same build. This process makes it a great choice for prototyping parts that will at some point be overmolded—such as a soft, grippable handle for a power tool or a weatherproof, gasketed cover for a scientific instrument housing. In addition, digital photopolymers in white, black, and clear/translucent are available.

Accordingly, if you want to validate an overmold design, this is probably a good place to start. However—and this is where the caution comes in—be sure to check with one of our applications engineers that your 3D-printed part is also suitable for molding. Some designers get caught in a jam with a particular part design, only to find that it can't be manufactured cost-effectively in large quantities.



Post-Processing Options

At Protolabs, you can choose from a variety of 3D printing finishing options that strengthen parts, improve cosmetic appearance, and compound functional benefits.

Clear coating is commonly applied to parts to create a clear cosmetic finish. Painting is also possible. Some sanding and polishing will be needed to make the surface smooth, after which the part can be masked off and painted with whatever colors you like—just send the Pantone® numbers with your design upload together with a CAD model indicating where each color goes. The parts are sprayed with an automotive-grade paint. Soft-touch painting is also available.

Plating increases strength and durability of plastic parts. Electroless nickel plating is a great way to mimic a cast aluminum or magnesium part for light-weighting purposes.

Dyeing of SLA, SLS, MJF, and PolyJet parts is possible at Protolabs. SLA parts can be dyed black, green, red, blue, or yellow. The finished parts are simply bathed in hot dye for a short time for a consistent color. This option is one of the fastest, lowest-cost ways to make printed parts cosmetically appealing. There's no chance of masking off certain areas like there is with painting, but for SLA, SLS, MJF, and PolyJet parts, especially those made of translucent acrylic or polycarbonate-like materials, this is often an excellent option.



Decaling provides a great way to attach company logos, safety warnings, and other graphics to improve cosmetics or functionality. While we don't supply these products, we can apply them for you. Note that adhesive and thermal-transfer decals won't stick to the rough surface typical of some 3D-printed parts, making sanding or otherwise smoothing of the target surface a prerequisite to decal application.

Texturing makes printed parts less slippery, improves ergonomics, and enhances cosmetic appearance. When prototyping parts that will later be injection molded, it's possible to apply a spray texture to get a Mold-Tech equivalent finish used in many mold cavities. This same technique can be used to apply a soft-touch paint or urethane clear coat to a 3D-printed part, which improves weather- and sun-resistance on the UV-curable materials used with SLA.

Polishing is possible on 3D-printed parts to create a high-quality finish. Again, some level of smoothing is needed to apply paint and decals, but highly cosmetic surfaces can be taken even further. If this is a requirement, you'll need to identify your finish expectations on your part with a drawing or screenshot.



Heat treating metal parts built with direct metal laser sintering (DMLS) eliminates heat-induced stress and potential warping. It's also used to harden DMLS metals, strengthen them, make them less prone to cracking and fatigue, or make them more pliable. If you're looking for an extremely tough and hardened 3D-printed metal, stainless steel 17-4 PH is a solid option.

Secondary machining is possible on DMLS parts if a highly accurate, smooth surface is specified. Other high-requirement operations for DMLS include boring or reaming close tolerance holes or tapping of those that require threads. And depending on the material, inserts of various kinds can be heat-staked or glued into place.

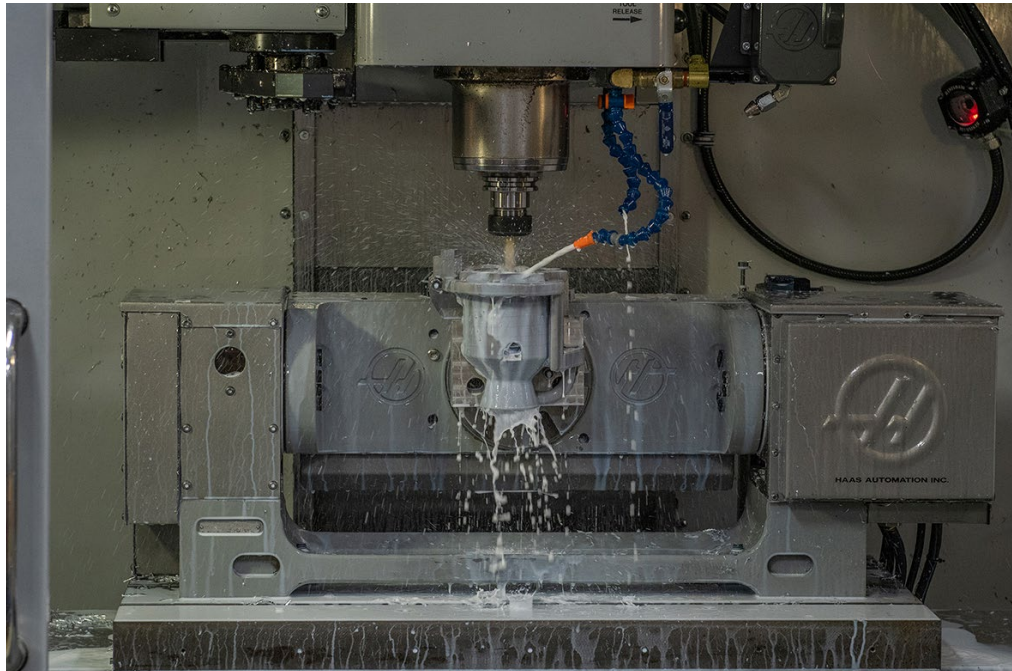

Finally, **smoothing** is one of the most common options requested for 3D-printed parts, and it's easy to see why because smoothing can:

- ▶ Improve aesthetics
- ▶ Allow for better coating and paint or dye adhesion
- ▶ Aid in chemical resistance
- ▶ Help lessen corrosion potential
- ▶ Improve durability
- ▶ Reduce porosity, sealing surfaces for easier cleaning and sterilization
- ▶ Eliminate surface defects that could become weak or failure points
- ▶ Minimize friction effects
- ▶ Improve conductivity
- ▶ Improve water resistance
- ▶ Create injection molded-like surfaces on additive parts

This is by no means a comprehensive list, but it gives you some points of consideration when evaluating your part texture. Check out our [tech tip](#) on improving 3D printing surface finishes for a lot more detail.



Cutting Costs

The various 3D printing processes offer great potential for cost reductions throughout development. Three of these technologies—SLS, MJF, and DMLS—can cut costs through accelerated production, reduced tooling costs and work-in-process, less waste, and parts that remain strong despite being lighter in weight. SLS, MJF, and DMLS are especially important to those thousands of companies that are 3D printing end-use parts.

Here are six design considerations that create greater functionality, lower weight, reduced manufacturing costs for 3D-printed parts:

1 Optimize the Design

Well-designed 3D printed parts follow many of the same rules as those made with [injection molding](#). Use gradual transitions between adjoining surfaces. Eliminate large differences in cross-section and part volume. Avoid sharp corners that often create residual stress in the finished workpiece. Watch that thin, unsupported walls don't grow too tall to avoid buckling or warping. Also, surfaces with shallow angles tend to leave ugly "stair-stepping" that makes them unsuitable for cosmetic features. Flatten them out where possible.

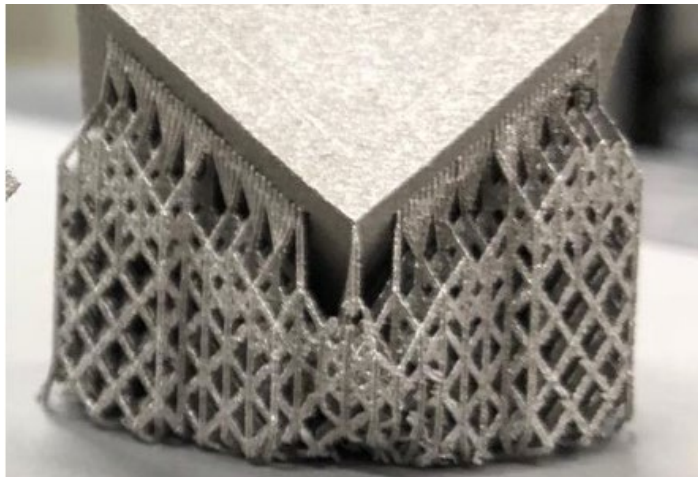

Support structures on DMLS parts help prevent curl that can occur during the sintering process.

2 Less is More

Conversely, the most dramatic 3D-printed part designs leverage 3D printing's ability to create organic shapes, such as honeycombs and complex matrices. Don't be afraid to use these shapes, provided doing so creates a lighter, stronger part. Nor should you fear placing holes or channels into your part design. With traditional manufacturing, drilling holes in a solid block of material increases part cost and waste. Not so in the additive world, where more holes mean less powder and less processing time. Just remember, 3D printed holes don't need to be round. Often, an elliptical, hexagonal, or free-form hole shape would better suit the part design and be easier to print.

3 Consider Next Steps in the Design Cycle

Just because you can print parts with lots of holes it doesn't mean you should, especially if the plan is to make lots of such parts later. Because 3D printing offers tremendous design flexibility, it's easy to paint yourself into a corner by not considering how parts will be manufactured post-prototyping. As we've noted, an increasing number of companies are finding 3D printing suitable for end-use parts, but many parts will transition from printing to machining, molding, or casting as production volumes grow. That's why it's important to perform a [design for manufacturability analysis](#) early on in the design cycle, assuring cost-effective production throughout the part's life cycle.

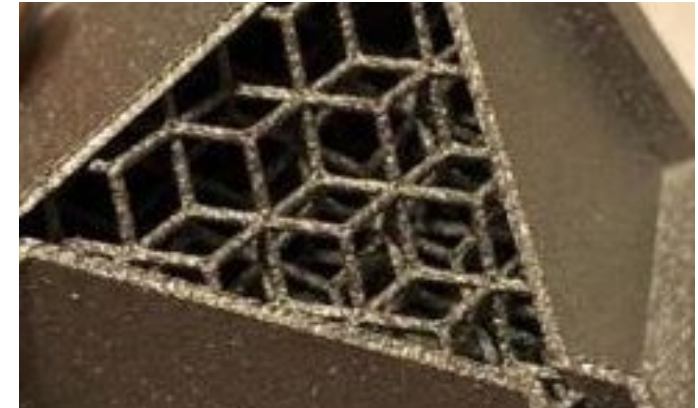

A simple internal matrix can be designed to create a lighter part.

4 Avoid Unnecessary Secondary Operations

Plastic parts produced via SLS need no support structures during the build process, so post-processing is usually limited to bead blasting, painting, reaming, and tapping of holes, and machining of critical part features. DMLS, on the other hand, often requires extensive scaffold-like structures to support and control movement of the metal workpiece—without them, surfaces may curl and warp. This is especially true with overhanging geometries—wide T-shapes, for example, which require build supports beneath the arms that will have to be machined or ground away, thus increasing cost and lead time. The story is similar but less dramatic with SLS, where cured resin supports are easily removed with a hand grinder and sandpaper. Where possible, Protolabs will work to orient parts in a way to reduce these overhangs and other unfriendly features, but part designers can help by avoiding them.

5 Watch the Tolerances

Designers and engineers should avoid “over-tolerancing” their parts—doing so may force them to be built using thinner layers (increasing build time and cost). It might require secondary machining operations to meet overly zealous print dimensions. And because of the design flexibility afforded with 3D printing, there is potential that some of the tolerance stacking between mating surfaces from multi-part assemblies to be eliminated..

6 Look at the Big Picture

3D printed parts might cost more up front, but don't let that scare you. With additive, you have tremendous possibility for part count reduction, reduced weight and greater structural integrity, lower assembly costs, internal passages for cooling or wiring, and other part features that are not possible with traditional part designs. Also, keep in mind that fixtures, molds, and other types of tooling are not needed with 3D printing, eliminating costs that might not be directly associated to the price of the individual piece part. Focusing on the part's price tag, rather than product functionality and “the big picture,” may leave you designing the same parts you did yesterday, eliminating opportunities to reduce overall manufacturing costs.

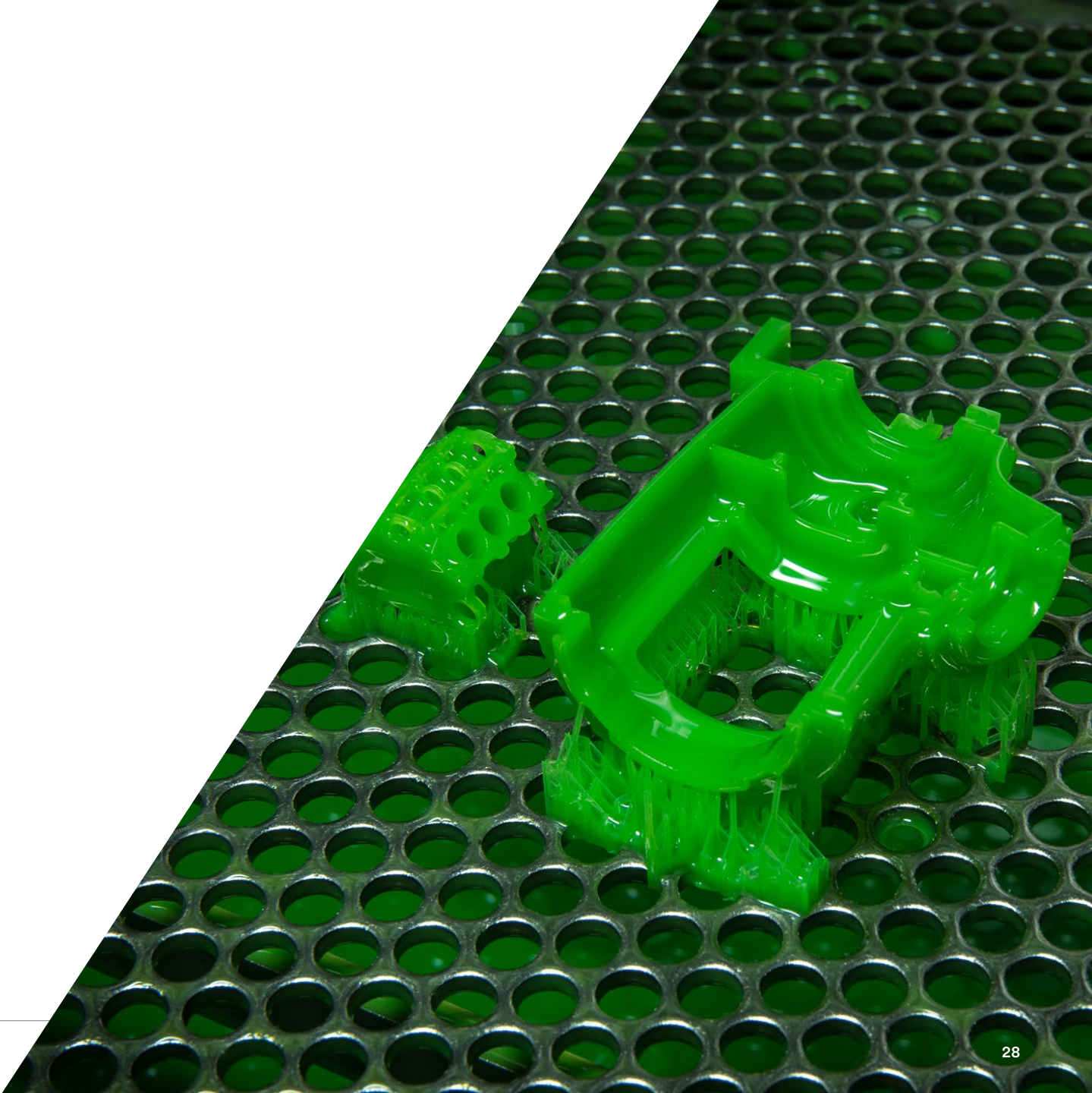



3D Printing and Injection Molding

Whether you need production parts or are just prototyping, 3DP is a great starting point, and may offer everything that you need.

Economies of Scale

Additive manufacturing works well for designers and engineers who need a concept model of a product or prototypes for form and fit testing. But some additive processes and materials build fully functional production parts (ahem, DMLS). The medical and aerospace industries embrace printed part production, as do dentistry and jewelry makers. Right now, additive materials and the commercial machines that use those materials are still expensive, so low quantities make sense for 3D printing. Processes like injection molding—that involve an initial tooling investment, but lower per-part price as quantities increase—remain a logical next step after prototyping.



Making the Move to Molding

Building a part in thousands of thin layers from the bottom up affords those designing CAD models for 3D printing the opportunity to create highly complex geometries that are often impossible to mold. But what happens when additive parts are ready to scale to injection molding?

The importance of moldability considerations like draft, radii, and uniform wall thickness are minimal in 3D printing, once a shift is made into injection molding, these elements become much more critical. At Protolabs, our automated software identifies moldability issues and recommends solutions in an interactive quote. That might mean a bit of design retooling, but it can quickly turn a printed part into a production-ready part.

3D Printing vs. Injection Molding

A few things that can't be denied. 3D printing is the way to go if your part has difficult or complex geometries. For example, if you need a hidden channel that curves through the inside of a part, additive manufacturing will get you there. If you need larger quantities (and the geometries will allow it), the investment in a mold might make more sense.

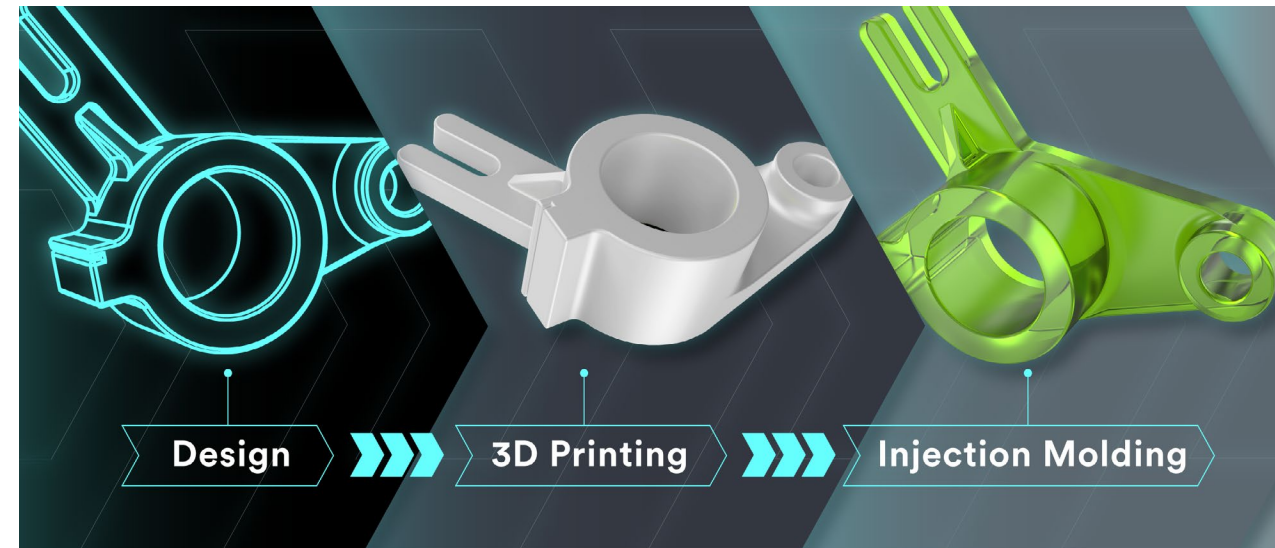

Why Protolabs for Custom 3D Printing?



Unmatched Quality

Our industry-leading tolerances and surface finish quality stems from a dedicated process engineering and quality team for each 3D printing technology. We also offer a proprietary material called Microfine™, which can build micro-resolution features as small as 0.0025 in. (0.0635mm). Our facilities are also ITAR/ISO 9001 and AS9100 certified for DMLS, MJF, SLS.

Consultative Quoting

Get design feedback from our experienced engineering team. We have helped thousands of customers bring their products to market with quality 3D-printed parts. We will also work with you to determine optimal part orientation based on your application's requirements.

Wide Material Selection

Across our six 3D printing technologies, we use a range of commercial-grade thermoset resins and thermoplastic and metal powders to 3D print parts that are suitable for various part applications and industries. If required for your parts, we offer a variety of post-processing options such as heat treating, secondary machining, plating, painting, and dyeing to further enhance mechanical properties and cosmetics.

Scale and Production

Our facility is home to more than 130 3D printing machines that produce metal and plastic parts. This means we'll always have capacity when you need parts fast—whether it's a small batch of parts or production-level volumes.

If you have any questions regarding your quote or design, talk with our applications engineers to help guide you through the process. We look forward to working with you on your next project!





Contact Us

5540 Pioneer Creek Dr.
Maple Plain, MN 55359
United States

P 877-479-3680

F 763-479-2679

E customerservice@protolabs.com



Get an instant 3D printing quote
with interactive pricing and lead times
based on material, resolution, and finish.

