

2.1 OVERVIEW

This chapter discusses explosive threat parameters and measures needed to protect shelters from blast effects. Structural systems and building envelope elements for new and existing shelters are analyzed; shelters and FEMA model building types are discussed; and protective design measures for the defined building types are provided, as are design guidance and retrofit issues. The purpose of this chapter is to offer comprehensive information on how to improve the resistance of shelters when exposed to blast events.

2.2 EXPLOSIVE THREAT PARAMETERS

A detonation involves supersonic combustion of an explosive material and the formation of a shock wave. The three parameters that primarily determine the characteristics and intensity of blast loading are the weight of explosives, the type of the explosives, and the distance from the point of detonation to the protected building. These three parameters will primarily determine the characteristics and intensity of the blast loading. The distance of the protected building from the point of explosive detonation is commonly referred to as the stand-off distance. The critical locations for detonation are taken to be at the closest point that a vehicle can approach, assuming that all security measures are in place. Typically, this would be a vehicle parked along the curb directly outside the facility, or at the vehicle access control gate where inspection takes place. Similarly, a critical location may be the closest point that a hand carried device can be deposited.

There is also no way to effectively know the size of the explosive threat. Different types of explosive materials are classified as High Energy and Low Energy and these different classifications greatly influence the damage potential of the detonation. High Energy explosives, which efficiently convert the material's chemical

energy into blast pressure, represent less than 1 percent of all explosive detonations reported by the FBI Bomb Data Center. The vast majority of incidents involve Low Energy devices in which a significant portion of the explosive material is consumed by deflagration, which is a process of subsonic combustion that usually propagates through thermal conductivity and is typically less destructive than a detonation. In these cases, a large portion of the material's chemical energy is dissipated as thermal energy, which may cause fires or thermal radiation damage.

For a specific type and weight of explosive material, the intensity of blast loading will depend on the distance and orientation of the blast waves relative to the protected space. A shock wave is characterized by a nearly instantaneous rise in pressure that decays exponentially within a matter of milliseconds, which is followed by a longer term but lower intensity negative phase. The initial magnitude of pressure is termed the peak pressure and the area under a graph of pressure plotted as a function of time, also known as the airblast pressure time history, is termed the impulse (see Figure 2-1). Therefore, the impulse associated with the shock wave considers both the pressure intensity and the pulse duration. As the front of the shock-wave propagates away from the source of the detonation at supersonic speed, it expands into increasingly larger volumes of air; the peak incident pressure at the shock front decreases and the duration of the pressure pulse increases. The magnitude of the peak pressures and impulses are reduced with distance from the source and the resulting patterns of blast loads appear to be concentric rings of diminishing intensity. This effect is analogous to the circular ripples that are created when an object is dropped in a pool of water. The shock front first impinges on the leading surfaces of a building located within its path and is reflected and diffracted, creating focus and shadow zones on the building envelope. These patterns of blast load intensity are complicated as the waves engulf the entire building. The pressures that load the roof, sides, and rear of the building are termed incident pressures, while the pressures that load the building envelope directly opposite the explosion are termed reflected pressures. Both the intensity of peak pressure and the impulse

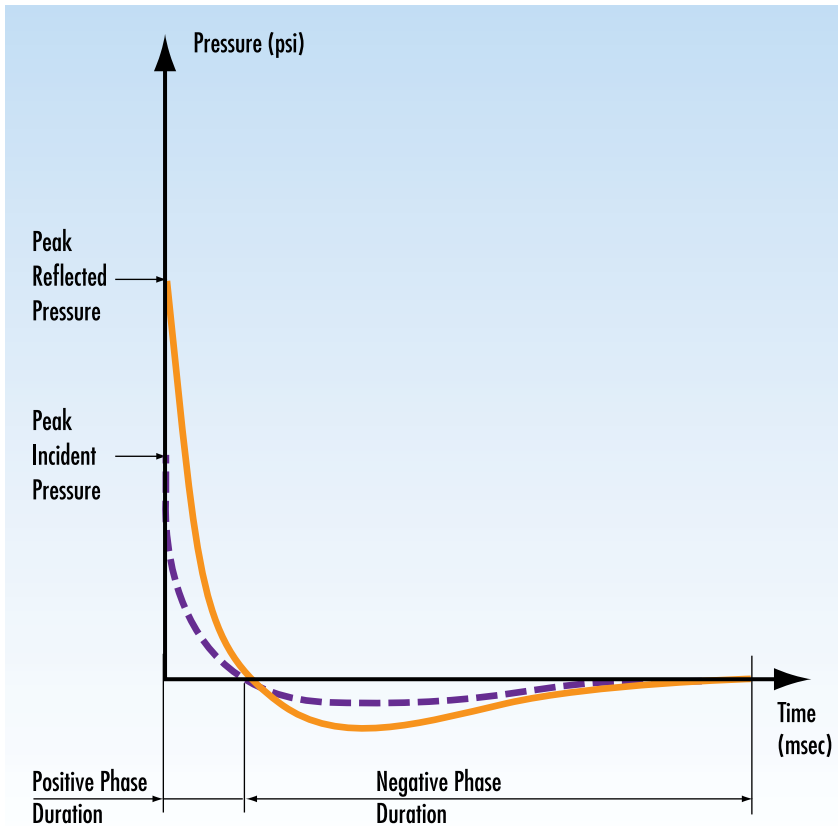

Figure 2-1
Airblast pressure time
history

affect the hazard potential of the blast loading. A detailed analysis is required to determine the magnitude of pressure and impulse that may load each surface relative to the origin of the detonation.

The thresholds of different types of injuries associated with damage to wall fragments and/or glazing are depicted in Figure 2-2. This range to effects chart shows a generic interaction between the weight of the explosive threat and its distance to an occupied building. These generic charts, for conventional construction, provide information to law enforcement and public safety officials that allow them to establish safe evacuation distances should an explosive device be suspected or detected. However, these distances are so site-specific that the generic charts provide little more than general guidance in the absence of more reliable site-specific information. Based on the information provided in the chart, the

onset of significant glass debris hazards is associated with stand-off distances on the order of hundreds of feet from a vehicle-borne explosive detonation while the onset of column failure is associated with stand-off distances on the order of tens of feet.

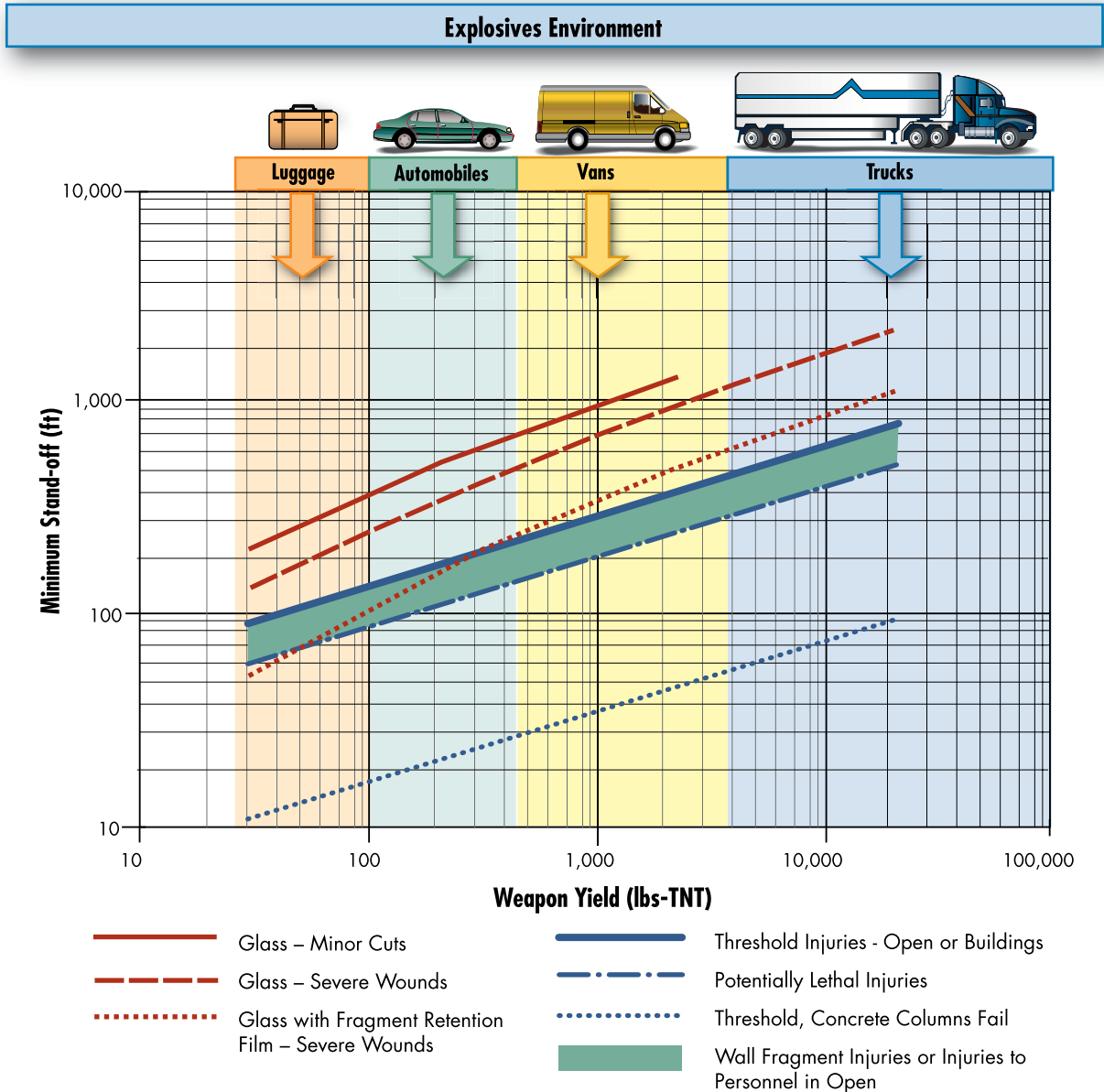

Figure 2-2 Range to effects chart

SOURCE: DEFENSE THREAT REDUCTION AGENCY

2.2.1 Blast Effects in Low-rise Buildings

Many shelters can be part of low-rise buildings. Although small weights of explosives are not likely to produce significant blast loads on the roof, low-rise buildings may be vulnerable to blast loadings resulting from large weights of explosives at large stand-off distances that may sweep over the top of the building. The blast pressures that may be applied to these roofs are likely to far exceed the conventional design loads and, unless the roof is a concrete deck or concrete slab structure, it may fail. There is little that can be done to increase the roof's resistance to blast loading that doesn't require extensive renovation of the building structure. Figure 2-3 shows the ever expanding blast wave as it radiates from the point of detonation and causes, in sequence of events, the building envelope to fail, the internal uplift on the floor slabs, and eventually the engulfment of the entire building.

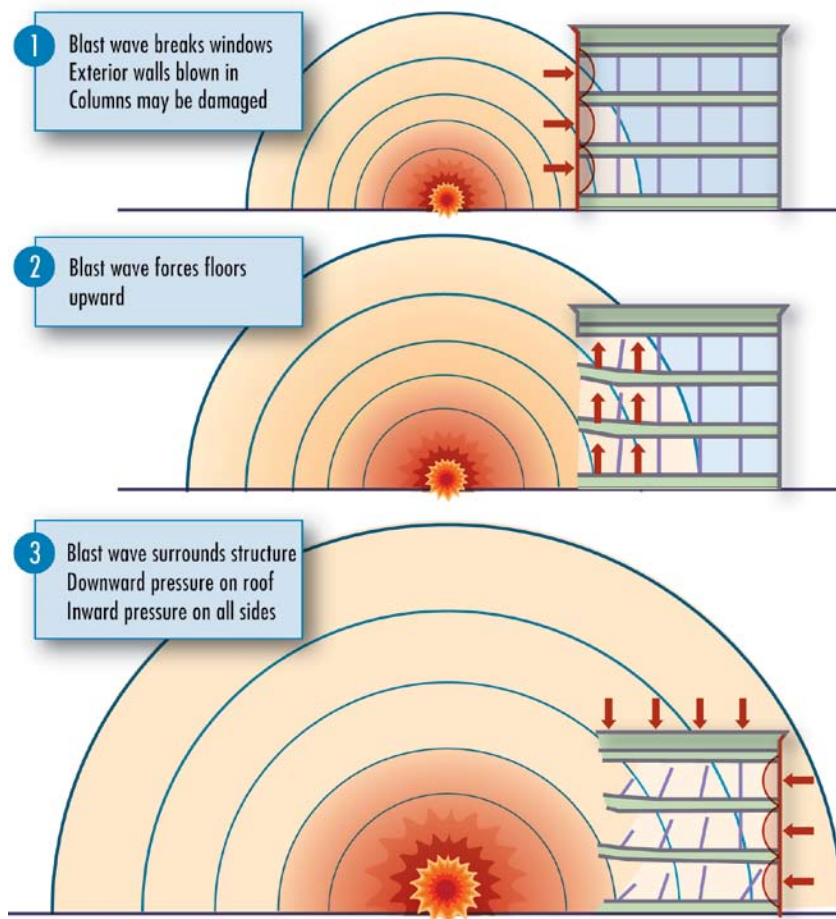

Figure 2-3
Blast damage

SOURCE: NAVAL FACILITIES
ENGINEERING SERVICE CENTER,
*USER'S GUIDE ON PROTECTION
AGAINST TERRORIST VEHICLE
BOMBS*, MAY 1998

In addition to the blast pressures that may be directly applied to the exterior columns and spandrel beams, the forces collected by the building envelope will be transferred through the slabs to the structural frame or shear walls that transfer lateral loads to the foundations. The extent of damage will be greatest in close proximity to the detonation; however, depending on the intensity of the blast, large inelastic deformations will extend throughout the building and cause widespread cracking to structural and nonstructural partitions.

In addition to the hazard of impact by building envelope debris propelled into the building or roof damage that may rain down, the occupants may also be vulnerable to much heavier debris resulting from structural damage. Progressive collapse occurs when an initiating localized failure causes adjoining members to be overloaded and fail, resulting in a cascading sequence of damage that

is disproportionate to the originating extent of localized failure. The initiating localized failure may result from a sufficiently sized parcel bomb that is in contact with a critical structural element or from a vehicle sized bomb that is located a short distance from the building (see Figure 2-4). However, a large explosive device at a large stand-off distance is not likely to selectively fail a single structural member; any damage that results from this scenario is more likely to be widespread and the ensuing collapse cannot be considered progressive. Although progressive collapse is not typically an issue for buildings three stories or shorter, transfer girders and non-ductile, non-redundant construction may produce structural systems that are not tolerant of localized damage conditions. The columns that support transfer girders and the transfer girders themselves may be critical to the stability of a large area of floor space.



Figure 2-4
Alfred P. Murrah Federal
Office Building

SOURCE: U.S. AIR FORCE

As an example, panelized construction that is sufficiently tied together can resist the localized damage or large structural deformations that may result from an explosive detonation. Although the explosive detonation opposite the Khobar Towers destroyed the exterior facade, the panelized structure was sufficiently tied together to permit relatively large deformations without loss of structural stability (see Figure 2-5). This highlights the benefits of ductile and redundant detailing for all types of construction.

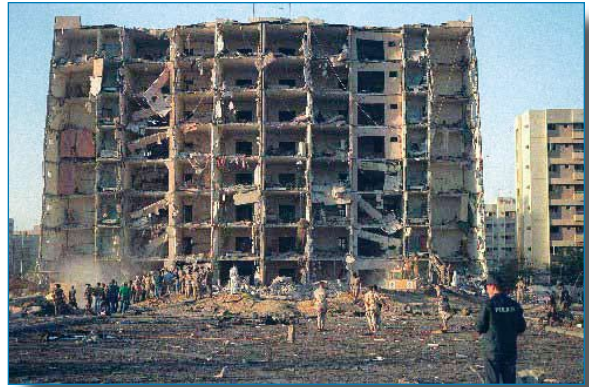

Figure 2-5
Khobar Towers

SOURCE: U.S. AIR FORCE

To mitigate the effects of in-structure shock that may result from the infilling of blast pressures through damaged enclosures, nonstructural overhead items should be located below the raised floors or tied to the ceiling slabs with seismic restraints. Nonstructural building components, such as piping, ducts, lighting units, and conduits must be sufficiently tied back to the building to prevent failure of the services and the hazard of falling debris.

The contents of this manual supplement the information provided in FEMA 361, *Design and Construction Guidance for Community Shelters* and FEMA 320, *Taking Shelter From the Storm: Building a Safe Room Inside Your House*. Although this publication does not specifically address nuclear explosions and shelters that protect against radiological fallout, this information may be found in FEMA TR-87, *Standards for Fallout Shelters*. The contents of FEMA 452, *A How-To Guide to Mitigate Potential Terrorist Attacks Against Buildings* will help the reader identify critical assets and functions within buildings, determine the threats to these assets, and assess the vulnerabilities associated with those threats.

2.2.2 Blast Effects in High-rise Buildings: The Urban Situation

High-rise buildings must resist significant gravity and lateral load effects; although the choice of framing system and specific structural details will determine the overall performance, the lower floors, which are in closest proximity to a vehicle-borne threat, are inherently robust and more likely to be resistant to blast loading than smaller buildings. However, tall buildings are likely to be located in dense urban environments that tend to trap the blast energy within the canyon like streets as the blast waves reflect off of neighboring structures. Furthermore, tall buildings are likely to contain underground parking and loading docks that can introduce significant internal explosive threats. While these internal threats may be prevented through rigorous access control procedures, there are few conditions in which vehicular traffic can be restricted on city streets. Anti-ram streetscape elements are required to maintain a guaranteed stand-off distance from the face of the building.

In addition to the hazard of structural collapse, the façade is a much more fragile component. While the lower floor façade is likely to fail in response to a sizable vehicle threat at a sidewalk's distance from the building, the peak pressures and impulses at higher elevations diminish due to the increased stand-off distance and the associated shallow angle of incidence (measured with respect to the vertical height of the building). Although reflections off of neighboring structures are likely to affect the intensity of blast loads, the façade loads at the upper floors will be considerably lower than the loads at the lower floors and the extent of façade debris will reflect this. A detailed building-specific analysis of the structure and the façade is required to identify the inherent strengths and vulnerabilities. This study will indicate the safest place to locate the shelter.

2.3 HARDENED CONSTRUCTION

2.3.1 Structural System

A shelter will only be effective if the building in which it is located remains standing. It is unreasonable to design a shelter within a building with the expectation that the surrounding structure may collapse. Although the shelter must be able to resist debris impact, it is not reasonable for it to withstand the weight of the building crashing down upon it. Therefore, the effectiveness of the shelter will depend on the ability of the building to sustain damage, but remain standing. The ability of a building to withstand an explosive event and remain standing depends on the characteristics of the structure. Some of these characteristics include:

- **Mass.** Lightweight construction may be unsuitable for providing resistance to blast loading. Inertial resistance may be required in addition to the strength and ductility of the system.
- **Shear capacity.** Shear is a brittle mode of failure and primary members and/or their connections should therefore be designed to prevent shear failure prior to the development of the flexural capacity.
- **Capacity for resisting load reversals.** In response to sizable blast loads, structural elements may undergo multiple cycles of large deformation. Similarly, some structural elements may be subjected to uplift pressures, which oppose conventional gravity load design. The effects of rebound and uplift therefore require blast-resistant members to be designed for significant load reversals. Depending on the cable profile, pre-tensioned or post-tensioned construction may provide limited capacity for abnormal loading patterns and load reversals. Draped tendon systems designed for gravity loads may be problematic; however, the higher quality fabrication and material properties typical for precast construction may provide enhanced performance of precast elements designed and detailed to resist uplift and rebound effects resulting from blast loading. Seated connection systems for

steel and precast concrete systems must also be designed and detailed to accommodate uplift forces and rebound resulting from blast loads. The use of headed studs is recommended for affixing concrete fill over steel deck to beams for uplift resistance.

- **Redundancy.** Multiple alternative load paths in the vertical-load-carrying system allow gravity loads to redistribute in the event of failure of structural elements.
- **Ties.** An integrated system of ties in perpendicular directions along the principal lines of structural framing can serve to redistribute loads during catastrophic events.
- **Ductility.** Structural members and their connections may have to maintain their strength while undergoing large deformations in response to blast loading. The ability of a member to develop inelastic deformations allows it to dissipate considerable amounts of blast energy. The ratio of a member's maximum inelastic deformation to a member's elastic limit is a measure of its ductility. Special detailing is required to enable buildings to develop large inelastic deformations (see Figure 2-6).

Historically, cast-in-place reinforced concrete was the preferred material for explosion-mitigating construction. This is the material used for military bunkers, and the military has performed extensive research and testing of its performance. Among its benefits, reinforced concrete has significant mass, which improves its inertial resistance; it can be readily proportioned for ductile behavior and may be detailed to achieve continuity between members. Finally, concrete columns are less susceptible to global buckling in the event of the loss of a floor system. However, steel may be similarly detailed to take advantage of its inherent ductility and connections may be designed to provide continuity between members. Similarly, panelized precast concrete systems can be detailed to permit significant deformations in response to explosive loading, as demonstrated by the performance of Khobar Towers.

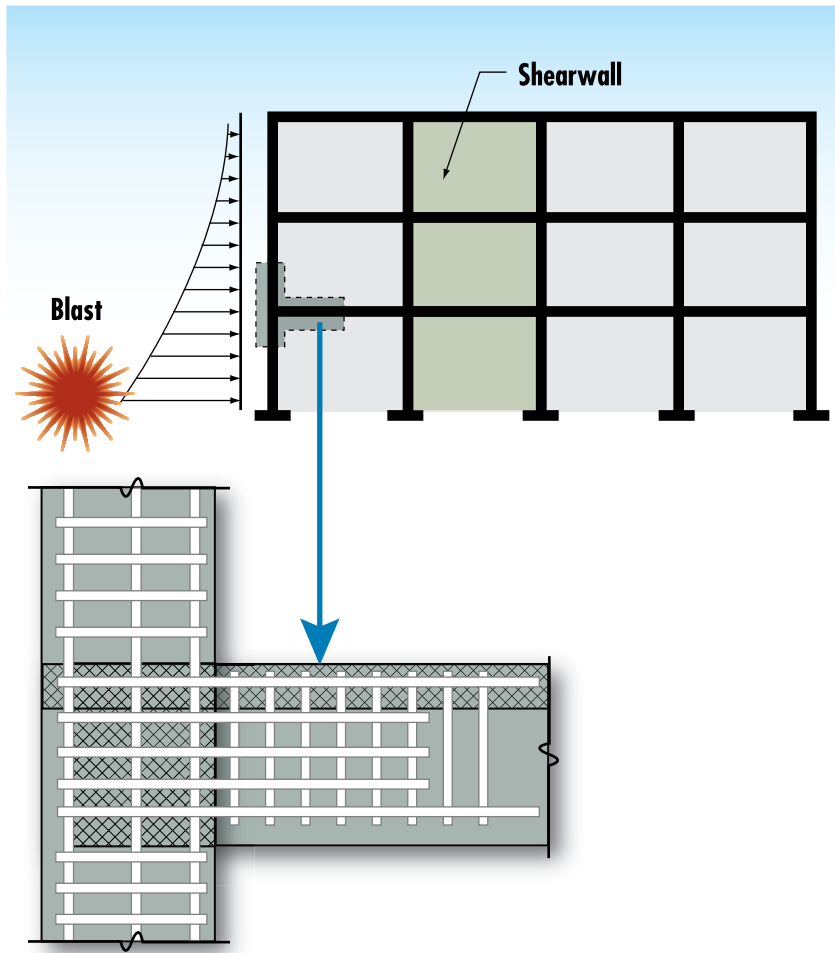

Figure 2-6
Ductile detailing of
reinforced concrete
structures

Protective design further requires the system to accept localized failure without precipitating a collapse of a greater extent of the structure. By allowing the building to bridge over failed components, building robustness is greatly improved and the unintended consequences of extreme events may be mitigated. However, it may not be possible for existing construction to be retrofitted to limit the extent of collapse to one floor on either side of a failed column. If the members are retrofitted to develop catenary behavior, the adjoining bays must be upgraded to resist the large lateral forces associated with this mode of response. This may require more extensive retrofit than is either feasible or desirable. In such a situation, it may be desirable to isolate the collapsed region rather than risk propagating the collapse to adjoining bays. The retrofit of existing buildings to protect against a potential

progressive collapse resulting from extreme loading may therefore best be achieved through the localized hardening of vulnerable columns. These columns need only be upgraded to a level of resistance that balances the capacities of all adjacent structural elements. At greater blast intensities, the resulting damage would be extensive and create global collapse rather than progressive collapse. Attempts to upgrade the building to conform to the alternate path approach would be invasive and potentially counterproductive.

2.3.2 Loads and Connections

Because the shelter will likely suffer significant damage in response to extreme loading conditions, the shelter must be able to withstand both the direct loading associated with the natural or manmade hazard and the debris associated with the damaged building within which it is housed.

Structural systems that provide a continuous load path that supports all vertical and lateral loads acting on a building are preferred. A continuous load path ties all structural components together and the fasteners used in the connections must be capable of developing the full capacity of the members. In order to provide comprehensive protection, the capacity of each component must be balanced with the capacity of all other components and the connection details that tie them together. Because all applied loads must eventually be transferred to the foundations, the load path must be continuous from the uppermost structural component to the ground.

After the appropriate loads are calculated for the shelter, they should be applied to the exterior wall and roof surfaces of the shelter to determine the design forces for the structural and nonstructural elements. The continuous load path carries the loads acting on a building's exterior façade and roof through the floor diaphragms to the gravity load-bearing system and lateral load-bearing system. The individual components of the façade and roof must be able to develop these extraordinary forces, though

deformed, and transfer them to the underlying beams, trusses, girders, shear walls, and columns that provide the global structural resistance. These structural systems must also be able to develop uplift forces and load reversals that may accompany these extreme loading conditions. Uplift forces and load reversals are typically applied contrary to the conventional design loads and, therefore, details must be developed that account for these contrary patterns of deformation (see Figure 2-7). Seismic detailing that addresses ductile behavior despite multiple cycles of load reversals are generally well suited for all of these extreme loading conditions and building-specific details must consider each threat condition. Some construction materials, however, are better suited to developing a load path that can withstand loads from multiple directions and events. Cast-in-place reinforced concrete and steel moment frame construction is more commonly detailed to provide load paths than in "progressive collapse" designs utilizing panelized or masonry load-bearing construction. Nevertheless, appropriate details must be developed for nearly all structural systems.

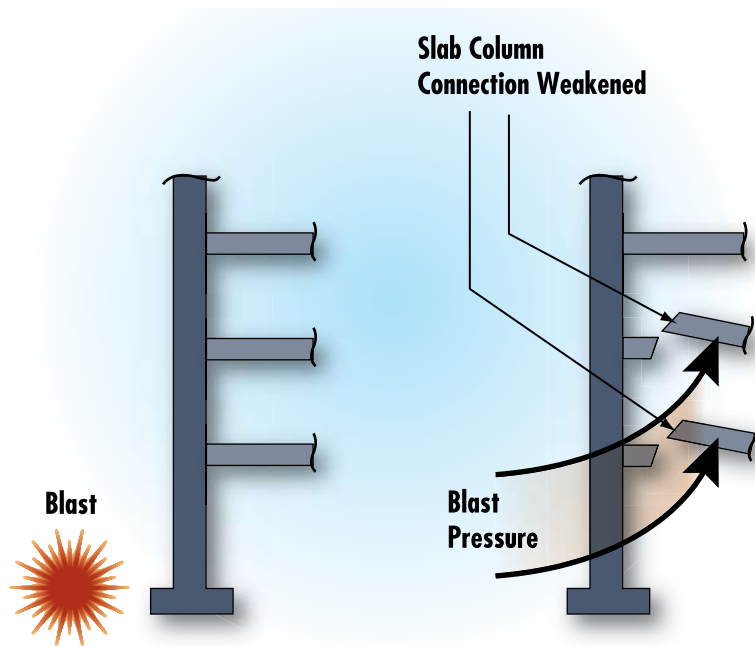
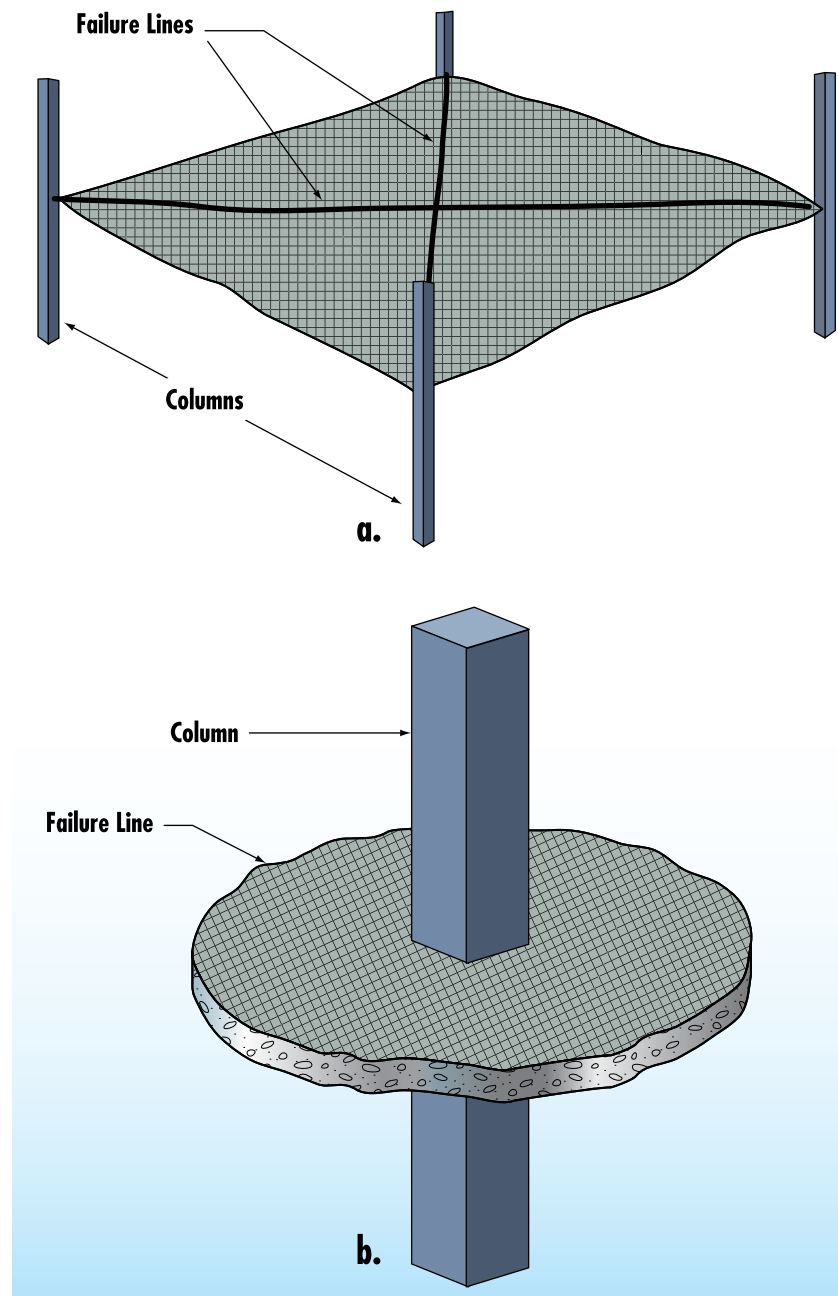

Figure 2-7
Effects of uplift and load
reversals

Floor slabs are typically designed to resist downward gravity loading and have limited capacity to resist uplift pressures or the upward deformations experienced during load reversals that may precipitate a flexural or punching shear failure (see Figure 2-8). Therefore, floor slabs that may be subjected to significant uplift

Figure 2-8
Flat slab failure mechanisms



pressures, such that they overcome the gravity loads and subject the slabs to reversals in curvature, require additional reinforcement. If the slab does not contain this tension reinforcement, it must be supplemented with a lightweight carbon fiber application that may be bonded to the surface at the critical locations. Carbon fiber reinforcing mats bonded to the top surface of slabs would strengthen the floors for upward loading and reduce the likelihood of slab collapse from blast infill uplift pressures as well as internal explosions in mailrooms or other susceptible regions. This lightweight high tensile strength material supplements the limited capacity of the concrete to resist these unnatural loading conditions. An alternative approach would be to notch grooves in the top of concrete slabs and epoxy carbon fiber rods into grooves; although this approach may offer a greater capacity, it is much more invasive.

Similarly, adequate connections must be provided between the roof sheathing and roof structure to prevent uplift forces from lifting the roof off of its supports. Reinforcing steel, bolts, steel studs, welds, screws, and nails are used to connect the roof decking to the supporting structure. The detailing of these connections depends on the magnitude of the uplift or catenary forces that may be developed. The attachment of precast planks to the supporting structure will require special attention to the connection details. However, as with all other forms of construction, ductile and redundant detailing will produce superior performance in response to extreme loading.

Wall systems are typically connected to foundations using anchor bolts, reinforcing steel and imbedded plate systems properly welded together, and nailed mechanical fasteners for wood construction. Although these connections benefit from the weight of the structure bearing against the foundations and the lateral restraint provided by keyed details, the connections must be capable of developing the design forces in both the connectors and the materials into which the connectors are anchored.

2.3.3 Building Envelope

Façade components that must transfer the collected loads to the structural system must be designed and detailed to absorb significant amounts of energy associated with the extreme loading through controlled deformation. The duration of the extreme loading significantly influences the criteria governing the design of the building envelope systems. Significant inelastic deformations may be permitted for extraordinary events that impart the extreme loading over very short periods of time (e.g., explosive detonations). The building envelope system need only be designed to resist the direct shock wave, rebound, and any reflections off of neighboring buildings, all of which will occur within a matter of milliseconds (see Figure 2-9).



Figure 2-9
Blast damaged façade

Resistance to blast is often compared to resistance to natural hazards with the expectation that the protection against one will provide protection against the other. Therefore, as a first step, one should consider any inherent resistance derived from a building's design to resist environmental loading. Extreme wind loading resulting from tornadoes may similarly be of short enough duration to permit a large deformation of the façade in response to the peak loading. Certainly, the debris impact criteria will be similar to that for blast loading. However, hurricane winds may persist for extended periods of time and the performance criteria for façade components in response to these sustained pressures permit smaller deformations and less damage to the system. Breach of the façade components would permit pressures to fill the

building and loads to be applied to nonstructural components. Anchorages and connections must be capable of holding the

façade materials intact and attached to the building. Brittle modes of failure must be avoided to allow ductile deformations to occur.

2.3.4 Forced Entry and Ballistic Resistance

Ballistic-resistant design involves both the blocking of sightlines to conceal the occupants and the use of ballistic-resistant materials to minimize the effectiveness of the weapon. To reduce exposure, the safe room should be located as far as possible into the interior of the facility and walls should be arranged to eliminate sightlines through doorways. In order to provide the required level of resistance, the walls must be constructed using the appropriate thickness of ballistic-resistant materials, such as reinforced concrete, masonry, mild steel plate, or composite materials. The required thickness of these materials depends on the level of ballistic resistance; however, resistance to a high level of ballistic threat may be achieved using 6.5 inches of reinforced concrete, 8 inches of grouted concrete masonry unit (CMU) or brick, 1 inch mild steel plate, or $\frac{3}{4}$ inch armor steel plate. A $\frac{1}{2}$ -inch thick layer of bullet-resistant fiberglass may provide resistance up to a medium level of ballistic threat. Bullet-resistant doors are required for a high level of protection; however, hollow steel or steel clad doors with pressed steel frames may be used with an appropriate concealed entryway. Ballistic-resistant window assemblies contain multiple layers of laminated glass or polycarbonate materials and steel frames. Because these assemblies tend to be both heavy and expensive, their number and size should be minimized. Roof structures should contain materials similar to the ballistic-resistant wall assemblies. Ratings of bullet-resisting materials are presented in Table 2-1.

Table 2-1: UL 752 Ratings of Bullet-resisting Materials

Rating	Ammunition	Grain	Minimum Velocity (fps)
Level 1	9 mm full metal copper jacket with lead core	124	1,185
Level 2	.357 Magnum jacketed lead soft point	158	1,250
Level 3	.44 Magnum lead semi-wadcutter gas checked	240	1,350
Level 4	.30 caliber rifle lead core soft point	180	2,540
Level 5	7.62 mm rifle lead core full metal copper jacket, military ball	150	2,750
Level 6	9 mm full metal copper jacket with lead core	124	1,400
Level 7	5.56 mm rifle full metal copper jacket with lead core	55	3,080
Level 8	7.62 mm rifle lead core full metal copper jacket, military ball	150	2,750

UL = Underwriters Laboratories

Forced entry resistance is measured in the time it takes for an aggressor to penetrate the enclosure using a variety of hand tools and weapons. The required delay time is based on the probability of detecting the aggressors and the probability of a response force arriving within a specified amount of time. The different layers of defense create a succeeding number of security layers that are more difficult to penetrate, provide additional warning and response time, and allow building occupants to move into defensive positions or designated safe haven protection (see Figure 2-10). The rated delay time for each component comprising a defense layer (walls, doors, windows, roofs, floors, ceilings, and utility openings) must be known in order to determine the effective delay time for the safe room. Conventional construction offers little resistance to most forced entry threat severity levels and the rating of different forced entry-resistant materials is based on standardized testing under laboratory conditions.

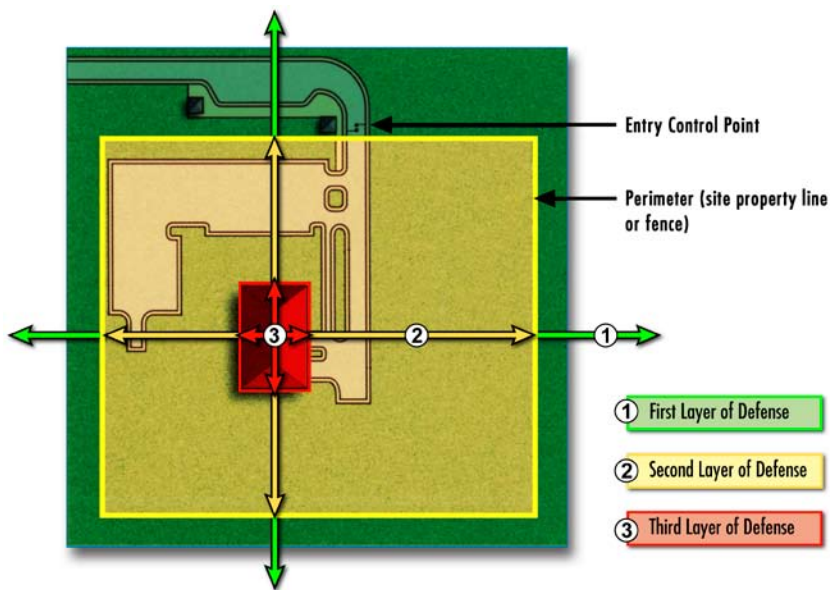

Figure 2-10
Layers of defense

2.4 NEW CONSTRUCTION

The design of new buildings to contain shelters provides greater opportunities than the retrofit of existing buildings. Whether the entire building or just the shelter is to be resistant to the explosive terrorist threat may have a significant impact on the architectural and structural design of the building. Furthermore, unless the building is required to satisfy an established security design criteria, the weight of explosive that the building is to be designed to resist must be established by a site-specific threat and risk assessment. Even so, given the evolving nature of the terrorist threat, it is impossible to predict all the extreme conditions to which the building may be exposed over its life. Therefore, even if the building is not to be designed to resist any specific explosive threat, the American Society of Civil Engineers *Minimum Design Loads for Buildings and Other Structures* (ASCE-7) requires the building to be designed to sustain local damage without the building as a whole “being damaged to an extent disproportionate to the original local damage.” The building can therefore be designed to prevent the progression of collapse in the unlikely event a primary member loses its load carrying capacity. This minimum design feature, achieved through the indirect prescriptive method or direct alternate path approach, will improve the structural

integrity and provide an additional measure of safety to occupants. Incorporating continuity, redundancy, and ductility into the design will allow a damaged building to bridge over a failed element and redistribute loads through flexure or catenary action. This will limit the extent of debris that might otherwise rain down upon the hardened shelter. Where specific threats are defined, the vulnerable structural components may be hardened to withstand the intensity of explosive loading. The local hardening of vulnerable components in addition to the indirect prescriptive detailing of the structural system to bridge over damaged components will provide the most protection to the building.

2.4.1 Structure

Both steel frame and reinforced concrete buildings may be designed and detailed to resist the effects of an exterior vehicle explosive threat and an interior satchel explosion. Although steel construction may be more efficient for many types of loading, both conventional and unconventional, cast-in-place reinforced concrete construction provide an inherent continuity and mass that makes it desirable for blast-resistant buildings.

Reinforced concrete is a composite material in which the concrete provides the primary resistance to compression and shear and the steel reinforcement provides the resistance to tension and confines the concrete core. In addition to ductile detailing, which allows the reinforced concrete members to sustain large deformations and uncharacteristic reversals of curvature, the structural elements are typically stockier and more massive than their steel frame counterparts. The additional inertial resistance as well as the continuity of cast-in-place construction facilitates designs that are capable of sustaining the high intensity and short duration effects of close-in explosions. Furthermore, reinforced concrete buildings tend to crack and dissipate large amounts of energy through internal damping. This limits the extent of rebound forces and deformations.

Blast-resistant detailing requires continuous top and bottom reinforcement with tension lap splices staggered over the spans, confinement of the plastic hinge regions by means of closely spaced ties, and the prevention of shear failure prior to developing the flexural capacity (see Figure 2-11). One- or two-way slabs supported on beams provide the best resistance to near contact satchel threats, which may produce localized breach, but allow the structure to redistribute the gravity loads. Concrete columns must be confined with closely spaced spiral ties, steel jackets, or composite wraps. This confinement increases the shear resistance, improves the ductility, and protects against the shattering effects resulting from a near contact explosion. Cast-in-place exterior walls or precast panels are best able to withstand a sizable stand-off vehicular explosive threat and may be easily detailed to interact with the reinforced concrete frame as part of the lateral load-resisting system.

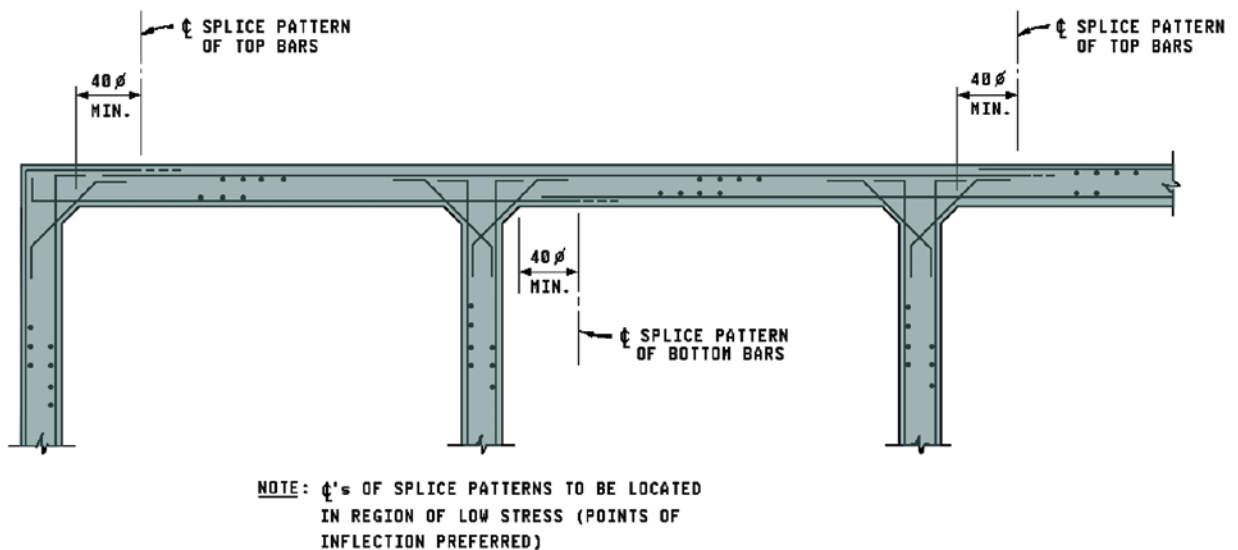

Figure 2-11 Multi-span slab splice locations

Steelwork is generally better suited to resist relatively low intensity, but long duration effects of large stand-off explosions. Steel is an inherently ductile material that is capable of sustaining large deformations; however, the very efficient thin-flanged sections make the conventional frame construction vulnerable to localized damage. Complex stress combinations and concentrations may occur that cause localized distress and prevent the section from developing its ultimate strength. Steel buildings may experience significant rebound and must therefore be designed to support significant reversals of loading. Concrete filled tube sections or concrete encased flanged sections may be used to protect the thin-flanged sections and supplement the inertial resistance. Concrete encasement should extend a minimum of 4 inches beyond the width and depth of the steel flanges and reinforcing bars may be detailed to tie into the concrete slabs.

To allow the concrete encasement to be tied into the floor slabs, the typical metal pan with concrete deck construction will require special detailing. Metal deck construction provides a spall shield to the underside of the slabs, which provides additional protection to a near contact satchel situated on a floor. However, the internal explosive threat will also load the ceiling slabs from beneath and the beams must contain an ample amount of studs, which far exceeds the requirements for conventional gravity design, to transfer the slab reactions to the steel supports without pulling out. If the slabs are adequately connected to the steel-framing members, these beams will be subjected to abnormal reversals of curvature. These reversals will subject the mid-span bottom flanges to transient compressive stress and may induce a localized buckling. Because the blast loads are transient, the dominant gravity loads will eventually restore the mid-span bottom flange to tension; however, unless it is adequately braced, the transient buckling will produce localized damage.

The concrete encasement of the steel beams will provide torsional resistance to the cross-section and minimize the need for intermediate bracing. If the depth of the composite section is to be minimized by embedding the steel section into the thickness of

the slab, the slab reinforcement must either be welded to the webs or run through holes drilled into the webs in order to maintain continuity. All welding of reinforcing steel must be in accordance with seismic detailing to prevent brittle failures. Steel columns require full moment splices and the relatively thin flange sections require concrete encasement to prevent localized damage. To take full advantage of the steel capacity and dissipate the greatest amount of energy through ductile inelastic deformation, the beam to column connections must be capable of developing the plastic flexural capacity of the members. Connection details, similar to those used in seismic regions, will be required to develop the corresponding flexural and shear capacity (see Figure 2-12). Connecting exterior cast-in-place reinforced concrete walls to the steel frame will require details that transfer both the direct blast loads in bearing and the subsequent rebound effects in tension. Precast panels are simply supported at the ends and, unless they span over multiple floors, they lack the continuity of monolithic cast-in-place wall construction. Cold joints in the cast-in-place construction require special detailing and the connection details for the precast panels must be able to resist both the direct blast loads in bearing and the subsequent rebound effects in tension.

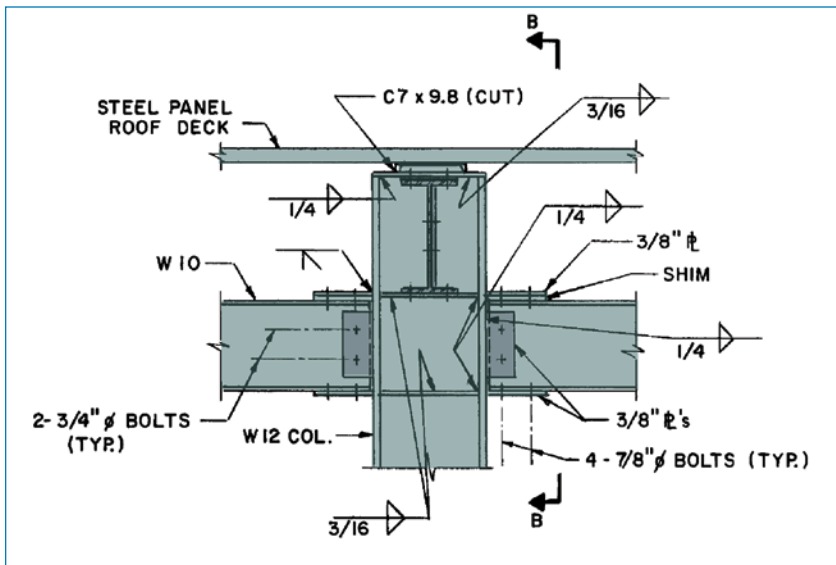

Figure 2-12
Typical frame detail at
interior column

Regardless of the materials, framed buildings perform best when column spacing is limited and the use of transfer girders is limited. Bearing wall systems that rely on interior cross-walls will benefit from periodically spaced longitudinal walls that enhance stability and control the lateral progression of damage. Bearing wall systems that rely on exterior walls will benefit from periodically spaced perpendicular walls or substantial pilasters that limit the extent of wall that is likely to be affected.

Free-standing columns do not have much surface area; therefore, air-blast loads on columns are limited by clear-time effects in which relief waves from the free edges attenuate the reflected intensity of the blast loads. Where the exterior façade inhibits clear-time effects prior to façade failure, the columns will receive the full intensity of the reflected blast pressures. Large stand-off explosive threats may produce large inelastic flexural deformations that could initiate $P-\Delta$ induced instabilities. Short stand-off explosive threats may cause shear, base plate, or column splice failures. Near contact threats may cause brisance, which is the shattering of reinforced concrete sections. Confinement of reinforced concrete members by means of spiral reinforcement, steel jackets, or carbon fiber wraps may improve their resistance. Encasement of steel sections will inhibit local flange and web plate deformations that could precipitate a section failure. Exterior column splices should be located as high above grade level as practical and match the capacity of the column section.

Load-bearing walls do not benefit from clear-time effects as columns do and therefore collect the full intensity of the reflected blast pressure pulse. Nevertheless, reinforced concrete load-bearing walls are particularly effective if adequately reinforced. Fully grouted masonry walls, on the other hand, are more brittle and seismic levels of reinforcement greatly increase the ductility and performance of masonry walls. Continuous reinforced bond beams, with a minimum of one #4 bar or equivalent, are required in the wall at the top and bottom of each floor and roof level. Interior horizontal ties are required in the floors perpendicular to the wall. The ties are equivalent to a #4 bent bar at a maximum

spacing of 16 inches that extends into the slab and the wall the greater of the development length of the bar or 30 inches. Vertical ties are required from floor to floor at columns, piers, and walls. The ties should be equivalent to a #4 bar at a maximum spacing of 16 inches coinciding with the horizontal ties. The ties should be continuous through the floor and extend into the wall above and below the floor the greater of the development length of the bar or 30 inches. Partition walls surrounding critical systems or isolating areas of internal threat, such as lobbies, loading docks, and mailrooms, require fully grouted reinforced masonry construction. It is particularly difficult to extend the reinforcement to the full height of the partition wall and develop the reaction forces. Reinforced bond beams are required as for load-bearing walls.

Flat roof systems are exposed to the incident blast pressures that diffuse over the top of the building, causing complex patterns of shadowing and focusing on the surface. Subsequent negative phase effects may subject the pre-weakened roof systems to low intensity, but long duration suction pressures; therefore, lightweight roof systems may be susceptible to uplift effects. Two-way beam slab systems are preferred for reinforced concrete construction and metal deck with reinforced concrete fill is preferred for steel frame construction. Both of these roof systems provide the required mass, strength, and continuity to resist all phases of blast loading. The performance of conventional precast concrete plank systems depends to a great extent on the connection details, and these connections need to be detailed to provide continuity. Flat slab and flat plate construction requires continuous bottom reinforcement in both directions to improve the integrity and special details at the columns to prevent a punching shear failure. Post-tensioned slab systems are particularly problematic because the cable profile is typically designed to resist the predominant patterns of gravity load and the system is inherently weak in response to load reversals.

2.4.2 Façade and Internal Partitions

The building's façade is its first real defense against the effects of a bomb and is typically the weakest component that will be subjected to blast pressures. Debris mitigating façade systems may be designed to provide a reasonable level of protection to a low or moderate intensity threat; however, façade materials may be locally overwhelmed in response to a low intensity short stand-off detonation or globally overwhelmed in response to a large intensity long stand-off detonation. As a result, it is unreasonable to design a façade to resist the actual pressures resulting from the design level threat everywhere over the surface of the building. In fact, successful performance of the blast-resistant façade may be defined as throwing debris with less than high hazard velocities. This is particularly true for the glazed fenestration. The peak pressures and impulses that are used to select the laminated glazing makeup are typically established such that no more than 10 percent of the glazed fenestration will produce debris that is propelled with high hazard velocities into the occupied space in response to any single detonation of the design level threat. The definitions of high hazard velocities were adapted from the United Kingdom hazard guides and correspond to debris that is propelled 10 feet from the plane of the glazing and strikes a witness panel higher than 2 feet above the floor. Similarly, a medium level of hazard corresponds to debris that strikes the witness panel no higher than 2 feet above the floor. A low level of hazard corresponds to debris that strikes the floor no farther than 10 feet from the plane of the glazing and a very low level of hazard corresponds to debris that strikes the floor no farther than 3.3 feet from the plane of the glazing. Glass hazard response software was developed for the U.S. Army Corps of Engineers, the General Services Administration, and the Department of State to determine the performance of a wide variety of glazing systems in response to blast loading. These simplified single-degree-of-freedom dynamic analyses account for the strength of the glass prior to cracking and the post-damage capacity of the laminated interlayers. While many of these glass hazard response software remain restricted, the American Society for Testing and Materials (ASTM) 2248 relates the design of glass to resist blast loading to an equivalent 3-second equivalent wind load.

In order for the glazing to realize its theoretical capacity, it must be retained by the mullions with an adequately sized bite, by means of a structural silicone adhesive, or a combination of the two. Furthermore, in order for the mechanical bite and silicone adhesive to be effective, the mullion deformations over the length of the lite must be limited (see Figure 2-13). Unfortunately, the maximum extent of deformation that the mullion may sustain prior to dislodging the glass is poorly defined. A conservative limit of 2 degrees is often assumed for typical protective glazing systems; however, advanced analytics may justify a significantly greater mullion deformation limit. Mullions must therefore be able to accept the reaction forces from the edges of the glazed elements and remain intact and attached to the building. Analyses of mullion deformations and anchorage details are required to demonstrate the safe performance of the glazed fenestration.

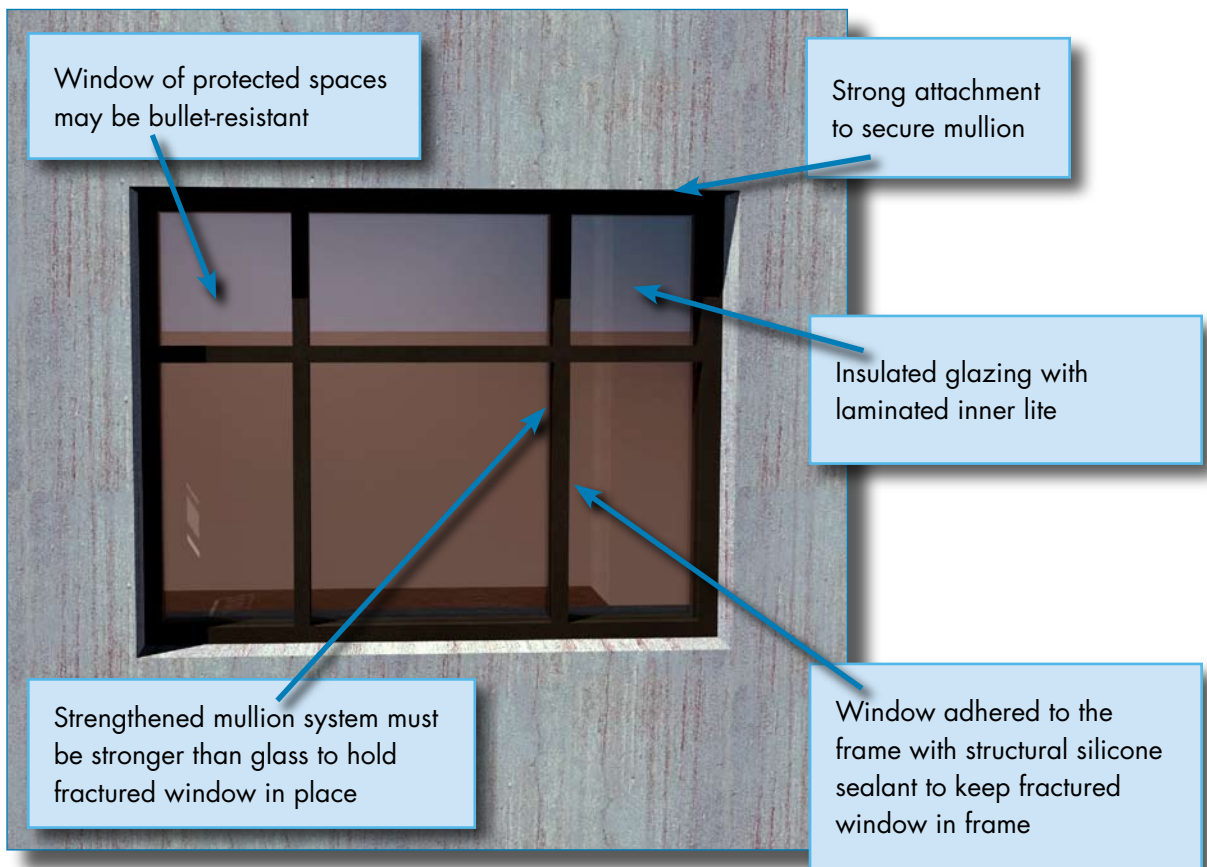

Figure 2-13 Protective façade design

Curtainwall systems are inherently lightweight and flexible façade systems; however, well designed curtainwall systems demonstrated, through explosive testing, considerable resilience in response to blast loading. Furthermore, the glazed components are subjected to less intense loads as their flexible supports deform in response to the blast pressures. A multi-degree-of-freedom model of the façade will determine the accurate interaction of the individual mullions and the phasing of the interconnecting forces. Because all response calculations must be dynamic and inelastic, the accurate representation of the phasing of these forces may significantly affect the performance. Curtainwall anchors are attached directly to the floor slabs where the large lateral loads may be transferred directly through the diaphragms into the lateral load-resisting systems.

Façade systems may contain combinations of glazing, metal panels, precast concrete, or stone panels. Metal panels provide little inertial resistance, but are capable of developing large inelastic deformations. The fasteners that attach these panels to the mullions or metal studs must be designed to transfer the large membrane forces. Stone panels provide significant inertial resistance, but are relatively brittle and have little strength beyond their modulus of rupture. Stud wall systems that restrain these façade panels may deform within acceptable levels and develop a membrane stiffening capacity, and strain energy methods may be used to calculate their response. However, the anchorage of the studs to the floor and ceiling slabs are likely to limit the forces they can develop.

Precast panels may easily be designed to provide inelastic deformation in response to the design level threats. However, the design of their anchorage to hold them to the building during both the direct loading and subsequent rebound phase require more robust details. Because the primary load carrying elements may buckle in response to the large collected forces, precast panels are attached directly to the floor slabs where the forces may be transferred through the diaphragms to the lateral load-resisting elements. Where mullions are attached within punched out openings in

precast panels, the spacing of the anchorages will determine the span of the mullions and the force each anchorage is required to resist. Embedded anchors within the precast panels will be required to accept these anchorage forces.

Fully grouted and reinforced CMU façades may be designed to accept the large lateral loads produced by blast events; however, it is often difficult to detail them to transfer the reaction forces to the floor slabs. A continuous exterior CMU wall that bears against the floor slabs may avoid many of the construction and connection difficulties, but this is not typical construction practice. Brick or stone veneer does not appreciably increase the strength of the CMU wall, but the added mass increases its inertial resistance.

2.5 EXISTING CONSTRUCTION: RETROFITTING CONSIDERATIONS

Although retrofitting existing buildings to include a shelter can be expensive and disruptive to users, it may be the only available option. When retrofitting existing space within a building is considered, data centers, interior conference rooms, stairwells, and other areas that can be structurally and mechanically isolated provide the best options. Designers should be aware that an area of a building currently used for refuge may not necessarily be the best candidate for retrofitting when the goal is to provide comprehensive protection.

An existing area that has been retrofitted to serve as a shelter is unlikely to provide the same degree of protection as a shelter designed as new construction. When existing space is retrofitted for shelter use, issues have arisen that have challenged both designers and shelter operators. For example, glass and unreinforced masonry façades are particularly vulnerable to blast loading. Substantial stand-off distances are required for the unprotected structure and these distances may be significantly reduced through the use of debris mitigating retrofit systems. Furthermore, because blast loads diminish with distance and incidence of blast wave to the loaded surface, the larger threats at larger

stand-off distances are likely to damage a larger percentage of façade elements than the more localized effects of smaller threats at shorter stand-off distances. Safe rooms that may be located within a building should therefore be located in windowless spaces or spaces in which the window glazing was upgraded with a fragment retention film (FRF).

2.5.1 Structure

The building's lateral load-resisting system, the structural frame or shear walls that resist wind and seismic loads, will be required to receive the blast loads that are applied to the exterior façade and transfer them to the building's foundation. This load path is typically through the floor slabs that act as diaphragms and interconnect the different lateral load-resisting elements. The lateral load-resisting system for a building depends to a great extent on the type of construction and region. In many cases, low-rise buildings do not receive substantial wind and seismic forces and, therefore, do not require substantial lateral load-resisting systems. Because blast loads diminish with distance, a package sized explosive threat is likely to locally overwhelm the façade, thereby limiting the force that may be transferred to the lateral load-resisting system. However, the intensity of the blast loads that may be applied to the building could exceed the design limits for most conventional construction. As a result, the building is likely to be subjected to large inelastic deformations that may produce severe cracks to the structural and nonstructural partitions. There is little that can be done to upgrade the existing structure to make it more ductile in response to a blast loading that doesn't require extensive renovation of the building; therefore, safe rooms should be located close to the interior shear walls or reinforced masonry walls in order to provide maximum structural support in response to these uncharacteristically large lateral loads.

Unless the structure is designed to resist an extreme loading, such as a hurricane or an earthquake, it is not likely to sustain extensive structural damage without precipitating a progressive collapse. The effects of a satchel-sized explosive in close contact

to a column or a vehicle-borne explosive device at a sidewalk's distance from the façade may initiate a failure of a primary structure that may propagate as the supported loads attempt to redistribute to an adjoining structure. Transfer girders that create long span structures and support large tributary areas are particularly susceptible to localized damage conditions. As a result, safe rooms should not be located on a structure that is either supported by or underneath a structure that is supported by transfer girders unless the building is evaluated by a licensed professional engineer. The connection details for multi-story precast structures should also be evaluated before the building is used to house a safe room.

Nonstructural building components, such as piping, ducts, lighting units, and conduits that are located within safe rooms must be sufficiently tied back to a solid structure to prevent failure of the services and the hazard of falling debris. To mitigate the effects of in-structure shock that may result from the infilling of blast pressures through damaged windows, the nonstructural systems should be located below the raised floors or tied to the ceiling slabs with seismic restraints.

2.5.2 Façade and Internal Partitions

Safe rooms in existing buildings should be selected to provide the space required to accommodate the building population and should be centrally located to allow quick access from any location within the building, enclosed with fragment mitigating partitions or façade, and within robust structural systems that will resist collapse. These large spaces are best located at the lower floors, away from a lightweight roof and exterior glazing elements. If such a space does not exist within the existing building, the available spaces may be upgraded to achieve as many of these attributes as possible. This will involve the treatment of the exterior façade with fragment mitigating films, blast curtains, debris catch systems, spray-on applications of elasto-polymers to unreinforced masonry walls, and hardening of select columns and slabs with composite fiber wraps, steel jackets, or concrete encasements.

2.5.2.1 Anti-shatter Façade. The conversion of existing construction to provide blast-resistant protection requires upgrades to the most fragile or brittle elements enclosing the safe room. Failure of the glazed portion of the façade represents the greatest hazard to the occupants. Therefore, the exterior glazed elements of the façade and, in particular, the glazed elements of the designated safe rooms, should be protected with an FRF, also commonly known as anti-shatter film (ASF), “shatter-resistant window film” (SRWF), or “security film.” These materials consist of a laminate that will improve post-damage performance of existing windows. Applied to the interior face of glass, ASF holds the fragments of broken glass together in one sheet, thus reducing the projectile hazard of flying glass fragments.

Most ASFs are made from polyester-based materials and coated with adhesives. ASFs are available as clear, with minimal effects to the optical characteristics of the glass, and tinted, which provides a variety of aesthetic and optical enhancements and can increase the effectiveness of existing heating/cooling systems. Most films are designed with solar inhibitors to screen out ultraviolet (UV) rays and are available treated with an abrasion-resistant coating that can prolong the life of tempered glass.¹ However, over time, the UV absorption damages the film and degrades its effectiveness.

According to published reports, testing has shown that a 7-mil thick film, or specially manufactured 4-mil thick film, is the minimum thickness that is required to provide hazard mitigation from blast. Therefore, a 4-mil thick ASF should be utilized only if it has demonstrated, through explosive testing, that it is capable of providing the desired hazard level response.

The application of security film must, at a minimum, cover the clear area of the window. The clear area is defined as the portion of the glass unobstructed by the frame. This minimum application, termed daylight installation, is commonly used for retrofitting windows. By this method, the film is applied to the exposed glass

¹ Abrasions on the faces of tempered glass reduce the glass strength.

without any means of attachment or capture within the frame. Application of the film to the edge of the glass panel, thereby extending the film to cover the glass within the bite, is called an edge to edge installation and is often used in dry glazing installations. Other methods of retrofit application may improve the film performance, thereby reducing the hazards; however, these are typically more expensive to install, especially in a retrofit situation.

Although a film may be effective in keeping glass fragments together, it may not be particularly effective in retaining the glass in the frame. ASF is most effective when it is used with a blast tested anchorage system. Such a system prevents the failed glass from exiting the frame (see Figure 2-14).

The wet glazed installation, a system where the film is positively attached to the frame, offers more protection than the daylight installation. This system of attaching the film to the frame reduces glass fragmentation entering the building. The wet glazing system utilizes a high strength liquid sealant, such as silicone, to attach the glazing system to the frame. This method is more costly than the daylight installation.

Securing the film to the frame with a mechanically connected anchorage system further reduces the likelihood of the glazing system exiting the frame. Mechanical attachment includes anchoring methods that employ screws and/or batten strips that anchor the film to the frame along two or four sides. The mechanical attachment method can be less aesthetically pleasing when compared to wet glazing because additional framework is necessary and is more expensive than the wet glazed installation.

Window framing systems and their anchorage must be capable of transferring the blast loads to the surrounding walls. Unless the frames and anchorages are competent, the effectiveness of the attached films will be limited. Similarly, the walls must be able to withstand the blast loads that are directly applied to them and accept the blast loads that are transferred by the windows. The strength of these walls may limit the effectiveness of the glazing upgrades.

Figure 2-14
Mechanically attached
anti-shatter film

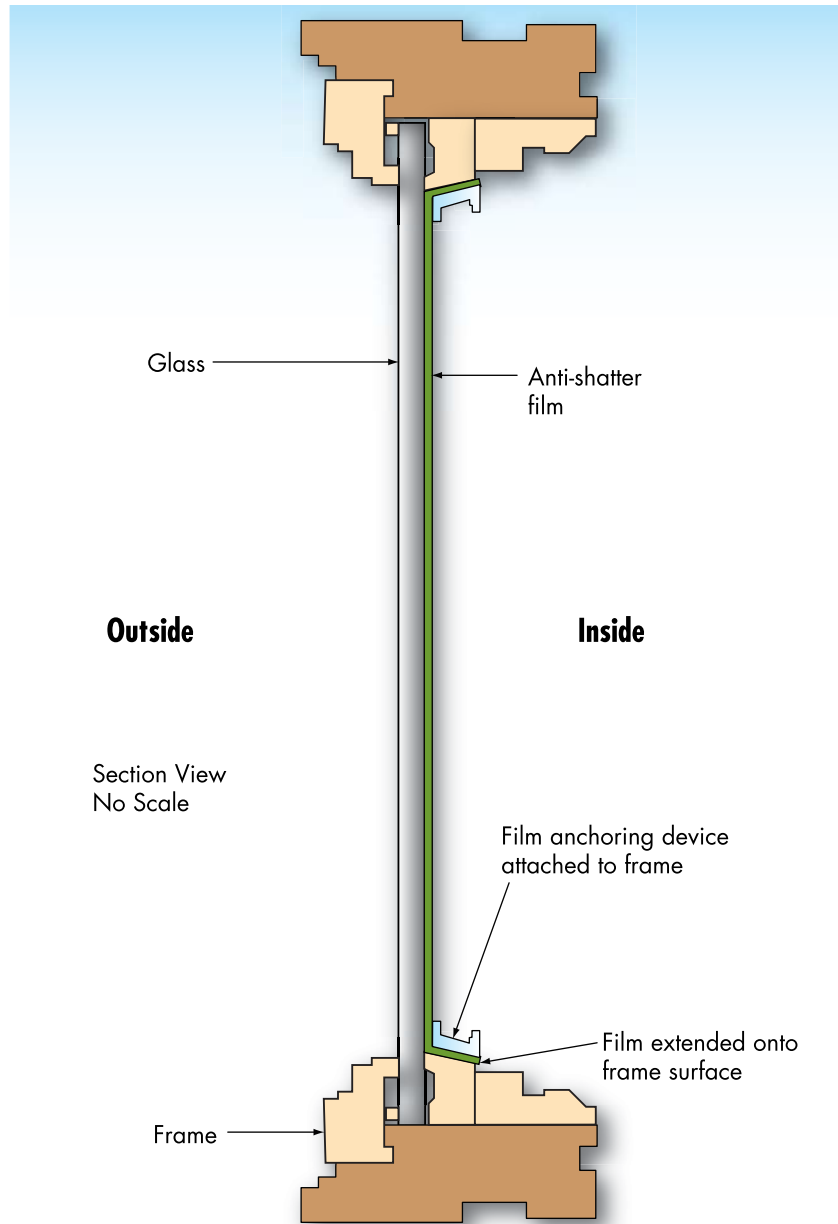

If a major rehabilitation of the façade is required to improve the mechanical characteristics of the building envelope, a laminated glazing replacement is recommended. Laminated glass consists of two or more pieces of glass permanently bonded together by a tough plastic interlayer made of polyvinyl butyral (PVB) resin. Once sealed together, the glass “sandwich” behaves as a single unit. Annealed, heat strengthened, tempered glass, or

polycarbonate glazing can be mixed and matched between layers of laminated glass in order to design the most effective lite for a given application. When fractured, fragments of laminated glass tend to adhere to the PVB interlayer rather than falling free and potentially causing injury.

Laminated glass can be expected to last as long as ordinary glass, provided it is not broken or damaged in any way. It is very important that laminated glass is correctly installed to ensure long life. Regardless of the degree of protection required from the window, laminated glass needs to be installed with adequate sealant to prevent water from coming in contact with the edges of the glass. A structural sealant will adhere the glazing to the frame and allow the PVB interlayer to develop its full membrane capacity. Similar to attached film upgrades, the window frames and anchorages must be capable of transferring the blast loads to the surrounding walls.

2.5.2.2 Façade Debris Catch Systems. Blast curtains are made from a variety of materials, including a warp knit fabric or a polyethylene fiber. The fiber can be woven into a panel as thin as 0.029 inch that weighs less than 1.5 ounces per square foot. This fact dispels the myth that blast curtains are heavy sheets of lead that completely obstruct a window opening and eliminate all natural light from the interior of a protected building. The blast curtains are affixed to the interior frame of a window opening and essentially catch the glass fragments produced by a blast wave. The debris is then deposited on the floor at the base of the window. Therefore, the use of these curtains does not eliminate the possibility of glass fragments penetrating the interior of the occupied space, but instead limits the travel distance of the airborne debris. Overall, the hazard level to occupants is significantly reduced by the implementation of the blast curtains. However, a person sitting directly adjacent to a window outfitted with a blast curtain may still be injured by shards of glass in the event of an explosion.

The main components of any blast curtain system are the curtain itself, the attachment mechanism by which the curtain is affixed to the window frame, and either a trough or other retaining

mechanism at the base of the window to hold the excess curtain material. The blast curtain with curtain rod attachment and sill trough differ largely from one manufacturer to the next. The curtain fabric, material properties, method of attachment, and manner in which they operate all vary, thereby providing many options within the overall classification of blast curtains. This fact makes blast curtains applicable in many situations.

Blast curtains differ from standard curtains in that they do not open and close in the typical manner. Although blast curtains are intended to remain in a closed position at all times, they may be pulled away from the window to allow for cleaning and blind or shade operation. However, the curtains can be rendered ineffective if installed such that easy access would provide opportunity for occupants to defeat their operation. The color and openness factor of the fabric contributes to the amount of light that is transmitted through the curtains and the see-through visibility of the curtains. Although the color and weave of these curtains may be varied to suit the aesthetics of the interior décor, the appearance of the windows is altered by the presence of the curtains.

The curtains may either be anchored at the top and bottom of the window frame or anchored at the top only and outfitted with a weighted hem. The curtain needs to be extra long, with the surplus either wound around a dynamic tension retainer or stored in a reservoir housing. When an explosion occurs, the curtain feeds out of the receptacle to absorb the force of the flying glass fragments. The effectiveness of the blast curtains relies on their use and no protection is provided when these curtains are pulled away from the glazing (see Figure 2-15).

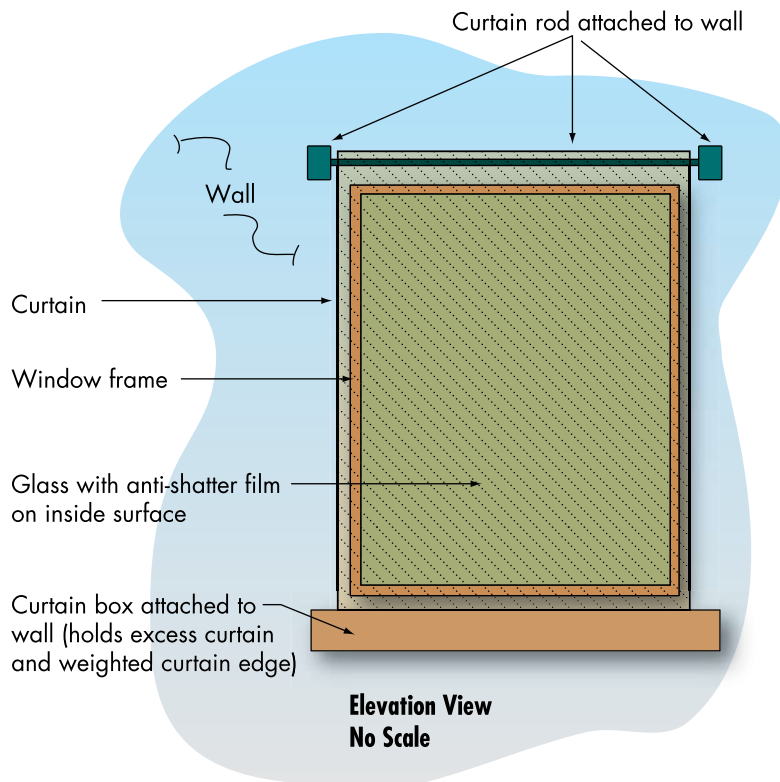

Figure 2-15
Blast curtain system

Rigid catch bar systems were designed and tested as a means of increasing the effectiveness of filmed and laminated window upgrades. Anti-shatter film and laminated glazing are designed to hold the glass shards together as the window is damaged; however, unless the window frames and attachments are upgraded as well to withstand the capacity of the glazing, this retrofit will not prevent the entire sheet from flying free of the window frames. The rigid catch bars intercept the filmed or laminated glass and disrupt their flight; however, they are limited in their effectiveness, tending to break the dislodged façade materials into smaller projectiles.

Rigid catch systems collect huge forces upon impact and require considerable anchorage into a very substantial structure to prevent failure. If either the attachments or the supporting structure are incapable of restraining the forces, the catch system will be dislodged and become part of the debris. Alternatively, the debris

may be sliced by the rigid impact and the effectiveness of the catch bar will be severely reduced. Finally, the effectiveness of debris catch systems are limited where double pane, insulated glazing units (IGUs) are used. Since anti-shatter film or laminated glass is typically applied to only the inner surface of an IGU, debris from the damaged outer lite could be blown past the catch bar into the protected space.

Flexible catch bars can be designed to absorb a significant amount of the energy upon impact, thereby keeping the debris intact and impeding their flight. These systems may be designed to effectively repel the debris and inhibit their flight into the occupied spaces; they also may be designed to repel the debris from the failed glazing as well as the walls in which the windows are mounted. The design of the debris restraint system must be strong enough to withstand the momentum transferred upon impact and the connections must be capable of transferring the forces to the supporting slabs and spandrel beams. However, under no circumstances can the design of the restraint system add significant amounts of mass to the structure that may be dislodged and present an even greater risk to the occupants of the building.

Cables are extensively used to absorb significant amounts of energy upon impact and their flexibility makes them easily adaptable to many situations. The diameter of the cable, the spacing of the strands, and the means of attachment are all critical in designing an effective catch system. These catch cable concepts have been used by protective design window manufacturers as restraints for laminated lites. The use of cable systems has long been recognized as an effective means of stopping massive objects moving at high velocity. An analytical simulation or a physical test is required to confirm the adequacy of the cable catch system to restrain the debris resulting from an explosive event.

High performance energy absorbing cable catcher systems retain glass and frame fragments and limit the force transmitted to the supporting structure. These commercially available retrofit products consist of a series of ¼-inch diameter

stainless steel cables connected with a shock-absorbing device to an aluminum box section, which is attached to the jambs, the underside of the header, and topside of the sill. The energy absorbing characteristics allow the catch systems to be attached to relatively weakly constructed walls without the need for additional costly structural reinforcement. To reduce the possibility of slicing the laminated glass, the cable may either be sheathed in a tube or an aluminum strip may be affixed to the glass directly behind the cable.

2.5.2.3 Internal Partitions. Unreinforced masonry walls provide limited protection against airblast due to explosions. When subjected to overload from air blast, brittle unreinforced CMU walls will fail and the debris will be propelled into the interior of the structure, possibly causing severe injury or death to the occupants. This wall type has been prohibited for new construction where protection against explosive threats is required. Existing unreinforced CMU walls may be retrofitted with a sprayed-on polymer coating to improve their air blast resistance. This innovative retrofit technique takes advantage of the toughness and resiliency of modern polymer materials to effectively deform and dissipate the blast energy while containing the shattered wall fragments. Although the sprayed walls may shatter in a blast event, the elastomer material remains intact and contains the debris.

The blast mitigation retrofit for unreinforced CMU walls consists of an interior and optional exterior layer of polyurea applied to exterior walls and ceilings (see Figure 2-16). The polyurea provides a ductile and resilient membrane that catches and retains secondary fragmentation from the existing concrete block as it breaks apart in response to an air blast wave. These fragments, if allowed to enter the occupied space, are capable of producing serious injury or death to occupants of the structure.

Figure 2-16
 Spray-on elastomer coating

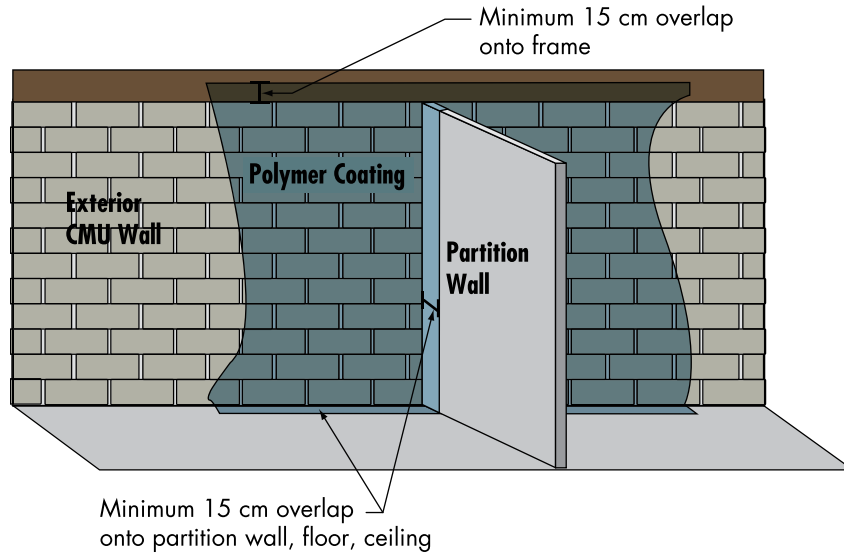

In lieu of the elastomer, an aramid (Geotextile) debris catching system may be attached to the structure by means of plates bolted through the floor and ceiling slabs (see Figure 2-17). Similar to the elastomer retrofit, the aramid layer does not strengthen the wall; instead, it restrains the debris that would otherwise be propelled into the occupied spaces.

Figure 2-17
 Geotextile debris catch system

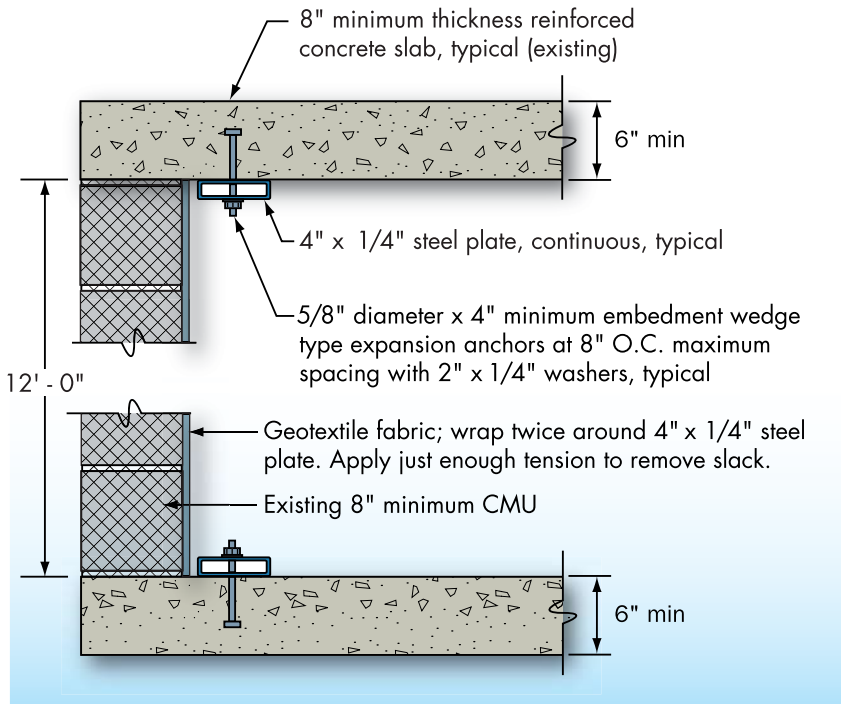

Alternatively, an unreinforced masonry wall may be upgraded with an application of shotcrete sprayed onto the wall with a welded wire fabric. This method supplements the tensile capacity of the existing wall and limits the extent of debris that might be propelled into the protected space. Steel sections may also be installed up against existing walls to reduce the span and provide an alternate load transfer to the floor diaphragms. Load-bearing masonry walls require additional redundancy to prevent the initiation of a catastrophic progression of collapse. Therefore, the fragment protection that may be provided by a spray-on elasto-polymer, a fabric spall shield, or a metal panel must be supplemented with structural supports that can sustain the gravity loads in the event of excessive wall deformation. The design of stiffened steel-plate wall systems to withstand the effects of explosive loading is one way of achieving such redundancy and fragment protection. These load-bearing wall retrofits require a more stringent design, capable of resisting lateral loads and the transfer of axial forces. Stiffened wall panels, consisting of steel plates to catch the debris and welded tube sections spaced some 3 feet on center to supplement the gravity load carrying capacity of the bearing walls, must be connected to the existing floor and ceiling slabs by means of base plates and anchor bolt connectors (see Figure 2-18).

A steel stud wall construction technique may also be used for new buildings or the retrofit of existing structures requiring blast resistance. Commercially available 18-gauge steel studs may be attached web to web (back to back) and 16-gauge sheet metal may be installed outboard of the steel studs behind the cladding (see Figure 2-19). While the wall absorbs a considerable amount of the blast energy through deformation, its connection to the surrounding structure must develop the large tensile reaction forces. In order to prevent a premature failure, these connections should be able to develop the ultimate capacity of the stud in tension. Ballistic testing of various building cladding materials requires a nominal 4-inch thickness of stone, brick, masonry, or concrete. Forced entry protection requires a ¼-inch thick layer of A36 steel plate that is behind the building's veneer and welded or screwed to the steel stud framing in lieu of the 16-gauge sheet metal.

Figure 2-18
Stiffened wall panels

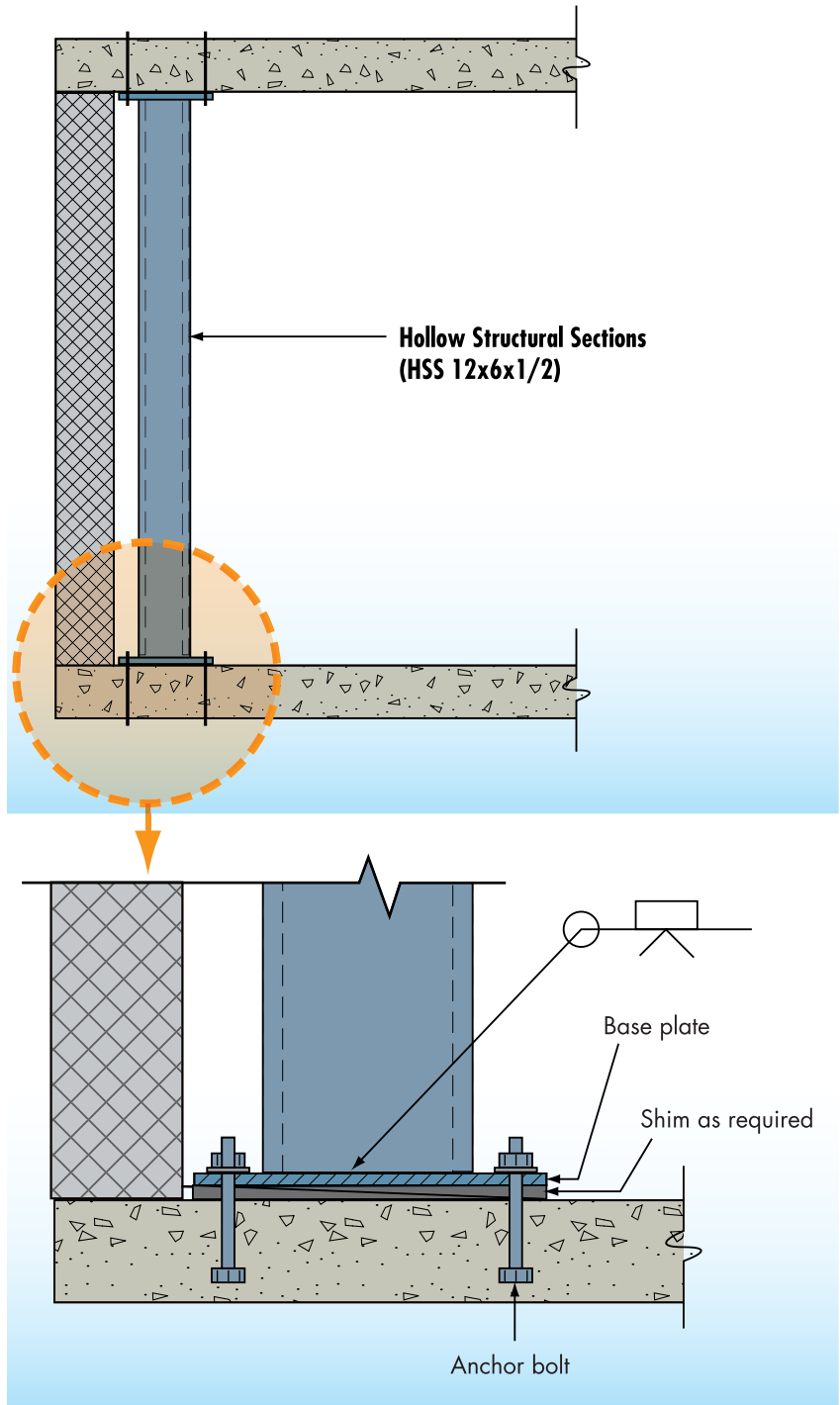

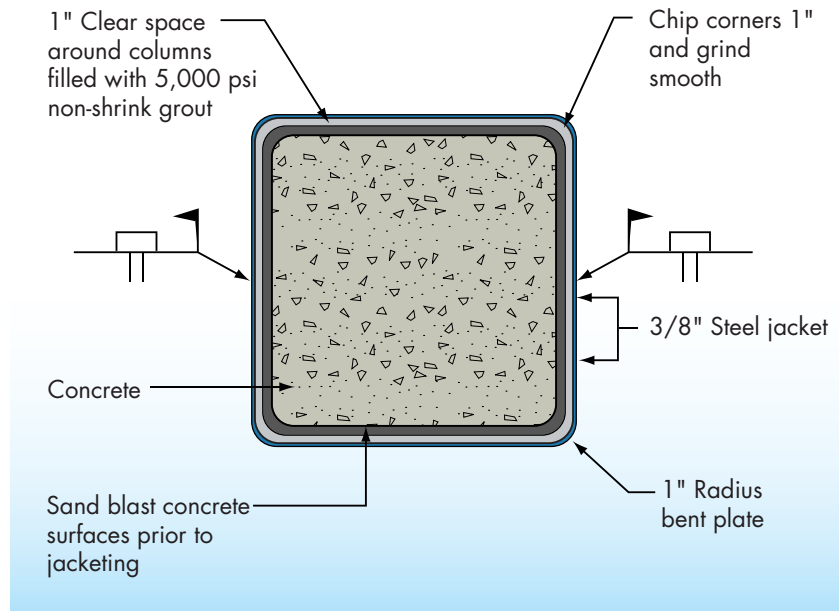

Figure 2-19 Metal stud blast wall

Internal installations require an interstitial sheathing of $\frac{1}{2}$ -inch A36 steel plate. Regardless whether a $\frac{1}{4}$ -inch steel plate or a 16-gauge sheet metal is used, the interior face of the stud should be finished with a steel-backed composite gypsum board product.

2.5.2.4 Structural Upgrades. Conventionally designed columns may be vulnerable to the effects of explosives, particularly when placed in contact with their surface. Stand-off elements, in the form of partitions and enclosures, may be designed to guarantee a minimum stand-off distance; however, this alone may not be sufficient. Additional resistance may be provided to reinforced concrete structures by means of a steel jacket or a carbon fiber wrap that effectively confines the concrete core, thereby increasing the confined strength and shear capacity of the column, and holds the rubble together to permit it to continue carrying the axial loads (see Figure 2-20). The capacity of steel flanged columns may be increased with a reinforced concrete encasement that adds mass to the steel section and protects the relatively thin flange sections. The details for these retrofits must be designed to resist the specific weight of explosives and stand-off distance.

Figure 2-20
Steel jacket retrofit detail



2.5.3 Checklist for Retrofitting Issues

A Building Vulnerability Assessment Checklist was developed for FEMA 426 and FEMA 452 to help identify structural conditions that may suffer in response to blast loading. Each building in consideration needs to be evaluated by a professional engineer, experienced in the protective design of structures, to determine the ability to withstand blast loading.

In addition, the following questions will help address key retrofitting issues. Issues related to the retrofitting of existing refuge areas (e.g., hallways/corridors, bathrooms, workrooms, laboratory areas, kitchens, and mechanical rooms) that should be considered include the following:

- **The roof system.** Is the roof system over the proposed refuge area structurally independent of the remainder of the building? If not, is it capable of resisting the expected blast, wind, and debris loads? Are there openings in the roof system for mechanical equipment or lighting that cannot be protected during a blast or high-wind event? It may not be reasonable to retrofit the rest of the proposed shelter area if the roof system is part of a building that was not designed for high-wind load requirements.
- **The wall system.** Can the wall systems be accessed so that they can be retrofitted for resistance to blast and high-wind pressures and missile impact? It may not be reasonable to retrofit a proposed shelter area to protect openings if the wall systems (load-bearing or non-load-bearing) cannot withstand blast and wind pressures or cannot be retrofitted in a reasonable manner to withstand blast or wind pressures and missile impacts.
- **Openings.** Are the windows and doors vulnerable to blast and wind pressures and debris impact? Are doors constructed of impact-resistant materials (e.g., steel doors) and secured with six points of connection (typically three hinges and three

latching mechanisms)? Are door frames constructed of at least 16-gauge metal and adequately secured to the walls to prevent the complete failure of the door/frame assemblies? Does the building rely on shutter systems for resistance to the effects of hurricanes? There is often only minimal warning time before a CBRE or tornado event; therefore, a shelter design that relies on manually installed shutters is impractical. Automated shutter systems may be considered, but they would require a protected backup power system to ensure that the shutters are closed before an event.

2.6 SHELTERS AND MODEL BUILDING TYPES

This section will provide basic FEMA model building types to describe protective design and structural systems for shelters in the most effective manner. This section is based on FEMA 310, *Handbook for the Seismic Evaluation of Buildings*, which is dedicated to instructing the design professional on how to determine if a building is adequately designed and constructed to resist particular types of forces. Graphics included in this section were prepared for FEMA 454, *Designing for Earthquakes: A Manual for Architects*.

2.6.1 W1, W1a, and W2 Wood Light Frames and Wood Commercial Buildings

Small wood light frame buildings (<3,000 square feet) are single or multiple family dwellings of one or more stories in height (see Figure 2-21). Building loads are light and the framing spans are short. Floor and roof framing consists of closely spaced wood joists or rafters on wood studs. The first floor framing is supported directly on the foundation, or is raised up on cripple studs and post and beam supports. The foundation consists of spread footings constructed of concrete, concrete masonry block, or brick masonry in older construction. Chimneys, when present, consist of solid brick masonry, masonry veneer, or wood frame with internal metal flues. Lateral forces are resisted by wood frame diaphragms and shear walls. Floor and roof diaphragms consist of straight or diagonal wood sheathing, tongue and groove planks, or plywood.

Shearwalls consist of straight or diagonal wood sheathing, plank siding, plywood, stucco, gypsum board, particle board, or fiberboard. Interior partitions are sheathed with plaster or gypsum board.

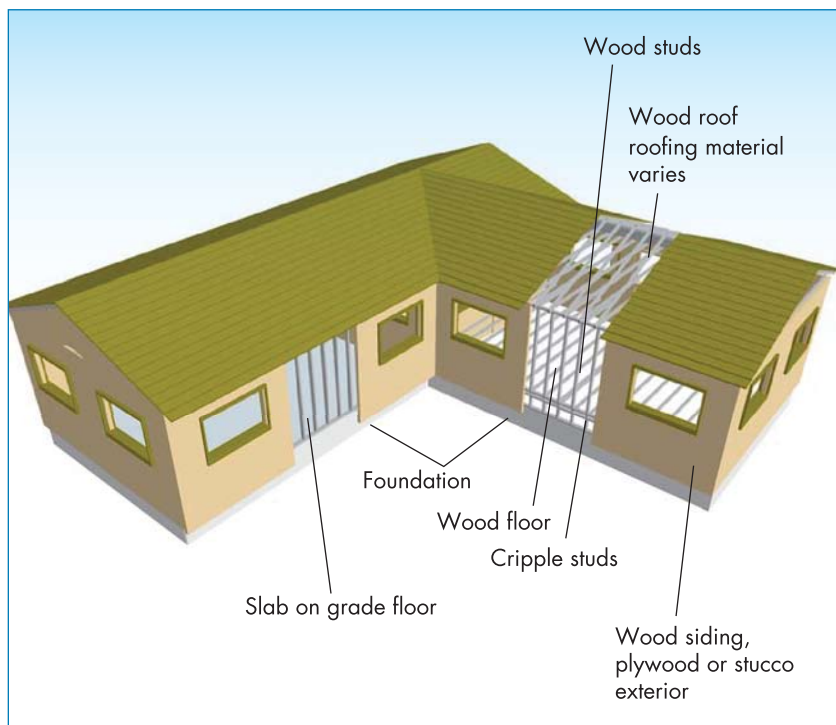

Figure 2-21
W1 wood light frame
< 3,000 square feet

Large wood light frame buildings (> 3,000 square feet) are multi-story, multi-unit residences similar in construction to W1 buildings, but with open front garages at the first story (see Figure 2-22). The first story consists of wood floor framing on wood stud walls and steel pipe columns, or a concrete slab on concrete or concrete masonry block walls.

Wood commercial or industrial buildings with a floor area of 5,000 square feet or more carry heavier loads than light frame construction (see Figure 2-23). In these buildings, the framing spans are long and there are few, if any, interior walls. The floor and roof framing consists of wood or steel trusses, glulam or steel beams, and wood posts or steel columns. Lateral forces are resisted by wood diaphragms and exterior stud walls sheathed with plywood,

stucco, plaster, straight or diagonal wood sheathing, or braced with rod bracing. Large openings for storefronts and garages, when present, are framed by post-and-beam framing. Lateral force resistance around openings is provided by steel rigid frames or diagonal bracing.

Figure 2-22
W1a wood light frame
> 3,000 square feet



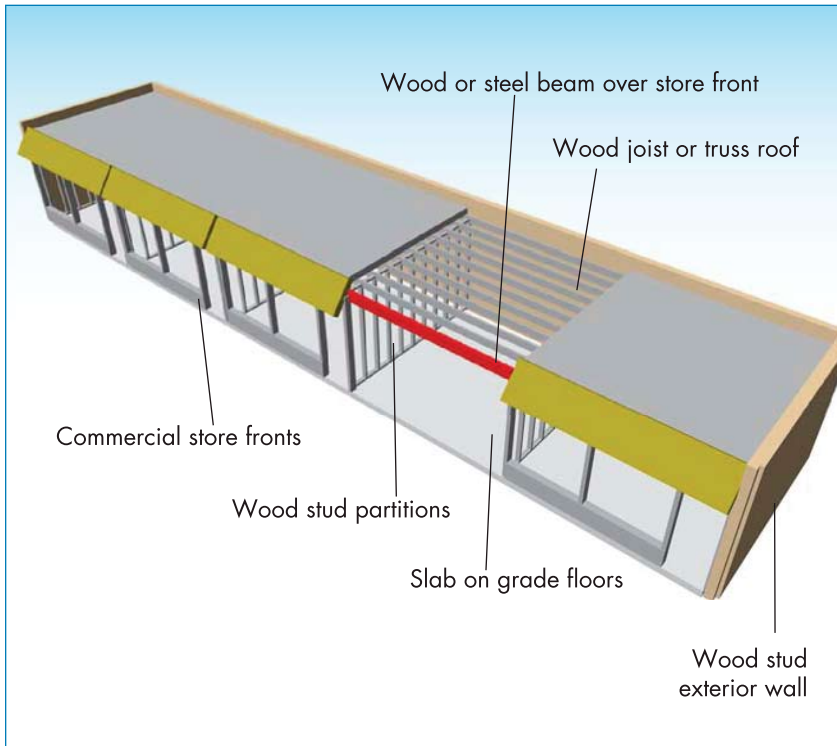

Figure 2-23
W2 wood commercial
buildings

Light wood frame structures do not possess significant resistance to blast loads although larger wood commercial buildings will be better able to accept these lateral loads than light frame wood construction. These buildings are likely to suffer heavy damage in response to 50 pounds of TNT at a stand-off distance of 20 to 50 feet. A shelter would best be located in a basement where the protection to blast loading would be provided by the surrounding soil. Large explosive detonations in close proximity to the building will not only destroy the superstructure, but the effects of ground shock are likely to fail the foundation walls as well; therefore, protected spaces should be located interior to the building. Locating the shelter on the ground floor, for slab on grade structures, provides the maximum number of floors between occupants and possible roof debris. Debris catch systems may be installed beneath roof rafters of single-story buildings; however, the effectiveness of the debris catch system will be limited if the zone of roof damage is extensive.

Metal stud blast walls built within the existing building may be used to supplement the enclosure; however, in order for these walls to develop their resistance to lateral loads, they must be anchored to an existing structure. Windows enclosing the selected shelter must either be laminated or treated with an anti-shatter film. Either the laminated glass or the anti-shatter film should be anchored to the surrounding wall with a system that can develop but not overwhelm the capacity of the wall. A conservative estimate of the ultimate capacity of an existing wall may be determined, in the absence of actual design information, by scaling the code specified wind pressures with the appropriate factor of safety.

2.6.2 S1, S2, and S3 Steel Moment Frames, Steel Braced Frames, and Steel Light Frames

Steel moment frame and braced frame buildings with cast-in-place concrete slabs or metal deck with concrete fill supported on steel beams, open web joists, or steel trusses are well suited for a hardened shelter construction. Lateral forces in steel moment frame buildings are resisted by means of rigid or semi-rigid beam-column connections (see Figure 2-24). When all connections are moment-resisting connections, the entire frame participates in lateral force resistance. When only selected connections are moment-resisting connections, resistance is provided along discrete frame lines. Columns are oriented so that each principal direction of the building has columns resisting forces in strong axis bending. Diaphragms consist of concrete or metal deck with concrete fill and are stiff relative to the frames. Walls may consist of metal panel curtainwalls, glazing, brick masonry, or precast concrete panels. When the interior of the structure is finished, frames are concealed by ceilings, partition walls, and architectural column furring. Foundations consist of concrete spread footings or deep pile foundations.

Lateral forces in steel braced frame buildings are resisted by tension and compression forces in diagonal steel members (see Figure 2-25). When diagonal brace connections are concentric to

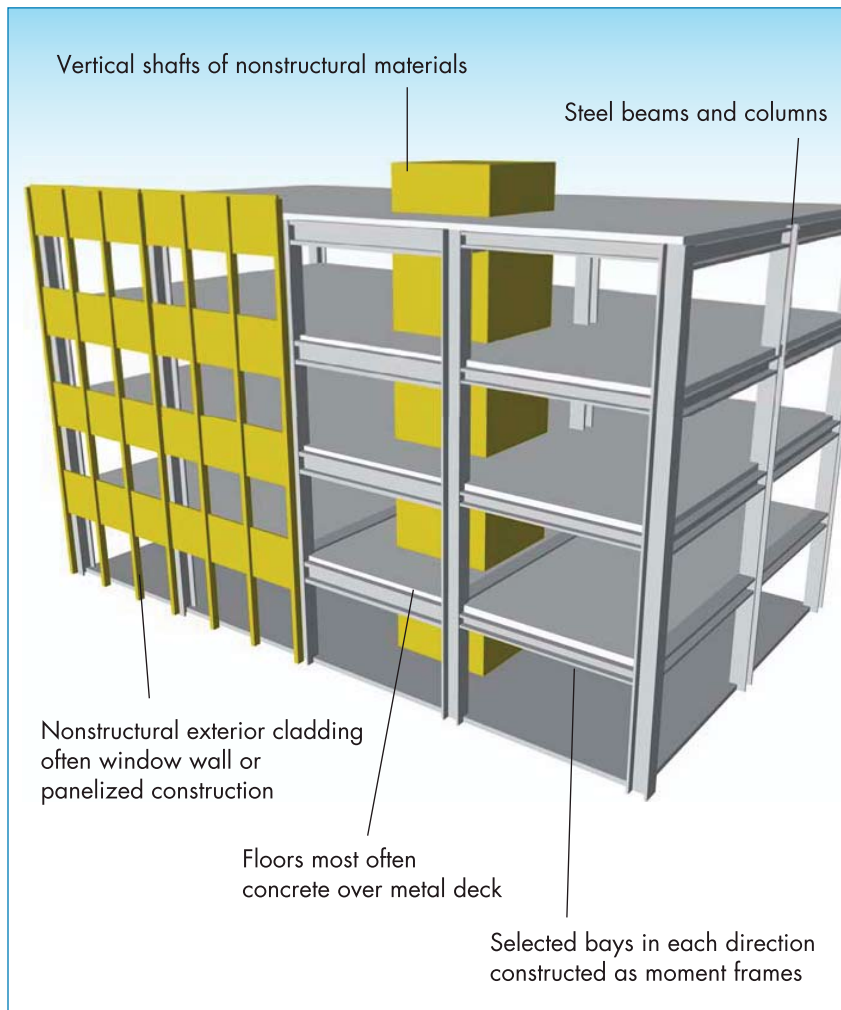
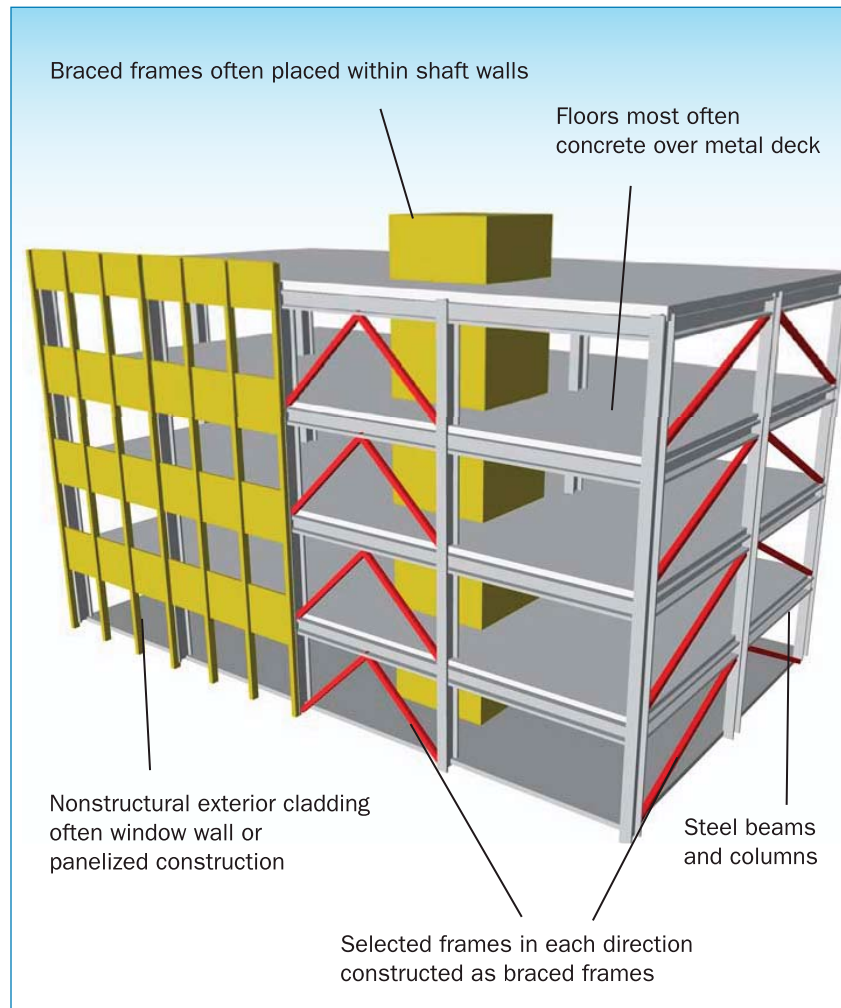

Figure 2-24
S1 steel moment frames

beam column joints, all member stresses are primarily axial. When diagonal brace connections are eccentric to the joints, members are subjected to bending and axial stresses. Diaphragms consist of concrete or metal deck with concrete fill and are stiff relative to the frames. Walls may consist of metal panel curtainwalls, glazing, brick masonry, or precast concrete panels. When the interior of the structure is finished, frames are concealed by ceilings, partition walls, and architectural furring. Foundations consist of concrete spread footings or deep pile foundations.

Figure 2-25
S2 steel braced frames



Light frame steel structures are pre-engineered and prefabricated with transverse rigid steel frames (see Figure 2-26). They are one-story in height and the roof and walls consist of lightweight metal, fiberglass, or cementitious panels. The frames are designed for maximum efficiency and the beams and columns consist of tapered, built-up sections with thin plates. The frames are built in segments and assembled in the field with bolted or welded joints. Lateral forces in the transverse direction are resisted by the rigid frames. Lateral forces in the longitudinal direction are resisted by wall panel shear elements or rod bracing. Diaphragm forces are resisted by untopped metal deck, roof panel shear elements, or a system of tension-only rod bracing.

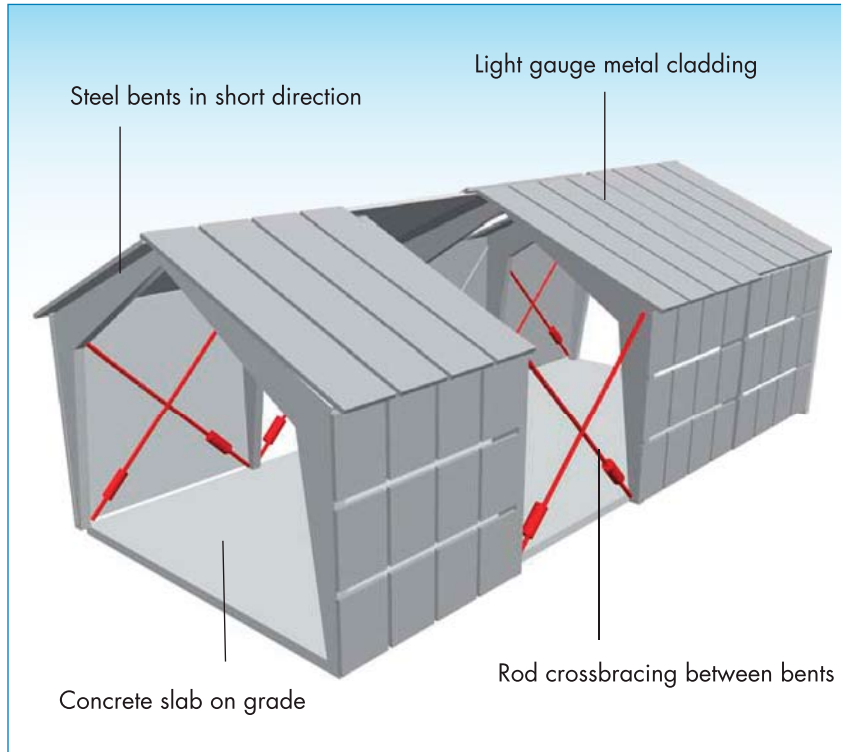

Figure 2-26
S3 steel light frames

Steel moment frame structures provide excellent ductility and redundancy in response to blast loading. Steel braced frames may similarly be designed to resist high intensity blast loads; however, they are less effective in resisting the progression of collapse following the loss of a primary load-bearing element. As a result, first floor steel columns of existing buildings may be concrete encased and first floor splices may be reinforced to increase their resistance to local failure that could precipitate a progression of collapse. The exterior façade represents the most fragile element and is likely to be severely damaged in response to an exterior detonation. Debris may be minimized by means of reinforced masonry, sufficiently detailed precast panels, or laminated glass façade. Nevertheless, a shelter within steel frame buildings would best be located within interior space or a building core. Hardened interior partitions may easily be constructed and anchored to existing floor slabs, and lightweight metal gauge walls may be used to retrofit existing buildings. Metal deck roofs with rigid insulation supported by bar joist structural elements possess minimal

resistance to blast pressures. The additional mass, stiffness, and strength of metal deck roofs with concrete fill make them much better able to resist the effects of direct blast loading and the subsequent rebound. Therefore, lightweight roofs of light frame steel structures are likely to be severely damaged in response to any sizable blast loading and a shelter should either be located in the basement or as interior to the building (as far from the exterior façade) as possible.

2.6.3 S4 and S5 Steel Frames with Concrete Shearwalls and Infill Masonry Walls

Steel frame buildings with concrete or infill masonry shear walls with cast-in-place concrete slabs or metal deck with concrete fill supported on steel beams, open web joists, or steel trusses are well suited for a hardened shelter construction. When lateral forces are resisted by cast-in-place concrete shear walls, the walls carry their own weight. In older construction, the steel frame is designed for vertical loads only. In modern dual systems, the steel moment frames are designed to work together with the concrete shear walls in proportion to their relative rigidity (see Figure 2-27). In the case of a dual system, the walls should be evaluated under this building type and the frames should be evaluated under S1 steel moment frames. Diaphragms consist of concrete or metal deck with or without concrete fill. The steel frame may provide a secondary lateral-force-resisting system, depending on the stiffness of the frame and the moment capacity of the beam-column connections.

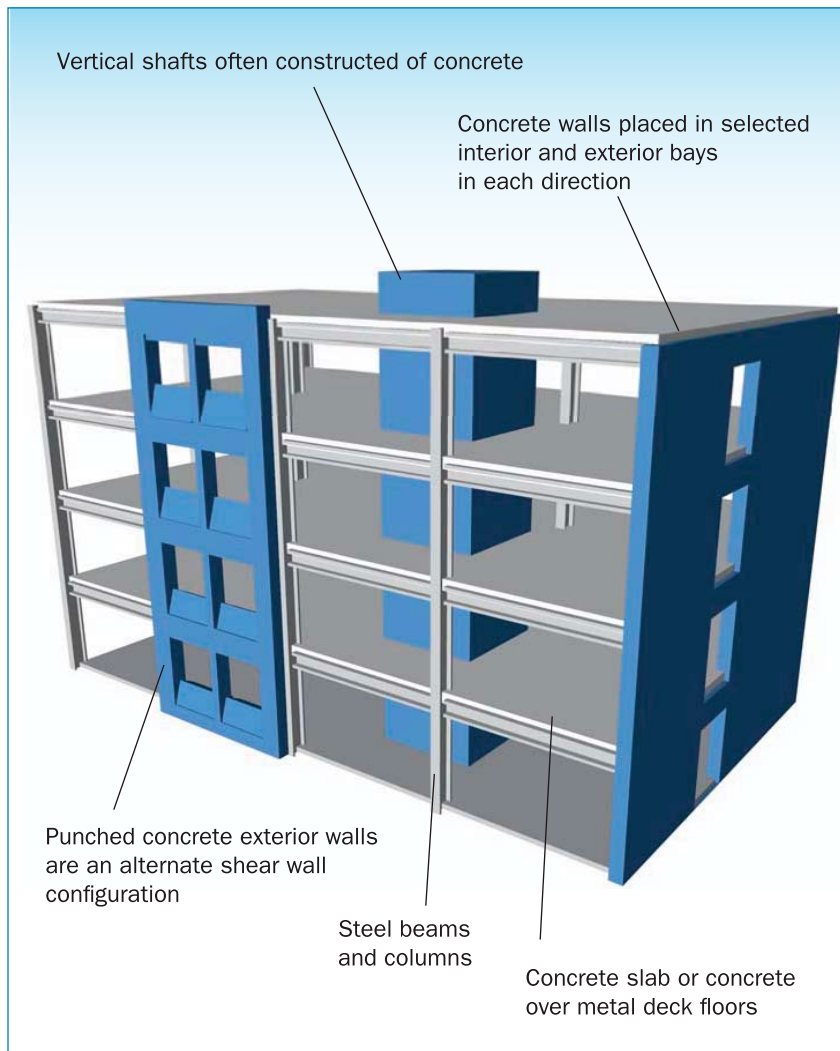
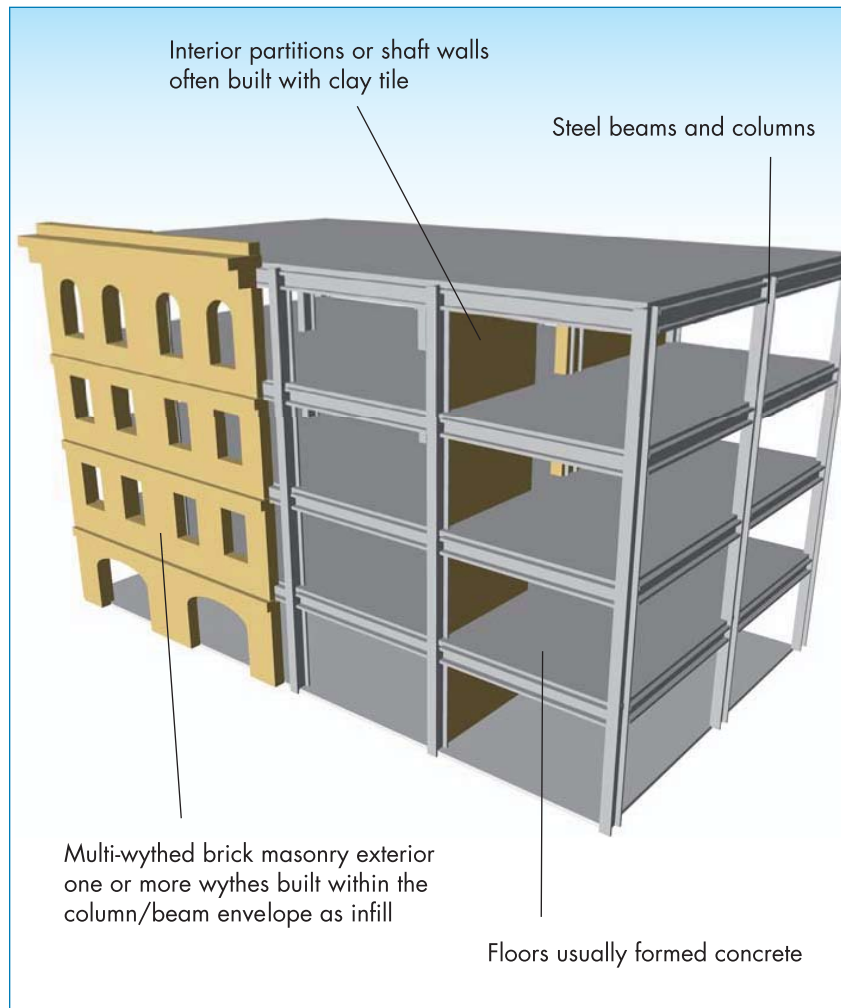

Figure 2-27
S4 steel frames with
concrete shearwalls

Steel frames with infill masonry walls is an older type of building construction (see Figure 2-28). The walls consist of infill panels constructed of solid clay brick, concrete block, or hollow clay tile masonry. Infill walls may completely encase the frame members, and present a smooth masonry exterior with no indication of the frame. The lateral resistance of this type of construction depends on the interaction between the frame and infill panels. The combined behavior is more like a shear wall structure than a frame structure. Solidly infilled masonry panels form diagonal compression struts between the intersections of the frame members. If the walls are offset from the frame and do not fully engage the frame

members, the diagonal compression struts will not develop. The strength of the infill panel is limited by the shear capacity of the masonry bed joint or the compression capacity of the strut. The post-cracking strength is determined by an analysis of a moment frame that is partially restrained by the cracked infill. The diaphragms consist of concrete floors and are stiff relative to the walls.

Figure 2-28
S5 steel frames with infill masonry walls



Steel frame structures with either concrete shear walls or infill masonry walls are not moment connected; therefore, the frame is more vulnerable to collapse resulting from the loss of a column. As a point of reference, steel moment frame buildings with lightly reinforced CMU infill walls are likely to suffer heavy damage in

response to 500 pounds of TNT at a stand-off distance of 50 feet or less. The first floor steel columns of existing buildings may be concrete encased and first floor splices may be reinforced to increase their resistance to local failure that could precipitate a progression of collapse. The exterior façade is likely to be damaged in response to an exterior detonation and debris may be minimized by means of reinforced masonry, sufficiently detailed precast panels, or laminated glass façade. Nevertheless, a shelter within these buildings would best be located within interior space or a building core, preferably enclosed on one or more sides by the shear walls. Existing masonry infill walls may be retrofitted to supplement existing reinforcement by either grouting cables within holes cored within the walls or with a spray-on application of a shotcrete and welded wire fabric or a polyurea debris catch membrane. Alternatively, hardened interior partitions may easily be constructed and anchored to existing floor slabs, and light-weight metal stud walls may be used to retrofit existing buildings.

2.6.4 C1, C2, and C3 Concrete Moment Frames, Concrete and Infill Masonry Shearwalls - Type 1 Bearing Walls and Type 2 Gravity Frames

These buildings consist of a frame assembly of cast-in-place concrete beams and columns. Floor and roof framing consists of cast-in-place concrete slabs, concrete beams, one-way joists, two-way waffle joists, or flat slabs. Lateral forces are resisted by concrete moment frames that develop their stiffness through monolithic beam-column connections (see Figure 2-29). In older construction, or in regions of low seismicity, the moment frames may consist of the column strips of two-way flat slab systems. Modern frames in regions of high seismicity have joint reinforcing, closely spaced ties, and special detailing to provide ductile performance. This detailing is not present in older construction. Foundations consist of concrete spread footings or deep pile foundations.

Figure 2-29
C1 concrete moment
frames

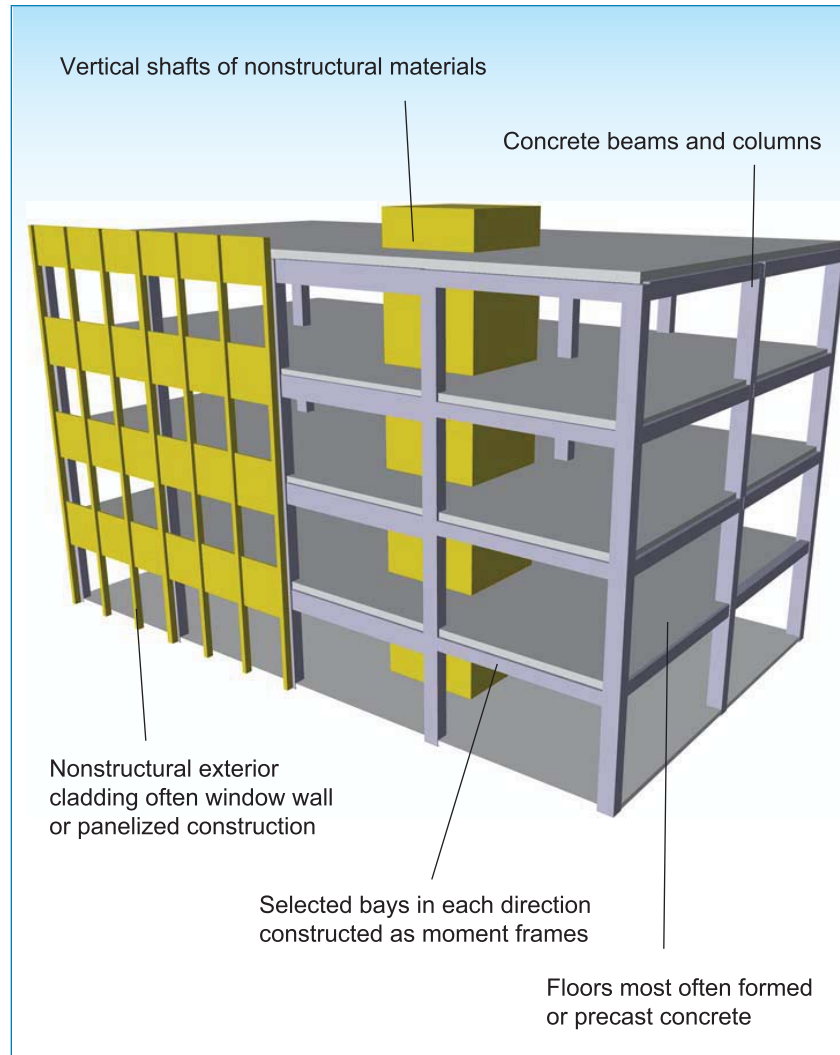

Concrete and infill masonry shearwall building systems have floor and roof framing that consists of cast-in-place concrete slabs, concrete beams, one-way joists, two-way waffle joists, or flat slabs. Floors are supported on concrete columns or bearing walls. Lateral forces are resisted by cast-in-place concrete shear walls or infill panels constructed of solid clay brick, concrete block, or hollow clay tile masonry (see Figures 2-30, 2-31, and 2-32). In older construction, cast-in-place shear walls are lightly reinforced, but often extend throughout the building. In more recent construction, shear walls occur in isolated locations and are more heavily reinforced with boundary elements and closely spaced ties

to provide ductile performance. The diaphragms consist of concrete slabs and are stiff relative to the walls. Foundations consist of concrete spread footings or deep pile foundations. The seismic performance of infill panel construction depends on the interaction between the frame and infill panels. The combined behavior is more like a shear wall structure than a frame structure. If the infilled masonry panels are in line with the frame, they form diagonal compression struts between the intersections of the frame members; otherwise, the diagonal compression struts will not develop. The strength of the infill panel is limited by the shear capacity of the masonry bed joint or the compression capacity of the strut. The post-cracking strength is determined by an analysis of a moment frame that is partially restrained by the cracked infill. The shear strength of the concrete columns, after cracking of the infill, may limit the semiductile behavior of the system.

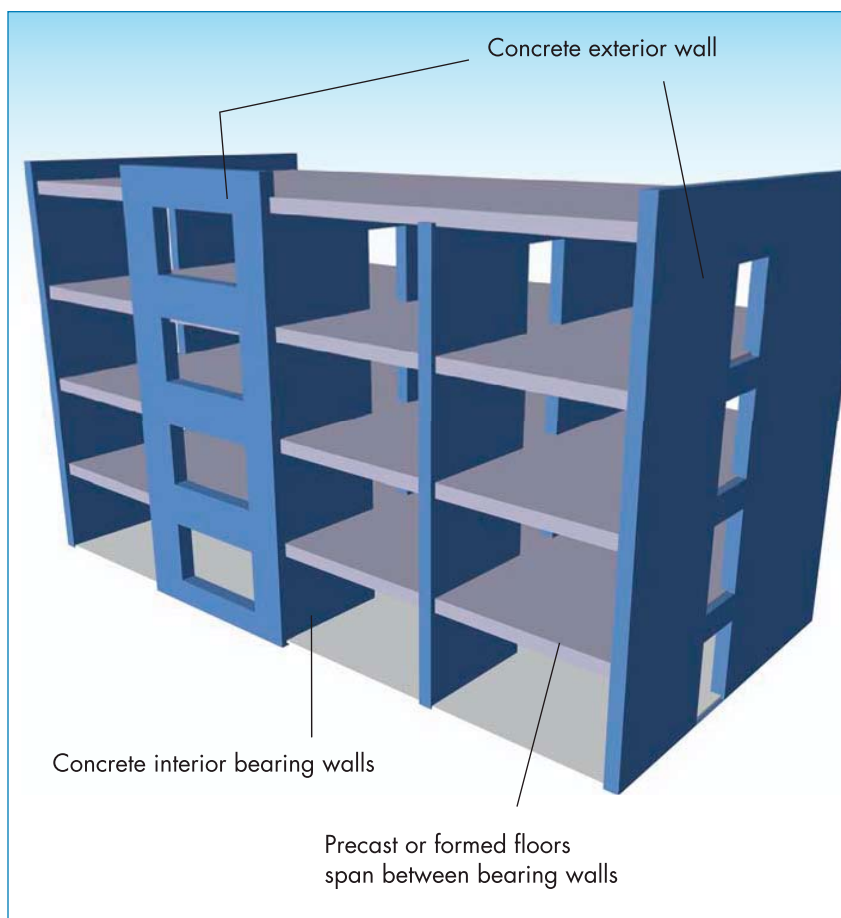
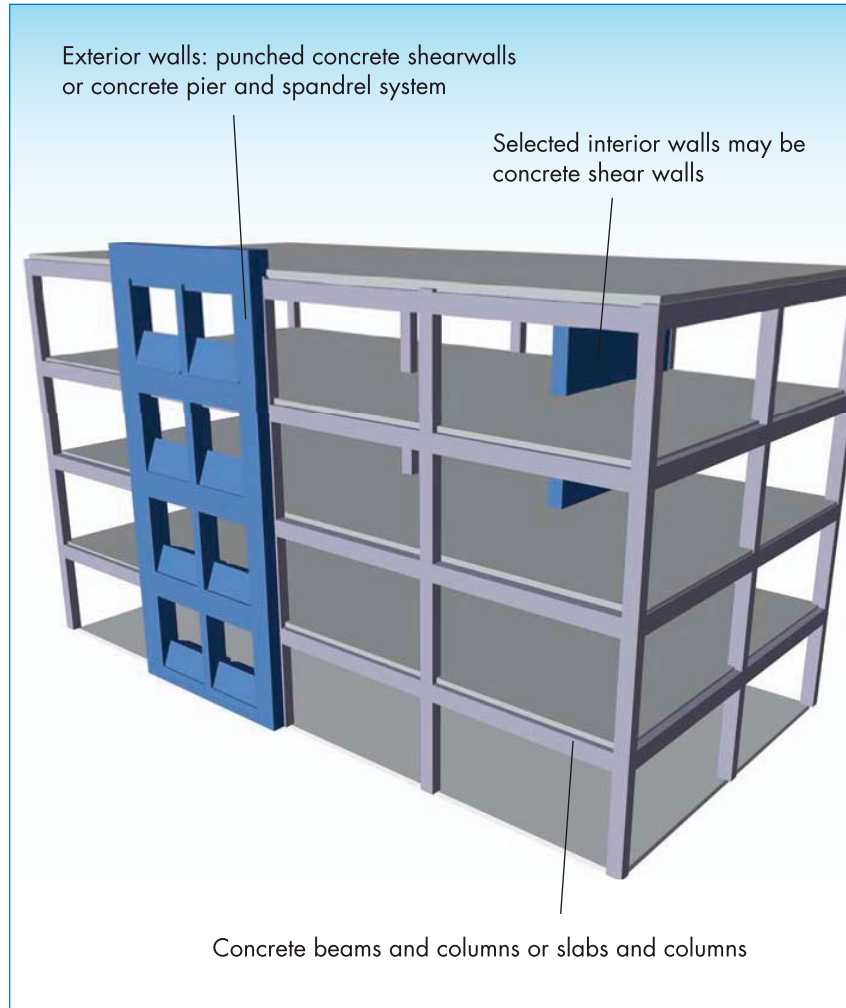

Figure 2-30
C2 concrete shearwalls
– type 1 bearing walls

Figure 2-31
C2 concrete shearwalls
– type 2 gravity frames



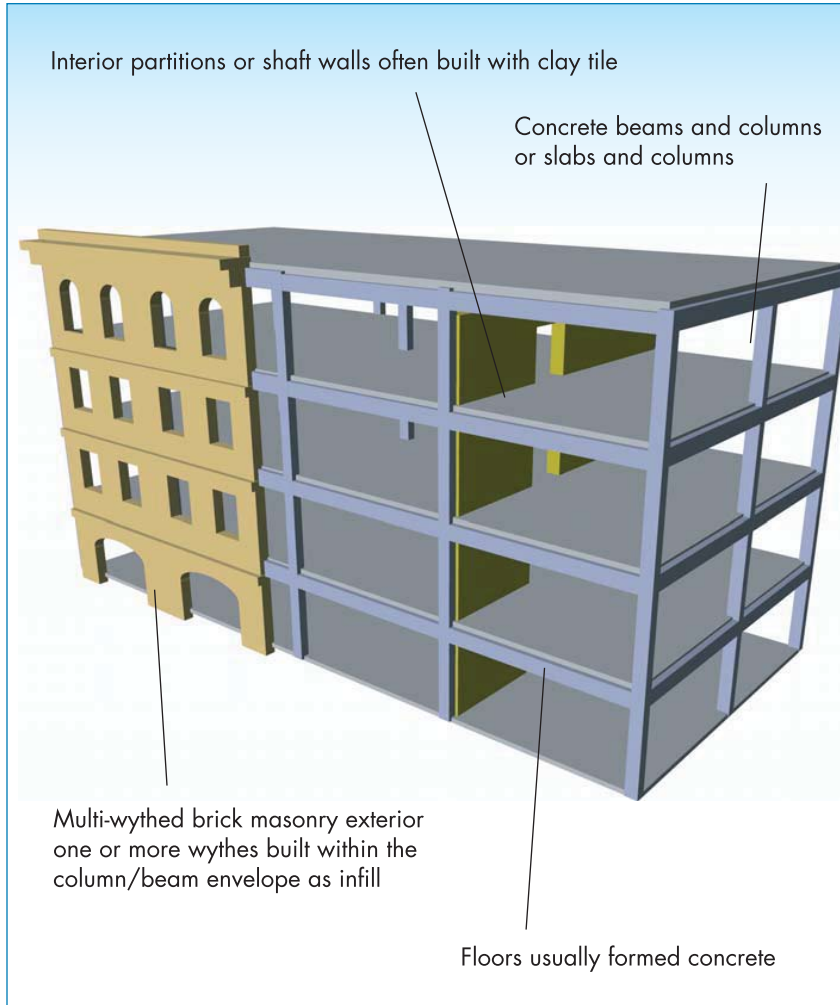

Figure 2-32
C3 concrete frames with
infill masonry shearwalls

Unless sited in a seismic zone, concrete frame structures are not typically designed and detailed to develop large inelastic deformations and withstand significant load reversals. As a point of reference, a building with 8-inch thick reinforced concrete load-bearing exterior walls and interior columns is likely to suffer heavy damage in response to 500 pounds of TNT at a distance of 70 feet or less. The exterior façade is likely to be damaged in response to an exterior detonation and debris may be minimized by means of reinforced masonry, sufficiently detailed precast panels, or laminated glass façade. Nevertheless, a shelter within concrete frame and shearwall buildings would best be located within interior space or a building core, preferably enclosed on one or more sides

by the shear walls. Existing masonry infill walls may be retrofitted to supplement existing reinforcement by either grouting cables within holes cored within the walls or with a spray-on application of a shotcrete and welded wire fabric or a polyurea debris catch membrane. Alternatively, hardened interior partitions may easily be constructed and anchored to existing floor slabs, and lightweight metal stud walls may be used to retrofit existing buildings.

2.6.5 PC1 and PC2 Tilt-up Concrete Shearwalls and Precast Concrete Frames and Shearwalls

Tilt-up concrete buildings are one or more stories in height and have precast concrete perimeter wall panels that are cast on site and tilted into place (see Figure 2-33). Floor and roof framing consists of wood joists, glulam beams, steel beams, open web joists, or precast plank sections. Framing is supported on interior steel or concrete columns and perimeter concrete bearing walls. The floors consist of wood sheathing, concrete over form deck, or composite concrete slabs. Roofs are typically untopped metal deck, but may contain lightweight concrete fill. Lateral forces are resisted by the precast concrete perimeter wall panels. Wall panels may be solid, or have large window and door openings that cause the panels to behave more as frames than as shear walls. In older construction, wood framing is attached to the walls with wood ledgers. Foundations typically consist of concrete spread footings or deep pile foundations.

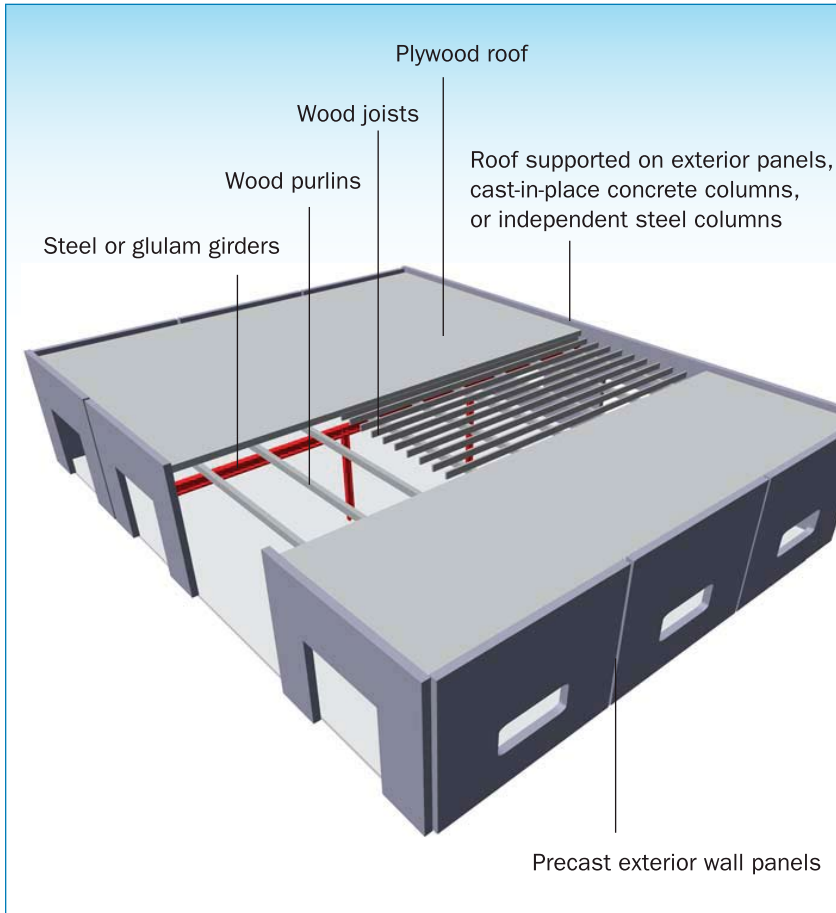
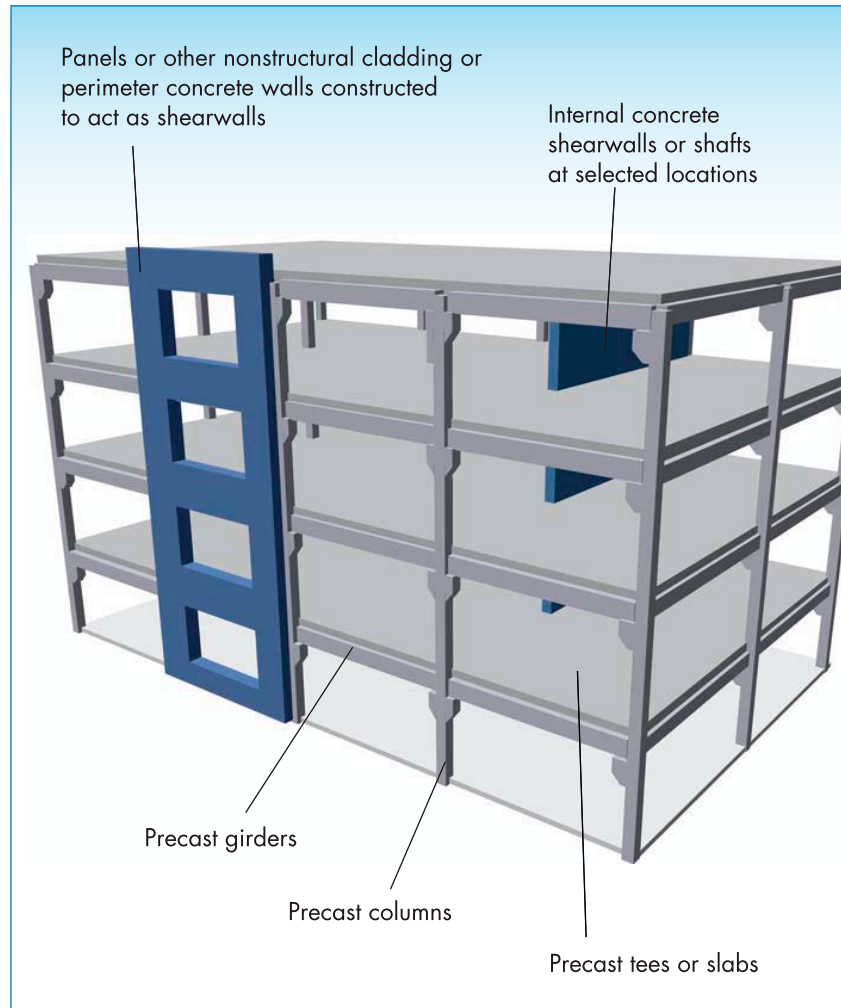

Figure 2-33
PC1 tilt-up concrete
shearwalls

Precast concrete frames and shearwalls consist of precast concrete planks, tees, or double-tees supported on precast concrete girders and precast columns (see Figure 2-34). Lateral forces are resisted by precast or cast-in-place concrete shear walls. Diaphragms consist of precast elements interconnected with welded inserts, cast-in-place closure strips, or reinforced concrete topping slabs.

Figure 2-34
PC2 precast concrete
frames and shearwalls



Precast construction benefits from higher quality wall and frame components than cast-in-place structures; however, it lacks the continuity of construction present in these systems. The resistance blast loading depends, to a great extent, on the mechanical connections between the components. Designers must consider the blast loading effects when designing and detailing these connections. A shelter would best be located in a basement where the protection to blast loading would be provided by the surrounding soil. Large explosive detonations in close proximity to the building will not only destroy the superstructure, but the effects of ground shock are likely to fail the foundation walls as well; therefore, protected spaces should be located interior to the

building. Locating the shelter in the basement, for slab on grade buildings, provides the maximum number of floors between occupants and possible roof debris. Debris catch systems may be installed beneath roof rafters of single-story buildings; however, the effectiveness of the debris catch system will be limited if the zone of roof damage is extensive.

Metal stud blast walls built within the existing building may be used to supplement the enclosure; however, in order for these walls to develop their resistance to lateral loads, they must be anchored to an existing structure. Windows enclosing the selected shelter must either be laminated or treated with an anti-shatter film. Either the laminated glass or the anti-shatter film should be anchored to the surrounding wall with a system that can develop, but not overwhelm the capacity of the wall. A conservative estimate of the ultimate capacity of an existing wall may be determined, in the absence of actual design information, by scaling the code specified wind pressures with the appropriate factor of safety.

2.6.6 RM1 and RM2 Reinforced Masonry Walls with Flexible Diaphragms or Stiff Diaphragms and Unreinforced Masonry (URM) Load-bearing Walls

These buildings have bearing walls that consist of reinforced brick or concrete block masonry. Wood floor and roof framing consists of wood joists, glulam beams, and wood posts or small steel columns. Steel floor and roof framing consists of steel beams or open web joists, steel girders, and steel columns. Lateral forces are resisted by the reinforced brick or concrete block masonry shear walls. Diaphragms consist of straight or diagonal wood sheathing, plywood, or untopped metal deck, and are flexible relative to the walls (see Figure 2-35). Foundations consist of brick or concrete spread footings.

Figure 2-35
RM1 reinforced masonry
walls with flexible
diaphragms

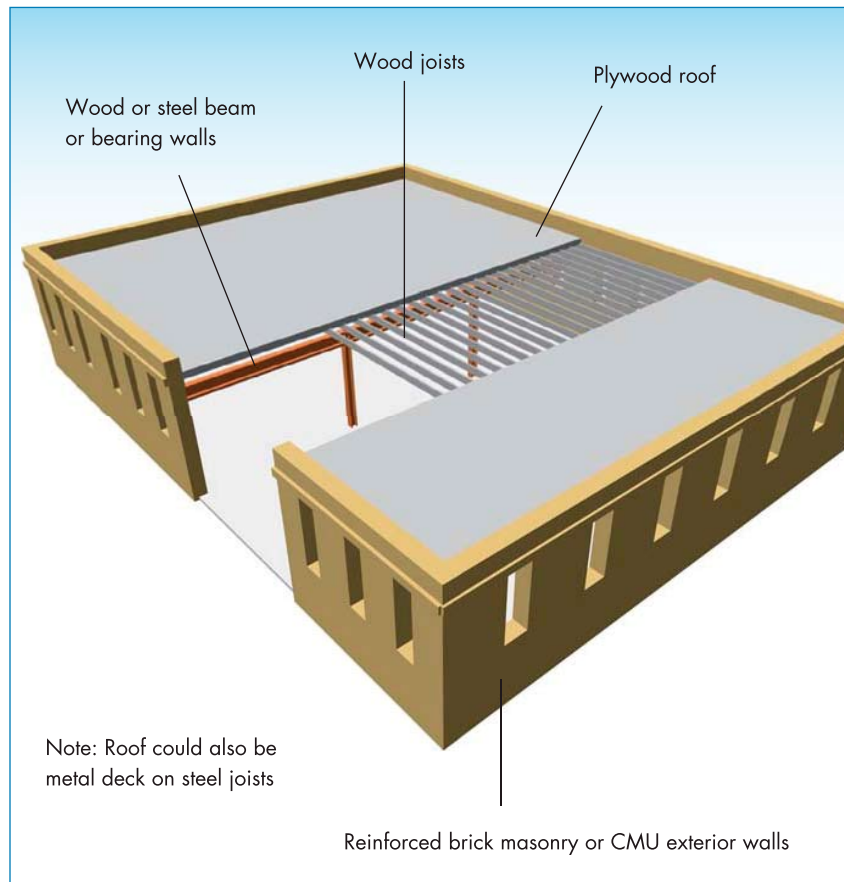

Buildings with reinforced masonry walls and stiff diaphragms are similar to RM1 buildings, except the diaphragms consist of metal deck with concrete fill, precast concrete planks, tees, or double-tees, with or without a cast-in-place concrete topping slab, and are stiff relative to the walls (see Figure 2-36). The floor and roof framing is supported on interior steel or concrete frames or interior reinforced masonry walls.

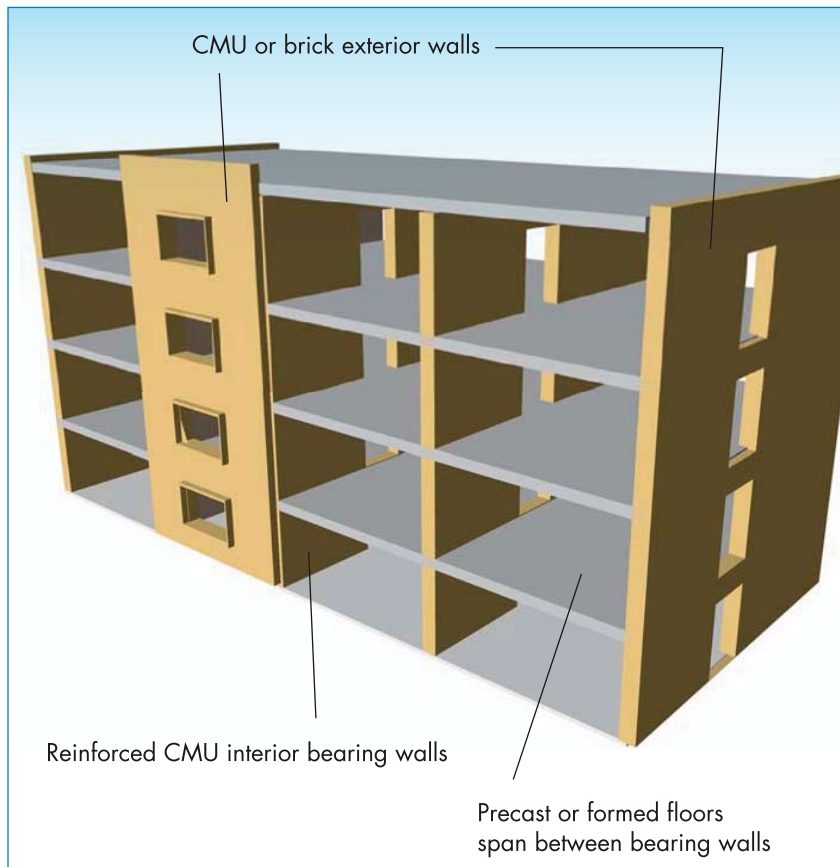
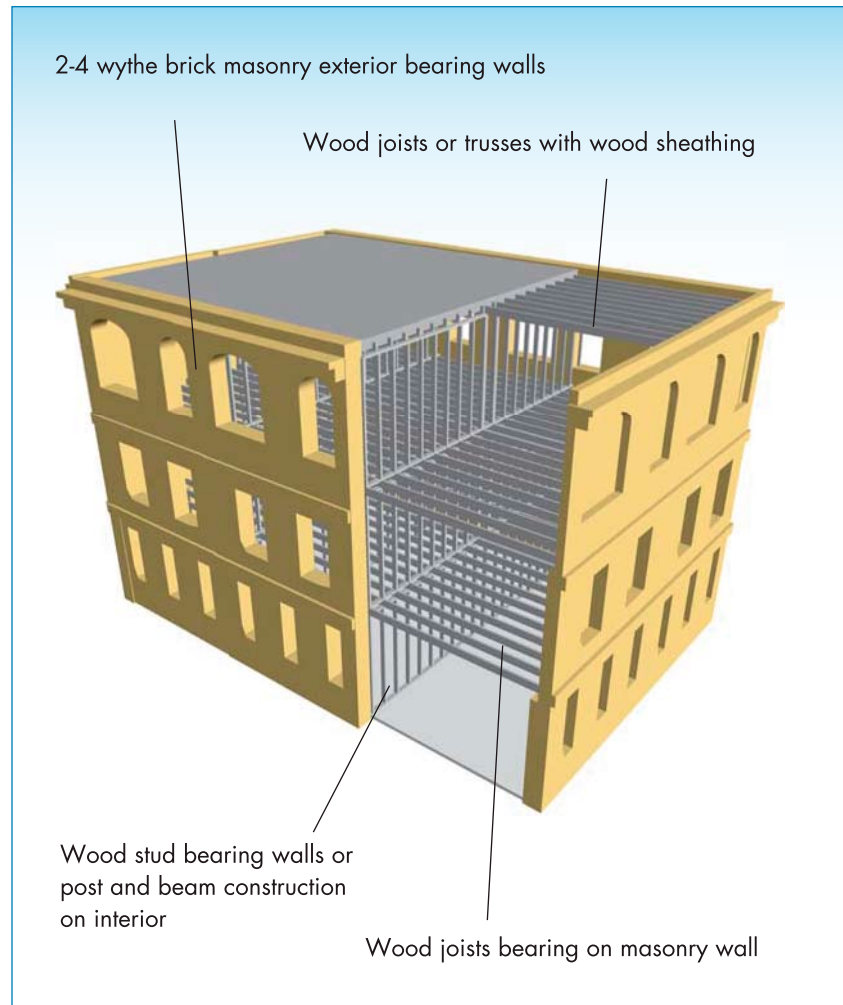

Figure 2-36
RM2 reinforced masonry
walls with stiff diaphragms

Unreinforced load-bearing masonry buildings often contain perimeter bearing walls and interior bearing walls made of clay brick masonry (see Figure 2-37). In older construction, floor and roof framing consists of straight or diagonal lumber sheathing supported by wood joists, on posts and timbers. In more recent construction, floors consist of structural panel or plywood sheathing rather than lumber sheathing. The diaphragms are flexible relative to the walls. When they exist, ties between the walls and diaphragms consist of bent steel plates or government anchors embedded in the mortar joints and attached to framing. Foundations consist of brick or concrete spread footings. As a variation, some URM buildings have stiff diaphragms relative to the unreinforced masonry walls and interior framing. In older construction or large, multi-story buildings, diaphragms may consist of

cast-in-place concrete. In regions of low seismicity, more recent construction consists of metal deck and concrete fill supported on steel framing.

Figure 2-37
URM load-bearing walls



Unless sited in a seismic zone, reinforced masonry structures are not typically detailed to develop significant inelastic deformations and withstand significant load reversals. Unreinforced masonry structures are extremely brittle. As a point of reference, a reinforced masonry building with 8-inch thick reinforced CMU exterior walls is likely to suffer heavy damage in response to 500 pounds of TNT at a distance of 150 feet or less. An unreinforced masonry building with reinforced CMU pilasters will suffer heavy

damage in response to 500 pounds of TNT at a distance of 250 feet or less. At these loads, the structure supported by the load-bearing masonry wall is likely to suffer localized collapse. Grout and additional reinforcement may be inserted within the cores of existing masonry walls; however, a stiffened steel panel provides the most effective way to restrain the debris and assume the gravity loads following the loss of load carrying capacity within the wall. A shelter within these buildings would best be located within interior space or a building core, preferably enclosed on one or more sides by the shear walls.

2.6.7 Conclusions

Despite the various types of construction, the following protective measures may be used to establish a hardened space that will limit the extent of debris resulting from an explosive event. A shelter is best located within interior space or a building core at the lowest levels of a building or on the ground floor for a slab on grade structure. A debris catch system should be installed beneath the roof rafters of a single-story building. The exterior façade should be either reinforced masonry or precast panels and windows should either be laminated or treated with an anti-shatter film that is anchored to the surrounding walls. First floor steel columns may be concrete encased and first floor splices may be reinforced. Existing masonry infill walls may be retrofitted by either grouting cables within holes cored within the walls or with a spray-on application of a shotcrete and welded wire fabric or a polyurea debris catch membrane. Hardened interior partitions, such as metal stud blast walls, may be used to enclose the shelter and these walls should be anchored to an existing structure. A stiffened steel panel may be constructed interior to existing load-bearing masonry walls.

2.7 CASE STUDY: BLAST-RESISTANT SAFE ROOM

Consider the example of a safe room established in the stairwell of a multi-story office building: it may be assumed the original

construction did not provide for reinforced masonry or reinforced concrete enclosures. To achieve the greatest stand-off distance and isolate the safe room from a vehicle-borne explosive threat, the stairwell should be interior to the structure. This will provide the maximum level of protection from an undefined explosive threat. Although it is common to place emergency stairs within the building core, one can only reasonably expect a reinforced concrete or reinforced masonry stair enclosure for a shearwall lateral resisting structural system. Due to the large difference in weight and constructability, a stud wall with gypsum board stair enclosure will be routinely used in lieu of reinforced masonry or concrete for framed construction. The stair enclosures may therefore be designed or upgraded to include 16-gauge sheet metal supported by 18-gauge steel studs that are attached web to web (back to back). These walls must be adequately anchored to the existing floor slabs to develop the plastic capacity of the studs acting both in flexure and in tension. Alternatively, fully grouted reinforced masonry stairwell enclosures, #4 bars in each cell, may be specified. The masonry walls must be adequately anchored to the existing floor slabs to develop the ultimate lateral resistance of the wall in order to transfer the reaction loads into the lateral resisting system of the building. Doors to the stairway enclosures are to be hollow steel or steel clad, such as 14-gauge steel doors with 20-gauge ribs, with pressed steel frames; double doors should utilize a center stile. Doors should open away from the safe room and be securely anchored to the wall construction, locally reinforced around the door.

Any windows within the stairwell enclosures are to contain laminated glass, utilizing 0.060 PVB, that is adhered within the mullions with a ½-inch bead of structural silicone. The mullions are to be anchored into the surrounding walls to develop the full capacity of the glazing materials. Alternatively, a 7-mil anti-shatter film may be applied to existing windows and mechanically attached to the surrounding mullions to develop the full capacity of the film. A wet glazed attachment of the film may alternatively be applied; however, this provides a less reliable bond to the existing mullions.

Floor slabs within an interior stairwell will be isolated from the most direct effects of an exterior explosive event and will not be subjected to significant uplift pressures resulting from an exterior explosive event. Nevertheless, for new construction, floor slabs should be designed to withstand a net upward load of magnitude equal to the dead load plus half the live load for the floor system.

For new construction, the structural frames are to be sufficiently tied as to provide alternate load paths to surrounding columns or beams in the event of localized damage. These tie forces should, at a minimum, conform to the DoD Unified Facilities Criteria (UFC) 4-023-03, *Design of Buildings to Prevent Progressive Collapse*. For reinforced concrete structures, seismic hooks and seismic development lengths, as specified in Chapter 21 of the American Concrete Institute (ACI) 318-05, should be used to anchor and develop steel reinforcement. Internal tie reinforcement should be distributed in two perpendicular directions and be continuous from one edge of the floor or roof to the far edge of the floor or roof, using lap splices, welds, or mechanical splices. In order to redistribute the forces that may develop, the internal ties must be anchored to the peripheral ties at each end (see Figure 2-38). Steel structures must be similarly tied, and each column must be effectively held in position by means of horizontal ties in two orthogonal directions at each principal floor level supported by that column.

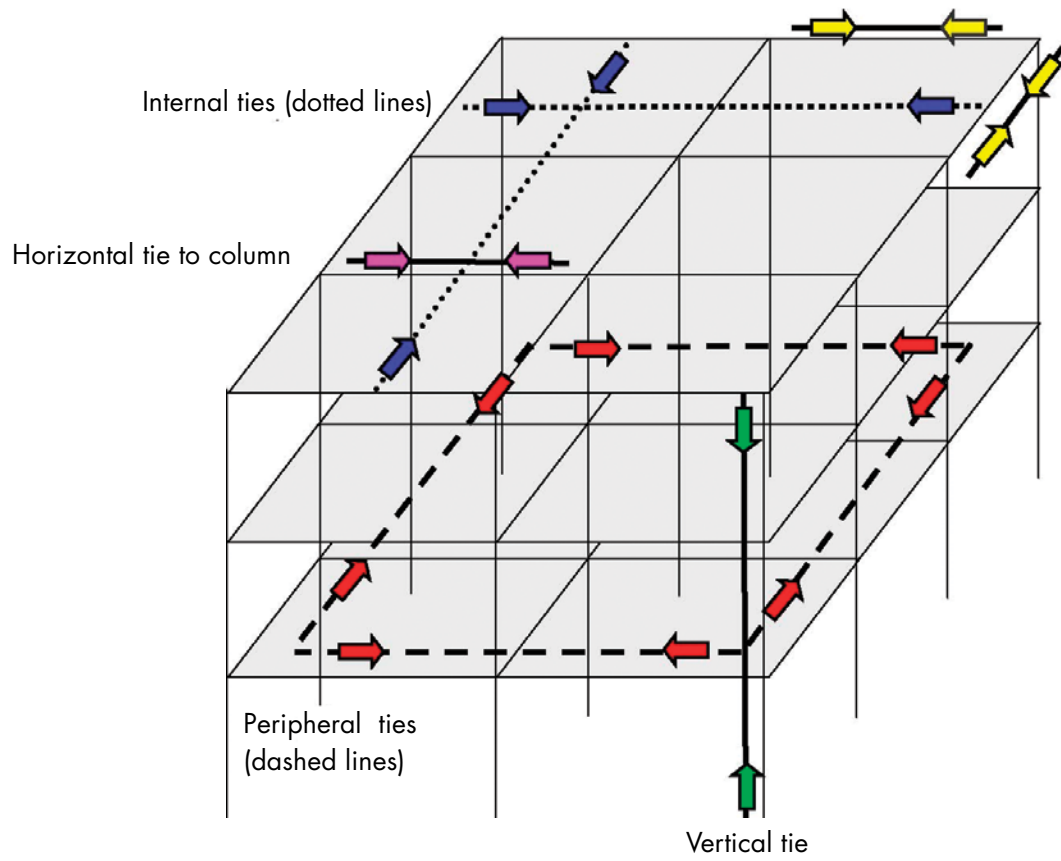

Figure 2-38 Schematic of tie forces in a frame structure