



# SportsPlay™

*We put the value in play!*

## TABLE OF CONTENTS



05

Mushroom Kottage



06

Modular Play Structures



20

Modular Components



26

Tot Town™ Houses, Sand and Water



28

Spring Riders and Sand Diggers



30

See Saws and Slides



32

Merry Go Rounds



34

Climbers



40

Swings and Wheelchair Accessible Swings



44

Classic Fitness



48

Basketball Game Standards



54

Game Standards, Tennis, Football, Baseball, Soccer and Lacrosse



60

Site Amenities and Wheelchair Accessible Tables



70

Shade Structures



### SportsPlay Equipment, Inc.—The Leader in Providing Play Equipment for Children of All Abilities

We take great pride in manufacturing exciting and fun products for the playground that allow children to play together, regardless of their physical abilities. Our wheelchair accessible platform swing remains the industry standard for its category.

In addition, all of SportsPlay's modular playground designs can be ADA compliant and fully customized. And we also make a wide variety of other park and playground products that provide play equipment and recreational solutions for children of all ages and abilities. For instance, our JennSwing® ADA swing seats are well-known for providing a fun, highly comfortable, and secure swinging experience for children with special needs. Be sure to check out our entire catalog of SportsPlay products—we put the value in play!



SportsPlay™ Equipment Inc., is proud to offer IPEMA certified products.

In the interest of public playground safety, IPEMA provides a third party certification service whereby a designated independent laboratory validates a manufacturer's certification of conformance to the ASTM F-1487 (excluding section 10 and 12.6.1), Standard Consumer Safety Performance Specification for Public Use, standard. The use of this seal signifies that SportsPlay Equipment has received written validation from the independent laboratory that the product associated with the use of this seal conforms with the requirements of ASTM F-1487. A list of validated products may be found at the IPEMA's website: [www.ipema.org](http://www.ipema.org).



SportsPlay™ Equipment Inc., is a member in good standing of IPEMA the international Play Equipment Manufacturers Association. IPEMA is a member driven international trade organization, which represents and promotes an open market for manufacturers of play equipment and surfacing.

# We put the Value in Play!

Our mission is to provide fun equipment of exceptional safety, durability and value on the playground and in the neighborhood.



Please visit SportsPlay Equipment's social media sites including YouTube, Facebook, Instagram, and LinkedIn for special announcements and more information.

## MUSHROOM KOTTAGE

Children ages 9 months to 2 years can explore this mushroom shaped playhouse. The Mushroom Kottage features many manipulative play events that encourage and develop gross motor skills, perceptual-cognitive and linguistic-social skills.



Pawprints and turtles for tactile exploration



Inside mirror



Play mailbox



Play rings

### TOT TOWN® MUSHROOM KOTTAGE

<b>301-145</b> (Partially Assembled)
<b>301-145A</b> (Fully Assembled)
<b>Ages:</b> 9 months-2 years
<b>Dimensions:</b> 56" W x 8' L x 5' H
<b>Use Zone:</b> 20' x 16'6"
<b>Weight:</b> 310 lbs.

Inside, young explorers can find shapes that encourage tactile development and identification. Outside, the side bench helps build standing skills.

For indoor or outdoor use

Easy to install and clean





# QUICK SHIP UNITS

Need quality playground equipment shipped in one week? Our Quick Ship Program offers 12 exciting playgrounds (in the 3.5" post design only). Choose between natural or primary schemes only.

### All Modular Systems:

- Factory installed aluminum cap, powder coated to match post.
- Factory installed threaded rivet nuts for secure desk mounting.
- Playground decks are 12 gauge punched steel.
- 3.5" & 5" O.D. 13 gauge steel post with a zinc rich interior, corrosion protection coating and triple coat protection on the exterior.
- Direct bolt component bracket with rubber gasket and 4 self-tapping tamper resistant torx screws.

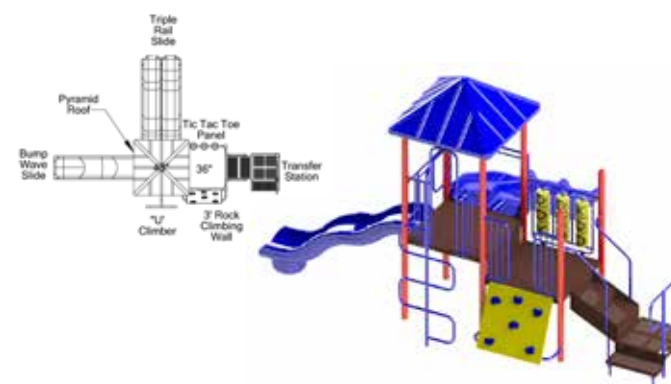

<b>911-255</b>	
Ages:	5-12 years
Total Number of Events:	6
Use Zone:	32' x 30'
Weight:	1,469 lbs.



<b>911-256</b>	
Ages:	5-12 years
Total Number of Events:	6
Use Zone:	32' x 28'
Weight:	1,433 lbs.

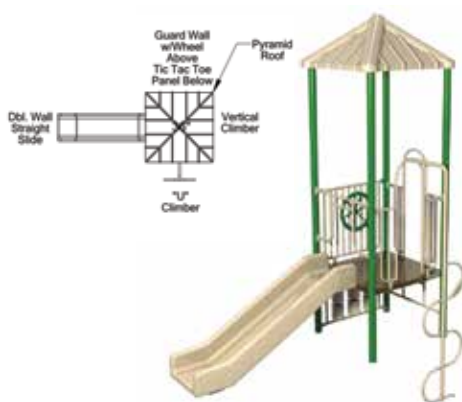

<b>911-249</b>	
Ages:	2-12 years
Total Number of Events:	5
Use Zone:	24' x 18'
Weight:	788 lbs.

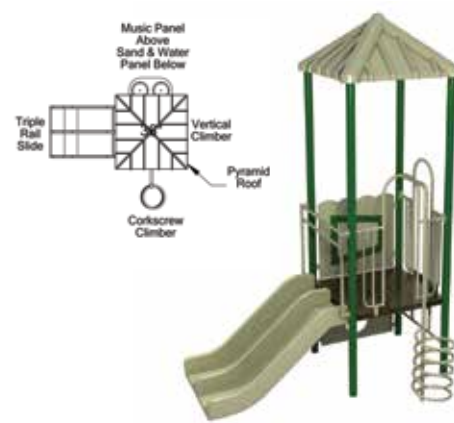

<b>911-250</b>	
Ages:	2-12 years
Total Number of Events:	5
Use Zone:	22' x 21'
Weight:	871 lbs.



<b>911-251</b>	
Ages:	2-12 years
Total Number of Events:	5
Use Zone:	26' x 19'
Weight:	939 lbs.



<b>911-257</b>	
Ages:	5-12 years
Total Number of Events:	9
Use Zone:	26' x 35'
Weight:	2,016 lbs

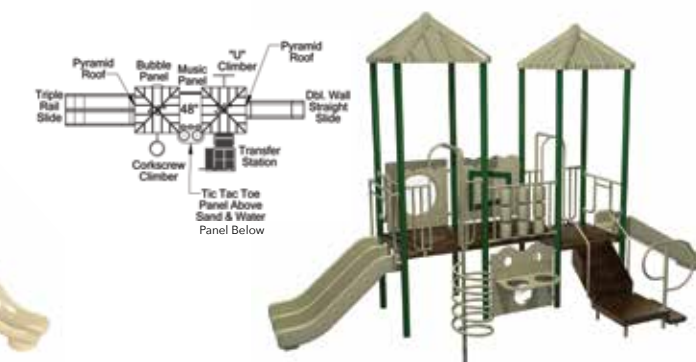

<b>911-258</b>	
Ages:	5-12 years
Total Number of Events:	9
Use Zone:	39' x 23'
Weight:	1,970 lbs.



<b>911-252</b>	
Ages:	2-12 years
Total Number of Events:	5
Use Zone:	28' x 21'
Weight:	1,014 lbs.

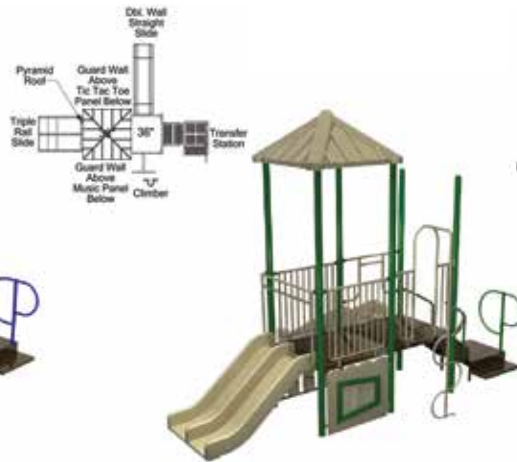

<b>911-253</b>	
Ages:	2-12 years
Total Number of Events:	6
Use Zone:	30' x 25'
Weight:	1,415 lbs.



<b>911-254</b>	
Ages:	2-12 years
Total Number of Events:	8
Use Zone:	30' x 26'
Weight:	1,452 lbs.

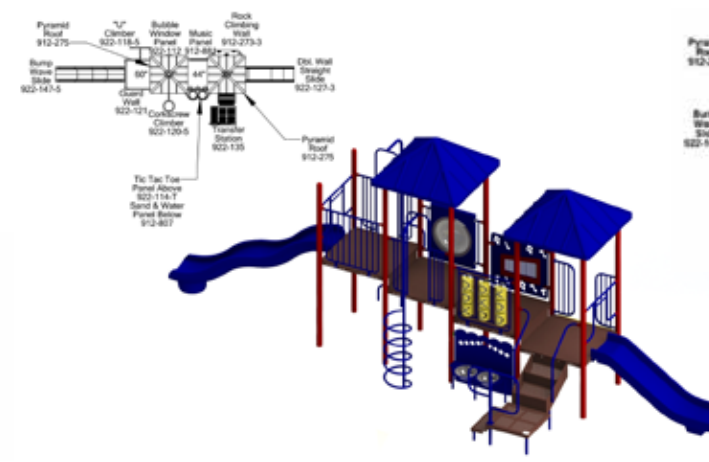

<b>911-259</b>	
Ages:	5-12 years
Total Number of Events:	10
Use Zone:	26' x 44'
Weight:	3,078 lbs.

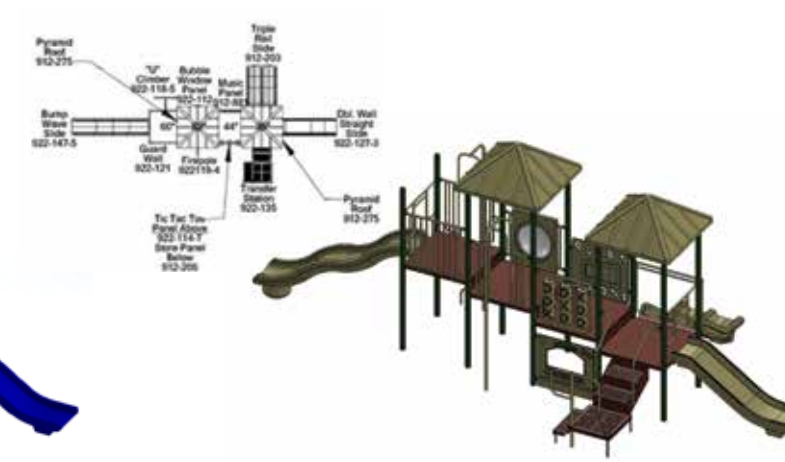

<b>911-260</b>	
Ages:	5-12 years
Total Number of Events:	10
Use Zone:	26' x 44'
Weight:	3,002 lbs.



# MODULAR PLAY STRUCTURES

All modular playgrounds will be made in colors shown in catalog, unless specified. Whether you require 3.5" or 5" OD posts, our Modular Play Structures offer clampless construction for ease of installation.



Although both Kurt and Ray are shown with Bump Wave Slide, units will ship with Straight Slide shown on 3D.

## KURT

<b>911-110NB</b> (5" posts)	
<b>911-210NB</b> (3.5" posts)	
<b>Ages:</b>	2-12 years
<b>Total Number of Events:</b>	3
<b>Elevated Events:</b>	2
<b>Ground Level Events:</b>	1
<b>Dimensions:</b>	16' x 8'
<b>Use Zone:</b>	28' x 20'
<b>Weight:</b>	929 lbs.

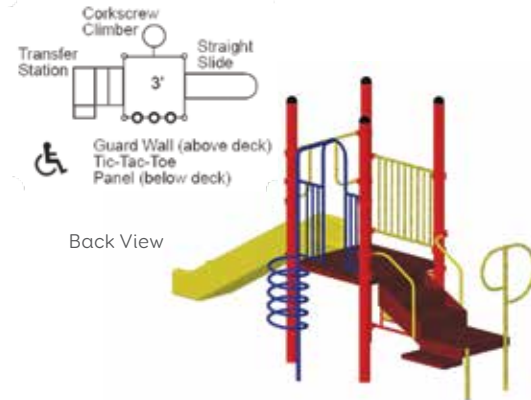

## MINNIE

<b>911-121B</b> (5" posts)	
<b>911-221B</b> (3.5" posts)	
<b>Ages:</b>	2-12 years
<b>Total Number of Events:</b>	4
<b>Elevated Events:</b>	3
<b>Ground Level Events:</b>	1
<b>Dimensions:</b>	7' x 14'
<b>Use Zone:</b>	19' x 26'
<b>Weight:</b>	1,041 lbs.

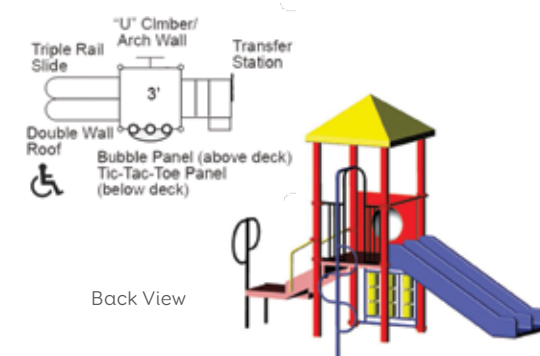

Add Transfer Station to make this unit ADA.

## RAY

<b>911-110B</b> (5" posts)	
<b>911-210B</b> (3.5" posts)	
<b>Ages:</b>	2-12 years
<b>Total Number of Events:</b>	5
<b>Elevated Events:</b>	4
<b>Ground Level Events:</b>	1
<b>Dimensions:</b>	8' x 12'
<b>Use Zone:</b>	20' x 24'
<b>Weight:</b>	893 lbs.

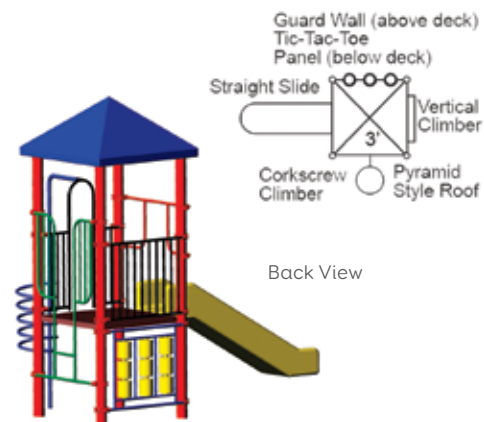

## JEREMY

<b>911-116B</b> (5" posts)	
<b>911-216B</b> (3.5" posts)	
<b>Ages:</b>	2-12 years
<b>Total Number of Events:</b>	4
<b>Elevated Events:</b>	3
<b>Ground Level Events:</b>	1
<b>Dimensions:</b>	5' x 14'
<b>Use Zone:</b>	17' x 26'
<b>Weight:</b>	895 lbs.

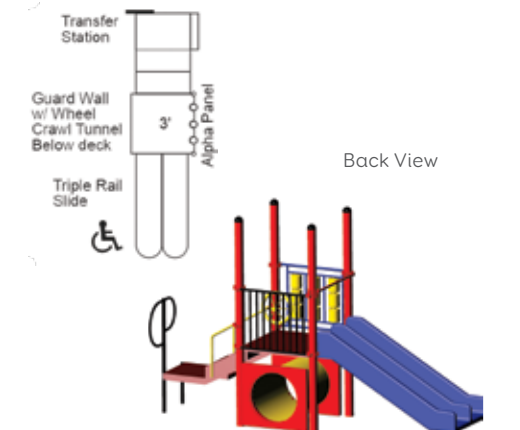



### TESS

911-138B (5" posts)	
911-238B (3.5" posts)	
Ages:	2-12 years
Total Number of Events:	5
Elevated Events:	3
Ground Level Events:	2
Dimensions:	12' x 18'
Use Zone:	24' x 30'
Weight:	1,377 lbs.

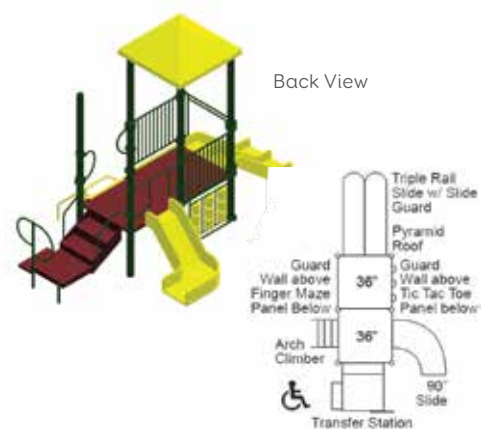

### AMY

911-117B (5" posts)	
911-217B (3.5" posts)	
Ages:	5-12 years
Total Number of Events:	6
Elevated Events:	5
Ground Level Events:	1
Dimensions:	20' x 14'
Use Zone:	32' x 26'
Weight:	2,033 lbs.

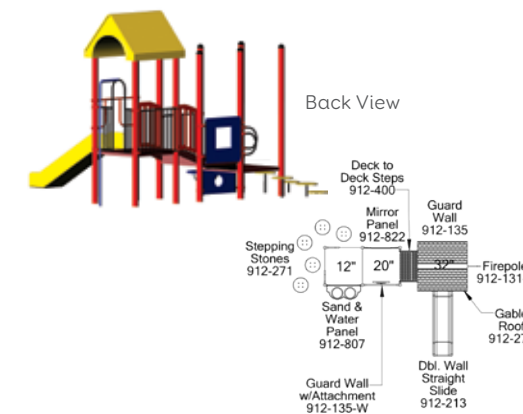

One additional ground event and transfer station needed to make ADA.



### MALLORY

911-120B (5" posts)	
911-220B (3.5" posts)	
Ages:	2-12 years
Total Number of Events:	5
Elevated Events:	5
Ground Level Events:	0
Dimensions:	22' x 15'
Use Zone:	34' x 27'
Weight:	1,657 lbs.

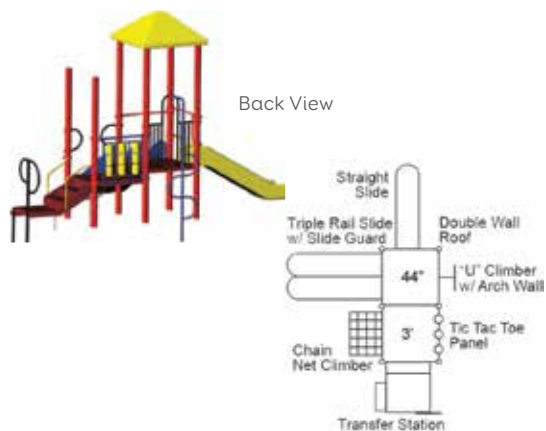

Additional ground events needed to make ADA 2.



### MARIE

911-118B (5" posts)	
911-218B (3.5" posts)	
Ages:	5-12 years
Total Number of Events:	6
Elevated Events:	6
Ground Level Events:	1
Dimensions:	21' x 13'
Use Zone:	32' x 25'
Weight:	1,633 lbs.

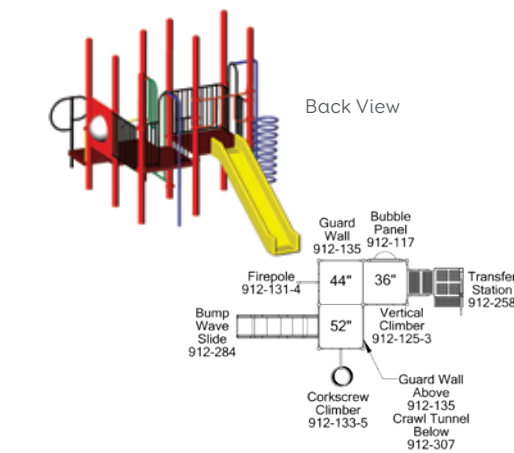

Additional ground events needed to make ADA 1.



Additional ground events needed to make ADA 2.

### LAUREN

911-128B (5" posts)

911-228B (3.5" posts)

Ages:	2-12 years
Total Number of Events:	6
Elevated Events:	6
Ground Level Events:	0
Dimensions:	22' x 20'
Use Zone:	34' x 32'
Weight:	1,725 lbs.

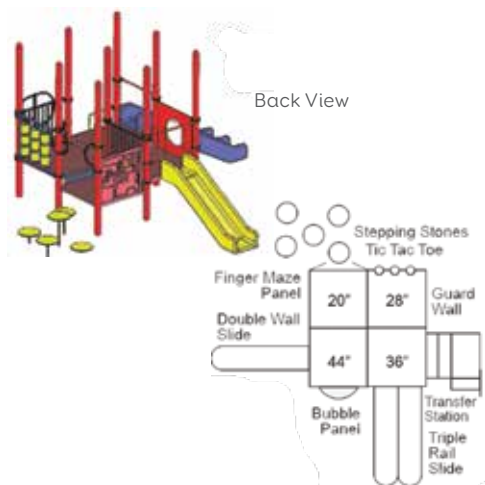

### ABBY

911-125B (5" posts)

911-225B (3.5" posts)

Ages:	2-12 years
Total Number of Events:	8
Elevated Events:	6
Ground Level Events:	2
Dimensions:	25' x 11'
Use Zone:	37' x 23'
Weight:	2,027 lbs.

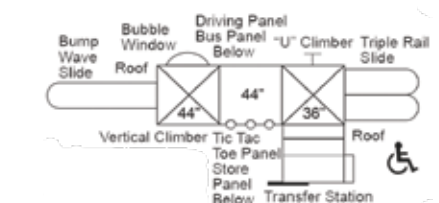

Additional ground events needed to make ADA 2.

### SOPHIA

911-145B (5" posts)

911-245B (3.5" posts)

Ages:	2-12 years
Total Number of Events:	6
Elevated Events:	6
Ground Level Events:	0
Dimensions:	24' x 14'
Use Zone:	36' x 26'
Weight:	2,000 lbs.

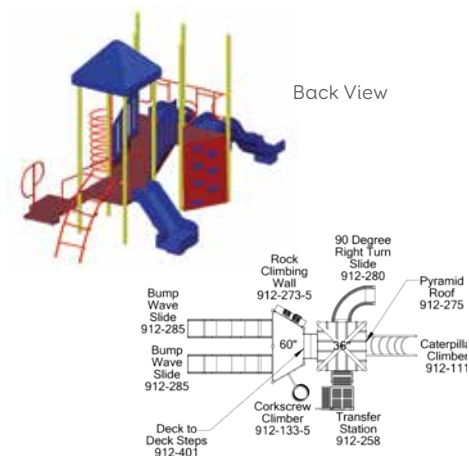

Additional ground events needed to make ADA 1.

### JAIME

911-141B (5" posts)

911-241B (3.5" posts)

Ages:	5-12 years
Total Number of Events:	8
Elevated Events:	6
Ground Level Events:	2
Dimensions:	18' x 25'
Use Zone:	30' x 37'
Weight:	2,385 lbs.

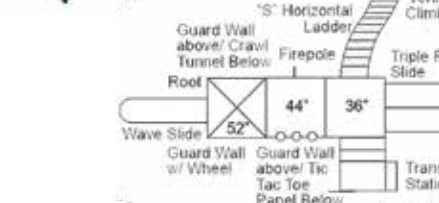



Additional ground events needed to make ADA 1.

### SETH

<b>911-142B (5" posts)</b>	
<b>911-242B (3.5" posts)</b>	
Ages:	5-12 years
Total Number of Events:	6
Elevated Events:	5
Ground Level Events:	1
Dimensions:	20' x 15'
Use Zone:	32' x 27'
Weight:	2,112 lbs.

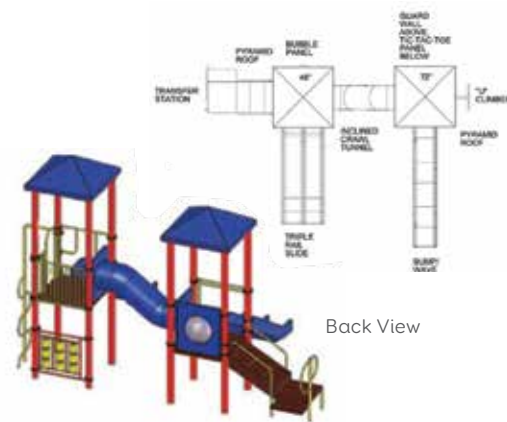

Additional ground events needed to make ADA 2.

### BOBBIE

<b>911-124B (5" posts)</b>	
<b>911-224B (3.5" posts)</b>	
Ages:	2-12 years
Total Number of Events:	8
Elevated Events:	7
Ground Level Events:	1
Dimensions:	13' x 21'
Use Zone:	25' x 33'
Weight:	2,272 lbs.

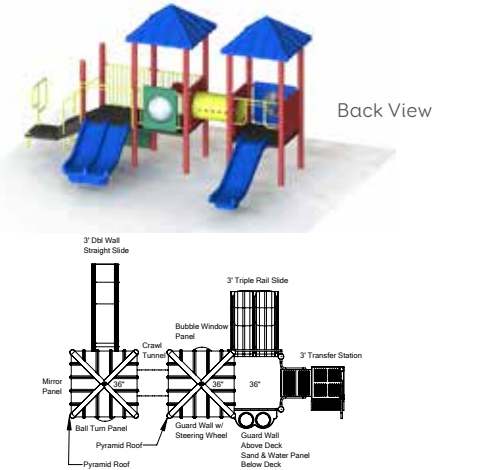

Additional ground events needed to make ADA 1.

### RICHARD

<b>911-122B (5" posts)</b>	
<b>911-222B (3.5" posts)</b>	
Ages:	5-12 years
Total Number of Events:	6
Elevated Events:	5
Ground Level Events:	1
Dimensions:	13' x 24'
Use Zone:	25' x 36'
Weight:	2,825 lbs.

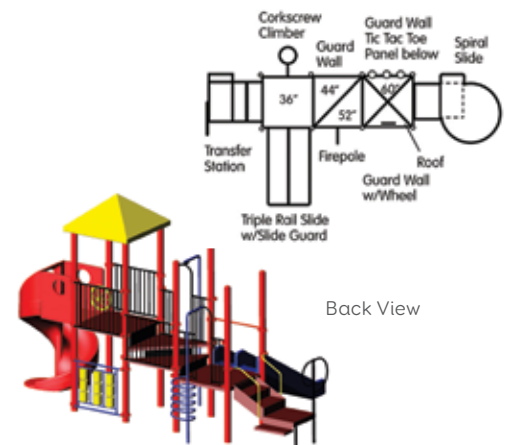

Additional ground events needed to make ADA 1.

### ZACK

<b>911-131B (5" posts)</b>	
<b>911-231B (3.5" posts)</b>	
Ages:	5-12 years
Total Number of Events:	7
Elevated Events:	6
Ground Level Events:	1
Dimensions:	22' x 15'
Use Zone:	34' x 27'
Weight:	2,268 lbs.

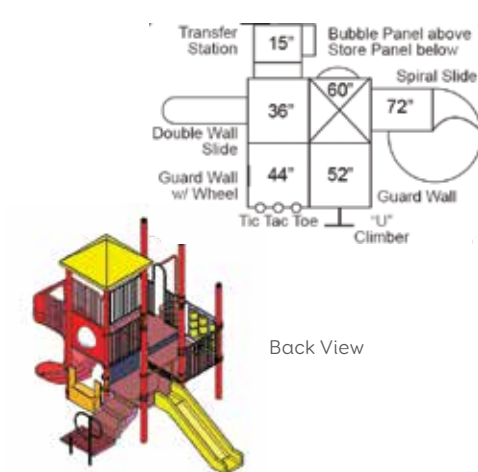





### ALICIA

911-132B (5" posts)
911-232B (3.5" posts)
Ages: 5-12 years
Total Number of Events: 11
Elevated Events: 10
Ground Level Events: 1
Dimensions: 38' x 27'
Use Zone: 50' x 39'
Weight: 2,558 lbs.

Additional ground events needed to make ADA 2.

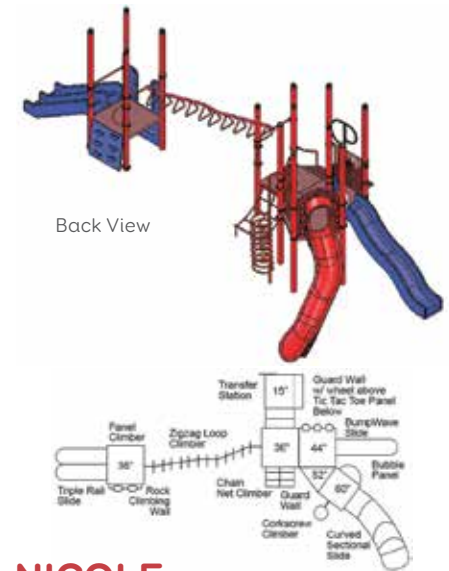

### CHRISTEL

911-126B (5" posts)
911-226B (3.5" posts)
Ages: 5-12 years
Total Number of Events: 9
Elevated Events: 9
Ground Level Events: 0
Dimensions: 17' x 32'
Use Zone: 44' x 29'
Weight: 2,969 lbs.

Three additional ground events and transfer station needed to make ADA.



### MEGAN

911-144B (5" posts)
911-244B (3.5" posts)
Ages: 2-12 years
Total Number of Events: 11
Elevated Events: 7
Ground Level Events: 4
Dimensions: 17' x 30'
Use Zone: 29' x 42'
Weight: 3,042 lbs.

Three additional ground events and transfer station needed to make ADA.

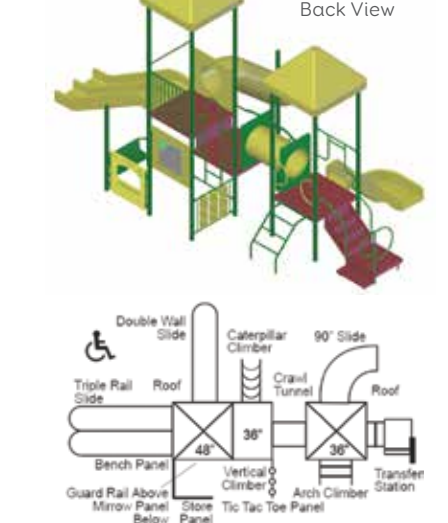

Alicia



Christel



Megan

### NICOLE

911-107B (5" posts)
911-207B (3.5" posts)
Ages: 5-12 years
Total Number of Events: 13
Elevated Events: 13
Ground Level Events: 0
Dimensions: 32' x 37'
Use Zone: 44' x 39'
Weight: 2,567 lbs.

Four additional ground events and transfer station needed to make ADA.

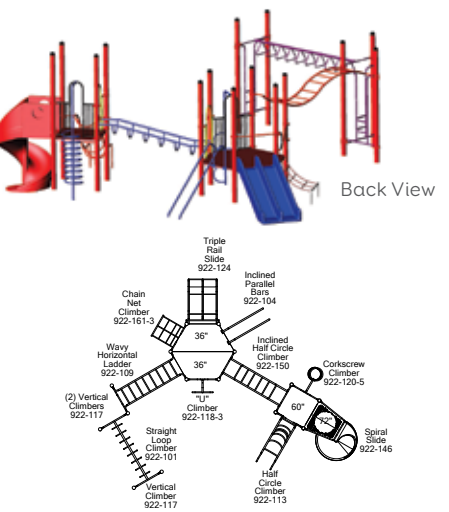

### LILY

911-167B (5" posts)
911-267B (3.5" posts)
Ages: 2-12 years
Total Number of Events: 8
Elevated Events: 7
Ground Level Events: 1
Dimensions: 15' x 32'
Use Zone: 27' x 44'
Weight: 3,800 lbs.

Additional ground events needed to make ADA 2.

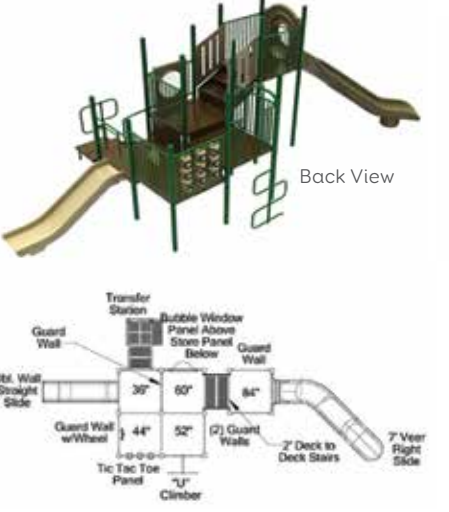

### CODY

911-166B (5" posts)
911-266B (3.5" posts)
Ages: 5-12 years
Total Number of Events: 11
Elevated Events: 10
Ground Level Events: 1
Dimensions: 24' x 36'
Use Zone: 36' x 48'
Weight: 4,530 lbs.

Additional ground events needed to make ADA 2.



Nicole



Additional ground events needed to make ADA 4.

### THOMAS

911-134B (5" posts)
911-234B (3.5" posts)
Ages: 5-12 years
Total Number of Events: 17
Elevated Events: 14
Ground Level Events: 3
Dimensions: 41' x 36'
Use Zone: 55' x 48'
Weight: 7,925 lbs.

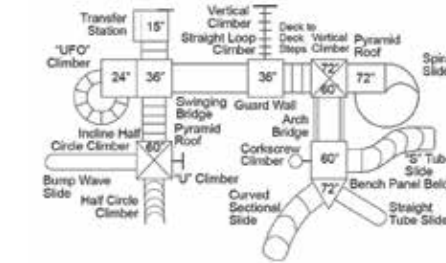

### KATHERINE

911-129B (5" posts)
911-229B (3.5" posts)
Ages: 5-12 years
Total Number of Events: 13
Elevated Events: 13
Ground Level Events: 0
Dimensions: 35' x 26'
Use Zone: 47' x 38'
Weight: 4,807 lbs.

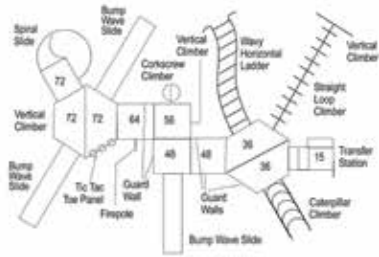

### TAYLOR

911-165B (5" posts)
911-265B (3.5" posts)
Ages: 5-12 years
Total Number of Events: 9
Elevated Events: 6
Ground Level Events: 3
Dimensions: 23' x 21'
Use Zone: 35' x 33'
Weight: 4,226 lbs.

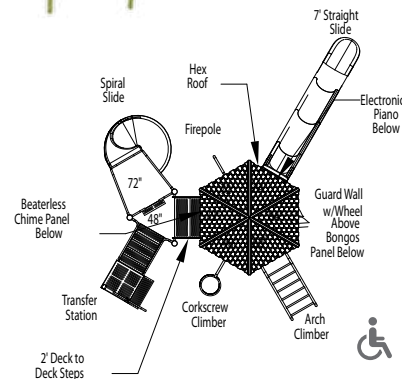

Additional ground events needed to make ADA 2.



**BUMP WAVE SLIDE**  
922-147-4 4' Deck 130 lbs.  
922-147-5 5' Deck 140 lbs.  
922-147-6 6' Deck 150 lbs.



**6' CURVED SECTION SLIDE**  
912-218 5' Deck 530 lbs.  
912-216 6' Deck 530 lbs.



**SPIRAL SLIDE**  
922-146 5' Deck 628 lbs.  
922-146 6' Deck 628 lbs.



**TRIPLE RAIL SLIDE**  
922-124 3' Deck 118 lbs.  
922-125 4' Deck 128 lbs.



**CATERPILLAR CLIMBER**  
922-110 3' Deck 86 lbs.



**HALF CIRCLE CLIMBER**  
922-113 5' Deck 116 lbs.



**INCLINED HALF CIRCLE CLIMBER**  
922-150 2' Rise 140 lbs.



**ARCH CLIMBER**  
922-159-3 3' Deck 56 lbs.  
922-159-4 4' Deck 61 lbs.  
922-159-5 5' Deck 65 lbs.



**DOUBLE WALL STRAIGHT SLIDE**  
922-127-3 3' Deck 113 lbs.  
922-127-4 4' Deck 123 lbs.  
922-127-5 5' Deck 133 lbs.



**90° RIGHT TURN SLIDE**  
922-145 3' Deck 118 lbs.



**STRAIGHT TUBE SLIDE**  
922-140-4 4' Deck 220 lbs.  
922-140-5 5' Deck 228 lbs.  
922-140-6 6' Deck 240 lbs.



**"S" TUBE SLIDE**  
922-134-5 5' Deck 228 lbs.  
922-134-6 6' Deck 240 lbs.



**PAD CLIMBER**  
922-122-3 3' Deck 78 lbs.  
922-122-4 4' Deck 94 lbs.  
922-122-5 5' Deck 112 lbs.  
922-122-6 6' Deck 128 lbs.



**ROCK CLIMBING WALL**  
922-144-3 3' Deck 55 lbs.  
922-144-4 4' Deck 65 lbs.  
922-144-5 5' Deck 75 lbs.  
Green or blue rocks.

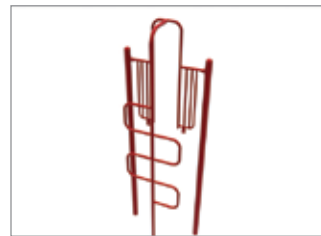

**"U" CLIMBER**  
922-118-3 3' Deck 66 lbs.  
922-118-4 4' Deck 68 lbs.  
922-118-5 5' Deck 71 lbs.  
922-118-6 6' Deck 75 lbs.



**CORKSCREW CLIMBER/ ARCH WALL**  
922-120-3 3' Deck 90 lbs.  
922-120-4 4' Deck 93 lbs.  
922-120-5 5' Deck 96 lbs.  
922-120-6 6' Deck 99 lbs.



**90° CRAWL TUNNEL WITH END PANELS**  
922-151 235 lbs.



**CRAWL TUNNEL WITH END PANELS**  
922-153 145 lbs.



**"UFO" CLIMBER**  
922-103 62 lbs.



**INCLINED CRAWL TUNNELS**  
922-148 85 lbs.



**PANEL CLIMBER**  
912-267-3 3' Deck 85 lbs.  
912-267-4 4' Deck 95 lbs.  
912-267-5 5' Deck 115 lbs.



**CHAIN NET CLIMBER**  
922-161-3 3' Deck 55 lbs.  
922-161-4 4' Deck 58 lbs.  
922-161-5 5' Deck 63 lbs.



**BEDROCK CLIMBER**  
922-143 3' Deck 110 lbs.



**STEPPING STONES**  
922-142 18" diameter 145 lbs.  
Set of five



**STRAIGHT LOOP CLIMBER**  
922-101 73 lbs.



**STRAIGHT HORIZONTAL LADDER**  
922-105 79 lbs.



**WAVY HORIZONTAL LADDER**  
922-109 88 lbs.



**VERTICAL CLIMBER PROTECTIVE BARRIER**  
922-116-3 3' Deck 52 lbs.  
922-116-4 4' Deck 54 lbs.  
922-116-5 5' Deck 56 lbs.  
922-116-6 6' Deck 58 lbs.



**STEP LADDER WITH ARCHED ENTRY**  
922-155-3 3' Deck 142 lbs.  
922-155-4 4' Deck 168 lbs.  
922-155-5 5' Deck 194 lbs.  
922-155-6 6' Deck 220 lbs.  
922-155-7 7' Deck 246 lbs.  
922-155-8 8' Deck 272 lbs.



**DECK TO DECK STEPS**  
922-156 1' Rise 150 lbs.  
922-157 2' Rise 175 lbs.  
ADA size 8" rise step.



**TRANSFER STATION**  
922-135 3' Deck 200 lbs.  
922-136 4' Deck 250 lbs.  
Transfer deck meeting ADA guidelines allows transfer onto the modular structure and access to the play components.



**ZIG ZAG LOOP CLIMBER**  
922-111 148 lbs.



**RING CLIMBER**  
922-106 61 lbs.



**"S" HORIZONTAL LADDER**  
922-108 65 lbs.

SportsPlay Color Options

Post, clamp, and accent powder coat colors



Slides, roofs, and crawl tunnels colors

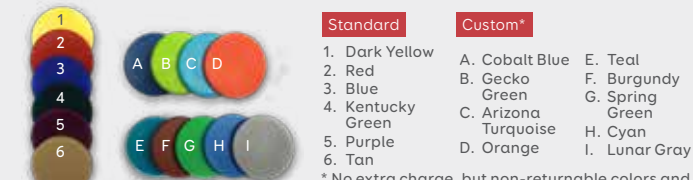

\* No extra charge, but non-returnable colors and longer lead time.



**ADA ACCESSIBLE RAMP**  
922-167 302 lbs.



**12 RUNG WALL WITH STEERING WHEEL**  
922-121 Wall 40 lbs.  
922-121W Wall with Steering Wheel 45 lbs.



**ARCH BRIDGE**  
912-406 Metal Planks 405 lbs.



**FIRE POLE/ARCH WALL**  
922-119-3 3' Deck 60 lbs.  
922-119-4 4' Deck 62 lbs.  
922-119-5 5' Deck 64 lbs.  
922-119-6 6' Deck 66 lbs.



**SOLAR PANEL**  
912-302 60 lbs.



**PUPPET THEATER PANEL**  
912-414 60 lbs.



**BENCH PANEL**  
922-169 40 lbs.



**JUMP PANEL**  
912-854-4 4' Jump 60 lbs.  
912-854-5 5' Jump 60 lbs.



**INCLINED PARALLEL BARS**  
922-104 3' Deck only 60 lbs.



**SUBMARINE TALK PHONE**  
912-122 38 lbs./pair



**SWINGING BRIDGE**  
922-162 Metal Planks 536 lbs.  
For use on 3' deck.



**LOG ROLL**  
912-303 70 lbs.



**NUMBERS/SHAPE PANEL ALPHABET PANEL**  
912-121S Numbers 60 lbs.  
912-121A Alphabet 60 lbs.



**HEX ROOF**  
902-277 Polyethylene 170 lbs.  
902-277S Steel 493 lbs.



**SLANTED ROOF**  
902-278 120 lbs.



**GABLE ROOF**  
902-276 Polyethylene 60 lbs.  
902-276S Steel 219 lbs.



**CHIN/TURNING BAR**  
922-102 12 lbs.



**MIRROR PANEL**  
912-822 60 lbs.



**DRIVE PANEL**  
912-228 55 lbs.



**TIC TAC TOE PANEL**  
922-114T 46 lbs.  
922-175T 46 lbs. Below Deck



**PYRAMID ROOF**  
902-275 Polyethylene 92 lbs.  
902-275S Steel 193 lbs.



**ADA BORDER RAMP**  
902-503 110 lbs.  
Available in black and blue.



**6' BORDER TIMBERS**  
902-511 10 lbs.  
Includes one spike. 12" H.



**STONE BORDER TIMBERS**  
902-517 Straight section 15 lbs.  
902-518 Curved section 15 lbs.  
All include spikes. 10" H.



**FINGER MAZE PANEL**  
912-202 60 lbs.



**SAND AND WATER PANEL**  
912-807 70 lbs.



**STORE PANEL**  
902-206 55 lbs.



**HAPPY FACE PANEL**  
912-260 4' Deck 50 lbs.



**SQUARE DECK**  
922-177 154 lbs.



**HEX DECK**  
922-178 298 lbs.



**TRIANGLE DECK**  
922-176 71 lbs.



**HALF SQUARE DECK (Not Shown)**  
922-179 77 lbs.



**HALF HEX DECK (Not Shown)**  
922-180 150 lbs.



**BALL TURN PANEL**  
912-232 65 lbs.



**MULTI-LINGUAL PANEL**  
912-306 60 lbs.

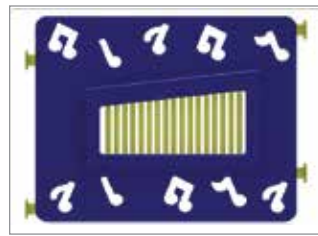

**MUSIC PANEL**  
912-881 70 lbs.



**BUBBLE PANEL**  
922-112 43 lbs.

## PLAYGROUND SIGNS



**AGES 2-12 PLAY AREA SIGN**  
902-821 25 lbs.



**ACCESSIBLE PLAY AREA SIGN**  
902-821-1 25 lbs.



**AGES 2-5 PLAY AREA SIGN**  
902-821-2 25 lbs.



**AGES 5-12 PLAY AREA SIGN**  
902-821-5 25 lbs.



# ELECTRONIC AND MUSIC PANELS

These exciting interactive **electronic and music panels** are sold as **Modular Components** or as free standing panels between 3.5" posts, in your choice of post colors. Videos of these panels are available on [www.sportsplayinc.com](http://www.sportsplayinc.com) or YouTube. ADA versions also available.

## Electronic Battery Operated Panels



**DRUMS**  
922-220 50 lbs.



**SUNNY SIDE FARM**  
922-221 50 lbs.



**DRIVING PANEL**  
922-222 50 lbs.  
Note: on modular, for lower deck only.



**PIANO**  
922-219 50 lbs.

## Mechanically Operated Panels



**MAKE IT RAIN**  
922-216 40 lbs.



**BALL MAZE**  
922-217 40 lbs.



**TWIST**  
922-223 40 lbs.



**TUMBLE BALL**  
922-215 45 lbs.

## Musical Instrument Panels



**BONGOS**  
922-225 60 lbs.



**CHIMES**  
922-224 60 lbs.



**TONGUE DRUMS**  
922-218 60 lbs.



**MUSICAL BELLS**  
922-214 60 lbs.

## ADA Panels



**ADA TIC-TAC-TOE PANEL**  
902-208 35 lbs.



**ADA DRIVE PANEL**  
902-217 30 lbs.

# THEME PLAY



## TOT TOWN EXPRESS

<b>911-130B (5" posts)</b>	
<b>911-230B (3.5" posts)</b>	
Ages:	2-12 years
Total Number of Events:	7
Elevated Events:	7
Ground Level Events:	0
Dimensions:	38' x 10'
Use Zone:	50' x 22'
Weight:	3,850 lbs.

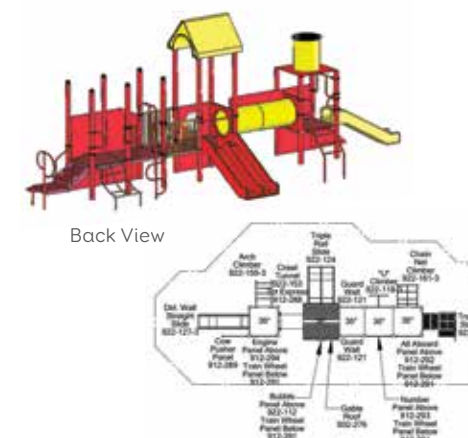

## CASTLE

<b>911-135B (5" posts)</b>	
<b>911-235B (3.5" posts)</b>	
Ages:	5-12 years
Total Number of Events:	8
Elevated Events:	5
Ground Level Events:	3
Dimensions:	23' x 34'
Use Zone:	35' x 46'
Weight:	4,899 lbs.

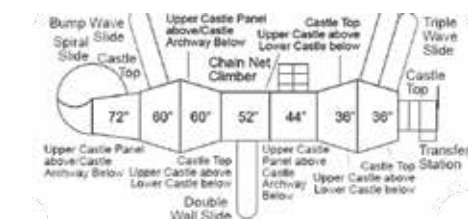

HDPE only available in green/tan for Castle.



# TOT TOWN® PLAY LINE

Our Tot Town® products are made of durable polyethylene perfect for indoor or outdoor recreation. Brighten your play area with these great opportunities for creative exploration.

## TOT TOWN® CLIMBER CHALLENGE

<b>902-873</b> (Multi/Camo Color Option)	
<b>902-879</b> (Single Color Option—photo not shown)	
Ages:	5-12 years
Dimensions:	4' L x 4' W x 90" H
Use Zone:	16' x 16'
Weight:	825 lbs.



Camo Option



Multi Color Option



## TOT TOWN® OCTO TOSS

<b>902-805</b>	
Ages:	2-5 years
Dimensions:	5'10" L x 6' H
Weight:	120 lbs.

## TOT TOWN® TWO SIDED CLIMBER CHALLENGE

<b>902-884</b>	
Ages:	5-12 years
Dimensions:	4' L x 4' W x 90" H
Use Zone:	16' x 16'
Weight:	670 lbs.



## TOT TOWN® SINGLE SAND & WATER

<b>902-806-SD</b> (With Drain)	
Dimensions:	4' L x 4' W x 2' H



## TOT TOWN® SAND/WATER TABLE

<b>902-806</b>	
Dimensions:	8' L x 7' W x 2' H
Weight:	200 lbs.
24" bowls, 1/2" drain plugs; includes one lid for sand bowl.	



## TOT TOWN® KIDDIE KORRAL

<b>902-880</b>	
Ages:	2-5 years
Dimensions:	10' W x 10' D x 42" H
Use Zone:	22' x 22'
Weight:	382 lbs.

Consists of Spinner Maze, Mirror, Dual Driving, Music, Dino Spin, Alphabet, and Bubble Panels



## TOT TOWN® SAILBOAT SANDBOX

<b>902-824</b>	
Ages:	2-5 years
Dimensions:	8'6" W x 6' D x 5'6" H
Weight:	266 lbs.



## TOT TOWN® LARGE SANDBOX

<b>902-833</b>	
Ages:	2-5 years
Dimensions:	8' W x 4' D x 11' H
Weight:	92 lbs.



## TOT TOWN® SMALL SANDBOX

<b>902-832</b>	
Ages:	2-5 years
Dimensions:	4' W x 4' D x 11' H
Weight:	52 lbs.



## TOT TOWN® TOT HOUSE 2

<b>902-802</b> (Outdoor)	
Ages:	2-5 years
Dimensions:	3'10" W x 4' D x 6'5" H
Use Zone:	14' x 14'
Weight:	386 lbs.



## TOT TOWN® TOT HOUSE 1

<b>902-803</b> (Primary Outdoor)	
<b>902-888</b> (Pink Outdoor)	
Ages:	2-5 years
Dimensions:	4'2" W x 4'2" D x 4'6" H
Use Zone:	16'6" x 16'6"
Weight:	365 lbs.

\$50 DONATION!

SportsPlay will donate \$50 to cancer research for every Pink Tot Town® House 1 sold.



### ALUMINUM SPRING RIDERS

SportsPlay offers Spring Riders that are either Rotomolded or Aluminum with powder coated finish. We offer lifetime guarantee on all aluminum riders. All single Spring Riders are appropriate for children ages 2 to 5 years old.



#### PONY

361-502
Use Zone: 13' x 15'
Weight: 61 lbs.



#### ZEBRA

361-503
Use Zone: 13' x 15'
Weight: 61 lbs.



#### MUSTANG

361-501
Use Zone: 13' x 15'
Weight: 61 lbs.



#### DERBY

361-507
Use Zone: 13' x 15'
Weight: 61 lbs.

#### BRONCO

361-504
Use Zone: 13' x 15'
Weight: 61 lbs.

#### ECLIPSE

361-508
Use Zone: 13' x 15'
Weight: 61 lbs.

### PORTABLE SAND DIGGER

361-509P
Weight: 50 lbs.



### SAND DIGGER

361-509
Weight: 30 lbs.



### ADA SAND DIGGER

361-509H
Weight: 30 lbs.



All sand diggers ship UPS.

**PINK PONY**

361-506
Use Zone: 13' x 15'
Weight: 61 lbs.

**\$15 DONATION!**

SportsPlay will donate \$15 to cancer research for every Pink Pony sold.



Bronco



Eclipse

### OTHER SPRING RIDERS



School Bus

### SCHOOL BUS

902-812B
Dimensions: 4' x 6'
Use Zone: 16' x 18'
Weight: 540 lbs.



Fire Truck

### FIRE TRUCK

902-812F
Dimensions: 4' x 6'
Use Zone: 16' x 18'
Weight: 540 lbs.

School Bus and Fire Truck can accommodate more than one child at a time.

### FROG RIDER

361-510
Use Zone: 14' x 15'
Weight: 79 lbs.

### WHALE RIDER

361-511
Use Zone: 14' x 15'
Weight: 79 lbs.



Frog Rider



Whale Rider



# SEE SAWS AND SLIDES



### TEETER SPRING RIDER

<b>361-505</b>
<b>Ages:</b> 2-5 years
<b>Dimensions:</b> 2' W x 6' L x 16" with 12"surfacing
<b>Use Zone:</b> 14' x 18'
<b>Weight:</b> 149 lbs.

### SEE SAWS

<b>Ages:</b> 5-12 years
<b>801-212M-H (2 seats)</b>
<b>Dimensions:</b> 2' W x 12' L
<b>Use Zone:</b> 14' x 24'
<b>Weight:</b> 150 lbs.
<b>801-212-H (4 seats)</b>
<b>Dimensions:</b> 4' W x 12' L
<b>Use Zone:</b> 16' x 24'
<b>Weight:</b> 200 lbs.
<b>801-312-H (6 seats)</b>
<b>Dimensions:</b> 8' W x 12' L
<b>Use Zone:</b> 20' x 24'
<b>Weight:</b> 310 lbs.
<b>801-412-H (8 seats)</b>
<b>Dimensions:</b> 12' W x 12' L
<b>Use Zone:</b> 24' x 24'
<b>Weight:</b> 360 lbs.
<b>801-612-H (12 seats)</b>
<b>Dimensions:</b> 20' W x 12' L
<b>Use Zone:</b> 32' x 24'
<b>Weight:</b> 535 lbs.

NOTE: SportsPlay see saw seats are available in RED, BLUE, GREEN, YELLOW, and TAN. Unless specified at time of order, the color of the see saw seats will be determined based on availability.



801-212-H



### 6' BUMP WAVE SLIDE

<b>902-292</b>
<b>Ages:</b> 5-12 years
<b>Dimensions:</b> 3' x 17'
<b>Use Zone:</b> 15' x 29'
<b>Weight:</b> 695 lbs.



### 6' SECTIONAL SLIDE

<b>902-293</b>
<b>Ages:</b> 5-12 years
<b>Dimensions:</b> 7' x 16'
<b>Use Zone:</b> 19' x 28'
<b>Weight:</b> 755 lbs.



### 6' SPIRAL SLIDE

<b>902-294</b>
<b>Ages:</b> 5-12 years
<b>Dimensions:</b> 6' x 12'
<b>Use Zone:</b> 18' x 24'
<b>Weight:</b> 920 lbs.



### 6' TUNNEL SLIDE

<b>902-296</b>
<b>Ages:</b> 2-5 years
<b>Dimensions:</b> 6' x 17'
<b>Use Zone:</b> 18' x 29'
<b>Weight:</b> 750 lbs.



### 3' JR. SLIDER

<b>311-145</b>
<b>Ages:</b> 2-5 years
<b>Dimensions:</b> 2' x 11'
<b>Use Zone:</b> 14.5' x 23'
<b>Weight:</b> 390 lbs.



### 4' AND 5' SUPER SLIDE

<b>Ages:</b> 5-12 years
<b>421-408 (4' Super Slide)</b>
<b>Dimensions:</b> 2' x 8'
<b>Use Zone:</b> 14' x 25'
<b>Weight:</b> 330 lbs.
<b>421-510 (5' Super Slide)</b>
<b>Ages:</b> 5-12 years
<b>Dimensions:</b> 9' x 12'
<b>Use Zone:</b> 14' x 27'
<b>Weight:</b> 370 lbs.

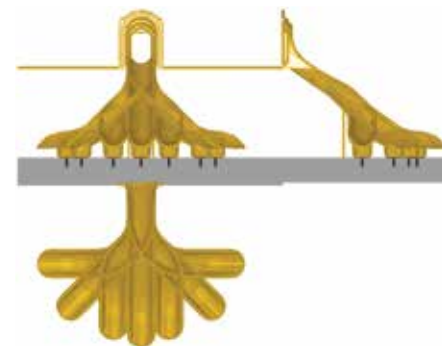

7' and 8' slides are available in multiple configurations as shown in the illustration.



7' Sec Straight slide



8' Right Snake turn slide

### 7' SLIDE

<b>Ages:</b> 5-12 years
<b>Weight:</b> 724 lbs.
<b>902-311 (Ind. Sec left turn)</b>
<b>Use Zone:</b> 23' x 27'
<b>902-312 (Ind. Sec left veer)</b>
<b>Use Zone:</b> 24' x 34'
<b>902-313 (Ind. Sec right turn)</b>
<b>Use Zone:</b> 23' x 27'
<b>902-314 (Ind. Sec right veer)</b>
<b>Use Zone:</b> 24' x 34'
<b>902-315 (Ind. Sec straight)</b>
<b>Use Zone:</b> 16' x 33'
<b>902-316 (Ind. Sec left snake)</b>
<b>Use Zone:</b> 17' x 33'
<b>902-317 (Ind. Sec right snake)</b>
<b>Use Zone:</b> 17' x 33'

### 8' SLIDE

<b>Ages:</b> 5-12 years
<b>Weight:</b> 764 lbs.
<b>902-310 (Ind. Sec straight)</b>
<b>Use Zone:</b> 16' x 36'
<b>902-318 (Ind. Sec left turn)</b>
<b>Use Zone:</b> 26' x 28'
<b>902-319 (Ind. left veer)</b>
<b>Use Zone:</b> 26' x 37'
<b>902-320 (Ind. right turn)</b>
<b>Use Zone:</b> 26' x 28'
<b>902-321 (Ind. right veer)</b>
<b>Use Zone:</b> 26' x 37'
<b>902-322 (Ind. left snake)</b>
<b>Use Zone:</b> 18' x 37'
<b>902-328 (Ind. right snake)</b>
<b>Use Zone:</b> 18' x 37'

### SportsPlay Color Options

Post, clamp, and accent powder coat colors



Slides, roofs, and crawl tunnels colors

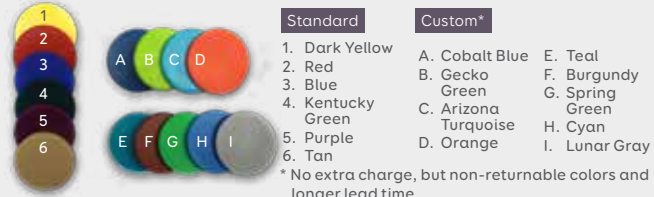

- |                   |                      |                 |
|-------------------|----------------------|-----------------|
| <b>Standard</b>   | <b>Custom*</b>       |                 |
| 1. Dark Yellow    | A. Cobalt Blue       | E. Teal         |
| 2. Red            | B. Gecko Green       | F. Burgundy     |
| 3. Blue           | C. Arizona Turquoise | G. Spring Green |
| 4. Kentucky Green | D. Orange            | H. Cyan         |
| 5. Purple         |                      | I. Lunar Gray   |
| 6. Tan            |                      |                 |
- \* No extra charge, but non-returnable colors and longer lead time.





# MERRY GO ROUNDS



## 6' ROUND\* MERRY GO ROUND

<b>301-142</b>	
Ages:	5-12 years
Dimensions:	6' diameter
Use Zone:	18' diameter
Weight:	595 lbs.
Capacity:	8 children
Weight Capacity:	3,500 lbs. max.

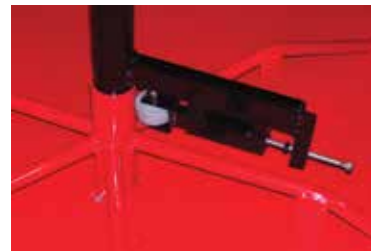

Governor for 6', 8', 10' Merry Go Rounds



Multi-color 10' Round Merry Go Round

## 10' ROUND\* MERRY GO ROUND

<b>301-146</b>	
<b>301-146M (Multi-color)</b>	
Ages:	5-12 years
Dimensions:	10' diameter
Use Zone:	22' diameter
Weight:	1,071 lbs.
Capacity:	14-16 children
Weight Capacity:	7,000 lbs. max.



\*For the 6', 8' and 10' Merry Go Rounds, please specify Red with Yellow, Green with Tan, or Purple with White.



## 8' ROUND\* MERRY GO ROUND

<b>301-143</b>	
<b>301-143M (Multi-color)</b>	
Ages:	5-12 years
Dimensions:	8' diameter
Use Zone:	20' diameter
Weight:	935 lbs.
Capacity:	10-12 children
Weight Capacity:	5,250 lbs. max.



Multi-color 8' Round Merry Go Round





# CLIMBERS



Super Dome



Geo Dome



Jr. Geo Dome

## SUPER DOME

<b>501-121 (400 lbs.)</b>	
Ages:	5-12 years
Dimensions:	17' diameter
Use Zone:	29' diameter
Weight:	400 lbs.
Height:	7'
Capacity:	5,000 lbs.

## GEO DOME

<b>301-133 (Permanent Galvanized)</b>	
<b>302-133 (Portable Galvanized)</b>	
Ages:	2-5 years
Dimensions:	8' diameter
Use Zone:	20' diameter
Weight (Permanent Galvanized):	130 lbs.
Weight (Portable Galvanized):	125 lbs.
Height:	4'
Capacity:	1,000 lbs.

## JR. GEO DOME

<b>301-134 (Permanent Galvanized)</b>	
<b>302-134 (Portable Galvanized)</b>	
Ages:	2-5 years
Dimensions:	80" diameter
Use Zone:	18'8" diameter
Weight (Permanent Galvanized):	97 lbs.
Weight (Portable Galvanized):	92 lbs.
Height:	40"

**FOR ALL DOMES:**  
Upcharge for all painted domes. All dome products ship UPS.

Options for SportsPlay Domes:



Painted Dome

## SENSORI TUNNEL

<b>521-105</b>	
Ages:	2-5 years
Dimensions:	2' x 17' x 3'
Use Zone:	14' x 29'
Weight:	190 lbs.



## WHEEL THRU ARCADE

<b>381-115</b>	
Ages:	5-12 years
Dimensions:	3' x 10' x 53"
Use Zone:	16' x 22'
Weight:	190 lbs.



## HALF MOON RUNG CLIMBER

<b>501-123</b>	
Ages:	5-12 years
Dimensions:	2' W x 9.5' L x 6' H
Use Zone:	14' x 21.5'
Weight:	510 lbs.



## PARALLEL CLIMBER

<b>902-268</b>	
Ages:	5-12 years
Dimensions:	1' x 11'
Use Zone:	13' x 23'
Weight:	592 lbs.



## QUADCLIMBER

<b>501-119</b>	
Ages:	5-12 years
Dimensions:	14' x 14' x 11'6"; 7' arches
Use Zone:	26' x 26'
Weight:	512 lbs.



## HALF MOON CLIMBER

<b>501-122</b>	
Ages:	5-12 years
Dimensions:	2' W x 9.5' L x 6' H
Use Zone:	14' x 21.5'
Weight:	313 lbs.



## ROCK WALL TUNNEL

<b>902-875</b>	
Ages:	5-12 years
Dimensions:	30" x 86" x 70"
Use Zone:	19'2" x 17'10"
Weight:	280 lbs.



### NET CLIMBER

<b>301-135 (Permanent)</b>	
<b>302-135 (Portable)</b>	
<b>Ages:</b>	5-12 years
<b>Dimensions:</b>	Top 2' wide 6' H x 7' W x 7' L
<b>Use Zone:</b>	19' x 19'
<b>Weight (Permanent):</b>	177 lbs.
<b>Weight (Portable):</b>	155 lbs.



### CORRAL "THE MINI COURSE"

<b>511-301 (Galvanized)</b>	
<b>511-301P (Painted)</b>	
<b>Ages:</b>	5-12 years
<b>Dimensions:</b>	16' diameter
<b>Use Zone:</b>	28' diameter
<b>Weight (Galvanized):</b>	495 lbs.
<b>Weight (Painted):</b>	595 lbs.



### SCRAMBLER

<b>121-108P (Painted)</b>	
<b>121-108 (Galvanized)</b>	
<b>Ages:</b>	5-12 years
<b>Dimensions:</b>	7' H x 7' W x 6' L
<b>Use Zone:</b>	17' x 19'
<b>Weight (Painted):</b>	300 lbs.
<b>Weight (Galvanized):</b>	140 lbs.



### HERCULES CLIMBER II

<b>501-117P (Painted)</b>	
<b>501-117 (Galvanized)</b>	
<b>Ages:</b>	5-12 years
<b>Dimensions:</b>	10' x 10' x 140" H
<b>Use Zone:</b>	22' x 22'
<b>Weight (Galvanized):</b>	390 lbs.

Top ladder 80" high; 140" high slide poles.



### HERCULES CLIMBER V

<b>902-299</b>	
<b>Ages:</b>	5-12 years
<b>Dimensions:</b>	12' x 17' x 8' H
<b>Use Zone:</b>	24' x 29'
<b>Weight:</b>	688 lbs.



### HERCULES CLIMBER III

<b>501-118P (Painted)</b>	
<b>501-118 (Galvanized)</b>	
<b>Ages:</b>	5-12 years
<b>Dimensions:</b>	18' x 22' x 80" H
<b>Use Zone:</b>	30' x 33' 6"
<b>Weight (Galvanized):</b>	985 lbs.



### HERCULES CLIMBER VI

<b>902-301</b>	
<b>Ages:</b>	5-12 years
<b>Dimensions:</b>	17' x 17' x 8' H
<b>Use Zone:</b>	29' x 29'
<b>Weight:</b>	788 lbs.



### HERCULES CLIMBER IV

<b>902-298</b>	
<b>Ages:</b>	5-12 years
<b>Dimensions:</b>	10' x 17' x 8' H
<b>Use Zone:</b>	22' x 29'
<b>Weight:</b>	770 lbs.



### HERCULES CLIMBER VII

<b>902-300</b>	
<b>Ages:</b>	5-12 years
<b>Dimensions:</b>	19' x 17' x 8' H
<b>Use Zone:</b>	31' x 29'
<b>Weight:</b>	770 lbs.



# PLAY SHELLS

## EARLY YEARS PLAYSCAPE

<b>371-042</b> (Permanent)	
<b>372-042</b> (Portable)	
Ages:	2-5 years
Dimensions:	16' x 11'
Use Zone:	28' x 23'
Weight (Permanent):	412 lbs.
Weight (Portable):	417 lbs.
Capacity:	20 children

## A UP/DOWN CRAWL THRU

<b>311-102</b> (Permanent)	
<b>312-102</b> (Portable)	
Dimensions:	3' x 11' 3"
Use Zone:	15' x 24'
Weight (Permanent):	155 lbs.
Weight (Portable):	160 lbs.

## B RING CLIMBER

<b>301-102</b> (Permanent)	
<b>302-102</b> (Portable)	
Dimensions:	6' x 6'
Use Zone:	17' x 18'
Weight (Permanent):	97 lbs.
Weight (Portable):	99 lbs.

## C RABBIT HUTCH

<b>301-141</b> (Permanent)	
<b>302-141</b> (Portable)	
Dimensions:	5' x 5'
Use Zone:	17' x 17'
Weight (Permanent):	250 lbs.
Weight (Portable):	250 lbs.



**LIFETIME GUARANTEE**  
on all Aluminum Components



## CHARLOTTE THE SPIDER

<b>111-113</b>	
Ages:	5-12 years
Dimensions:	12' W x 12' L x 3' H
Use Zone:	29' x 29'
Weight:	350 lbs.
Capacity:	12 children

## TURTLE CLIMBER

<b>301-144</b>	
Ages:	2-5 years
Dimensions:	5' W x 8' L x 3' H
Use Zone:	18' x 20'
Weight:	290 lbs.



# SWINGS

All swing frames and swing frame yokes will be made in colors shown in catalog, unless specified.

## PRIMARY TRIPOD SWINGS

2-3/8" Top Rail, 1-7/8" OD Legs

		Seats:	Use Zone:	Weight:	IPEMA Certified:
8'	581-2208	2	32' x 33'	195 lbs.	
	581-4208	4	32' x 44'	284 lbs.	
	581-6208	6	32' x 55'	370 lbs.	
	581-8208	8	32' x 66'	475 lbs.	
10'	581-220	2	40' x 33'	220 lbs.	✓
	581-420	4	40' x 44'	320 lbs.	✓
	581-620	6	40' x 55'	445 lbs.	✓
	581-820	8	40' x 66'	530 lbs.	✓
12'	581-222	2	48' x 33'	240 lbs.	✓
	581-422	4	48' x 44'	360 lbs.	✓
	581-622	6	48' x 55'	445 lbs.	✓
	581-822	8	48' x 66'	590 lbs.	✓



Primary Tripod Swings

## PRIMARY BIPOD SWINGS

2-3/8" Top Rail, 1-7/8" OD Legs

		Seats:	Use Zone:	Weight:	IPEMA Certified:
8'	581-218	2	32' x 27'	146 lbs.	✓
	581-418	4	32' x 38'	243 lbs.	✓
	581-618	6	32' x 49'	340 lbs.	✓
	581-818	8	32' x 60'	437 lbs.	✓
10'	581-218x	2	40' x 27'	164 lbs.	✓
	581-418x	4	40' x 38'	270 lbs.	✓
	581-618x	6	40' x 49'	377 lbs.	✓
	581-818x	8	40' x 60'	485 lbs.	✓



Primary Bipod Swings

## MODERN SWINGS

2-3/8" Legs and Top Rail

		Seats:	Use Zone:	Weight:	IPEMA Certified:
8'	581-238	2	32' x 27'	208 lbs.	✓
	581-438	4	32' x 38'	390 lbs.	✓
	581-638	6	32' x 49'	480 lbs.	✓
	581-838	8	32' x 60'	575 lbs.	✓



Modern Bipod Swings

### Modifications available:

- Change height of swing set.
- Substitute seats, chains and hangers.
- Paint swing set to match your playscape.
- Add bays.
- Color change—no charge for yokes. Comes in your choice of eleven powder coat colors for swing fittings.

All swings come with galvanized steel pipes, self lubricating hangers, 4/0 galvanized welded chain and black cut proof seats.



Modern Tripod Swings



3.5" OD Arch Post Swing



5" OD Arch Post Swing



4.5" OD Single Post Swing

## MODERN TRIPOD SWINGS

2-3/8" Legs and Top Rail

		Seats:	Use Zone:	Weight:	IPEMA Certified:
8'	581-230-8	2	32' x 33'	300 lbs.	
	581-430-8	4	32' x 44'	440 lbs.	
	581-630-8	6	32' x 55'	470 lbs.	
	581-830-8	8	32' x 66'	700 lbs.	
10'	581-230	2	40' x 31'	320 lbs.	✓
	581-430	4	40' x 42'	460 lbs.	✓
	581-630	6	40' x 53'	575 lbs.	✓
	581-830	8	40' x 64'	720 lbs.	✓

## HEAVY DUTY MODERN SWINGS

2-3/8" Legs, 3-1/2" Top Rail

		Seats:	Use Zone:	Weight:	IPEMA Certified:
8'	581-240-8	2	32' x 33'	345 lbs.	
	581-440-8	4	32' x 44'	475 lbs.	
	581-640-8	6	32' x 55'	600 lbs.	
	581-840-8	8	32' x 66'	725 lbs.	
10'	581-240	2	40' x 31'	365 lbs.	✓
	581-440	4	40' x 42'	495 lbs.	✓
	581-641	6	40' x 53'	620 lbs.	✓
	581-840	8	40' x 64'	760 lbs.	✓
12'	581-242	2	48' x 33'	380 lbs.	✓
	581-442	4	48' x 44'	560 lbs.	✓
	581-643	6	48' x 55'	645 lbs.	✓
	581-842	8	48' x 66'	790 lbs.	✓

## ARCH POST SWING

3-1/2" Top Rail, 8' H

		Seats:	Use Zone:	Weight:	IPEMA Certified:
3.5" Outer Diameter	581-602	2	32' x 24'	591 lbs.	
	581-604	4	32' x 35'	798 lbs.	
	581-606	6	32' x 46'	1,019 lbs.	
	581-608	8	32' x 56'	1,240 lbs.	
5" Outer Diameter	581-702	2	32' x 24'	591 lbs.	
	581-704	4	32' x 36'	798 lbs.	
	581-706	6	32' x 48'	1,019 lbs.	
	581-708	8	32' x 60'	1,240 lbs.	

## SINGLE POST SWING

2-3/8" Top Rail, 8' H

		Seats:	Use Zone:	Weight:	IPEMA Certified:
4.5" Outer Diameter	581-502	2	32' x 24'	355 lbs.	
	581-504	4	32' x 36'	510 lbs.	
	581-506	6	32' x 48'	790 lbs.	
	581-508	8	32' x 60'	815 lbs.	

All swing frames and swing frame yokes will be made in colors shown in catalog, unless specified.



### HEAVY DUTY T SWING

3-1/2" Legs and Top Rail, 7'6" H

	Seats:	Use Zone:	Weight:
581-352	2	30' x 24'	230 lbs.
581-353	3	30' x 29'	270 lbs.



### HEAVY DUTY TIRE SWING

3-1/2" Legs and Top Rail, 7'6" H. Yellow or Blue colored plastic tire. Comes with swivel hanger and chain.

	Ages:	Use Zone:	Weight:
581-367	5-adult	28' x 36'	460 lbs.



### BIRD'S NEST SEAT SWING

5" arch post frame. Comes with 48" diameter nest seat and special bird's nest seat swing hangers and swing limiters.

	Ages:	Use Zone:	Weight:
581-371	5-12 years	24' x 32'	655 lbs.

## SWING SEATS AND ACCESSORIES

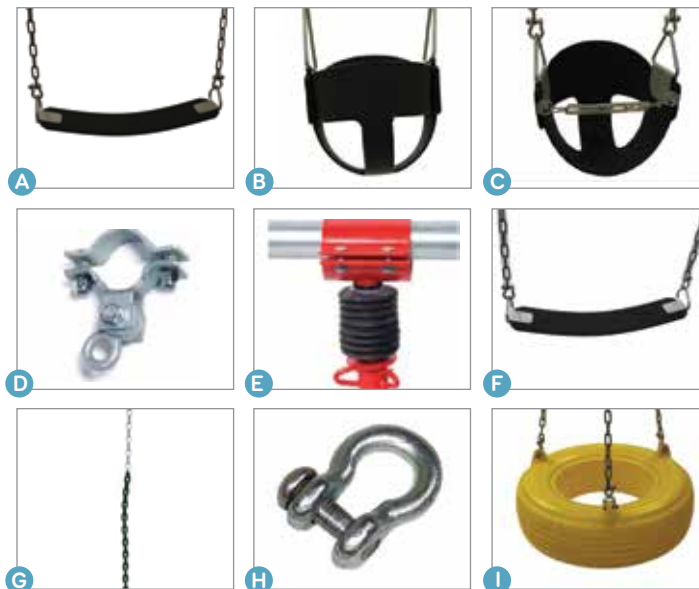

- A CUT PROOF BELT SEAT**  
Red, Blue, Yellow, Green, or Tan.  
582-955 (Black) 3 lbs.  
582-955C 3 lbs.
- B INFANT SEAT**  
582-964 9 lbs.
- C TODDLER SAFETY BELT**  
582-961 5 lbs.
- D STANDARD HANGERS**  
For 2-3/8" OD Top Rails.  
582-504 2 lbs.  
For 3.5" OD Top Rails.  
582-505 2 lbs.
- E HEAVY DUTY SWIVEL HANGERS**  
For 2-3/8" OD Top Rails.  
582-508 2 lbs.  
For 3.5" OD Top Rails.  
582-509 3 lbs.
- F PLASTIC CHAIN COVER 1'**  
582-906
- G COATED CHAIN PAIR**  
For 8" H Top Rail. Available in Yellow, Blue or Green.  
582-903 10 lbs.
- H "D" SHACKLE**  
342-506 4 oz.
- "D" SHACKLE WRENCH**  
(not shown)  
342-506K 2 oz.
- I PLASTIC TIRE SEAT**  
75 lb. limit. Yellow or Blue 28' 1-4" OD.  
342-904 25 lbs.

#### Items Not Shown

- "S" HOOK PLIERS**  
582-512 7 lbs.
- "S" HOOK**  
3/8" x 3" L  
582-901 3 oz.
- 1' 4/0 GALVANIZED CHAIN**  
582-902 1/3 lbs.
- ALUMINUM RING**  
4-1/2" ID  
582-915 1 lbs.
- TRAPEZE BAR**  
Includes "S" hooks  
582-922 3 lbs.

## WHEELCHAIR ACCESSIBLE SWINGS



JennSwing® and Swing Platform, 581-483, shown here.

### SWING PLATFORM WITH FRAME

		Ground Space:	Use Zone:	Weight:	Capacity:
Adult with To/Fro Hangers	381-404H (Permanent)	8' x 8'	20' x 32'	265 lbs.	800 lbs.
	382-404H (Portable)	8' x 8'	20' x 32'	265 lbs.	800 lbs.
Swing Frame Only with To/Fro Hangers	381-403H (Permanent)	8' x 8'	20' x 32'	148 lbs.	800 lbs.
	382-403H (Portable)	8' x 8'	20' x 32'	148 lbs.	800 lbs.

		Dimensions:	Weight:
Adult Swing Platform	382-408	32" W x 38" L	123 lbs.

Ships UPS

		Ground Space:	Use Zone:	Weight:
2 Bay ADA Swing with 2 wheelchair platforms	581-482	20' x 8'	32' x 32'	615 lbs.
2 Bay ADA Swing with 1 wheelchair platform and 1 JennSwing	581-483	20' x 8'	32' x 32'	575 lbs.
2 Bay ADA Swing Frame Only with To/Fro Hangers, 7' and 11' Bays	581-484F	23'6" x 6'6"	37' x 33'	450 lbs.
3 Bay ADA Swing Frame Only with To/Fro Hangers, 27', 11' bay	581-486F	30' x 8'	32' x 42'	480 lbs.

### ARCH POST FRAME WITH SWING PLATFORM

581-702-WC



Swing Platform—portable shown (382-404H).

### PULL CHAIN

	Dimensions:	Weight:
582-965	2-3/8" OD Rail	25 lbs.
582-960	3 1/2" OD Rail	26 lbs.

8' chain and attachment; allow self propulsion; add to any frame.

## JENNSWING®

382-411B (Ocean Blue)
382-411G (Jungle Green)
382-411R (Fire Engine Red)
382-411Y (Banana Yellow)
382-411P (Bubble Gum Pink)
<b>Dimensions:</b> 14" W x 11" D x 45" H
<b>Capacity:</b> 125 lbs.

Knee to foot = 14" L; Seat Back = 24" L



# CLASSIC FITNESS

**Keep your community healthy with a SportsPlay Fitness Course!** Child obesity continues to increase at an alarming rate. Currently, over 32% of children ages 6 to 11 years are overweight and 18% are obese. More than 12 million U.S. children are obese—nearly one in six. Overweight children face many health concerns, including damage to growing bones and cartilage, Type 2 Diabetes, heart disease and poor mental health. SportsPlay offers a wide range of Fitness Course activities to stimulate and challenge children to run, climb, jump, pull and push. Fitness Course activities are economical and provide unlimited configuration possibilities. Start small and add on later or create a large fitness challenge course to help your children stay healthy and fit. All fitness equipment is recommended for ages **five years to adult**.



SportsPlay's Fitness Courses are available in galvanized steel or choose one of the powder coated colors shown. There is a charge for each painted Fitness Course Product. See page 23 for color options.

## INSTRUCTIONAL SIGNS

<b>511-199</b>	<b>50 lbs.</b>
Available for all fitness station products.	

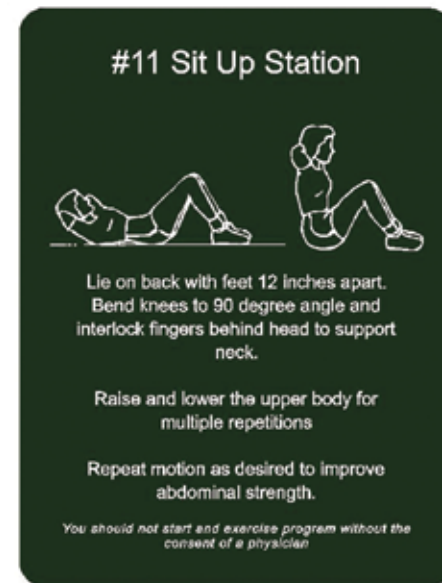

### A AGILITY POLES

<b>511-145P (Painted)</b>	
<b>511-145 (Galvanized)</b>	
<b>Dimensions:</b>	<b>Poles: 3'6" H</b>
<b>Weight (Galvanized):</b>	<b>50 lbs.</b>

### B OVER/UNDER BARS

Three 2' and three 5' H bars	
<b>511-143P (Painted)</b>	
<b>511-143 (Galvanized)</b>	
<b>Dimensions:</b>	<b>Poles: 4' x 18'</b>
<b>Weight (Galvanized):</b>	<b>50 lbs.</b>

### C ROPE CLIMB

<b>511-146P (Painted)</b>	
<b>511-146 (Galvanized)</b>	
<b>Dimensions:</b>	<b>3' x 8'</b>
<b>Use Zone:</b>	<b>12' x 16'</b>
<b>Weight (Galvanized):</b>	<b>80 lbs.</b>

### D CURVED BALANCE BEAM

<b>511-107CP (Painted)</b>	
<b>Dimensions:</b>	<b>12' x 2'</b>
<b>Use Zone:</b>	<b>24' x 14'</b>
<b>Weight:</b>	<b>50 lbs.</b>

### E STEPPING STONES

Set of five	
<b>511-152</b>	
<b>Dimensions:</b>	<b>18" Diameter of each stone</b>
<b>Use Zone:</b>	<b>16' x 20' Depending on setup</b>
<b>Weight:</b>	<b>55 lbs.</b>

### F PARALLEL CLIMBER

<b>902-268</b>	
<b>Dimensions:</b>	<b>1' x 11'</b>
<b>Use Zone:</b>	<b>13' x 23'</b>
<b>Weight:</b>	<b>592 lbs.</b>

### G TIRE CHALLENGE

<b>902-874</b>	
<b>Dimensions:</b>	<b>8' L x 4' W x 8" H</b>
<b>Use Zone:</b>	<b>20' x 16'</b>
<b>Weight:</b>	<b>150 lbs.</b>

### H RING CLIMBER

<b>511-150P (Painted)</b>	
<b>511-150 (Galvanized)</b>	
<b>Dimensions:</b>	<b>4' x 10'</b>
<b>Use Zone:</b>	<b>16' x 22' Uses 3.5" posts</b>
<b>Weight:</b>	<b>463 lbs.</b>

### I S HORIZONTAL LADDER

<b>511-151P (Painted)</b>	
<b>511-151 (Galvanized)</b>	
<b>Dimensions:</b>	<b>4' x 10'</b>
<b>Use Zone:</b>	<b>16' x 22' Uses 3.5" posts</b>
<b>Weight:</b>	<b>358 lbs.</b>

### J NINE STATION FITNESS COURSE

<b>511-219P (Painted)</b>	
<b>511-219 (Galvanized)</b>	
<b>Dimensions:</b>	<b>41.5' x 61"</b>
<b>Use Zone:</b>	<b>53.5' x 73'</b>
<b>Weight (Painted):</b>	<b>2,026 lbs.</b>
<b>Weight (Galvanized):</b>	<b>1,926 lbs.</b>

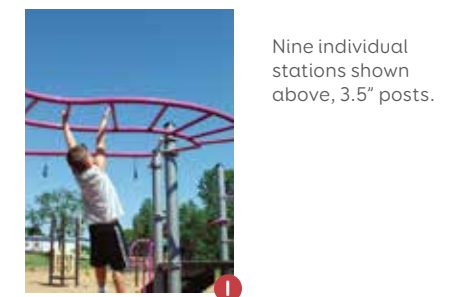
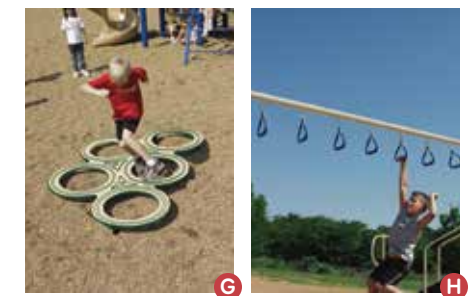

Nine individual stations shown above, 3.5" posts.

SportsPlay fitness products are designed to be interchanged. Let a SportsPlay distributor help you design a fitness course that is right for your space and budget.

## STEP 1

Determine the size of your fitness space.

## STEP 2

Select the events that provide the desired exercise and fitness challenges.

## STEP 3

Select the color that is right for your environment. Selecting galvanized (natural steel) will provide value by lowering your costs.

## STEP 4

Select instructional signage (optional) to complete your fitness course.

### 9 UNIT COURSES

	Items:	Painted or Galvanized:	Dimensions:	Weight:
511-209P	1-9 (w/ Challenge Ladder)	Painted	47' x 46'	1,195 lbs.
511-209	1-9 (w/ Challenge Ladder)	Galvanized	47' x 46'	995 lbs.
511-206P	1-9 (w/ Horizontal Ladder)	Painted	47' x 47'	1,200 lbs.
511-206	1-9 (w/ Horizontal Ladder)	Galvanized	47' x 47'	1,000 lbs.
511-200P	1-9 (w/ Jr. Horizontal Ladder)	Painted	46' x 46'	1,195 lbs.
511-200	1-9 (w/ Jr. Horizontal Ladder)	Galvanized	46' x 46'	995 lbs.

### 12 UNIT COURSES

	Items:	Painted or Galvanized:	Dimensions:	Weight:
511-215P	Items 1-12 (w/ Horizontal Ladder)	Painted	64' x 47'	1,625 lbs.
511-215	Items 1-12 (w/ Horizontal Ladder)	Galvanized	64' x 47'	1,425 lbs.

Allow 6' between each event. See page 23 for color options. Pallet charge for painted items.

#### A BOARDING NET

511-103P (Painted)
511-103 (Galvanized)
Dimensions: 1' x 5'
Use Zone: 13' x 17'
Weight (Galvanized): 110 lbs.
Height: 8'

#### D STALL BAR FENCE

511-102P (Painted)
511-102 (Galvanized)
Dimensions: 3' x 6'
Use Zone: 12' x 18'
Weight (Galvanized): 100 lbs.
Height: 7'
3' wide sections

#### B VAULT BAR

511-113P (Painted)
511-113 (Galvanized)
Dimensions: 1' x 6'
Use Zone: 13' x 18'
Weight: 85 lbs.
Height: 3.6'

#### E TRIPLE HORIZONTAL BAR

501-876P (Painted)
501-876 (Galvanized)
Dimensions: 1' x 15'
Use Zone: 13' x 27'
Weight (Galvanized): 110 lbs.
Height: Three 5' long bars; adjustable to 8' high.

#### C SWING BARS

511-119P (Painted)
511-119 (Galvanized)
Dimensions: 7' x 15'
Use Zone: 19' x 27'
Weight (Galvanized): 220 lbs.
Height: 7'

#### F POLE CLIMB

511-105P (Painted)
511-105 (Galvanized)
Dimensions: 4' x 8'
Use Zone: 16' x 20'
Weight (Galvanized): 125 lbs.
Height: 8'



A



B



C



D

#### G HORIZONTAL LADDER

501-416P (Horizontal Ladder—Painted)
501-416 (Horizontal Ladder—Galvanized)
Ground Space: 2' x 16' x 7' H
Use Zone: 14' x 27'
Weight (Galvanized): 155 lbs.
511-109P (Challenge Ladder Inclined—Painted)
511-109 (Challenge Ladder Inclined—Galvanized)
Ground Space: 2' x 13'
Use Zone: 14' x 27' with ladder height of 5'8" to 6'8"
Weight (Galvanized): 150 lbs.
501-410P (Jr. Horizontal Ladder—Painted)
501-410 (Jr. Horizontal Ladder—Galvanized)
Ground Space: 2' x 10' x 6' H
Use Zone: 14' x 22'
Weight (Galvanized): 110 lbs.



E



G

#### H ALUMINUM BALANCE BEAM

511-107P (Painted)
511-107 (Galvanized)
Dimensions: 12' L x 4" W x 16" H
Use Zone: 24' x 15' 6"
Weight: 40 lbs.



F

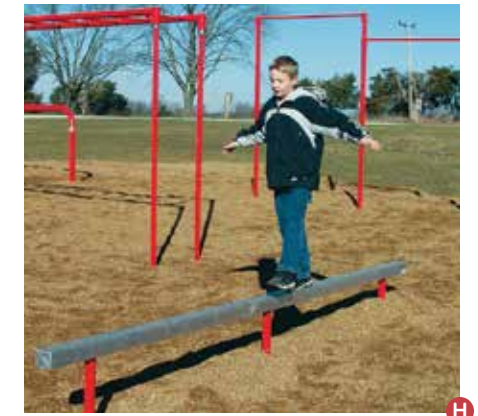

H

#### I PARALLEL BARS

511-108P (Painted)
511-108 (Galvanized)
Dimensions: 2' W x 12' L x 3' 6" H
Use Zone: 14' x 24'
Weight: 76 lbs.



I

#### J CHAIN RING LADDER

511-115P (Painted)
511-115 (Galvanized)
Dimensions: 8' x 8'
Use Zone: 20' x 20'
Weight (Galvanized): 225 lbs.
Height: 90" High; 12 rings spaced 1'6" apart.



J

#### K SIT UP STATION

511-114P (Painted)
511-114 (Galvanized)
Dimensions: 2'6" W x 6' L x 1.5' H
Use Zone: 14'6" x 18'
Weight (Galvanized): 80 lbs.



K

#### L PULL SLIDE

511-111P (Painted)
511-111 (Galvanized)
Dimensions: 2' x 12'
Use Zone: 14' x 14'
Weight (Galvanized): 120 lbs.



L





# BASKETBALL GAME STANDARDS

## SportsPlay Aluminum Backboard

- The Undisputed Champion!
- Over Half a Million Sold!
- Outstanding Value!
- Guaranteed for Life!

When it comes to outdoor basketball, aluminum is the clear choice.

- Better rebound than steel boards.
- Twice as thick and half the weight of steel
- Maintenance Free
- Rust Free



Heavy Duty 4.5" Bent Post Backstop



Standard 3.5" Bent Post Backstop



**542-600** Aluminum

Official size and shape, with unbroken playing surface. One piece permanent mold cast aluminum alloy backboard. 54" W x 35" H with 1-1/2" deep ribs and edge.

## COMPLETE BENT POST BACKSTOPS

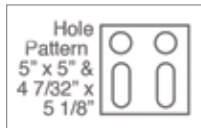

		Description:	Weight:
Heavy Duty 4.5" Outer Diameter Post	541-616	Aluminum Fan	215 lbs.
	541-616M	Aluminum Fan with nylon net	215 lbs.
	541-916	Acrylic Rectangle	261 lbs.
	541-951	1' Post Extension	8 lbs.
	541-216	Steel Rectangular-Mini	274 lbs.
	541-116	Steel Rectangular-Full	330 lbs.

Shown with optional border and target. Complete with post, backboard and double strength super goal with steel chain net and 4' extension. Powder coated posts additional charge. Color options shown below.

Steel Mini Board: 54.5" W x 35.5" H, Full Board: 72" W x 48" H

		Description:	Weight:
Standard 3.5" Outer Diameter Post	541-614	Aluminum Fan	145 lbs.
	541-951	1' Post Extension	8 lbs.
	541-514	Steel Rectangular-Mini	204 lbs.

Complete with post, backboard and single rim goal and nylon net and 3' extension. Powder coated posts additional charge. Color options shown below.

Steel Mini Board: 54.5" W x 35.5" H

### SportsPlay Color Options

Post, clamp and accent powder coat colors



## BASKETBALL ALUMINUM BACKBOARDS

Sportsplay guarantees its cast aluminum fan backboards for life when mounted "goal to post." If damaged under normal conditions, return backboard to our St. Louis, Missouri plant freight prepaid for a brand new replacement board, shipped freight collect.

## SportsPlay Super Strong Goal to Post Mounting System

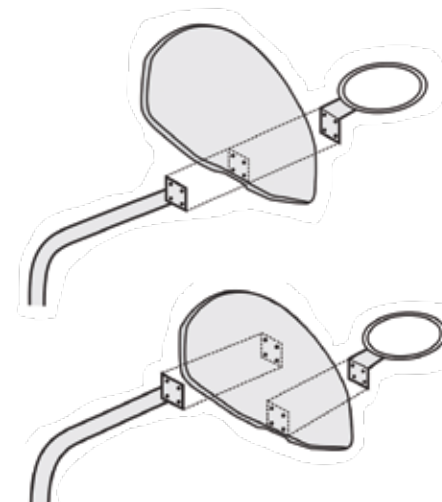

The **RIGHT** way to mount a backboard.

The goal and backboard are bolted together directly to the post forming a solid unit. All forces of "slam dunking" are safely absorbed by the heavy steel post, not the backboard.

The **WRONG** way to mount a backboard.

The goal is mounted only to the backboard and is not supported by the post. The force of "slam dunking" must be resisted by the backboard alone, which can easily bend and shatter.

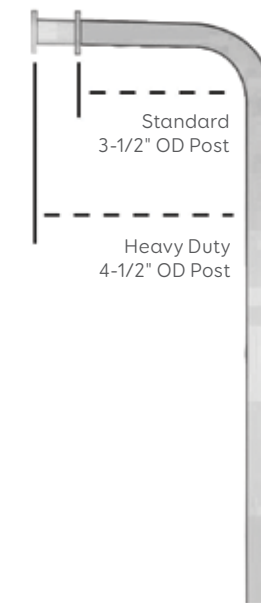

## SPORTSPLAY GOALS AND NETS



### SUPER GOAL AND NYLON NET

**542-973**  
Weight: 18 lbs.

Official 18" diameter with 5/8" top and 1/2" bottom steel rings and 1/2" heavy duty braces for greater strength and rigidity than single ring goals. Front mount bracket is 3/16" x 7" wide. Twelve no-tie holders and 120 thread count nylon net.



### SUPER GOAL AND STEEL CHAIN NET

**542-972**  
Weight: 18 lbs.

Official 18" diameter with 5/8" top and 1/2" bottom steel rings and 1/2" heavy duty braces for greater strength and rigidity than single ring goals. Front mount bracket is 3/16" x 7" wide.



### OFFICIAL GOAL AND NYLON NET

**542-917**  
Weight: 13 lbs.

Official 18" diameter with 5/8" steel ring and 1/2" heavy duty braces. 3/16" thick x 7" wide front mount bracket. Twelve no-tie holders and 120 thread count nylon net.



# COMPLETE BASKETBALL SYSTEMS



Tandem Six Backstop

## TANDEM SIX BACKSTOP

3.5" OD reinforced with 3.5" OD

	Description:	Weight:
541-636	Aluminum Fan	239 lbs.
541-936	Acrylic Rectangle	285 lbs.

Backboard and goal are mounted with the exclusive "goal to post" system. Complete with backboard and Official Goal and Nylon Net.

## SUPER SEVEN BACKSTOP

4.5" OD reinforced with 3.5" OD

	Description:	Weight:
541-637	Aluminum Fan	268 lbs.
541-937	Acrylic Rectangle	314 lbs.

Complete with backboard and double-strength Super Goal with steel chain net, mounted with SportsPlay's exclusive "goal to post" system. Braces are pictured but not included.



Wall Mounted Backstops

## WALL MOUNTED BACKSTOPS

	Description:	Weight:
531-601	1' Overhang	85 lbs.
531-602	2' Overhang	95 lbs.
531-603	3' Overhang	105 lbs.
531-604	4' Overhang	115 lbs.
531-605	5' Overhang	125 lbs.
531-606	6' Overhang	135 lbs.

Tripod design features "goal to post" mount for maximum strength. Complete with white Lifetime Aluminum Fan backboard, Official Goal and Nylon Net.



542-600 Aluminum

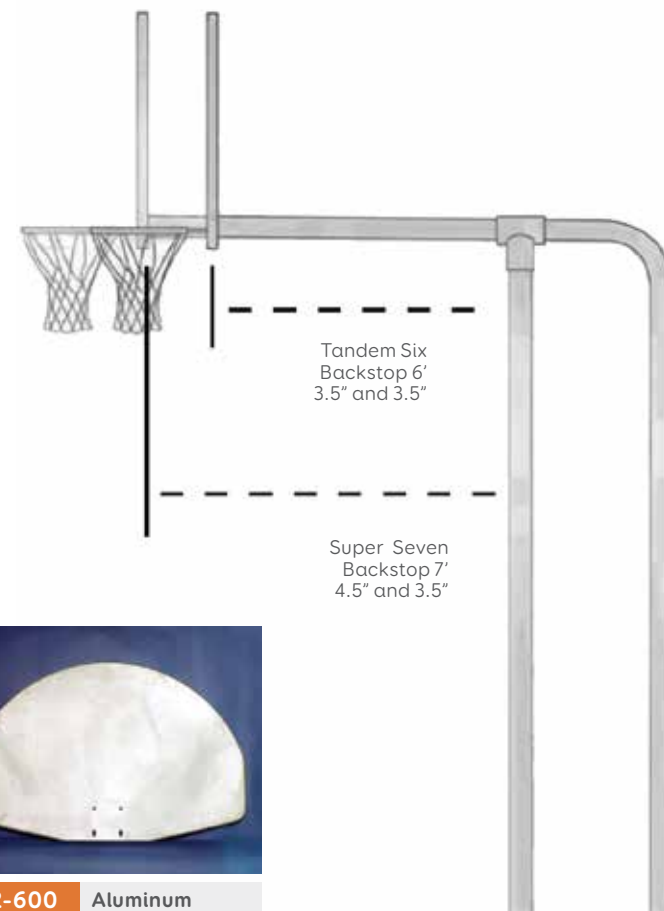

Adjustable Backstop

## 3.5" ADJUSTABLE BACKSTOP

	Description:	Weight:
541-656	Aluminum Fan	145 lbs.

The 3' long extension locks to the pipe anywhere between 0' and 10' with 2 set screws. Complete with pole, adjustable extensions, backboard and 542-917 Official Goal and Nylon Net.

## 4.5" ADJUSTABLE BACKSTOP

	Description:	Weight:
541-657	Aluminum Fan	215 lbs.

Reinforced 4' adjustable extensions mounted on a 13' 6" long, steel post. Complete with white Lifetime Aluminum Fan Backboard and 542-917 Official Goal and Nylon Net.



Reinforced Bent Post Backstop

## REINFORCED BENT POST BACKSTOP

3.5" OD reinforced with 2-3/8" OD

	Description:	Weight:
541-624	Aluminum Fan	153 lbs.
541-924	Acrylic Rectangle	199 lbs.

An extra rigid backstop with 3' extension. Complete with backboard, Official Goal and Nylon Net.



Double Basketball Backstop

## DOUBLE BASKETBALL BACKSTOP

	Description:	Weight:
541-864	Aluminum Fan 4' ext.	290 lbs.
541-866	Aluminum Fan 6' ext.	315 lbs.

Space saver for center court use. Complete with white Lifetime Aluminum Fan Backboards and 542-917 Official Goals and Nylon Nets.

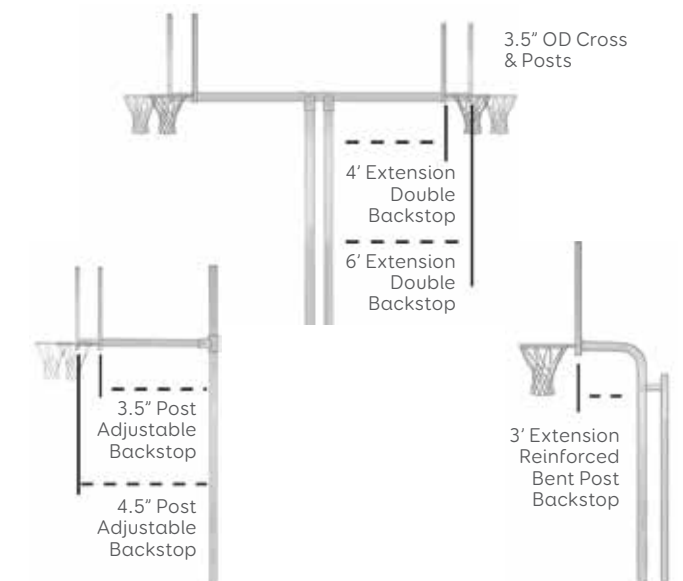



# ADJUSTABLE BASKETBALL SYSTEMS

- 38" x 60" Acrylic Backboard 3/8" thick
- Break away rim
- Adjustable from 7'6" to 10'



Adjustable Basketball Set (Pad not included. Shown with official goal.)



Funball



## COMPLETE BENT POST BACKSTOPS

Heavy Duty 4.5" OD Post

**541-916 (Acrylic Rectangle)**  
**Weight: 461 lbs.**

Complete with post, backboard and super goal chain net. Powder coated posts additional charge. Color options shown on page 60.



## WALL MOUNT SET

**532-659 (Wall mount set—4' extension)**  
**Weight: 340 lbs.**

Adjusts from 7'-10'

## ADJUSTABLE BASKETBALL SET

**532-933 (Surface mount set)**  
**Weight: 450 lbs.**

Pad not included

## FUNBALL

**902-501**  
**Ages: 5-12 years**  
**Weight: 98 lbs.**

3-1/2" OD post; 30" OD rotomolded polyethylene shell; 10.5" opening for balls; 10' H; ADA version-adjustable height.

## ACCESSIBLE FUNBALL

**902-501H**  
**Ages: 5-12 years**  
**Weight: 85 lbs.**

3-1/2" OD post; 30" OD rotomolded polyethylene shell; 10.5" opening for balls; 10' H; ADA version-adjustable height.

# BASKETBALL SYSTEM COMPONENTS

**A ALUMINUM FAN**  
 Ships UPS  
**542-600 38 lbs.**

**B POLYETHYLENE FAN**  
**542-500 60 lbs.**

**C STEEL RECTANGLE BACKBOARD**  
 54.5" W x 35.5" H  
**542-800 (Mini) 97 lbs.**  
 72" W x 48" H  
**542-900 (Full Size) 153 lbs.**

**D ACRYLIC RECTANGLE**  
 60" W x 38" H  
**542-200 93 lbs.**

**E BREAKAWAY GOAL**  
 Heavy Duty Double Rim;  
 Ships UPS  
**542-976 29 lbs.**

**F REPLACEMENT NETS**  
 Ships UPS  
**542-902 (Nylon) 2.7 oz.**  
**542-903 (Steel Chain) 1.5 lbs.**

**G PAINTED TARGET AND BORDER ONLY**  
 Aluminum and steel boards  
**541-998**

**H BACKBOARD BRACE**  
 Package with 3.5" post;  
 Ships UPS  
**542-558 15 lbs.**

Package with 4.5" post;  
 Ships UPS  
**542-668 15 lbs.**

**I ADJUSTABLE MOUNTING BOARD**  
 3.5" post; Ships UPS  
**542-353 30 lbs.**  
 4.5" post; Ships UPS  
**542-654 50 lbs.**

### Items Not Shown

**ALUMINUM FAN WITH GOAL AND NET**  
 Ships with Official Goal and Nylon Net 542-917.  
**542-617 60 lbs.**

**ACRYLIC RECTANGLE WITH GOAL AND NET**  
 Ships with Official Goal and Nylon Net 542-917.  
**542-200G 106 lbs.**

**PAINTED TARGET ONLY**  
 Aluminum boards  
**541-999**

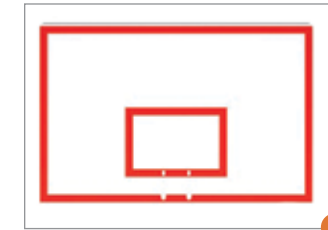
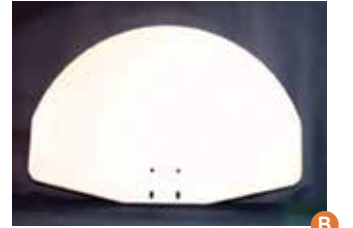



## GAME STANDARDS AND TENNIS



Height-adjustable from 8' to 10'

Rollers for easy moving

Portable Adjustable Basketball Game Standard.

### OFFICIAL TENNIS POST

<b>571-106</b> Galvanized
<b>571-106-C</b> Green Powder Coat
<b>Weight:</b> 82 lbs./pair

3.5" OD. Net reel and net fittings included; meets USLTA standards; Ships UPS.

### TENNIS NET

<b>572-922</b>
<b>Weight:</b> 12 lbs.

3 mm double braid polyethylene netting 42' long; First 5 rows double netting; 2.5" double reinforced headband; 8 rows nylon stitching; 6 mm vinyl coated steel cable. Tape nylon bottom and dowels; Ships UPS.

### NET REEL

<b>572-917</b>
<b>Weight:</b> 6 lbs.

Ships UPS.



### PORTABLE ADJUSTABLE BASKETBALL GAME STANDARD

<b>532-661</b> Aluminum Fan
<b>Weight:</b> 359 lbs.

30" x 30" base; floor protectors; wheels; adjustable net eyes; 2' extension adjusts from 8' to 10'; includes backboard, official goal and net. Must be anchored to floor using 531-350 wood floor plate or 351-352 concrete floor anchor.

### HEAVY DUTY OUTDOOR VOLLEYBALL NET

<b>572-954</b>
<b>Weight:</b> 10 lbs.

4" mesh 24 thread knotted nylon webbed edges, double treated with black vinyl and reinforcing white vinyl; volleyball net measures 32' x 3'; Ships UPS.

### GROUND SOCKET

	Post OD:	Length:	Weight:
<b>571-202</b>	2-3/8"	2'6"	15 lbs.
<b>571-203</b>	2-7/8"	2'6"	18 lbs.
<b>571-204</b>	3-1/2"	2'6"	21 lbs.
<b>571-205</b>	4-1/2"	4'	33 lbs.

Solid support; quick removal for all game standards. Supplied with neoprene seal safety cap, wrench and limit pin, creating a 6" debris trap; Ships UPS. Sold individually.

### MULTI-PURPOSE GAME STANDARD

<b>571-108</b> Fixed
<b>Weight:</b> 55 lbs./pair
<b>571-109</b> Adjustable
<b>Weight:</b> 55 lbs./pair

2-3/8" OD Adjustable net eyes. 10'6" long for use with Ground Sockets.



Fixed

Adjustable

### STANDARD PORTABLE GAME STANDARD

<b>532-330</b>
<b>Dimensions:</b> 24" x 24" x 9"
<b>Weight:</b> 300 lbs./pair

150 lbs. concrete filled base; 8'6" post made of 1-7/8" OD galvanized steel; 2 adjustable double net eyes allow you to change net height with ease.

### HEAVY DUTY PORTABLE GAME STANDARD

<b>532-340</b>
<b>Dimensions:</b> 24" x 24" x 9"
<b>Weight:</b> 600 lbs./pair

300 lbs. concrete filled based; 2-3/8" OD galvanized steel game post adjustable to 10'; 2 adjustable double net eyes allow you to change net height with ease.



### TETHER BALL

<b>572-100</b>
<b>Weight:</b> 2 lbs.

Official 5 ply rubber covered ball; with white nylon cord; Tether Ball color subject to change; Ships UPS.

### TETHER BALL POST

<b>571-110</b>
<b>Weight:</b> 40 lbs.

10' tall; Tether Ball sold separately; not to be used with portable game standard; 24' diameter use zone; 2-3/8" OD.

### TWO PIECE TETHER BALL POST

<b>571-1102</b>
<b>Weight:</b> 40 lbs.

2-3/8" OD; Ships UPS.

## FOOTBALL

### SINGLE POST PITCH FORK FOOTBALL GOAL

<b>561-445</b>
<b>Dimensions:</b> 10' Uprights
<b>Weight:</b> 660 lbs./pair

<b>561-445M</b>
<b>Dimensions:</b> 20' Uprights
<b>Weight:</b> 700 lbs./pair

<b>561-445P</b> (Powder Coated)
<b>Dimensions:</b> 10' Uprights
<b>Weight:</b> 760 lbs./pair

<b>561-445MP</b> (Powder Coated)
<b>Dimensions:</b> 20' Uprights
<b>Weight:</b> 800 lbs./pair

Specify 23'4" or 18'6" Cross bar; single bent 4-1/2" OD galvanized steel support with 5' extension; 3-1/2" OD galvanized steel crossbar; 1-7/8" OD galvanized steel uprights; uprights extend 10' or 20' above crossbar, depending on model.

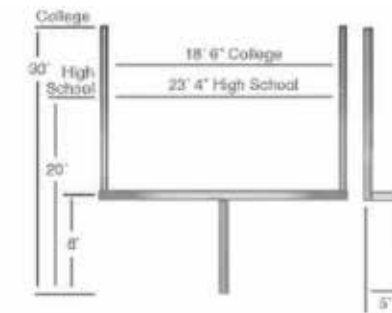

Single Post Pitch Fork Football Goal

### FOOTBALL GOAL

<b>561-443</b> (Heavy Duty)
<b>Weight:</b> 600 lbs./pair

3.5" OD galvanized steel support posts and crossbar; 1-7/8" OD galvanized steel uprights; specify 23'4" or 18'6" crossbar.

<b>561-442</b> (Standard)
<b>Weight:</b> 500 lbs./pair

2-3/8" OD galvanized steel support posts and crossbar; 2-3/8" OD galvanized steel uprights; specify 23'4" or 18'6" crossbar.

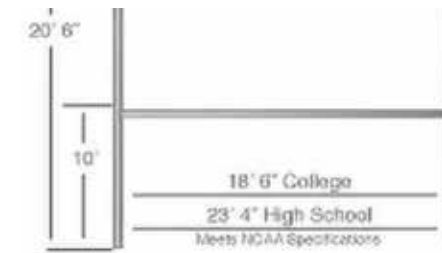

Single Post Pitch Fork Football Goal

### COMBO FOOTBALL SOCCER GOAL

<b>561-451</b> (Goal and Supports)
<b>Weight:</b> 760 lbs./pair

<b>561-449</b> (Goal Only)
<b>Weight:</b> 650 lbs./pair

<b>561-450</b> (Net Supports Only)
<b>Weight:</b> 100 lbs./pair

Specify 23'4" or 18'6" Cross bar; 2 7/8"; OD main frame; bottom opening is 8' x 24'; 2-3/8" OD uprights; 1-7/8" OD crossbars; 1-7/8" OD Net Supports; Net attachments are welded to lower frame; soccer net not included.

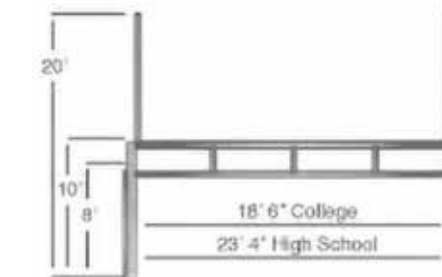

Combo Football Soccer Goal



# BASEBALL

## SportsPlay Baseball Backstops

- Prefabricated sports panels cut installation costs in half
- Panels can be replaced or rescreened individually
- Easy to install
- 2-3/8" OD pipe frames
- Replaceable in the event of vandalism

## PORTABLE BASEBALL BACKSTOP

<b>552-410</b>	
Weight:	640 lbs.
<b>552-411 (With Hood)</b>	
Weight:	725 lbs.

Use with 552-151 transporter listed below.

## BACKSTOP TRANSPORTER

<b>552-151</b>	
Weight:	70 lbs.

Easily transports SportsPlay portable backstop.

## PROTECTIVE SCREENS

<b>551-105</b>	
Weight:	180 lbs.

Protective dugouts; includes two sports panels and three 2-3/8" OD support posts. 20' x 5'3".

## SPORTS PANELS

<b>552-351 (11 Gauge Wire)</b>	
Weight:	64 lbs.
<b>552-355 (9 Gauge Wire)</b>	
Weight:	74 lbs.

Pre-assembled 5'3" x 9'7" panel; 1" OD frame with center reinforced brace; 11 gauge or 9 gauge wire fastened with 3/8" aluminum rods stainless steel clamps.



Portable Baseball Backstop



551-528

## FOUL POLES

<b>551-527 (10' Without Wing)</b>	
Weight:	200 lbs./pair
<b>551-526 (20' Without Wing)</b>	
Weight:	350 lbs./pair
<b>551-528 (20' With Wing)</b>	
Weight:	580 lbs./pair

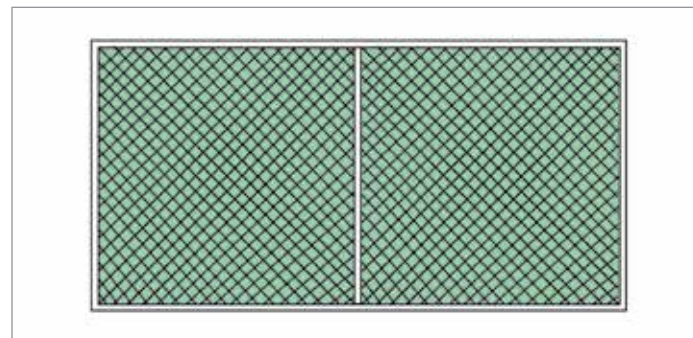

Sports Panels



Protective Screens

## BASEBALL BACKSTOP PREFABRICATED PANELS

	Center Panels:	Weight	5' Hood:	45" Wings:
<b>551-110</b>	10' W x 10'7" H	195	N/A	N/A
<b>551-410</b>	10' W x 10'7" H	480	N/A	2 (10')
<b>551-411</b>	10' W x 10'7" H	640	1	2 (10')
<b>551-420</b>	20' W x 10'7" H	650	N/A	2 (10')
<b>551-421</b>	20' W x 10'7" H	840	1	2 (10')
<b>551-510</b>	10' W x 15' 11" H	730	N/A	2 (10')
<b>551-511</b>	10' W x 15' 11" H	850	1	2 (10')
<b>551-210</b>	10' W x 10' 7" H	325	N/A	2 (5'3")
Additional backstop sizes not shown				
<b>551-520</b>	20' W x 15' 11" H	940	N/A	2 (10')
<b>551-521</b>	20' W x 15' 11" H	1,140	1	2 (10')
Extra Heavy Duty 9 gauge wire				
<b>551-522</b>	20' W x 15' 11" H	1,200	1	2 (10')



All Backstops products available with black vinyl coating. Call for pricing.



551-110



551-410

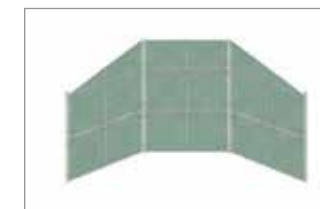

551-411

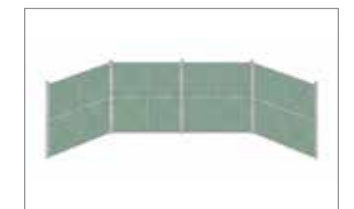

551-420

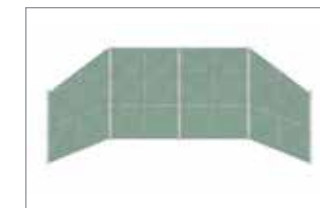

551-421

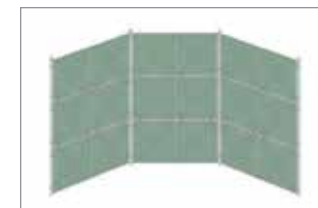

551-510



551-511



551-210



551-411



551-521



# SOCCER

Our soccer goal features a white powder coated finish and is manufactured to meet the requirements of today's competitive soccer specifications.

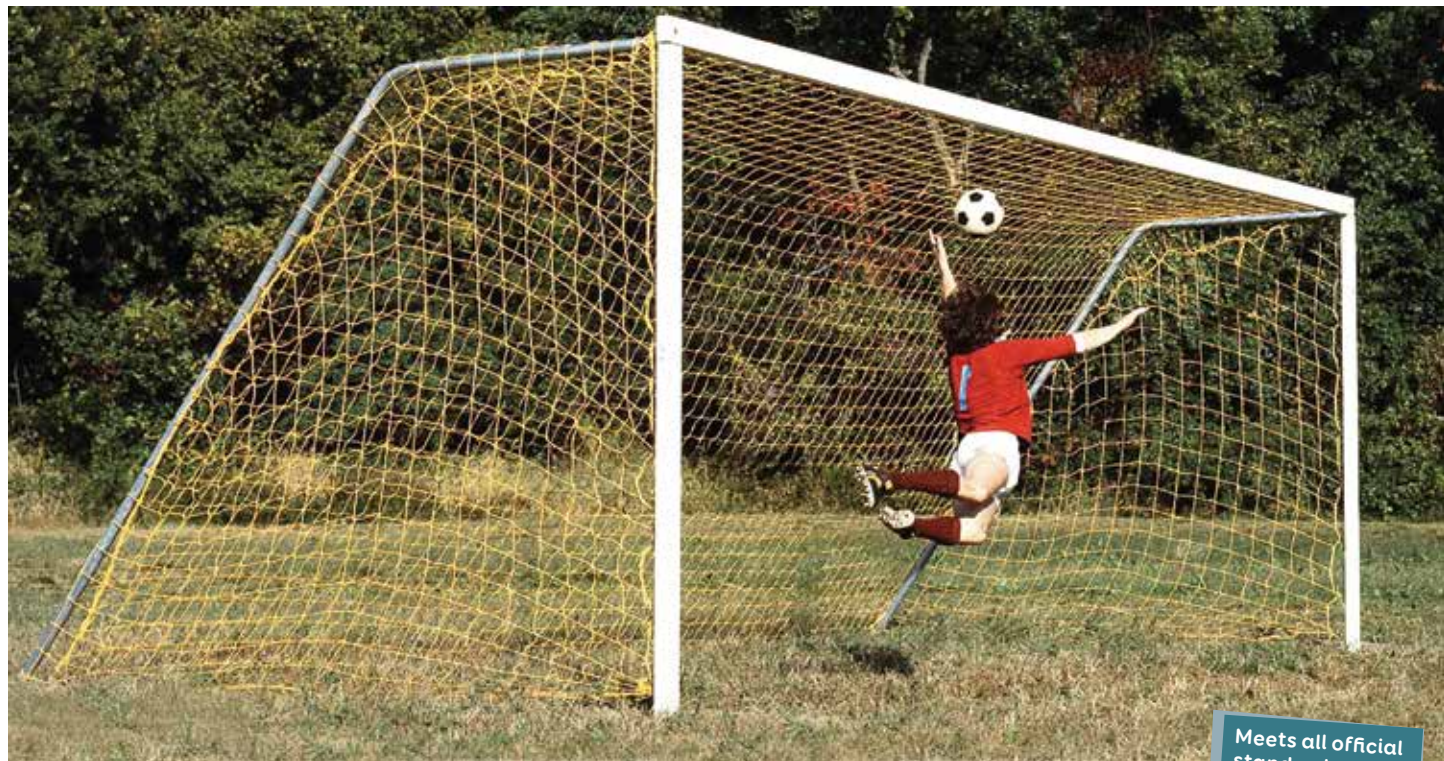

Official Steel Soccer Goal

Meets all official standards



Portable Steel Soccer Goal

## PORTABLE STEEL SOCCER GOAL

**562-501**  
Weight: 600 lbs./pair

2" x 4" welded steel main frame, powder coated white; net attachments are welded to the rear of goal at 12" intervals; 1-7/8" OD rear supports; hardware and four anchors for positioning goal are included; nets not included.

## SOCCER NET

**562-930 (Pair)**  
Dimensions: 24' W x 8' H x 10' D  
Weight: 16 lbs./pair

Orange 5" square mesh, 3 mm polyethylene; Ships UPS.

## OFFICIAL STEEL SOCCER GOAL

**561-501**  
Weight: 530 lbs./pair

2" x 4" welded steel main frame, powder coated white; Net attachments are welded to the rear of goal at 12" intervals; 1-7/8" OD rear supports; nets not included.

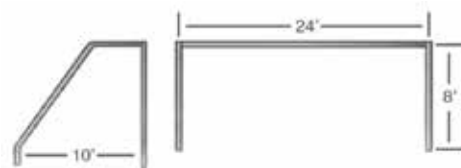

## 12' JR SOCCER GOAL

**561-505**  
Weight: 280 lbs./pair

2-3/8" OD galvanized steel pipe; can be used with ground sockets to make portable units; nets not included.

## NET FOR 12' JR SOCCER GOAL

**562-931**  
Weight: 15 lbs./pair

Nylon vinyl with taped edges, weather resistant; Ships UPS.

## 24' JR SOCCER GOAL

**561-505-24**  
Weight: 330 lbs./pair

Can be used with ground sockets to make portable units; nets not included.

## NET FOR 24' JR SOCCER GOAL

**562-930**  
Weight: 16 lbs./pair

Nylon vinyl with taped edges, weather resistant; Ships UPS.

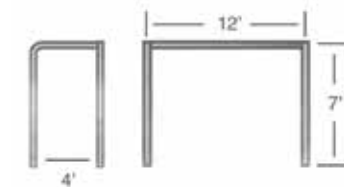
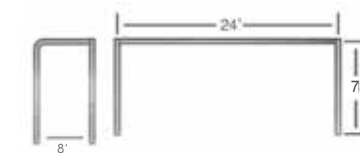

Jr Soccer Goal

# LACROSSE



Lacrosse Goal and Net—Side View



Lacrosse Goal and Net—Front View

## LACROSSE GOAL AND NET

**561-605 (Permanent)**  
**562-605 (Portable)**  
Dimensions: 6' W x 6' H x 7' D  
Regulation size  
Weight: 85 lbs.

## REPLACEMENT NETS

**562-934**  
Weight: 15 lbs.

3 mm. Braided nylon.



# SITE AMENITIES

## Coating color options



Blue Green Black Brown Red Tan

## Frame Color Options



Silver Black



Easy to install with rivet nuts

## STANDARD RECTANGULAR PICNIC TABLE

		Length:	Weight:
2-3/8" Walk Through Frame	Beveled Edge Perforated Steel		
	602-605	6'	280 lbs.
	602-606	8'	287 lbs.
	602-637	10'	400 lbs.
1-5/8" Walk Through Frame	Beveled Edge Perforated Steel		
	602-611	6'	240 lbs.
	602-612	8'	291 lbs.

Specify coating and frame color; Specify portable (P) surface mount (S) or in-ground (I) when ordering.



# PICNIC TABLES

## STANDARD RECTANGULAR PICNIC TABLE

		Length:	Weight:
2-3/8" Bolt Through Frame	Beveled Edge Perforated Steel		
	602-633	6'	250 lbs.
	602-634	8'	343 lbs.
1-5/8" Bolt Through Frame	Beveled Edge Perforated Steel		
	602-629	6'	250 lbs.
	602-630	8'	290 lbs.

Specify coating and frame color; Specify portable (P) surface mount (S) or in-ground (I) when ordering.



## DOUBLE CANTILEVER PICNIC TABLE WITH 4" SQUARE TUBING

		Length:	Weight:
Beveled Edge Perforated Steel			
601-649	6'	370 lbs.	
601-650	8'	400 lbs.	

Specify coating and frame color; Specify portable (P) surface mount (S) or in-ground (I) when ordering.



## CANTILEVER PICNIC TABLE WITH 4" SQUARE TUBING

		Length:	Weight:
Beveled Edge Perforated Steel			
601-744	46" square	341 lbs.	

30" H x 78" W; 20" to seat; Specify coating and frame color; Specify in-ground (I) or surface mount (S) when ordering.





### STRAIGHT PICNIC TABLE WITH 4" SQUARE TUBING

	Length:	Weight:
	Beveled Edge Perforated Steel	
601-657	6'	374 lbs.
601-658	8'	380 lbs.

Specify coating and frame color, Specify in-ground (I) or surface mount (S) when ordering.



### SQUARE PICNIC TABLE WITH 1-5/8" FRAME

	Length:	Weight:
	Beveled Edge Perforated Steel	
602-647	46" square	220 lbs.

Specify coating and frame color; Specify portable (P) surface mount (S) or in-ground (I) when ordering.

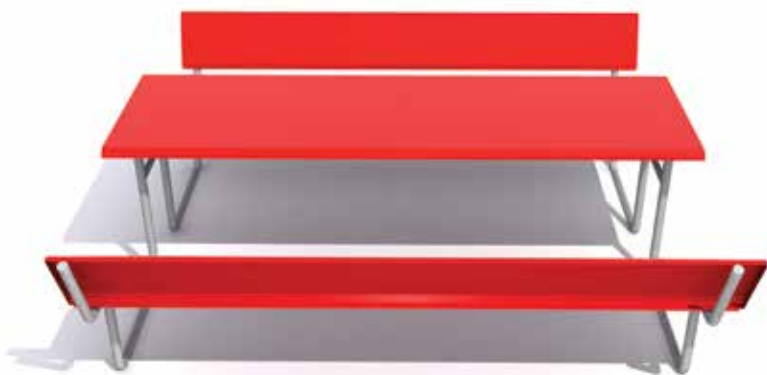

### RECTANGULAR PICNIC TABLE WITH BACK 2-3/8" WALKTHROUGH FRAME

	Length:	Weight:
	Perforated Steel	
602-754	6'	416 lbs.
602-752	8'	463 lbs.

Specify coating and frame color; Specify surface mount (S), in-ground (I) or portable (P).



### EARLY YEARS RECTANGULAR PICNIC TABLE

	Length:	Weight:
	Beveled Edge Perforated Steel	
602-703	4'	202 lbs.
602-704	6'	254 lbs.
602-705	8'	312 lbs.

Support legs are 1-5/8" powder coated galvanized steel tubing. 20" high, 12" high seats; Specify coating and frame color; Specify portable (P) surface mount (S) or in-ground (I) when ordering.



### EARLY YEARS BENCH WITH BACK

Rolled Edge Perforated Steel	
602-707	
Dimensions:	3' L
Weight:	90 lbs.

Support legs are 1-5/8" powder coated galvanized steel tubing; Specify coating and frame color; Specify surface mount (S), in-ground (I) or portable (P) when ordering.



### OUTDOOR TABLE AND CHAIRS

902-830 (Permanent)	
Ages:	2-5 years
Dimensions:	58" L x 25" W x 26" H
Weight:	36 lbs.

Table and chairs are durable polyethylene. Table top available in Red or Blue only. Chairs available in Yellow, Red, Blue, Green, Tan, White, or Black.



### EARLY YEARS SQUARE PICNIC TABLE

Beveled Edge Perforated Steel	
602-698	
Dimensions:	46" square
Weight:	275 lbs.

Support legs are 1-5/8" powder coated galvanized steel tubing. 20" high, 12" high seats; Specify coating and frame color; Specify portable (P) surface mount (S) or in-ground (I) when ordering.





## WHEELCHAIR ACCESSIBLE PICNIC TABLES



### WHEELCHAIR ACCESSIBLE PICNIC TABLE WITH CENTER ENTRY

Heavy Duty 2-3/8" OD pipe frames

Perforated Steel	
<b>602-756</b>	
Weight:	520 lbs.
Dimensions:	Table 8' L, Seats 30" L

Specify coating and frame color; Specify surface mount (S), in-ground (I) or portable (P) when ordering.



### WHEELCHAIR CANTILEVER PICNIC TABLE WITH 4" SQUARE TUBING

Beveled Edge Perforated Steel	
<b>602-748</b>	
Weight:	220 lbs.
Dimensions:	46" square

Specify coating and frame color; Specify surface mount (S), in-ground (I) when ordering.



### WHEELCHAIR ACCESSIBLE SQUARE PICNIC TABLE WALK THROUGH FRAME

Beveled Edge Perforated Steel	
<b>602-672</b>	
Weight:	285 lbs.
Dimensions:	46" x 55"

Specify coating and frame color; Specify surface mount (S), in-ground (I) or portable (P) when ordering.



### WHEELCHAIR ACCESSIBLE RECTANGULAR PICNIC TABLE WALK THROUGH

	Length:	Weight:
2-3/8"	Beveled Edge Perforated Steel	
	<b>602-669</b>	8' 276 lbs.
1-5/8"	Beveled Edge Perforated Steel	
	<b>602-667</b>	8' 270 lbs.

Specify coating and frame color. Specify surface mount (S), in-ground (I) or portable (P) when ordering.





# BENCHES



## STANDARD BENCH WITH BACK

	Length:	Weight:
	Beveled Edge Perforated Steel	
601-677	6'	132 lbs.
601-678	8'	173 lbs.

Specify coating and frame color; Specify surface mount (S), in-ground (I) or portable (P) when ordering.



## STANDARD BENCH WITHOUT BACK

	Length:	Weight:
	Beveled Corner Perforated Steel	
601-685	6'	92 lbs.
601-686	8'	117 lbs.

20" H x 12" W; Support legs are 2-3/8" powder coated galvanized steel tubing. Specify coating and frame color; Specify surface mount (S), in-ground (I) when ordering.



## SINGLE BENCH WITH SHADE

	Length:	Weight:
	Beveled Edge Perforated Steel	
602-763	6'	384 lbs.
602-760	8'	500 lbs.



## DOUBLE BENCH WITH SHADE

	Length:	Weight:
	Beveled Edge Perforated Steel	
602-758	6'	560 lbs.
602-761	8'	660 lbs.



## TEAM BENCH WITHOUT BACK

	Length:	Weight:
	Beveled Edge Perforated Steel	
601-695	10'	110 lbs.
601-696	15'	150 lbs.

Seat supports are 2-3/8" powder coated galvanized steel tubing; Specify coating and frame color; Specify surface mount (S), in-ground (I) or wall mount when ordering.



## DOUBLE BENCH

	Length:	Weight:
	Beveled Edge Perforated Steel	
602-759	6'	350 lbs.
602-762	8'	440 lbs.

## CUSTOMIZE YOUR PICNIC TABLE OR BENCH WITH LOGO ARTWORK AND/OR LETTERING OF YOUR CHOICE!

Our new machinery can make custom logos or lettering on any of our benches or picnic tables. Shown here are just a couple of examples. Contact Customer Service to place your customization order.



### BENCH OR TABLE CUSTOMIZATION PROOF CHARGE

601-700

### BENCH OR TABLE CUSTOMIZATION CUT CHARGE (per plank)

601-701



### TRASH CAN

Perforated Steel

**601-708** (32 gal.)

Weight: 80 lbs.

**601-709** (55 gal.)

Weight: 114 lbs.

Thermoplastic coated. Available in Brown, Red, Tan, Black, Green and Blue. Specify in-ground (I), surface mount (S) or portable (P) when ordering. Both in-ground (I) and surface mount (S) require 601-725, Receptacle Mounting Post. Note: Shown with optional liner.

### FLAT TOP STEEL TRASH CAN LID

**601-721** (32 gal.)

Weight: 22 lbs.

**601-722** (55 gal.)

Weight: 35 lbs.

Available in Brown, Red, Tan, Black, Green and Blue.

### HEAVY DUTY PLASTIC DOME TRASH CAN LID

**601-715** (32 gal.)

Weight: 20 lbs.

**601-716** (55 gal.)

Weight: 30 lbs.

Liner is required for Dome Lid.

### HEAVY DUTY PLASTIC TRASH LINER

**601-723** (32 gal.)

Weight: 10 lbs.

**601-724** (55 gal.)

Weight: 15 lbs.

### RECEPTACLE MOUNTING POST

Weight: 10 lbs.

**601-725** (32 gal.)

**601-726** (55 gal.)

Specify in-ground (I) or surface mount (S) when ordering.



### FLAGPOLES

**801-112** (15' Flagpole)

Weight: 85 lbs.

**801-113** (20' Flagpole)

Weight: 115 lbs.

**801-114** (25' Flagpole)

Weight: 160 lbs.

**801-115** (30' Flagpole)

Weight: 200 lbs.

**801-116** (35' Flagpole)

Weight: 230 lbs.

**801-117** (40' Flagpole)

Weight: 265 lbs.

### BIKE RACKS



#### "N" BIKE RACK

Weight: 25 lbs.

**801-171**

**801-171S**

**801-171P** (Painted)



#### "M" BIKE RACK

Weight: 33 lbs.

**801-172**

**801-172S**

#### 3 LOOP BIKE RACK

Weight: 27 lbs.

**801-174**

**801-174S**

Ships UPS.

#### 2 LOOP BIKE RACK

Weight: 25 lbs.

**801-173**

**801-173S**

Ships UPS.



#### 7 LOOP BIKE RACK

Dimensions: 13'6" long

**801-169**

Weight: 132 lbs.

**801-169S**

Weight: 134 lbs.

#### 5 LOOP BIKE RACK

Dimensions: 9'6" long

**801-170**

Weight: 94 lbs.

**801-170S**

Weight: 96 lbs.



Bike racks shown above are available in a surface mount option. Please specify when ordering. "S" in model number designates surface mount.



#### SINGLE ENTRY BIKE RACK

	Length:	Capacity:	Weight:
Permanent			
<b>801-175</b>	5' long	5 bikes	50 lbs.
<b>801-176</b>	10' long	9 bikes	100 lbs.
<b>801-178</b>	20' long	18 bikes	150 lbs.
Portable			
<b>802-175</b>	5' long	5 bikes	65 lbs.
<b>802-176</b>	10' long	9 bikes	100 lbs.
<b>802-178</b>	20' long	18 bikes	150 lbs.

1-5/8" OD pipe; 2'8" W x 2'9" H; 801-175 and 802-175; Ships UPS.



#### DOUBLE ENTRY BIKE RACK

	Length:	Capacity:	Weight:
Permanent			
<b>801-185</b>	5' long	9 bikes	65 lbs.
<b>801-188</b>	10' long	18 bikes	110 lbs.
Portable			
<b>802-185</b>	5' long	9 bikes	65 lbs.
<b>802-188</b>	10' long	18 bikes	110 lbs.

1-5/8" OD pipe; 2'8" W x 2'9" H; 801-185 and 802-185; Ships UPS.

### BRONZE PLAQUES

**902-993**

Dimensions: 2" x 4"

Weight: 1 lbs.

**902-994**

Dimensions: 8" x 10"

Weight: 3 lbs.

1/4" solid bronze plaques with recessed text and graphics that are paint-filled. Comes with mounting fasteners. 2" x 4" plaque can be affixed to a new order of SportsPlay bench or table, upon request. Call Customer Service for more details.



902-994

902-993



## SHADE STRUCTURES

SportsPlay Shade Structures are low maintenance, overhead canopies that are an ideal, cost effective shade solution. The fabric is knitted, high density polyethylene, which is UV stabilized and lock stitched, which means it will not fade, mold or rot. If torn, the lock stitch will prevent the canopy from unraveling. While providing shade play areas, our canopies help block out up to 95% of UV rays.

- Guaranteed for at least eight years against UV degradation
- Extends the life of playground equipment
- Endorsed by the American Cancer Association
- Extremely durable
- Enhances the overall appearance of play areas

SportsPlay Shade Structure nets have tiny holes that allow hot air to escape through the roof of the structure. Even with these holes, the standard netting has a high "water run off rate" of up to 93% which tends to keep the area underneath the shade structure partially dry.



901-091



901-092



901-093

## STAND ALONE SHADE STRUCTURES

	Dimensions:	Weight:
901-091	12' x 20'	442 lbs.
901-092	18' x 20'	490 lbs.
901-093	20' x 24'	573 lbs.

Available in Red, Blue, Green or Yellow.

### FOR ALL SHADES:

Specify R (Red), B (Blue), G (Green), or Y (Yellow) after product # when ordering.

## TERMS AND CONDITIONS

**MINIMUM ORDER:** All orders must exceed \$30.00 net in merchandise. Orders for less than \$30.00 will be subject to a \$10.00 handling charge.

**PRICES:** Prices exclude shipping & handling. Prices are subject to change without notice.

**RECEIPT OF SHIPMENT/CUSTOMER RESPONSIBILITY:** Before signing for your order, check to see that you are receiving the same number of cartons, bundles, welded frames, etc., indicated on your receipt. It is imperative that you check your shipment against your order and against the parts list(s) provided within assembly instruction(s) to ensure that all items, product components, and individual parts are included. You will have 10 days to report anything missing from your order—after that, if you have not notified SportsPlay, "missing" materials will need to be purchased. Note any visible damage on your receipt and have the driver note this also. Damage that is found after you unpack the shipment (concealed damage) must be reported to SportsPlay Customer Service immediately. Please closely inspect your shipment! Most freight companies allow 10 days from receipt to report concealed damage or missing components. NOTE: If you discover damage of any kind, DO NOT DESTROY ANY ORIGINAL SHIPPING CARTONS. All SportsPlay merchandise is shipped unassembled unless otherwise specified in the catalog.

**TAXES:** Taxes may be added to an invoice unless a satisfactory resale certificate or tax exempt certificate is provided.

**TERMS:** All invoices are due and payable 30 days from the invoice date. We do not ship COD.

**FREIGHT CLAIMS:** Customers, upon delivery, are expected to check products against packing list and sign the order short otherwise claims will not be honored. SportsPlay will not honor freight claims on concealed damage 14 days past delivery date.

**RETURNS AND EXCHANGES:** Returns will not be accepted without prior written authorization from SportsPlay. Restocking charges and all freight charges may apply. Absolutely no returns will be authorized on equipment which has been installed or equipment which has been in storage for more than 90 days. Returns on any items in an unusable condition subject to a 50% cancellation fee.

**CANCELLATION OF ORDERS:** Orders cancelled with SportsPlay after any customer work has been done or after they have been loaded on the trailer are subject to a 10% cancellation fee. Cancellation of any custom orders subject to a 50% cancellation fee.

**INSTALLATION:** All products delivered knocked down (not assembled) unless otherwise noted. Detailed assembly instructions and a packing list are included in the hardware bag(s) of your shipment and should be carefully checked against the order immediately.

**CATALOG ERRORS & PRODUCT CHANGES:** Due to the possibility of typographical errors in this catalog, as well as fluctuations in raw material costs, prices and descriptions are subject to change without notice. SportsPlay reserves the right to change product specifications or colors at any time without incurring obligations. Pictures may not reflect changes made to meet new CPSC guidelines.

**SHIPPING & HANDLING CHARGES:** All shipments are F.O.B. origin, and shipping and handling is not included in the price. Freight charges include normal tail gate delivery within the continental United States. (Additional charges will be added for shipments out of the continental U.S.) "Inside Delivery" requests must be specified on the order. There are additional charges for "Inside Delivery," "Residential" and "Call Before Delivery." Please call for an estimate on these charges.

### Did you know?

Legislation is now being considered in many states in the USA making it compulsory to provide shade for children's outdoor play areas.

## TERMS AND CONDITIONS (CONT.)

***Lifetime\* Warranty is offered on the following:***

Aluminum Domes • Aluminum Rings • Spring Rider Aluminum Ponies • Cast Aluminum Backboards

Metal Modular Units/Components:

**Limited Lifetime\* Warranty:** Steel Support posts • Aluminum clamps

**Limited 15-year Warranty:** Main support materials • Decks

**Limited 10-year Warranty:** Plastic components

**Limited 3-year Warranty:** Fun Center polyethylene and plastic components

**Limited 1-year Warranty:** All products not listed above.

\*Lifetime warranty pertains to the life of the equipment. The LIFETIME warranty for Aluminum Fan Backboards only applies to aluminum fan backboards in which the goal is mounted directly to the post as recommended by the manufacturer and installed per manufacturers instructions. The warranty will be voided for all backboards not installed per these requirements. Use of any other attachment method will void all warranties written, expressed or implied. If any of these products are damaged under normal use conditions, return the broken parts to SportsPlay Equipment, Inc. at their Park Hills, Missouri plant. SportsPlay will send you a brand-new replacement part. You pay only the return and outbound freight. Repair/Replacement orders for warranted products will be for the component part only. (Not the entire product.) Contact your SportsPlay distributor for a return authorization.

Warranties apply to structural failure caused by defective materials or defective workmanship, and with normal use and proper maintenance and installation. Damages from misuse, vandalism, lack of maintenance, improper installation, unauthorized repairs or modifications, acts of God or acts beyond SportsPlay's control, or cosmetic issues such as scratches, dents or fading of colors, are not covered by the warranty, nor does the warranty cover the cost of freight or labor for removal and installation of repaired or replacement parts. Warranties are limited to repair or replacement of defective parts. A repaired or replacement part is covered only for the original warranty period. All warranties begin on the delivery date of the goods. Warranties are non-transferable and only apply to end users who purchase new products directly from SportsPlay or an authorized SportsPlay distributor for personal or business use and not for purpose of re-distribution or re-sale.

**NO OTHER WARRANTIES APPLY. SPORTSPRAY EXPRESSLY DISCLAIMS ALL OTHER WARRANTIES, WHETHER EXPRESS OR IMPLIED, INCLUDING BUT NOT LIMITED TO ANY WARRANTY OF MERCHANTABILITY OR FITNESS FOR A PARTICULAR PURPOSE. THE ABOVE WARRANTIES EXCLUDE ANY LIABILITY OTHER THAN AS EXPRESSLY STATED INCLUDING, BUT NOT LIMITED TO, ANY INDIRECT, SPECIAL, INCIDENTAL, CONSEQUENTIAL OR PUNITIVE DAMAGES.**

500 Newton / Park Hills, MO 63601 / (800) 727-8180 Fax: (314) 389-9034



**YOUR SPORTSPLAY DISTRIBUTOR:**

Call: 1-800-727-8180 for a distributor near you.

Visit SportsPlay on the web at [www.sportsplayinc.com](http://www.sportsplayinc.com)

