

Jet Bot Combo

User manual

VR7MD97714* / VR7MD96514* Series

- Before operating this unit, please read the instructions carefully.
- For indoor use only

Wi-Fi MODEL

Connecting SmartThings

1. Launch the QR Code Reader app to scan the QR image attached to the product.
2. When the SmartThings app is running, tap '**Add**' to connect the SmartThings app to the product.

Registering the product / Reading the manual / Customer support

1. Launch the QR Code Reader app to scan the QR image attached to the product.
2. When the SmartThings app is running, press '**Product support**'.
3. Select '**Product registration**', '**Manual**' or '**Customer support**'.

* Product registration may not be available in all countries.

NON Wi-Fi MODEL

Registering the product / Reading the manual / Customer support

1. Launch the QR Code Reader app to scan the QR image attached to the product.
2. Select '**Product registration**', '**Manual**' or '**Customer support**'.

* Product registration may not be available in all countries.



SAMSUNG

Contents

Safety information	3
Preparation	12
Product overview	12
Installation	15
Installing	15
Operation	18
Preparing Clean Water Tank	18
Charging the Jet Bot Combo	19
Using the Jet Bot Combo	22
SmartThings App	25
Before using SmartThings	25
Using the SmartThings App	27
Maintenance	30
Cleaning and maintaining the Clean Station	30
Descaling the Steamer	38
Maintaining and cleaning the Jet Bot Combo	39
Cleaning and maintaining the Sensor Window	48
Troubleshooting	49
Voice Guidance Checklist	49
Corrective measures before reporting a problem	52
Appendix	56
Product Specification	56

Safety information

- Before operating the appliance, please read this manual thoroughly and retain it for your reference.
- Because the following operating instructions cover various models, the characteristics of your vacuum cleaner may differ slightly from those described in this manual.

Caution/Warning symbols used

WARNING

Indicates that a danger of death or serious injury exists.

CAUTION

Indicates that a risk of personal injury or material damage exists.

Other symbols used

NOTE

Indicates that the following text contains additional important information.

Failure to meet these requirements could cause damage to the internal parts of the vacuum and void your warranty.

Safety information

General

1. This appliance is not intended for use by persons (including children) with reduced physical, sensory or mental capabilities, or lack of experience and knowledge, unless they have been given supervision or instruction concerning use of the appliance by a person responsible for their safety.
2. Children should be supervised to ensure that they do not play with the appliance.
3. If the supply cord is damaged, it must be replaced by the manufacturer, its service agent or similarly qualified persons in order to avoid a hazard.
4. Do not use the vacuum cleaner on a wet rug or floor.
5. Do not pull or carry by the cord, use the cord as a handle, close the door on the cord, or pull the cord around sharp edges or corners. Keep the cord away from heated surfaces.
6. Do not unplug by pulling on the cord. To unplug, grasp the plug, not the cord.
7. Do not use a damaged power plug, a power cord or a loose power outlet.

State of California Proposition 65 Warning

WARNING

Cancer and Reproductive Harm - www.P65Warnings.ca.gov.



For battery recycling go to call2recycle.org
or call 1-800-822-8837

Regulatory Notice

1. FCC Notice

WARNING

- Any changes or modifications not expressly approved by the party responsible for compliance could void the user's authority to operate the equipment.
- This device complies with Part 15 of FCC Rules. Operation is Subject to following two conditions:
 1. This device may not cause harmful interference, and
 2. This device must accept any interference received including interference that cause undesired operation.
- For product available in the USA/Canada market, only channel 1 ~ 11 can be operated. Selection of other channels is not possible.

FCC STATEMENT:

- This equipment has been tested and found to comply within the limits for a Class B digital device, pursuant to part 15 of the FCC Rules. These limits are designed to provide reasonable protection against harmful interference in a residential installation.
- This equipment generates, uses, and can radiate radio frequency energy and, if not installed and used in accordance with the instructions, may cause harmful interference to radio communications. However, there is no guarantee that interference will not occur in a particular installation. If this equipment does cause harmful interference to radio or television reception, which can be determined by turning the equipment off and on, the user is encouraged to try to correct the interference by one or more of the following measures:
 - Reorient or relocate the receiving antenna
 - Increase the separation between the equipment and receiver
 - Connect the equipment into an outlet on a different circuit from that to which the receiver is connected
 - Consult the dealer or an experienced radio/TV technician for help.

FCC RADIATION EXPOSURE STATEMENT:

- This equipment complies with FCC radiation exposure limits set forth for an uncontrolled environment. This equipment should be installed and operated with a minimum distance of 20 cm between the radiator and your body. This device and its antenna(s) must not be co-located or operation in conjunction with any other antenna or transmitter.

2. IC Notice

- The term "IC" before the radio certification number only signifies that Industry Canada technical specifications were met. Operation is subject to the following two conditions: (1) this device may not cause interference, and (2) this device must accept any interference, including interference that may cause undesired operation of the device.
- This Class B digital apparatus complies with Canadian ICES-003.
- Cet appareil numérique de la classe B est conforme à la norme NMB-003 du Canada.
- For product available in the USA/Canada market, only channel 1 ~ 11 can be operated. Selection of other channels is not possible.

Safety information

IC RADIATION EXPOSURE STATEMENT:

- This equipment complies with IC RSS-102 radiation exposure limits set forth for an uncontrolled environment. This equipment should be installed and operated with minimum distance 20 cm between the radiator & your body. This device and its antenna(s) must not be co-located or operation in conjunction with any other antenna or transmitter.

Open Source License Notice

- This device uses open source software. Open Source Licenses are available on the product menu.
- Tap “Settings > Network > Software Update > Legal Information” on the device for more details.

Installation

WARNING

When installing the Clean Station, make sure the cord does not get damaged in any way.

- There is a risk of fire or electric shock.

CAUTION

When installing the Clean Station, do not leave the cord carelessly on the floor since the Jet Bot Combo may get caught by it.

Do not install the Clean Station in an area with a dark floor.

- If the floor around the Clean Station is dark, recharging is hindered.

Do not install the Clean Station on a rug or carpet where contamination may occur.

- If the Jet Bot Combo returns for charging with the Mops still wet, rug or carpet may be contaminated.

NOTE

Install the Clean Station in a place where the floor and wall are level.

If the cleaning area is wooden floors, it is best to install the Clean Station along the grain of wooden floors.

Always keep the Clean Station's power cord plugged.

- If power is not supplied to the Clean Station, the Jet Bot Combo cannot find it and cannot automatically recharge.
- If the Jet Bot Combo is left detached from the Clean Station, the battery will drain naturally.

Do not place the Clean Station in a place where people pass by frequently, in entrance way or narrow passage.

- People may trip over it and be injured, or product damage may occur.

Power

WARNING

Please prevent any risk of electric shock or fire.

- Do not damage the power cord.
- Do not pull the power cord too hard or touch the power plug with wet hands.
- Do not use a power source other than Rated voltage of charger and also do not use a multi-outlet to supply power to a number of devices at the same time. (Do not leave the cord carelessly on the floor.)
- Do not use damaged power plugs, power cords, or loose outlets.

Clean dust or any foreign matter on the pin and the contact part of the power plug.

- There is a risk of electric shock or malfunction.

Use a socket that is properly grounded for safety. Do not ground the appliance to a gas pipe, plastic water pipe, or telephone line.

- This may result in electric shock, fire, an explosion, or problems with the product.
- Never plug the power cord into a socket that is not grounded correctly and make sure that it is in accordance with local and national regulations.

Before use

WARNING

Do not use the Jet Bot Combo near a heater or combustible materials.

- Do not use the Jet Bot Combo near fire or flame such as a movable heater, a candlelight, a desk lamp, a fireplace, etc. or in a place where combustible materials such as gasoline, alcohol, thinner, etc. exist.

Make sure there are no dangerous objects around the Jet Bot Combo's cleaning area to prevent collision and unplug any electric heaters or fans.

The Jet Bot Combo is intended for household use therefore do not use it in an attic, basement, storage, an industrial building, out of indoor space, places with moisture (such as a bathroom, a laundry room), on the table or shelves.

- The Jet Bot Combo can be damaged or malfunction.

Be sure the Jet Bot Combo does not suck in or touch any kind of liquids (water, beverage, filth, etc.).

- The Jet Bot Combo can be severely damaged and it may contaminate other areas if the wheels pass through liquid.

Always keep the Cliff Sensor clean for your safety.

When the power cord is damaged, Contact Customer Service to get it replaced by a certified repairman.

- There is a risk of fire or electric shock.

CAUTION

Be sure the Dustbin is inserted before using the Jet Bot Combo.

To clean all areas of your house, open all rooms and follow these recommendations for proper automatic recharging.

- Always keep the Clean Station's power cord plugged.
- Install the Clean Station where the Jet Bot Combo can easily find.
- Do not leave any objects in front of the Clean Station.

Safety information

Do not use the Jet Bot Combo on black colored floors.

- The Jet Bot Combo may not be able to operate normally.

Do not place any objects within 0.5 m of either side of the Clean Station or within 1 m of the front of the Clean Station.

Make sure the Clean Station's charging contact is not damaged or have any foreign matter on it.

Move any obstacles that may disturb the Jet Bot Combo's movement (such as children's indoor swing or slides) before cleaning.

Do not use the Jet Bot Combo in a place which is narrower than its turning radius 0.5 m or less.

Before operating the Jet Bot Combo, remove the objects which could break such as glass, a frame, a mirror, and porcelain items so that the Jet Bot Combo works without interruption.

Use both hands to carry the product.

Do not push the Clean Station.

Using the Jet Bot Combo on a thick carpet may damage both the Jet Bot Combo and the carpet.

- The Jet Bot Combo cannot pass over a carpet with fiber longer than 2 cm.

If the carpet is not fixed on the floor, Jet Bot Combo may not be able to pass over it.

Do not use the Jet Bot Combo on tables or other high surfaces.

- There is a risk of damage if it falls.

The Jet Bot Combo may bump into chairs or desk legs, therefore move them away for faster and efficient cleaning.

When the Jet Bot Combo is operating, do not lift it up or carry it to another area.

Do not hold by Driving Wheels of the Jet Bot Combo when carrying it to another area.

Do not allow children to sit on the Jet Bot Combo and do not place an object on the Jet Bot Combo.

- It may cause malfunction of the LiDAR sensor and the Jet Bot Combo.

Remove any large papers or plastic bags immediately when using the Jet Bot Combo since they may block the intake.

Do not lie down around the Jet Bot Combo that is running.

- Your hair may be caught in the brush, resulting in physical injury.

Do not allow children to play with the Jet Bot Combo.

Make sure hair, fingers, towels do not get caught in the Spin Brush, brush or the wheels of the Jet Bot Combo.

Leave over 3 cm space from the inner doorstep placed in the entrance. The Jet Bot Combo may climb over it.

Prevent any damage to the Jet Bot Combo by complying with the following.

- Do not clean the Jet Bot Combo by spraying water directly onto it or use a volatile substance such as benzene, thinner, or alcohol to clean it.

Do not disassemble or repair the Jet Bot Combo. This should only be done by a certified repairman.

Do not store the Jet Bot Combo in a car.

Be careful that the LiDAR sensor is not exposed to a direct light such as sun light, infrared light, etc.

- The direct light can affect the performance of the LiDAR sensor.

When carrying the Jet Bot Combo, be careful not to let it drop.

- The impact from the drop can affect the operation or performance of the LiDAR sensor.

Remove objects that are 1 cm or less in height and light in weight before cleaning, as they can be caught and get dragged around or be caught in the Jet Bot Combo's brush or Driving Wheels while it is operating. (Only compliant to model VR7MD97714*)

Remove objects that are 9 cm or less in height and light in weight before cleaning, as they can be caught and get dragged around or be caught in the Jet Bot Combo's brush or Driving Wheels while it is operating. (Fixed objects are detected by pressure on the bumper and avoided.) (Only compliant to model VR7MD96514*)

- However, obstacles in the front center that are more than 5 cm in height and less than 4 cm in width are detected.

Entry under furniture lower than approximately 14 cm in height may be blocked as it may be detected as an obstacle.

If oil such as cooking oil is on the floor, the Jet Bot Combo may become stationary because the floor is slippery. Remove the oil first before cleaning with the Jet Bot Combo.

Watch your hands while placing the Waste Water Tank and Clean Water Tank, since they may get stuck in the Clean Station.

Do not drink the water from both Waste Water Tank and Clean Water Tank.

Be careful of the steam or high temperature water while Mops are being cleaned.

NOTE

The Jet Bot Combo may get caught on thresholds of entrance door or veranda, etc. during cleaning.

- Move the Jet Bot Combo to an area where it can move easily, and then restart the cleaning.

In a dark area, the Jet Bot Combo may not recognize an object.

- Before cleaning, remove obstacles on the floor.

The Jet Bot Combo cannot completely clean areas which it cannot enter, such as small space between the corner, between the sofas or walls, etc.

- Please use another cleaning tool to clean.

The Jet Bot Combo cannot vacuum clumps of dust, so some may remain on the floor after cleaning.

- Please use another cleaning tool to clean.

During periods where temperature and humidity are high, it is recommended to replace the Dust Bag every 1 ~ 2 months. If the Clean Station smells, replace the Dust Bag immediately no matter the fullness of the Dust Bag.

If there is a larva in the suctioned dust, it can multiply in the Dust Bag. Clean the Clean Station with a wet tissue and replace the Dust Bag.

When detaching the Waste Water Tank and Clean Water Tank, a small amount of remaining water may fall out. If water droplets fall, wipe it off before use.

If you want to purchase an additional Mop, check the Mop's model name (VCA-RPW97), then contact your nearest SAMSUNG Electronics retailer.

- Mops are consumables therefore need to be replaced every 1 ~ 3 months.

If the Mops are contaminated by foreign substances on the floor, odor may occur.

- If the smell persists, remove the Mops from the Mop Spin Board, soak it in water with neutral detergent for about 30 minutes, wash it, and dry it completely.

Safety information

Cleaning and maintenance

If you washed the Dustbin and filter with water

- Dustbin: Completely wipe out the water.
- Filter: Completely dry it in the shade before use.

CAUTION

Watch your fingers when attaching or detaching the filter, since they may get stuck.

To avoid blockages by foreign matter, do not let the Jet Bot Combo vacuum up toothpicks, cotton swabs, etc.

If it is difficult to remove foreign matter from the brush, Contact Customer Service.

Since the brush sweeps dirt up from the floor during cleaning, foreign matter such as a thin and long thread, long hair, etc. may get caught in it, so check and clean it regularly.

Turn off the Jet Bot Combo before cleaning or maintenance work.

If a brush or a brush cover is not assembled correctly after the maintenance work, scratches may occur on the floor, or product malfunction may occur. Assemble them correctly by checking the maintenance method.

Always keep the Obstacle Sensor Window, Cliff Sensor Window and the Carpet detect Sensor Window clear.

- If foreign matter accumulates, sensors may malfunction.

If you want to purchase an additional Dust Bag, check the Dust Bag's model name (VCA-RDB95), then Contact Customer Service.

If you want to clean the Mops additionally, use product's intensive steam cleaning function to clean or dry the Mops.

Do not dry Mops in the dryer.

- Usage of a high-temperature dryer may cause shrinkage of the Mops.

The brush may stop or make a sound temporarily due to sucking in a large amount of hair or hair accumulating on the brush.

- Check and clean it regularly.

Foreign matter such as a thin and long thread, hair, etc. may get caught in the Spin Brush, so check and clean it regularly.

Battery usage

If the battery overheats during charging, it may take longer to charge. When auto charging is not working, do the following.

- Unplug the Clean Station's power plug and then plug it back on.
- Check whether there is any foreign matter on the charging pins and clean charging pins of the Jet Bot Combo and the Clean Station with a dry cloth or rag.
- Check for any obstacles such as reflective objects, chairs, etc. near the Clean Station.

If the Jet Bot Combo is left detached from the Clean Station, the battery will drain naturally.

- Try to keep the Jet Bot Combo charged on the Clean Station. (However, turn off the power switch and leave the Clean Station unplugged when planning to leave the house for long periods of time by going on a business trip or vacation, etc.)

NOTE

Please Contact Customer Service when replacing batteries.

- Using batteries from other products can cause malfunction.

This battery is exclusively for the SAMSUNG Electronics Jet Bot Combo, do not use it for any other products or purposes.

Do not disassemble or modify the battery.

Do not throw the battery out in fire or heat it.

Do not connect any metallic object to the charging contacts (+, -).

Store the battery indoors (at 0 °C ~ 40 °C).

If the battery malfunctions, do not disassemble it yourself. Contact Customer Service.

As the battery is used over a length of time, the battery charging time and usage time decreases. In this case, Contact Customer Service.

Do not disassemble the battery yourself and make sure short circuit of +, - poles does not occur.

When battery leak occurs, make sure it does not touch your skin or eyes.

If the battery is stored below 0 °C, the battery protection mode will activate and will not charge.

- Store it at a room temperature for a certain period of time then charge.

Preparation

Product overview

Accessories

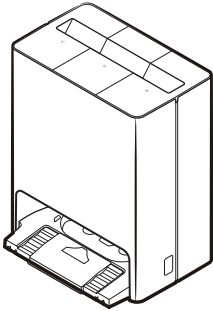

Clean Station

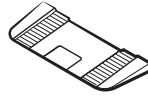

Extra Plate



Washing Plate



Power Cord



Cleaning Tool

Before you begin

Parts diagram

Jet Bot Combo

Top(Front)

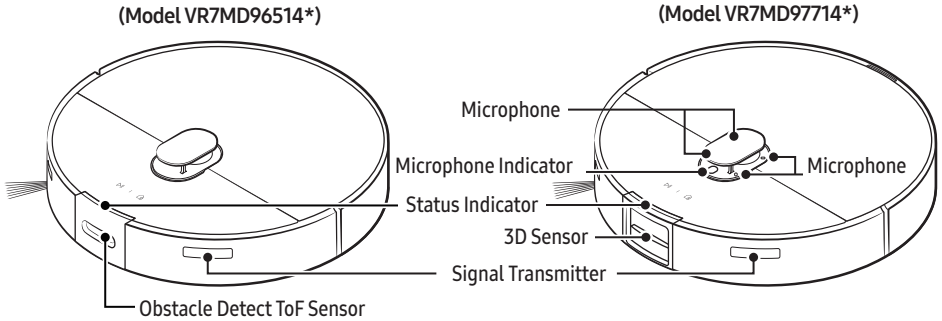

Top(Back)

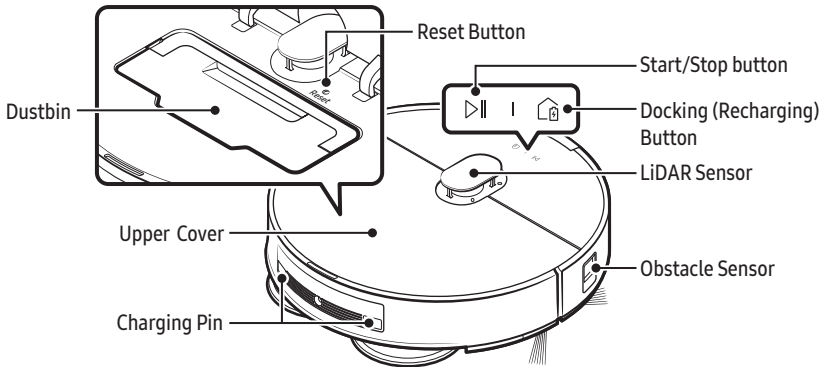

Bottom

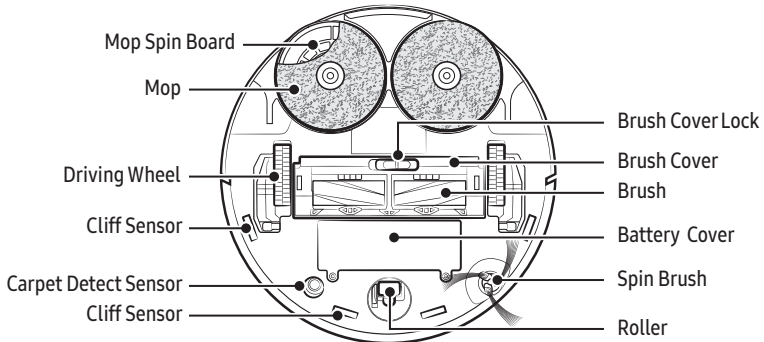

Before you begin

Clean Station

Front

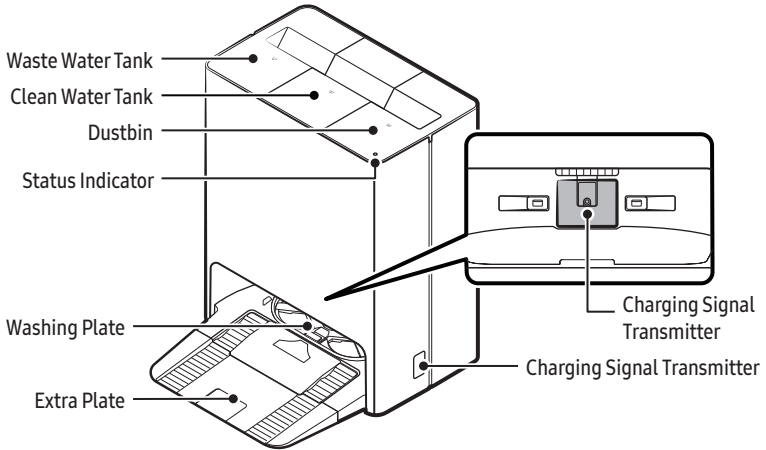

Rear

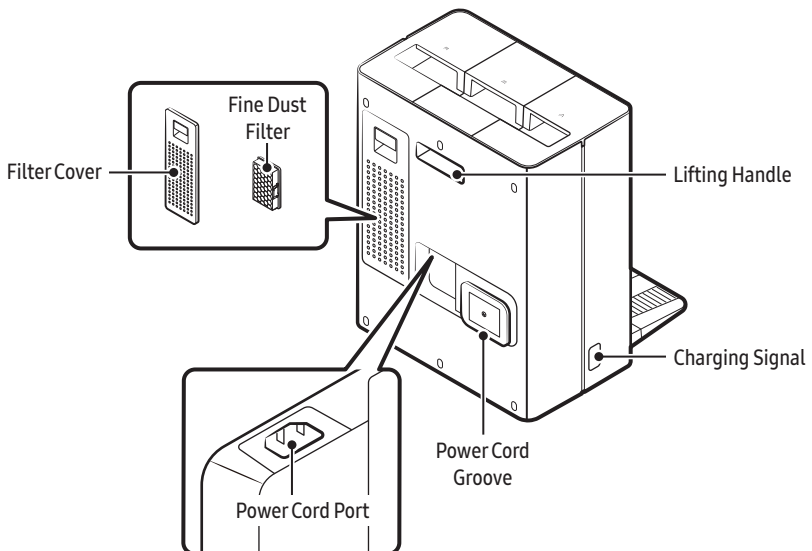

Installation

Installing



Scan the QR code to see a video on how to use the product.

Installing a Clean Station

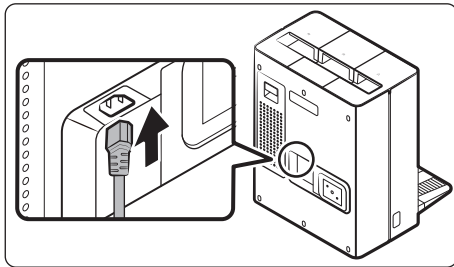
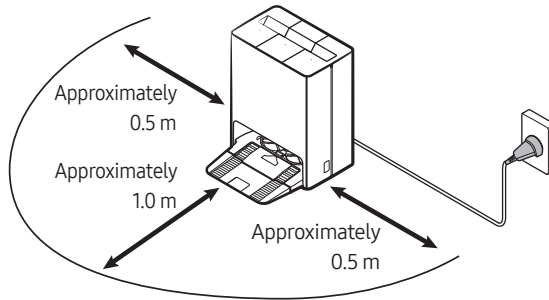

1. Connect the provided power cord to the bottom of the Clean Station.

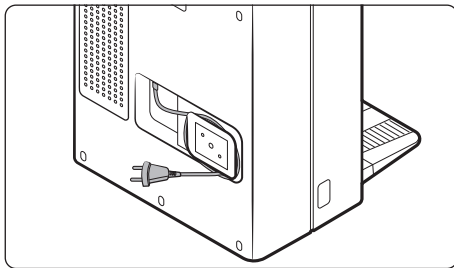

2. Organize the power cord into the fixing groove at the rear of the Clean Station.

Installation

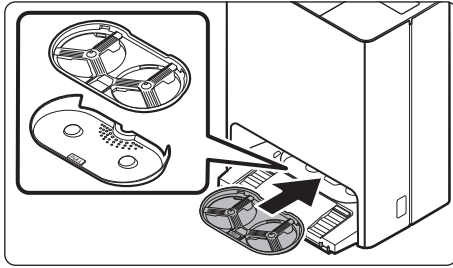

3. Assemble the Washing Plate to the Clean Station.

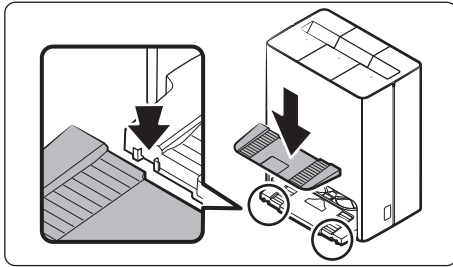

4. Assemble the Extra plate to the Clean Station.

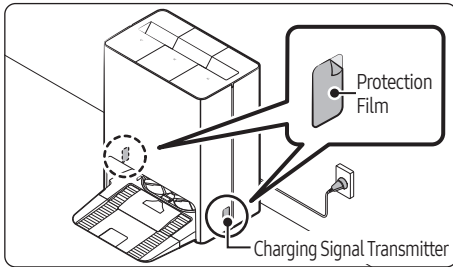

5. Place the Clean Station on an even floor and near an electrical outlet and plug it in.
- Remove the protection film on Charging Signal Transmitter.

NOTE

- Install the Clean Station in a place where the floor and wall are leveled.
- If the power cord is too long for the installation environment, coil the power cord around the cable management post, then put it in the fixing groove at the rear of the Clean Station.
- If you rotate the Clean Station 45 degrees after installation or choose to install the Clean station in a new location more than 1 meter away from the previous installation location, recreate the map using the SmartThings App. (Some places may not be cleaned if you use the existing map).

Installing a Jet Bot Combo

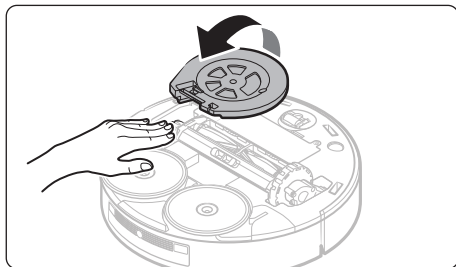

1. Before using the Jet Bot Combo, lift the Spin Brush Cover in the direction of the arrow shown.

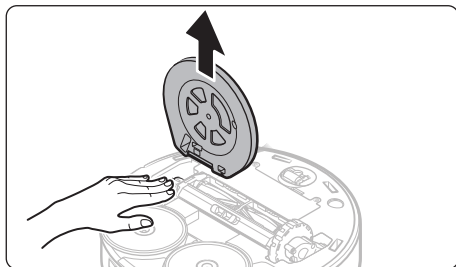

2. Detach the Spin Brush Cover.

 **NOTE**

- Press the Driving Wheels and remove the Spin Brush Cover.
- Remove the Spin Brush Cover and discard it.

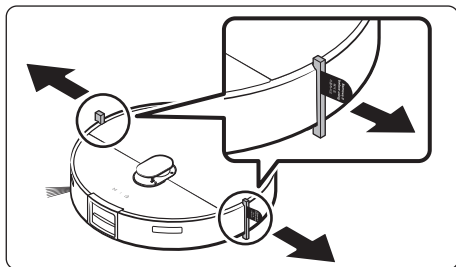

3. Remove the bumper protection gaskets which are attached to both sides.

Operation

Preparing Clean Water Tank

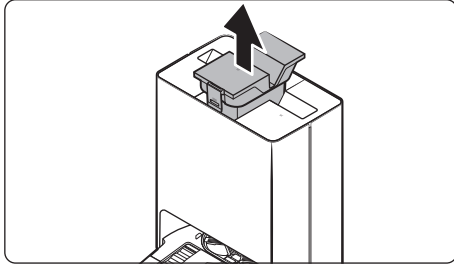

1. Detach the Clean Water Tank from the Clean Station by pulling the handle on the top.

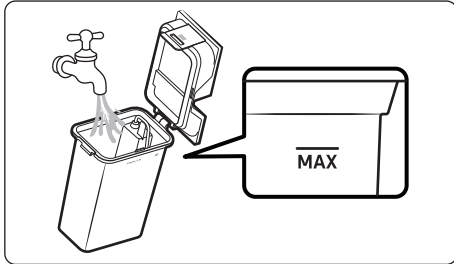

2. Open the lid and fill it with clean water up to the **MAX** water line.

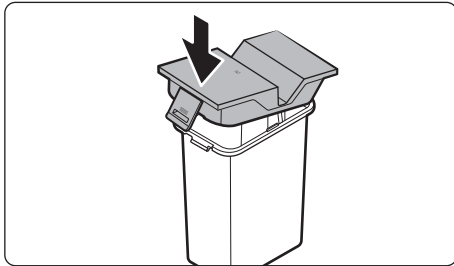

3. Close the lid.

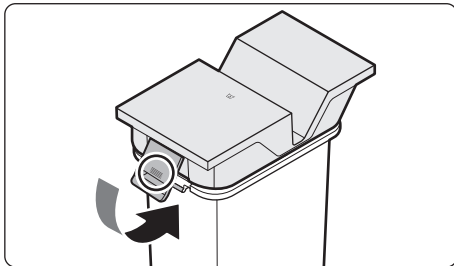

4. Be sure that the hook is fixed by pressing the indicated area shown, you should hear it click.
 - If the lid is not fully closed, the product may malfunction or may result in problems with the product.

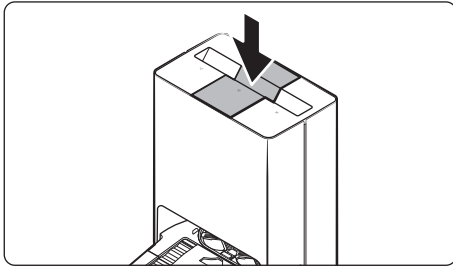

5. Insert the Clean Water Tank into the Clean Station.

Charging the Jet Bot Combo

Before using the Jet Bot Combo for the first time, charge it completely. (For the charging time and usage time, refer to the 'Product Specification'.)

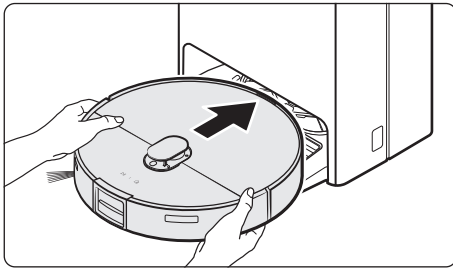

1. Place the Jet Bot Combo on the Clean Station manually to start charging.
 - Make sure the charging terminals on the Jet Bot Combo and the Clean Station are aligned.

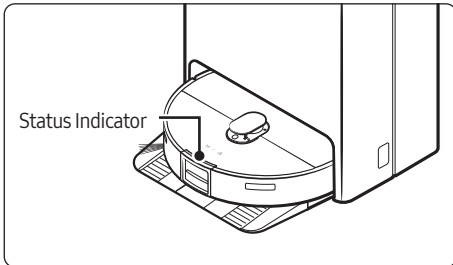

2. Check the charging status.
 - When charging starts, the Status Indicator of the Jet Bot Combo turns on (red, orange, or yellow depending on charging progress). It rises gradually, and changes to green when the charging is complete.

Operation

Auto charging

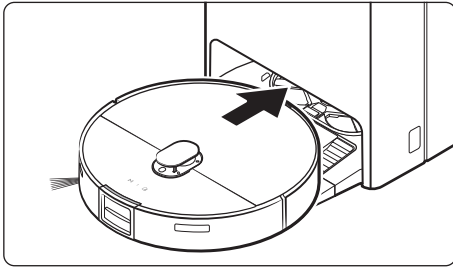



The Jet Bot Combo automatically returns to the Clean Station when it completes cleaning or when the battery is low to recharge.

Docking (Recharging)



You can return the Jet Bot Combo to the Clean Station while cleaning to recharge.

- Press the  on the Jet Bot Combo or use the SmartThings App to select the recharging function.
- If the Jet Bot Combo fails to return to the Clean Station for charging, it turns to Power-Saving Mode. To cancel the Power-Saving Mode, press the .

Manual Charging (Discharged Jet Bot Combo)

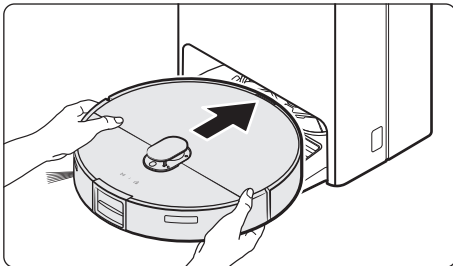

Move the Jet Bot Combo manually onto the Clean Station to recharge.

Checking if recharging does not work

Check the Clean Station's installation status

- Check whether the Clean Station has been installed in a place where the Clean Station cannot guide the Jet Bot Combo to return.
- Check whether the distance between the Clean Station and the Jet Bot Combo is over 5 m.
 - It may take a longer time for the Jet Bot Combo to return to the Clean Station.

Charge the Jet Bot Combo manually for the following conditions.

- When the Clean Station is installed in a corner
- When the battery is completely discharged
- When the Jet Bot Combo is stuck in an obstacle (e.g., furniture)
- When the Jet Bot Combo cannot climb a threshold near the Clean Station. (It should be less than 1.5 cm.)
- When the Jet Bot Combo's Status Indicator turns red and stays red with the Jet Bot Combo not working.

NOTE

- Keep the Clean Station's power on at all times.
- If the power switch of the Jet Bot Combo is off, the Jet Bot Combo will not be able to recharge because it cannot find the Clean Station.
- If the Jet Bot Combo is left detached from the Clean Station, the battery drains naturally.

Operation

Using the Jet Bot Combo

For the normal use of the Jet Bot Combo's functions, the SmartThings connection is required.

- For downloading and installing the SmartThings App, refer to the 'SmartThings App'.

Using the control panel

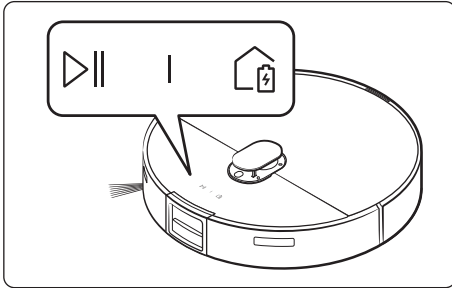

Start cleaning

Press the ▶ on the Jet Bot Combo to start cleaning in Auto Clean.

Stop cleaning

- Press the | on the Jet Bot Combo to stop operation while cleaning.
 - When pressing the 🏠, the Jet Bot Combo returns to the Clean Station and starts charging.
 - If the Jet Bot Combo does not operate for 20 minutes after it stops operation, it automatically returns to the Clean Station to recharge.

Power-Saving Mode

- When not cleaning, you can set the Power-Saving Mode by pressing the ▶ for about 7 seconds.
- In the Power-Saving Mode, press the ▶ to cancel the Power-Saving Mode.

Operation status on the LED Status Indicator



Classification		Color		Meaning
Jet Bot Combo	While operating	Red	Blinking without moving	An error occurs
			Blinking while moving	Auto returning to the Clean Station due to low battery
			On	Operating stops due to low battery
	While charging	Red, orange, or yellow (depending on charging progress)		Charging
			Green	Charging is complete
			Violet	Software is being updated
Clean Station	White	On (for 5 seconds)	Clean Station's power is on.	
		On	Empty Dust function is working, Charging (1 minute after, it is off.), Cleaning and drying the Mops.	
	Red	Blinking	Dustbin's lid is open, Fine Dust Filter cleaning notification.	
		On	Clean Station's Dust Bag/ Waste Water Tank is full, Clean Water Tank inside the Clean Station is empty, Clean water tank/ Waste water tank/ Washboard not placed.	

NOTE

- During the first 20 minutes of charging, the Status indicator turns red.
- If the Jet Bot Combo starts charging from the depleted status, the Status Indicator turns red and slowly blinks for about 20 minutes.
- The Jet Bot Combo's night mode (18:00 ~ 06:00) operates only when the Jet Bot Combo is charging, and in the night mode, Jet Bot Combo's LED brightness is adjusted to 20% within the set time when time synchronization is set through a smartphone.

Operation

Using additional functions

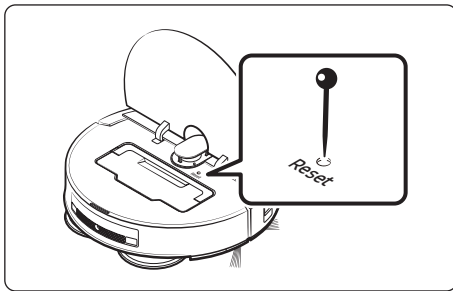

Additional functions	Operation
Energy-Saving Mode	<p>When charging is complete, the Jet Bot Combo automatically enters the Power-Saving Mode. While the Jet Bot Combo is docked on the Clean Station, press and hold the  for 7 seconds to set it to the Power-Saving Mode, and to cancel the Power-Saving Mode, start cleaning or press the  for 7 seconds.</p> <ul style="list-style-type: none">• But, if the Jet Bot Combo is in the Power-Saving Mode, once booting is complete by pressing , set/cancel the Energy-Saving Mode.• When the Jet Bot Combo is in the Energy-Saving Mode, the power is turned off after charging is complete which means the Wi-Fi reception waiting is not enabled, therefore the Jet Bot Combo cannot be controlled with the SmartThings app.

Resetting the Jet Bot Combo



When you are in need of resetting the Jet Bot Combo while in use, use a clip or a needle to poke deeply into the reset hole until you feel it click.

How to reset to the factory default

- Open the Jet Bot Combo's cover and press the Reset button, then  and  will blink in white when pressed and held for 7 seconds, then proceed to reset to factory default.
- When the factory default setting is complete, the Jet Bot Combo automatically restarts.
- After the factory default setting, the device status on the SmartThings App changes to offline status.
 - In the SmartThings app, long-press the device card to delete the device using the edit action.
 - Please re-register the device to your smartphone.

SmartThings App



Before using SmartThings

- The SmartThings App is only compatible with models that have a Wi-Fi function.
- If you do not have a Wi-Fi router, you cannot use the SmartThings App.

1. Setting up the wireless router

- Please refer to the user manual of your wireless router for the settings of the wireless router.
- SAMSUNG Jet Bot Combo supports both Wi-Fi 2.4GHz and 5GHz.
- SAMSUNG Jet Bot Combo supports IEEE 802.11b/g/n and Soft-AP.
 - IEEE 802.11n is recommended.
- SAMSUNG Jet Bot Combo supports only DHCP (Dynamic Host Configuration Protocol). Check whether the DHCP server option function is activated on the wireless router.
- The Jet Bot Combo supports the WEP-OPEN, WPA-PSK/TKIP, and WPA2-PSK/AES for the authentication and encryption protocols.
 - WPA2-PSK/AES is recommended.
 - Confirm that your router has a unique SSID and password.
- The quality of your wireless network connection may be influenced by the surrounding wireless environment.
- If your Internet service provider has permanently registered the MAC address (a unique identification number) of your PC or modem, your Jet Bot Combo may not be able to connect to the Internet. Ask your Internet service provider about the procedure to connect an apparatus other than a PC to the Internet.
- If your internet service provider requires your ID or password to connect to the internet, your Jet Bot Combo may not be able to connect. If this is the case, you must enter your ID or password when connecting to the Internet.
- The Jet Bot Combo may not be able to connect to the Internet because of firewall issues. Contact your Internet service provider to resolve these issues.
- Some wireless routers may transmit an abnormal Domain Name Server (DNS) address even if the Internet is not connected. If this occurs, contact the manufacturer of your wireless router and your Internet service provider.
- If you still cannot connect to the Internet even after trying the procedure provided by your Internet service provider, please contact Customer Service.
- If your router is not a Wi-Fi certified product, the Jet Bot Combo may not be able to connect to the Internet.

NOTE

- When pressing and holding the  button for 3 seconds, the network status is guided by voice.
- Setting Wi-Fi On/Off function: Hold the  button down for 3 seconds and then the  button for 3 seconds to switch the Wi-Fi off or on to use again while the vacuum cleaner is on standby or charging.

2. Downloading the SmartThings App

Download and install the SmartThings App from the markets (Google Play Store, Apple App Store, or SAMSUNG Galaxy Store).

NOTE

- SmartThings is incompatible with some tablets and some mobile devices.
- Visit Play Store or App Store to see if your mobile device is compatible with SmartThings.
- The supporting software version of the SmartThings app is subject to change according to the OS supporting policy the manufacturer provides. In addition, as for the SmartThings app or the functions that the app supports, the new application update policy on the existing OS version can be suspended due to usability or security reasons.
- The SmartThings app is subject to change without notice to improve usability or performance. As the mobile phone OS version is updated every year, the SmartThings is also updated continually according to the latest OS.
- If you have enquiries regarding the items mentioned above, please contact us on st.service@samsung.com.

SmartThings App

3. Setting up a SAMSUNG account

- You must sign in to a SAMSUNG account before using the SmartThings App.
- To set up a SAMSUNG account, you can follow the directions provided by the SmartThings App.
- If you have a SAMSUNG smartphone, you can add your SAMSUNG account in the setting app of your smartphone and it will automatically sign in to your SAMSUNG account and you can use the SmartThings App.

4. Registering a device to the SmartThings App

- 1) Connect your smartphone to your wireless router.
 - If the smartphone is not connected, turn on the Wi-Fi in the Settings App and select a wireless router you want to connect to.
 - Set your smartphone to use Wi-Fi only and connect a device.
- 2) Launch the SmartThings App on your smartphone.
- 3) If a pop-up saying that a new device has been found appears, tap ADD NOW.
 - If the pop-up does not appear, add a device by selecting the 'Home appliances' category → 'Robot cleaner' and the Jet Bot Combo to connect.
 - You can add a device by selecting 'Nearby search'. (Bespoke Jet Bot)
 - If you scan the SmartThings QR code attached on the Jet Bot Combo, you can connect to the Jet Bot Combo more easily.
- 4) Provide the authentication when you are directed to do so.
- 5) [Android] The connection to your wireless router will be progressed automatically.
 - [iOS] Open the setting app, and select the wireless router in the Wi-Fi list.
- 6) When the product registration is complete, the Jet Bot Combo device card is added.



NOTE

- When the Jet Bot Combo cannot be registered to the SmartThings App
 - Refer to the SmartThings App guide or pop-up messages.
 - Confirm that the UPnP option of your wireless router is active, and then try the registration procedure again.
 - Confirm that your wireless router is operating in a wireless mode and if not, change it to the wireless mode and try again.
 - If you have two or more Jet Bot Combos, turn off the other Jet Bot Combo, and then try to register your Jet Bot Combo again.
 - Change the name of the wireless router which has the same SSID to be distinguished from each other.
- If the Jet Bot Combo and smartphone are not connected to the same wireless router, a response can be delayed depending on the network environment.
 - When the wireless router is changed, the connection between the Jet Bot Combo and the SmartThings App is disconnected.
 - After changing the wireless router, register your Jet Bot Combo again at the SmartThings App.

5. Software Update

- When the Power-Saving Mode is deactivated on the Jet Bot Combo and is placed on the Clean Station, the Jet Bot Combo connects to the server and checks for software updates. If a new software is found, the Jet Bot Combo will automatically download and update it.
- If the Status Indicator of the Jet Bot Combo turns violet and stays violet while charging, it means that the Jet Bot Combo is being updated. Please wait until rebooting is complete.

Using the SmartThings App

Functions	Explanation
Cleaning report	<ul style="list-style-type: none"> You can check recent cleaning histories and results. (Max 50)
Cleaning mode	<ul style="list-style-type: none"> You can choose between [Dust Suction + Mop], [Dust Suction] or [Mop] mode. <ul style="list-style-type: none"> When using [Dust Suction + Mop] mode or [Mop] mode, be sure to attach a Mop. If you do not attach a Mop, water will spill on the floor.
Suction power	<ul style="list-style-type: none"> You can choose between Max/Smart/Normal/Quiet.
Driving mode	<ul style="list-style-type: none"> You can choose between Area then walls/Walls first/Quick cleaning in a zigzag pattern.
Water level	<ul style="list-style-type: none"> Water spray volume can be changed depending on the cleaning environment.
Scheduled cleaning	<ul style="list-style-type: none"> You can start designated cleaning at a scheduled time. <ul style="list-style-type: none"> If the Jet Bot Combo is not charging on the Clean Station, or power is not supplied to the Clean Station, the scheduled cleaning does not start.
Downtime	<ul style="list-style-type: none"> At a designated time, the Jet Bot Combo stops cleaning and returns to the Clean Station. <ul style="list-style-type: none"> Cleaning can start arbitrarily during Downtime.
Home monitoring (only compliant to model VR7MD97714*)	<ul style="list-style-type: none"> The Home monitoring function is turned on by default. If you want to deny access or re-allow this function, press  and , which are located at the top of the product simultaneously for 3 seconds. <ul style="list-style-type: none"> This function is provided specifically for Pet care therefore use of this function for other purposes is prohibited. SAMSUNG is not responsible for the usage of this function in other purposes. The camera can be turned on via the SmartThings App when cleaning to get a stream of the activity. Designated area of choice can monitored through the front camera of the Jet Bot Combo.
Clean Station maintenance	<ul style="list-style-type: none"> You can check the status of the Clean Water Tank, Waste Water Tank and the Dust Bag. Perform Mop wash (from washing to drying) or only perform additional drying. You can set the Mop washing interval and Drying time. You can set the Jet Bot Combo to empty out the Dustbin automatically.
Manage map	<ul style="list-style-type: none"> You can manage maximum of 4 maps corresponding the structure of the unit. You can set the followings: Set no-go zone, Edit Map, Edit furniture and appliances, Delete map, Rename, etc. (Edit furniture and appliances : model VR7MD97714* model only)

SmartThings App

Functions	Explanation						
Driving settings	<ul style="list-style-type: none"> Set detailed driving options. <ul style="list-style-type: none"> Repeat: Clean repetitively until the battery is used out. Continue cleaning after charging: If the battery runs out while in the process of cleaning, the Jet Bot Combo recharges then continues to clean any areas left uncleaned. Smart charging: If the area left to clean is small, recharges only a portion and continues to clean. Set the Mopping options. <ul style="list-style-type: none"> Carpet cleaning: Set how the Jet Bot Combo would respond when it meets a carpet. <table border="1" data-bbox="381 520 1039 762"> <tbody> <tr> <td>Vacuum only</td> <td>Lift Mops while crossing over the carpet.</td> </tr> <tr> <td>Clean while avoiding carpet</td> <td>Avoid carpet.</td> </tr> <tr> <td>Auto clean by pile length</td> <td>When the fiber is short, lift the Mops and perform Dust suction cleaning. When the fiber is long, clean by avoiding the carpet, lastly, remove the Mops and perform Vacuum only function.</td> </tr> </tbody> </table> Set obstacle options. (only compliant to model VR7MD97714*) <ul style="list-style-type: none"> Set size of the obstacles, Pet waste detection, etc. 3D sensor can be calibrated to increase the accuracy of obstacle detection. 	Vacuum only	Lift Mops while crossing over the carpet.	Clean while avoiding carpet	Avoid carpet.	Auto clean by pile length	When the fiber is short, lift the Mops and perform Dust suction cleaning. When the fiber is long, clean by avoiding the carpet, lastly, remove the Mops and perform Vacuum only function.
Vacuum only	Lift Mops while crossing over the carpet.						
Clean while avoiding carpet	Avoid carpet.						
Auto clean by pile length	When the fiber is short, lift the Mops and perform Dust suction cleaning. When the fiber is long, clean by avoiding the carpet, lastly, remove the Mops and perform Vacuum only function.						
Use room customization	<ul style="list-style-type: none"> You can set the cleaning method appropriate for each room. 						
Mop washing interval	<ul style="list-style-type: none"> Mop washing interval settings. <ul style="list-style-type: none"> Set when and where to start cleaning the Mops. 						
Find Robot Vacuum	<ul style="list-style-type: none"> Plays sound so that the Robot vacuum can be found. 						
Lights	<ul style="list-style-type: none"> Turns the light of the Robot vacuum on or off while charging. 						
Sound	<ul style="list-style-type: none"> You can set the guidance sound of the Robot vacuum to voice, Beep, or Mute, and you can adjust the volume and select the voice style depending on the selected item. 						
Language	<ul style="list-style-type: none"> Supports 14 languages. 						

- When the Jet Bot Combo does not have a saved map, it studies cleaning space through Auto Clean function which starts from the Clean Station. Once studying is done, a map is saved.
- Room Clean or Spot Cleaning works regardless of choice sequences of the areas.
- If the Jet Bot Combo cannot recognize its current location, it starts Auto Clean.
- The Jet Bot Combo automatically performs a system check and restarts once a week.
- When the Dust Suction + Mopping or Mop only option is selected from the Auto clean by pile length of the Carpet cleaning options, the Jet Bot Combo may not be able to clean beyond the carpet. Change the Carpet cleaning options or change to Mopping after vacuuming.
- When cleaning around furniture/areas/uncleaned areas, cleaning is carried out on an hourly (20 minutes) cleaning cycle even if the Mop cleaning time is set for each area. (The robot cleans by area: VR7MD97714* model only)

Open Source Announcement

The software included in this product contains open source software. To obtain the source code covered under licenses which have the obligation of publishing source code (e.g. GPL, LGPL... etc), please visit <http://opensource.samsung.com/> and search by model name.

It is also possible to obtain the complete corresponding source code in a physical medium such as a CD-ROM; a minimal charge will be required.

The following URL <http://10.250.141.155/solve/getTotalProjectList.do> leads to open source license information as related to this product. This offer is valid to anyone in receipt of this information.

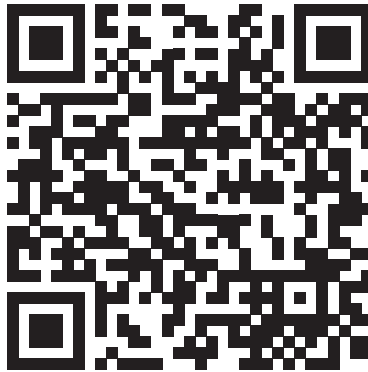

Maintenance

Cleaning and maintaining the Clean Station

- Be sure that the power code of the Clean Station is unplugged before handling with the Clean Station.
- When cleaning the exterior, wipe with water only.
 - Do not use detergent.

Cleaning the Waste Water Tank

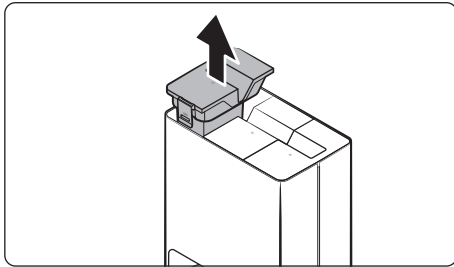

1. Detach the Waste Water Tank from the Clean Station by pulling the handle on the top.

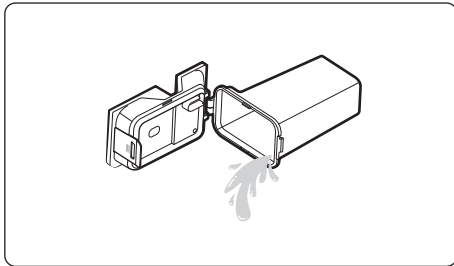

2. Open the lid and empty out the Waste Water Tank and clean it thoroughly.

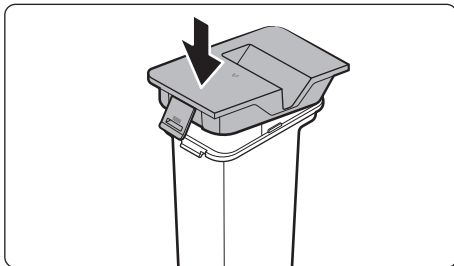

3. Close the lid.

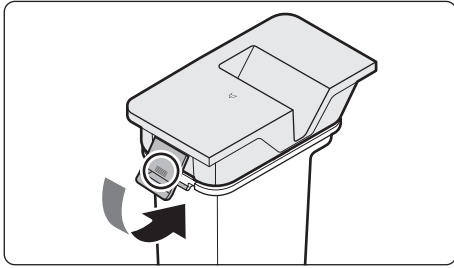

4. Be sure that the hook is fixed by pressing the indicated area shown, you should hear it click.
 - If the lid is not fully closed, the product may malfunction or may result in problems with the product.

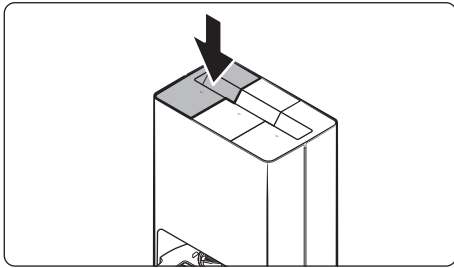

5. Insert the Waste Water Tank in the Clean Station.

Maintenance

Replacing the Dust Bag

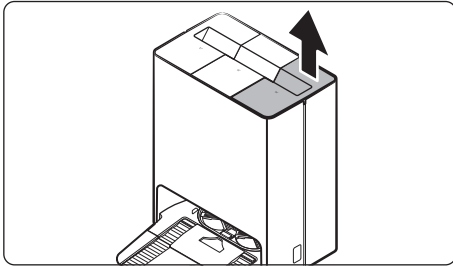

1. Detach the lid by pulling the handle on the top.

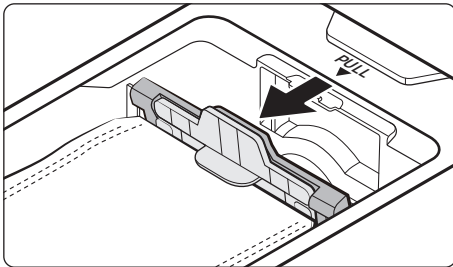

2. Hold the Dust Bag guide handle and push it in the direction of the arrow shown.

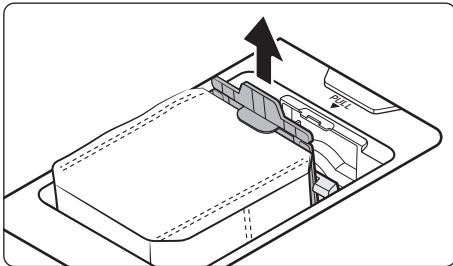

3. Detach the Dust Bag from the product by pulling it upward.
 - Trash out the used Dust Bag.

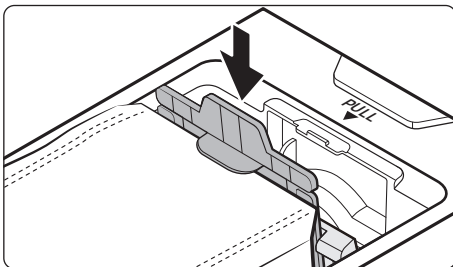

4. Replace it with a new Dust Bag.
 - Put a new Dust Bag into the Dust Bag by fitting into the grooves on the holder in the direction of the arrow shown.

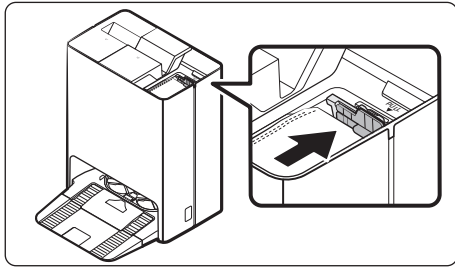

5. Push the top of the Dust Bag guide holder in the direction of the arrow shown until you hear it click.

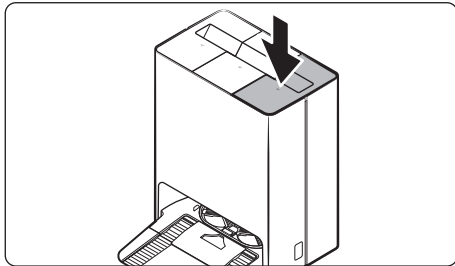

6. Close the lid.

Maintenance

Cleaning the Fine dust Filter

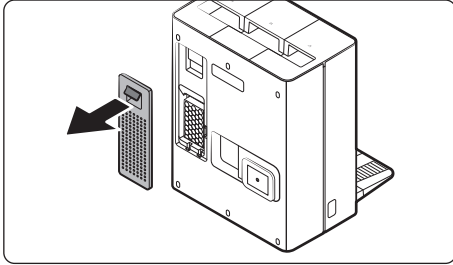

1. Grasp the grooves at the rear of the Clean Station and detach the Fine dust Filter cover.

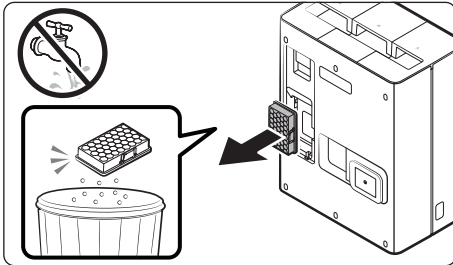

2. Detach the Fine dust Filter and shake out the dust.

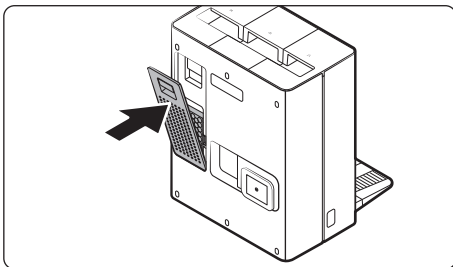

3. Re-attach the Fine dust filter and the Filter cover until you hear them click.

Cleaning the Washing Plate

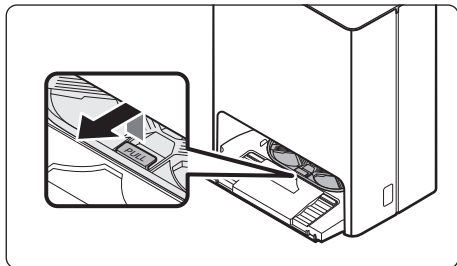

1. Detach the Washing Plate by lifting the handle that says 'PULL'.



2. Clean the cover with water and dry it completely in the shade.

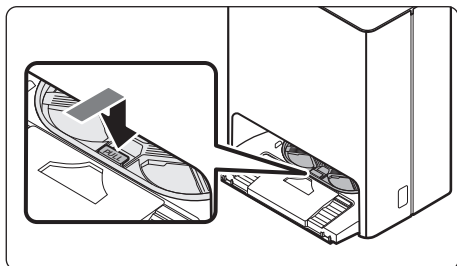

3. Insert the Washing Plate back into the Clean Station.

NOTE

- Rinse the Washing Plate only with clean water.
 - Do not use detergent.

Maintenance

Cleaning the bottom cover

⚠ CAUTION

- Be sure that both the Clean Water Tank and the Waste Water Tank are disassembled before lying the Clean Station on its side.
- Detach both the Extra Plate and the Washing Plate.
 - A risk of personal injury or material damage exists.
- Remove any moist left on the floor after detaching the Washing Plate.

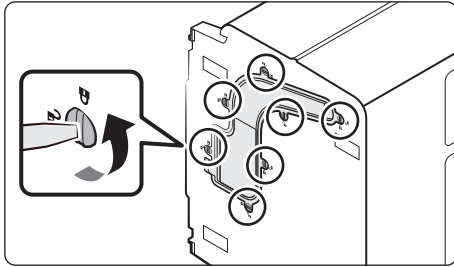

1. Lay the Clean Station on its side and turn the 7 fixed screws on the bottom cover in the unlock direction (🔓).

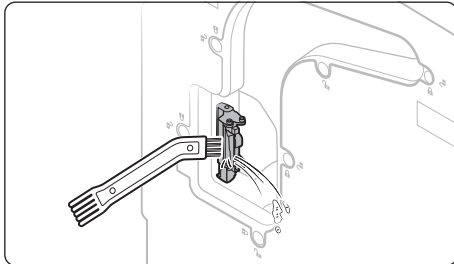

2. Detach the bottom cover and remove any foreign matter.

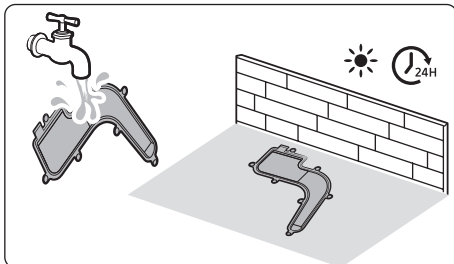

3. Clean the cover with water and dry it completely in the shade.

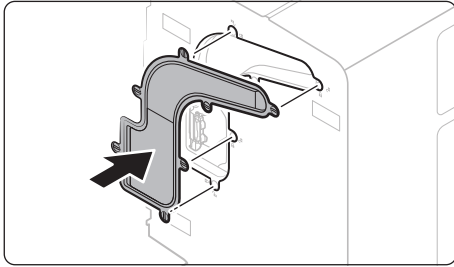

4. Attach the bottom cover to the Clean Station.

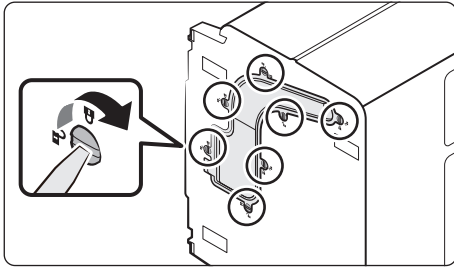

5. Turn the 7 fixed screws in the lock direction (🔒).

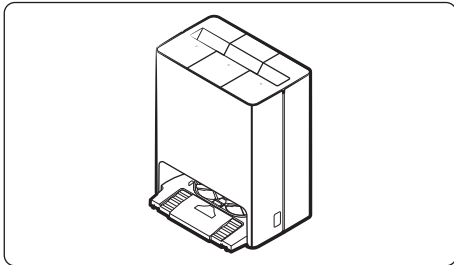

6. Be sure to stand the Clean Station upright back to its position after cleaning.

Maintenance

Descaling the Steamer

Descaling

1. Press the ▷|| and 🏠 buttons on the top of Jet Bot Combo simultaneously for 7 seconds.
2. Dilute 100g of citric acid into water (1L) in the Clean Water tank and insert it into the Clean Station.
3. Press the ▷|| and 🏠 buttons on the top of Jet Bot Combo simultaneously for 7 seconds.
4. The cleaning takes about 2 hours, and when it is done, you will be notified by the Voice guidance.

Rinsing

1. Pour water into the Clean Water Tank.
2. Press the ▷|| and 🏠 buttons on the top of Jet Bot Combo simultaneously for 7 seconds.
3. Rinsing takes about 15 minutes, and when it is done, you will be notified by the Voice guidance.

CAUTION

- Do not put anything other than citric acid and water when descaling.
- Do not use citric acid other than when descaling.

NOTE

- Due to the nature of the product, it is recommended to carry out descaling once a year.
- Descaling cannot be paused and product will be ready to be used once all procedures including rinsing are done.
- If a descaling alarm goes off, be sure to descale to maintain product quality.
- The steam cleaning function cannot be used after a certain period of time has passed after the descaling alarm goes off.

Maintaining and cleaning the Jet Bot Combo

Before maintenance work, you should set the Jet Bot Combo as Power-Saving Mode.

Emptying and cleaning the Dustbin

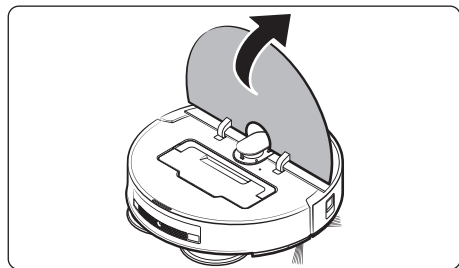

1. Detach the Upper Cover by lifting the center of it.

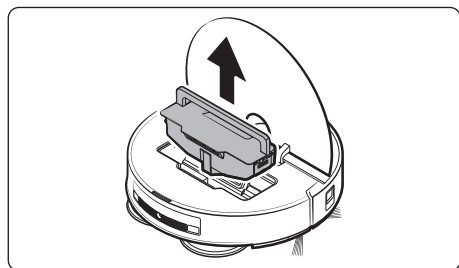

2. Hold the Dustbin handle and lift the Dustbin up.

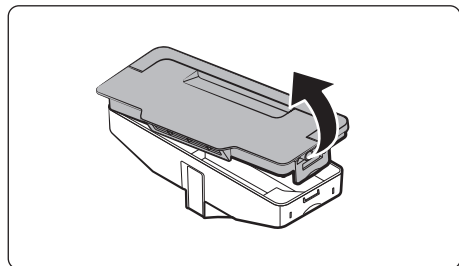

3. Open the Dustbin cover by pulling and lifting the hook on the side of the Dustbin.

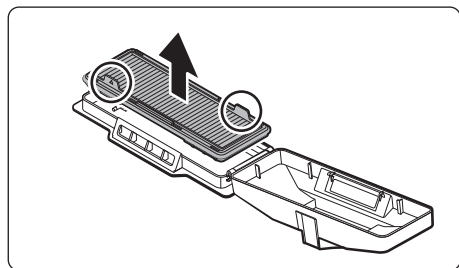

4. Detach the Pre-motor Filter from the Dustbin cover.

Maintenance

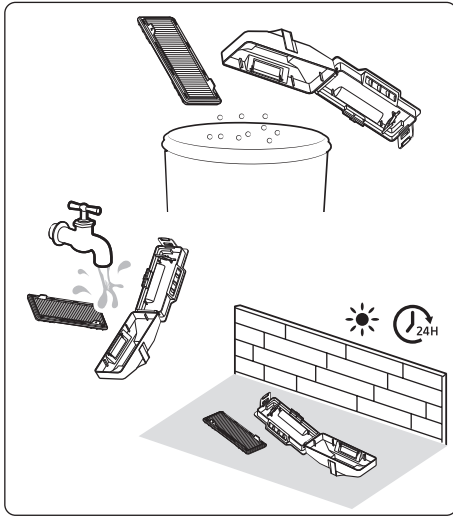

5. Remove the dust from both the Pre-motor Filter and the Dustbin, clean them with water and dry both completely in the shade.

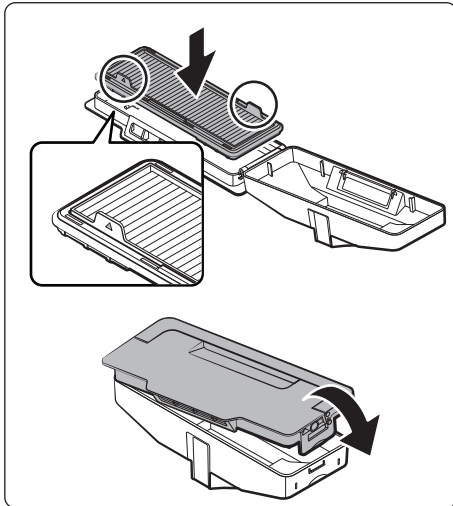

6. Attach the Pre-motor Filter to the DustBin's lid, then close the Cover.
 - Insert the Pre-motor Filter's handles facing upward.
 - Push the Dustbin's lid until you hear it click, so that it remains closed.

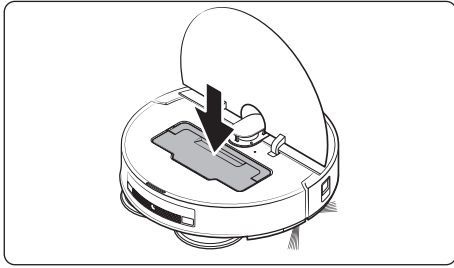

7. Insert the Dustbin into the Jet Bot Combo.
 - Hold the Dustbin's handle and insert it into the Jet Bot Combo, then put the handle down.

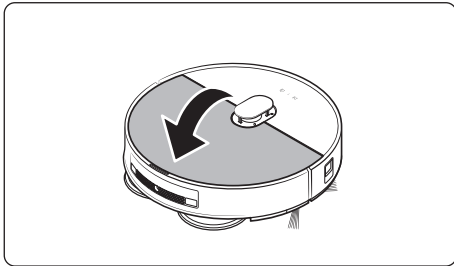

8. Close the Upper lid.

Maintenance

Cleaning the brush

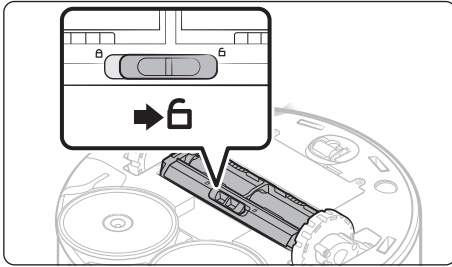

1. Push the Brush Cover Lock to the right to unlock.

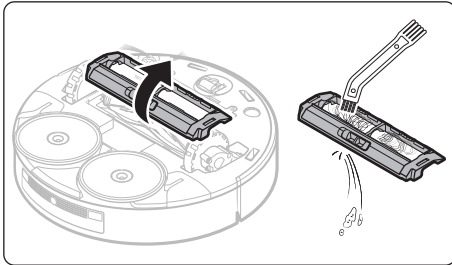

2. Detach the brush and use the Cleaning tool to clean the brush.

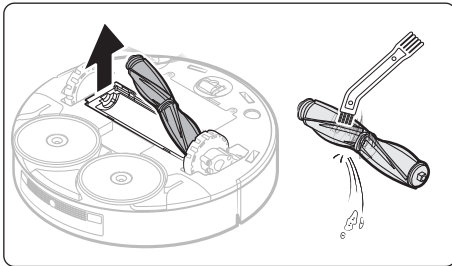

3. Detach the brush cover and use the Cleaning tool to clean the brush.
 - Lift up the left side of the brush first then pull the brush from the groove on the right.

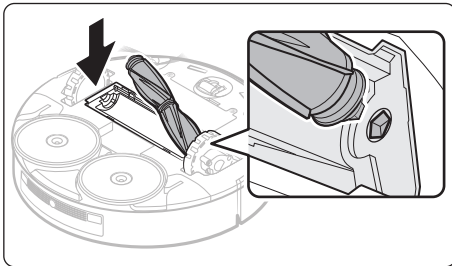

4. Attach the right side of the brush into the groove first then push the left side into it.

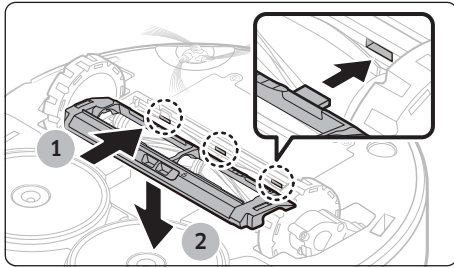

5. Assemble the brush cover by aligning the 3 hooks attached to the rear of the brush cover with the grooves.
 - Be sure that the hooks are aligned with the grooves.

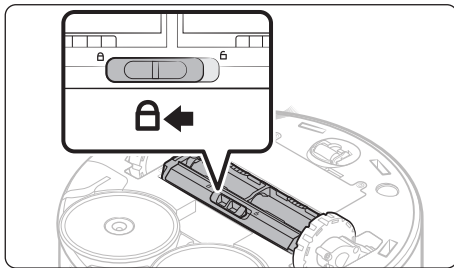

6. Push the Brush Cover Lock to the left to lock.

Maintenance

Cleaning the Roller

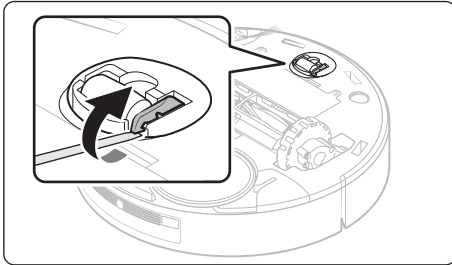

1. Use a flat-head screwdriver to lift the Roller's set hook in the direction of the arrow shown.

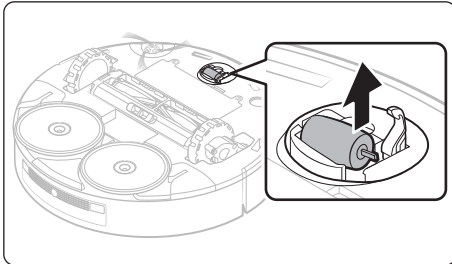

2. Detach the Roller by lifting it upward.

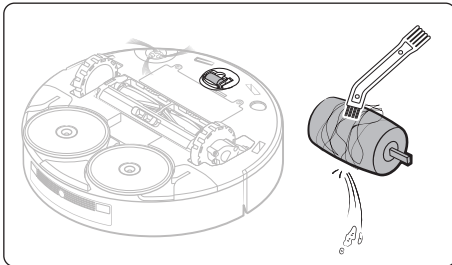

3. Use the Cleaning tool to clean the Roller.

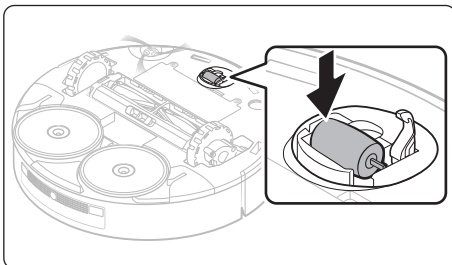

4. Re-insert the Roller.

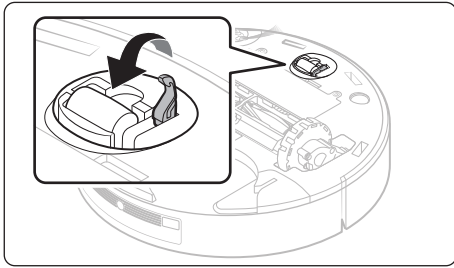

5. Fix the Roller's set hook until you hear it click.

Cleaning the Spin Brush

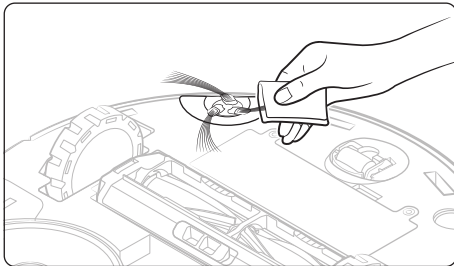

Wrap around the Spin Brush with a steamed towel or such for around 10 seconds and clean it.

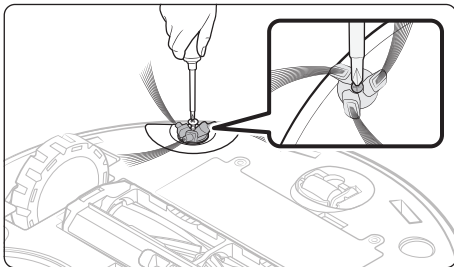

When hair, threads, etc. are tangled in the Spin Brush, use a screwdriver to detach the Spin Brush then remove anything that is tangled.

Maintenance

Cleaning the Driving Wheel

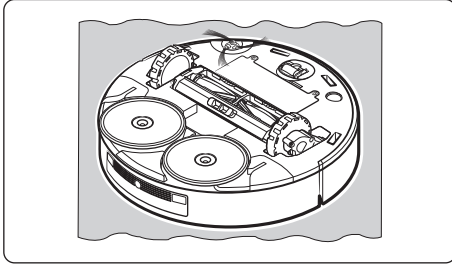

1. Place a soft cloth down first, turn the Jet Bot Combo over, and place it gently on the cloth.

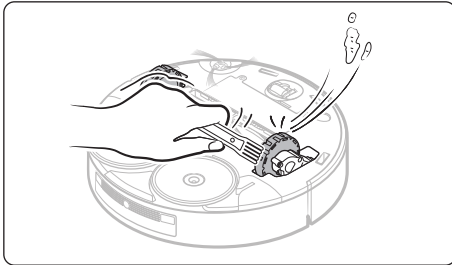

2. Clean the Driving Wheels using the Cleaning tool.

Cleaning the Mops

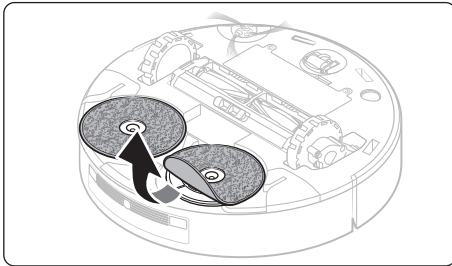

1. Detach both Mops attached to the bottom of the Jet Bot Combo.

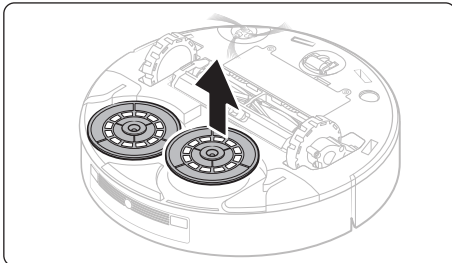

2. Detach both Mop Spin boards.

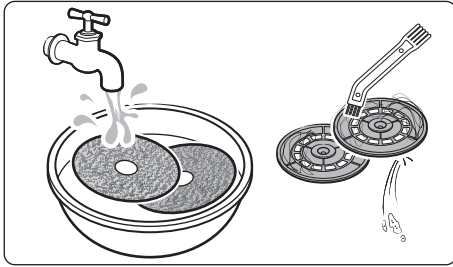

3. Clean the Mops and the Mop Spin boards.

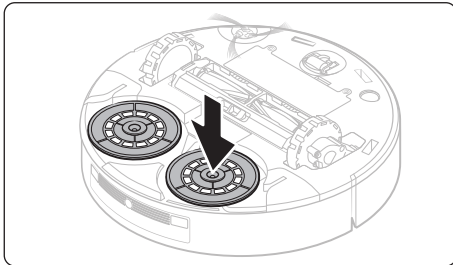

4. Attach both Mop Spin boards.

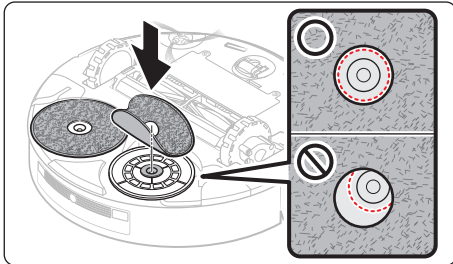

5. Attach both Mops onto the product.

- Attach the two Mops by aligning them with the groove in the center so that they do not overlap each other.
- Fold the Mop as shown in the picture and attach it aligned with the center of the Mop Spin board.

Maintenance

Cleaning and maintaining the SensorWindow

If the Sensor Window gets contaminated, it may have a negative impact on the performance quality. To maximize the quality of performance, wipe the Sensor Window with a soft cloth regularly. Refer to the diagrams below for the locations of each Sensor.

Jet Bot Combo

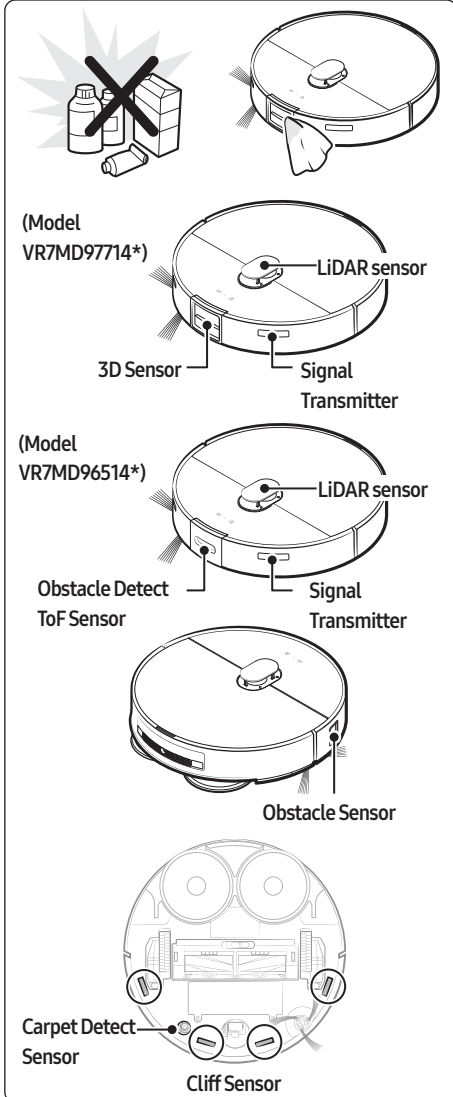

Clean Station

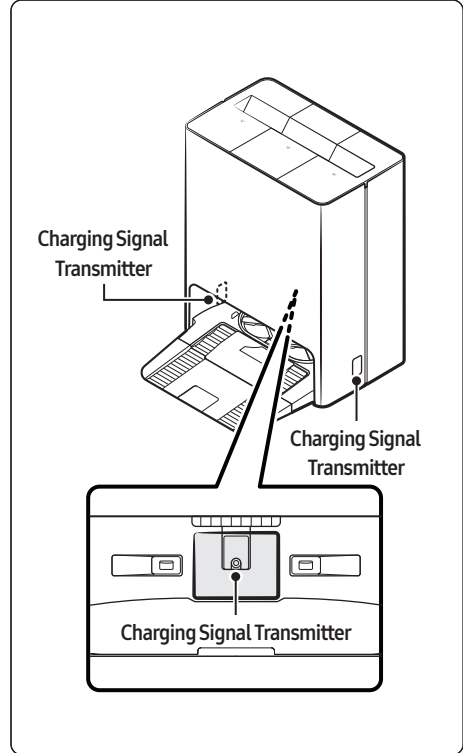

Troubleshooting

Voice Guidance Checklist

1. The Status Indicator turns red and blinks with a Voice guidance.
2. Press the Reset button and check the instructions below and take appropriate actions.
3. When pressing the Reset button of the Jet Bot Combo, the Status Indicator turns white.

Voice Guidance	Checklist
It's difficult to move. Please move me somewhere else.	The Jet Bot Combo is caught, stuck or trapped while moving around. <ul style="list-style-type: none">• Set the Jet Bot Combo as Power-Saving Mode and move it to another area.
Please remove the brush and take out whatever's stuck in there.	Foreign matter caught in the brush <ul style="list-style-type: none">• Set the Jet Bot Combo as Power-Saving Mode and remove the foreign matter from the brush.
Something's stuck in the side brush. Please remove it.	Foreign matter caught in the Spin Brush <ul style="list-style-type: none">• Set the Jet Bot Combo as Power-Saving Mode and remove the foreign matter from the Spin Brush.
Please check the left wheel to see if there's something stuck in it.	Foreign matter caught in the left Driving Wheel <ul style="list-style-type: none">• Set the Jet Bot Combo as Power-Saving Mode and remove the foreign matter from the left Driving Wheel.
Please check the right wheel to see if there's something stuck in it.	Foreign matter caught in the right Driving Wheel <ul style="list-style-type: none">• Set the Jet Bot Combo as Power-Saving Mode and remove the foreign matter from the right Driving Wheel.
Something is caught in the left Mop.	Foreign matter caught in the left Mop <ul style="list-style-type: none">• Set the Jet Bot Combo as Power-Saving Mode and remove the foreign matter by detaching the Mop Spin board.
Something is caught in the right Mop.	Foreign matter caught in the right Mop <ul style="list-style-type: none">• Set the Jet Bot Combo as Power-Saving Mode and remove the foreign matter by detaching the Mop Spin board.
Something's wrong with the front bump sensors. Please open the cover and check. The bumper might be jammed, or there might be something stuck in there.	Bump Sensor needs to be checked. <ul style="list-style-type: none">• Press the Reset button to turn it back on.• When the Status Indicator remains in red color and blinks, check if there's any small foreign matter between the bumper and the main body. If there is, remove the foreign matter.
Something's wrong with the LiDAR bump sensor. The LiDAR cap might be jammed, or there might be something stuck in there.	Bump Sensor needs to be checked. <ul style="list-style-type: none">• Press the Reset button to turn it back on.• When the Status Indicator remains in red color, check if there's any foreign matter between the LiDAR sensor and the main body. If there is, remove the foreign matter.
Can't see anything. Please clean the front with a soft cloth.	Foreign matter accumulated on the Obstacle Sensor Window. <ul style="list-style-type: none">• Set the Jet Bot Combo as Power-Saving Mode and clean the Obstacle Sensor Window at the front with a soft cloth.

Troubleshooting

Voice Guidance	Checklist
Something's wrong with the cliff sensor. Please clean the 4 small black windows underneath with a soft cloth.	Foreign matter accumulated on the Cliff Sensor <ul style="list-style-type: none"> Set the Jet Bot Combo as Power-Saving Mode and clean the 4 small black windows underneath with a soft cloth.
Please insert the bin so cleaning can start.	Dustbin is not inserted. <ul style="list-style-type: none"> Detach the Dustbin and insert it again.
The LIDAR sensor needs to be reset. Press the Reset button to turn it on again. If that doesn't fix it, contact Customer Service.	There is a problem with the LiDAR sensor <ul style="list-style-type: none"> Press the Reset button to turn it back on. If the notice remains, contact Customer Service.
Something's wrong with the main system. Press the Reset button to turn it on again. If that doesn't fix it, contact Customer Service.	There is a problem with the main system <ul style="list-style-type: none"> Press the Reset button to turn it back on. If the notice remains, contact Customer Service.
Robot vacuum is in a no-go zone and can't move. Move it out of this zone.	The result of the location recognition indicates that the Jet Bot Combo is placed within the No-go Zones. <ul style="list-style-type: none"> Check the No-go Zones of the mobile App.
The 3D sensor needs to be reset. Press the Reset button to turn it on again. If that doesn't fix it, contact Customer Service.	There is a problem with the 3D sensor <ul style="list-style-type: none"> Press the Reset button to turn it back on. If the notice remains, contact Customer Service.
The object recognition sensor needs to be reset. Press the Reset button to turn it on again. If that doesn't fix it, contact Customer Service.	There is a problem with the object recognition sensor <ul style="list-style-type: none"> Press the Reset button to turn it back on. If the notice remains, contact Customer Service.
The monitoring camera needs to be reset. Press the Reset button to turn it on again. If that doesn't fix it, contact Customer Service.	There is a problem with the monitoring camera sensor <ul style="list-style-type: none"> Press the Reset button to turn it back on. If the notice remains, contact Customer Service.
The AI processor isn't working properly. Press the Reset button to turn it on again. If that doesn't fix it, contact Customer Service.	<ul style="list-style-type: none"> Press the Reset button to turn it back on. If the notice remains, contact Customer Service.
Reset the battery connection by pressing the Reset button to turn it on again. If you hear this message again after that, contact Customer Service.	There is problem with the battery connection. <ul style="list-style-type: none"> Press the Reset button to turn it back on. If the notice remains, contact Customer Service.
Something went wrong with the battery connection. Reinsert the battery or press the Reset button to turn it on again. If you hear this message again after that, contact Customer Service.	There is problem with the battery connection. <ul style="list-style-type: none"> Press the Reset button to turn it back on. If the notice remains, contact Customer Service.
Please attach the Waste Water Tank.	<ul style="list-style-type: none"> Insert the Waste Water Tank
Insert the Washing space.	<ul style="list-style-type: none"> Insert the Tub.
The Washing space is full.	<ul style="list-style-type: none"> Empty out the Tub.
The Washing space of the Clean Station is full, so the station can't wash the robot vacuum's Mop. Empty the Washing space.	<ul style="list-style-type: none"> Empty out the Tub.
There's no Clean Water Tank in the Clean Station, so the station can't wash the robot vacuum's Mop. Insert a Clean Water Tank and start again.	<ul style="list-style-type: none"> Insert the filled Clean Water Tank and restart the cleaning.

Voice Guidance	Checklist
There's no Waste Water Tank in the Clean Station, so the station can't wash the robot vacuum's Mop. Insert a Waste Water Tank and start again.	<ul style="list-style-type: none"> • Insert the Waste Water Tank and restart the cleaning.
There's no washing plate in the Clean Station, so it can't wash the robot vacuum's mop. Check if it's installed correctly and start again.	<ul style="list-style-type: none"> • Insert the Washing Plate and restart the cleaning.
The Clean Water Tank of the Clean Station is empty, so it can't wash the robot vacuum's mop. Fill it with water and start again.	<ul style="list-style-type: none"> • Fill the water and restart the cleaning.
The Waste Water Tank of the Clean Station is full, so the station can't wash the robot vacuum's Mop. Empty it and start again.	<ul style="list-style-type: none"> • Empty out the water and restart the cleaning.
The Washing space of the Clean Station is full, so the station can't wash the robot vacuum's Mop. Empty it and start again.	<ul style="list-style-type: none"> • Empty out the water and restart the cleaning.
A leak was detected in the Clean Station, so the station can't wash the robot vacuum's Mop. If the error persists, contact Customer Service.	<ul style="list-style-type: none"> • If the same problem occurs continuously, contact Customer Service.
There's no Clean Water Tank in the Clean Station, so the station can't wash the robot vacuum's Mop. Insert a Clean Water Tank	<ul style="list-style-type: none"> • Insert the filled Clean Water Tank.
There's no Waste Water Tank in the Clean Station, so the station can't wash the robot vacuum's Mop. Insert a Waste Water Tank.	<ul style="list-style-type: none"> • Insert the Waste Water Tank.
There's no washing plate in the Clean Station, so the station can't wash the robot vacuum's Mop. Install the plate properly.	<ul style="list-style-type: none"> • Insert the Washing Plate.
The Clean Water Tank of the Clean Station is empty, so it can't wash the robot vacuum's mop. Fill it with water.	<ul style="list-style-type: none"> • Fill the water.
The Waste Water Tank of the Clean Station is full, so the station can't wash the robot vacuum's Mop. Empty it.	<ul style="list-style-type: none"> • Empty out the water.
The Washing space of the Clean Station is full, so the station can't wash the robot vacuum's Mop. Empty it.	<ul style="list-style-type: none"> • Empty out the water.

- You can find details of the check at the SmartThings App.

Troubleshooting





Corrective measures before reporting a problem

If the product is not faulty, a service fee may be charged, therefore make sure to read the manual thoroughly.

Symptom	Checklist
The Jet Bot Combo is not working at all.	<ul style="list-style-type: none"> • Check if the Status Indicator is on. • Check if the Jet Bot Combo's battery is depleted. • When the Jet Bot Combo's Status Indicator turns red and stays red, place the Jet Bot Combo manually on the Clean Station to charge it. • When you manually charge the Jet Bot Combo due to complete discharge of its battery, the buttons on the Jet Bot Combo do not work. When charging is partially complete (about 10-20 minutes later), the Status Indicator is on and the buttons work again.
The Jet Bot Combo has stopped during cleaning.	<ul style="list-style-type: none"> • When the Jet Bot Combo's Status Indicator turns red and stays red, place the Jet Bot Combo manually on the Clean Station to charge it. • When the Jet Bot Combo is immobilized by an obstacle such as a cord, obstacles, threshold, a raised spot, etc., pick it up and move it away from the obstacle. <ul style="list-style-type: none"> - If any fabric or string is caught in a Driving Wheel, set the Jet Bot Combo as Power-Saving Mode and remove the fabric or string before using it again. • Check whether the No-go Zones are set.
Suction power is weak.	<ul style="list-style-type: none"> • When there's too much dust in the Dustbin, suction power may get weakened. Set the Jet Bot Combo as Power-Saving Mode and empty the Dustbin. • If the brush at the bottom of the Jet Bot Combo is blocked by foreign matter, set the Jet Bot Combo as Power-Saving Mode and remove foreign matter from the brush. • When noise suddenly increases, set the Jet Bot Combo as Power-Saving Mode and empty the Dustbin.
The Jet Bot Combo cannot find the Clean Station.	<ul style="list-style-type: none"> • Check if there's a power failure or whether the power plug is unplugged. • Remove any obstacles around the Clean Station that may prevent the Jet Bot Combo from returning to the Clean Station. • When there's foreign matter on the charging terminals, clean them with a soft cloth, as charging can be affected. • Clean the foreign matter off the terminals.
Something's wrong with the Mops.	<ul style="list-style-type: none"> • Check if there's foreign matter by detaching the Mop Spin board.
The Mops don't operate properly.	<ul style="list-style-type: none"> • Check if there's foreign matter by detaching the Mop Spin board and resume cleaning. • If the same problem occurs continuously, contact Customer Service.
The Jet Bot Combo is cleaning in Dust Suction Mode although it is set as Mop/Mop + Dust Suction cleaning Mode.	<ul style="list-style-type: none"> • When the Mop Spin board is not assembled, the mode changes to Mop/Mop + Dust Suction cleaning Mode and starts cleaning. • Check if both sides of the Mop Spin board are attached. • If the same problem occurs continuously, contact Customer Service.

Symptom	Checklist
The Jet Bot Combo suddenly cleans diagonally.	<ul style="list-style-type: none"> • Check if the Clean Station is installed along the grain of wooden floors or tiles. • The Jet Bot Combo may clean in a diagonal direction if it is moving to another area using the shortest route. It may also move at a diagonal if it did not make contact with an obstacle at a right angle, if it was charged in a skewed direction at the Clean Station, or If the floor material is wooden or tile.
Jet Bot Combo does not clean some places.	<ul style="list-style-type: none"> • Check whether the Clean Station is installed in a narrow passage or near a room door and move it to another place. <ul style="list-style-type: none"> - If the Clean Station is installed in a narrow passage or near a room door, the Jet Bot cannot pass through the passage or the door. • Check whether the places the Jet Bot does not clean are set as No-go Zones.
The Jet Bot Combo cannot find a room.	<ul style="list-style-type: none"> • If the Jet Bot Combo does not start cleaning from the Clean Station, or if the Clean Station is reinstalled to a new position of 45 degree or 1 m or more from the previous installed place, the Jet Bot Combo cleans all areas, which is not based on the created map. <ul style="list-style-type: none"> - Start cleaning from the Clean Station. - When the Jet Bot Combo creates a map and the Jet Bot Combo starts cleaning, make sure the Jet Bot Combo starts operating parallel to the wall. - Remove obstacles within 0.5 m of the left and right side and 1 m of the front side of the Clean Station.
The map which the Jet Bot Combo has created is different from the saved map and the map is also drawn askew.	
The Jet Bot Combo does not detect and crosses No-go Zones.	<ul style="list-style-type: none"> • If the Jet Bot Combo does not start cleaning from the Clean Station, the set No-go Zones function does not work. Therefore, start cleaning from the Clean Station to use the function.
The Intelligent Power Control function works on a normal floor.	<ul style="list-style-type: none"> • Check whether the floor is not even and then the Jet Bot Combo works with its body a bit lifted up. • Check whether there are any foreign matter on the Cliff Sensor which is at the bottom of the Jet Bot Combo. • Check whether the floor color is dark.
The Intelligent Power Control function does not work.	<ul style="list-style-type: none"> • When the Jet Bot Combo cleans a carpet with short fiber and bright color, it may recognize the carpet as a floor and then the Intelligent Power Control function may not work.
The Jet Bot Combo makes a squeaking sound while cleaning.	<ul style="list-style-type: none"> • Check whether the brush cover on the bottom is properly assembled. • The rubber that sweeps away dust may make a sound due to friction with the floor, however it will disappear after a certain period of time. • If the same problem occurs continuously, contact Customer Service.
SmartThings App cannot be installed.	<ul style="list-style-type: none"> • To check the compatibility of the SmartThings App with your smartphone, visit 'Play Store' or 'App Store'. • The supporting OS version for the SmartThings App may change later. • For rooted smart devices, standard installation and use will not be guaranteed.

Troubleshooting

Symptom	Checklist
I have installed the SmartThings App, but the Jet Bot Combo fails to be connected.	<ul style="list-style-type: none"> Connect the Jet Bot Combo to a wireless router by referring to the 'SmartThings App' of the user manual.
I fail to log into the SAMSUNG account.	<ul style="list-style-type: none"> Check your ID and password on the screen of the SAMSUNG account.
During product registration, the wireless router I want to connect cannot be searched.	<ul style="list-style-type: none"> Cancel the product registration, run the SmartThings App again, and try the product registration again.
During product registration, the password of the connecting wireless router is not input correctly.	<ul style="list-style-type: none"> Cancel the product registration, run the SmartThings App again, and try the product registration again. Press and hold the wireless router you want to connect on the network list, and delete the network to initialize the password.
During product registration,  button is pressed and held as instructed but the next step does not appear	<ul style="list-style-type: none"> Press the  button until you hear it beep. If the next step does not appear within seconds, press  once more. In the case of iOS, hold down the  button on the Jet Bot Combo for at least 3 seconds and then select the 'Next' button on the screen.
A message of the product registration failure appears.	<ul style="list-style-type: none"> Try the product registration procedure again by referring to the pop-up messages. Please refer to the "Setting up the wireless router" in the user manual. Please refer to the steps for completing the product registration in the user manual section "Registering a device to the SmartThings App". When the product registration fails repeatedly, restart the SmartThings App and try the product registration. The SAMSUNG account for both App log in and the product registration must be the same. All users should use the SAMSUNG account issued by the country which launches the product.
The Jet Bot Combo is not connected to Wi-Fi.	<ul style="list-style-type: none"> Check the setting status of the wireless router.
Even though the Jet Bot Combo is connected to a smartphone without a problem, the Jet Bot Combo does not work with the smartphone.	<ul style="list-style-type: none"> Try turning off the SmartThings app and turning it back on, or disconnect and reconnect the smartphone and the wireless router. Alternatively, press the  button on the Jet Bot Combo to put it into Power-Saving Mode, then turn it off, wait a few minutes, and then turn on the SmartThings app again.
The Jet Bot Combo on the SmartThings App fails to start.	<ul style="list-style-type: none"> Check if the Jet Bot Combo is offline status on the SmartThings App. Connect the wireless router to Jet Bot again by referring to the 'SmartThings App' on the manual.

Symptom	Checklist
<p>The 'Offline' message of the Jet Bot Combo appears on the SmartThings App though the Jet Bot Combo's registration has completed without a problem.</p>	<ul style="list-style-type: none"> • Close the SmartThings App and then run it again. • Check whether there is an internet connection problem of the wireless router. Especially, a firewall may interrupt standard operation.
<p>The 'Offline' message of the Jet Bot Combo appears on the SmartThings App during normal operation of the App.</p>	<ul style="list-style-type: none"> • If the Jet Bot Combo is distant from a wireless router, connection cut may occur. • Close the SmartThings App and restart the App. • If the connection cut occurs repeatedly, try the product registration again. • When the SSID/password of a wireless router is changed, try the product registration again. • Check whether the Jet Bot Combo is in the Power-Saving Mode. Press the ▷ to cancel the Power-Saving Mode.
<p>A map cannot be saved.</p>	<ul style="list-style-type: none"> • To create a map, you need to register the device first and then start creating a map with the SmartThings App. • When the Jet Bot Combo starts cleaning from the Clean Station and completes cleaning one time in Auto Clean, a map is saved.
<p>When controlling with a smartphone, a response is delayed.</p>	<ul style="list-style-type: none"> • If the Jet Bot Combo and the smartphone are not connected to the same wireless router, a response can be delayed depending on the network environment.

Appendix

Product Specification



Classification	Items	VR7MD97714*	VR7MD96514*
Mechanical specifications	Weight	Jet Bot Combo : 4.8 kg	
		Clean Station : 14.0 kg	
	Size (mm) (Width X Height X Depth)	Jet Bot Combo : 359 X 100 X 364	
		Clean Station : 444 X 547 X 510	
Cleaning Methods	LiDar Location detection		
Button Methods	Touch type		
Electrical specifications	Power consumption	Jet Bot Combo : 70 W (Spot Cleaning) Clean Station : 1200 W	
	Battery specification	Lithium-ion 14.4 V / 63.36 Wh	
Cleaning part	Cleaning functions	Auto Clean, Room Clean, Spot Cleaning, The robot cleans by area	Auto Clean, Room Clean, Spot Cleaning
	Additional functions	Energy-Saving Mode, Downtime Mode, Scheduled Cleaning, No-go Zones, The Home monitoring, Pet care service, Bixby Voice Recognition	Energy-Saving Mode, Downtime Mode, Scheduled Cleaning, No-go Zones
	Charging time	Dust suction + Mopping / Mop : About 300 minutes Dust Suction : About 240 minutes	
	Charging type	Auto charging / Manual charging	
Wi-Fi	Frequency range	2412 - 2472 MHz	
	Transmitter power (Max)	20 dBm	
Bluetooth (BLE)	Frequency range	2402 - 2480 MHz	
	Transmitter power (Max)	20 dBm	

Usage Time

Suction Mode	Suction Power	Usage Time
Dust suction + Mopping	Max	About 70 minutes
	Smart	About 80 minutes
	Normal	About 80 minutes
	Quiet	About 150 minutes
Dust Suction	Max	About 110 minutes
	Smart	About 110 minutes
	Normal	About 120 minutes
	Quiet	About 180 minutes
Mop	-	About 130 minutes

NOTE

Charging and usage time may differ depending on the conditions of use.

If you have any questions or comments relating to SAMSUNG products, please contact the SAMSUNG customer care center.

Country	Customer Care Center	Web Site
CANADA	1-800-SAMSUNG (726-7864)	www.samsung.com/ca/support (English) www.samsung.com/ca_fr/support (French)
U.S.A	1-800-SAMSUNG (726-7864) 1-844-SAM-PAYS (726-7297)	www.samsung.com/us/support

