

# Conference Proceedings 10<sup>th</sup> International Conference on Hand-Arm Vibration

7-11 June 2004

Flamingo Hilton Resort  
Las Vegas, Nevada, USA



Douglas D. Reynolds, Ph.D. (Editor)



## **Welcome to Las Vegas, the entertainment capital of the world:**

The 10th International Hand-Arm Vibration Conference will be the second time this international conference has been hosted in the US. The first was the 2nd International Hand-Arm Vibration Conference, which was held in Cincinnati, Ohio, in 1975.

Hand-arm vibration syndrome (HAVS) was first identified in the US in the small Midwestern town of Bedford, Indiana, in 1918. Dr. Alice Hamilton, the first American physician to devote her life to the practice of industrial medicine, was summoned to Bedford at the request of limestone quarry cutters and carvers who used pneumatic hammers and other similar tools. After daily use of their tools, these workers complained of tingling and/or numbness in their fingers (paraesthesia) often followed by painful attacks of finger blanching. The finger blanching increased in severity and duration with increased exposure to hand-induced vibration from their tools. Dr. Hamilton's study in 1918 was one of the first to establish a relationship between Raynaud's Phenomenon (of occupational origin) and the use of vibrating hand-held tools.

Dr. William Taylor hosted the 1st International Hand-Arm Vibration Conference in Dundee, Scotland, in 1972. He wanted to establish an international forum to publicly present and discuss the results of research that addressed the medical, epidemiological, engineering, and legal aspects of HAVS. Since then, international conferences have been held in Cincinnati (1975), Ottawa (1981), Helsinki (1985), Kanazawa (1989), Bonn (1992), Prague (1995), Umea (1998), and Nancy (2001). All of these conferences have significantly contributed to the body of knowledge and public awareness of the many issues related to HAVS. The published proceedings from these conferences have become blueprints for assessing the prevalence of HAVS in worker populations, for developing national and international standards related to hand-arm vibration, and for developing ergonomic and engineering strategies for reducing the number of cases of HAVS in worker populations.

Research results presented at previous international hand-arm vibration conferences have significantly enhanced our understanding of the medical, epidemiological, and engineering aspects of hand-arm and hand tool vibration. This understanding has been essential to the development of strategies for reducing worker exposure to hand-transmitted vibration and for decreasing the prevalence of HAVS in worker populations. However, much work still remains. We hope to continue this tradition of knowledge transfer at the 10th International Hand-Arm Vibration Conference in Las Vegas.

The upcoming conference will run for five days instead of the usual four. During this time, there will be fourteen technical sessions devoted to presenting the results of research from researchers around the world. As a means of hopefully attracting more tool manufacturers and other practitioners in fields related to hand-arm and hand tool vibration to the conference, there will be four tutorial sessions. These sessions will be designed to educate practitioners in areas related to the medical, ergonomic, testing, engineering, and legal aspects of HAVS.

On behalf of the Local Committee, the International Advisory Committee, and others who will assist in sponsoring the 10th International Hand-Arm Vibration Conference, I wish to extend to you a cordial invitation to come to Las Vegas in June 2004.

I look forward to seeing you in Las Vegas in 2004

A handwritten signature in black ink that reads "Douglas D. Reynolds". The signature is written in a cursive, flowing style.

Douglas D. Reynolds, Ph.D.  
Chair of the International Advisory Committee

**© Copyright 2006 Douglas D. Reynolds**

All rights reserved. No part of this publication may be reproduced, stored in a retrieval system, or transmitted, in any form or by any means, electronic, mechanical, photocopying, recording, or otherwise, without the written prior permission of the editor and of the authors of the respective papers published in this conference proceedings.

## Conference Technical Sponsors

**Center for Mechanical & Environmental Systems Technology  
Howard R. Hughes College of Engineering  
University of Nevada, Las Vegas  
Las Vegas, Nevada, USA**

**National Institute for Occupational Safety and Health  
Center for Disease Control  
Morgantown, West Virginia, USA**

## Conference Corporate Sponsors

**Brüel & Kjær**

**Chase Ergonomics**

**Impacto Protective Products**

**Larson Davis**

**Quest**

**Svantek**

Conference Organizer  
Center for Mechanical & Environmental Systems Technology (CMEST)  
University of Nevada, Las Vegas

Local Committee

Douglas D. Reynolds, Chair  
Martin Cherniak  
Ren Dong  
Tom Jetzer  
Linda Reynolds  
Donald Wasserman  
Jack Wasserman

International Advisory Committee

Makoto ARIIZUMI, Japan	Nokolai IZMEROV, Russia
Massimo BOVENZI, Italy	Ladislav LOUDA, Czech Republic
Antony BRAMMER, Canada	Ronnie LUNDSTROM, Sweden
Eberhard CHRIST, Germany	Setsuo MAEDA, Japan
Patrice DONATI, France	Bernard MARTIN, U.S.A.
Heinrich DUPUIS, Germany	Akira OKADA, Japan
Makoto FUTATSUKA, Japan	Illmari PYYKKO, Finland
Gosta GEMNE, Sweden	Douglas REYNOLDS, U.S.A.
Michael GRIFFIN, U.K.	Jukka STARCK, Finland

Place and Date

Flamingo Las Vegas Resort, Las Vegas, Nevada, USA  
7-11 June, 2004

Conference Secretariat

**Scientific Secretariat:**

Douglas REYNOLDS  
Center for Mechanical & Environmental  
Systems Technology  
University of Nevada, Las Vegas  
4505 Maryland Parkway  
Las Vegas, NV 89154-4040, USA

Telephone: +1 702 895 3807  
Fax: +1 702 895 4677  
Email: reynolds@clark.nscee.edu

**Registration:**

Linda REYNOLDS  
Secretariat Conference HAV 2004  
3939 Briarcrest Court  
Las Vegas, NV 89120-1305, USA

Telephone +1 702 458 1681  
Fax: +1 702 454 0085  
Email: lkr@fremont.vegasnet.org

**Web Site:** [www.cmest.unlv.edu](http://www.cmest.unlv.edu)

# TABLE OF CONTENTS

<b>Welcome to Las Vegas, the entertainment capital of the world .....</b>	<b>iii</b>
<b>Conference Technical Sponsors.....</b>	<b>v</b>
<b>Conference Corporate Sponsors.....</b>	<b>v</b>
<b>Conference Organizer .....</b>	<b>vi</b>
<b>Local Committee.....</b>	<b>vi</b>
<b>International Advisory Committee .....</b>	<b>vi</b>
<b>Place and Date.....</b>	<b>vi</b>
<b>Conference Secretariat.....</b>	<b>vi</b>
<b>TABLE OF CONTENTS .....</b>	<b>vii</b>
<b>Occupational Hand-Arm Vibration in the U.S. ....</b>	<b>1</b>
A Unique Historical Perspective of Occupational Hand-Arm Vibration in the U.S. from 1918-2004; .....	3
D. Wasserman, D. Reynolds	
<b>Medical I – Focus Session (G. Gemne - Session Coordinator).....</b>	<b>11</b>
The Relationship Between the Stockholm Scale and Clinical Neurological Tests in the Assessment.....	13
of the Sensorineural Component of Hand-Arm Vibration Syndrome; R. House, M. Wills, L. Lander	
Risks of Occupational Exposures to Hand-transmitted Vibrations: VIBRISKS; M. J. Griffin, C. H. Lewis,.....	15
M. Bovenzi, P. Lemerle, R. Lundström	
Questions and Tests Useful in the Diagnosis of HAVS; H. Mason, J. Elms, K. Poole.....	21
<b>Medical II – Epidemiology 1 – Cross-Sectional Studies (M. Bovenzi - Session Coordinator).....</b>	<b>31</b>
Disability in the Upper Extremity and Quality of Life in Hand-Arm Vibration Syndrome; K. Poole, H. Mason.....	33
Neurological, Vascular and Musculoskeletal Symptoms in Hands, Fingers and Upper Extremities Among .....	45
Drivers of Terrain Vehicles; C. Åström, B. Rehn, L. Larsson, R. Lundström, T. Nilsson, G. Sundelin	
Hand-Arm Vibration Syndrome Among Quarry Workers in Vietnam; M. Futatsuka, M. Shono, H. Sakakibara, .....	47
P. Quan	
Relation Between Hand-Arm Vibration Exposure and Symptoms Among Workers Within .....	53
Heavy-Engineering Production Workshop; L. Burström, M. Hagberg, R. Lundström, T. Nilsson	
<b>Medical III – Epidemiology 2 – Perspective &amp; Population Studies (N. Harada - Session Coordinator).....</b>	<b>57</b>
Prospective Versus Retrospective Incidence of Raynaud’s Phenomenon and the Relation to Vibration .....	59
Exposure; M. Hagberg, L. Burström, R. Lundström, T. Nilsson	
A 13 Year Revisit of a Shipyard Characterized by High Levels of Vibration-Induced Disease; M. Cherniack,.....	61
T. F. Morse, A.J. Brammer, R. Lundstrom, J. Meyer, G . Neely,T. Nilsson, D. Peterson, E. Toppila, N. Warren, R.W. Fu, H. Bruneau, M. Croteau	
A Longitudinal Study of Vibration-Induced White Finger in Compensation Claimants; M. Bovenzi, .....	63
A. D. Vedova, C. Negro	

Segmental Nerve Conduction Velocity in a Vibration Exposed Population; M. Cherniack, A.J. Brammer,.....	71
R. Lundstrom, J. Meyer, T. F. Morse, G. Neely, T. Nilsson, D. Peterson, E. Toppilla, N. Warren, R. W. Fu, H. Bruneau	
Effect of Vibration-Induced Peripheral Nerve Injury on Axoplasmic Transport; J. Yan, H. S. Matloub, .....	73
J. R. Sanger, L. Zhang, D. A. Riley	
<b>Measurement I – Focus Session (P. Pitts - Session Coordinator) .....</b>	<b>75</b>
Metrics for Hand-Arm Vibration Exposure; A.J. Brammer .....	77
Exposure Evaluation and Risk Assessment for Hand-Arm Vibration; C. Nelson.....	79
Measurement of Hand-Transmitted Vibration Exposures; S. Maeda, R. G. Dong .....	89
<b>Measurement II (R. Dong - Session Coordinator) .....</b>	<b>95</b>
Modeling and Verification of Influencing Factors in Hand-Arm Vibration Measurements; M. Gasparetto, .....	98
G. Moschioni, B. Saggin, M. Tarabini	
Developing Measuring Strategies for Unusual Workplaces; U. Kaulbars .....	105
Uncertainty in Human Vibration Measurement: Instrumentation and Measurement Issues; P. M. Pitts .....	111
Examples of a Measurement Artifact; the ‘dc Shift’; G. S. Paddan .....	119
Frequency Weighting of Hand-Arm Vibration, Y. Tominaga .....	127
<b>Medical IV – Vibrotactile Thresholds (M. Cherniack - Session Coordinator).....</b>	<b>137</b>
Reference Vibrotactile Perception Thresholds on the Fingertip Obtained with Malaysian Healthy People .....	139
Using ISO 13091-1 Equipment; R. Daud, S. Maeda, N. N. M. Kameel, M. Y. Ripin, N. Bakrun, R. Zein, M. Kido, K. Higuchi	
Provoked Responses in Tactile Perception from Exposure to Simulated Power Tool Vibration; D.R. Peterson .....	145
A.J. Brammer, M.G. Cherniack	
Effect of Handle Temperature on Temporary Threshold Shift of Fingertip Vibration Sensation Induced by Acute....	147
Vibration Exposure; K. Yokoyama, Y. Takahashi, M. Inoue, M.S. Laskar, M.H. Mahbub, T. Nakayama, H. Ohnari, N. Harada	
Changes in Vibrotactile Perception with Manual Work: A Prospective Study of Forestry Workers; A.J. Brammer, ..	153
P.Sutinen, I. Pyykkö, E. Toppilla, J. Starck	
<b>Measurement III (S. Maeda - Session Coordinator).....</b>	<b>155</b>
Analysis of Fingertip/Probe Interaction in the Vibrotactile Tests; J. Z. Wu, R.G. Dong, A.W. Schopper .....	157
An Investigation of the Relationship between Vibration-Induced White Finger and Power Absorption; R.G. Dong, .	161
T.W. McDowell, D.E. Welcome, J.Z. Wu	
A Pilot Study of Glove Effects on a Force Matching Method; T.W. McDowell, R.G. Dong, D.E. Welcome .....	169
Design of a New Instrumented Glove for the Measurement of the Contact Pressure Distribution at the Hand.....	175
Handle Interface; D. Feutry, P. Lemerle, L. Claudon	
<b>Tool Design I – Focus Session (J. Wasserman - Session Coordinator).....</b>	<b>179</b>
Modeling the Vibration Characteristics of Pneumatic Hammers; W. Bloxson, D. Reynolds .....	181
Method for Assessing the Reduction of Risks of Musculo-skeletal Disorders Achieved by an Ergonomic Design of	195
Vibrating Tools; E. Christ.	
Evaluation of Instrumentation for Measuring Biodynamic Responses of the Hand-Arm System; D.E. Welcome, .....	203
R.G. Dong, T.W. McDowell, J.Z. Wu	



<b>Tool Design II – Mechanical Impedance (E. Christ - Session Coordinator) .....</b>	<b>207</b>
A Comparison of Anthropomorphic Model Responses of Human Hand-Arm Systems; K.K. Sinha, A. Shanker .....	209
A Comparison of Reported Mechanical Impedance Data of the Human Hand-Arm system; R.G. Dong, C. Warren, D.E. Welcome, J.Z. Wu	221
Mechanical Impedance Characteristics of the Hand and Arm; A. K. Moustafa, D. Reynolds.....	229
Influence of Handle Size and Shape on the Biodynamic Response of the Hand-Arm System; P. Marcotte, Y. Aldien, P. É. Boileau, S. Rakheja and J. Boutin	231
Influence of Hand Forces and Handle Size on Human Hand-Arm Vibration Absorbed Power; P. Marcotte, Y. Aldien, P. É. Boileau, S. Rakheja and J. Boutin	233
<b>Medical V – Vascular/Physiology (N. Olsen - Session Coordinator).....</b>	<b>235</b>
Hand-Transmitted Vibration at One Hand Causes Temporary Shifts of Skin Temperatures at the Fingertips of Both Hands; K. Nishiyama, K. Taoda	237
Changes of Peripheral Circulation by Silver Spike Point Therapy Among Workers Exposed to Hand-Arm Vibration; S. Sakaguchi, N. Miyai, H. Yamamoto, Y. Minami, K. Terada, K. Tomida, I. Morioka, K. Miyashita	243
Effects of Cold-Stress Test Using Different Covering Methods on Heart Rate Variability in Healthy Subjects; M Inoue, K Suizu, M Yoshimura, S Shirono, H Morita, H Kan, S Yamamoto, N Harada	249
Impaired Manipulative Dexterity and Hand Functional Difficulties in Patients with Hand-Arm Vibration Syndrome; H. Sakakibara, H. Mamoru, N. Toibana	255
Is There a Relation Between Exposure to Hand-Arm Vibration and Myocardial Infarction?; L. Burström, T. Nilsson, C. Reuterwall	257
<b>Measurement IV (T. Bremmer - Session Coordinator).....</b>	<b>261</b>
Work Computer for Prevention of Over Exposure to Hand-Transmitted Vibration; S. Maeda	263
Hand-Arm Vibration Exposure from Hydraulic Tools Used in U.S. Railroad Maintenance-of-Way Track Operations; D.E. Wasserman, J.F. Wasserman, L. Mullinix, D. Logsdon	267
Effect of Push/Pull Force on Perception of Vibration at a Steering Wheel; R. A. Haasnoot, N.J. Mansfield	287
Tool Testing Using Resistance Sensors – Preparing for Glove Testing; J. Wasserman, D. Logston, D. Wasserman, S. T. Kandala	295
<b>Legal – Focus Session (T. Jetzer - Session Coordinator).....</b>	<b>307</b>
A Medical Assessment Process for a Large Number of Miners and Ex-Miners with Compensation Claims for Hand-Arm Vibration Syndrome; K.L. McGeoch, I.J. Lawson, F. Burke, G. Proud, J. Miles	309
Adjudication and Worker’s Compensation of Hand-Arm Syndrome in Quebec: Unresolved problems; S. Roy, P. Duguay, P. Massicotte, P.-É. Boileau, A. Simpson	319
Hand-Arm Vibration Syndrome: An Analysis of Occupational Morbidity from a State Compensation Database; C. J. Martin, S. Edla	321
Hand-Arm Vibration Syndrome: Health Promotion, Education and Follow-up; L. Brown, I. Kudla, Ron House, M. Wills, P. Pelmeur	323
<b>Measurement V (N. Mansfield - Session Coordinator) .....</b>	<b>325</b>
Magnitude Dependence of Equivalent Comfort Contours for Vertical Hand-Transmitted Vibration; M. Morioka, M. J. Griffin	327
Rats Will Work with Vibrating Tools: New Avenues for Animal-Based HAVS Research; W. G. Lindsley, T. R. Wade, and K. Krajnak	333

Evaluation of Finger Skin Blood Flow in Workers Exposed to Hand-Arm Vibration Using Laser Doppler ..... 337 Perfusion Imaging; N. Miyai, K. Terada, K. Tomida, S. Sakaguchi, Y. Minami, H. Yamamoto, I. Morioka, K. Miyashita	337
The Effects of Finger Force and Visual Distractions on the Measurement of Thermal Perception Thresholds; ..... 343 W. P. Smutz, A.W. Schopper, D.E. Welcome, R.G. Dong, M.E. Andrew	343
<b>Medical VI – Hand-Arm Vibration in Women (S. Yamada - Session Coordinator) ..... 345</b>	<b>345</b>
Reference Values of Vibrotactile Perception Thresholds at the Fingertips for Women; B. Harazin, J. Kuprowski, ... 347 A. Harazin-Lechowsk, V. Socholik	347
Work-Related Disorders of the Upper Limb in Female Workers Using Orbital Sanders; M. Bovenzi, P. Nataletti,.... 355 B. Alessandrini, Tullio Poian	355
Women Injured by Hand-Arm Vibration – Who Cares?; S. H. Bylund..... 365	365
<b>Medical VII – Blood Pressure/Blood Flow (M. Griffin - Session Coordinator) ..... 367</b>	<b>367</b>
The Effect of Vibration Exposure on the Function of Arteriole and Artery of the Finger; N. Olsen..... 369	369
Influence of Room Temperature on Finger Systolic Blood Pressure Response to Finger Cooling in Healthy ..... 375 Subjects; M.S. Laskar, K. Ohmura, M. Inoue, K. Yokoyama, J. Inagaki, Y. Takahashi, M.H. Mahbub, H. Ohnari, N Harada	375
Effects of Impulsive Vibration on Human Red Blood Cells; H. Ando, T. Ishitake, K. Nieminen, E. Toppila, ..... 383 J. Starck	383
Effect of Vibration Magnitude and Push Force on Finger Blood Flow; A. J. L. Welsh, M. J. Griffin ..... 389	389
<b>Prevention I – Focus Session (D. Wasserman - Session Coordinator) ..... 399</b>	<b>399</b>
Development of Prevention Strategy for Hand-Arm Vibration Disorder in Japan; S. Yamada..... 401	401
Plans for Effective Implementation of the European Vibration Directive; C. Nelson, P. Brereton ..... 407	407
Effective Intervention with Ergonomics, Antivibration Gloves, and Medical Surveillance to Minimize Hand-Arm .. 415 Vibration Hazards in the Workplace; T. Jetzer, P. Haydon, and D. Reynolds	415
The Revision of the Glove Vibration Isolation Standard: ISO 10819; P. Voss ..... 419	419
<b>Prevention II – Antivibration Gloves (C. Neslon - Session Coordinator) ..... 421</b>	<b>421</b>
Predicting the Effects of Push Force on the Transmission of Vibration through Glove Materials to the Palm of the . 423 Hand; M. J. O’Boyle, M. J. Griffin	423
Antivibration Gloves Effectiveness: In Field and Laboratory Tests and Proposal for a New Standard; P. Nataletti,.. 433 P. Lenzuni, A. Lunghi, A. Pieroni, E. Marchetti	433
Can the Measured TTS be Used as an Indicator of the Effectiveness of Anti-Vibration Gloves?; S. Maeda..... 435	435
Issues to be Considered in the Revision of ISO 10819: E. Wolf, D. Reynolds..... 443	443

## **Occupational Hand-Arm Vibration in the U.S.**



# A UNIQUE HISTORICAL PERSPECTIVE OF OCCUPATIONAL HAND-ARM VIBRATION IN THE U.S. FROM 1918-2004

D. E. Wasserman<sup>1</sup> and D. D. Reynolds<sup>2</sup>

<sup>1</sup> Formerly: Chief, Occupational Vibration & Noise Group, NIOSH, Cincinnati, Ohio

Currently: Occupational Vibration & Biomedical Engineering Consultant, Cincinnati, Ohio, USA

<sup>2</sup> Center for Mechanical & Environmental Systems Technology, University of Nevada, Las Vegas, Las Vegas, Nevada, USA

## Introduction

The evolution of occupational hand-arm vibration [HAV] with its irreversible medical effects collectively known as Hand-Arm Vibration Syndrome [HAVS] spans many decades. Medically, HAV was first diagnosed in France in 1862 when Dr. Maurice Raynaud, a Paris physician, first described a debilitating condition of the fingers and hands of several of his female-housewife patients that was characterized by tingling and/or numbness [paresthesia] followed by painful, cold-triggered, episodic finger blanching attacks of one or more fingers. This condition was known as idiopathic or primary Raynaud's disease. In 1911, Loriga in Italy first noted Raynaud-type symptoms in miners using pneumatic vibrating power tools. However, the definitive medical and epidemiological study would occur seven years later in the U.S. During the winter of 1918, Dr. Alice Hamilton, an occupational physician working for the U.S. Government, was called to the Oolitic limestone quarries of Bedford, Indiana. There she conducted and later published the first comprehensive medical study of vibrating pneumatic 'air hammer' tools and their associated Raynaud-type symptoms in a group of Bedford limestone cutters and carvers. Dr. Hamilton found an 80% prevalence of finger blanching [i.e. Raynaud's Phenomenon] in the fingers and hands of the Bedford tool workers. Without the benefit of modern medicine and engineering technology in 1918, she correctly stated and concluded:



Figure 1 Alice Hamilton, MD

“Among the men who use the air-hammer for cutting stone there appears very commonly a disturbance in the circulation of the hands which consists in spasmodic contraction of the blood vessels of certain fingers, making them blanched, shrunken, and numb. These attacks come on under the influence of cold, and are most marked, not when the man is at work, but usually in the morning or after work. ... The fingers affected are numb and clumsy when the vascular spasm persists. As it passes over, there may be decided discomfort and even pain, but the hands soon become normal in appearance and as a usual thing the men do not complain of discomfort between the attacks. ... The condition is undoubtedly caused by the use of the air-hammer; it is most marked in those branches of stonework where the air-hammer is most continuously used and it is absent only where the air-hammer is used little or not at all. Stonecutters who do not use the air-hammer do not have this condition of the fingers. ... Men who have given up the use of the air-hammer for many years may still have their fingers turn white and numb in the cold weather. The trouble seems to be caused by three factors: (1) long-continued muscular contractions of the fingers in holding the tool, (2) the vibrations of the tool, and (3) cold. It is increased by too continuous use of the air hammer, by grasping the tool too tightly, by using a worn, loose air hammer, and by cold in the working place. If these features can be eliminated the trouble can be decidedly lessened.”

Six decades later in 1978 a NIOSH team that was led by the late Dr. W. Taylor conducted and repeated another HAV air-hammer study at the same 1918 Bedford, Indiana, limestone quarries and found an 80% HAVS prevalence as did Dr. Hamilton. Apparently nothing had changed since 1918, except there was now a new group of afflicted tool workers doing the same work.

After the 1918 Hamilton HAV study, there followed a three decade hiatus of HAV activities in the U.S. In 1946 Dr. Edward Dart, an occupational physician, described the effects of vibrating hand tools on 112 workers in the U.S. aircraft industry during WWII. He noticed these workers complained of pain, swelling, and increased vascular tone in their hands, as well as, tenosynovitis. Again, there was another hiatus of occupational HAV studies in the U.S. until the early 1960's when Ash et. al. and Ash and Williams at Ohio State University reported that Raynaud's phenomenon had been

clinically diagnosed in seven hard rock miners who regularly used vibrating pneumatic tools. Also at this same time, with world-wide reports linking HAV exposure to HAVS, a study by Louis Pecora of U.S. industries appeared, stating:

“A preliminary survey of the literature on the incidence of Raynaud’s Phenomenon of occupational origin in this country revealed a conspicuous lack of information concerning both the numbers of workers affected and the number using small hand-held vibratory tools. An attempt was made to estimate the number of workers using vibrating tools and the number afflicted with Raynaud ’s phenomenon of occupational origin. All of the information thus gathered indicates [in 1960] that Raynaud ’s phenomenon of occupational origin may not be completely evaluated, but may have become an uncommon disease approaching extinction in this country.”

This implausible and unfortunate study would haunt the health and safety of U.S. HAV exposed workers for several years and create yet another hiatus of occupational HAV medical studies in the U.S. until the 1970’s. Ironically, at this same time, both U.S. and European gasoline-powered chain saw manufactures were already developing antivibration chain saws to be later introduced into European and other workplaces where HAVS had been reported.

### **NIOSH Occupational Vibration Activities**

U.S. Public Law 91-596, the Occupational Safety & Health Act, was passed in 1971 to protect the health and safety of U.S. workers. The law authorized the creation of the National Institute for Occupational Safety & Health [NIOSH] and the Occupational Safety & Health Administration [OSHA]. NIOSH’s responsibilities were and are to perform comprehensive research into all aspects of occupational health and safety and to develop suitable criteria for establishing safe and healthful working environments. After the passage of the Occupational Safety & Health Act, NIOSH began to establish numerous programs that examined a variety of physical and chemical agents to which U.S. workers were regularly exposed in a multiplicity of workplaces. One of the new NIOSH programs was established to investigate the health and safety effects of both occupational hand-arm [HAV] and whole-body [WBV] vibration in U.S. workplaces. From 1971 through 1984, D. Wasserman was appointed as the first Chief of the NIOSH Occupational Vibration & Noise Group in NIOSH’s Cincinnati, Ohio, facility.

A comprehensive systematic occupational vibration program was developed by NIOSH in 1971 that consisted of four phases. Phase I sought to identify those U.S. industries and worker populations exposed to occupational vibration. Phase II sought to establish an in-house vibration test facility. Phase III included conducting both laboratory and field vibration studies. Phase IV was the establishment of vibration criteria documents that would be the precursor to potential U.S. vibration standards. The results of Phase I identified that in the 1970’s some 8 million workers were exposed to occupational vibration in the U.S. Of these workers, 6.8 million were exposed to WBV, and 1.2 million were exposed to HAV. With regard to the HAV population, workers were primarily exposed to hand-induced vibration from a variety of pneumatic tools, followed by electric, gasoline-powered, and hydraulic tools. It is reasonable to assume that these exposed worker population numbers have increased since the 1970’s. Since HAV and WBV exposures are distinctly different as are their respective medical affects, two separate parallel NIOSH programs were developed: one for WBV and another for HAV. With regard to the HAV program, all of the engineering aspects of HAV exposures, measurements, modeling, analysis, etc. [1972 –1984] was assigned to and implemented by Dr. D. Reynolds in his role, as HAV [extramural] Chief Engineer.

In 1975, at the request of the late Dr. W. Taylor, NIOSH agreed to host the Second International Conference on Hand-Arm Vibration in Cincinnati, Ohio. The conclusions and recommendations of this week-long conference included:

- The acknowledgement of a world-wide HAVS problem with prevalences approaching 89%;
- The acknowledgement that Pecora’s finding that HAVS did not exist in the U.S. was most likely not valid;
- The need to develop better non-invasive HAVS medical tests;
- The need to develop better HAV measurement and analysis tests and methods;
- The need to develop a better HAV dose-response relationship; and
- The need for medical/HAVS studies and corresponding HAV testing of various pneumatic power tools, as one of the largest category of vibrating power tools.

These conclusions and recommendations became the catalyst and template for virtually all NIOSH HAV studies through 1984.

Because of the result of the 2<sup>nd</sup> International Conference on Hand-Arm Vibration and limited funding and few qualified personnel resources within NIOSH, the NIOSH WBV program was temporally placed on hold. NIOSH efforts

were focused exclusively on developing and performing HAV/HAVS studies. The following events occurred between 1976 and 1978:

- Dr. W. Taylor agreed to leave Scotland and become a NIOSH medical visiting scientist, working at the NIOSH Cincinnati, Ohio, facility for an extended period of time. Dr. P. Pelmeur also agreed to collaborate on an as needed basis. Dr. S. Samueloff, an internationally known blood flow physician from Israel, agreed to become a NIOSH visiting scientist. The first major HAV program since Dr. Hamilton would be to develop and execute major comprehensive multi-faceted HAV/HAVS studies in the U.S. on pneumatic vibrating tools. The tools that were investigated included: (1) chipping and grinding power tools extensively used in iron foundry operations and shipyards and (2) jack-leg drills and jackhammers used in underground mining operations. Dr. Hamilton's 1918 Oolitic limestone air-hammer study that was originally conducted in Bedford, Indiana, was also repeated at the same limestone quarries in Bedford, Indiana.
- The comprehensive study design called for simultaneous components of: (1) epidemiology, (2) medical testing, (3) medical/work history questionnaire, (4) HAV engineering measurements and analyses, and (5) development of and laboratory testing of a group of non-invasive HAVS diagnostic tests. The HAVS diagnostic tests, if efficacious, could later be used in workplace situations. These tests were two-point finger discrimination, finger depth sense [neurological tests], photocell-blood flow plethysmography. The diagnostic tests would all be field tested and the results independently compared to individual worker HAVS diagnosis by the examining physicians led by Dr. W. Taylor.
- A large 45-ft trailer was obtained by NIOSH, gutted, and then converted into a mobile HAVS medical testing facility.
- In 1977, the NIOSH HAVS/HAV study team consisted of 22 epidemiologists, statisticians, physicians, physiologists, engineers, and trained technicians.
- Permission was sought and granted for NIOSH to conduct HAV/HAVS studies at: (1) two large commercial U.S. gray iron foundries in the Midwest, (2) the US Navy shipyard in Philadelphia [via NAVY Bureau of Medicine & Surgery], (3) a large uranium mine in New Mexico, and (4) the Oolitic limestone quarries of Bedford, Indiana.
- Trial runs for virtually every aspect of the NIOSH HAV/HAVS study were completed to minimize potential field problems in the fall of 1977.
- The NIOSH HAV/HAVS study commenced in January 1978. Foundry and shipyard worker medical/epidemiology field data were collected from 385 volunteer workers. Data were collected from 50 volunteer stone cutters in Bedford, Indiana. Data were collected from 134 volunteer uranium miners in Grants, New Mexico. Medical/epidemiological data were collected from a total of 569 volunteer workers. Simultaneously, extensive onsite tri-axial HAV tool acceleration data were obtained from numerous pneumatic tools used by these workers. These tools included pneumatic chipping hammers, grinders, stone cutters, jack-leg drills, and jack-hammers. The HAV study medical results documented:
  - A nearly 50% prevalence of HAVS in the commercial gray iron foundries with a 1-2.4 year latent period for the onset of finger blanching;
  - A 20% prevalence of HAVS in the U.S. Navy shipyards with a 19 year latent period for the onset of finger blanching;
  - A 17% prevalence of HAVS in the New Mexico uranium mine with a 4.5 year latent period for the onset finger blanching; and
  - An 80% prevalence of HAVS in the Bedford, Indiana, stone quarries (identical to the findings of Dr. Hamilton's 1918 study)

Correspondingly, excellent tri-axial HAV tool measurements were obtained for all the tools used by the workers who were medically examined.

By 1982 the results of the 1960 Pecora study had been shown to be incorrect. Information now existed, documenting that many workers in the U.S. suffered from irreversible HAVS. The results of the major NIOSH HAV/HAVS study were presented in HAVS reports, journal publications, and meetings with stakeholder groups. In 1983, the US Surgeon General's Office/CDC/ NIOSH officially published the NIOSH Current Intelligence Bulletin #38 - Vibration Syndrome, which stated in part:

“Occupational health & safety professionals, employers, and workers should be alerted to recent information on the potential hazards of vibrating hand tools. A comprehensive study recently completed by NIOSH demonstrates the seriousness of vibration syndrome in workers and provides an accurate measure of the prevalence of vibration syndrome ...., the Institute concludes that vibrating hand tools can cause vibration syndrome, a condition also known as vibration white finger and as Raynaud’s Phenomenon of occupational origin. ... Of particular concern is evidence of advanced stages of vibration syndrome after exposures as short as one year. NIOSH recommends that jobs be redesigned to minimize the use of vibrating hand tools and that powered hand tools be redesigned to minimize vibration.”

After these public revelations, it was time to begin developing and implementing processes and solutions to minimize the prevalence of HAVS among U.S. workers. However, these efforts suffered a major setback when in 1984, citing financial constraints, NIOSH made an administrative decision to cease all further hand-arm [and whole-body] vibration activities.

In 2000 after a 16 year hiatus, NIOSH in Morgantown, West Virginia, initiated several new HAV/HAVS studies. Using the results of the past NIOSH studies, NIOSH researchers have chosen to concentrate their applied research efforts in the following areas:

- The development of a better HAV-HAVS dose-response-relationship;
- The developed of better HAV measurements techniques using modern instrumentation;
- The determination and understanding of HAVS etiology using animal models;
- The use of advanced microscopic technologies to determine if adverse effects from vibrating tools can be predicted from physical changes in the capillaries at the base of the fingernail that are too small to see with the naked eye;
- The development of computer models of stress and strain on the fingertips from vibrating tool handles, as measured by the degree to which the soft tissues of the fingertips are compressed or displaced by the vibrating handle;
- The assessment of IR imaging of the hands as a potential method for identifying the presence and severity of HAVS; and
- The investigation of the effectiveness of antivibration gloves through tests using an instrumented handle that simulates specific tools and tool vibration characteristics.

### **Occupational Vibration Standards in the U.S.**

U.S. occupational health and safety consensus standards began in 1938 with the creation of the American Conference of Governmental Industrial Hygienists [ACGIH] and their standards termed, *Threshold Limit Values*, that are used for hundreds of chemical and physical agents found in U.S. workplaces. When the results of the NIOSH HAV studies were published, D. Wasserman and Drs. Taylor, Pelmeur, and Brammer were asked to meet and work with the ACGIH and help them develop their HAV standard. In 1984, the ACGIH established the very first U.S. HAV standard, which is used to this day.

Other U.S. occupational vibration consensus standard activities span some four decades under the aegis of the American National Standards Institute [ANSI] and their association with the European based International Organization for Standardization [ISO]. In the 1960’s, Dr. Henning VonGierke, Head of the USAF Aerospace Medical Research Laboratories, organized the ISO Technical Committee (TC) 108/Subcommittee (SC) 4, Human Exposure to Shock and Vibration. This technical committee formed the world’s first group of scientists, physicians, and engineers who were dedicated to protecting workers from the effects of whole-body and hand-arm vibration exposure. This group’s first output in 1974 was the ISO 2631 WBV standard. This was followed in 1979 by the ANSI S3.18 WBV standard in the U.S. In 1986, the ISO 5349 HAV standard was issued. The ANSI S3.34 HAV standard was issued in the U.S. during the same year. NIOSH issued their HAV Criteria Document No. 89-106 in 1989. Thus, there are currently three HAV health standards in the U.S.: ACGIH, ANSI S3.34, NIOSH No. 89-106. To date, the U.S. Occupational Safety & Health Administration [OSHA] has not adopted any HAV standard.

Currently, U.S. ANSI Working Group S2.39, Human Exposure to Shock & Vibration, is chaired by Dr. D. Reynolds. This working group manages all ANSI and ISO standards activities in the U.S. related to human exposure to vibration and shock. It is currently working to gain concurrence and approval to revise the current ANSI S3.34-1986 to conform to ISO 5349-2001 (Parts 1 and 2) and the European Union’s Human Vibration Directive 2002/44EC for HAV. (ANSI S3.34-1986 was revised and published in 2006 as ANSI S2.70-2006)



## **The Control of Hand-Arm Vibration**

Controlling HAV exposure to minimize its effects on workers is multi-faceted. It will often require the simultaneous use of:

- Lower vibration power tools;
- Antivibration full-finger protective gloves that meet or exceed the requirements of glove standards ANSI S3.40-2002/ISO 10819-1996; and
- Sensible work practices.

Numerous antivibration gasoline powered chain saws were introduced in the 1970's when it was clear that these tools were related to HAVS. Atlas-Copco, a Swedish company, introduced a pneumatic tool line of antivibration/ergonomic products in 1980. Over the years a few other manufacturers have followed their lead. ISO published ISO 10819 in 1986. This standard specifies testing procedures and performance requirements for protective gloves to be classified as antivibration gloves. ErgoAir, Chase Ergonomics, and Ergodyne in the U.S. have developed polymer viscoelastic materials and air bladder technologies that can be used in gloves to reduce hand-transmitted vibration. Impacto Protective Products in Canada and Valeo in the U.S. use air bladder technology developed by ErgoAir in antivibration gloves they market. In addition to low vibration tools and antivibration gloves, workers also need to use sensible work practices. These practices include:

- Let the tool do the work;
- Use a minimum grip on the tool consistent with safe work practices;
- Keep the hands warm & dry;
- Use a tool as instructed by the tool manufacturer and only when and as necessary;
- Seek medical attention if signs or symptoms of HAVS appear; and
- Do not smoke.

In areas of HAV & WBV vibration measurements, innovative U.S. electronic engineering and technology firms are striving to both simplify the required [triaxial] measurement techniques and simultaneously reduce the cost of their vibration measurement equipment. Hopefully, this will make occupational vibration workplace measurements and data processing as easy and common-place as current noise survey measurements.

## **HAV/HAVS in the Future**

The ultimate mission of those who work in the area of occupational vibration is the control and ultimately the elimination of HAVS from the workplace. For this to become a true reality, an understanding of HAVS etiology is critical to establishing a clear and defensible dose-response relationship for HAV. This is essential to establish required specifications for hand-held vibrating products that will not harm the fingers and hands of tool users. The same is also true for WBV exposure. Since 1918 there have been numerous epidemiology studies in a variety of industries worldwide that conclude virtually the same thing - the continual and long-term uses of hand-held power tools that have exceptionally high vibration levels cause HAVS in workers who use these tools.

What is now needed is knowledge of the etiology of HAVS - namely, why and how vibration affects the hand and fingers, resulting in irreversible HAVS. As early as 1976, D. Wasserman, proposed a method for answering these basic questions. He proposed looking at the hand-tool vibration interaction at the cellular level. Cells are the basic building blocks of living systems, and they form tissues, which become specific organs in our bodies. In the past few years, a small segment of current HAVS research is starting to move very slowly into the etiology direction. Blood flow in animal tissue under vibratory conditions is being investigated, and animal models are being proposed. Further studies are necessary that investigate perfuse living cells in vitro that are exposed to an organized regime of changing sinusoidal vibratory input frequencies [at constant acceleration amplitudes and exposure durations], looking for changes in cell transport dynamics, as well as, cellular resonances as a function of vibration frequency. Follow-on studies need to examine the effects of varying input acceleration amplitudes [at constant frequencies and exposure durations] and of varying vibration exposure durations [at constant frequencies and constant acceleration amplitudes]. Once information is obtained from these studies, a similar series of studies can be implemented for various body organs, including the fingers and hands. Since most occupational HAV exposures contain a spectrum of frequencies that can be Fourier transformed into their elemental sinusoidal components, only discrete sinusoidal vibration input frequencies should be first examined.

Later the research can be expanded to examine the effects associated with actual HAV tool spectra. This proposed research will result in a clearer and more defensible HAV dose-response relation.

## **References [as cited by section]**

### **Introduction**

- Ashe W., Cook M., and Old J. 1962. Raynaud's Phenomenon of occupational origin. *Arch. of Environmental Health*, Vol. 5, pp.333-343.
- Ashe W., and Williams N. 1964. Occupational Raynauds , Part II. *Arch. of Environmental Health*, Vol. 9, pp. 425-433.
- Dart E. 1946. Effects of high speed vibrating tools on operators engaged in the airplane industry. *Occupational Medicine*, Vol.1, pp.515-550.
- Hamilton A. 1918. A study of spastic anemia in the hands of stonecutters: An effect of the air-hammer on the hands of stonecutters. USBL, *Industrial Accidents & Hygiene Series 236 (19)*, Washington, DC.
- Loriga G. 1911. Pneumatic tools: Occupation and health. *Ball.Inspet. Lorboro*, Vol.2, pp.35-37.
- Pecora L., Udel M., and Christman R. 1960. Survey of the current status of Raynaud's Phenomenon of occupational origin. *Amer. Industrial Hygiene Association Journal*, Vol. 21, pp.80-83.
- Raynaud M. 1862. Local asphyxia and symmetrical gangrene at the extremities. [M.D. thesis-Paris, France]. 1888, English translation in: *Selected Monographs*, New Sydenham Society, London, UK.
- Taylor W., Wasserman D., Behrens V., Reynolds D., and Samueloff S. 1984. Effect of the air-hammer on the hands of stonecutters. The limestone quarries of Bedford, Indiana revisited. *British Journal of Industrial Medicine*, Vol. 41, pp. 289-295.

### **NIOSH Occupational Vibration Activities**

- Behrens V., Wasserman D., Taylor W., Samueloff S., and Reynolds D. 1984. Vibration syndrome inworkers using pneumatic chipping & grinding tools. *Journal of Occupational Medicine (Special Supplement)*, Vol.4, pp.766-788.
- Carlson W., Samueloff S., Taylor W., and Wasserman D. 1979. Instrumentation for the measurement of sensory loss in the fingertips. *Journal of Occupational Medicine*, Vol. 21(4), pp. 260-264.
- Dong R., Rakheja S., Schopper, A., Han B., and Smutz B. 2001. Hand-transmitted vibration & biodynamic response of the human hand-arm: a critical review. *Critical Reviews in Biomedical Engineering*, Vol 29(4), pp.393-439.
- Dong R., et al. 2002 Effectiveness of a new method (TEAT) to assess vibration transmissibility of gloves. *Internatl. Journal of Industrial Ergonomics*, Vol .30, pp.33-48.
- NIOSH: 1983. Vibration Syndrome. *Current Intelligence Bulletin No. 38*. NIOSH Pub. #83-110, Cincinnati, OH.
- Rakheja S., Dong R., Welcome D., and Schopper A. 2002. Estimation of tool-specific isolation performance of antivibration gloves. *Internatl. Journal of Industrial Ergonomics*, Vol.30, pp. 71-87.
- Rakheja S., Wu Z., Dong R., and Schopper A. 2002. A comparison of biodynamic models of the human hand-arm system for applications to hand-held power tools. *Journal of Sound & Vibration*, Vol 249(1), pp.55-82.
- Reynolds D. 1977. Hand-arm vibration: a review of 3 years research. *Proc. Of the 2<sup>nd</sup>. Internatl. Occupational Hand-Arm Vibration Conference*. NIOSH #77-170, Cinti., OH
- Reynolds D., Basel R., Wasserman D., and Taylor W. 1984. A study of hand vibration in chipping & grinding operations: Vibration acceleration levels measured on pneumatic tools used in chipping & grinding operations. *Journal of Sound & Vibration*, Vol. 95(4), pp. 479-497.
- Reynolds D., and Falkenberg R. 1984. A study of hand vibration in chipping & grinding operations: Four-degree-of-freedom lumped parameter model of the vibration response of the human hand. *Journal of Sound & Vibration*, Vol. 95(4), pp.499-514.

- Reynolds D., Basel R., Wasserman D., and Taylor W. 1984. A study of hand vibration in chipping and grinding operations: Power levels into the hands of operators of pneumatic tools used in chipping & grinding operations. *Journal of Sound & Vibration*, Vol. 95(4), pp. 515-524.
- Samueloff S., Miday R., Wasserman D., Behrens V., et al. 1981. Peripheral vascular insufficiency test using photocell plethysmography. *Journal of Occupational Medicine*, Vol. 23(9), pp. 643-646.
- Wasserman D., and Badger D. 1972. The NIOSH plan for developing industrial vibration exposure criteria. *Journal of Safety Research*, Vol.4, pp. 146-154.
- Wasserman D., Badger D., Doyle T., and Margolies L. 1974. Industrial vibration-an overview. *Journal of the American Society of Safety Engineers*, Vol.19(6), pp.38-43.
- Wasserman D., and Taylor W.[Eds.]. 1977. Proceedings of the 2<sup>nd</sup>. International Occupational Hand-Arm Vibration Conference. DHHS/NIOSH Pub#77-170, Cinti.,OH.
- Wasserman D., Carlson W., Samueloff S., et al. 1979. A versatile simultaneous multifinger photocell plethysmography system for use in clinical & occupational medicine. *Journal of Medical Instrumentation*, Vol.13(4), pp.232-234.
- Wasserman D., Taylor W., Behrens V., Samueloff S., and Reynolds D. 1982. Vibration white finger disease in U.S. workers using chipping and grinding hand tools. Vol. I-Epidemiology. DHHS/NIOSH Pub.# 82-118, Cinti., OH.
- Wasserman D., Reynolds D., Behrens V., Taylor W., Samueloff S., and Basel R. 1982. Vibration white finger disease in U.S. workers using chipping and grinding hand tools. Vol.II-Engineering.DHHS/NIOSH Pub.# 82-101, Cinti., OH.
- Wasserman D., Behrens V., Pelmeur P., Ilka R., Reynolds D., et al. 1991. Hand Arm Vibration Syndrome in a group of U.S. uranium miners exposed to hand-arm vibration. *Applied Occupational & Environmental Hygiene*, Vol.6, pp.183-187.
- Wasserman D., Hudock S., Wasserman J., Mullinix L., et al. 2002. Hand-arm vibration in a group of hand-operated grinding tools. *Human Factors & Ergonomics in Manufacturing*, Vol 12(2), pp.211-226.
- Wu J., Dong R., Rakheja S., and Schopper A. 2002. Simulation of mechanical responses of fingertip to dynamic loading. *Med. Engr. & Physics*, Vol.24, pp.253-264.

### **Occupational Vibration Standards in the U.S.**

- American Conference of Gov't. Industrial Hygienists. 1984-2004. ACGIH-TLV for Hand-Arm Vibration. Cincinnati, OH.
- American National Standards Institute. 1986. ANSI S3.34: Guide for the measurement & evaluation of human exposure to vibration transmitted to the hand. New York, NY.
- International Standards Organization. 1996. ISO 10819: Hand-arm vibration-method for the measurement & evaluation of the vibration transmissibility of gloves at the palm of the hand. Geneva. [IBID: ANSI S3.40-2002/ISO 10819-1996].
- National Institute for Occupational Safety & Health. 1989. NIOSH #89-106: Criteria for a recommended standard: Occupational exposure to hand-arm vibration. Cincinnati, OH.
- American National Standards Institute. 2006. ANSI S2.70: Guide for the measurement & evaluation of human exposure to vibration transmitted to the hand. New York, NY.

### **The Control of Hand-Arm Vibration**

- Reynolds D., Weaver D., and Jetzer T.1996. Application of a new technology to the design of effective anti-vibration gloves. *Cent. Eur. Journal of Public Health*, Vol.4, pp.140-144.
- Reynolds D., and Jetzer T. 1998. Use of air bladder technology to solve hand tool vibration problems. Proceedings of the 8<sup>th</sup>. International Conference on Hand-Arm Vibration. Umea, Sweden.
- Wasserman D., Wasserman J., and Ahn J. 2001. Instrumentation for measuring coupling forces of hand-held tools. *Sound & Vibration*, Vol. 35(7), pp.22-25.

### **HAV/HAVS in the Future**

- Cezeaux J., Lindsley W., and Wiseman L. 2002. Effects of vibration on vascular permeability in rats. In: Recent Developments in Biomedical Engineering [J. Vossoughi, Ed.], ISBN: 1-930636-01-6, Medical & Engineering Publishers, Inc., Boston.
- Curry B., Govindaraju S., et al. 2003. Evidence for frequency-dependent arterial damage in vibrated rat tails. 38<sup>th</sup>. UK Conference on Human response to Vibration. Institute of Naval Medicine, Gosport, U.K., Sept. 17-19.
- Govindaraju S., Curry B., et al. 2003. Vibration-induced vascular damage is reduced by pretreatment of a vasodilator. 38<sup>th</sup>. U.K. Conference on Human Response to Vibration. Institute for Naval Medicine, Gosport, U.K., Sept. 17-19.
- Lau C., O'Dowd A., and Belch J. 1992. White blood cell activation in Raynaud's Phenomenon of systemic sclerosis & vibration induced white finger syndrome. Ann. Rheum. Diseases, Vol 51, pp.249-252.
- Lindsley, W., Johnson C., Cezeaux J., and Kashon M. 2001. Effect of vibration on IL-8 production by dermal microvascular endothelial cells. Proceedings of the Biomedical Engineering Society Annual Meeting, Durham, NC, Oct. 4-7.
- Lundberg G., Dahlin L., Danielsen N., et al. 1987. Intraneural edema following exposure to vibration. Scand. Journal Work-Environ.-Health, Vol.13, pp.326-329.
- Pelmeur P. and Wasserman D. 1998. Hand-Arm Vibration: A Comprehensive Guide for Occupational Health Professionals. OEM Medical Publishers, Beverly Farms, MA.
- Wasserman D. 1976. A theory of biological cell resonance & its relationship to occupational health. Proceedings of the NIOSH Conference on Occupational Shiftwork & Health, DHEW/NIOSH Pub. # 76-203, pp.263-269.

**Medical I – Focus Session**  
**G. Gemne - Session Coordinator**



# **THE RELATIONSHIP BETWEEN THE STOCKHOLM SCALE AND CLINICAL NEUROLOGICAL TESTS IN THE ASSESSMENT OF THE SENSORINEURAL COMPONENT OF HAND-ARM VIBRATION SYNDROME**

R. House<sup>1</sup>, M. Wills<sup>1</sup>, L. Lander<sup>2</sup>

<sup>1</sup> Gage Occupational and Environmental Health Unit, St Michael's Hospital and University of Toronto, Toronto, Ontario, Canada

<sup>2</sup> Harvard School of Public Health, Harvard University, Boston, Massachusetts

## **Introduction**

The Stockholm classification of the sensorineural component of Hand-arm Vibration Syndrome (HAVS) is based on symptom reporting and physical examination (Brammer et al, 1987). The relationship between commonly used clinical tests of peripheral neurological function and the sensorineural Stockholm Scale of HAVS requires further evaluation. In particular it would be useful to determine which tests are predictive of the Stockholm Scale and could be used for a more objective rating of impairment. This information would be helpful for individual clinical assessment and management, determination of work restrictions and workplace accommodations as well as for epidemiologic purposes.

## **Objectives**

To investigate the relationship between the sensorineural Stockholm Scale of HAVS and commonly used tests of peripheral neurological function including nerve conduction studies (NCS) and current perception threshold (CPT) measurement as well as other clinical, occupational and demographic variables.

## **Methods**

The study was based on the standardized evaluation of 162 patients assessed for HAVS over a three year period at a specialized Occupational Medicine Clinic at St Michael's Hospital in Toronto, Canada. Most of the patients referred for HAVS assessment at the clinic were from the mining, construction or automotive industries but a wide variety of occupations were included in the sample. All of the patients had had their medical histories and physical examinations carried out in a standardized fashion with the results recorded on standardized forms. As well, the clinical tests had all been done in the same standardized format in all of the patients throughout the three years included in the study for patient recruitment. The evaluation of the sensorineural Stockholm Scale in the patients was based on the medical history and physical examination and was blinded to the results of the other tests. The relationship between the NCS and CPT measurements and the sensorineural Stockholm Scale was first examined using bivariate analysis. Following this the occupational, demographic and clinical test data including the results from NCS and CPT were compared to the Stockholm impairment scale using multivariate logistic regression.

## **Results**

There were NCS abnormalities in 57 (35.2%) of the 162 patients. Only one patient had diffuse digital sensory neuropathy. The most common neurological abnormalities were carpal tunnel syndrome (35 patients; 21.6%) and ulnar neuropathy (14 patients; 8.64%) which are not considered part of the sensorineural component of HAVS. The CPT results were statistically significantly associated with the sensorineural Stockholm Scale in the bivariate analysis. The multivariate logistic modeling also indicated that the CPT results had a statistically significant association with the sensorineural Stockholm Scale. This was observed in the overall sample and after stratification for abnormal NCS results. There was no significant association between the NCS results and the neurological Stockholm Scale.

## **Conclusions**

CPT measurement can be used to aid in the assessment of the sensorineural impairment of HAVS. NCS may be used to demonstrate objectively the presence of carpal tunnel syndrome and ulnar neuropathy but rarely demonstrates the digital sensory neuropathy of HAVS. Future research should focus on the use of CPT in combination with other quantitative sensory tests such as vibration perception threshold (VPT) and temperature perception threshold (TPT) in the diagnosis and impairment rating of the sensorineural component of HAVS.

### **References**

Brammer AJ, Taylor W, Lundborg G, 1987. Sensorineural stages of the hand-arm vibration syndrome. *Scandinavian Journal of Work Environment and Health*. Vol 13(4), pp 279-283.



# **RISKS OF OCCUPATIONAL EXPOSURES TO HAND-TRANSMITTED VIBRATION: VIBRISKS**

M. J. Griffin<sup>1</sup>, C. H. Lewis<sup>1</sup>, M. Bovenzi<sup>2</sup>, P. Lemerle<sup>3</sup>, R. Lundström<sup>4</sup>

<sup>1</sup> Human Factors Research Unit, Institute of Sound and Vibration Research, University of Southampton, Southampton, SO17 1BJ, England

<sup>2</sup> Clinical Unit of Occupational Medicine, Department of Public Health Sciences, University of Trieste, Trieste 34129, Italy

<sup>3</sup> Institut National de Recherche et de Sécurité, Vandoeuvre, France

<sup>4</sup> Department of Biomedical Engineering & Informatics, Umeå University Hospital and Department of Occupational Medicine, Umeå University, Sweden

## **Abstract**

VIBRISKS seeks to improve understanding of the risk of injury from hand-transmitted vibration and whole-body vibration by means of epidemiological studies supported by fundamental laboratory research. VIBRISKS is a consortium of six partners from six European countries (France, Germany, Italy, Sweden, The Netherlands, UK). The four-year research project, which commenced in 2003, involves three work packages devoted to hand-transmitted vibration and three work packages devoted to whole-body vibration. This paper summarizes the research on hand-transmitted vibration. Work package 1 defines methods to be used in studies of disorders caused by hand-transmitted vibration in work package 2 and integrates the results of the epidemiological studies in work package 2 with the results of experimental and modeling studies in work package 3. Work package 1 will also utilize the results of the research to define procedures that can be applied by occupational health workers for minimizing risk, screening exposed individuals and managing individuals with symptoms. Work package 2 involves longitudinal studies in workers exposed to hand-transmitted vibration. Work package 3 involves experimental studies of the acute effects of hand-transmitted vibration on vascular and neurological function and the development of a finite element model of the biodynamic responses of the finger to vibration and force.

## **Introduction**

Occupational exposures to hazardous levels of hand-transmitted vibration are common around the world. Some outcomes of exposure to hand-transmitted vibration are well recognized. For example, finger blanching (vibration-induced white finger) and sensorineural disorders are commonly diagnosed in workers exposed to hand-transmitted vibration and form part of the hand-arm vibration syndrome. For other disorders, such as carpal tunnel syndrome and osteoarthritis, the risks arising from exposure to hand-transmitted vibration are less well established.

The number of persons injured by exposure to hand-transmitted vibration within the European Union is not known, but may be estimated at many millions. This implies a significant negative impact on the well-being of many individual workers. There is a consequent social burden and financial costs to the state and, in some cases, the industry in which the vibration exposures were produced.

Within countries of the European Union, there are large differences in the recognition of the various disorders associated with exposure to vibration. There are also differences in the methods of diagnosing disorders and the means of controlling risk.

VIBRISKS is a European Union research project involving a consortium of six partners from six European countries (France, Germany, Italy, Sweden, The Netherlands, UK). The four-year research project, which commenced in 2003, involves three work packages devoted to hand-transmitted vibration and three work packages devoted to whole-body vibration.

VIBRISKS seeks to improve understanding of the risk of injury from both hand-transmitted vibration and whole-body vibration by means of epidemiological studies supported by fundamental laboratory research. This paper summarizes the hand-transmitted vibration research in VIBRISKS.

## **Objectives**

The objectives of the hand-transmitted vibration studies in VIBRISKS are to:

- advance understanding of acute effects of hand-transmitted vibration on peripheral circulation.

- improve knowledge of the exposure-response relationship between hand-transmitted vibration and the development of chronic vascular and neurological disorders.
- improve understanding of factors that result in the progression of the symptoms and signs of vascular disorders, so as to improve understanding of the benefits of health surveillance.
- improve health surveillance guidelines to minimize risk (primary prevention), the screening of exposed workers, and the management of individuals with symptoms (secondary prevention).

*Work package 1: HTV support and integration of results*

Work package 1 supports the studies of disorders caused by hand-transmitted vibration in Work package 2 and the experimental and modeling studies in Work package 3 and integrates the findings from these two packages into procedures that can be applied by occupational health workers for minimizing risk, screening exposed individuals and managing individuals with symptoms.

The objectives are to:

- define and agree methods to be used in the epidemiological studies in Work package 2;
- integrate the findings from epidemiological studies in Work package 2 with the results of experimental studies in Work package 3 so as to define predictive dose-response models;
- provide improved health surveillance guidance for primary prevention (prevention of injuries in workers exposed to hand-transmitted vibration) and secondary prevention (preventing the progression of disorders).

*Task 1.1 Preparation for epidemiological studies of HTV*

Research conducted within a previous EU research network (Vibration Injury Network: VINET) resulted in methods of diagnosing disorders caused by hand-transmitted vibration. These methods have been further developed and adopted for the VIBRISKS studies.

A self-administered questionnaire, a questionnaire for administration by health professionals, and a follow-up questionnaire have been defined and translated into appropriate languages. The six-page self-administered questionnaire includes basic questions on personal identification, social history with reference to smoking and drinking habits, and medical history. Self-reported vascular, sensorineural and musculoskeletal complaints in the upper extremities (finger colour changes, tingling, numbness, pain in the neck and upper limbs, and effects of symptoms in the hands and fingers) are also investigated. The clinically-administered questionnaire includes a comprehensive set of questions devoted to personal, occupational, social, medical and symptom histories, as well as a section dedicated to physical examination with particular reference to vascular, neurological and musculoskeletal systems. Exposure to hand-transmitted vibration and ergonomic risk factors are investigated in a section of the clinically-administered questionnaire. Personal, social and medical histories in the clinical administered questionnaire provide more details than those included in the self-administered questionnaire, whereas questions on symptoms in the finger-hand-arm system are almost identical in both questionnaires. Color charts have been produced to assist the identification of color changes in the fingers. A guide to the diagnosis of carpal tunnel syndrome has also been produced.

For testing peripheral vascular response to cold, the partners are using multi-channel plethysmography (*HVLab* multi-channel plethysmograph), allowing simultaneous measurement of finger systolic blood pressure on four fingers after thermal provocation at  $30^{\circ}\text{C} \pm 1^{\circ}\text{C}$  and after thermal provocation at  $10^{\circ}\text{C} \pm 1^{\circ}\text{C}$ . The test procedure will be consistent with DIS 14835-1 (2004).

For neurological disorders, vibrotactile perception thresholds (at 31.5 Hz and 125 Hz) will be obtained according to ISO 13091-1:2001 (using either the *HVLab* vibrometer or the *HVLab* tactile perception meter). Thermal thresholds for the perception of heat and cold will be obtained using the *HVLab* thermal aesthesiometer. The Purdue pegboard (measuring finger dexterity and hand-eye coordination) and the Jamar hand dynamometer (measuring hand grip force) will also be used.

A diagnostic procedures manual has been produced by the partners to unify their methods of applying the questionnaires and the various tests of vascular and neurological function. This also defines the environmental conditions for testing. The project members involved in the use of diagnostic methods have been trained on the use of the apparatus.

The diagnostic procedures manual will be further developed from experience gained during the project and is expected to provide a useful outcome from the research.

#### *Task 1.2 Integration of findings and model development*

When the results of the epidemiological studies in work package 2 become available, the partners will collectively interpret the data so as to relate vibration dose and injury, and identify effects of confounding variables. Models will be developed to predict the onset, severity and progression of injuries over time, taking account of confounding variables.

#### *Task 1.3 Provision of health surveillance guidelines*

The models provided by Task 1.2 will be used to draft guidelines for occupational health workers.

#### *Work package 2: HTV epidemiological work*

Work package 2 involves coordinated longitudinal studies in workers exposed to hand-transmitted vibration.

For primary prevention, dose-response relationships for hand-transmitted vibration are required to allow technical and administrative solutions. Secondary prevention requires understanding of the natural history of vibration-related illness and the factors causing, or predicting, its progression. Hence two categories of investigation are envisaged, emphasizing dose-response and natural history of disorders:

- (i) the investigation of the dose-response relationships between vibration exposure and development of (a) vascular disorders (VWF) and (b) neurological disorders (e.g. numbness, tingling and elevated vibrotactile and thermotactile thresholds) of the upper limb;
- (ii) the investigation of factors causing, or predicting, progression (i.e. natural history) of vascular and neurological disorders; to determine how often mild cases of the hand-arm vibration syndrome get worse and how rapidly; whether those destined to get worse can be predicted (to aid earlier detection), and if so, whether advice can be tailored to individuals; to determine whether factors resulting in the onset of disorder also predict the development of disorder. It is particularly hoped to improve current understanding of the development of the neurological components of the hand-arm vibration syndrome.

#### *Task 2.1 Dose-response studies of workers exposed to HTV*

Workers exposed to hand-transmitted vibration (mainly caused by chain saws, hand-held grinders and impact wrenches) in Italy and Sweden are being surveyed annually. It was considered that different patterns of vibration-induced neurological and vascular disorders between Nordic (e.g. Sweden) and Mediterranean (e.g. Italy) countries could also reflect differences in some socio-demographic and climatic variables.

In the longitudinal studies of vibration-exposed workers, the principal dependent variables will be symptoms and signs of vascular, neurological and musculoskeletal dysfunction in the upper limbs which will be investigated by means of questionnaires and objective tests (finger systolic blood pressures, finger re-warming times, vibrotactile and thermotactile thresholds, manual dexterity and grip strength). The follow-up questionnaire will be used to assess any changes in symptoms. The changes will be also investigated by comparing vascular responses to cold provocation (i.e. changes in finger systolic blood pressures) during the various follow-up periods. Any ameliorating effects of vibration protectors (e.g. gloves or the adoption of tools with low vibration) will be included as both clinical (anamnestic) and objective tools.

The principal independent variables are vibration exposure and postural stressors. The vibration-exposed workers to be investigated were chosen to assess whether exposure to vibration with different spectral characteristics (magnitude and frequency), such as those from chain saws, grinders and other hand-held vibrating tools, may be associated with different patterns and occurrence of vascular and neurological disorders in the upper limbs.

Vibration will be measured and combined with daily exposure durations and years of exposure to form alternative cumulative measures of exposure severity. Postural stressors will be quantified at the workplace in terms of work postures, forces and repetitiveness. Additional independent variables will include personal characteristics (age, anthropometry, use of medicines, smoking, drinking), psychosocial factors, and previous jobs.

Vibration will be measured according to the recommendations of the current international standards (ISO 5349-1 and ISO 5349-2, 2001). In addition to frequency weighting according to ISO 5349, vibration spectra in the frequency

range 6.3 to 1250 Hz will be obtained to allow alternative estimates of unweighted acceleration magnitude. Both frequency-weighted and unweighted acceleration magnitudes will be used, together with exposure duration, to obtain measures of cumulative (lifetime) vibration dose. Vibration will be measured on representative samples of tools used by the study workers by applying measurement methods in the field according to ISO 5349-2, 2001.

Using the measures of vibration magnitude and exposure duration, it will be possible to construct, for each subject, various alternative vibration ‘doses’, of the general form:

$$dose = \sum_i [a_i^m t_i]$$

where  $a_i$  and  $t_i$  are the acceleration magnitude and the exposure duration respectively, for tool  $i$ . In these doses, the relative importance of the acceleration,  $a$ , (weighted or unweighted) and the total exposure duration,  $t$ , depends on the value of  $m$ . Doses with  $m = 0, 1, 2$ , and  $4$  will be computed for each subject, with both frequency-weighted acceleration and unweighted acceleration (Griffin et al, 2002).

### *Task 2.2 Natural-history studies of HTV exposed workers*

The natural history of the development of components of the hand-arm vibration syndrome will be studied within existing health surveillance programs in an engineering company in the UK. Using a cross-sectional questionnaire, workers with symptoms will be identified and invited to provide a history of symptoms, risk factors, and exposure to vibration. Vibrotactile and thermal thresholds and vascular function following cooling will be measured in those with VWF considered to be at stage 1 or greater, and in a selection of those with no vascular symptoms. Subjects will be followed-up at annual intervals by questionnaires and those reporting worsening symptoms will be interviewed and tested. Information on the pattern and extent of exposure to hand-transmitted vibration over the period of follow-up will be collected, so that any progression of symptoms can be related to these parameters. Analysis will focus on (i) how often established cases of VWF get worse; (ii) how rapidly they get worse; (iii) whether those destined to get worse can be predicted (to aid earlier detection) by either clinical means or objective testing; and if so, (iv) whether advice can be better tailored to individual circumstances.

### *Work package 3: HTV experimental work*

Work package 3 is designed to support the epidemiological research with experimental and modeling studies.

The establishment of a relationship between exposure to hand-transmitted vibration and injury requires an appropriate means for assessing vibration dose that accounts for the observed effects of vibration magnitude, vibration frequency, vibration duration and vibration direction, as well as factors such as grip force. Previous collaborative work between the partners and others has identified problems with current standardized procedures for the evaluation of hand-transmitted vibration. The specific objectives of work package 3 are:

- (i) to conduct experimental studies of the acute effects of hand-transmitted vibration so as to provide improved ‘weightings’ for the acute effects of the frequency and duration of hand-tool vibration, and the grip force exerted by operators. These are required for the interpretation of the epidemiological data and the establishment of appropriate dose response models in work package 1.
- (ii) to model the hand-arm system so as to assist the interpretation of the epidemiological studies in work package 2, where the grip force and posture may be important confounding factors not taken into account in previous studies.

### *Task 3.1 Laboratory studies of vascular and neurological effects of hand-transmitted vibration*

Laboratory experiments are investigating acute effects of hand-transmitted vibration on vascular function (finger blood flow) and neurological function (vibration perception thresholds and thermotactile thresholds). The studies are designed to systematically investigate the effects of vibration magnitude, vibration frequency and vibration duration.

Laboratory experiments will be undertaken collaboratively by the University of Southampton and the University of Trieste to investigate the acute effects of hand-transmitted vibration on measures of vascular function (finger blood flow) so as to consolidate current knowledge and better define the effects of vibration magnitude, frequency and duration (see Bovenzi *et al.*, 1998, 1999, 2000, 2001). Complementary studies of the effects of hand-transmitted vibration on neurological function will be performed by the Swedish partner.

In the studies of the effects of hand-transmitted vibration on vascular function, the experiments will investigate the effects of vibration frequency (from 16 to 250 Hz), vibration magnitude (from 1 to 176 ms<sup>-2</sup> r.m.s.), and vibration duration (from 0.03 to 1 hour). Further experiments are planned to explore the effects of intermittent exposure to hand-transmitted vibration. The results will be combined to develop alternative measures of vibration dose with alternative time-dependencies. The relationships between the various vibration doses and acute vascular effects will be assessed.

#### *Task 3.2 Laboratory studies of effects of hand-transmitted vibration on the detection of symptoms*

Laboratory studies will investigate whether prior exposure to vibration on the day of a diagnostic test influences test results. The findings will be used to identify the length of time required between an occupational exposure to hand-transmitted vibration and the commencement of diagnostic testing.

Laboratory studies designed by the University of Southampton and the University of Trieste will investigate whether conditions in the field are likely to influence the results obtained from the vascular objective diagnostic tests used to detect symptoms (i.e. whether prior exposure to vibration on the day of the test influences vascular function). Similar studies with neurological function will be performed by the Swedish partner. The findings will be used to establish an improved definition of test conditions, especially the length of time required between the last occupational exposure to tool vibration and the commencement of objective testing.

#### *Task 3.3 Biodynamic modeling of hand-arm system*

Two-dimensional and three-dimensional finite element biodynamic models are being developed by INRS in France to represent the applied forces, pressures and internal stresses resulting from contact of a finger with a vibrating surface. The models will take into account bone geometry and joints in addition to the characteristics of the soft tissues.

The models are intended to assist the interpretation of the above laboratory experimental studies of finger blood flow and neurological function with varying characteristics of vibration and contact forces, and will therefore use similar boundary conditions.

Measurements of the mechanical impedance of the finger will be made by INRS and compared to the calculated impedance derived from modal analyses of the three-dimensional finite element model developed in the research.

It is hoped that the modelling studies will improve understanding of the effects of contact force and vibration frequency on mode shapes in the finger, the mechanical impedance of the finger, and pressure maps in the finger. This may assist the interpretation of the various experimental studies of the frequency-dependence of vascular or neurological responses of the finger to hand-transmitted vibration.

### **Partners**

The four partners in VIBRISKS involved in hand-transmitted vibration research are:

1. University of Southampton, UK (Co-ordinator): ISVR and MRC. The VIBRISKS project is coordinated by Professor Michael Griffin and managed by Dr Christopher Lewis in the ISVR. The ISVR also leads work package 1 and is a participant in work packages 2 and 3. Dr Keith Palmer of the MRC Environmental Epidemiology Unit at the University of Southampton is leading a project in work package 3.
2. University of Trieste, Italy: Clinical Unit of Occupational Medicine, Department of Public Health Sciences. Professor Massimo Bovenzi of the University of Trieste leads work package 2 and is an active participant in work packages 1 and 3. Dr. Iole Pinto, of the Physical Agents Laboratory at the Department of Prevention, Siena, is subcontracted to assist with measurements of occupational exposures to hand-transmitted vibration in work package 2.
3. INRS: Institut National de Recherche et de Sécurité, Vandoeuvre, France. Dr Pierre Lemerle of INRS leads work package 3 and is responsible for the development of biodynamic models.
4. UMH: Department of Biomedical Engineering and Informatics, Umeå University Hospital and Department of Occupational Medicine, Umeå University, Sweden. Professor Ronnie Lundström of UMH, together with Professor Lage Burström of NIWL, Professor Mats Hagberg of Department of Occupational Medicine, Göteborg University and Dr Tohr Nilsson, Department of Occupational Medicine, Sundsvall Hospital are collaborating on epidemiological studies within work package 2 and is a participant in work package 1. Professor Ronnie Lundström and Professor Lage Burström are also participating in experimental studies within work package 3.

The following partners are collaborating with the above four partners on whole-body vibration research:

5. Bundesanstalt für Arbeitsmedizin, Berlin, Germany: Dr Helmut Seidel, Dr Barbara Hinz and Dr Ralph Blüthner.
6. Coronel Institute, University of Amsterdam, Netherlands: Dr Carel Hulshof and Dr Jos Verbeek.

### **Acknowledgements**

This research is supported by the European Commission under the Framework 5 Quality of Life and Management of Living Resources programme - Project No. QLK4-2002-02650 (VIBRISKS).

### **Bibliography**

Further information on VIBRISKS and VINET may be found via <http://www.humanvibration.com>

### **References**

- Bovenzi M., Lindsell C.J., Griffin M.J. (1998) Duration of acute exposures to vibration and finger circulation. *Scandinavian Journal of Work, Environment and Health* 24:130–137.
- Bovenzi M., Lindsell C.J., Griffin M.J. (1999) Magnitude of acute exposures to vibration and finger circulation. *Scandinavian Journal of Work, Environment and Health* 25:278–284.
- Bovenzi M., Lindsell C.J., Griffin M.J. (2000) Acute vascular response to the frequency of vibration transmitted to the hand. *Occupational and Environmental Medicine* 57:422–430.
- Bovenzi M., Lindsell C.J., Griffin M.J. (2001) Response of finger circulation to energy equivalent combinations of magnitude and duration of vibration. *Occupational and Environmental Medicine* 58:185–193.
- Bovenzi M., Welsh, A.J.L., Griffin, M.J. 2004) Acute effects of continuous and intermittent vibration on finger circulation. *International Archives of Occupational and Environmental Health* (77: 255–263.
- Griffin, M.J., Bovenzi, M., Nelson, C.M. (2004) Dose-response patterns for vibration-induced white finger. *Occupational and Environmental Medicine* 60:16–26.
- International Organization for Standardization (2001) Mechanical vibration - vibrotactile perception thresholds for the assessment of nerve dysfunction - Part 1: Methods of measurement at the fingertips. International Standard, ISO 13091-1:2001(E).
- International Organization for Standardization (2001) Mechanical vibration - measurement and evaluation of human exposure to hand-transmitted vibration - Part 1: General requirements. International Standard, ISO 5349-1.
- International Organization for Standardization (2002) Mechanical vibration - measurement and evaluation of human exposure to hand-transmitted vibration - Part 2: Practical guidance for measurement at the workplace, ISO 5349-2:2002(E).
- International Organization for Standardization (2004) Mechanical vibration and shock - Cold provocation tests for the assessment of peripheral vascular function - Part 1: Measurement and evaluation of finger skin temperature. DIS 14835-1: 2004(E).
- International Organization for Standardization (2004) Mechanical vibration and shock - Cold provocation tests for the assessment of peripheral vascular function - Part 2: Measurement and evaluation of finger systolic blood pressure. DIS 14835-2: 2004(E).

# QUESTIONS AND TESTS USEFUL IN THE DIAGNOSIS OF HAVS

H. Mason, J. Elms, and K. Poole

Health and Safety Laboratory, Broad Lane, Sheffield, United Kingdom.

## Abstract

This study investigated which questions and quantitative tests were the best predictors of hand-arm vibration syndrome (HAVS) diagnosis and staging within a health surveillance assessment.

167 male workers underwent a physician-led HAVS assessment, including quantitative testing. Additional presumptive HAVS staging was performed at various points within the assessment. Logistic regression analyses were used to compare the influence of various tests and questions on defining abnormality or staging.

There was close agreement between the self-reporting of digital blanching and the final vascular staging. Two questions within the medical interview gave 94% correct predictions with high specificity and sensitivity against the physicians' final assessment of the presence of vascular HAVS. A cold provocation vascular test did not appear to influence the final vascular staging. This study reinforces the importance of obtaining a true history of vascular symptoms. There was fair agreement between presumptive neurosensory staging based on reported symptoms and the final staging. However, the diagnosis of HAVS and final neurosensory staging was influenced by contributions from the medical interview and quantitative tests. Analysis of symptom questions used within the medical interview suggested that four questions gave 86% correct predictions for the diagnosis of the presence of sensorineural HAVS, although the specificity was only 52%.

## Introduction

Current guidance in the UK suggests that employers should provide a health surveillance programme where daily vibration exposures are likely to exceed  $2.8\text{ms}^{-2}$  (Health and Safety Executive 1994; Health and Safety Executive 2001).

The current health surveillance programme in the UK recommends the inclusion of a screening questionnaire, and a number of questionnaires have been suggested for use (Faculty of Occupational Medicine of the Royal College of Physicians 1993; Health and Safety Executive 1994; Vibration Injury Network 2002), including physician-led questionnaires or self-reporting symptom questionnaires. Generally these questionnaires are similar, attempting to elicit symptoms and their severity for the vascular, neurosensory and musculoskeletal components of HAVS. Some element of questioning may be used to confirm a non-vibrational cause for any relevant symptoms or to detect other possible health problems (e.g. carpal tunnel syndrome), which are associated with work-practices where vibrating tools are used. The questionnaire within a medical interview may be accompanied by a number of physical examinations or clinical manoeuvres to aid diagnosis of HAVS, to eliminate confounding conditions, or to detect non-HAVS conditions associated with vibrating tool use.

A number of authors have suggested that quantitative tests can supplement the information gained from the medical interview (or symptom questionnaire) as well as the reliability of the diagnosis and staging (McGeoch 1994; Pelmear 1994; Lawson 1996; Kent 1998; Allen 2002). Some of these tests (e.g. Semmes-Weinstein monofilaments, Purdue pegboard, grip dynamometry) could be used in the 'doctor's office', whereas other quantitative tests (e.g. Vibrotactile Perception Threshold and Temperature Perception Threshold) are only appropriate for use in a referral centre. Currently there is no single test that has been shown to diagnose the individual components of HAVS, and multiple testing strategies have been advocated.

Implementation of the European Physical Agents Directive (vibration) in the UK in 2005 will mean that many more workers will need some form of health surveillance. In light of this, the HSE, and the Faculty of Occupational Medicine are currently re-assessing their guidance on HAVS health surveillance (Faculty of Occupational Medicine of the Royal College of Physicians 1993; Health and Safety Executive 2001). The purpose of this study was to investigate which questions and tests used in our current assessment are the best predictors of HAVS, to establish the value of quantitative tests in diagnosis of HAVS, and to assess whether any particular test, or combination of tests, was most predictive of its severity.

The study was based on workers referred to the Health and Safety Laboratory (HSL) within the context of health surveillance programs rather than medico-legal cases. The assessment used a combination of medical interview, physical examination and quantitative testing, and was largely based on the strategy used for the UK miner compensation

assessment (Lawson 2003). However, some additional tests and presumptive Stockholm workshop staging were introduced during the assessment in this study. We have assumed that the final Stockholm staging after the complete assessment represents the “true” staging for the individual.

## **Methodology and Population**

### *Overview of health surveillance assessment*

The Health surveillance assessments were based on those defined in the Department of Trade and Industry (DTI) miners compensation scheme (Lawson 2003). The assessment used a standardised questionnaire and simple tests, with more detailed quantitative test methods. The assessments were performed in the laboratory at a room temperature of 22°C (± 2°C). The clients were allowed to acclimatise to the temperature of the laboratory for at least 15 minutes before the assessment was commenced. Noise levels in the laboratory were kept at a minimum. The client initially undertook a technician-led vibration exposure questionnaire during the acclimatisation period. They were asked to abstain from caffeine, alcohol and nicotine prior to the assessment, and also to refrain from the use of vibrating tools for at least two hours before arriving at the Health and Safety Laboratory. The sensorineural tests and clinicians assessment was performed before the vascular test. The physicians undertaking the medical interview, physical examination, and diagnosis using the data had been formally trained for the DTI miners scheme and had subsequent considerable experience of examining HAVS cases within an health surveillance context. For the purpose of this study the assessment process has been divided into three consecutive stages, all leading to a final staging and assessment.

The first stage consists of the following elements. An HAVS technician recorded the current and past employment in conjunction with the vibration exposure history. The client was then interviewed by the clinician using initially open questions (e.g. asked “How do your hands trouble you?”) and was allowed to explain in their own words their symptomology. Following this, the client was asked a series of direct questions to determine whether they had experienced blanching in their fingers and in what circumstances, when these symptoms began, and whether any family member presented with these symptoms. The Griffin scoring system (Griffin 1990) was applied to each hand to record the extent of blanching. Further questioning was employed to determine whether the client experienced numbness and tingling in their fingers and when these symptoms began, whether they suffered symptoms of night waking, and finally whether they experienced any problems with the muscles and joints of their hands/arms, and any dexterity problems at room temperature. Within this study the physician was then asked to make an initial HAVS staging on the basis of the client’s history of exposure, the medical interview and their reported symptoms in accordance with the Stockholm Workshop scaling (Brammer 1987; Gemne 1987; Gemne 1995).

The second stage of the assessment followed on with physical examination including blood pressure for both right and left sides and the examination of hands, fingers, wrists and forearms. The examination was designed to identify other pathologies that may result in similar vascular or sensorineural symptoms (such as peripheral arterial disease, trauma and neurogenic causes; trauma to the neck or arm, peripheral nerve entrapment, peripheral neuropathy). Allen’s, Adson’s, Tinel’s and Phalen’s tests were carried out using standard procedures. A positive Tinel’s or Phalen’s test in conjunction with self-reporting of night-waking with pain, numbness or tingling in the hands was presumed to be indicative of carpal tunnel syndrome. As part of the physical examination, the physician applied a number of simple quantitative tests. To assess the manual dexterity, the client performed the Purdue Pegboard (Tiffin 1948) and nine hole peg-test (Mathiowetz 1985). Grip strength, using a Jamar dynamometer, was then used to assess the muscle strength of the hand, and monofilaments (Weinstein Enhanced Sensory Tests™) were used to measure touch perception. The Purdue Pegboard and mean grip strength tests were undertaken in accordance to the procedures set out in the DTI miner’s assessments (Lawson 2003). The clinician was then asked to make a second HAVS staging based on client’s history of exposure, medical interview, their reported symptoms, their physical examination and the ‘simple’ quantitative test results.

The Purdue and nine-hole pegboard tests were repeated for both hands. Monofilaments were applied perpendicularly to the volar base and tip of the index and little finger, the palm and the thumb tip on both hands. Each filament (Table 1) was randomly applied to the skin locations and the lowest stimulus detected (without the client looking) was recorded. A monofilament hand score was calculated by adding the ID of the lowest stimulus detected for each of the test sites (hand score minimum = 6, and maximum = 30).



**Table 1** Weinstein Enhanced Sensory Tests™ monofilaments

THRESHOLD (G)	ID	LEVER COLOUR	SENSATION
0.07	1	Green	Within normal range
0.2	2	Blue	Tactile sensation reduced
2	3	Purple	Protective sensation reduced
4	4	Red	Loss of protective sensation
200	5	Orange	Insensitive

The third stage of the assessment involved more complex, quantitative tests. This test panel consisted of three tests standardized in DTI miners compensation scheme (Lawson 2003), the Vibration Perception Threshold test (VPT), Thermal Perception Threshold test (TPT) and Finger skin rewarming after cold provocation test (CPT). These tests were carried out by trained technicians. Participants were given a third HAVS staging for the sensorineural component of HAVS on the results of the ‘quantitative’ tests, using the abnormality scoring criteria defined for the Department of Trade and Industry miner’s compensation claim assessments (Lawson 2003), Tables 2 and 3. The VPT and TPT abnormality scores were added to produce a final sensorineural score for each hand. If the clinician diagnosed the client had a loss of dexterity in a warm environment, and the client had an abnormal Purdue Pegboard test result, and the sensorineural score  $\geq 9$ , then 10 was added to the final sensorineural score for the hand.

The vascular staging was determined by the results of the first two stages of the assessment; with the CPT results used as additional information for the physician. Each hand was assigned a blanching score (Griffin Score), which was used in the definition of the vascular staging (table 3). The CPT results was used as additional information for the physician, but did not feed directly into the scoring system (Lawson 2003).

Using the information gained from all stages of the medical assessment, the physician then came to a final conclusion and assigned a final HAVS staging for the vascular and neurological component for both hands. Using the guidelines from the DTI assessments, the 2Sn sensorineural staging of HAVS was also sub-divided into 2Sn early and 2Sn late (table 3).

**Table 2** Sensorineural scoring system based in VPT and TPT tests (Lawson 2003)

‘QUANTITATIVE’ TEST	SCORING SYSTEM
VPT (index and little finger) 31.5Hz	$<0.3\text{ms}^2 = 0$ , $\geq 0.3\text{ms}^2 < 0.4\text{ms}^2 = 1$ , $\geq 0.4\text{ms}^2 = 2$
VPT (index and little finger) 125Hz	$<0.7\text{ms}^2 = 0$ , $\geq 0.7\text{ms}^2 < 1.0\text{ms}^2 = 1$ , $\geq 1.0\text{ms}^2 = 2$
TPT (index and little finger) Neutral Zone	$<21^\circ\text{C} = 0$ , $\geq 21^\circ\text{C} < 27^\circ\text{C} = 2$ , $\geq 27^\circ\text{C} = 4$
CPT	$\leq 300\text{s} = 0$ , $>300\text{s} \leq 600\text{s} = 1$ , $>600\text{s} = 2$

**Table 3** Modification of the Stockholm Workshop Scales used in the assessment (Lawson 2003)

STAGE	Symptoms
0 Sn	Vibration exposed but no symptoms
1 Sn	Intermittent numbness and/or tingling with a sensorineural score $\geq 3$ , $< 6$
2 Sn (early)	Intermittent or persistent numbness and/or tingling, reduced sensory perception with a score of $\geq 6$ , $< 9$
2 Sn (late)	As 2Sn (early), but with a sensorineural score of $\geq 9$ , $\leq 16$
3 Sn	Intermittent or persistent numbness and/or tingling, reduced manual dexterity and an sensorineural score of $\geq 19$
0 V	No attacks
1 V	Attacks affecting only the tips of the distal phalanges of one or more fingers, usually a blanching score of 1-4
2 V	Occasional attacks of whiteness affecting the distal and middle (rarely also the proximal) phalanges of one or more fingers, usually a blanching score of 5-16
3 V	Frequent attacks of whiteness affecting all of the phalanges of most of the fingers, usually a blanching score $\geq 18$
4 V	As 3V, but with trophic skin changes

## Population

The Health and Safety Laboratory undertakes health surveillance assessments for HAVS in industrial workers exposed to vibration and referred by their company's occupational health physician/nurse, or by their general practitioner. Analysis of symptom questions used within the medical interview was performed on a data set of 365 individuals assessed between November 1999 and August 2003 and who gave permission for analysis of their results. A smaller subset of 167 individuals attending the centre from May 2002 to August 2003, when monofilament and nine hole pegboard testing was added to the assessment, agreed to use of their data. None of the referrals from May 2002-August 2003 who were included in the study were considered to have primary Raynaud's disease. .

## Data analysis

During the assessment each individual was given a sensorineural and vascular staging for the dominant and non-dominant hand. However, only the dominant hand was analyzed and presented in this paper. Accordingly, we also investigated the 'simple' and 'quantitative' tests for the dominant hand only. The VPT and TPT tests were undertaken on the index and little finger. As the final HAVS staging is determined for the hand rather than each finger, the average of the test results for the index and little finger was used for the statistical analysis. For the CPT, the outcome metrics from the index, middle, ring and little finger were averaged for analysis.

Cohen's Kappa analysis was used to determine whether the presumptive staging within the assessments were in agreement with the final staging. Logistic regression, in which the outcome was the final diagnosis of HAVS (sensorineural or vascular), was used to determine which questions and tests (simple and complex) were the best predictors of final staging or drove the changes from one severity stage to the next stage.

All of the tests used in the assessment for the sensorineural and vascular components of HAVS were included to determine which tests could be used within a simple diagnostic assessment. Age was included as a potential confounding factor.

## Results

### Patient demographics

The mean age of the study population was 45 years (sd = 9, range 21-63) and the mean length of vibration exposure was 22 years (sd = 10, range 1-42). 87% of the participants were right-handed and 13% were left-handed. 8% of subjects did not have HAVS but had suspected carpal tunnel syndrome (CTS). This presumptive diagnosis of CTS was based on positive Tinels and Phalen's tests, and a report of 'tingling and/or numbness woke them at night' or a previous diagnosis of carpal tunnel syndrome. These individuals with solely a diagnosis of suspected CTS were excluded from all subsequent statistical analysis, except those analyses to determine the predictive value of symptom questions. After excluding those subjects with CTS only, 88% of the population had HAVS (vascular or sensorineural) either on the dominant or non-dominant hand, and of these, 39% also had co-existing the criteria for suspected carpal tunnel syndrome. 16% of individuals had no symptoms in their dominant hand, 41% had sensorineural symptoms only and less than 1% had vascular symptoms only. The distribution of the final sensorineural and vascular staging for the dominant hand is described in table 4.

**Table 4** Distribution of final sensorineural and vascular staging for the dominant hand in the subset of workers who had monofilaments and nine hole peg testing

Staging	0 Sn	1 Sn	2 Sn	3 Sn	Totals
0 V	25	23	39	0	87
1 V	3	4	8	0	15
2 V	2	12	26	1	41
3 V	0	2	7	1	10
4 V	0	0	0	0	0
Totals	30	41	80	2	153

### Agreement between presumptive staging throughout assessment and final staging

The strength of agreement between the initial sensorineural staging and final sensorineural staging was fair ( $\kappa = 0.377$ ), whereas between the second sensorineural stage and final sensorineural stage was moderate ( $\kappa = 0.446$ ) (table 5). This fair to moderate agreement of the first two sensorineural stages with the final staging suggests the final staging is influenced by the quantitative tests introduced in stage 3 of the assessment. However, the moderate level of agreement between the third staging, based on quantitative testing, and final assessment staging also suggests that quantitative tests alone do not predict the final assessment.

**Table 5** Agreement between sensorineural staging

	Kappa
Initial Staging-Final Staging	0.377
Second Staging-Final Staging	0.446
Third Staging-Final Staging	0.548
Initial Staging-Second staging	0.548
Initial Staging-Third Staging	0.208
Second Staging-Third Staging	0.241

The strength of agreement between the initial vascular staging and final vascular staging was very good ( $\kappa = 0.929$ ), as was the agreement between the second vascular stage and final vascular stage ( $\kappa = 0.956$ ). This level of agreement suggests that the quantitative tests introduced into section 3 of the assessment, including the cold provocation test, were not influencing the staging process, which was driven by information from the initial vibration exposure and medical questionnaire.

*Questions, 'simple' and quantitative tests used in the prediction of HAVS.*

Logistic regression analysis was undertaken to determine the best predictor variables for the presence or absence of sensorineural HAVS and predictors for staging. For the logistic regression analysis, individuals were only included if they had results for all of the predictors variables in the analysis.

The presence of sensorineural component of HAVS ('normal' or 'abnormal') was predicted initially using 'simple' tests and questions. The model suggested that questions on tingling and numbness in the fingers, age and monofilament hand score gave correct prediction in 94% of subjects with a sensitivity of 98% and a specificity of 73%. The regression was repeated to include the 'quantitative' tests. Variables included in the final model were tingling and numbness in the fingers, monofilament hand score, and average thermal perception threshold neutral zone. The percentage of correct predictions in this model was 96% with a sensitivity of 99% and a specificity of 81%.

The 'simple' tests and questions included in the model to predict the transition from 0Sn or stage 1Sn diagnosis were tingling and numbness in the fingers, age and nine-hole peg test score. The percentage of correct predictions using this model was 85% with a sensitivity of 93% and a specificity of 74%. The regression was again repeated to include the quantitative tests. The variables included in the model were tingling and numbness in the fingers, age and average thermal perception threshold neutral zone. The percentage of correct predictions using the final model was 90% with a sensitivity of 95% and a specificity of 82%.

Interestingly, we were unable to calculate a good predictor model using 'simple' and 'quantitative' tests and questions for the transition stage 1Sn to 2Sn early. The regression analysis was undertaken to determine the best predictor variables for the change in final stage outcome of HAVS from stage 2Sn 'early' to 2Sn 'late'. We were unable to calculate a good prediction model using 'simple' tests and questions, although the prevalence of abnormality in both monofilament and Purdue pegboard tests were significantly increased in 2Sn 'late' compared to 2Sn 'early'. However, when the complex quantitative tests were included, the percentage of correct predictions using the final model was 84% with a sensitivity of 87% and a specificity of 80%. Variables included in this model were monofilament hand score, and average thermal perception threshold neutral zone.

Logistic regression analysis was undertaken to determine the best predictor variables for the presence or absence of vascular HAVS and predictors of transitions between staging. For the following analysis questions, simple and quantitative tests were included in the regression, however in each case the quantitative tests were not significant in the model. The model to predict the outcome of 'normal' or 'abnormal' final staging included the question 'Have you

ever suffered with your fingers going white on exposure to cold?' and the test of grip strength. The percentage of correct predictions using the final model was 87% with a sensitivity of 97% and a specificity of 79%.

The model to predict the outcome of stage 1V to 2V and 2V to 3V suggested that the final staging was driven by the Griffin score only. The regression analysis was repeated for the vascular staging, removing the questions regarding blanching and the Griffin score and using available quantitative tests, both neurosensory and vascular tests. Such an analysis may be illuminating for situations within any HAVS assessment, where responses to questions cannot be relied upon. We were unable to calculate a predictor model from 1V to 2V using only 'simple' and 'quantitative' tests. However, we were able to calculate a model for vascular HAVS/no HAVS using Purdue pegboard and grip strength and from 2V to 3V using only grip strength, although the models had low sensitivities (51% and 22% respectively).

Cross tabulation with a common Odds Ratio estimate was undertaken for all symptom questions asked within the medical interview against the presence or absence of HAVS (sensorineural or vascular) as defined in the final assessment (table 6). Logistic regression analysis was undertaken using the statistically significant questions identified in table 6. Positive responses to sensorineural questions '*Do you suffer from numbness in response to the cold?*' '*Do you suffer from tingling in response to the cold?*' '*Do you suffer from tingling (for longer than 20 minutes) after using vibratory tools?*' and '*Do you suffer from numbness (for longer than 20 minutes) after using vibratory tools?*' were included in the model, which had a sensitivity of 94%, specificity of 52%, with 86% of the cohort correctly assigned. The question '*Are you experiencing any stiffness with the muscles and joints of your hands or arms?*' was excluded from the final model as although it increased the specificity of the model to 59%, it reduced the sensitivity to 92%. The value of the question "*Does tingling/and or numbness waken you at night?*" to screen for CTS was investigated, 13% of those individuals who were assessed to have HAVS only, also reported that tingling/and or numbness woke them at night.

This method was also repeated for the vascular component using the vascular questions with statistically significant odds ratios from table 1. Positive responses to the questions '*Have you ever suffered with your fingers going white on exposure to cold?*' and '*Do you suffer from numbness during attack of whiteness?*' provided a sensitivity of 98%, specificity of 88% with 94% of the cohort correctly assigned. The inclusion of the other statistically significant questions did not increase the predictive power of the model.

## Discussion

This study investigated the role of questions and a number of quantitative tests for diagnosing and staging the severity of HAVS. The outcomes of this study are predicated by the assumption that the final staging (after the medical interview, physical examination, and quantitative testing) is most likely to reflect the true status of HAVS in an individual. The problems of definition of a "gold standard" diagnosis for HAVS have been widely debated.

Subjects within this study were investigated using the diagnostic strategy developed for the DTI UK miners compensation scheme (Lawson 2003), applied within a health surveillance referral setting and allowing the physician to use their clinical expertise in assigning the final HAVS staging. The physicians involved were asked to document a presumptive Stockholm staging at three steps within the process as well as for the final outcome of staging. Two quantitative tests (Semmes-Weinstein monofilaments and the nine-hole pegboard) were added to the original testing strategy.

This study investigated which questions and tests were most useful in driving the final staging, in terms of identifying those who have any severity of HAVS and between the stages to identify changes in severity of symptoms. Within the DTI assessment strategy there are certain tests (VPT and TPT) embedded within the definition of each specific stage as well as at transitions between different stages. Therefore such tests would tend *a priori* to act as "good" drivers in the staging of HAVS and this bias needs to be recognised.

**Table 6** Odds ratio for each question used to predict the final outcome of HAVS

QUESTION	SENSORINEURAL		VASCULAR	
	ODDS RATIO (+/-CI) OF ABNORMAL RESPONSE)	P	ODDS RATIO (+/-CI) OF ABNORMAL RESPONSE)	P
Do you suffer from tingling after using vibratory tools?	3.381 (1.945-5.878)	0.000	1.694 (1.093-2.627)	0.018
Do you suffer from tingling in response to cold?	9.589 (5.149-17.858)	0.000	4.258 (2.675-6.776)	0.000
Do you suffer from tingling during attack of whiteness?	-	-	53.743 (27.396-105.426)	0.000
Do you suffer from tingling at other times?	1.373 (0.805-2.344)	0.244	0.512 (0.335-0.782)	0.002
Is the tingling persistent?	1.333 (0.640-2.775)	0.441	0.985 (0.579-1.678)	0.956
Do you suffer from numbness after using vibratory tools?	3.305 (1.847-5.913)	0.000	3.159 (2.051-4.865)	0.000
Do you suffer from numbness in response to cold?	10.420 (5.723-18.973)	0.000	9.659 (5.439-17.151)	0.000
Do you suffer from numbness during attack of whiteness?	-	-	270.600 (97.964-747.461)	0.000
Do you suffer from numbness at other times?	1.218 (0.679-2.187)	0.508	0.708 (0.455-1.104)	0.127
Is the numbness persistent?	3.269 (0.980-10.910)	0.042	2.219 (1.099-4.477)	0.023
Does the tingling and/or numbness waken you at night	1.553 (0.840-2.871)	0.158	0.713 (0.458-1.111)	0.134
Are you experiencing any pain with the muscles and joints of your hands or arms?	0.988 (0.564-1.732)	0.967	0.881 (0.572-1.359)	0.568
Are you experiencing any swelling of the muscles and joints of your hands or arms?	1.343 (0.500-3.605)	0.557	1.062 (0.525-2.148)	0.866
Are you experiencing any stiffness with the muscles and joints of your hands or arms?	2.393 (1.198-4.781)	0.011	0.901 (0.574-1.415)	0.652
Are you suffering with weakness of grip?	1.658 (0.899-3.058)	0.103	1.422 (0.910-2.221)	0.121
Do you have any problems with fine movements and dexterity of your fingers at room temperature?	1.569 (0.826-2.978)	0.166	1.142 (0.720-1.811)	0.574
Have you ever suffered your fingers going white on cold exposure?	-	-	1098.880 (147.154-8205.94)	0.000

The study population were derived from health surveillance referrals, not medicolegal cases which may suffer significant bias in reporting of symptoms. About 8% of the referrals appeared not to have HAVS, but were tentatively diagnosed as carpal tunnel syndrome from their reported symptoms and physical examination tests such as Phalen's and Tinel's tests. Approximately, a further tenth of the population studied did not appear to have HAVS. The cohort also confirmed that sensorineural symptoms and hence Stockholm staging, could be apparent without any evidence of blanching and vascular staging. 57% of the population were staged as 0V but around three-quarters of these individuals had a sensorineural score of 1Sn or above. Of interest was that only a limited number of these subjects were staged as 3Sn in contrast to the DTI miners' assessment group where the percentage of stage 3Sn was considerably higher (Lawson 2003). While the lack of 3Sn cases may have limited the research questions surrounding diagnosis for this stage, this low percentage may reflect the true prevalence of severe neurosensory HAVS cases in the UK workplace.

The very high level of agreement ( $\kappa=0.93$ ) between the initial HAVS vascular staging after medical interview and the final HAVS staging at the end of the assessment supports the idea that vascular diagnosis is largely driven by the

subject's reporting of blanching. In this present study, the cold provocation test used had little influence on the pre-test probability of a vascular diagnosis of HAVS. On a simplistic basis the poor performance of the cold provocation test used in the DTI miners assessment format was confirmed (Mason 2003; Proud 2003).

The initial presumptive diagnosis of vascular HAVS in our study was determined after a medical interview, not just a symptom questionnaire. For a presumptive diagnosis of HAVS, the subject had to give a convincing description of the blanching associated with HAVS and its extent and frequency. In addition they were questioned about the time of initial appearance of blanching attacks in relation to occupational vibration exposure as well possible familial history of blanching that may indicate an alternative diagnosis of primary Raynaud's. Other, but rare causes of "blanching phenomena" may include thoracic outlet syndrome, hypothenar hammer, rheumatoid arthritis, and scleroderma. Thoracic outlet syndrome may be suggested by the position of the arms, or the work activity when blanching occurs and also by a positive Adson's test, although the predictive power of this test has been questioned with 13% false positives (Rayan and Jensen 1995). Therefore it cannot be concluded that simple questionnaire data can be used adequately as a tool to identify, differentially diagnose or stage the severity of vascular HAVS. However, when the interviewer can be convinced that significant misreporting of symptoms by the subject has not occurred the use of an appropriate medical interview may be a pragmatic solution. Other authorities (Pelmeur 2003) have suggested that a true vascular diagnosis can only be made using a battery of tests but the cost implications for health surveillance of a large number of subjects with significant HAVS would be very large.

In contrast to the vascular component, the strength of agreement in our study between initial sensorineural staging after the medical interview and final staging was only fair ( $\kappa=0.38$ ). There was a small improvement to the extent of this agreement after addition of simple "doctor's office" quantitative tests ( $\kappa=0.45$ ). Staging by DTI scores based on vibrotactile and thermal perception measurements also gave moderate agreement ( $\kappa=0.55$ ) with the final staging. This data can be interpreted on the basis that staging of sensorineural HAVS is not readily assessed by medical interview alone with a single question on the subject's perception of their manual dexterity being included. Likewise, though our final staging was influenced *a priori* by scoring of performance in quantitative VPT & TPT tests, the scores alone were not adequate at defining the final staging. Thus the addition of some form of quantitative neurosensory testing together with the medical interview was necessary to reach our final staging.

The role of quantitative tests within HAVS diagnosis continues to be debated. A number of investigators have noted that quantitative tests are valuable in confirming and staging the severity of HAVS. Their use within assessments for medicolegal or compensation reasons are widespread, and they have been applied in many research investigations of HAVS. However, the number of published papers that have addressed their role specifically within a routine health surveillance is relatively limited (McGeoch 1994; McGeoch 1995; Johnson 1996; Lawson 1996; Lawson 1997; Kent 1998; McGeoch 2000; Yamada 2002). The lack of an agreed "gold standard" has hampered progress in defining a role for quantitative tests in establishing diagnosis or staging severity of HAVS. In interpreting the data from this study, the evidence that certain quantitative tests drive the assessment process was recognised.

Binary logistic regression analysis was used to indicate the combination of questions, and quantitative tests (simple and complex) that were used for defining HAVS stages. To a large extent the analysis strengthened some of the conclusions on diagnosis that have already been found by other approaches. Reporting of blanching of the fingers was the driver of a vascular diagnosis of HAVS, with the Griffin score on the extent of blanching driving the changes in category of staging. A high percentage of correct predictions were obtained in this analysis, suggesting that in the absence of a "gold standard" diagnosis, our physicians' final assessment of vascular HAVS and its severity is based heavily on subjective reporting of blanching and its extent. The quantitative CPT test had little to no value. However, the repeatability of the Griffin score based on subject recall of their symptom has not been well described in the literature.

It was also apparent within this study of health surveillance referrals that the physicians were not convinced that significant subject bias on the reporting of their symptoms was apparent. However, this study attempted to define a model that could diagnose vascular HAVS without the reliance on replies to questions on blanching or Griffin score. This would identify if it was possible to accurately predict a vascular case of HAVS, where there are concerns that the subject is deliberately biasing their symptoms. The logistic regression analysis failed to find a useful combination of questions and tests that would have significant diagnostic power in this context.

Binary logistic regression analysis of the neurosensory component of HAVS suggested that the questions that address numbness and tingling were important. However, significant increases in specificity of defining the presence of neurosensory HAVS were obtained when neutral zone TPT and monofilament test results were included. The accuracy of prediction from responses to questions on tingling and numbness together with TPT and monofilaments was 96%. Whereas using the same questions, without the TPT test gave a slightly lower prediction of 94%. If we assume that such strategies may be used in populations where the disease prevalence is 10-15%, positive predictive values of 20-40% would be expected where TPT is not included, increasing to 36-48% where TPT testing is included and also suggested that significant number of HAVS neurosensory cases would not be missed using such strategies. The logistic regression analysis used to define 1Sn from 0Sn also supported the use of the TPT test. While a good model was not possible for discriminating 1Sn to 2Sn “early” and 2Sn “early to 2Sn “late” using only a simple test, there was evidence of changes in prevalences of abnormality in Purdue pegboard and monofilaments in the 2Sn early/late division which was largely defined by VPT and TPT. Such data may help support the division of stage 2Sn. However, defining 2Sn “early” to 2Sn “late” was possible using a TPT neutral zone and monofilaments, resulting in a correct predictive value of 84%. Overall, it appeared from the logistic regression analysis that the TPT and monofilaments were useful but tests alone did not accurately predict the neurosensory severity. Both questioning within the medical interview and the physicians expertise in clinical assessment were also critical.

Six specific questions (four neurosensory and two vascular) used within our medical interview appeared to have high predictive value for the presence of HAVS. The sensitivity and specificity from positive responses to the two vascular questions would reflect a positive and negative predictive value of 47% and >99% for a vibration exposed population with a 10% prevalence of HAVS. Therefore if these two vascular questions were used as a preliminary screening tool within a workplace health surveillance scheme, approximately equal numbers of non-VWF and VWF cases would be referred for further investigation. The sensitivity and specificity for positive responses to the four neurosensory symptoms questions would reflect positive and negative predictive values of 22% and 99% with a 10% prevalence of neurosensory HAVS. These values are calculated on a single application of the questions, but in practice within a health surveillance scheme, such questions would be used on a regular basis. Used as a preliminary screening tool, a positive response would lead to approximately four-times the number of non-HAVS, as HAVS, cases being referred for further investigation. These findings are consistent with the confounding effects of a high incidence of neurosensory symptoms, (such as tingling, numbness, in the upper limbs) self reported by the general population (Pamer 2000). However the screening questions for both vascular and neurosensory components of HAVS would identify almost all of the cases who require further examination and confirmation of diagnosis.

## References

- Allen, J., S. McGrann and K. McKenna (2002). Use of questionnaire screening for vibration white finger in a high risk industrial population. *International Archives of Occupational and Environmental Health* 75(1-2): 37-42.
- Brammer, A. and W. Taylor (1987). Sensorineural Stages of Hand-Arm Vibration Syndrome. *Scandinavian Journal of Work, Environment and Health* 13(4): 279-283.
- Faculty of Occupational Medicine of the Royal College of Physicians (1993). *Hand-Transmitted Vibration: Clinical Effects and Pathophysiology. Part 1: Report of a Working Party.* London, Royal College of Physicians of London: 1-47.
- Faculty of Occupational Medicine of the Royal College of Physicians (1993). *Hand-transmitted vibration: clinical effects and pathophysiology. Part 1: report of working party. Part 2 Background papers.* London, Chamelon press.
- Gemne, G., A. Brammer, M. Hagberg, R. Lundstrom, T. Nilsson and eds (1995). *Stockholm Workshop 94. Hand-arm vibration syndrome: Diagnostics and quantitative relationships to exposure - Proceedings,* Stockholm, Arbete Och Halsä.
- Gemne, G., I. Pyykko, W. Taylor and P. Pelmear (1987). *The Stockholm Workshop Scale for the Classification of Cold-Induced Raynaud's Phenomenon in the Hand-Arm Vibration Syndrome (Revision of the Taylor-Pelmear Scale).* *Scandinavian Journal of Work, Environment and Health* 13(4): 275-278.
- Griffin, M. (1990). *Handbook of human vibration.* London, Academic Press.
- Health and Safety Executive (1994). *Hand-Arm Vibration.* Sudbury, Suffolk, HSE Books.
- Health and Safety Executive (2001). *Hand-Arm Vibration,* HSE Books, Suffolk.

- Johnson, K. L., J. C. Hans and M. A. Robinson (1996). Development of a vibratory white finger prevention program for shipyard workers: an exploratory study. *American Journal Preventative Medicine* 12(6): 478-81.
- Kent, D., R. Allen, P. Bureau, M. Cherniack, J. Hans and M. Robinson (1998). Clinical Evaluation of Hand-Arm-Vibration Syndrome in Shipyard Workers: Sensitivity and Specificity as Compared to Stockholm Classification and Vibrometry Testing. *Connecticut Medicine* 62(2): 75-83.
- Lawson, I. and K. McGeoch (2003). A medical assessment process for a large volume of medico-legal compensation claims for hand-arm vibration. *Occupational Medicine* 53(5): 302-308.
- Lawson, I. and D. Nevell (1997). Review of Objective Tests for the Hand-Arm Vibration Syndrome. *Occupational Medicine* 47(1): 15-20.
- Lawson, I. J. and K. L. McGeoch (1996). Objective tests exist to aid diagnosis of hand-arm vibration syndrome. *British Medical Journal* 313(7065): 1148.
- Mason, H., K. Poole and J. M. Saxton (2003). A critique of a UK standardised test of finger rewarming after cold provocation in the diagnosis and staging of hand-arm vibration. *Occup Med* 53(5): 325-330.
- Mathiowetz, V., K. T. Weber, N. Kashman and G. Volland (1985). Adult norms for the nine hole peg test of finger dexterity. *Occupational Therapy J Research* 5: 24-38.
- McGeoch, K. and W. Gilmour (1994). Sensorineural Objective Tests in the Assessment of Hand-Arm Vibration Syndrome. *Occupational and Environmental Medicine*. 51(1): 57-61.
- McGeoch, K. and W. Gilmour (2000). Cross sectional study of a workforce exposed to hand-arm vibration [HAV]: with objective tests and the Stockholm workshop scales. *Occupational and Environmental Medicine* 57: 35-42.
- McGeoch, K. L. and C. L. Welsh (1995). Results of independent medical interview and examination in the diagnosis and assessment of hand-arm vibration syndrome. *Cent Eur J Public Health* 3 Suppl: 107-8.
- Palmer, K. and M. Griffin (2000). Prevalence of Reynaud's Phenomenon in Great Britain and Its Relation to Hand Transmitted Vibration : A National Postal Survey. *Occupational and Environmental Medicine*. 57(7): 448-452.
- Palmer, K., M. Griffin and H. Bendall (2000). The prevalence of sensorineural symptoms attributable to hand transmitted vibration in Great Britain: a national postal survey. *American Journal Industrial Medicine* 38: 99-107.
- Pelmear, P. (2003). The clinical assessment of hand-arm vibration. *Occupational Medicine* 53(5): 337-341.
- Pelmear, P. L. and R. Kusiak (1994). Clinical assessment of hand-arm vibration syndrome. *Nagoya Journal Medical Science* 57 Suppl: 27-41.
- Proud, G., F. Burke, I. Lawson, K. McGeoch and J. Miles (2003). Cold provocation testing and hand-arm vibration syndrome- an audit of the results of the Department of Trade and Industry scheme for the evaluation of miners. *British Journal of Surgery* 90: 1076-1079.
- Rayan, G. and C. Jensen (1995). Thoracic outlet syndrome: provocative examination manoeuvres in a typical population. *Journal Shoulder Elbow Surgery* 4: 113-117.
- Tiffin, J. and E. Asher (1948). The Purdue pegboard: norms and studies of reliability and validity. *J Appl Psychol* 32: 234-247.
- Vibration Injury Network (2002). Research Network on detection and prevention of injuries due to occupational vibration exposures, [www.human-vibration.com/VINET](http://www.human-vibration.com/VINET). 2002.
- Yamada, S. (2002). National regulations for diagnostics in health surveillance, therapy and compensation of hand-transmitted vibration injury in Japan. *International Archives of Occupational and Environmental Health* 75: 120-128.



**Medical II – Epidemiology 1 – Cross-Sectional Studies**  
**M. Bovenzi - Session Coordinator**



# DISABILITY IN THE UPPER EXTREMITY AND QUALITY OF LIFE IN HAND-ARM VIBRATION SYNDROME (HAVS)

H. Mason, K. Poole

Health and Safety Laboratory, Broad Lane, Sheffield, UK.

## Abstract

This study investigated the extent of upper extremity disability and deficit in Quality of Life (QoL) caused by HAVS, whether such effects were related to the Stockholm Workshop Staging (SWS) and if the extent of disability could be identified from quantitative testing. Individuals, who had been SWS staged, were sent the well-validated DASH and the SF-36v2 QoL questionnaires for self-administration. A response rate of 50% was obtained.

HAVS cases had significantly worse DASH disability, QoL physical and mental component scores compared to published normal values. HAVS cases with apparent co-existing CTS had even higher disability scores. There was a clear, linear relationship between both the DASH disability score and the physical component of the QoL and sensorineural (Sn) SWS, but not with the vascular SWS. Individuals at SWS Sn3 also had a reduction in the mental component QoL scores. Stepwise regression analyses showed that DASH disability score, and both QoL components were related to Stockholm sensorineural rather than vascular staging. Both physical constructs (QoL and DASH) showed consistent significant relationships with tests of handgrip strength=purdue pegboard>thermal perception test. These findings may have important implications regarding management of the affected worker, medico-legal issues and the assessment of vibration-exposed workers.

## Introduction

It has been estimated that some 4.2 million men are exposed to hand-arm vibration in their workplaces in the United Kingdom (Palmer and Griffin 2000). Of these at least 1.2 million are exposed to doses in excess of the suggested action level equivalent of  $2.8\text{ms}^{-2}$  for 8 hours. Large numbers of individuals suffer from Hand-arm vibration syndrome (HAVS) and are a significant cause of civil compensation claims and applications for Industrial Injuries Benefit. However, the extent of disability in HAVS cases, and the impact of their disease upon their quality of life, is unknown.

Exposure to hand-arm vibration can lead to a combination of neurological, vascular and musculoskeletal symptoms termed hand-arm vibration syndrome (HAVS). The main neurological and musculoskeletal symptoms experienced by individuals with HAVS include tingling and numbness in the hands, changes in sensory perception, weakness of grip in the hands and loss of manual dexterity. The main vascular symptom seen in HAVS is blanching of the fingers particularly in response to cold. Both the neurological and vascular symptoms are graded separately according to the Stockholm Workshop Scale, which is now widely used (Brammer et al 1987; Gemne et al. 1987; Health and Safety Executive 2001).

Difficulties in performing everyday activities such as handwriting, picking up small objects, opening lids and lifting and carrying activities have also been reported in HAVS (Cederlund et al. 2001). However, the Stockholm scales are symptom-led rather than based on functionality or disability. The effects of HAVS on functionality and quality of life may be important in not only determining an individual's ability to continue in their current job but also their appropriate functioning in home and social life. Anecdotally it has been reported that individuals with HAVS may only start to experience disabling problems at the later stages on the Stockholm Workshop Scales, but published evidence for this is lacking.

The Disabilities of the Arm, Shoulder, and Hand (DASH) questionnaire was developed as an outcomes instrument for use in patients based on questions on function, symptoms and pain experienced in the upper extremity (Hudak et al. 1996). Normal values for the United States population have been published (Hunsaker 2002) and it is increasingly being used internationally. The DASH questionnaire has been shown to have higher scores in upper extremity disorders (SooHoo 2002; Gummesson et al. 2003) and respond well to changes in symptoms following surgery for Carpal Tunnel Syndrome (Gay et al. 2003).

The SF-36 is a well validated, standardized, published questionnaire that has been used widely as a general quality of life tool in relation to specific diseases (Tarlov et al 1989; Garratt et al 1993; Beaton et al. 1997; Jenkinson et al 1999), and has been shown to be responsive to upper extremity problems (SooHoo 2002). While the SF-36 measures eight multi-item scales variables (physical functioning, social functioning, role limitations due to physical problems, role limitations due to emotional problems, mental health, energy and vitality, pain and general perception of health), two

summary scales (physical and mental components) can also be obtained. The SF-36 has undergone minor linguistic modification for use in the United Kingdom (SF-36v2) with normative values for the United Kingdom being available in the literature (Jenkinson et al 1999).

The main aims of this study were to apply the DASH and SF-36v2 questionnaires to individuals with HAVS to establish whether there is any evidence that HAVS causes significant disability in the upper extremity and reduction in their quality of life, and how this relates to staging using the Stockholm Workshop Scales. The relationship between quantitative testing, which has been used to help stage HAVS cases (McGeoch and Gilmour 2000; Lawson and McGeoch 2003), and any disability and quality of life decrement was also explored. The findings from this study and associated work may have important implications for the management of affected individuals with HAVS, their redeployment and compensation issues concerning HAVS.

### **Population and Methods**

Male individuals who had been referred to the HAVS assessment unit at HSL, and had given permission for the results of their HAVS medical assessment to be used anonymously for research purposes were included in this study. The DASH and SF-36v2 questionnaires were mailed with pre-paid return envelopes, to individuals along with a covering letter explaining the purpose of the study. If a response was not received from an individual within 4 weeks the questionnaires and covering letter were mailed for a second time. If a response was still not received the individual was not contacted again. Questionnaire responses in individuals were compared to their original diagnosis given by a physician at the HSL HAVS referral unit, and their Stockholm Workshop Staging.

A standard assessment was performed by a physician in order to stage for the sensorineural and vascular components of HAVS in each hand according to the Stockholm Workshop Scales. The assessment is based on that detailed by Lawson *et al* for the UK coalminers (Lawson and McGeoch 2003). It involved completion of a medical, symptom and vibration exposure questionnaire, followed by a basic upper extremity examination, measurement of blood pressure, and performance of Adson's, Tinel's and Phalen's tests. The following quantitative tests (Lawson and McGeoch 2003) were then conducted: Purdue peg-board, maximal hand-grip strength, vibrotactile perception threshold (31.5 and 125Hz), thermal perception threshold and cold-provocation test (rewarming of skin temperature following immersion of the hand in 15°C for 5 minutes). The physician also indicated whether the symptoms are likely to be related solely to HAVS, or whether the individual may have Carpal Tunnel Syndrome (CTS) (based upon self-reported night waking because of tingling/numbness, Tinel's and Phalen's tests), or both HAVS and CTS. This led to four groups defined within the study cohort:- No HAVS or CTS; HAVS only; HAVS and suspected CTS; and suspected CTS only.

A standardized score for the DASH questionnaire was calculated according to the original documentation; missing answers were handled as recommended. A normalized score (mean=50) compared to the reference values for males was also calculated according to the scheme of the American Academy of Orthopaedic Surgeons (AAOS) (Hunsaker 2002). The SF36v2 questionnaire was scored, and missing values handled, according to the recommended method (Ware et al. 2000). This leads to a standardized score on a 0-100 scale, with the higher scores relating to better Quality of Life. Normalised values for the two summary scales, the physical component scale (PCS) and the mental component scale (MCS), were derived using UK normal values (Jenkinson et al 1999) according to the recommended procedure (Ware et al. 2000), which could then be compared to normative values for males published in the literature.

Disability and QoL in the four derived diagnostic groups (No HAVS or CTS; HAVS only; HAVS and suspected CTS; and suspected CTS only) were compared to published normal values. The differences between the normalised scores for the DASH disability score and the summary scales (PCS and MCS) for the SF36v2 and published normal values for males were calculated for each individual. The mean differences for each group were then compared to zero using one-sample t-tests and differences in means between groups were investigated using one-way ANOVA and post-hoc tests with Bonferroni correction.

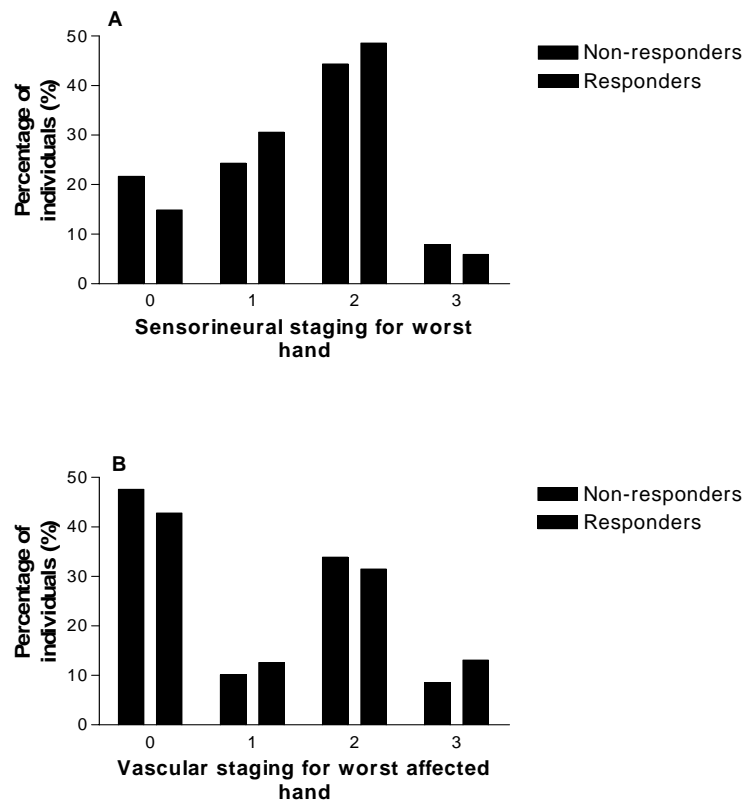
The relationship between disability, QoL scores and Stockholm staging was investigated after exclusion of individuals who had been diagnosed as having suspected CTS only, as they would potentially bias the 0Sn group. Staging was based on the worst hand. Multiple linear stepwise regression analysis was used which included age, years of vibrating tool use, time gap between HAVS assessment and questionnaires and current use of vibration producing tools as potential explanatory and confounding factors. One-way ANOVA with post-hoc tests and Bonferroni correction were used to test for differences between the stages. The relative influence of the frequency of any reported finger blanching or extent of blanching calculated by the Griffin score on disability was also investigated.

The relationship between disability and QoL scores and quantitative tests used at the HAVS assessment was explored by correlation analysis. The quantitative test results for both hands were summed for this analysis. Linear

stepwise regression analysis was used to determine which combination of staging (sensorineural or vascular) and standardized tests (purdue pegboard, grip strength, thermal perception threshold, vibrotactile perception threshold, cold-provocation test) that best explained the disability and QoL outcome measures.

### Results

A total of 444 individuals who had attended the HAVS referral centre were sent the questionnaires and covering letter on the first mailing. After this a total of 174 completed questionnaires were received (39%). After the second mailing, a final response rate of 50% was achieved. The mean age at the time of their HAVS assessment for those who did not respond was significantly lower (43.4yrs SD 8.84) than that for those who did send the questionnaires back (46.3yrs SD 8.7) ( $p=0.001$ ). However, the proportion of individuals falling into each staging category was similar for both the responders and non-responders (figure 1).



**Figure 1** Comparison of Stockholm Workshop Staging between responders/non-responders. Each bar represents the percentage in each Stockholm Workshop Staging category

Of the 222 replies received it was possible to calculate valid DASH Disability scores and Quality of Life summary scales for 210 individuals. Of these 93.8% were in employment at the time of sending out the questionnaires and 45.6% were still using vibration producing tools at work. The average time between HAVS assessment and sending out the questionnaires was 1.4 years (SD 0.94), and this ranged between 0.02 and 3.6 years. The number of individuals falling into each Stockholm Workshop staging and the relationship between sensorineural and vascular staging for these 210 individuals is shown in table 1.

**Table 1** Number of individuals in each Stockholm workshop staging category for whom DASH Disability and Quality of Life score were calculated

		Sensorineural				Total
		0	1	2	3	
<b>Vascular Staging</b>	<b>0</b>	26	27	37	1	91
	<b>1</b>	2	11	14		27
	<b>2</b>	4	20	34	7	65
	<b>3</b>		9	14	4	27
	<b>Total</b>	32	67	99	12	210

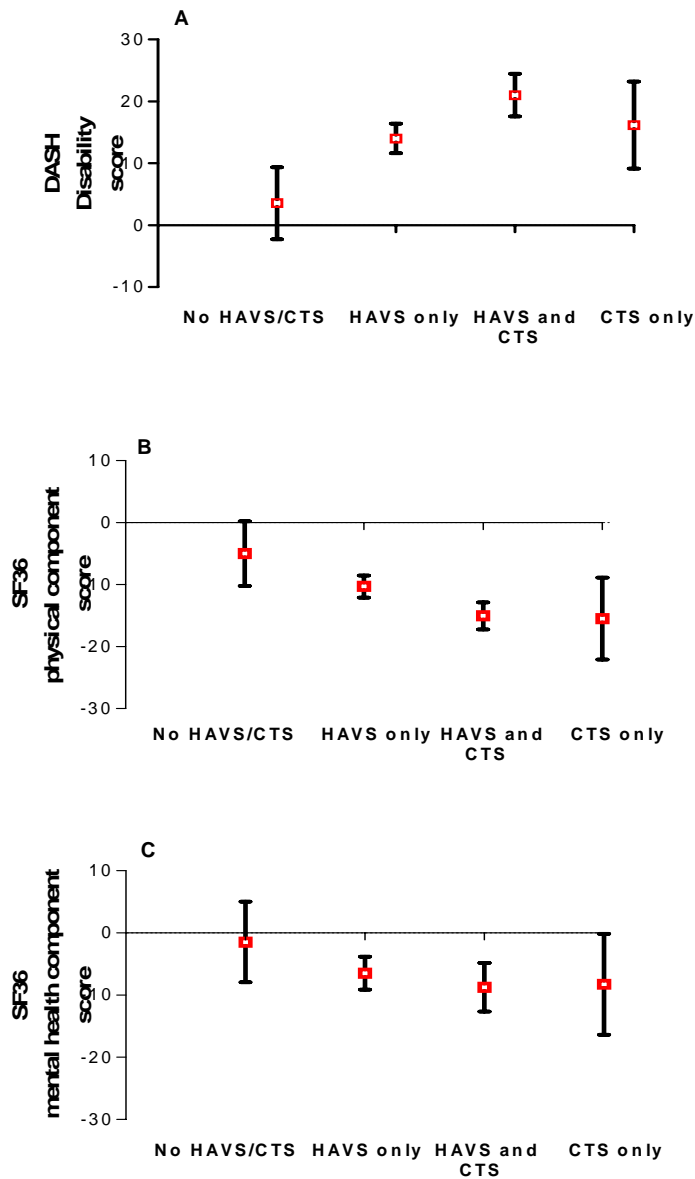
**Table 2** Mean (SD) DASH Disability standardized score, summary QoL scores (PCS – physical component summary scale; MCS – mental component summary scale) and age

	No HAVS/ CTS	HAVS only	HAVS + CTS	CTS only
Disability Score	12.66 (17.09)	27.99 (18.99)	38.27 (20.09)	31.15 (18.61)
PCS	45.63 (10.08)	40.36 (9.77)	35.60 (8.63)	35.16 (11.91)
MCS	49.69 (12.55)	44.69 (14.48)	42.43 (15.54)	42.92 (14.66)
Age (years)	41.02 (8.16)	49.10 (8.65)	46.58 (7.64)	48.41 (8.25)
Number in group	16	118	63	13

Table 2 presents the mean (SD) for the DASH Disability score and the two summary scales for Quality of Life for each group defined by their hand-arm vibration syndrome (HAVS) and CTS status. Generally, each of the symptomatic groups had higher DASH scores (greater disability) and lower quality of life scores when compared to the group who did not have HAVS or CTS.

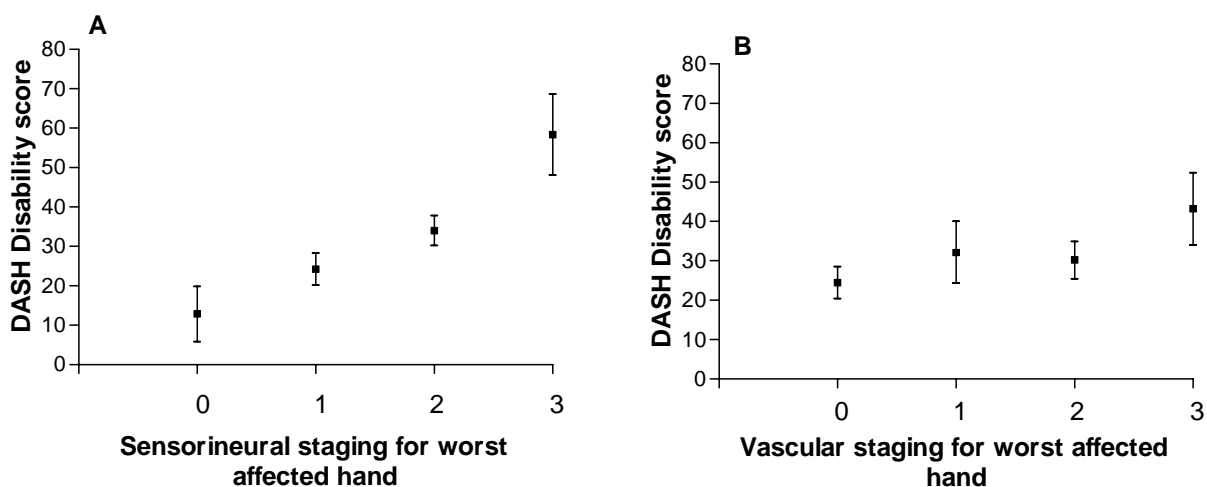
The mean differences between the DASH disability score and published normal values were significantly greater than zero for all three symptom groups ( $p < 0.001$ ), showing that individuals with a diagnosis of HAVS or CTS have increased disability scores for the upper extremity when compared to normal values (figure 2). The group without HAVS or CTS were not significantly different from normal values. The mean differences were significantly greater for the HAVS only ( $p = 0.018$ ) and the HAVS and CTS group ( $p < 0.001$ ) when compared to the no HAVS or CTS group. The HAVS and CTS group also had a greater disability score when compared to the HAVS only group ( $p = 0.004$ ). The mean difference for the disability score for the CTS only group was not statistically significantly different to that for any other symptomatic group. The mean age for the HAVS only group was significantly greater than that for the no HAVS or CTS group ( $p = 0.002$ ), but there were no other differences between groups (table 2). The proportion of individuals falling into each Stockholm Workshop Stage in the HAVS only and HAVS and CTS groups were similar with chi-squared analysis showing that there were no significant differences in the proportions for sensorineural ( $p = 0.240$ ) or vascular staging ( $p = 0.927$ ). Therefore, the differences between the groups in DASH Disability score do not seem to be explained by differences in age or distribution of staging between the groups.

The mean differences from normal for the QoL summary scales were significantly lower than zero for all three symptomatic groups (except the CTS only group for the Mental health component scale), showing that as a group individuals with either HAVS or CTS have reduced QoL compared to published normal values (figure 2). For both of these summary scales the mean differences for the ‘no HAVS and CTS’ group was not significantly different from zero, showing that this group was not any different from published normal values. There were no significant differences between the groups for the mental health summary scale, however the mean difference for the physical component scale for the ‘HAVS and CTS group’ was significantly lower than that for either the ‘no HAVS or CTS’ group ( $p = 0.003$ ) or the ‘HAVS only’ group ( $p = 0.016$ ).



**Figure 2** Differences from normative values for DASH Disability and QoL summary scores. Mean  $\pm$  2 SEM of the differences from published normal values for DASH Disability score (A), physical component summary scale (B) and mental component summary scale (C),

The DASH disability score increased with greater sensorineural Stockholm Workshop Scaling, but there was no such a clear relationship with vascular staging (figure 3). The DASH disability score was significantly greater for both stage 2Sn and 3Sn when compared to 0Sn ( $p < 0.001$ ), and when compared to 1Sn ( $p = 0.004$  and  $p < 0.001$  respectively). Furthermore, the stage 3Sn group had a significantly higher disability score than the 2Sn group ( $p < 0.001$ ). When the disability score was related to vascular staging the 3V group was found to have a significantly greater score than both the 0V and 2V groups ( $p < 0.001$  and  $p = 0.025$  respectively).



**Figure 3** Relationship between DASH Disability score and Stockholm Workshop Staging with mean  $\pm$  2 standard errors of the mean DASH Disability score versus staging of the worst affected hand according to the Stockholm Workshop Scales

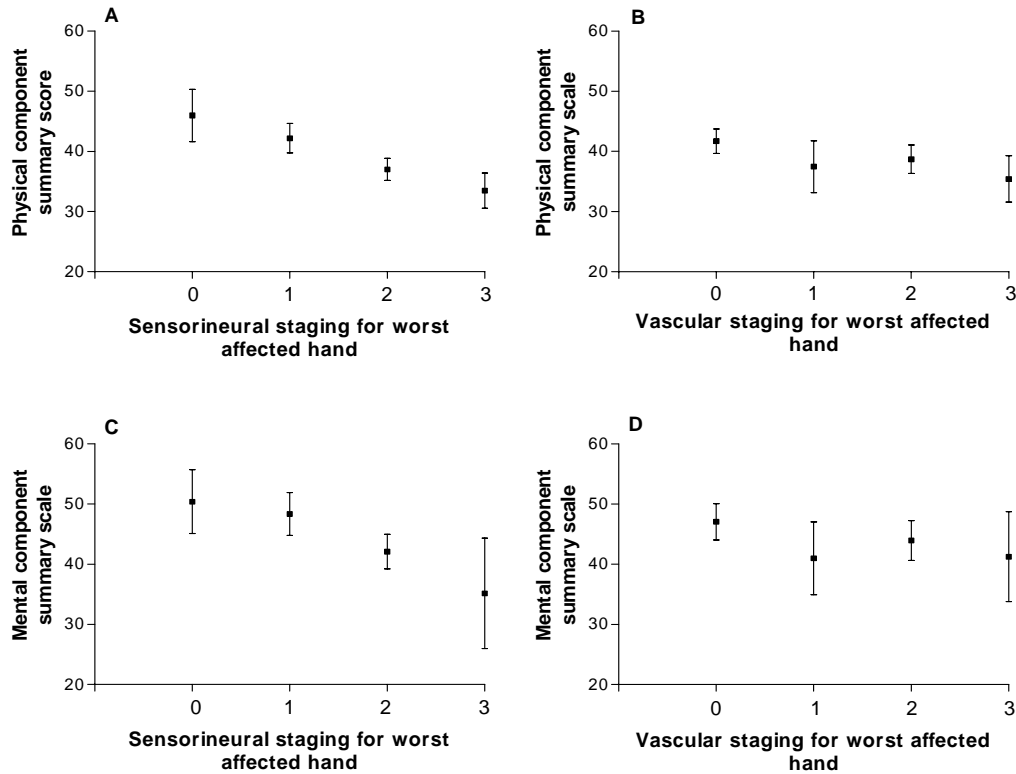
Linear stepwise regression analysis suggested that sensorineural stage, current use of vibrating tools and years of vibrating tool use were significant explanatory variables for the DASH disability score ( $R^2 = 0.231$ ), but vascular staging and time between assessment and questionnaire and age were not. A further analysis investigated whether the additional explanatory variables associated with vascular form of HAVS, namely the frequency of blanching attacks in winter and the extent of blanching by Griffin score in worst affected hand influenced the model. This analysis led to only sensorineural staging and frequency of blanching being used within the model for the DASH score ( $R^2 = 0.236$ ); vascular staging, age, Griffin score and years of vibrating tool use were not significant.

Both the physical and mental component summary scale for QoL measures showed a strong inverse relationship with sensorineural staging, which was not found with vascular staging (figure 4). For the Physical component scale stage 2 and 3Sn had significantly lower mean scores than 0Sn ( $p=0.001$ ), and 1Sn ( $p=0.004$  and  $p=0.015$  respectively) groups. For the Mental component summary scale stage 3Sn had significantly lower mean scores than 0Sn ( $p=0.018$ ), and 1Sn ( $p=0.017$ ). In addition, stage 2Sn had lower scores than 1Sn ( $p=0.046$ ). When the mean summary scales were compared across vascular staging the only significant difference between groups was for the Physical component scale where the 3V group had a significantly lower mean score than the 0V group ( $p=0.024$ ). Regression analysis relating the summary scales to sensorineural and vascular staging and other potential explanatory factors revealed that sensorineural staging, time between assessment and questionnaire, and age were best related to the physical component scale ( $R^2 = 0.155$ ) and sensorineural staging alone was the only significant explanatory factor for the mental component summary score ( $R^2 = 0.049$ ).

The standardized tests that showed the best correlation with the DASH disability score and the Physical component summary scale for QoL were Purdue pegboard measurements for manual dexterity and maximum hand grip strength (table 3). Interestingly TPT was also consistently significantly correlated with both physical outcome measures.

Stepwise linear regression was used to investigate which combination of standardized tests, Stockholm staging (vascular and neurosensory) and the confounding factors of time between assessment and questionnaire, age, current vibrating tool gave the best relationship to both the DASH disability score and QoL outcomes. The DASH disability score was best explained by a model containing sensorineural staging, purdue pegboard and grip strength ( $R^2 = 0.353$ ). The physical component scale summary score was best described by sensorineural staging, purdue pegboard and time between assessment and questionnaire ( $R^2 = 0.175$ ), whereas the mental component scale summary score was related to grip strength and sensorineural staging ( $R^2 = 0.115$ ).





**Figure 4** Relationship between QoL summary scales and Stockholm Workshop Staging showing mean  $\pm$  2 standard errors of the mean physical component summary score versus sensorineural (A) or vascular (B) staging and the mean mental component summary score versus sensorineural (C) or vascular (D) staging of the worst affected hand according to the Stockholm Workshop Scales.

**Table 3** Correlation coefficients between DASH Disability and QoL summary score with standardized tests thermal perception threshold, vibrotactile perception threshold and cold-provocation test. \*\*  $p < 0.01$  level, \* $p < 0.05$  level

	DASH Disability score	Physical component summary	Mental component summary
<b>TPT</b>	0.36 **	-0.25**	-0.22**
<b>VPT (31.5Hz)</b>	0.17 *	-0.01	-0.09
<b>VPT (125Hz)</b>	0.20**	-0.116	-0.09
<b>CPT</b>	-0.14	0.117	0.03
<b>Purdue Pegboard</b>	-0.43**	0.26**	0.14
<b>Hand grip strength</b>	-0.40**	0.20**	0.27**

### Discussion

There has been very little work published investigating the impact of HAVS on performance of everyday activities that may impact on an individual's ability to do their job safely and lead a normal social life (Cederlund et al. 1999; Cederlund et al. 2001; Palmer et al. 2002). To our knowledge the effect of this occupational disease on an established QoL tool has not been reported previously. Our findings show that individuals who have been diagnosed with HAVS, report a significant effect on their ability to perform everyday activities involving the arm, shoulder or hand, and they also experience a reduced QoL. Difficulties in using the upper limb to perform everyday tasks and QoL appear related to sensorineural staging of the Stockholm Workshop Scales, rather than vascular staging. These results may have important implications for the management of individuals with HAVS and compensation within civil litigation or state benefit schemes.

Individuals who had been referred to the HSL HAVS assessment as part of their health surveillance were approached to take part in this study. Overall we received a 50% response rate to our questionnaire mailing, which is similar to other postal studies involving vibration exposed individuals (Palmer et al. 2001; Palmer et al. 2002). There was a slight difference in the mean ages of the responders and non-responders, but the proportion of individuals falling into each Stockholm Workshop staging was similar. Overall, we believe that the individuals who replied to the questionnaires were representative of attendees at the HAVS referral centre.

One of the main strengths of this study is that all of the individuals taking part had undergone a full medical assessment with standardised testing following which the physician gave a considered diagnosis and staging for the sensorineural and vascular components of HAVS according to the Stockholm Workshop Scales. However, the addition of this research study to the routine referral service meant that questionnaires were then sent out to individuals with a variable time between the HAVS assessment and sending out the questionnaires. The average time was 1.4 years and this ranged between 0.02 and 3.6 years. While a potential confounding factor, we do not believe that it distorted greatly the findings of this study, as time was only a significant factor in the multiple regression model for the physical component of QoL. Furthermore, it has been reported that over a 1-6 year period where individuals have been removed from exposure that the majority of individuals remain at the same staging (Bovenzi and Franzinelli 1994; Cherniack et al. 2003), and approximately half of our cohort continued to be exposed to vibrating tools. Generally, we feel that even if some individuals had changed staging over the follow-up time period, this is likely to be a very small proportion of the population, and is more likely to introduce noise and variability in the data, rather than produce artefactual relationships.

To investigate the impact of HAVS or CTS on disability and quality of life all individuals were divided into four groups depending upon diagnosis, namely 'No HAVS or CTS'; 'HAVS only'; 'HAVS and CTS'; 'CTS only'. Although one group was defined as 'No HAVS or CTS', it could not be assumed that this group was 'normal' as they were a referral group with a history of vibrating tool use. Therefore, we wanted to compare our measured values with published normative data for males. We could not find any UK normal values published for the DASH questionnaire and so have used values based on the US general population (Hunsaker 2002). However for the QoL scales, UK normative values were available and have been used for comparison (Jenkinson et al 1999). All three diagnostic groups, unlike the 'no HAVS or CTS' group, had significantly higher DASH disability scores when compared to such normative data, showing that HAVS and/or CTS leads to a degree of disability. Interestingly, we have also shown that a diagnosis of HAVS with a presumptive diagnosis of CTS leads to even greater disability than HAVS alone. The prevalence of presumptive CTS in individuals exposed to hand-arm vibration is greater than in unexposed individuals (Chatterjee et al 1982; Bovenzi et al 1991; Gerr et al. 1991) and therefore there could be a considerable number of individuals who have significant disability in the upper limb. The reasons for greater disability in this group are unclear. Those with co-existing diagnoses may experience more neurosensory disturbances affecting an individual's ability to perform tasks requiring good sensory perception and manual dexterity, or that it reflects a CTS-associated increased prevalence of hand pain or loss of muscle strength in the hand which is more disabling.

This appears to be the first study to apply the entire DASH and SF36v2 questionnaires to a HAVS population. Anecdotally it has been reported that individuals with HAVS may only start to experience disabling problems at the later stages on the Stockholm Workshop Scales. Certainly, according to the Stockholm Workshop Scales clinically obvious reduced tactile discrimination and manipulative dexterity would qualify an individual as a 3Sn (Brammer et al 1987; Health and Safety Executive 2001). The current study has found an almost linear increasing DASH disability score and decreasing QoL summary scales with sensorineural Stockholm staging. However, both physical outcomes (DASH and SF36v2) were only shown to be statistically different from 0Sn at 2Sn or above. This analysis may raise important questions regarding what DASH disability score reflects significant disabling disease and when individual's should be removed from further vibration exposure. The linearity of relationship between physical outcomes versus Stockholm workshop staging would argue for an approach to keep Stockholm sensorineural score as low as reasonably practical, whereas the differences between groups may argue for keeping any neurosensory staging below 2Sn. Current guidance in the UK (Health and Safety Executive 2001) recommends that individuals should be removed from vibration exposure if they are 3Sn or likely to become 3Sn, this needs to be viewed against our finding that the mental component of the SF36v2 is also significantly depressed at 3Sn compared to 0Sn, suggesting that 3Sn reflects a stage where demonstrable socio-psychological problems outside the direct patho-physiological effect of vibration are found. However, if individuals at lower sensorineural stages are experiencing significant disabling disease, removal at an earlier stage may need to be reconsidered. It should also be noted that sensorineural HAVS is often more prevalent (Bovenzi et al. 1980; Behrens et al. 1981; Faerkkilae et al 1988; Dasgupta et al 1996; McGeoch 2000) and appears less reversible than vascular HAVS (Futatsuka et al. 1985; Ogasawara and Sakakibara 1997).

We did not find a relationship between disability or QoL outcomes and vascular staging according to the Stockholm Workshop Scales. This was surprising given the historical bias for vascular symptoms in Industrial Injury Benefit for

HAVS in the UK. The fact that we did not find a relationship may be because there is genuinely no relationship between vascular symptoms and extent of disability, although this seems unlikely, or it could be that the current Stockholm Workshop vascular staging does not adequately assess vascular severity. Although the Stockholm Workshop Scale has become the accepted means of staging severity (Health and Safety Executive 2001), it has come under some criticism (Palmer et al 1997). In particular, the vascular scale has been criticised on the mixing of the characteristics of frequency and extent of blanching at various stages (Palmer et al 1997). A general population study found that difficulties in performing certain tasks involving the upper limbs are more strongly related to the frequency of blanching attacks than the extent of blanching (Palmer et al. 2002). Our data based on an occupational cohort reinforces this. The Stockholm Workshop Scale, emphasising the extent of blanching, may weaken the ability of the scale to reflect disability.

In this cohort we were also able to investigate which tests were best related to disability and quality of life outcome measures. The tests that best explained the DASH disability score were the Purdue pegboard and hand grip strength. The correlation coefficient that we found between the Purdue pegboard and DASH disability score was similar to that found by Cederlund (Cederlund et al. 2001) when correlating their Evaluation of Daily Activities Questionnaire to the Purdue pegboard, but our relationship between disability score and hand-grip was weaker (Cederlund et al. 2001). It may be that these tests have a role to play in assessing disability as an adjunct to the symptom-led Stockholm Workshop Scale. Other functionality tests (e.g. pinch grip) should also be investigated to establish their usefulness.

It was not an aim of this study to establish a predictive model for DASH disability or QoL outcomes. However, we have investigated which combination of factors are related to the disability outcomes. A combination of sensorineural staging, Purdue pegboard and hand grip were best predictors of the DASH score, explaining some 60% of its variation.

In conclusion, individuals with HAVS have increased difficulties in everyday activities and a reduced QoL. Individuals with HAVS and CTS appear to be at greater risk. These difficulties may impact upon both work and home life. They appear related to sensorineural staging on the Stockholm Workshop Scales but not vascular staging, although the frequency of any blanching attacks was significant. At present it is not clear what constitutes significant disability, but Stockholm stage 3Sn is clearly associated with mental status morbidity and 2Sn is associated with statistically significant poorer disability outcomes on both the specific upper extremity and general questionnaire. These data may have important implications for decisions regarding removal of individuals from exposure and redeployment. The SF36v2 and DASH questionnaires may be useful epidemiological tools to compare HAVS with other occupational diseases in terms of both general and upper arm disability, and effects on quality of life.

## References

- Beaton, D., S. Hogg-Johnson and C. Bombardier (1997). Evaluating changes in health status: Reliability and responsiveness of five generic health status measures in workers with musculoskeletal disorders. 1997. 50(1): p. 79-93.
- Behrens, V., W. Taylor and D. Wasserman (1981). Vibration Syndrome In Workers Using Pneumatic Chipping And Grinding Tools. Vibration Effects on the Hand and Arm in Industry. A. Brammer. New York, Wiley and Sons: 147-155.
- Bovenzi, M. and A. Franzinelli (1994). Hand-Arm Vibration Syndrome among Travertine Workers : A Follow up Study. Occupational and Environmental Medicine 51(6): 361-365.
- Bovenzi, M., L. Petronio and F. DiMarino (1980). Epidemiological Survey of Shipyard Workers Exposed to Hand-Arm Vibration. International Archives of Occupational Environmental Health 46: 251-266.
- Bovenzi, M. and A. Zadini (1991). Occupational Musculoskeletal Disorders in the Neck and Upper Limbs of Forestry Workers Exposed to Hand-Arm Vibration. Ergonomics 34(5): 547-562.
- Brammer, A. and W. Taylor (1987). Sensorineural Stages of Hand-Arm Vibration Syndrome. Scandinavian Journal of Work, Environment and Health 13(4): 279-283.
- Cederlund, R., A. Isacson and G. Lundborg (1999). Hand function in workers with hand-arm vibration syndrome. J Hand Ther 12(1): 16-24.
- Cederlund, R., U. Nordenskiöld and G. Lundborg (2001). Hand-arm vibration exposure influences performance of daily activities. Disability 23(13): 570-7.
- Chatterjee, D. and D. Barwick (1982). Exploratory Electromyography in the Study of Vibration-Induced White Finger in Rock Drillers. British Journal of Industrial Medicine 39(1): 89-97.

- Cherniack, M., A. Brammer, J. Meyer, T. Morse, D. Peterson and R. Fu (2003). Skin temperature recovery from cold provocation in workers exposed to vibration: a longitudinal study. *Occupational and Environmental Medicine* 60: 962-968.
- Dasgupta, A. and J. Harrison (1996). Effects of Vibration on the Hand-Arm System of Miners in India. *Occupational Medicine* 46(1): 71-78.
- Faerkkilae, M. and I. Pyykkoe (1988). Forestry Workers Exposed to Vibration : A Neurological Study. *British Journal of Industrial Medicine* 45(3): 188-192.
- Futatsuka, M., T. Ueno and T. Sakurai (1985). Follow Up Study Of Vibration Induced White Finger In Chain Saw Operators. *British Journal of Industrial Medicine* 42(4): 267-271.
- Garratt, A., Ruta, DA, Abdalla MI, Buckingham JK, Russell IT. (1993). The SF-36 health survey questionnaire: an outcome measure suitable for routine use in the NHS? *British Medical Journal* 306: 1440-1444.
- Gay, R., P. Amadio and J. Johnson (2003). Comparative responsiveness of the Disabilities of the Arm, Shoulder, and hand, the Carpal Tunnel Questionnaire, and the SF-36 to clinical change after Carpal Tunnel Release. *Journal of Hand Surgery* 28A(2): 250-254.
- Gemne, G., I. Pyykko, W. Taylor and P. Pelmear (1987). The Stockholm Workshop Scale for the Classification of Cold-Induced Raynaud's Phenomenon in the Hand-Arm Vibration Syndrome (Revision of the Taylor-Pelmear Scale). *Scandinavian Journal of Work, Environment and Health* 13(4): 275-278.
- Gerr, F., R. Letz and P. Landrigan (1991). Upper-Extremity Musculoskeletal Disorders of Occupational Origin. *Annual Review of Public Health* 12(K01): 543-566.
- Gummeson, C., I. Atroshi and C. Ekdahl (2003). The disabilities of the arm, shoulder and hand (DASH) outcome questionnaire: longitudinal construct validity and measuring self-rated health change after surgery. *Musculoskeletal Disorders* 4: 11-15.
- Health and Safety Executive (2001). *Hand-Arm Vibration*, HSE Books, Suffolk.
- Hudak, P., P. Amadio and C. Bombardier (1996). Development of an Upper Extremity Outcome Measure: The DASH (Disabilities of the Arm, Shoulder and Hand). *American Journal Industrial Medicine* 26: 602-608.
- Hunsaker, F. (2002). The American Academy of Orthopaedic Surgeons Outcomes Instruments. Normative values from the general population. *Journal of Bone and Joint Surgery*, 84-A(2): 208-215.
- Jenkinson C, Stewart-Brown S, Petersen S, Paice C. (1999). Assessment of the SF-36 version 2 in the United Kingdom. *Journal of Epidemiology and Community Health* 53: 46-50.
- Lawson, I. and K. McGeoch (2003). A medical assessment process for a large volume of medico-legal compensation claims for hand-arm vibration. *Occupational Medicine* 53(5): 302-308.
- Lindsell, C. and M. Griffin (1998). Standardised diagnostic methods for assessing components of the hand-arm vibration syndrome. *CRR 197/1998*. Sudbury, Suffolk, HSE Books. 25: 1-87.
- McGeoch, K. and W. Gilmour (2000). Cross sectional study of a workforce exposed to hand-arm vibration [HAV]: with objective tests and the Stockholm workshop scales. *Occupational and Environmental Medicine* 57: 35-42.
- Ogasawara, C. and H. Sakakibara (1997). Longitudinal Study on Factors Related to the Course of Vibration-Induced White Finger. *International Archives of Occupational and Environmental Health* 69(3): 180-184.
- Palmer, K. and D. Coggon (1997). Deficiencies of the Stockholm Vascular Grading Scale for Hand-Arm Vibration. *Scandinavian Journal of Work, Environment and Health* 23(6): 435-439.
- Palmer, K. and M. Griffin (2000). Prevalence of Reynaud's Phenomenon in Great Britain and Its Relation to Hand Transmitted Vibration : A National Postal Survey. *Occupational and Environmental Medicine*. 57(7): 448-452.
- Palmer, K. and M. Griffin (2002). The Clinical Grading of Raynaud's Phenomenon and Vibration-Induced White Finger : Relationship between Finger Blanching and Difficulties in Using the Upper Limb. *International Archives of Occupational and Environmental Health* 75(1-2): 29-36.
- Palmer, K., M. Griffin, H. Syddall, C. Cooper and D. Coggon (2002). The clinical grading of Raynaud's phenomenon and vibration-induced white finger: relationship between finger blanching and difficulties in using the upper limb. *International Archives of Occupational and Environmental Health* 75(1-2): 29-36.

Palmer, K., M. Griffin, H. Syddall, B. Pannett, C. Cooper and D. Coggon (2001). Exposure to hand-transmitted vibration and pain in the neck and upper limbs. *Occupational Medicine* 51(7): 464-467.

SooHoo, F. (2002). Evaluation of the construct validity of the DASH Questionnaire by correlation to the SF-36. *Journal of Hand Surgery* 27A: 537-541.

Tarlov, A., Ware JE, Greenfield S, Nelson EC, Perrin E, (1989). The medical outcomes study. An application of methods for monitoring the results of medical care. *Journal of the American Medical Association* 262: 925-930.

Ware, J., M. Kosinski and J. Dewey (2000). *How to Score Version 2 of the SF-36 Health Survey*. Lincoln, RI, QualityMetric Incorporated.



# NEUROLOGICAL, VASCULAR AND MUSCULOSKELETAL SYMPTOMS IN HANDS, FINGERS AND UPPER EXTREMITIES AMONG DRIVERS OF TERRAIN VEHICLES

C. Åström<sup>1</sup>, B. Rehn<sup>2</sup>, L. Larsson<sup>1</sup>, R. Lundström<sup>2</sup>, T. Nilsson<sup>3</sup>, G. Sundelin<sup>1</sup>

<sup>1</sup> Physical therapy, department of community medicine and rehabilitation, Umeå University, 901 87 Umeå, Sweden

<sup>2</sup> Occupational medicine, department of public health and clinical medicine, Umeå University, 901 87 Umeå, Sweden

<sup>3</sup> Department of occupational and environmental medicine, Sundsvall, Sweden

## Introduction

Neurological, vascular and musculoskeletal symptoms in the hands, such as numbness, white fingers and pain, are phenomena of hand-arm vibration syndrome (HAVS), and often reported from workers that use handheld vibrating tools and exposed to hand-arm vibration (HAV) in their occupational routines (Griffin, 1990).

## Objective

The purpose of this cross-sectional study was to assess the risk of neurological, vascular and musculoskeletal symptoms in hands, fingers and upper extremities among professional drivers of various types of terrain vehicles.

## Relevance

This study focuses on symptoms of HAVS, generated from other vibration sources than hand-held power tools.

## Methods and Materials

### *Subjects*

The study group included 141 drivers of forest machines, 99 drivers of snowmobiles, 60 drivers of snowgroomers and 110 reindeer herders (a group that use a variety of terrain vehicles in their everyday work). To be included in the driving group the subjects had to have worked professionally with terrain vehicles for at least three years (exposed group). The control group consisted of 122 randomly selected males from the general population with no more than one year of exposure to driving any kind of terrain vehicle (unexposed group).

### *Questionnaire*

A self-administered questionnaire was sent to the study group. Subjective symptoms of HAVS in left and right fingers, hands and arms were asked for. In addition, each individual estimated their lifetime exposure duration of driving terrain vehicles. The respondents also gave details about their smoking habits.

### *Analysis*

Prevalence odds ratios (POR) were determined by means of logistic regression analysis for symptoms. The POR were adjusted for age, smoking and cumulative exposure time.

## Results

Results indicate that most groups of drivers have significantly increased risks of sensation of cold in hand or finger (adjusted POR: 3.6-4.4). Drivers of snowgroomers and reindeer herders also have a significantly increased risk for numbness, white fingers, and musculoskeletal symptoms in wrist or elbow (adjusted POR: 2.7-8.1). Drivers of forest machines did not have a significantly increased risk for any of the symptoms.

## Conclusion

Drivers of various terrain vehicles have an increased risk for symptoms of HAVS, compared to a referent group. The results in this study suggest an association between exposure to HAV generated from steering devices in terrain vehicles and symptoms of HAVS.

### **References**

Griffin MJ., 1990. Handbook of Human Vibration. Academic Press, London, ISBN 0-12-303040-4.

### **Acknowledgment**

This work was financially supported by the National Institute for Working Life, Sweden



# HAND ARM VIBRATION SYNDROME AMONG QUARRY WORKERS IN VIETNAM

M. Futatsuka<sup>1</sup>, M. Shono<sup>1</sup>, H. Sakakibara<sup>2</sup>, P. Quan<sup>3</sup>

<sup>1</sup> Graduate School of Medical Sciences, Kumamoto University, 1-1-1 Honjo, 860-8556, Kumamoto, Japan

<sup>2</sup> Nagoya University School of Sciences, 1-1-20 Daikominami, Higashi, 461-8673, Nagoya, Japan

<sup>3</sup> National Institute of Labor Protection, 1 Yetkieu Str., Hanoi, Vietnam

## Abstract

Few studies have focused on the health effects of vibrating tools in the tropical area. Work conditions and health effects related to rock drill operation were studied in Vietnam. In this study on 102 workers, including 73 rock drill operators, we aimed to clarify: (1) risk estimation of vibration exposure (2) occurrence of vibration-induced white finger (VWF) (3) prevalence of hand-arm vibration syndrome (HAVS). Total equivalent unweighted r.m.s. acceleration of rock drills made in China or Russia, were 45~55 /sec<sup>2</sup>. According to the work observation, daily exposure time were 160-210min.. We found no clear evidence of VWF. There a several reason that no worker indicated VWF: (1) warmer work conditions (2) younger in age and less work experience (3) seasonal change in operation work (4) healthy worker's effect. On the other hand, 5-10% of rock drill operators could be suffered from moderate HAVS which was sensori-neural type dominant. There may be some different feature of HAVS in the tropical area.

## Introduction

FUTATSUKA has stated that the tropical climate inhibited the occurrence of vibration-induced white finger (VWS) based on the study on the risk estimation of hand-arm vibration syndrome (HAVS) among the chain saw operators of the tropical forestry<sup>1)-3)</sup>. However, few studies have focused on the health effects of vibrating tools in the tropical area. This study examined the health effects of vibrating tools among the quarry workers in Vietnam, focusing on the following aspects of their working situation: (1) vibration exposure of rock drill as determined by observation and measurements; (2) life history and subjective complaints ascertained by interviews; and (3) occurrence of HAVS estimated by health examinations.

ISO has already set up international standards for hand-transmitted vibration, although the standards were based only on information from developed countries. Because of the lack of data on tropical area, it is impossible assess the impact of the labor situation on the health of workers in tropical area. This study was aimed particularly to clarify the characteristic of HAVS due to rock drill operation as ascertained by risk estimation of vibration in tropical area.

## Subjects and Methods

Fifty quarry companies in Qui Nhon area, the southern part of Vietnam which produce quarry stone 30% of total country were selected for the study as shown in Fig.1. The number of subjects were 73 rock drill operators and 29 control workers in the same companies with mean age of 31.2±7.7 and 33.4±8.6 years, median operation time of 4.0 years, respectively as shown in Fig. 2.

The subjects' life histories, employment histories, histories of illness, and subjective complaints were checked by interview. The function tests consisted of peripheral circulatory and sensorineural tests, including cold provocation in the upper extremities. Peripheral circulatory function was assessed by measuring finger skin temperature, finger nail compression tests, and recovery rates after a cold provocation test (immersion of a hand in water at 10 for 10 minutes). Sensory function was assessed on the basis of the threshold of vibration and pain sensation. The ambient temperature of the testing room was 27.5-30.0 during the test procedure.



Figure 1 Map of Vietnam

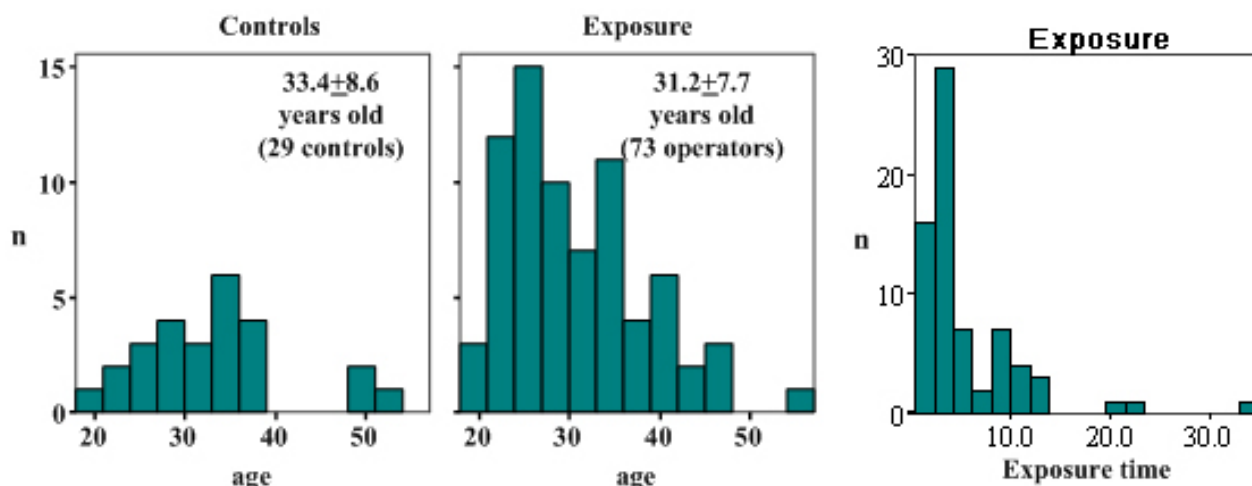


Figure 2 Age and exposure time of the subjects

### Results and Discussion

Total equivalent unweighted r.m.s. acceleration of rock drills, made in China or Russia, were 45-55m/sec<sup>2</sup>. According to the observation of their work, daily exposure time were 160-210 min. as shown in Fig. 3. Regarding major subjective complaints, as shown in Tab. 1, no workers were identified as having history of white finger. The prevalence of finger hypoesthesia was 67.6% (always 16.2%) in rock drill operators and 3.8% in control workers. Weakness of hands, hypoesthesia of fingers, coldness of hands were significantly higher than that of controls. The prevalence rate by exposure time is shown in Tab. 2. Muscle and joints impairments and noise induced disturbances were significantly higher in the long exposure group.



Figure 3 Picture of Tool Operator

Table 1 Prevalence of subjective complaints among in the rock drillers

Complaints	rock drillers		control	
	Prevalence	always	Prevalence	always
COLDNESS OF HANDS AND LEGS	15 (20.3%)*	1 (1.4%)	0	0
HYPESTHESIA OF FINGERS	50 (67.6)*	12 (16.2)	2 (6.8)	0
TREMOR/SHIVERING OF FINGERS	22 (29.8)*	7 (9.5)	2 (6.8)	0
DEXTERITY DISTURBANCE	6 (8.2)	3 (4.1)	2 (6.8)	0
WEAKNESS OF HANDS	64 (86.5)*	17 (23.0)	2 (6.8)	0
MOBILITY DISTURBANCE OF ELBOW	14 (18.9)	6 (8.1)	2 (6.8)	0
SHOULDER/NECK STIFFNESS	15 (20.3)	5 (6.8)	4 (13.8)	0
LOW BACK PAIN	40 (54.1)	11 (14.9)	11 (37.9)	1 (3.8)
EASINESS TO BE TIRED	53 (71.7)	14 (18.9)	18 (62.1)	1 (3.8)
HEADACHE	29 (39.2)	2 (2.7)	10 (34.5)	0
DIZZINESS	40 (54.0)*	6 (8.1)	10 (34.5)	0
TINNITUS	35 (47.3)*	7 (9.5)	5 (17.2)	2 (7.7)
HEARING LOSS	20 (27.1)	11 (14.9)	4 (13.8)	2 (7.7)

\*P<0.05

**Table 2** Prevalence of subjective complaints by exposure time

Complaints	rock drillers	
	Less 5 years	More 5 years
COLDNESS	10 (19.6%)	5 (13.9%)
HYPOSTHESIA	28 (54.9)	22 (61.1)
TREMOR	15 (29.4)	8 (22.2)
DEXTERITY OF DISTURBANCE	3 (5.9)	4 (11.1)
WEAKNESS	41 (80.4)	23 (63.9)
MOBILITY OF DISTURBANCE OF ELBOW	5 (9.8)	10 (27.8)*
SHOULDER STIFFNESS	6 (11.8)	11 (30.6)*
LOW BACK PAIN	21 (41.2)	23 (63.9)*
EASINESS TO BE TIRED	37 (72.5)	28 (77.8)
HEADACHE	17 (33.3)	15 (41.7)
DIZZINESS	26 (51.0)	19 (52.8)
TINNITUS	16 (31.4)	19 (52.8)*
HEARING LOSS	6 (11.8)	13 (36.1)*

\*P<0.05

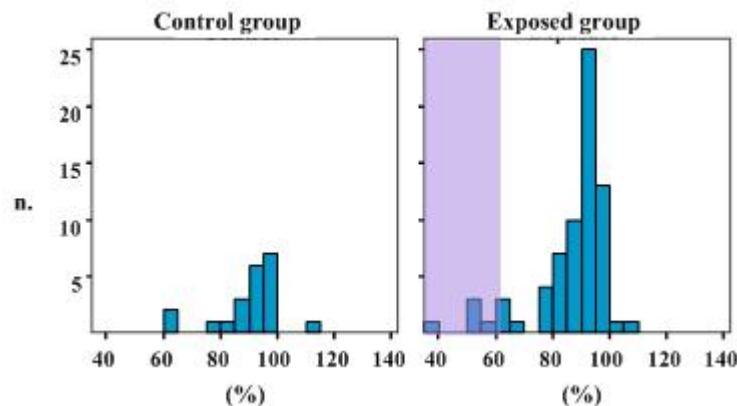
The prevalence of recovery rate of skin temperature after cold water immersion test (10 , 10min.<60%) was 5 (6.8%) of operators and none of controls as shown in Fig. 4. The prevalence of the abnormal findings of vibration sensation (125Hz.>7.5dB) was 12 (16.2%) of operators and 2 (7.7%) of controls, and pain sensation (>3g) was 19 (25.7%) of operators and none of controls (P<0.05) as shown in Fig. 5.

The prevalence of having both subjective complaints (hypoesthesia of fingers) and abnormal findings of functional tests (both vibration and pain sensation) was 5 (6.8%) of operators.

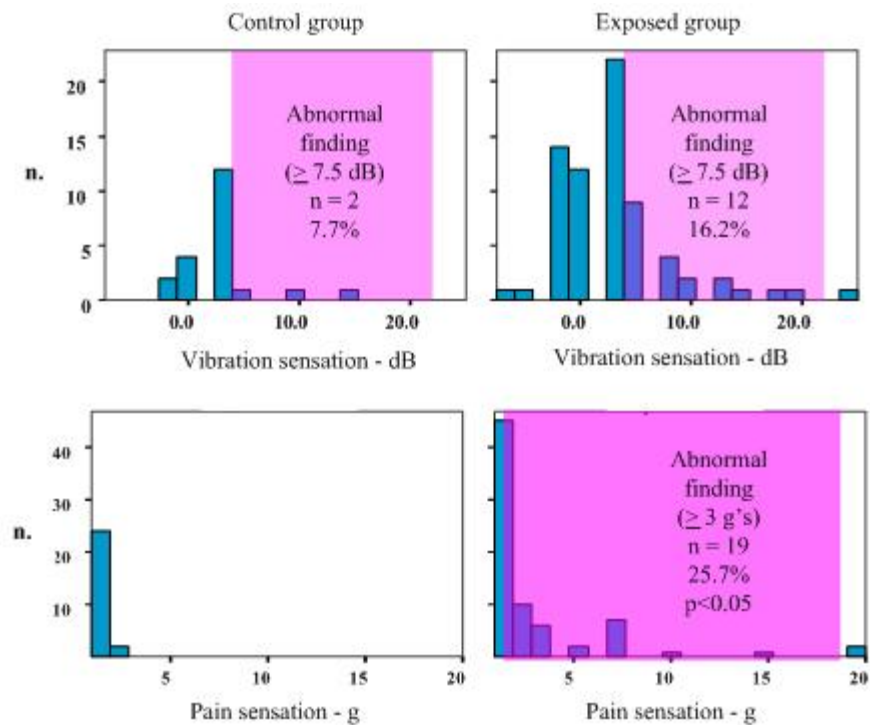
The reasons that no worker indicated VWF may be explained as follows: (1) warmer ambient work conditions (higher than 20 throughout the year), (2) younger in age and less work experience (3) seasonal change in operation work (impossible to use rock drills during rainy season for 2-3 months of the year); and (5) healthy workers' effects in a cross-sectional health examination, as same findings in our studies of chain saw operators in the tropical rain forests.<sup>1)-3)</sup>

On the other hand, 5-10 % of rock drill operators could be suffered from moderate HAVS which was sensori-neural type dominant. As shown in Tab. 3, factor analysis of functional tests suggested that circulatory and sensori-neural function were clearly independent. There may be some different feature of HAVS in the tropical area.

Comprehensive occupational health administration on HAVS, the effects of noise, and dust for quarry works is, thus, needed.



**Figure 4** Recovery rata of skin temperature



**Figure 5** Distribution of the threshold of sensation

**Table 3** Factor analysis of the functional tests (Promax)

	1	2	3	4
Vibration sensation				
(before cold imm.)	0.810	0.056	0.077	0.160
(20min. After imm.)	0.673	-0.268	-0.002	-0.031
Skin temperature				
(before cold imm.)	-0.097	0.779	0.053	0.131
(20min. After imm.)	-0.183	0.512	0.074	0.039
Nail pressure test				
(before cold imm.)	-0.102	-0.451	0.157	0.161
Nobility of elbow joint				
(Extension)	-0.076	-0.143	1.000	-0.002
(Flexion)	-0.306	-0.262	-0.467	0.076
Tapping ability	-0.034	0.089	0.034	-1.004
Grip force	0.266	0.151	-0.065	0.277
Pain sensation	0.059	0.049	0.011	0.210

#### Acknowledgement

This study is international cooperative study between Japan and Vietnam (National Institute of Labor Protection: Director. Prof. Ph.D. Le Van Trinh). We are grateful to and acknowledge the contribution of the staff of the quarry companies and the Preventive Medicine Center of Quang Ninh province.

#### References

Futatsuka, M., Inaoka, T., Ohtsuka, R., Moji, K., Sakurai, T. 1991. A preliminary study on the function tests of the vibration syndrome in tropical rain forest workers. *J. Human Ergol.*, 15, 95-99.

Futatsuka, M., Inaoka, T., Ohtsuka, R., Sakurai, T., Moji, K., Igarashi, T. 1995. Hand-arm vibration in tropical rain forestry workers. *Cent. Enr. J. Public Health*, 3, 90-92.

Futatsuka, M., Inaoka, T., Ohtsuka, R., Sakurai, T., Moji, K., Igarashi, T. 1996. Life and health of chain saw operators in tropical rain forests: changes in work conditions and health due to the mechanization of forestry. *Environ. Sciences*, 4, 135-145.



# RELATION BETWEEN HAND-ARM VIBRATION EXPOSURE AND SYMPTOMS AMONG WORKERS WITHIN A HEAVY-ENGINEERING PRODUCTION WORKSHOP

L. Burström, M. Hagberg, R. Lundström, T. Nilsson

National Institute for Working Life, Department of Work and the Physical Environment,  
P.O. Box 7654 SE-907 13 Umeå, Sweden, Email:lage.burstrom@niwl.se

## Abstract

The aim with the investigation was to study the relation between on-set time for symptoms (vascular and neurological) and the vibration load at the time for on-set, among a group of vibration exposed workers. Information on self-stated year for first occurrence of symptoms was collected by means of questionnaires. Through interviews data were obtained on self-stated estimations of daily exposure time, type of tool and number of months/years with different exposures. The estimations of the vibration magnitudes of exposure were based on conducted measurements. From these data the individual vibration exposure at time for onset of the symptoms were calculated.

The result shows that there was a high incidence of symptoms among the group of workers at this company. Moreover, the first onset of symptoms appeared after in average 12 years of exposure. For the workers the symptoms of vascular or neurological disorders started after about the same number of exposure years. The calculated accumulated acceleration was best correlated with onset time of symptoms. Furthermore, since the workers exposure to vibration is below the action level established in the European vibration directive, the results suggest that the action level is not a safe level for developing vascular and neurological symptoms.

## Introduction

Occupational work with vibrating hand held power tools is associated with an increased occurrence of symptoms and signs of disorders in the vascular and neurological systems of the upper extremities. The vascular symptom is known as vibration-induced white finger (VWF) and the neurological symptom is characterised by a peripheral, diffusely distributed neuropathy with predominant sensory impairment. Several studies have been presented that have tried to establish exposure-response relationships between hand-transmitted vibration and different disorders. However, there is still a lack of information about the relation between exposure and disorders. The present study focuses on the occurrence of vascular and neurological symptoms among a group of workers within a heavy engineering production workshop.

## Methods

The study base was a cohort of worker at a department of a company, which produces paper and pulp-mill machinery. Their work task consists mainly of welding, plating and grinding on iron and stainless steel. The workers exposure to vibration has its dominating origin in the use of grinders and hammers. These two types of tools correspond to about 85 - 95% of the total daily use of hand-held tools. The study started in 1987 and has been followed up in 1992, 1997 and 2002. In 1987 68 workers listed on the employee rosters were included in the study population. Today the cohort consists of 87 workers.

Information on self-stated year for first occurrence of vascular and neurological symptoms was collected by means of questionnaires. Through interviews data were obtained on self-stated estimations of daily exposure time, type of tool and number of years with different exposures. The estimations of the vibration magnitudes of exposure were based on earlier conducted measurements on different types of tools.

The individual vibration exposure before onset of the symptoms was calculated both as energy-equivalent acceleration for their working time and as accumulated vibration exposure. The energy-equivalent acceleration for each individual has been estimated using the formula;

$$a_{ekv} = \left\langle \frac{1}{T} \cdot \sum_{i=1}^n \left[ (a_{h,w,Work_i})_{eq,i(8)} \right]^2 \cdot t_i \right\rangle^{1/2} \quad [\text{m/s}^2]$$

where:

- $a_{eqv}$  = 8 hours energy-equivalent acceleration until symptom [ $m/s^2$ ]  
 $(a_{h,w,Work_i})_{eqv,i(8)}$  = 8 hours energy-equivalent acceleration during i:th time period for  $Work_i$  [ $m/s^2$ ]  
 $t_i$  = duration of the acceleration  $(a_{h,w,Work_i})_{eqv,i(8)}$  [year]  
 $T$  = total working time until symptom [year]  
 $n$  = total number of jobs.

The accumulated vibration acceleration for each individual has been estimated using the formula;

$$a_{cum} = \sum_{i=1}^n (a_{h,w,Work_i}) \cdot t_i \quad [mh/s^2]$$

where:

- $a_{cum}$  = accumulated vibration acceleration until symptom [ $mh/s^2$ ]  
 $a_{h,w,Work_i}$  = vibration acceleration during i:th time period for  $Work_i$  [ $m/s^2$ ]  
 $t_i$  = duration of the acceleration  $a_{h,w,Work_i}$  for  $Work_i$ , i.e. Hours/Days x Days/Year x Years [h]. Working days per year was set to 200  
 $n$  = total number of jobs.

## Results

Among the 87 workers at the company 53 (61 %) have reported either vascular (39 %) and/or neurological symptoms (47 %). Over the study period the distribution of symptoms have changed from vascular to neurological symptoms.

The incidence for vascular symptoms was 24.2 per 1000 exposure years and for neurological symptoms 36.1 per 1000 exposure years. On average, the first symptoms started after about 12 years of exposure. Vascular symptoms developed after a shorter period of exposure compared to neurological symptoms, 11.6 and 13.0 years, respectively (Table 1). The exposure time varies between 5700 and 6100 hours before onset of symptoms. The energy-equivalent daily acceleration exposure and accumulated vibration exposure was found to be 2.1-2.3  $m/s^2$  and 38600-41600  $mh/s^2$ , respectively.

**Table 1** Mean value for on set time for vascular and neurological symptoms as well as daily and accumulated acceleration to on set. In the table is also given the number (n) of workers in each group.

	On set time (year)	Exposure time (h)	Daily acceleration ( $m/s^2$ )	Accumulated acceleration ( $mh/s^2$ )
Vascular (n=34)	11.6	6100	2.1	38600
Neurological (n=41)	13.0	5700	2.3	41600

The onset time for 10 % of the whole working group to develop first symptom was about 5 exposure years. The onset time for vascular or neurological symptoms was 7 exposure years. Estimations of exposure years, according to ISO 5349-1 (1), shows that with the actual vibration exposure the prediction for 10 % prevalence of vibration-induced white finger among the workers is between 12 and 14 years.

The best correlation between numbers of years before onset of vascular or neurological symptoms and vibration load was found to be the accumulated acceleration ( $R=0.62$  and  $R=0.47$  respectively). The exposure time was also correlated



with the onset time but with a lower degree of explanation of the variance. The equivalent acceleration had very low relation to the number of years before onset.

### **Discussion**

Epidemiologic surveys of vibration-exposed workers have shown that the prevalence of vascular and neurological symptoms varies from a few percent to more than 80 (2, 3, 4, 5). In the present study the prevalence of vascular and neurological symptoms among the workers was reported to be 39 % and 47 %, respectively. Earlier investigations among the same study group have shown prevalence for vascular symptoms of 40 – 45% (6). The incidence for vascular and neurological symptoms was 24 and 36 per 1000 exposure years, respectively. This incidence is high compared to the incidence among non – exposed (7).

For the workers the symptoms of vascular or neurological disorders started after about the same number of exposure years. This is in agreement with the exposure-response relationship included in ISO 5349-1, which is thought to cover all biological effects of hand-transmitted vibration. But the result is not in agreement with earlier studies where have been shown that the neurological system is far more sensitive to vibration exposure (8).

At a mean daily exposure of 2.1-2.3 m/s<sup>2</sup>, the onset time for vascular or neurological symptoms, for 10 % of the whole working group was found to be 7 years. The corresponding prediction, according to ISO 5349-1, was 12 to 14 years. The present study supports the view that the standard ISO 5349-1 underestimates the risk for these disorders. Furthermore, since the workers exposure to vibration is below the action level established in the European vibration directive, the results suggest that the action level is not a safe level for developing vascular and neurological symptoms.

### **Conclusions**

Notwithstanding that the vibration load among the workers are lower than the action level established in the European vibration directive, the vibration dosage for the workers is still a risk factor, why more efforts should be spent to decrease the vibration exposure.

### **Acknowledgement**

The financial support of the Swedish Council for Work Life Research is gratefully acknowledged. A special thanks to Rebecka Vilhelmsson how conducted all the statistical analysis.

### **References**

- International Organization for Standardization. Mechanical vibration - Measurement and assessment of human exposure to hand-transmitted vibration - Part 1: General guidelines. 2nd Committee Draft, ISO/CD 5349-1, 1997.
- Griffin MJ. Hand-arm vibration standards and dose-effect relationship. In: Brammer AJ, Taylor W, eds. *Vibration Effects on the Hand and Arm in Industry*. New York: John Wiley & Sons, 1982:259- 268.
- Griffin MJ. *Handbook of human vibration*. London: Academic Press, 1990.
- Starck J, Pekkarinen J, Pyykkö I. Physical characteristics of vibration in relation to vibrationinduced white finger. *Am Ind Hyg Assoc J* 1990;51:179-184.
- Bovenzi M. Vibration induced vibration finger and cold response of digital arterial vessels in occupational groups with various patterns of exposure to hand-transmitted vibration. *Scand J Work Environ Health* 1998;24:138-144.
- Nilsson T, Burström L, Hagberg M. Risk assessment of vibration exposure and white fingers among platers. *Int Arch Occup Environ Health* 1989;61:473-481
- Hagberg M, Burström L, Lundström R, Nilsson T. Prospective versus retrospective incidence of Raynaud's phenomenon and the relation to vibration exposure. Abstract for 10th International Conference on Hand-Arm Vibration 7–11 June 2004, Las Vegas, USA.
- Lundström R, Lindmark A, Widman L, Jacobsson B. Comparison of thermal perception thresholds on the fingertip for vibration exposed and controls. In: Lundström R, Lindmark A, eds. *Eighth International Conference on Hand-Arm Vibration 9–12 June 1998, Umeå, Sweden, Proceedings*. Umeå : National Institute for Working Life, Arbetslivsrapport:4, 2000:175- 176.



**Medical III – Epidemiology 2 – Perspective & Population Studies**  
**N. Harada - Session Coordinator**



# **PERSPECTIVE VERSUS RETROSPECTIVE INCIDENCE OF RAYNAUD'S PHENOMENON AND THE RELATION TO VIBRATION EXPOSURE**

M. Hagberg, L. Burström, R. Lundström, T. Nilsson

Department of Occupational and Environmental Medicine  
Göteborg University and Sahlgrenska University Hospital  
Box 414, SE-405 30 Göteborg, Sweden

## **Introduction**

Raynaud's phenomenon is the attack of cold-induced digital blanching. It occurs idiopathic more often among women than men. Raynaud's phenomenon is also one of the main components of the "vibration syndrome" that is the digital blanching caused by the exposure to hand-arm vibration. Vibration induced White Finger (VWF) is the term for Raynaud's phenomenon among vibration exposed workers. The published cohort studies have mostly been retrospective asking the worker whether finger blanching occurs and the date of the first occurrence (Griffin et al. 2003). Thus there is a lack of prospective cohort studies on the exposure response of Raynaud's phenomenon. Bovenzi and co-workers (Bovenzi et al. 1998) did a 5 year prospective study of 68 forestry workers where 3 new cases of vibration induced white fingers occurred.

## **Objectives**

To assess and compare the incidence of Raynaud's phenomenon in relation to vibration exposure in a retrospective and a prospective cohort consisting of office and metal workers.

## **Methods**

The source population consisted of 500 office workers and 200 male metal workers. At baseline and at follow up a questionnaire was answered at the time for a medical examination. The retrospective cohort included all workers answering yes to the question "Do you have white (pale) fingers of the type that appears when exposed to damp and cold weather". Raynaud's phenomenon (white fingers) WF was defined as having answered yes to the question, indicating in hand-diagram and given a year of onset. Time at risk was computed as the time from the age of 16 years until event or to being censored. The prospective cohort included all workers being without symptoms at baseline. Time to event was computed as the number of years to the first follow up with symptoms (5, 10 or 15 years) or to being censored. Vibration exposure dose was in this paper defined as the product of total exposure hours and 8-hours weighted vibration exposure level according to ISO 5349. Also leisure time exposure (hobbies, snowmobiling, motorcycling etc) was included in this measure based on interviews. Survival curves were obtained for exposed and none exposed. Hazards ratios were computed by Cox regression

## **Results**

The retrospective incidence of Raynaud's phenomenon was 15.9 per 1000 exposure years among exposed and 2.43 per 1000 years among the not exposed. There was a greater survival for the none exposed compared to the vibration exposed. The exposure response curve based on quartiles showed that exposure less than 7578 hour x level ( $m/s^2$ ) showed similar survival as the non-exposed. The second, third and fourth quartile showed similar steep survival function for white fingers.

The prospective incidence of Raynaud's phenomenon was 13.6 per 1000 exposure years among exposed and 4.97 per 1000 years among the not exposed. The prospective analysis showed marked decreased survival for the 4<sup>th</sup> quartile. The estimated hazard ratio for the quartile  $>18086$  hour x level ( $m/s^2$ ) cohort for vibration exposure was 5.

## **Conclusions**

There was a lower incidence of Raynaud's phenomenon in the prospective cohort analysis of workers compared to a retrospective analysis probably due to a secondary healthy worker effect. A distinguishable dose-response relationship was seen for dose corresponding to an exposure of 0,94 to 1,88 for 10 years in the retrospective cohort analysis.

The findings support that the EU directive of  $2.5 m/s^2$  as an action level limit is not too low.

### **References**

- Bovenzi, M., B. Alessandrini, et al. (1998). "A prospective study of the cold response of digital vessels in forestry workers exposed to saw vibration." *Int Arch Occup Environ Health* 71(7): 493-8.
- Griffin, M. J., M. Bovenzi, et al. (2003). "Dose-response patterns for vibration-induced white finger." *Occup Environ Med* 60(1): 16-26.

# A 13-YEAR REVISIT OF A SHIPYARD CHARACTERIZED BY HIGH LEVELS OF VIBRATION-INDUCED DISEASE

M. Cherniack<sup>1</sup>, T. F. Morse<sup>1</sup>, A.J. Brammer<sup>1,2</sup>, R. Lundstrom<sup>3</sup>, J. Meyer<sup>1</sup>, G. Neely<sup>4</sup>, T. Nilsson<sup>5</sup>, D. Peterson<sup>1</sup>, E. Toppila<sup>6</sup>, N. Warren<sup>1</sup>, R.W. Fu<sup>1</sup>, H. Bruneau<sup>1</sup>, M. Croteau<sup>1</sup>

<sup>1</sup> Ergonomics Technology Center, University of Connecticut Health Center, Farmington, CT USA

<sup>2</sup> Institute for Microstructural Sciences, National Research Council, Ottawa, ON Canada

<sup>3</sup> University Hospital, Department of Biomedical Engineering and Informatics, Umeå, Sweden

<sup>4</sup> National Institute for Working Life, Department of Work and the Physical Environment, Umeå, Sweden

<sup>5</sup> Department of Occupational and Environmental Medicine, Sundsvall Hospital, Sundsvall, Sweden

<sup>6</sup> Department of Physics, Institute of Occupational Health, Helsinki, Finland.

## Introduction

In a 1988 study of 288 shipyard workers, a progressive association was observed between cumulative exposure to vibration and the vascular and neurological symptoms of the hand arm vibration syndrome (HAVS) [Letz et al. 1993]. There were exposed and unexposed participants; out of 103 with the highest current exposures, 71% had vascular symptoms and 83% had sensorineural symptoms. Historically, symptom prevalence began to accumulate at between 1800-7000 hours of exposure. In 2001, the same shipyard was reinvestigated following more than a decade of workforce reduction, anti-vibration tool replacement, and elimination of jobs with high vibratory exposure.

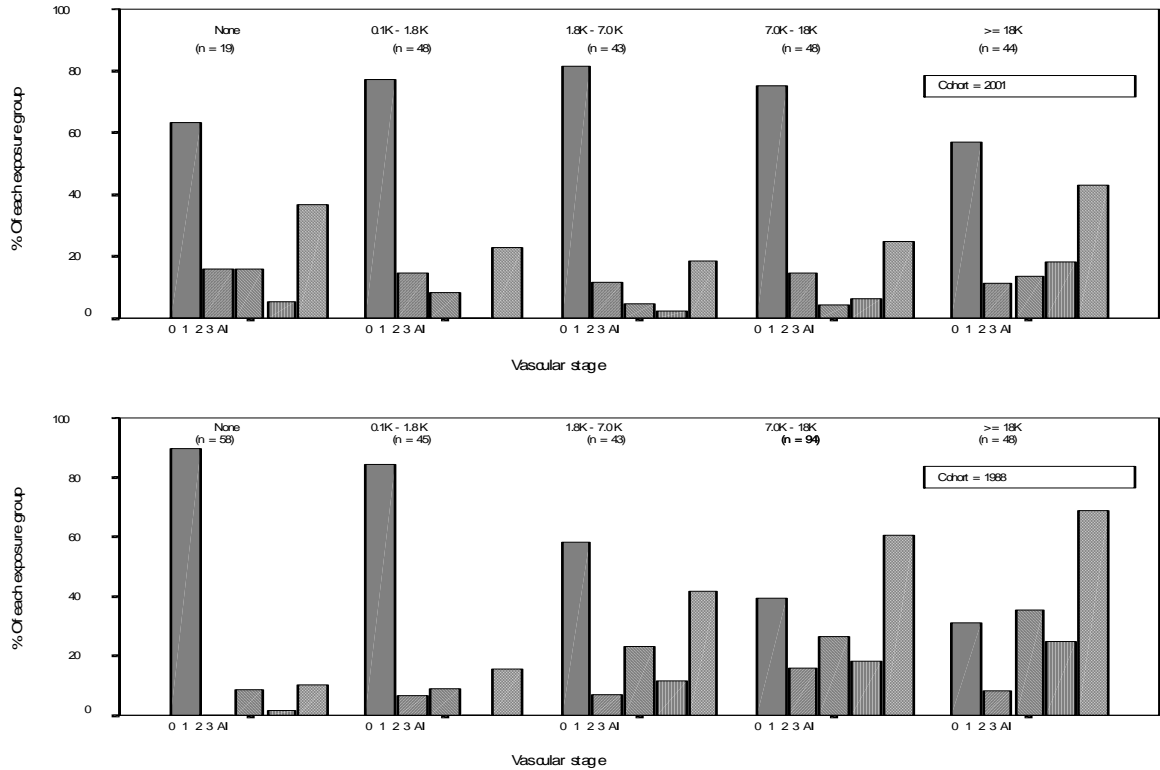
## Methods

Selection procedures were different for the two studies, a consequence of the near elimination of the most highly exposed jobs. In 2001, two hundred and fourteen (214) subjects were selected to equally represent four current weekly vibration exposure time intervals – 0 h, >0< 5h, e”5<20h, e”20 h. Because of elimination of the jobs with high weekly exposure, the 1988 cohort were recategorized to match these same time intervals. The study represents two largely non-overlapping cross-sections that are compared on the basis of exposure duration. Sub-cohorts with essentially unaltered work tasks, such as welders and shipfitters, were segregated for comparison. Estimates of exposure and reported symptoms were derived from a common questionnaire. Symptom staging included use of the Stockholm Workshop Scale (Gemne et al. 1987). Vibration levels from selected tools were also examined.

## Results

The shipyard trades population had declined by 78% between 1988 and 2001, resulting in a study population, biased towards seniority, that was on average 9.6 years older than in 1988. Current weekly exposure hours were similar in the low and medium vibration exposure groups, but in 2001 vibratory tool use in the high exposure group was reduced by an average of 9.3 h per week (34.1 to 24.8 h) compared to 1988. Cumulative hours of vibratory tool exposure were higher in 2001 than in 1988; among welders and shipfitters, two groups with similar job content across the decade, estimated cumulative hours of exposure were 5 times higher, due to comparative longevity. Among comparable high current exposure groups, vascular symptoms were 67% more prevalent in 1988 but sensorineural symptoms were 40% more prevalent in 2001. The effects of cumulative exposure on symptom prevalence differed in 2001 from 1988. In 2001, sensorineural symptoms were already present in 52.6% of the non-exposed population, and prevalence increased by smaller increments to 80% in those with more than 18,000 hours of cumulative exposure. Although vascular symptoms were unexpectedly high (36.8%) in the unexposed group in 2001, between 100 and 18,000 hours of exposure, 75.0-81.4% of participants were asymptomatic, until cumulative vibratory tool use exceeded 18,000 hours. A comparison of vascular symptoms at various levels of cumulative exposure is presented in Figure 1.

Overall exposure response relationships were diluted in 2001 compared to 1988. When symptom severity was regressed polychotomously on estimated exposure (log cumulative hours), the OR was weaker in 2001 than in 1988 for sensorineural symptoms: 1.44 [CI 1.04-1.98] versus 2.35 [CI 1.48-3.73]. This was also true for vascular symptoms: 1.70 [CI 1.06-2.71] versus 3.99 [CI 2.27-7.01].



**Figure 1** Vascular Stage and Cumulative Hours of Exposure 1988 and 2001

### Conclusions

Vascular symptoms were reduced in 2001 compared with 1988 at similar current and cumulative levels of vibratory exposure. Neurological symptoms were more prevalent in the older 2001 cohort, but associations with vibration exposure were weaker. Historical studies are complicated when intervention and exposure reduction are features of the work environment. Exposure magnitude appears to be a more important predictor of symptoms than exposure duration.

### References

- Letz R, Cherniack M, Gerr F, Hershman D, Pace P: A cross-sectional epidemiologic survey of shipyard workers exposed to hand-arm vibration. *Br J Indus Med* 1993; 49:53-62.
- Gemne G, Pyykko I, Taylor W, Pelmeur PL. The Stockholm workshop scale for the classification of cold-induced Raynaud's phenomenon in the hand-arm vibration syndrome (revision of the Taylor-Pelmeur Scale). *Scand J Work Environ Health* 1987;13:275-58.



# A FOLLOW UP STUDY OF VIBRATION-INDUCED WHITE FINGER IN COMPENSATION CLAIMANTS

M. Bovenzi, A. D. Vedova, C. Negro

Clinical Unit of Occupational Medicine, Department of Public Health Sciences,  
University of Trieste, Trieste 34129, Italy

## Abstract

The aim of this follow up clinical study was to investigate the changes in vascular symptoms and the cold response of digital vessels in 73 vibration-exposed workers claiming for VWF compensation. The subjects were followed up over a mean time period of 4.1 (range 1-11) years. They underwent a medical interview, a physical examination and a standardised cold test with measurement of finger systolic blood pressure. During the follow up period, all subjects continued to work with vibratory tools. At the first examination, 29 vibration-exposed workers had a positive history of VWF. There were 14 new cases of VWF during the follow up period ( $p < 0.05$ ). On a group basis, a significant increase in the vasoconstrictor response to cold was observed over the follow up time in both the incident cases of VWF and the workers with no symptoms of finger whiteness. Abnormal cold response was not associated with either age or smoking habit. These findings suggest that impairment to digital vasculature can develop over a short time in workers with current exposure to hand-transmitted vibration. That a few extra years of continued work with vibratory tools have caused a significant increase in the occurrence of VWF among currently active workers argues for the implementation of preventive measures as required by the European Directive on mechanical vibration (2002/44/EC).

## Introduction

The prognosis of vibration-induced white finger (VWF) is still uncertain. Studies have reported that VWF may improve, persist or worsen in workers with current or previous exposure to hand-transmitted vibration. It has been suggested that cessation or reduction of vibration exposure may be associated with some reversibility of VWF, but the rate of remission of peripheral vascular symptoms over time is not well-known (Bovenzi et al, 1998; Futatsuka et al, 1989; Koskimies et al, 1992; Riddle and Taylor, 1981). On the other hand, there is clinical and epidemiological evidence that continued use of vibrating tools is associated with an unfavourable prognosis for VWF (Bovenzi et al, 1994; Ogasawara and Sakakibara, 1997; Östman et al, 1996). Most of the longitudinal studies of the prognosis of VWF, however, are based on anamnestic findings. Only a few investigators have monitored the natural course of VWF by means of objective clinical tests, in addition to health history (Bovenzi et al, 1998; Ekenvall and Carlson, 1987; Kurozawa et al, 2002; Petersen et al, 1995).

The aim of this follow up study was to investigate the changes in vascular symptoms and the cold response of digital vessels in a group of claimants for VWF compensation.

## Materials and Methods

### *Subjects and medical investigation*

From 1988 to 2002, 177 workers claiming for VWF compensation were sent to us by the National Insurance Institute for clinical and laboratory examinations. One hundred and four subjects were compensated, while 73 did not obtain compensation because of a negative medical history for VWF, positive history of VWF but negative cold test results, or incomplete administrative documentation. Of these 73 subjects, 10 were construction workers, 11 caulkers, 30 grinders, 9 welders, and 13 mechanics. Table 1 reports the characteristics of the study population at the first examination.

This selected worker group was followed up over a mean time period of 4.1 (range 1-11) years. Following the first examination, 44 subjects underwent a second re-examination, and 29 were re-examined twice. During the follow up period, all subjects continued to work with vibrating tools. At each follow-up, workers underwent a medical interview, a complete physical examination and a standardised cold test. Subjects were interviewed on their work history, state of health, and consumption of tobacco and alcohol. The anamnestic diagnosis of VWF was based on the following criteria (Olsen et al, 1995): (i) positive history of cold provoked episodes of well demarcated blanching in one or more fingers; (ii) first appearance of finger blanching after the start of occupational exposure to hand-transmitted vibration and no other probable causes of Raynaud's phenomenon; (iii) experience of finger blanching attacks during the last two years. VWF symptoms were staged according to the Stockholm scale (Gemne et al, 1987). An increase or a fall of finger

whiteness in at least six phalanges was required to define, respectively, a deterioration or an improvement of the number of phalanges affected with Raynaud's phenomenon over the follow up period.

### *Cold Test*

The cold test was performed with the subject in a supine position after a rest period of 20 – 30 minutes in a laboratory room with an ambient temperature of 21 – 23°C. The cold test consisted of strain-gauge plethysmographic measurement of finger systolic blood pressure (FSBP) during local cooling according to a standardised technique (Nielsen and Lassen, 1977). A double inlet plastic cuff for both air filling and water perfusion was placed on the middle phalanx of the third left finger. In the subjects with subjective symptoms of VWF, the most affected finger was cooled. The test finger was warmed and cooled with water circulating at 30°C and 10°C with a digit cooling system. Two air filled cuffs were applied, one to the proximal phalanx of the test finger (for ischaemia during cooling), and one to the middle phalanx of a reference finger of the same hand (usually the fourth finger). The cold test was performed by pressurising the air cuffs to a suprasystolic level (210 mmHg) and perfusing the water cuff with water, initially at 30°C and then at 10°C. After five minutes of ischaemic cooling, FSBP was measured by a strain gauge in the distal phalanx of the test and reference finger. The results of the cold test was expressed as the change of systolic blood pressure in the test finger at 10°C ( $FSBP_{t,10^\circ}$ ) as a percentage of the pressure at 30°C ( $FSBP_{t,30^\circ}$ ), corrected for the change of pressure in the reference finger during the examination ( $FSBP_{ref,30^\circ}$   $FSBP_{ref,10^\circ}$ ):

$$\frac{(FSBP_{t,10^\circ} - 100)}{(FSBP_{t,30^\circ} - (FSBP_{ref,30^\circ} - FSBP_{ref,10^\circ}))} \quad (\%)$$

To avoid nicotine induced vasoconstrictive effects on the digital vessels, tobacco users refrained from smoking for at least two hours before testing.

The cold test at the various surveys was performed by the same method and apparatus (Digitmatic 2000, Medimatic A/S, Copenhagen, Denmark).

In a previous study of the cold response of digital arteries in 455 normal subjects, we found that  $FSBP\%_{10^\circ}$  averaged 94.8% (SD 11.8), (Bovenzi, 2002). For medicolegal purposes, in the present study the finding of  $FSBP\%_{10^\circ} < 60\%$  (mean 3 SD in normals) was considered an abnormal response of the digital vessels to cold provocation. The same criterion was applied to define an improvement or a deterioration of the cold response over the follow up period, that is an improvement whether  $FSBP\%_{10^\circ}$  changed from a value lower to a value higher than 60%, a deterioration whether  $FSBP\%_{10^\circ}$  changed in the opposite direction.

### *Statistical Methods*

Data analysis was performed with the statistical software Stata v. 8.2 (Stata Corporation, 2003) and StatXact v. 4.0.1 (Cytel Software Corporation, 1992). Continuous variables were summarised using means or medians as measures of central tendency and standard deviations (SD), quartiles or range as measures of dispersion. The Kruskal-Wallis one-way analysis of variance was used to compare independent groups. The McNemar test was used to test the equality of response rates in paired dependent data. The  $\chi^2$  statistic was applied to independent data tabulated in 2 x 2 or 2 x k contingency tables. The relation between repeated measures of  $FSBP\%_{10^\circ}$  and several individual and exposure variables was assessed by the generalised estimating equations method for longitudinal data in order to account for the within subject correlation (Diggle et al, 1994).

## **Results**

At the first examination, the worker groups were comparable for age, anthropometric characteristics, smoking and drinking habits (Table 1). Daily vibration exposure (hours) was greater in the caulkers ( $p=0.025$ ) and total duration of usage of vibrating tools (years) was greater in the welder group ( $p<0.05$ ). Almost all workers reported sensorineural disturbances (tingling and/or numbness) in their fingers and hands. VWF symptoms were more frequent in caulkers, grinders and mechanics when compared with construction workers and welders ( $p<0.05$ ). Mean latency time for VWF was 7.0 (range 1 – 35) years. There was no association between VWF symptoms and drinking or smoking habits.

At the first examination, 29 vibration-exposed workers had a positive history of VWF. Of these workers, 26 reported unchanged digital vascular complaints, and 3 recovered from white finger during the follow up (Table 2). The three workers who recovered from finger blanching had been classified as VWF stage 1 ( $n=2$ ) and stage 2 ( $n=1$ ).

**Table 1** Characteristics of the study population at the first examination. Values are given as medians (quartiles) or numbers (%).

	Construction workers (n=10)	Caulkers (n=11)	Grinders (n=30)	Welders (n=9)	Mechanics (n=13)
Age (yr)	53 (46-54)	49 (45-52)	48 (43-52)	50 (44-52)	46 (44-53)
BMI (kg/m <sup>2</sup> )	26 (24-30)	27 (24-29)	26 (24-28)	25 (24-26)	27 (24-28)
Smokers	1 (10.0)	6 (54.6)	16 (53.3)	3 (33.3)	5 (38.5)
Drinkers	7 (70.0)	6 (54.6)	20 (66.6)	4 (44.4)	9 (69.2)
Exposure: hr/d	2 (1-3)	4 (3-5)	2.5 (2-5)	2 (1-3)	2 (1-3)**
days/y	100 (80-200)	200 (150-220)	200 (150-220)	150(100-180)	200 (150-220)*
years	20 (4-30)	20 (16-24)	21 (16-29)	34 (30-36)	23 (15-30)*
VWF: Stage	1 (10.0)	2 (18.2)	3 (10.0)	0 (0)	2 (15.4)
1	0 (0)	2 (18.2)	5 (16.7)	0 (0)	4 (30.8)
Stage	0 (0)	2 (18.2)	7 (23.3)	1 (11.1)	0 (0)
2	1 (10.0)	6 (54.6)	15 (50.0)	1 (11.1)	6 (46.2)†
Stage					
3					
Stage					
1+2+3					
Sensorineural symptoms	10 (100)	11 (100)	27 (90.0)	9 (100)	13 (100)

BMI: body mass index; Kruskal-Wallis test: \*p<0.05, \*\*p=0.025; <sup>2</sup> test: †p<0.05

**Table 2** Change in vascular disorders from the first to the last examination in the vibration-exposed workers. Values are given as numbers.

	No vasospastic symptoms/signs	Change in vascular disorders		
		Improved	Stationary	Deteriorated
VWF	30	3	26	14*
VWF stage	30	7	20	16*
Number of phalanges with VWF	30	6	16	21*
Abnormal cold response (FSBP% <sub>10°</sub> <60%)	45	6	14	8

McNemar test: \*p<0.05

There were 14 new cases of white finger during the follow up period (p<0.05): eight new cases were classified as VWF stage 1, four as VWF stage 2, and two as VWF stage 3. Among the new VWF cases, 4 were construction workers, 4 welders, 3 grinders, 2 mechanics, and 1 caulker. Significant deterioration in the distribution of VWF stages and the number of phalanges affected with whiteness was observed over the follow up period (p<0.05). However, 4 workers showed an amelioration of VWF stage: one subject improved from stage 2 to stage 1, and three men changed from stage 3 to stage 2.

At the end of the follow up, 40 out of 73 workers (54.8%) had a positive history of VWF, 3 subjects had recovered from VWF, and 30 men complained of cold fingers and hands without episodes of finger whiteness. Of the workers affected with digital ischaemic attacks, 14 were in VWF stage 1 (19.2%), 14 in VWF stage 2 (19.2%), and 12 in VWF stage 3 (16.4%).

Cold response of the digital arteries deteriorated in 8 workers (all among the incident cases of VWF), while improvement in the cold test (FSBP%<sub>10°</sub> > 60%) was observed in 6 subjects (3 with recovery from VWF, and 3 with amelioration of VWF stage).

Analysis of repeated measures of FSBP during local cooling by the generalised estimating equations (GEE) method for longitudinal data showed that both abnormal cold response of digital arteries (FSBP%<sub>10°</sub> < 60%) and closing phenomenon of the digital arteries (zero FSBP%<sub>10°</sub>) were significantly associated with the presence of VWF (Table 3). Moreover, exaggerated vasoconstrictor response to cold was related to the duration of exposure since the first examination (i.e. follow up time), whereas VWF symptoms were associated with daily exposure time during the follow up.

**Table 3** Logistic regression of vibration-induced white finger (VWF) and finger systolic blood pressure during local cooling to 10°C (FSBP%<sub>10°</sub>) on individual and exposure variables in the vibration exposed workers (n=73). FSBP%<sub>10°</sub> is dichotomised at either 60% of the pressure at 30°C or at zero value (closure of the digital arteries). The generalised estimating equations (GEE) method was used to account for correlation between repeated measures of both dependent and independent variables withing subject during the follow up period. Odds ratios (OR) and robust 95% confidence intervals (95% CI) are shown.

Predictors	VWF	FSBP% <sub>10°</sub> < 60%	Zero FSBP% <sub>10°</sub>
	OR (95% CI)	OR (95% CI)	OR (95% CI)
Age (yr)	0.97 (0.92-1.03)	0.95 (0.89-1.01)	1.04 (0.95-1.12)
Smoking (pack-yr)	1.01 (0.99-1.03)	1.00 (0.97-1.02)	0.97 (0.94-1.01)
Daily vibration exposure (hr)	1.19 (1.01-1.41)	1.06 (0.86-1.30)	0.99 (0.74-1.31)
Follow up time (yr)	1.07 (0.97-1.19)	1.15 (1.01-1.32)	0.98 (0.80-1.20)
VWF (0=no/1=yes)		4.24 (1.93-9.31)	6.57 (1.95-22.1)

**Table 4** Linear regression of FSBP%<sub>10°</sub> on individual and exposure variables in the vibration- exposed workers according to their VWF status during follow up. Estimates of regression coefficients (robust standard errors) by the GEE method are shown.

Predictors	FSBP% <sub>10°</sub> during follow up		
	Never VWF (n=30)	Incident cases of VWF (n=14)	Prevalent cases of VWF (n=26)†
Intercept	135 (30.0)	70.9 (32.1)	14.0 (38.5)
Age (yr)	-0.78 (0.59)	0.11 (0.67)	0.41 (0.79)
Smoking (pack-yr)	-0.31 (0.18)	-0.09 (0.22)	0.49 (0.26)
Daily vibration exposure (hr)	-1.92 (1.58)	-2.00 (3.43)	-1.97 (2.55)
Follow up time (yr)	-2.86 (1.01)**	-4.14 (1.82)*	0.04 (1.78)

†Three subjects, who had recovered from VWF, were excluded from analysis

\*p=0.02; \*\*p<0.01

Marginal linear regression (GEE method) of FSBP%<sub>10°</sub> on individual and exposure variables showed that the reduction of FSBP%<sub>10°</sub> (i.e. deterioration) was significantly related to the follow up time in both the incident cases of VWF ( 4% per year) and the workers with no symptoms of finger whiteness ( 3% per year), (Table 4). FSBP%<sub>10°</sub> at the first examination and changes in FSBP%<sub>10°</sub> during the follow up were not associated with either age or smoking habit.

## Discussion

VWF is a peripheral vascular disorder of occupational origin which is compensated in many industrialised countries. In a recent recommendation for a European schedule of occupational diseases (2003/670/EC), the Commission of the European Communities includes “*angioneurotic diseases caused by mechanical vibration*” (Annex I, item 505.02) among health disorders which show a direct link with occupation on the basis of clinical and epidemiological evidence. “*Osteoarticular diseases of the hands and wrists caused by mechanical vibration*” are also included in the new Commission recommendation (Annex I, item 505.01). In Italy, both VWF and bone and joint disorders of the upper limb are included in the official schedule of occupational diseases in industry (item 52) and agriculture (item 27), (DPR No. 336/1994). Moreover, pre-employment and yearly follow up health surveillance is prescribed for workers occupationally exposed to hand-transmitted vibration. At present, vibration-induced upper-limb disorders represent the fifth

occupational disease compensated in Italy. To obtain compensation, workers complaining VWF symptoms must undergo a series of clinical and laboratory examinations to assess objectively the presence of vascular disorders and their severity.

The results of this follow up study of VWF in active vibration-exposed workers claiming for compensation are consistent with the findings of other investigations which suggest that continued work with hand-held vibrating tools is significantly associated with an increase in the occurrence of VWF, increased severity of digital vasospastic symptoms, and increased responsiveness of digital arteries to cold. In a cohort study of welders exposed to hand-transmitted vibration, Östman et al (1996) found that among workers with continued vibration exposure, none showed subjective improvement, 56% claimed unchanged problems and 44% reported worse symptoms. In a follow up clinical study of 353 Japanese workers receiving treatment for hand-arm vibration syndrome, it was observed that continued use of vibratory tools was associated with an unfavourable prognosis for VWF (Ogasawara and Sakakibara, 1997). In a follow up study of the course of VWF in 55 Swedish men, patients who continued to work with vibratory tools reported an increase in subjective symptoms which were associated with an increased vasoconstrictor response of the digital arteries to a standardised cold test (Ekenvall and Carlsson, 1987). In a group of active stoneworkers using percussive and rotary tools, a 38% onset of new cases of VWF was observed in a six-year follow up period (Bovenzi et al, 1994). In a follow up clinical investigation of 102 patients with advanced stages of VWF, Petersen et al (1995) reported that continued exposure to hand-transmitted vibration had a negative influence on VWF reversibility.

It is worth noting that most of the aforementioned studies pointed out that cessation or reduction of vibration exposure were associated with either recovery from VWF or improvement of VWF stages. In some studies of forestry workers, the decrease in the incidence of VWF in active chain sawyers was attributed to the use of lighter anti-vibration (AV) chain saws and the introduction of administrative measures curtailing daily saw usage time and improving the organisation of forest work (Futatsuka et al, 1989; Koskimies et al, 1992). It should be noted, however, that new cases of VWF have been reported in active workers who used AV tools of new generation (Bovenzi et al, 1998; Olsen and Nielsen, 1988; Riddle and Taylor, 1982). These findings suggest that health surveillance should be maintained in workers whose work experience is limited to AV tools only. This is also consistent with the provisions established by the new European Directive 2002/44/EC on the protection of workers against risks arising from mechanical vibration (2002).

In this study, an abnormal response of digital arteries to cold provocation was associated with both VWF symptoms and the duration of vibration exposure since the first examination. As expected, digital arterial hyperresponsiveness to cold was significantly related to the follow up time in the incident cases of VWF. However, a significant reduction of FSBP%<sub>10°</sub> (i.e. aggravation) was also observed in workers with no positive history of episodes of finger blanching attacks during the follow up period. Similar findings have been reported by other researchers who investigated prospectively the changes in the occurrence of VWF by means of medical interview and cold test (Bovenzi et al, 1998; Olsen et al, 1982; Olsen and Nielsen, 1988). These authors observed a deterioration of FSBP% during cooling in asymptomatic workers who had operated only AV tools. This means that damage to the vasoconstrictor mechanisms in the digital vessels may occur even in subjects exposed to hand-transmitted vibration of low intensity.

The results of this clinical investigation indicate that, when combined with reliable work and health histories, FSBP measurement after finger cooling is an accurate laboratory testing method to detect cold-induced digital vasospasm and to confirm VWF symptoms objectively. Moreover, the cold test may be useful for disclosing increased hyperreactivity in cold-induced vasoconstrictor response in vibration-exposed workers with a negative anamnesis for finger blanching attacks. In this follow up study, some subjects without VWF symptoms exhibited an exaggerated digital arterial response to cold, suggesting that FSBP measurement during local cooling may be useful to uncover preclinical Raynaud's phenomenon.

In this study, there were no significant associations between VWF symptoms and smoking, and between the results of the cold test and smoking both at the first examination and during the follow up. The role of tobacco consumption on the course of VWF is still a controversial matter. The findings of some clinical and epidemiological studies suggest that smokers have a poorer prognosis for VWF (Cherniack et al, 2000; Ekenvall and Carlsson, 1987; Petersen et al, 1995). It has been reported that after cessation or reduction of vibration exposure the rate of VWF recovery was greater and the improvement in the cold response of digital vessels was more evident in non-smokers or ex-smokers than in current smokers. On the contrary, other studies have reported no influence of smoking on either the progression of VWF in current users of vibratory tools or the reversibility of VWF in ex-users (Bovenzi et al, 1998; Futatsuka and Sakurai, 1986; Ogasawara and Sakakibara, 1997). Even though the adverse effects of smoking on arterial function are well known, nevertheless its contribution to the onset and development of VWF symptoms, as well as its influence on VWF reversibility, are not yet established.

In conclusion, this clinical investigation showed that 14 new cases of VWF occurred in a selected group of currently active vibration-exposed workers after one to 11 years of observation. Moreover, the cold response of digital arteries

deteriorated significantly during the follow up period not only in the incident cases of VWF but also in the vibration-exposed workers with no digital vasospastic symptoms during the follow up. In the incident cases of VWF, finger blanching attacks became visible after 3.4 (SD 1.8) years since the first examination. This finding suggests that impairment to digital vasculature can develop over a short time in workers with current exposure to hand-transmitted vibration from power tools. That a few extra years of continued work with vibratory tools have caused a significant increase in the occurrence of VWF symptoms and signs among currently active men employed in various industrial sectors, is a matter of concern for the occupational health physician. This argues for the adoption and implementation of preventive measures to improve the safety and health of vibration-exposed operators at work as required by the European Directive on mechanical vibration (2002).

### Acknowledgement

This research was supported by the European Commission under the Quality of Life and Management of Living Resources programme - Project No. QLK4-2002-02650 (VIBRISKS).

### References

- Bovenzi, M. 2002. Finger systolic blood pressure indices for the diagnosis of vibration-induced white finger. *International Archives of Occupational and Environmental Health*, vol 75, pp 20-28.
- Bovenzi, M., Franzinelli, A., Scattoni, L. and Vannuccini, L. 1994. Hand-arm vibration syndrome among travertine workers: a follow up study. *Occupational and Environmental Medicine*, vol 51, pp 361-365.
- Bovenzi, M., Alessandrini, B., Mancini, R., Cannavà, M.G. and Centi, L. 1998. A prospective study of the cold response of digital vessels in forestry workers exposed to saw vibration. *International Archives of Occupational and Environmental Health*, vol 71, pp 493-498.
- Cherniack, M., Clive, J. and Seidner, A. 2000. Vibration exposure, smoking, and vascular dysfunction. *Occupational and Environmental Medicine*, vol 57, pp 341-347.
- Commission Recommendation of 19 September 2003 concerning the European schedule of occupational diseases (2003/670/EC). *Official Journal of the European Union*, L 238/28, 25.9.2003.
- Diggle, P.J., Liang, K.Y. and Zeger, S.L. 1994. *Analysis of longitudinal data*. Oxford: Oxford University Press.
- Directive 2002/44/EC of the European Parliament and the Council of 25 June 2002 on the minimum health and safety requirements regarding the exposure of workers to the risks arising from physical agents (vibration) (sixteenth individual Directive within the meaning of Article 16(1) of Directive 89/391/EEC). *Official Journal of the European Communities*, L 117/13, 6.7.2002.
- Ekenvall, L. and Carlsson, A. 1987. Vibration white finger: a follow up study. *British Journal of Industrial Medicine*, vol 44, pp 476-478.
- Futatsuka, M. and Sakurai, T. 1986. A case-control study on the prognosis of vibration syndrome. *International Archives of Occupational and Environmental Health*, vol 58, pp 113-120.
- Futatsuka, M., Ueno, T. and Sakurai, T. 1989. Cohort study of vibration-induced white finger among Japanese forest workers over 30 years. *International Archives of Occupational and Environmental Health*, vol 61, pp 503-506.
- Gemne, G., Pyykkö, I., Taylor, W. and Pelmear, P.L. 1987. The Stockholm Workshop scale for the classification of cold-induced Raynaud's phenomenon in the hand-arm vibration syndrome (revision of the Taylor-Pelmear scale). *Scandinavian Journal of Work Environment & Health*, vol 13, pp 275-278.
- Koskimies, K., Pyykkö, I., Starck, J. and Inaba, R. 1992. Vibration syndrome among Finnish forest workers between 1972 and 1990. *International Archives of Occupational and Environmental Health*, vol 64, pp 251-256.
- Kurosawa, Y., Nasu, Y., Hosoda, T. and Nose, T. 2002. Long-term follow-up study on patients with vibration-induced white finger (VWF). *Journal of Occupational and Environmental Medicine*, vol 44, pp 1203-1206.
- Nielsen, S.L. and Lassen, N.A. 1977. Measurement of digital blood pressure after local cooling. *Journal of Applied Physiology*, vol 43, pp 907-910.
- Ogasawara, C. and Sakakibara, H. 1997. Longitudinal study on factors related to the course of vibration-induced white finger. *International Archives of Occupational and Environmental Health*, vol 69, pp 180-184.

- Olsen, N. and Nielsen, S.L. 1988. Vasoconstrictor response to cold in forestry workers: a prospective study. *British Journal of Industrial Medicine*, vol 45, pp 39-42.
- Olsen, N., Nielsen, S.L. and Voss, P. 1982. Cold response of digital arteries in chain saw operators. *British Journal of Industrial Medicine*, vol 39, pp 82-88.
- Olsen, N., Hagberg, M., Ekenvall L., Futatsuka, M., Harrison, J., Nasu, Y., Welsh, C., Yamada, S. and Yoshida, M. 1995. Clinical and laboratory diagnostics of vascular symptoms induced by hand-arm vibration. Report from discussion in a working group. In: Gemne, G., Brammer, A.J., Hagberg, M., Lundström, R. and Nilsson, T. (eds.). *Proceedings of the Stockholm Workshop 94. Hand-arm vibration syndrome: Diagnostics and quantitative relationships to exposure. Arbete och Hälsa*, vol 5, pp 181-186.
- Östman, F., Lundborg, G., Bornmyr, S. and Lilja, B. 1996. Is vibration-induced white finger a reversible syndrome if vibration is stopped? *Journal of Hand Surgery*, vol 21B, pp750-752.
- Petersen, R., Andersen, M., Mikkelsen, S. and Nielsen, S.L. 1995. Prognosis of vibration induced white finger: a follow up study. *Occupational and Environmental Medicine*, vol 52, pp 110-115.
- Riddle, H.F.V. and Taylor, W. 1982. Vibration-induced white finger among chain sawyers nine years after the introduction of anti-vibration measures. In: Brammer, A.J. and Taylor, W. (eds.) *Vibration effects on the hand and arm in industry*. New York: John Wiley & Sons, pp 169-172.





# SEGMENTAL NERVE CONDUCTION VELOCITY IN A VIBRATION EXPOSED POPULATION

M. Cherniack<sup>1</sup>, A.J. Brammer<sup>1,2</sup>, R. Lundstrom<sup>3</sup>, J. Meyer<sup>1</sup>, T. F. Morse<sup>1</sup>, G. Neely<sup>4</sup>,  
T. Nilsson<sup>5</sup>, D. Peterson<sup>1</sup>, E. Toppilla<sup>6</sup>, N. Warren<sup>1</sup>, R. W. Fu<sup>1</sup>, H. Bruneau<sup>1</sup>

- <sup>1</sup> Ergonomics Technology Center, University of Connecticut Health Center, Farmington, CT USA  
<sup>2</sup> Institute for Microstructural Sciences, National Research Council, Ottawa, ON Canada  
<sup>3</sup> University Hospital, Department of Biomedical Engineering and Informatics, Umeå, Sweden  
<sup>4</sup> National Institute for Working Life, Department of Work and the Physical Environment, Umeå, Sweden  
<sup>5</sup> Department of Occupational and Environmental Medicine, Sundsvall Hospital, Sundsvall, Sweden  
<sup>6</sup> Department of Physics, Institute of Occupational Health, Helsinki, Finland.

## Introduction

This study was designed to investigate whether sensory nerve conduction velocity (SNCV) was selectively slowed in the fingers of vibration exposed workers, and whether a laboratory approach could be adapted for robust field use. Segmental SNCV was measured from the wrists to the palm and along the digits of a population of vibration-exposed shipyard workers. The approach, which involved SNCV methods development, was derived from the procedure of Sakakibara et al. (1994, 1998). The study population consisted of 217 shipyard workers, including 179 with current exposure and a comparison sub-group of 28 subjects without symptoms or a history of vibratory exposure.

## Methods

Following acclimatization and skin surface warming to  $>31^{\circ}\text{C}$ ., wrist-palm, palm-proximal digit, and digital sensory segments were determined from stimulation at the wrist with recording electrodes placed distally, and adjusted to individual anatomy, preserving proportional anthropometric relationships. Onset latencies were used in calculating NCVs, in order to present a common reference, given the absence of recognized normal latency values for atypical sensory nerve segments. Because of the short segments and concern over possible artifacts, two blinded reviewers independently assessed each of 3012 tests, with strict exclusion criteria. Altogether, 185 tests (6.8%) were excluded.

## Results

Wrist-palm and digital segments were slower than palm-proximal digit segments for dominant and non-dominant hands and for both ulnar and median nerves. For the dominant hand median nerve of participants with current exposure, the SNCV was 41.4 m/s (SD 8.0) for the wrist-palm segment, 50.8 (SD 9.5) for the palm segment, and 42.1(SD 9.3) for the digital segment. As the following table shows, velocities were uniformly higher in the unexposed subjects. Segmental SNCV for the ulnar nerve was slower for exposed subjects within the digits, but identical for more proximal measurements. Temperature had an important effect on nerve conduction velocity, but not equally across segments. Because of these segmental differences, use of fixed rather than anthropometrically adjusted distances influenced SNCV and definition of pathology, since standard distance measurements included variable proportional lengths of slow conduction digits. Subjects with clinically diagnosed carpal tunnel syndrome (CTS) were as likely to have slowed nerve conduction in the digits across the wrists. Other explanatory variables had modest effect on SNCV.

**Table 1** SNCV in vibration exposed and non-exposed shipyard workers

	Exposed Subjects n=179			Unexposed Subjects n=28		
	<i>Mean m/s</i>	<i>SD</i>	<i>Min – Max</i>	<i>Mean m/s</i>	<i>SD</i>	<i>Min – Max</i>
<b>Median Nerve – dominant</b>						
Proximal digit – distal digit*	2.1	9.3	23 – 79	45.7	7.6	32 – 65
Palm – proximal digit	53.1	12.7	20 – 88	53.0	8.2	38 – 68
Wrist – palm*	41.4	8.0	24 – 70	44.9	6.9	31 – 57
<b>Ulnar Nerve – dominant</b>						
Proximal digit – distal digit	42.5	11.9	20 – 82	46.3	12.1	27 – 79
Palm – proximal digit	53.1	12.7	20 – 88	52.2	13.1	23 – 74
Wrist – palm	50.1	8.6	23 – 83	51.4	6.1	38 – 64

### **Conclusions**

Reduced SNCV in the digits may be a consequence of industrial exposure to vibration. Each sensory nerve segment appeared to have a different characteristic velocity and different pattern of association with skin temperature. There are differences between median and ulnar nerve segments, with potentially important consequences when standard distances are used to assess wrist-digit velocity.

### **References**

Sakakibara H, Kondo T-A, Miyao M, Yamada S (1994) Digital nerve conduction velocity as a sensitive indication of peripheral neuropathy in vibration syndrome. *Am J Indus Med* 26:359-366.

Sakakibara H, Hirata M, Hashiguchi T, Toibana N, Koshiyama H (1998) Affected segments of the median nerve detected by fractionated nerve conduction measurement in vibration-induced neuropathy. *Indus Health* 36:155-159.

# EFFECT OF VIBRATION-INDUCED PERIPHERAL NERVE INJURY ON AXOPLASMIC TRANSPORT

J. Yan<sup>1</sup>, H. S. Matloub<sup>1</sup>, J. R. Sanger<sup>1</sup>, L. Zhang<sup>1</sup>, D. A. Riley<sup>2</sup>

<sup>1</sup> Department of Plastic Surgery, Medical College of Wisconsin, 9200 W. Wisconsin Avenue, Milwaukee, WI 53226

<sup>2</sup> Department of Cell Biology, Neurobiology, and Anatomy, Medical College of Wisconsin, 9200 W. Wisconsin Avenue, Milwaukee, WI 53226

## Objective

Although occupational vibration exposure injury is a very common injury to the peripheral nerve, its essential etiology remains unclear. This study was undertaken to explore the effect of vibration exposure on axoplasmic transport of the peripheral nerve.

## Materials and Methods

In this study there were 3 groups of 10 rats each.

**Group A** (Control group-without vibration): 2% 5 $\mu$  conjugated WGA-HRP was injected into the soleus muscle, left hind leg. After a 24-hour survival time, the soleus muscle, its nerve branch, tibial nerve, sciatic nerve and the spinal cord were harvested. The soleus muscles were weighed. Sections of all specimens were cut on a freezing microtome and processed using TMB procedures.

**Group B** (Vibration group): After injection, hind limbs of the rats were secured on the vibration platform (120 volt, 60 HZ, A.C. 15 watts), 5 hours vibration 2 times per day. After a survival time of 24 hours, slides of specimens were processed as in previous group.

**Group C**: (Vibration 5 hours x 10 days): After the last vibration exposure, WGA-HRP was injected into the soleus muscle. After injection, 2 rats had a 24-hour survival time, another 8 rats had a 48-hour survival time, free from vibration; then all were sacrificed.

## RESULTS

**Group A**: In the peripheral nerve, a very homogeneously blue-purplish stain was obtained without any tracer stasis in any part of the transport path. Intensely labeled motor neurons were found in the anterior horn column. The mean number of cells was 29, the mean number of dendrites, 3.5.

**Group B**: Abundant tracer deposits remained in the peripheral nerve. The stasis was manifested by a dense, rough line, or dispersive spots with thick tracer deposit. Some dense deposit silted in the intraneural venules of the tibial nerve. In this group, no labeled neurons were found in the spinal cord.

**Group C**: Only slight positive transport stain was found in 3 rats. Others stained negatively. In peripheral nerve: Some transported tracer had been retained and expanded the interfascial space; some deposit had leaked out through the epineurium.

The soleus muscle of Group C was obviously atrophied after 10 days of vibration. The comparative difference on the weight of soleus muscle between Group A and Group C has statistical significance ( $p < 0.01$ ).

Another interesting result is that all fresh tissue slides of the spinal cord from the vibration groups (Group B and Group C) showed high tissue fragility while those of the control group did not. On the counterstain (neutral red), stained cytoplasm of the neurons in the vibrated groups was less dense than that of the control group.

## CONCLUSIONS

1. In this model, vibration exposure immediately impeded axoplasmic transport of peripheral nerves.
2. Axoplasmic transport obstruction caused by vibration exposure for a short time would be reversible, but the injury is cumulative. The longer the vibration exposure, the more severe the injury.
3. Vibration exposure will induce muscle atrophy and metabolic change of the neurons, resulting in damaged axoplasmic transport.



## **Measurement I – Focus Session**

P. Pitts - Session Coordinator



# METRICS FOR HAND-ARM VIBRATION EXPOSURE: AN INTRODUCTION

A.J. Brammer

Ergonomic Technology Center, University of Connecticut Health Center,  
Farmington, CT 06030, U.S.A., and Institute for Microstructural Sciences,  
National Research Council, Ottawa, Ontario K1A 0R6, Canada

## Introduction

Exposure of the hands to vibration commonly occurs when operating hand-held tools, or when holding objects subjected to vibration. The purpose of this paper is to provide an introduction to the metrics employed for characterizing the magnitude of the motion of a surface in contact with the hand, and for characterizing the exposure, that is, a combination of the magnitude of the stimulus and the time for which it occurs.

The metrics to be used for assessing the development of the hand-arm vibration syndrome (HAVS) are prescribed in standards prepared by the International Organization for Standardization (ISO), the American Conference of Governmental Industrial Hygienists (ACGIH) and other standards' writing bodies. The underlying concepts and formulation of the metrics are considered here. A short bibliography provides further information.

## Definition

Vibration may be defined as a time-varying disturbance of a mechanical, or biological, system from an equilibrium condition for which the long-term average of the motion will tend to zero, and on which may be superimposed either translations or rotations, or both. At present, translations and rotations are considered less important than oscillatory motion for the development of HAVS.

### *Characterization of vibration magnitude*

Most practical vibration sensors record the instantaneous acceleration of the motion, which is related to the human response, and are insensitive to (slow) translations or rotations, so that a simple averaging over time of the motion of a vibrating system will result in zero. To overcome the negative portion of the acceleration-time history canceling the positive portion, the acceleration-time history is first squared before being averaged to form the mean squared acceleration. The square root of this function forms the basis for the metric, namely the root mean squared (r.m.s.) acceleration.

Human response to vibration also depends on the frequency of the stimulus. To equate the potential for injury from different vibration frequencies within multi-frequency stimuli, the acceleration-time history is filtered to adjust the relative contributions from different frequencies. The magnitude metric thus formed is the frequency-weighted r.m.s. acceleration.

The vibration magnitude is commonly determined in three mutually perpendicular directions related to the anatomy of the hands (ISO 5349-1, 2001). The overall vibration, or so-called vibration total value, is established by combining the frequency-weighted r.m.s. accelerations recorded in the different directions. In practice, the measurements performed depend on whether the components of the motion in the three directions are of similar magnitude (e.g., chain saw), or the component motion in one direction clearly exceeds that in other directions (e.g., chipping hammer).

### *Characterization of vibration exposure*

The health disturbances associated with HAVS are assumed to be related to the exposure, which is constructed from the magnitude of the stimulus, its frequency content and duration. Almost all assessment procedures involve the daily exposure, though there are different approaches to its estimation.

The ISO employs the vibration total value averaged over an eight-hour working day. This metric is termed the eight-hour energy-equivalent vibration total value, or A(8). In practice, the exposure may last for less than the working day, or the working day may involve operating more than one power tool or process in which vibration enters the hands. In these circumstances the daily exposure is estimated by combining the exposures calculated for each tool or process, and converting the combined exposure to A(8).

The ACGIH lists ranges of exposure durations within the workday (e.g., 4 – 8 hours), and specifies the maximum frequency-weighted r.m.s. acceleration component allowed during each time period.

Though not included in any definition of exposure, which describes the vibratory stimulus in contact with, but external to, the body, the compressive (grip) and thrust (feed) forces exerted by the hands during a manual task need to be considered when assessing the coupling of vibration into the hands.

### **References**

ACGIH. 2003. Threshold Limit Values and Biological Exposure Indices. American Conference of Governmental Industrial Hygienists, Cincinnati, OH.

Brammer, A.J. and Peterson, D.R. 2002. Vibration, mechanical shock and impact. In Kutz, M (ed.) Standard Handbook for Biomedical Engineering. McGraw Hill, New York.

Griffin, M.J. 1990. Handbook of Human Vibration. Academic Press, London.

ISO 5349-1. 2001. Mechanical Vibration Measurement and Evaluation of Human Exposure to Hand Transmitted Vibration Part 1: General Guidelines. International Organization for Standardization, Geneva.

ISO 5349-2. 2001. Mechanical Vibration Measurement and Evaluation of Human Exposure to Hand Transmitted Vibration Part 2: Practical Guidance for Measurement at the Workplace. International Organization for Standardization, Geneva.

Pelmear, P.L. and Wasserman, D.E. (eds.) 1998. Hand Arm Vibration. OEM Press, Beverly Farms, MA (2nd edition).



# EXPOSURE EVALUATION AND RISK ASSESSMENT FOR HAND-ARM VIBRATION

Chris M Nelson

Health and Safety Executive, Magdalen House, Bootle, UK, L20 3QZ.

## Abstract

This paper provides an overview of the current internationally agreed method for evaluating personal daily exposures to hand-arm vibration as described in ISO 5349 (Parts 1 & 2). It discusses sampling strategies for vibration measurements in the workplace and the correct identification of exposure duration information; the calculation of exposure from more than one source of vibration is also described.

The role of daily exposure values as a tool for the assessment of vibration injury risk, is explored, in the context of current knowledge of the dose-effect relationships for the components of hand-arm vibration syndrome, known weaknesses of the standard exposure evaluation methods and realistic uncertainties in real exposure values.

Finally, various exposure limits and action levels, as adopted by national authorities, are described and their role in the assessment and control of risk is discussed.

## Introduction

International Standard 5349-1:2001 (International Organization for Standardization, 2001a) contains the internationally agreed method for the evaluation of daily exposure to hand-transmitted vibration. The Standard also includes (in Informative Annexes) some cautious guidance on the likely health effects from hand-transmitted vibration at different levels of exposure.

Other papers presented in this conference Focus Session look at some of the theoretical and practical aspects of making hand-arm vibration measurements. This paper shows how values obtained from vibration measurements can be used to evaluate the daily exposures of workers and, most importantly, how an understanding of exposure levels can help employers in their assessment of risks to health when planning actions to prevent vibration injuries.

## Evaluating The Exposure

A worker's exposure depends on the magnitude of the vibration and on how long the exposure lasts. Individual daily exposures are determined from the average vibration magnitude and the associated exposure duration for each relevant work process. The standardised daily vibration exposure is the vibration magnitude measured according to ISO 5349-1:2001 (the r.m.s. frequency-weighted acceleration) and normalised to a reference exposure duration of 8 hours; this expression of daily exposure is the 8-hour energy-equivalent acceleration, known as the  $A(8)$  value.

## The Vibration Magnitude

The vibration magnitude should be obtained from measurements made on either the tool/work process itself or on a similar tool under similar operating conditions. The ISO 5349-1:2001 method produces three frequency-weighted root-mean square (r.m.s.) acceleration magnitudes measured in each of three directions, x, y and z, which are then combined using the root-sum-of-squares procedure to give the 'vibration total value',  $a_{hv}$ , as shown in equation (1):

$$a_{hv} = \sqrt{a_{hw x}^2 + a_{hw y}^2 + a_{hw z}^2} \quad (1)$$

For many employers wishing to assess risks from vibration, the resources to carry out good quality vibration measurements in the workplace may not be available. In many such cases it is possible to obtain a sufficiently accurate estimate of vibration exposure by using vibration data measured elsewhere on a similar tool, and in similar operating conditions. This is discussed further in the 'Exposure Uncertainties' section below.

## The Exposure Duration

Information about the duration of the exposure is usually best obtained by a combination of enquiry and observation. Note that the duration of interest is the total time for which the hand is actually exposed to the *measured* vibration (sometimes known as the ‘trigger time’ or ‘contact time’). This is often considerably shorter than the time estimated by operators when asked how long they operate their power tools: they tend to think of the total time on the job, rather than the shorter time spent actually operating the machine(s).

Where the work is predictable and repetitive (especially in some manufacturing operations) it is often easier to obtain accurate exposure time information, by observing the time required for one or more work cycles and combining this with information about the amount of work done in a day (e.g. the number of components made).

## Calculating The A(8) Value

The A(8) value is derived from an average vibration magnitude and the total daily duration of exposure to that magnitude of vibration:

$$A(8) = a_{hv} \sqrt{\frac{T}{T_0}} \quad (2)$$

where  $a_{hv}$ , is the frequency-weighted *vibration total value*, measured in accordance with ISO 5349-1:2001,  $T$  is the total duration of exposure to vibration  $a_{hv}$  and  $T_0$  is the reference duration of 8 hours (28800 seconds).

## Matching The Exposure Duration To The Vibration Magnitude

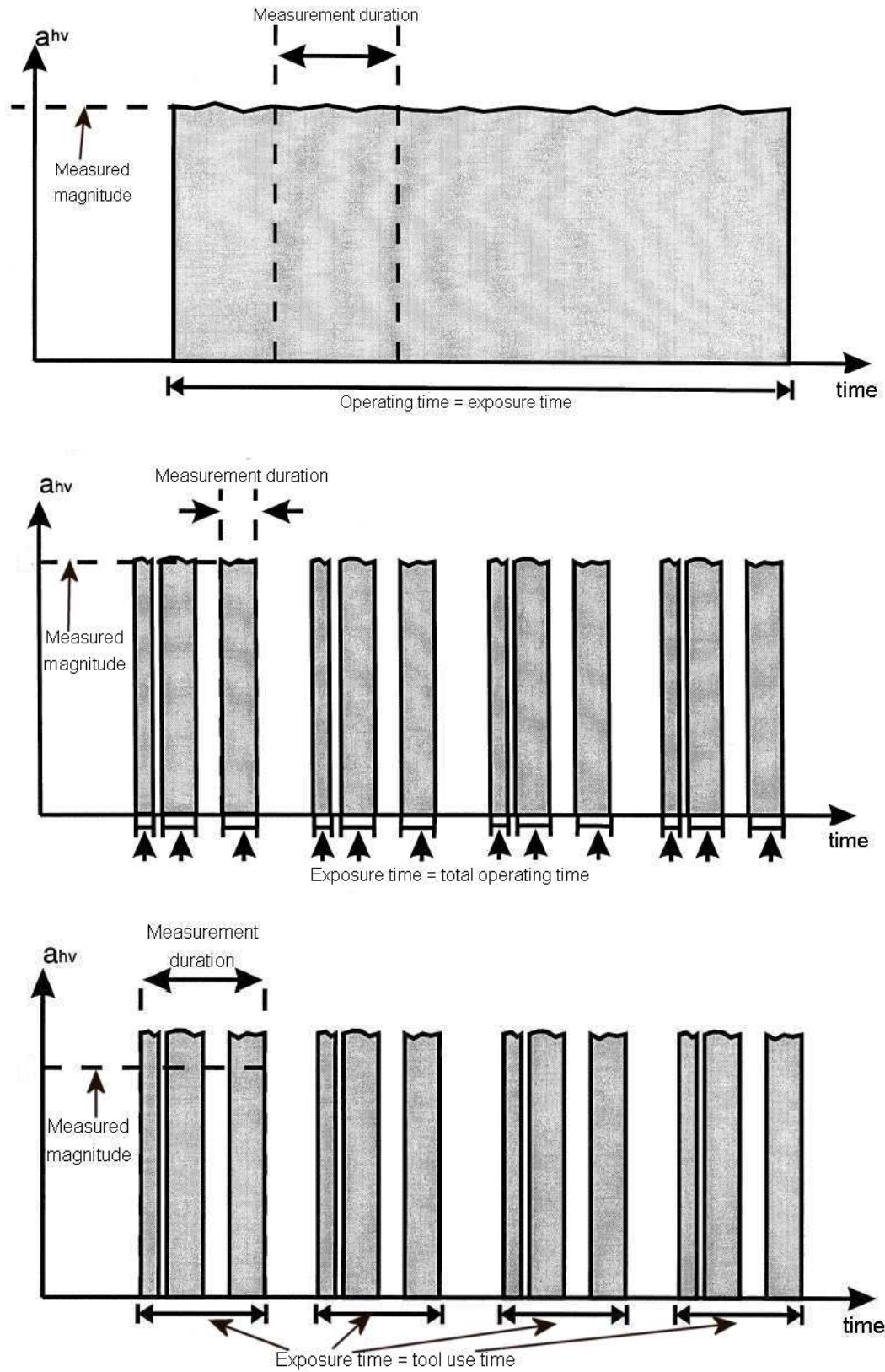
When a magnitude and duration are combined to give an exposure value, it is important to ensure that they are matched; that is, that the vibration magnitude is measured over an appropriate period of time so that the average (r.m.s.) acceleration value obtained is representative of the average vibration for the exposure duration quoted. To illustrate this point, three different scenarios are illustrated in Figure 1. These graphs are adapted from Part 2 to the Standard, ISO 5349-2:2001 (International Organization for Standardization, 2001b).

In the upper graph, the vibration exposure is uninterrupted over a long period of time. This is the most simple situation; examples might include the use of lawnmowers, floor polishers, etc. The vibration is measured for long enough to obtain a good average value and the exposure duration is the entire duration of the job.

In the middle graph, the tool is operated many times for short periods. The vibration can be measured only during the periods of vibration, perhaps because the hand is not in contact with the vibrating surface at other times. (An example might be the use of a pedestal grinder, where each period of operation involves processing a different workpiece.) In this situation, the exposure duration used to calculate exposure will be the sum of all the individual periods of tool operation (i.e. the total ‘trigger time’) and not the overall period of work. It would be good practice to repeat the measurement several times and to take an average. The exposure duration would then be obtained by observation to find the mean duration of an operation and then multiplying this by the number of operations in the day.

Finally, in the lower graph, a vibrating tool is used intermittently over several minutes to carry out a job. The job is repeated several times a day. In this example, the vibration measurement continues throughout one complete cycle of the job, including the periods when the tool is not operating. This results in a lower average magnitude than occurs during the actual tool operation. However, the appropriate exposure duration will be the time spent on that activity during the day (the measurement duration multiplied by the number of repeated cycles of the work) and not the ‘trigger time’.

These examples show the necessity for a clear understanding of the nature and pattern of the person’s work, so that the appropriate measurements can be planned. It is important to identify the work tasks that are likely to make a significant contribution to the person’s daily exposure, and then, for each one, to plan the necessary measurements and observations to obtain an average vibration magnitude for which the appropriate exposure duration can be identified. If the work process (and the vibration) is likely to vary with time, then sample measurements should be made through the day and averaged. Alternatively, where appropriate, the measurement should be made over a long period, which may involve measuring continuously over several cycles where the work is repetitive.



**Figure 1** Different scenarios for matching measured vibration magnitude and exposure duration (adapted from ISO 5349-2:2001).

The examples also demonstrate that, if the exposure is estimated using vibration measurements made by a third party, possibly in a different workplace (for example vibration data provided by a tool manufacturer or obtained through a trade association), it is important to know enough about the work patterns and the measurement sampling times so that an appropriate daily exposure duration can be established to match the magnitudes used in the exposure calculation.

ISO 5349-2:2001 contains useful practical guidance the planning and execution of workplace vibration measurement and exposure evaluation.

### Exposure To Two Or More Sources Of Vibration

If a worker is exposed during a working day to more than one type of vibration (for example if he or she uses two or more different power tools) then a *partial vibration exposure* can be obtained for each, using equation (2). They can then be combined into a single daily exposure:

$$A(8) = [A_1(8)^2 + A_2(8)^2 + A_3(8)^2 + \dots]^{\frac{1}{2}} \quad (3)$$

It is not necessary to use equations (2) and (3) to determine daily exposure, as various more user-friendly alternatives are available. One well-known example is the nomogram, linking vibration magnitude, exposure duration and daily exposure. An example is included in the British national guidance on HAV (Health and Safety Executive, 1994).

Other aids to exposure calculation include spreadsheet-based calculators such as that in Figure 2. In this example, the user enters between one and six pairs of values in the *Vibration Magnitude* and *Exposure Duration* columns. The partial exposures (from individual tools or processes) and the total daily exposure are displayed as both A(8) values and the alternative ‘exposure points’ (as described elsewhere (Nelson & Brereton, 2004)). By comparing the partial exposures, the user can see which components of the day’s work are contributing most to the overall daily vibration exposure and thus where priorities lie for remedial action.

**HAND-ARM VIBRATION EXPOSURE CALCULATOR**

	Vibration magnitude m/s <sup>2</sup> r.m.s.	Time to reach EAV 2.5 m/s <sup>2</sup> A(8)		Time to reach ELV 5 m/s <sup>2</sup> A(8)		Exposure duration		Partial exposure m/s <sup>2</sup> A(8)	Partial exposure points
		hours	minutes	hours	minutes	hours	minutes		
Tool or process 1	2.0	12	30	>24			15	0.4	2
Tool or process 2	6.0	1	23	5	33	0.5		1.5	36
Tool or process 3	3.5	4	5	16	20	1	30	1.5	37
Tool or process 4									
Tool or process 5									
Tool or process 6									

Instructions for use:

- Enter vibration magnitudes and exposure durations in the white areas.
- To calculate, press the Enter key, or move the cursor to a different cell.
- The results are displayed in the yellow areas.
- To clear all cells, click on the 'Clear' button.
- For more information, click the HELP tab below.

Daily exposure m/s <sup>2</sup> A(8)	Total exposure points
2.2	75

Clear

Version 2 August 2003

**Figure 2** Spreadsheet calculator for daily personal vibration exposures (available at [www.hse.gov.uk/vibration](http://www.hse.gov.uk/vibration))

## Risk Assessment

The principle reason for evaluating a person's daily vibration exposure (as represented by the  $A(8)$  value) is to assess the risk of vibration injury so that controls can be put in place and, where appropriate, to ensure that legal limits for vibration exposure are not exceeded. It is important to note that exposure evaluation is not the same process as risk assessment, but that it usually forms a valuable part of the risk assessment process.

## Dose-Effect Relationships

If an exposure value is to be used for risk assessment, we need to know the relationship between the exposure and the likelihood of any resulting cases of hand-arm vibration syndrome (HAVS). This is not a simple matter. Firstly, HAVS is not a single disease, but an umbrella term for a group of vascular, sensorineural and musculoskeletal complaints, all of which have been linked with vibration exposure, but which are likely to have different dose-effect relationships, for example with regard to vibration frequency. Secondly, the risks for different people will vary for each of the different components of HAVS, according to: individual predisposition, any pre-existing disease and various personal and environmental factors such as operating technique, posture, grip and feed forces, temperature in the workplace as well as vibration exposure.

An Informative Annex to ISO 5349-1:2001 contains guidance on the relationship between vibration exposure and health effects; it provides a quantitative relationship only for the vascular component of HAVS (vibration-induced white finger). The annex stresses the tentative nature of this relationship, which is illustrated in Table 1 and Figure 3.

**Table 1** Values of the daily vibration exposure  $A(8)$  which may be expected to produce episodes of finger blanching in 10% of persons exposed for a given number of years  $D_y$  (from ISO 5349-1:2001)

$D_y$ , years	1	2	4	8
$A(8)$ , $m/s^2$	26	14	7	3.7

For  $A(8)$  values in the range 3 to 26  $ms^{-2}$  the relationship gives the daily exposure and the number of years before 10% of individuals would be expected to have vascular symptoms (for example, 3.7  $m/s^2$   $A(8)$  in 8 years). It should not be used to predict the risk for an individual. While a 'safe' level of exposure cannot be defined with confidence, the annex states that symptoms are rare in persons exposed at an  $A(8)$  of 2  $ms^{-2}$  and unreported at 1  $ms^{-2}$ .

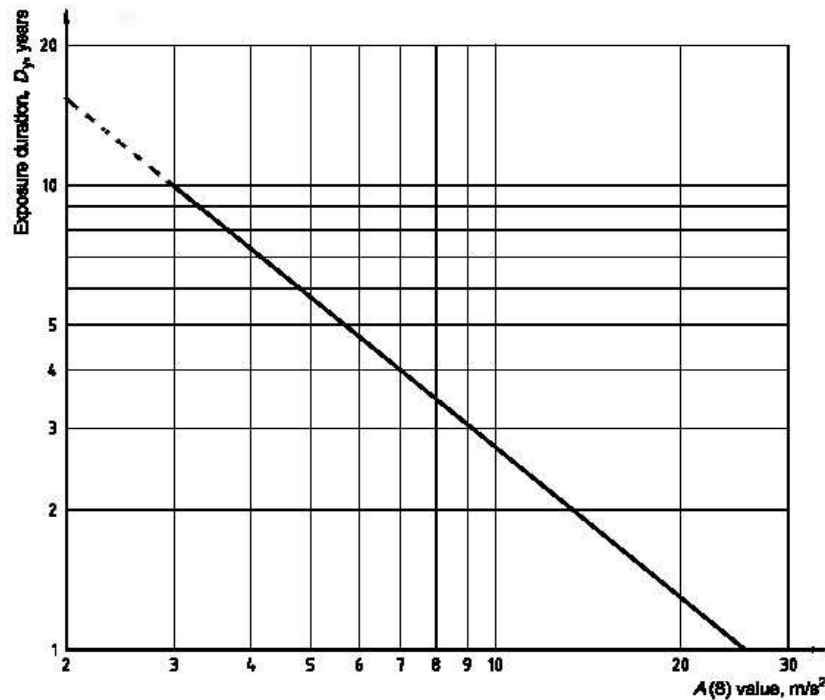
Knowledge of the daily exposure is a useful predictor of risk from HAV, but the limitations of this dose-effect relationship must be recognized. It is not yet possible to establish equivalent guidance for the sensorineural or musculoskeletal effects of vibration, but higher exposure is generally assumed to carry increased risk for all components of hand-arm vibration syndrome. Griffin, 2004, observed that quantitative knowledge of the exposure is often not the best means of predicting risk because of the intrinsically poor accuracy of the method of evaluation and the guidance on health effects in ISO 5349-1:2001.

A reliable indicator of risk is information showing that broadly similar exposures have resulted in vibration injuries; this information may come from reports of vibration-related ill health, either in the same workplace or in similar circumstances elsewhere. The results of health surveillance can be important in this respect, acting as a supplement to on-going risk reviews and demonstrating whether or not the employer's risk control systems are working.

## Exposure Uncertainties

It is usually difficult to establish a daily exposure with precision, and ISO 5349-2:2001 suggests that the uncertainty associated with an  $A(8)$  value may be as much as 40%. However, it is not always necessary (or meaningful) to know an exact exposure value; an employer may just need to know if the exposure is excessive (e.g. if a limit or action value is likely to be exceeded) and whether remedial action is required. It may be sufficient to estimate the daily exposure without making measurements in the workplace, provided suitable information on the likely vibration magnitude is available from another source, such as the manufacturer of the tool. If the information is not available, or does not represent the relevant use of the tool, then measurement in the workplace may be necessary. However, hand-transmitted vibration is notoriously variable and the uncertainty of a typical measured vibration magnitude in the field has been shown to be of the order of  $\pm 20\%$  (Pitts, 2003), so it should not be assumed that measurement in the workplace gives the 'correct' value. The substantial degree of uncertainty associated with both vibration magnitudes and daily exposure

values should be taken into account when comparing the vibration emissions of tools and when using exposure values to demonstrate levels of risk or the improvements brought about by a change of equipment or work practice.



**Figure 3** Vibration exposure for predicted 10% prevalence of vibration-induced white finger in a group of exposed persons (from ISO 5349-1:2001)

### Limitations Of Current Standards

The evaluation method in ISO 5349-1:2001 is used widely and is referred to in national regulations and guidelines for controlling risk of vibration injury. Exposure values obtained in accordance with the Standard will usually provide an indication of the severity of the exposure which is useful for the assessment of risk. However, the Standard is not perfect. It is important to recognize that the method was developed from experience with common rotary and percussive tools (chainsaws, chipping hammers, grinders, etc.) in the 1970s. For some tools or processes with substantially different characteristics the method may not provide magnitudes of vibration that reflect the risk (for example, modern die grinders generating vibration at high frequencies, or sand rammers which generate large vibration displacements at the lower end of the frequency range, may not be suited to the standard frequency weighting). If the impulsiveness or crest factor of the vibration is important, it may be that r.m.s. averaging of acceleration is inappropriate; there is no reason to suppose it is the most appropriate averaging method: it was convenient for analogue instruments and was adopted arbitrarily (Griffin, 1990) as was the related energy-equivalent method for describing daily exposures.

Furthermore, the dose-response relationships between the standardised expression of exposure and the resultant health effects are tentative and incomplete, and it is only for vascular injury that there is any international agreement on a numerical relationship. It seems likely that musculoskeletal complaints will be caused by lower frequencies of vibration than those normally associated with vascular and sensorineural effects. This suggests that alternative frequency weightings may be beneficial. There is currently no account taken of the effect of coupling forces between the hand and the vibrating surface (i.e. grip and feed forces), although these forces are known to affect the acceleration on the surface and the absorption of energy in the hand and arm. An International Standard for defining and describing contact forces is currently being developed, and this should aid uniform recording of contact force information. No agreed methods yet exist for using contact force values to predict risk of vibration injury. However, when carrying out an assessment, it is good practice to record and report, at least qualitatively, factors in addition to the vibration exposure parameters which are likely to affect the risk of injury. Examples include: operator posture, contact forces applied, ergonomic design of tools and workstation, workplace temperature, etc.

It is probable that elements of the evaluation method in ISO 5349-1:2001, such as the frequency weighting and averaging procedures, could be improved (Nelson, 2001; Griffin *et al.*, 2003). The committee responsible for ISO 5349-1 (ISO/TC108/SC4) reviews the Standard periodically and will propose revisions when these can be justified by the evidence available. As the standard is now very widely used the evidence for a substantial change would have to be convincing, not only technically but in terms of the predicted benefits to health and the cost to industry of the changes.

In addition to ISO 5349, there are International Standards for the measurement of the vibration emission of machines (e.g. the ISO 8662 series). They are used to measure the same frequency-weighted r.m.s. acceleration quantity as that in ISO 5349, but they specify standardized modes of operation for the machines during vibration testing and are used by manufacturers for providing information for their customers on vibration. (For machines sold in Europe, declaration of vibration emission is a legal requirement under a European Directive.) Some of these standards do not currently represent the likely vibration of the machines in typical use and are now under revision. This process should, in time, improve the quality of the information available to employers when selecting suitable work equipment and when assessing and managing the vibration risks associated with its use. Improved declared tool emission values should also reduce the need for measurements to be made in the workplace.

### **Vibration Exposure Limits And Action Levels**

In the 1970s, early drafts of ISO 5349 and some national standards for vibration assessment (notably in Japan, Sweden, USSR, Czechoslovakia and the UK) included many different recommendations for exposure limits (Griffin, 1990). More recently, many countries have adopted ISO 5349 (or a broadly similar method), which does not specify limits, but some national authorities have set daily exposure action levels and/or limits to help employers assess and manage the risks. These may be included in guidance on good practice; in other cases they carry legal status and are enforceable. Three examples are discussed below.

#### **The European Union**

From July 2005, employers in European Union Member States must comply with the requirements of the 'Vibration Directive' (European Parliament and the Council of the European Union, 2002) to protect their employees from risks from vibration at work (see Nelson & Brereton, 2004). The Vibration Directive establishes two exposure criteria:

the *exposure action value* (EAV) at  $2.5 \text{ ms}^{-2} A(8)$  above which employers must implement a programme of risk control actions and health surveillance; and

the *exposure limit value* (ELV) at  $5 \text{ ms}^{-2} A(8)$  above which exposure will be prohibited.

The Directive must be implemented in the national law of each Member State. It specifies minimum standards; if existing requirements are more stringent (such as in Denmark which has an existing exposure limit of  $3 \text{ ms}^{-2} A(8)$ ) the existing standards must be retained.

#### **Japan**

Japan has an occupational exposure limit (OEL) of  $2.8 \text{ ms}^{-2} A(8)$ . This represents a substantially lower exposure (and thus an increased level of worker protection) than the European ELV. However, the OELs are recommendations (Japan Society for Occupational Health, 1999) and do not have legal status equivalent to the EU Directive described above.

(The Japanese OEL of  $2.8 \text{ ms}^{-2} A(8)$  should not be confused with the action level of the same numeric value, currently recommended in the United Kingdom (Health and Safety Executive, 1994). The UK action level (which will be superseded in 2005 by the requirements of the EU Directive) is based on the old single dominant axis method of exposure assessment as recommended in the former British Standard (British Standards Institution, 1987). It is approximately  $4 \text{ ms}^{-2} A(8)$  when expressed as a vibration total value in accordance with ISO 5349-1:2001.)

### United States of America

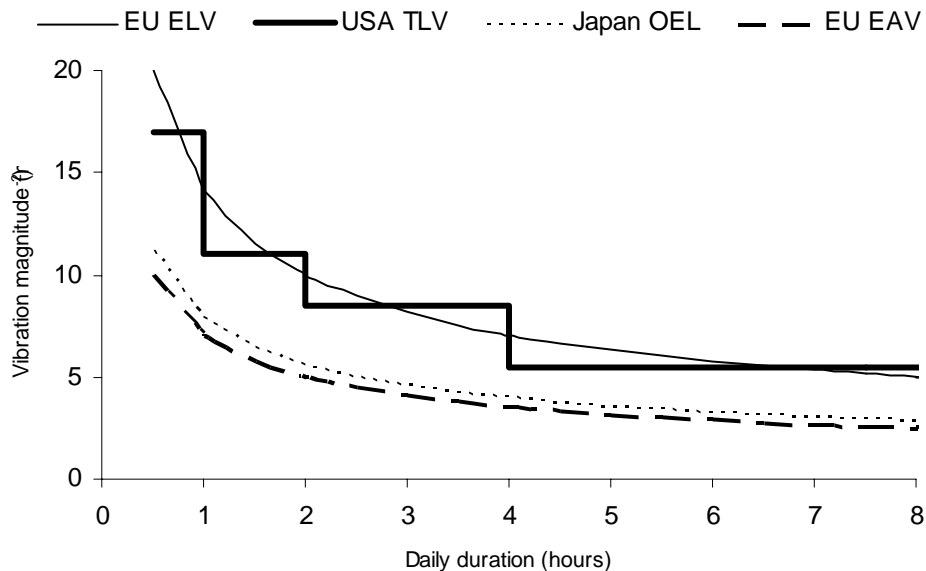
In the USA the ACGIH publishes annual recommendations for Threshold Limit Values (TLVs) (American Congress of Government Industrial Hygienists, 2003). As in Japan, these are used as guidance for employers for compliance with general health and safety duties. The TLVs are not expressed as A(8) values, but as maximum vibration magnitudes for four bands of daily exposure time (e.g. 4 m/s<sup>2</sup> for exposures lasting between 4 and 8 hours). The magnitudes are those for the dominant axis as specified in the first edition of ISO 5349 (International Organization for Standardization, 1986). The TLVs are shown in Table 2. In the third column of this table the magnitudes have been multiplied by 1.4 (as suggested in ISO 5349-1:2001), and rounded, to allow comparison with other exposure criteria based on the vibration total value.

**Table 2** ACGIH threshold limit values for hand-arm vibration.

Total daily exposure duration	Maximum magnitude, ms <sup>-2</sup> (dominant axis)	Maximum magnitude, ms <sup>-2</sup> (approx. vibration total value)
4 hours and less than 8	4	5.5
2 hours and less than 4	6	8.5
1 hour and less than 2	8	11
less than 1 hour	12	17

Figure 4 shows the European, Japanese and American criteria as vibration magnitude (vibration total value) as a function of exposure time. The European EAV and ELV and the Japanese OEL follow similar shaped curves, since they are all defined as A(8) values. The American TLVs appear as a step function in this format, but it is interesting to note how closely this follows the EU ELV.

Exposure action values and limits can provide a useful aid to risk assessment in that they provide a benchmark for identifying particularly high exposures. Compliance with them means that the most harmful exposures are probably avoided, and that control measures and health surveillance will be put in place where there is a clear risk. However, none of the national exposure criteria discussed above can be said to represent a boundary for ‘safe’ levels of exposure, so it remains good practice for employers to eliminate the vibration or reduce it to the lowest level that is reasonable, irrespective of the level of exposure, and also to address any other ergonomic or environmental factors likely to affect the risk of vibration injury.



**Figure 4** National exposure action and limit values for hand-arm vibration.



## Conclusions

Exposure evaluation, as standardized in ISO 5349-1:2001 is a valuable aid to risk assessment and planning for control. It is also essential for demonstrating compliance with applicable exposure limits (for example the ELV in European Union Member States). It is important that the vibration magnitude and exposure duration values used in exposure evaluation are as accurate as possible, and ISO 5349-2:2001 contains practical advice for achieving this; however, large uncertainties are inevitable in HAV exposure evaluation and this must be recognised when interpreting exposure data.

Knowledge of the dose-effect relationships for the different components of HAVS is incomplete so it is inappropriate to rely entirely on a numerical exposure value to assess the risk of vibration injury in a population or an individual. Indeed, the only agreed (tentative) dose-effect relationship relates only to the vascular component. Assessment of the risk (informing decisions on control actions) needs therefore to take account of the exposure value and also other recognised contributors to risk factors (ergonomic factors, for example) and any evidence of harm such as reported symptoms in similar populations of workers, and the results of health surveillance.

## References

- American Congress of Government Industrial Hygienists (2003). Threshold Limit Values and Biological Exposure Indices. Cincinnati, OH, USA.
- British Standards Institution (1987) BS 6842. British Standard Guide to Measurement and evaluation of human exposure to vibration transmitted to the hand.
- European Parliament and the Council of the European Union (2002) *Official Journal of the European Communities* Directive 2002/44/EC on the minimum health and safety requirements regarding the exposure of workers to the risks arising from physical agents (vibration). OJ L177, 6.7.2002, p13.
- Health and Safety Executive (1994) Hand-Arm Vibration. HSG88. HSE Books, UK.
- International Organization for Standardization (1986). ISO 5349. Mechanical vibration and shock – Guidelines for the measurement and the assessment of human exposure to hand-transmitted vibration.
- International Organization for Standardization (2001a). ISO 5349-1. Mechanical vibration and shock – Measurement and evaluation of human exposure to hand-transmitted vibration – Part 1: General requirements.
- International Organization for Standardization (2001b). ISO 5349-2. Mechanical vibration and shock – Measurement and evaluation of human exposure to hand-transmitted vibration – Part 2: Practical guidance for measurement at the workplace.
- Japan Society for Occupational Health (1999) Recommendation of occupational exposure limits <http://joh.med.uoeh-u.ac.jp/oel/index.html> (accessed 2 June 2004)
- Griffin MJ (1990) Handbook of Human Vibration. Academic Press, London.
- Griffin, MJ (2004) Minimum health and safety requirements for workers exposed to hand-transmitted vibration and whole-body vibration in the European Union; a review. *Occupational and Environmental Medicine* 2004 May; **61**(5): 387-97.
- Griffin, MJ, M Bovenzi & CM Nelson (2003) Dose-response patterns for vibration-induced white finger. *Occupational and Environmental Medicine* 2003; **60**: 16-26.
- Nelson, CM (2001) The standard frequency weighting for hand-transmitted vibration: implications of a proposed revision. Proceedings of the 9<sup>th</sup> International Conference on Hand-Arm Vibration, 5-8 June 2001, Nancy, France. *Note Scientifique & Technique* No 242, 280-287. Institut Nationale de Recherche et de Sécurité (INRS).
- Nelson, CM & PF Brereton (2004) Implementation of a European Vibration Directive: Plans for Hand-Arm Vibration. Presented at the 10th International Conference on Hand-Arm Vibration, Las Vegas, USA. 7-11 June 2004.

Pitts, PM (2003) Uncertainty in evaluating exposure to hand-transmitted vibration. *Acoustics Bulletin* Sept/Oct 2003 16-23. Institute of Acoustics, St Albans, UK.

# MEASUREMENT OF HAND-TRANSMITTED VIBRATION EXPOSURES

S. Maeda<sup>1</sup> and R. G. Dong<sup>2</sup>

<sup>1</sup> Department of Human Engineering, National Institute of Industrial Health, Japan

<sup>2</sup> Engineering & Control Technology Branch, National Institute for Occupational Safety and Health, USA

## Abstract

This study reviews and outlines the major methods, instrumentation, practices, and pitfalls of the exposure measurement of hand-transmitted vibration. Several solutions to the major problems involved in the measurement are also proposed.

## Introduction

The development of hand-arm vibration syndrome could be affected by many factors such as vibration magnitude and direction, vibration frequency characteristics, hand-tool coupling action and contact force, hand-arm posture, environmental temperature, smoking, gender, age, individual difference, daily exposure duration, total exposure duration, etc (Griffin, 1990; 1997; ISO 5349-1, 2001). While all these factors may be taken into account, the vibration magnitude, the frequency characteristics, and the exposure duration are generally believed to be the most important factors considered in the risk assessment of the exposure. The current international standard on HTV (ISO 5349-1, 2001) was established based on this concept. Technical guidance for the measurement of HTV can be found in ISO 5349-2 (2001). The requirements of the instrumentation are documented in ISO/DIS 8041 (2003). While the measurement of many powered hand tools (such as chipping hammers, rock drills, and jackhammers) remains a very challenging task, the exposure duration has been frequently estimated based on workers' claims. This paper outlines the major methods, instrumentation, practices, and pitfalls of the HTV exposure measurement, and several solutions to the problems involved in the measurement.

## Standardized Measurement Method

A laser vibrometer can be used to accurately measure the vibration. However, thus far, it has been difficult to use such technology for field measurement. This is mainly because the measured target is usually unstable and the desired measuring points are often covered by the hands. Therefore, accelerometers are most frequently used in the measurement.

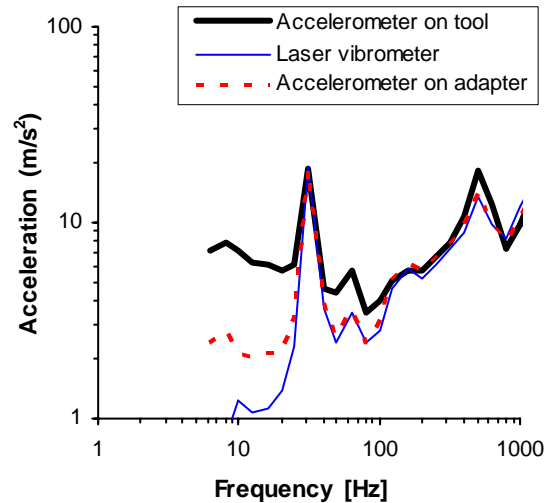
ISO 5349 recommends that the fundamental resonant frequency of the accelerometer used should be more than five times the maximum frequency of concern. For HTV exposure, it is necessary to measure the vibration up to 1,250 Hz (1/3 octave-band center frequency) (ISO 5349-1, 2001). Therefore, the fundamental resonant frequency of the accelerometers should be greater than 7,000 Hz. For this reason, piezoelectric accelerometers are most frequently used in the HTV measurement. Installing accelerometers on a tool or a vibrating work piece may change the mechanical structure and properties, and thus affect the vibration characteristics. To minimize this effect, it is recommended that the mass of the accelerometers and their mounting systems be less than 5% of the mass of the tool or the working piece (ISO 5349-2, 2001). Vibration in three orthogonal axes defined in ISO 5349-1 (2001) should be measured. The accelerometers should be installed on the tool or work piece at locations as close as possible to the hand's grasping positions. The recommended mounting locations on typical tools and the mounting methods are described in ISO 5349-2 (2001).

## A Major Problem: DC-shift

Directly exposing many piezoelectric accelerometers to moderate or severe shocks, as usually occurs on many percussive tools, can cause a DC-shift (the resting output varying after each shock). DC-shift may also occur in the measurement of vibration generated by some grinders. The DC-shift can result in an erroneous spectrum in a large frequency range (e.g. up to 200 Hz was reported by Kitchener, 1977). The vibration components in this frequency range usually compose more than 90% of the weighted acceleration value because the current weight of frequencies higher than 200 Hz is very small (ISO 5349-1, 2001). Hence, the DC-shift can result in a substantial overestimation of the vibration magnitude.

Figure 1 shows a comparison of the accelerations measured using three different approaches. These measurements were performed on a chipping hammer for evaluating the measurement methods (Dong et al., 2002). The acceleration measured using the accelerometer directly installed on the tool handle shows a significant DC-shift. Although the DC-shift does not affect the dominant vibration in this case, it causes a significant overestimation of the weighted

acceleration required for the risk assessment (ISO 5349-1, 2001), as shown in Table 1. When the DC-shift is reduced to a certain level, as that obtained with the adapter method shown in Figure 1, the DC-shift problem may not be critical.



**Figure 1** Comparison of vibration spectra measured using three different methods: accelerometer (PCB 5611A) on chipping hammer (mechanical filter: 3mm rubber pad; an accelerometer (PCB SEN026) on a palm adapter with a rubber contact pad; and a laser vibrometer (Poly PI PSV-300)

**Table 1** Acceleration root-mean-square (rms) values calculated using the spectra measured from the three methods.

Measurement Method	Unweighted			Weighted (ISO 5349-1, 2001)		
	Tool	Adapter	Laser	Tool	Adapter	Laser
Acceleration ( $m/s^2$ rms)	44.0	37.8	38.0	18.2	11.4	10.6
Ratio relative to laser value	1.16	0.99	1.00	1.71	1.08	1.00

It is extremely difficult to totally eliminate the DC-shift in the measurement of shock/impact vibration. Mechanical filters are generally used to resolve the DC-shift problem (ISO 5349-2, 2001). However, the use of some mechanical filters may not guarantee the solution of the DC-shift problem. For example, when the accelerometer PCB5611A was used with the filter B&K UA0059, the DC-shift was worse than that shown in Figure 1 (Dong et al., 2004). Therefore, it is essential to select an appropriate combination of the accelerometer and mechanical filter in the measurement, and to evaluate the measurement setup before conducting a formal measurement experiment.

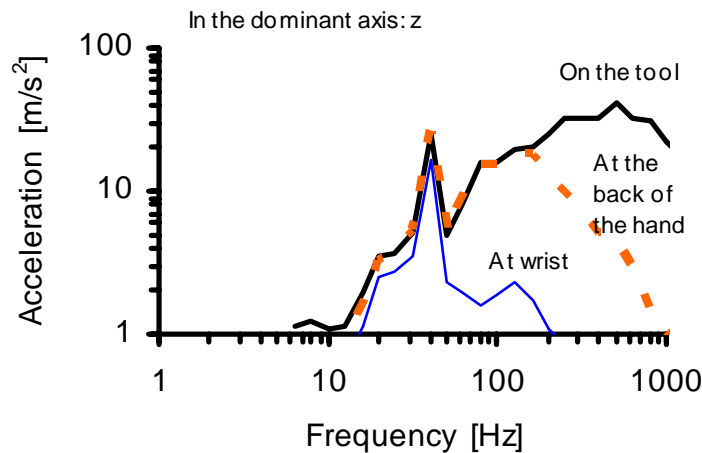
As a preliminary evaluation, one can compare the measured data with the reported data for the same type of tools. Many reports of tool vibration data are available (e.g. Ikeda et al., 1998; <http://umetech.niwl.se/Vibration/HAVHome.html>). There is usually a large range of the vibration magnitudes for the same type of tool (e.g. Ward, 1998). If the measured value is more than the highest value of the reported data, one should pay additional attention to the further evaluation of the measurement.

Further evaluation can be done using many different methods. A laser vibrometer can be used to accurately evaluate the DC-shift (Tasker, 1986) and the in-situ calibration of the measurement system (Dong et al., 2004), as shown in Figure 1. The characteristics of the DC-shift in a time history can also be used to help determine the validity of the vibration measurement (Griffin, 1990). There are several simpler and more practical methods for assessing the DC-shift and/or its effect. The first method is to calculate the displacement of the vibration component at the low frequencies (e.g. 10 Hz) from the measured acceleration if the vibration spectrum is available or the vibration at a specific low frequency can be determined (ISO 5349-2, 2001). The displacement ( $D$ ) can be calculated from:

$$D = \frac{A_u}{(2\pi f)^2} \quad (1)$$

where  $A_u$  is the unweighted acceleration at a specific frequency,  $f$ . The calculated displacement is compared with the visually observed displacement to determine whether the measurement is realistic. Because the visual observation is usually inaccurate, this method may only be used to identify an obvious DC-shift.

The second method is to use the on-the-hand method to measure the tool vibration (Tokita and Ohkuma, 1990), similar to that used for some glove tests (ANSI 3.40, 1989; Dong et al., 2003). Human hands can usually effectively absorb or isolate the high frequency vibration components and eliminate the DC-shift in the accelerometer. The vibration transmissibility at the back of the hand may be near unity at frequencies less than 150 Hz (Tokita and Ohkuma, 1990). The dominant vibration frequencies of the percussive or impact tools are usually less than 60 Hz. Therefore, the weighted accelerations measured on these tools should not be very different from those measured using the on-the-hand method. As an example, Figure 2 shows three acceleration spectra collected at three locations (on the tool, at the back of the hand, and at wrist) when operating a chipping hammer (Dong et al., 2003). The acceleration spectrum measured on the back of the hand at frequencies less than 100 Hz is very similar to that collected on the tool. As shown in Table 2, the frequency-weighted acceleration measured on the tool is very similar to that measured on the hand back. The total acceleration measured at the wrist is also close to those at the other two locations. These observations suggest that it is acceptable to use the weighted acceleration measured on the hand to represent the weighted acceleration of this particular tool. These observations also suggest that the low frequency components measured on the hand back can be used to represent those measured on the tool. This feature provides an effective approach to correct the DC-shift effect.



**Figure 2** Three acceleration spectra each measured on the tool, at the back of the hand, and at wrist, respectively, which were obtained in a previous study (Dong et al., 2003).

**Table 2** Frequency-weighted accelerations ( $m/s^2$  rms) measured at three locations (on the tool, on the back of the hand, and at wrist) (Dong et al., 2003)

Tool_x	Tool_y	Tool_z	Tool_Sum
3.57	1.77	13.44	14.02
Hand_x	Hand_y	Hand_z	Hand_Sum
3.25	4.58	13.15	14.30
Wrist_x	Wrist_y	Wrist_z	Wrist_Sum
8.19	6.42	7.59	12.88

The third method is to use an anti-vibration glove in the vibration measurement. A palm adapter equipped with a tri-axial accelerometer can be held in the palm of the hand within the glove (Dong et al., 2002). The glove cannot significantly isolate the low frequency components (<20 Hz) but it can usually be effective in reducing the high frequency components and minimize the DC-shift. In the experiment, one should not push on the tool too hard. This may cause the glove to bottom out, thus, result in the DC-shift in the accelerometer held at the palm (Dong et al., 2003). If the low frequency components measured with the accelerometer at the palm are significantly lower than those recorded on the tool, there is likely a DC-shift in the accelerometer mounted on the tool.

### **Measurement Devices**

Many commercial devices are available for the vibration measurement. Multi-channel instruments that can perform frequency analyses are the best for the measurement. However, such instruments can be expensive and inconvenient to use at workplaces. For field applications, it is preferred to have a portable device that can directly provide the weighted acceleration value. Portable multi-channel signal analyzers (up to 6 channels) have been available. The most convenient portable device is human vibration meters that can simultaneously measure and record three axes of signals. A caution in the use of such a device is that the device cannot tell you whether the acceleration signal is valid. This may be critical for the measurement on percussive tools. The above-mentioned on-the-hand method and the glove method can be used to help assess the validity of the measurement. The best anti-vibration gloves currently available on the market can reduce the weighted acceleration on percussive tools by less than 30% (Griffin, 1998; Rakheja et al., 2002; Dong et al., 2002; 2003). If the difference between the weighted accelerations simultaneously measured on the tool and inside the glove at the palm would be significantly more than 30%, one should seriously doubt whether the measurements are valid.

With the fast progress of the computer technology, it is anticipated that some portable systems that can effectively perform spectrum analyses will be available in the near future. Such a development will certainly make the measurement more convenient and reliable.

### **Measurement of Exposure Duration**

The exposure duration is probably the most important factor for the risk assessment of hand-arm vibration syndrome (Griffin et al., 2003). It may not be difficult to accurately quantify the daily exposure in a short period but it is very difficult to accurately quantify the lifetime exposure duration (Griffin, 1997).

The lifetime exposure duration is usually estimated from workers' claims. The estimation of the lifetime exposure based on the employment history of a worker may be more reliable than that based on the worker's memory or impression (Griffin, 2003). Daily exposure duration has been measured using many different methods. Workers' claims have also been widely used for the estimation. A study has reported that workers tend to overestimate the daily exposure duration (Palmer et al., 2000). Videotaping or on-site observation using stop watches can provide a fairly accurate measure of the daily exposure duration. This approach, however, is demanding on the human resources. Acoustic data loggers may also be employed for the measurement. This approach, however, may pose difficulties in isolating the tool-generated noise signal from those arising from other sources in the workplace. Monitoring power or fuel used by the tool or counting the work pieces may also provide fairly reasonable estimation of the daily exposure duration.

With the fast progress of the computer technology, it is possible to develop more effective systems for measuring both the vibration magnitude and the exposure duration. Several examples of new developments have been reported (Gillmeister et al., 2001; Dong et al., 2001; Maeda, 2004). It is anticipated that the quantification of the vibration exposure may become more convenient and reliable in the near future.

### **References**

- Dong RG, Bader J, Welcome D., Rakheja S, Schopper AW, 2001. An accurate method for measuring the exposure duration of hand-transmitted vibration. Proceeding of the 36<sup>th</sup> UK Conference on Human Response to Vibration: 416-424.
- Dong RG, McDowell T, Welcome D, Rakheja S, Caporali SA, Schopper AW, 2002. Effectiveness of a transfer function method for evaluating vibration isolation performance of gloves when used with chipping hammers. *Journal of Low Frequency Sound, Vibration, and Control* 21 (3): 141-156.
- Dong RG, McDowell TW, Welcome TW, Smutz WP, Schopper AW, Warren C, Wu JZ, Rakheja S, 2003. On-the-hand measurement methods for assessing effectiveness of anti-vibration gloves. *International Journal of Industrial Ergonomics* 32: 283-298.

- Dong RG, McDowell TW, Welcome DE, Warren C, Schopper AW, 2004. An evaluation of the standardized chipping hammer test specified in ISO 8662-2. *The Annals of Occupational Hygiene* 48(1): 39-49.
- Gillmeister F, Schenk TH, and Melzig-Thiel R, 2001. A personal dosimeter for daily vibration exposure. *Proceeding of the 9<sup>th</sup> International Conference on Hand-Arm Vibration*.
- Griffin MJ, 1990. *Handbook of human vibration*. London: Academic Press.
- Griffin MJ, 1998. Evaluating the effectiveness of gloves in reducing hazards of HTV. *Occup. & Environ. Med.* 55, 340-348.
- Griffin MJ, 1997. Measurement, evaluation, and assessment of occupational exposures to hand-transmitted vibration. *Occup Environ Med* 54(2):73-89.
- HAV DATABASE: <http://umetech.niwl.se/Vibration/HAVHome.html>.
- Ikeda K, Ishizuka H, Sawada A, and Urushiyama K, 1998. Vibration acceleration magnitudes of hand-held tools and workpieces. *Ind Health* 36(2):197-208
- ISO/DIS 8041, 2003. Human response to vibration – Measuring instrumentation.
- ISO 5349-1, 2001. Mechanical Vibration and Shock – Measurement and evaluation of human exposure to hand-transmitted vibration –Part 1: General requirements.
- ISO 5349-2, 2001. Mechanical vibration and shock – Measurement and evaluation of human exposure to hand-transmitted vibration – Part 2: Practical guidance for measurement at the workplace.
- Kitchener R, 1977. The measurement of hand-arm vibration industry. *Proceeding of the 2<sup>nd</sup> International Conference on Hand-Arm Vibration*: 153-159.
- Maeda S, 2004. Work computer for prevention of over exposure to hand-transmitted vibration. *Proceeding of the 10<sup>th</sup> International Conference on Hand-Arm Vibration*.
- Palmer KT, Haward B, Griffin MJ, et al., 2000. Validity of self reported occupational exposure to hand-transmitted and whole body vibration. *Occup Environ Med* 57: 237-41.
- Rakheja S, Dong RG, Welcome D, and Schopper AW, 2002. Estimation of tool-specific isolation performance of anti-vibration gloves. *International Journal of Industrial Ergonomics* 30: 71-87.
- Tasker EG, 1986. Assessment of vibration levels associated with hand-held roadbreakers. *Scan J. Work Environ Health* 12: 407-412.
- Tokita Y, Ohkuma T, 1989. Hand-arm transmitted vibration dosimeter. *The Proceeding of the 5<sup>th</sup> International Conference on Hand-Arm Vibration*: 53-57.
- Ward T, 1998. Vibration emission of road breakers: comparison of emission test data with vibration in real use. *Proceeding of the 33<sup>rd</sup> UK Conference on Human Response to Vibration*.





**Measurement II**  
R. Dong - Session Coordinator



# MODELLING AND VERIFICATION OF INFLUENCING FACTORS IN HAND ARM VIBRATION MEASUREMENTS

M. Gasparetto, G. Moschioni, B. Saggin, M. Tarabini

Dipartimento di Meccanica, Politecnico di Milano-Polo Regionale di Lecco  
Via M. d'Oggiono 18/A, 23900, Lecco, Italy

## Abstract

This paper is focused on the evaluation of the effect of influencing factors in Hand Arm Vibration Measurements. The implementation and validation of a model for a generic Hand Arm Vibration measuring process is presented and discussed. Hand Arm Vibration (hereafter referred to as HAV) measurements are nowadays largely performed either for research purposes or for hand-held tools characterization and workers' risk assessment. The international standards coding this kind of measurement, ISO 5349s, precisely define procedures, instrumentation and data processing to be adopted. Despite the accurate definition of measurement methods, the application of these standards still leads to wide dispersion of measurement data (de Meester, 1998). This paper describes the results of an experimental campaign carried out to investigate the reasons for such dispersion. First step of the research is the implementation of an experimental campaign that allows, through statistical inference analysis, formulating a probabilistic assessment about the influence of some parameters on the measured level of vibration. The model derived from this analysis allows to evaluating quantitatively the effects of influencing factors in Hand Arm Vibration measurements. In the last part uses data obtained from a specific HAV measurement process are compared with the model prediction, showing that measurement data dispersion can be quite accurately explained considering influencing factors variability.

## Introduction

The study intends to assess the effect of influencing factors in HAV measurements. Figure 1 shows a schematization of the measuring process evidencing the causes of measurement dispersion or, in other words, of measurement uncertainty. Measurement uncertainty can be predicted by combination through the model of:

- measurement chain uncertainty;
- process repeatability;
- variance of influencing parameters.

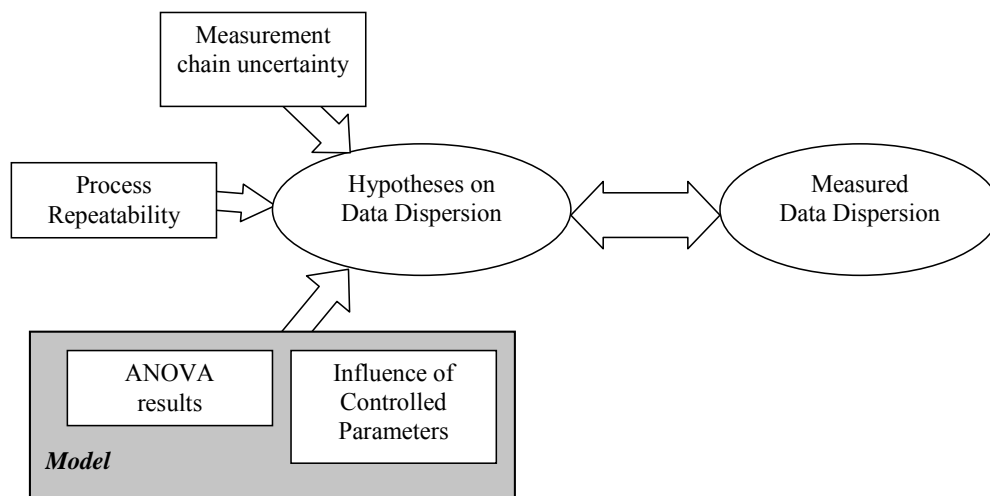


Figure 1 Block diagram of the proposed method

Comparing such a prediction with actual measurements enables to verify the effectiveness of the implemented model. The variability of the HAV measurement data depends on several factors involved in the process. Under this perspective, a generic HAV measurement procedure can be studied as an interaction between three groups of factors:

operator related factors: all aspects having an influence on the hand arm system mechanical impedance. These factors are basically the forces that the operator transmits to the tool handle, wrist and elbow angles and operator muscular structure (Gurram, 1995);

process related factors: also the mere repetition of the same process, independently from operator's action, leads to statistically distributed measured data;

measurement chain borne uncertainty: measurement chain introduces uncertainties that affect the measured vibration level.

Each of the above could be in principle evaluated separately.

Influence of operator related factors can be evaluated by analysing the hand-arm mechanical impedance changes (Gurram, 1998). Process variability can be estimated through process automation; i.e. by substituting the operator's action with properly designed machinery. Measurement chain borne uncertainty can be evaluated from the instruments accuracies according to the ENV 13005 (ISO GUM) procedure.

Influencing parameters on a generic HAV measurement process have been studied by performing an experimental campaign, where the "possibly" influencing factors were considered (Gasparetto, 2004). Test matrix was based on a reduced two level factorial design, limiting the investigation to single factor influence, adopting therefore a linear model. Data analysis has been carried out using ANOVA method. The validation of the derived model has been carried out on an arbitrarily chosen process (namely the drilling of blocks of concrete) following these simple steps:

1. determination of process variability through the process automation (inner limit of HAV data dispersion);
2. determination of measurement chain borne uncertainty through metrological statements
3. repetition of the drilling process controlling the parameters that ANOVA test had evidenced as meaningful;
4. comparison between calculated data dispersion and observed data dispersion (step 3).

### **Influencing Parameters on HAV level.**

Influencing parameters in HAV measurement have been highlighted using the ANOVA test, which allows probabilistic verification of assessments about the influence of each parameter on the dependent variable (in our case the "vibration level"). The first step, probably the most critical, is the selection of the independent variables. Too many parameters lead to large test matrixes, i.e. to a huge number of tests; conversely, disregard of significant parameters leads to high data noise that might even mask the effect of considered parameters.

Factors selection was based on literature analysis, modeling of the system and preliminary explorative test results. Bibliographical researches and the impedance-based model outlined as possible significant factors:

feeding force;

grasping force;

operator's body structure and characteristics;

angle between the direction of the vibration and the axis of the forearm;

mounting method of the accelerometer;

vibration waveform;

vibration magnitude.

Analysis of the test data, lead to the following results:

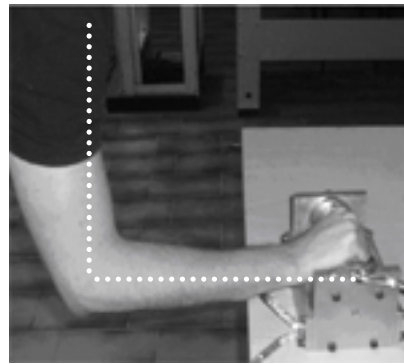
influencing factors are the accelerometer mounting method, the feeding and the grasping forces;

meaningless factors appear to be the ones related to non-linearity in the hand-arm system response.

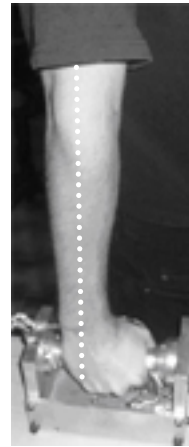
Moreover the analysis evidenced that:

in order to define the influence of the operator's body structure, the body mass is not a complete indicator.

the indication of the elbow angle is not a sufficient of to identify arm configuration. Variance of populations of "straight elbow" is approximately half that of populations of "right angle elbow".



a) Right-angle elbow



b) straight elbow

**Figure 2** Different elbow conditions

Another useful result of the test campaign is the quantitative prediction of the effect of a specific parameter on the dependent variable. Each significant factor introduces a variation on the dependent variable. From data analysis one can determine the ‘sensitivity’, calculating the ratio between the variation of the dependent variable and the variation of a specific factor. Results are reported in Table 1, summarizing the influence of every factor on the dependent variable.

**Table 1** Contribution of single factors on measured level of vibration (p-value = 0.05)

<b>ANOVA Factor</b>	<b>Factor Contribution (<math>\beta</math>)</b>
Feeding Force	<b>3% over 90 N</b>
Grasping Force	<b>3% over 90 N</b>
Operator’s body Structure	<b>Uncertain (4% over 20 kg)</b>
Elbow angle	<b>Uncertain (3% over 90°)</b>
Fixation Method of the Accelerometer	<b>18%</b>
Vibration Waveform	<b>Negligible</b>
Vibration Amplitude	<b>Negligible</b>

### Process variability

As already mentioned, even the mere repetition of a specific process brings to a data dispersion that represents the inner limit of the HAV measurement. In order to evaluate such limit, the operator’s action was replaced with properly designed machinery.

Process variability has been evaluated by means of an impact drill used to make 100 holes in ten concrete blocks. A schematisation and a picture of the machinery are shown in Figure 3a and b.

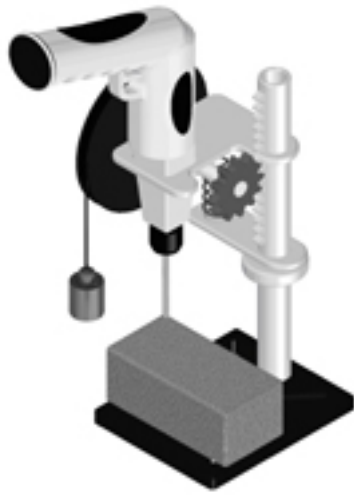
The system provides a constant feeding force for the drilling by means of a dead weight system. Drilling tests and acceleration measurement were made according to the ISO 5349 indications; un-weighted acceleration is the RMS value of a 6 second test; net feeding force was 180 N.

Tests results are shown in Figure 4.

Normality of samples was checked to evidence anomalous behaviours and exclude outliers. Results are resumed in Table 2.

If p-value is greater than the threshold level, normality test is passed. Threshold level has been chosen equal to 5% (Montgomery, 2000). Furthermore hypotheses tests on equality of means and standard deviation between the global mean and the one-block-mean gave positive results. Unweighted standard deviation of the global test was 12.47 m/s<sup>2</sup>. This parameter, combined with the measurement chain uncertainty, represents the inner limit for the HAV measurement.

It has to be noticed that the acceleration level recorded during these repeatability test was almost half than with the operator. Nevertheless, the meaning of this round of tests wasn't to reproduce the human hand action, but just to investigate process repeatability.

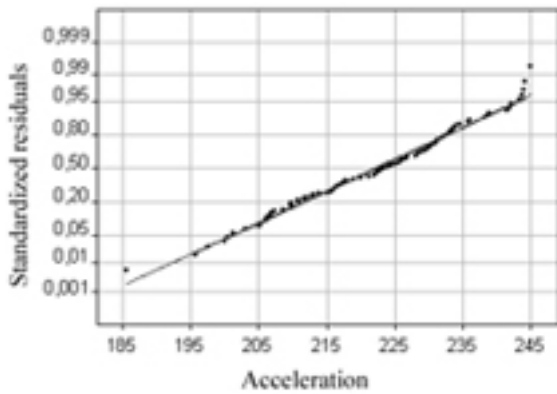


(a)



(b)

**Figure 3** Schematic and picture of the machinery used to drill concrete blocks



Number of Tests :	100
Mean:	222.2 m/s <sup>2</sup>
Standard Deviation:	12.47 m/s <sup>2</sup>
Min. Value:	185.6 m/s <sup>2</sup>
Max. Value:	245.0 m/s <sup>2</sup>
Q1:	212.8 m/s <sup>2</sup>
Q2:	231.1 m/s <sup>2</sup>

**Figure 4** Normality test and descriptive statistics

**Table 2** Normality test on repeatability drilling test

Block N°	Mean [m/s <sup>2</sup> ]	Dev. St. [m/s <sup>2</sup> ]	P-Value
1	224.9	11.08	0.315
2	220.3	14.07	0.894
3	212.2	12.96	0.415
4	223.6	11.44	0.981
5	217.9	17.31	0.813
6	222.1	9.83	0.124
7	226.9	10.64	0.480
8	222.4	10.67	0.327
9	226.4	11.76	0.512
10	225.5	11.55	0.231

### Measurement Chain uncertainty

According to Guide to Expression of Uncertainty in Measurements [ISO, 1993] measurement chain uncertainty can be obtained combining uncertainties due to every measuring element. Measurement chain for acceleration is represented in Figure 3 b. A miniature triaxial charge accelerometer is fixed directly on the drill handle. Anti-alias filter cut-off frequency has always been set at 1 kHz.

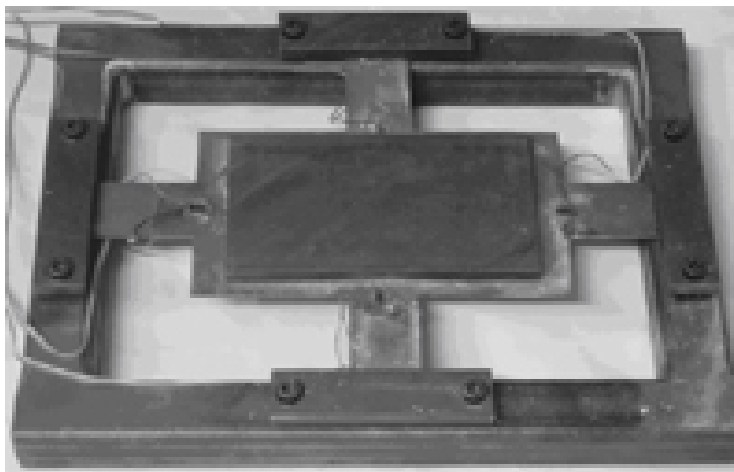
Global acceleration measurement chain uncertainty, excluding non-linearity errors, is 0.25 %. The same measurement chain was used both for tests made on the device of Figure 3 and for tests carried out by operators.

Force measurement chain uncertainty is 0.3%: such value affects both the model parameters and the measurements.

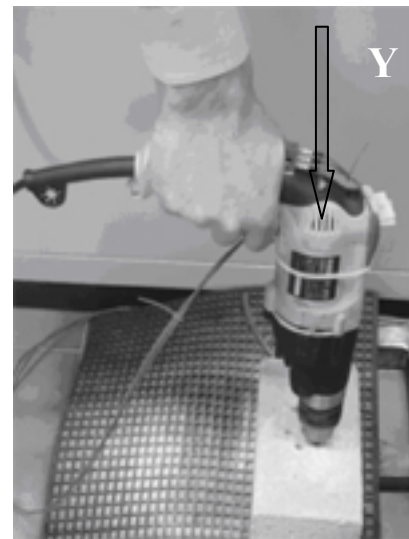
### Procedure for method validation

The combination of measurement chain uncertainty, process variability, contribution of disturbing factors as predicted by the model, allows calculating “supposed data dispersion”. The latter can be compared with the measured data dispersion on the real drilling process, according to the scheme of Figure 1.

To allow prediction with the model the influencing parameters should be measured or controlled. In the test the feeding force has been controlled, at this purpose a properly designed load cell based on strain gage, illustrated in Figure 5a has been used.



(a)



(b)

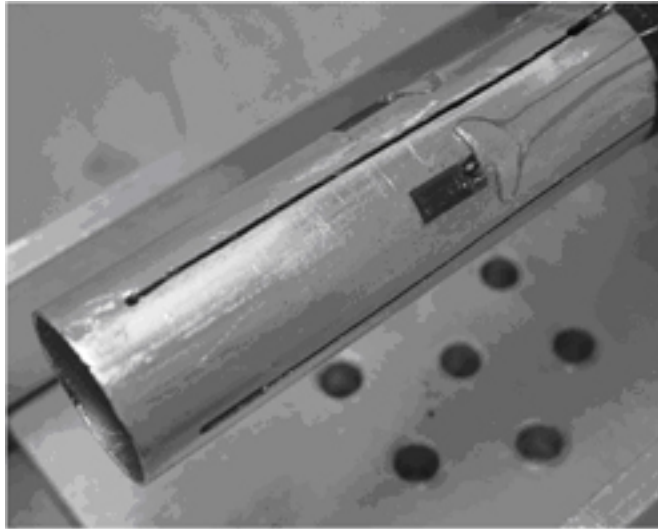
**Figure 5** (a) load cell used for feeding force control, (b) picture of measurement during the drilling

As long as measurement of grasping force requires the interposition of a medium between the hand and the vibrating surface, grasping force is not measured but just “subjectively” quantified: operator is required to maintain the same grip force during all the tests by subjective perception. The resultant of the grasping force on the handle is null, but the resultant of pressure on “half handle” is an indicator of the pressure. During the test campaign for model implementation the grasping force has been quantified, with a special instrumented handle (Figure 6); in that case the subjective indication “low” and “high” has been associated with a force of about 100 N and 10 N respectively.

Elbow configurations considered are the same considered in the previous test set-up, i.e. square angle elbow and straight elbow, also in this case there is not an actual measurement but a subjective judgement.

### Results

As previously mentioned, results are based on the comparison between the “supposed acceleration level” and the measured acceleration level, and between the “supposed dispersion” and the measured dispersion.



**Figure 6** Handle used for grip force measurement.

### Level Prediction

In this first part a single operators performed six tests with straight elbow and six with right angle elbow. Starting from straight arm configuration, using the model results it is possible to forecast the acceleration of “square angle arm” condition.

The model used for calculation is based on the hypothesis of linear dependence between acceleration and influencing factors. Such hypothesis was the basis of the adopted two-level factorial DOE implemented for model building, and can be expressed as:

$$a_2 = a_1 \prod_i (1 + \beta^*_i), \quad \beta^*_i = \beta_i \cdot \frac{\delta Q}{Q_{ref}} \quad (1)$$

where  $\beta_i$  is the contribution of the  $i$ -th factor of Table 1,  $\delta Q$  is the variation of the parameter whose contribution is  $\beta_i$  (i.e.  $90^\circ$  for the elbow angle) and  $Q_{ref}$  is the reference variation of the parameter; all the above refers to the tests described in Table 1 . Accelerations (measured along  $y$  direction of Figure 5 are shown in Table 3.

**Table 3** Real process data dispersion: comparison between different elbow angle

Condition	Feeding Force [N]	Dev. St Feeding Force [N]	Grasping Force [N]	Elbow angle	RMS acc [m/s <sup>2</sup> ]	Dev. St. Acc [m/s <sup>2</sup> ]
1	104	4.7	100	0 °	409	17.7
2	106	3.2	100	90 °	427	18.7

In our test, starting from configuration 1, foreseen acceleration for configuration 2 is  $422 \text{ m/s}^2$ . The measured value of acceleration (on Table 3) is  $427 \text{ m/s}^2$ : prediction given from the model is quite good if compared with method variance. The difference between theoretical and experimental results can be attributed to  $\beta_i$  coefficients, which are obtained on the basis of results of an experimental test campaign on an electro-dynamic shaker that has internal impedance different from tool impedance. It has to be noticed that these coefficients provide for generic indications on acceleration behaviour, and are not to be intended as an instrument for acceleration prediction.

When considering different operators with different body masses in the same elbow condition it is possible to validate once again model results. Test results are shown in Table 4. Foreseen r.m.s. acceleration, using model results, is  $430 \text{ m/s}^2$ ; measured r.m.s. acceleration is  $432 \text{ m/s}^2$ .



**Table 4. Real process data dispersion: comparison between different operators**

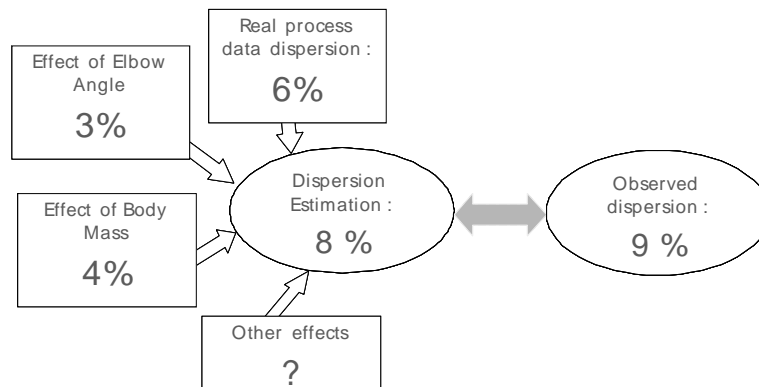
Operator	Mass [kg]	Feeding Force [N]	Dev. St Feeding Force[N]	Grasping Force [N]	Elbow angle	RMS acc [m/s <sup>2</sup> ]	Dev. St. Acc [m/s <sup>2</sup> ]	Uncertainty
1	95	104	4.7	100	0	410	17.7	6 %
2	70	102	5.5	100	0	432	21.3	6 %

It can be noticed that in the real drilling process the level of feeding and grasping force has not been changed. In a real drilling process the operator tightens the handle and pushes the tool with non-null-forces. Variation induced from feeding force is 3 % over 90N. When feeding force is not controlled, the force that operators push the tool with has a dispersion that is much lower than 90 N, so the variation calculated using the model is less than 3%. Such factor would give a negligible contribution to the global variability.

A further validation can be achieved by comparing “predicted” and “observed” data dispersions.

*Data Dispersion Prediction*

Data dispersion can be estimated using the model and the variances of influencing parameters, combined with drilling process variability and measurement chain uncertainty. All measurements are influenced by measurement chain uncertainty, either force measurements (0.3 %) or acceleration (0.25 %) ones (Fig. 7).



**Figure 7 Data dispersion**

Prediction of uncertainty on acceleration measurement can be obtained combining:

process data dispersion: 6 %;

variation due to elbow angle: 4 %;

variation due to operator mass changes: 3 %;

acceleration measurement chain uncertainty 0.25 %;

feeding force standard deviation (1.4 %) and force measurement chain uncertainty (0.3 %) scaled by  $\beta_1$  factor (3 % over 90 N).

Percentages are the ratios between standard deviation and the RMS of the population. Furthermore, there are influences of non measured parameters such as wrist angle, grasping force, etc. that cannot be quantified.

Global standard uncertainty can be estimated in 8 %. Observed data dispersion is 9 %. Variability of real process is larger than the supposed because of the influence of non measured parameters. Furthermore the “real drilling process” is composed by 24 tests, and standard deviation estimation is done on the basis of 24 measurement data. Variance estimation is therefore affected by the limited number of data.

Values of acceleration during repeatability test are radically different from those recorded in the tests carried out by operators. The adopted assumption that the relative dispersion is applicable also to the case of normal drilling rests on the linearity assumption that is the basis of the parametric approach.

### Conclusions

In this paper a linear model for HAV measurement prediction has been proposed and validated, finding a quite good agreement between predicted and observed data. Such model is useful to foresee the dispersion of the acceleration under different test conditions. Once again results validate the hypotheses that if test conditions are not fixed, variation of measurement data can be really relevant. Furthermore, in the analysis it has been considered the unweighted acceleration; the frequency weighting curve provided by ISO 5349 give more relevance to low frequencies, judged more annoying for the operator. The use of the unweighted acceleration in the model verification is based on the observation that this parameter is more selective than the frequency weighted. It has to be noticed that the analysis of the effects of influencing parameters on weighted acceleration instead of unweighted may lead to different (sometimes even opposite) results [Gasparetto, 2004].

### Acknowledgements

The activity reported is part of a research project, sponsored by Italian Ministry of Research, focused on the assessment of measurement uncertainty in standardized measurement performed “in field”.

### Reference

- F. Angrilli, P. Cappa, F. Crenna, S. Debei, G. D’Emilia, M. Gasparetto, F. Iaconis, N. Paone, G. B. Rossi, B. Saggin, “Study and experimentation for a procedure for the evaluation of measurement uncertainty in hand-transmitted vibrations”, *IMEKO 2004, Genova*;
- L. Burstrom , “The influence of biodynamic factors on the mechanical impedance of the hand and arm”, National Institute for Working Life, *Elsevier science*, 1995;
- M. Gasparetto, G. Moschioni, B. Saggin, M. Tarabini, “Analysis of Influencing Parameters in Hand Arm Vibration Measurements”, *IMEKO 2004, Genova*;
- M. Gasparetto, G. Moschioni, B. Saggin, M. Tarabini: “Instrumentation chain for hand-arm transmitted vibration measurement”, *Second International Workshop on Advanced Environmental Sensing and Monitoring Technologies*, Como, July 2003 Ed. Esculapio
- R. Gurram, S. Rakheja, G.J Gouw, “Mechanical impedance of the human hand-arm system subject to sinusoidal and stochastic excitations”, *International Journal of Industrial Ergonomics* Vol: 16, Issue: 2, August, 1995
- International Organization for Standardization (ISO), “Guide to expression of uncertainty in measurements”, 1993;
- International Organization for Standardization (ISO 5348), “Mechanical vibration and shock, mounting of accelerometers”, 1992:
- M. de Meester, “Reproducibility and value of hand arm vibration measurement using the ISO 5349 method and compared to a recently developed method” *8<sup>th</sup> International Conference on Hand-Arm Vibration*, Umeå, Sweden, 1998;
- Douglas C. Montgomery: ”Design & Analysis of Experiments”, Fifth Edition, Arizona State University, John Wiley, June 2000;
- FAAA Williams J. Huges technical center, “Anthropometry and biomechanics”, pages 14-43, 14-47 1996.

# DEVELOPING MEASURING STRATEGIES FOR UNUSUAL WORKPLACES

U. Kaulbars

Berufsgenossenschaftliches Institut für Arbeitsschutz – BIA  
Alte Heerstraße 111, 53754 Sankt Augustin, Germany

## Introduction

The effects on vibration on the hand-arm system are measured and evaluated according to ISO 5349, Parts 1 and 2.

In accordance with this standard, the vibration is measured at the point where it is transmitted into the hands. In the case of hand-held or hand-guided tools, this point will generally be at the handle. For such tools, the standards for evaluation of vibration exposure provide good guidance for methods of coupling the accelerometer and the measurement point.

If the vibration is transmitted through the workpiece or an inserted tool, the measurement standards only offer general advice, because of the wide range of workpieces that might be encountered. Such measurements therefore require a degree of expertise from the person performing the measurement. This is also true for working procedures with very short measuring intervals, several short breaks or frequent movement of the hands or taking the hand off the contact point.

This paper reports on hand-arm vibration assessments made on three types of machine: a bone saw, a shoe pounding machine and dental laboratory machines. For each the paper discusses the measurement strategies, features of the measurement methods and results of the exposure assessments.

### Working with a Bonecutting Bandsaw

The mechanical work of parting meat and bones was done mainly in refrigerated rooms, for reasons of hygiene. With these stationary machines, the vibration is transmitted via the material being processed, which has cooled to the ambient temperature.

The additional effect of cold and moisture as a contributing factor in circulatory disorders due to vibration is well known. In such cases, the vibration-induced injuries are especially unpleasant.

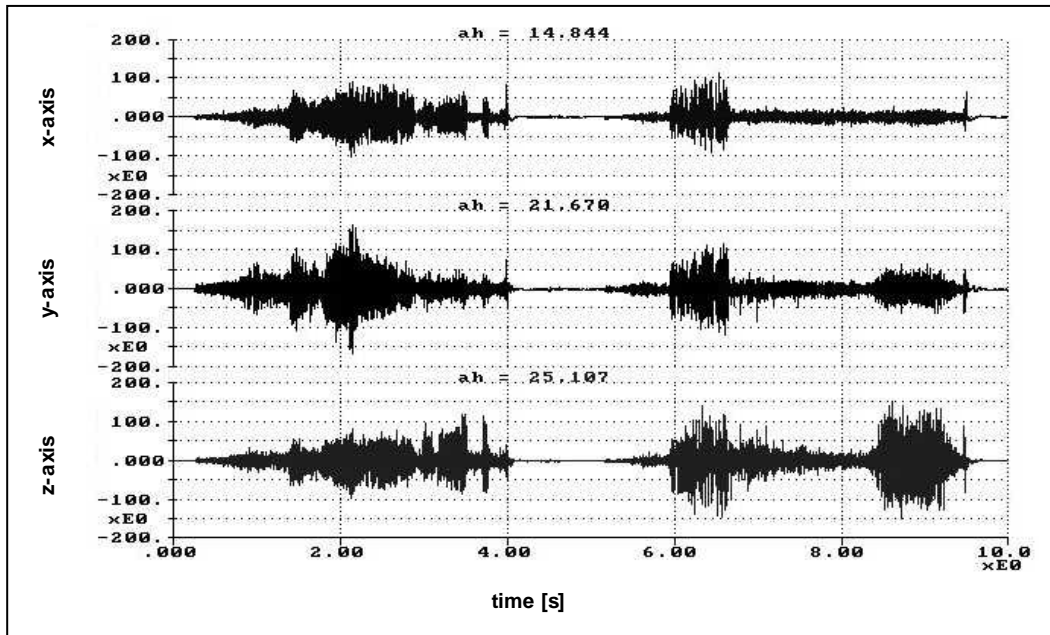
The tri-axial acceleration transducer was fastened to a fixed point near the contact surface for the hand (see Figure 1). The usual method of fastening it with adhesive proved to be problematical, so a screw fastening was chosen instead.

Besides the coupling of the transducers, the brief measurement time is also problematical.

Since the individual parting operations only take a few seconds, a work cycle was simulated for metrological reasons. In order to cover a worst-case assumption, the measurements were performed on a cattle bone, which is larger and harder than a pig bone. The exposure parameter ‘total vibration value’,  $a_{hv}$ , was determined over the working cycle of several parting operations. Figure 2 shows the unweighted acceleration over time of two parting operations. The root-mean-square values of the unweighted acceleration, including the brief interruptions for repositioning, amount to  $a_h = 14$  to  $25 \text{ m/s}^2$ , depending on the measurement axis.



**Figure 1** Bone saw for butcher's and abattoir work



**Figure 2** Unweighted acceleration over time

At a total vibration value  $a_{hv} = 1 \text{ m/s}^2$  for the work cycle (Also for 8 hours, we observe that  $A(8) = 1 \text{ m/s}^2$ ), the vibration effect caused by the bandsaw was far below the threshold values of the EU Directive on the protection of workers from vibration exposure.

Moreover with a daily continuous exposure of  $A(8) = 1 \text{ m/s}^2$  according to ISO 5349-1, hand-arm injuries caused by vibration have not been substantiated to date.



**Figure 3** Pounding machine in the shoemaking industry



**Figure 4** Attaching the acceleration transducer to the last

## Working with a Pounding Machine

Modern pounding machines used in the shoemaking industry are fully automated, for reasons of effectiveness, and thus involve no vibration exposure. For job lots, or in older production facilities, the shoe-upper is drawn over a last and worked with the rotating pounding roller (see Figure 3). The last is made of plastic or wood and forms the surface by which the vibrations are transmitted to the hand.

Figure 4 shows the attachment of a tri-axial acceleration transducer weighing 13 g by means of an adapter and a glued joint.

One work cycle per shoe amounts to about 6 seconds for the pounding and set-up time.

In order to obtain a sufficiently long measurement time, the process was simulated, and 10 pounding operations were performed during the measurement time of 20 s (see Figure 5).

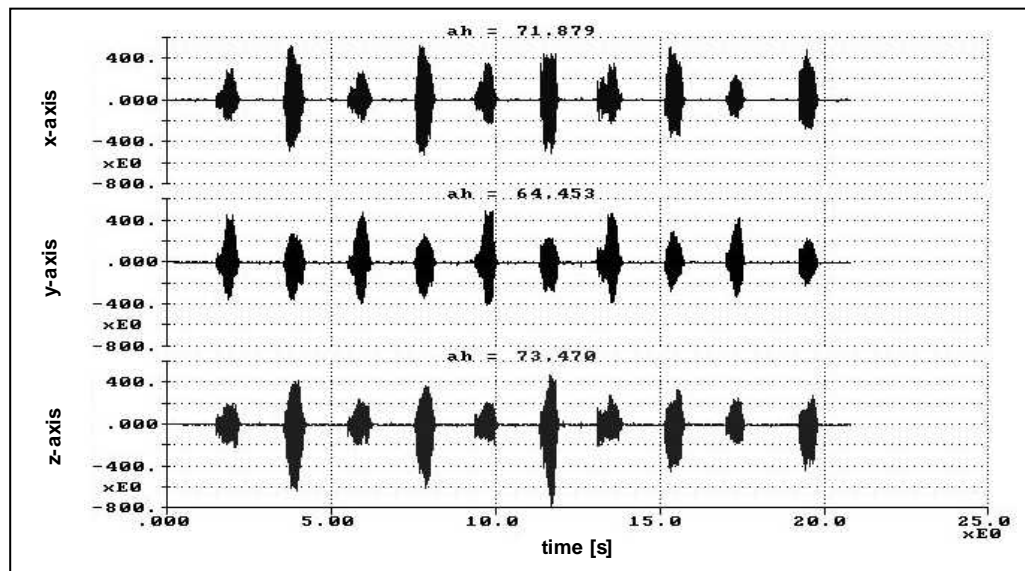


Figure 5 Unweighted acceleration over time

Thus the set-up times were shortened. In calculating the daily dose, these shortened set-up times, which increase the measured value, must be allowed for by adjusting the exposure time.

The total vibration value was determined to be  $a_{hv} = 3.8 \text{ m/s}^2$ . Thus there is only a danger from hand-arm vibration if a daily duration of exposure of 3 hours 27 minutes is exceeded. That corresponds to production of about 3,116 pairs of shoes per day.

In Germany, the vibration exposure from these machines was previously considered to be the cause of bone and joint damage; recently the syndrome of “white-finger disease” has been assumed instead.

The procedure according to VDI 2057 permits a differentiated evaluation of the various vibration ailments on the basis of the frequency composition. It was not possible to classify pounding machines as exclusively high-frequency or low-frequency devices by means of the criteria defined in the VDI guidelines. So, since these machines cannot be categorised vibration exposure from the pounding machines cannot be excluded as the cause of certain types of vibration injuries from this point of view.

### Work in a Dental Laboratory

In dental laboratories, mainly high-speed grinding machines are employed. These are hand-held straight grinders with a drive shaft or a motor-driven handpiece, or stationary polishing machines.

The workpieces processed are dentures of plastic, or the preliminary metal frames. During the operation, the tool and workpiece are held with a large coupling force (see Figure 6).

Figures 7 and 8 show the fastening of the three acceleration transducers to the grinding machine and the workpiece by means of adapters. The results clearly show that the greater vibration, with  $a_{h,v} = 3.72 \pm 0.86 \text{ m/s}^2$ , is at the workpiece. At the grinding machine the vibration value is  $a_{h,v} = 1.91 \pm 0.07 \text{ m/s}^2$ . A large spread of vibration readings is seen, due to the workpiece being turned in the hands and the movement of the machine around the workpiece.

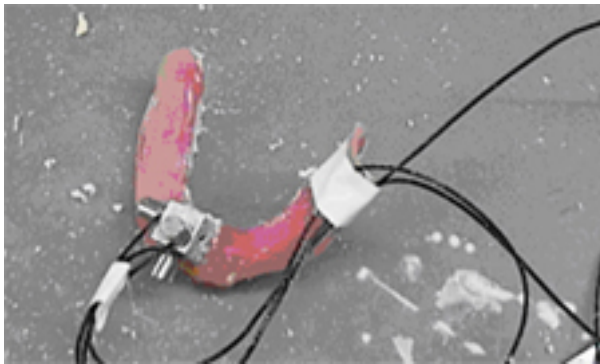
The vibration effect from the stationary polishing machines (see Figure 9) is the lowest, at  $a_{h,v} = 1.64 \pm 0.3 \text{ m/s}^2$ , as is to be expected for polishing operations.



**Figure 6** Adaptation of workpieces in a dental laboratory



**Figure 7** Attachment of the acceleration transducers to a straight grinder



**Figure 8** Attachment of the acceleration transducers to the workpiece



**Figure 9** Stationary polishing machine

Exposures that are relatively high, at  $a_{h,v} = 12.6 \pm 1.9 \text{ m/s}^2$ , can also occur when machining metal frames for pattern casting (see Figure 10).

## Discussion and Conclusion

ISO 5349, with its description and explanation of relevant variables, provides useful assistance in recording the vibration effects of even atypical equipment and operations. However, considerable measuring experience is also needed.

Both a knowledge of vibration metrology and knowledge of the mode of operation of the objects to be measured and of the processes to be studied are needed for the necessary specification of a measurement strategy.

Information on the measurement signal to be expected is important in any case, and should be obtained by a preliminary test or by personal impression.

The choice of the measurement time determines how representative the reading is of a period of operation. Therefore, the exposure time can only be determined in conjunction with the measurement time.

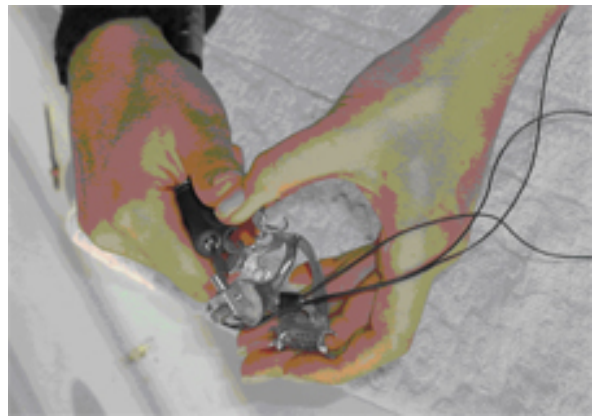
This presentation is intended to help enlarge the range of experience of people doing measurements, and to encourage discussion.

## References

ISO 5349:2002: Mechanical vibration- Measurement and evaluation of human exposure to hand-transmitted vibration- Part 1: General requirements, Part 2: Practical guidance for measurement at the workplace, Geneva, 2002.

Directive 2002/44/EC of the European Parliament and the Council on the minimum health and safety requirements regarding the exposure of workers to the risks arising from physical agents (vibration). Official Journal of the EC No. L 177/13 of 6 July 2002, p. 13-19.

VDI 2057 – Human exposure to mechanical vibration. Part 2: Hand-arm-vibration (09.02) Beuth, Berlin 2002



**Figure 10 Milling a steel frame for a denture**





# UNCERTAINTY IN HUMAN VIBRATION MEASUREMENT: INSTRUMENTATION AND MEASUREMENT ISSUES

P. M. Pitts

Health and Safety Laboratory, Buxton, Derbyshire, UK, SK17 9JN

## Abstract

In 2005 Member States of the European Union will introduce legislation that will require assessment of an individual's exposure to vibration. This is already producing a growing demand for human vibration measurement and there are an increasing number of "simple" vibration instruments available on the market. Since 1990, ISO 8041 has provided a base document for human response to vibration instrument manufacturers. Most current instruments claim conformance with this standard. However, concerns that ISO 8041 was inadequate for measurement of hand-arm vibration on percussive tools, and a substantial revision of ISO 2631-1 meant that a revision of ISO 8041 was necessary. The revision of ISO 8041 is being prepared in ISO (TC108/SC3), and was issued as a Draft International Standard in 2003. The revision of ISO 8041 introduces a more thorough and more demanding specification for vibration instruments and defines a full range of pattern evaluation and verification tests. This paper reviews the changes introduced by the revision of ISO 8041, a standard that we are likely to see published in Spring 2005.

## Introduction

Measurement of human exposure to vibration is traditionally carried out by researchers: specialists in measurement who have an understanding of the potential sources of error in measurement. This specialist knowledge means we have great confidence in the values we present, and means that non-specialists can use our results with confidence. Or can they?

Human vibration exposure measurements are now widely used. In the European Union we have legislation that requires manufacturers to produce low-vibration machines and to report vibration emissions of those machines. In 2005 Member States of the European Union will introduce legislation that will require assessment of individuals' exposure to vibration. There is, therefore, a growing demand for human vibration measurement and there are an increasing number of "simple" vibration instruments available on the market. Now anyone can attach a transducer to a machine and produce a vibration value. How reliable are these values?

International Standard ISO 8041 is intended to support the standards defining the human-response to vibration measurement methods, ISO 2631 for whole-body vibration and ISO 5349 for hand-arm vibration. Since 1990, ISO 8041 has provided a base document for human response to vibration instrument manufacturers. Most current instruments claim conformance with this standard. However, concerns that ISO 8041 was inadequate for measurement of hand-arm vibration on percussive tools, and a substantial revision of ISO 2631-1, meant that a revision of ISO 8041 was necessary.

## Need For Revision Of ISO 8041

### *Frequency Weightings Prior To 1997*

ISO 2631 has a number of parts for different applications. Prior to the revision in 1997; ISO 2631/1-1985 had two frequency "dependencies" for vertical and transverse whole-body vibration directions (principally two sets of equal sensitivity curves, with a pair of corresponding frequency-dependent weighting factors). A further two frequency dependencies were defined in other parts of this standard: ISO 2631-2:1989 and ISO 2631/3-1985.

ISO 5349 was first published in 1986, and defined a single frequency weighting as a straight-line function based on third-octave bands from 6.3 to 1250 Hz.

These four dependencies were rationalized into the five smooth-curved frequency-weightings defined in ISO 8041:1990:

1. Whole-body, vertical direction (z-axis),
2. Whole-body, horizontal directions (x- and y-axes),
3. Whole-body, combined vertical and horizontal exposure, mainly for building vibration issues where subjects may be either sitting/standing or lying (W-B combined),
4. Low-frequency motion, mainly for motion sickness studies.
5. Hand-arm vibration

Revision Of ISO 2631

In 1997 an extensive revision of ISO 2631 Part 1 was published. The revision followed the lead provided by an earlier British Standard, BS 6841:1987, and introduced a series of frequency weightings for different types of vibration exposure. The two principal whole-body weightings for z- and x/y-axes were replaced by the five weightings:  $W_c$ ,  $W_d$ ,  $W_e$ ,  $W_j$  and  $W_k$  and the motion sickness weighting  $W_f$  was also included in Part 1.

In addition, revisions of ISO 2631 part 2 and ISO 2631 part 4 have introduced new weightings  $W_m$  for building vibration (to replace the old whole-body combined weighting) and  $W_b$  for railway vibration (taken directly from the British Standard BS 6841:1987).

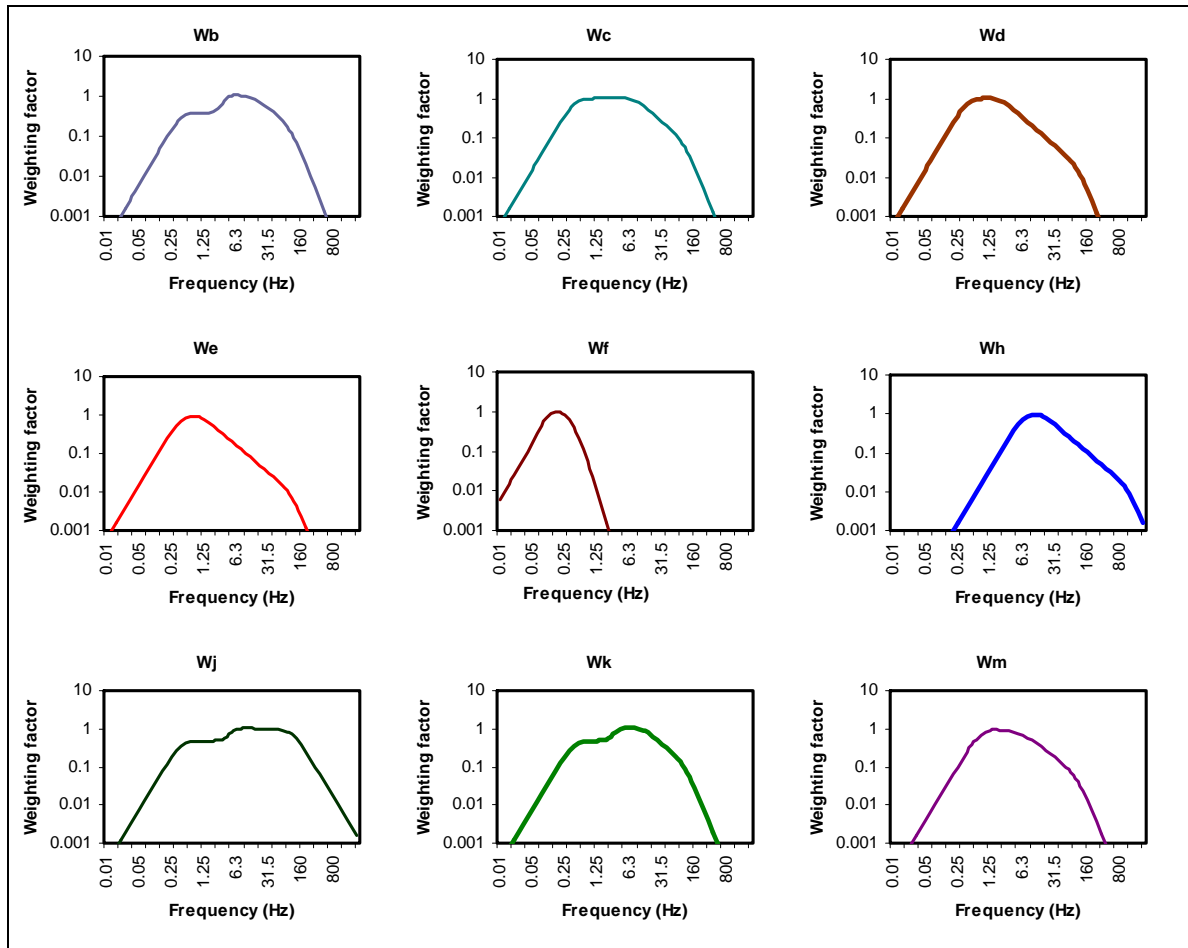


Figure 1 Frequency weightings from ISO 2631 and ISO 5349

There are now a total of 9 human response frequency weightings shown in Figure 1 (including the hand-arm frequency weighting):

- $W_b$  = Vertical whole-body vibration, z-axis seated, standing or recumbent person, based on ISO 2631-4
- $W_c$  = Horizontal whole-body vibration, x-axis seat back, seated person, based on ISO 2631-1
- $W_d$  = Horizontal whole-body vibration, x- or y-axis seated, standing or recumbent person, based on ISO 2631-1
- $W_e$  = Rotational whole-body vibration, all directions, seated person, based on ISO 2631-1
- $W_f$  = Vertical whole-body vibration, z-axis motion sickness, seated or standing person, based on ISO 2631-1
- $W_h$  = Hand-arm vibration, all directions, based on ISO 5349-1
- $W_j$  = Vertical head vibration, x-axis recumbent person, based on ISO 2631-1

$W_k$  = Vertical whole body vibration, z-axis seated, standing or recumbent person, based on ISO 2631-1

$W_m$  = Whole-body vibration in buildings, all directions, based on ISO 2631-2

The full revision of ISO 8041 needed to consider the new parameters such as vibration dose value (VDV), motion sickness dose value (MSDV), maximum transient vibration value (MTVV) and vibration total value. It also needed to address the other concerns, such as the need for instruments to have sufficient measurement ranges to provide reliable measurement of hand-arm vibration on percussive tools.

A Standard on instrumentation also needed to deal with electromagnetic compatibility (EMC), measurement uncertainty pattern evaluation, verification and field calibration; all issues that had not been a part of the original version of the standard.

#### *Revision of ISO 5349*

In 2001 a revision of ISO 5349 was published, as ISO 5349-1:2001, alongside a new Part 2 document ISO 5349-2:2001 on practical workplace measurement. While this revision did not change the frequency weighting, or the basic measurement method, it did introduce the reporting of a vibration total value, representing the combined vibration magnitude from all three axes. ISO 5349-2 also highlighted the problems of measurement of hand-arm vibration, particularly on percussive machines and the importance of good, rigid, accelerometer-mounting systems.

#### *Amendment And Revision Of ISO 8041*

The introduction of new frequency weightings in the 1997 revision of ISO 2631, meant that ISO 8041:1990 was out-of-date. As a temporary fix, an amendment to ISO 8041:1990 was issued in 1999. However, this amendment only dealt with changes resulting directly from changes to the frequency weightings; other issues needed to await a full revision.

### **Revision Issues**

#### *Number of Instrument Classes*

ISO 8041:1990 defined two classes of human vibration instrument, type 1 and type 2, with type 1 requiring conformance to a generally tighter specification. The case for having multiple types is based on the assumption that less expensive instrumentation can be constructed that will produce results with slightly higher uncertainties associated with them. However, for human vibration measurement, a greatest potential for very large errors comes from the inability of a meter to handle the large measurement ranges, and for instrument manufactures, the greatest cost element comes from producing a meter that has a large measurement range.

After much discussion, it was agreed that the revision of ISO 8041 would have just one class of instrument, with a minimum measurement range that was capable of handling the majority of measurement situations.

#### *Testing Hierarchy*

An instrument standard needs to provide a base specification for instruments, and should also provide test procedures to assess whether an instrument achieves the required specification.

It is essential that an instrument design be confirmed to be capable of meeting the full instrument specification, including environmental tests, EMC tests and detailed measurement performance. However, full evaluation of an instrument testing is expensive, and is not appropriate for testing of batches of instruments, or for periodic (e.g. annual or bi-annual) calibrations by, or on behalf of, the instrument user.

The revision of ISO 8041 includes the basic specification for a human-vibration instrument, and a hierarchy of 3 levels of testing. The first level is the pattern evaluation; this is the testing recommended for instruments produced commercially, which will demonstrate that an instrument design is capable of meeting the required specification. The second level is intended for routine testing of instruments, and also for one-off instruments (typically of the type constructed by researchers, from combinations of other equipment such as charge-amplifiers, data recorders and frequency analysers or data processors). This second level does not consider aspects such as EMC or environmental testing and has a reduced number of measurement performance tests. The final level is a field check, to be performed by users before and after sets of measurements, to verify basic functionality and sensitivities.

### *Calibrators*

As with noise measurement, a day-to-day human-vibration measurement relies on a field calibrator to check the instrument sensitivities, and to indicate that the instrument is working correctly. Unlike noise measurement, there is no standard specification for human-vibration field calibrators.

To allow field-testing of instruments, the ISO 8041 revision has introduced an informative specification for field calibrators. It is hoped that this specification will develop in future revisions.

### *Measurement Range*

The dynamic range required for hand-arm vibration measurement is potentially very large, and the frequency weighting shape means that it is common to have vibration signals dominated by high-frequency short-duration vibration components, where the lower-frequency components are important contributors to the overall frequency weighted result.

Whole-body vibration is less sensitive than hand-arm vibration to problems of measurement range. However, intermittent shocks often occur in whole-body vibration, and for measures such as MTVV and VDV it is important that these shocks are measured accurately.

ISO 8041:1990 allowed meters with ranges of much less than 40dB to claim conformance with the specification. Such meters are easily overloaded by impulsive signals, and if the sensitivity is reduced, to avoid overload, a lot of important low-frequency information is lost in the instrument's noise floor.

The revision of ISO 8041 is requiring a measurement range of at least 60dB for both hand-arm and whole-body applications. This requirement is within the capability of modern instruments and will ensure that all instruments are capable of performing good human-vibration measurements on most machinery types.

### *Impulse And Phase Response*

The objective for specification and assessment of performance of a instrument, is to specify only the features and measurement parameters that are required on all instruments of that type and test the instrument using only those required features. Instrument manufacturers may choose to provide additional functionality, but the test standard should not force the inclusion of features purely so that the meter can be tested.

For human vibration meters, the phase response is an important characteristic for some types of measurement. Unfortunately phase cannot be tested directly using the required measurement parameters and instrument facilities.

The majority of human-vibration measurements are long-term r.m.s measurements. As such they are relatively insensitive to phase response. However, where the meter is designed to measure parameters such as VDV, peak and MTVV, then the result may be dependent on the phase response.

Figure 2 illustrates the problem. The upper graph shows a fundamental and harmonic signal combined to give a resultant wave form, there is no phase shift between the zero crossing of the fundamental and a zero-crossing of the harmonic signal. The resultant wave has a maximum value close to 1. The lower graph introduces a 45-degree phase shift between the fundamental and its harmonic. In this case, the resultant wave has different shape, and a maximum value well over 1.

While modern instruments can be designed to have very well controlled phase responses, there is a particular problem for human vibration instruments that results from the severe slopes of the frequency weightings that occur within the main parts of the frequency ranges.

Human-vibration frequency weightings are defined by a series of equations, that define both magnitude and phase of the frequency weightings. The weightings are based on simple analogue filter functions, to ensure that they can be easily incorporated into instrumentation. However, modern digital instruments are capable of being designed with any arbitrary phase response, and there is a real possibility that manufacturers might chose to build an instrument with zero phase response (i.e. a filter that does not introduce any phase change across the whole of the human-response frequency range).

Figure 3 shows examples of the magnitude and phase response for the  $W_k$  and  $W_h$  frequency weightings as defined by ISO 2631-1:1997 and ISO 5349-1:2001. As can be seen, the phase changes rapidly with frequency across the entire frequency range. As Figure 2 illustrated, phase response will have an impact on the maximum frequency-weighted values, and consequently on any parameters that are sensitive to these maximum values, such as VDV and MTVV for whole-body vibration. For hand-arm vibration measurements made in accordance with ISO 5349-1:2001, the phase-response is not important. However, ISO Technical specification ISO/TS 15694:2004 for measurement of single shocks

to the hand-arm system includes a series of parameter definitions, most of which are sensitive to phase response. The phase response is therefore something that cannot be overlooked for hand-arm vibration measurement.

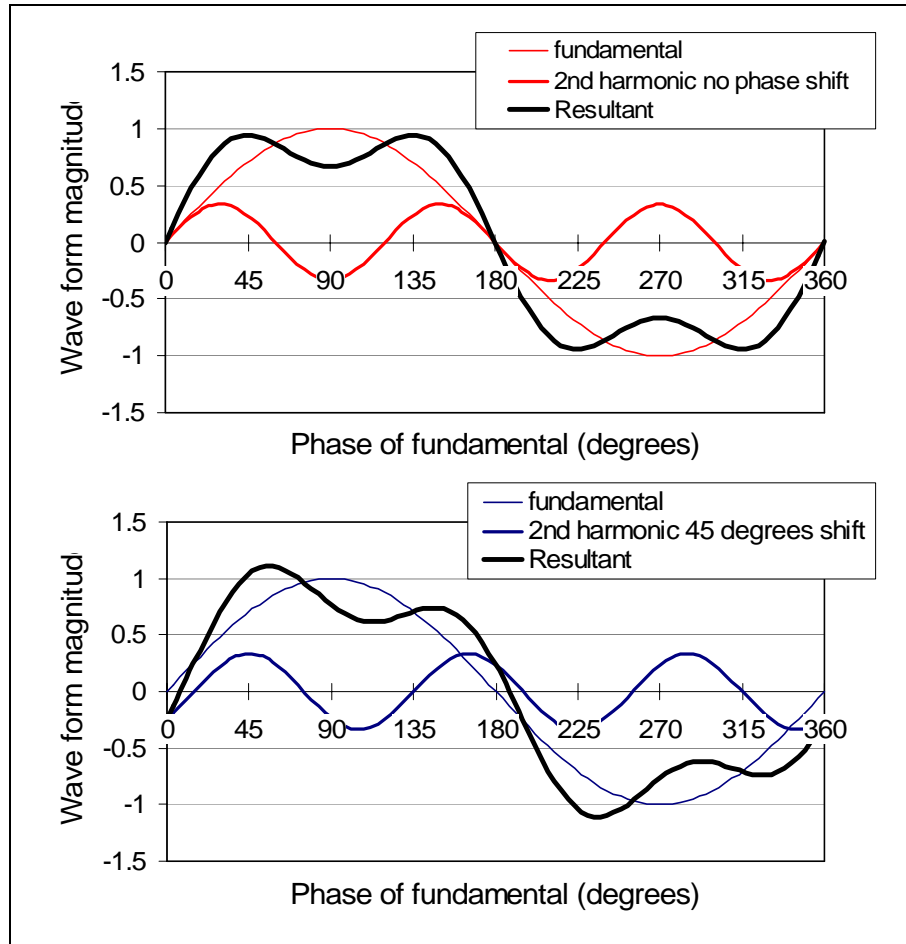


Figure 2 Illustration of phase-shift errors

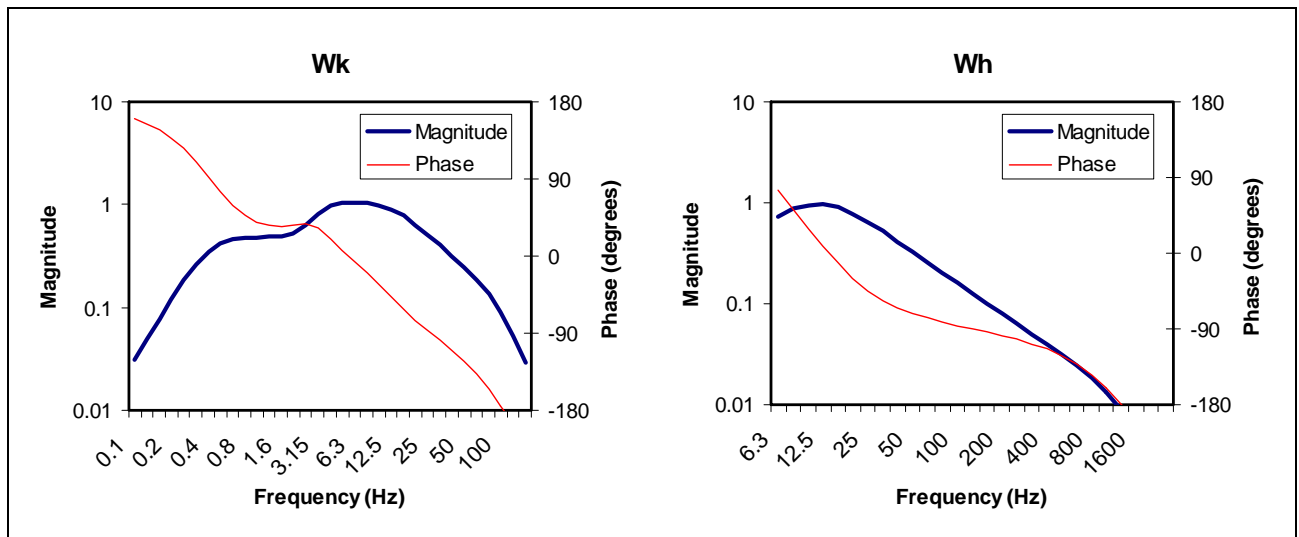


Figure 3 Examples of magnitude and phase response for weightings  $W_k$  and  $W_h$

The revision of ISO 8041 needed to include some testing of phase response. However, there is no requirement for a human vibration meter to indicate phase, therefore any test needed to be an indirect test. The test developed is based on a saw-tooth waveform. A saw-tooth has been chosen as signal that includes a fundamental frequency and its second harmonic. The maximum value of this combination of signals will be very sensitive to phase changes, and therefore provides a means of detecting phase errors indirectly (i.e. by observing any impact on measured parameters).

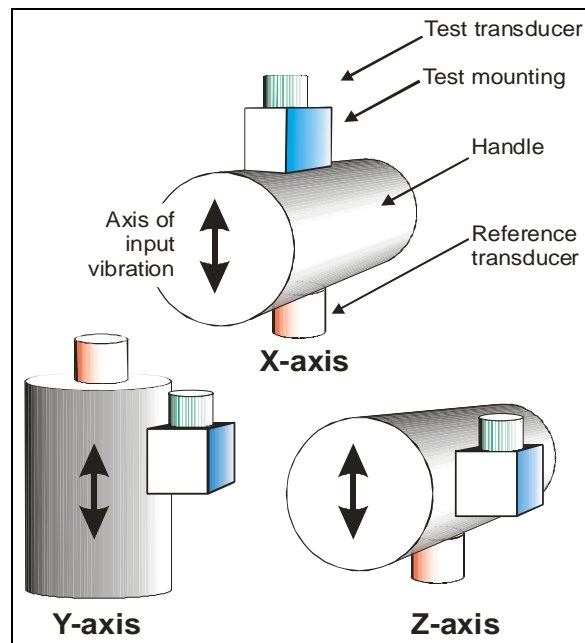
A second method for testing has also been included as an optional method. This method seeks to evaluate the “characteristic phase deviation” (CPD), a value that is used to specify tolerances on the phase errors (the CPD recognises that the absolute phase error is not important, it is actually the rate of change of phase-shift error with frequency that is important).

### *Transducer Mounting Systems*

The errors from poor mounting systems can easily be much larger than errors from any other source. A poor mounting system can introduce a significant resonance, well inside the measurement frequency range. This is a particular problem for hand-arm vibration measurement, where the mounting has to fix on to a small structure, and provide a mount that is rigid for frequencies up to 1500 Hz and beyond.

The existing version of ISO 8041 does not deal with transducer mounting systems, and concentrates on the performance of the instrument electronics, and (to a limited degree) the performance of the vibration transducer. However, manufacturers often supply mounting systems as part of the instrument package, and the reliability of some mounting systems being supplied in this way is questionable.

The revision of ISO 8041 has introduced an optional test of hand-arm vibration transducer mountings. It is based on simple, single axis shaker tests, illustrated in Figure 4. These are designed to establish that the mounts are capable of fixing transducers firmly to a handle and, will provide good performance over the necessary frequency range.



**Figure 4** Mounting tests

### *Uncertainty Of Testing*

In common with other new instrumentation and calibration standards, the revision of ISO 8041 has needed to consider the uncertainty of measurement during testing in all the specifications and tests. All tolerances given in the revised standard include an allowance for the uncertainty of measurement of a given performance parameter and an allowance for the permitted variation in the performance of the instrument.

One important issue affecting the uncertainty of testing is the uncertainty of the calibration of reference vibration transducers. The primary and secondary calibration of vibration transducers is defined by the ISO 16063 series. These define tests and tolerances on calibration procedures. In human vibration measurement we never use these calibration tests, but the performance of our instrumentation must be related back to these standards.

The frequency ranges covered by human-vibration standards extend to very low frequencies that are actually well below the frequency ranges for which accepted calibration methods exist. Motion-sickness measurement is a big problem. The lowest frequency for which ISO 16063 tests are developed is about 0.4Hz; the same frequency as the upper end of the motion-sickness frequency range.

Generally calibration checks for transducers used for motion sickness measurements have been based on the method of inverting the transducer, to generate a 2g change in output. While this dc-method has been accepted as being a reliable check of the measurement systems, it is not a test that can be relied on as a true test of the sensitivities of transducer and instrumentation in the frequency range of the measurement. For this reason, the revision of ISO 8041 has required that calibration checks be carried out at a frequency that is within the measurement frequency range.

### **Conclusion**

To produce a reliable measurement of hand-arm vibration, it is important that you have a good understanding of the work task you are assessing, the instrumentation you are using and the mechanisms by which errors can be generated. Using instrumentation that meets the requirements of ISO 8041 cannot prevent poor measurement; understanding the limitations of instrumentation and the potential sources of error can improve the reliability of your measurement.

The revision of ISO 8041 is being prepared in ISO (TC108/SC3) it was issued as a Draft International Standard (DIS) in 2003. The final draft version (FDIS) will be issued mid 2004 and if it receives sufficient support the new standard is likely to be published in Spring 2005.

### **Acknowledgements**

The author would like to recognise the contributions from other members of ISO TC 108 SC 3 JWG 1 who have assisted with the revision of ISO 8041 and whose work is summarised in this paper.

### **References**

European Parliament and the Council of the European Union (1997) *Official Journal of the European Communities* Directive 98/37/EC on the approximation of the laws of the Member States relating to machinery. OJ L207, 23.7.1998.

European Parliament and the Council of the European Union (2002) *Official Journal of the European Communities* Directive 2002/44/EC on the minimum health and safety requirements regarding the exposure of workers to the risks arising from physical agents (vibration). OJ L177, 6.7.2002, p13.

International Organization for Standardization ISO 2631/1-1985. Evaluation of human exposure to whole-body vibration – Part 1: General requirements.

International Organization for Standardization ISO 2631-2:1989. Evaluation of human exposure to whole-body vibration – Part 2: Continuous and shock-induced vibration in buildings (1 to 80 Hz).

International Organization for Standardization ISO 2631/3-1985. Evaluation of human exposure to whole-body vibration – Part 3: Evaluation of exposure to whole-body z-axis vertical vibration in the frequency range 0,1 to 0,63 Hz.

International Organization for Standardization ISO 2631-1:1997. Mechanical vibration and shock - Evaluation of human exposure to whole-body vibration – Part 1: General requirements.

International Organization for Standardization ISO 2631-2:2003 Mechanical vibration and shock - Evaluation of human exposure to whole-body vibration – Part 2: Vibration in buildings (1 Hz to 80 Hz).

International Organization for Standardization ISO 2631-4:2001. Mechanical vibration and shock - Evaluation of human exposure to whole-body vibration – Part 4: Guidelines for the evaluation of the effects of vibration and rotational motion on passenger and crew comfort in fixed-guideway transport systems.

International Organization for Standardization ISO 5349-1986. Mechanical vibration – Guidelines for the measurement and the assessment of human exposure to hand-transmitted vibration.

International Organization for Standardization ISO 5349-1:2001. Mechanical vibration and shock – Measurement and evaluation of human exposure to hand-transmitted vibration – Part 1: General requirements.

International Organization for Standardization ISO 5349-2:2001. Mechanical vibration and shock – Measurement and evaluation of human exposure to hand-transmitted vibration – Part 2: Practical guidance for measurement in the workplace.

International Organization for Standardization ISO 8041:1990. Human response to vibration - Measuring instrumentation.

International Organization for Standardization ISO 8041/Amd.1:1999. Human response to vibration - Measuring instrumentation. Amendment 1.

International Organization for Standardization ISO/DIS 8041:2003. Human response to vibration - Measuring instrumentation.

International Organization for Standardization ISO/TS 15694:2004. Mechanical vibration and shock – Measurement and evaluation of single shocks transmitted from hand-held and hand-guided machines to the hand-arm system

International Organization for Standardization ISO 16063-1:1998, Methods for the calibration of vibration and shock transducers – Part 1: Basic concepts



# EXAMPLES OF A MEASUREMENT ARTIFACT: THE ‘DC SHIFT’

G. S. Paddan

Institute of Naval Medicine, Crescent Road, Alverstoke, Gosport, Hampshire, PO12 2DL  
United Kingdom

## Abstract

A measurement artifact that commonly occurs during the measurement of vibration on percussive and impact tools is known as a ‘dc shift’. The effect of this is to artificially inflate the measured vibration magnitude, thus indicating an erroneous measurement. The presence of dc shifts can usually be determined by inspection of both the time history and the frequency content of the vibration signal. Although the normal precautions were taken during the vibration measurements (such as the use of mechanical filters), 13 examples of dc shifts were measured on 7 impact-type tools. The data contaminated by dc shifts measured on the tools have been analysed using high-pass filters ranging from 1 Hz to 20 Hz. Power spectral densities have been calculated for the dc-shift contaminated time histories. The corresponding vibration magnitudes have shown that the high-pass frequency that should be used depends on the main frequencies of operation of the tool. Displacements corresponding to the artificially inflated low-frequency component for some of the tools have shown values as high as 214 mm for riveting operations.

## Introduction

An anomaly that has been encountered during the measurement of vibration on percussive tools using piezoelectric accelerometers is known as a ‘dc shift’. This phenomenon does not indicate the true acceleration measured on the tool but signifies a measurement artifact possibly due to overloading of the measurement transducer. The transducers that are generally used to measure acceleration are piezoelectric devices which comprise a crystal that generates an electrical charge when the crystal is ‘squeezed’. This phenomenon has been widely reported in the literature (e.g. EN ISO 5349-2, 2001; Griffin, 1990; Chu, 1987) and continues to be the subject of discussion (Holmes and Paddan, 2003) and cause of inconvenience as reported recently by Dong *et al.* (2004).

European Standard EN ISO 5349-2 (2001) states that “*Where there is any doubt about the quality of the acceleration signal (e.g. DC-shift, ...) it is useful to have information from frequency analysis ...*”. The Standard also states that “*... any measurements showing signs of DC-shift should be disregarded*”; using such a harsh strategy, all data indicating any signs of dc shifts, however small, would be discarded. The presence of dc shifts usually requires inspection of both the time history and the frequency domain data; contamination by dc shifts cannot usually be determined from only the vibration magnitudes.

The occurrence of dc shifts during the measurement of high magnitude shocks has been reported by O’Conner and Lindquist (1982) with the use of a mechanical filter being a potential solution. The possibility of such artifacts has also been considered during the measurement of vibration on tools used in chipping and grinding operations (Reynolds *et al.*, 1982). Nelson and Griffin (1992) reported on different ways of improving the measurement of hand-arm vibration. They advocate the use of a high-pass filter with a cut-off frequency at about 20 Hz.

Vibration measurements were made on many hand-held tools some of which inadvertently resulted in dc shifts; these data have been high-pass filtered at different frequencies to further understand the nature of the dc-shift problem. The aim of this paper is to present examples of dc shifts that have occurred while measuring vibration on different hand-held tools.

## Equipment and Procedure

Vibration measurements were made on 7 hand-held tools which produced a total of 13 acceleration time histories that showed the presence of dc shifts. Table 1 shows details of the vibration tools used in the various surveys, the accelerometers used to measure the vibration and the parameters used during the acquisition of the time histories. All tools used in the study were impact-type including riveting tools (guns and dollies), impact wrenches and needle scalars.

Measurements of vibration were made using mounting systems fitted with three piezoelectric accelerometers orientated in mutually orthogonal axes. Apart from the measurements made on tools 1 and 3, the accelerometers used (Brüel and Kjør 4371) were attached on to the tool using mechanical filters (B&K UA 0559). Acceleration signals were acquired using a *HVLab* data acquisition and analysis system. The acceleration signals were low-pass filtered (antialiasing) and then sampled into the computer system.

Although acceleration measurements were made in three translational axes on 7 hand-held tools, only those data that showed dc shifts are used in this study.

**Table 1** Details of tools used and measurements made

Tool number	Tool details	Measurement identification	Accelerometer used	Measurement duration (s)	Sample rate (samples per second)	Low-pass antialiasing filter (Hz)
1	Reaction bar (dolly), 0.63 kg (used with MacDonald G4 riveting gun, rivet NAS 1097 AD 6-6)	Measurement 1, Measurement 2, Measurement 3	B&K 4374	10	5041	1250
2	Ingersoll-Rand 197C/1 impact wrench, 4.25 kg, used on 21 mm nut	Measurement 4, Measurement 5	B&K 4371 with B&K UA 0559 mechanical filters	10	5041	1250
3	Chicago Pneumatic 4X (CP-4444), 1.5 kg, AERO 1" cyl, riveting gun	Measurement 6, Measurement 7, Measurement 8	B&K 4374	5	5050	1600
4	Ingersoll-Rand AVC13 riveting gun used on 7/32" mild steel rivet, and 3/16" aluminium rivet	Measurement 9, Measurement 10	B&K 4371 with B&K UA 0559 mechanical filters	8	5041	1250
5	Trelawney 2BP, needle scaler	Measurement 11	B&K 4371 with B&K UA 0559 mechanical filters	16	5041	1250
6	Trelawney V300, needle scaler	Measurement 12	B&K 4371 with B&K UA 0559 mechanical filters	16	5041	1250
7	IPT NVR-28, needle scaler	Measurement 13	B&K 4371 with B&K UA 0559 mechanical filters	16	5041	1250

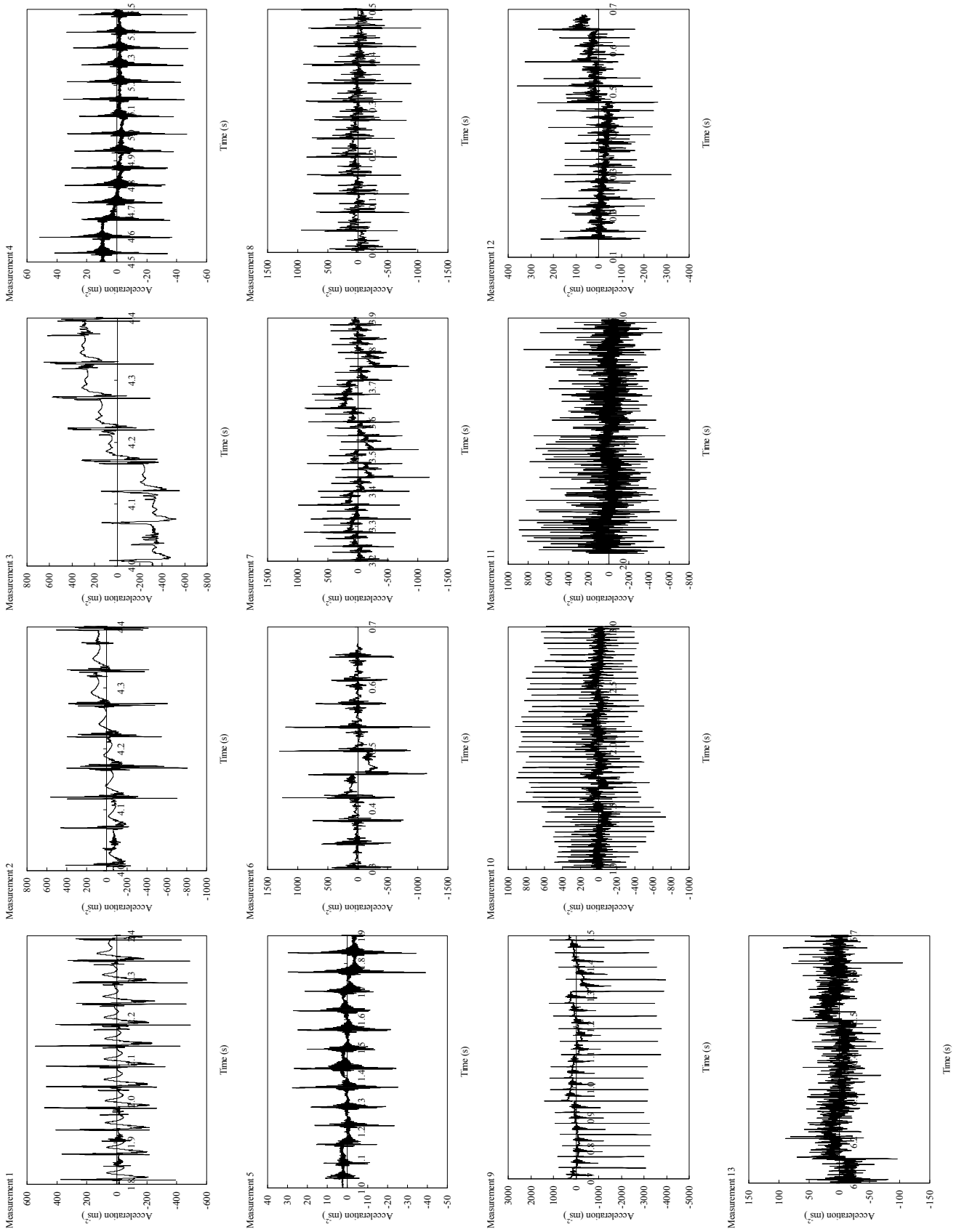
### Analysis

Power spectral densities were calculated from the acceleration waveforms; these show the distribution of energy across the frequency spectrum. A frequency resolution of 4.92 Hz was used. The number of degrees of freedom for the power spectral densities ranged from 100 to 320 for the measurement durations ranging from 5 s to 16 s (Bendat and Piersol, 1986).

The acceleration time histories were high-pass filtered using a 4-pole Bessel characteristic filter. The data were filtered using 20 frequencies ranging from 1 Hz to 20 Hz. Acceleration signals were frequency-weighted using the hand-arm frequency weighting  $W_h$  specified in EN ISO 5349-1 (2001). Root-mean-square vibration magnitudes were calculated from the unweighted and the frequency-weighted acceleration time histories.

### Results and Discussion

Figure 1 shows specific sections of the time histories illustrating the dc shift phenomenon for the 13 measurements. The distinct characteristics of dc shifts can be seen in all time histories; the dc values of the acceleration time histories settle at different values compared to the value before the impacts. Assuming that there are no large movements of the tools during use, the dc level prior to the impact and following the impact should correspond to zero acceleration. The gradual increase in the dc level is clearly seen in some of the measured data, such as measurements 2 and 3. It is seen that there are different degrees of contamination by dc shifts. For example, measurement 1 shows a slight increase in the dc value over the time history shown. However, measurement 3 shows a much greater increase in the dc value. The effect of measurement 3 on the measured acceleration data would be greater than that of measurement 1. Note that the scales for the acceleration magnitude and time shown in the 13 time histories are different. Although not experienced in these measurements and not shown in these time histories, another problem that sometimes can occur with the signal, as a consequence of the dc shift, is clipping: the acceleration signal is near the maximum acceleration that the equipment is set up to measure.



**Figure 1** Sections of time histories for 13 measurements showing the dc-shift phenomenon.

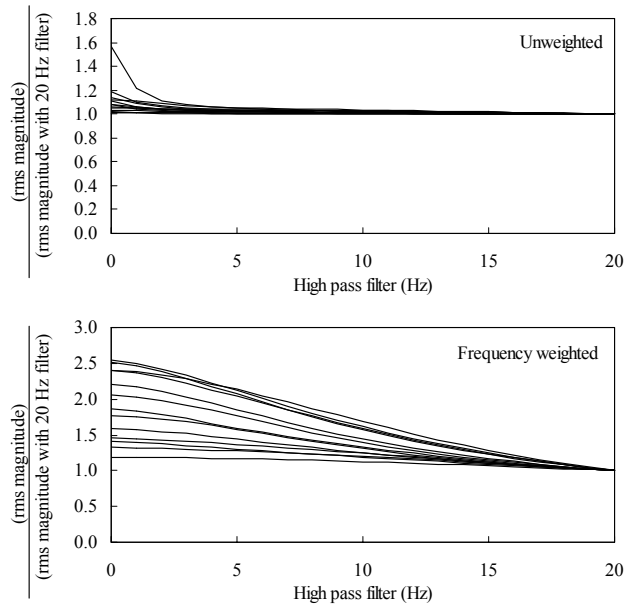
The 13 time histories were high-pass filtered at 20 frequencies ranging from 1 Hz to 20 Hz. The acceleration time histories were then frequency-weighted using the hand-arm weighting,  $W_h$ . Vibration magnitudes (r.m.s. values) were calculated for both the unweighted and the frequency-weighted time histories. As an example of the effect of the filtering and the frequency weighting, Table 2 shows vibration magnitudes for measurements 1 and 3. The effect of the frequency weighting is to significantly reduce the vibration magnitude for all time histories. Vibration magnitude of the time histories reduced as the frequency of the high-pass filtering increased. However, it is difficult to compare the relative effects of the frequency weighting and the high-pass filtering since the absolute vibration magnitudes for the different measurement sets are different.

**Table 2** Effect of high-pass filter and frequency-weighting on vibration magnitudes ( $\text{ms}^{-2}$  r.m.s.) for measurements 1 and 3

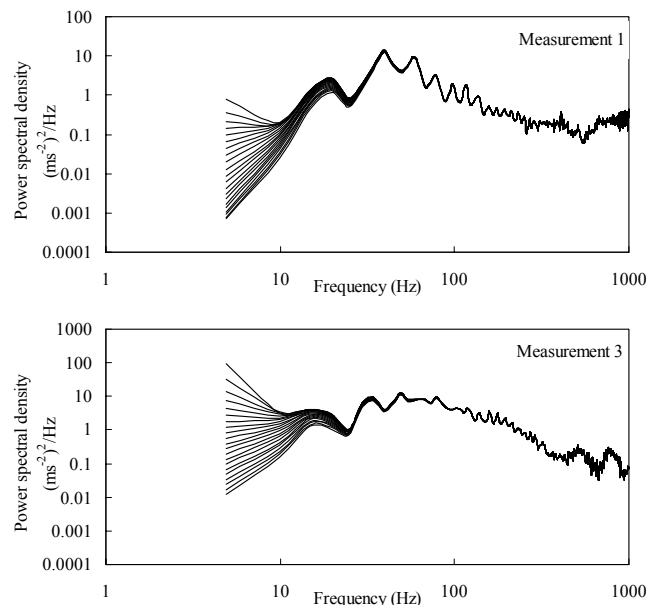
High-pass filter frequency (Hz)	Measurement 1		Measurement 3	
	Unweighted	Weighted	Unweighted	Weighted
0	25.20	7.41	48.67	10.99
1	25.06	7.40	37.75	10.84
2	25.02	7.38	34.62	10.63
3	24.99	7.36	33.52	10.45
4	24.96	7.33	33.04	10.25
5	24.92	7.29	32.78	10.07
6	24.89	7.25	32.61	9.89
7	24.84	7.20	32.48	9.71
8	24.80	7.15	32.36	9.54
9	24.75	7.09	32.26	9.37
10	24.69	7.03	32.16	9.21
11	24.64	6.97	32.06	9.05
12	24.57	6.90	31.96	8.89
13	24.51	6.82	31.86	8.73
14	24.43	6.75	31.75	8.58
15	24.36	6.67	31.65	8.44
16	24.29	6.59	31.55	8.29
17	24.21	6.51	31.44	8.15
18	24.12	6.42	31.34	8.02
19	24.04	6.33	31.23	7.88
20	23.95	6.25	31.12	7.75

In order to overcome the differences in absolute vibration magnitudes for the measurement sets, Figure 2 shows the vibration magnitudes for the high-pass filtered and the frequency-weighted data *relative* to the vibration magnitude calculated with a high-pass filter of 20 Hz. Therefore, the data shown in Figure 2 correspond to ratios of vibration magnitudes at different high-pass frequency filters to the vibration magnitude at 20 Hz high-pass filter. The unweighted vibration magnitudes show that the effect of the high-pass filter was the greatest for low frequencies. Apart from measurement 3, the effect of the high-pass filter was to reduce the unweighted vibration magnitude by 20%. The high-pass filter has a greater effect on the frequency-weighted vibration magnitude than the unweighted vibration magnitude. The effect of the high-pass filter depends on the degree of contamination by the dc shift. It is seen from Figure 2 that the greatest effect of the high-pass filter was on measurement 12 (highest curve) and the least effect was on measurement 1 (lowest curve). Measurement 1 shown in Figure 1 appeared to demonstrate the least dc-shift contamination.

Figure 3 shows the effect of the high-pass filter on the power spectral densities of vibration for measurements 1 and 3. The main frequency of operation for the tool in measurement 1 (reaction bar during riveting) appears to be about 20 Hz; however, inspection of the time history in Figure 1 shows that there are intermediate peaks which would indicate a frequency of about 40 Hz. This is clearly seen from the spectral data shown in Figure 3. The peak corresponding to 20 Hz is of lower magnitude compared to the peak at 40 Hz; therefore, it would be expected that the high-pass filters would have only a small effect on the overall vibration magnitudes. This was evident from the vibration magnitudes in Table 2 and Figure 2.



**Figure 2** Ratio of vibration magnitudes for unweighted and frequency-weighted data compared to the vibration with a high-pass filter at 20 Hz.



**Figure 3** Power spectral densities for measurements 1 and 3 showing the effect of filtering (0 Hz highest line; 20 Hz lowest line)

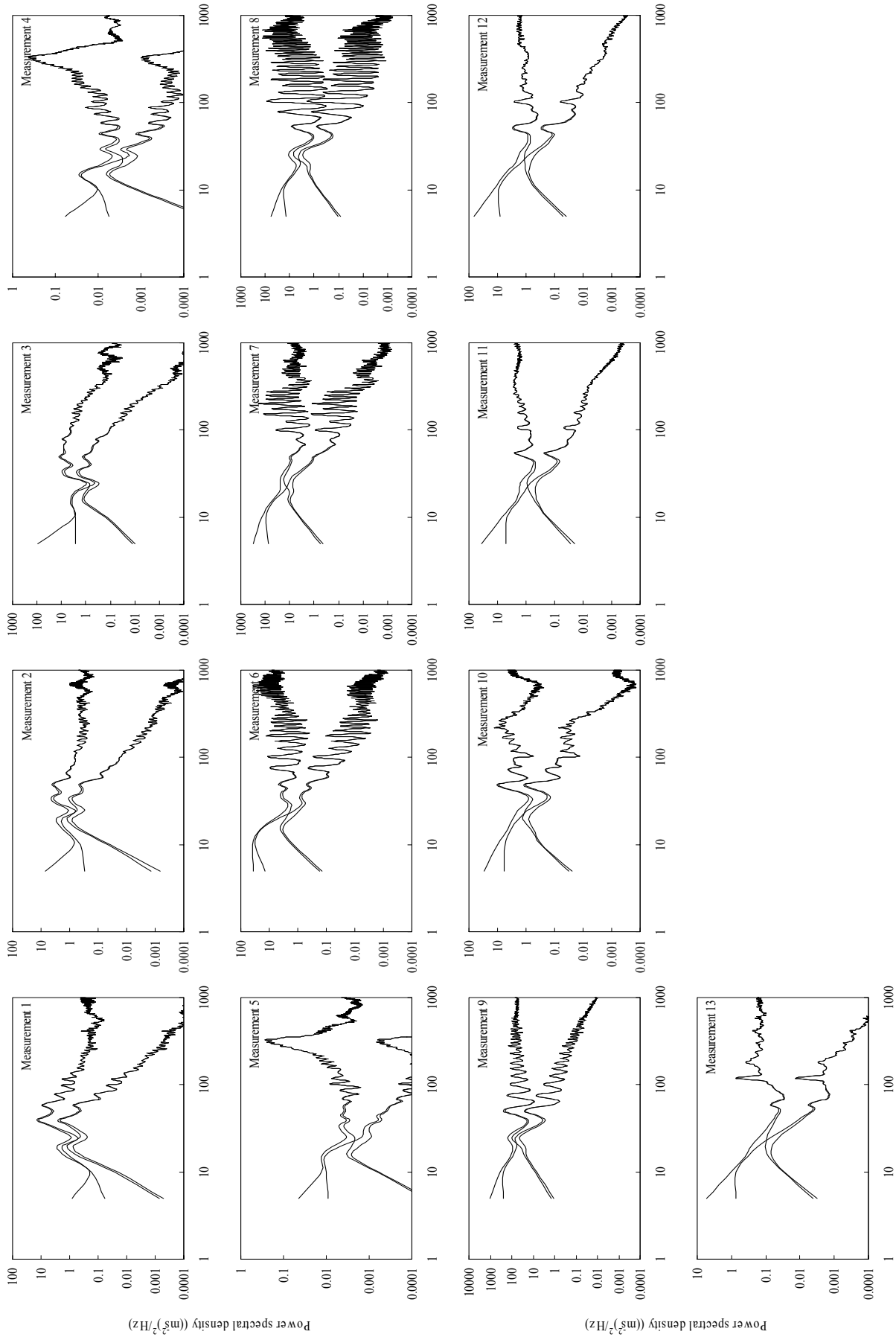
Measurement 3 shows a number of peaks in the power spectral density corresponding to the operation of the riveting gun. The main frequency appears to be about 20 Hz with intermediate peaks which would generate different harmonics of the main frequency. The time history for measurement 3 in Figure 1 shows that the dc shift had a significant effect resulting in large changes in the dc value. This would be shown as corresponding to a large dc component in the frequency spectrum; this is clearly shown in Figure 3. Application of the high-pass filter has greatly reduced the low-frequency component; this is reflected as a significant reduction in the vibration magnitude (see Table 2).

Power spectral densities were also calculated for the different high-pass filters using the frequency-weighted time histories. Figure 4 shows the effect of the 20-Hz high-pass filter on the unweighted and the frequency-weighted time histories. For measurements 1 and 3, the power spectral densities show that the high-pass filter had the greatest effect on frequencies below 20 Hz than the frequency weighting; the hand-arm frequency weighting attenuates all frequencies above 16 Hz. It is seen that for measurements 1 and 3, the 20-Hz frequency peak for measurement 1 had a smaller influence on the power spectral density than the 20-Hz frequency peak in measurement 3. Thus, measurement 3 would be more affected by the 20-Hz high-pass filter than measurement 1. This can be partly seen in Figure 2.

An indication of the contamination of the data by a dc shift can be determined by calculating the displacement of the tool corresponding to the power spectral density shown at low frequencies. If the displacement calculated appears to be unrealistic, then the chances are that the data are contaminated by dc shifts. Table 3 shows the unweighted power spectral density values occurring at 4.92 Hz for the 13 measurements (as shown in Figure 4, no frequency weighting and no high-pass filter) and the corresponding calculated displacements. Measurement 1 shows a displacement of 6 mm; this corresponds to a plausible displacement of the dolly (reaction bar) during a riveting operation. However, a displacement of 64 mm on the dolly (measurement 3) during a repeat operation appears to be an indication of dc shifts. Displacements of 116 mm (measurement 7) and 214 mm (measurement 9) occurring during riveting operations clearly show suspect data likely to be contaminated by dc shifts. This shows the importance of estimating the displacements corresponding to the spectral information shown at low frequencies.

**Figure 4** Effect of frequency weighting and high-pass filter on the power spectral densities for the 13 measurements. For frequencies above 20 Hz, two higher curves correspond to the unweighted data, and two lower curves correspond to the frequency-weighted data. For frequencies below about 20 Hz, two higher curves correspond to no high-pass filter, and two lower curves correspond to a 20-Hz high-pass filter.

(Figure is on following page)



**Table 3** Displacements estimated from the low frequency spectral information for the 13 measurements.

Measurement	PSD value at 4.9 Hz ((ms <sup>-2</sup> ) <sup>2</sup> /Hz)	Displacement (peak-peak, mm)
1	0.8	6
2	6.9	17
3	96	64
4	0.06	2
5	0.05	1
6	37	40
7	317	116
8	59	50
9	1078	214
10	30	36
11	36	39
12	65	53
13	5.3	15

The high-pass filter frequencies used in this study range from 1 Hz to 20 Hz (as recommended by Nelson and Griffin, 1992). It was seen from Table 2 and Figure 2 that, although all vibration data were high-pass filtered at frequencies ranging from 1 Hz to 20 Hz, not all time histories required the 20-Hz filtering. Lower cut-off frequencies could be used for some time histories depending on the main frequencies of operation on the tool. However, there will be cases where higher frequencies could justifiably be excluded; frequencies as high as 25 Hz have been excluded in a study by Dong *et al.* (2004).

It is seen that for the 13 different measurements, 7 measurements were made with mechanical filters inserted between the accelerometers and the tool; 6 measurements were made without mechanical filters. However, all measurements demonstrated dc shifts. It is stated in EN ISO 5349-2 (2001) that “*A means to avoid DC-shift can be a mechanical filter, ...*”. Mechanical filters appear not to completely eliminate the presence of dc shifts; the use of mechanical filters is recommended as these *reduce* the likelihood of the occurrence of dc shifts. The ineffectiveness of the mechanical filter in eliminating dc shifts has also been reported by Dong *et al.* (2004).

### Conclusions

The dc shift is an artifact that can artificially inflate the calculated vibration magnitude. The presence of dc shifts can usually be identified from the acceleration time history and the unexpected low-frequency components present in the power spectral density. Time histories can be high-pass filtered to exclude the effect of the dc shift; the cut-off frequency used for the high-pass filter depends on the dominant frequencies present in the operation of the tool. The calculation of displacements corresponding to the low frequency in the power spectral density can also be used to determine the presence of dc shifts.

### References

- Bendat, J.S. and Piersol, A.G. 1986. Random data: Analysis and measurement procedures. John Wiley and Sons, New York. Second Edition. ISBN 0-471-04000-2.
- Chu, A. 1987. Zeroshift of piezoelectric accelerometers in pyroshock measurements. The Shock and Vibration Bulletin, Bulletin 57, Part 1, pp 71-80, January 1987. Presented at the Pyrotechnic Shock Workshop (56<sup>th</sup> Shock and Vibration Symposium).
- Dong, R.G., Mcdowell, T.W., Welcome, D.E., Warren, C. and Schopper, A.W. 2004. An evaluation of the standardized chipping hammer test specified in ISO 8662-2. The Annals of Occupational Hygiene, 48(1), pp 39-49.
- European Standard. 2001. Measurement and evaluation of human exposure to hand-transmitted vibration – Part 1: General requirements. EN ISO 5349-1:2001.

European Standard. 2001. Measurement and evaluation of human exposure to hand-transmitted vibration – Part 2: Practical guidance for measurement at the workplace. EN ISO 5349-2:2001.

Griffin, M.J. 1990. Handbook of human vibration. Academic Press Limited, London. ISBN 0-12-303040-4.

Holmes, J. and Paddan, G.S. 2003. An investigation into ways of dealing with a d.c. shift when assessing exposure to hand-arm vibration. United Kingdom Conference on Human Response to Vibration, Institute of Naval Medicine, Alverstoke, Gosport, 17th to 19th September 2003. pp 361-371. ISBN 0-9546028-0-3.

Nelson, C.M. and Griffin, M.J. 1992. Improving the measurement and evaluation of hand-transmitted vibration. Proceedings of the 6<sup>th</sup> International Conference on Hand-Arm Vibration, Bonn, May 1992. pp 613-623.

O'Connor, D.E. and Lindquist, B. 1982. Method for measuring the vibration of impact pneumatic tools. In: Brammer, A.J., Taylor, W. (eds.) Vibration effects on the hand and arm in industry. Wiley, New York. pp 97-101. ISBN 0-471-88954-7.

Reynolds, D.D., Wasserman, D.E., Basel, R., Taylor, W., Doyle, T.E. and Asburry, W. 1982. Vibration acceleration measured on pneumatic tools used in chipping and grinding operations. In: Brammer, A.J., Taylor, W. (eds.) Vibration effects on the hand and arm in industry. Wiley, New York. pp 225-238. ISBN 0-471-88954-7.



# FREQUENCY WEIGHTING OF HAND-ARM VIBRATION

Y. Tominaga

Institute for Science of Labour, 216, Sugao, Miyamae-ku, Kawasaki, 216, Japan

## Abstract

A new frequency weighting method to estimate hand-arm vibration was obtained by the epidemiological method. In this study, the influence of a frequency component was first estimated by the method of multivariate analysis, then a simple form weighting curve was introduced. Compared with the present ISO 5349-1 system, the temporary weighting curve obtained better explained the relationship between rates of symptoms and vibration exposure among vibrating tool users. Although this method is based on limited data, it suggests that the current curve described in ISO 5349-1 should be changed to estimate high frequency areas higher and low frequency areas low.

## Introduction

In regard to the frequency weighting method surrounding ISO 5349-1, it has been said that the method does not adequately reflect the risk of vibration-induced white finger phenomena, VWF. Since the 1980's, some investigators pointed out that the method overestimates for low frequency range and other pointed out an underestimation for high frequency (Tominaga, 1981; Taylor et al., 1990, Bovenzi, 1998). We need a new method of frequency weighting that is proved medically.

The purpose of this paper is to find a better frequency weighting method by comparing the relationship between the vibration exposure dosage and the effects among users of vibrating tools.

## Material

This study is based on information obtained before 1980. In order to know the tendency in the dose-effect relationship, we need a wide variety of data to show the rate of symptoms. Old data must be used due to the fact that during the 1970's drastic change in equipment improvement and work methods lowered the reports of severe effects from vibration exposure.

To keep the quality of data, diagnosis and the judgment of condition and/or vibration measurement constant, the data was extracted from records of the investigation which I either conducted myself or consulted thoroughly with the examining team. The vibration exposure of the subjects and diagnosis among them were studied in the similar way to the current methods.

### *Subjects*

Workers were chosen based on the type of tool and operating period. All subjects used the same single vibration tool, and did not use any other such tool. They were divided into 16 groups. Each group worked the same site (Table 1) with the same tool. Their working environments are described below:

- Group #1, #2, #3: The chipping hammer groups started the use of the tools around 1936 and worked outdoors around hills.
- Group #4 - #7: The chipping hammer groups had worked in 3 factories manufacturing electric motors. They used the same type of tool as group #1, #2, and #3, but worked indoors.
- Group #8, #9: The jackhammer groups worked at the same sites as #1, #2, and #3.
- Group #10, #11: The leg drill groups, who had worked in a metal mine, used a two-man system. Some workers had previously worked in other mines or dams prior to the survey.
- Group #12: The sand rammer group used a long type of tool, having a length of 1.5 m, in two foundries. Rammers were used for non-percussive sand patting in foundries and not for backfilling or soil pawing on building sites.
- Group #13: The sand rammer group used a short type of tool having a length of 60 cm. They worked in foundries of a vehicle manufacturing company patting sand on tables with hands raised high. They

did not use the tool for backfilling or soil pawing. This group used rammers for only sand patting similar to group #11.

Group #14, #15, #16: The chainsaw groups had used “old types” of chainsaw from 1957 to 1965. Group #14 worked in the middle or northern Japan. Group #15 and #16 worked in the southwestern area of Japan. Chain saws had been used widely in Japan since 1957. After several years, the vibration effects received a lot of attention. From 1957 to 1970, there were many attempts to reduce the vibration exposure in chainsaw use. However it was not until 1970 that the drastic reduction occurred due to the appearance of “Anti-Vibration type” chain saws. Operation time was also decreased and vibration exposure was controlled to less than 2 hrs. a day. Several years after 1957, there was a special time period on the vibration exposure in chain saw operators. Chainsaws used in this time period are called “old type” in this paper.

Temperatures at work sites in winter were, 5 – 10 degrees Celsius for stone quarries, 13-15 degrees for the mine, 10-15 degrees for factories and foundries, and 0-10 degrees for chainsaw groups. Three chainsaw groups, #14, #15, and #16, were examined in 1965 – 1966. Other groups were examined in 1976 – 1977.

**Table 1** Subjects

Group	Tool	VWF (%)	Numbness (%)	Joint pain (%)
1	Chipping hammer	8.7	17.4	13.0
2	Chipping hammer	9.5	14.3	9.5
3	Chipping hammer	18.2	31.8	13.6
4	Chipping hammer	8.0	24.0	16.0
5	Chipping hammer	8.0	12.0	8.0
6	Chipping hammer	40.0	52.0	20.0
7	Chipping hammer	20.8	54.2	20.8
8	Jack hammer	0.0	11.1	11.1
9	Jack hammer	45.0	45.0	20.0
10	Rock drill leg type	38.9	27.8	33.3
11	Rock drill leg type	55.0	50.0	10.0
12	Sand rammer L	0.0	4.8	28.6
13	Sand rammer S	0.0	45.8	45.8
14	Chain saw ‘old’	38.5	34.6	19.2
15	Chain saw ‘old’	30.8	-	-
16	Chain saw ‘old’	55.7	-	-

### *Symptoms*

A single medical team examined all groups except two chainsaw groups (#15, #16), using a Japanese standard, which includes a medical interview and objective tests. A trained doctor diagnosed them by the same standard and I, myself, was involved in all aspects of these examinations, including personally interviewing each member and documenting their history of vibration exposure. For two groups of chainsaw operators, another team in the same institute did medical tests and interviews. In this case I helped them in preparation but did not join these group’s examinations.

In this paper, three kinds of symptoms were used as objects of analysis. They were VWF (vibration-induced white finger), finger numbness and tingling and pain in the upper limb joints. Prevalence rates in groups are shown in Table 2. The rate of VWF did not include light cases such as rare happenings on a single finger. Those who complained of Raynaud’ phenomena before the use of vibrating tools were checked and excluded from VWF. In two groups of chainsaw operators (#15, #16), symptoms of numbness and pain were not shown. It was because a different doctor

interviewed them and he might have used a different diagnosis standard for those two symptoms. Therefore, the data was not applicable to this study.

Table 2 Prevalence rate of Symptom

Group	Tool	VWF (%)	Numbness (%)	Joint pain (%)
1	Chipping hammer	8.7	17.4	13.0
2	Chipping hammer	9.5	14.3	9.5
3	Chipping hammer	18.2	31.8	13.6
4	Chipping hammer	8.0	24.0	16.0
5	Chipping hammer	8.0	12.0	8.0
6	Chipping hammer	40.0	52.0	20.0
7	Chipping hammer	20.8	54.2	20.8
8	Jack hammer	0.0	11.1	11.1
9	Jack hammer	45.0	45.0	20.0
10	Rock drill leg type	38.9	27.8	33.3
11	Rock drill leg type	55.0	50.0	10.0
12	Sand rammer L	0.0	4.8	28.6
13	Sand rammer S	0.0	45.8	45.8
14	Chain saw 'old'	38.5	34.6	19.2
15	Chain saw 'old'	30.8	-	-
16	Chain saw 'old'	55.7	-	-

#### *Total exposure time*

During the interviews, when workers answered how many hours they had used the tool, their answers were more than the actual time. In several surveys for the chipping hammer users and the chainsaw users, actual exposure time was 30 % to 70 % of what they had said. Personal operating time was averaged geometrically in the groups.

#### *Vibration measurement*

In regards to the vibration data, a few different ways were used. Some measurements were taken from simulated sites in Table 1. Others were performed at experimental sites for the same model of tool. In each way the tool used in this study was the same tool and model used in the work group.

These measurements used a method in ISO 5349, which was discussed during the stage of CD (Committee Draft) and DIS (Draft International standard). At that time, it did not use the mechanical filter and three axes transducer. Without the mechanical filter, the DC-shift phenomena could occur. In this study, vibration data of percussive tools was checked for evidence of too great of low frequency components to determine occurrence of a DC-shift. Regarding the vibration direction, both the simultaneous measurement by 3 axes pick-up and the separate measurements by single axis pick-up for 3 axes data were included.

The vibration data of the same type were averaged logarithmically in each direction and the vector sums of 3 axes were calculated to every frequency component of the 1/3 Oct. band. The vibration data for one kind of a tool was then applied to the worker groups using the same tool.

Figure 1, 2, and 3 show the vector sum values in each 1/3-octave band. Workers used the chipping hammer, in Fig. 1 of the type having an open bow handle. For the data of the chain saw, in Fig.3, the higher data between the front and rear handle was recorded.

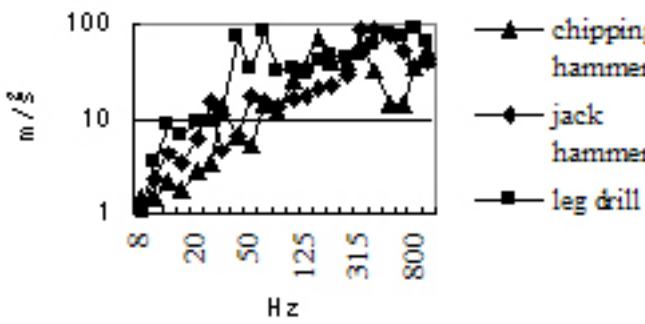


Figure 1 Vibration of air hammer/drill

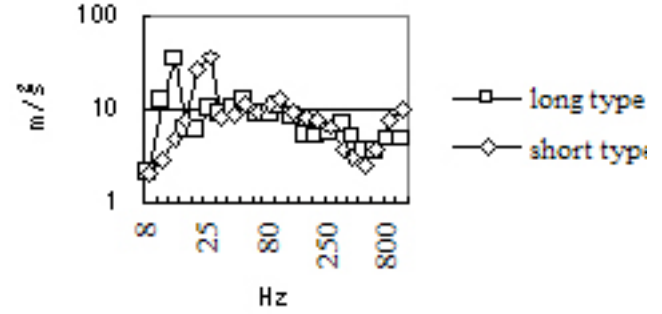


Figure 2 Vibration of sand rammer

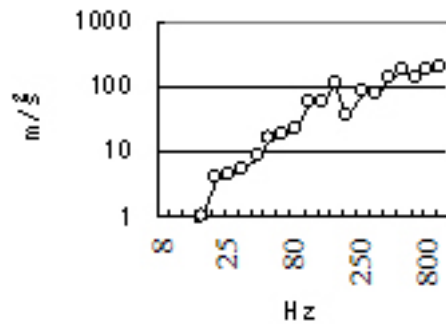


Figure 3 Vibration of "old" chain saw

#### Vibration exposure

In this study, the frequency element of vibration exposure was determined as a form which combined the acceleration in an 1/3 oct. band and the exposure time. Several forms were tested. They were combinations among  $a_i$  (acceleration in  $i_{th}$  band;  $i = 1, 2, \dots, 22$ ),  $a_i^2$ ,  $T$  (total exposure time) and  $T^{1/2}$ . The logarithmic transformation was also tested.

As shown in Table 1, exposure time was treated as the total exposure time. Vibration exposure per day and tool use days per year were not calculated because they were not needed for this study.

### Method

#### Detection of influence of frequency by multivariate analysis

The Multi-Regression Analysis, MRA, and the Principal Component Analysis, PCA, were used in this study.

MRA was used to detect the influence of frequency. The frequency element of vibration was shown in 22 frequency bands of 1/3 oct. from 8Hz to 1kHz. MRA was used in order to evaluate those frequencies. However, since 22 frequency elements had high correlation to each other, when they were directly used for MRA the problem of multi co-linearity arose and a stable solution could not be obtained. Generally, variables having mutual high correlation are summarized or thinned out and reduced in number. However, the regression coefficients are not given to all frequencies by this method. In order to resolve the problem of multi co-linearity and to obtain regression coefficients to all frequency elements, PCA was used as a preprocessing step for MRA in this study.

PCA is a multivariate statistical technique for simplifying complex data sets. Given  $k$  observations on  $i$  variables, the goal of PCA is to reduce the dimensionality of the data matrix by finding  $j$  new variables, where  $j$  is less than  $i$ . Termed principal components these  $j$  new variables together account for as much of the variance in the original  $i$  variables as possible while remaining mutually uncorrelated and orthogonal. Each principal component,  $PC_j$ , is a linear combination of the original variables, and so the result of MRA, regression coefficients, can be applied to all of 22 frequency elements when  $PCs$  were used as the dependent variables for MRA.

The procedure of processing is shown below using equations in the case of  $\{dose_{i,k}\}$ , and  $response$ . PCA gives  $PCs$  as a linear combination of the original variables.

$$PC_{j,k} = \sum_{i=1}^{22} (\alpha_{i,j} \cdot dose_{i,k}) \quad (1)$$

where:

- $PC_{j,k}$  = score of  $k$  group for  $j$  principal component  
 $\alpha_{i,j}$  = coefficient of eigen vector  
 $dose_{i,k}$  = vibration dose in  $i$  1/3 oct. band in  $k$  group

When  $PC_j$  were used as the independent variable, the result of MRA is shown as below.

$$\hat{response}_k = \beta_0 + \sum_j (\beta_j \cdot PC_{j,k}) \quad (2)$$

where:

- $\hat{response}_k$  (hat) = estimate of rate in group  $k$   
 $\beta_j$  = regression coefficient

This equation could be changed as below,

$$\hat{response}_k = \beta_0 + \sum_{i=1}^{22} (u_i \cdot dose_{i,k}) \quad (3)$$

where:

- $u_i$  = influence coefficient for  $i$  1/3 oct. band

where:

$$u_i = \sum_j (\alpha_{i,k} \cdot \beta_j) \quad (4)$$

When  $dose$  is defined as  $dose = a^2 \cdot T$ , and  $Pr^2$  is used for  $response$ , equation (3) is the square form of the “power equivalent” vibration dose.

$$\hat{Pr}_k^2 = \beta_0 + \sum_i (u_i \cdot a_{i,k}^2 \cdot T_k) \quad (5)$$

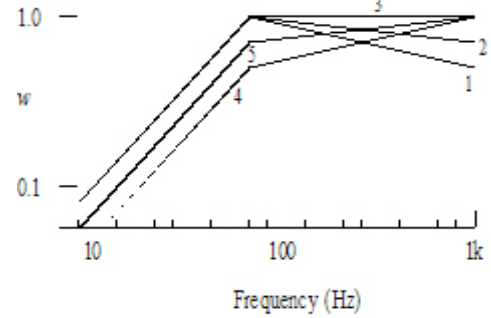
In this study, PCA was performed on the frequency element of vibration dose in several forms. The forms were the correlation and/or covariance matrix of  $\{a_{i,l}\}$ ,  $\{a_{i,l}^2\}$ ,  $\{a_{i,\square} \cdot T_k^{1/2}\}$ ,  $\{a_{i,k} \cdot T_k\}$ ,  $\{a_{i,k}^2 \cdot T_k\}$  and the log transformation of them, where,  $a_{i,l}$  means the acceleration in  $i$  1/3 oct. band of  $l$  tool and  $T_k$  means exposure time of  $k$  subject group.

Leading principal components,  $PC_j$ , from  $\{a_{i,l}\}$  and  $\{a_{i,l}^2\}$  which have the cumulative proportion contribution above 0.9 were used with  $T_k$  to MRA as the independent variable and  $PC_j$  based on  $\{a_{i,\square} \cdot T_k^{1/2}\}$ ,  $\{a_{i,k} \cdot T_k\}$ ,  $\{a_{i,k}^2 \cdot T_k\}$  were used as the independent variable directly. The dependent variable of MRA was the rate of symptom  $Pr$ , or its square value  $Pr^2$ . The dependent variable was normalized when it was used with  $PCs$  based on the correlation matrix. When  $Pr$  was zero, zero was applied as  $\log(Pr)$ . The number of the group which showed 0% is in the range from 21 to 27 persons, and there is no significant difference between 0% and 1% in this number.

When the original data was  $\{a_i^2 \cdot T\}$ , the influence coefficient,  $u_i$ , corresponds to the equation (3). In other cases, the influence coefficient,  $u_i$ , does not correspond but shows some information for frequency influence.

### Weighting method by simple form line

Based on the result of multivariate analysis, a straight line on the logarithmic scale was tested as an example of a simple form of the weighting line. The new line was chosen from five lines as shown in Fig. 4 which were broken at 63 Hz, and had the slope beyond 63 Hz was in the range from -3 dB/oct. to +3 dB/oct.. The slope below 63 Hz was 6 dB/oct.. For reference, the line in ISO 5349 and flat line from 8 Hz to 1 kHz were also tested.



**Figure 4** Simple form weighting line

In this test dependent variable was  $\log(Pr)$  and independent variable were  $\log(Vsum)$  and  $\log(T)$ . The result was estimated by the same above mentioned method.  $Vsum$  means vector sum of acceleration defined as equation (6).

$$Vsum = \left( \sum_i (w_i \cdot a_{i,k})^2 \right)^{1/2} \quad (6)$$

## Results

### Principal component analysis

The result of the PCA showed that 22 frequency components were projected to several new axes which were perpendicular to each other. In order for the cumulative proportion contribution to exceed 0.9, one or four PCs were needed depending on original data.

### Multi regression analysis

The result of MRA varied due to multiple original data forms. The results were examined and evaluated using the following points: (1) Statistical significance, (2) The adjusted coefficient of determination, (3) The residual variance, and (4) The strong influence by a specific group. The residual variance was measured with the ratio of the standard deviation between the residual and the symptom rate. High evaluated results are shown in Table 3.

For the symptom of VWF, the best result was obtained when original data form was  $\{\log(a_{i,l} T_k^{1/2})\}$ . Although not shown in a table, results of analysis from the logarithmic data normally showed high coefficient of determination and small standard deviation.

When the original data was  $\{a_{i,l}^2 \cdot T_k\}$ , a worse result than logarithm-ized data was shown. Although it was the form corresponding to “power equivalent”, the original form had too widely spread elements in the higher  $a$  and  $T$  areas.

**Table 3** Result of MRA for symptom VWF

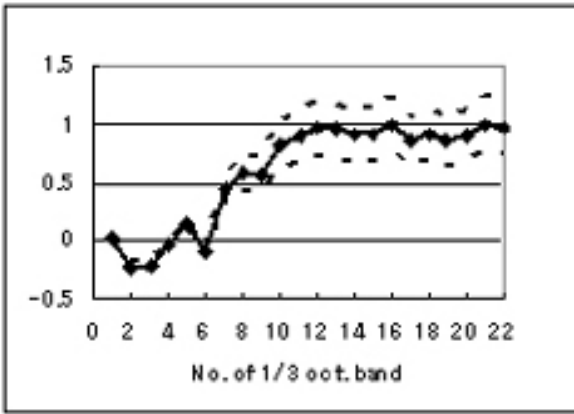
Original data form to PCA	Dependent variable	Independent variable	Adjusted coefficient of determination	F-value of ANOVA	SD ratio
$\{\log(a_{i,l} T_k^{1/2})\}$	$\log(Pr)$ (VWF)	$PC_j$	0.8325	75.57	0.3953
logarithmic base data showed similar result above					
$\{a_{i,l}^2 T_k\}$	$Pr^2$ (VWF)	$PC_j$	0.5832	11.50	0.6010
$\{a_{i,l} T_k^{1/2}\}$	$Pr$ (Numbness)	$PC_j$	0.5472	8.86	0.6190
$\{\log(a_{i,l}^2)\}$	$\log(Pr)$ (Pain)	$PC_j + \log(T)$	0.3896	5.15	0.7190

From original data of all forms, results of MRA showed that frequency elements above 63 Hz were effective and that elements lower than 63 Hz could be disregarded.

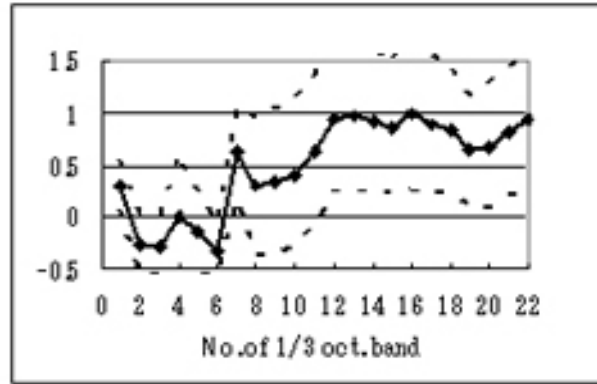
For the symptom of numbness, the best result was obtained from the original data  $\{a_{i,l} T_k^{1/2}\}$ . However, the residual variance was not high enough and the error range of regression coefficients was too large.

For the symptom of joint pain, the significant result was obtained only from the case where  $\{\log(a_{i,l}^2)\}$  was used as original data. However, the result had a high residual variance and was influenced strongly by a specific group.

The coefficient of frequency influence,  $u_i$ , for the symptom VWF and numbness were shown in Fig. 5 and Fig. 6. Dotted line in the figures show the confidence limit of 95 %.



**Figure 5** Influence of frequency for VWF (based on  $\{\log(a_{i,r} T^{1/2}_k)\}$ )



**Figure 6** Influence of frequency for numbness (based on  $\{\log(a_{i,r} T^{1/2}_k)\}$ )

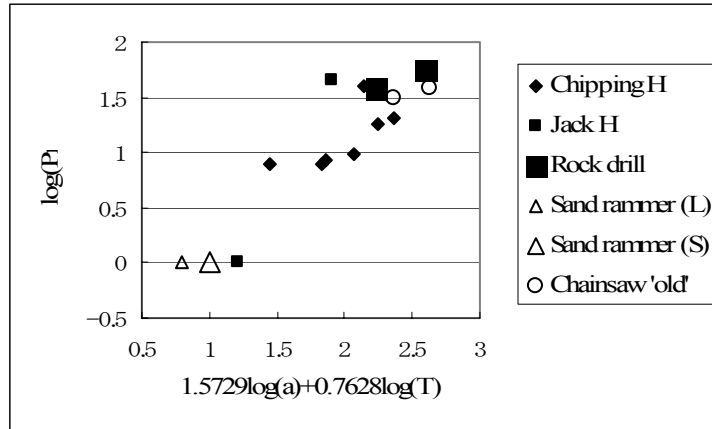
*Simple form line*

Results of MRA in order to test five lines were shown in Table 4. The line No. 2 which had a slight down slope above 63 Hz, -1.5 dB/Oct. was the best among those lines. In Fig. 7 the relationship of  $\log(Pr)$  and  $\log$  of the vibration dose by the line 2 was shown. The other four lines and the flat line showed similar good result. The result of ISO's line had a low coefficient of determination and a high standard deviation ratio. Moreover, the coefficient given to the term of  $V_{sum}$  was less than zero.

Table 4 Result of MRA for VWF (weighting line 2)

Weighting line	Adjusted coefficient of determination	Ratio of Standard deviation	Regression coefficient	
			for $\log(V_{sum})$	for $\log(T)$
Line1	0.8147	0.6193	1.8269	0.7039
Line 2	0.8207	0.6039	1.5729	0.7628
Line 3	0.8202	0.5824	1.3496	0.7971
Line 4	0.8202	0.5614	1.1937	0.8092
Line 5	0.8194	0.5798	1.1007	0.8081
Flat line	0.6321	0.5860	1.6201	0.8124
ISO5349	0.2195	0.8535	-0.3095	0.9386

$$\log(Pr)_{\text{estimated}} = \beta_0 + \beta_1 \cdot \log(V_{sum}) + \beta_2 \cdot \log(T)$$



**Figure 7** Weighted vibration dose and rate of VWF

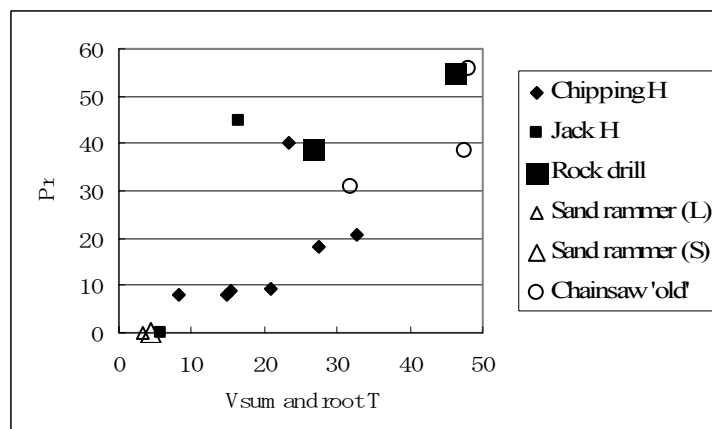
For the symptom of the numbness and the pain no significant result could obtain.

The regression analysis for  $Pr$  and  $a^2 \cdot T$ , showed that line 2 was the best also (Fig. 8). The adjusted coefficient of determination was 0.6429 and the standard deviation ratio was 0.5778. Line 1, Line 3, and the flat line also showed the good result. The result for the symptom of numbness was significant statistically but poor. The result was shown in Table 5.

**Table 5** Result of Regression analysis (weighting line 2)

Weighting line	VWF		Numbness	
	Adjusted coefficient of determination	Ratio of Standard deviation	Adjusted coefficient of determination	Ratio of Standard deviation
Line 1	0.6379	0.5814	0.2329	0.8415
Line 2	0.6429	0.5778	0.2158	0.8508
Line 3	0.6257	0.5910	not significant	not significant
Flat line	0.6321	0.5860	0.1923	0.8634

$$Pr_{estimated} = \beta_0 + \beta_1 \cdot (Vsum \cdot T^{1/2})$$



**Figure 8** Weighted vibration dose and rate of VWF



## **Discussion and Conclusion**

A new weighting line was introduced, which could better explain the data. The group with many VWF influenced people had a high estimated vibration exposure dose. On the other hand, the result obtained from ISO's curve was not good and biased to the exposure time. The Line 2 in Fig. 6 which has the slope -1.5 dB/oct. beyond 63 Hz and 6 dB/oct. below 63 Hz is recommended.

However, there are some common limits in reference to the original data of this study. The data was obtained from small groups and sampling of tool type was biased. The data did not include the group

having long exposure time and low rate of symptom. The vibration measurement had a limit of frequency less than 1.4 kHz. Since many of the subject groups contained about 20 people, the value of rate was thought to have half the range of fluctuation. It could be thought that the same is said of the amount of vibration or exposure time.

This result is a suggestion, which means that the higher frequency area should be evaluated higher and the low frequency area lower than the method of ISO 5349-1.

On the estimation of the vibration dose there is another issue of trade off between vibration value and exposure time. The result in Table 4 and Fig. 7 suggests that the trade off relationship may depend on the weighting curve. Acceleration was estimated high when weighting curve was high in higher frequency.

For the symptom of joint pain, the standard deviation of the rate was small originally, it might not be specific.

## **Reference**

- ISO 5349-1. 2001. Mechanical vibration – Measurement and evaluation of human exposure to hand transmitted vibration – Part 1: General requirements. ISO, Geneva
- Tominaga, Y. 1981. Dose-Response Relation for the Vibration Syndrome. *Vibration effects on the hand and arm in industry* edited by A. J. Brammer and W. Taylor, Wiley-Interscience. pp 277-281.
- Taylor W et al.. 1990. Hand-Arm Vibration Syndrome Health Effects and Safety Standards. *Hand-Arm Vibration* edited by A. Okada, W. Taylor, H. Dupuis, Kyoei-Press Co.. pp 63-66.
- Bovenzi, M. 1998. Exposure-response relationship in the hand-arm vibration syndrome: an overview of current epidemiology research. *Int Arch Occup Environ Health*, pp 509-519.



**Medical IV**

M. Cherniack - Session Coordinator



# REFERENCE VIBROTACTILE PERCEPTION THRESHOLDS ON THE FINGERTIP OBTAINED WITH MALAYSIAN HEALTHY PEOPLE USING ISO 13091-1 EQUIPMENT

R. Daud<sup>1</sup>, S. Maeda<sup>2</sup>, N. N. M. Kameel<sup>3</sup>, M. Y. Ripin<sup>1</sup>,  
N. Bakrun<sup>1</sup>, R. Md. Zein<sup>1</sup>, M. Kido<sup>4</sup>, K. Higuchi<sup>4</sup>

<sup>1</sup> Ergonomics Division, National Institute for Occupational Safety and Health, Malaysia

<sup>2</sup> Department of Human Engineering, National Institute of Industrial Health, Japan

<sup>3</sup> ErgoConsult Sdn Bhd, Malaysia. (Former member of Ergonomics Division).

<sup>4</sup> JICA Project, National Institute of Occupational Safety and Health, Malaysia

## Abstract

The purpose of this paper is to clarify the reference of vibrotactile thresholds for healthy people in Malaysia.

## Introduction

Occupational exposures to hand-transmitted vibration cause a variety of disorders of the fingers, hand, and arms. These include neurological disturbances and vascular disorders (sometimes called Raynaud's phenomenon or vibration-induced white finger) (Griffin, 1990).

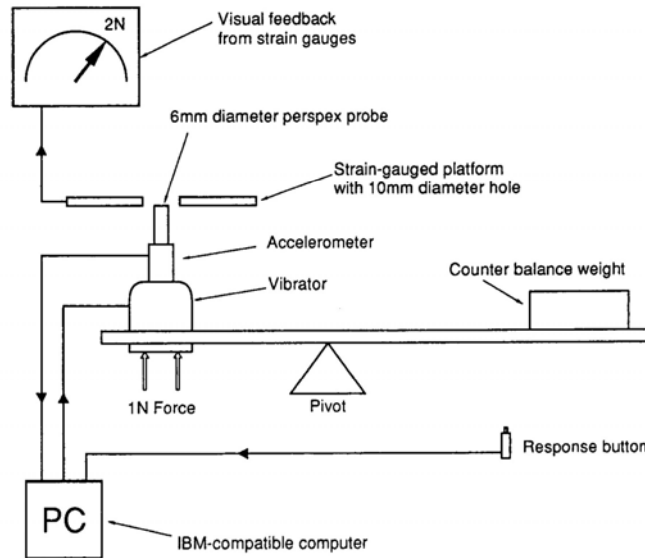
Fingertip vibrotactile thresholds have been used to quantify the neuropathy produced by hand-transmitted vibration (Hayward et al, 1986; Lundborg et al, 1986; Brammer, 1987; Jezter et al, 1987; Lundborg et al, 1987). Vibrotactile thresholds have also been used to estimate the acute physiological effects of hand-transmitted vibration exposure on the sensory system and investigate a permissible limit for occupational exposure to vibration. Many studies have related the temporary threshold shifts (TTS) in vibratory sensation to the severity of vibration exposure (Malinskaya et al, 1964, Radzyukevich, 1969; Harada, 1978a; Harada, 1978b; Nishiyama et al, 1981; Hayward, 1984; Maeda et al, 1987; Maeda et al, 1989; Harada et al, 1991; Maeda, 1991; Maeda et al, 1991; Taoda, 1991). Vibration sense thresholds at the fingertips are sometimes used to evaluate the neuropathy, and the vibrotactile thresholds on the fingers are known to depend on these specifics, measuring equipments, procedure, and method or algorithm (Maeda, 1991; Maeda, 1994; Maeda et al, 1994; Maeda et al, 1995; Lindsell, 1997; Maeda et al, 1997). Researchers around the world have used many different types of vibrotactile measurement equipment. Since 1991 the working group 8 (Vibrotactile Perception) of ISO/TC108/SC4 has been involved in optimizing testing procedures and interpreting vibrotactile perception thresholds. The vibrotactile perception thresholds measurement equipment standard, ISO 13091-1 (2001), was published in ISO/TC108/SC4/WG8 on 2001. And also, the vibrotactile perception thresholds for the assessment of nerve dysfunction for analysis and interpretation of measurements at the fingertips standard, ISO 13091-2 (2001), was published on 2003. In the ISO 13091-2 standard, the reference VPT data were obtained from few research papers. Malaysian people's VPT data was not included in the standard.

The main objective of this study is to measure the fingertip vibrotactile thresholds for the purpose of getting the reference data for the Malaysian people. Besides that, it is also to find a comparison of vibrotactile perception thresholds for male and female. The findings of this study for healthy people will then be compared to ISO 13091-2 by implementation of ISO equipment.

In Malaysia, the study that related to occupational exposures to hand-transmitted vibration had not been carried out and this study can be a good platform and source of reference data for future study.

## Equipment Specification

The computer driven *HVLab* tactile vibrometer developed at the University of Southampton's Institute of Sound and Vibration Research and Human Factors Research Unit. The vibrometer unit housed a vibrator, which was mounted on a counter balance, so as to provide a constant upward force of contact between the probe and the subject's finger as shown in Fig. 1, (ISO-type equipment) which provides computer-controlled measurements of tactile thresholds for vibration stimuli. It consists of a vibrometer and a force meter and a pre-determined set of selected vibration frequencies (in a range 16 to 500 Hz) is automatically presented. During the measurement of the vibrotactile threshold, the magnitude of the vibration is automatically increased until the subject presses the response button. The magnitude is then decreased until the button is released. The process is repeated several times to establish a threshold level for perception of vibration by a similar method to that used in automatic recording audiometers (the Bekesy method). A pre-determined set of selected vibration frequencies (in the range 16 to 500 Hz) is automatically presented. The acceleration magnitude corresponding to the vibrotactile threshold at each frequency is computed at the end of each test using procedure defined in BS 6655 (British Standard Institution 1986) and ISO 6189



**Figure 1** Vibrotactile measurement equipment (ISO-type equipment)

**Table 1** Measurement conditions of the ISO 13091-1 standard equipment.

Contents	ISO 13091-1			
Mechanoreceptor	SAI,	FAI,	FAII	
Frequency (Hz)	4.0,	31.5,	125	
Other frequencies (Hz)	3.15; 5.0	20; 25	100; 160	
Subject support	full length of forearm, hand and finger;			
seat with back rest				
Skin temperature	27 - 36 C			
Test room temperature	20 - 30 C			
Probe tip geometry	flat-ended cylinder, $0.2 \text{ mm} < \text{edges radii} < 0.7 \text{ mm}$			
Smooth to touch				
Probe tip diameter	4.0 mm	2.1 mm diameter		
Skin-stimulator contact	No Surround - Method A Surround - Method B			
skin indentation	1.5	0.8 mm	1.5	0.8 mm
probe-surround gap				1.5 0.6 mm
surround force				0.7 N to 2.3 N
Measurement algorithm	variant of up-down, or von Bekesy			
Vibration measurement	r.m.s. magnitude and frequency of stimuli			

(International Organization for Standardization 1983). First, the peaks (the vibration magnitudes when the response button is pressed) and then through (the magnitude when the button is released) are average separately. The vibrotactile threshold is then taken as the mean of the average peak and the average through. Warning are given if any of the following conditions apply: (1) there are less than 6 reversals (i.e., button presses and releases; the first reversal at every frequency is ignored); (2) the peaks deviate by more than 10 dB among themselves; and (3) the troughs deviate by more than 10 dB among themselves. Standard deviations are also computed, from the square root of the mean variance of the peaks and troughs. A vibrogram, showing the acceleration magnitude at each reversal as a function of time may be viewed on the screen or output to a printer. The system is controlled by an IBM PC compatible computer, which generates the vibration signals to drive the vibrator, monitors the vibration magnitude and the response button and computes the threshold values. As shown in Table 1, the ISO 13091-1 standard defines the requirements for measurement conditions to measure the vibrotactile perception thresholds.

### Experimental Condition

To measure the vibrotactile thresholds using ISO 13091-1 standard equipment, Table 2 shows the used experimental conditions in this experiment. In this experiment, two different frequencies of vibrotactile were selected for preferential activation of separate afferent classes, 31.5 Hz to preferentially fast adapting I (FA I) units and 125 Hz to activate the fast adapting II (FA II) as Pacinian units.

**Table 2** Experimental condition of Method B used in this experiment.

Vibration frequency	31.5 Hz and 125 Hz
Contact area	6 mm diameter (28 mm <sup>2</sup> )
Surrounding	10 mm
Finger push force	2 N
Probe contact force	1 N
Measuring finger	The index finger of right-hand
Each frequency test time	30 s
Measuring method	Bekesy method
Level rate	3 dB/s
Room temperature	22 – 26 C
Finger skin temperature	Above 23 C

### Subjects

Thirty-two subjects (8 males and 24 females) age 22 to 51 participated in this study. The mean age and standard deviation (SD) for males and female is 28.1 years (SD 3.23 years) and 31.7 years (SD 7.32 years) respectively. All subjects are a healthy people and having no history of neuromuscular or vascular disorders. None of them had prior occupational experience operating powered hand tools or had suffered any serious injuries in upper extremity. Table 3 shows other subject body characteristics.

**Table 3** Physical characteristic of the subjects in this experiment.

	<b>n</b>	<b>Age</b> <b>Mean (SD)</b>	<b>Weight (kg)</b> <b>Mean (SD)</b>	<b>Height (m)</b> <b>Mean (SD)</b>
<b>Male</b>	8	28.1 (3.23)	66.27 (13.71)	167.4 (7.16)
<b>Female</b>	24	31.7 (7.32)	55.94 (12.15)	153.8 (3.83)

### Procedure

The instruction sheet shown in Appendix A was presented to the subject before measuring the data. Room temperature was held in the range 22 to 26 C. First, the right-hand finger temperature was measured because it is known that skin temperature will affect vibrotactile thresholds<sup>3)</sup>. The experiment was performed only when the finger temperature was above 23 C.

Each subject was seated with the right forearm laid on an armrest and put the index finger on the right hand on the vibration tip. The subjects have to watch a meter carefully to maintain his push force to the appointed level (2N). Then the technician will start to measure and for the first time the subject will do a practical test to make them clear with the vibration that will appear at the fingertips. After they are familiar with the vibration, the technician will do the actual test and take about 30 second. Fig. 2 shows the HVLab tactile vibrometer and the real measurement at Ergonomics Division of NIOSH in Malaysia.



**Figure 2** Real experimental scene at Ergonomics Division of NIOSH in Malaysia.

### Analytical Methods

For each group of subjects, group means and standard errors were calculated for the detection threshold of each test frequency at the right-hand index fingertip. To analyze the effects of gender, frequency, and age on vibrotactile thresholds, a three way ANOVA with repeated measures, formatted as A x B x C with repeated measures on variables B and C, was used to analyze all the data. Variable A defined as gender, B was defined as frequency and variable C was defined as age.

### Results and Discussion

Table 4 shows the VPT mean results of the current experiment. Three way ANOVA were used to analyze the effects of gender, frequency, and age on vibrotactile thresholds. The results shows that it is significantly effect for frequency ( $F=20.171$ ,  $p=0.002$ , for age ( $F=3.129$ ,  $p=0.043$ ) and for gender ( $F=10.633$ ,  $p=0.010$ ). The overall results of the current study are in agreement with the vibrotactile perception data of the ISO 13091-2 standard.

**Table 4** 50 percentile of vibrotctile perception thresholds for healthy Malaysian persons expressed in metres per second squared of the current results.

Gender	Age years(SD)	Mean 31.5 Hz (SD)	Mean 125 Hz (SD)
Males	28.1(3.2)	0.134(0.065)	0.228(0.09)
Females	31.5(7.4)	0.132(0.098)	0.364(0.413)

From this study it shows that the Malaysian healthy people's vibrotactile perception threshold data at 31.5 Hz and 125 Hz were consistent with the reference data of the ISO 13091-2 standard. Since in Malaysia there is no study have been carried out, this study can be a platform for other study to get a reference data

In order to investigate whether there is any difference in Reference Data of ISO 13091-2, and the mean value of the VPT data obtained in the current experiment, Reference Data of ISO 13091-2 was assumed to be the mean value from a certain population, and t test for a single sample was performed between these experiment data. Consequently, in all data, the hypothesis was not rejected with the significant level  $\alpha= 0.05$ . And these data were compared with the ISO reference data as shown in Table 5 on the ISO 13091-2 standard.

**Table 5** 50 percentile of vibrotctile perception thresholds for healthy persons expressed in metres per second squared of the ISO 13091-2 standard.

Gender	Age years	31.5 Hz	125 Hz
Males	30	0.10	0.25
Females	30	0.12	0.32

The overall results of the current study are in agreement with the vibrotactile perception data of the ISO 13091-2 standard.



## Conclusion

From the comparison of these data as a pilot study, it was clear that the Malaysian healthy people's vibrotactile perception threshold data were consistent with the reference data of the ISO 13091-2.

## Acknowledgement

This study was supported by NIOSH-JICA project of JICA. We would like to thank all NIOSH, DOSH and JICA staff in Malaysia who took part in this research.

## References

- Brammer AJ, 1987. Assessment of impaired tactile sensation. *Scand J Work Environ Health* 13, 380-4
- Griffin MJ, 1990. *Handbook of human vibration*. Academic Press, London.
- Harada N, 1978a. Studies on the changes in the vibratory sensation threshold at the fingertip in relation to some physical parameters of exposed vibration. Part 1. A study on the methods of vibration exposure and measurement of the vibratory sensation threshold. *Jpn J Hyg* 33, 699-705.
- Harada N, 1978b. Studies on the changes in the vibratory sensation threshold at the fingertip in relation to some physical parameters of exposed vibration. Part 2. A study on the equal TTS curves of the vibratory sensation and the hygienic allowable limit of portable mechanized tool. *Jpn J Hyg* 33, 706-17.
- Harada N, Griffin MJ, 1991. Factors influencing vibration sense thresholds used to assess occupational exposure to hand-transmitted vibration. *Brit J Ind Med* 48, 185-92.
- Hayward R, 1984. Temporary threshold shifts in vibrotactile sensitivity: effects of vibration duration, intensity, and frequency. In: *Proceedings of U.K. informal group meeting on human response to vibration*, Heriot-Watt University, Edinburgh, 21-22 September. 36-46.
- Hayward R, Griffin MJ, 1986. Measures of vibrotactile sensitivity in persons exposed to hand-arm vibration. *Scand J Work Environ Health* 12, 423-7.
- ISO 13091-1, 2001. *Mechanical vibration – Vibroactile perception thresholds for the assessment of nerve dysfunction – Part 1: Methods of measurement at the fingertips*,
- ISO 13091-2, 2001. *Mechanical vibration – Vibroactile perception thresholds for the assessment of nerve dysfunction – Part 2: Analysis and interpretation of measurements at the fingertips*,
- Jezter T, Conrad H, Heithoff K, 1987. The role of CT scanning and vibrometry testing in the diagnostic evaluation of carpal tunnel syndrome. In: *Proceedings of Volvo-IFSSH Conference on the prevention of brachial injuries and cumulative trauma disorders*, Stockholm. 53-7.
- Lindsell, C.J, 1997. Vibrotactile thresholds: Effects of contact forces and skin indentation. In: *Proceedings of the United Kingdom Informal Group Meeting on Human Response to Vibration*. Southampton: ISVR.
- Lundborg G, Lie-Stenstrom A-K, Sollerman C, Stromberg T, Pyykko I, 1986. Digital vibrogram: a new diagnostic tool for sensory testing in comparison neuropathy. *Hand Surg* 11A, 693-9.
- Lundborg G, Sollerman C, Stromberg T, Pyykko I, Rosen B, 1987. A new principle for assessing vibrotactile sense in vibration-induced neuropathy. *Scand J Work Environ Health* 13, 375-9.
- Maeda S, Kume Y, 1987. Temporary threshold shift on finger-tip vibratory sensation induced by exposure to octave band vibration. *J. Jpn Ind Manage Associ* 38, 243-8.
- Maeda S, Kume Y, 1989. Temporary threshold shift on finger-tip vibratory sensation induced by exposure to spectrum vibration. *J. Jpn Ind Manage Associ* 40, 336-42.
- Maeda S, 1991. Comparison of the effects of hand-transmitted continuous vibration and shock vibration on temporary threshold shifts in fingertip vibratory sensation. In: *Proceedings of the Anglo-French vibration meeting and the United Kingdom informal group meeting on human response to vibration*, H.S.E., Buxton, 25-27 September. 40-56.
- Maeda, S., 1991. A comparison of measuring equipment and measuring algorithm for vibrotactile thresholds on the fingers. In: *Proceedings of the United Kingdom Informal Group Meeting on Human Response to Vibration*. Southampton, England:ISVR, Southampton, England.

- Maeda S, Kume Y, 1991. Temporary threshold shift on finger-tip vibratory sensation induced by exposure to intermittent vibration (on the exposure-equivalent rule). *J. Jpn Ind Manage Associ* 42, 105-11.
- Maeda, S., 1994. A comparison of vibration acceleration magnitude obtained with different vibrotactile threshold measuring equipment. In: *Proceedings of the Japan Informal Group Meeting on Human Response to Vibration*. Kawasaki:NIH.
- Maeda S, Griffin MJ, 1994. A comparison of vibrotactile thresholds on the finger obtained with difference equipment. *Ergonomics* 37, 1391-406.
- Maeda, S. and Griffin, M.J., 1995. A comparison of vibrotactile thresholds on the finger obtained with different algorithms. *Arbete och Hals*. 5, 85-95.
- Maeda, S., Morioka, M., Yonekawa, Y., Kanada, K., Takahashi, Y., 1997. A comparison of vibrotactile thresholds on the finger obtained with ISO type equipment and Japanese equipment. *Industrial Health*. 35, 343-52.
- Malinskaya NN, Filin AP, Shkarinov LN, 1964. Problem of occupational hygiene in operating mechanical tools. *Vestnik Academy Med Sci, USSR*, 19, 31-6.
- Nishiyama K, Watanabe S, 1981. Temporary threshold shift of vibratory sensation after clasping a vibrating handle. *Int Arc Occup Environ Health* 49, 21-3.
- Radzyukevich TM, 1969. Interrelation of temporary and permanent shifts of vibration and pain sensitivity threshold under the effect of local vibration. *Gigiena Truda I Professional'nye Zabolevaniya* 14, 20-3.
- Taoda K, 1991. Temporary threshold shift of vibratory sensation (TTSv) induced by the composite band vibration exposure. *J Shiga Univ Med Sci* 6, 117-26.

# ROVOKED RESPONSES IN TACTILE PERCEPTION FROM EXPOSURE TO SIMULATED POWER TOOL VIBRATIONS

D.R. Peterson<sup>1</sup>, A.J. Brammer<sup>1,2</sup>, M.G. Charniack<sup>1</sup>

<sup>1</sup> Biodynamics Laboratory, Department of Medicine, University of Connecticut, Farmington, CT 06030-6210 USA

<sup>2</sup> Institute for Microstructural Sciences, National Research Council, Ottawa, Ontario K1A 0R6 Canada

## Introduction

Repetitive shock and vibration are routinely encountered with the use of powered and manual hand tools and have been associated with neurologic and neurovascular disorders of the hand. This study was designed to assess the extent and duration of temporary threshold shifts (TTS), produced by continuous or impulsive vibratory simulation, in three different mechanoreceptor populations that determine sensory function in the fingers.

## Method

To study the effects of temporal vibration patterns that are characteristic of real tools, waveforms consisting of exponentially decaying sinusoidal signals have been synthesized to simulate impacts containing predominantly low or high carrier frequencies (125 or 1250 Hz). Repetition rates were varied from 4 to 32 impacts per second while holding the frequency-weighted acceleration of the generated stimulus at specific RMS values. (ISO 5349-1, 2001) In addition to impact simulations, waveforms that contain continuous vibration frequencies of 125 and 1250 Hz serve for comparisons with continuous vibration exposure. The stimulus was generated using an electro-dynamic vibration exciter driven by the synthesized waveform and was coupled to the hand-arm system by means of a handle containing acceleration and grip sensors (Figure 1). The repetition rates of the transient stimulus were chosen to both be representative of common power tools and fall within the range of frequencies at which the vibration perception threshold (VPT) is mediated by a single mechanoreceptor population. (ISO 13091-1, 2001) The VPTs were measured using a custom tactometer. (Brammer et al., 1991) TTS in vibrotactile perception was determined at selected time intervals following termination of the stimulus over a 50-minute recovery period following an 8-minute exposure interval. Ten subjects, 5 having industrial experience with vibratory tools and 5 without industrial experience, were recruited for this study.

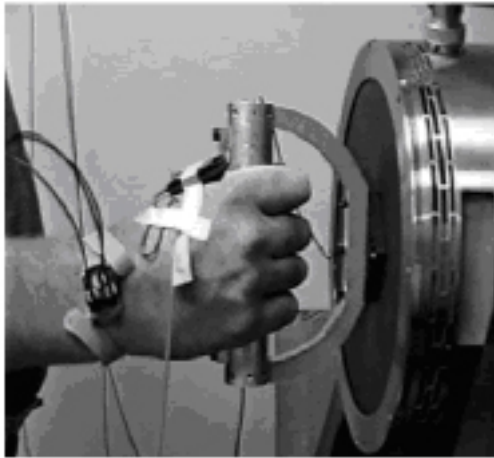


Figure 1 Stimulus Handle

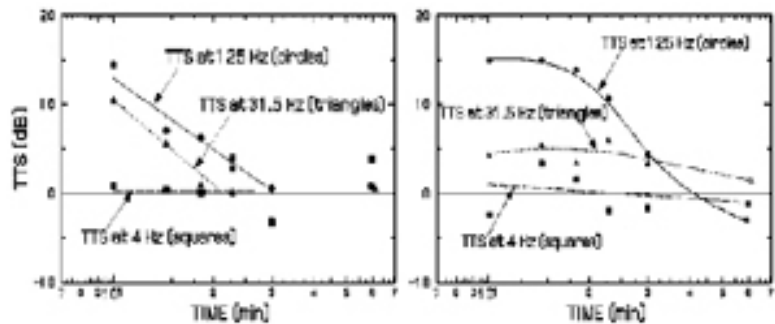


Figure 2 Common Stimulus Response Functions for TTS

## Results

TTS occurred after exposure to relatively low frequency-weighted accelerations ( $\leq 2.0$  m/s<sup>2</sup>) at the lower carrier frequency (125 Hz). Shock type stimuli frequently produced less short-term physiologic change than continuous vibration under these experimental conditions. Table 1 presents the mean maximum TTS of the subject group and shows differential effects at the three frequencies, which were chosen to elicit responses from the SAI (4 Hz), FAI (32 Hz), and FAII (125 Hz) mechanoreceptor populations. Substantial differences in response were also observed between subjects, both in the magnitude of the TTS and in the form and rate of the recovery function. On average, there was little or no TTS at 4 Hz in response to any of these stimuli. As presented in Figure 2, recovery commonly followed a logarithmic

time dependence after the termination of exposure approaching the un-adapted threshold recorded prior to the stimulus after about 20 min for TTS at 125 Hz, and 10 min for TTS at 31.5 Hz. The TTS at 31.5 Hz seems to be, on average, little affected by the nature of the stimuli in contrast to that at 125 Hz, which is substantially less for the slower repetition rate (Table 1).

**Table 1** Mean Maximum TTS

STIMULUS	MEAN MAXIMUM TTS (dB)		
	4 Hz	32 Hz	125 Hz
Shock, 4 repetitions per second, 125 Hz carrier	0.9	6.4	7.8
Shock, 4 repetitions per second, 1250 Hz carrier	1.5	2.5	0.9
Shock, 16 repetitions per second, 125 Hz carrier	1.8	4.5	12.8
Shock, 16 repetitions per second, 1250 Hz carrier	0.3	0.3	3.2
Shock, 32 repetitions per second, 125 Hz carrier	0.1	7.0	13.9
Shock, 32 repetitions per second, 1250 Hz carrier	0.8	3.1	4.9
Continuous, 125 Hz	0.8	6.4	13.3
Continuous, 1250 Hz	0.3	0.7	3.7

### Conclusions

The results contradict current engineering approaches to tool design and exposure control. Small variations in mechanoreceptor response, delineated by the temporal variations the vibration waveforms, suggest that the primary influence on TTS is more related to the frequency-weighting function used to form  $a_w(t)$ , than the procedure for summing shocks. The results also suggest that the relative hazards of vibration at different frequencies may be inappropriately quantified by the ISO weighting.

### References

- Brammer, A.J. and Piercy, J.E. 1991. Measuring vibrotactile perception thresholds at the fingertips of power tool operators. Proc. UK Informal Group on Human Response to Vibration, Buxton, UK. pp. 1-7
- ISO 5349-1. Mechanical vibration - Measurement and evaluation of human exposure to hand-transmitted vibration - Part 1: General requirements. International Standards Organization, Geneva, 2001
- ISO 13091-1. Mechanical vibration - Vibrotactile perception thresholds for the assessment of nerve dysfunction - Part 1: Methods of measurement at the fingertips. International Standards Organization, Geneva, 2001

# EFFECT OF HANDLE TEMPERATURE ON TEMPORARY THRESHOLD SHIFT OF FINGERTIP VIBRATION SENSATION AND FINGER SKIN TEMPERATURE

K. Yokoyama, Y. Takahashi, M. Inoue, K. Suizu, M. S. Laskar, M. H. Mahbub, H. Ohnari, N. Harada

Department of Hygiene, Yamaguchi University School of Medicine, Ube 755-8505, Japan

## Abstract

There are some reports on effects of vibration frequency, acceleration, and room temperature on temporary threshold shift (TTS) of fingertip vibration sensation. Handle temperature seems to affect TTS of fingertip vibration sensation. The aim of the present study was to investigate the effect of different handle temperatures on TTS of fingertip vibration sensation. Six healthy male subjects were exposed to acute vibration with frequency at 125 Hz and acceleration at  $46 \text{ m/s}^2$  (rms) at different handle temperatures of 10, 20 or 30 °C for 0.5, 1, 3, 5 or 10 min in a temperature controlled room at  $24 \pm 1$  °C. Immediately after vibration exposure or handle gripping only, the fingertip vibration sensation threshold at 125 Hz was measured at the tip of the right-middle finger. The TTS was larger at lower handle temperature after acute vibration exposure of same duration. After gripping of the handle at lower temperature, the TTS was larger with longer gripping durations. The FST decreased when subjects were gripping handle with or without vibration exposure with 3, 5 or 10 min of gripping time. From the results, it can be concluded that TTS is large at lower handle temperature and is larger with acute vibration exposure followed by the situation with longer handle gripping time.

## Introduction

Hand-arm vibration syndrome has been investigated in Japan from about 1960. There is a little number of people still recognizing as a designated sufferer on their job. Measurements of vibratory sensation have been useful in investigating hypoesthesia in vibration tool operators and for evaluating the acute effects of vibration exposure. Temporary threshold shift (TTS) of fingertip vibration sensation is considered as a bio effect evaluation parameter. Several researchers ((Nishiyama et al, 1981; Harada et al, 1991; Yonekawa et al, 1998) investigated TTS of fingertip vibration sensation induced by vibration exposure. The TTS of fingertip vibration sensation is influenced by gripping force, gripping time, vibration acceleration level, vibration exposure frequency, etc. But the effect of handle temperature on TTS of fingertip vibration sensation has not been investigated well. Therefore, the aim of this study was to investigate the effect of handle temperature on the TTS of fingertip vibration sensation, and the effect of handle temperature on finger skin temperature (FST) was also investigated.

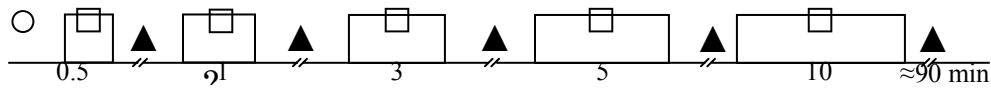
## Subjects and Methods

Six male university students (age:  $22.7 \pm 1.1$ , BMI:  $21.0 \pm 1.9$ ) participated in this study. They were without any history of peripheral neuropathy or of upper limb disorders. All subjects gave written informed consent before being included in the study.

The handle made by duralumin weighted 0.8 kg was mounted on Electro-mechanical Shaker driven by a power amplifier and a vibration controller (MES652 AKASHI, Japan) for grasping by the subjects. It was hollowed and water flowed through. A thermostat water circulation control device (UA-100G TOKYO RIKAKIKAI, Japan) was used to control the temperature of flowing water, and the handle temperature was controlled at 10, 20 or 30 °C. The handle was equipped with a strain gauge enabling monitoring the grip force with a signal conditioner (CDV-700A KYOWA, Japan). The grip force was constant at 10 N. The posture of subjects during the study was controlled; they were sitting on a chair and the arm along with the forearm was extended forward making approximately 90° angle with the trunk.

Room temperature was kept constant at  $24 \pm 1$  °C. Vibration frequency acceleration was  $46 \text{ m/s}^2$  (rms) and vibration exposure frequency was 125 Hz. The vibration exposure conditions (exposure or without exposure) and handle temperature of 10, 20 or 30 °C were randomized.

Figure 1 shows the details of the experimental protocol. At first, fingertip vibration sensation was measured for three times, and then the subjects gripped the handle with or without vibration. The handle gripping times were for 0.5, 1, 3, 5 or 10 min. After vibration exposure, the TTS of fingertip vibration sensation on the right-middle fingertip and FST on dorsal part of the right middle phalanx were measured.



**Figure 1** Experimental protocol

- : Measurements of initial fingertip vibration sensation threshold and finger skin temperature (FST);
- : Handle gripping time (with or without vibration);
- ▲: Measurement of fingertip vibration sensation threshold at 0.25 min, 0.5 min, 1 min, and thereafter every minute after handle gripping until the fingertip vibration sensation threshold returns to the initial, and FST measured at the same time.

Vibration sensation threshold was measured using a vibratory sensation meter (AU-02A RION, Japan). Before and after acute vibration exposure or handle gripping only, fingertip vibration sensation threshold was measured on the subjects. Vibrotactile test frequency was 125 Hz. Before exposure, fingertip vibration sensation was measured for three times. After acute vibration exposure or handle gripping only, the vibration sensation threshold was measured and the TTS of fingertip vibration sensation was calculated.

At the same time of vibration sensation threshold measurements, the FST was measured on the dorsal part of the right-middle phalanx by a digital thermometer (MODEL-D317 TAKARA, Japan) before and after acute vibration exposure or handle gripping only.

The TTS of fingertip vibration sensation and FST at 0.25 min after handle gripping for 0.5, 1, 3, 5 or 10 min with or without acute vibration exposure were presented as mean  $\pm$  SD. Three-way analysis of variance was used to investigate effect of handle temperature during handle gripping with or without acute vibration exposure.

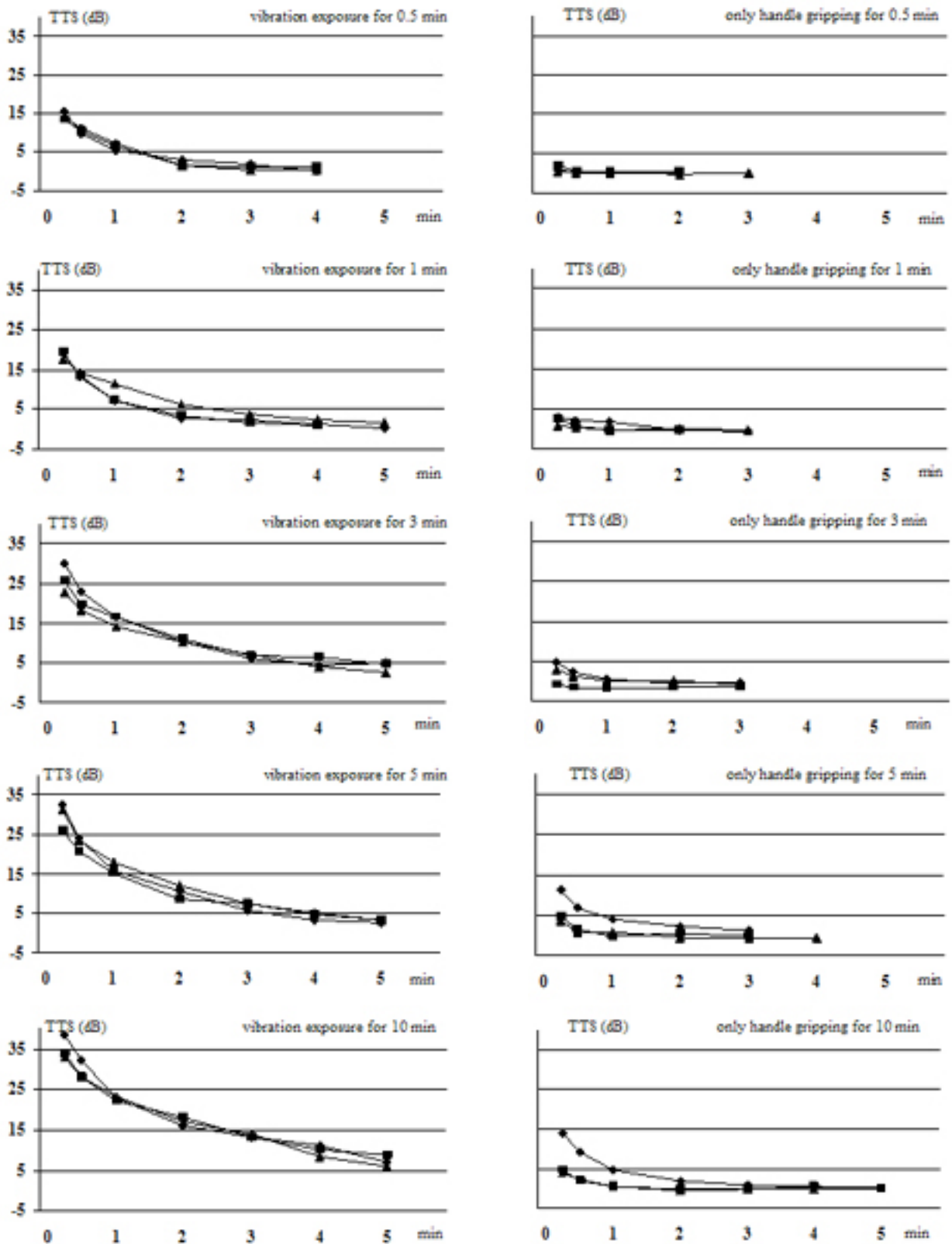
## Results

Figure 2 shows the recovery process of the TTS of fingertip vibration sensation after handle gripping for 0.5, 1, 3, 5 or 10 min at handle temperature of 10, 20 or 30 °C with or without acute vibration exposure. The TTS of fingertip vibration sensation at 10 °C handle temperature was larger than those at other temperatures with handle gripping time for 0.5, 1, 3, 5 or 10 min with acute vibration exposure. The recovery curves of the TTS of fingertip vibration sensation showed similar levels after the same handle gripping time with acute vibration exposure at handle temperature of 10, 20 or 30 °C and the values returned to the initials after 10 min maximum. The recovery curves of the TTS of fingertip vibration sensation measured after handle gripping without acute vibration exposure also returned to the initials similarly, but the time required for was 5 min maximum.

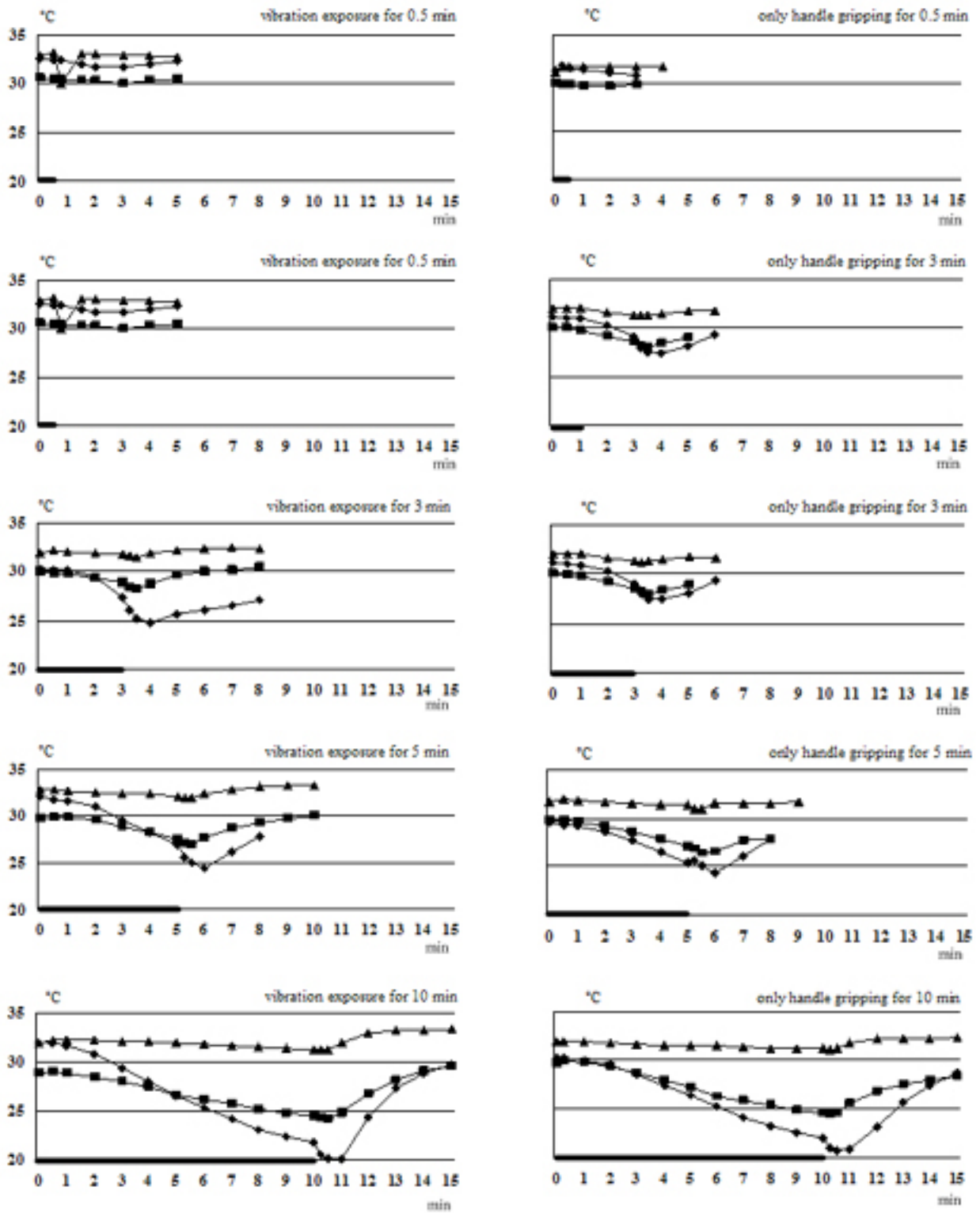
Figure 3 shows the recovery process of the FST after handle gripping for 0.5, 1, 3, 5 or 10 min at handle temperature of 10, 20 or 30 °C with or without acute vibration exposure. When handle gripping time was 0.5 or 1 min with or without acute vibration exposure, the FST did not change so much. The FST decreased just after handle gripping with or without acute vibration exposure and an increase was observed thereafter when handle gripping time was 3, 5 or 10 min.

Table 1 shows the TTS of fingertip vibration sensation measured on the right-middle fingertip at 0.25 min after handle gripping with or without acute vibration exposure. The handle temperature (10, 20 or 30 °C) factor after 0.5 and 1 min of handle gripping time was not significant. The vibration exposure factor (with or without) was significant with all handle gripping times ( $p < 0.01$ ). The handle temperature (10, 20 or 30 °C) factor was significant after 3, 5 ( $p < 0.05$ , respectively) or 10 min ( $p < 0.01$ ) of handle gripping time. The TTS of fingertip vibration sensation is larger in case of longer handle gripping time followed by the condition with acute vibration exposure. The TTS of fingertip vibration sensation tended to be larger when the handle temperature was lower.

Table 2 shows the FST measured on the right-middle finger at 0.25 min after handle gripping with or without acute vibration exposure. The handle temperature factor was significant after handle gripping time of 0.5, 1, 3, 5 or 10 min ( $p < 0.05$ , respectively). The vibration exposure factor was not significant for all situations of FST at 0.25 min after handle gripping with or without acute vibration exposure.



**Figure 2** Recovery process of the temporary threshold shift of fingertip vibration sensation after handle gripping for 0.5, 1, 3, 5 or 10 min at handle temperature of 10, 20 or 30 °C with or without acute vibration exposure. Data are mean values of 6 subjects. ♦: 10 °C, ■: 20 °C, ▲: 30 °C.



**Figure 3** Changes of finger skin temperature during and after handle gripping for 0.5, 1, 3, 5 or 10 min at handle temperature of 10, 20 or 30 °C with or without acute vibration exposure. Data are mean values of 6 subjects.

◆: 10 °C, ■: 20 °C, ▲: 30 °C, : gripping time.



**Table 1** TTS of fingertip vibration sensation at 0.25 min after handle gripping with or without acute vibration exposure; TTS<sub>0.25</sub> (dB)

Handle temperature	Vibration exposure	TTS <sub>0.25</sub> (dB)				
		Handle gripping time				
		0.5 min	1 min	3 min	5 min	10 min
10 °C	Yes	15.6 ± 3.9	19.0 ± 3.6	30.3 ± 6.0	31.8 ± 3.6	38.6 ± 7.8
	No	1.0 ± 1.0	2.8 ± 2.4	4.9 ± 4.1	11.5 ± 5.5	13.9 ± 6.2
20 °C	Yes	13.6 ± 3.8	18.2 ± 4.6	25.7 ± 5.0	26.3 ± 2.7	33.8 ± 4.2
	No	1.7 ± 2.8	2.2 ± 1.7	1.2 ± 1.4	4.7 ± 2.3	4.6 ± 4.2
30 °C	Yes	14.2 ± 7.1	18.3 ± 7.4	25.6 ± 3.2	30.1 ± 7.1	32.7 ± 4.9
	No	0.6 ± 0.7	1.1 ± 2.0	3.2 ± 1.9	3.8 ± 4.2	4.0 ± 3.6
Handle temperature factor		ns	ns	*	*	**
Vibration exposure factor		**	**	**	**	**

Data are mean ± SD. ns, not significant, \*: p<0.05, \*\*: p<0.01 (Three-way analysis of variance).

**Table 2** Finger skin temperature measured on the right-middle finger at 0.25 min after handle gripping with or without acute vibration exposure; FST<sub>0.25</sub> (°C)

Handle temperature	Vibration exposure	FST <sub>0.25</sub> (°C)				
		Handle gripping time				
		0.5 min	1 min	3 min	5 min	10 min
10 °C	Yes	32.5 ± 1.8	32.0 ± 1.8	27.6 ± 3.8	26.0 ± 1.1	21.0 ± 1.4
	No	31.7 ± 2.1	30.5 ± 3.3	29.0 ± 2.4	24.9 ± 3.3	21.1 ± 3.1
20 °C	Yes	30.4 ± 3.0	30.0 ± 3.9	28.3 ± 3.8	27.1 ± 2.7	24.3 ± 1.6
	No	29.8 ± 4.0	29.8 ± 4.1	28.2 ± 3.1	26.9 ± 2.2	24.3 ± 2.0
30 °C	Yes	33.0 ± 1.2	32.1 ± 2.3	31.7 ± 1.1	32.0 ± 0.5	31.2 ± 0.7
	No	31.7 ± 2.7	32.0 ± 1.4	31.3 ± 1.7	31.3 ± 1.3	31.0 ± 0.8
Handle temperature factor		**	**	*	**	**
Vibration exposure factor		ns	ns	ns	ns	ns

Data are mean ± SD. ns: not significant, \*: p<0.05, \*\*: p<0.01 (Three-way analysis of variance).

## Discussion

The study investigated the effect of different handle temperatures on the TTS of fingertip vibration sensation after handle gripping with or without acute vibration exposure. The TTS of fingertip vibration sensation was observed after all

handle gripping times at different handle temperatures with or without acute vibration exposure. The TTS of fingertip vibration sensation was larger when handle gripping time was longer at the same handle temperature with or without acute vibration exposure. Moreover, the TTS of fingertip vibration sensation was further larger when handle temperature was lower. When handle gripping time with or without acute vibration exposure was the same, the TTS of fingertip vibration sensation was larger with acute vibration exposure. The difference in the TTS of fingertip vibration sensation was small when handle temperature was lower and handle gripping time was longer.

The FST decreased when subjects were gripping handle with or without vibration exposure with 3, 5 or 10 min of gripping time. It is reported that FST changes by vibration exposure test (Kondo et al, 1987). It is pointed out that a reduction in FST after vibration exposure depends on gripping force (Sakurai, 1977). Moreover, FST was reported to decrease by vibration exposure (Sakurai, 1977, Scheffer et al, 1989). But the changes in FST in these studies were not so large.

In the present study, when handle temperature was 10 °C with or without vibration exposure and gripping was for 10 min, the FST declined about for 10 °C. Handle temperature factor influenced more on FST than gripping force and room temperature, and that is due to difference in heat conductivity between air and metal. Gradual loss of sensitivity has been reported when hand skin temperature was lowered to 20 °C and 15 °C from 40 °C and 25 °C, respectively (Verrillo et al, 1986). It has been reported that there are some differences in the density of tactile units in palm and fingertip areas of the human hand (Vallbo et al, 1984).

Handle temperature may affect FST and consequently FST changes may influence TTS of fingertip vibration sensation. It can be concluded that the TTS of fingertip vibration sensation is large at lower handle temperature and is larger with acute vibration exposure followed by the situation with longer handle gripping time.

### References

- Harada, N. and Griffin, M.J. 1991. Factors influencing vibration sense thresholds used to assess occupational exposures to hand transmitted vibration. *British Journal of Industrial Medicine*, vol 48, pp 185-182.
- Kondo, T., Sakakibara, H., Miyao, M., et al. 1987. Effect of exposure to hand-transmitted vibration on digital skin temperature change. *Industrial Health*, vol 25, pp 41-53.
- Nishiyama, K. and Watanabe, S. 1981. Temporary threshold shift of vibration sensation after clasping a vibrating handle. *International Archives of Occupational and Environmental Health*, vol 49, pp 21-33.
- Nishiyama, K., Taoda, K., Yamashita, H. and Watanabe, S. 1994. Application of a new, self-recording, vibratory sensation meter to measure temporary threshold shift of vibratory sensation caused -by local vibration exposure. *International Archives of Occupational and Environmental Health*, vol 66, pp 97-102.
- Sakurai, T. 1977. Vibration effects on hand-arm-system part 2. observation of skin temperature. *Industrial Health*, vol 15, pp 59-66.
- Scheffer, M. and Dupuis, H. 1989. Effect of combined hand-arm vibration and cold on skin temperature. *International Archives of Occupational and Environmental Health*, vol 61, pp 375-378.
- Yonekawa, Y., Maeda, S., Morioka, M., Kanada, K. and Takahashi, Y. 1998. Prediction of TTS for hand intermittent vibration. *Industrial Health*, vol 36, pp 191-196.
- Vallbo, A.B. and Johanson, R.S. 1984. Properties of cutaneous mechanoreceptors in the human hand related to touch sensation. *Human Neurobiology*, vol 3, pp 3-14.
- Verrillo, R.T. and Bolanowski, S.J.Jr. 1986. The effects of skin temperature on the psychophysical responses to vibration on glabrous and hairy skin. *Journal of Acoustical Society of America*, vol 80, No2, pp 528-532.

# CHANGES IN VIBROTACTILE PERCEPTION WITH MANUAL WORK: A PROSPECTIVE STUDY OF FORESTRY WORKERS

A. J. Brammer<sup>1,2</sup>, P. Sutinen<sup>3</sup>, I. Pyykkö<sup>4</sup>, E. Toppila<sup>4,5</sup>, J. Starck<sup>5</sup>

<sup>1</sup> Ergonomic Technology Center, University of Connecticut Health Center, Farmington, CT U.S.A.

<sup>2</sup> Institute for Microstructural Sciences, National Research Council, Ottawa, ON Canada

<sup>3</sup> Department of Physical Medicine and Rehabilitation, North Karelia Central Hospital, Joensuu, Finland

<sup>4</sup> Department of Otorhinolaryngology, Tampere University Hospital, Tampere, Finland

<sup>5</sup> Department of Physics, Institute of Occupational Health, Helsinki, Finland

## Introduction

Symptoms suggestive of reduced tactile function are commonly reported as numbness in the fingers or hands, paresthesias, a reduction in handgrip or difficulty performing fine manipulative tasks. Such symptoms are commonly experienced by manual workers, and especially by persons who operate power tools (2Coutu-Wakulczyk et al. 1997). The purpose of the present work was to explore the potential for detecting small changes in mechanoreceptor-specific vibrotactile perception threshold (VPT) at the fingertips of a manual worker, and whether this metric, which, by implication, reflects changes in tactile acuity, is related to the commonly described sensorineural symptoms.

## Methods

A five-year prospective study was conducted on a small group of manual workers (N=23) who operate chain saws, or brush cutters, for evidence of work-related sensory changes in their hands. The workers initially constituted almost 20 % of a larger cohort, 30% of which reported neurosensory symptoms in 1990 (Koskimies et al., 1992). The workers underwent a physical examination and completed a questionnaire about their health and work. A recently developed method was employed for detecting small changes in mechanoreceptor-specific VPTs related to tactile function in individual hands (Brammer et al., in preparation). The method involves determining the change in threshold over a time interval of several years, as well as the shift in threshold relative to the mean VPT recorded at the fingertips of healthy persons. The statistical significance of the observed threshold change is assessed against the known threshold test-retest repeatability for the apparatus and measurement algorithm. The magnitude of the threshold shift is assessed against the distribution of VPTs observed in a population of healthy persons.

## Results

Of the 23 persons admitted to the study in 1990, 18 returned for re-examination in 1995. Four of the missing workers were no longer working (non-work related disease or injury): one worker could not be traced. The results are based on data from the 18 workers who attended both examinations.

In 1995, 33% of the workers reported numbness in the hands, 22% reported nocturnal numbness in the arms that caused awakening at night, 33% reported pain in the hands, forearm, (upper) arm or throughout the upper extremity, and 39% reported neck pain. The maximum handgrip force was measurably less in five subjects, and static and dynamic tests of arm upper extremity and upper torso strength would suggest a reduced work capacity in these forest workers. In all 10/18 (56%) subjects reported one or more symptoms. Eleven percent of the workers were smokers.

Statistically significant positive threshold shifts (i.e., reductions in acuity) were found in one hand in 1990 (3%), and five hands in 1995 (14%) ( $p < 0.0014$ ). Four patterns of threshold shift could be identified, involving either one or both hands, and either one or both median and ulnar sensory nerves. The most common pattern involved both hands and both nerves.

Statistically significant positive threshold changes (i.e., reductions in acuity) were recorded in 50% of the hands over the five-year period ( $p < 0.0014$ ). If the threshold change applicable to lifestyle and environmental factors during the five years is included, then 33% of the workers are found to be experiencing work-related threshold changes in their hands. The threshold shifts were correlated to the total time operating chain saws, and both threshold shifts and threshold changes were negatively correlated to the maximum handgrip.

When using the threshold shift recorded in 1995 as a test for the presence or absence of numbness, the positive predictive value of the threshold shift recorded in the hand with worse tactile acuity was 71% and the false positive rate 18%. The sensitivity was 83% and the specificity was 82%.

### **Conclusions**

While only 14% of the hands possessed VPTs that were reduced in acuity relative to those of the hand of healthy persons in 1995, 50% of the hands deteriorated in acuity over the course of the study. Thus the prognosis for these workers is disturbing if the current pattern of work is continued. The threshold shift, as constructed in this analysis, may be used as a predictor of numbness.

### **References**

Brammer, A.J., Piercy, J.E., Pyykkö, I., Toppila, E. and Starck, J. Method for detecting small changes in vibrotactile perception related to tactile function. (in preparation)

Coutu-Wakulczyk, G., Brammer, A.J. and Piercy, J.E. 1997. Association between a quantitative measure of tactile acuity and hand symptoms reported by operators of power tools. *J Hand Surg*, 22A: 873-881.

Koskimies, K., Pyykkö, I., Starck, J. and Inaba, R. 1992. Vibration syndrome among Finnish forest workers between 1972 and 1990. *Int Arch Occup Environ Health*, 64: 251-256.

**Measurement III**  
S. Maeda - Session Coordinator



# ANALYSIS OF FINGERTIP/PROBE INTERACTION IN THE VIBROTACTILE TESTS

J. Z. Wu, R.G. Dong, A.W. Schopper

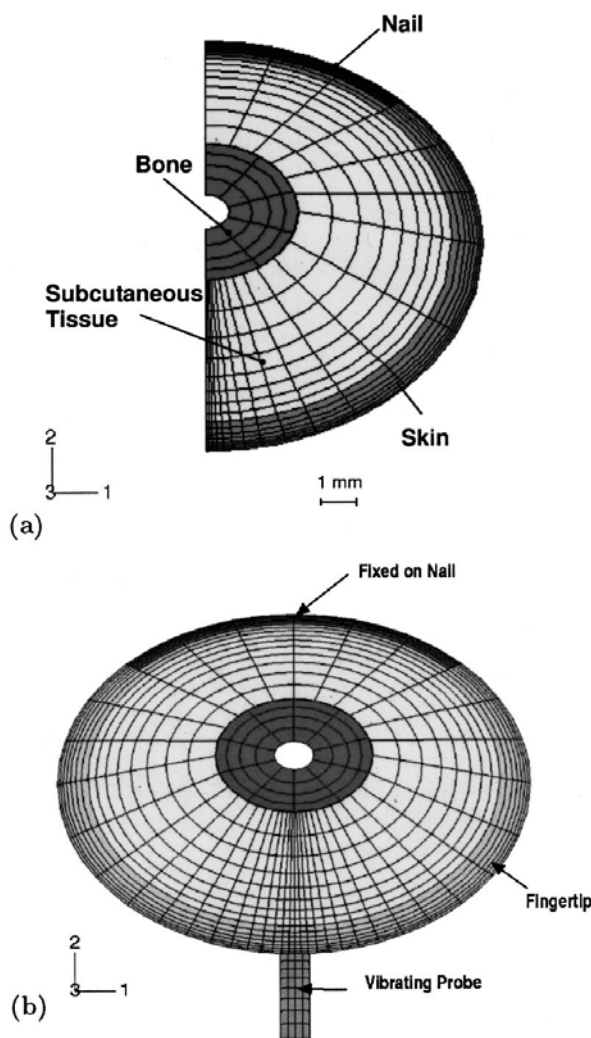
National Institute for Occupational Safety and Health, Morgantown, West Virginia, USA

## Introduction

The measurement of vibrotactile perception threshold has been often used to assist in the diagnosis of the severity of peripheral neuropathy associated with hand-arm vibration syndrome (Lindsell and Griffin, 1999). The vibration perception threshold has been found to depend on the contact force, vibration frequency and magnitude, and finger skin temperature. However, the biomechanics of the tactile sensation underlying these phenomena remains unclear. Since the mechanoreceptors embedded in the skin sense their mechanical environment, the variations in the test conditions will influence the stress/strain distributions in the soft tissues and thus affect the reliability of the test results. The purpose of the present study is to analyze, theoretically, the effects of decoupling of the probe from the skin surface on vibrotactile threshold.

## Method

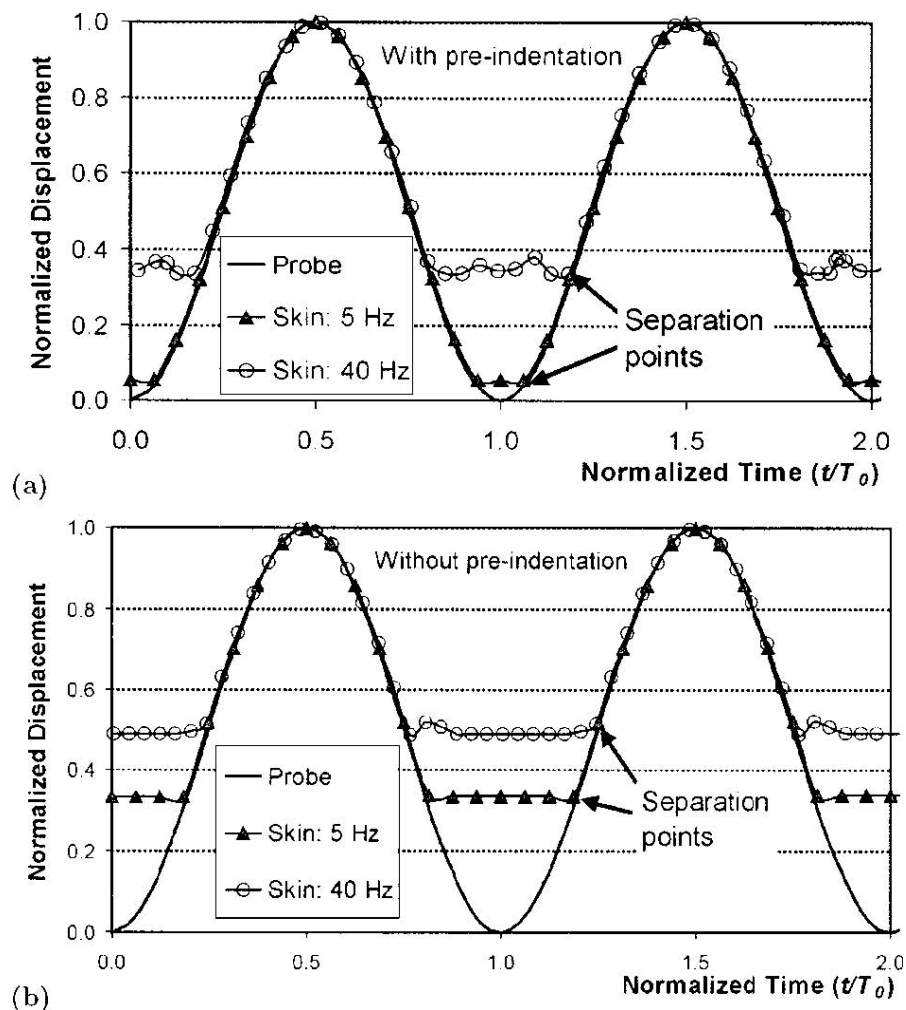
The mechanical responses of the fingertip are analyzed using a multilayered two-dimensional finite element model (Fig. 1a) (Wu et al., 2003). The fingertip is assumed to be composed of a skin layer representing epidermis and dermis, subcutaneous tissue, bone, and nail. The dimensions of the fingertip are assumed to be representative of the index finger of a male subject. The skin tissue is assumed to be hyperelastic and linearly viscoelastic. The subcutaneous tissue is assumed to be a biphasic material composed of a fluid phase and a hyperelastic solid phase. The nail and the bone are considered as linearly elastic. The numerical simulations have been designed to mimic the experiments conducted by Goodwin et al. (1989). The fingertip is assumed to be fixed on the nail surface, while a steel probe is subjected to a vertical sinusoidal motion (Fig. 1b). The proposed model is used to predict the time-dependent deformation profile of the skin surface, the time histories of the contact force, and the time-dependent distributions of stress/strain within the soft tissues of the fingertip. Since fingertips are believed to sense the spatial summations of stimuli (Goble et al., 1996), we have further analyzed the variations in the spatial summations of the vertical deformation, horizontal and vertical strains,  $u_2$ ,  $E_{11}$ , and  $E_{22}$ , respectively, within soft tissues around the stimulus spot.



**Figure 1** Finite element model of the fingertip/probe interaction. (a) The fingertip model. (b) The modeling of the response of a fingertip to repeated loading.

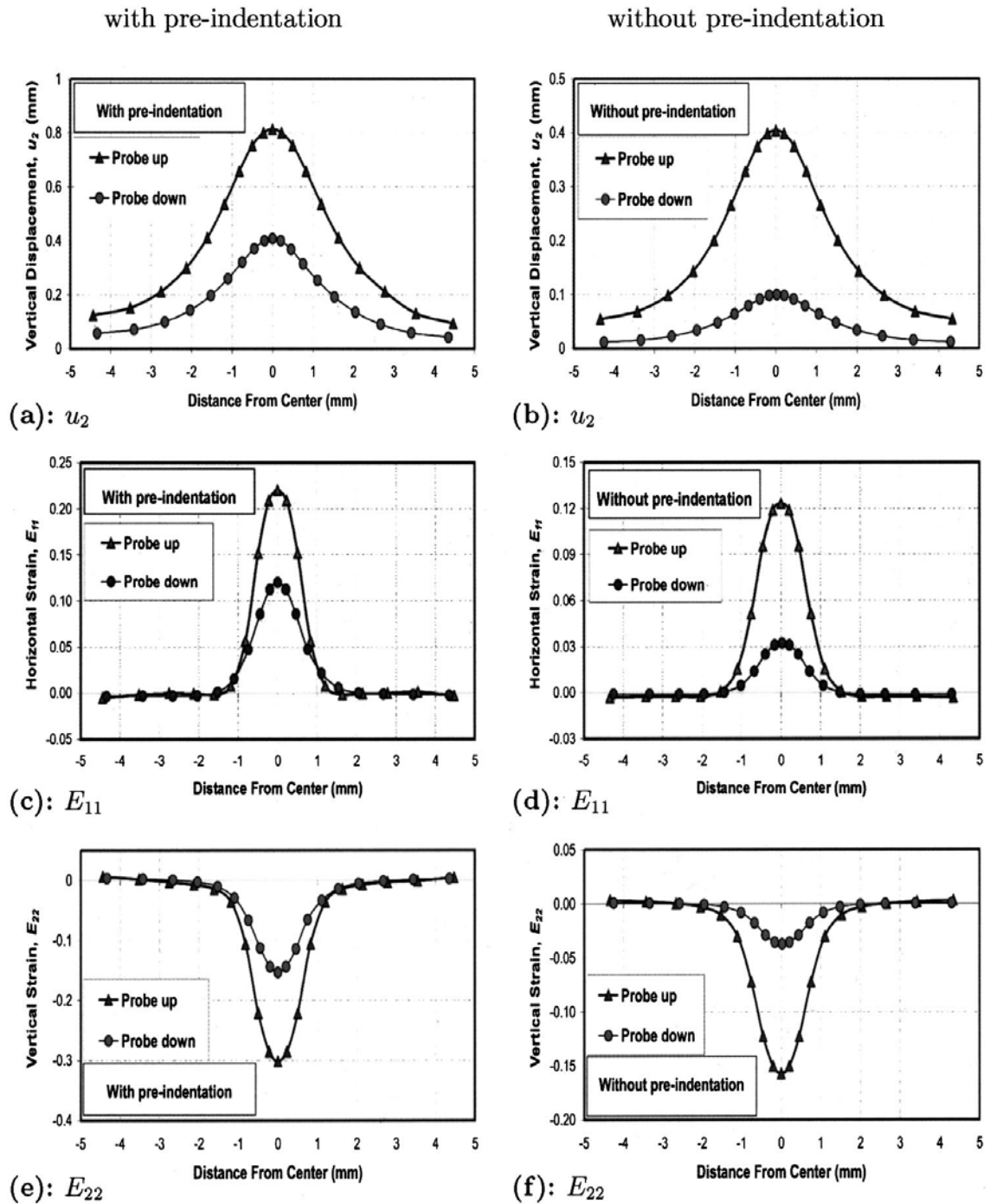
## Results

The prescribed displacements of the probe are compared with the steady-state displacement responses at the skin surface at two different vibrating frequencies ( $f=5$  and  $40$  Hz) as derived from the tests with and without pre-indentations in Figs. 2a and 2b, respectively. In these figures, the displacement is normalized with respect to peak-to-peak (p-p) displacement of the probe, such that the instances of separation between the probe and the skin surface can be compared with each other. The time has been normalized to the period of sinusoidal displacement,  $t_0$ . We further analyzed the distributions of the tissue strains at a depth of  $0.8$  mm under the skin surface where the mechanoreceptors are located. Typical distributions of vertical displacement ( $u_2$ ) horizontal and vertical strains ( $E_{11}$  and  $E_{22}$ ) are depicted in Fig. 3. The variations in spatial summations of these variables have been calculated numerically to analyze the effects of probe/skin decoupling on fingertip sensitivity to the vibrations. We found that the variations associated with  $u_2$  and  $E_{22}$  for the tests with pre-indentation are greater than those without pre-indentation by factors of 20%–50%; while the variation associated  $E_{11}$  shows little variation.



**Figure 2** Predicted skin surface displacement history compared with the sinusoidal movement prescribed on the probe for tests with two vibrating frequencies. (a) with pre-indentation; (b) without pre-indentation.





**Figure 3** Distributions of vertical displacement,  $u_2$ , horizontal and vertical strains,  $E_{11}$  and  $E_{22}$ , respectively, at a depth of 0.8 mm within the soft tissue of fingertip at probe-up and probe-down positions

### Discussion and Conclusions

The numerical simulations show that, for certain vibration frequencies and amplitudes, the probe can decouple from the skin surface during sinusoidal motion, which is consistent with the experimental observations by Goodwin et al. (1989). Since the mechanoreceptors embedded in the skin sense their mechanical environment, the separation of the probe from the skin surface during vibrotactile tests will influence the stress/strain in the skin and thus influence the reliability of the results. Our numerical results suggest that the decoupling of the vibrating probe from the skin surface will reduce the variations in the strains in the skin which the mechanoreceptors can sense and, consequently, a finger's sensitivity to vibration pulses might be reduced.

### **Bibliography**

- Lindsell, C. and Griffin, M.J. 1999. Thermal thresholds, vibrotactile thresholds and finger systolic blood pressures in dockyard workers exposed to hand-transmitted vibration. *Int Arch Occup Environ Health*, vol 72, pp 377–386.
- Goble, A.K., Collins, A.A., and Cholewiak, R.W. 1996. Vibrotactile threshold in young and old observers: the effects of spatial summation and the presence of a rigid surround. *J Acoust Soc Am*, vol 99, pp 2256–2269.
- Goodwin, A.W., John, K.T., and Darian-Smith, I. 1989. Skin profiles during sinusoidal vibration of the fingerpad. *Exp Brain Res*, vol 77, pp 79–86.
- Wu, J.Z., Dong, R.G., Schopper, A.W., and Smutz, W.P. 2003. Analysis of skin deformation profiles during sinusoidal vibration of fingerpad. *Ann Biomed Eng*, vol 31, pp 867-878.

# AN INVESTIGATION OF THE RELATIONSHIP BETWEEN VIBRATION-INDUCED WHITE FINGER AND POWER ABSORPTION

R.G. Dong, T.W. McDowell, D.E. Welcome, J.Z. Wu

National Institute for Occupational Safety and Health, Morgantown, West Virginia, USA

## Abstract

The major objective of this study is to find whether the vibration power absorption (VPA) has a stronger association with vibration-induced white finger (VWF) than the acceleration measured on power hand tools. While the basic mechanical impedance data required to estimate the power absorption were gathered in our laboratory, the required vibration exposure information and medical data were obtained from previously published studies. This study finds that the power absorption of the hand-arm system and that measured at the palm are strongly correlated to the square of the frequency-weighted acceleration (ISO 5349-1, 2001) or the weighted acceleration is highly correlated to the square root of the VPA. Hence, if the weighted acceleration tends to overestimate the effects of low frequency vibration, these energy measures will also overestimate the effects of low frequency vibration. The medical data support this finding. The power absorption measured at the fingers correlates better with finger disorders than the total power absorption, probably because the finger energy method partially overcomes the deficiencies of the total energy method. Among the five vibration dose measures, unweighted acceleration shows the strongest correlation to finger disorders. This suggests that the most important factor associated with the vibration-induced finger disorders is the acceleration actually transmitted to the fingers. Therefore, the vibration transmissibility on the fingers can be used as a frequency weighting function for quantifying and evaluating vibration exposure. This transmissibility-based weighting method may also be applied for wrist problems and other components of hand-arm vibration syndrome. Further studies are required to test these hypotheses.

## Introduction

About 30 years ago, it was proposed that vibration energy/power absorption might be a significant etiological factor in vibration-induced disorders (Lidström, 1973, 1977). It was also suggested that the energy dissipation in the hand would provide a better indication of vibration damage than would a measure of the vibration acceleration spectrum. Since then, the energy method has been used in many studies (e.g. Reynolds et al., 1984; Lundström, 1986; Burström, 1990; Sörensson, 1998; Bylund and Burström, 2003). However, some doubts on the energy method have been raised (Griffin, 1990; Dong et al., 2004). Our review (Dong et al., 2001) indicated that the validity of this method has been far from sufficiently established. The total energy method that has been used almost exclusively in the past has several fundamental deficiencies; and the method is thus questionable for studying vibration-induced finger disorders or vibration-induced white finger (VWF) (Dong et al., 2004). Further studies are required to clarify these issues.

The specific aims of this study are to examine the relationships among the acceleration measures (weighted and unweighted accelerations) and the three vibration power absorption measures (power absorption measured at the fingers, power absorption measured at the palm of the hand, and total hand-arm power absorption), to investigate their correlations to the finger disorders, and to find whether vibration power absorption (VPA) has a stronger association with the finger disorders than the acceleration measured on power hand tools.

## Methods

In the first part of the study, a series of analyses of the correlations among the five measures were performed. The power absorption was calculated from:

$$P_j = \sum_{i=1}^{22} \operatorname{Re}(Z_i)_j \left( \frac{a_{ui}}{2\pi f_i} \right)^2, \quad j = \begin{cases} f(\text{finger}) \\ p(\text{palm}) \\ h(\text{hand}) \end{cases} \quad (1)$$

$a_{ui}$  =  $i$ th 1/3 octave band unweighted acceleration (tool vibration spectrum)

$f_i$  =  $i$ th 1/3 octave band center frequency (8 to 1,000 Hz)

The mechanical impedance values of the fingers, the palm of the hand, and the entire hand-arm system were measured using the method reported in an earlier study (Dong et al., in press). The impedance in the  $z_n$ -direction was

measured. A broad-band random vibration spectrum was used as the excitation. Three coupling force combinations (15 N grip + 35 N push, 30 N grip + 45 N push, and 50 N grip + 50 N push) were used in the mechanical impedance measurement. Eight male subjects participated in the test. The posture used in the experiment is the same as that for the anti-vibration glove test specified in ISO 10819 (1996).

The unweighted acceleration and the weighted acceleration according to ISO 5349-1 (2001) were calculated from:

Unweighted acceleration ( $A_u$ ):

$$A_u = \sqrt{\sum_{i=1}^{22} (a_{ui})^2} \quad (2)$$

Weighted acceleration ( $A_w$ ):

$$A_w = \sqrt{\sum_{i=1}^{22} (w_i a_{ui})^2} \quad (3)$$

$w_i$ : The  $i$ th frequency weight (ISO 5349-1, 2001)

Twenty tool vibration spectra reported by Griffin (1997) were used in these calculations.

In the second part of the study, the correlations between the prevalence of vibration-induced finger disorders and the five vibration dose measures were examined. Four groups of workers exposed to hand-transmitted vibration were selected in this study. Each group of workers exclusively used one of the following four types of tools: rammers (low frequency spectra), chisels/chipping hammers (mixed middle and high frequency spectra), grinders (high frequency spectra), and rock drills (mixed low, middle, and high frequency spectra). Since the dominant exposure direction of the hands in the operation of a rammer is usually in  $y_1$ -direction, the mean impedance value recommended in ISO 10068 (1998) was used in the power calculation for this tool. The other power calculations are the same as those used in the first part of this study.

The medical examination data reported in three previous studies (Lidström, 1977; Xu et al., 1990; Tominaga, 1993) were used in the present study. The vibration spectra for these four types of tools and the workers' exposure duration were also reported by Xu et al. (1990). Therefore, each of the five vibration dose measures was evaluated using the reported vibration exposure data and their corresponding reported medical data. Unfortunately, the exposure duration of the rammer working group was not clearly reported (Xu et al., 1990). To make up for this, the medical data and exposure duration of the rammer working group from Tominaga's study (1993) were used. In the study by Lidström (1977), the data for total vibration power absorption were reported, but the required spectra were not reported. The vibration acceleration spectra (rock drill, chipper, and grinder) were reconstructed based on previously reported experimental data (Griffin, 1997). The reconstruction was carried out by matching the calculated VPA values using the mechanical impedance (MI) of hand-arm system measured in the present study with the VPA data reported in Lidström's study (1977). The study by Lidström measured the total power absorption in three axes. To make the exposure data directly comparable, an average ratio of the total vibration value (the root-sum-of-squares of three-axial components) and the dominant axial vibration value was used to adjust the calculated value from the dominant axial spectrum. The ratio was taken as 1.2 for chipping hammers, rock drills, and rammers, and 1.33 for grinders (Nelson, 1997).

For the purpose of the present study, the 4-hour equivalent acceleration,  $A(4)$  (ISO 5349, 1986), and power absorption,  $P(4)$ , are calculated and further used to calculate the exposure dose. The doses are calculated from:

Weighted acceleration dose:

$$A_w \text{Year} = A_w(4) \times \text{No. of years exposed to vibration} \quad (4)$$

Unweighted acceleration dose:

$$A_u \text{Year} = A_u(4) \times \text{No. of years exposed to vibration} \quad (5)$$

Vibration power absorption doses:

Finger:  $E_f = P_f(4) \times \text{No. of years exposed to vibration}$

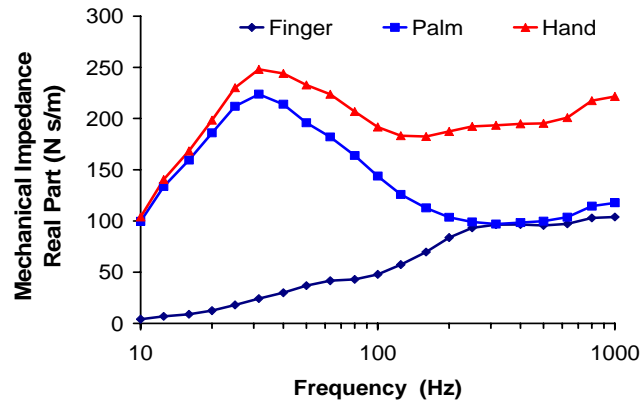
Palm:  $E_p = P_p(4) \times \text{No. of years exposed to vibration}$

Hand:  $E_h = P_h(4) \times \text{No. of years exposed to vibration}$

(6)

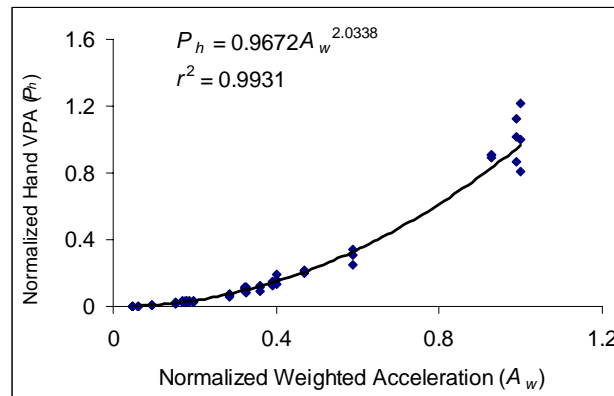
## Results

Figure 1 shows examples of the real part of the mechanical impedance (MI) values measured at the fingers and the palm, together with their summation that forms the total MI of the entire hand-arm system. As the results indicate, the MI at the palm has an obvious resonant range from 25 to 63 Hz. At frequencies below 100 Hz, the palm MI accounts for the majority of the total hand MI. At the low frequencies, the palm MI is substantially greater than the finger MI.



**Figure 1** Mechanical impedance (real part) of the fingers, the palm, and the entire hand-arm system for the test combination of 30 N grip and 45 N push.

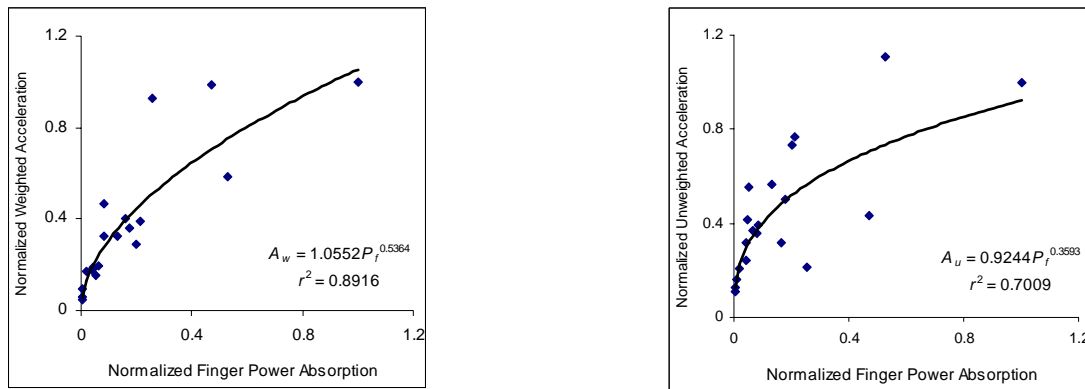
Figure 2 shows the correlation between weighted acceleration and the total power absorption that was calculated using 20 reported tool spectra (Griffin, 1997). In this figure, the VPA data are normalized to the rock drill value for the test combination of G30N + P45N. The weighted acceleration data are also normalized to the corresponding rock drill value. The results indicate that the total power absorption (hand VPA) is approximately equal to the square of the weighted acceleration. As determined from the constant-velocity weighting (ISO 5349-1, 2001), the weighted acceleration at frequencies higher than 16 Hz is approximately proportional to the velocity of the tool vibration. Hence, the total power absorption is approximately proportional to the square of the velocity.



**Figure 2** Correlation of the total hand-arm power absorption (hand VPA) vs. weighted acceleration. The power absorption data for all three coupling combinations are used in the analysis, and  $r$  is the Pearson correlation coefficient.

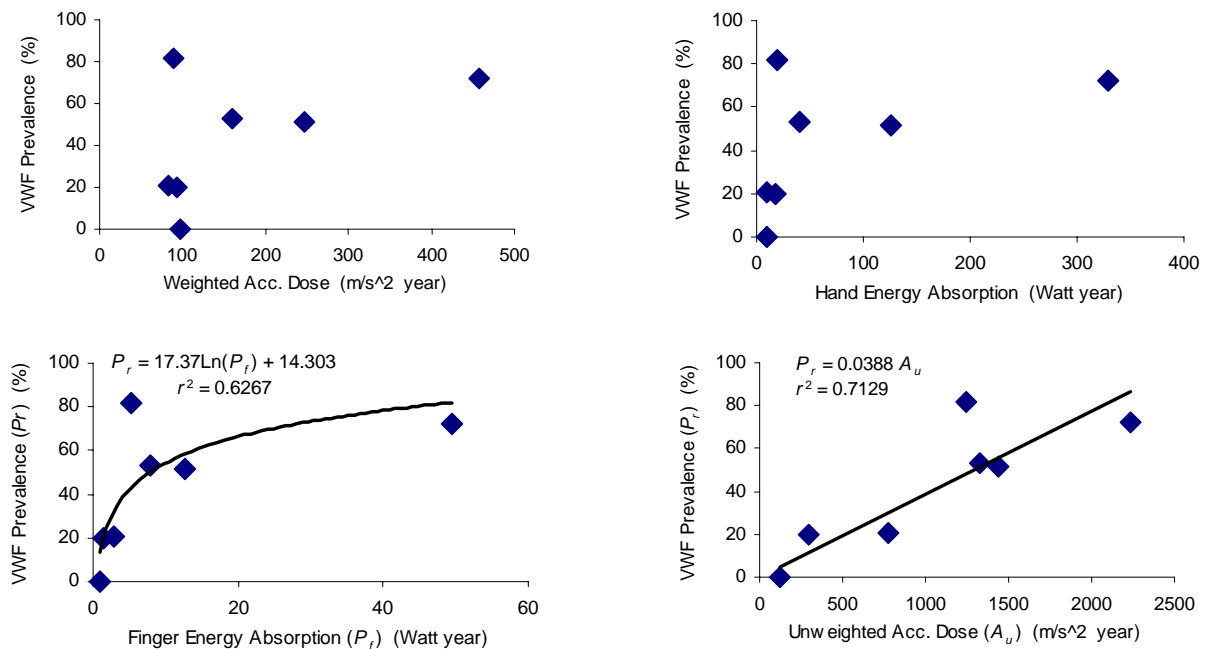
The weighted acceleration is poorly correlated to unweighted acceleration (Griffin, 1997). Hence, the hand VPA is also poorly correlated to unweighted acceleration. Since the palm VPA is very similar to the hand VPA at frequencies lower than 100 Hz, as shown in Figure 1, these two power absorption measures are strongly correlated ( $r > 0.99$ ,  $p <$

0.001). The finger VPA is somewhat correlated to both weighted acceleration and unweighted acceleration ( $p < 0.01$ ), as shown in Figure 3.



**Figure 3** Correlations between the finger power absorption (finger VPA) and weighted and unweighted acceleration (VPA for 30 N grip and 45 N push. Data normalized to rock drill values)

The above correlation analyses indicate that while the unweighted acceleration can be considered as an independent measure, the weighted acceleration, hand VPA, and palm VPA can be classified into one group as another independent measure. The finger VPA is somehow related to these two measurement groups.



**Figure 4** Correlations between finger disorder prevalence and four vibration dose measures (weighted acceleration, hand VPA, finger VPA, and unweighted acceleration). The VPA data are calculated from impedance data for the combination of 30 N grip and 45 N push.

Figure 4 shows the results of the analyses of the correlations between the medical data (prevalence of vibration-induced finger disorders) and the four types of vibration dose measurement. The results indicate that the correlation between the finger disorders and weighted acceleration is very poor. The exposure dose of the ramming working catalog is higher than or very comparable with that of the grinding catalog. However, the prevalence of the finger disorders for the ramming catalog is 0%, which is dramatically different from the grinding catalog (20% and 82%). This indicates that the effects of the low frequency vibration generated by the rammers are greatly overestimated, or the high frequency vibration from the grinders is relatively underestimated. The basic relationship between the hand VPA and the finger disorders is similar to that between weighted acceleration and the finger disorders. The consideration of the vibration

exposure direction for the rammers reduces the ramming dose, which improves the relationship slightly. However, the overall correlation remains poor.

The finger VPA shows a suggestively reliable correlation to the finger disorders ( $p < 0.10$ ), although the relationship is nonlinear. The unweighted acceleration dose shows the strongest correlation to the finger disorders ( $p < 0.05$ ). The linear correlation relationship also makes this measure suitable for practical application.

### **Discussion and Conclusions**

Although there are some uncertainties in the medical data and exposure conditions, the results of this study provide basic information for evaluating the five different vibration dose measures. While uncertainties remain, a few conclusions can be drawn from these results.

#### *Total energy method (hand VPA)*

Compared with the tool acceleration method, the advantages of the energy method are that many influencing factors (e.g. the exposure direction, the hand-tool coupling condition, individual differences) can be taken into account in the vibration exposure quantification. However, the results of this study suggest that these advantages are not sufficient to support the use of the total hand VPA as an indicator of vibration-induced finger disorder risk. The VPA may be responsible only for a portion of vibration-induced injuries or disorders. Most critically, the total energy method has several fundamental deficiencies (Dong et al., 2004). It ignores the energy concentration effect, the distribution characteristics at different locations and frequencies, and the differences between different tissues' resistances and adaptations to injuries or disorders. The VPA at low frequencies is mostly transmitted from the palm and distributed through the entire hand-arm system. It is not reasonable to associate such VPA directly with finger disorders. The strong correlation between the hand VPA and the square of weighted acceleration also suggests that the total energy method would not be theoretically better than an acceleration measurement. The medical data further confirm these theoretical evaluations. It is also technically more difficult to measure the VPA than acceleration, especially at workplaces. Hence, this study concludes that overall, the hand VPA (total power absorption) is not better than conventional acceleration measurement for evaluating the risk of vibration-induced finger disorders.

#### *Finger energy method (finger VPA)*

While keeping the advantages of the energy method, the measurement of local finger VPA can partially overcome the deficiencies of the total energy method, which may explain why the finger VPA shows a better relationship with VWF than the hand VPA. This suggests that if the energy absorption is really an etiological factor of vibration-induced finger disorders, the finger energy method is better for both risk assessment and mechanism studies. The identification of the detailed power/energy absorption distribution may lead to a better understanding of vibration exposure. For such a purpose, the best energy measure is vibration power absorption density (= VPA per unit volume of tissue), which needs further study.

#### *Palm energy method (Palm VPA)*

A previous study has indicated that the weighted acceleration recommended in the current standard (ISO 5349-1, 2001) is better than unweighted acceleration for wrist injury prediction (Malchaire et al., 2001). Since the palm VPA is strongly correlated to weighted acceleration, the palm VPA may also be a good measure for vibration-induced wrist injury assessments. Furthermore, the palm resonance frequency (25-63 Hz) is in the range of the dominant vibration frequencies of many percussive tools. Resonance may play a role in the development of disorders in the wrist-arm-shoulder system. The energy method also has some unique advantages, as mentioned above. Therefore, the palm energy method may be useful for studying vibration-induced disorders in the wrist-arm-shoulder system. Because the palm VPA is also very strongly correlated to the hand VPA, the total energy method may also be used to serve the same purpose.

#### *Weighted and unweighted acceleration*

The results of this study suggest that unweighted acceleration is generally better than any energy absorption measure for assessing the risk of vibration-induced finger disorders. The results also suggest that unweighted acceleration is better than the frequency-weighted acceleration recommended in the current ISO 5349-1 (2001). This conclusion is consistent with those of a recently published epidemiological study (Griffin et al., 2003) and several earlier studies (e.g. Pelmear et al., 1989). This also further supports the NIOSH-published position on this issue (NIOSH, 1989).

### *A new hypothesis*

The correlation between unweighted acceleration and finger disorders may be explained by a new hypothesis. The real mechanical stimuli that directly act on the tissues and cause injuries and disorders are vibration-induced tissue stresses and deformations. These stresses and deformations may be linear or non-linear functions of the unweighted acceleration acting on the fingers. The tissues' resistances and adaptations to injuries and/or disorders depend on the tissues' physical and biological properties, which are generally location-specific. Hence, a major factor on the developments of the finger disorders is the vibration-induced stresses and deformations in the fingers. Because tool handle vibration can be effectively transmitted to the fingers in a large frequency range (>500 Hz) during typical use of most vibrating tools, the unweighted acceleration measured on the tool handle is closely associated with the stresses and deformations, thus with finger disorders.

The vibration-induced finger stresses and deformations are also likely strongly correlated with the finger vibration power absorption density. Hence, if the vibration power absorption is really a significant etiological factor in vibration-induced disorders, the energy concept also supports this hypothesis.

### *A new frequency weighting approach*

Based on the proposed theory, it may be acceptable to use the vibration transmissibility measured at the fingers as the weighting function to quantify and evaluate vibration exposure for the risk assessment of finger disorders. This method may also be extended to determine the frequency weighting functions for other vibration-induced disorders. In general, separate weighting functions can be developed for the fingers, palm, wrist, and other components of the hand-arm system based on the vibration transmissibility measured at those locations. For example, vibration transmissibility at the wrist may be used to generate the frequency weighting for the evaluation of vibration-induced wrist problems. The resonant effect can also be automatically taken into account with the transmissibility weighting. The transmissibility is also likely influenced by many other factors such as hand-tool coupling condition, vibration exposure direction, individual differences, etc. Therefore, the advantages of the above-mentioned energy method can be retained with the transmissibility method. It has been technically feasible and reliable to determine the transmissibility of vibration at several specific locations of the finger-hand-arm system. The proposed theory and frequency weighting method can be further refined by studying vibration-induced stresses and deformations, as well as their distributions using finite element methods (Wu et al., 2003).

## **Summary**

This study finds that when compared to weighted acceleration or any of the energy measures, unweighted acceleration is a better vibration measure for the risk assessment of vibration-induced finger disorders. Based on this finding, a hypothesis and frequency weighting method are proposed. Replacing the current frequency weighting method (ISO 5349-1, 2001) with the proposed weighting method will likely have a profound impact not only upon scientific research, risk assessment, and general prevention strategy, but also on the development and selection of powered hand tools and anti-vibration devices. Therefore, further studies are necessary to test the new hypothesis before the new location-specific weighting method is recommended for practical applications. Nevertheless, the proposed new hypothesis and weighting method provide an opportunity to establish a robust vibration exposure theory.

## **References**

- Burström, L. 1990. Absorption of vibration energy in the human hand and arm. Doctoral Thesis, Tekniska Hogskolanilulea Lulea University of Technology.
- Bylund, S.H., and Burström, L. 2003. Power absorption in women and men exposed to hand-arm vibration. *International Archives of Occupational and Environmental Health* 76: 313-317.
- Dong, R.G., Rakheja, S., Schopper, A.W., Han, B., and Smutz, W.P. 2001. Hand-transmitted vibration and biodynamic response of the human hand-arm: A critical review. *Critical Reviews in Biomedical Engineering* 29: 393-439.
- Dong, R.G., Schopper, A.W., McDowell, T.W., Welcome, D.E., Wu, J.Z., Smutz, W.P., Warren, C., and Rakheja, S. 2004. Vibration energy absorption (VEA) in human fingers-hand-arm system. *Medical Engineering and Physics* 26(7): 483-492.
- Dong, R.G., Welcome, D.E., McDowell, T.W., and Wu, J.Z. 2004. Biodynamic response of human fingers in a power grip subjected to a random vibration. *Journal of Biomechanical Engineering*, 126: 446-456.



- Griffin, M., Bovenzi, M., and Nelson, C.M. 2003. Dose-response patterns for vibration-induced white finger. *Occupational and Environmental Medicine* 60: 16-26.
- Griffin, M.J. 1990. *Handbook of human vibration*. Academic Press, London.
- Griffin, M.J. 1997. Measurement, evaluation, and assessment of occupational exposures to hand-transmitted vibration. *Occupational & Environmental Medicine* 54: 73-89.
- ISO 10819, 1996: Mechanical vibration and shock -- hand-arm vibration -- method for the measurement and evaluation of the vibration transmissibility of gloves at the palm of the hand. International Organization for Standardization, Geneva, Switzerland.
- ISO 10068, 1998: Mechanical vibration and shock -- free, mechanical impedance of the human hand-arm system at the driving point. International Organization for Standardization, Geneva, Switzerland.
- ISO 5349, 1986: Mechanical vibration -- measurement and evaluation of human exposure to hand-transmitted vibration. International Organization for Standardization, Geneva, Switzerland.
- ISO 5349-1, 2001: Mechanical vibration -- measurement and evaluation of human exposure to hand-transmitted vibration -- part 1: General requirements. International Organization for Standardization, Geneva, Switzerland.
- Lidström, I.M. 1973. Measurement of energy dissipation by the body when using a vibrating tool. *Nordisk Hygenisk Tidskrift* 2:41-45.
- Lidström, I.M. 1977. Vibration injury in rock drillers, chisellers, and grinders. Some views on the relationship between the quantity of energy absorbed and the risk of occurrence of vibration injury. In: *Proceedings of the international conference on hand-arm vibration*, Cincinnati, OH: 77-83.
- Lundström, R. 1986. Absorption of mechanical energy in the skin of human hand while exposed to vibration. *Journal of Low Frequency Noise and Vibration* 3: 113-120.
- Malchaire, J., Piette, A., and Cock, N. 2001. Associations between hand-wrist musculoskeletal and sensorineural complaints and biomechanical and vibration work constraints. *Annals of Occupational Hygiene* 45: 479-491.
- Nelson, C.M. 1997. Hand-transmitted vibration assessment - a comparison of results using single axis and triaxial method. In: *Proceedings of the 32nd UK conference on human vibration*: 3-14.
- NIOSH. 1989. Criteria for a recommended standard: Occupational exposure to hand-arm vibration, NIOSH publication 89-106. U.S. Department of Health and Human Services, National Institute for Occupational Safety and Health, Cincinnati, OH.
- Pelmear, P.L., Leong, D., Taylor, W., Nagalingam, M., and Fung, D. 1989. Measurement of vibration of hand-held tools: Weighted or unweighted? *Journal of Occupational Medicine* 31: 902-908.
- Reynolds, D.D., Basel, R., Wasserman, D.E., and Taylor, W. 1984. A study of hand vibration on chipping and grinding operators, part III: Power levels into the hands of operators of pneumatic tools used in chipping and grinding operations. *Journal of Sound and Vibration* 95: 515-524.
- Sörensson, A. 1998. Energy absorption and transmission in the hand and arm during high frequency vibration and impact. *Doctoral Thesis, National Institute of Working Life, Umea*.
- Tominaga, Y. 1993. The relationship between vibration exposure and symptoms of vibration syndrome. *Journal of Science of Labor*: 1-14.
- Wu, J.Z., Dong, R.G., Smutz, W.P., and Schopper, A.W. 2003. Modeling of time-dependent force response of fingertip to dynamic loading. *Journal of Biomechanics* 36: 383-392.
- Xu, Z., Ding, H.C., Ding, M.P., Liu, J.C., and Wang, H. 1990. A study of dose-effect relationships for vibration induced white finger. In: *Proceedings of the 5th international conference on hand-arm vibration*, Kanazawa, Japan: 305-308.



# **A PILOT STUDY OF GLOVE EFFECTS ON A FORCE MATCHING METHOD**

T.W. McDowell, R.G. Dong, D.E. Welcome

National Institute for Occupational Safety and Health (NIOSH), Morgantown, West Virginia, USA

## **Abstract**

In order to maintain proper control over a vibrating power tool and to achieve desired productivity, a tool operator must apply repetitive feed and grip forces. Studies have shown that a forceful hand-tool coupling may increase the transmission of vibration from a tool to the hand-arm system. The current international standard for assessing hand-arm vibration does not consider the hand coupling force. This is partially due to the lack of a practical and affordable hand force measurement method. While instrumented tool handles can be used to measure hand forces during work tasks, there are difficulties associated with their use in field studies. Tool handle instrumentation may not be robust enough to withstand harsh work environments. Moreover, measurements obtained via instrumented tool handles may fail to deliver an accurate representation of actual work task forces. As an alternative, NIOSH researchers are studying a psychophysical technique known as force matching. As a part of this research, a pilot study was conducted to explore the influence of glove use on force matching accuracy. The study involved two types of antivibration gloves. The results of the study revealed no differences between glove types. The researchers found that while subjects tended to overestimate the forces applied during a simulated chipping hammer work task, the use of antivibration gloves significantly increased force matching accuracy.

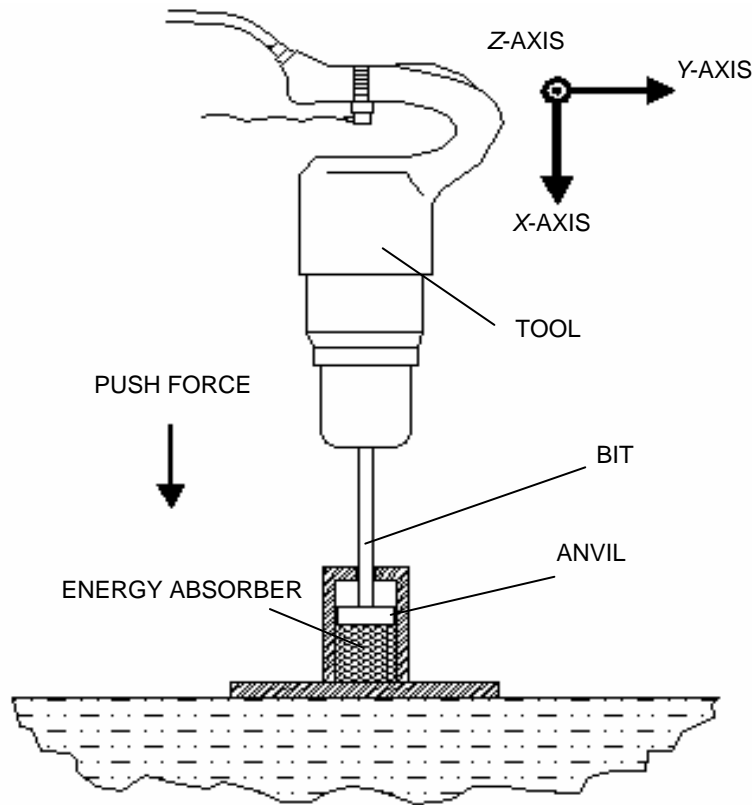
## **Introduction**

Operating powered hand tools such as chipping hammers and rock drills frequently requires forceful and repeated push and grip actions to control the tools and attain the desired productivity. Many of these tools are also known to generate high magnitudes of hand-transmitted vibration. A tight hand-tool coupling imposes high stresses on the anatomical structure of the hand-arm system and impedes peripheral circulation; it also increases hand-arm vibration (HAV) transmissibility (Brammer, 1982; Hartung et al., 1993; Riedel, 1995; Dong et al., in press). Although the importance of hand coupling force has been recognized, the current international HAV assessment standard (ISO-5349-1, 2001) has not accounted for this factor. This is partially due to the lack of a practical method for quantifying the hand coupling force. Several approaches have been proposed to modify the assessment methodology to include the hand force effect (Riedel, 1995; Kaulbars, 1996). An international committee has drafted a working document in an effort to develop a generally acceptable method for quantifying hand coupling forces (ISO/WD 15230, 2001). While it is technically feasible to accurately measure hand forces using instrumented handles or flexible force sensors (see Welcome et al., 2001), quantifying hand forces applied to tools in the workplace remains a formidable research task.

Several researchers have used psychophysical approaches such as perceived effort ratings as bases for characterizing forces associated with materials handling tasks and for designing lifting capacity models (Snook, 1978; Garg et al., 1980; Karwowski et al., 1984; Ciriello et al., 1990). As a convenient force quantifying approach, a psychophysical technique called magnitude production or the force matching method has been used to quantify various hand and arm forces (e.g. Stevens, 1960; Gescheider, 1997). It has been shown that humans have the ability to memorize and replicate the forces and movements associated with work tasks. Studies show that subjects can reproduce familiar forces and movements based on skin and subcutaneous sensory feedback and position sense (Hammar-skjöld et al., 1990; Wiktorin et al., 1996; Bao, 2000). Subjects have demonstrated extraordinary abilities to correctly rank weights and forces (Wang et al., 1991; Karwowski et al., 1992; Kumar and Simmonds, 1994). While these psychophysical techniques for characterizing forces produced by humans have proven to be remarkably accurate and repeatable, the use of force matching techniques for measuring hand forces applied to vibrating tools has not been seriously studied. To examine and refine this technique, NIOSH researchers have planned a series of systematic studies. As part of this process, this pilot study focused on glove use as an influencing factor on force matching accuracy.

## **Method**

This pilot study employed a simulated chipping hammer workstation (see Figure 1). The workstation was fabricated based on the design presented in the ISO chipping hammer test standard (ISO 8662-2, 1992). Briefly, the chisel bit of a pneumatic chipping hammer is replaced with an anvil bit. The bit is inserted into an energy absorber filled with steel balls. The energy absorber is firmly bolted to a concrete slab. Except at high push forces ( $\geq 200$  N), this simulated workstation delivers consistent tool vibration emissions (Dong et al., 2004). This design also limits lateral tool movements; thus, the subject can monitor and accurately control the applied push force.



**Figure 1** Simulated chipping hammer workstation

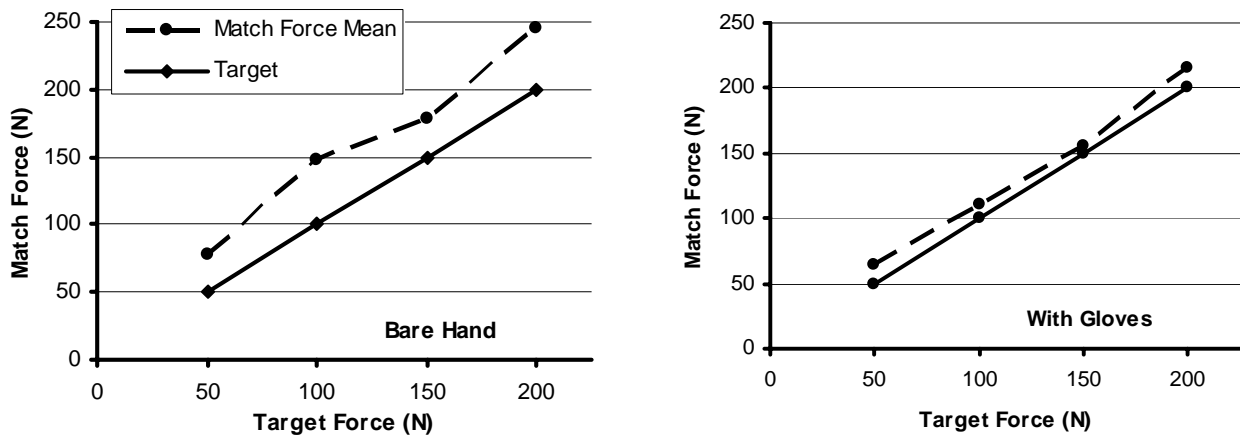
Six healthy adult male subjects participated in the pilot study. The subjects were students recruited from a local university. None of the subjects had prior experience with chipping hammers. During each trial, the test subject stood on a platform and applied a downward push force on the handle of an operating tool. The subject assumed an arm posture similar to that specified in the ISO standard (ISO 8662-2, 1992). Four push force levels (50, 100, 150, and 200 N) were examined. A force plate (Kistler, 9286AA) was used to measure the applied push force. To provide visual feedback for the subject, the push force was displayed as a strip chart on a computer monitor. The pneumatic chipping hammer's actuator was fixed in the "on" position; a test engineer remotely controlled the on/off operation of the tool by way of a pushbutton-operated solenoid valve. At the end of an 8-second tool operation period, the chipping hammer was turned off. Immediately after the tool stopped, the subject removed his hands from the tool handle, turned 180° on the force plate, and positioned his hands on a handle dynamometer mounted adjacent to the workstation platform (refer to Figure 2). Two piezoelectric force sensors were integrated within the handle dynamometer, and a summing algorithm was employed to measure the push force imparted by the subject. The handle dynamometer was mounted on a height-adjusted platform so that the subject could assume the same posture that was used during tool operation. Without the aid of visual feedback, the subject then attempted to reproduce the push force he applied during the tool operation. Two types of antivibration gloves (air bladder and visco-elastic) were examined along with the bare-handed condition. Thus, there were 12 different combinations of push force and glove condition. Each combination was performed twice by every subject for a total of 24 trials per test session. The order of the 24 trials was randomized for each subject. The data were analyzed with a mixed-model, two-way analysis of variance (ANOVA) using Minitab™ statistical software (release 13).



**Figure 2** Handle dynamometer used for force matching measurements

### Results

The variable of interest was the disparity between the force matching attempt and the tool operation target force. First, the results of the trials with the two different gloves were compared with each other. No differences between gloves were found ( $p > 0.10$ ). Next, the results of the glove trials were lumped together and compared with the bare-handed results. As can be seen in Figure 3, the match force mean values are well correlated with the target forces; subjects tended to overestimate the push force whether they were wearing gloves or not. However, the match force mean values were significantly higher during the bare-handed trials than when gloves were used ( $p < 0.01$ ).



**Figure 3** Mean force matching values compared with target forces with and without gloves.

### Discussion

There are psychophysical sensations associated with the voluntary production of an isometric force or the motion of a limb. There is evidence that a person's awareness of such force production or movement stems from both efferent (central) and afferent (peripheral) signals (see Roland and Ladegaard-Pedersen, 1977; McCloskey et al., 1983; Cafarelli and Layton-Wood, 1986). Vibration is known to stimulate muscle spindle primary and secondary endings as well as Golgi-Mazzoni bodies, Meissner corpuscles, and Pacinian corpuscles located in the dermis and subcutaneous tissues (Burke et al., 1976; Lundström, 1986). The results of several studies have shown that vibration exposure temporarily impairs the excitability of mechanoreceptive units (e.g. Lidström et al., 1982; Lundström and Johansson, 1986).

Vibration has also been shown to affect muscle responses during grip exertions (Radwin et al., 1987). It has also been reported that vibration may interfere with one's sense of position and effort when producing sub-maximal isometric forces (Cafarelli and Kostka, 1981; Miall et al., 2000). Therefore, the added stimulation of tool-emitted vibration might mislead subjects into false interpretations of the sensations associated with grip and push forces applied to vibrating tool handles. Theoretically, the disturbances caused by tool vibration might lead to inaccurate force matching.

Some studies have shown that antivibration gloves are effective at attenuating vibration in certain circumstances (Goel and Rim, 1987). However, other studies have raised doubts about antivibration glove effectiveness (Gurram et al., 1994; Griffin, 1998). If antivibration gloves do, indeed, substantially reduce vibration transmitted to the hand-arm system, subjects wearing these gloves would have the potential for improved awareness of the sensory and motor signals associated with isometric force production. Naturally, it would be reasonable to assume that this improved awareness would result in more accurate force matching outcomes.

In this pilot study, the chipping hammer handle and the handle dynamometer used for force matching measurements differed slightly in shape, size, and texture. Tool handle geometry may play a significant role in a subject's ability to reproduce hand/tool coupling forces. Psychophysical measurements such as discomfort ratings have shown to vary greatly with tool configuration (Kihlberg et al., 1993). As indicated in a study by McCloskey (1974), the shape, size, and friction coefficient of the surface of an object affect the afferent clues, and, in turn, these physical characteristics play an important role in a subject's ability to estimate an object's weight. It has also been shown that tactile afferent information is important for a subject's judgment of isometric finger forces (Henningsen et al., 1995). These findings further support the notion that afferent information transmitted from the fingers and palm plays an important role in a subject's force matching ability. It is hypothesized that glove use will weaken tactile perception and other sensory signals generated by the mechanoreceptors in the fingers and the palm during grasping and pushing operations. Therefore, glove use may diminish the influence of the handle geometrical differences. This may further explain the increased accuracy during the gloved-hand trials.

### **Conclusion**

A refined version of this force matching technique may prove to be a convenient and reliable method for quantifying hand forces used by workers in the field. However, there are many factors that need to be studied and accounted for before such a method can be appropriately applied. As a start, the effect of glove use was explored in this pilot study. The results indicate that glove use may increase the accuracy of this force matching technique.

### **References**

- Bao, S. 2000. Technical report 65-1-2000: Grip strength and hand force estimation. State of Washington Department of Labor and Industries, Safety & Health Assessment & Research for Prevention, Olympia, WA, USA.
- Brammer, A.J. 1982. Relations between vibration exposure and the development of the vibration syndrome. In: AJ Brammer and W Taylor (Eds.) *Vibration effects on the hand and arm in industry*. Wiley and Sons, New York, pp 283-290.
- Burke, D., Hagbarth, K.-E., Löfstedt, L., and Wallin, B.G. 1976. The responses of human muscle spindle endings to vibration during isometric contraction. *Journal of Physiology*, vol 261, pp 695-711.
- Cafarelli, E., and Kostka, C.E. 1981. Effect of vibration on static force sensation in man. *Experimental Neurology*, vol 74, pp 331-340.
- Cafarelli, E., and Layton-Wood, J. 1986. Effect of vibration on force sensation in fatigued muscle. *Medicine and Science in Sports and Exercise*, vol 18, pp 516-521.
- Ciriello, V.M., Snook, S.H., Blick, A.C., and Wilkinson, P.L. 1990. The effects of task duration on psychophysically-determined maximum acceptable weights and forces. *Ergonomics*, vol 33, pp 187-200.
- Dong, R.G., McDowell, T.W., Welcome, D.E., Warren, C., and Schopper, A.W. 2004. An evaluation of the standardized chipping hammer test specified in ISO 8662-2, 1992. *Annals of Occupational Hygiene*, vol 48, pp 39-49.
- Dong, R.G., Welcome, D.E., McDowell, T.W., and Wu, J.Z. in press. Biodynamic response of human fingers in a power grip subjected to a random vibration. *Journal of Biomechanical Engineering*. (scheduled for August 2004 publication)
- Garg, A., Mital, A., and Asfour, S.S. 1980. A comparison of isometric strength and dynamic lifting capability. *Ergonomics*, vol 23, pp 13-27.

- Gescheider, G.A. 1997. *Psychophysics: The fundamentals*. Third Edition. Lawrence Erlbaum Associates, Mahwah, NJ, USA.
- Goel, V., and Rim, K. 1987. Role of gloves in reducing vibration: An analysis for pneumatic chipping hammer. *American Industrial Hygiene Association Journal*, vol 48, pp 9-14.
- Griffin, M.J. 1998. Evaluating the effectiveness of gloves in reducing hazards of hand-transmitted vibration. *Occupational and Environmental Medicine*, vol 55, pp 340-348.
- Gurram, R., Rakheja, S., and Gouw, G. 1994. Vibration transmission characteristics of the human hand-arm and gloves. *International Journal of Industrial Ergonomics*, vol 13, pp 217-234.
- Hammarskjöld, E., Harms-Ringdahl, K., and Ekolm, J. 1990. Shoulder-arm muscular activity and reproducibility in carpenters' work. *Clinical Biomechanics*, vol 5, pp 81-87.
- Hartung, E., Dupuis, H., and Scheffer, M. 1993. Effects of grip and push forces on the acute response of the hand-arm system under vibrating conditions. *International Archives of Occupational and Environmental Health*, vol 64, pp 463-467.
- Henningsen, H., Ende-Henningsen, B., and Gordon, A.M. 1995. Contribution of tactile afferent information to the control of isometric finger forces. *Experimental Brain Research*, vol 105, pp 312-317.
- ISO 8662-2, 1992: Hand-held portable power tools -- measurement of vibrations at the handle -- part 2: Chipping hammers and riveting hammers. (International Organization for Standardization, Geneva, Switzerland).
- ISO 5349-1, 2001: Mechanical vibration -- measurement and evaluation of human exposure to hand-transmitted vibration -- part 1: General requirements. (International Organization for Standardization, Geneva, Switzerland).
- ISO/WD 15230, 2001: Definition and guidelines for the measurement of the coupling forces for operators exposed to hand-arm vibration. (International Organization for Standardization, Geneva, Switzerland).
- Karwowski, W., Ayoub, M.M., Alley, L.R., and Smith, J.L. 1984. Fuzzy approach in psychophysical modeling of human operator-manual lifting system. *Fuzzy Sets and Systems*, vol 14, pp 65-76.
- Karwowski, W., Shumate, C., Yates, J.W., and Pongpatana, N. 1992. Discriminability of load heaviness: Implications for the psychophysical approach to manual lifting. *Ergonomics*, vol 35, pp 729-744.
- Kaulbars, U. 1996. Measurement and evaluation of coupling forces when using hand-held power tools. *Central European Journal of Public Health*, vol 4, pp 57-58.
- Kihlberg, S., Kjellberg, A., and Lindbeck, L. 1993. Pneumatic tool torque reaction: Reaction forces, displacement, muscle activity and discomfort in the hand-arm system. *Applied Ergonomics*, vol 24, pp 165-173.
- Kumar, S., and Simmonds, M. 1994. The accuracy of magnitude production of submaximal precision and power grips and gross motor efforts. *Ergonomics*, vol 37, pp 1345-1353.
- Lidström, I.M., Hagelthorn, G., and Bjerker, N. 1982. Vibration perception in persons not previously exposed to local vibration and in vibration exposed workers. In: A Brammer and W Taylor (Eds.) *Vibration effects on the hand and arm in industry*. John Wiley, New York, pp 59-65.
- Lundström, R. 1986. Responses of mechanoreceptive afferent units in the glabrous skin of the human hand to vibration. *Scandinavian Journal of Work, Environment & Health*, vol 12, pp 413-416.
- Lundström, R., and Johansson, R.S. 1986. Acute impairment of the sensitivity of skin mechanoreceptive units caused by vibration exposure of the hand. *Ergonomics*, vol 29, pp 687-698.
- McCloskey, D.I. 1974. Muscular and cutaneous mechanisms in the estimation of the weights of grasped objects. *Neuropsychologia*, vol 12, pp 513-520.
- McCloskey, D.I., Gandevia, S.C., Potter, E.K., and Colebatch, J.G. 1983. Muscle sense and effort: Motor commands and judgments about muscular contractions. In: JE Desmedt (Ed.) *Motor control mechanisms in health and disease*. Raven Press, New York, pp 151-167.
- Miall, R.C., Ingram, H.A., Cole, J.D., and Gauthier, G.M. 2000. Weight estimation in a 'deafferented' man and in control subjects: Are judgments influenced by peripheral or central signals? *Experimental Brain Research*, vol 133, pp 491-500.
- Radwin, R.G., Armstrong, T.J., and Chaffin, D.B. 1987. Power hand tool vibration effects on grip exertions. *Ergonomics*, vol 30, pp 833-855.

- Riedel, S. 1995. Consideration of grip and push forces for the assessment of vibration exposure. *Central European Journal of Public Health*, vol 3, pp 139-141.
- Roland, P.E., and Ladegaard-Pedersen, H. 1977. A quantitative analysis of sensations of tension and of kinesthesia in man. *Brain*, vol 100, pp 671-692.
- Snook, S.H. 1978. The design of manual handling tasks. *Ergonomics*, vol 21, pp 963-985.
- Stevens, S.S. 1960. The psychophysics of sensory function. *American Scientist*, vol 48, pp 226-253.
- Wang, M.-J.J., Liu, C.-M., and Shih, Y.-C. 1991. A method for determining the difference threshold of judging weight difference in material handling. *International Journal of Industrial Ergonomics*, vol 8, pp 335-343.
- Welcome, D.E., Rakheja, S., Dong, R.G., Westfall, B., and Schopper, A.W. 2001. A preliminary study of the relationship of hand grip and push forces to total coupling forces. 36th United Kingdom Group Conference on Human Response to Vibration, Farnborough, UK.
- Wiktorin, C., Selin, K., Ekenvall, L., Kilbom, Å., and Alfredsson, L. 1996. Evaluation of perceived and self-reported manual forces exerted in occupational materials handling. *Applied Ergonomics*, vol 27, pp 231-239.



# DESIGN OF A NEW INSTRUMENTED GLOVE FOR THE MEASUREMENT OF THE CONTACT PRESSURE DISTRIBUTION AT THE HAND/HANDLE INTERFACE

D. Feutry<sup>1</sup>, P. Lemerle<sup>2</sup>, L. Claudon<sup>3</sup>

<sup>1</sup> Institut National de Recherche et Sécurité, Département Ingénierie des Equipements de Travail, Laboratoire de Modélisation des Systèmes Mécaniques de Prévention, Avenue de Bourgogne, 54501 Vandoeuvre Les Nancy, FRANCE

<sup>2</sup> Institut National de Recherche et Sécurité, Département Ingénierie des Equipements de Travail, Laboratoire de Modélisation des Systèmes Mécaniques de Prévention, FRANCE

<sup>3</sup> Institut National de Recherche et Sécurité, Département Homme au Travail, Laboratoire de Biomécanique et d'Ergonomie, FRANCE

## Abstract

Studies related to hand-arm vibration, hand-tool handle ergonomics, and more generally the evaluation of hand-arm system work situations lack an efficient device to measure the force at the hand-handle interface. The instrumented glove presented in this article may provide a solution to this metrological need. Based on capacitive pressure sensors, it allows measurement of the pressure distribution at the hand-handle interface of tools. Devices tested in previous studies generally comprised a limited number of individual sensors. In contrast to these devices, our system is instrumented with sensor matrices allowing to place 219 sensors on the internal surface of the hand. The sensor arrangement has been designed to optimise the precision of measuring the pressure distribution of "Grip" type actions, while maintaining complete hand mobility. Taking the form of a glove, this measurement device will be easy to use and capable of being used on most tool handles. Ultimately, the glove will incorporate a hand posture measurement device allowing assessment of coupling force on the basis of pressure distribution without the need to know the geometry of the handle.

## Introduction

When evaluating intense hand-arm system work situations, and particularly during the use of hand-held tools, whether powered or not, particular attention must be paid to biomechanical aspects such as the forces exerted on the tool. The methods traditionally employed to evaluate these forces include handle instrumentation, subjective estimation of the user, and recordings of the electromyographical (EMG) activity of the muscles involved in gripping. Subjective methods have been proposed for quite some time, unfortunately the accuracy of this type of tool is relatively low. EMG recording is frequently carried out in field studies to estimate the forces exerted by the operator, but the use of this technique has certain limitations (signal standardization, linearity of the force-EMG relationship, only the activity of the superficial muscles can be recorded, etc.).

Another alternative to evaluate the forces at the hand-object interface is the use of pressure sensors. Measurement of the pressure distribution in the hand has already been the subject of previous studies examining the design of the handles of hand-held tools or containers (Fellows and Freivalds, 1989; Bishu *et al.*, 1993; Yun *et al.*, 1992; Björing *et al.*, 1998). The aim was to prevent excessive pressures in the hand, as reported by Hall and Kilbom (1993) and Johansson *et al.* (1999). However, the systems to measure the pressure distribution in these studies included a limited number of sensors. The pressure was not measured in numerous zones of the palm side of the hand and the fingers, and hence the information yielded was incomplete.

The aim of the present study is therefore to propose the development of a system to measure the pressure distribution at the hand-handle interface of tools. The measurement system developed takes the form of an instrumented glove that can be used on most tool handles in conditions representative of those of their common use, without the necessity of knowing the geometry of the handle to assess the coupling forces (if the glove incorporates hand posture measurement).

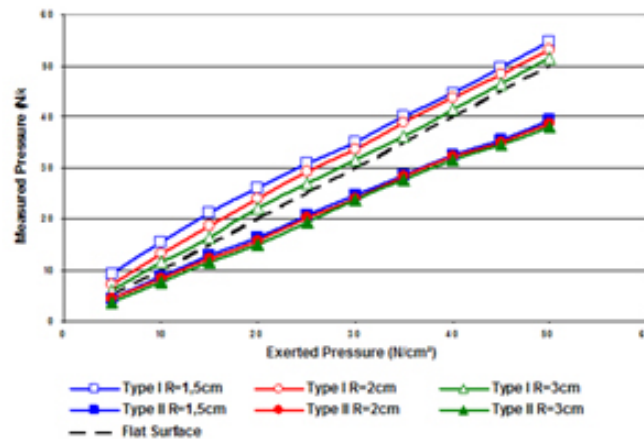
## Technological choices and characterization of the sensors

The technology retained is capacitive pressure sensors. These sensors are composed of two metal armatures separated by a dielectric material, which produce a variable capacitance under the effect of pressure. Sensors of this type have been employed by Gurram *et al.*, (1995) to study the pressure distribution in the hand during "Grip" type movements in dynamic conditions, with very encouraging results. Ko *et al.*, (1999) also confirmed the suitable behaviour of this type of sensor in terms of temperature insensitivity, measurement sensitivity and robustness.

The prototype of the pressure distribution measurement glove was equipped with pressure sensors manufactured by the company NOVEL gmbh. These sensors were selected on the basis of criteria such as lightness, reduced size, flexibility, low hysteresis, measurement range from 0 - 70 N/cm<sup>2</sup>, and correct measurement reproducibility.

A characterization phase of the NOVEL pressure sensors was conducted by Dantigny (1998), Feutry (2000) to identify the parameters that could modify the response and the accuracy of these sensors. The tests carried out highlighted that the application of a normal force spread unevenly over the active surface of the sensor produces an underestimation of this force ( $F = P_{\text{measured}} \times \text{Surface}$ ) of 15 % on average with a standard deviation of 3.8 %. If this normal force is applied to part of the surface of the sensor, the underestimation error increases: for example, for a force of 43 N spread from the centre of the sensor over 50 % of its surface, the error is on average 45 % with a standard deviation of 7 %. The curvature of the load bearing surface also constitutes a source of measurement error. Two types of behaviour relative the curvature were observed: for the majority of the sensors, the error linked to curvature resulted in an additive constant linked the radius of curvature but independent of the pressure exerted. For the other sensors, the error is independent of the radius of curvature but is characterised by linear distortion of the exerted pressure / measured pressure relationship (cf. Figure 1). Finally, the presence of shearing hardly modifies the response of the NOVEL sensors: the error is under 5 % for shear force of less than 30 % of the normal force applied.

The response of the NOVEL sensor in dynamic conditions has also been analysed using an electrodynamic exciter and a force measurement platform. The results of studies in sinusoidal and random conditions demonstrated good dynamic behaviour over the frequency range tested (0-200 Hz), with an accuracy of 15 % on average, which is similar to the accuracy observed in static charge conditions. However, their bandwidth is limited by the current performance of measurement electronics. In particular, bandwidth is inversely proportional to the number of sensors used simultaneously.



**Figure 1** Curvature effect on sensor accuracy. Two behaviours can be observed : Behaviour Type I (75% of the sensors) and Behaviour Type II (25% of the sensors)

### Design of prototype gloves

An initial prototype of an instrumented glove (Figure 2) comprising an individual sensor and five strips, each including 10 sensors, was produced. This prototype was tested on reference handles (instrumented handles allowing the measurement of grip force) in static conditions and on the handles of jack hammers in operation, Dantigny (1998). However, it appeared necessary to increase the number of sensors in order to improve the coverage zone of the palm of the hand in particular.

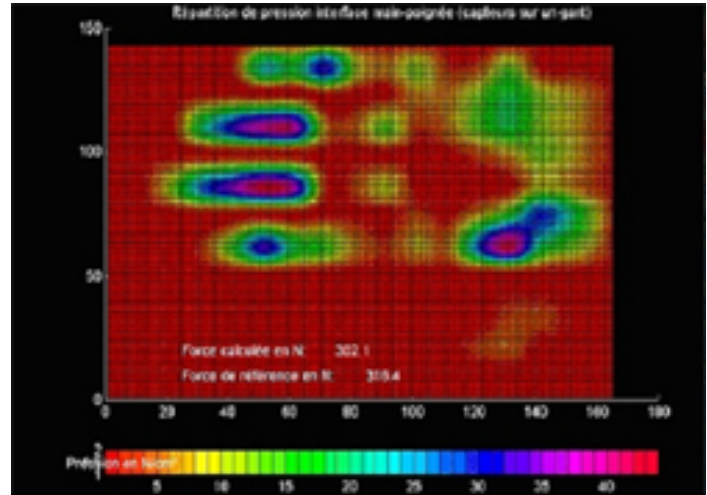
After several trials, a final prototype was designed (cf. Figure 3). The sensor distribution retained was the result of a compromise between hand coverage by the sensors and maintaining hand mobility. The principle of this sensor distribution is based on a representation of the hand by a system of linked bodies. Each body is covered with an independent matrix of sensors, thus keeping zones without sensors close to the different joints while not reducing the mobility of the hand.



**Figure 2** First prototype comprising 51 sensors



**Figure 3** Mechanical lay-out of the new prototype. Distribution of the sensors on the hand



**Figure 4** Pressure distribution during a “Grip” type grasping movement of a cylindrical handle with a grip force of 316 N

The distribution of the sensors on the hand also takes into account the experience acquired with the first prototype (cf. Figure 2). In this respect, the results of the “Grip” type actions showed that the pressure in the palm of the hand is distributed at the base of the fingers below the metacarpophalangeal joints, on the ball of the thumb, on the hypothenar and on the inter-segment commisure between the thumb and the index finger. At finger level, the maximum pressures were located in the middle of the two last phalanges (cf. Figure 4).

The distribution of the sensors of the new prototype allows suitable coverage of the zones of maximum pressure observed in the palm of the hand. In contrast, the loss of information is greater close to the finger joints. Indeed, the more the hand is open, the greater the distance between the matrices of two successive phalanges.

Finally, the dimensions of the sensors were chosen in relation to the results of the characterization of the NOVEL sensors. Starting out from the observation that a non-uniform application of pressure or application on part of the surface of the sensor results in a significant measurement error, the density of the sensors of the new prototype was increased along the fingers. The total number of sensors is now 219: on the palm of the hand 100 sensors (10 mm by 5 mm) are distributed, and 119 sensors (5 mm by 5 mm) are placed along the fingers.

### Conclusion

The results obtained with the previous prototypes showed both the potential of this measurement system and the need to continue making further progress with the glove.

The design of the prototype (cf. Figure 3) meets certain requirements, including a compromise between the extent of the pressure distribution measurement zone and retention of the functional abilities of the hand. Sensor distribution has been optimized on the basis of the characterisation of the sensors employed and the experience acquired with the first prototypes in the area of pressure distribution measurement.

The operational character of this new sensor distribution still remains to be analysed. An initial step will consist of comparing the pressure distribution measured with this glove and that obtained by pressure sensors fitted to a reference handle. Alongside this step, the accuracy of the coupling force measurement (grip and push/pull forces) will also be evaluated. The pressure distribution measurement system will then be associated with a virtual reality glove to allow measurement of the relative positions of the fingers, which are necessary to calculate the coupling forces.

### References

- Bishu R., Wang W., & Chin AA.,1993. Force distribution at the container hand/handle interface using force-sensing resistors. *International Journal of Industrial Ergonomics* 11, 225-231.
- Björling G., Johansson L., & Hägg G.,1998. The pressure distribution in the hand when holding powered drills. The effects of vibrations, push forces, two hand grip and direction – a pilot study. *Advances in Occupational Ergonomics and Safety*, S. Kumar Ed., IOS Press, pp. 436-438.

- Dantigny F., 1998. Caractérisation de capteurs de pression pour la mesure de forces de poussée et de préhension exercées sur une poignée d'outil. Document de travail INRS MAV-DT-375/FD.
- Fellows G., & Freivalds A., 1989. The use of force sensing resistors in ergonomic tool design. In Proceedings of Human Factors Society, 33<sup>rd</sup> annual meeting, pp. 713-717.
- Feutry D., 2002. Mesure de la distribution de pression à l'interface main-poignée d'outils à main et évaluation des forces de couplage. Document de travail INRS IET-NP/02DT-002/Dfy.
- Fransson-Hall C., & Kilbom A., 1993. Sensitivity of the hand to surface pressure. *Applied Ergonomics* 24 (3), 181-189.
- Guram R., Rakheja S., & Gouw G.J., 1995. A study of hand grip pressure distribution and EMG of finger flexor muscles under dynamic loads. *Ergonomics* 38 (4), 684-699.
- Johansson L., Kjellberg A., Kilbom A., & Hägg G., 1999. Perception of surface pressure applied to the hand. *Ergonomics* 42 (10), 1274-1282.
- Ko W.H., & Wang Q., 1999. Touch mode capacitive pressure sensors. *Sensors And Actuators. A, Physical*, 75 (3), 242-251.
- Yun M. H., Kotami K., & Ellis D., 1992. Using force sensitive resistors to evaluate hand tool grip design. In Proceedings of the Human Factors Society, 36<sup>th</sup> annual meeting, pp. 806-810

**Tool Design I - Focus**  
J. Wasserman - Session Coordinator



# DYNAMIC MODELING OF RECIPROCATING, PNEUMATIC IMPACT TOOLS

W. A. Bloxsom, D. D. Reynolds

Center for Mechanical & Environmental Systems Technology (CMEST), University of Nevada, Las Vegas  
4505 Maryland Parkway, Box 454027, Las Vegas, Nevada, USA

## Abstract

Reciprocating, pneumatic impact tools have been in existence for decades. Tool modifications in the past have usually been time and labor-intensive iterative processes, often requiring multiple prototypes. Low-vibration hand tools are needed to comply with new industrial hand-arm vibration guidelines. To reduce costs associated with tool redesign and modification, the operation of reciprocating, pneumatic impact tools has been modeled by computer code. Difficulties associated with modeling the vibration response of a tool associated with a rapid succession of impacts occurring without regard to regular time or space intervals have been overcome. The modeled tool compares favorably with experimental data.

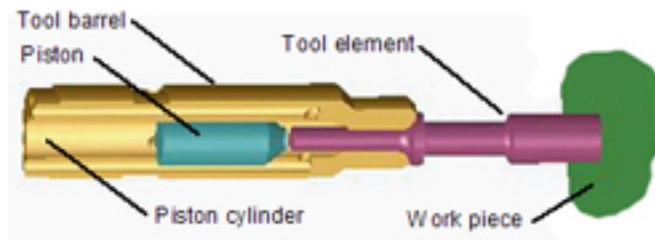
## Introduction

Vibration energy induced into the hand-arm from the operation of reciprocating hand tools has been linked to degenerative conditions of the circulatory and neurological systems in the hands and fingers, often referred to as hand-arm vibration syndrome (HAVS). Low vibration hand tools must be developed to reduce the potential for contracting HAVS. These tools can be used for longer work periods, as defined by ISO 5349 [1], without resulting in the occurrence of HVAS.

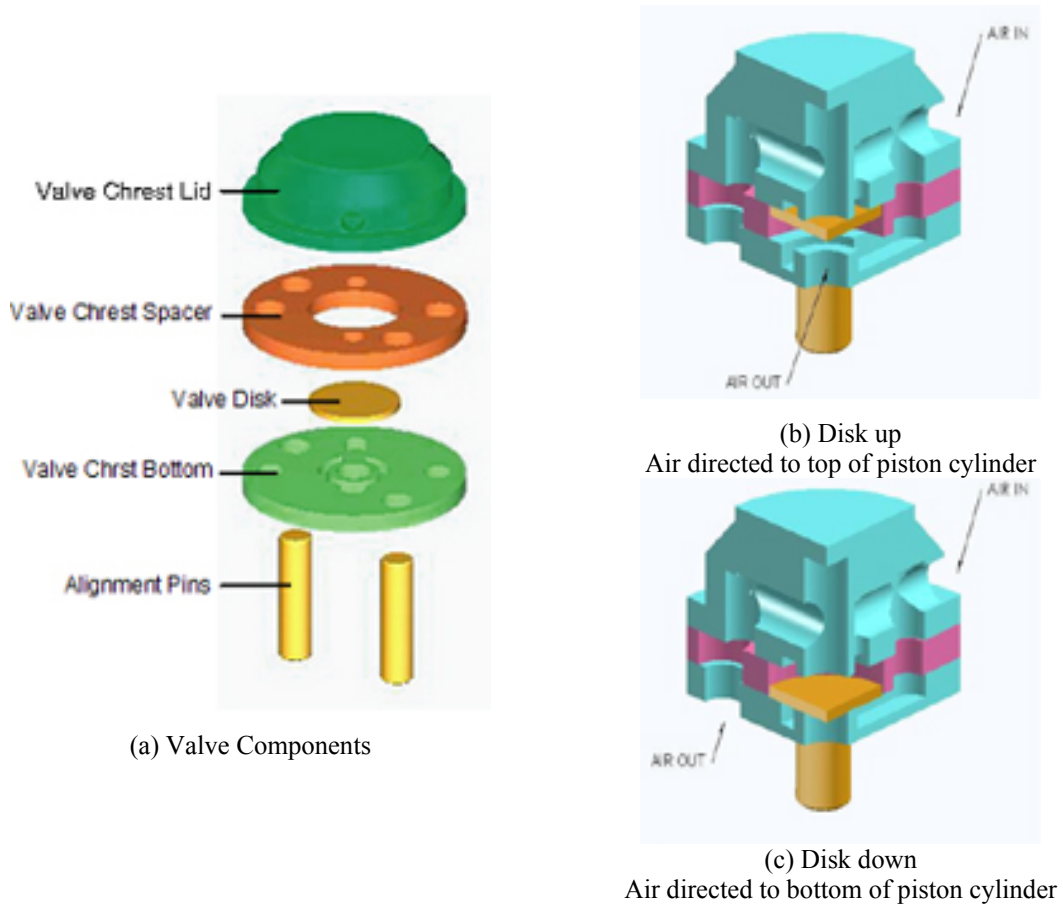
Using an analytical computer model of reciprocating, pneumatic impact tools will significantly reduce the costs associated with tool redesign and development. Modeling pneumatic impact tools not only requires evaluating displacements, velocities, and accelerations of multiple tool components, it also requires accounting for multiple collisions of these components, which occur over varying component spatial locations and differing time increments.

## Tool Anatomy of Typical Reciprocating, Pneumatic Impact Tools

Reciprocating, pneumatic impact tools have the following characteristics. A piston reciprocates axially in the barrel of the tool (Figure 1). The piston impacts the tool element near the bottom of its stroke. The tool element impacts the work piece, bounces back, and then impacts the bottom of the tool barrel. A small disk in a valve chest provides the switching for the pneumatic cycling of the tool (Figure 2). The valve disk has two positions: one to allow line air pressure to the top of the piston to accelerate it downward toward the tool element (Figure 2b) and the other to direct line air pressure to the bottom side of the piston to facilitate moving it back to the top of the cylinder (Figure 2c). As the piston moves within the cylinder the piston uncovers exhaust ports that drop the air pressure within that portion of the cylinder to an ambient level causing the valve disk to change positions and the opposite end of the cylinder to be pressurized.



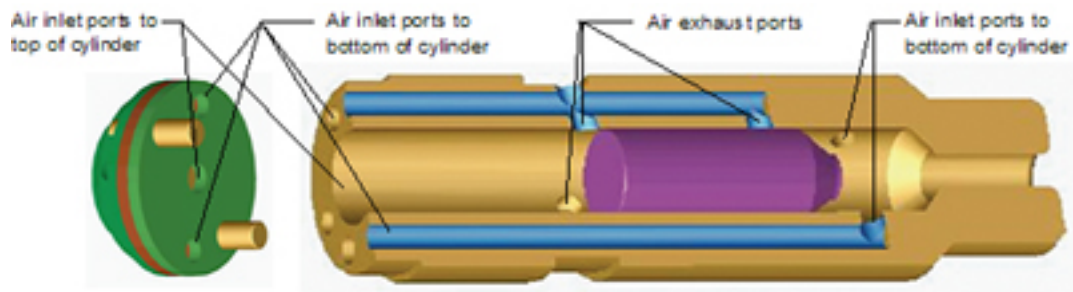
**Figure 1** Reciprocating, pneumatic impact hammer



**Figure 2** Typical Air Valve Assembly

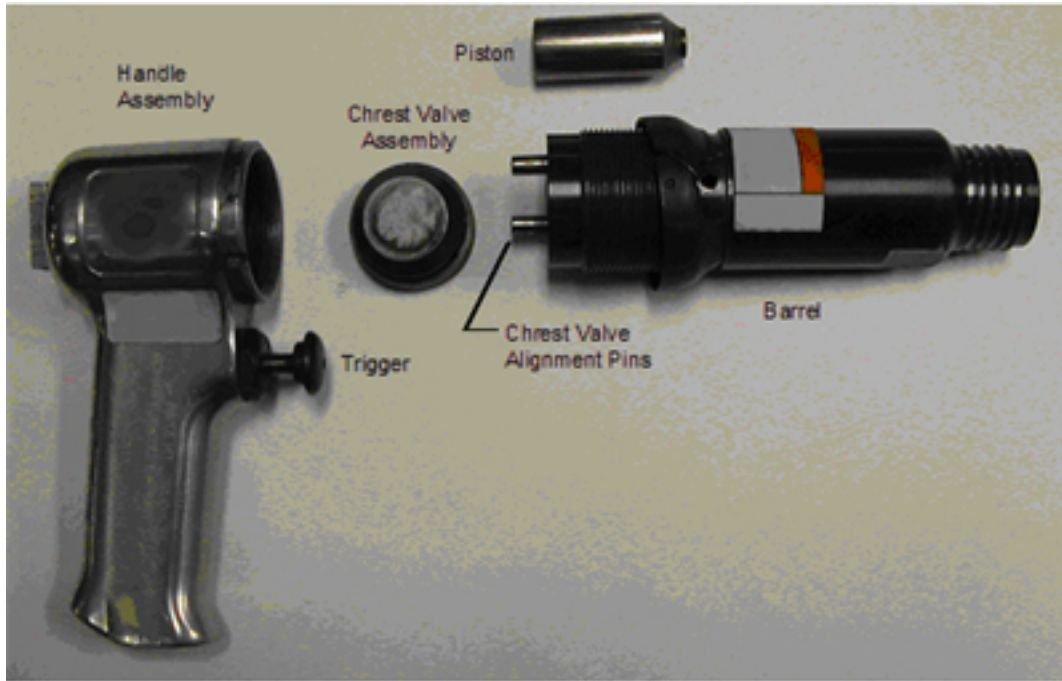
The tool barrel (Figure 3) houses the cylinder where the piston operates and contains conduits and ports to in a cyclic fashion introduce compressed air to and exhaust compressed air from the top and bottom sides of the piston. The upper end of the tool barrel threads into the tool handle (Figure 4), while the lower end of the barrel maintains the proper alignment of the tool element.

The tool handle has several functions (Figure 4). The line air is connected to the handle. The void within the handle provide a plenum for compressed air. An operator-controlled trigger is linked to a spool valve that allows compressed air to move to the remainder of the tool. The valve chest, which is placed on top of the cylinder, is compressed between the barrel and the rear of the threaded cavity within the handle assembly. The handle is clasped by the tool operator.



**Figure 3** Typical Tool Barrel with Inlet and Exhaust Ports





**Figure 4** Typical Tool Assembly

### **Vibration Tests**

Only one-dimensional axial motion of reciprocating, pneumatic impact tools was investigated. The axial motion was aligned with the up and down motion of the tool piston. Experimental test data were also limited to the axial orientation of the tool. Acceleration values of the tool handle and of the repetitive impacts of the tool element on a test mass were measured for simulated test conditions.

The impact acceleration values of the working element of the tool were sufficiently high that it was not possible to directly measure them. An alternative method, therefore, was used to measure them. Figure 5 shows a picture of the single-degree-of-freedom (SDOF) test fixture that was used to measure the impact acceleration of the tool element. The SDOF mass, which was approximately 70 kg, was aligned on four vertical shafts with linear bearings. The four shafts were anchored into a massive steel base. The SDOF mass was supported by a wheel barrel inner tube that acted as a spring and damping element for the test fixture. The stiffness (85,040 N/m) and damping ( $\xi = 0.121$ ) properties of the inner tube and the resonance frequency of the test fixture (5.58 Hz) were reported by Markle [2].

The acceleration values of the tool handle and SDOF mass were measured with PCB model 350b04 accelerometers connected to a Bruel & Kjaer Portable Pulse system. The Portable Pulse system displayed and recorded the time domain signals of the accelerometers. It also provided 1600 line FFT spectra over the frequency range from 0 to 800 Hz. The FFT signals were averaged over ten cycles of operation. The digital signals from the Portable Pulse were copied to a comma delimited Microsoft Excel file for later use in the MATLAB computer code for the model of reciprocating, pneumatic impact tools. Figure 6 shows a typical output from the Bruel and Kjaer Portable Pulse System.

For the test results reported in this paper, the tool element that was used in the tests was a blunted tool element. The tool operator was instructed to orient his arm to coincide with the axial direction of the tool.

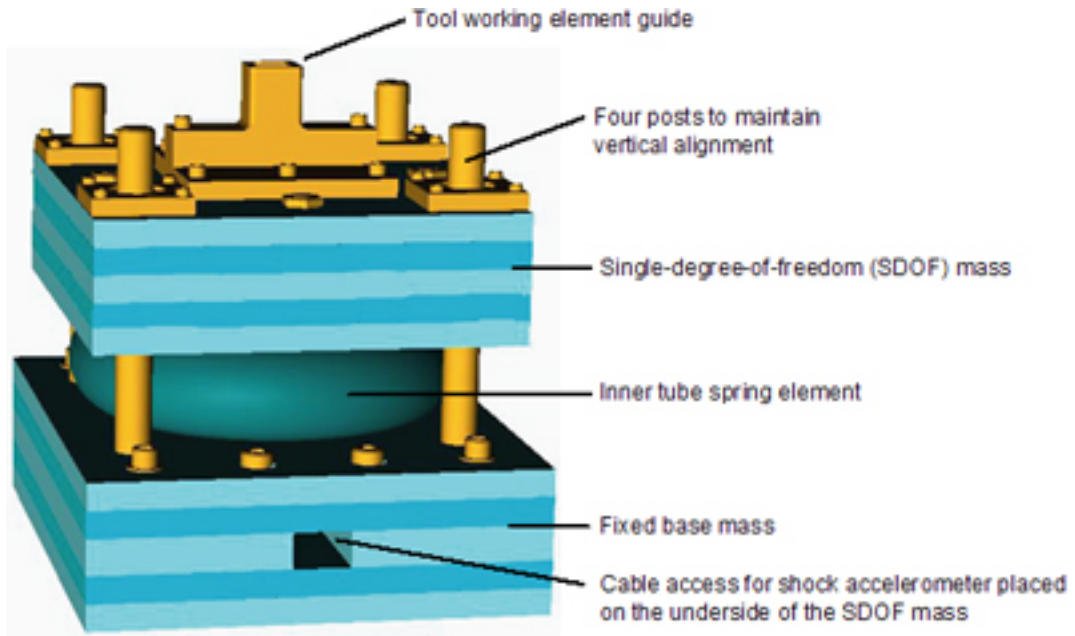


Figure 5 Single-Degree-of-Freedom Test System

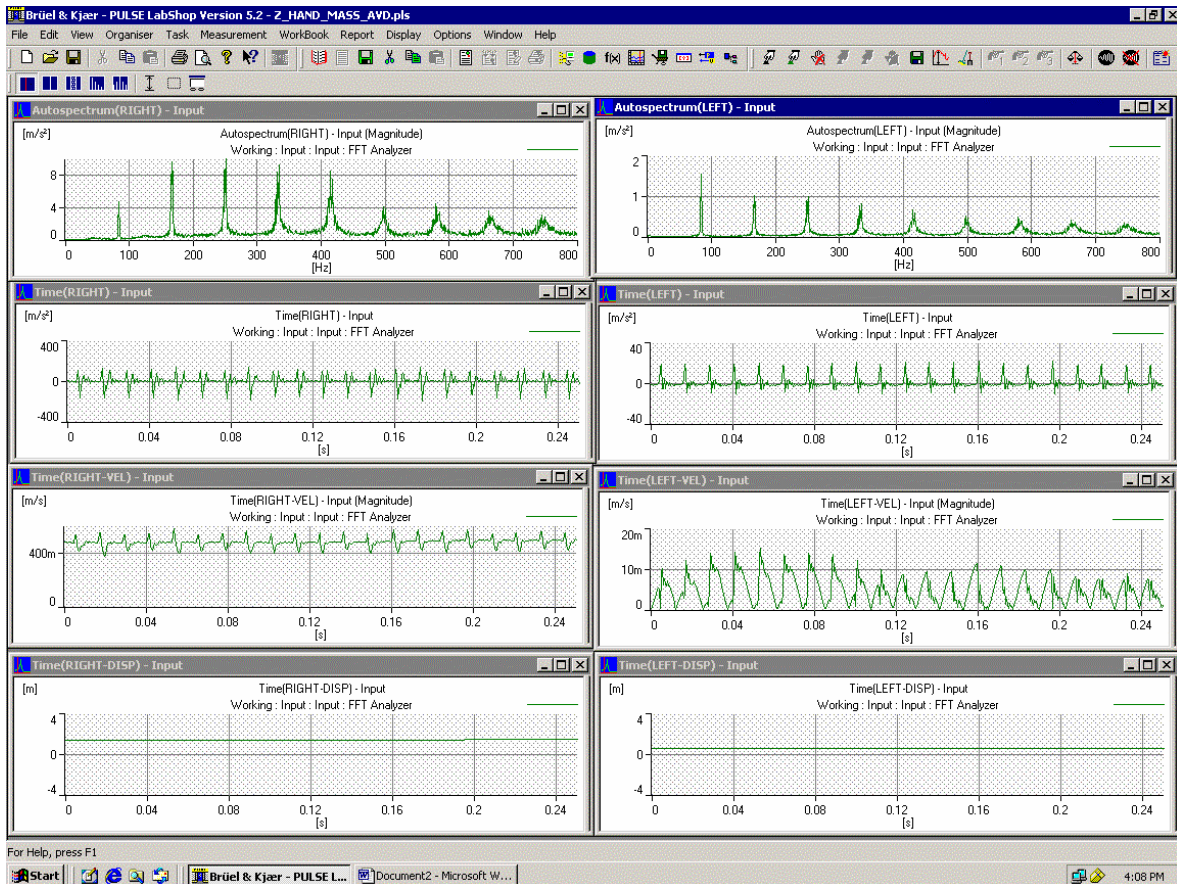


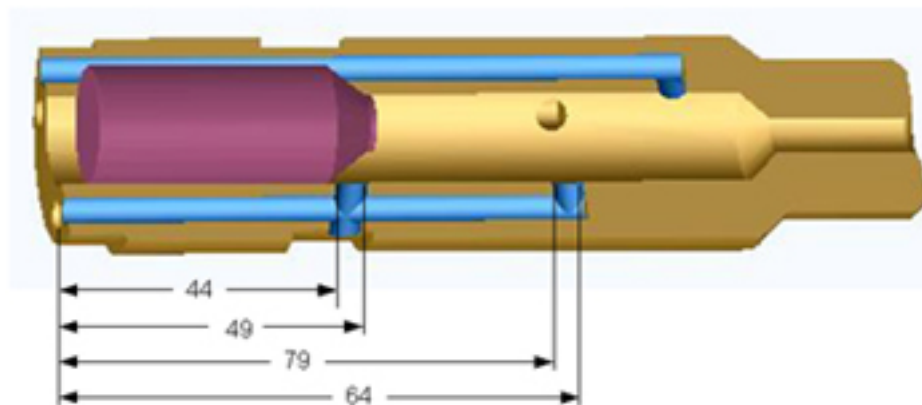
Figure 6 Typical Outputs from Bruel & Kjaer Portable Pulse System

### Analytical Model

The computer code was written in MATLAB because of its intrinsic graphic display and array manipulation capabilities. SI units were used in all of the calculations. Graphic outputs used a displacement scale in millimeters (mm) to avoid preceding zeros or scientific notation. The motions of the moving components were incremented in 0.0005-s intervals.

The tool was disassembled and each component piece weighed. The motion of the valve disk was not included in the model since its mass was very small compared with the remainder of the tool. Its contribution to any vibration was, therefore, judged to be insignificant. The values of the masses of the piston, barrel, entire valve assembly, and tool element were obtained. Critical dimension associated with the exhaust ports in the barrel are shown in mm in Figure 7.

The operation of the tool was modeled as a series of component impacts. The piston impacts the tool element, the tool element impacts the SDOF mass, and the tool element rebounds and impacts the barrel of the tool. Over the life of a typical tool and tool element, there are tens of thousands of impacts involving the piston, tool element, and barrel. There is no discernable damage from these multiple collisions; therefore, the collisions were assumed to be perfectly elastic with a coefficient of restitution of one. The tool-element-to-test fixture impact caused little damage. The coefficient of restitution was assumed to be 0.97.

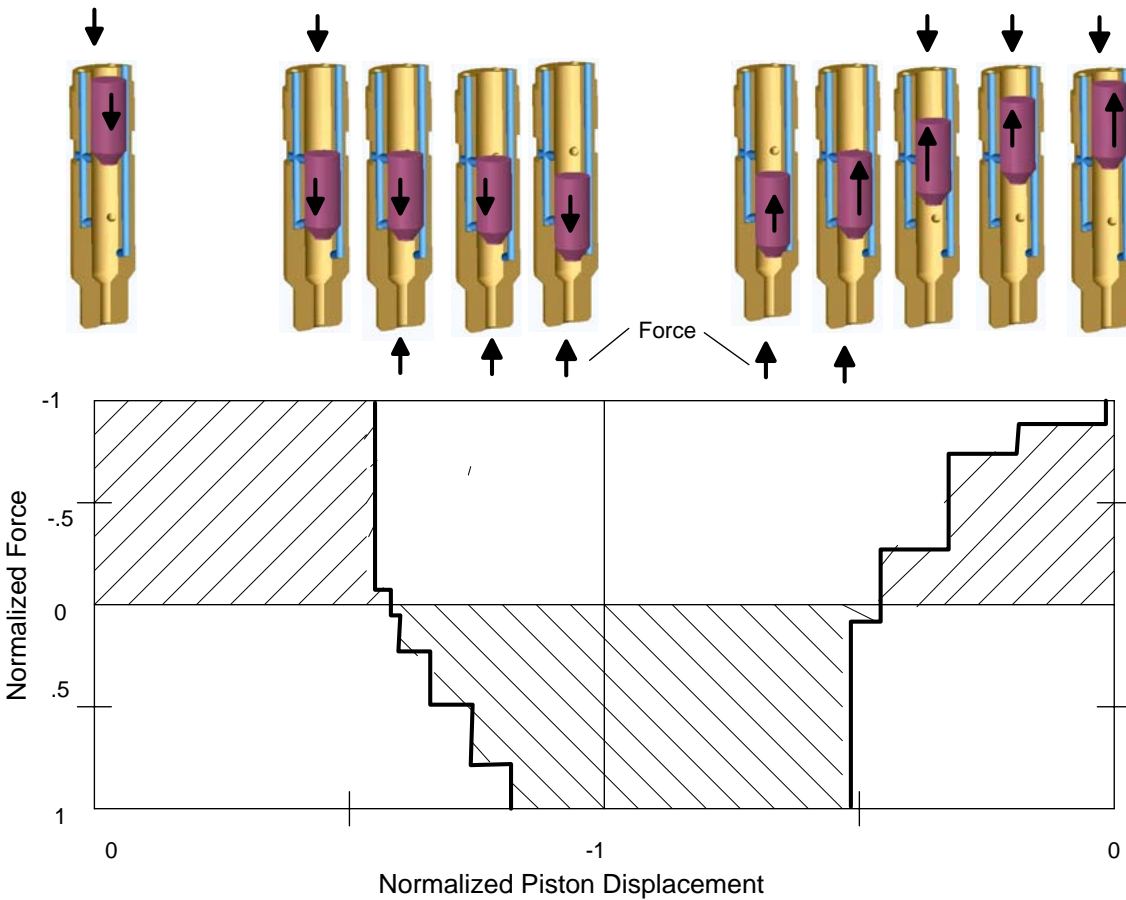


**Figure 7** Cross-section of Barrel Showing Dimensions in mm to Exhaust Ports

The air pressure within the cylinder was modeled. When the motion of the piston within the cylinder opened an inlet or exhaust port (Figure 7), it was assumed that the change in air pressure was not instantaneous. A pressure-time curve could not be created because pressure changes were a function of the displacement of the piston, not of time. A pressure profile (Figure 8) based on incrementing pressure relative to piston location was created by trial and error. The normalized force in Figure 8 is cylinder pressure times piston surface area divided by the maximum piston force. The maximum pressure was  $6.21 \times 10^5$  Pa, and the maximum force was 176 N. When the tool operated at a frequency of 60 Hz, there was approximately 0.017 second per cycle of the piston. At discrete time steps of 0.0005 second, there were approximately 34 time steps per cycle. The time steps were sufficiently small to increment the modeled air pressure changes in a manner that was representative of actual tool operation.

When the dynamic motions associated with a reciprocating, pneumatic impact hammer being operated by a human operator were modeled, several interactions were simultaneously modeled and monitored in the resulting computer code. These included:

1. The interaction of the tool with the human operator,
2. The motion of the piston within the barrel of the tool,
3. The interaction of the piston with the tool element,
4. The interaction of the tool element with the SDOF mass,
5. The dynamic motion of the SDOF mass, and
6. The interaction of the tool element with the barrel of the tool.



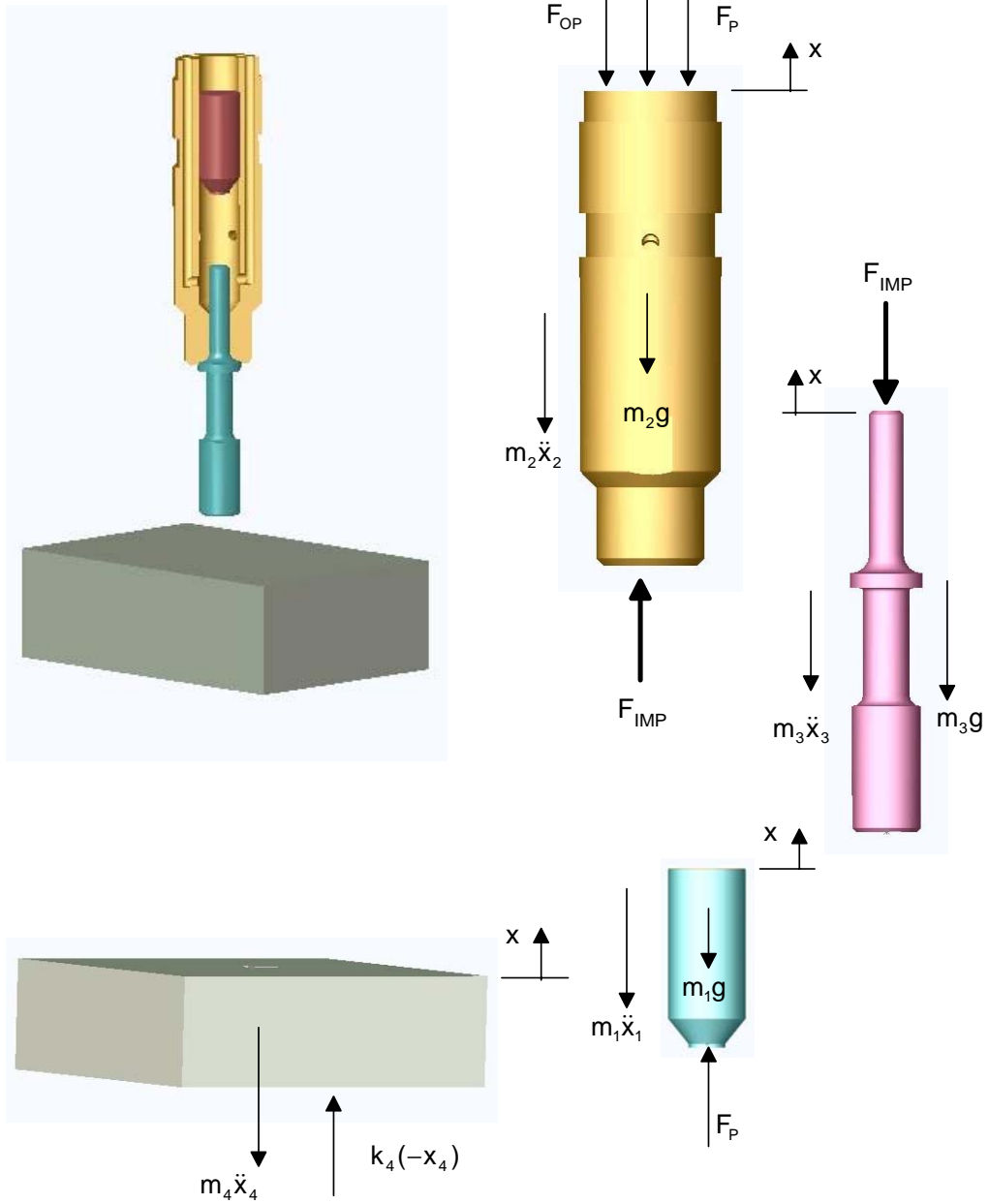
**Figure 8** Assumed Normalized Forces Acting on Piston through One Cycle of Operation of Tool

Changes in cylinder air pressure, gravity, and momentum transfers associated with impacts between the piston and tool element dictated the motion of the piston within the barrel cylinder. Accelerations, velocities, and displacements of the different system components were determined by summing forces at each time step using Newtonian mechanics. At each time step, the global displacements of the piston, tool, tool element, and SDOF mass determine what occurs at that time step. In the computer code, six conditions were checked and addressed at each time step. They were:

1. All of system components (masses) are in contact.
2. Piston impacts the tool element when it is in contact with the SDOF mass,
3. Piston impacts the tool element when it is not in contact with the SDOF mass,
4. Tool element impacts the SDOF mass,
5. Tool element impacts the barrel of the tool after rebounding from impact with SDOF mass, and
6. None of the components is in contact.

If there was contact between moving components, the velocity from the previous time step was used in a linear momentum relationship to determine the new velocity at the current time step. A coefficient of restitution equation was used as the second equation to resolve the linear momentum equation and its two unknowns. Figure 9 shows a typical free body diagram.

**CHISEL IMPACTING TOOL  
CHISEL NOT CONTACTING MASS**



**Figure 9** Typical Free Body Diagram

The equations of motions for the piston and tool element (components with no stiffness or damping) were obtained from:

$$\ddot{x} = \frac{F}{m} \tag{1}$$

$$\dot{x} = \ddot{x} \cdot \Delta t + \dot{x}_{\text{previous}} \tag{2}$$

$$x = \frac{1}{2} \ddot{x} \cdot \Delta t^2 + \dot{x} \cdot \Delta t + x_{\text{previous}} \quad (3)$$

The force,  $F$ , was comprised of the force associated with air pressure (piston only), force associated with gravity, and force resulting from impacts. When an impact occurred:

$$F_{\text{IMP}} = \frac{m(\dot{x}_{\text{new}} - \dot{x}_{\text{previous}})}{\Delta t} \quad (4)$$

and

$$m_1 \dot{x}_{1\text{-new}} + m_2 \dot{x}_{2\text{-new}} = m_1 \dot{x}_{1\text{-previous}} + m_2 \dot{x}_{2\text{-previous}} \quad (5)$$

$$e = \frac{\dot{x}_{2\text{-new}} - \dot{x}_{1\text{-new}}}{\dot{x}_{2\text{-previous}} - \dot{x}_{1\text{-previous}}} \quad (6)$$

$$m_3 \dot{x}_{3\text{-new}} + m_2 \dot{x}_{2\text{-new}} = m_3 \dot{x}_{3\text{-previous}} + m_2 \dot{x}_{2\text{-previous}} \quad (7)$$

$$e = \frac{\dot{x}_{2\text{-new}} - \dot{x}_{3\text{-new}}}{\dot{x}_{2\text{-previous}} - \dot{x}_{3\text{-previous}}} \quad (8)$$

The kinematics of the piston and tool element were resolved using Newtonian mechanics. An acceleration value was calculated from the new velocity. The acceleration value was then used to calculate a force using Newton's Second Law. The force was summed with the gravitational force acting on the tool element. A new acceleration value was extracted from the combined force associated with the current time step. The acceleration and velocity were used to determine the displacement during the time step. Displacements were added to the global displacements of the tool components from the previous time step to calculate new global displacements. The relevant equations of motions associated with the free body diagrams in Figure 9 are:

$$\sum F_{m1} = 0 = -m_1 \ddot{x}_1 - m_1 g + F_p \quad (9)$$

$$\ddot{x}_1 = F_p / m_2 - g \quad (10)$$

$$\sum F_{m2} = 0 = -m_2 \ddot{x}_2 - m_2 g - F_p - F_{\text{OP}} - F_k \quad (11)$$

$$\ddot{x}_2 = (-F_p - F_{\text{OP}} - F_k) / m_2 - g \quad (12)$$

$$\sum F_{m3} = 0 = -m_3 \ddot{x}_3 - m_3 g - F_{\text{IMP}} \quad (13)$$

$$\ddot{x}_3 = -F_{\text{IMP}} / m_3 - g \quad (14)$$

$$\sum F_{m4} = 0 = -m_4 \ddot{x}_4 - m_4 g + k_4(-x_4) \quad (15)$$

$$\ddot{x}_4 = (k_4(-x_4)) / m_4 - g \quad (16)$$

There were separate sets of equations for each of the six conditions that were check and addressed at each time step.

The tool connected to the hand-arm system of the operator, which had stiffness and damping associated with it. The stiffness value (525,000 N/m) and damping coefficient (545 N·s/m) were obtained from work reported by Reynolds [3].

The determination of their incremental motion was more complicated. Published information on the impact dynamics of masses with springs and dampers are limited to either a single impact followed by free vibration or a single impact at a fixed location within each cycle. The pneumatic impact tools have impacts between tool components at nearly every time step. Typically, after the piston impacts the tool element, there is a tool-element-to-SDOF impact every other time step, separated by the tool element alternately impacting the barrel of the tool. As the tool element velocity decreases, the impacts slow to a SDOF mass impact every fourth or fifth time step. Additionally, the spatial relation and velocity of the tool and the SDOF mass change at each impact with the tool element.

Many solution methods were used to describe the interaction of the tool with the hand-arm systems of the operator. Fourier series, Laplace transforms, convolution integral, and initial condition (displacement and velocity) solutions were tried. None of these methods yielded an acceptable steady-state solution for the overall system model. The particular solution to the forced response of a damped single-degree-of-freedom vibration system was found to give results very close to experimentally measured results. This solutions is:

$$x(t)_{\text{tool-new}} = \frac{F(t)_{\text{tool-new}} / k_{\text{tool}}}{\sqrt{(1-r^2)^2 + (2 \cdot \xi \cdot r)^2}} \cdot \cos(\omega \cdot t + \phi) + x_{\text{tool-old}} \quad (17)$$

where:

- $F(t)_{\text{tool-new}}$  = the applied force at the current time step
- $k_{\text{tool}}$  = stiffness of the hand-arm system
- $m_{\text{tool}}$  = mass of the tool
- $c_{\text{tool}}$  = damping of the hand-arm system
- $\omega$  = operating frequency of the tool
- $\xi$  = damping ratio of the hand-arm system [  $\xi = c_{\text{tool}} / (2\sqrt{m_{\text{tool}}k_{\text{tool}}})$  ]
- $\omega_n$  = resonance frequency [  $\omega_n = \sqrt{k_{\text{tool}}/m_{\text{tool}}}$  ]
- $r$  = frequency ratio ( /  $\omega_n$  )

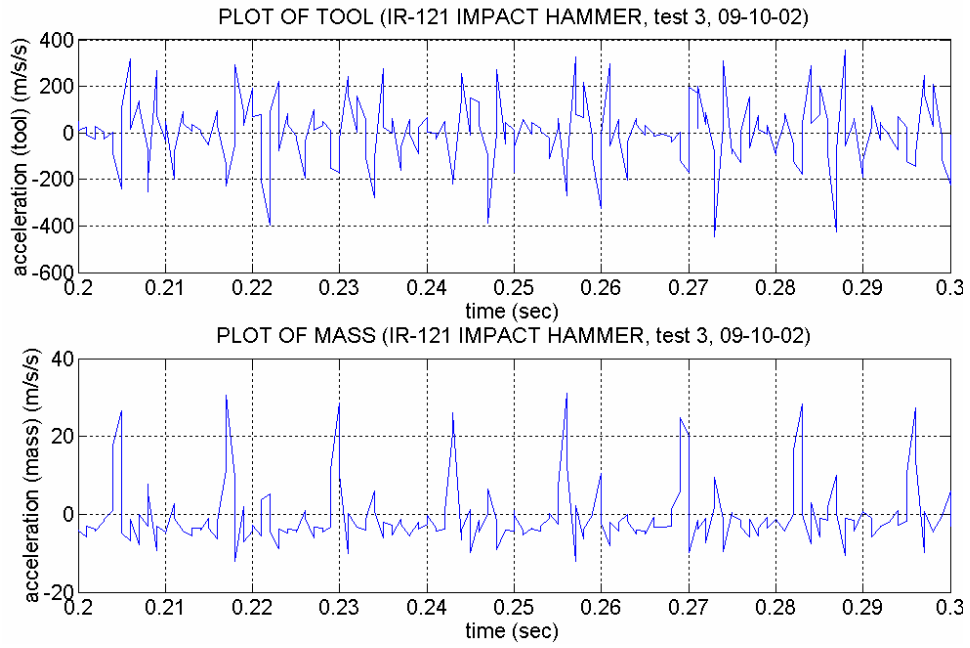
A similar equation was used to resolve the motion of the SDOF mass, which was supported by an inner tube (spring).

The tool and SDOF mass were impacted by the tool element numerous times during each piston-tool-element cycle. The impacts did not occur, however, at ever time step. During non-impact time steps, the particular response to a forced response in a damped system was compared to a harmonic response from initial conditions (displacement and velocity). It was found that the displacements and accelerations from the two methods were within a few percent of each other. The velocity calculated from the forced response method was almost 1.3 times that of the initial condition response. The code modeling the tool was adjusted to lower the calculated forced response velocity accordingly.

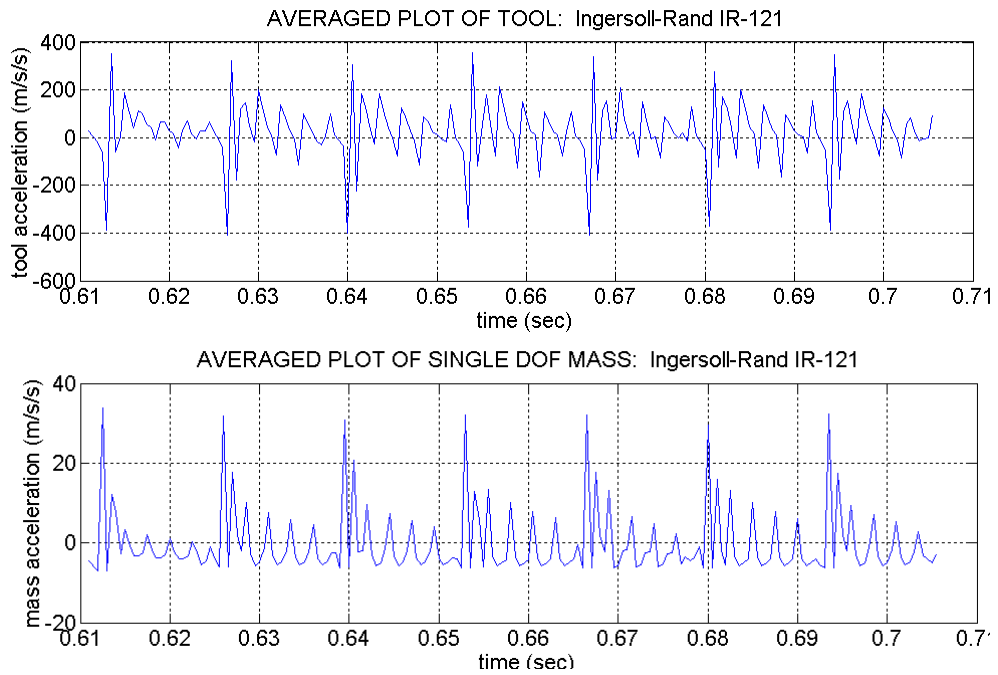
To create a computer model that achieved steady state and correlated well with experimentally obtained data, the initial values of stiffness and damping associated with the hand-arm system were modified to tune the model. The initial values of stiffness and damping were based on different displacements and lower velocity changes. The new stiffness values were assumed to be linear over the range of the displacements in this model. The damping was also used in a linear manner.

### **The Comparison of Experimental and Modeled Data**

The MATLAB computer code for the tool model was iterated through 40 s of simulation. The initial condition with the tool, piston, tool element, and SDOD mass in contact was altered with the first piston impact of the tool element. The modeled motion of the tool and SDOF mass depicted what the operator usually perceives. The vibration and displacement values are higher at startup than at steady state. In a short period of time, the tool element created a space for itself between the tool and SDOF mass.



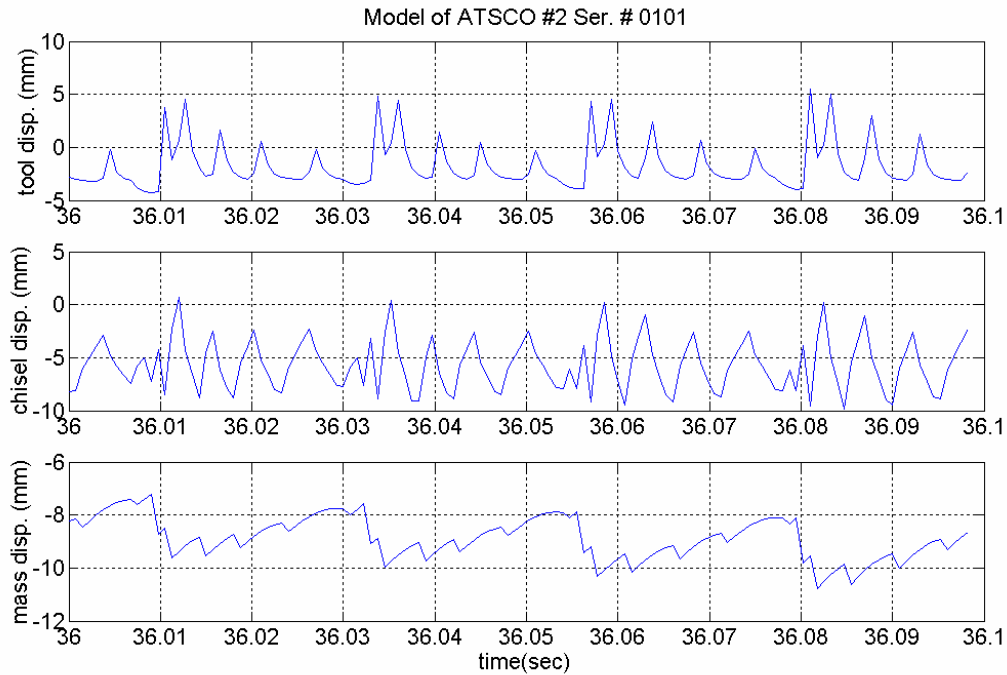
(a) Experimental Test Results for Bruel & Kjaer Portable Pulse System:  
Tool Handle – Top; SDOF Mass - Bottom



(b) Results Predicted by Computer Model: Tool Handle – Top; SDOF Mass - Bottom

**Figure 10** Acceleration Values of Tool Handle and SDOF Mass for Tool with Chisel





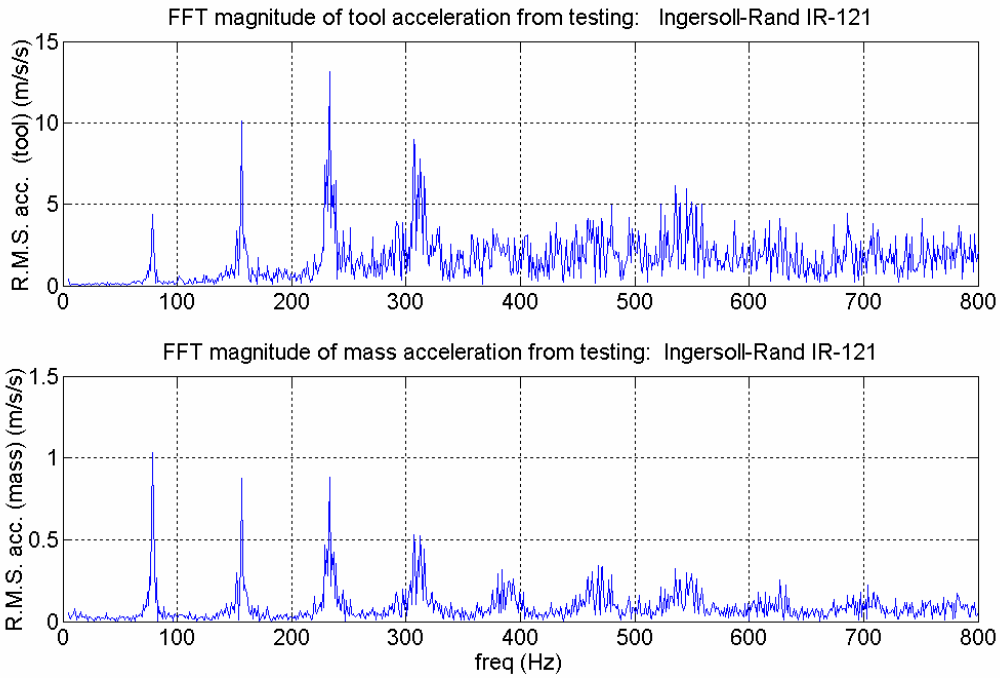
**Figure 11** Displacement Values from Model data for the Tool (top), the Tool Element (middle), and SDOF Mass (bottom)

The acceleration signals from the experimental data (Figure 10a) and the model (Figure 10b) in the time domain are similar in shape and magnitude. The modeled steady state displacements of the tool, tool element, and SDOF appear to be reasonable (Figure 11). Figure 12 shows a comparison of the FFT acceleration values of the tool handle and SDOF mass as a function of frequency obtained from the Bruel & Kjaer Portable Pulse System (Figure 12a) and computer model (Figure 12b).

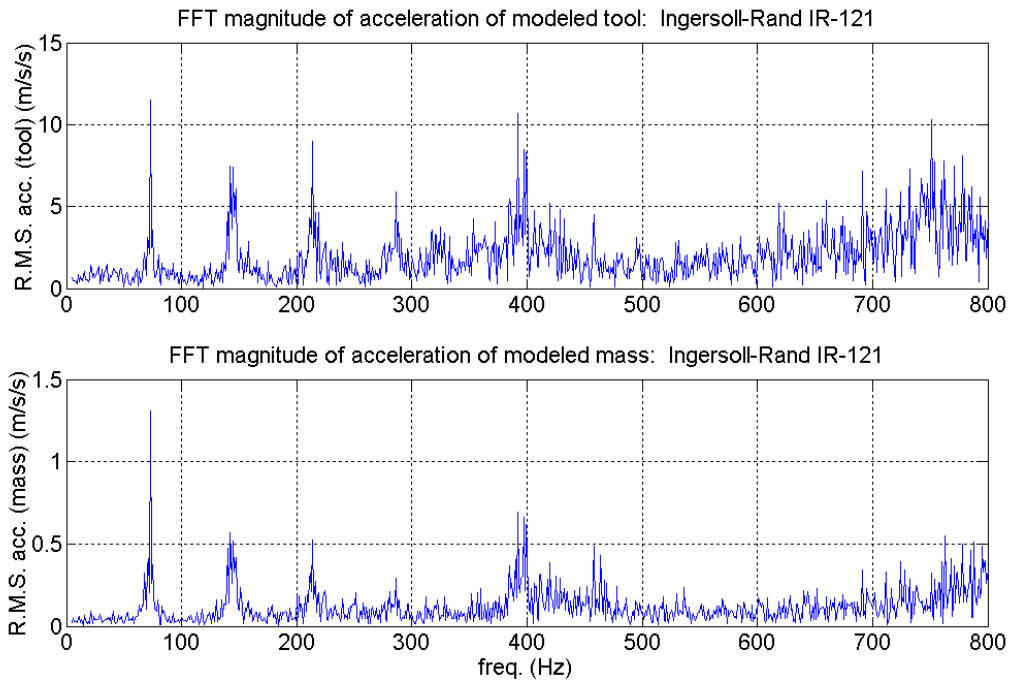
ISO 5349 specifies that third octave band acceleration values be weighted and summed from the third octave frequency bands from 5 to 1,250 Hz. The use of a time increment of 0.0005 s allowed 2000 time increments per second. The Nyquist frequency is 1,000 Hz with the highest 130 Hz of that number being uncertain. The FFT resolution of the experimental data was 1600 lines. Therefore, the experimental data is valid to only 800 Hz. Although not done over the frequency range prescribed by ISO 5349, the data were compared over the range of third octave center frequencies from 5 to 800 Hz. The appropriate ISO 5349 third octave band weighting was applied and the acceleration values were summed in accordance with ISO 5349, albeit to a lower frequency. The ISO weighted acceleration values are:

Tool (from Bruel & Kjaer Portable Pulse system)	22.193 m/s <sup>2</sup>
Tool (from model)	21.843 m/s <sup>2</sup>
SDOF mass (from Bruel & Kjaer Portable Pulse system)	1.744 m/s <sup>2</sup>
SDOF mass (from model)	1.528 m/s <sup>2</sup>

The model predicted that the piston cannot impact the top of the cylinder. Such an impact causes an impulsive change in direction of the velocity of the piston. This causes the piston to move at ever-increasing velocities until the program crashes. Tool manufacturers verified the fact that the piston does not impact the top of the cylinder.



(a) Experimental Test Results for Bruel & Kjaer Portable Pulse System:  
Tool Handle – Top; SDOF Mass - Bottom



(b) Results Predicted by Computer Model: Tool Handle – Top; SDOF Mass - Bottom

**Figure 12** FFT Acceleration Values of Tool Handle and SDOF Mass for Tool with Chisel

### Summary

The internal operation of reciprocating, pneumatic impact tools were analyzed and documented. The internal motion of the tool was modeled by the computer code.

The single degree-of-freedom test fixture was constructed to facilitate the testing of the impact hammers.

The Bruel & Kjaer Portable Pulse system was ideal for the tests reported in this paper because it provided the ability to simultaneously obtain time and frequency domain data from the SDOF mass and tool.

The interaction of the tool, tool element, and SDOF mass were modeled spatially in the dynamic operation of the tool.

The computer code imposes no limitations except naturally occurring constraints on the location of the impacts.

The computer code models the dynamics of individual components either by Newtonian mechanics (those with no springs) or by the particular solution to the displacement response of a harmonic forcing function where the forcing function is actually an impulsive force.

### Conclusions

It was shown that the piston could not impact the top of the cylinder without chaotic results.

The MATLAB computer model is general enough to model several different reciprocating, pneumatic impact tools.

The model allows insight into the motion of the tool element that is difficult to quantify by testing.

The model provides a reasonable portrayal of the motions involved in reciprocating, pneumatic impact tools and provides a platform for inexpensive analytical investigation and tool modification.

The model develops a method for the analysis of impacts that are:

- Rapid in succession,
- Occurring without regard to consistency of time intervals, and
- Occurring without regard to magnitude or spatial constraints.

### Recommendations

- Conduct dynamic pressure testing to further define tool pressure profile.
- Model various attenuating devices to investigate the effectiveness of the methods.
- Modify the code to have a minimum of 3200 time steps per second to produce a frequency domain analysis that extends to 1600 Hz to allow for more accurate correlation to ISO 5349.
- Construct a prototype attenuated, two degree-of-freedom tool prototype from the results of the computer model for testing and evaluation.

### References

Technical Committee ISO/TC 108, M.V.A.S., *Mechanical Vibration - Guidelines for measurement and the assessment of human exposure to hand-transmitted vibration*. 1986, ISO (International Organization for Standardization): Switzerland, ISO 5349, 12 pages.

Markle, J. G., Reynolds, D. D., 2000, "A Test Fixture for Measuring the Impact Forces and Vibration of Impact-Type Tools, 35<sup>th</sup> United Kingdom Group Meeting on Human Responses to Vibration.

Reynolds, D.D. and R.J. Falkenberg, *A Study of Hand Vibration on Chipping and Grinding Operators, Part II: Four-Degree-of-Freedom Lumped Parameter Model of the Vibration Response of the Human Hand*. Journal of Sound and Vibration, 1984. **vol. 95**(4): p. 499-514.



# METHOD FOR ASSESSING THE REDUCTION OF THE RISK OF MUSCULO-SKELETAL DISORDERS BY USING ERGONOMICALLY DESIGNED VIBRATING TOOLS

Eberhard Christ

Berufsgenossenschaftliches Institut für Arbeitsschutz – BIA,  
Alte Heerstrasse 111, 53754 Sankt Augustin, Germany

## Abstract

The CUELA system for registering bodily posture and load handling during work, developed by BIA, has been used for the quantitative evaluation of the reduction in health risks by excessive stressing of the body during grinding work in a shipyard. The conventional angle grinder, used in crouching body position was replaced by a belt sander, operated in standing position. The vibration exposure has been reduced from 10.7 m/s<sup>2</sup> to 0.96 m/s<sup>2</sup> (total vibration value). The ergonomic assessment of the grinding work results in a minimisation of potentially harmful body postures from 90.9 % of working time with the angle grinder to 6.2 % using the belt sander.

## Introduction

Bone and joint damage of the upper extremities has been recognized as an occupational disease in Germany since 1929. Initially only applying to mining, it has subsequently been extended to other branches of industry, and especially to the construction industry. More than 500 workers in German industry apply annually to have this type of disease recognized as an occupational disease. The EU Directive 2002/44/EC on the protection of workers from vibration cites the elimination of the causes of muscular and skeletal injury as an important preventive aim.

**EU-Directive 2002/44/EC:** Taken from legal arguments (3) –

... to introduce measures protecting workers from the risks arising from vibrations owing to their effects on the health and safety of workers, in particular **musculo/bone structure**, neurological and vascular disorders.

In order to enable firms using vibrating tools to select especially low-emission vibrating devices, manufacturers on the European Single Market are obliged to list the devices' vibration emission values in the information for the user. In its essential safety requirements, the EU Machinery Directive 98/37/EC also demands for hand-held and hand-guided machinery that ergonomic design principles receive special attention when such equipment is designed. Manufacturers can document to the user the achieved reduction in vibration by quoting the vibration emission values.

**EU-Directive 98/37/EC:** Taken from annex 1 (essential safety and health requirements) –

1.1.2.(d) – Under the intended conditions of use, the discomfort, fatigue and psychological stress faced by the operator must be reduced to the minimum possible **taking ergonomic principles** into account.

1.5.9 – Machinery must be so designed and constructed that **risks resulting from vibrations** ... are reduced to the lowest level....

2.2 – Portable hand-held and hand-guided machinery – The instructions must give the following information: **the weighted r.m.s. acceleration value** ... if it exceeds 2,5 m/s<sup>2</sup>.

However, any reduction in health risks or in excessive stressing of the body due to the ergonomic improvements mentioned can usually only be qualitatively assessed and not objectively measured. By taking the example of an ergonomically modified grinding workplace in a shipyard, we wish – in addition to the measurement-based demonstration of the achieved reduction in vibration – to present the CUELA method (**computer-supported registration and long-term analysis of musculo-skeletal load**) for the measurement-based characterization of changes in ergonomic loading (Ellegast, R. et al, 2000).

## Grinding Workplace in a Shipyard



**Figure 1** Preparation of the weld seam with an angle grinder

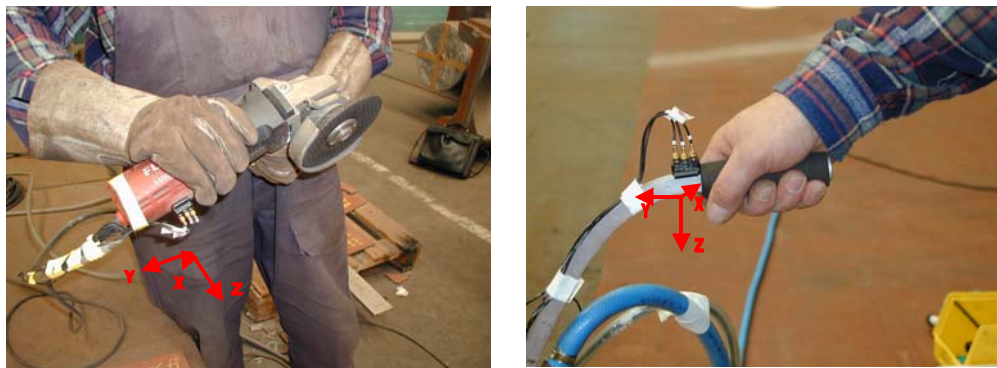


**Figure 2** Preparation of the weld seam with a turbo belt sander

Traditionally, the manual grinding of horizontally laid iron plates to prepare the weld seam is an important work process in shipbuilding (Figures 1 and 2). The advance preservation of iron plates has considerably increased the extent of manual grinding, as the paint film has to be removed prior to welding. Conventionally, the worker guides the electric angle grinder in a crouching position. To relieve the spine, he kneels on the cold iron plate. The grinder is situated at arm's length below the face, and the operator is exposed not only to vibration and noise, but also to inhaled dusts and vapors. The goal in improving this working method, which is health-hazardous on several counts, was to enable grinding to be carried out with an upright body posture. To this end, the shipyard converted a conventional electric angle grinder into its own turbo belt sander. The grinder can then be operated in much the same way as a lawnmower, with the operator walking upright. The guide bar permits precise adherence to the marked grinding track and the application of the required pressure to the grinding belt. Thanks to the greater distance between the face and the grinding process, the quantity of dusts and vapors inhaled is reduced. The typical out-of-balance vibrations of the rotating grinding disc on the angle grinder do not occur on the belt sander. The achieved ergonomic improvement is obvious. By using the CUELA system, we wish to quantitatively assess this improvement.

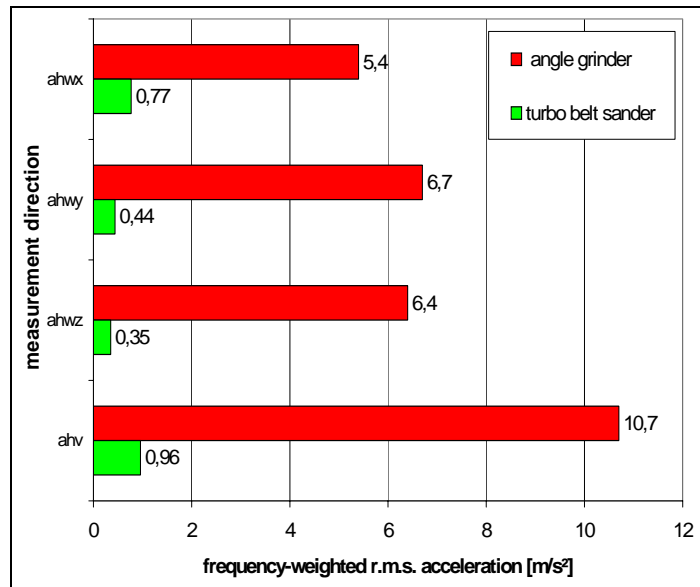
## Measurement Results

### *Vibration Load*



**Figure 3** Accelerometer mounting and coordinate system

To determine the vibration exposure, the accelerometers for the x-, y- and z-axes were attached to the tool's handgrips immediately next to the hand in accordance with ISO 5349, Part 2 (Figure 3). The frequency-weighted hand-transmitted vibration values  $a_{hw(x,y,z)}$  were determined for all three measurement axes. The total vibration value  $a_{hv}$  was also calculated.

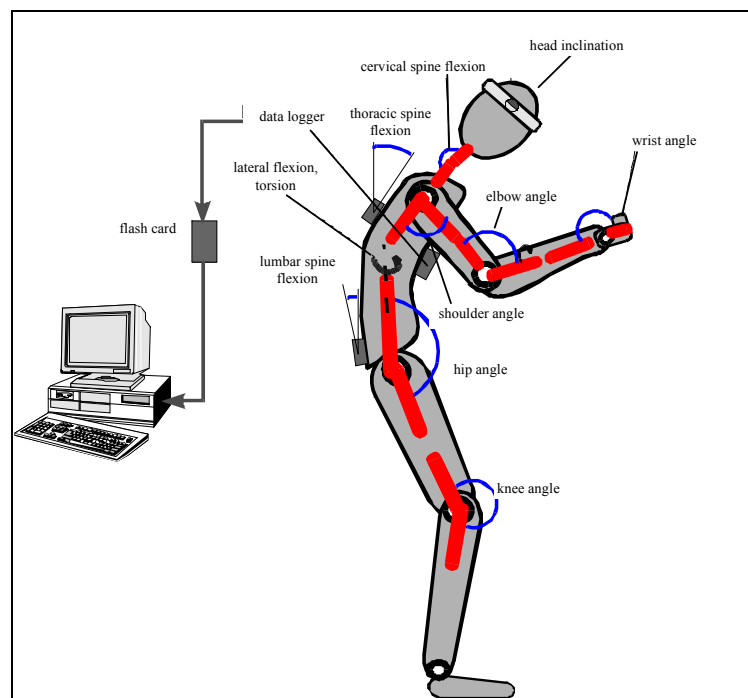


**Figure 4** Vibration exposure – measurement results

Figure 4 containing the results of vibration measurement for the conventionally used electric angle grinder and the new turbo belt sander show the anticipated marked drop in the effects of vibration. The frequency-weighted acceleration values from work with the hand-held angle grinder range from 5.4 m/s<sup>2</sup> (x-axis) to 6.7 m/s<sup>2</sup> (y-axis). The total vibration value is 10.7 m/s<sup>2</sup>. For the hand-guided turbo belt sander, values between 0.35 m/s<sup>2</sup> (z-axis) and 0.77 m/s<sup>2</sup> (x-axis) were measured. The total vibration value for this has been calculated to be 0.96 m/s<sup>2</sup>.

#### *Ergonomic Assessment With the CUELA System*

Until now, motion studies to determine incorrect musculo-skeletal posture at the workplace have been conventionally carried out with visual methods or by evaluating individual frames of video recordings. This is not only insufficiently accurate, but also time- and labor-intensive. The CUELA system permits high accuracy with a low input of time and labor. It consists of advanced sensors (inclination meters, gyroscopes, potentiometers) and a portable minicomputer attached to the working person's clothing (Figure 5). This means that the CUELA system is suitable for use not only in the laboratory, but also at any workplace without hampering the person's movements in the performance of his/her work.



**Figure 5** Measurement and storage of body angles during grinding work

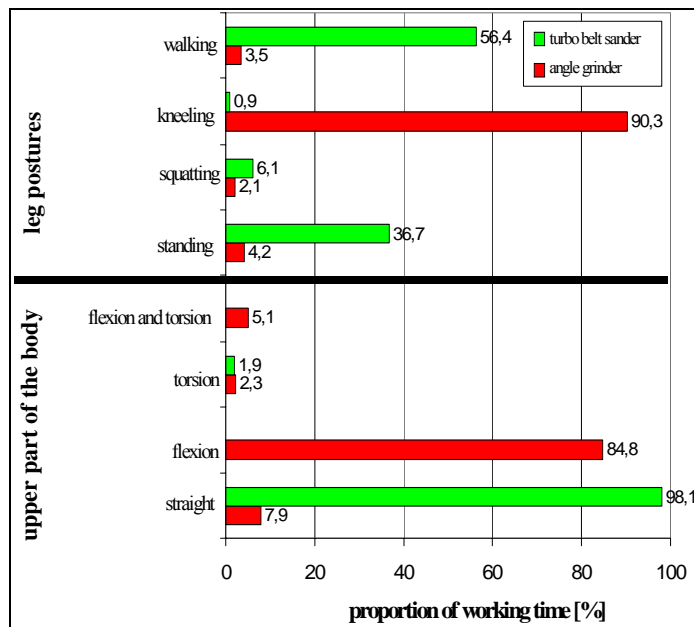
The relevant load data from the sensors for the hand-arm-shoulder system and also for the middle and lower regions of the body are stored with high time resolution (scanning frequency 50/s) on a flash card in the minicomputer fastened

to the person. It is possible to store all the sensor data for the period of a complete work shift lasting 8 hours. Immediately after work, the data are transferred to another computer, where they are directly available for evaluation. The CUELA software developed for this application by the BIA permits the visualization of the recorded joint angles and body pitches and rotations at any measured point in time with the aid of a 3-dimensional computer figure. A video image recorded at the same time is automatically displayed.

**Table 1** CUELA system: Measured body angles and types of sensors

Joint/bodily region	Degree of freedom	Measuring sensor
Head	Inclination, flexion/extension	Inclinometer
Cervical vertebrae	Flexion/extension	Calculated
Dorsal vertebrae/Lumbar vertebrae (seperately)	Inclination, flexion/extension, side inclination	Inclinometer, gyroscope
Pelvis	Inclination (sagittal)	Inclinometer, gyroscope
Hip joint	Flexion/extension	Potentiometer
Knee joint	Flexion/extension	Potentiometer
Scapula	Depression/elevation, anterior/posterior	Potentiometer
Shoulder joint	Flexion/extension, ad-/abduction, inner/outer rotation	Potentiometer
Elbow joint	Flexion/extension	Potentiometer
Forearm	Pro-/supination	Potentiometer
Hand joint	Flexion/extension, radial/ulnar duction	Potentiometer

As an example of this, the flexion, adduction and inner rotation of the shoulder joints during grinding work are displayed. Clearly visible is the repetitive motion with the angle grinder (pay attention to the scaling) during work in a crouching or kneeling position. By comparison, the equivalent motions during work in an upright posture with the turbo belt sander are much less pronounced.

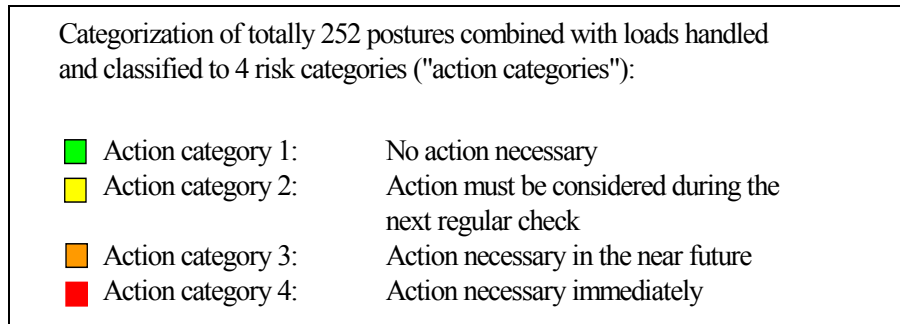


**Figure 6** Analysis of working postures recording

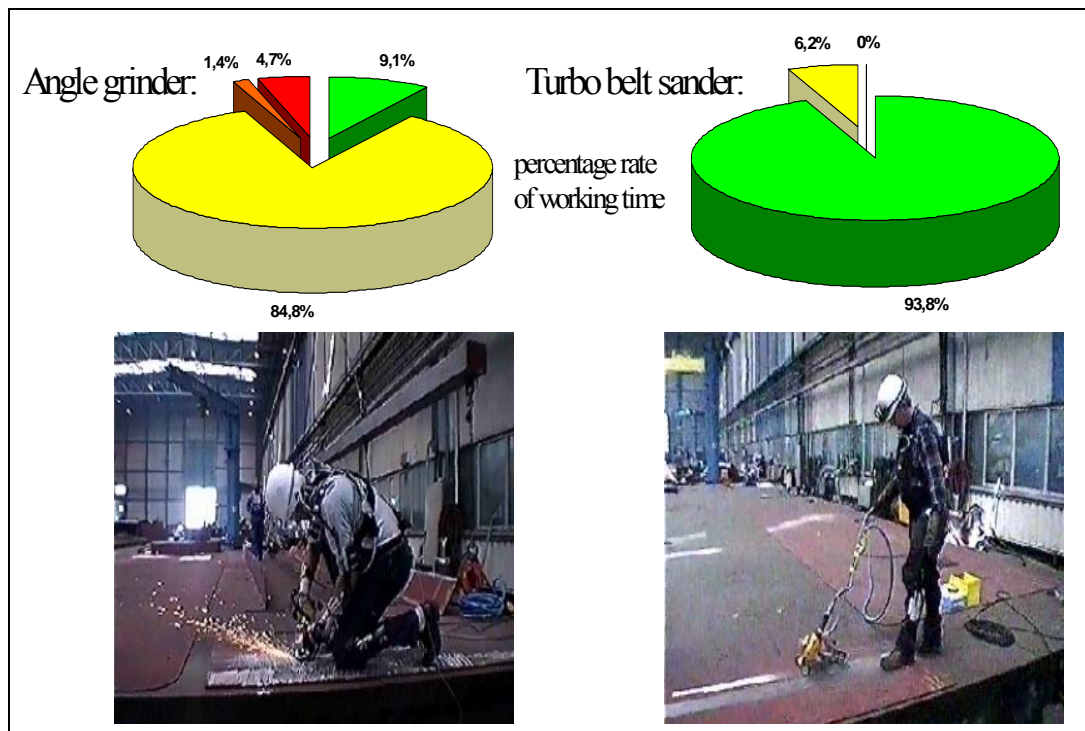


Comparing the two work processes, Figure 6 shows the results of the body posture analysis highlights the elimination of the unfavorable kneeling position and the severe bending of the trunk. During grinding with the turbo belt sander, the upright, unrotated posture of the upper body predominates.

For the assessment of the body posture measurement results, the OWAS method (**Ovako Working Posture Analysing System**) developed in Finland was employed (Karhu, O. et al, 1977). To this end, a total of 252 different body postures were classified and assigned statistically to four action categories (Figure 7). The user is thus given a list of priorities for the ergonomic design of the work process. After taking certain measures, the CUELA system makes it possible to monitor performance and optimize the measures if required.



**Figure 7** Ergonomic assessment (categorization) by OWAS

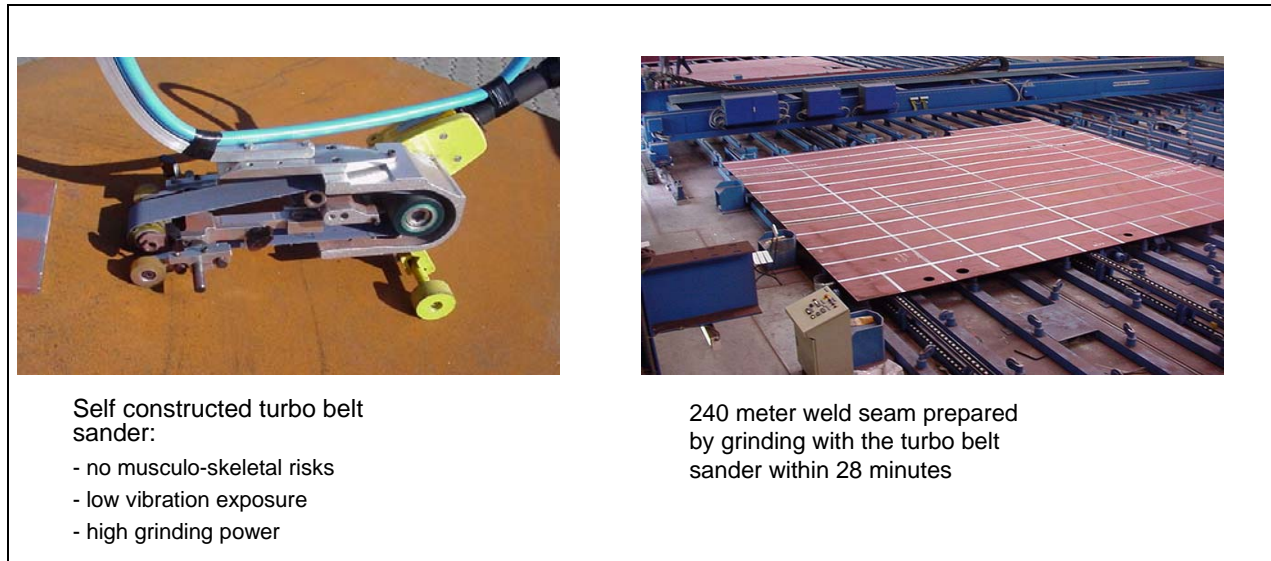


**Figure 8** Assessment of musculo-skeletal risks at the grinding process: Action categories for preventive measures

The OWAS analysis showed that, during work with the angle grinder, no need for ergonomic improvement was identified for only 9.1% of working time (Figure 8). During 90.9% of working hours, the adopted posture is therefore considered potentially harmful to the musculo-skeletal system. By using the new grinding method with the turbo belt sander, 93.8% of working time is considered non-injurious to health. Only 6.2% of working time is assigned here to action category 2.

## Conclusions

The successful example of the use of a hand-guided belt sander instead of a hand-held angle grinder shows that the effective reduction in the vibration exposure is also capable of yielding major ergonomic improvements at the same time (Figure 9). As proof of their effectiveness, the combination of both measures to improve occupational health and safety – one of the key demands of the EU Machinery Directive – requires not only the measurement of the key vibration data, but also an objective, checkable assessment of the ergonomically enhanced design. The CUELA system developed by the BIA has proven ideal for this. The ergonomic design of vibrating hand-held and hand-guided tools must also take account of the physical effort of operating staff in the envisaged applications at the workplace and if necessary provide suitable guidance for handling.



**Figure 9** Successful ergonomic design of grinding work

The employer is in a position to make a considerable improvement to health-hazardous working conditions by selecting suitable equipment and working methods. The declaration of the vibration emission values demanded by the EU Machinery Directive for all hand-held and hand-guided tools represents an important step in this direction.

Ergonomic improvements result not only in a reduction in musculo-skeletal loads and thus to a reduction in the level of illness-related absence from work, but can also yield direct economic benefits, as can be clearly seen in the presented example of grinding work in shipbuilding. To grind a 2-m long and 50-mm wide track, the electric angle grinder takes 3.5 minutes. With the turbo belt sander, this task can now be accomplished in 14 seconds.

## References

Directive 2002/44/EC of the European Parliament and the Council of 25 June 2002 on the minimum health and safety requirements regarding the exposure of workers to the risks arising from physical agents (vibration) (sixteenth individual directive within the meaning of Article 16(1) of Directive 89/391/EEC). Official Journal of the European Communities L 177/06.07.2002, p. 13-19. Internet: <http://europa.eu.int/eur-lex>.

Directive 98/37/EC of the European Parliament and of the Council of 22 June 1998 on the approximation of the laws of the Member States relating to machinery. Official Journal of the European Communities L 207/23.07.1998, p. 1-46. Internet: <http://europa.eu.int/eur-lex>.

Ellegast, R. and Kupfer, J. 2000: Portable posture and motion measuring system for use in ergonomic field analysis. In: Ergonomic Software Tools in Product and Workplace Design, edited by Kurt Landau, Stuttgart, Germany.

ISO 5349-2:2001: Mechanical vibration – Measurement and evaluation of human exposure to hand-transmitted vibration. Part 2: Practical guidance for measurement at the workplace.

Karhu, O., Kausi, P. and Kuorinka, I. 1977: Correcting working postures in industry: A practical method for analysis. Appl. Ergonomics 8/1977, p. 199-201.

### **Acknowledgement**

This projekt has been supported by Mr. H. Gese, Norddeutsche Metall Berufsgenossenschaft, Hannover and Mr. R. Bliedung, Neptun Stahlbau GmbH, Rostock



# EVALUATIONS OF INSTRUMENTATION FOR MEASURING BIODYNAMIC RESPONSES OF THE HAND-ARM SYSTEM

D.E. Welcome, R.G. Dong, T.W. McDowell, J.Z. Wu

National Institute for Occupational Safety and Health, Morgantown, West Virginia, USA

## Introduction

The biodynamic response (BR) of human hand-arm system is one of the important foundations for the future standardization on the measurement and risk assessment of hand-transmitted vibration (Griffin, 1994). It is also useful for the design of improved vibrating tools and the development of anti-vibration devices. There are considerable differences among the previously reported datasets of the biodynamic response. The large variations could have resulted from many different sources or factors. Those factors may be broadly classified into two categories: (1) natural factors and (2) instrumentation problems. While the natural factors can be either controlled during the experiment or considered as fixed or random variables in the study design, the systematic errors caused by the instrumentation problems could lead to misleading results and improper conclusions. Therefore, the specific aims of this study are to develop a systematical methodology for the calibration and evaluation of instrumentation, and to comprehensively examine a measurement system equipped with a new instrumented handle developed at the National Institute for Occupational Safety and Health (NIOSH).

## Method

The design of the NIOSH instrumented handle is shown in Fig. 1. The handle was originally designed to measure the BR distribution at the fingers and the palm of the hand in a power grip (Dong et al., 2002), to perform grip distribution pressure study (Welcome et al., 2001), and to evaluate anti-vibration gloves (Dong et al., 2003). It has also been used to investigate the BR of the entire hand-arm system because the summation of the finger and palm BRs is the total BR of the system. The basic design of the NIOSH handle has also been adopted by several other investigators (Marcotte et al., 2003). This handle is used to demonstrate the proposed system evaluation methods.

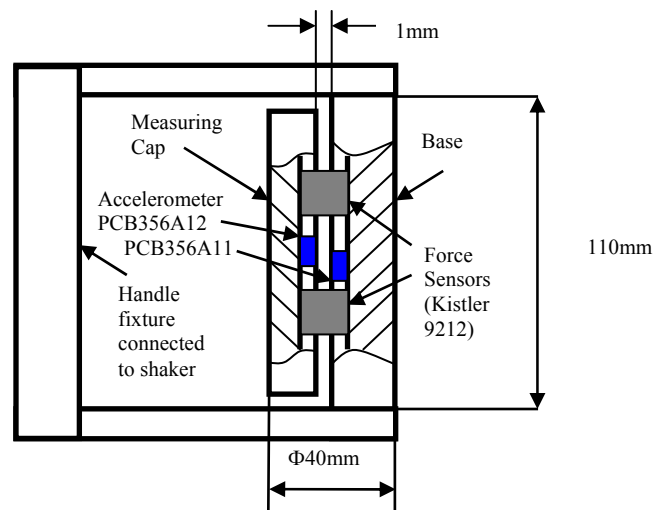


Figure 1 NIOSH instrumented handle

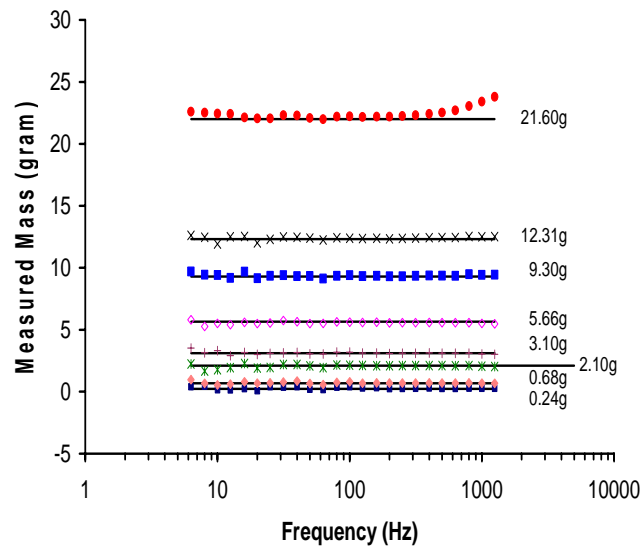
The static calibration of the force measurement system was performed with the instrumented handle installed in the handle fixture. Dead weights ranging from 30 N in tension to 200 N in compression were used as loads for the calibration. Each weight was hung on the measuring cap using a string loop at three different handle locations: at the middle of the handle and directly over each of the two force sensors (directly outside of the force sensors for tension). The frequency response functions of the handle-fixture system with and without a hand coupling were examined by applying a chirp excitation (uncontrolled sweep sinusoid vibration) to the measurement system from 20 Hz to 3,200 Hz. A scanning laser vibrometer (PSV 300H) was also used to examine the vibration distribution on the surface of the measuring cap subjected to a sinusoidal vibration (141 m/s<sup>2</sup> rms) at several high frequencies (1000, 1500, 2000, 2500, and 3000 Hz). To examine the effect of the hand coupling on the vibration distribution, the vibration at the two ends of the measuring cap with and without hand coupling was also measured with the laser vibrometer. Several small pieces of metal in the range of 0.68g -21.60g and a piece of electric tape (0.24g) were used as calibration weights to conduct the dynamic calibration of the measurement system. Both sinusoidal and random vibrations were used in the calibration tests, with the vibrations controlled using a feedback test system. While the dynamic calibration was performed with pure mass, the measurement system's capability of detecting the responses of a single mass-spring system was also explored. Combined static and dynamic loads were applied on the handle in the tangential direction of the handle vibration to evaluate the behavior of the instrumented handle under shear and bending loads. The handle mass cancellation was performed using the following formula:

$$Z_{\text{Hand}}(\alpha) = Z_{\text{Total}}(\alpha) - Z_{\text{Handle}}(\alpha) \quad (1)$$

where  $Z_{\text{Hand}}$  is the BR of the hand-arm system,  $Z_{\text{Total}}$  is the response measured in a subject test, and  $Z_{\text{handle}}$  is the handle response (without hand coupling).

## Results

The instrumented handle displays excellent linear behavior. The force measurement is independent to the force load position along the handle. The original handle-fixture system has a fundamental resonant frequency of 1,452 Hz, and a secondary resonant frequency of 2,536 Hz. With the fingers positioned on the measuring cap, the resonant frequencies of the handle-fixture system were only marginally reduced (~50 Hz). The measuring cap did not display obvious bending (distribution difference < 3%) up to 1,500 Hz. The hand coupling had no significant effect (<5%) on the vibration distribution below 2,000 Hz. The measured dynamic mass is very consistent to the calibration mass as shown in Fig. 2. The 1D system responses on the handle were also reliably detected with the handle. The shear and bending loads have little effect on the handle behaviors. With an improved fixture design, the fundamental resonant frequency becomes 1,924 Hz, which further improved the handle behaviors.



**Figure 2** Samples of calibration results

## Discussion and Conclusion

This study addressed the fundamental instrumentation issues that have not been systematically reported and summarized. The information, methods, and results presented in this paper can be used to help establish a generally acceptable methodology for the further measurement and investigation of the BR. This study demonstrated that the proposed methods for instrumentation calibration and evaluation can help identify and correct the potential system problems, improve the design of the handle-fixture structures, avoid major measurement errors, debug data errors, and assure the accuracy of the experimental data. Therefore, the methodology can be directly used to help collect reliable and consistent data to improve the current ISO 10068 (1998), and to establish a trustable database of human hand-arm system biodynamic responses for both research purposes and practical applications. The NIOSH handle is acceptable for the BR measurement up to at least 1,500 Hz.

## Bibliography

- Griffin, M.J., Foundations of hand-transmitted vibration standards, Nagoya J. of Med. Sci., 1994; Suppl. 57: 147-164.
- Dong RG, McDowell TW, Welcome D, Wu JZ, Warren C, Smutz, WP, and Schopper, AW, (2002). Mechanical Energy Absorption in Human Fingers Exposed to Hand-Transmitted Vibration," In J. Vossoughi (Ed.), Biomedical Engineering: Recent Developments. Medical and Engineering Publishers, Inc.: 159-160.
- Welcome D, Rakheja S, Dong RG, Westfall B, Schopper AW. (2001). A preliminary study of the relationship of hand grip and push forces to total coupling forces." Proceedings of the 36<sup>th</sup> United Kingdom Group Meeting on Human Responses to Vibration, Farnborough, UK: 368-375.

Dong RG, McDowell TW, Welcome DE, Rakheja S, Smutz WP, Warren C, Warren C, Wu JZ, Schopper AW (2003). Effectiveness of anti-vibration gloves. NORA Symposium 2003, Arlington, Virginia, USA: 45.

Marcotte P, Aldien Y, Boileau PE, Rakheja S, and Boutin J. Influence of hand size and coupling forces on the biodynamic response of the hand-arm system, Institute of Naval Medicine, 38th United Kingdom Conference on Human Responses to Vibration, Alverstoke, Gosport, UK, (2003).

ISO 10068, 1998: Mechanical vibration and shock -- free, mechanical impedance of the human hand-arm system at the driving point. International Organization for Standardization, Geneva, Switzerland.





**Tool Design II**  
E. Christ - Session Coordinator



# A COMPARISON OF ANTHROPOMORPHIC MODEL RESPONSES OF HUMAN HAND-ARM SYSTEM

K.K. Sinha, A. Shanker

Institute of Technology, Banaras Hindu University  
Varanasi-221005, India

## Abstract

The present paper deals with a comparison of vibratory responses of anthropomorphic model of hand-arm system with other models. In anthropomorphic modelling hand-arm system is considered to be made of number of segments of certain standard geometrical shapes. A seventeen segmented anthropomorphic model of hand-arm system has been proposed in which hand-arm system has been divided in upper arm, lower arm, palm and fingers. Further the fingers have been divided in namely distal phalanx, middle phalanx and proximal phalanx and the segments are considered to be of ellipsoidal shape. Corresponding to the seventeen segmented anthropomorphic model a seventeen degree of freedom vibratory model of hand-arm system has been developed. Based on certain assumptions (2003) the mass, stiffness and damping values of different elements of the model has been determined. The damping values of the elements of the vibratory model have been found by first obtaining the damping ratio values of the different segments of the anthropomorphic model and analyzing this. The damping ratio values of the segments of anthropomorphic model have been found experimentally by finding the frequency response of these segments and analysing this. Response of the whole hand-arm model has been obtained theoretically and experimentally and has been analysed and compared with other models.

## Introduction

Vibration is an oscillatory motion. The human body is exposed to vibrations in many occupations. Hand-transmitted vibration means vibration entering the body through hands. The causes of severe hand-transmitted vibration are the tools and the processes in industry, agriculture, mining and construction, where the hands and fingers grasp or push vibrating objects. The vibrations from tools gripped in the hand are transmitted to adjacent areas of the hand, to the arm, to the shoulder and to the head. Prolonged exposure to hand-arm vibration (HAV) has long been associated with a complex of vascular, neurological and musculoskeletal disorders often referred to as hand-arm vibration syndrome (HAVS) among the operators of hand-held power tools.[1990].

Many vibration exposures of the hand occur at low magnitudes or for short duration and are more reasonably associated with discomfort or annoyance than injury or disease e.g. car steering-wheel, shakers and electric razor vibration. The occurrence of HAVS and the rate of degeneration have been attributed to several physical and biodynamic factors such as intensity, frequency and direction of HAV duration and pattern of exposure grip force and posture.

Experimentation in human beings for such investigations has limitations and also poses considerable complexities in the data analysis due to inter and intra subject variabilities. A viable alternative is to approximate the human hand-arm system by a mathematical model and analyze the desired behavior of the model vis-à-vis the approximations involved in the modeling and the practical observations. The applications of mechanical equivalent or biodynamic models of the human hand and arm offer considerable potential to carry out assessments through both analytical and experimental analysis where the involvement of human subject could be considerably reduced [1996]. The hand-arm vibration models when integrated with the analytical model of a power tool could permit efficient evaluations of the tool design factors and vibration attenuation devices. Over the past 30 years, a number of biomechanical models of the human hand and arm have been proposed to study the vibration characteristic in the coupled hand, tool and work piece system. These include the single d.o.f. models reported by Dickman [1958] Reynolds and Soedel [1972] and Abrams[1971] two d.o.f. models proposed by Miwa et al[1979]; three d.o.f. freedom models proposed by Daikoku and Ishikawa[1990] Gurram et al[1995], Reynolds and Falkenberg [1984-1982], Meltzer [1979] and Mishoe and Suggs [1977] and four degree of freedom models proposed by Reynolds and Falkenberg [1984] and Gurram[1993]. Wood et al (1978) developed a distributed parameter dynamic model of the hand and forearm and entire hand-forearm-upper arm system. Orne (1974) treated human ulna as a viscoelastic beam. Calado (1987) presented a study of methods of modeling the hand finger system.

The model developed in this work is laid on anthropomorphic model of human hand-arm system. The problem of anthropomorphic modeling dealing with the identification of body segments with some closely resembling geometrical bodies has been widely reported in the literature.(1964,1980). Bart and Gionotti (1975) developed an anthropomorphic model of human body which was later used in the development of a 15 d.o.f. undamped vibratory model of human body by Nigam and Malick (1987).Sinha (1997) generalized this model by introducing the damping

elements. Based on the anthropomorphic model of Bartz and Gionotti (1975), for whole body a simple model of 17 segments of hand-arm system has been developed.

The response of the model can be better determined by incorporating the damping elements in the model. The damping in a system can be obtained either from free vibration decay curve or from frequency response curves. Coermann (1963) discussed the ways of finding the damping ratio of human body by considering it a single spring mass system. Lundstorm (1984) reported measures of mechanical impedance over the frequency range 20-10,000 Hz determined by applying a vibration probe to 10 points on the finger and the hand resting on a small palm-up table. The point mechanical impedance has been obtained by Mann and Griffin (1990). Dynamic models of the hand and arm have been proposed (1958, 1963, 1978) by different investigators but they primarily reflect selected impedance measurements without modeling the influence of factors which alter impedance. Some experimental study of hand-arm impedance has been done by Lion and Griffin (1996) which takes into account the effect of grip force.

In the following section a 17 segmented anthropomorphic model of human hand-arm system in hanging position has been proposed and corresponding to this anthropomorphic model, a seventeen degree of freedom vibratory model of human hand arm system have been developed (2003). A systematic analysis for the evaluation of masses and stiffness and damping values of the model elements has been proposed. The justifications and limitations of the assumptions made in the analysis have been discussed. The damping of the model elements have been obtained from the corresponding damping ratio of the anthropomorphic model segments, which have been obtained from the frequency response curve of force vibration tests. The responses of the whole hand-arm system have been obtained and a comparison of vibratory responses with other models proposed has been done. The suitability of this model with other models has been discussed.

### Symbols

$a_i, b_i, c_i$  = semi-axes of ellipsoid;  $d_i$  = half length of the truncated ellipsoid;  $E$  = Elastic modulus of the ellipsoidal segment;  $E_b$  = Elastic modulus of bone;  $E_t$  = Elastic modulus of tissue;  $i$  = subscripts for ellipsoidal segments or spring elements; d.o.f. = degree of freedom;  $GN = (10^3)^3N$ ;  $KN = 10^3N$ ;  $S_i$  =  $i$ th segment,  $S_{si}$  = stiffness of  $i$ th segment;  $C_{si}$  = damping of  $i$ th segment;  $M_i$  = mass of  $i$ th segment (or mass of  $i$ th element of the vibration model);  $K_i, C_i$  = stiffnesses and damping of  $i$ th element of the vibration model.

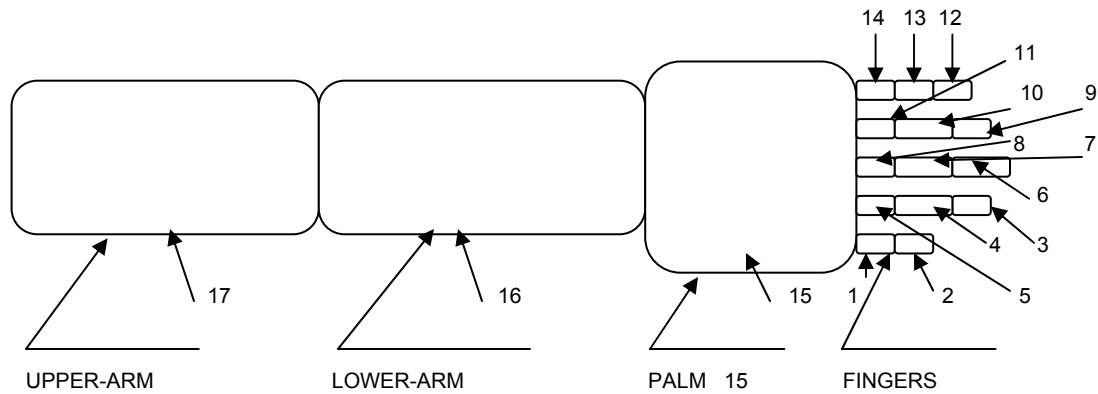
### Analysis of the Model

#### *Steps for Model Development*

The modeling of a hand-arm system like any other lumped-parameter modeling involves the following steps:

1. The segmentation of the hand-arm system
2. The evaluation of mass and stiffness values of the individual segments,
3. Lumping the segments at discrete points and connecting them through mass-less springs and dashpot elements.
4. Evaluating the stiffnesses and damping of connecting springs and dashpots via the stiffness and damping values of the individual segments.

A hand-arm system has physically distinct segments like upper arm, lower arm, palm and fingers. Further the fingers have proximal phalanx, middle phalanx and distal phalanx. This has been indeed the basis of anthropomorphic modelling. Based on the anthropomorphic model of Bartz and Gionotti (1975) for the whole body, a seventeen segmented hand-arm system model with 16 joints have been considered (fig 1).



**Figure 1** Anthropomorphic Model of the Hand-Arm System (1, 2, 3, etc. are Segment Numbers)

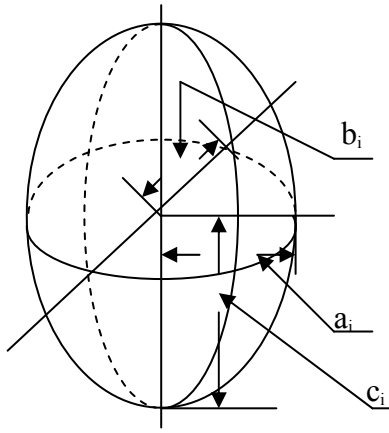
The basic assumptions involved in the development of the model are;

1. For computing the mass and dimensional properties, the system segments are considered to be ellipsoids (1964, 1980). This assumption will help in computing mass and dimensional properties of the system segments.
2. Though a hand-arm system is really not a homogeneous mass, the average densities of different body segments are nearly the same (1975). The average density of each segments of the hand-arm system is therefore taken to be the same and equal to the average density of the whole body.
3. In modeling, it is assumed that the hand-arm system is in hanging position, the spring elements are considered to be axial, and thus permitting the vibrations in only axial or vertical direction only. This indeed is a major assumption as joints in a human body provide many degrees of freedom. However with an excitation coming from the finger to the hanging hand, the axial or vertical vibrations are likely to be dominant.
4. For computing the stiffness of the various system segments, the ellipsoids are considered to be truncated at the ends. (Fig. 2-b). This assumption is for the reason that in a realistic model like fig-1 the adjacent ellipsoids must have an overlapping contact area. A model with point contacting ellipsoids would in fact be fragile, while overlapping provides rigidity to the model.
5. With regard to the mechanical properties in the axial direction, the ellipsoids are considered to be identical and linearly elastic homogeneous bodies. The assumption of elastic linearity is obviously to account for linearity of the spring elements. In fact human body vibratory models with linear springs and dashpots have been suggested by other investigators (1987).
6. Disregarding the effects of other factors, the axial deformation in the ellipsoids is assumed to be contributed by bones and tissues. At any cross-section of body due to overlapping of tissues area around bone area fleshy constituent plays greater role. Based on the above, an empirical relationship for the modulus of elasticity of hand segments has been proposed in Eqn.-1.

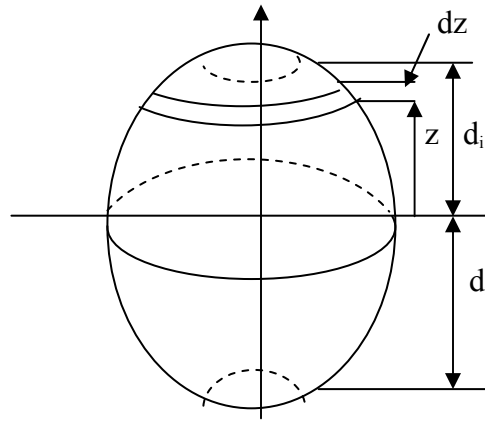
$$E = \sqrt[3]{Eb \times Et^2} \quad (1)$$

7. The damping ratio of system segments and whole system has been assumed to be much less than one. In order to determine the damping ratio of the hand-arm system segments experimentally from the frequency response curve of the hand-arm system segments, a single degree of freedom system is assumed and the damping ratio is obtained from the prominent peak. The damping ratios of whole hand-arm system have been determined from the frequency response curve of whole hand-arm system.

#### *Mass Stiffnesses and Damping of Ellipsoidal Segment*



**Figure 2a** An Ellipsoidal Segment



**Figure 2b** A Truncated Ellipsoid

Based on the first two assumptions as discussed in the previous section, the mass of individual segments becomes proportional to its volume and can be expressed as a fraction of total body mass. Thus, if  $a_i$ ,  $b_i$  and  $c_i$  are the semi-axes of an  $i$ th ellipsoid (fig. 2-a), then its mass,  $M_i$ , can be obtained as:

$$M_i = \frac{M a_i b_i}{\sum_1^n a_j b_j c_j} \quad (2)$$

where  $n$  is the number of segment and  $M$  is the total hand mass. The expression for axial stiffness  $S_{Si}$  of the ellipsoid can be obtained as:

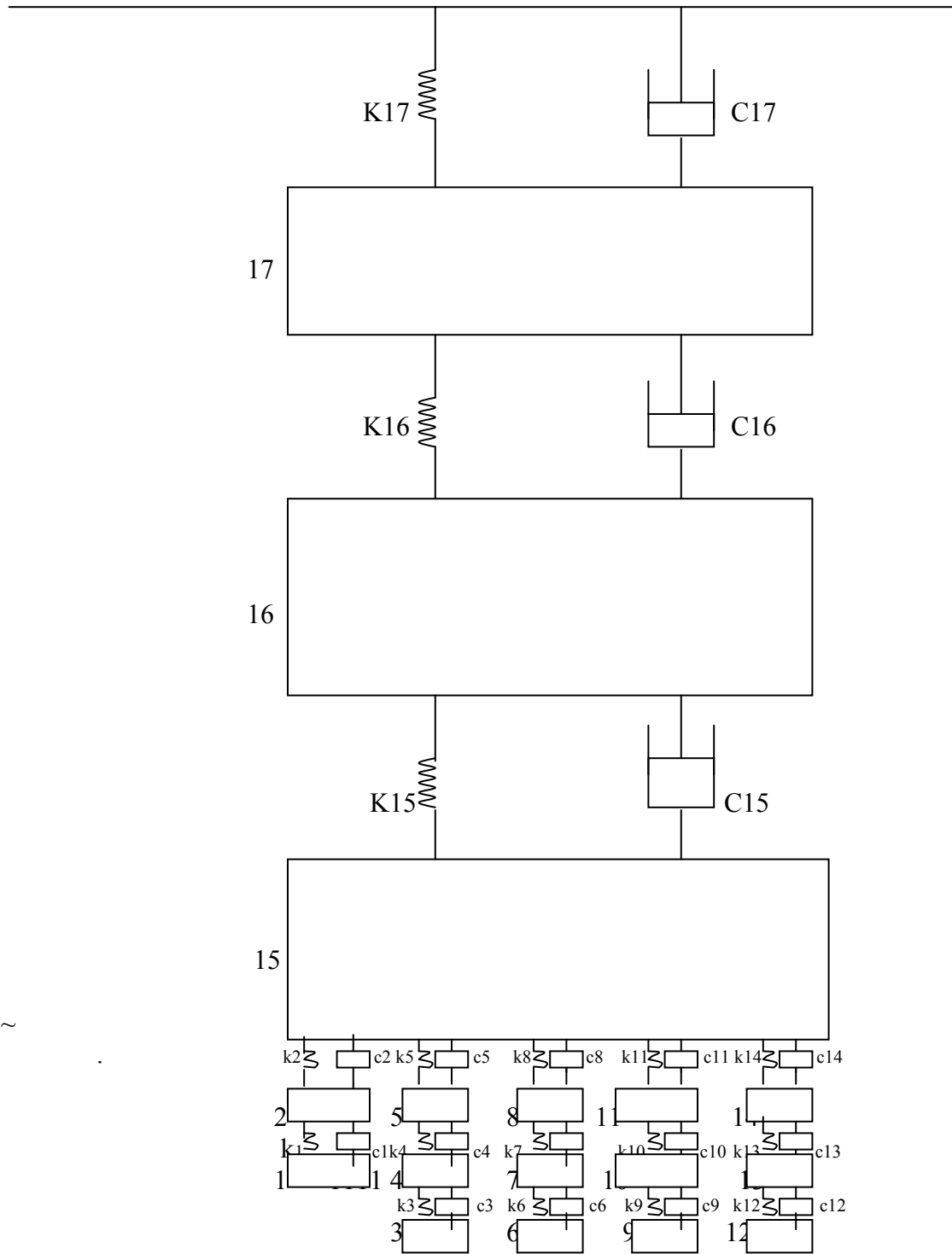
$$S_{Si} = 2.14 \times 10^6 \frac{a_i \times b_i}{c_i} \left( \frac{N}{m^2} \right) \quad (3)$$

The damping ratio is obtained experimentally, and thus equation (4) can be used to determine the damping of the system.

$$C_{Si} = 2 \xi_i \sqrt{S_i M_i} \quad (4)$$

#### *The Vibratory Model*

Having identified the distinct segments of the hand-arm system the vibratory model is conceived by replacing the segments with rigid masses and connecting them through linear massless spring and dashpot elements. Fig. 3 is the vibratory model so developed. In fig. 3 the mass of each rigid element is equal to the mass of the corresponding segment of fig. 1. The stiffnesses of the spring elements are obtained by suitable combination of the stiffnesses of the adjacent segments. The various segments in the model are physically connected in a series fashion. For a segment, the stiffness of upper half and lower half from the centre of gravity of that segment will be equal, and numerically it will be twice the stiffness of that segment. A series combination is taken when subdividing the length of a segment and parallel combination is used when subdividing the area normal to the loading (Table 1). Similarly other stiffnesses and damping elements of the vibratory model have been obtained.

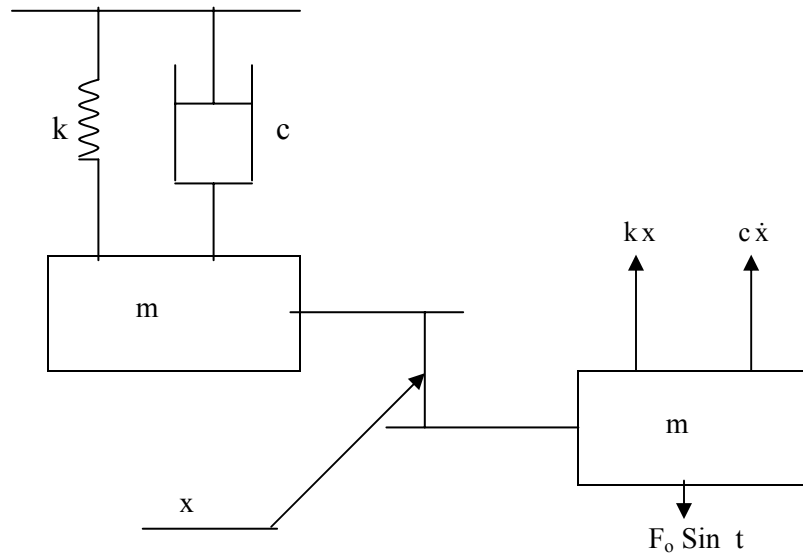


**Figure 3** Vibratory Model of Human Hand-Arm System (1, 2, 3, etc. are Model Element Numbers)

**Table 1** Stiffness Elements

$K_1$	$2S_1$ series $2S_2$	$2S_1S_2/(S_1+S_2)$
-------	----------------------	---------------------

### Determination of the Damping Ratio from the Frequency Response

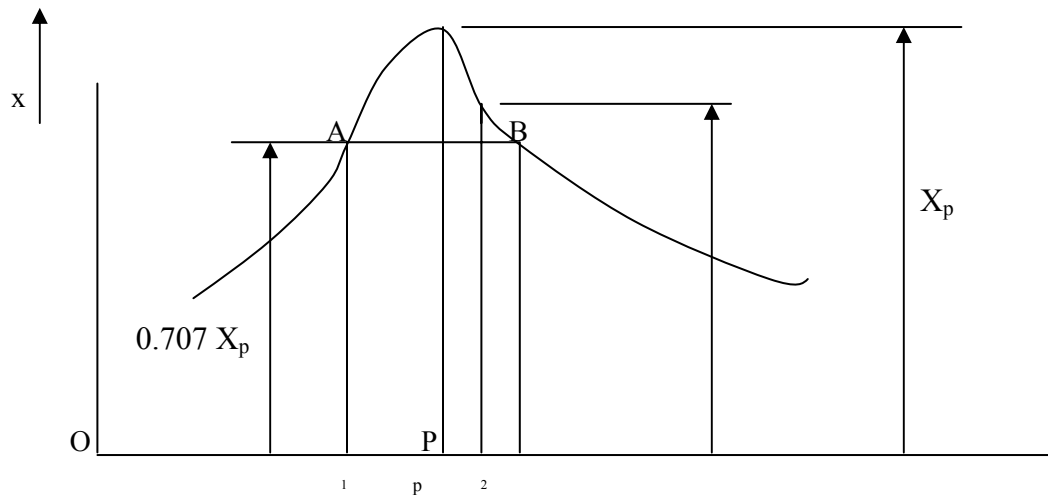


**Figure 4a** Schematic of Single d.o.f System      **Figure 4b** Free-Body-Diagram of Single d.o.f. Systems

A spring-mass system having viscous damping excited by a sinusoidal force  $F_0 \sin \omega t$  (fig 4a) is used to determine the values of damping ratio ( $\xi$ ) for the various segments of the hand.

The damping ratio of the different segments of the system can be determined by considering it a single d.o.f. system and exciting the system beyond the natural frequency of the system and a resonance curve (fig-5) is obtained. The damping ratio is obtained by drawing a horizontal line at  $x = 0.707 X_p$ , where  $X_p$  is the peak amplitude of vibration at resonance frequency  $\omega_p$ . This line will intersect the frequency response curve at two points, A & B. The corresponding values of abscissas are  $\omega_1$  and  $\omega_2$ , and  $\omega_p$  is the peak frequency. Thus, the damping ratio,  $\xi$ , can be obtained from:

$$\xi = \frac{AB}{2 \times OP} \tag{5}$$



**Figure 5** Determination of  $\xi$  from the Resonance Curve



## Experimental Program and Results

For the present purpose, an Indian persons of an average built has been selected for their anthropomorphic measurement and frequency responses. Anthropomorphic measurements of their hand-arm system are given in Table 2. For the frequency response determination, aluminum fixtures for different arm segments have been made that closely fit the corresponding segment (fig. 6) The excitation of the different segments of hand-arms of all the persons were done at frequencies from 2 to 50 Hz in intervals of 2 Hz, using an B&K Mini-shaker Type 4810 (fig. 7). The corresponding amplitudes were measured from the frequency response curves. Figure 8 shows the frequency response curve of lower arm obtained from these above test. The values of damping ratios of hand-arm segments were determined (Table 3). Table 4 gives the masses, stiffnesses and damping values of the various elements of the vibratory model The experimental frequency response of the whole hand –arm system have been obtained by giving excitation at one of the finger tip and measuring the response at the shoulder joint (fig. 9). Theoretical frequency response of the whole hand-arm system has been obtained by matrix inversion method (fig. 9), and the damping ratio of the whole hand-arm system has been obtained similarly as previously discussed. The experimental frequency responses match very closely to the theoretical frequency responses, which also prove the correctness of the modeling procedure.



Figure 6 Photographs of Some Fixtures

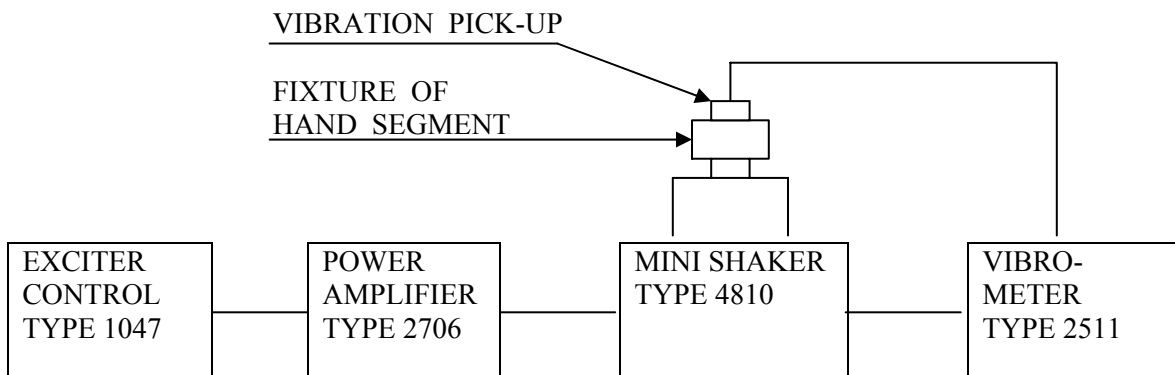
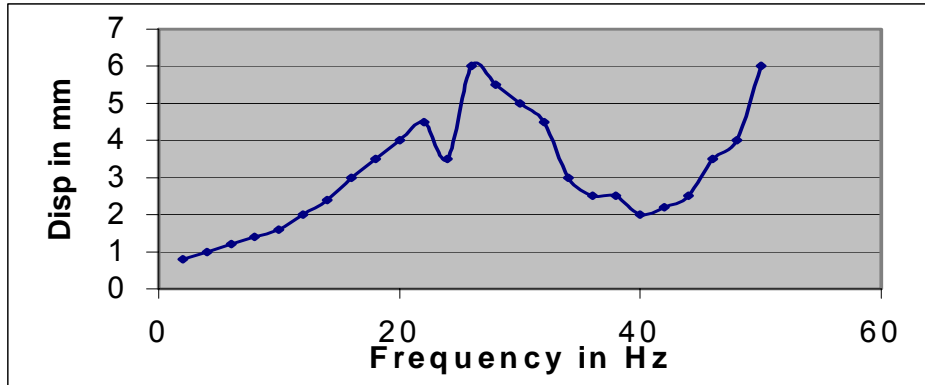


Figure 7 Experimental Set-up for Exciting Hand Segment



**Figure 8** Frequency Response of Lower Elbow of Pancham

**Table 2**  
Anthropomorphic Measurements and Total Hand-Arm Mass of an Average Person

	S <sub>1</sub>	S <sub>2</sub>	S <sub>3</sub>	S <sub>4</sub>	S <sub>5</sub>	S <sub>6</sub>	S <sub>7</sub>	S <sub>8</sub>	S <sub>9</sub>	S <sub>10</sub>	S <sub>11</sub>	S <sub>12</sub>	S <sub>13</sub>	S <sub>14</sub>	S <sub>15</sub>	S <sub>16</sub>	S <sub>17</sub>
Length	3.20	4.00	2.50	3.00	5.00	2.60	3.50	5.20	2.50	3.00	5.10	2.50	2.50	4.50	10.00	25.00	25.50
Circum.	7.00	7.00	6.00	6.50	7.00	6.00	6.50	7.00	5.00	5.50	6.00	4.80	5.00	5.50	21.00	19.00	24.00
Breadth	1.50	2.00	1.30	1.50	1.80	1.50	1.60	2.00	1.30	1.20	1.80	1.20	1.35	1.60	2.50	5.20	6.40

[(a<sub>i</sub> = Circumference/2 , b<sub>i</sub> = breadth/2, C<sub>i</sub> = Length/2), (Total Hand-arm System Mass = 3.00 Kg)]

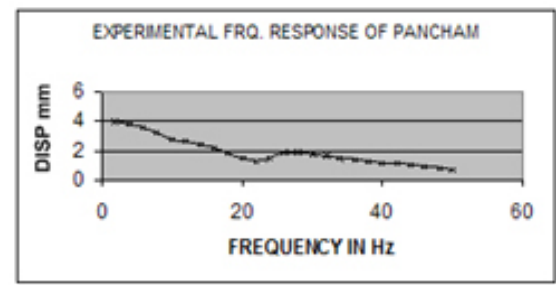
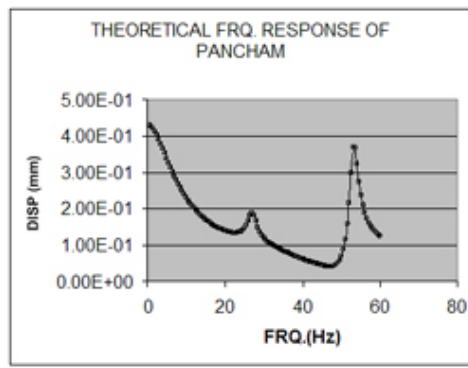
**Table 3**  
Damping Ratio Values of the Different Segments as Obtained from the Forced Vibration Tests

S <sub>1</sub>	S <sub>2</sub>	S <sub>3</sub>	S <sub>4</sub>	S <sub>5</sub>	S <sub>6</sub>	S <sub>7</sub>	S <sub>8</sub>	S <sub>9</sub>	S <sub>10</sub>	S <sub>11</sub>	S <sub>12</sub>	S <sub>13</sub>	S <sub>14</sub>	S <sub>15</sub>	S <sub>16</sub>	S <sub>17</sub>
0.186	0.186	0.186	0.186	0.186	0.186	0.186	0.186	0.186	0.186	0.186	0.186	0.186	0.186	0.400	0.233	0.180

**Table 4**  
Masses, Stiffnesses and Damping Values of the Various Elements of the Vibratory Model

	S <sub>1</sub>	S <sub>2</sub>	S <sub>3</sub>	S <sub>4</sub>	S <sub>5</sub>	S <sub>6</sub>	S <sub>7</sub>	S <sub>8</sub>	S <sub>9</sub>	S <sub>10</sub>	S <sub>11</sub>	S <sub>12</sub>	S <sub>13</sub>	S <sub>14</sub>	S <sub>15</sub>	S <sub>16</sub>	S <sub>17</sub>
Mass(Kg)	0.014	0.023	0.008	0.012	0.026	0.010	0.015	0.029	0.007	0.010	0.023	0.006	0.007	0.016	0.213	1.000	1.58
Stiff.(KN/m)	11.59	5.527	10.89	9.713	5.431	10.94	9.661	5.169	9.146	8.187	4.804	2.994	7.761	4.675	15.43	16.33	41.22
Damp.(N-S/m)	5.253	7.566	3.794	1.960	5.962	4.224	5.224	7.566	3.183	4.094	6.396	0.957	3.344	5.543	50.61	57.42	128.7

(1, 2, etc. are Element Numbers, e.g., M<sub>1</sub>, M<sub>2</sub>, K<sub>1</sub>, K<sub>2</sub>, C<sub>1</sub>, C<sub>2</sub>, etc.)



**Figure 9** Theoretical and Experimental Frequency Response at Shoulder Joint for an Excitation at Finger Tip

### Discussion

Table 5 given below gives the natural frequencies and damping ratio values of some models.

**Table 5**  
Natural Frequencies (Hz) and Damping Ratios of Hand-Arm Vibration Models

MODEL	Natural Frequencies			Damping Ratios (Total Hand-Arm System)		
	xh	yh	zh	xh	yh	zh
Wood et al		13.3; 27.2		-	Distributed	-
Reynolds	25.4	25.0	30.0	0.71	1.09	1.02
Miwa	-	94.2	192.5		0.99	1.16
Mishoe	216.1 296.3	94.2 239.9	45.9 60.3 362.5	1.42 45.97	0.38 47.45	0.33 0.57
Daikoku	3.6 33.5 462.4	4.3 41.2 576.2	3.9 75.0 1147.4	0.60 0.60 3.00	0.06 0.59 10.52	0.28 0.48 1.94
Reynolds 3 d.o.f. model	4.1 50.4 323.6	2.9 202.8 333.4	4.6 436.1 587.4	3.36 0.34 1.03	1.86 3.19 0.93	334.44 0.48 0.30
Gurram 3 d.o.f.	3.8 9.1 46.8	3.1 62.7 320.8	2.2 5.2 635.8	6.04 0.03 1198.7	3.21 2.90 3.17	2.36 42.31 0.10
ISO-10068	2.4 3.8 66.1	4.4 7.3 285.9	4.2 66.9 119.6	1.39 0.09 9.85	2.85 0.11 2.26	0.16 0.45 9.48
Reynolds 4 d.o.f. model	3.5 50.3 157.0 345.9	1.7 71.3 149.5 172.4	3.2 49.7 469.8 711.9	2.68 0.06 150.9 1.02	1.71 0.44 45.29 1.53	1060.28 283.29 0.57 0.98
Gurram 4 d.o.f	5.5 9.1 82.2 136.2	6.3 104.9 308.8 801.6	2.7 8.0 25.2 672.0	12.66 0.18 35.64 2.59	1.24 0.19 3.40 11.83	2.94 3.52 15.44 0.23
ISO-10068	1.9 4.9 20.4 737.9	2.1 4.3 42.6 305.9	2.4 3.8 132.9 695.2	1.62 0.16 7.91 17.71	10.77 0.11 0.62 28.33	1.55 36.38 0.05 4.32

*Natural Frequencies*

Knowledge of natural frequencies is useful because at these frequencies the vibration transmission will be excessive. For practical purposes these frequencies should be avoided.

Two of natural frequencies that can be observed from the frequency response curves are 27.5 Hz and 53.5 Hz (since is much less than one,  $p = n$ ). For a seventeen degree of freedom system there should have been 17 natural frequencies. There may be some hidden natural frequencies or natural frequencies above 60 Hz. Some of the natural frequencies of hand-arm models of human body models obtained by other investigators are listed in Table 4. These are comparable to the two values listed above.

*Damping Ratios*

The damping ratio of the hand-arm system was obtained from the frequency response curve of whole hand-arm system. The two measured values of 0.0833 and 0.0132 are much less than one. These damping ratio values are in the lower range of those reported by other investigators (Table 5).

**Conclusions:**

Most models that have been developed to characterise their DPMI (Driving point mechanical Impedance) characteristics consist of linear and time invariant inertial, inertial and dissipative elements. They do not represent the biomechanical

properties of the hand-arm system. Although great efforts were employed to develop these models, only minimal evidence exists on their applications for either analytical or experimental assessments [1996-1986]. Methodologies employed to identify the models and their parameters raise additional concern regarding their suitability. The identifications based upon curve fitting a target dataset do not represent a unique solution. Further, the lack of applications of these models may be partly attributed to wide variations among the reported biodynamic data and test conditions employed in different studies [1995, 1998].

The modeling procedure presented in this paper involves several simplifying assumptions, and it appears to be fairly good. While there is no agreement among the reported models in terms of the natural frequencies of the human hand and arm, the models suggest the existence of natural frequencies in the 20-50 Hz and 60-80 Hz bands. The values reported in this are within this range.

The damping ratio values of the hand-arm system have been obtained by considering them to be much less than one. The damping ratio values of the selected models vary from a low value of 0.06 to a high value of 1060. While the knowledge of dissipative properties of the human hand and arm are not well known to enable quantitative comparisons, the models with relatively high damping ratio would pose difficulties in realizing a mechanical hand-arm simulator.

### References:

- Abrams C.F. (1971) Ph.D. Thesis, North Carolina State University. Modeling the vibration characteristics of the human-hand by the driving point mechanical impedance method.
- Bartz J.A and Gionotti, C.R.(1975)"Computer program to generate dimensional and inertial properties of human body" ASME journal of Engineering for Industry, vol-97,1975,pp 49-57.
- Calado, E.J.S (1987) Dynamic linearity of the upper limbs and dynamic characteristic and power dissipated in the human hand and fingers Ph.D. thesis, University of Southampton.
- Coerman R (1963), The vertical impedance of human body in sitting and standing position low frequencies." Human Vibration Research" Pergamann Press Ltd., page 1-27
- Daikoku M. and Ishikawa F.1990 Proceedings of Fifth International Conference on Hand-Arm Vibration, Kanzawa, Japan, Mechanical Impedance and Vibration model of hand-arm system.
- Dickman, D.(1958):A mechanical model for the vibration excitation of the human hand and arm system." International zeitschess feir angeiveliz physiologic 17.
- Goldman, D.L. and Von-Gierke, H.E. (1961)" Effect of Shock and Vibration on man in chapter 44, Shock and Vibration Handbook vol-3., Eds C.M. Harris and C.E. Crede, McGraw -Hill.
- Greene, P.R. and Macmohan, T.A., reflex stiffness of man's antigravity muscles during knee bends, while carrying extra weights" Journal of Biomechanics vol-12, 1979, pp. 881-891.
- Griffin, M.J. (1990) Handbook of Human Vibration. London: Academic Press.
- Gurram R., Rakheza S. and Gouw G.J. 1995 International Journal of Industrial Ergonomics16 ,135-145.Biodynamic Response of the human hand-arm system subject to sinusoidal and stochastic excitations.
- Gurram R. 1993 Ph.D. Thesis, Concordia University ,Montreal. A study of vibration response characteristics of the human hand-arm system.
- Hanavan, E.P.(1964) "A Mathematical model of the human body" AMRL Technical report, 64-102 Wright Patterson Air Force Base, Ohio,1964.
- Hatze H, (1980) "A mathematical model for the computational determination of parameter values of anthropomorphic segments." Journal of Biomechanics. Vol-3, 1980, pp 833-843.
- ISO-10068 1998 Mechanical vibration and shock-free, mechanical impedance of the human hand-arm system at the driving point.
- Jahn R. and Hesse. M. 1986 Scandinavian Journal of Work, Environment &Health,12,342-346. Applications of hand-arm models in the investigation of the interaction between man and machine
- Kinne J. and Melzig-Thiel R.1996 Central European Journal of Public Health40,53-56, Derivation of mean impedance curves as a basis for mechanical models of human hand-arm system
- Lion J and Griffin M.J.(1996)Experimental study of hand-arm impedance. Proceedings of Internoise 96 1689 to 1694

- Lundstrom. R (1984) Local vibration mechanical impedance of the human hands glabrous skin. Journal of Biomechanics 17:137-144
- Mann N.A.J, Griffin M.J. (1990) Effect of contact conditions on the mechanical impedance of the finger centr. eur. J. Publ.Health 4, No.1 p 46-49.
- Meltzer G.1979 Proceedings of the International Symposium on Man under Vibration Suffering and Protection, U dine, Italy, 210-221. A vibration model for the human hand-arm system
- Miwa, T. ,Y. Yonekawa Y., Nara A.,,Kanada K. and Baba K.1979 Industrial Health17,85-122 Vibration isolators for portable vibrating tool . Part-1. Agrinder.
- Mizrahi,J. and Susak,Z.” In-vivo elastic and damping response of human leg to impact forces ASME journal of biomechanical engg. Vol-104,1982,pp63-66.
- Mishow JW, Suggs C.W.,(1977)Hand-arm vibration part-1,vibration response to the human hand. Jr. of Sound and Vibration 1977,53; 545-58
- Mishoe J.W. and Suggs C.W. 1977, Journal of Sound and Vibration 95,499-514. A Study of hand-vibration on chipping and grinding operators. Part-2: four –degree of freedom lumped parameter model of the vibration response of the human hand.
- Nigam S.P. and Mallick M. (1987)” A study on a vibratory model of human body. Transactions of ASME, Jr.of Biomechanical Eng. Vol-109, May 1987, pp-148-153
- Orne,D.(1974)” The in vivo driving point impedance of the human ulna, a viscoelastic beam model” Journal of Biomechanics, vol-7 1974 “249-259.
- Reynolds, D.D. and Falkenberg R.J.(1985)Three or four degrees of freedom models of the vibration response of the human hand in “vibration effects on the had-arm in Industry (Bramer, A.J and Tailor New-York Wiley:) .
- Reynolds, D.D. and Soedel W. (1972) Dynamic Response of the hand-arm system to a sinusoidal input. Journal of Sound& Vibration 21,339-353
- Sinha, K.K. and Shanker, A.(1977),”Vibration modeling and analysis of human body through anthropomorphic modeling”. Proceedings of 32<sup>nd</sup> U.K. group meeting on human response to vibration, Institute of Sound and Vibration Research, University of Southampton, Southampton U.K. 17-19 September, 1977, pp- 235- 245 .
- Suggs, C.W.((1974), Modeling of the dynamic characteristic of the hand-arm system, in the vibration syndrome proceedings of a conference of the Medical Engineering and Legal-Aspects of hand-arm vibration, University of dundee,1214July1972 (Taylor, woods) pp.169186, Lyden, Academic Press, ISBN O126847606
- Wood L.A., Suggs C.W. Abrose C.R.(1978) Hand-arm vibration part-3, A distributed parametric dynamic model of the hand-arm system. Jr. of Sound and Vibration, part-1 1978, 57, 157-69.



# A Comparison and Evaluation of Reported Mechanical Impedance Data of the Human Hand-Arm System

R.G. Dong, C. Warren, D.E. Welcome, T.W. McDowell, J.Z. Wu

National Institute for Occupational Safety and Health, Morgantown, West Virginia, USA

## Abstract

The measured mechanical impedance (MI) of the human hand-arm system may be useful for the estimation of vibration power transmission and absorption, the design of tools and test rigs, and the analysis of anti-vibration gloves. There are many sets of published MI data, but there is considerable variability among them. It is hypothesized that these differences may stem from natural factors as well as from errors in instrumentations and calculating algorithms. The natural factors include individual differences, coupling force differences, hand-arm posture variations, and tool handle design differences. Potential instrumentation and calculation errors include sensor errors, improper mass cancellation, and data analysis program errors. In this paper, several sets of MI data are compared and evaluated. It appears that the current ISO 10068 (1998) standard contains recommendations that are based in part on unreliable data. Consequently, computer models recommended in the same standard may also be problematic. Therefore, it is recommended that the standard be revised.

## Introduction

The mechanical impedance ( $Z$ ) of the hand-arm system is defined as the ratio of the dynamic force ( $F$ ) acting at the hand-tool handle interface and the tool vibration velocity ( $V$ ), which can be expressed as follows:

$$Z = F/V \quad (1)$$

The mechanical impedance can be used for many different purposes. For example, it can be used to estimate vibration power transmission and absorption (e.g. Reynolds et al., 1984; Burström, 1990), conduct tool and tool test rig designs (e.g. Miwa et al., 1979; Jahn and Hesse, 1986; Dobry et al., 1992), and perform anti-vibration glove analysis (e.g. ISO 13753, 1999; Dong et al., 2003a; Dong et al., in press).

There are many sets of data on the mechanical impedance (MI) of the human hand-arm system in the literature. These data sets have considerable differences (Gurram et al., 1995; Dong et al., 2001). It is not clear why they are so different, although many of them were measured under similar experimental conditions. The identification of the causes of the differences may help improve the quality of the MI data and the reliability and confidence of their applications. To enhance the understanding of the characteristics of the hand-arm mechanical impedance and to improve ISO 10068 (1998), this study compared and evaluated the data sets that were measured in the  $z_h$ -direction (along the forearm). The specific aims of this study were to examine the validity of these data sets, especially those used for the synthesis of the impedance values recommended in the current ISO-10068 (1998), and to explore the causes of the large differences among the reported data.

## Method

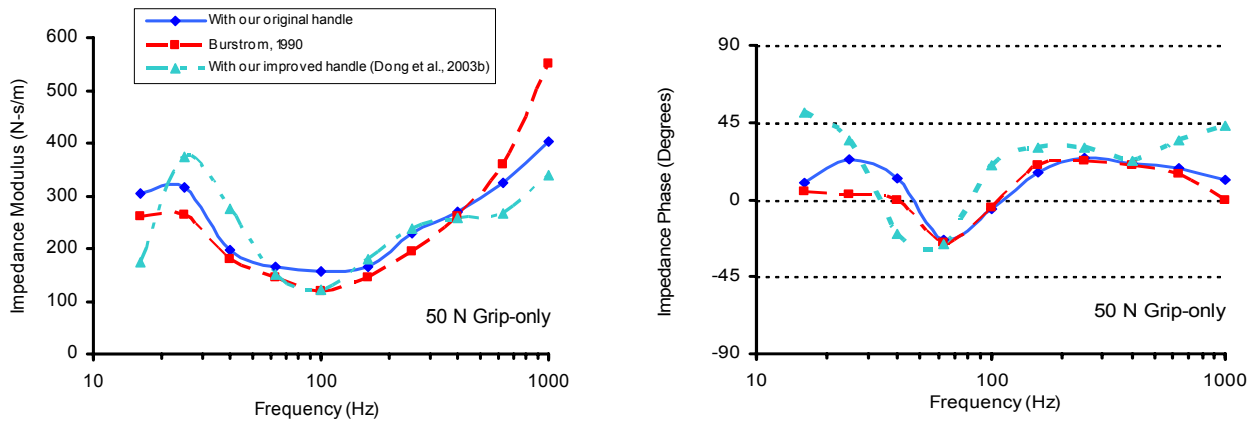
For practical applications, the biodynamic response in the  $z_h$ -direction is probably the most important among the three axial components. It is also relatively easier to model and understand the dynamic behaviors of the hand-arm system in this vibration exposure direction. Therefore, this study focused on the comparison and evaluation of the test data measured in this direction. While a few sets of test data used in this study were obtained directly from the current researchers, most of the data were derived from the published curves using a two-dimensional digitizer.

The response in the  $z_h$ -direction at frequencies lower than 100 Hz depends mainly on the mechanical properties of the palm-hand-arm system (Dong et al., 2003b). The skeletal structure of the system indicates that, as a rough approximation, it is reasonable to model the palm soft tissue as a spring-damper component and the rest of the hand-arm components as a lumped mass on the spring-damper for the simulation of the dynamic behaviors in the frequency range. This is further supported by the fact that the hand-arm MI has a single resonant peak in the majority of the reported MI

data (e.g. Miwa, 1964; Kihlberg, 1995; Lenzuni et al., 2001; Dong et al., 2003b; Marcotte et al., 2003). This simple computer model was used to evaluate the reported data sets.

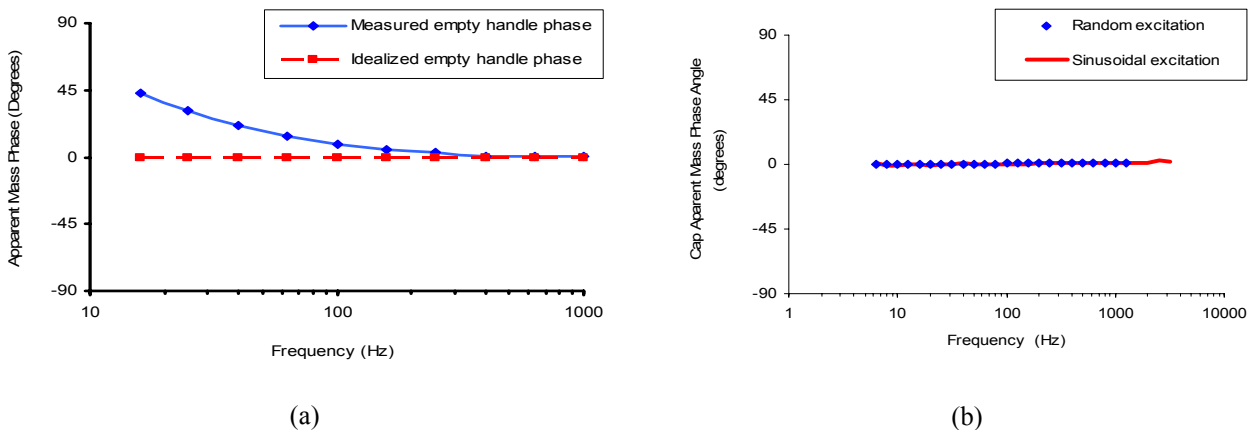
## Results

Figure 1 shows the comparison of three sets of mechanical impedance data. They were measured under very similar test conditions (50 N grip-only, sinusoidal excitation, z-direction). The data measured with our original instrumented handle (unpublished data) agree fairly well with the data reported by Burström, (1990). While our experiment used six male subjects, the study by Burström used five male and five female subjects. After adjusting for the gender effect, a better agreement between these two sets of data can be obtained.



**Figure 1** Comparison of three sets of data

However, when we further examined our raw data, we found a problem with our instrumented handle. The signal from the accelerometer (PCB 339B24) had a very large phase difference from that of the force sensor (Kistler 9212) in the empty handle (without hand coupling) test, as shown in Figure 2a. Ideally, the phase angle of the apparent mass (= force/acceleration) of the handle should be zero. After improving the handle structure (lighter handle and better sensor screw connection) and replacing the original accelerometer with another one (PCB 356A12), the phase angle is almost perfect as expected, as shown in Figure 2b.



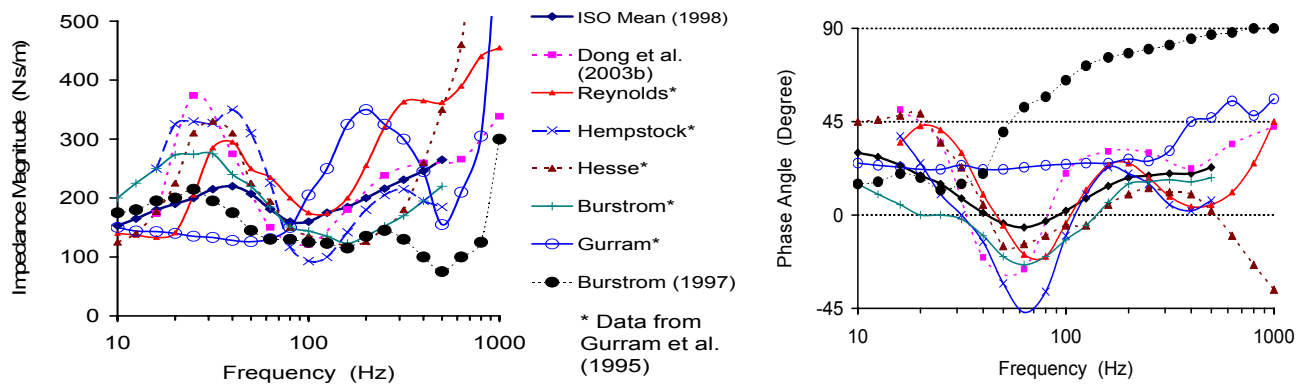
**Figure 2** Phase angle of the apparent mass of our instrumented handle: (a) our original handle; (b) our improved handle (Dong et al., 2003b)

A further experiment with the improved handle was performed with the same six subjects, and the data are also shown in Figure 1 (Dong et al., 2003b). Although the basic trend is similar, the data measured with the improved handle



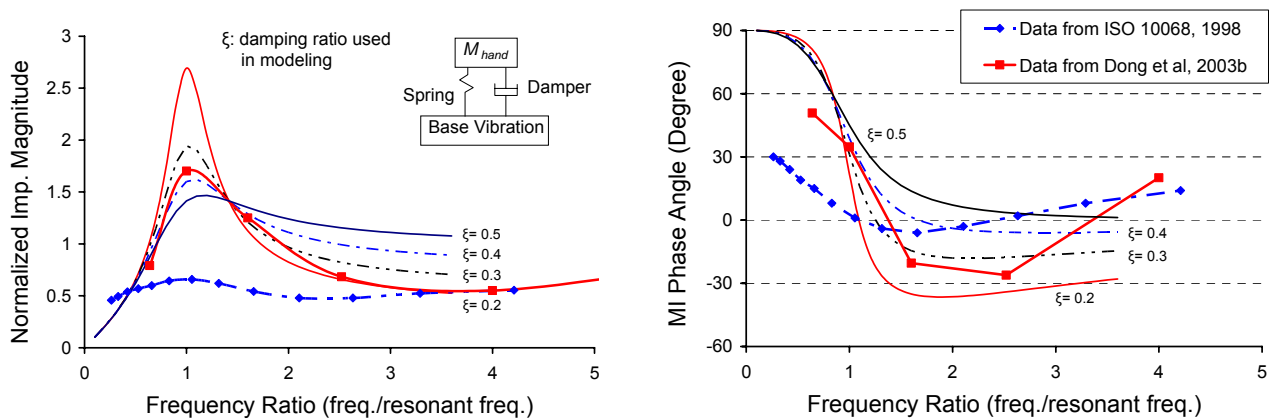
are obviously different from those with the original handle in the low frequency range. The new data are also more comparable with many other data reported in the literature (e.g. Miwa, 1964; Kihlberg, 1995). This experience suggests that some of the differences among the reported MI data likely resulted from undetected errors in the instrumentation and/or calculating algorithms.

Several typical examples of data sets reported in the literature are presented in Figure 3, together with the mean values of the ISO data (ISO 10068, 1998). Obviously, there are considerable differences among these data sets. The basic trend of the ISO data is consistent with the majority of the reported data. The magnitude peak value of ISO data is approximately at 38 Hz, which is slightly lower than the corresponding zero phase frequency (40 Hz). This feature is consistent with the theoretical prediction (see Figure 4) and the characteristics of many other experimental data. However, the peak value of the ISO data is lower than that of the majority of other data sets.



**Figure 3** A comparison of several data sets of the hand-arm mechanical impedance in the  $Z_h$ -direction

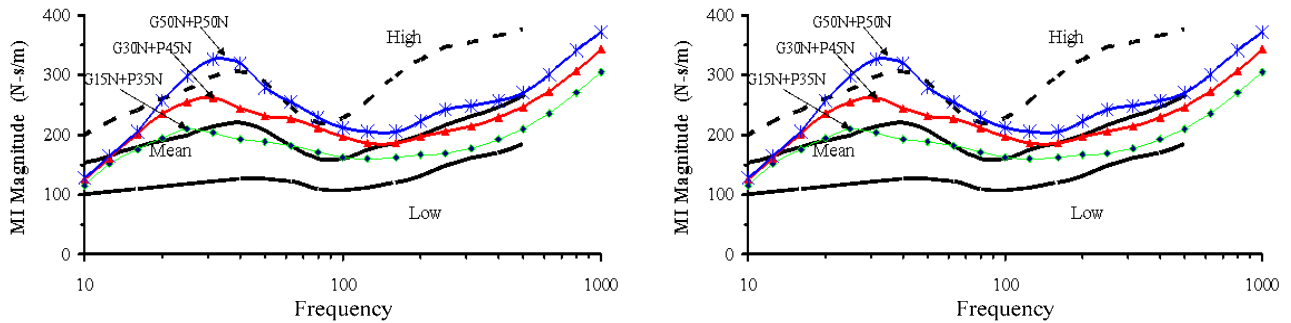
Figure 4 shows the comparison of the results from the modeling and an experiment (Dong et al., 2003b), together with the ISO-recommended mean values (ISO 10068, 1998). While our experimental data show a fairly good agreement with the theoretical predictions in the resonant frequency range, the ISO-recommended values do not reasonably fit this model.



**Figure 4** A comparison of the normalized impedance data from the computer modeling, ISO-10068 (1998), and a previous study (Dong et al., 2003b). The normalized magnitude =  $IM/(M_c \times \omega_n)$ , where  $IM$  is the impedance,  $M_c$  is the hand-arm effective mass (1.4 kg), and  $\omega_n$  is the resonant frequency.

Figure 5 shows the comparison of the ISO data and our data measured from a broad-band random excitation with 8 subjects. Our results demonstrate that increasing the hand-handle coupling force increases the resonant frequency and the peak value. The phase angle of the ISO mean value surprisingly agrees with those obtained in our study. However, the ISO peak value is only comparable to that measured under a combined grip (15 N) and push action (35 N). In the

standard, the values under a similar combined action (30 N grip and 50 N push) are also specified, which are very similar to the mean values (ISO 10068, 1998) shown in Figures 3 and 5. The combined coupling action (30 N grip and 50 N push) is also used in the standardized glove test condition (ISO 10819, 1996). The results shown in Figure 5 indicate that the ISO data are obviously lower than our experimental data measured under the equivalent test condition in the frequency range from 16 Hz to 125 Hz. Furthermore, the peak value of our data measured under the 50 N grip and 50 N push also obviously exceed the ISO high limit.



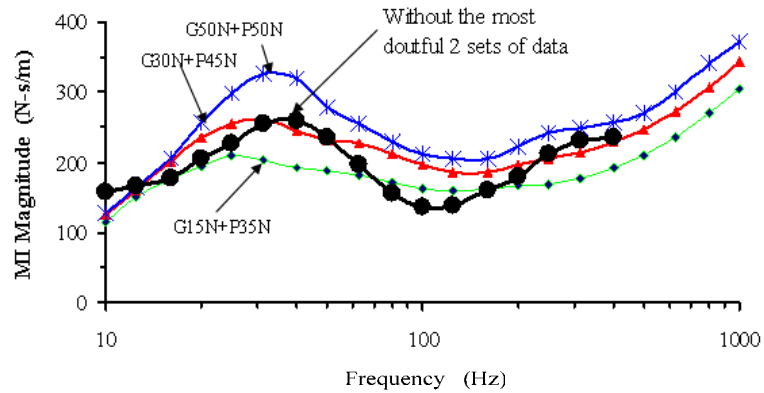
**Figure 5** Comparison of the ISO data and our data measured with 8 subjects subjected to a broad-band random excitation

### Discussion

There are many factors and sources that could result in large variations, which may be broadly classified into (1) natural factors and (2) instrumentation problems. The natural factors include individual differences, coupling force, hand-arm posture, handle size etc. As people have different heights and weights, the variations resulting from the natural factors reflect the diversity of the impedance values.

The model may be suitable only for a steady-state response that may be obtained from a sinusoidal excitation. The ISO data show a better comparison with the data obtained under a random excitation (see Figure 5). This may be one of the reasons that the ISO data do not reasonably fit the modeling results. This also suggests that the ISO data may not be applicable to tools generating dominant sinusoidal vibration components in the resonant frequency range (20-63 Hz). The impedance values measured under many tool vibration spectra are similar to that obtained under sinusoidal excitation (Kihlberg, 1995). The resonant peak of the impedance for a sinusoidal vibration is also much higher than the ISO high limit. These may be important deficiencies of the current ISO 10068 (1998).

Another reason that the ISO data do not fit the model is because the synthesis of the ISO values used several sets of unusual data (Gurram et al., 1995). As shown in the modeling results and many experimental data, an obvious resonance should appear in the 20-63 Hz frequency band. However, some sets of data show a fairly flat response in this frequency range (see Figure 3). Unfortunately, 2 out of the 7 sets (30%) of data used in the synthesis of the ISO-recommended values have a very flat response in this frequency range (Gurram et al., 1995). This may at least partially explain why the ISO mean values have a fairly flat response in the resonant frequency range. If the two most doubtful sets of data are eliminated, the synthesized values become much more comparable to those measured under the 30 N grip and 45 N push, as shown in Figure 6.



**Figure 6** The effect of the elimination of the two most doubtful sets of data

The possible instrumentation problems mainly include sensor errors, poor performance of the instrumented handle, inappropriate handle mass cancellation, and errors in the program used for the impedance calculation. Practically, no instrumentation is perfect, and small errors (e.g. < 10%) are not critical. However, a large instrumentation error could lead to misleading results and improper conclusions. For example, the near  $90^{\circ}$  phase angle at the high frequency (>500 Hz) shown in Figure 3 would suggest that the human hand at such a frequency would behave like a solid rock with little elasticity and damping, which is unrealistic.

If the data measured in the  $Z_h$ -direction are invalid, the data measured in the other directions using the same instrumentation would also be questionable. These observations cast doubt on the validity of the current ISO-recommended impedance data in the other two directions. Consequently, the computer models established based on these data may not be valid either, which at least partially explains why the models recommended in the same ISO standard have problems for practical applications (Rakheja et al., 2002). The invalidation of the models may further jeopardize another ISO standard (ISO 13753, 1999) for glove material evaluation, because this standard requires the use of the mechanical data recommended in ISO 10068 (1998).

Effectively, there is only one set of MI data recommended in the MI standard (ISO 10068, 1998). Tool and operation-specific MI data may be required in practical tool designs, glove evaluations, and vibration energy studies. While the MI data under different natural factors could be very different, this standard does not provide the specific values. This may be a fundamental deficiency of the standard.

The results of this study suggest that the current ISO 10068 (1998) should be revised. Three revision approaches are proposed and described as follows:

*Approach 1 (minor revision):* keep the current format of the standard, eliminate the questionable data, collect more reliable data, and modify the recommended data, models, and the descriptions of the standard.

*Approach 2 (major revision):* in addition to performing the tasks in Approach 1, further express the MI data and model parameters as functions of the natural factors.

*Approach 3 (totally rewrite the standard):* the measurement methodology of biodynamic response (e.g. apparent mass, mechanical impedance, power absorption, and apparent stiffness) as the main body of the standard; the MI data as examples in one or three appendices; the examples of models and their parameters in an appendix; the effects of grip and feed forces in an appendix; similarly, the effects of other factors in different appendices.

To address all the important issues discussed in this paper, the third option may be the best choice. No matter which approach is chosen, further studies of the mechanical impedance of the hand-arm system are required to collect more reliable experimental data.

## Conclusions

Based on the observations and results of this study, several conclusions are drawn as follows:

A large part of the differences among the reported hand-arm mechanical impedance data result from natural factors (e.g. coupling force, posture, individual difference, et al.), which are normal and natural phenomena. The ISO 10068 should reflect the influence of the natural factors on the recommended MI data.

The rest of the differences likely result from undetected problems in the instrumentation and/or calculating algorithms. While no instrumentation system is perfect, and small errors are acceptable for practical engineering applications, a serious problem could lead to erroneous conclusions. Therefore, it is essential to carefully examine the measurement system and eliminate any serious problem. It is also very important to carefully examine the data when they are included in the standard.

The trend of the MI data recommended in the current ISO 10068 (1998) is consistent with that of the majority of the reported data. Hence, the recommended data may be qualitatively acceptable.

However, besides a few fundamental deficiencies and many limitations, the standardized data and models include some unreliable experimental data. These problems significantly affect the value of this standard. Therefore, the current ISO 10068 (1998) should be revised.

## References

- Burström, L. 1990. Absorption of vibration energy in the human hand and arm. Doctoral Thesis, Tekniska Hogskolanilulea Lulea University of Technology.
- Dobry, M.W., Barczewski, R., and Stammers, C.W. 1992. A pneumatic tool vibration isolator. *Journal of Sound and Vibration* 153: 171-175.
- Dong, R.G., McDowell, T.W., Welcome, D.E., Rakheja, S., Smutz, W.P., Warren, C., Wu, J.Z., and Schopper, A.W. 2003a. Effectiveness of anti-vibration gloves. 2003 NORA Symposium, Arlington, VA, USA: 45.
- Dong, R.G., Rakheja, S., McDowell, T.W., Welcome, D.E., Wu, J.Z., Warren, C., Barkley, J., Washington, B., and Schopper, A.W. in press. A method for determining the transmissibility of antivibration gloves using biodynamic responses of the hand-arm system. *Journal of Sound and Vibration*.
- Dong, R.G., Rakheja, S., Schopper, A.W., Han, B., and Smutz, W.P. 2001. Hand-transmitted vibration and biodynamic response of the human hand-arm: A critical review. *Critical Reviews in Biomedical Engineering* 29: 393-439.
- Dong, R.G., Wu, J.Z., McDowell, T.W., Welcome, D.E., and Schopper, A.W. 2003b. Vibration energy transmitted from a simulated tool handle to human fingers and the palm of the hand. *Proceedings of the 38th United Kingdom Conference on Human Responses to Vibration*, Alverstoke, Gosport, UK: 455-460.
- Gurram, R., Rakheja, S., and Brammer, A.J. 1995. Driving-point mechanical impedance of the human hand-arm system: Synthesis and model development. *Journal of Sound and Vibration* 180: 437-458.
- ISO 10819, 1996: Mechanical vibration and shock -- hand-arm vibration -- method for the measurement and evaluation of the vibration transmissibility of gloves at the palm of the hand. (International Organization for Standardization, Geneva, Switzerland).
- ISO 10068, 1998: Mechanical vibration and shock -- free, mechanical impedance of the human hand-arm system at the driving point. (International Organization for Standardization, Geneva, Switzerland).
- ISO 13753, 1999: Mechanical vibration and shock -- hand-arm vibration -- method for measuring the vibration transmissibility of resilient materials when loaded by the hand-arm system. (International Organization for Standardization, Geneva, Switzerland).
- Jahn, R., and Hesse, M. 1986. Applications of hand-arm models in the investigation of the interaction between man and machine. *Scandinavian Journal of Work, Environment & Health* 12: 343-346.

- Kihlberg, S. 1995. Biodynamic response of the hand-arm system to vibration from an impact hammer and a grinder. *International Journal of Industrial Ergonomics* 16: 1-8.
- Lenzuni, P., Lundström, R., and Burström, L. 2001. Frequency and magnitude functional dependence of absorbed power resulting from vibration transmitted to the hand and arm (paper 8-3). 9th International Conference on Hand-Arm Vibration, Nancy, France.
- Marcotte, P., Aldien, Y., Boileau, P.E., Rakheja, S., and Boutin, J. 2003. Influence of hand size and coupling forces on the biodynamic response of the hand-arm system. Proceedings of the 38th United Kingdom Conference on Human Responses to Vibration, Alverstone, Gosport, UK.
- Miwa, T. 1964. Studies on hand protectors for portable vibration tools. *Industrial Health* 2: 95-105.
- Miwa, T., Yonekawa, Y., Nara, A., Kanada, K., and Baba, K. 1979. Vibration isolators for portable vibrating tools, part 1: A grinder. *Industrial Health* 17: 85-122.
- Rakheja, S., Wu, J.Z., Dong, R.G., and Schopper, A.W. 2002. A comparison of biodynamic models of the human hand-arm system for applications to hand-held power tools. *Journal of Sound and Vibration* 249: 55-82.
- Reynolds, D.D., Basel, R., Wasserman, D.E., and Taylor, W. 1984. A study of hand vibration on chipping and grinding operators, part III: Power levels into the hands of operators of pneumatic tools used in chipping and grinding operations. *Journal of Sound and Vibration* 95: 515-524.



# MECAHNICAL IMPEDANCE CHARACTERISTICS OF THE HAND AND ARM

A. K. Moustafa, D. Reynolds

Center for Mechanical & Environmental Systems Technology, Howard R. Hughes College of Engineering  
University of Nevada, Las Vegas, Las Vegas, Nevada, USA

## Introduction

Over the years, many investigators have conducted tests, measuring the mechanical impedance of the hand-arm system. The results of these investigations were incorporated into ISO 10068 (5). In recent years, using modern instrumentation, new impedance measurements of the hand-arm system have been made (1-4). This paper explores some of the issues that should be considered when conducting these tests.

## Method

Past investigators have discussed the importance of substracting the mechanical impedance of the handle from the measured mechanical impedance of the hand and arm and the handle. Two methods have been proposed. One consists of electronically subtracting the mechanical impedance of the handle mass using a mass-cancel circuit. The second involves measuring the mechanical impedance of the handle alone and of the hand and arm plus the handle. The mechanical impedance of the handle is then mathematically subtracted from the mechanical impedance of the hand and arm plus the handle.

A push force of 50 N and grip force of 25 N were used for the mechanical impedance tests that were conducted. The Vibration View frequency controller was used to drive the electromechanical shaker at a constant velocity of 0.01 m/s over a frequency range of 5-1000 Hz. The SignalCalc PC-based FFT analyzer was used to process the force and acceleration signals to measure the driving point mechanical impedance of the handle and the handle plus the hand and arm.

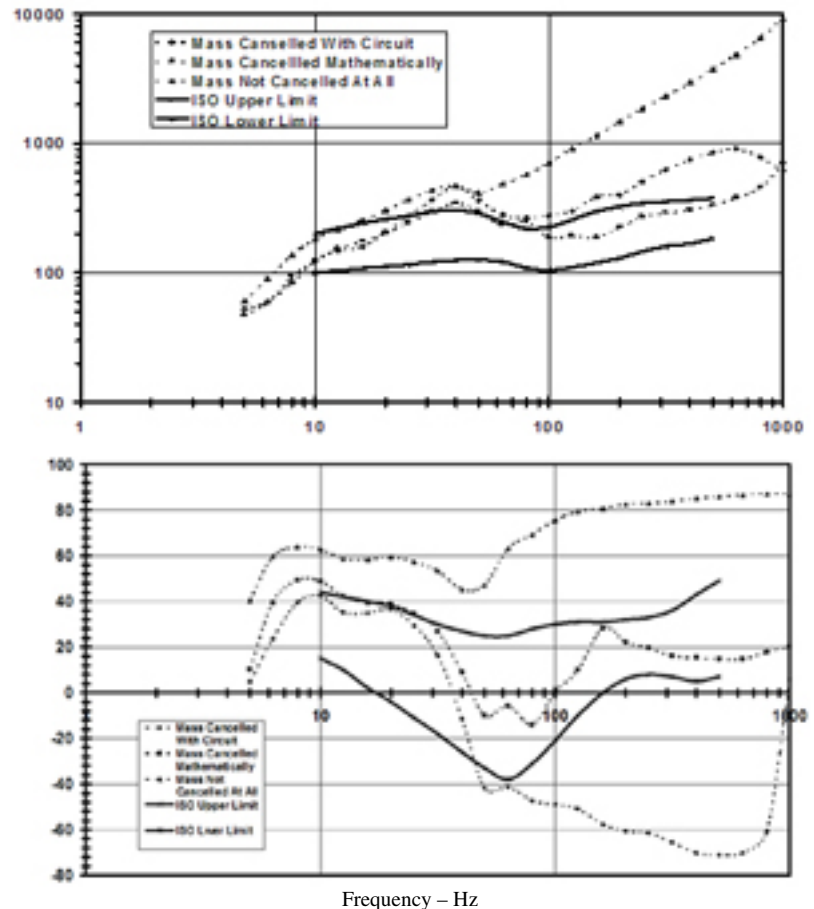


Figure 1 Mechanical Impedance - Mass Cancellation

## Results

Figure 1 shows the measured mechanical impedance of: (1) hand plus handle, (2) mechanical impedance of the hand with the mechanical impedance of the handle electronically subtracted, and (3) mechanical impedance of the hand with the mechanical impedance of the handle mathematically subtracted. The figure demonstrates the importance of subtracting the impedance of the handle. The figure also indicates that more accurate results are obtained by mathematically subtracting the mechanical impedance of the handle. Figure 2 shows a comparison of the measured mechanical impedance of the hand and arm with the hand-arm mechanical impedance reported by R. Dong and with the mechanical impedance range reported in ISO 10068..

## References

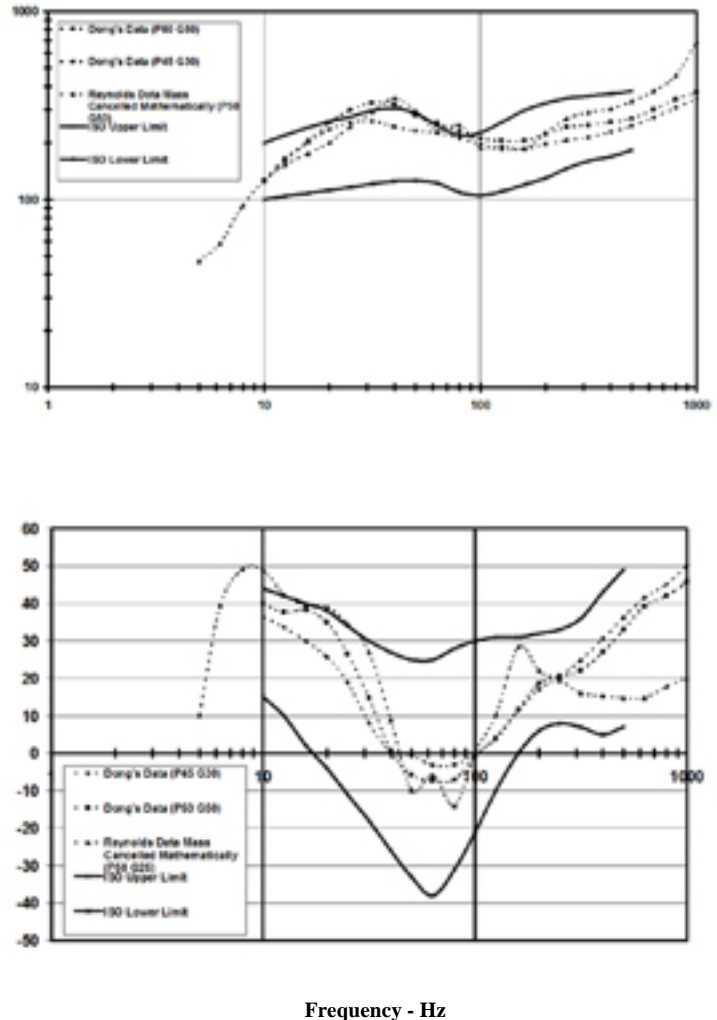
Burström L. (1997). The influence of biodynamic factors on the mechanical impedance of the hand and arm, *Int Arch Occup Environ Health* 69 (1997) 437-446.

Dong RG, Wu JZ, McDowell TW, Welcome DE (2003). Vibration energy transmitted from a simulated tool handle to human fingers and the palm of the hand. In: *Proceedings of the 38<sup>th</sup> UK Conference on Human Response to Vibration*. INM, Alverstoke, Gosport, England.

Gurram R, Rakheja S, and Brammer AJ (1995). Driving-point mechanical impedance of the human hand-arm system: synthesis and model development, *J Sound Vib.* 180: 437-458.

Marcotte, P., Aldien, Y., Boileau, P.-É., Rakheja, S. and Boutin, J. (2003) Influence of handle size and coupling forces on the biodynamic response of the hand-arm system. *Proceeding of the 38<sup>th</sup> UK Conference on Human Response to Vibration*. Gosport, England.

ISO 10068 (1998): Mechanical vibration and shock - free, mechanical impedance of the human hand-arm system at the driving point. ISO, Geneva, Switzerland.



**Figure 2** Comparison of Measured Hand-Arm Mechanical Impedance



# INFLUENCE OF HANDLE SIZE AND SHAPE ON THE BIODYNAMIC RESPONSE OF THE HAND-ARM SYSTEM

P. Marcotte<sup>1</sup>, Y. Aldien<sup>2</sup>, P.-É. Boileau<sup>1</sup>, S. Rakheja<sup>2</sup> and J. Boutin<sup>1</sup>

<sup>1</sup> IRSST, 505 de Maisonneuve W., Montreal, QC, Canada

<sup>2</sup> Concordia University, 1455 de Maisonneuve W., Montreal, QC, Canada

## Introduction

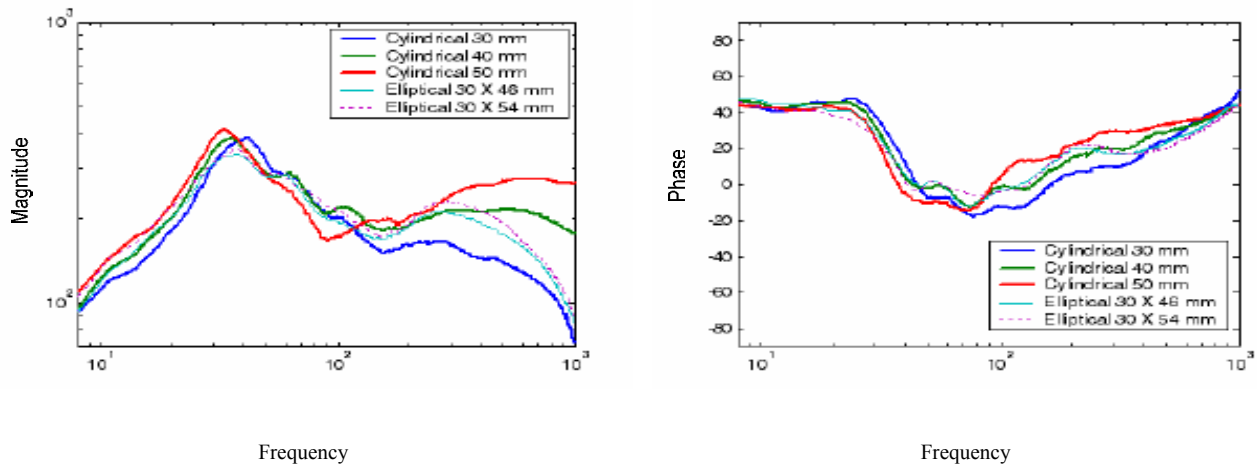
The exposure to hand-arm vibration arising from the operation of hand held power tools has been linked to several disorders, globally known as hand-arm vibration syndrome (HAVS). The risk of developing HAVS depends upon many factors, such as the tool handle vibration level, the duration of exposure, the susceptibility of individuals to hand-arm vibration, as well as to the mechanical coupling between the hand-arm system and the tool handle (Griffin, 1990; Reidel, 1995). The mechanical coupling between the hand and the tool handle has been mainly considered through the free driving point mechanical impedance (DPMI) of the hand-arm system. Several studies have shown that the DPMI depends upon many factors, such as the direction, frequency and level of vibration, as well as upon the push and grip forces exerted on the handle (Burstrom, 1997; Gurram et al., 1995). Through measurements performed on cylindrical handles of different diameters, it has been shown that the DPMI also depends on the handle size (Marcotte et al., 2003). The hand held power tools frequently employ non-circular cross-section handles, which may further influence the mechanical coupling of the hand with the handle, and the DPMI response. The DPMI response of the human hand-arm coupled with elliptical handles of different major and minor radii are measured in this study in order to enhance an understanding of the effect of handle shape on the biodynamic responses under vibration along  $z_h$  direction.

## Methods

The DPMI responses of the hand-arm system were measured for seven healthy male subjects under  $z_h$  axis vibration using three cylindrical (30, 40 and 50 mm diameter) and two elliptical (30x46 mm and 30x54 mm) handles. The elliptical handles were built by placing rectangular inserts (16 and 24 mm thick) between the two halves of the 30 mm cylindrical handle. The handles were instrumented to obtain different measures of mechanical coupling between the hand and handle (namely the grip and push forces, and contact force), and the DPMI (Marcotte et al., 2003). The DPMI was measured under broadband random excitation (8–1000 Hz) with frequency-weighted rms acceleration equal to 2.5 and 5.0  $m/s^2$ , as computed according to ISO 5349-1:2001 standard (2001). Each measurement lasted seven seconds (25 averages with an overlap of 75 %), while the subjects were asked to maintain the push and grip forces near the required values using visual feedback from the force displays. For each subject and each handle, the DPMI was measured for three grip forces (10, 30 and 50 N) and three push forces (25, 50 and 50 N) resulting in nine different force combinations.

## Results

The DPMI magnitude and phase responses of the human hand-arm coupled with all five handles, averaged over all seven subjects for the 30 N grip and 50 N push force combination, are shown in Figure 1. The DPMI magnitude response attained with elliptical handles show some interesting trends. At frequencies below 25 Hz, the DPMI magnitude of the 30x46 mm handle is very close to that of the 40 mm cylindrical handle, while the DPMI magnitude of the 30x54 mm handle is closer to that of the 50 mm cylindrical handle. It should be noted that the circumferences of 30x46 and 30x54 handles are comparable to those of the 40 and 50 mm diameter cylindrical handles. However, at frequencies above 100 Hz, important differences arise between the responses of the cylindrical and elliptical handles. Both elliptical handles (30x46 and 30x 54mm) seem to follow a similar trend in DPMI magnitude in the 150 to 300 Hz frequency range (sharp increase in magnitude with increasing frequency) which corresponds more closely to that observed with the larger 40 and 50 mm cylindrical handles. However, above 300 Hz, the DPMI magnitude of the elliptical handles follow the trend of the smaller 30 mm cylindrical handle. These results thus suggest that the handle shape and size have considerable influence on the DPMI magnitude, the extent of which depends upon the frequency range considered.



**Figure 1** Influence of handle size and shape on the DPMI: mean measured data (7 subjects, 30 N grip and 50 N push forces,  $a_w = 2.5 \text{ m/s}^2$ ).

### Conclusion

Measurements of the DPMI on seven healthy male subjects using five different handles (three cylindrical and two elliptical handles) have shown that the handle shape has considerable influence on the DPMI magnitude. At frequencies below 25 Hz, the DPMI magnitude response measured with the elliptical handles tends to follow that of the larger cylindrical handles (40 and 50 mm), while at frequencies above 300 Hz, the DPMI magnitudes of the elliptical handles approach trends similar to that of the smaller 30 mm cylindrical handle.

### References

- Burström, L. (1997) The influence of biodynamic factors on the mechanical impedance of the hand and arm. *International Archives of Occupational Environmental Health*, 69, 437-446.
- Griffin, M.J. (1990) *Handbook of human vibration*, Academic Press, London.
- Gurram, R., Rakheja, S. and Brammer, A.J. (1995) Driving-point mechanical impedance of the human hand-arm system: synthesis and model development. *Journal of Sound and Vibration*, 180 (3), 437-458.
- International Standard ISO 5349-1 (2001) *Mechanical vibration – Measurement and evaluation of human exposure to hand-transmitted vibration – Part 1: General requirements*.
- Marcotte, P., Aldien, Y., Boileau, P.-É., Rakheja, S. and Boutin, J. (2003) Influence of handle size and coupling forces on the biodynamic response of the hand-arm system. *Proceeding of the 38<sup>th</sup> UK Conference on Human Response to Vibration*. Gosport, England.
- Reidel, S. (1995) Consideration of grip and push forces for the assessment of vibration exposure. *Cen. Eur. J. of Public Health*, 3, 139-141.

# INFLUENCE OF HAND FORCES AND HANDLE SIZE ON HUMAN HAND-ARM VIBRATION ABSORBED POWER

Y. Aldien<sup>1</sup>, P. Marcotte<sup>2</sup>, S. Rakheja<sup>1</sup>, P.-É. Boileau<sup>2</sup> and J. Boutin<sup>2</sup>

<sup>1</sup> Concordia University, 1455 de Maisonneuve W., Montreal, QC, Canada

<sup>2</sup> IRSST, 505 de Maisonneuve W., Montreal, QC, Canada

## Introduction

Prolonged occupational exposure to hand-arm vibration arising from the operation of hand-held power tools has been associated with vascular, musculoskeletal and neurological disorders, collectively known as hand-arm vibration syndrome (HAVS). The biodynamic responses of the human hand-arm exposed to vibration have been widely characterized on the basis of measured force and acceleration due to transmitted vibration in terms of driving-point mechanical impedance (DPMI), apparent mass (APMS) or absorbed power. Unlike the DPMI or the APMS, the absorbed power increases considerably with the vibration magnitude and exposure duration, and has thus been suggested as a better measure of the vibration dose and the injury risk (Griffin, 1990; Lidström, 1977). Apart from the vibration magnitude and exposure duration, the absorbed power is known to depend upon many factors, such as the hand-handle interface forces, handle size and geometry, hand-arm posture, and direction and frequency of the transmitted vibration (Burstrom, 1994). This study concerns the measurement of power absorbed by the human hand-arm system exposed to  $z_h$ -axis vibration as function of the handle size, intensity of vibration, and the hand-handle interface forces, characterized in terms of the grip, push, coupling and contact forces.

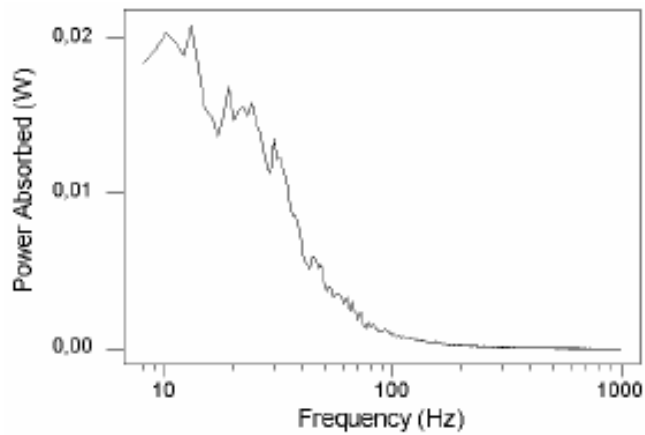
## Method

Three instrumented cylindrical handles with different diameters (30, 40 and 50 mm) were designed and instrumented for measurements of hand-handle forces and power absorbed by the hand-arm system. Each handle consisted of two aluminum semi-circular sections, which were joined together through two force sensors for measuring the grip force. An accelerometer was also mounted within one of the semi-circular section of each handle to measure the handle acceleration. Each handle was mounted on an electrodynamic shaker through a support fixture and two force transducers to measure the static and dynamic push forces. Furthermore, the overall hand-handle contact force, corresponding to each combination of grip and push forces, was measured using a flexible pressure sensing grid. Laboratory measurements were performed using seven healthy adult male subjects exposed to two different levels (2.5 and 5  $\text{ms}^{-2}$  weighted) of broad-band random vibration of the handle in the 8-1000 Hz frequency range. For each handle, the measured data were analyzed to derive the power absorbed by the human hand and arm under nine different grip and push forces combinations. The measured pressure data and the corresponding grip and push forces were applied to obtain estimates of the hand-handle contact and coupling forces, where the latter were computed from direct summation of the applied grip and push forces. Each measurement was repeated twice, while the subjects used the feedback from the display of the mean forces to control the grip and push forces to the required values.

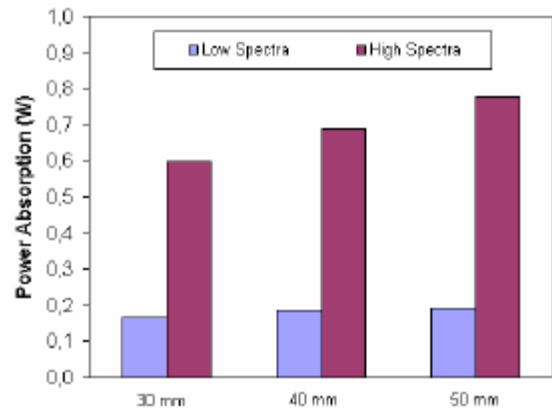
## Results

The measurements of absorbed power revealed good repeatability for each subject, while the inter-subject variability was less than 10 %. The results showed that the concentration of absorbed power occurs at vibration frequencies below 150 Hz, irrespective of the hand forces, handle size and intensity of vibration (Figure 1). The results further revealed that the absorbed power is strongly dependent upon the handle size, grip/push forces, coupling and contact forces, and the vibration intensity, in a highly nonlinear manner. The influence of vibration magnitude on the absorbed power was most important; showing increases in absorbed power with increasing vibration magnitude. Increasing the handle size resulted in increase in the total absorbed power, as shown in Figure 2, while the increase was more pronounced under higher magnitude spectrum. Furthermore, absorbed power was found to vary with variations in either grip or push forces.

The results of ANOVA involving three handle diameters, nine levels of grip/push forces and two levels of vibration magnitudes corroborated the significance of all studied factors. Further analyses of the mean absorbed power data in relation to the hand-handle coupling and contact forces suggested that the absorbed power is more correlated with the coupling force.



**Figure 1** Mean spectrum of absorbed power (40 mm diameter handle; 30 N grip and 50 N push force)



**Figure 2** Influence of handle size and vibration magnitude on the mean absorbed power (30 N grip and 50 N push force)

### Conclusion

The absorbed power of the human hand-arm exposed to vibration is strongly influenced by vibration magnitude, handle diameter and the hand forces exerted on the vibration handle. The absorbed power is more correlated with coupling rather than the contact force. This conclusion is consistent with other observations, i.e. namely a larger handle leads to lower contact force and higher absorbed energy, when compared to that of smaller handle. Considering that the coupling force represents equal contribution of grip and push forces, and the contact force emphasizes a considerable larger weighting on the grip force, the results suggest that the total amount of absorbed power of the hand-arm system would likely be most dependent on push force. This could mean that the upper lateral side of the palm, where most of the push and a fraction of the grip forces are applied, is where most absorbed power enters the hand.

### References

- Burström, L. (1994) The influence of individual factors on the absorption of vibration energy in the hand and arm, *J. of Low Freq. Noise, Vib., and Active Control*, Vol. 13, 115-122.
- Griffin, M.J. (1990) *Handbook of human vibration*, Academic Press, London.
- Lidström, I.-M. (1977) Vibration injury in rock drillers, chisellers and grinders. Some views on the relationship between quantity of energy absorbed and the risk of occurrence of vibration injury. *Proc. of the Int. Occ. Hand-Arm Vibration Conf.*, NIOSH.

**Medical V**

N. Olsen - Session Coordinator



# HAND-TRANSMITTED VIBRATION AT ONE HAND CAUSES TEMPORARY SHIFT OF SKIN TEMPERATURE AT FINGERTIPS OF BOTH HANDS

K. Nishiyama and K. Taoda

Shiga University of Medical Science, Seta, Otsu, Japan

## Abstract

The purpose of this study is to clarify the relationships between the characteristics of vibration exposure to one hand and the variation of skin temperature of fingertips of both sides.

Twenty healthy male students with normal vibratory sensations contributed.

Left hand grips a vibrated metallic The controlled parameters were center frequency of 63, 200 and 500 Hz, magnitude of 0, 10, 20, 40 and 80 m/s<sup>2</sup>, ripping duration, 0.1, 0.3, 0.5, 1, 2 and 4 m., and grip strength, 5, 10, 20 and 40 N without push-pull force. Thermistors detected the skin temperature the both middle fingertips, at dorsal sides through at 15, 10, 5 and 0 m before grip and after cessation of the grip, every min till 5 min, then, 7 and 10 m

The vibration exposure induced the decrease of skin temperature on both fingertips. The magnitude of decrease depends on the magnitude of vibration and grip strength. All frequencies induced the significant decrease of skin temperature on the exposed fingertip. On the contralateral fingertip, the magnitude of 80 m/s<sup>2</sup> induced the significant decrease,

The observed frequency dependence on skin temperature on both fingertips suggests the necessity of revision of the current frequency weighting standards.

## Introduction

The original purpose of this study is to discuss the validity of present "Frequency weighting for HAV" defined by many standards such as ISO 5349. Pathological effects of hand-arm vibration depend on the intensity and frequency spectrum of the vibration and others. However, the frequency weighting for hand-transmitted vibration as defined in hand-transmitted vibration standards such as ISO 5349 based on psychological measures such as subjective perception threshold, intolerance, and unpleasantness. Therefore, we have been wondering if such frequency weighting is the golden standard or not as other specialist pointed out. It is necessary, of course, not to neglect such sensation. The problem is if it is enough or not.

The temporary threshold shift of vibratory sensation (TTS<sub>v</sub>) and warm sensation (TTS<sub>w</sub>) at the fingertips of the hand exposed to vibration were dependent on its frequency and intensity for normal students (Nishiyama and Watanabe, 1981 and Hirose et al, 1992). The most effective frequency was in the range of 200 - 250 Hz under the same exposure duration and grasping force. In addition, they increased with a rise in the acceleration. The equal contours for TTS<sub>v</sub> were markedly different from the frequency weighting as defined in hand-transmitted vibration standards.

Finger skin temperature and the threshold of cool sensation tended to decrease slightly after exposure to vibration under the above conditions, but they seemed to be scarcely affected by the frequency and intensity of the exposed vibration (Hirose et al, 1992).

The aim of present study is to clarify how the hand-transmitted vibration causes temporary shifts of the skin temperature at fingertips of both hands and what factors influence on the shifts.

## Subjects and Methods

Twenty healthy male students from 19 to 26 years old (mean 22 years) with normal vibratory sensations (125 Hz, less than or equal to 5.0 dB, 0.0 dB = 125 m p-p) contributed in the present study. All subjects had not to wash his hands 30 min before and during the experiment. The subject with smoking habit had not to smoke during the experiment day till its end. Each subject had to be seated in the sound- and vibration-proof experimental chamber that temperature was kept at 22 °C. The subject had to wait in the chamber till being adapted to its climate. It means that Skin temperature of fingertips is 30 °C or more continuously for 15 min before grip.

Methods of hand-arm vibration exposure were as follows. Left hand had to grip a metallic handle attached to an electric-dynamic shaker as shown Figure 1 and kept at the temperature of 32 °C. The grip began only after the subject had shown a stable vibratory sensation threshold for 15 min at least as skin temperature. A one third octave-band vibration by the shaker (IMV Co., Japan) vibrated the handle vertically. The parameters to be controlled were: Center frequency of 63, 200 and 500 Hz, magnitude of 0, 10, 20, 40 and 80 m/s<sup>2</sup>, ripping duration, 0.1, 0.3, 0.5, 1, 2 and 4 m., and grip strength, 5, 10, 20 and 40 N without push-pull force.



**Figure 1** Posture of the right hand gripping the handle

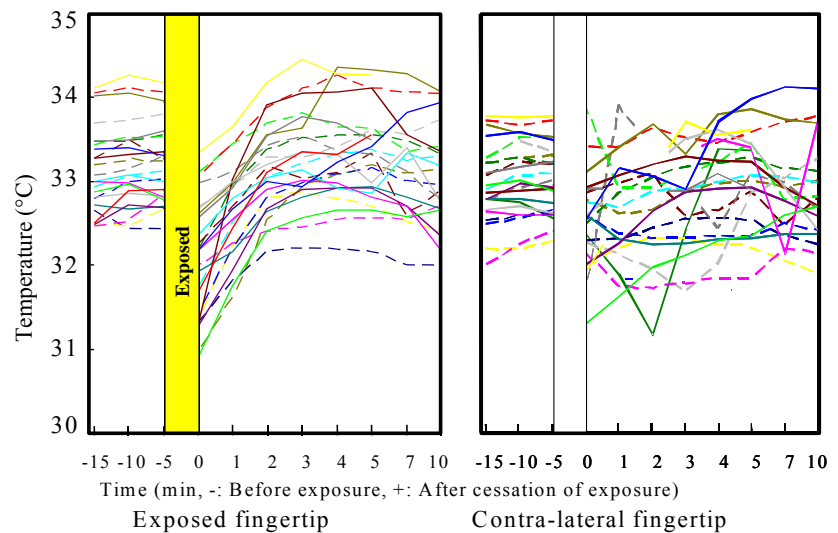
We manually measured and recorded the skin temperature the both middle fingertips, at dorsal sides through thermistors (Thermometer MGS III 2L322, Shibaura Electronics Co., Japan) at 15, 10, 5 and 0 m before grip and after cessation of the grip, every min till 5 min, then, 7 and 10 m during the primary experiment of TTSv (Nishiyama et al. 1994, Nishiyama et al. 1996a, Nishiyama et al. 1996b).

One session (a 3 and half h period in the morning or afternoon with 10 or 30 min rest period was repeated for at least three days at the same time for each subject.

In the preliminary analysis, the mean temperature of the reference was 32.9 ( $\sigma = 1.1$ ) °C at both fingertips as Figure 2 shows. Their distribution seems to be rather large to analyze the effect of vibration. Especially the contralateral response is complicated, although some effects seem to be induced by the vibration exposure.

Thus, to evaluate the influence on the skin temperature, we use the temporary shift of skin temperature, that was abbreviated to TSst,t. We defined the TSst,t as a Difference between skin temperature at t minutes after each grip and skin temperature at immediately before the grip.

Statistical analyses were carried out using SPSS for Windows 10.0J. The effect of the above factors on TSst was analyzed by the subprogram GLM Multivariate Analysis of Variance (MANOVA) and Repeated Measurement Analysis. Time after the cessation of the exposure and before the exposure was defined as a covariate. As long as the significance was confirmed, the Student-Newman-Keuls (SNK) test through One-Way ANOVA was carried out based on a significance level of  $P < 0.05$  for a posteriori contrast to examine type 1 error in order to compare all possible pairs of group means.



**Figure 2** Average skin temperatures for all subjects at fingertips after exposure of vibration. Each line by subject



Figure 3 shows the average temporary shift of skin temperature at fingertips before and after exposure of vibration for all subjects. The hand-transmitted vibration to one hand caused significant temporary shifts of skin temperature at the fingertips of both hands till 2 min after the cessation of grip (SNK test), although the shift of contralateral fingertip is rather small. TSst at the exposed fingertip showed a clear bounce around 5 min after the cessation as similar as TTSv and TTSw and the ipsilateral is more than 0 °C. They do not still become or recover to 0 °C after 10 m. Paired t-test showed the significant difference of TSst between the both fingertips on each time. MANOVA clarified the significant main effect of the subject and time after the cessation of exposure on both fingertips.

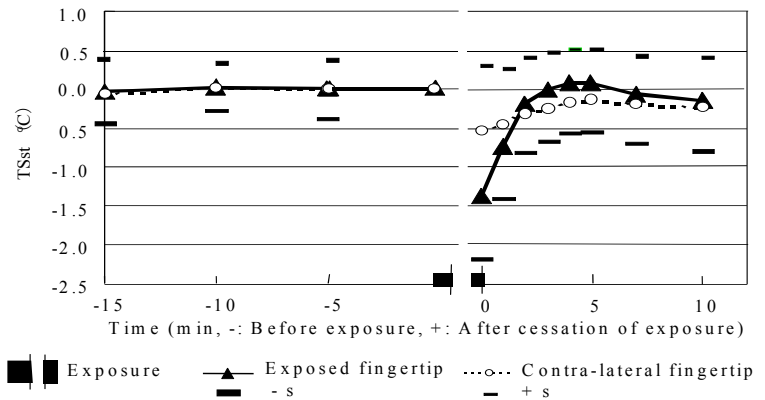
Figure 4 shows the shift by fingertip and center frequency with the all magnitude; grip strength of 10 N, gripping duration 1 m, and number of subjects is 10. The exposed fingertips show that the shift immediately after the exposure is larger than the shift without vibration exposure. But it seems to be no difference between frequencies.

On the other hand, the contralateral fingertips do not show clear effect of the exposure as the ipsilateral.

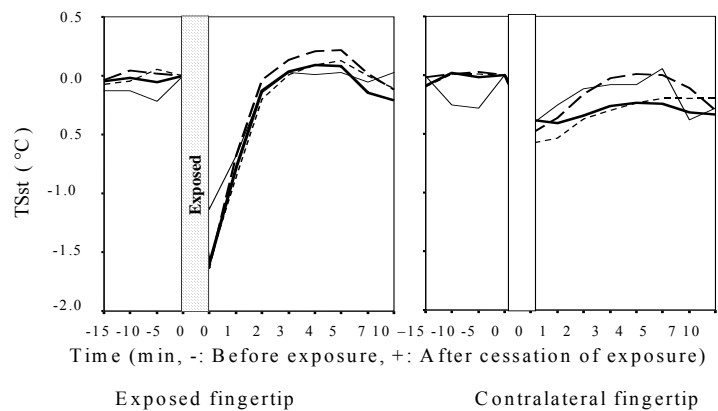
Figure 5 shows the shift by fingertip and magnitude with the all frequency under the same conditions as just above-mentioned. The exposed fingertips do not show the difference just after the grip, although they show somewhat different recovery processes. However, the contralateral fingertips show rather clear difference. The larger magnitude corresponds to the larger shift during whole the 10 minutes after the grip.

Figure 6 shows the frequency dependency of the shift immediately after the grip by fingertip and magnitude and center frequency for the same condition as mentioned above. Furthermore, on the fingertip of the unexposed contralateral hand, it clarified the additional main effect of intensity and frequency of the exposed vibration, grip strength. That TSst seemed larger as the frequency of the exposed vibration lowered.

The shift of fingertips gripping and being exposed to vibration is significantly different from the shift in case of gripping without vibration exposure. The shift of contralateral

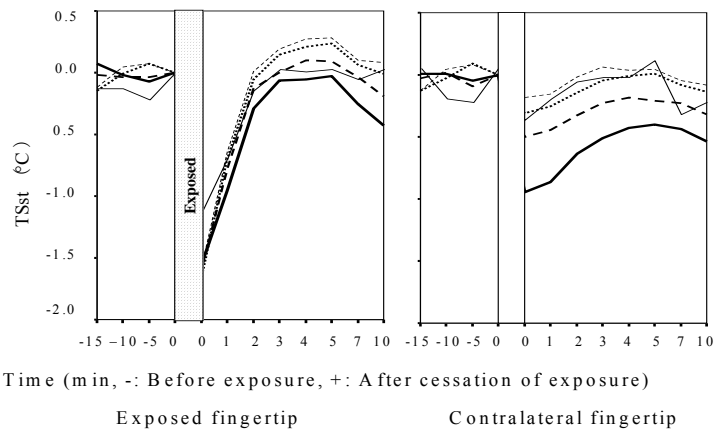


**Figure 3** Average shift of skin temperature for all subjects at fingertips after exposure of vibration



**Figure 4** TSst by fingertip and center frequency  
Magnitude=10, 20, 40 and 80 m/s<sup>2</sup>, grip=10 N,  
gripping duration=1 m and n=10

Exposed frequency (Hz)    ..... 63    --- 200    — 500    — Not exposed



**Figure 5** TSst by magnitude

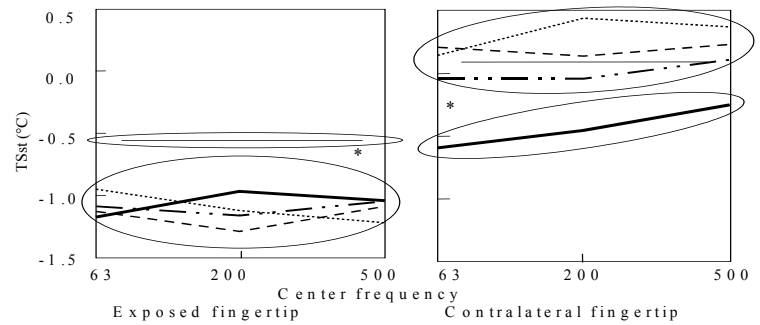
Frequency=63, 200 and 500 Hz, grip=10 N,  
gripping duration=1 m, n=10

Magnitude (m/s<sup>2</sup>):    ..... 10    ..... 20    - · - 40    — 80    — Not exposed

fingertips for  $80 \text{ m/s}^2$  is significantly different from the shift for the less magnitude conditions. There is no statistical interaction of center frequency and magnitude for both fingertips.

Figure 7 shows the shift by fingertip and duration to expose to the vibration with the frequency of frequency of 200 Hz and magnitude of  $40 \text{ m/s}^2$ . The grip power is 40 N, and the number of subjects is 7.

The exposed fingertips show that the longer exposure duration corresponds to the larger shift. However, the contralateral fingertips do not show clear difference because of missing data. It also shows slight differences at the ipsilateral fingertip between the exposed and unexposed conditions but no statistical significance.

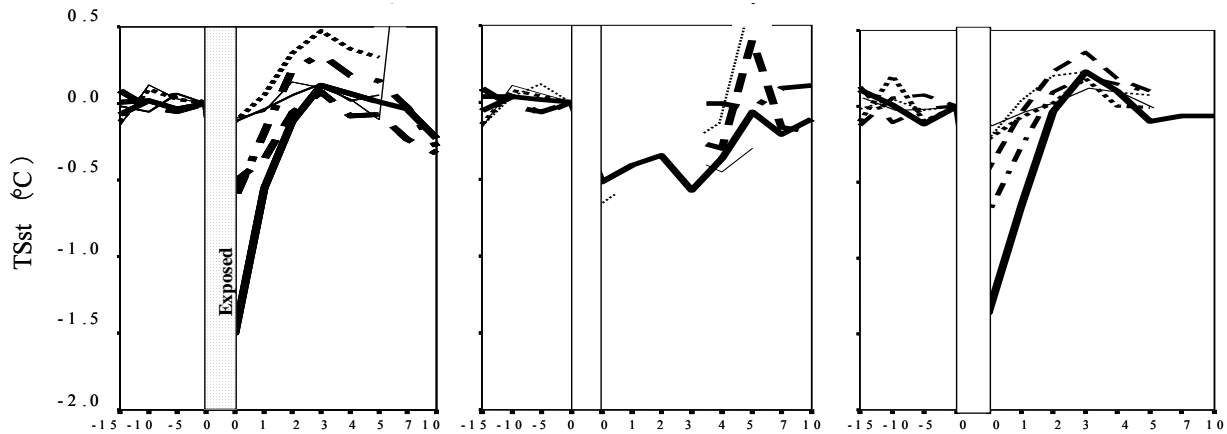


**Figure 6** TSst by fingertip, magnitude and center frequency

Grip=10 N, Gripping duration=1 m, n=10

\*:  $p < 0.05$  (Group contrast, SNK-test)

Magnitude-( $\text{m/s}^2$ ): ..... 10 - - - 20 - · - · 40 — 80 — Not exposed



**Figure 7** TSst by fingertip, exposure and duration; Frequency=200 Hz, magnitude= $40 \text{ m/s}^2$ , grip=40 N, n=7

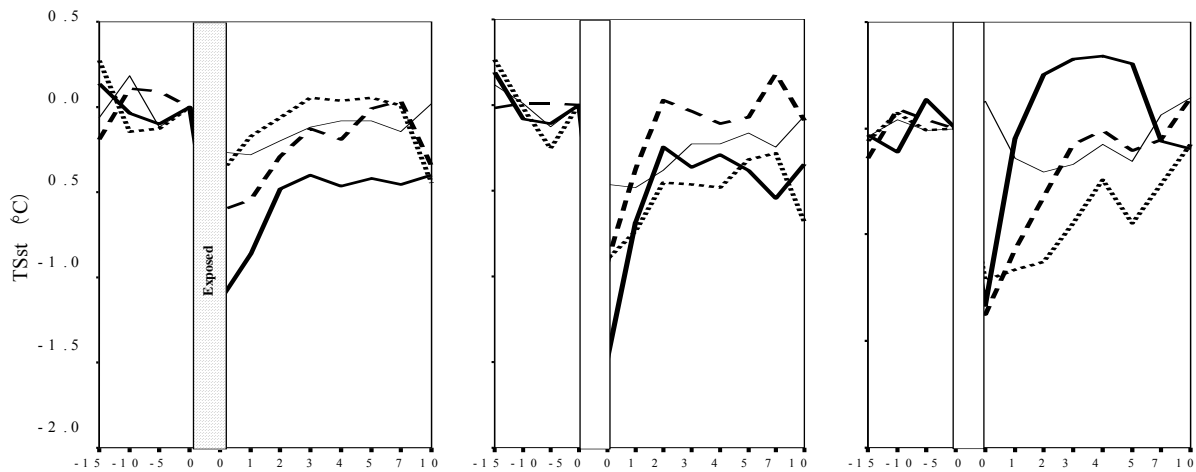
Duration: — .1 ..... .3 - - - .5 - - - 1 - · - 2 — 4

### Results

Figure 8 shows the shift by fingertip and grip strength with the frequency of 200 Hz and magnitude of  $40 \text{ m/s}^2$  with the grip duration of 4 m for 3 subjects. The exposed fingertips show that the larger grip strength corresponds to the larger shift during whole 10 minutes after exposure. The contralateral fingertips show that the larger grip strength corresponds to the larger shift immediately after the exposure.

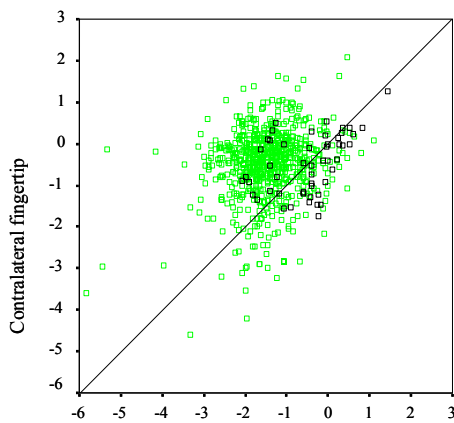
On the other hand, the contralateral fingertips immediately after gripping without vibration exposure show the same shift, more than or equal to 10 N. However, the recovery process is rather different between the different grip strength.

Figure 9 shows the correlation of the temperature shift between the both fingertips immediately after the gripping for all conditions. Pearson's correlation coefficient after the vibration exposure is 0.21 and is smaller than that after the gripping without vibration exposure, that is, 0.43. The rather small correlation coefficient of the shifts between the both fingertips after vibration exposure suggests that the vibration exposure probably independently affect on both fingers.

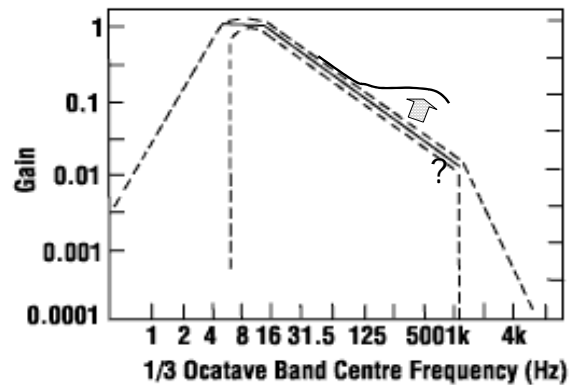


**Figure 8** TSst by exposure and grip strength; Frequency=200 Hz, magnitude=40 m/s<sup>2</sup>, gripping duration=4 m, n=3

Magnitude (N): — 5    - - - 10    - - - 20    — 40



**Figure 9** Correlation of temperature shift (°C) between both fingertips just after grip for all conditions



**Figure 10** Possible revision of frequency weighting for HAV (ISO 5349)

### Discussion and conclusion

This study clarified the effect of the vibration exposure to one hand on the skin temperature of the fingertip on both hands and its dependency on some parameters, although our preceding studies on vibratory and temperature sensation. Some subjects showed rather large TTSv,0 in our preceding study (Nishiyama, et al., 1994). Among such subjects, the larger TSst might be induced. However, present study did not clarify the inter-person differences and the correlation of frequency dependency between TTSv,0 and TSst. If it correlates well, it is possible to have a hypothesis that some response or reflex of the vibratory perception system induces more contralateral vasoconstriction that resulted in the decrease of the skin temperature.

Anyway the present result suggests some physiological system innervates the contralateral peripheral blood circulation by the hand-transmitted vibration.

We could compare the results of our preceding study with the many kinds of hand-arm vibration limits as shown in this figure “Comparison of limits for hand-transmitted vibration”, proposed edited (Griffin, 1990). By comparing with the graphs, our results supported more the pattern of the curves proposed by Adeeva-Galaninna modification to USSR 191-55 (cited by Griffin, 1990) and Axellson (1968, cited by Griffin, 1990). However, the preceding study was still rather subjective or perceptual, because, our study used the sensation such as vibratory and warm perception. Another problematic issue is that, although it is well known that HAV can induce the large permanent and pathological threshold shift of such sensation, the relationship between the temporary and permanent shifts of such sensation is still in vague.

Present study shows the significant change of the skin temperature at both fingertips induced by the exposure to vibration with the frequency up to 500 Hz. Thus, this study suggests that the pattern of the yellow graph proposed by Czechoslovakian Ministry of Health is more reasonable than the current frequency weighting.

Finally, it is probably better to revise the frequency weighting for HAV as guided by ISO 5349 as shown by an arrow and curve as other researchers recommended.

However, to clarify how much increase the gain of the present frequency weighting, it is necessary to study furthermore.

### References

Griffin M.J. 1990. Handbook of Human Vibration, Academic Press.

Hirosawa, I., Nishiyama, K. and Watanabe, S. 1992. Temporary threshold shift of temperature sensation caused by vibration exposure. International Archives of Occupational and Environmental Health, vol 63, pp531-535.

ISO 5349-1. Mechanical vibration-measurement and evaluation of human exposure to hand-transmitted vibration. Part 1: General requirements. Geneva: International Organization for Standardization, 2001.

Nishiyama, K., and Watanabe, S. 1981. Temporary threshold shift of vibratory sensation after clasping a vibrating handle. International Archives of Occupational and Environmental Health, vol 49: 21-23.

Nishiyama K, Taoda K, Yamashita H, Watanabe S. 1994. Application of a new, self-recording, vibratory sensation meter to measure temporary threshold shift of vibratory sensation caused by local vibration exposure. International Archives of Occupational and Environmental Health, vol 66: 97-102.

Nishiyama K, Taoda K, Yamashita H, Watanabe S. 1996. The temporary threshold shift of vibratory sensation induced by the composite band vibration exposure. International Archives of Occupational and Environmental Health, vol 68: 255-261.

Nishiyama K., Taoda K., Yamashita H., Watanabe S. 1996. Temporary threshold shift of vibratory sensation induced by a vibrating handle and its gripping force. International Archives of Occupational and Environmental Health, vol 69: 45-52.

# CHANGES OF PERIPHERAL CIRCULATION BY SILVER SPIKE POINT THERAPY AMONG WORKERS EXPOSED TO HAND-ARM VIBRATION

Sakaguchi S<sup>1,2</sup>, Miyai N<sup>1</sup>, Yamamoto H<sup>1</sup>, Minami Y<sup>1</sup>, Terada K<sup>1</sup>,  
Tomida K<sup>1</sup>, Morioka I<sup>3</sup>, Miyashita K<sup>1</sup>

<sup>1</sup> Department of Hygiene, School of Medicine, Wakayama Medical University, 811-1 Kimiidera, Wakayama, 641-8509, Japan

<sup>2</sup> Department of Clinical Research on Acupuncture, Kansai College of Oriental Medicine, 2-11-1 Wakaba, Kumatori-cho, Sennan-gun, Osaka, 590-0482, Japan

<sup>3</sup> Department of Health and Nursing Science, Wakayama Medical University, 580 Mikazura, Wakayama, 641-0011, Japan

## Abstract

The purpose of this study was to investigate the changes of peripheral circulation through silver spike point (SSP) therapy in 22 male forestry workers exposed to hand-arm vibration by analyzing fingertip photoplethysmogram. The association between the changes of peripheral circulation and the response of autonomic nervous function was also evaluated using the coefficient of variation of R-R interval (CVR-R), total number of white blood cells (WBC), and the ratio of granulocyte (GC) and lymphocyte (LC) as indices.

The SDPTG-index and  $-b/a$ , indices of plethysmogram wave pattern, increased significantly due to the therapy, suggesting the improvement of peripheral circulation. The average heart rate (HR) tended to decrease and the CVR-R did not change significantly. The total number of WBC and the ratio of LC decreased significantly as the result of the therapy.

The subjects were divided into two subgroups according to the CVR-R values; low-value group ( $n=8$ ), high-value group ( $n=14$ ). In the low-value group, the HR decreased while the SDPTG-index and  $c/a$  increased. In the high-value group, the CVR-R and the LC decreased while the WBC increased significantly.

These results suggest that the SSP therapy may improve the peripheral circulatory function through the enhancement of parasympathetic nerve activity of the subjects with impaired parasympathetic nervous function. Furthermore, the therapy suppresses the parasympathetic nervous function of the subjects with enhanced parasympathetic nervous function.

## Introduction

In recent years, silver spike point (SSP) therapy using a SSP electrode has been widely utilized to ease the muscle tension and pain (Hyodo, 1993). This therapy is similar to a low frequency electrical acupuncture that is based on the conception of acupoints (tsubo). It is effective when the SSP electrodes are compressed on the tsubo and is therefore called as 'acupuncture therapy without the insertion of acupuncture needle'. Since the procedure is very simple and the side effect and its complication are few, the therapy is more beneficial compared to the previous methods. Additionally, some researchers have indicated the effects of SSP therapy on peripheral circulation, but it is still unclear whether the therapy is effective for peripheral circulatory impairment in workers with vibration syndrome (Sakaguchi et al. 2001).

The fingertip photoplethysmogram (PTG) has been clinically used as a noninvasive assessment of peripheral circulation in relation to changes in wave amplitude. The second derivative of photoplethysmogram (SDPTG) was developed as a method allowing more accurate recognition of the inflection points and easier interpretation of the original plethysmogram wave (Sano et al. 1985). Several studies have reported that the analysis of SDPTG wave form can provide useful information concerning the arterial distensibility or the peripheral vascular tone, and therefore can be applied for the clinical diagnosis of several diseases that occurs with peripheral circulatory dysfunction (Takazawa et al. 1989).

The autonomic nervous function test using the coefficient of variation of R-R interval (CVR-R) is widely utilized as a noninvasive and objective method. Especially, the CVR-R measured when the subject at supine rest is considered to be useful for evaluating the tonus of parasympathetic nerve (Kageyama et al. 1978).

Recently, Abo and his co-researcher found the association between autonomic nervous activity and the component of white blood cell, especially with the ratio of granulocyte (GC) and lymphocyte (LC) (Abo 1998). They also indicated that the GC and LC, main components of the WBC, are systematically evolved from the macrophages and have the adrenalin receptor and the acetylcholine receptor severally. Consequently, the amount and the function of GC are reactivated by the sympathetic nerve stimulation. On the other hand, those of the LC are reactivated by the parasympathetic nerve stimulation.

This study was designed to examine the effects of SSP therapy on peripheral circulation of workers who are occupationally exposed to hand-arm vibration by analyzing the SDPTG waveform. We also evaluated the association between the changes of peripheral circulation and the response of autonomic nervous function using the CVR-R values, WBC and the ratio of GC and LC as indices.

### Subjects and Methods

The subjects were 22 male forestry workers (56.4±9.0 years) who have some symptoms related hand-arm vibrating exposure, i.e. coldness, numbness, pain underwent a special medical examination for vibration syndrome in Wakayama Prefecture in Japan. Subjects were excluded if they were hypertensive, as defined by currently using antihypertensive medication or having a resting blood pressure of  $\geq 140/90$ mmHg taken at the examination; and had an electrocardiographic evidence of cardiac arrhythmia.

The SSP therapy was performed using Felicia TRIMIX (NIHON MEDIX, Japan). The SSP electrodes (Fig.1) were attached to LI4 and LI10 (Fig.2) of the right side of the upper limbs, and the stimulation was kept 1Hz for 10 minutes (The association of oriental therapy 1992). The stimulation strength was restricted to the comfortable levels for subjects without any sign of pain.

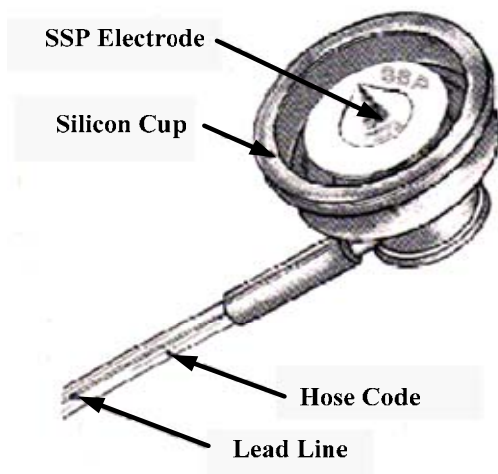


Figure 1 SSP electrode

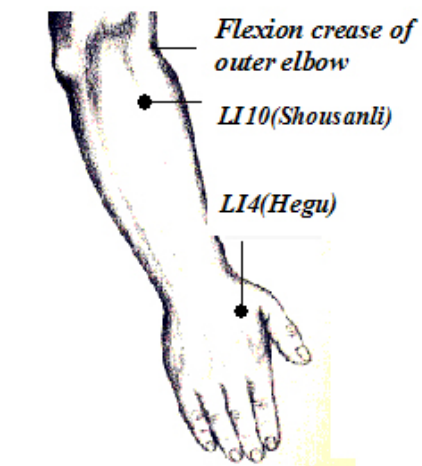


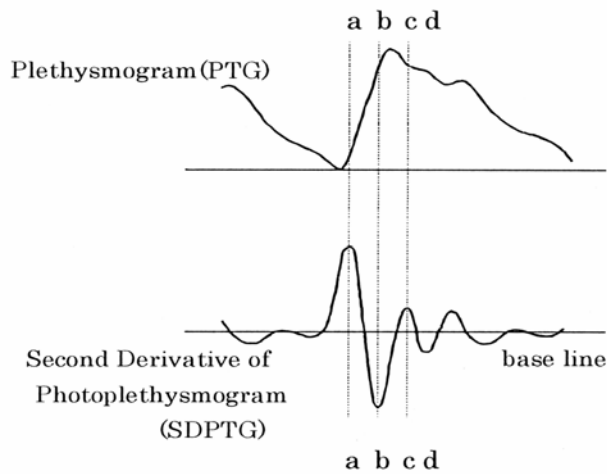
Figure2 Stimulation points (acupoints) by the SSP therapy

The SDPTG wave and CVR-R the standard second limb lead electrocardiogram (ECG) were recorded at the supine position simultaneously before and after the SSP therapy by FCP-3166 (FUKUDA DENSHI, Japan). The measurements were performed in a quiet room with a temperature of 20.4±2.5°C after the subjects having a rest for the adaptation to the room temperature.

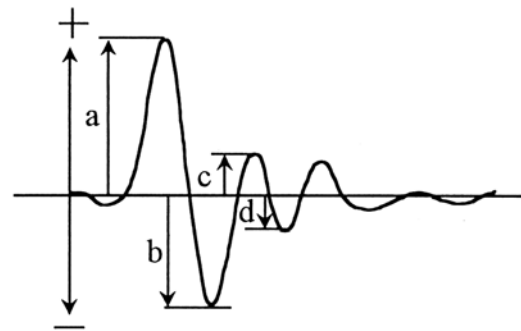
The SDPTG recording was performed 2 times at the second digit of the right hand. The SDPTG wave is obtained by two-time differential of the PTG, and it reflects the time transition of blood content quantity in the peripheral blood vessel (Fig.3). Four waves per pulse are usually recorded in SDPTG recordings. They are named as first positive wave (a), first negative wave (b), second positive wave (c) and second negative wave (d). Quantitative analysis for the waveform pattern is to be made by calculating the ratio of the height of each component waveform from baseline (-b/a, c/a and d/a). The SDPTG-index  $(-b+c+d/a)$  was also calculated as a comprehensive parameter of SDPTG waveform (Fig.4).

The CVR-R values were automatically calculated using 100 beats of HR observed in a supine position after sufficiently resting in quiet room. The age-specific standard values of CVR-R were estimated by the following equation:  $CVR-R = -0.066 \times \text{age} + 6.840$  (Fujimoto et al. 1987).

The blood samples were taken from median cubital vein before and after the therapy, and the total number of WBC and the ratio of GC and LC were calculated.



**Figure 3** Waveform samples of PTG and SDPTG



**Figure 4** Parameters obtained from SDPTG waveform  
 Ratio of the height of each component :  $-b/a, c/a, d/a$   
 SDPTG-index :  $(-b+c+d)/a$

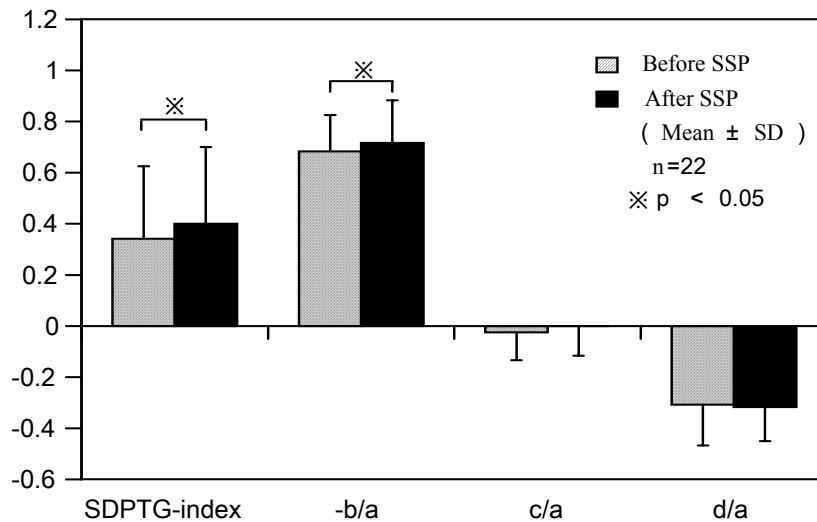
**Figure 4** Parameters obtained from SDPTG waveform

The differences in each parameter before and after the SSP therapy were analyzed by paired t-test. The differences between groups were tested by unpaired t-test.

### Results

The vibrating tools subjects mainly operating were chain saw and bush cleaner. The average period of operating tools was 18 years. The total operating time (TOT) was 1,500 to 49,000 hours (median; 21,300 hours).

The changes in the SDPTG parameters of the subjects before and after the therapy are shown in Fig.5. The SDPTG-index and  $-b/a$  increased significantly after the application of SSP therapy ( $p < 0.05$ ) (Fig.5).



**Figure 5** Changes in SDPTG parameters before and after SSP therapy

The average heart rate of subjects had tendency to decrease after the therapy ( $p < 0.06$ ). The CVR-R values did not change significantly (Table1).

**Table 1** Heart rate and CVR-R before and after SSP therapy

	Before SSP	After SSP
Heart rate (beats/min)	0.8±8.4	59.8±8.8 <sup>†</sup>
CVR-R (%)	.9±1.6	3.4±1.5

<sup>†</sup>;  $p < 0.06$  (Mean±SD)

The WBC and LC of subjects decreased significantly ( $p<0.01$ ,  $p<0.05$ ). The GC did not change significantly after the therapy (Table 2).

**Table 2.** Leucocyte subset before and after SSP therapy

	Before SSP	After SSP
WBC (/mm <sup>3</sup> )	4,700±1,100	4,500±1,200**
Granulocyte (%)	56.7±10.9	57.3±10.5
Lymphocyte(%)	36.8±10.5	35.9±10.2*

\*\*;  $p<0.01$  \*;  $p<0.05$  (Mean±SD)

The subjects were divided into two subgroups according to the CVR-R values by contrasting with the age-specific standard values; low-value group (n=8), high-value group (n=14). There were no significant differences in age, period of operating tools and TOT between the two subgroups. In the low-value group whose CVR-R lower than standard value, the HR had a tendency to decrease ( $p<0.08$ ), and SDPTG-index and c/a had a tendency to increase ( $p<0.08$ ). On the other hand, in the high-value group whose CVR-R higher than the standard value, CVR-R values and the ratio of LC had a tendency decrease ( $p<0.08$ ), and WBC decreased significantly ( $p<0.05$ )(Table 3)

### Discussion

We investigated the changes of peripheral circulation by the SSP therapy among workers exposed to hand-arm vibration using the SDPTG parameters as indices. The SDPTG-index and -b/a increased after the application of SSP therapy. These results suggest that the peripheral circulation is improved by the therapy and therefore the therapy may be effective for the vibration-induced peripheral circulatory impairment. This finding is concordance with a previous report (Imai et al. 1994).

**Table 3** Changes in measurements before and after the SSP therapy in the low and high CVR-R groups

	Low group (n=8)		High group (n=14)	
	Before	After	Before	After
SDPTG-index	0.28±0.35	0.37±0.31 <sup>†</sup>	0.37±0.26	0.42±0.30
-b/a	0.64±0.15	0.66±0.14	0.70±0.15	0.75±0.18
c/a	-0.05±0.14	0.02±0.09 <sup>†</sup>	-0.01±0.10	-0.01±0.13
d/a	-0.29±0.22	-0.32±0.16	-0.32±0.13	-0.32±0.13
HR (beats/min)	63.6±8.3	2.1±7.4 <sup>†</sup>	59.2±8.3	58.4±9.4
CVR-R (%)	2.55±0.45	2.50± 0.71	4.68±1.52	3.87±1.55 <sup>†</sup>
WBC (/mm <sup>3</sup> )	4.5±1.5	4.5±1.5	4.8±0.9	4.6±1.0*
Granulocyte (%)	52.2±9.3	53.1±9.1	59.3±11.2	59.7±10.7
Lymphocyte (%)	41.3±9.2	40.2±8.3	34.2±10.7	33.4±10.2 <sup>†</sup>

\*;  $p<0.05$ , <sup>†</sup>;  $p<0.08$  (Mean±SD)

It has been shown that the CVR-R values change by reflecting the activity of parasympathetic nervous function. Since the measurement of CVR-R can evaluate the autonomic nervous function without affecting the heart rate, the method has been commonly used in clinical research. In this study,

the CVR-R values did not change significantly as the result of the therapy. The average CVR-R values (3.9%) in the study subjects measured before application of the therapy was higher than the expected (3.1%). Furthermore, Kobayashi et al. reported that the average CVR-R values in the patients with hand-arm vibration syndrome were 2.2% (Kobayashi et al. 1987). Based on these findings, the parasympathetic nervous function of the present subjects is considered to be relatively high and therefore the SSP therapy does not act effectively peripheral circulation in the subgroups with enhanced parasympathetic nervous function.



The reason is unclear for the decrease of WBC beyond the analytical error of 3%, but it is possible that this response of WBC is the specific induced by the SSP therapy. According to Abo's theory (Abo 1998), decrease of the LC after the SSP therapy implies the low activity of the parasympathetic nervous function. Our findings differ from the assumption that the SSP therapy inhibits the activity of the sympathetic nerve function. However the response of LC also indicated that the therapy normalized against the high activity of the parasympathetic nervous function.

In the low-value group, the SDPTG parameters increased significantly and the heart rate decreased significantly. It is suggested that the peripheral circulation had tendency to be improved by the SSP therapy, and this response seems to be result from the enhancement of parasympathetic nervous function. On the other side, in the high-value group, the CVR-R values and LC had tendency to decrease, and the SDPTG parameters did not change significantly after the therapy. These results lead to the possibility that the SSP therapy suppress the parasympathetic nervous function without affecting the peripheral circulatory function.

In conclusion, the SSP therapy improved the peripheral circulation among workers with have some symptoms relating hand-arm vibration exposure, and it was supposed that the mechanism of improvement related with the autonomic nervous function.

#### References

- Abo T. 1998. Relationship of leukocytes by the autonomic nervous system –New rule on the cooperation of neuro-endocrine-immune system. *Biotherapy*; 12(5): 557-563(in Japanese).
- Fujimoto J, Hirota A, Hata M et al. 1987. Normal Reference Values and Prediction Evaluations of Autonomic Nerve Functions Based on Variations in the R-R Interval in Electrocardiographs. *Journal of the Japan Diabetes Society*; 30(2): 167-173(in Japanese).
- Hyodo M. *Clinical SSP therapy*. 1993. The society of SSP therapy, Tokyo: 9-11 (in Japanese).
- Imai K, Watsuji T, Ishihara K et al. 1994. Silver Spike Points (SSP) therapy and medical treatment in a patient with vibration syndrome. *The Bulletin of Meiji University of Oriental Medicine*; 14: 13-19 (in Japanese)
- Kageyama S, Mochio S, Abe M. 1978. A proposal of quantitative autonomic function test. A non-invasive technique using coefficient of variation of R-R interval in ECG. *Neurological Medicine*; 9, 594-596 (in Japanese)
- Kobayashi F, Watanabe T et al. 1987. Evaluation of autonomic nervous activity in patients with vibration disease using electrocardiographic R-R interval variations. *Industrial Health*; 25; 83-87.
- Sakaguchi S, Miyashita K. 2001. The effects of silver spike point therapy on peripheral circulatory function in workers exposed to hand-arm vibration. *The journal of Japanese association of physical medicine balneology and climatology*; 64(2): 77-86 (in Japanese).
- Sano Y, Kataoka S, Ikuyama M et al. 1985. The assessment and application of peripheral circulation by acceleration plethysmography. *The Labor Science*; 3(3): 129-143 (in Japanese).
- Takazawa K, Ibukiyama T. 1989. The useful for second derivative of photoplethysmogram. *Clinical Inspection*; 33: 856-862 (in Japanese).
- The association of oriental therapy. 1992. The acupoints and meridians, Ido-no-nihonsha, Tokyo (in Japanese).



# EFFECTS OF COLD-STRESS TEST USING DIFFERENT COVERING METHODS ON HEART RATE VARIABILITY IN HEALTHY SUBJECTS

M Inoue, K Suizu, M Yoshimura, S Shirono, H Morita, H Kan, S Yamamoto, N Harada

Department of Hygiene, Yamaguchi University School of Medicine  
1-1-1, Minamikogushi, Ube-City, 755-8505, Japan

## Abstract

This study aims to compare autonomic nervous activity observed during cold-stress test using different hand covering methods during water immersion as follows; polyethylene gloves, natural rubber gloves, and bare hands. Six normal healthy male students volunteered to participate in the test through which electrocardiogram was recorded. After recording baseline data for 5 min, subjects were to put on specified gloves or nothing according to the protocol and immersed both hands into stirred water at 12 °C for 5 min. The subjects removed their hands from the water to discard the gloves and kept at rest for 20 min of recovery thereafter. Then, heart rate variability was analyzed as autonomic nervous system indexes for each 5 min during pre-immersion, hand immersion, and recovery time. Significant differences in high frequency (0.15-0.40 Hz) component power were found in case of bare hands and natural rubber glove use ( $p < 0.05$ , respectively). Low frequency (0.04-0.15 Hz) to high frequency component power ratio was changed significantly only in case of bare hands ( $p < 0.05$ ). Our results support that covering methods during hand immersion influenced heart rate variability in healthy subjects and indicated that hand immersion into cold water may influence both sympathetic and parasympathetic nervous activity.

## Introduction

Disturbance of peripheral vascular circulation is one of the most important characteristics observed in patients with hand-arm vibration syndrome (HAVS) and vibration-induced white finger is the most distinctive symptom in HAVS patients when exposed to cold environment. In Japan, workers with occupational vibration exposure are obligated to undergo annual health examination twice a year, and workers suspected for HAVS should be examined by cold-stress test of hand immersion into cold water as a more detail examination.

This test is performed to evaluate peripheral vascular function using the value of finger skin temperature and has been applied in clinical diagnosis and epidemiology studies of HAVS. Some problems on this test have been under discussion; water temperature and hand immersion time (Harada et al, 1999), effect of evaporating after removing from the water on finger skin temperature (Lindsell et al, 2001; Suizu et al, 2004), and subject suffering during cold water immersion (Suizu et al, 2004). Water temperature and hand immersion time varied among countries and researchers 0-15°C and 0.5-20 min, respectively (Harada et al, 1999). Waterproof gloves are available to prevent evaporation and hand pain during water immersion, but different effects are observed by different types of gloves (Suizu et al, 2004). Therefore, the method is to be standardized for the assessment of peripheral vascular function in HAVS and is currently under review within the International Organization for Standardization (ISO) (ISO/DIS 14835-1, 2004). In the ISO discussion of finger skin temperature measurement, it has been proposed that an examinee should put on a glove on hand during water immersion, stating the following: "The use of water proof covering during immersion will prevent cooling of the hands after removal from the water due to evaporation" (ISO/DIS 14835-1, 2004).

We have previously reported the influence of waterproof covering on finger skin temperature and hand pain, and proposed polyethylene glove use during water immersion (Suizu et al, 2004). The response of peripheral vessels during cold-stress test may not be dependent of single mechanism since several studies on vibration-induced white finger have shown that local changes in vessels and autonomic nervous system were associated with the onset (Harada, 1994; Nakamoto, 1990). It has been demonstrated that hyperactivity of the sympathetic nervous system was contributed to the severity of vibration-induced white finger (Harada, 1994). A significant increase in plasma norepinephrine during cold exposure was found in vibration-induced white finger patients when compared with control subjects (Nakamoto, 1990). Then autonomic nervous system activity during cold-stress test should also be considered to evaluate waterproof covering effect. Several previous studies have shown the effect of cold-stress test on the autonomic nervous system using heart rate variability and reported a higher response of sympathetic nerve activity to water immersion in patients with HAVS than healthy controls (Sakakibara, 2002; Takahashi, 2002). However, there is little information on the effect of waterproof covering on the autonomic nervous system. In our previous study on the effect of waterproof covering on finger skin temperature, we recorded electrocardiogram (ECG) in digital audio tape. In this study, we analyzed heart rate variability of healthy male students to investigate autonomic nervous activity during cold-stress test using different covering methods.

## Subjects and methods

Six healthy volunteer male students, without any history of hypertensive disease, with leisure-time physical activity in a club, and right-handed, participated in this study. Written informed consent was obtained from all participants. Their mean characteristics were  $21.3 \pm 1.0$  years in age and  $21.0 \pm 1.9$  in body mass index.

This examination was performed in accordance with the measurement procedure recommended in the document of ISO working group (ISO/DIS 14835-1, 2004). Three days in October and November were selected for the experiment to avoid warm or cold season. All the subjects were requested to put on two items of clothing for upper and lower body, respectively, together with socks, and to avoid smoking, use of other drug stimulants from 3 h and alcohol drinking from 12 h prior to examination. The examination was conducted between 10:00 and 17:00, of which time 1 h before and 4 h after eating was avoided. The experimental room temperature was controlled at  $21.0 \pm 1.0$  °C. In the room, the subjects stayed for 30 min prior to examination in a seated and relaxed posture without physiological or psychological stress. Each subject was planned to undertake only one examination in a day, so the examinations with other methods were performed in the other days. The time to be examined for each subject was the same in all three days. All the subjects were randomly assigned to the three methods.

In this study, we examined the effect of different covering methods during hand immersion on heart rate variability as follows; use of natural rubber gloves (SD glove, Sanko, Japan), use of polyethylene gloves (Saniment gloves, Iuchi, Japan), and bare hands. Both kinds of gloves were of L size. Surface ECG was recorded continuously for all subjects and kept in a digitized form with digital audio tape. After ensuring stable ECG signals, baseline values were recorded for 5 min. Then, after putting on waterproof covering, subjects immersed both hands to the level of the wrist into stirred water controlled at 12 °C for 5 min. After 5-min immersion, both hands were removed from the water bath, and immediately the gloves were removed; water drops on the hands were carefully wiped off with a soft towel in case of bare hands. ECG signals were also continuously stored for 5 min during immersion and for 30 min of recovery thereafter.

ECG signals obtained during the cold-stress test were processed with BIMUTAS II (Kissei Comtec Co., Japan), biological signal analyzing software, to analyze the power spectra of R-R intervals. The data were restored into a microcomputer with an A/D converter at a sampling frequency of 1000 Hz, and R-R intervals were translated to amplitude using spline interpolation. Then Fourier transformation using 256-point time series of continuous successive R-R intervals was done. Two components of the power spectra of R-R intervals were extracted, low frequency component (LF: 0.04-0.15 Hz) and high frequency component (HF: 0.15-0.40 Hz). While HF component power is related to parasympathetic signal purely, LF component power reflects sympathetic and parasympathetic modulation and is influenced by baroreflex activity. Therefore, the ratio of the LF to the HF component power (LF/HF ratio) was calculated and was used as an indicator of sympatho-vagal balance.

Baseline values of the ECG data were analyzed for 5 min, which excluded one minute before hand immersion into water bath. During immersion for 5 min, 256-point time series of R-R intervals were analyzed. The recovery-time data were analyzed in four consecutive 5-min series with the first series after removing the covering or wiping off drops on the hands (Recovery 1-4).

Data of heart rate variability were analyzed using two-way analysis of variance with repeated measures (time and subject effect) in each method and were compared using a multiple comparison test among the six consecutive series of 5-min R-R intervals. These statistical analyses were performed with commercial statistical soft program for Windows on a personal computer. A p-value of less than 0.05 was chosen for statistical significance.

## Results

Table 1 presents LF component power changes during the cold-stress test with or without covering in three kinds of methods. No significant change was found in any methods through the total experiment while the values tended to increase during hand immersion from the baseline values. Table 2 shows HF component power changes in the three different methods. A significant change was found in the experiment without covering and in the experiment using natural rubber gloves ( $p < 0.05$ , respectively). Multiple comparison test have shown a higher value during hand immersion into cold water than baseline value both in the experiment without covering and in the experiment using natural rubber gloves ( $p < 0.01$ , respectively). Although HF component power during hand immersion increased, there was no difference through the total changes of HF component power in the experiment using polyethylene gloves. Table 3 shows LF/HF changes in the three patterns of experiments. A significant change in LF/HF was found only in the experiment without covering ( $p < 0.05$ ). Multiple comparison test have shown a lower value during hand immersion into cold water than baseline value in the experiment without covering ( $p < 0.05$ ). There was a tendency in the recovery time of all experiments that the changed-values by hand immersion recovered up to their baseline values, respectively.

**Table 1** LF component power changes during the cold-stress test in the three different methods

	LF (ms <sup>2</sup> )						p
	Pre	Immersion	Recovery 1	Recovery 2	Recovery 3	Recovery 4	
Bare hands	50962.0	80329.9	44453.5	53793.3	52683.1	38755.5	0.26
	29844.0	76045.0	32893.4	33920.4	35515.6	23798.3	
Polyethylene gloves	42449.4	50653.3	61718.8	79975.5	47596.9	46827.6	0.24
	13840.7	33569.0	57565.1	67562.3	26485.4	16614.2	
Natural rubber gloves	37410.3	35846.8	44206.7	40791.1	55954.3	42772.3	0.54
	7962.5	15315.2	28024.8	10379.8	24160.1	20525.3	

Upper and lower values of each factor show means and standard deviation, respectively

**Table 2** HF component power changes during the cold-stress test in the three different methods

	HF (ms <sup>2</sup> )						p
	Pre	Immersion	Recovery 1	Recovery 2	Recovery 3	Recovery 4	
Bare hands	12959.9	27386.1	15615.3	11801.5	14423.9	15367.9	0.02
	6518.2	20945.3	10147.8	6861.3	11648.0	14058.1	
Polyethylene gloves	15470.7	37049.4	19919.3	19860.8	23137.4	18785.0	0.09
	11023.4	38669.0	9949.9	11593.9	17071.8	16100.2	
Natural rubber gloves	12882.4	27786.2	16998.2	14135.7	15794.2	13619.4	0.02
	3816.6	16021.6	7373.3	5695.2	6344.0	3624.3	

Upper and lower values of each factor show means and standard deviation, respectively

**Table 3** LF/HF changes during the cold-stress test in the three different methods

	LF/HF						p
	Pre	Immersion	Recovery 1	Recovery 2	Recovery 3	Recovery 4	
Bare hands	4.2	3.1	3.1	4.7	4.1	3.2	0.02
	1.3	1.4	1.1	2.4	1.4	1.5	
Polyethylene gloves	3.6	2.3	2.9	3.9	2.5	3.5	0.29
	1.9	1.4	1.2	1.7	1.2	1.8	
Natural rubber gloves	3.1	1.5	3.8	3.7	4.4	3.6	0.33
	1.1	0.7	4.2	2.7	3.5	2.7	

Upper and lower values of each factor show means and standard deviation, respectively

### Discussion

In this study, different effects on heart rate variability were shown according to the covering methods indicating that hand covering diminished the effects on heart rate variability during hand immersion into cold water. The method of hand immersion into cold water is performed to have a decrease in finger skin temperature in order to evaluate abnormality of peripheral circulation in fingers exposed to vibration. To achieve that, the method is used widely in many countries and reports on the test condition including items of waterproof covering have been reviewed to standardize the cold-stress test within the ISO (Harada, 2002; ISO/DIS 14835-1, 2004). However, few reports concerned an effect of covering on heart rate variability during water immersion are found and we considered that our present study could provide suggestive data to develop discussion on which type of covering is better to use.

The HF power increased and LF/HF decreased during bare hand immersion into cold water in the present study. In the experiment using natural rubber gloves, there was a significant change in HF only, but not LF/HF, and no significant change in both HF and LF/HF was found in the experiment using polyethylene gloves. These results indicate that the use of waterproof covering influenced heart rate variability during cold-stress test and that polyethylene gloves may diminish the effects of hand immersion into the cold water on heart rate variability.

We have previously reported the effects of waterproof covering on finger skin temperature, indicating that the use of polyethylene gloves during water immersion is proper for cold-stress test comparing with natural rubber gloves and bare hands (Inoue et al, 2002). In the study, although natural rubber glove use suppressed not only hand pain during immersion but also finger skin temperature decrease, the use of polyethylene gloves showed the similar finger skin temperature as bare hands but with decreased hand pain. Considering our results, the polyethylene glove method may be proper for cold-stress test with water immersion for the following reasons; firstly finger skin temperature decreases to evaluate peripheral circulation (Inoue et al, 2002), secondly subject suffering is reduced (Inoue et al, 2002), thirdly the effect on heart rate variability is diminished in this study. Since most of workers exposed to occupational vibration for a long time are elderly, the third reason, particularly, is important for an examinee with hypertension or cardiovascular disease.

Several studies were investigated regarding heart rate variability during cold water immersion of bare hands in healthy subjects although different methods were applied according to the study. In a study of one hand immersion into water of 10 °C for 10 min, an increase in both LF and HF power was shown during hand immersion but not significant, LH/HF also did not change significantly (Sakakibara et al, 2002). A study performed in 14 healthy subjects using water of 10 °C for 10 min and of 15 °C for 3 min showed no significant change in LF%, HF%, and LF/HF (Takahashi, 2002). Our results of LF/HF during bare hand immersion decreased significantly and were not consistent with the previous findings. In accordance with a decrease of LF/HF, however, LF tended to increase and HF increased significantly in our results. We consider that these changes were reflected by an increase in sympathetic nervous activity which was followed by an increase in parasympathetic nervous activity. This may be a reflex mechanism of parasympathetic nervous system. Sakakibara et al reported that the HF power increased during hand immersion in healthy subjects, but not significant (Sakakibara et al, 2002). Nakamoto found a decrease in plasma norepinephrine halfway during one hand immersion into cold water (Nakamoto, 1990).

How could we explain the LF/HF decrease during hand immersion in our study? The LF/HF obtained in other studies did not change significantly (Sakakibara et al; 2002, Takahashi, 2002). Age factor may be contributed to the difference in LF/HF changes. While the healthy subjects in our study were young, the subjects in the previous studies aged 50 or 60 years old (Sakakibara et al, 2002; Takahashi, 2002). A significant difference in HF component power was found among age groups, demonstrating higher power of HF component in subjects aged 28-40 years compared with those aged 41-58 years (Heinonen et al, 1987). Parasympathetic nerve may be activated more in younger subjects than in older subjects. Another considerable factor is number of hands immersed into cold water. While the subject immersed their both hands in our study, only one hand was immersed into cold water in the previous studies. More precise examination is needed in order to clarify the association between hand immersion into cold water and heart rate variability.

In conclusion, the present study demonstrated that the use of waterproof covering delayed LF/HF decrease and that the HF component power during hand immersion into cold water increased which is suggestive for that polyethylene glove method is proper to perform cold-stress test. The different kinds of covering methods during hand immersion have influenced heart rate variability in healthy subjects. It has also been suggested from our present results that hand immersion into cold water influence both sympathetic and parasympathetic nervous activity. The mechanism is not clear and should be clarified because autonomic nervous system influences may contribute to finger skin temperature changes during cold-stress test.

## References

- Harada, N. 1994. Autonomic nervous function of hand-arm vibration syndrome patients. *Nagoya Journal of Medical Science*, vol 57, pp 77-85.
- Harada, N., Yoshimura, M. and Laskar, M.S. 1999. A minireview of studies conducted in Japan using finger-skin temperature during cold-stress tests for the diagnosis of hand-arm vibration syndrome. *International Archives of Occupational Environmental Health*, vol 72, pp 330-334.
- Harada, N. 2002. Cold-stress tests involving finger skin temperature measurement for evaluation of vascular disorders in hand-arm vibration syndrome: review of the literature. *International Archives of Occupational Environmental Health*, vol 75, 14-19.

- Heinonen, E., Färkkilä, M., Forsström, J., Antila, K., Jalonen, J., Korhonen, O. and Pyykkö, I. 1987. Autonomic neuropathy and vibration exposure in forestry workers. *British Journal of Industrial Medicine*, vol 44, pp 412-416.
- Inoue, M., Suizu, K., Nakamoto, M., Yokoyama, K., Laskar, M.S., Iwamoto, M., Shirono, S., Takahashi, S., Morita, H., Inagaki, J., Kan, H. and Harada, N. 2002. Effects of hand covering at immersion on finger skin temperature during cold-stress test for hand-arm vibration syndrome. *Proceedings of 10th Japan Group Meeting Human Response to Vibration*, pp 101-107.
- ISO/DIS 14835-1. 2004. Mechanical vibration and shock- Cold provocation tests for the assessment of peripheral vascular function- Part 1: Measurement and evaluation of finger skin temperature.
- Lindsell, C.J. and Griffin, M.J. 2001. Interpretation of the finger skin temperature response to cold provocation. *International Archives of Occupational Environmental Health*, vol 74, pp 325-335.
- Nakamoto, M. 1990. Responses of sympathetic nervous system to cold exposure in vibration syndrome subjects and age-matched healthy controls. *International Archives of Occupational Health*, vol 62, pp 177-181.
- Sakakibara, H., Luo, J., Zhu, S., Hirata, M. and Abe, M. 2002. Autonomic nervous activity during hand immersion in cold water in patients with vibration-induced white finger. *Industrial Health*, vol 40, pp 254-259.
- Suizu, K., Inoue, M., Fujimura, T., Morita, H., Inagaki, J., Kan, H. and Harada, N. 2004. Influence of waterproof covering on finger skin temperature and hand pain during immersion test for diagnosing hand-arm vibration syndrome. *Industrial Health*, vol 42, pp 79-82.
- Takahashi, S. 2002. Heart rate variability during cold water immersion test in patients with hand-arm vibration syndrome. *The Bulletin of the Yamaguchi Medical School*, vol 49, pp 7-14.





# IMPAIRED MANIPULATIVE DEXTERITY AND HAND FUNCTIONAL DIFFICULTIES IN PATIENTS WITH HAND-ARM VIBRATION SYNDROME

H. Sakakibara<sup>1</sup>, H. Mamoru<sup>2</sup>, N. Toibana<sup>3</sup>

<sup>1</sup> Nagoya University School of Health Sciences, Nagoya, Japan

<sup>2</sup> National Institute of Industrial Health, Kawasaki, Japan

<sup>3</sup> Tokushima Kensei Hospital, Tokushima, Japan

## Introduction

Neuromuscular impairments in hand-arm vibration syndrome (HAVS) include numbness and/or tingling of the fingers, damaged cutaneous perception and impaired manipulative dexterity, which can be associated with interfered social and work-related activities of vibration-exposed workers. The authors have quantitatively shown impaired manipulation in HAVS patients by measuring the performance time of the buttoning-unbuttoning task and the bean transfer task (Toibana et. al, 2002). In the present study, we further examined an association between hand functional difficulties in daily life and manipulative dexterity.

## Methods

The subjects were 29 patients with HAVS under treatment and 30 controls. The mean (SD) age was 59.7 (4.4) years and 58.5 (4.6) years, respectively. According to the Stockholm Workshop scales, HAVS patients were classified into 19 in 0SW, 3 in 1SW and 7 in 2SW; 3 in 1SN, 9 in 2 SN and 17 in 3SN. The controls had no white finger and finger numbness or tingling.

The subjects were questioned about hand functional difficulties in daily life: fastening buttons, picking coins, writing with a pen, dropping things, etc.

Performance for 30 seconds in Purdue Pegboard test (Model 32020, Lafayette Instrument Co., USA) was measured on subject's dominant hand. The three trials were averaged. Vibrotactile perception thresholds at 125 Hz on the index finger were also measured with a vibrometer (AU-02B, Rion, Japan). The 0dB was set at  $0.218\text{m/s}^2$  for 125Hz.

The room temperature was between 23 °C and 27 °C. Index finger temperature of all subjects was over 30 °C, and the mean (SD) was 32.4 (1.0) for patients and 31.7 (1.4) for controls.

## Results

As shown in Table 1, Purdue pegboard scores were significantly lower in the HAVS patients than the controls ( $p < 0.001$ ), while the number (%) of low performance (scores  $\leq 12$ ) was significantly higher in the HAVS patients ( $p < 0.001$ ). With increasing vibrotactile threshold in the HAVS patients, the mean scores tended to decrease ( $r = -0.378$ ,  $p < 0.05$ ), and the number of low performance increased.

Table 2 showed that HAVS patients with low scores  $\leq 10$  had the relatively high prevalence of hand functional difficulties. As Purdue pegboard scores were lower, hand difficulties among the HAVS patients tended to increase. Especially, using chopsticks ( $p < 0.05$ ), picking up coins ( $p < 0.05$ ), fastening buttons ( $p < 0.05$ ), turning door knobs ( $p < 0.05$ ), pouring from a teapot ( $p < 0.01$ ), and turning the page of newspaper ( $p < 0.01$ ).

## Conclusion

HAVS patients were likely to make low performance in Purdue pegboard test on dominant hand. The performance scores were significantly associated with increasing vibrotactile perception thresholds, and also some hand functional difficulties.

## References

Toibana N, Ishikawa N, Sakakibara H. 2002. Measurement of manipulative dexterity in patients with hand-arm vibration syndrome. *International Archives of Occupational and Environmental Health*, vol 75, pp 106-110.

**Table 1** Purdue pegboard scores on subject's dominant hand

		<b>Mean scores of Purdue pegboard</b>	<b>Number (%) of low performance ( scores ≤ 12)</b>
Controls	(n=30)	14.7 ± 1.6	2 ( 6.7%)
HAVS patients	(n=29)	11.0 ± 2.6 ***	20 (69.0%) ***
Vibrotactile threshold at 125Hz of HAV patients			
7.5 dB	(n= 3)	12.8 ± 2.0	1 (33.3%)
10 dB	(n=12)	11.3 ± 2.4 ***	8 (66.7%) ***
20 dB	(n=14)	10.4 ± 2.7 ***	11 (78.6%) ***

\*\*\* p<0.001, compared with the Controls by Dunnett's t-test or Fisher's Exact test

**Table 2** Hand functional difficulties among HAVS patients by Purdue pegboard scores

<b>Purdue pegboard scores</b>	<b>&gt; 12 (n=9)0%</b>	<b>&gt;10 (n=9)</b>	<b>10 &gt; (n=11)</b>	<b>trend p</b>
Using chopsticks	3 (33%)	3 (33%)	8 (73%)	0.045
Writing with a pen	5 (56%)	6 (67%)	9 (82%)	0.226
Picking up coins	5 (56%)	8 (89%)	11 (100%)	0.033
Fastening buttons	5 (56%)	8 (89%)	11 (100%)	0.033
Turning door knobs	1(11%)	1 (11%)	5 (46%)	0.041
Opening a jar lid	5 (56%)	8 (89%)	9 (82%)	0.420
Putting on a jacket	2 (22%)	1 (11%)	3 (27%)	0.561
Pouring from a teapot	2 (22%)	5 (56%)	10 (91%)	0.004
Turning the page of newspaper	3 (33%)	5 (56%)	11 (100%)	0.002
Dropping things	2 (22%)	3 (33%)	4 (36%)	0.607

# IS THERE A RELATION BETWEEN EXPOSURE TO HAND-ARM VIBRATION AND MYOCARDIAL INFARCTION?

B. Olofsson<sup>1</sup>, L. Burström<sup>2</sup>, T. Nilsson<sup>3</sup>, C. Reuterwall<sup>4</sup>

<sup>1</sup> Occupational Medicine, Department of Public Health and Clinical Medicine, Umeå, Sweden

<sup>2</sup> National Institute for Working Life, Department of Work and Physical Environment, Umeå, Sweden

<sup>3</sup> Department of Occupational and Environmental Medicine, Sundsvall, Sweden

<sup>4</sup> Research and Development Unit, Jämtlands County Council, Östersund, Sweden

## Abstract

The main objective of this study was to assess the risk of contracting Myocardial Infarction subsequent to vibration exposure. A second aim was to assess a possible exposure-response relationship. A population-based case-control study of risk factors for acute myocardial infarction was conducted. The Västernorrland heart epidemiology programme (VHEEP) was the source of the data and the study base comprised all Swedish citizens living in the county of Västernorrland, who were 45–65 years of age. Exposure information was collected via questionnaire and vibration exposure was assessed in 218 cases and 257 controls. Relative risks were estimated using odds ratios from binary logistic regression. The results showed that exposure to hand arm vibration increased the risk of acute myocardial infarction (OR<sub>overall</sub>: 1,57 95% CI: 1,05 to 2,36). It was not possible, however, to determine any exposure-response relationship.

## Introduction

Coronary artery disease is the name for diseases in the heart muscle, the myocardium. These diseases are caused by development of atherosclerotic plaques in the walls of arteries supplying the muscle cells with blood. These atherosclerotic plaques are initiated by one or more unknown factors that cause damage to the arterial wall and the injuries in the wall promote aggregation of substances, causing a partial obstruction in the artery. The obstruction leads to a reduced blood flow to the heart muscle, which in turn leads to ischemic heart disease. Ischemia is a condition of reduced blood flow, causing reduced oxygen supply to the heart muscle. The two main diagnoses of ischemic heart disease are angina pectoris and myocardial infarction, more known as a heart attack. With angina, the blood supply is reduced, which can weaken the muscle cells without killing them but when an infarction occurs, the artery is completely blocked, enabling the blood to reach all parts of the heart, which leads to death of part of the heart muscle.

Well known risk factors for developing coronary heart diseases are sustained high blood pressure, high blood cholesterol level, smoking, obesity and diabetes (Braunwald, 1992). These are all factors associated with genetic and lifestyle factors, but there are additional risk factors in the work environment that could either increase an already existing risk or constitute a risk by itself. Examples of chemical risk factors are exposure to carbon monoxide, carbon disulfide and particles and dust (Kristensen, 1989, Sjogren, 1997).

Epidemiological studies on vibration exposure in relation to risk factors for myocardial infarction (MI) have shown higher occurrence of hypertension amongst vibration exposed compared to unexposed controls (Idzior-Walus, 1987; Gobbato et al, 1981). Tamaian and Cocarla have shown a higher prevalence of ischemic heart disease for vibration exposed than for unexposed controls (Tamaian et al 1998). Studies addressing specifically the relationship between vibration exposure and myocardial infarction have not yet been published.

The aim of this study was to assess the risk of contracting acute myocardial infarction in relation to exposure to hand-arm transmitted vibrations and to assess if an exposure-response relationship is present.

## Materials and Method

The study base comprised all Swedish citizens living in the county of Västernorrland, who were 45–65 years of age during the period March 1993 to March 1995. A case-control study, Västernorrland heart epidemiology programme (VHEEP), was used, where cases were defined as all non-fatal and fatal first events of acute myocardial infarction (MI), first episode, and male and female controls were identified. Risk factors for myocardial infarction were studied and information on exposure and potential risk factors was collected by questionnaires.

A vibration exposure assessment was conducted on individual basis for both working- and leisure time separately and together. The assessment of exposure time was based upon self-stated, combined with expert made, estimations of daily exposure time at work and during leisure time combined with number of years at each occupation. The assessment of exposure magnitudes was based on reported type of vibration source and expert estimations based on earlier

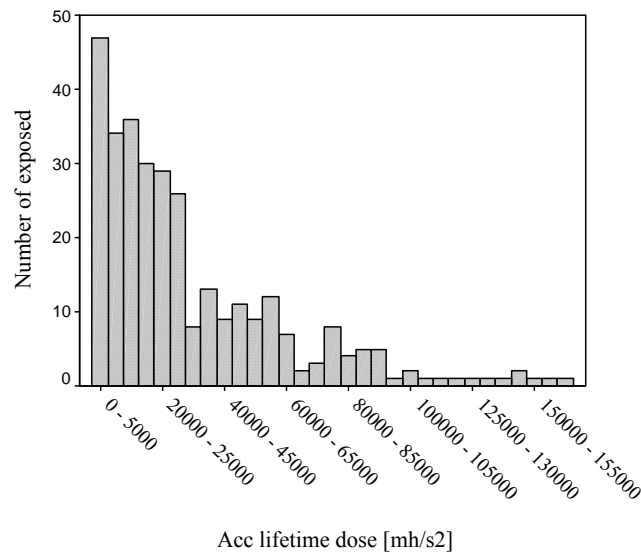
conducted measurements. The estimated vibration value used for statistical analyses was the accumulated vibration acceleration, stated in the SI-unit  $\text{mh/s}^2$ .

Only men with adequate exposure information and without insulin-treated diabetes type I were included in the statistical analysis. Estimates of relative risks were based on odds ratios from binary logistic regression. Adjustment were made for overweight, hypertension, smoking, diabetes (type II), exposure to whole body vibration, hospital catchment area and age. Estimations were first made for the exposure dicotomized into exposed/not exposed and then, in order to investigate a possible exposure-response relationship, for the exposure divided into three equally sized groups – low, intermediate and high exposure.

## Results

The results show that approximately 65 % of all the subjects ( $n=312$ ) had at some point in life been exposed to hand arm vibration, either during working time or during leisure time.

Figure 1 shows the distribution of accumulated lifetime dose (in  $\text{mh/s}^2$ ) of hand arm transmitted vibration among cases and controls combined. The exposure was divided in intervals of  $5000 \text{mh/s}^2$ . The upper limit for low exposure was about  $13000 \text{mh/s}^2$  and the upper limit for intermediate exposure was  $33000 \text{mh/s}^2$ . As seen in the figure, the distribution was fairly skewed.



**Figure 1** The exposure distribution among cases and controls combined. The exposure is expressed as accumulated lifetime dose ( $\text{mh/s}^2$ ) and is divided into intervals of  $5000 \text{mh/s}^2$

The results summarized in Table 1 show an overall increased risk of contracting myocardial infarction when exposed to hand arm vibration ( $\text{OR}=1,57$ ). The analysis when investigating an exposure-response relationship showed no trend in increased risk when more exposed. The exposure group with the lowest risk of contracting myocardial infarction was the high exposed ( $\text{OR}=1,38$ ), while the low and intermediate exposed groups had about the same risk ( $\text{OR}=1,66$  resp.  $1,69$ ).

## Discussion

The results show that working with vibrating machines is associated with an increased risk of acute myocardial infarction (MI). However, the results show no apparent exposure-response relationship. On the contrary, the group with the highest accumulated lifetime dose had the lowest risk of MI.

When interpreting the results one should take into account different aspects of potential confounders. Occupations associated with vibration exposure often implies exposure to other factors also connected to an increased risk of myocardial infarction, such as noise and inflammatory processes related to exposure to particles. The vibration-exposed subjects in this study are mainly blue-collar workers. Since blue-collar workers in general have a higher risk of contracting MI, the increased risk might be interpreted as an effect of social class. However, the individual risk factors (e.g. obesity, smoking) more common among this group are adjusted for, thereby reducing the risk of misinterpretation.

**Table 1** Crude and adjusted odds ratios for accumulated lifetime exposure to hand arm vibration divided into tertiles (HAV<sub>low</sub>, HAV<sub>medium</sub> and HAV<sub>high</sub>) and for vibration exposure regardless of exposure level (HAV<sub>overall</sub>)

	<i>OR<sub>crude</sub></i> (95% <i>CI</i> )	<i>N</i>		<i>OR<sub>adj</sub><sup>†</sup></i> (95% <i>CI</i> )	<i>N</i>	
		<i>Cases</i>	<i>Controls</i>		<i>Cases</i>	<i>Controls</i>
Non exposed		61	102		59	102
HAV <sub>low</sub>	1,91 (1,16 to 3,14)	56	49	1,66 (0,98 to 2,82)	51	49
HAV <sub>medium</sub>	1,70 (1,03 to 2,81)	52	51	1,69 (1,00 to 2,85)	52	51
HAV <sub>high</sub>	1,49 (0,90 to 2,45)	49	55	1,38 (0,82 to 2,34)	46	54
HAV <sub>overall</sub>	1,69 (1,15 to 2,49)	157	155	1,57 (1,05 to 2,36)	149	154

<sup>†</sup>OR<sub>adj</sub>: adjusted for overweight, hypertension, smoking, diabetes (type II), exposure to whole body vibration, hospital catchment area and age.

### Conclusion

Work with vibrating machines is associated with an increased risk for acute myocardial infarction.

### References

- Braunwald, E. e. (1992) *Heart Disease*, W. B. Saunders Company, Philadelphia.
- Kristensen, T. S. (1989) *Scand J Work Environ Health*, **15**, 245-64.
- Sjogren, B. (1997) *Occup Environ Med*, **54**, 466-9.
- Idzior-Walus, B. 1987. Coronary risk factors in men occupationally exposed to vibration and noise. *European Heart Journal*, vol 8, pp 1040-1046.
- Gobbato, F., Blasina, G., Crupi, A. and Patussi, V. 1981. May hand-arm vibration exposure be a hypertension-risk factor? (author's translation). *La Medicina del lavoro*, vol 72, pp 389-398.
- Tamaian, L-D., Cocarla, A. 1998. Occupational Exposure to Vibration and Ischemic Heart Disease. *Journal of Occupational Health* vol 40, pp 73-76.



## **Measure IV**

T. Bremmer - Session Coordinator





# **WORK COMPUTER FOR PREVENTION OF OVER EXPOSURE TO HAND-TRANSMITTED VIBRATION**

S. Maeda

Department of Human Engineering, National Institute of Industrial Health, Japan

## **Abstract**

A system (Work Computer) for evaluating the vibration exposure level and for informing the residual time for the health prevention (Hand-Arm Vibration Syndrome) according to the hand-transmitted vibration exposure to use the hand-held tools is proposed in this paper. This Work Computer composed of a hand adaptor accelerometer and battery powered electric indicator device or lap top computer. A tri-axial accelerometer is mounted to the hand adaptor according to the ISO 5349-1 standard. This Work Computer can show the exposure level, the elapsed time after using the hand-held vibration tools, the residual time until the work limit according to the vibration exposure health limit of ISO 5349-1 standard or EU Directive Vibration Action or Limit Values.

## **Introduction**

EU Directive, Physical Agent Directive (Vibration) was published in 2002. This Directive requires employers evaluate the hand-arm vibration daily exposure of the individual employee. In order to calculate the daily hand-arm vibration exposure, a calculator is preparing on the Web Site by HSE in UK. But, this calculator can't inform the vibration exposure and the permissible time to work during their works. Therefore, for preventing the vibration syndrome or for controlling the hand-arm vibration exposure dose, the development of a certain new equipment to inform the information of hand-arm vibration exposure to the employees or employers is needed.

A system (Work Computer) for evaluating the vibration exposure level and for informing the residual time for the health prevention (Hand-Arm Vibration Syndrome) is proposed in this paper. This Work Computer composed of a tri-axis accelerometer and a battery-powered electric device or lap top computer. The tri-axis accelerometer is mounted on the hand-adaptor according to the ISO 5349-2 standard. This Work Computer can show the exposure level, the elapsed time after using the hand-held tool, the residual time until the work limit according to the vibration exposure health limit of ISO 5349-1 standard or EU Directive vibration limits.

There are many instruments to measure the noise and vibration. These devices include Noise Meter, Infrasound Meter, Vibration Meter, Noise Dose Meter, Human Vibration Meter, and TTS meter. These instruments can only measure the exposure level or exposure magnitude. They do not inform the residual time for avoiding the vibration disease such as low back pain, hearing loss or vibration induced white finger to the workers during work. On the other hand, like the Dive Computer that can tell the decompression time for avoiding the decompression sickness during diving in underwater to the divers, the Work Computer can be used to prevent the over-dose of vibration exposure among workers using the hand-held tools.

This paper proposes the concept and system of Work Computer for the prevention of the hand-arm vibration syndrome.

## **Current measurement system**

There are many instruments to measure the vibration. Figure 1 shows the examples of these instruments.



**Figure 1** Examples of measurement instruments of vibration.

These instruments as shown in Figure 1 only inform the vibration level to the workers. In the next stage, the dose meters have been developed as show in Figure 2 to obtain the exposure dose to the workers.

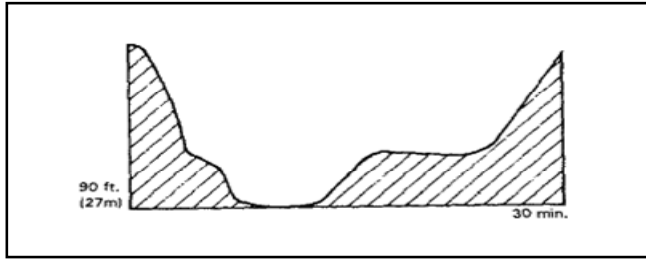
Although this Dose meter can calculate the vibration exposure dose to the workers during works, the workers can not obtain the residual time from the vibration exposure at the work places.



**Figure 2** Hand-arm transmitted vibration Dosimeter

### **Concept of Dive Computer**

In Figure 3, the bold line represents the actual dive profile, whereas the broken line represents the profile that must be looked up when using a decompression table in the conventional manner. The shaded area represents the time when less nitrogen should be absorbed than the tables assume has been absorbed. The ideal situation is to have a device that tracks the exact dive profile and then calculates the decompression requirement according to the actual dive done. Therefore, Dive Computer (Lippmann, J.,1990) has been developed to inform the decompression time to the divers as shown in Figure 4.



**Figure 3** A typical dive profile.



**Figure 4.** Examples of Dive Computers

### Concept of Work Computer

The ISO 5349-1 (2001) defines guidance for the assessment of hand-arm vibration with respect to health. It applies to people in normal health who are regularly exposed to vibration. It applies to rectilinear vibration along the x-, y- and z-basentric axes of the human hand. To characterize daily occupational vibration exposure, the 8 h frequency-weighted acceleration  $a_{w(8h)}$  can be measured or calculated according to the following formula with 8 h as the time period T.

$$a_{w(8h)} = a_{wrms} \times (T/28800) \tag{1}$$

where  $a_{w(8h)}$  is energy-equivalent acceleration related to 8 h daily reference exposure,  $a_{wrms}$  is root mean square frequency-weighted acceleration (ISO5349-1), T is daily vibration exposure duration. Also, ISO standard indicates health limits. Therefore, if workers can measure the root mean square frequency-weighted acceleration during works, they can calculate the residual work time to continue the work compared with the health limit value of the 8 h frequency-weighted acceleration of the ISO 5349-1 standard from Equation (1). So, if some instruments can measure the vibration exposure values between hand and hand-held tool handle, the workers can get or know the health guidance information from this instrument every moment. This is a concept of the Work Computer in this paper.



**Figure 5** Work Computer to lap top computer type.

This Work Computer is composed of a tri-axis accelerometer and lap top computer as shown in Figure 5.

A tri-axis accelerometer is mounted on the tool handle according to the ISO 5349-2 standard (2001). This Work Computer can show the exposure level, the elapsed time after starting to use the hand-held tools, the residual time until the work limit according to the vibration exposure health limit of ISO 5349-1 standard or EU Directive limit values. Table 1 shows the example of the calculation results of the Work Computer.

**Table 1** Example of the calculation results of the Work Computer.

Elapsed time (sec)	$a_{wrms}$ (ms-2 r.s.s.)	Residual time to continue the work (sec)
1	40	28544
2	40	28288
3	20	28224
4	40	27968
5	40	27712

### **Conclusions**

A system (Work Computer) for evaluating the vibration exposure level and for informing the residual time for the health prevention (Hand-arm vibration syndrome) according to the hand-transmitted vibration exposure to the workers from the hand-held tool vibration exposure was proposed in this paper.

### **Reference**

Health and Safety Commission, 2003. Proposals for new Control of Vibration at Work Regulations implementing the Physical Agents (Vibration) Directive (2002/44/EC) Hand-arm Vibration. Consultative Document CD190. HSE Books.

ISO 5349-1, 2001. Mechanical vibration and shock – Measurement and evaluation of human exposure to hand-transmitted vibration – Part 1: General requirements.

ISO 5349-2, 2001. Mechanical vibration and shock – Measurement and evaluation of human exposure to hand-transmitted vibration – Part 2: Practical guidance for measurement at the workplace.

Lippmann, J, 1990. Deeper into diving. J. L. Publications, Australia. ISBN 0 9590306 3 8.

# **HAND-ARM VIBRATION EXPOSURES FROM HYDRAULIC TOOLS USED IN U.S. RAILROAD MAINTENANCE-OF-WAY TRACK OPERATIONS**

D.E. Wasserman, J.F. Wasserman, L. Mullinix, D. Logsdon

Institute for the Study of Human Vibration, University of Tennessee  
Engineering School, Knoxville, Tenn. 37996, USA

## **Introduction**

Railroad 'maintenance-of-way' track operations are critical to the safety and integrity of all railroad rolling stock for both passenger and freight operations. In order to guarantee this integrity and safety, railroads must constantly scrutinize, examine, repair and/or replace worn out or damaged track and associated roadbeds. This requires the constant efforts of numerous road-crews nationwide who must perform their critical tasks on-site under virtually all climatic weather conditions. Most of these crews are regularly exposed to Hand-Arm Vibration [HAV] from a variety of specialized heavy-duty hydraulic powered hand-tools. Tool power is supplied via a single, large power supply located on a truck bed. This special truck operates normally on the open road, but also contains a retracted set of railroad wheels. In railroad mode, this truck is driven up to and straddles railroad track, the extra set of wheels is then lowered, comes into contact with the track, and the truck can be moved along track as needed. Maintenance-of-way road crews typically number 8-10 workers; there are several hundred such crews at work each day in railroad operations throughout the U.S. In addition to HAV tool exposures, some crew workers can also be exposed to Whole-Body Vibration from rail operated: track laying equipment, large spike tampers, and so-called 'ballast regulators' which shape and grade the crushed rock ballast forming the rail beds. Typical HAV tool daily exposures nominally is 4-5 hours/work-shift, 5 days/week, and depends on the condition of the track, track bed, climatic conditions, and the 'down time' needed to allow or divert rolling stock to proceed around the track repair sites. The purpose of this HAV study was to measure and evaluate triaxial acceleration exposures from typical maintenance-of-way railroad tools, all of which are hydraulically powered. A total of six different tool types were evaluated.

## **Railroad Power Tools Description**

TIE TAMPER is a 20-25lb. weight jack-hammer type tool, used with tamping attachments to compress small areas of crushed stone 'ballast' around the wood tie perimeter base.

SPIKE PULLER is a 15-20lb. weight tool, used to extract metal spikes from wood ties, which are fixed to rail base flanges at ground level.

SPIKE DRILL/DRIVER is a 20-25 lb. weight jack-hammer type tool, mostly used with rammer attachments to drive metal spikes into the wood tie base flanges at ground level.

RAIL SAW is a 10-15 lb. weight, special saw with a 12-18 in. diameter blade designed to cut metal rails. The designated cut is aligned, fixed, and made using a special metal fixture which straddles and clamps to a portion of track rail, exposing a small section of track rail to be cut. The power saw/ blade combination are attached to this fixture, with the blade positioned above, in line with the cut point over the exposed rail section. The operator turns on the power saw and then carefully brings the aligned/rotating saw blade gradually downward, precisely cutting the rail].

IMPACT WRENCH/BOLT TIGHTENER is a 20-25 lb. weight, classic heavy duty impact wrench/bolt tightener used to tighten connecting bolts between track sections.

TIE DRILL is a 8-10 lb. weight, industrial grade, hydraulically operated drill, using very long 12-18 in. drill bits, used to make holes in wood railroad ties.

## **Vibration Data Collection & Analysis**

In this study, triaxial HAV measurements and data processing were performed in accordance with the following standards: ANSI S3.34, ACGIH-TLV, ISO 5349. In particular, for each tool tested, PCB 356B11 triaxial accelerometers were used to collect HAV measurements from respective tool handles, close to where operator hand(s) grasp the tools, in accordance with basicentric coordinate system axial directions [ Z axis direction, motion parallel to the long bones of the hand-wrist-forearm; Y axis direction, motion moving across the knuckles; X axis direction, motion through the palm]. All tool measurements were obtained at an actual and typical railroad field site, while experienced railroad personnel operated each tool for a minimum of one full minute vibration performing actual work. All collected triaxial vibration tool data were DAT tape recorded [TEAC 135] on-site. Data processing was subsequently performed from these DAT

recordings; in particular, each vibration axis/tool was separately 1/3 octave Fourier spectrum analyzed using an IBM laptop PC with a Quik Vu ISA card interfaced to a DSP Siglab 2042 processor; a DELL workstation with MATLAB digital processing software were also used; for brevity and details, we have already described these data processing methods in other HAV tool studies and elsewhere (Wasserman et al, 2002; Wasserman, 1987).

Finally, ISO 5349 does not specify daily HAV exposures; ANSI S3.34 [1986] does graphically specify daily HAV exposures; the ACGIH HAV standard [1984-2004] does specify weighted numerical daily HAV exposures [4 m/sec/sec for 4 - 8 hrs/day; 6 m/sec/sec for 2- 4 hrs/day; 8 m/sec/sec for 1-2 hrs/day; 12 m/sec/sec for < 1 hr/day]. Note: 1g = 9.81 m/sec/sec

## Results

For the six different hydraulic railroad tools tested, the numerical weighted rms acceleration results, per axis are given next with corresponding HAV spectra Figs: 1-1 thru 1-27:

TIE TAMPER [10.76 m/sec/sec X; 4.92 m/sec/sec Y; 9.53 m/sec/sec Z; corresponding HAV spectra Figs. 1-1,2,3]

SPIKE PULLER [1.90 m/sec/sec X; 1.98 m/sec/sec Y; 2.03 m/sec/sec Z; corresponding HAV spectra Figs. 1-4,5,6]

SPIKE DRILL/DRIVER [17.86 m/sec/sec X; 3.96 m/sec/sec Y; 3.37 m/sec/sec Z; corresponding HAV spectra Figs. 1-7,8,9]

RAILSAW [6.17-10.00 m/sec/sec X; 4.64-4.67 m/sec/sec Y; 5.83-8.94 m/sec/sec Z; corresponding HAV spectra Figs. 1-10 thru 1-15]

IMPACT WRENCH/BOLT TIGHTNER [6.68-21.17 m/sec/sec X; 6.89-18.62 m/sec/sec Y; 4.28-17.75 m/sec/sec Z; corresponding HAV spectra Figs. 1-16 thru 1-21]

TIE DRILL [1.66-8.08 m/sec/sec X; 1.99-8.07 m/sec/sec Y; 4.25-5.25 m/sec/sec Z; corresponding HAV spectra Figs. 1-22 thru 1-27]

## Discussion & Conclusions

HAV data for each tool tested is summarized in relation to ANSI S3.34 and the ACGIH HAV standards in two tables/tool:

TIE TAMPER [refer to Tables Ia & b]: For daily HAV exposures using ANSI S3.34, Table Ia shows that this standard has been exceeded in the: X axis [1-2,2-4,4-8 hrs/day], Y axis [4-8 hrs/day], Z axis [1-2,2-4,4-8 hrs/day]. For daily HAV exposures using the ACGIH standard, Table Ib, shows that this standard has been exceeded in the : X axis [1-2, 2-4, 4-8 hrs/day], Y axis [4-8 hrs/day], Z axis [1-2,2-4,4-8 hrs/day]. CONCLUSION: The tested TIE TAMPER should be used for less than one hour/day.

SPIKE PULLER [refer to Tables IIa & b]: For daily HAV exposures using ANSI S3.34, Table IIa shows that this standard has NOT been exceeded in any of the three measurement axes. Similar results are shown in Table IIb for the ACGIH standard. CONCLUSION: The tested SPIKE PULLER can be used up to eight hours/day.

SPIKE DRILL/DRIVER [refer to Tables IIIa & b]: For daily HAV exposures using ANSI S3.34, Table IIIa shows that this standard has not been exceeded in either the Y or Z axes, but has been exceeded in the X axis [0.5-1, 1-2, 2-4, 4-8 hrs/day]. For daily HAV exposures using the ACGIH standard, Table III b, also shows that this standard has not been exceeded in either the Y or Z axes, but has been exceeded in the X axis [<1, 1-2,2-4,4-8 hrs/day]. CONCLUSION: The SPIKE DRILL/DRIVER tested should be used for less than 30 minutes/day.

RAIL SAW [refer to Tables IVa & b]: This rail saw must be operated using *both* hands located at two *different* positions/locations on the tool; at the tool top *and* a side handle. Thus for daily HAV exposures using ANSI S3.34, Table IVa shows that for the *side* handle position the standard has been exceeded in the: X axis [1-2, 2-4, 4-8 hrs/day], Y axis [4-8 hrs/day], Z axis [2-4, 4-8 hrs/day]. For the tool *top* position, this standard has been exceeded in the: X axis [2-4, 4-8 hrs/day], Y axis [4-8 hrs/day], Z axis [1-2, 2-4, 4-8 hrs/day]. For daily HAV exposures using the ACGIH standard, Table IV b shows for the *side* handle position, the standard has been exceeded in the: X axis [1-2, 2-4, 4-8 hrs/day], Y axis [4-8 hrs/day], Z axis [4-8 hrs/day]. For the tool *top* position, this standard has been exceeded in the: X axis [2-4, 4-8 hrs/day], Y axis [4-8 hrs/day], Z axis [1-2, 2-4, 4-8 hrs/day]. CONCLUSION: The tested RAIL SAW should be used less than one hour/day when grasping the top and/or side positions of this tool.

IMPACT WRENCH/BOLT TIGHTNER [refer to Tables Va & b]: This impact wrench/bolt tightner is heavy and physically demanding; it must be carefully steadied as it operated close to ground level as track sections are

precisely bolted together; thus it must be held with *both* hands near the tool front *and* at the rear handle. Thus for daily HAV exposures using ANSI S3.34, Table Va shows that for the *front* position this standard has been exceeded in the: Y axis [0.5-1, 1-2, 2-4, 4-8 hrs/day], Z axis [0.5-1, 1-2, 2-4, 4-8 hrs/day]. The X axis was not exceeded. For the *rear* handle tool position this standard has been exceeded in the: X axis [0.5-1, 1-2, 2-4, 4-8 hrs/day], Y axis [2-4, 4-8 hrs/day]. The Z axis was not exceeded. For daily HAV exposures using the ACGIH standard, Table V b shows for the *front* position the standard has been exceeded in all three axes: X axis [2-4, 4-8 hrs/day], Y [ $< 1$ , 1-2, 2-4, 4-8 hrs/day], Z [ $< 1$ , 1-2, 2-4, 4-8 hrs/day]. For the *rear* handle position, the standard has been exceeded in all three axes: X axis [ $< 1$ , 1-2, 2-4, 4-8 hrs/day], Y axis [2-4, 4-8 hrs/day], Z axis [4-8 hrs/day]. CONCLUSION: The tested IMPACT WRENCH/BOLT TIGHTNER should be used less than 30 minutes/day when grasping the front and/or rear positions of this tool.

TIE DRILL [refer to Tables VIa & b]: This special drill must be operated using both hands. The trigger handle is located at the top of the drill; a side handle is used to position and stabilize the drill since very long drill bits 12-18in. are used to drill holes in wooden railroad ties. Thus for daily HAV exposures using ANSI S3.34, Table VIa, shows at the *top* hand position this standard has been exceeded in the: X axis [2-4,4-8 hrs/day], Y axis [2-4, 4-8 hrs/day]. The Z axis has not been exceeded. For the *side* handle tool position this standard has not been exceeded in either of the three measurement axes. For daily HAV exposures using the ACGIH standard, Table VI b, shows for the *top* position this standard has been exceeded in all three axes: X [1-2, 2-4, 4-8 hrs/day], Y [1-2, 2-4, 4-8 hrs/day], Z [4-8 hrs/day]. For the *side* handle position, both the X and Y axes have not been exceeded, but the Z axis [4-8 hrs/day] has been exceeded. {Note: Since the ANSI S3.34 standard and the ACGIH standard, are very similar but *not* identical, thus it is customary to use the more conservative approach to evaluation of HAV data to minimize the risks of the tool operators being afflicted with Hand-Arm Vibration Syndrome [HAVS] (Pelmear & Wasserman, 1998)}. CONCLUSION: The tested TIE DRILL should be used less than one hour/day when grasping the tool in the *top* throttle position. Since both hands are needed to operate this tool, it is *not* possible to operate this tool only from the *side* handle position which *alone* would permit operation of this tool for up to four hours/day, thus the limiting factor on this tool's daily use is the top throttle position.

### Overall Study Conclusion

The overall results of this railroad maintenance-of-way hydraulic tool study indicates that one or more HAV standards have been exceeded, in one or more axes, depending on the tool type and daily usage. This hydraulic tool study adds to the HAV tool exposure data base, which here-to-fore has been mainly pneumatic, gasoline powered and electric tool data, thus showing that the use of these tools can also potentially pose risks of tool operators acquiring HAVS.

### References

- American Conference of Governmental Industrial Hygienists. 1984-2004. ACGIH-Threshold Limit Values for Physical Agents: Hand-Arm Vibration, Cincinnati, Ohio.
- American National Standards Institute. 1986. ANSI S3.34: Guide for the Measurement & Evaluation of Human Exposure to Vibration Transmitted to the Hand. New York, NY.
- International Standards Organization. 1986. ISO 5349: Guidelines for the Measurement & the Assessment of Human Exposure to Hand-Transmitted Vibration. Geneva, Switzerland.
- Pelmear P. and Wasserman D. 1998. Hand-Arm Vibration-A Comprehensive Guide for Occupational Health Professionals (2<sup>nd</sup> ed.). OEM Medical Publishers, Beverly Farms, MA.
- Wasserman D., Hudock S., Wasserman J., Mullinix L., Wurzelbacher S., and Siegfried K. 2002. Hand-arm vibration in a group of hand-operated grinding tools. Human Factors and Ergonomics in Manufacturing, Vol 12 (2), pp 211-226.
- Wasserman D. 1987. Human Aspects of Occupational Vibration. Elsevier Publishers, Amsterdam, The Netherlands.

TABLE Ia  
VIBRATING HAND-TOOL TESTING: RAILROAD/HYDRAULIC ‘TIE TAMPER’  
[Frequency range: 5.6-1400 Hz, see corresponding spectra]

Fig., ID#, Axis, Hand/position,	EXCEEDS ANSI S3.34:	0.5-1,	1-2,	2-4,	4-8 hrs./day
1-1, 0005, X, RH/Top, [Tool Working]		NO,	YES,	YES,	YES
1-2, 0005, Y, RH/Top, [Tool Working]		NO,	NO,	NO,	YES
1-3, 0005, Z, RH/Top, [Tool Working]		NO,	YES,	YES,	YES

TABLE Ib  
VIBRATING HAND-TOOL TESTING: RAILROAD/HYDRAULIC ‘TIE TAMPER’  
[Frequency range: 5.6-1400Hz, acceleration: (rms) m/sec/sec, Tool Working]

Fig., ID#, Axis, Hand/position,	Weighted (rms) accel.,	EXCEEDS:	ACGIH-TLV/HAV
1-1, 0005, X, RH/Top,	10.76	(1-2, 2-4, 4-8 hrs./day)	YES
1-2, 0005, Y, RH/Top,	4.92	(4-8 hrs/day)	YES
1-3, 0005, Z, RH/Top,	9.53	(1-2, 2-4, 4-8 hrs./day)	YES

TABLE IIa  
VIBRATING HAND-TOOL TESTING: RAILROAD/HYDRAULIC ‘SPIKE PULLER’  
[Frequency range: 5.6-1400 Hz, see corresponding spectra]

Fig., ID#, Axis, Hand/position,	EXCEEDS ANSI S3.34:	0.5-1,	1-2,	2-4,	4-8 hrs./day
1-4, 0006, X, RH/Top, [Tool Working]		NO,	NO,	NO,	NO
1-5, 0006, Y, RH/Top, [Tool Working]		NO,	NO,	NO,	NO
1-6, 0006, Z, RH/Top, [Tool Working]		NO,	NO,	NO,	NO

TABLE II b  
VIBRATING HAND-TOOL TESTING: RAILROAD/HYDRAULIC ‘SPIKE PULLER’  
[Frequency range: 5.6-1400 Hz, acceleration: (rms) m/sec/sec, Tool Working]

Fig., ID#, Axis, Hand/position,	Weighted (rms) accel.,	EXCEEDS:	ACGIH-TLV/HAV
1-4, 0006, X, RH/Top,	1.90	-----	NO
1-5, 0006, Y, RH/Top,	1.98	-----	NO
1-6, 0006, Z, RH/Top,	2.03	-----	NO



TABLE IIIa  
VIBRATING HAND-TOOL TESTING: RAILROAD/HYDRAULIC ‘SPIKE DRILL’  
[Frequency range: 5.6-1400 Hz, see corresponding spectra]

Fig., ID#, Axis, Hand/position, EXCEEDS ANI S3.34:	0.5-1,	1-2,	2-4,	4-8 hrs./day
1-7, 0007, X, RH/Top, [Tool Working]	YES,	YES,	YES,	YES
1-8, 0007, Y, RH/Top, [Tool Working]	NO,	NO,	NO,	NO
1-9, 0007, Z, RH/Top, [Tool Working]	NO,	NO,	NO,	NO

TABLE III b  
VIBRATING HAND-TOOL TESTING: RAILROAD/HYDRAULIC ‘SPIKE DRILL’  
[Frequency range: 5.6-1400 Hz, acceleration: (rms) m/sec/sec, Tool Working]

Fig., ID#, Axis, Hand/position, Weighted (rms) accel., EXCEEDS:	ACGIH-TLV/HAV		
1-7, 0007, X, RH/Top, 17.86	(<1, 1-2, 2-4, 4-8hrs/day) YES		
1-8, 0007, Y, RH/Top, 3.96	----- NO		
1-9, 0007, Z, RH/Top, 3.37	----- NO		

TABLE IV a  
VIBRATING HAND-TOOL TESTING: RAILROAD/HYDRAULIC ‘RAIL SAW’  
[Frequency range: 5.6-1400 Hz, see corresponding spectra]

Fig., ID#, Axis, Hand/position, EXCEEDS ANSI S3.34:	0.5-1,	1-2,	2-4,	4-8hrs./day
1-10, 0009, X, LH/Side, [Tool Working]	NO,	YES,	YES,	YES
1-11, 0009, Y, LH/Side, [Tool Working]	NO,	NO,	NO,	YES
1-12, 0009, Z, LH/Side, [Tool Working]	NO,	NO,	YES,	YES
-----				
1-13, 0009, X, RH/Top, [Tool Working]	NO,	NO,	YES,	YES
1-14, 0009, Y, RH/Top, [Tool Working]	NO,	NO,	NO,	YES
1-15, 0009, Z, RH/Top, [Tool Working]	NO,	YES,	YES,	YES

TABLE IV b  
VIBRATING HAND-TOOL TESTING: RAILROAD/HYDRAULIC ‘RAIL SAW’  
[Frequency range: 5.6-1400 Hz, acceleration: (rms) m/sec/sec, Tool Working]

Fig., ID#, Axis, Hand/position, Weighted (rms) accel., EXCEEDS:	ACGIH-TLV/HAV		
1-10, 0009, X, LH/Side, 10.00	(1-2, 2-4, 4-8hrs./day) YES		
1-11, 0009, Y, LH/Side, 4.64	(4-8hrs./day) YES		
1-12, 0009, Z, LH/Side, 5.83	(4-8hrs./day) YES		
-----			
1-13, 0009, X, RH/Top, 6.17	(2-4, 4-8hrs./day) YES		
1-14, 0009, Y, RH/Top, 4.67	(4-8hrs./day) YES		
1-15, 0009, Z, RH/Top, 8.94	(1-2, 2-4, 4-8hrs./day) YES		

TABLE V a  
VIBRATING HAND-TOOL TESTING: RAILROAD/HYDRAULIC ‘IMPACT WRENCH’  
[Frequency range: 5.6-1400 Hz, see corresponding spectra]

Fig., ID#, Axis, Hand/position, EXCEEDS ANSI S3.34:	0.5-1,	1-2,	2-4,	4-8hrs./day
1-16, 0010, X, LH/Front, [Tool Working]	NO,	NO,	NO,	NO
1-17, 0010, Y, LH/Front, [Tool Working]	YES,	YES,	YES,	YES
1-18, 0010, Z, LH/Front, [Tool Working]	YES,	YES,	YES,	YES
-----				
1-19, 0010, X, RH/Rear, [Tool Working]	YES,	YES,	YES,	YES
1-20, 0010, Y, RH/Rear, [Tool Working]	NO,	NO,	YES,	YES
1-21, 0010, Z, RH/Rear, [Tool Working]	NO,	NO,	NO,	NO

TABLE V b  
VIBRATING HAND-TOOL TESTING: RAILROAD/HYDRAULIC ‘IMPACT WRENCH’  
[Frequency range: 5.6-1400 Hz, acceleration: (rms)m/sec/sec, Tool Working]

Fig., ID#, Axis, Hand/position, Weighted (rms) accel., EXCEEDS:	ACGIH-TLV/HAV
1-16, 0010, X, LH/Front, 6.68	(2-4, 4-8hrs/day) YES
1-17, 0010, Y, LH/Front, 18.62	(<1, 1-2, 2-4, 4-8hrs/day) YES
1-18, 0010, Z, LH/Front, 17.75	(<1, 1-2, 2-4, 4-8hrs/day) YES
-----	
1-19, 0010, X, RH/Rear, 21.17	(<1, 1-2, 2-4, 4-8hrs/day) YES
1-20, 0010, Y, RH/Rear, 6.89	(2-4, 4-8hrs/day) YES
1-21, 0010, Z, RH/Rear, 4.28	(4-8hrs/day) YES

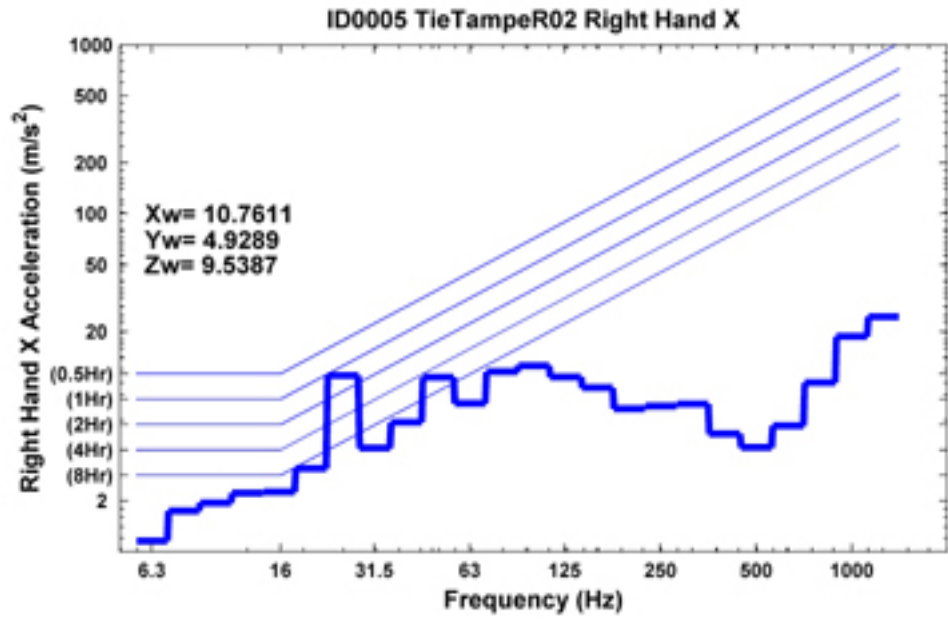
TABLE VI a  
VIBRATING HAND-TOOL TESTING: RAILROAD/HYDRAULIC ‘TIE DRILL’  
[Frequency range: 5.6-1400 Hz, see corresponding spectra]

Fig., ID#, Axis, Hand/position, EXCEEDS ANSI S3.34:	0.5-1,	1-2,	2-4,	4-8hrs/day
1-22, 0011, X, LH/Top, [Tool Working]	NO,	NO,	YES,	YES
1-23, 0011, Y, LH/Top, [Tool Working]	NO,	NO,	YES,	YES
1-24, 0011, Z, LH/Top, [Tool Working]	NO,	NO,	NO,	NO
-----				
1-25, 0011, X, RH/Side, [Tool Working]	NO,	NO,	NO,	NO
1-26, 0011, Y, RH/Side, [Tool Working]	NO,	NO,	NO,	NO
1-27, 0011, Z, RH/Side [Tool Working]	NO,	NO,	NO,	NO

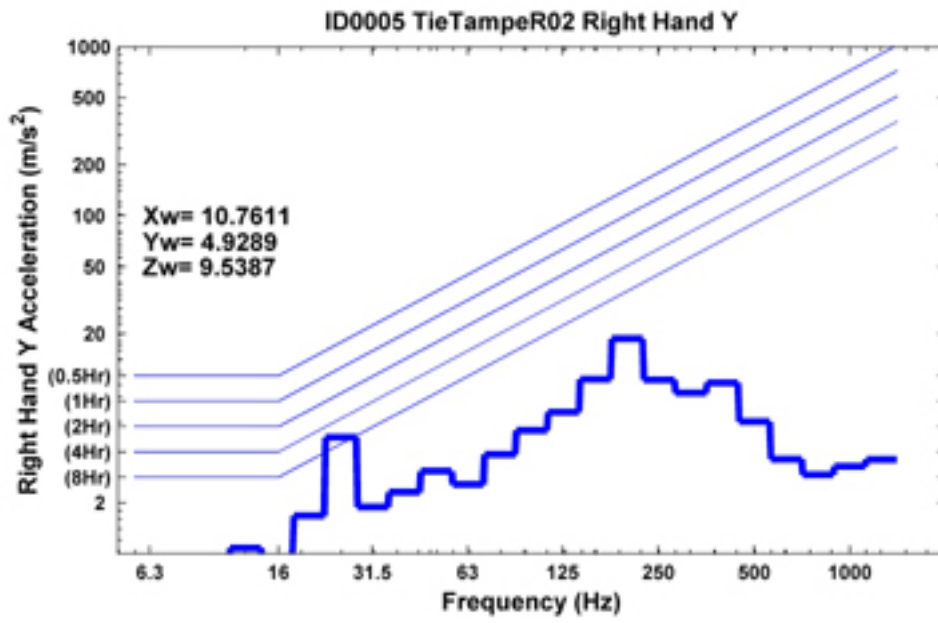
TABLE VI b  
 VIBRATING HAND-TOOL TESTING: RAILROAD/HYDRAULIC ‘ TIE DRILL ’  
 [Frequency range: 5.6-1400 Hz, acceleration: (rms) m/sec/sec, Tool Working]

Fig., ID#, Axis, Hand/position, Weighted (rms) accel., EXCEEDS:	ACGIH-TLV/HAV
1-22, 0011, X, LH/Top, 8.08 (1-2, 2-4, 4-8hrs/day)	YES
1-23, 0011, Y, LH/Top, 8.07 (1-2, 2-4, 4-8hrs/day)	YES
1-24, 0011, Z, LH/Top, 5.25 (4-8hrs/day)	YES
1-25, 0011, X, RH/Side, 1.66 -----	NO
1-26, 0011, Y, RH/Side, 1.99 -----	NO
1-27, 0011, Z, RH/Side, 4.25 (4-8hrs/day)	YES

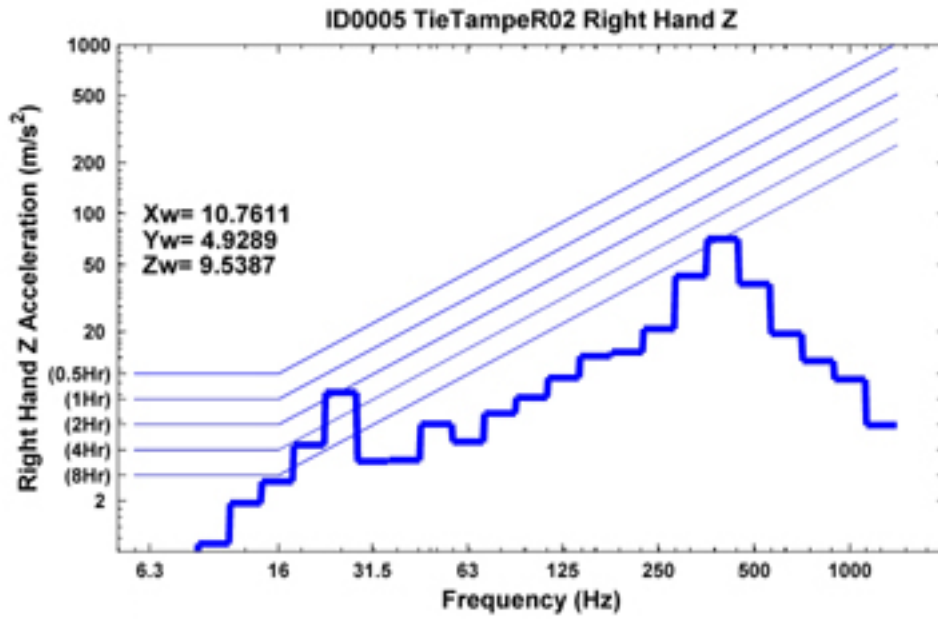
**ANSI S3.34/HAV Spectra:** Hydraulic Tool Tests of Railroad Maintenance-of-Way Operations



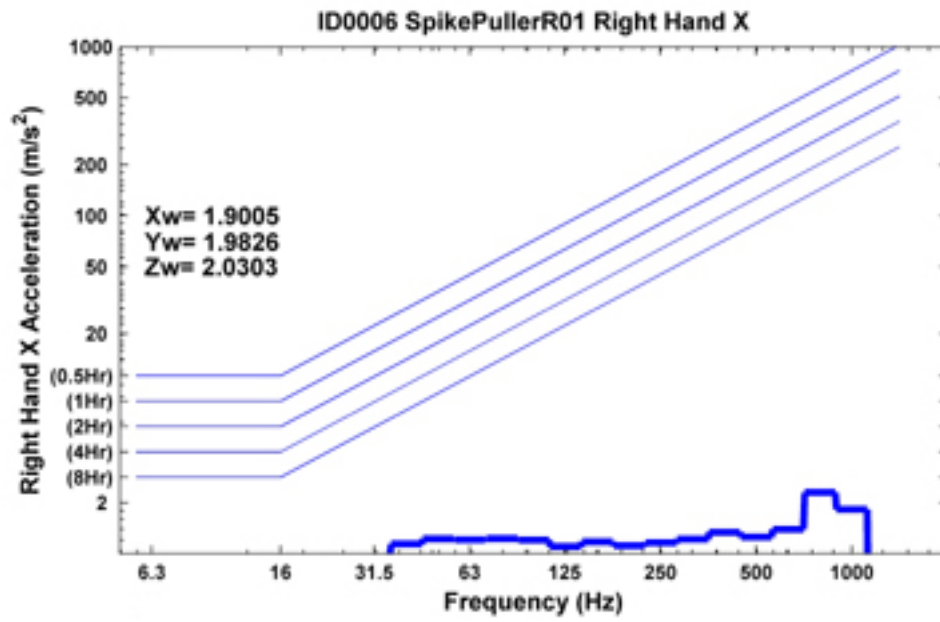
**Figure 1-1** TieTamper, Right Hand, X axis



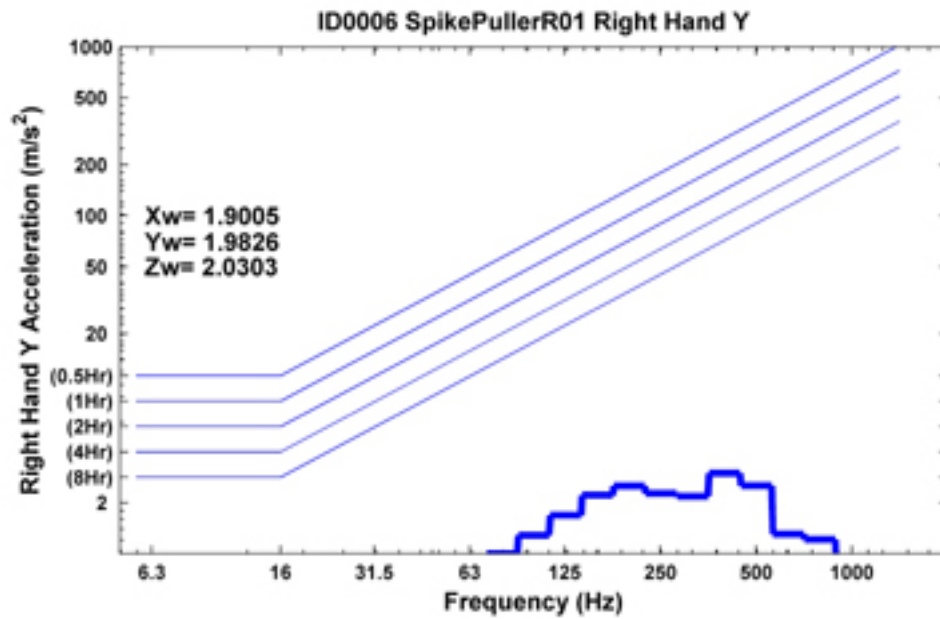
**Figure 1-2:** Tie Tamper, Right Hand, Y axis



**Figure 1-3:** TieTamper, Right Hand, Z axis.



**Figure 1-4** Spike Puller, Right Hand, X axis



**Figure 1-5** Spike Puller, Right Hand, Y axis

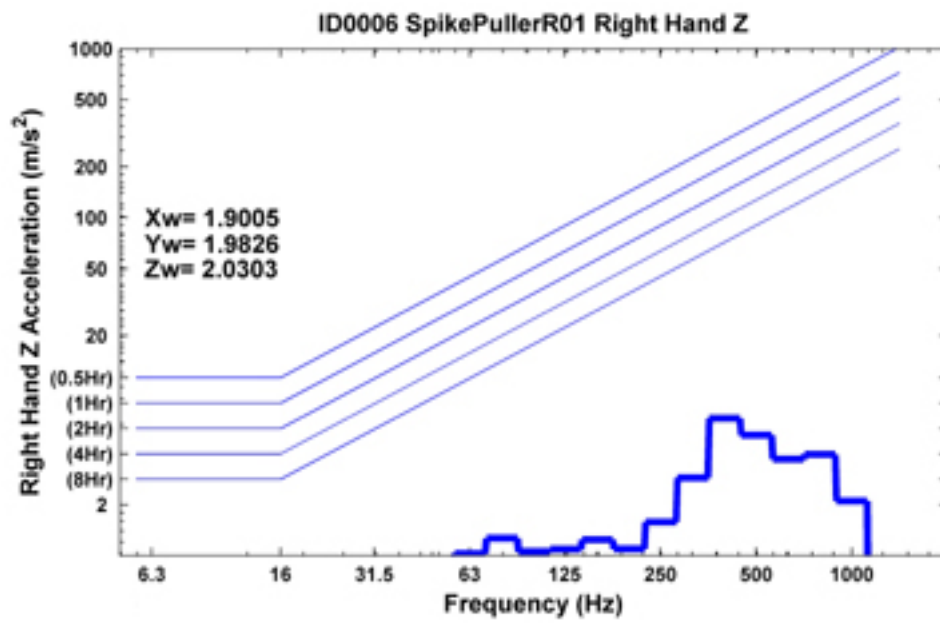


Figure 1-6 Spike Puller, Right Hand, Z axis

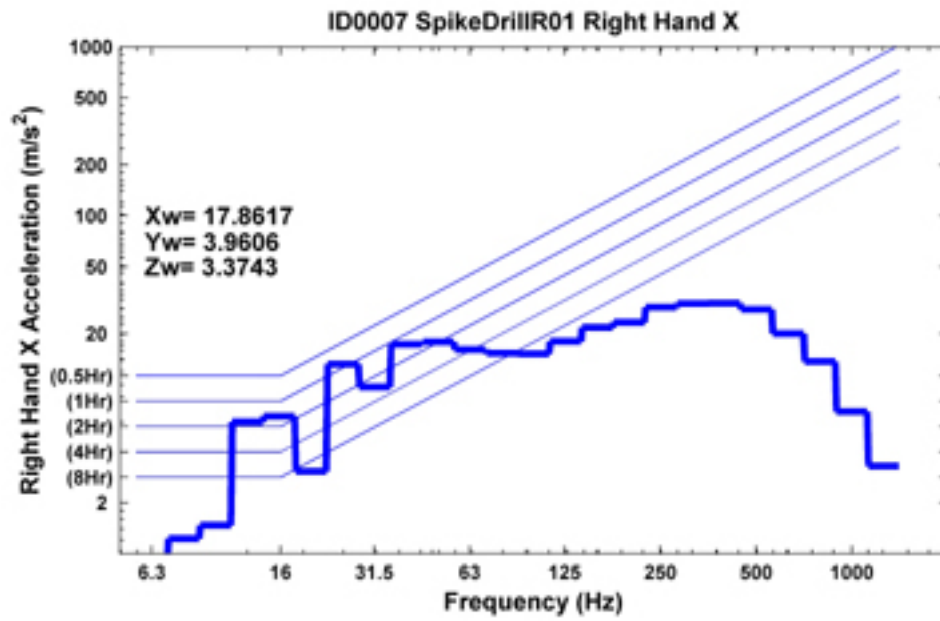


Figure 1-7 Spike Drill, Right Hand, X axis

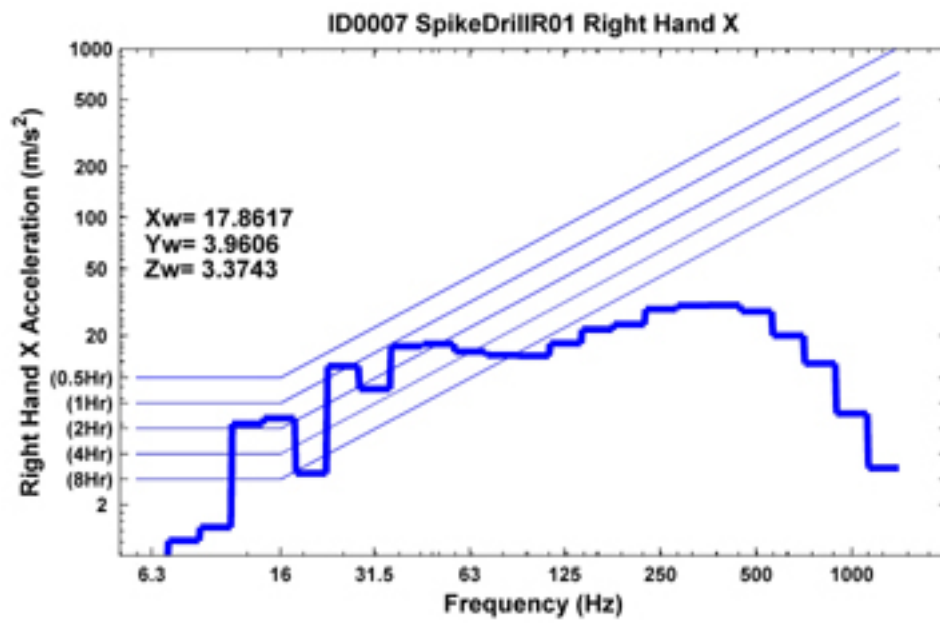


Figure 1-8 Spike Drill, Right Hand, Y axis

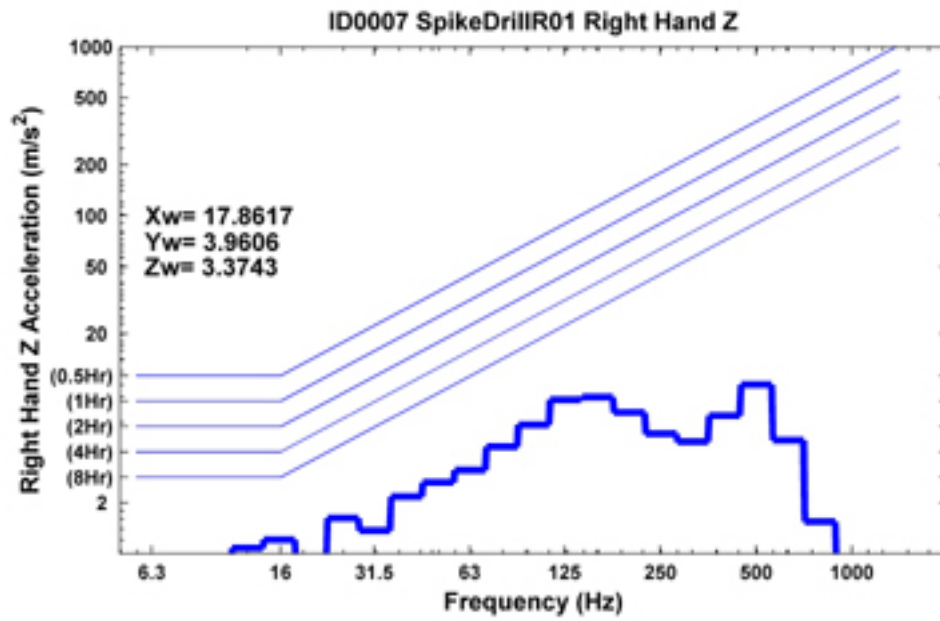


Figure 1-9 Spike Drill, Right Hand, Z axis

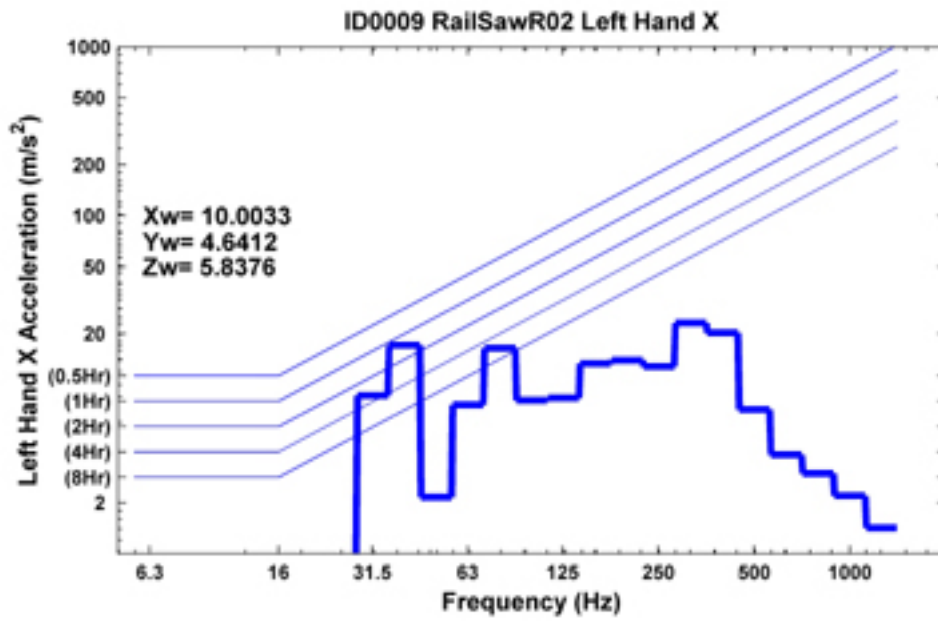


Figure 1-10 Rail Saw, Left Hand, X axis

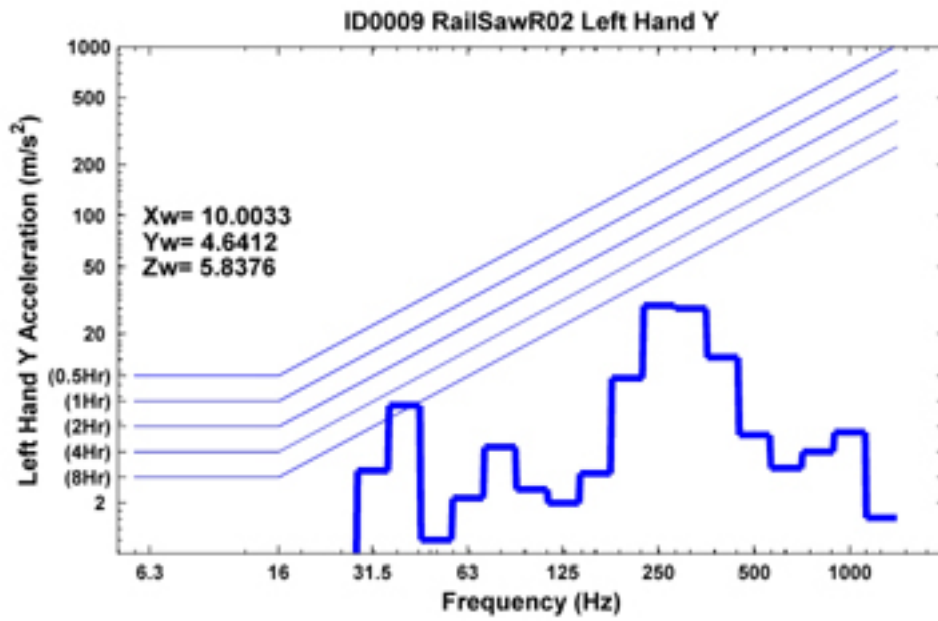


Figure 1-11 Rail Saw, Left Hand, Y axis



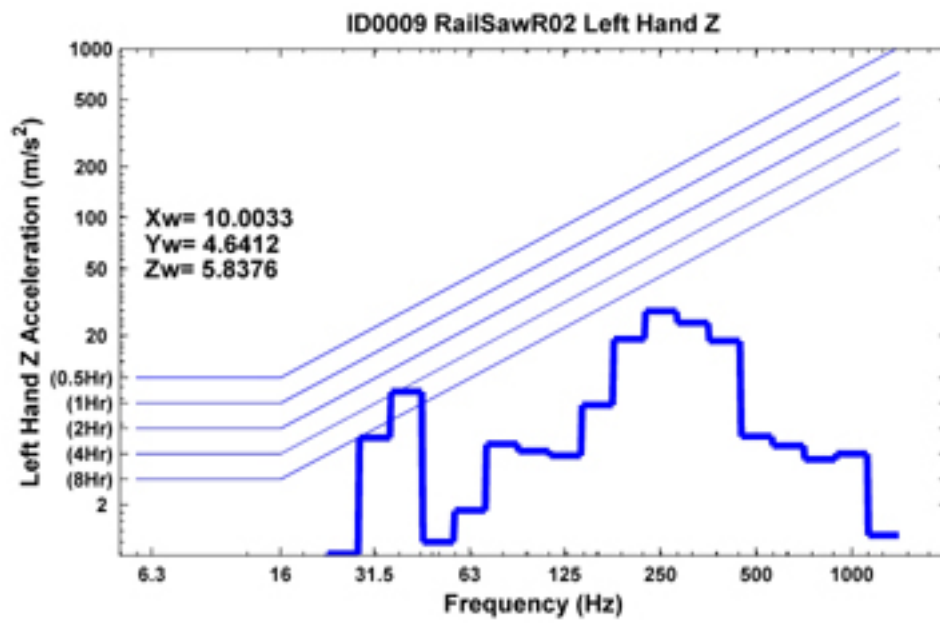


Figure 1-12 Rail Saw, Left Hand, Z axis

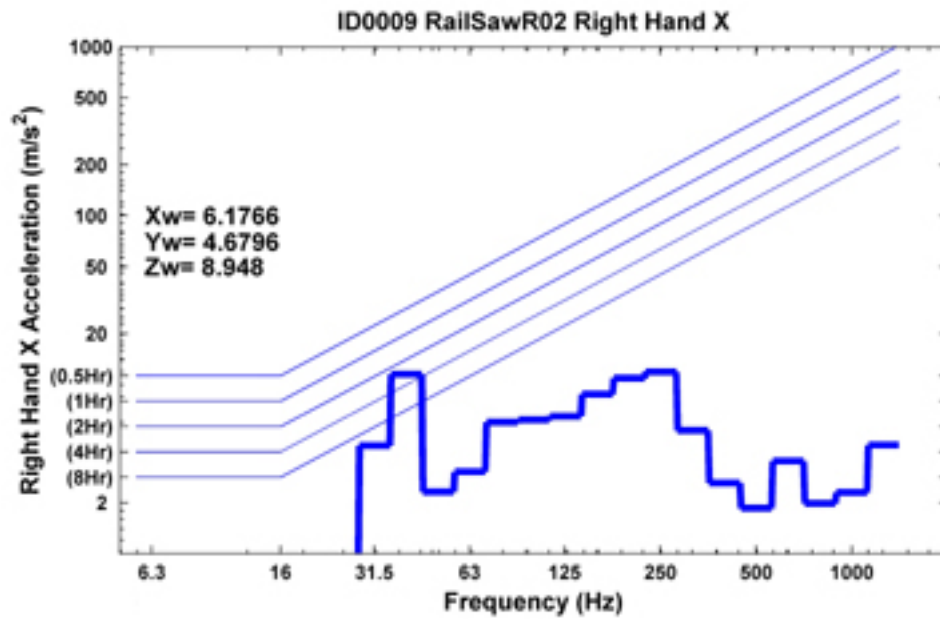


Figure 1-13 Rail Saw, Right Hand, X axis

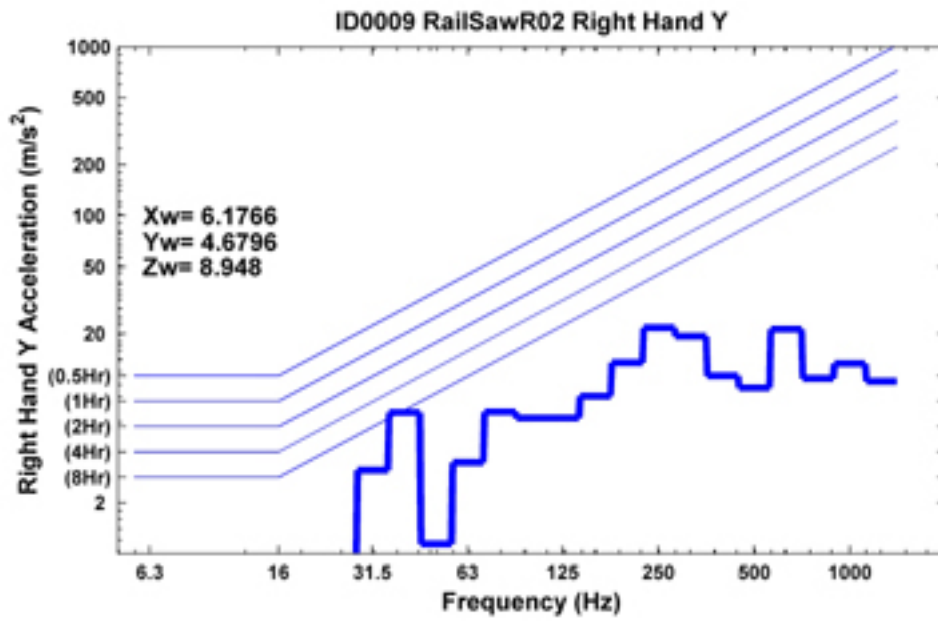


Figure 1-14 Rail Saw, Right Hand, Y axis

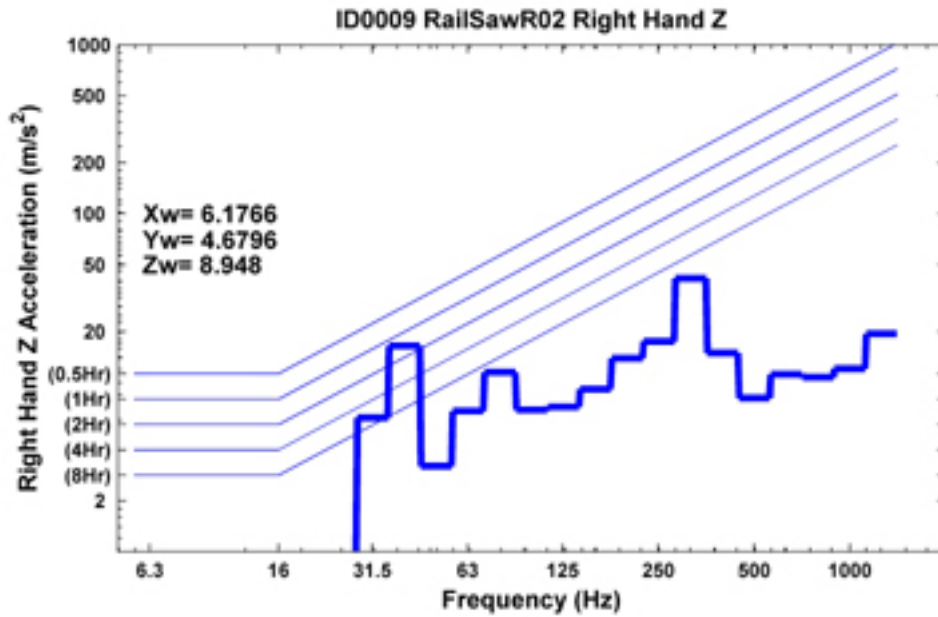


Figure 1-15 Rail Saw, Right Hand, Z axis

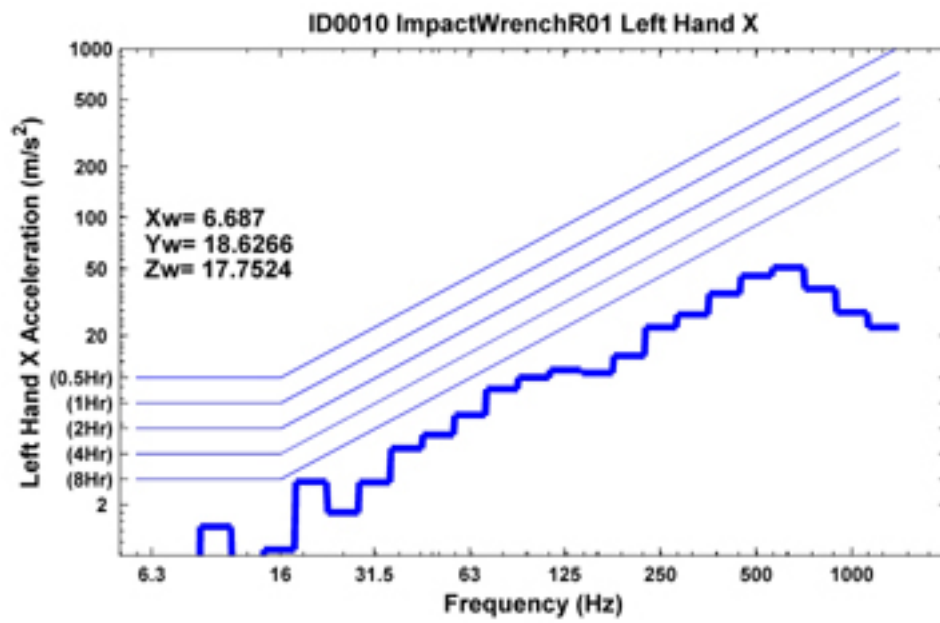


Figure 1-16 Impact Wrench, Left Hand, X axis

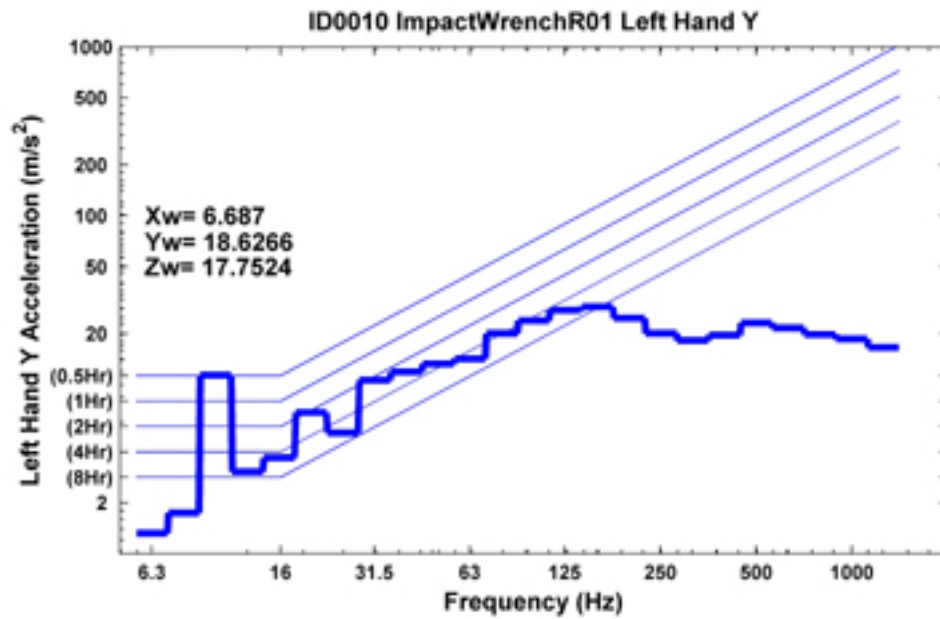


Figure 1-17 Impact Wrench, Left Hand, Y axis

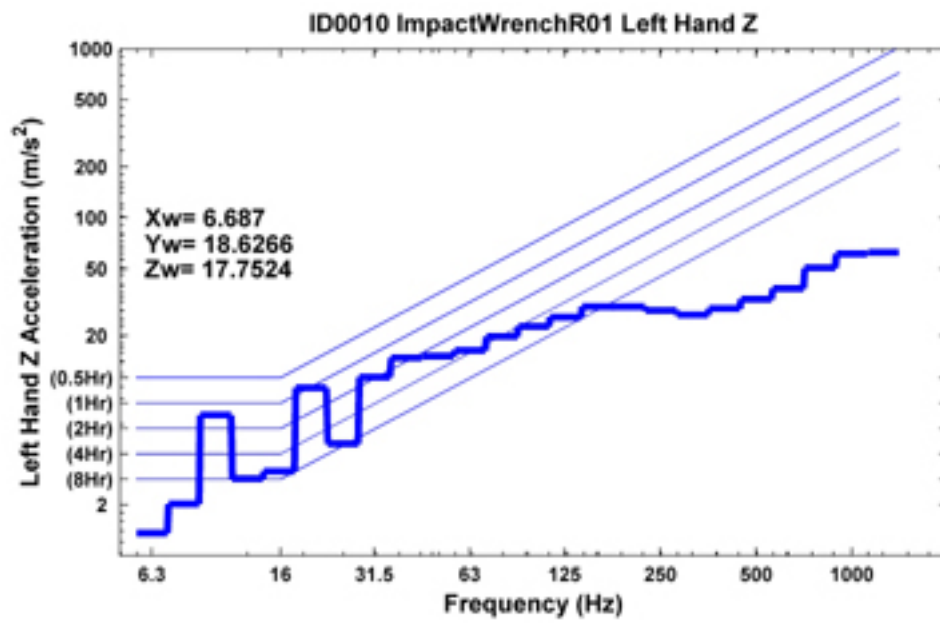


Figure 1-18 Impact Wrench, Left Hand, Z axis

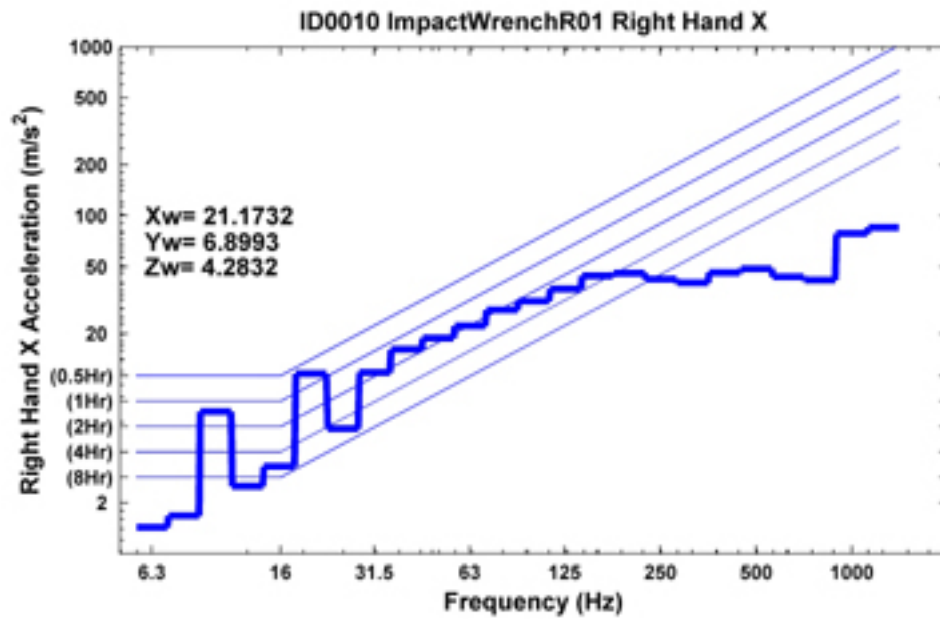


Figure 1-19 Impact Wrench, Right Hand, X axis

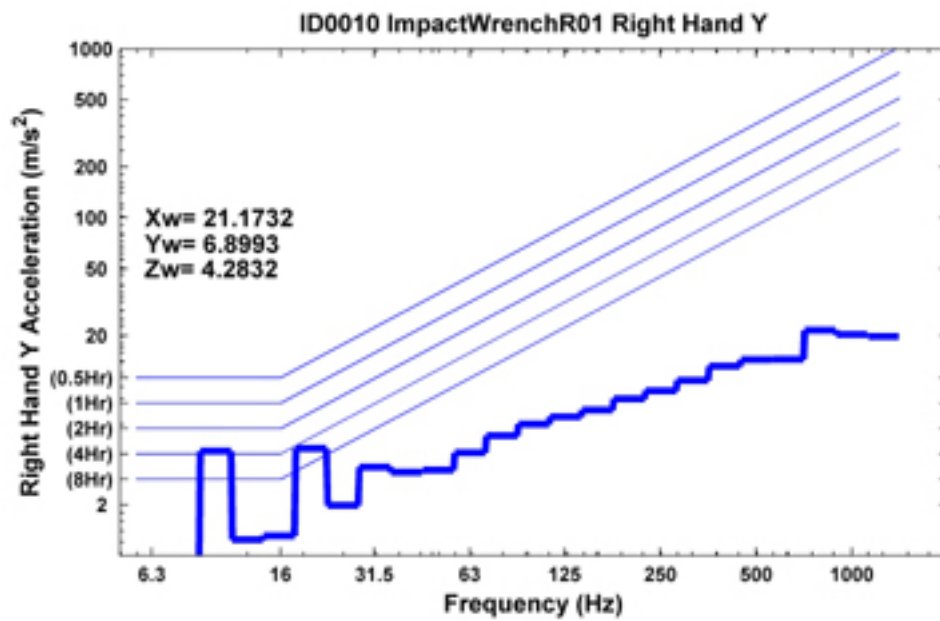


Figure 1-20 Impact Wrench, Right Hand, Y axis

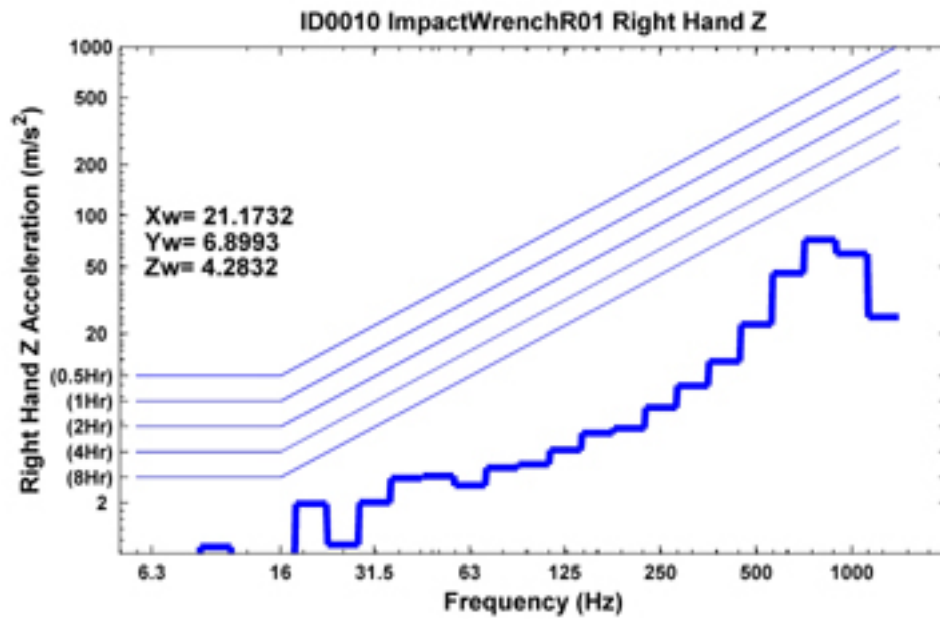


Figure 1-21 Impact Wrench, Right Hand, Z axis

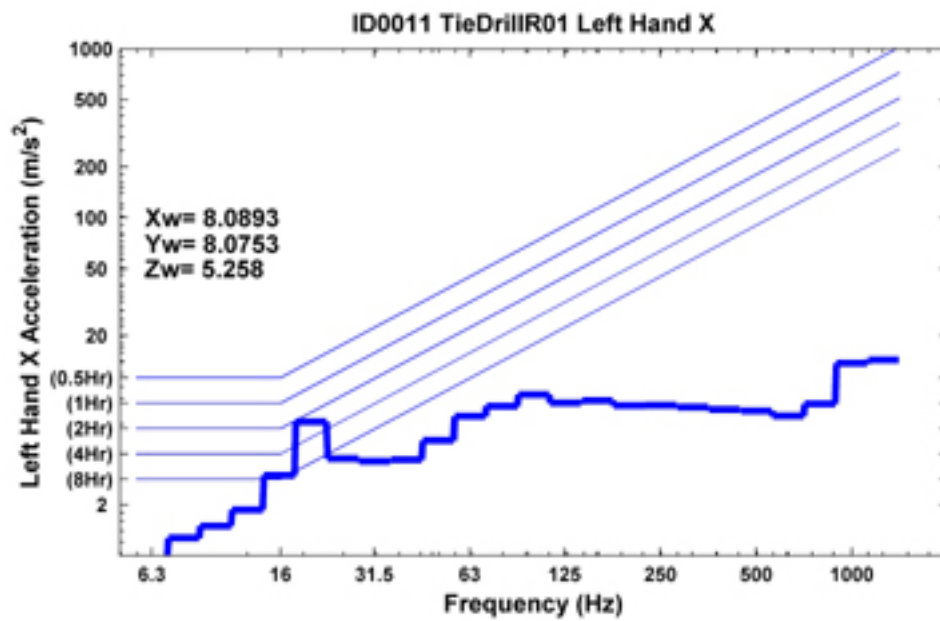


Figure 1-22 Tie Drill, Left Hand, X axis

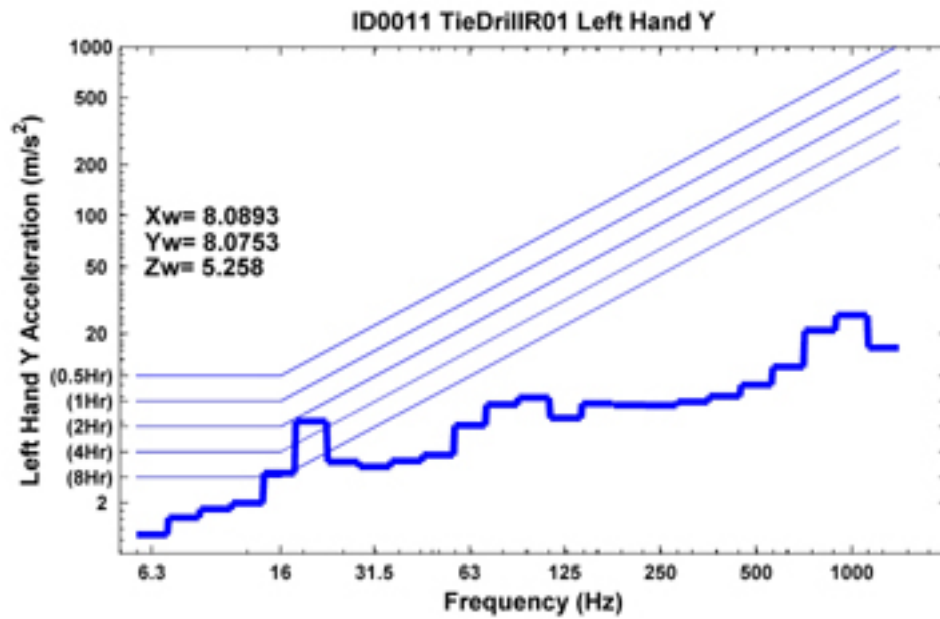


Figure 1-23 Tie Drill, Left Hand, Y axis

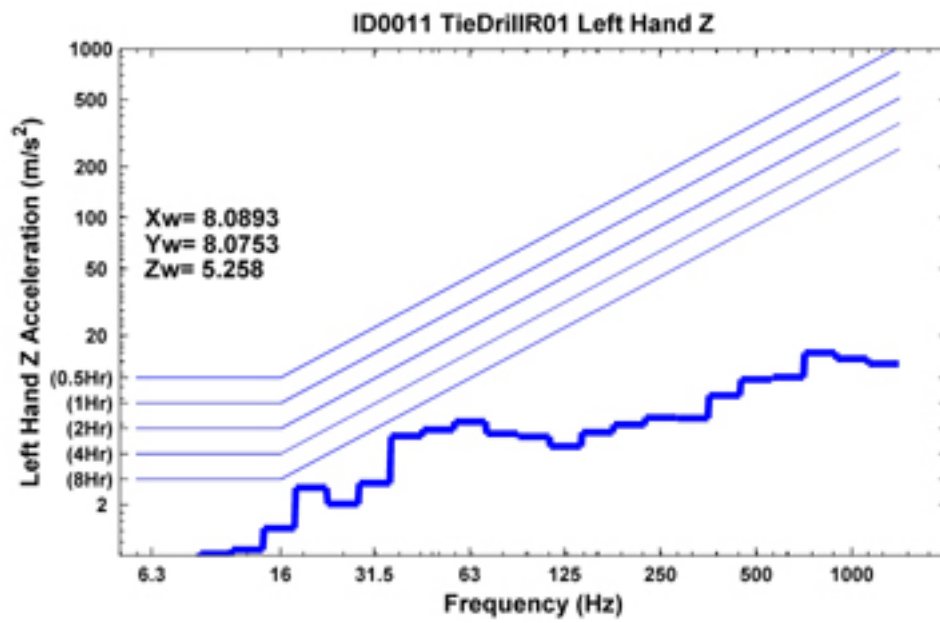


Figure 1-24 Tie Drill, Left Hand, Z axis

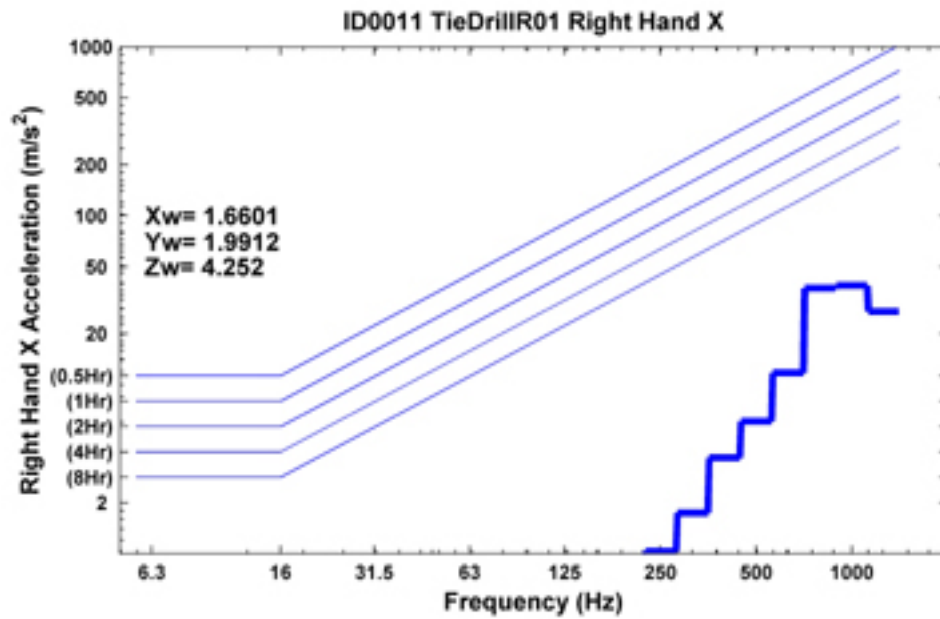
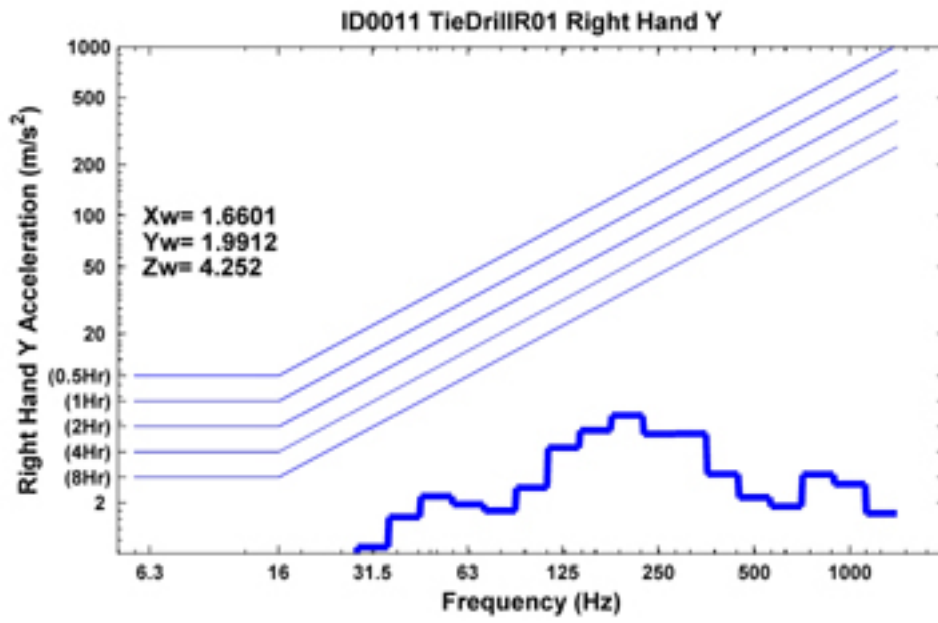
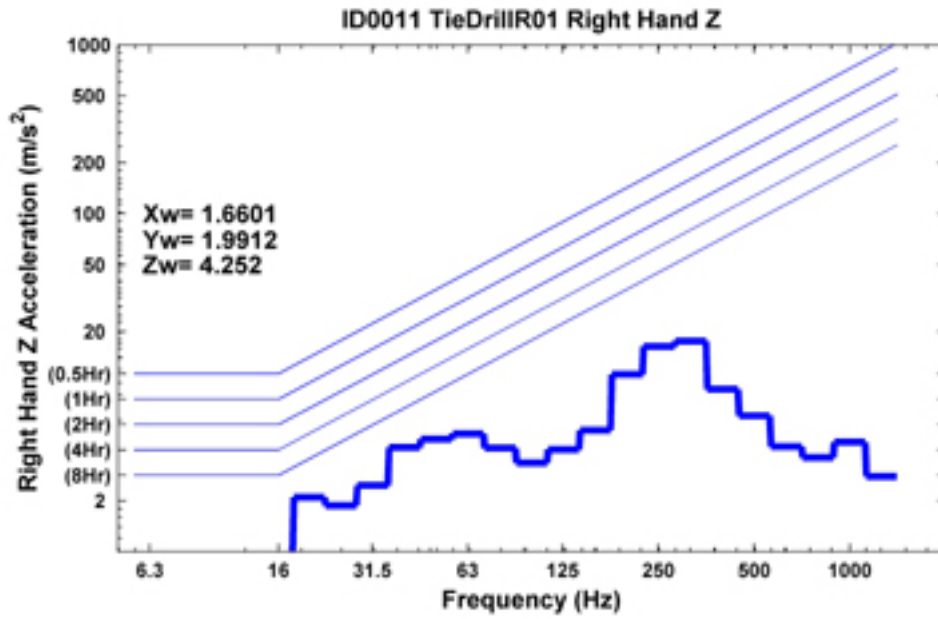


Figure 1-25 Tie Drill, Right Hand, X axis



**Figure 1-26** Tie Drill, Right Hand, Y axis



**Figure 1-27** Tie Drill, Right Hand, Z axis



# EFFECT OF PUSH/PULL AND GRIP FORCE ON PERCEPTION OF STEERING WHEEL VIBRATION

R. A. Haasnoot and N. J. Mansfield

Department of Human Sciences, Loughborough University, Loughborough, England

## Introduction

When gripping a tool or control (e.g. a steering wheel) the grip and feed (push / pull) forces will depend on, amongst other things, the nature of the tool (or control) and task. For example, an operator might push the tool harder if they consider that this improves its effectiveness (e.g. using a power drill) or they might grip harder whilst driving aggressively than when cruising on a clear straight road. It is currently unknown the extent to which these factors change the perception of vibration at the hand.

Although there is little data relating to the effect of grip and push / pull forces on the psychophysical responses to hand-arm vibration, there have been some studies investigating the biomechanical responses. Dong *et al.* (2001) reviewed the literature relating to the biomechanical response of the hand-arm system and noted that the studies where magnitude of feed-force have been investigated show little effect on the driving point mechanical impedance at frequencies over 100 Hz and the variation in impedance magnitude is less than 10% in the frequency range of 20 to 70 Hz. Despite variation in methodology, several studies investigating the influence of hand-grip force on mechanical impedance have shown that an increase in grip force gives a slight increase in the driving point mechanical impedance of the hand-arm system at least at relatively high frequencies (Gurram *et al.*, 1995; Burström, 1997). Only slight differences have been observed between ratings of magnitude of steering wheel vibration with low and high grip forces (Giacomin and Onesti, 1999), although the absolute magnitudes of the forces applied were neither controlled nor monitored by the experimenters.

The objective of the laboratory study presented in this paper was to investigate whether the push, pull or grip force affect the estimation of intensity of vibration at a steering wheel.

## Method

The experiment was conducted in four phases studying the effects of push, pull and grip force on perception of vibration as well as investigating the linearity of these forces. The method of intensity estimation was used for the experiment. For all phases a rotational sinusoidal vibration with a frequency of 63Hz and an unweighted magnitude of  $5\text{m/s}^2$  r.m.s. was used as a reference stimulus.

Subjects were instructed to grip and push / pull an instrumented steering wheel with a predetermined force, which was measured using strain gauges. Subjects were provided a visual feedback of both their grip and push / pull forces on an oscilloscope and stimuli would not start until the required combination of forces was achieved. The grip forces were chosen using findings from a previous explorative experiment (unpublished data) of grip forces used by participants when they were free to grip the steering wheel as they wished, the only instruction being to grip 'as if they were driving on a straight road'. Rotational accelerations were generated using a Ling V406 shaker attached to the steering wheel via a stinger rod and were measured using an Entran EGAS accelerometer, the output from which was conditioned and acquired to a PC based LabVIEW system.

### *Phase 1: Effect of push / pull force*

The test stimulus was a rotational sinusoidal vibration with the frequency of 125 Hz and a magnitude of  $5\text{m/s}^2$  r.m.s. The reference and test grip force was 40 N; the reference and test push / pull forces were 0 N and either 20 or 50 N respectively.

### *Phase 2: Effect of grip force*

The test stimulus was a rotational sinusoidal vibration with the frequency of 125 Hz and a magnitude of  $5\text{m/s}^2$  r.m.s. The reference and test push / pull force was 0 N; the reference and test grip forces were 25 N and either 20, 40, 60 or 80 N respectively.

### Phase 3: Linearity for push / pull force

The test vibration stimuli were rotational sinusoidal vibration with frequencies of 31.5 Hz and 100 Hz with a magnitude of 5 m/s<sup>2</sup> r.m.s. The reference and test grip force was 25 N; the reference and test push / pull forces were both 20 or 50 N.

### Phase 4: Linearity for grip force

The test vibration stimuli were rotational sinusoidal vibration with frequencies of 31.5 Hz, 125 Hz and 250 Hz with a magnitude of 5 m/s<sup>2</sup> r.m.s. The reference and test push / pull force was 0 N; the reference and test grip forces were both 25, 50 or 100 N.

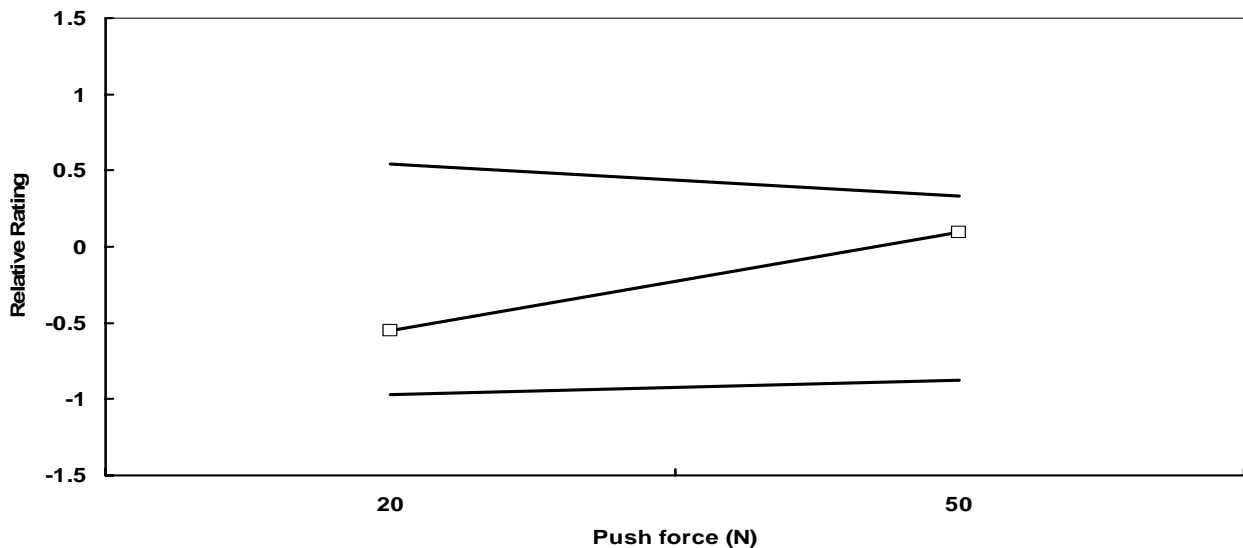
Participants rated the test stimulus using an intensity estimation scale, where the reference stimulus was compared with the test stimulus. A value of '100' would be assigned to a condition where the subjective intensity was equal for the test and reference; a value of '200' or '50' would be assigned to a condition where the test stimulus was twice or half as intense respectively as the reference. To minimise the effect of each participant using a different range of responses, data were normalised by subtracting the mean of each participant's responses from each individual rating and dividing by the standard deviation of each participant's set of responses. Therefore, each participant's set of responses had a mean value of 0 and a standard deviation of 1.

12 participants (6 male and 6 female) took part in each of the phases. The age of the participants ranged between 21 and 37 years with an average of 27.6 years. The experiment was approved by the ethical board of Loughborough University.

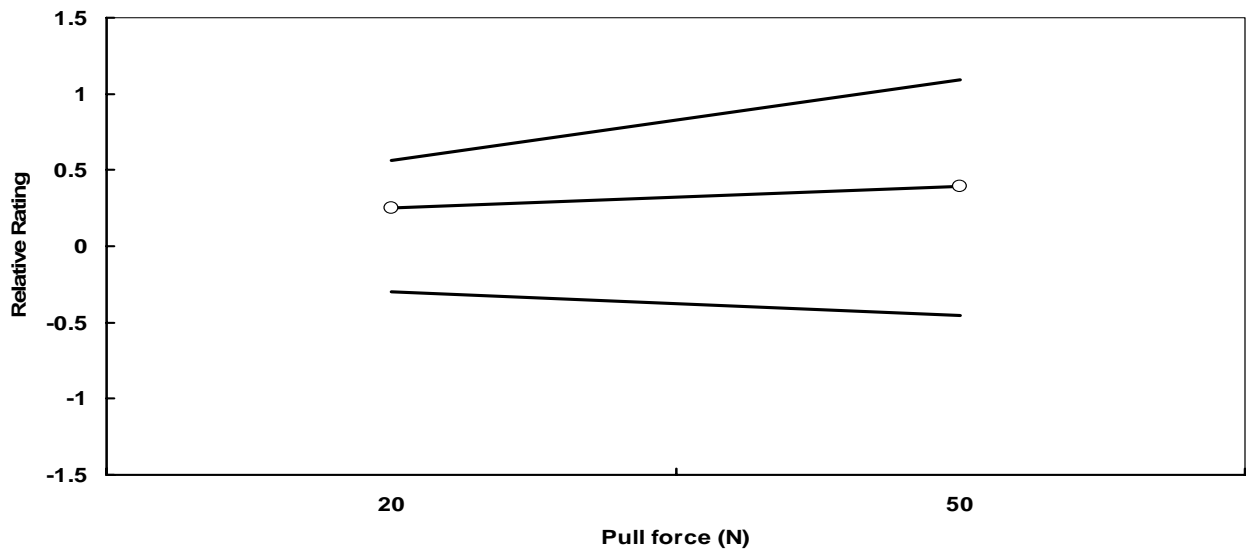
## Results

### Phase 1: Effect of push / pull force

In phase 1, the normalised scores showed that ratings of vibration magnitude increased as the push or pull force increased, although these increases were not statistically significant (Figure 1 and 2). The gradient of this effect depended on whether the force was push or pull. Furthermore, ratings were greater for the pull forces than the push forces. The pull force was perceived as significantly more intense at 20 N ( $p < 0.05$ , Wilcoxon) compared to push force. There was no significant difference between push and pull force at 50 N.



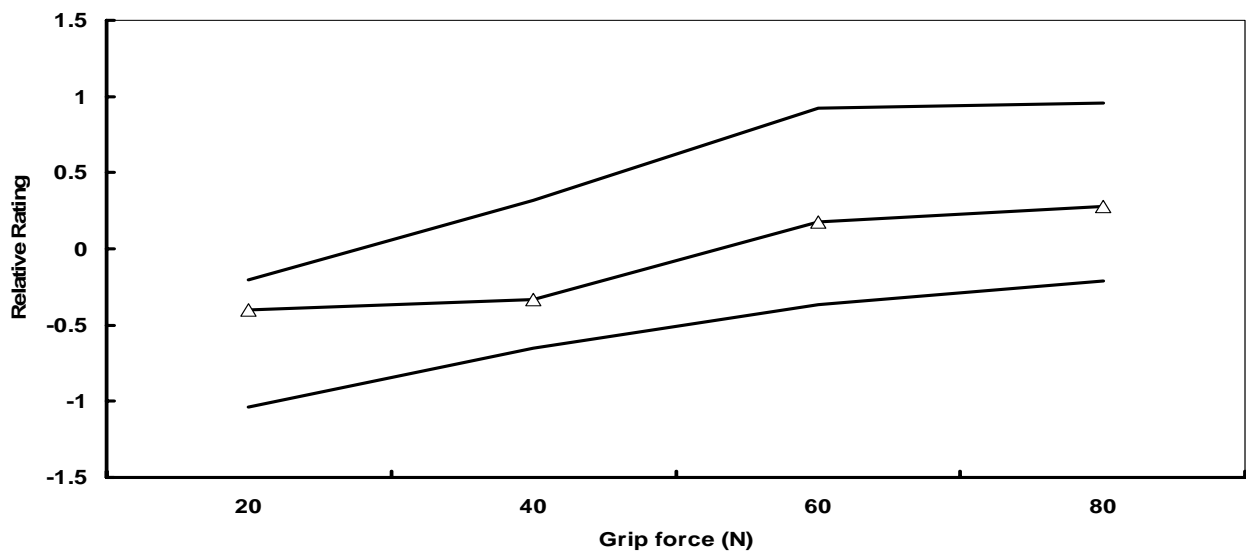
**Figure 1** Effect of push force on relative subjective rating of rotational steering wheel vibration. Data show the 25<sup>th</sup> percentiles, medians and 75<sup>th</sup> percentiles for test stimuli of 125Hz compared to a reference of 63Hz.



**Figure 2** Effect of pull force on relative subjective rating of rotational steering wheel vibration. Data show the 25<sup>th</sup> percentiles, medians and 75<sup>th</sup> percentiles for test stimuli of 125Hz compared to a reference of 63Hz.

*Phase 2: Effect of grip force*

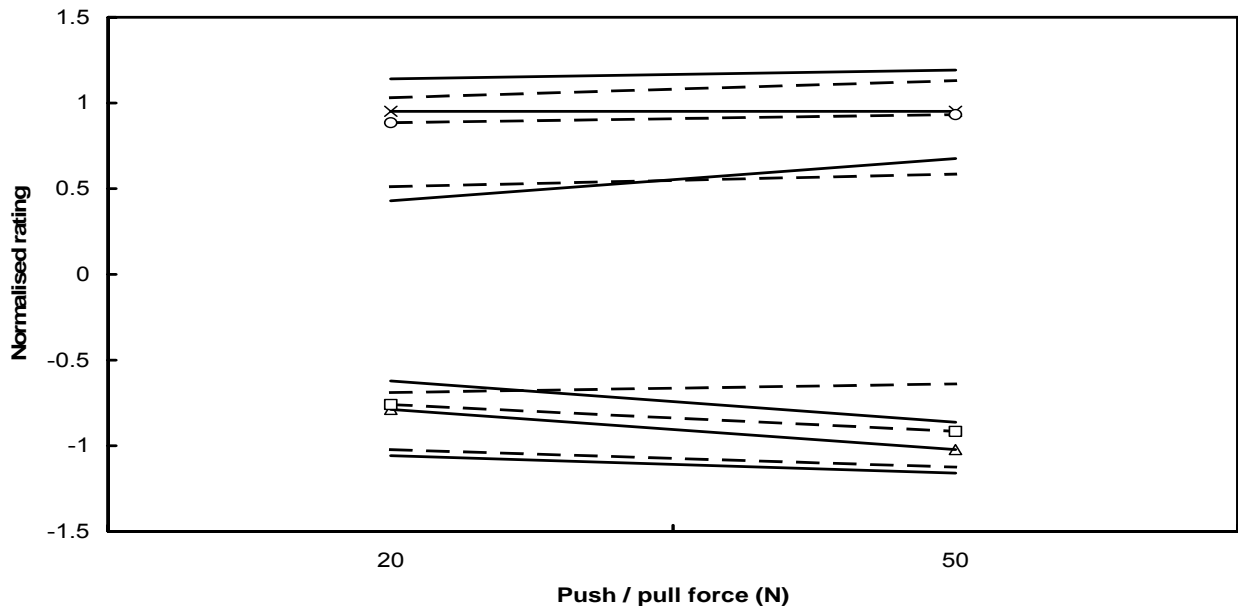
In phase 2, the normalized scores showed that ratings of vibration magnitude increased monotonically as the grip force increased (Figure 3). Differences between ratings were significant between the lower pair of responses (20 N and 40 N) and the higher pair of responses (60 N and 80 N; Wilcoxon:  $p < 0.001$ , 20 N and 60 N, 20 N and 80 N;  $p < 0.05$ , 40 N and 60 N, 40 N and 80 N).



**Figure 3** Effect of grip force (–Δ–) on relative subjective rating of rotational steering wheel vibration. Data show the 25<sup>th</sup> percentiles, medians and 75<sup>th</sup> percentiles for test stimuli of 125Hz compared to a reference of 63Hz.

*Phase 3: Linearity for push / pull force*

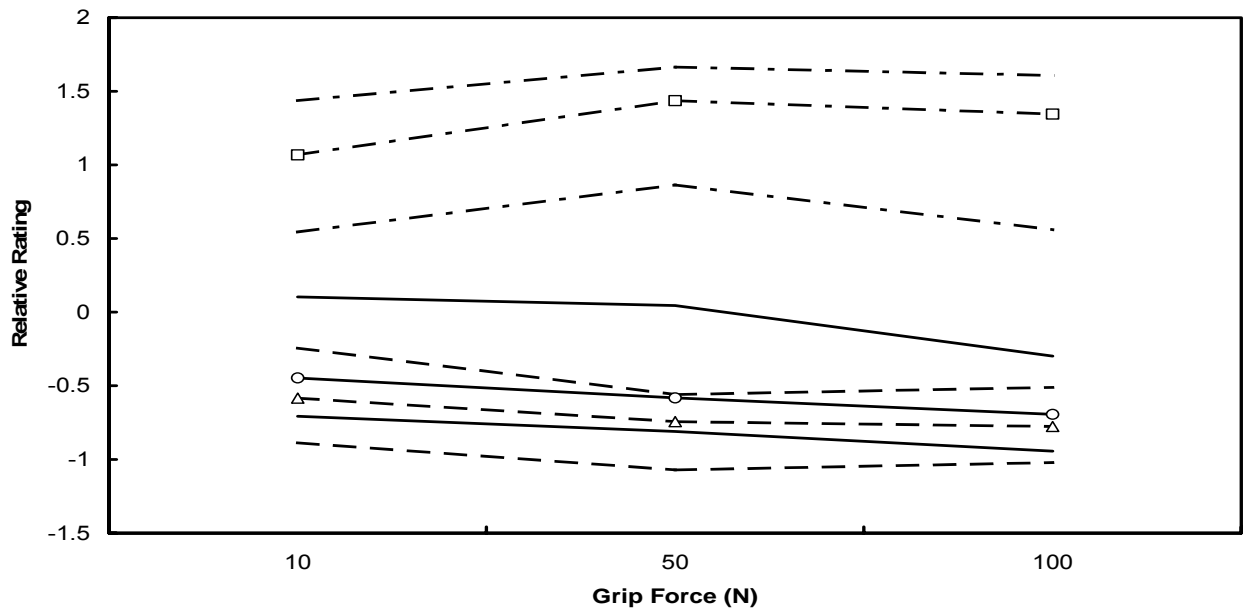
In phase 3, the normalised scores showed that ratings of vibration magnitude were greater for the 31.5 Hz stimulus than for the 100 Hz stimulus (Figure 4). However, the relative ratings only showed small changes for the low push / pull and high push / pull forces. As the reference and the test conditions used the same push / pull force, this indicates that the relative ratings of intensity were nominally linear with push / pull. There were no significant differences between the push or pull data or between the magnitude of push or pull for the 31.5 Hz vibration. At 100 Hz, there was a significant difference between the relative ratings of push and pull at 50 N ( $p < 0.01$ , Wilcoxon) but not at 20 N. Furthermore, at 100 Hz, there was a significant difference between the relative responses for push forces of 20 and 50 N ( $p < 0.01$ , Wilcoxon) but not for the pull forces.



**Figure 4** Linearity of push (–x–) and pull (–o–) force for 31.5 Hz and push (–Δ–) and pull (–□–) force for 100 Hz on relative subjective rating of rotational steering wheel vibration. Data show the 25<sup>th</sup> percentiles, medians and 75<sup>th</sup> percentiles for test stimuli compared to a reference of 63Hz.

*Phase 4: Linearity for grip force*

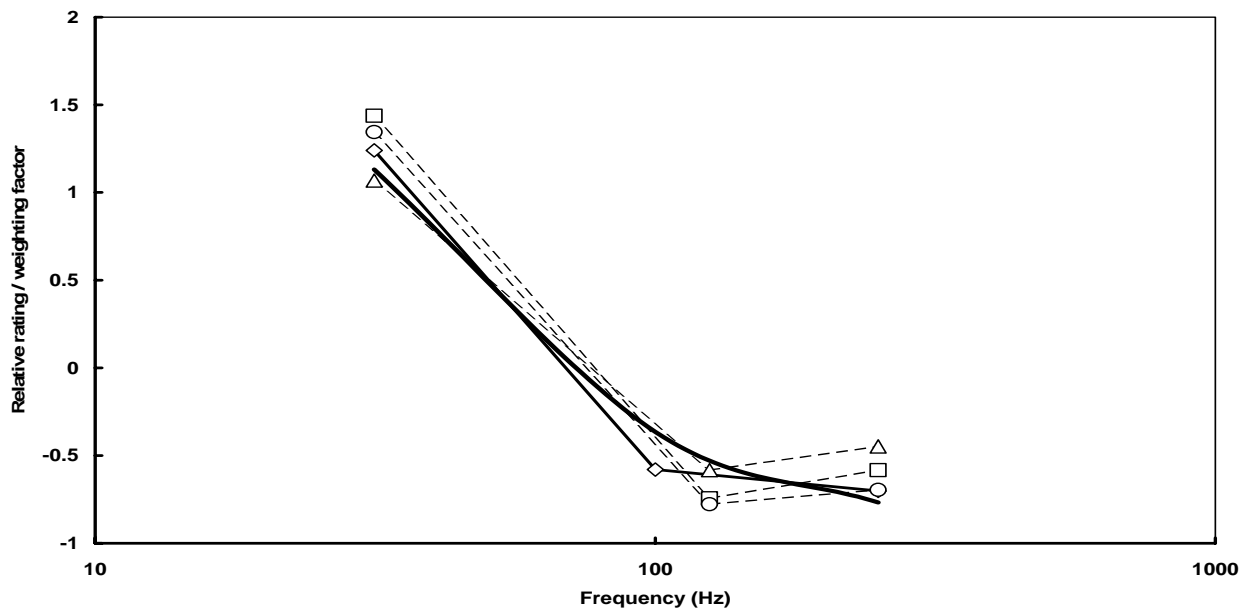
In phase 4, the normalised scores showed that ratings of vibration magnitude were greater for the 31.5 Hz stimulus than for the 125 Hz or 250 Hz stimuli (Figure 5). Median normalised responses were slightly greater for the 250 Hz stimulus than for the 125 Hz stimulus, although there were a substantial overlap of the interquartile ranges. The relative ranking of the responses for the three stimuli remained constant, irrespective of the forces used to grip during the reference and the test stimuli. Although there were some changes in the responses with grip forces, these were not consistent in direction and most were insignificant (significant differences were observed at 31.5 Hz between 10 and 50 N ( $p < 0.05$ , Wilcoxon), at 125 Hz between 10 and 50 N ( $p < 0.01$ ), at 250 Hz between 10 and 100 N ( $p < 0.01$ , Wilcoxon).



**Figure 5** Linearity of grip force for 31.5 Hz ( $-\square-$ ), linearity of grip force for 125 Hz ( $-\Delta-$ ) and linearity of grip force for 250 Hz ( $-\circ-$ ) on relative subjective rating of rotational steering wheel vibration. Data show the 25<sup>th</sup> percentiles, medians and 75<sup>th</sup> percentiles for test stimuli compared to a reference of 63Hz.

### Discussion

The median ratings for all conditions show good agreement with the effect of frequency on perception of vibration (Figure 6) reported in a previous study by Haasnoot and Mansfield (2003) as well as being comparable with the  $W_h$  weighting curve (ISO 5349-1, 2001) if scaled to have a mean of 0 and a standard deviation of 1 in the frequency range of interest.

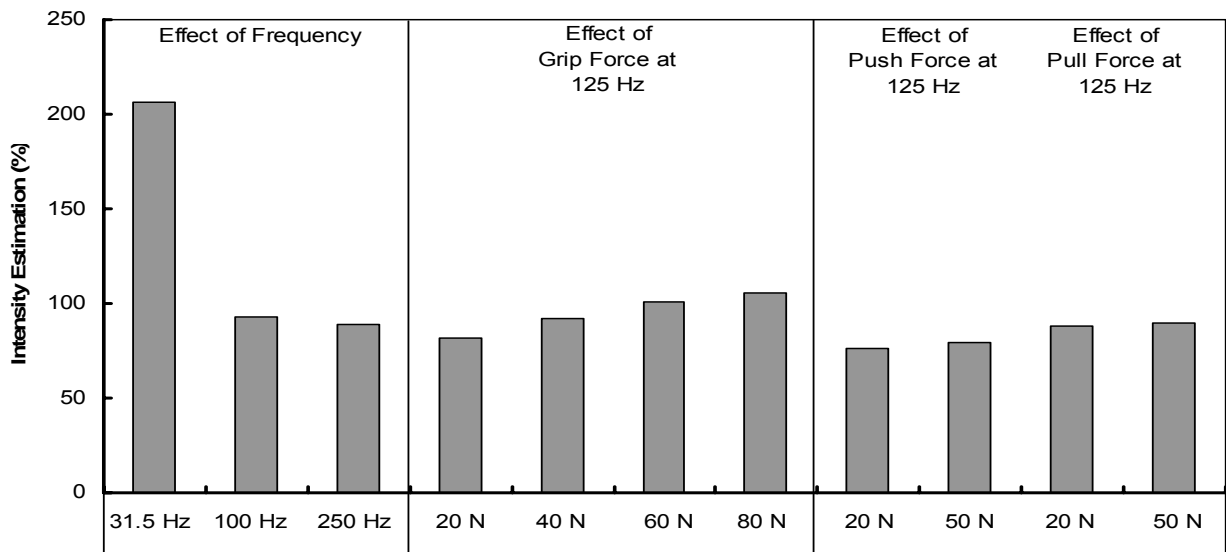


**Figure 6.** Effect of frequency on relative rating of perception of vibration at a steering wheel. Data presented in Haasnoot and Mansfield (2003) ( $-\diamond-$ ).  $W_h$ -curve ( $-$ ) from ISO 5349-1 (2001), scaled. Curves of linearity of grip with grip force of 10 N ( $-\Delta-$ ), 50 N ( $-\square-$ ) and 100 N ( $-\circ-$ ) from this experiment.

Giacomin and Onesti (1999) did not show an effect of grip on the perception of steering wheel vibration, although they did not control or monitor the magnitude of the grip force chosen by their participants. It should be noted that the +/-50N push / pull and grip forces equal to and higher than 80N were considered to be higher than experienced in a car; subjects commented that these forces were large and one subject (not included here) withdrew for the experiment due to not being capable of maintaining the high grip forces. It is possible that the subjects in Giacomin and Onesti's study gripped relatively lightly, compared to the forces studied here.

This study has shown that subjective ratings of the magnitude of steering wheel vibration are affected by the grip force. However, the response of an individual holding the steering wheel remains linear once the force has been attained. Therefore, to obtain good predictions of subjective responses to steering wheel vibration, a model should be developed that includes frequency and grip force. However, it is not necessary for the shape of the frequency-weighting curve to change with gripping condition, as this study has shown that the relative ratings of vibration magnitude are nominally linear with grip and push/pull force.

The normalization procedure emphasizes small differences (e.g. for the effect of push/pull force). If the non-normalized data are considered then the magnitude of the changes in response with gripping condition are relatively small in comparison with the changes in response with frequency of vibration (see Figures 7 and 8). Therefore, if wanting to predict the response of a driver using a steering wheel, the frequency weighting is likely to be more important than a model of the gripping condition.



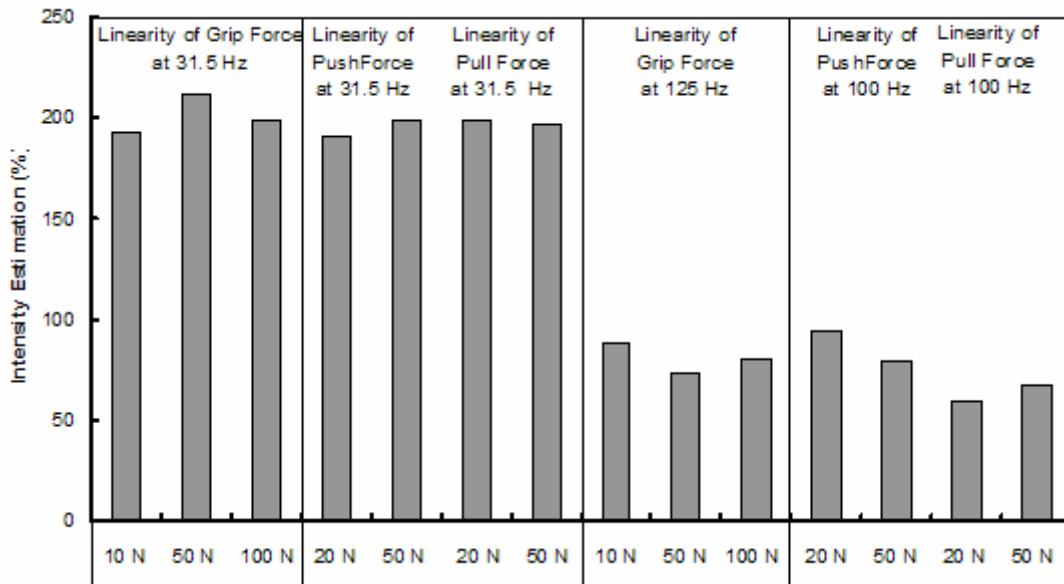
**Figure 7** The effect of frequency (from Haasnoot and Mansfield, 2003), grip force and push force on intensity ratings of vibration at a steering wheel (means of 12 participants in each experiment).

Figures 7 and 8 illustrate the raw scores of the participants' ratings. The first section in Figure 7 shows the effect of frequency of vibration at a steering wheel on the intensity rating. The second section shows the increasing rating with increasing grip force. Compared with the effect of frequency the increase in the rating scores with increasing grip force is significantly smaller. The same can be said for the third section, where the difference in rating for the push and pull forces (a small increase in rating can be seen, consistent for all participants) is much smaller than the effect of frequency.

No consistent trend of increase of rating with increasing forces could be found in the linearity of grip, push and pull force experiments (Figure 8). This figure also shows that the major contributor to the increase in rating is frequency.

### Conclusions

It is concluded that grip forces influence the perception of steering wheel vibration. As these forces increase, subjective ratings increase accordingly. Nevertheless, the effect of vibration frequency is considerably more important than the effect of push / pull or grip force when considering subjective responses.



**Figure 8** The chart shows the effect of pull force, linearity of grip, push and pull force on intensity ratings of vibration at a steering wheel (means of 12 participants in each experiment)

### References

- Burström, L. 1997. The influence of biodynamic factors on the mechanical impedance of the hand and arm. *International Archives of Occupational and Environmental Health*, 69, 437-446.
- Dong, R., Rakheja, S., Schopper, A. W., Han, B. and Smutz, W. P. 2001. Hand-transmitted vibration and biodynamic response of the human hand-arm: A critical review. *Critical Reviews in Biomedical Engineering*, 29, 393-439.
- Giacomin, J. and Onesti, C. 1999. Effect of frequency and grip force on the perception of steering wheel rotational vibration. SAE paper 99A4028.
- Gurram, R., Rakheja, S., and Brammer, A.J. 1995. Driving-point mechanical impedance of the human hand-arm system: synthesis and model development. *Journal of Sound and Vibration*, 180, 437-458.
- Haasnoot, R. A. and Mansfield, N. J. 2003. Effect of vibration envelope on relative sensation of vibration on a steering wheel. 38th UK conference on Human Response to Vibration, 17-19 September 2003, Alverstoke, UK.
- International Organization for Standardization. 2001. Mechanical vibration – Measurement and evaluation of human exposure to hand-transmitted vibration – Part 1: General requirements. International Standard, ISO 5349-1.





# TOOL TESTING USING RESISTANCE SENSORS – PREPARING FOR GLOVE TESTING

J. Wasserman, D. Logston, D. Wasserman, S. T. Kandala

Institute for the Study of Human Vibration, University of Tennessee  
Engineering School, Knoxville, Tenn. 37996, USA

## Introduction

It has been shown that excessive tool vibration can result in vibration white finger syndrome. The current standards have been based on the vibration measurements from the tool using triaxial accelerometers. The difficulty from this approach is that characteristics, such as grip force, are not included in the standard although it is believed that an increase in the static pressure will increase the transmission of the dynamic vibration energy into the hand.

In recent years, a capacitive sensing system has been developed to measure dynamic pressure. Various applications of this technique are being discussed in several papers at the conference. Since many factors such as sensor size, thickness and transducer electronics are involved, an alternative low-cost system is being evaluated.

A pressure sensing system has been developed, which has been shown to measure both the grip static pressure and the dynamic pressure produced by tools. The system has not been previously assessed on the potential variations based on a combination of handle and finger geometry.

This paper presents an initial assessment of the sensing system results by the comparison of information with a triaxial accelerometer on three commercial tools with relatively high levels of vibration. Two of the tool produced continuous vibrations while the third tool was an impact tool. Two of the tool tests (Continuous 2 and Impact) were conducted with the sensor on the skin over the shaft of the middle phalangeal bone of the index finger of the right hand. The other tool test (Continuous 1) was done so there was specific bone contact with the handle by both the index finger and by the metacarpal – phalangeal joint of the thumb.

## Sensor Characteristics

The Flexcell sensor (Figures 1 and 2) is a resistance device that requires special electronics for this application. Multiple tests showed a consistency in voltage to force relationship, however, the effects of temperature and long-term use can have an effect. However, because of the ability to determine quickly the current voltage/ force characteristic, the variation becomes less important. The initial testing demonstrated a constant relationship from 0 Hz to 1500 Hz, when the appropriate electronics is utilized. The testing also showed that the phase angle remained flat for 300 Hz and then became a linear variation with frequency. This result is that the maximum wave shape error will occur from 60 Hz to 300 Hz, but the level of distortions should be small.



Figure 1 Sensor



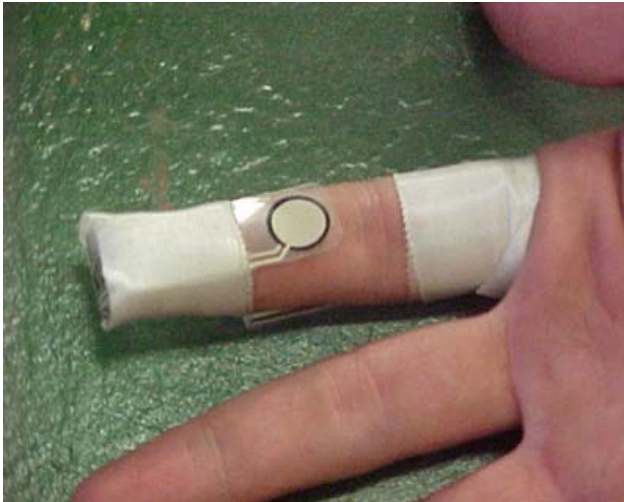
Figure 2 Sensor Size Related to Finger Size

## Procedure

The initial testing was conducted on three different tools. Two of the tools produced continuous vibration while the third tool was an impact tool. In one case, the sensor was taped to the tool (Figure 4) and the sensor was later placed on the side where the Metacarpal phalange joint of the thumb was present. The remaining cases had the sensor attached to the index finger as shown in Figure 3.

After the data was collected, frequency analysis was performed. The force data was then divided by the accelerometer data to allow zones of consistence which were verified by the use of coherence functions.

Coherence functions combine the relationships of magnitude and phase angle to see if these relationships are consistent and independent of magnitude. A value of 1 means the compared signals are completely consistent while a value of 0 means the signals are unrelated. In regions where the signals are very small compared to noise, the coherence will have a low value.



**Figure 3** Sensor Placement on Finger



**Figure 4** Sensor Placement on the Tool

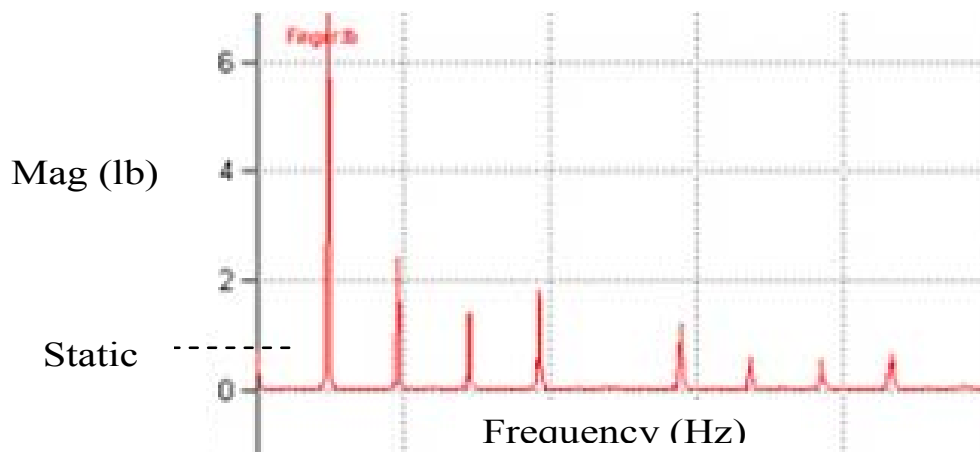
The tools were then used to perform their functions on normal manufacturing materials. The data from this testing is used to assess the potential variations in the dynamics testing. The next testing will be to use the tool with measurements being made with both a triaxial accelerometer and the pressure sensing transducer. The testing was performed at two locations on the main handle grip.

## Results

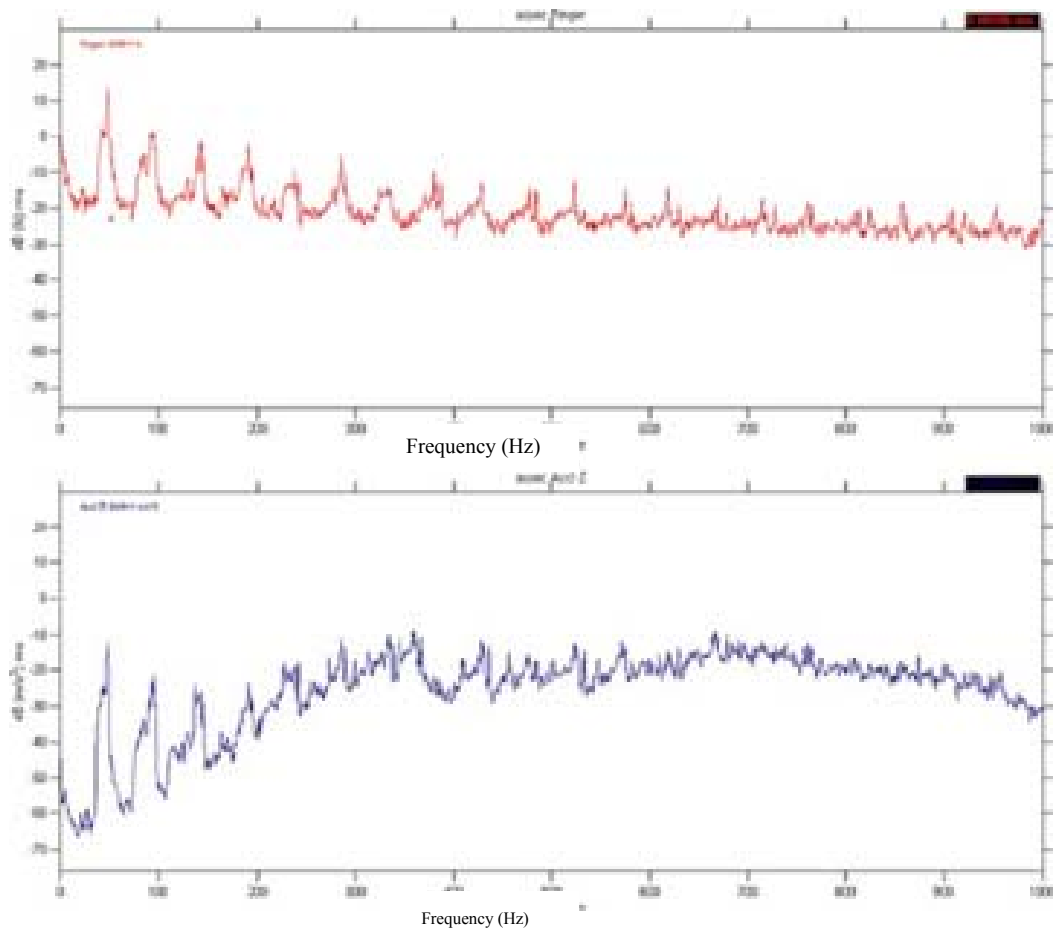
As shown in Figure 5, the transducer provides both the local static as well as dynamic load information, where the static is at 0 Hz.

This tool produces a set of harmonic peaks, which can be clearly seen from the force data. A similar set of peaks can be seen from the acceleration data as show in Figure 6. The transfer function and coherence functions also indicate relationships between 0 to 1000 Hz.

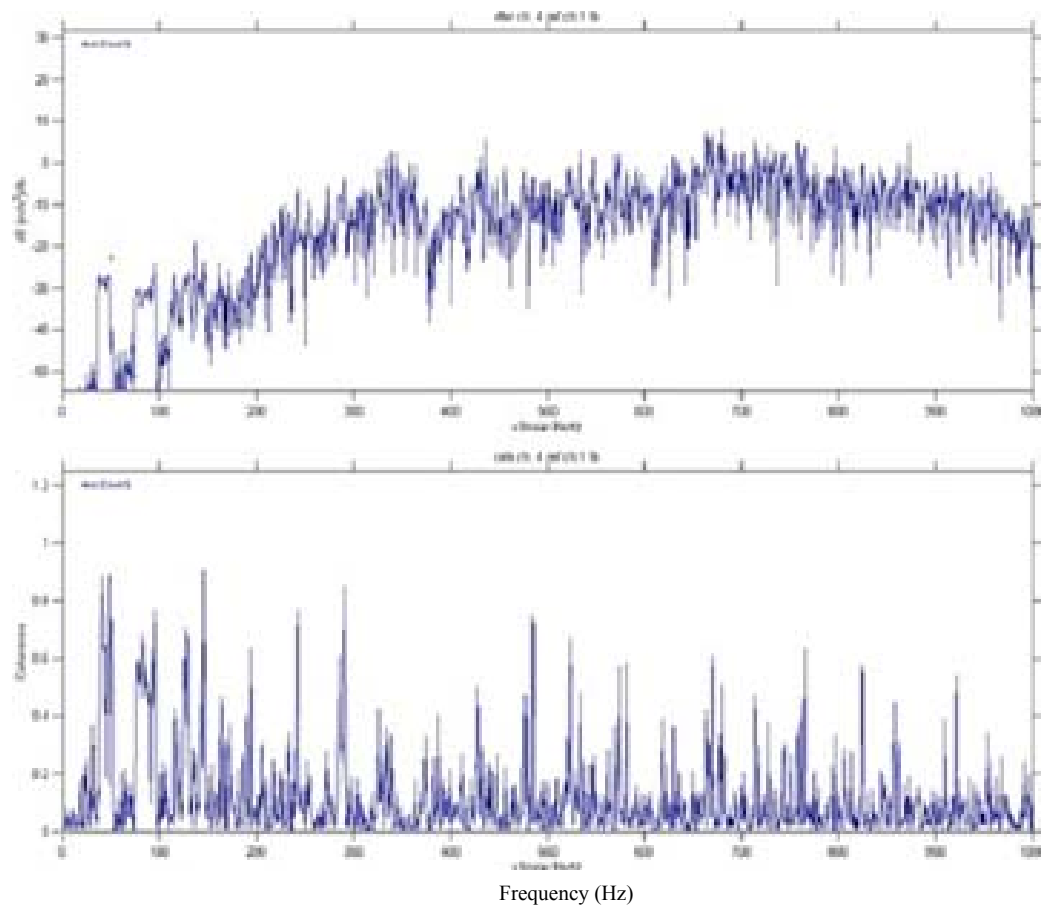
A more mathematical comparison between the force data and the acceleration data is by the computation of a transfer function with a coherence function. The normal use of the transfer function is a relationship between force and motion as a function of frequency. Since this approach is based generally based on linear systems, the coherence function is used to validate the linear relationship. As can be seen in Figure 7, two regions below 100 Hz show a continual ratio between the force and acceleration measurements. The coherence function is also relatively high.



**Figure 5** Static Load at 0 Hz



**Figure 6** Acceleration & Force Data for Continuous Tool 1 from Index Finger



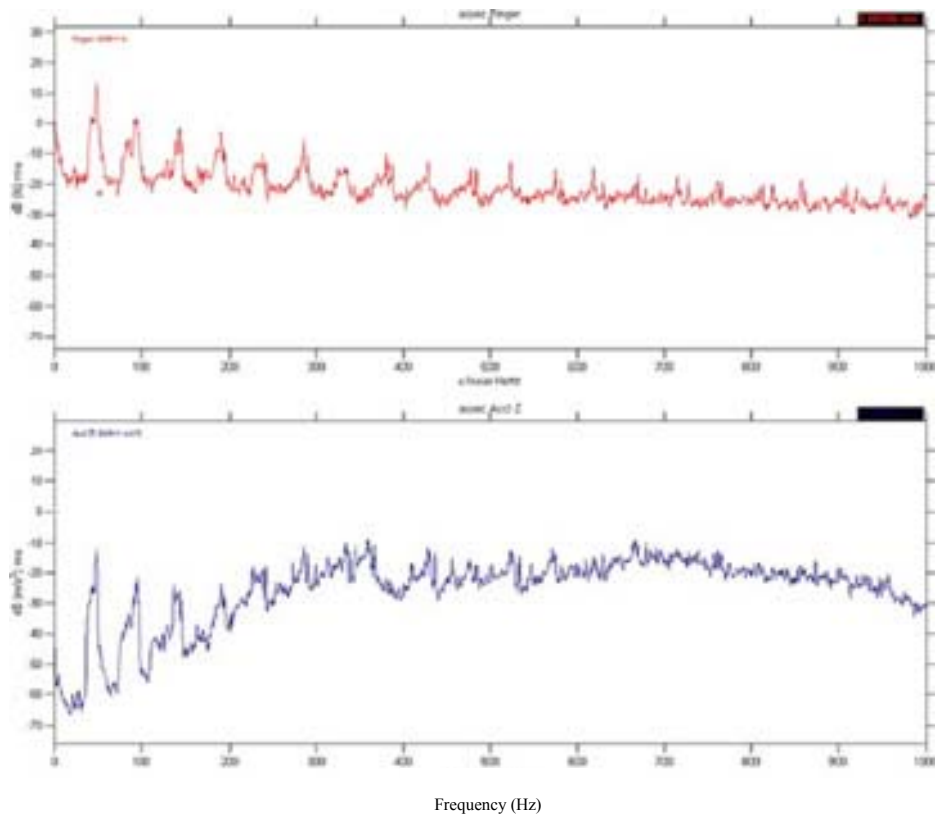
**Figure 7** Force / Acceleration Transfer & Coherence Functions for Continuous Tool 1 from the Index Finger

The relationships between the force transducer and the accelerometer are also shown when measurements were taken from the bony prominence on the palm of the hand. As can be seen, the relationships are very similar to the data from the index finger as shown in Figures 8 and 9. The values of the coherence function are also related to the magnitudes of the signals to the noise. As seen in Figure 10, the regions of low signals will relate to meaningless transfer function with a low value for the coherence function.

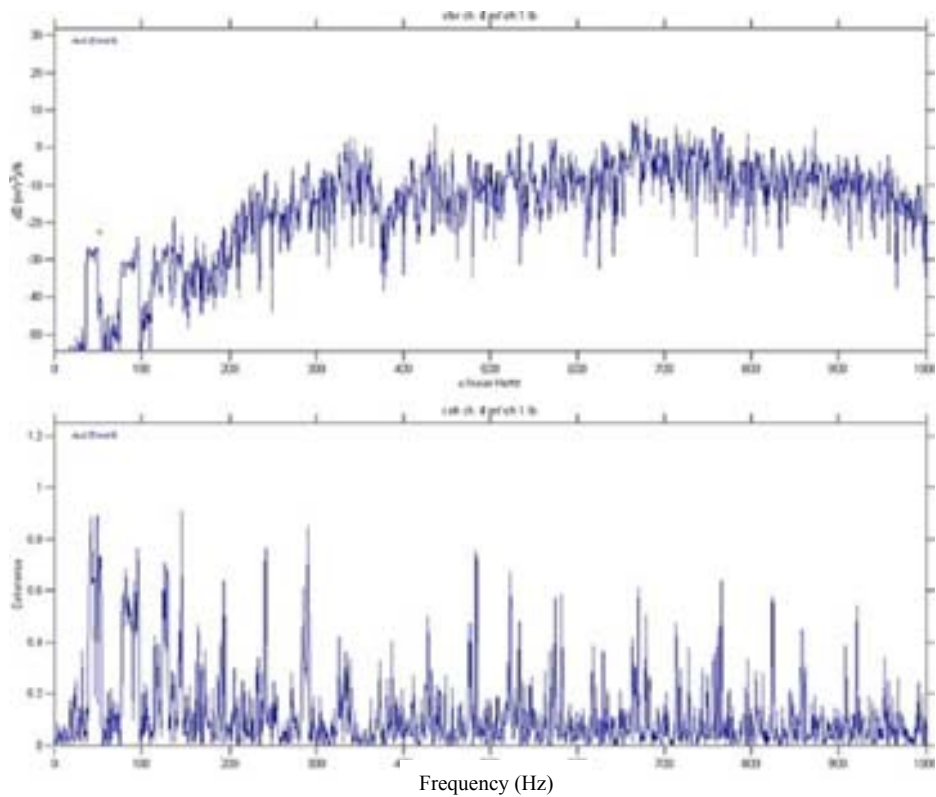
Figures 11 through 14 present the same data taken from the other two tools that have been tested.

The data from continuous tool 2 shows regions of similarity, although there are spike indicated from the force transducer that are not seen on the accelerometer.

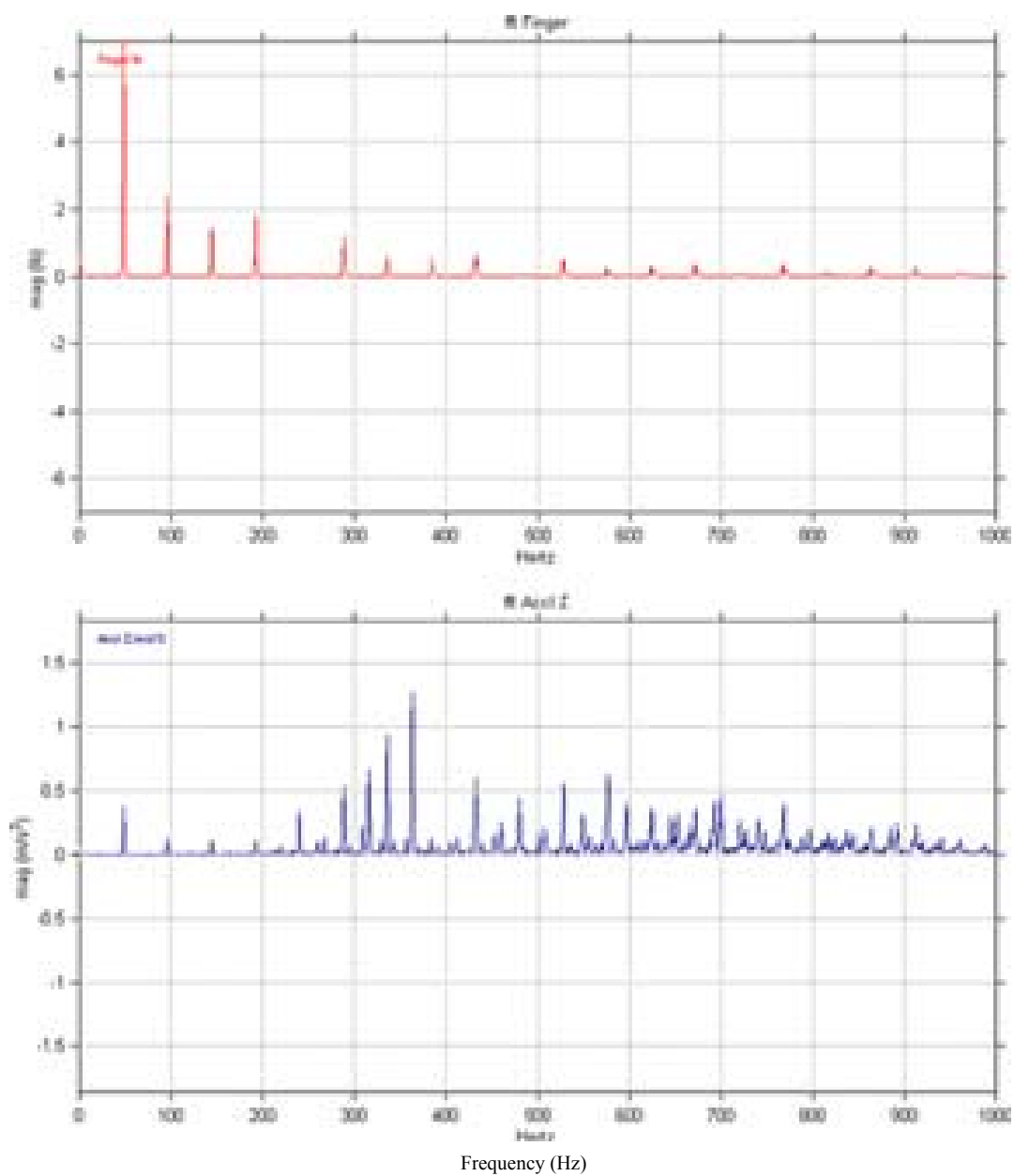
The impact tool shows clear agreement between the force and acceleration data from 0 to 250 Hz, however there are added peaks from 300 to 600 Hz shown on the force measurement. These peaks are also shown on the data from the continuous tool 2 force measurements.



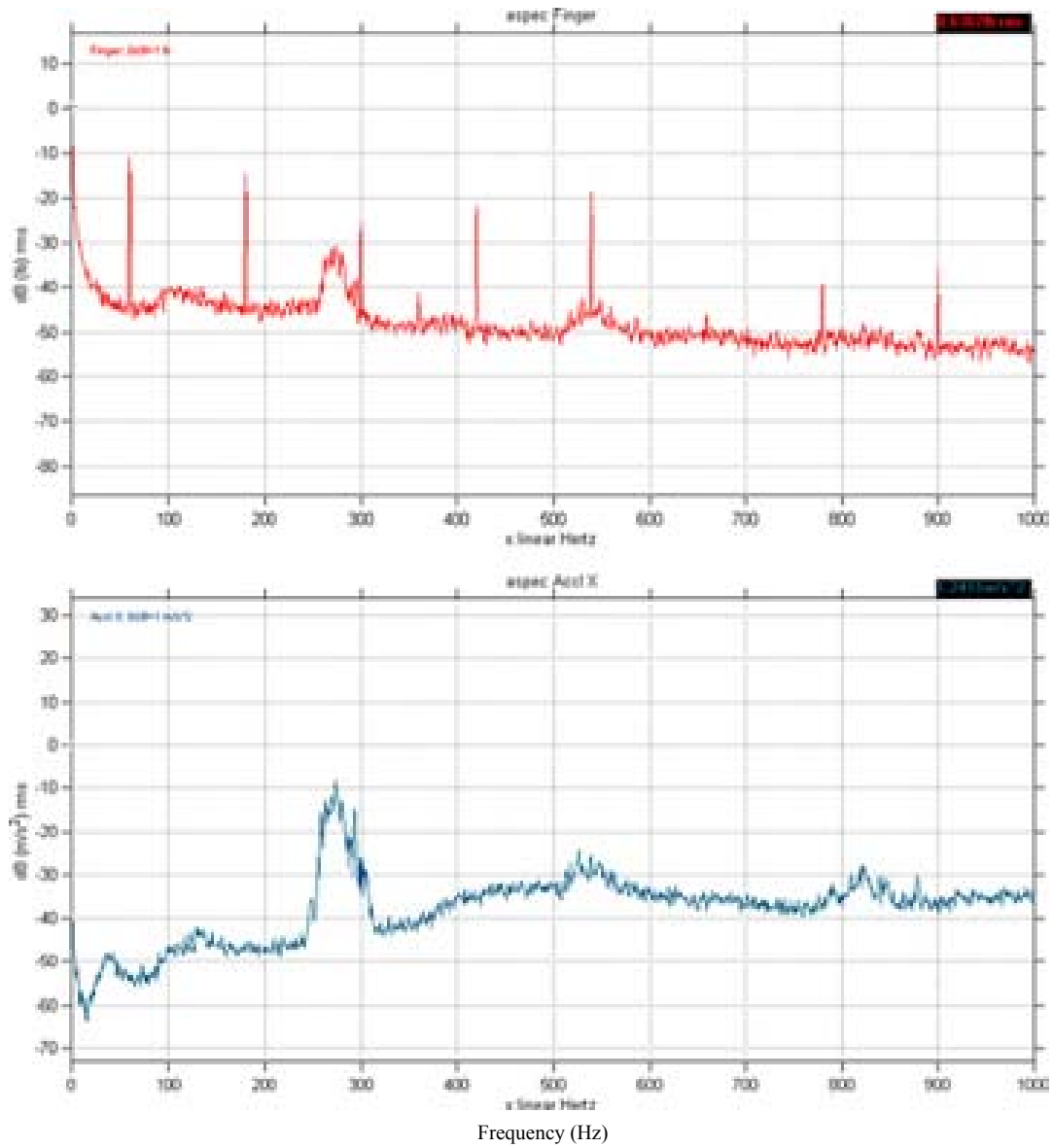
**Figure 8** Acceleration & Force Data for Continuous Tool 1 from Palm (thumb region)



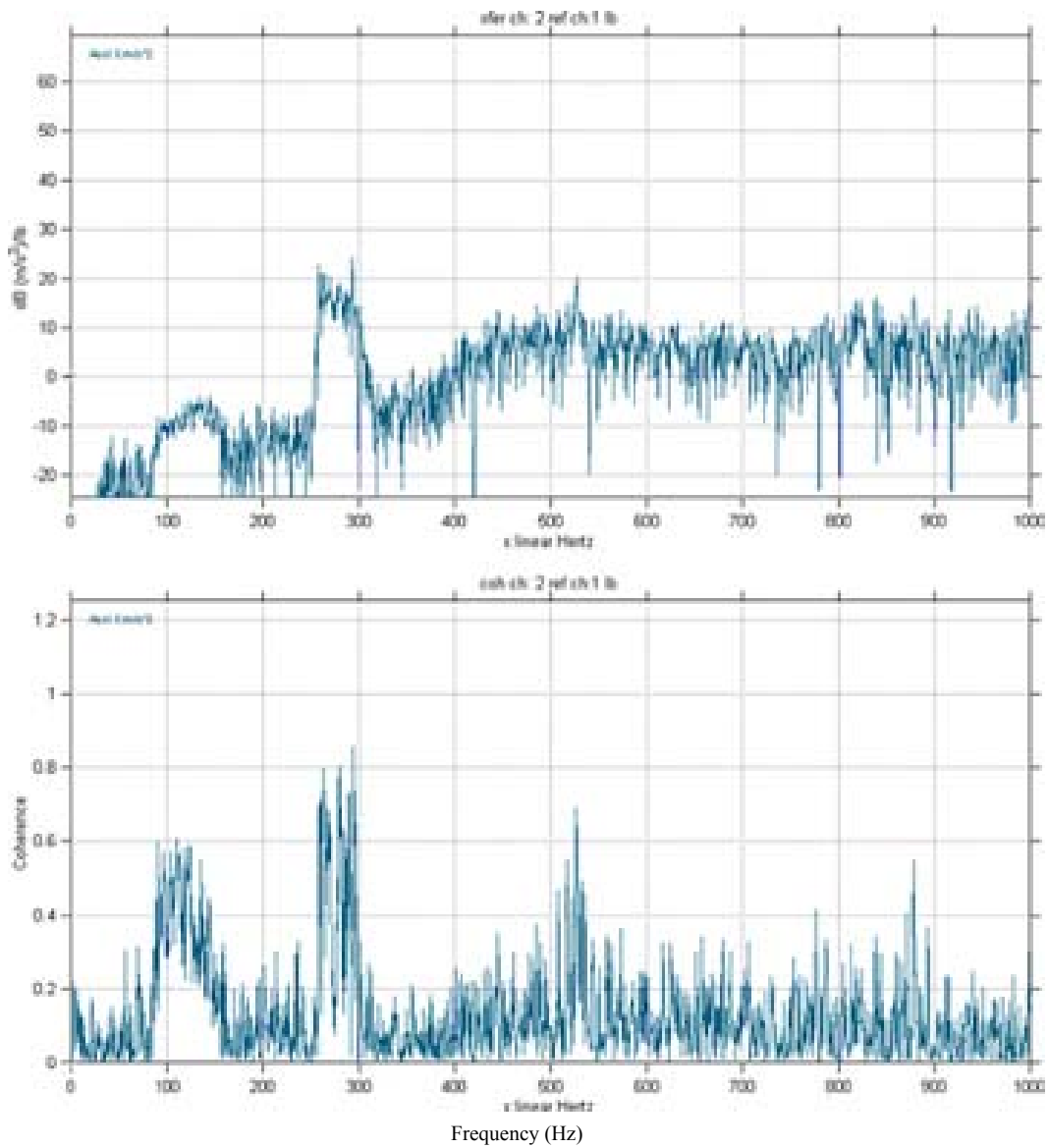
**Figure 9** Force /Acceleration Transfer & Coherence Functions for Continuous Tool 1 from the thumb region



**Figure 10** Acceleration & Force Data for Continuous Tool 1 from Index Finger

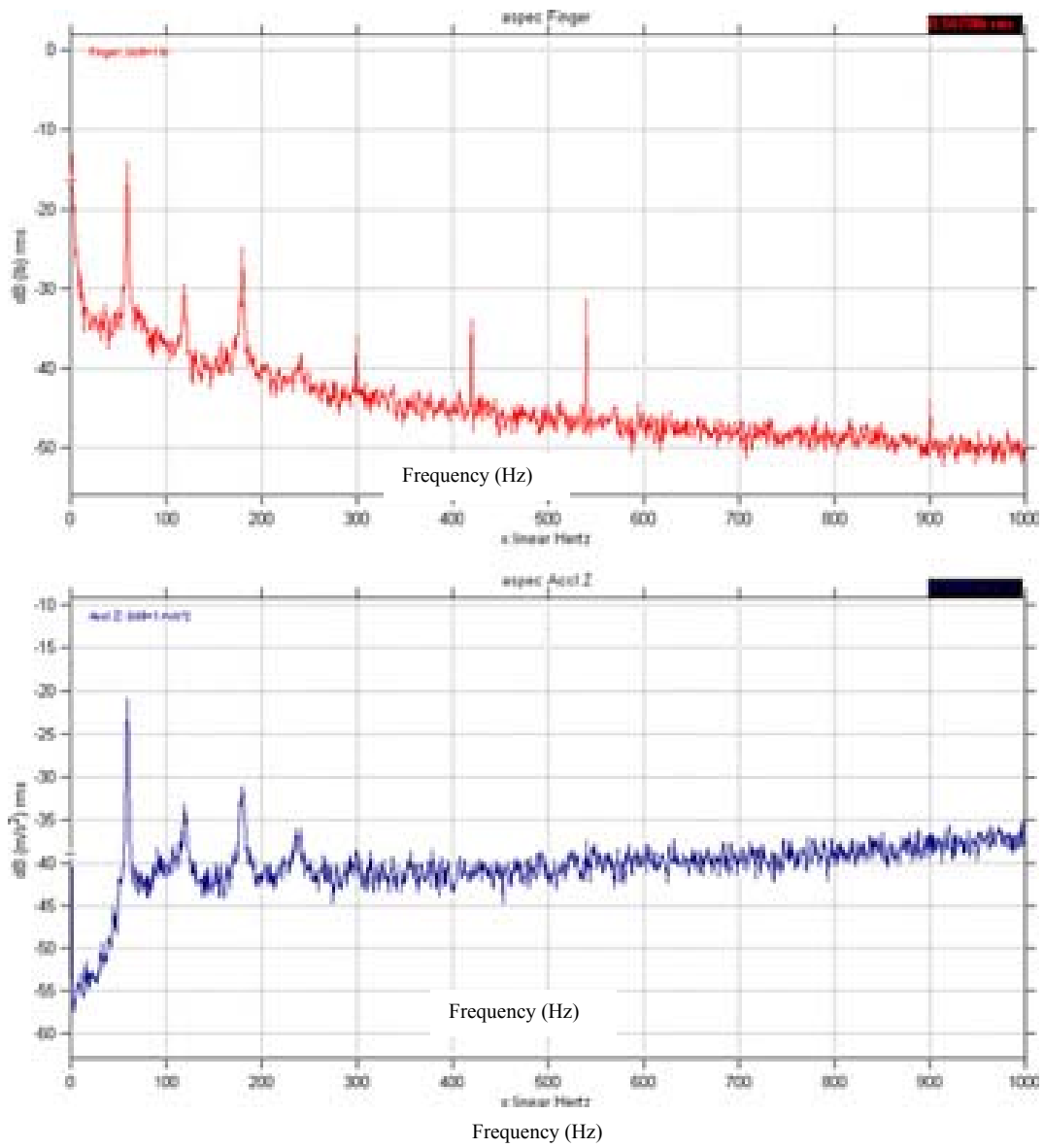


**Figure 11** Force and Acceleration Data for Continuous Tool 2

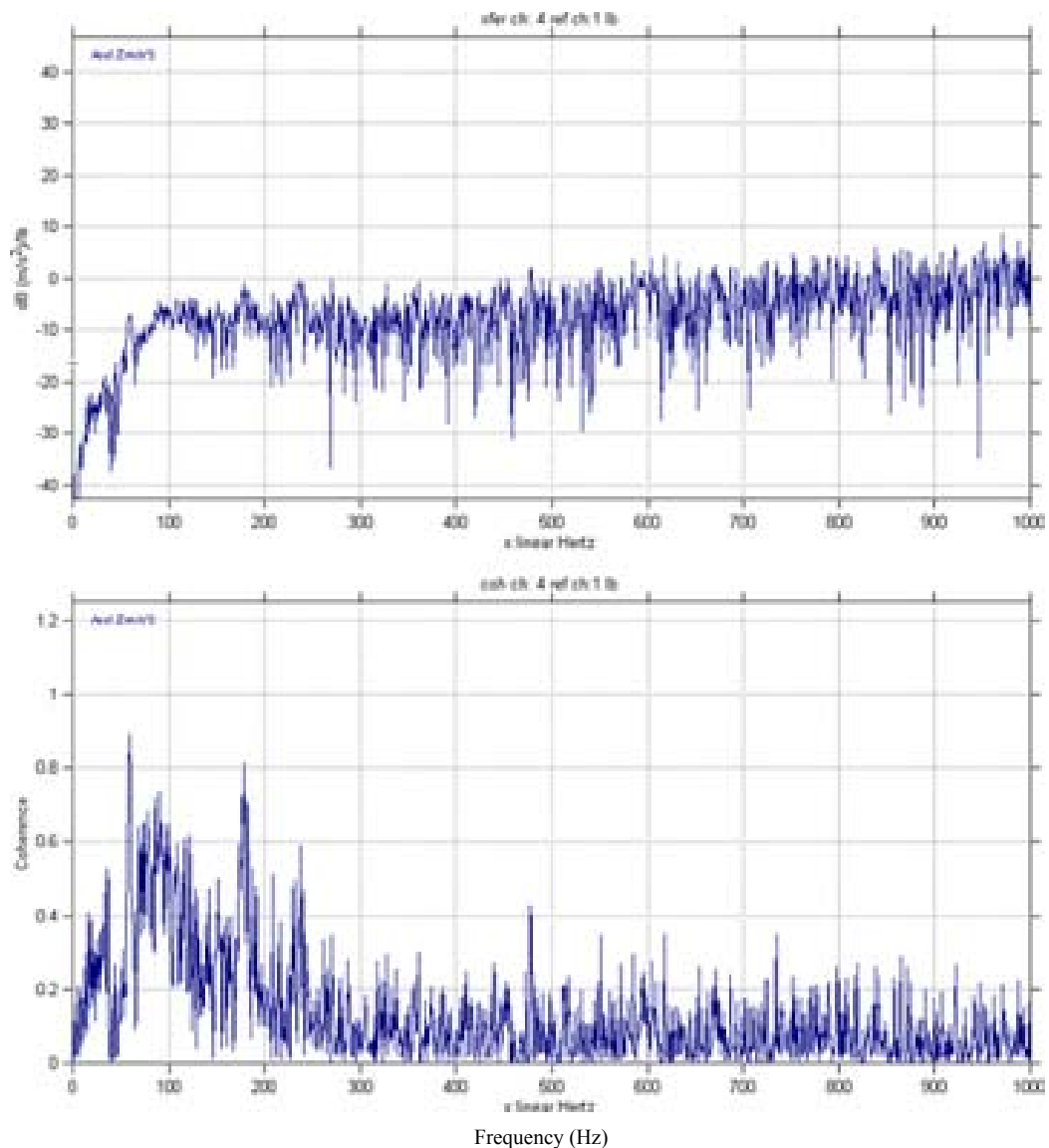


**Figure 12** Force / Acceleration Transfer and Coherence Functions for Continuous Tool 2





**Figure 13** Impact tool force and acceleration data



**Figure 14** Force – Force / Acceleration Transfer and Coherence Functions for Impact Tool

### Discussion

A review of the data shows that for all tools there are regions of agreement between the two different tool measurements. Figure 7 illustrates that there are two areas below 100 Hz where the ratio of the magnitudes is fairly constant and the coherence function has a value of 0.9 for the first region and 0.6 for the second region. The coherence function also shows regions of coherence above 0.5 to frequencies above 900 Hz. The coherence function shows lower values at the higher frequencies. This effect is due to the reduced magnitude of the forces as frequency increases as shown in Figure 10.

A significant observation is that although there are spikes in both the force and accelerometer at the same specific frequencies, the regions of maximum amplitude do not correlate.

The data from continuous tool 2 and the impact tool show that the magnitude spikes from the force transducer does not correlate with the accelerometer. The added spikes represent two factors in the measurements. The force and acceleration measurements are both of lower magnitude than the measurements from the continuous tool 1. The lower magnitudes allow secondary effects to become more obvious.

The most significant factor is that the force transducer for these tests is located on the shaft of the phalangeal bone. Because of the shape of the bone, the transfer of energy can be either the joints or the shaft of the bone depending on the shape of the tool handle. It is believed that the added peaks are the result of the transducer being able to move with the soft tissue from the taped base location. If the pressure is dominantly acting at the joints, the spikes can represent the

resonance of the transducer mounting rather than the motion of the tool. As seen, these spikes are superimposed on the tool forces for both of these tools.

### **Conclusion**

The resistance transducers can provide valuable information on the transfer of energy from the tool to the hand over a wide frequency range. Previous work has shown a linear relationship between a standard force transducer and this pressure resistance sensor. The combination of the ability to measure both the static force and dynamic forces over the wide range is significant.

This system does raise some questions as to the relationship of acceleration to the pressure dynamics experienced by the tissues of the hand; however, the system does have limitations. The system will have alterations in the static load as a function of tool temperature. This factor would require either a combination of compensation or frequent recalibration. For the current system, the long-term effects of pressure on the measurement characteristics has not been determined.

The effects of handle shape on vibrational energy transfer have not been studied. The effectiveness of anti-vibration gloves may be influenced by this effect and this system should be used in the future to better understand the handle shape factors.



**Legal – Focus Session**  
T. Jetzer - Session Coordinator



# **A MEDICAL ASSESSMENT PROCESS FOR A LARGE NUMBER OF MINERS AND EX-MINERS WITH COMPENSATION CLAIMS FOR HAND-ARM VIBRATION SYNDROME**

K. L. McGeoch<sup>1</sup>, I. J. Lawson<sup>2</sup>, F. Burke<sup>3</sup>, G. Proud<sup>4</sup>, J. Miles<sup>5</sup>

<sup>1</sup> 19 Stanely Avenue, Paisley, PA2 9LB

<sup>2</sup> Rolls-Royce plc, P.O.Box 31 Derby DE24 8BJ

<sup>3</sup> Derby Royal Infirmary, Derby

<sup>4</sup> Newcastle Upon Tyne

<sup>5</sup> Dpt Health Sciences, University of York

## **Abstract**

A High Court Judgment found that there was evidence of damage and a breach of a duty of care by British Coal with regard to Vibration White Finger in ex-miners [Armstrong & others 1996].

A medical assessment process (MAP) was developed to determine general damages.

195 doctors underwent a two-day training course. Eighteen examination centers were created across the United Kingdom (UK).

Standardization of the examination process across the UK, was critical to the success of the project. The examination consisted of symptom and medical history questionnaires, clinical examination and use of standardized tests. A modification of the Stockholm Workshop Scales and a scoring system were employed. Over 105,000 examinations have been completed

Analysis of results showed that 4.1% were assessed at 0SN, 18.4% at 1SN, 18.7% at 2 SN early and 36% at 2SN late with 22.9% at 3SN. 24.9% were at 0V, 15.3% at 1V, 37.7% at 2V and 22.1% at 3V

The sensorineural tests overcame the total reliance on the history however the CPT format used in this MAP was shown not to be of value in the assessment of the vascular component of HAVS.

The MAP was a practical method for assessing a large volume of claimants with suspected HAVS.

## **Introduction**

In 1996 a High Court Judgment found that there was evidence of damage and a breach of a duty of care by British Coal. [Armstrong, 1996] The court used the terminology Vibration White Finger. The “date of knowledge” was given as 1<sup>st</sup> January 1975.

On 31<sup>st</sup> December 1998 the British Coal Corporation ceased to exist and its liabilities were taken over by the Department of Trade and Industry (DTI), UK Government.

The claimants were represented by the Claimants Steering Group (CSG) on behalf of some seventy different firms of lawyers.

After all the appeals had been exhausted and to avoid further lengthy court cases, the Parties (DTI and CSG) agreed to a single medical assessment. This examination was to determine the presence or absence of disease caused by previous exposure to occupational vibration and, if present, the extent of the injury.

It was anticipated that there would be a large number of claims but initially it was not expected to reach 150,000. Not all claims fulfilled the criteria of vibration exposure required and some 40,000 were rejected before referral for a medical examination.

In 1998 one of the authors was requested to produce a “Medical Specification” which would be the basis of the single medical examination. With the agreement of the DTI, three other members with extensive experience of the medical aspects of occupational vibration exposure were recruited to form what was called the Independent Medical Advisory Group (IMAG). (Appendix 1)

The process described in this paper refers only to (a) general damages assessment and (b) labour market restriction. The severity of disability, such as fitness for gardening and car washing, was out-with the remit of IMAG.

The only instruction from the DTI was that the process should be fair to the claimant and fair to the taxpayer.

At the beginning, the DTI and the CSG wanted to use the Taylor Pelmear Classification and did not want to include any tests. Eventually the Parties were persuaded to recognize the importance of the neurological damage and agreed to the use of the Stockholm Workshop Scales (SWS) and the inclusion of the recommended tests. They also agreed a matrix of compensation scales based on the SWS for a) and b) above.

From the start it was obvious that there were political and legal dimensions. There were to be tight timescales for the completion of the contract. Every detail of the medical assessment process (MAP) had to be agreed by the Parties and this led to delays and to some aspects of the MAP being agreed without referral to IMAG.

The problem for IMAG was to create a MAP that would give similar results from all centers across the U.K. Software was developed to aid the required standardization.

The format, created under the guidance of Professor W. Taylor and used by Mitsui Babcock since 1990 and Rolls-Royce plc since 1995, was taken as the basis for the examination process.

The introduction of the neurological component in the Stockholm Workshop Scales opened the way for the assessment of the neurological damage caused by exposure to vibration.

The tests in the MAP were called standardized tests because criteria standards were defined and supported by normative data and only one test was truly objective. In the MAP the five standardized tests were the vibrotactile thresholds test (VTT) [Hayward R et al, 1986], [Harada N et al, 1991] and thermal aesthesiometry, (TA) [Ekenvall L et al, 1986] [Swerup C, 1987]. Purdue pegboard test (PPT) [Reddon JR et al, 1988], [Tiffin J et al, 1988] and grip strength using a Jamar dynamometer [Mathiowetz M et al, 1985], and a cold provocation test. (CPT) [Lindsell C J et al, 1998].

The rationale for the choice of the VTT and TA was based on the work by Mountcastle and others [Mountcastle, 1984]. Vibration stimulates a variety of mechanoreceptors, end organs and nerve fibers. Meissner corpuscles or fast adapting 1 (FA1) respond to frequencies between 5Hz and 60Hz while Pacinian corpuscles or fast adapting 11 (FA11) react to frequencies between 50Hz and 400Hz These signals are transmitted by the large myelinated A alpha and A beta fibers [Mountcastle, 1984].

There are cold and warm receptors in the skin of the fingertips. Messages from the cold receptors are transmitted by the small myelinated A delta fibers while those from the warm receptors use the unmyelinated C fibers.

The TA examined the cold receptors and the A delta fibers and the warm receptors and C fibers. The Temperature Neutral Zone (TNZ) was found by subtracting the cold threshold from the warm threshold.

Previous publications have described the use of such a scoring system but the populations have been relatively small [Lawson IJ, 1997], [McGeoch KL, 1994], [McGeoch KL, 2000].

Following publication of the ISVR/HSE Research report No 197 it was possible to refine the scoring system [Lindsell C, 1998]. (Table 1)

**Table 1** Scoring system for the VTT, TA and CPT tests

VIBROTACTILE THRESHOLD (VTT) Index and little finger		
At 31.5 Hz < 0.3 ms <sup>2</sup> = 0	0.3 ms <sup>2</sup> < 0.4 ms <sup>2</sup> = 1	0.4 ms <sup>2</sup> = 2
At 125 Hz < 0.7 ms <sup>2</sup> = 0	0.7 ms <sup>2</sup> < 1.0 ms <sup>2</sup> = 1	1.0 ms <sup>2</sup> = 2
THERMAL AESTHESIOMETRY (TA) (1°/SEC Index and little finger)		
Temperature Neutral Zone < 21°C = 0	21°C < 27°C = 2	27°C = 4
COLD PROVOCATION TEST (15°C FOR 5 MINS, 10 MINS RECOVERY)		
T(+4°) 300 SECS = 0	> 300 SECS 600 SECS = 1	> 600 SECS = 2



Raw scores on the VTT and TA were converted by the software into a points system; these points were then combined with equal weighting to generate an automatic neurological stage. The neurological component of the SWS was changed to include the appropriate combined score for each stage as shown in Table 2.

**Table 2** Modification of the Stockholm Workshop Scales for the sensorineural component.

STAGE	CRITERIA	ASSESSMENT	
		Left Hand	Right Hand
0SN	Vibration exposure but NO symptoms		
1 SN	Intermittent numbness and/or tingling with a sensorineural score of 3 < 6		
2SN (early)	Intermittent or persistent numbness, and/or tingling, reduced sensory perception with a score of 6 < 9		
2SN (late)	As 2 SN (early) but with a score of 9 – 16		
3 SN	Intermittent or persistent numbness and/or tingling, reduced manipulative dexterity and a SN score of 19		

As the standardized tests were not thought to be reliable at stage 1SN this stage could be awarded:

- a) If there was a good history of exposure to vibration and symptom history even when the VTT + TA score was less than 3.
- b) If the claimant was staged at 1V or higher as during vaso-spastic attack numbness and tingling would be experienced.

Stage 2SN was thought to cover a very wide range of neurological damage from claimants with relatively minor symptoms to those with significant sensory loss but short of actually leading to dexterity problem in a warm environment. For this reason the software used the combined VTT + TA score to divide this stage into 2SN early and 2SN late. The latter stage was awarded greater compensation. (Table 2)

Genuine stage 3SN cases were thought to have severe persistent neurological damage. The assessment of this stage undoubtedly caused the greatest difficulties. Before an award of a stage 3SN there had to be a complaint of a loss of dexterity in a warm environment, combined VTT + TA score of equal to or greater than 9, and an abnormal Purdue pegboard test.

With regard to the vascular component a blanching score was incorporated into the staging [ Rigby T A et al 1984], [Griffin M J 1990].

The software used this blanching score to generate an automatic vascular staging. The vascular component of the SWS was amended to include the appropriate range of blanching scores for each stage. Table 3

**Table 3** Modification of the Stockholm Workshop Scales for the vascular component.

STAGE	CRITERIA	ASSESSMENT	
		Left Hand	Right Hand
0 V	No attacks		
1 V	Attacks affecting only the tips of the distal phalanges of one or more fingers – usually a blanching score of 1 – 4		
2 V	Occasional attacks of whiteness affecting the distal and middle (rarely also the proximal) phalanges of one or more fingers – usually a blanching score of 5 – 16		
3 V	Frequent attacks of whiteness affecting all of the phalanges of most of the fingers – usually a blanching score of 18 or more		
4 V	As 3V and trophic changes		

Three pilot centers were commissioned to test the MAP. This required training of both doctors and nurses. After some months the pilot trial was judged to be 'fit for purpose' and a contract was put out to open tender. After the contract was awarded, with a start date of 1<sup>st</sup> August 1999, IMAG was replaced by the Medical Reference Panel. (MRP) consisting of the authors. The MRP had a greater quality assurance role as well as advising on evolving medical problems. (Appendix 2)

### **Claimants**

The claimants were categorized into 3 groups:

1. Claimants thought to have worked in areas where vibration was probably excessive.
2. Claimants whose vibratory exposure was of unknown severity.
3. Claimants with no known vibration exposure.

Claimants in categories 1 and 2 were referred for a MAP examination. A handling company arranged appointments for claimants at the appropriate geographical centre.

All claimants attending underwent the full MAP process even if the history suggested no diagnosis of HAVS.

### **Doctor training**

Doctors, from a variety of backgrounds, were recruited by a Medical Agency to criteria set by IMAG. A training course took two days and consisted of ten or fewer doctors. The first day covered all aspects of HAVS. On the second day the doctors were introduced to the details of the MAP. A satisfactory assessment was required before a doctor was allowed to examine claimants. The first two authors designed and carried out the training.

### **Nurse training**

The nurses were trained to perform the VTT, TA and CPT in a strictly controlled manner, during a course which lasted a day and a half.

### **Medical Assessment Process (MAP)**

To increase the speed of processing claims on arrival, and after initial form filling the claimant took one of two paths:

#### *Path 1*

The examining doctor completed -

- a) occupational history questions.
- b) symptomatology questionnaire.
- c) past medical history questionnaire.
- d) clinical examination

The nurse performed vibrotactile thresholds, thermal aesthesiometry and cold provocation tests.

At this point the results of the VTT, TA and CPT tests were presented to the doctor.

The doctor completed the conclusion section and entered whether they agreed with automatic staging.

#### *Path 2*

As path 1 except nurse performed the VTT and TA prior to the doctor examining the claimant. These test results were not presented until the doctor had completed their examination.

The CPT, when part of the MAP, was always performed after the examination by the doctor.

### **Occupational History of Exposure to Vibration**

The claimant detailed his occupation in the mines and vibratory tools used. Exposure in other employment was also recorded.

### **Symptomatology Questionnaire**

Avoiding the use of leading questions the claimant was asked about his hand problems. This was followed by more careful, focused and discreet questioning to elicit symptoms of blanching or other color changes if not volunteered. If there was a history of cold induced whiteness, information was recorded on when this was first noticed, whether episodes were all year round or just confined to the winter. The blanching score was recorded as described by Rigby and Griffin.

In the neurological section questions were asked about numbness and tingling, when these symptoms started, their distribution and when they occurred. For the sake of uniformity it was agreed that tingling and/or numbness for more than 20 minutes was abnormal and “persistent” referred to tingling and/or numbness that lasted for 2 hours or more. Interference with work, hobbies or sport was recorded. Details of any loss of dexterity in a warm environment were taken.

### **Past Medical History Questionnaire**

Past medical history details, including smoking and alcohol habits, were recorded.

Emphasis was placed on ascertaining whether white finger attacks occurred prior to entering the industry, whether feet, ears or nose were affected and whether there was a family history of Raynaud’s disease in first-degree relatives. Enquiry was made about attacks being precipitated by emotion. [Taylor et al, 1975]

Medication, and its commencement date, particularly for those drugs that could affect symptom presentation e.g. beta-blockers or calcium channel blockers, was recorded along with any effect on symptomatology.

### **Clinical Examination**

The doctors were required to examine the claimant, paying particular attention to abnormalities in cervical spine, shoulders, elbows, wrists and hands, specifically looking for signs of arthritis, circulatory problems, trophic changes, connective tissue problems or muscle wasting. Blood pressure in both arms, radial and ulnar pulses, Allen’s test to assess the vascular status [Ashbell et al, 1967] and Adson’s test to search for a possible thoracic outlet diagnosis [Adson A.W, 1947] were performed. Phalen [Heller L et al, 1986] and Tinel tests [Mossman S.S et al, 1987] were carried out to check if there was evidence of carpal tunnel syndrome.

The doctor carried out a test of dexterity using the Purdue pegboard test (PPT) and grip strength using a Jamar dynamometer. The results of the standardized tests were not presented to the doctor until the clinical examination was completed.

### **The VTT, TA and CPT tests**

All centers performed these tests in a similar environment. ( $22^{\circ}\text{C} \pm 2^{\circ}\text{C}$ ) Calibration and performance of the tests were tightly controlled.

As there is a lack of a gold standard to diagnose any stage of HAVS and as no single test has sufficient specificity or sensitivity previous researchers have recommended the use of a combination of tests to make the staging as accurate as possible. [Pelmeur P et al, 1992], [Working party Fac. Occup Med, 1993], [Health & Safety Executive, 1997]. The vibrotactile thresholds test (VTT) and thermal aesthesiometry (TA) were two of the recommended tests.

All the equipment was manufactured by HVLab, University of Southampton.

The VTT and TA tests were performed on both index and little fingers to test the Median and Ulnar nerves. The VTT was measured at 31.5 Hz and 125 Hz. The TA measured the warm and cold thresholds to find the temperature neutral zone. (TNZ)

In the cold provocation test (CPT) thermocouples were attached to all eight fingers. The hands were placed inside plastic gloves and after a settling period of two minutes, were immersed up to the wrist for five minutes at 15 C (T) and then, following removal of the gloves, the finger skin temperature was monitored for ten minutes after exiting the bath. The time to reach  $T+4^{\circ}\text{C}$  was measured.

### **Diagnosis**

The criteria for the diagnosis of HAVS were a history of exposure to vibration and complaint of appropriate symptoms. Evidence of abnormalities on clinical examination and results from the standardized tests aided the staging of a claimant with HAVS.

## Auditing

Auditing of the MAP reports was an integral part of the process. The results of every MAP examination were held on a database. There was internal auditing by the contract company and external auditing by four senior doctors with experience of HAVS. (Medical Reference Panel) Centre results underwent statistical analyses, the results being compared with the national results.

There was regular auditing of individual doctors and nurses.

## Statistical Methods

For the VTT and TA means and standard deviations of each measure were used to summarize the data for each measure. To examine the distributions, the 20<sup>th</sup>, 40<sup>th</sup>, 60<sup>th</sup> and 80<sup>th</sup> percentiles were calculated. Bivariate (Pearson product moment) correlations were used to examine the relationships between the measures

The vascular findings were subjected to receiver operating characteristic analysis.

## Results

The results from the right hand only are reported in the majority of these results. [Olsen et al 1995]

### Sample

The sample comprised 95599 males, with a mean age of 54.6 (SD 12.23). All had been employed by British Coal.

### Years of exposure

The mean vibration exposure was 21.6 years, range 5 – 45. (SD 10.35)

### Sensorineural Results

The correlation coefficients of the TA and VTT were examined. For the thermal aesthesiometry tests the correlations are all high, and similar to one another – ranging from 0.77 to 0.80, the only exception being the correlation of right hand little finger and left hand index finger, which is considerably lower (although still high), at 0.69.

For the vibrotactile tests, the correlations show a similar set of relationships, although there is a greater range in the size of the correlations, from a maximum of 0.90, to a minimum of 0.59. With the vibrotactile tests, there is a tendency for the correlations amongst similar measures to be higher. The correlations between measures on the same hand are higher than the correlations between hands.

### Sensorineural staging

The overall sensorineural breakdown by stages is shown in table 4.

**Table 4** Sensorineural staging right hand

<b>0SN</b>	<b>1SN</b>	<b>2SN(early)</b>	<b>2SN(late)</b>	<b>3SN</b>	<b>Number</b>
3880	177556	17870	34448	21845	95599
4.1%	18.4%	18.7%	36.0%	22.9%	100 Percent

### Vascular results

The findings were subjected to receiver operating characteristic analysis. This showed the area under the curve of 0.54 for both left and right hand, with 1.0 representing a perfect diagnosis and 0.50 representing a chance finding. Clinical severity correlated only very slightly with test results.

## Vascular staging

Table 5 shows the overall vascular staging.

**Table 5** Vascular staging right hand

<b>0V</b>	<b>1V</b>	<b>2V</b>	<b>3V</b>	<b>4V</b>	<b>Number</b>
23782	14582	36005	21168	62	95599
24.9%	15.3%	37.7%	22.1%	0.1%	100 Percent

A separate review process of the 62 stage 4 cases failed to confirm this staging and they were all relocated to other grades.

## Facts and figures

There were 18 examination centers spread across England, Scotland and Wales.

More than a 105,000 examinations have taken place in the centers. Domiciliary visit examinations were kept on a separate database and are not reported.

At the height of the contract 1,000 examinations were performed in a week.

195 doctors were trained in courses of 10 or less.

184 nurses were trained to perform the VTT, TA and CPT.

The average doctor examination time was 38 minutes.

VTT average time was 18 minutes, TA time 31 minutes and CPT 21 minutes.

The overall assessment time averaged 1 hour 48 minutes prior to removal of the CPT and 1 hour 27 minutes after removal of the CPT. In practice the claimant was in the Centre for over two hours.

## Discussion

Unfortunately British Coal's records of vibration exposure and dosage were either very poor or non-existent, ruling out reliable dose related findings. The duration of exposure to vibration given by the claimants during the examination rarely agreed with that suggested by the Coal Board records.

The MAP had to be constructed to take account of the large number of claimants to be examined by one of 195 doctors who seldom had any previous experience of HAVS.

Across the country there was a crucial need for standardization of the examination by the doctor, performance of the tests and in the final staging. This resulted in the examining doctor's power to override the built-in automatic software staging being strictly limited. Although this built-in rigidity had its drawbacks it has allowed the MAP to process 105,000 claimants in a relatively short time.

The doctor's diagnosis of the presence or absence of HAVS was the most important decision. This was based on the history of exposure to vibration and the presence of symptoms compatible with such a diagnosis. It was emphasized if the history was not consistent with a diagnosis of HAVS, the doctors had to record their reasons for their decision.

A database held the results of every examination. There was internal auditing by the contract company and external auditing by the MRP. Centre results underwent statistical analyses, which were compared with the national results. There was extensive auditing of individual doctor's results again for comparison with the overall national figures. The nurses also underwent auditing.

In view of the correlations found for the VTT and TA we are of the opinion that the benefit from testing the different end organ receptors and nerve pathways, when arriving at a sensorineural staging, has been demonstrated. However, even with this large population, we could not recommend one test as superior to the other. We investigated using the actual test results rather than the scoring system but did not find that this was of greater benefit.

Unfortunately the same cannot be said for the CPT. Two samples of some 20,000 cases showed only very weak association between the test results and the final vascular staging. After confirmation of these findings the CPT was

withdrawn from the MAP [Lawson I J et al, 2001, Proud G et al, 2003]. This action generated considerable controversy and debate amongst those specialists interested in HAVS and the Parties. However this lack of association had been previously found in other publications. [McGeoch KL, 2000], [Mason H, 2003].

Removal of the one truly objective test left the vascular staging entirely dependent on the history given by the claimant.

The best available estimate the authors were able to ascertain for the total mining workforce during this period was 300,000 miners. This estimate suggests that only between one third and one half of that population have been examined. This needs to be considered when interpreting our apparently high prevalence data.

### **Problems Experienced**

From the outset the need for each minute detail of the MAP to be agreed by the Parties caused frequent delays. Parts of the MAP had not been adequately tested prior to being included.

The fact that the claimants' solicitors could walk away from the agreed contract at any time gave them a very strong hand which they undoubtedly used.

Most of the normative data had been derived from working age populations and many in this cohort were above 65 years.

Research was not part of the remit of either IMAG or the MRP and was not funded. However access to the database was freely available.

The MAP was designed to allow time for the doctor to examine three claimants per session. This happened in the pilot trial. Unfortunately the Parties agreed to allow the service provider to allocate four claimants per session.

The MAP was not ideal where so many of the claimants were old with the associated degenerative diseases. Some had a short life expectancy. This led to pressure on the Government by the members of parliament representing the miners who demanded rapid settlements. This had the effect that not all medical aspects were decided by the MRP.

Auditing during the pilot trial had been detailed and satisfactory. However the tight timescales set at the onset of the contract meant that all the effort was put into opening new centers and for a period there was very limited internal or external auditing. Initial analysis of the different centre and doctor results showed that the required consistency across the country was not being achieved. When this was recognized steps were taken to remedy the problem with both internal auditing and externally by the MRP.

Because of these auditing problems analysis of the database has always looked at the results from the different periods of contract.

Some important problems, such as the diagnostic criteria regarding carpal tunnel syndrome, were not resolved before the contract started.

Early in the contract a problem arose with "late onset of symptoms". That is when symptoms first occurred more than two years after the exposure to vibration had ceased. Regrettably the Parties agreed a solution without consultation with the MRP.

For the sake of standardization the inbuilt rigidity required emphasis to be placed on the VTT and TA scores. This gave rise to anomalies when the automatic neurological staging was in conflict with the history.

Attempts at cheating were a definite but small factor. Several pamphlets listing the answers to questions were left by claimants in the centers! There was a web site explaining how to cheat at the tests but this was rapidly closed down.

Many lessons have been learned throughout the process that would help avoid mistakes in the future.

### **Conclusions**

Expensive litigation schemes are never likely to be based entirely on medical grounds and free of the political and partisan interference experienced with this contract.

The total cost to the UK Government is roughly 4 billion pounds. (approximately \$6,800,000,000)

The CPT format used in the MAP should not be used to evaluate the vascular component of HAVS in individual claimants.

The use of the sensorineural tests overcame the total reliance on the history given by the claimants. The correlations within the VTT and TA demonstrated the internal consistency of the tests and thus the test scores were consistent with reliable measures. This justifies their use until truly objective tests become available.

It is possible to process a large number of claimants in a standardized manner in a relatively short time.

### Appendix 1

The IMAG consisted of:

Professor M. J. Griffin, Dr. I. J. Lawson, Dr. K. L. McGeoch, Professor C.L. Welsh.

### Appendix 2

The MRP consisted of the authors.

Statistician: J. Miles

### References

- Adson A W. Surgical treatment for symptoms produced by cervical ribs and the scalenus anticus muscle. *Surg Gynecol Obstet* 1947; 85:687-700
- Armstrong W J and Others v British Coal Corporation reference number: U953155 Judgment on preliminary issues (High Court of Justice Queen's Bench Division, Law Courts, Newcastle Upon Tyne) 1996
- Ashbell T S, Kutz J E, Kleinert H E The digital Allen test. *Plast Reconstr Surg* 1967; 39:311-312.
- Ekenvall L, Nilsson BY, Gustavson P. Temperature and vibration thresholds in vibration syndrome. *Br J Ind Med* 1986; 43:825-9.
- Griffin M J, ed. Handbook of human vibration. London Academic Press.1990;571-575.
- Harada N, Griffin MJ. Factors influencing vibration thresholds used to assess occupational exposures to hand transmitted vibration. *Br J Ind Med*1991;48:185-92.
- Hayward R, Griffin MJ. Measures of vibrotactile sensitivity in persons exposed to hand transmitted vibration. *Scand J Environ Health* 1986;12:423-27
- Health & Safety Executive. Hand-Arm Vibration HS(G)88;1994:27 & 31.
- Heller L, Ring H, Costeff H, Solzi P. Evaluation of Tinel's and Phalen's signs in diagnosis of the carpal tunnel syndrome. *Eur Neurol* 1986; 25:40-42
- Lawson I J, Nevell D A. Review of objective tests for the hand arm vibration syndrome. *Occ.Med* 1997;47:15-20.
- Lawson IJ, McGeoch KL, Burke F, Proud G, Miles JNV. Cold provocation testing in a large volume of medico-legal compensation claims for HAVS. *Proceedings of the Ninth International Conference on Hand-Arm Vibration*, Nancy, France, 2001
- Lindsell C J, Griffin M J. Standardized diagnostic methods for assessing components of the hand-arm vibration syndrome. Institute of Sound and Vibration Research, University of Southampton for HSE. Contract Research Report 197;1998.
- Mason HJ, Poole K, Saxton J. A critique of a standardized test of finger rewarming after cold provocation in the diagnosis and staging of hand-arm vibration syndrome. *Occup Med* 2003; 53:325-330.
- Mathiowetz M, Kashman N, Volland G, Weber K, Dowe M, Rogers S Grip and pinch strength: Normative data for adults. *Arch Phys Med Rehabil* 1985; 66:69-72.
- McGeoch K L, Harper Gilmour W, Taylor W. Sensorineural objective tests in the assessment of the hand-arm vibration syndrome. *Occ Environ Med* 1994; 51:57-61.
- McGeoch KL, Gilmour WH. Cross sectional study of a workforce exposed to hand-arm vibration: with objective tests and the Stockholm workshop scales *Occup Environ Med* 2000; 1:35-42

- Mossman SS, Blau J N Tinel's sign and the carpal tunnel syndrome. *BMJ* 1987; 297:680.
- Mountcastle VB, Central nervous mechanisms in mechanoreceptive disorders. *American Physiological Society* 1984; 1:789-878.
- Olsen N et al. Clinical and laboratory diagnostics of vascular symptoms induced in hand-arm vibration. Report from discussion group. Proceedings Stockholm Workshop. *Arbete och Hals* 1995;5, pp.181-186.
- Pelmear PL, Wong L, Dembek B. Laboratory Tests for the evaluation of Arm Vibration Syndrome. Proceedings of 6th International Conference on Hand-Arm Vibration. Bonn, 1992:817-826
- Proud G, Burke F, Lawson IJ, McGeoch KL, Miles J. Cold provocation testing in hand-arm vibration syndrome – an audit of the results of the DTI scheme for the evaluation of miners. *B.J. Surgery* 2003; 90: 1076-1079.
- Reddon J R, Gill D M, Gauk S E, Maer M D Purdue Pegboard: test-retest estimates. *Perceptual and Motor Skills* 1988; 66:503 – 506
- Rigby T A, Cornish D Vibration Syndrome Research Panel. Guest Keen, and Nettlefolds (GKN Forgings Ltd.) and Rolls-Royce, Derby (England). 1984
- Swerup C, Nilsson BY. Dependence of thermal thresholds in man on the rate of temperature change. *Acta Physiol Scand* 1987 131, 623-4.
- Taylor W, Pelmear P L Introduction In: Taylor W, Pelmear P L, eds. *Vibration White Finger in Industry*. London: Academic Press 1975; XV -XX .
- Tiffin J, Asher E J. The Purdue Pegboard norms and studies of reliability and validity. *Journal of Applied Psychology* 1948; 32:234 – 247.
- Working Party to Faculty of Occupational Medicine of Royal College of Physicians Report part 1 Hand-transmitted Vibration London: RCP,1993, 11 & 27.



# ADJUDICATION AND WORKERS' COMPENSATION OF HAND-ARM VIBRATION SYNDROME IN QUEBEC: UNRESOLVED PROBLEMS

A. Turcot<sup>1</sup>, S. Roy<sup>1</sup>, P. Duguay<sup>2</sup>, P. Massicotte<sup>2</sup>, P.-É. Boileau<sup>2</sup>, A. Simpson<sup>1</sup>

<sup>1</sup> Institut national de santé publique du Québec, 945, avenue Wolfe, Sainte-Foy, Qc, Canada G1V 5B3

<sup>2</sup> Institut de recherche Robert-Sauvé en santé et en sécurité du travail, 505 De Maisonneuve West, Montréal, Qc Canada H3A 3C2

## Introduction

Studies indicate that exposure to hand-arm vibration is present in many industries and leads to occupational disease compensation claims for hand-arm vibration syndrome (HAVS).<sup>1</sup> <sup>2</sup>This paper presents the preliminary results of an analysis of 392 worker compensation claims that were submitted to the Quebec Workers' Compensation Board (CSST) between 1993 and 2002. The 392 claims were all filed in relation to a white finger vasospastic phenomenon. While the number of occupational disease claims is usually small in comparison to those filed for injury or trauma, those related to HAVS represent only a small proportion of the claims for occupational disease. This paper focuses on the problems related to workers' compensation based on an in-depth study of 150 of these 392 claims.

## Methodology

The files from the CSST's computerized database were selected according to the type of injury called "Raynaud's syndrome" (white finger). The computer data were analyzed whether they were accepted or refused by the CSST. The analyses were done for the following variables: year of claim, age, gender, region, economic activity, profession, location of injury, type of accident, causal agent of injury, number of days compensated, and total disbursement. For the second phase, each compensation file was thoroughly analyzed to extract information on vibration exposure assessment, the reported vascular, neurological and musculoskeletal symptoms, the type of medical examination performed, the number of consultants, the diagnostic methods used, the review of the tests results, the presence of personal and familial diseases, medication, impairment ratings, functional limitations and issues in the rehabilitation process. The data were collected and entered by 3 medical archivists.

## Results

Over the 10-year period from 1993 to 2002, there was an annual average of 30 claims for HAVS in Québec. This number represents less than 0.5% of occupational diseases, which allows the assumption that there was an underreporting of disease for all workers exposed to hand-arm vibration. Of the 392 claims, 7 involve women. The average age of the workers filing claims was established at 48.8 years with a median age of 50 years. The majority of these claims were from workers in the mining and forestry industries.

The presence of carpal tunnel syndrome was documented in 30% of the claims, while hearing impairment was reported in 20% of the claims. Some claims are still under legal dispute. Twenty-five percent of the 392 claims were rejected. On average, each compensated worker was absent for 421 calendar days. This absence is 7.5% longer than in all of the occupational injuries compensated in Québec (56 days). Furthermore, the average disbursement was Can\$35,279 per claim.

Preliminary findings of the analysis of 150 of the 392 claims reveal four types of discrepancies associated with the information reported in the files. These concern: 1) the establishment of the diagnosis and rating the severity of the vasospastic disease. The Stockholm severity classification scheme was not used in the assessment of the compensation claims. The presence of personal conditions such as smoking, diabetes, hyperlipidemia, intolerance to cold and vasospasms in the feet interferes with recognition of the disease. Thrombosis of the ulnar artery is frequently diagnosed in workers operating vibrating tools based on physical examination and/or confirmed by angiography. In this last case, it is hypothenar hammer syndrome<sup>3 4 5</sup>; 2) the use of different, non-standardized clinical tests. The environmental conditions and the interpretation of diagnostic test results vary from one centre to the next. Evaluation with complementary laboratory tests is not uniform in all of the files; 3) the lack of information on vibration exposure. The documentation of types of tools, exposure times and ergonomic and environmental factors is limited and sometimes contradictory. The source of the vibrations is more difficult to establish for certain trades and therefore easily contestable: operators of controls of heavy vehicles and sewing machines, diamond drill operators; and 4) differences in impairment and in functional limitation ratings. The impairment rating varies depending on the combination of severity of symptoms and their impact on leisure activities and on positive results to one of the 2 diagnostic tests, namely the

digital temperature recovery time and digital plethysmography. The recommendations are generally to avoid work with vibrating tools and to limit exposure to cold. In fact, many workers leave their jobs and also their employer.

### **Conclusion**

No formal medical approach has been applied for the recognition of this occupational disease in the compensation claims considered in this study. Some provinces in Canada have developed recognition criteria for the disease. However, abnormality thresholds have to be determined for the different objective tests. The findings indicate the urgent need to develop international guidelines to facilitate recognition of the disease by medical experts and adjudication officials, and at the same time, to allow rehabilitation of affected workers without jeopardizing their health.

### **References**

Pelmear, P.L. Taylor W., Wasserman D.E., Hand-arm vibration, A Comprehensive Guide for Occupational Health Professionals, Van Nostrand Reinhold, New York, 1992.

Lawson, I.J, Mc Geoch K.L., Burke F., Proud G., Cold provocation testing in a large volume of medico-legal compensation claims for HAVS, 9th International Conference on hand-arm vibration, Nancy, France, June 2001.

Cooke R.A., Hypothenar hammer syndrome: a discrete syndrome to be distinguished from hand-arm vibration syndrome, Occupational Medicine, vol.53, 2003, pp.320-324.

Noël B., Pathophysiology and classification of vibration white finger, Int Arch Occup Health, vol.73, 2003, pp.150-155.,

Noël B., Hand-arm vibration syndrome with proximal ulnar artery occlusion, VASA, vol.27, 1998, pp.176-178.

# HAND ARM VIBRATION SYNDROME: AN ANALYSIS OF OCCUPATIONAL MORBIDITY FROM A STATE COMPENSATION DATABASE

C. J. Martin, S. Edla

Institute of Occupational and Environmental Health, Department of Community Medicine  
West Virginia University School of Medicine  
PO Box 9190, Morgantown, West Virginia, USA, 26506-9190

## Introduction

Little is known about the burden of Hand Arm Vibration Syndrome (HAVS) in terms of treatment and indemnity costs for affected workers. In this study, we performed an analysis of the West Virginia Workers' Compensation Commission database (a state-mandated, monopolistic insurance system with near complete coverage of work-related injuries and illnesses for this state's workforce) for claims likely to reflect cases of HAVS.

## Subjects and Methods

We searched the database for the period of fiscal years 1995 – 2000 for compensated claims which included an International Classification of Disease, ninth edition diagnostic code of Raynaud's phenomenon (443.0), or vasospasm of the upper limb (443.9, 354.9, 337.9, 353.0, 353.2, 355.9). The Report of Occupational Injury or Illness forms for these claims were then reviewed. Any claim involving an obvious acute injury was excluded. Exposure to vibration was determined by the worker's description of job duties taken from this form as well as the occupation or industry. Cases were considered probable HAVS if vibration exposure was explicitly described by the worker. Possible cases were those in which significant exposure to segmental vibration could be reasonably inferred from the occupation or industry.

Incidence rates for industries were calculated using the average annual employment for six years in the relevant industries obtained from the state Bureau of Employment Programs. Industry specific relative risks were calculated as the ratio of the incidence of HAVS in that industry to the incidence of HAVS in all other industries. Because denominator data was not available for occupations, proportional injury ratios were calculated as the ratio of the proportion of HAVS cases in a specific occupation to the proportion of HAVS cases in all other occupations.

Cost comparisons to carpal tunnel syndrome (CTS) were made using published data. Cost extrapolations of HAVS to the national level were made assuming 1.45 million workers exposed to segmental vibration with a prevalence of HAVS in this group ranging from 6% to 50% (NIOSH, 1989).

## Results

107 compensated cases were identified in this six year period. 15 cases were considered probable, 92 possible. 68 cases were male and 39 were female with a mean age of 38.6 years. The incidence rate for probable cases was 0.4 per 100 000 person years and for both probable and possible cases 2.7 per 100 000 person years.

The industry and occupation-specific relative risks and proportional injury ratios are shown in Table 1:

**Table 1** Industry and occupation-specific relative risks (RR) and proportional injury ratios (PIR) for HAVS

Industry	RR	95% CI	Occupation	PIR	95% CI
Agriculture, Forestry	17.2*	8.9 – 33.0	Painters	5.9*	2.5 - 14.3
Construction	4.6*	2.9 – 7.4	Welders	2.6*	1.2 - 5.7
Manufacturing	4.7*	3.2 – 6.9	Carpenters	2.6	0.9 - 6.7
Mining	1.9	0.9 -4.1	Laborers	2.4*	1.7- 3.5
Transport	1.1	0.5 – 2.4	Operators	2.0	0.8 - 4.9
Services	0.3	0.1 – 0.5	Machinists	1.6	0.6 - 3.8

\*Statistically significant

The total cost of the 15 probable cases was \$777,212 during the six year period, of which \$285,862 consisted of medical payments and \$491,350 of indemnity costs. For all cases combined, the total was \$5,655,826 with \$2,013,777 medical and \$3,642,049 indemnity costs. The annual median medical cost was \$1530 per probable case with annual

median indemnity costs of \$5459 per probable case. Similar figures were found for probable cases. The annual median number of days lost from work was 40 for both groups.

Extrapolating to the national level, annual medical costs for HAVS range from \$133 million to \$1.1 billion with indemnity costs of \$475 million to \$3.9 billion.

### **Discussion**

A relatively low incidence of HAVS was found in this study. However, since an exclusive case definition based solely on vascular diagnoses was used, this figure is likely to significantly underestimate the true incidence in this population. Industries and occupations with well known elevated risks of HAVS were identified using our approach. These findings suggest that HAVS is a significant source of occupational morbidity both in this population and nationally with annual median medical costs and days lost from work in excess of those of CTS on a per case basis.

### **References**

National Institute of Occupational Safety and Health. 1989. Criteria for a recommended standard: Occupational exposure to hand-arm vibration syndrome. DHHS Publication No. 89-106.

# **HAND-ARM VIBRATION SYNDROME: HEALTH PROMOTION, EDUCATION AND FOLLOW-UP**

L. Brown, I. Kudla, Ron House, M. Wills, P. Pelmeur

Gage Occupational and Environmental Health Unit, St Michael's Hospital and University of Toronto  
Toronto, Ontario, Canada

## **Introduction**

HAVS is a sentinel health event of occupation (SHE (O), the occurrence of which serves as a warning that preventive efforts in the workplace likely need to be improved (Mullen & Murthy, 1991). The incidence of HAVS continues to increase among workers exposed to hand-arm vibration. In response to this trend, we have developed a HAVS Health Promotion & Education Model in conjunction with our specialty clinical assessment and diagnostic services. To evaluate the impact of this comprehensive model of care, we developed a HAVS Follow-up Questionnaire, which serves as an opportunity to reinforce health promotion and education, as well as monitor the worker's progress.

## **Objectives**

To develop a pilot project to assess the impact of the HAVS clinical assessment and health promotion/education model on long term functional outcomes, including occupational and non-occupational components.

## **Methods**

The development of the HAVS Health Promotion & Education Model includes the provision of advice regarding reducing risk factors for HAVS, symptom management and return to work issues. It utilizes a multidisciplinary team approach, with input from an occupational health physician, nurse practitioner, clinical occupational hygienist and laboratory technician. Information given to workers is also provided in a HAVS Display, consisting of pocket cards, information sheets and samples of antivibration gloves.

The HAVS Follow-up Questionnaire includes items from the Disabilities of the Arm-Shoulder-Hand (DASH) questionnaire (IWH, 1997), including the expanded work module, and the Laura Punnett Biomechanical Risk questionnaire (Punnett, 1998). The questions assess the impact of the hand-arm-shoulder problem on ability to work, including the use of personal protective equipment and workers' compensation issues, symptom management and quality of life. The questionnaire will be administered twice, including 6-months and 12-months following the initial clinical assessment.

## **Results**

The prospective analysis will provide a preliminary review of the data collected starting March 1, 2004. It will also highlight the components of the HAVS Health Promotion & Education Model and interventions that will have an impact on long term functional outcomes.

## **Summary**

We propose that an integral component of the HAVS comprehensive model of care is the multidisciplinary team approach to HAVS health promotion, education and follow up.

## **References**

Institute for Work and Health (IWH) and the American Academy of Orthopaedic Surgeons and COMSS (1997). DASH: Disabilities of the arm, shoulder and hand.

Mullan, RJ & Murthy, LI (1991). Occupational Sentinel Health Events: An updated list for physician recognition and public health surveillance. *American Journal of Industrial Medicine* (19): 775-799.

Punnett, L. (1998). Ergonomic stressors and upper extremity disorders in vehicle manufacturing: Cross sectional exposure-response trends. *Occupational & Environmental Medicine* (55): 414-420.



## **Measurement V**

N. Mansfield - Session Coordinator





# MAGNITUDE DEPENDENCE OF EQUIVALENT COMFORT CONTOURS FOR VERTICAL HAND-TRANSMITTED VIBRATION

M. Morioka and M. J. Griffin

Human Factors Research Unit, Institute of Sound and Vibration Research, University of Southampton, Southampton, SO17 1BJ, England

## Abstract

The strength of sensations caused by hand-transmitted vibration depend on the frequency and the magnitude of the vibration. Absolute perception thresholds, and the dependence of discomfort on vibration frequency (8 to 400 Hz) and vibration magnitude (0.16 to 99 ms<sup>-2</sup> r.m.s. and 0.002 to 0.126 ms<sup>-1</sup> r.m.s.), were determined for vertical vibration with a handle-grasping posture. The perception thresholds depended on vibration frequency with a U-shaped contour showing greatest sensitivity to acceleration around 125 Hz. The frequency-dependence of equivalent comfort contours strongly depended on vibration magnitude. At the higher vibration magnitudes investigated (greater than about 2 ms<sup>-2</sup> r.m.s.), the equivalent comfort contours were consistent with frequency weighting  $W_h$  as used in current standards for evaluating hand-transmitted vibration. At low vibration magnitudes, the shapes of the comfort contours were not the same as the reciprocal of the  $W_h$  frequency weighting. The results are partly explained by the receptor characteristics of the Pacinian and non-Pacinian systems in the glabrous skin of the hand.

## Introduction

Exposure to hand-transmitted vibration can cause discomfort and interfere with activities (Griffin, 1990). Vibration can also cause injury, including vascular and neurological disorders (Bovenzi, 1990), with more than 1 million workers in the UK estimated to be at risk (Palmer *et al.*, 2000). The European Physical Agents (Vibration) Directive (that comes into force in 2005) requires the minimization of risks from exposure to hand-transmitted vibration.

The current International Standard (ISO 5349-1, 2001) and British Standard (BS 6842, 1987) define a single frequency weighting,  $W_h$ , for the evaluation of human exposure to hand-transmitted vibration in any axis. The  $W_h$  weighting indicates greatest sensitivity to acceleration at frequencies between 8 and 16 Hz and sensitivity to acceleration reducing in proportion to frequency at frequencies greater than 16 Hz. Although all risks from hand-transmitted vibration are unlikely to be predictable from a knowledge of which vibration feels worst, the strength of sensation has greatly influenced the minimization of exposures to hand-transmitted vibration. The  $W_h$  weighting was derived from equivalent comfort contours and perception threshold contours determined by Miwa (1967) over the frequency range 3 to 300 Hz with the hand pressing on a flat plate.

Although it is intuitively obvious that increasing the vibration magnitude will result in increased discomfort, little is known about the rate at which discomfort increases with increasing vibration magnitude or how the frequency-dependence of sensitivity above thresholds (i.e. the shapes of equivalent comfort contours) depend on vibration magnitude.

Of four types of tactile receptor in the glabrous skin of the hand, two are fast adapting (i.e. FA I and FA II) and two are slow adapting (SA I and SA II) (Johansson and Vallbo, 1979). By 'masking' the threshold for feeling a vibration (i.e. the threshold is raised by a different type of vibration) three receptors (i.e. SA II, FA I and FA II) have so far been found to influence the detection of hand-transmitted vibration (Morioka and Griffin, 2004, awaiting publication). However, it is not known which receptors are involved in sensations (e.g. discomfort) at magnitudes above perception thresholds, which receptors are damaged by vibration, or what effect this damage has on the sense of touch.

The present study examines the effects on the discomfort caused by hand-transmitted vibration of vibration frequency, over the range 8 to 400 Hz, and vibration magnitude, from threshold levels to levels associated with discomfort and injury.

## Method

### Subjects

Twelve males with a mean age of 24.5 years (standard deviation, SD=1.7), a mean stature of 178.8 cm (SD=3.6) and a mean weight of 75.6 kg (SD=9.7) participated in the experiment.

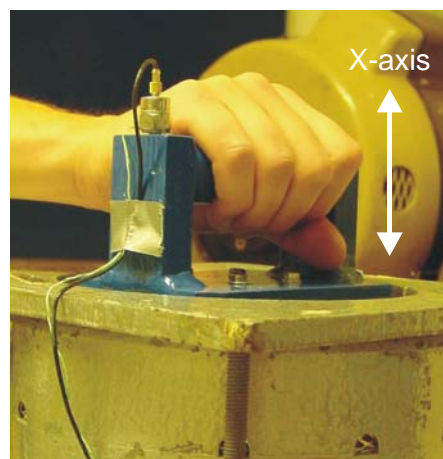
Skin temperatures of the hand were measured at the beginning of each session using the *HVLab* Tactile Aesthesiometer (by means of thermocouples). The tests only proceeded if the skin temperature was greater than 29 °C; the subjects were asked to warm up their hands if the temperature was below this criterion. The room temperature was 21 ± 2 °C. During the tests, the subjects were exposed to white noise at 75 dB(A) via a pair of headphones in order to prevent them from hearing the vibration and to assist their concentration on the vibration by masking any distracting sounds.

### Apparatus

The subjects were exposed to vertical hand-transmitted vibration via a 30 mm diameter handle mounted on a Derritron VP30 electrodynamic vibrator, or a Derritron VP 4 electrodynamic vibrator for perception threshold measurement. The vibration presented by the vibrators was acquired during the experiment by means of piezoelectric accelerometers attached on the handle. Cross-axis motions were also measured and were found to be less than 5% of the magnitude in the generated axis. Background vibration due to electric noise at 50 Hz was not perceptible (less than 0.008 ms<sup>-2</sup> r.m.s.).

### Stimuli and Procedure

The subjects were instructed to grasp the handle lightly and comfortably. Their forearms were positioned horizontal and level with the vibrating handle (no armrest) during the measurements. The vertical axis of vibration transmitted to the hand through the handle was perpendicular to the handle; the hand posture and axis of vibration are shown in Figure 1.



**Figure 1** Hand posture and axis of vibration.

Judgments of discomfort caused by the hand-transmitted vibration were determined using the method of magnitude estimation. A set of two motions, reference motion and test motion, were created; each motion lasted 2 seconds with an interval of 1 second between the motions. The motions had 0.5-second cosine-tapered ends. The reference motion was 5.0 ms<sup>-2</sup> r.m.s. at 50 Hz. The test motions were randomly selected from a range of frequencies from 8 to 400 Hz (in one-third octave steps). The test motions varied in velocity from 0.002 to 0.126 ms<sup>-1</sup> r.m.s. in 3 dB steps, corresponding to a minimum acceleration of 0.16 ms<sup>-2</sup> r.m.s. (at 12.5 Hz) and a maximum acceleration of 99 ms<sup>-2</sup> r.m.s. (at 125 Hz). The task of the subjects was to assign a number that represented the discomfort of the test motion relative to the reference motion, assuming the discomfort caused by the reference motion corresponded to '100'.

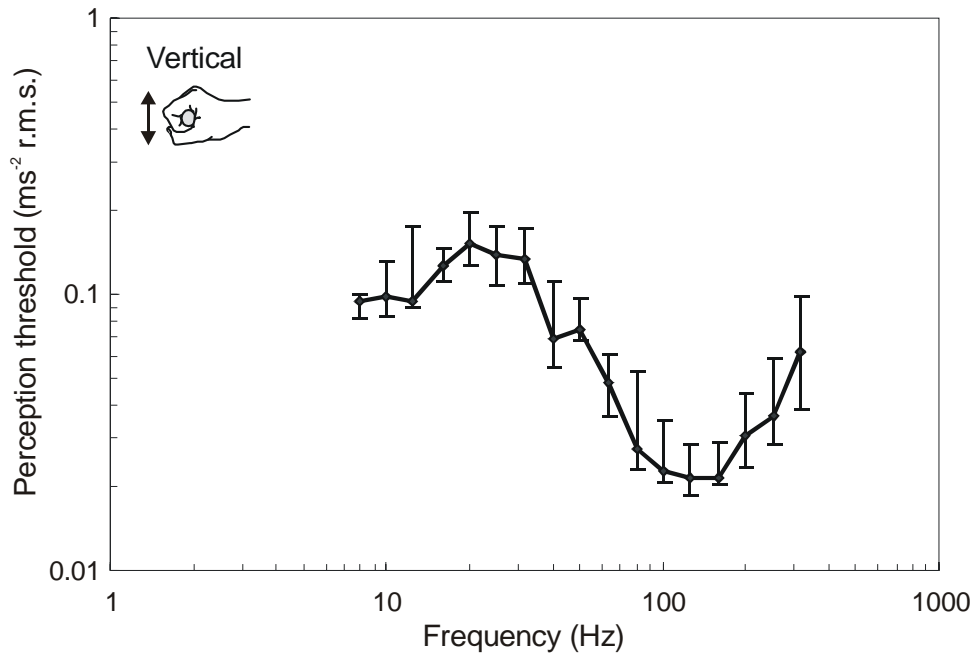
In a separate session, absolute thresholds for vibration perception were determined for frequencies from 8 to 315 Hz using the staircase method in conjunction with a three-down one-up rule. The threshold was calculated from the mean of the last two peaks and the last two troughs, omitting the first two reversals.

## Results

### Perception Thresholds

Median absolute thresholds of perception and the inter-quartile range (25<sup>th</sup> to 75<sup>th</sup> percentiles) for 12 subjects determined at each frequency over the range 8 to 315 Hz are shown in Figure 2. The perception thresholds strongly depended on vibration frequency (Friedman,  $p < 0.001$ ), presenting a U-shaped acceleration threshold contour with greatest sensitivity around 125 Hz. There were no significant differences in acceleration threshold between 12.5 and 31.5 Hz (Wilcoxon,  $p > 0.18$ ) or between 100 and 160 Hz (Wilcoxon,  $p > 0.09$ ). The results are similar to the perception threshold contours for hand-transmitted vibration determined in other studies (Miwa, 1967; Reynolds *et al.*, 1977; Brisben *et al.*, 1999; Morioka and Griffin 2000; Morioka, 2003).

High correlations in thresholds obtained at two frequencies may indicate that the detection response is mediated by the same receptor: a subject having a high threshold at one frequency would be expected to have a high thresholds at another frequency mediated by the same receptor. Consequently, if the same receptors are involved, thresholds will tend to be correlated between frequencies. There were high correlations between thresholds obtained at frequencies greater than 20 Hz (51 of 79 combinations being significant for Spearman  $r^2 > 0.6$ ,  $p < 0.05$ ).



**Figure 2** Median absolute perception thresholds determined between 8 and 315 Hz. Error bars represent inter-quartile range

#### *Growth of sensation*

The relationship between sensation magnitude,  $S$ , and vibration magnitude,  $a$ , was established for each frequency using Steven's Power law with an additive constant assuming no sensation below the perception threshold:

$$S = k(a - a_0)^n \quad (1)$$

where  $k$  is a constant,  $a_0$  is the perception threshold, the exponent  $n$  describes the rate of change of sensation with vibration magnitude,  $a$ . Linear regression was performed for each frequency (see Figure 3 for an example) using:

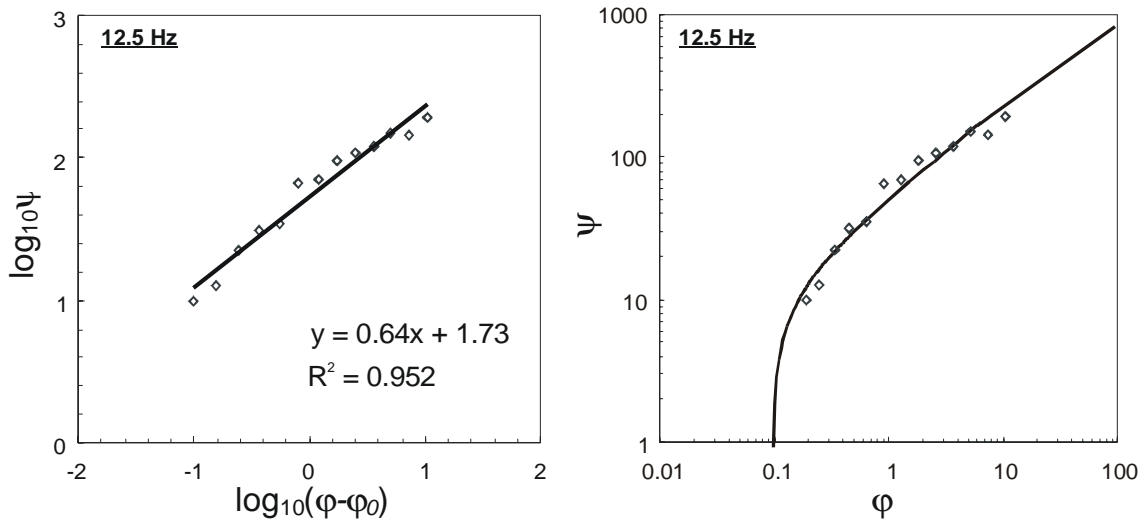
$$\log_{10} S = n \log_{10}(a - a_0) + \log_{10} k \quad (2)$$

The rate of growth of sensation,  $n$ , depended on frequency (varying from 0.14 to 0.73), with a decreased rate of growth with increasing frequency.

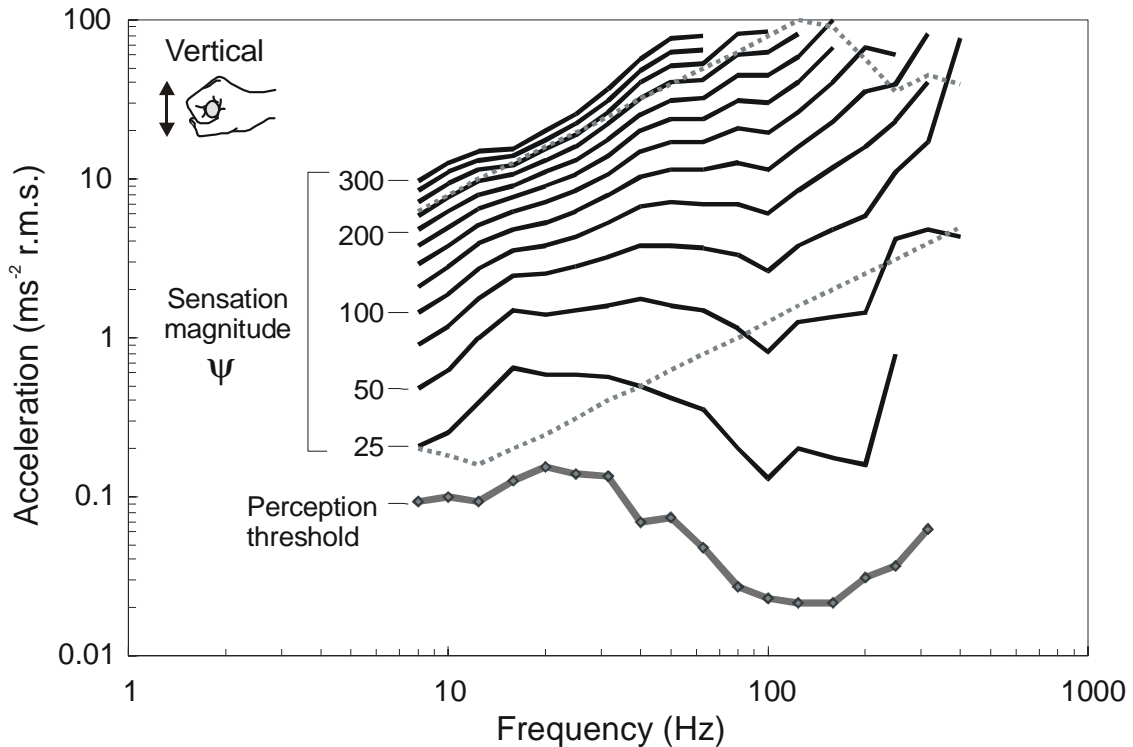
#### *Equivalent comfort contours*

The calculated vibration magnitudes,  $a$  (in acceleration), were plotted as a function of frequency for equivalent comfort contours with subjective magnitudes from 25 to 300 and are shown in Figure 4. The equivalent comfort contours illustrate the vibration magnitude required to produce the same sensations across the frequency range. They provide information on which frequencies produce greatest discomfort (a lower contour at a particular frequency indicates greater discomfort than at other frequencies).

The shapes of the equivalent comfort contours depend on the sensation magnitude. With high sensation magnitudes, the comfort contours approximate contours with approximately constant velocity. With low sensation magnitudes, the contours become similar in shape to the contour of the absolute perception threshold.



**Figure 3** An example of linear regression for 12.5 Hz data using Equation 2 (left graph). The data are then converted into sensation magnitude,  $\psi$ , as a function of vibration magnitude,  $\phi$  (right graph).  $\phi_0 = 0.095 \text{ ms}^{-2}$  r.m.s. (median threshold at 12.5 Hz).



**Figure 4** Equivalent comfort contours for sensation magnitudes from 25 to 300. Median absolute perception thresholds determined between 8 and 315 Hz are also shown. Dotted lines indicate the range of stimuli investigated in this study (equivalent comfort contours beyond these lines were determined by extrapolation of the regression line).

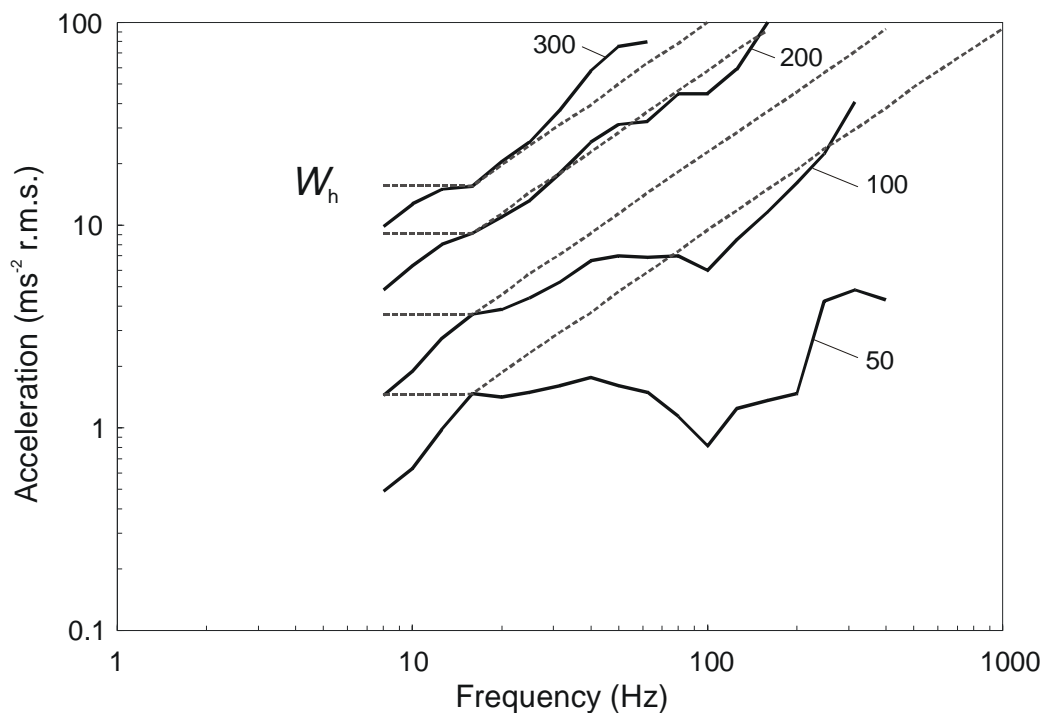
### Discussion

The threshold contours for vertical hand-transmitted vibration displayed a strong frequency-dependence. High correlations within frequencies greater than 20 Hz suggested that the detection of hand-transmitted vibration at these frequencies might have been mediated by the same receptor. It has been suggested in previous studies that the Pacinian system (FA II) is likely to be responsible for perception thresholds in a hand-grasping posture at frequencies greater than 31.5 Hz (Morioka and Griffin, 2000) and with steering wheel vibration at frequencies greater than 16 Hz (Morioka, 2003), whereas the non-Pacinian system (possibly dominated by Meissner corpuscles, FA I) is likely to be responsible at

frequencies below 31.5 Hz (Morioka and Griffin, 2000) and below 8 Hz (Morioka, 2003). The responses of receptors overlap across frequency ranges, so the frequency boundary separating the regions mediated by two different receptors is ambiguous. For the present results, it is suggested that perception thresholds of vibration transmitted to the hand at frequencies greater than about 20 Hz may have been mediated by the Pacinian system (FA II) while at frequencies less than about 20 Hz may have been mediated by a non-Pacinian system (FA I).

A frequency-dependence was also evident in the equivalent comfort contours at supra-threshold levels of hand-transmitted vibration. The shapes of the equivalent comfort contours depended on the vibration magnitude, reflecting a frequency-dependent response to vibration magnitude. The results show a general trend to reduced sensitivity to vibration acceleration with increasing frequency, except at lower vibration acceleration below about  $2 \text{ ms}^{-2}$  r.m.s., where there is an inverse trend of increased sensitivity to vibration acceleration with increasing frequency from 16 to 100 Hz. For example,  $10 \text{ ms}^{-2}$  r.m.s., hand-transmitted vibration produced a greater strength of sensation at 16 Hz than at 100 Hz, whereas at  $1 \text{ ms}^{-2}$  r.m.s., hand-transmitted vibration produced a greater strength of sensation at 100 Hz than at 16 Hz vibration. A study of masked thresholds determined with a whole hand applied on a rigid flat plate concluded that individual thresholds for FA II, SA II, and FA I receptors lie within 30 dB above the absolute thresholds (Morioka and Griffin, 2004; awaiting publication). It appears that the mediation of these receptors produces different strengths of discomfort across the investigated range of vibration frequencies and magnitudes, resulting in changes in the shape of the equivalent comfort contours with vibration magnitude. The present results do not confirm whether the discomfort is produced by the mediation of a single receptor or the combined mediation of two or more receptors.

The reciprocal of the current frequency weighting,  $W_h$  in BS 6842 (1987) and ISO 5349-1 (2001), has been overlaid on the equivalent comfort contours determined in the present study (Figure 5). The equivalent comfort contours approximate to the shapes of the frequency weighting at high subjective magnitudes (i.e. greater than a subjective magnitude of 200). At low subjective magnitudes, the frequency weighting underestimates sensitivity to vibration at frequencies greater than 16 Hz or, conversely, overestimates sensitivity at low frequencies. A change in the shape of equivalent comfort contours with the magnitude of hand-transmitted vibration indicates that a single frequency weighting cannot represent the frequency-dependence of sensations over the range of vibration magnitudes investigated.



**Figure 5** Equivalent comfort contours for hand-transmitted vibration in the vertical axis overlaid with the reciprocals of the frequency weighting,  $W_h$  at sensation magnitudes equivalent to 50 100 200 and 300 at 16 Hz.

## Conclusions

Thresholds for vertical hand-transmitted vibration determined over the frequency range 8 to 315 Hz showed a frequency-dependence, presenting greatest sensitivity around 125 Hz. The thresholds were likely to have been mediated by the Pacinian system at frequencies greater than about 20 Hz and by the non-Pacinian system at frequencies less than about 20 Hz. The change in the shape of the comfort contours with vibration magnitude reported here might be due to differential mediation of receptors responsible for perception at different vibration magnitudes. The equivalent comfort contours are consistent with the shape of the current frequency weighting,  $W_h$ , but only at high vibration magnitudes.

## References

- Bovenzi, M. 1990. Medical aspects of the hand-arm vibration syndrome. *International Journal of Industrial Ergonomics* 6, pp 61-73.
- Brisben AJ, Hisao SS, Johnson KO (1999) Detection of vibration transmitted through an object grasped in the hand. *American Physiological Society* 1548-1558.
- British Standard Institution (1987) Measurement and evaluation of human exposure to vibration transmitted to the hand, BS 6841.
- Griffin, M.J. 1990 *Handbook of human vibration*. Academic Press, London, ISBN: 0-12-303041-2.
- International Organization for Standardization 2001. Mechanical vibration – Measurement and assessment of human exposure to hand-transmitted vibration – Part 1: General guidelines. International Standard ISO 5349-1.
- Johansson RS, Vallbo ÅB (1979) Tactile sensibility in the human hand: Relative and absolute densities of four types of mechanoreceptive units in glabrous skin. *Journal of Physiology* 286, 283-300.
- Miwa, T. 1967. Evaluation methods for vibration effects. Part 1: Measurements of threshold and equal sensation contours on hand for vertical and horizontal sinusoidal vibrations. *Industrial Health* 5, pp 213-220.
- Morioka M (2003) Perception thresholds for vertical steering wheel vibration. The 38th United Kingdom Conference on Human Response to Vibration, held at Institute of Naval Medicine, Alverstoke, Gosport, UK.
- Morioka, M. and Griffin, M.J. 2000. Comparison of absolute thresholds for vibration at the fingertip and on the hand in two different postures. *Proceedings of the 8th International Conference on Hand-Arm Vibration*, 9-12 June 1998, Umeå, Sweden, pp 165-170.
- Morioka, M. and Griffin, M.J. 2004 (Awaiting publication) Independent responses of Pacinian and non-Pacinian receptors for hand-transmitted vibration detected from masked thresholds.
- Palmer, K.T., Griffin, M.J., Bednall, H., Pannett, B. and Coggon, D.N. 2000. Prevalence and pattern of occupational exposure to hand transmitted vibration in Great Britain: findings from a national survey. *Occupational and Environmental Medicine*, 57, (4), pp 218-228.
- Reynolds DD, Standlee KG, Angevine EN (1977) Hand-arm vibration, Part III: Subjective response characteristics of individuals to hand-induced vibration. *Journal of Sound and Vibration* 51(2), 267-282.

# **RATS WILL WORK WITH VIBRATING TOOLS: NEW AVENUES FOR ANIMAL-BASED HAVS RESEARCH**

O. Wirth, W. G. Lindsley, T. R. Wade, and K. Krajnak

National Institute for Occupational Safety and Health, Morgantown, West Virginia, USA

## **Abstract**

A novel animal preparation for studying hand-arm vibration syndrome (HAVS) is described. Rats were trained with operant conditioning to pull on a bar in sessions conducted 5 days per week. Following training, which lasted approximately 2 weeks, vibration ( $147 \text{ m/s}^2$  at 63 Hz) was applied to the bar in a single exposure session that lasted up to 5 hours. The cumulative duration of contact with the vibrating bar was determined as well as other behavioral measures such as response rate, force, and duration. Results showed that the rats easily learned the bar-pulling response and accumulated on average approximately 2 hours of contact with the vibration stimulus. The present animal model may make possible many new and important avenues for HAVS research.

## **Introduction**

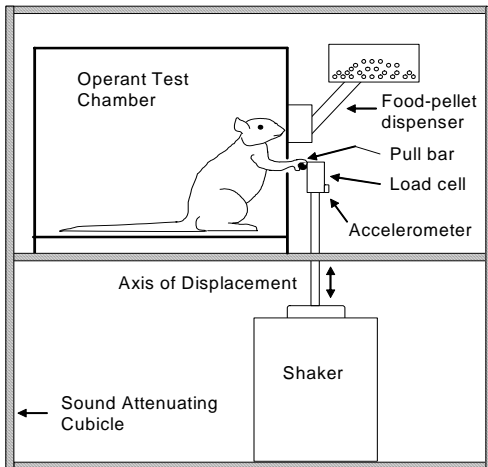
Laboratory animals have been used in multiple ways to study the effects of vibration exposure to limb structures. Some of the effective methods have included vibrating the whole-bodies of rabbits (Kaleta, Markiewicz, & Wroblewski, 1973) and rats (Jurczak, 1974), the tails of rats (Chang, Ho, & Yu, 1994; Curry et al., 2002; Hellstrom, 1974; Okada, 1986), or the hind feet of rats (Hansson et al., 1988; Lundborg et al., 1987; Okada, Okuda, Inaba, & Ariizumi, 1985) and dogs (Azuma, Ohhashi, & Sakaguchi, 1980). Prolonged vibration exposures have provided evidence of damage to vascular structures (Okada, Inaba, & Furuno, 1987), neural structures (Chang et al., 1994), and muscle (Chang et al., 1994; Necking et al., 1992). Because this damage is thought to underlie the overt symptoms of HAVS (hand-arm vibration syndrome), such as pain, numbness, or loss of sensation, these and similar animal preparations provide alternative means by which the physiological mechanisms of HAVS can be studied experimentally.

Invariably, the animals in these preparations must be either anesthetized or physically restrained during the vibration exposure. Although anesthesia and restraint ensure constant and controlled contact between the vibration stimulus and the tail or limb structures, they complicate or even preclude the investigation of some functional and physiological aspects of HAVS development, detection, and prevention. The present paper describes a novel animal preparation for studying HAVS that leaves the animal awake and unrestrained.

## **Method**

Twelve male, 12-week-old Sprague-Dawley rats were food restricted to 80% of their free-feeding weight. Operant test chambers were equipped with a custom-designed pull-bar assembly that allowed for the continuous, real-time recording of pull force (Figure 1). The bar was positioned in a horizontal orientation and vibrated at 63 Hz,  $147 \text{ m/s}^2$  along the vertical axis via the attached shaker.

Initial training occurred in the first 4 weeks with no vibration. Each rat was trained to pull a bar to receive food pellets. Across sessions, the time between pellet deliveries increased until a response produced a pellet, on average, every 45 s. Training sessions ended after the delivery of 100 pellets. On the vibration exposure day, the session began with no vibration and, following every reinforcer thereafter, the magnitude of vibration was increased by increments of  $4.9 \text{ m/s}^2$  up to a maximum of  $147 \text{ m/s}^2$ , where it remained for the remainder of the session. Exposure sessions lasted 5 hr or until no responding occurred for at least 15 min, whichever came first.



**Figure 1** Rat-paw vibration apparatus.

**Table 1** Vibration and behavioral parameters.

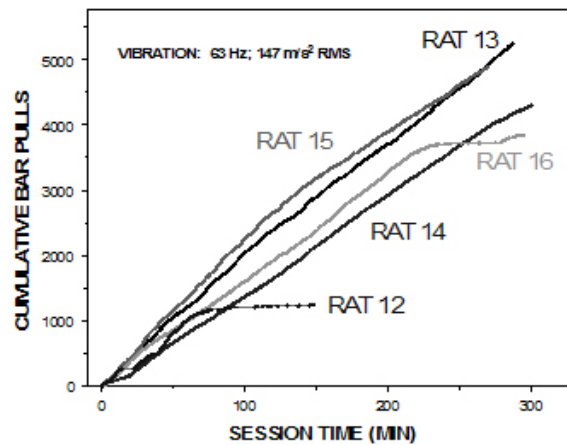
	Mean	Range
Vibration exposure (min)	92	8-114
Session duration (min)	292	163-300
Repetitions (#)	5,641	1,243-12,227
Response rate (per min)	15	3.1-32.8
Response duration (S)	0.79	0.1-13.2
Peak force (N)	0.22	0.10-0.30
Force-time integral (N S)	0.13	0.02-0.28

## Results and Discussion

All rats voluntarily and repeatedly pulled on a vibrating bar to achieve an acute vibration exposure similar to those studied with other preparations. Numerous repetitions occurred during the exposure session that resulted in up to ~2 hr of cumulative contact with the vibration (Table 1). Figure 2 shows that, in general, the temporal patterning of bar pulls was fairly stable during the vibration-exposure session. Thus, the vibration exposure was spread uniformly throughout the session, at least until the rat cease responding (e.g., Rats 13 and 16).

It is possible to make minor adjustments to the response requirements and schedule of reinforcement, thus allowing higher or lower pull forces, longer exposures, and even multiple sessions to achieve prolonged vibration exposures across several days, weeks, or even months.

The present model has a number of advantages over previously described animal models. For example, by using a volitional model of HAVS we can determine the functional and biological effects of vibration in the absence of additional stress or changes caused by anesthesia or restraint. We also can determine how various exposure variables, such as pull force and posture, affect the probability of developing HAVS. Finally, by exposing the forelimbs to vibration, we can study the effects of vibration that are specifically related to changes in the upper half of the body. By targeting the forelimb, for example, we can study the mechanisms vibration-induced disorders that may be caused by changes in the cervico-thoracic autonomic ganglia and associated neural pathways.



**Figure 2** Representative cumulative records showing the pattern of bar pulls during the vibration-exposure session.



## References

- Azuma, T., Ohhashi, T., & Sakaguchi, M. 1980. An approach to the pathogenesis of "white finger" induced by vibratory stimulation: acute but sustained changes in vascular responsiveness of canine hindlimb to noradrenaline. *Cardiovascular Research*, vol 14(12), pp 725-730.
- Chang, K. Y., Ho, S. T., & Yu, H. S. 1994. Vibration induced neurophysiological and electron microscopical changes in rat peripheral nerves. *Occupational & Environmental Medicine*, vol 51(2), pp 130-135.
- Curry, B. D., Bain, J. L., Yan, J. G., Zhang, L. L., Yamaguchi, M., Matloub, H. S., & Riley, D. A. 2002. Vibration injury damages arterial endothelial cells. *Muscle & Nerve*, vol 25(4), pp 527-534.
- Hansson, H. A., Dahlin, L. B., Lowenadler, B., Lundborg, G., Paleus, S., & Skottner, A. 1988. Transient increase in insulin-like growth factor I immunoreactivity in rat peripheral nerves exposed to vibrations. *Acta Physiologica Scandinavica*, vol 132(1), pp 35-41.
- Hellstrom, B. 1974. Effects of local vibration on the rat tail circulation. *Internationales Archiv fur Arbeitsmedizin*, vol 33(4), pp 285-295.
- Jurczak, M. E. 1974. The effect of prolonged vibration on permeability of the vascular endothelium to proteins. Mechanism of extravascular displacement of proteins. *Acta Physiologica Polonica*, vol 25(1), pp 59-65.
- Kaleta, Z., Markiewicz, L., & Wroblewski, T. E. 1973. Reactivity of arteries to neurohormones in experimental vibration. *Materia Medica Polona*, vol 5(3), pp 186-189.
- Lundborg, G., Dahlin, L. B., Danielsen, N., Hansson, H. A., Necking, L. E., & Pykko, I. 1987. Intra-neural edema following exposure to vibration. *Scandinavian Journal of Work, Environment & Health*, vol 13(4), pp 326-329.
- Necking, L. E., Dahlin, L. B., Friden, J., Lundborg, G., Lundstrom, R., & Thornell, L. E. 1992. Vibration-induced muscle injury. An experimental model and preliminary findings. *Journal of Hand Surgery - British Volume*, vol 17(3), pp 270-274.
- Okada, A. 1986. Physiological response of the rat to different vibration frequencies. *Scandinavian Journal of Work, Environment & Health*, vol 12(4), pp 362-364.
- Okada, A., Inaba, R., & Furuno, T. 1987. Occurrence of intimal thickening of the peripheral arteries in response to local vibration. *British Journal of Industrial Medicine*, vol 44(7), pp 470-475.
- Okada, A., Okuda, H., Inaba, R., & Ariizumi, M. 1985. Influence of local vibration on plasma creatine phosphokinase (CPK) activity. *British Journal of Industrial Medicine*, vol 42(10), pp 678-681.



# EVALUATION OF FINGER SKIN BLOOD FLOW IN WORKERS EXPOSED TO HAND-ARM VIBRATION USING LASER DOPPLER PERFUSION IMAGING

Miyai N<sup>1</sup>, Terada K<sup>1</sup>, Tomida K<sup>1</sup>, Sakaguchi S<sup>1</sup>, Minami Y<sup>1</sup>, Yamamoto H<sup>1</sup>,  
Morioka I<sup>1,2</sup>, Miyashita K<sup>1</sup>

<sup>1</sup> Department of Hygiene, School of Medicine, Wakayama Medical University, 811-1 Kimiidera, Wakayama 641-8509, Japan

<sup>2</sup> Department of Health and Nursing Science, Wakayama Medical University, 580 Mikazura, Wakayama 641-0011, Japan

## Abstract

Continuous monitoring of finger skin blood perfusion was performed in 12 men with vibration-induced white finger (VWF) and 15 exposed controls before, during and after the cold provocation test (10°C, 10min), using the laser Doppler perfusion imager (LDPI). The mean blood perfusion values in both groups reduced markedly as a result of the immersion of the hand in cold water. In the controls, however, the mean value augmented gradually to the end of the cold provocation, while that in the VWF subjects remained at the lowest level. After removal of the hand from cold water, the skin blood perfusion in the controls recovered rapidly and reached nearly to the baseline value. In the VWF subjects, it had a slight increase immediately following the cold immersion and no tendency to be augmented as the time span increased. The VWF subjects had significantly lower perfusion values compared to the controls in the last several minutes of the cold provocation test and the following recovery. The present results suggest that the LDPI technique may be useful in visualizing and quantifying the peripheral vascular effects of cold water immersion on the finger skin blood perfusion and thus can provide more detailed and accurate information that may help detect the peripheral circulatory impairment in the fingers of vibration-exposed workers.

## Introduction

Several objective tests have been developed to detect circulatory impairment in the fingers of vibration-exposed workers. Measurement of finger skin temperature in combination with local cooling of the hand in order to stimulate vasoconstriction is most commonly used in the survey of vibration syndrome. Laser Doppler velocimetry has been widely used as a noninvasive method for the measurement of finger blood flow to surface tissue (Holloway et al. 1977). In conventional instruments, the laser light is transmitted to and from the tissue by optical fibers positioned over the site of interest. The perfusion within an approximately 1 mm<sup>3</sup> tissue volume at the tip of the probe is recorded, and no information is attained as to how the perfusion varies over the skin surface regardless that tissue perfusion frequently shows a substantial spatial variation resulting in significant differences in perfusion values even at adjacent sites. Laser Doppler perfusion imaging (LDPI) is a new technique for mapping of cutaneous blood flow (Fullerton et al. 1995; Wårdell et al. 1993). The method employs a two-dimensional horizontal scanning of the flow of a specific tissue, and makes it possible to visualize the spatial variation over a region of interest. It can allow for detailed analysis of the peripheral vascular response following the immersion of the hand in cold or hot water.

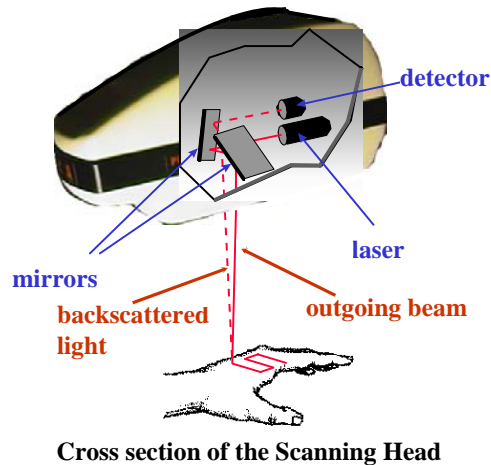
The present study was undertaken to evaluate the peripheral circulatory function of the workers exposed to hand-arm vibration by monitoring of the response of finger skin blood perfusion to a cold provocation test using the LDPI technique.

## Subjects and Methods

The present subjects examined were 12 men with vibration-induced white finger (VWF) who had worked using chainsaw on private forestry enterprises. From public service workers who were mainly working to maintain the public roads or afforesting and gardening on a farm and using bush cutter, 15 men without any signs of symptoms related to vibration syndrome were selected and treated as exposed controls. None of both groups of subjects took medication at the time of examination. All subjects signed a written informed consent form after receiving a detailed explanation of the study aims and procedures. The protocol of this study was approved by the Ethic Committee of the Wakayama Medical University.

The finger skin blood flow was measured by the laser Doppler perfusion imager (PeriScan PIM-II, PERIMED Co, Sweden). The equipment is a camera-like device intended for two-dimensional mapping of the superficial tissue blood perfusion (Figure 1). The low power (1mW) laser beam (wave length, 670nm) successively scans the tissue step-wise throughout a large number of measurement sites (Wårdell et al. 1994). In the tissue the light is scattered and frequency

shifted at interaction with the moving blood cells according to the Doppler principle. The sampling depth is in the order of a few hundred micrometers (Jakobsson et al. 1993). A fraction of the back-scattered and Doppler broadened light is detected by a photo-detector positioned in the scanner head. For each measurement point, the Doppler broadening and the magnitude of the Doppler signal are calculated and a signal is generated that scales linearly with tissue perfusion defined as the product of the blood cell velocity and concentration. The result is presented as a two-dimensional color image on a computer monitor.



**Figure 1** The PIM-II laser Doppler Perfusion Imager system for non-invasive imaging of superficial tissue. Based on the well-known laser Doppler principle, it collects back-scattered light without touching the tissue and generates color-coded images of the spatial distribution of the tissue perfusion.

The scanner head was placed in parallel with the surface of the finger, and the laser beam scanned over the area of 3×3 cm at the tip of the subject's most severely affected finger. During scanning, the area of interest is placed right under the scanning head with the laser beam pointing at the center of the measurement area. The distance between the tissue surface and the lower part of the scanner head during image capturing was fixed to 15 cm. System specific changes in skin mean perfusion (average value in region of interest), measured in volts, were used as the evaluation parameter for quantification of alternations in skin blood perfusion.

The finger skin temperature was also taken by an electrode thermistor (Takara Thermistor D922, TECHNOL SEVEN Co, Japan) attached to the skin of index finger. Simultaneous measurements of the finger skin blood flow and temperature were performed every min before, during and following a 10-min recovery period after the hand was immersed into the cold water (10 C, 10min). All measurements were performed in a quiet and air-conditioned room (24.3±0.3 C) after the subjects having a sufficient rest for the adaptation to room temperature.

All statistical analysis was conducted using the SPSS statistical package 12.0 (SPSS Software, Inc., Chicago, Illinois). Analysis of covariance (ANCOVA) was used for comparisons of the data between the groups controlling for the effects of age and room temperature as a covariate. The level of significance was defined as  $p < 0.05$ .

## Results

The characteristics of the two groups as well as the outline of disorders in the VWF subjects were shown in Table 1. There was a significant difference in age between the groups ( $p < 0.05$ ), and therefore the further analyses were performed with adjusting the effect of age. The results of analysis of covariance revealed that the VWF subjects were exposed to high level of vibration for significantly longer time compared to the exposed controls. On the Stockholm Workshop scale (Gemne et al. 1987), four subjects with VWF had Raynaud's phenomenon in their hand of testing side classified into Stage 3 (severe), six of them were into Stage 2 (moderate) and two into Stage 1 (mild). All the subjects with VWF suffered from numbness in their hands; nine were recognized to be in the stage of 2SN and three were in 1SN (Brammer et al. 1987).

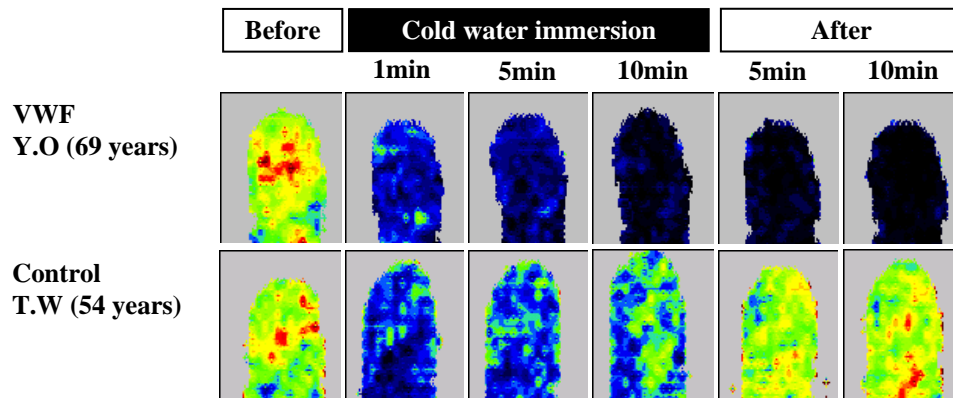
**Table 1** Characteristics of the subjects with the VWF and exposed controls

	VWF (n=12)	Control (n=15)
Age (years)	67.9 ± 5.7	52.1 ± 6.8
Systolic blood pressure (mmHg)	138.2 ± 18.8	134.9 ± 19.5
Diastolic blood pressure (mmHg)	81.1 ± 16.3	80.5 ± 15.3
Vibration exposure (year)	29.5 ± 6.4	19.4 ± 9.0*
Daily exposure (hours/day)	6.1 ± 1.3	3.5 ± 0.6*
Chain saw usage (days/year)	140.4 ± 24.6	-
Bush cutter usage (days/year)	153.5 ± 28.7	58.2 ± 31.5**
Stage of VWF (stage [n])	1[2], 2[6], 3[4]	-
Stage of sensory reduction (stage [n])	1SN[3], 2SN[9]	-

Values are shown as means ± SD.

\*p<0.05, \*\*p<0.01 compared with the VWF after controlling for age by ANCOVA.

The baseline finger skin temperature of subjects in the VWF and control groups was not significantly different. As the result of the immersion of the hand into cold water the skin temperature of both groups was gradually decreasing, and the VWF subjects had lower temperature compared with the controls; however no significant differences could be obtained. During a period of 10-min following the cold immersion, the controls tended to have recovery in their skin temperature from the 3rd min after removal of the hand from cold water. Analysis of covariance showed significant differences in the finger skin temperature of the controls compared to the VWF subjects from the 6th min to 10th min after the cold provocation test.

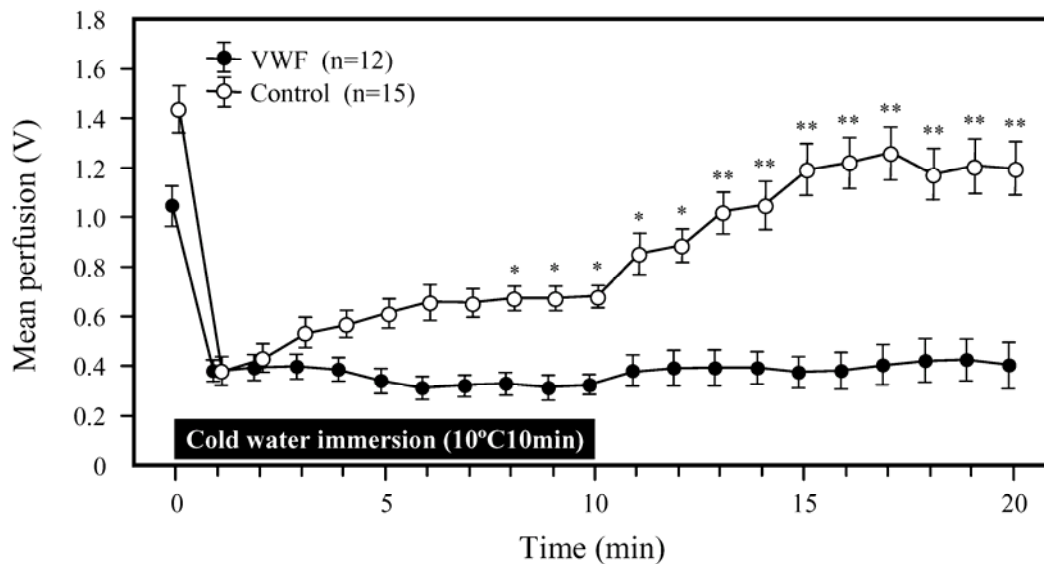


**Figure 2** Visualization of fingertip skin blood perfusion in one subject from each of the VWF and control groups before, during and following the cold provocation test

Examples of the relative changes in skin blood perfusion imaging in the tip of the test finger in one of each group before, during, and after the cold water immersion were shown in Figure 2. At each point in the image the skin blood perfusion is color-coded using a scale ranging from dark blue (lowest value) to red (highest value). The difference in the responses of skin blood perfusion under the condition of cold immersion between the VWF subjects and controls was clearly demonstrated in this sequence of images.

To each measurement point a numerical perfusion value was measured in terms of volt (V) and used as the basis for calculation of the mean perfusion values. Figure 3 summarised the mean values in skin blood perfusion during the course of observation for both groups of subjects. When the hand was immersed in the cold water the skin blood perfusion values reduced markedly, and a cold-induced vasoconstriction was noticed in both the VWF subjects and controls. In the controls, the skin blood perfusion augmented gradually from the 2nd min to the end of the cold immersion, while the perfusion in the VWF subjects remained at the same lowest level observed immediately after the immersion. Furthermore, during the recovery period following the cold provocation test, the skin perfusion in the controls recovered rapidly and attained nearly to the baseline value already 5 min after the removal of the hand from cold water. In the

VWF subjects, the skin perfusion had a slight increase immediately following the cold immersion and no tendency to be augmented as the time span increased. The significant differences in the finger skin perfusion of the VWF subjects and controls were found from the 8th to the 10th min during the cold immersion and over following recovery period after controlling for age and room temperature.



**Figure 3** Mean perfusion values in the fingertip of the VWF subjects and controls before, during and following the cold provocation test. Values are shown as means  $\pm$  SEM. \* $p < 0.05$ , \*\* $p < 0.01$  compared with the VWF after controlling for age and room temperature by ANCOVA.

### Discussion

The primary objective of this study was to examine the usefulness of the LDPI technique to investigate peripheral vascular response to cold water immersion in workers with vibration syndrome. We have found the significant difference in the patterns of the finger skin perfusion during and following cold water immersion between the subjects with VWF and exposed controls without any symptom of vibration syndrome. Therefore, repeated imaging of finger skin blood perfusion based on LPDI technique may be a valuable means for detection of impaired vascular regulation in the fingers of vibration-exposed workers.

Laser Doppler blood flowmetry has been proposed for the measurement of finger blood flow to surface tissue (Holloway et al. 1977). The technique can be used for identifying the presence of and response to a vasoconstrictive stimulus such as cold water immersion test, and it has been applied for some workers using hand-held vibrating tools (Olsen et al. 1988, Mirbod et al. 1998). A clear drawback with laser Doppler flowmetry is, however, that the probe covers only a small area (less than  $1 \text{ mm}^2$ ) and, therefore, local differences in skin blood flow may markedly influence results obtained. By using the LDPI technology this limitation is overcome, and mean values over larger areas can be calculated. The LDPI technology can be considered a further development of the genetic laser Doppler flowmeter of which the intended use is to continuously monitor the tissue blood perfusion in a single spot. By the introduction of the imaging concept, the spatial heterogeneity in the tissue blood perfusion can be investigated, while at the same time averaging the blood perfusion over an area of a specific extension increases the reproducibility.

It has been shown hand-arm vibration induces a decrease in blood flow in normal fingers as a result of vascular injury and abnormalities in vasoregulatory function (Welsh et al. 1980). The pathophysiology of VWF includes components of an exaggerated vasoconstriction and impaired vasodilatation manifested under the cold condition. Cold provocation testing of the hand simulates the interruption of finger blood flow that is presumed to occur in cold environments. The two general approaches to cold provocation test are blood pressure and skin temperature measurements. The finger skin blood pressure tests may record interruption of digital blood flow in a context of vasoconstriction, whereas skin temperature recovery test are measure of vasodilatation (Virokanas et al. 1991). Therefore, inconsistent findings such as an absence of abnormal finger blood pressure against a delayed skin temperature recovery could be observed in some cases (Cherniack et al. 2003). It has been also noted that there is lack of concordance between skin temperature and symptoms of vibration related vasospastic disease assessed by the Stockholm workshop scale (Lawson et al. 2001). Repeated monitoring of finger skin perfusion using LDPI can investigate the

different aspects of vascular reflection induced by cold exposure. In Addition, when compared to the skin temperature, measurement of the skin perfusion after the cold immersion could expeditiously detect differences in the vascular capacity of those with VWF and symptom-free workers. This might be due to the fact that skin temperature has generally less pronounced increase and requires longer recovery time compared to skin blood perfusion.

In LDPI technique, the lack of standardized procedures for assessment of skin blood perfusion and complex interpretation of clinical data are seems to be main disadvantages. Although these procedures should be further developed, LDPI may provide a beneficial method for clinical investigation and monitoring of peripheral circulatory functions of vibration-exposed workers.

### **Conclusion**

The results of this study suggest that the LDPI employing multiple point recording and spatial mapping will become an important quantitative tool for the study of changes in finger skin blood flow after application of cold water provocation. It can therefore provide more detailed and accurate information that may help detect the impaired vascular regulation in the fingers among workers exposed to hand-arm vibration.

### **Acknowledgements**

This work was financially supported by a Trust Grant from Japanese Ministry of Health, Labour and Welfare for scientific research on accidents.

### **References**

- Brammer, A.J., Taylor, W., Lundborg, G. 1987. Sensorineural stages of the hand-arm vibration syndrome. *Scand J Work Environ Health*. 13, 279-83.
- Cherniack, M., Brammer, A., Meyer, J., Morse, T., Peterson, D., Fu, R. 2003. Skin temperature recovery from cold provocation in workers exposed to vibration: a longitudinal study. *Occup Environ Med*. 60, 962-8.
- Fullerton, A., Serup, J. 1995. Laser Doppler image scanning for assessment of skin irritation. *Curr Probl Dermatol*. 23, 159-68.
- Gemne, G., Pyykkö, I., Taylor, W., Pelmear, P.L. 1987. The Stockholm Workshop scale for the classification of cold-induced Raynaud's phenomenon in the hand-arm vibration syndrome (revision of the Taylor-Pelmear scale). *Scand J Work Environ Health*. 13, 275-8.
- Holloway, G.A. Jr., Watkins, D.W. 1977. Laser Doppler measurement of cutaneous blood flow. *J Invest Dermatol*. 69, 306-9.
- Jakobsson, A.J., Nilsson, G.E. 1993. Prediction of sampling depth and photon pathlength in laser Doppuler flowmetry. *Medical and biological engineering and computing*. 31, 301-7.
- Lawson, I.J., Mcgeoch, K.L., Burke, F., Proud, G. 2001. Cold provocation testing in a large volume of medico-legal compensation claims for HAVS. *Proceedings of 9th International Conference on Hand-Arm Vibration*. 219-24.
- Mirbod, S.M., Yoshida, H., Jamali, M., Miyashita, K., Takada, H., Inaba, R., Iwata, H. 1998. Finger skin temperature and laser-Doppler finger blood flow in subjects exposed to hand-arm vibration. *Ind Health*. 36, 171-8.
- Olsen, N., Petring, O.U. 1988. Vibraton elicited vasoconstrictor reflex in Raynaud's phenomena. *Br J Ind Med*. 45, 415-9.
- Virokanas, H., Rintamaki, H. 1991. Finger blood pressure and rewarming rate for screening and diagnosis of Raynaud's phenomenon in workers exposed to vibration. *Br J Ind Med*. 48, 480-4.
- Wårdell, K., Jakobsson, A., Nilsson, G.E. 1993. Laser Doppler perfusion imaging by dynamic light scattering. *IEEE Trans Biomed Eng*. 40 (4), 309-16.
- Wårdell, K. 1994. Laser Doppler perfusion imaging. Methodology and skin applications. *Linköping Studies in Science and Technology Dissertations, thesis 329, Linköping*.
- Welsh, C.L. 1980. The effect of vibration on digital blood flow. *Br J Surg*. 67, 708-10.





# THE EFFECTS OF FINGER FORCE AND VISUAL DISTRACTIONS ON THE MEASUREMENT OF THERMAL PERCEPTION THRESHOLDS

W. P. Smutz, A.W. Schopper, D.E. Welcome, R.G. Dong, M.E. Andrew

National Institute for Occupational Safety and Health, Morgantown, West Virginia, USA

## Introduction

The thermal perception threshold (TPT) test has been used by several investigators to measure the decreased sensitivity of the mechanoreceptors in persons exposed to hand-transmitted vibration.<sup>1-3</sup> The measurement of increased TPT at the fingertips is considered an alternative approach for the objective early detection of vibration induced sensorineural disorders, which may be the first sign of hand-arm vibration syndrome.<sup>4</sup> An aesthesiometer is usually used to measure the TPT. The finger force required to keep the fingertip in contact with the temperature-controlled plate for the test has been either totally uncontrolled or controlled via visual feedback to a test subject.<sup>5</sup> It is unclear whether the finger force should be controlled. If controlled with visual feedback, the test subjects may become distracted by having to watch the force meter during the test and this might adversely affect the assessment of the thermal threshold. To improve the test method, the specific aim of this study was to test the hypotheses that (a) the method for controlling finger force during the test would affect the magnitudes of the TPTs, and (b) that variation in finger force levels would affect the magnitudes of the TPTs.

## Method

Twelve male participants were used in the study. The participants were students recruited from a local university and had an average age of  $26.7 \pm 4.1$  years. Thermal perception thresholds were measured using an aesthesiometer (Institute of Sound and Vibration Research, UK). Nine different contact force levels were investigated: 0.5, 1, 2, 3, 4, 6, 8, 10, and 12 N. Two different methods of controlling the contact finger force were used. In Method 1, visual feedback was provided to the participants, similar to that used by Maeda and Sakakibara.<sup>5</sup> In Method 2, the finger force is controlled automatically using a counterbalance system (Figure 1). The surface was initially maintained at 32.0 °C. The temperature of the plate was then raised or lowered at a rate of 1.0 °C/sec. Four trials were performed for each test condition. The sequence of the test conditions was randomized. The mean hot or cold thresholds and the neutral zone (the difference between the mean hot threshold and the mean cold threshold) were calculated for each test condition. A two way mixed model was used to perform the analysis of variance (ANOVA) with a compound symmetric correlation structure in the model residual matrix. Because of the numerous force levels post hoc comparisons were not adjusted for multiple pairwise comparisons.

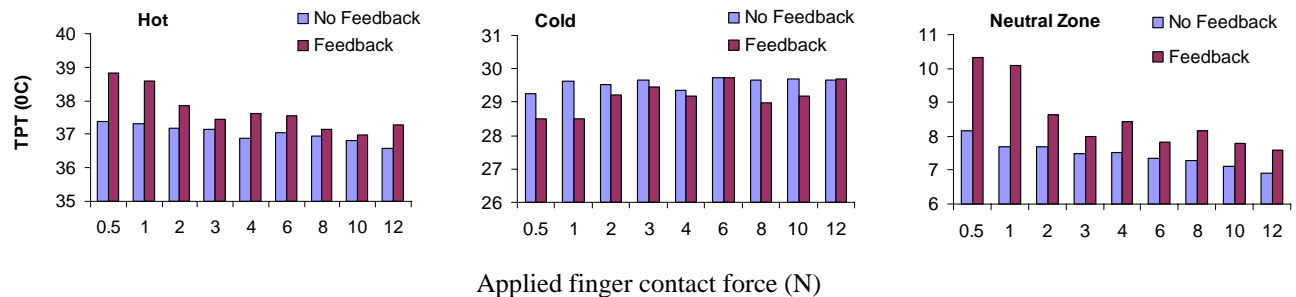


**Figure 1** Finger contact force maintained automatically with no visual feedback.

## Results and Discussions

Results show that the participants have a faster response to changes in temperature with the no feedback method than they did with the feedback method (Figure 2). In a two way mixed ANOVA, the interaction between feedback condition and force level was found insignificant ( $p > 0.1$ ). Examination of the main effects showed that the differences between the temperature thresholds for feedback vs. no feedback were significant ( $F_{1/195} = 9.06$ ,  $p = 0.003$  for cold test;  $F_{1/195} = 15.36$ ,  $p = 0.0001$  for hot test;  $F_{1/195} = 19.16$ ,  $p < 0.0001$  for neutral zone). In post-hoc tests of feedback vs no feedback for each separate force level there were no significant differences at any force level for the cold condition. For the hot condition feedback vs no feedback was significant only at 0.5 N. For the neutral zone feedback vs no feedback was only significant at 0.5 N and 1 N. The effects of the finger force on the TPTs were also significant ( $F_{8/195} = 1.98$ ,  $p = 0.051$ ).

for cold test;  $F_{8/195} = 2.81$ ,  $p = 0.006$  for hot test;  $F_{8/195} = 3.17$ ,  $p = 0.002$  for neutral zone). For the feedback-controlled hot measurements, the post-hoc analyses revealed significant differences between the TPT at 0.5 N and those at 3, 4, 6, 8, 10, and 12 N and between the TPT at 1 N and those at 3, 6, 8, 10, and 12 N ( $p < 0.05$ ). For the feedback-controlled cold measure, the post-hoc analyses revealed significant differences between the TPT at 0.5 N and those at 3, 6, and 12 N and between the TPT at 1 N and those at 3, 6, and 12 N ( $p < 0.05$ ). For the neutral zone, the post-hoc analyses revealed significant differences between the TPTs at 0.5 and 1 N and those at all other conditions ( $p < 0.05$ ). However, the differences among the TPTs measured at the force levels greater than 1 N were not significant ( $p > 0.05$ ).



**Figure 2** Thermal perception thresholds (hot, cold, and neutral zone)

The coefficients of variation (COV = standard deviation/mean) of the neutral zone TPT data measured at the middle force levels (2 to 8 N) were in the range of 0.366-0.541. They were generally lower than those at the two extremes of the force levels (0.501-0.549), regardless of feedback or no feedback condition. This is probably because it is more difficult for the subjects to maintain a stable force at the low (due to subtle adjustment) and high ends (due to possible fatigue).

In conclusion, this study found that the TPTs measured at greater than 1 N finger force are more sensitive than those at lower force levels, but at the higher force levels the TPT differences are not significant. Hence, it is not necessary to tightly control the finger force but it is better to use the middle range force for the test. The automatic force control device can help achieve more sensitive TPT measurements.

## References

- Lindsell CJ, Griffin MJ (1999) Thermal thresholds, vibrotactile thresholds and finger systolic blood pressures in dockyard workers exposed to hand-transmitted vibration. *Int Arch Occup Environ Health* 72: 377-386
- Nilsson T, Lundstrom R (2001) Quantitative thermal perception thresholds relative to exposure to vibration. *Occup Environ Med* 58: 472-478
- Maeda S, Sakakibara H (2002) Thermotactile perception thresholds measurement conditions. *Ind Health* 40: 353-361
- Bovenzi M, Apostoli P, Alessandro G, Vanoni O (1997) Changes over a workshift in aesthesiometric and vibrotactile perception thresholds of workers exposed to intermittent hand transmitted vibration from impact wrenches. *Occup Environ Med* 54: 577-587
- Sakakibara H, Maeda S, Yonekawa Y (2002) Thermotactile threshold testing for the evaluation of sensory nerve function in vibration-exposed patients and workers. *Int Arch Occup Environ Health* 75: 90-96.

**Medical VI – Hand-Arm Vibration in Women**  
S. Yamada - Session Coordinator



# REFERENCE VALUES OF VIBROTACTILE PERCEPTION THRESHOLDS AT THE FINGERTIPS FOR WOMEN

B. Harazin<sup>1</sup>, J. Kuprowski<sup>2</sup>, A. Harazin-Lechowska<sup>3</sup>, V. Socholik<sup>4</sup>

<sup>1</sup> Occupational Health Protection Unit, Faculty of Public Health, Medical University of Silesia, 18 Medykow str, 40-752 Katowice, Poland

<sup>2</sup> MEDICUS Diagnostic-Therapeutic Centre, Outpatient Clinic of Occupational Medicine, 8 Lesna str, 59-300 Lubin, Poland

<sup>3</sup> Occupational Health Protection Unit, Faculty of Public Health, Medical University of Silesia, 18 Medykow str, 40-752 Katowice, Poland

<sup>4</sup> Regional Center of Occupational Medicine, 42 Warszawska str, 40-008 Katowice, Poland

## Abstract

**Objectives:** The measurement of vibrotactile perception thresholds (VPTs) at the fingertips in workers is one of the diagnostic methods of hand-arm vibration syndrome. The aim of the study was to determine reference VPT values for healthy women using measuring systems designed according to the requirements of the ISO 13091-1 standard.

**Materials and Methods:** The study covered 140 healthy women aged 19-55 years. The VPT measurements were carried out using a new vibrotactile meter of the P8 type (EMSON-MAT, Poland), developed according to the ISO 13091-1 standard. Measurements were taken for the index, middle and ring fingers of both hands at the frequencies of: 4 Hz, 25 Hz, 31.5 Hz, 63 Hz, 125 Hz and 250 Hz. Predicted values of vibrotactile perception thresholds for 30-year old women were obtained by linear regression analysis of threshold data.

**Results:** It was observed that values of perception thresholds increased from about 85 dB to 115 dB (re  $10^{-6}\text{ms}^{-2}$ ) as a function of frequency and age. The frequency-dependent changes were not linear, however, but displayed a constant sensitivity in the range of 25 Hz -125 Hz. The VPT values were found to slightly increase with age.

**Conclusions:** The current data can be useful in determining normative VPT values for the assessment of peripheral neuropathy in women. In view of the fact that the ISO 13091-1 standard contains several VPT measurement methods, a possibility should be considered of preparing the normative values for each method.

## Introduction

Occupational peripheral neuropathies in the upper extremities are unfavourable complications, resulting from exposure to hand-arm vibration or to various chemicals. These neuropathies are often manifested by changes in the vibrotactile perception thresholds (VPTs). Impaired vibration perception at the fingertips is far more common among individuals exposed to hand-transmitted vibration in comparison with a group of workers not exposed to such vibration (Bovenzi, 1998, Flodmark and Lundborg, 1997, Lundström et al, 1999, Nakamoto et al, 1998). Epidemiological researches indicate that peripheral neuropathies occur from several to up to 80% of operators using a variety of electrical or pneumatic hand-held vibrating tools such as: grinders, hammers, sawing machines, drills, moulder's rammer etc. (Brammer et al, 1990, Gemne and Kihlberg, 1990, Mirbrod et al, 1999). Detection of impaired vibrotactile sense constitutes one of the methods used in the diagnosis of hand-arm vibration syndrome (Aatola et al, 1990, Virokannas, 1992).

VPT values depend on mechanoreceptor populations and parameters of the vibrating stimulus. Numerous experimental studies were carried out during the last two decades concerning properties of mechanoreceptors localized in the skin of fingers. The obtained results deepened our understanding of the perception range of the tactile stimulus and were used in the development of the international ISO 13091-1 standard on methods of VPT measurements at the fingertips (ISO 13091-1, 2001).

According to the new international standard ISO 13091-2:2003, it is necessary to obtain reference values of VPTs at the fingertips for healthy women and men. However, insufficient data has not been acquired for women so far. This study set out to determine the VPT reference values for healthy women using the measuring systems designed according to the requirements of the ISO 13091-1 standard.

## Material and Methods

### Subjects

One hundred forty healthy women aged 19-55 years participated in the study as volunteers. They represented different professions and were not occupationally exposed to vibration. Subjects were qualified for pallesthesiometric examinations on the basis of internal and neurological histories and results of selected examinations of the upper extremities. The following data were recorded in the questionnaire examination: age, height, weight, education, information on professions and course of work, use of alcohol/tobacco etc., results of measurements of arterial blood pressure of the right and left upper extremities, description of status of upper extremities with special emphasis laid on movement limitations in wrist joints, occurrence of contractures, scars, thickening of epidermis and data from other examinations, such as: current complaints, past diseases, currently used medications.

Subjects were denied participation in the examinations if they were in treatment for diseases evoking peripheral neuropathies such as: hyperfunction or hypofunction of thyroid, diabetes, neck pain, alcohol disease. Also rejected were subjects complaining of pain, reduced muscle power, numbness, tingling sensation in the upper extremities.

The subjects came from four age groups: below 25, 26-35, 36-45 and 46-55 years, each consisting of at least 30 women. Group composition was as follows: Group I - mostly high school students (88.6%) and administrative personnel, group II - nurses, lab technicians and university students, group III - nurses, laborers and administrative workers, group IV -laborers (50%), lab technicians, physicians. Their physical characteristics and the mean finger skin temperature are given in Table 1.

**Table 1** Characteristics of subjects (n =140)

		Age group (year)			
		I (< 25 )	II (26-35 )	III (36-45)	IV (46-55)
Number of subjects		35	33	36	36
Age (year)[mean $\pm$ SD.]		22,7 $\pm$ 1,5	30,5 $\pm$ 3,4	41,3 $\pm$ 3,0	49,0 $\pm$ 2,2
BMI (kg/m <sup>2</sup> )[mean $\pm$ SD.]		20,8 $\pm$ 2,2	23,3 $\pm$ 4,0	24,7 $\pm$ 3,8	28,6 $\pm$ 7,3
Smoking (%)		5,7	27,3	41,7	33,3
Finger skin temperature (°C) [mean $\pm$ SD.]	Left hand	29,4 $\pm$ 3,0	28,7 $\pm$ 2,7	30,1 $\pm$ 2,4	30,0 $\pm$ 2,6
	Right hand	29,5 $\pm$ 3,2	29,0 $\pm$ 2,7	30,3 $\pm$ 2,6	30,0 $\pm$ 2,8

### Measuring system

The VPT measurements were carried out using a new vibrotactile meter of the P8 type (EMSON-MAT, Poland), which was developed according to the ISO 13091-1:2001 standard . The measuring system consisted of a vibrometer unit, a subject response button, a set of vibrotactile meter working state indicators and the vibrometer software. In the vibrometer unit, a counterbalanced vibration exciter was used to drive a stimulating probe and a piezoelectric accelerometer to measure the acceleration magnitude. The stimulating probe was a flat-ended perspex cylinder, 5 mm in diameter. A subject kept her forearm and hand on the unit box resting the palm on a special support, which ensured required contact between the fingertip and the probe. The center of the stimulating probe tip was located on the distal phalanx at a point midway between the center of the whorl and the fingernail. The probe was pressed by the subject's finger with a constant force of 0.1 N. The static force between the probe and the finger was monitored by the subjects themselves. Adopting the method for counterbalancing the weight of the stimulator, the subjects watched two small diodes placed at the panel of the vibrometer unit near the stimulating probe. Whenever the static force was too strong or too weak, one of the diodes lit up.

The P8 vibrometer software was used with an IBM PC compatible computer (Harazin et al, 2003). It controlled the course of the measuring procedure, displayed measurement data as well as computed and stored the results in the database.

The Von Békèsy algorithm was used to determine vibrotactile perception thresholds. In this method the vibration magnitude was increasing until the subject was able to perceive it. Then the subject pressed the button held in the other

hand. This caused a decrease in the vibration level until the subject no longer perceived the vibration stimulus. Releasing of the button caused the vibration level to increase again. Direction of continuous stimulus magnitude change was then reversed. The vibration magnitude was increased and decreased with a continuous stimulus at a constant rate of 2 dB/s ( 4 dB/s until the first response).

This procedure was repeated three times by the automatic test program to establish the threshold level at a selected vibration frequency. The VPT value was calculated from the arithmetic mean of the mean peak (ascending thresholds) and the mean trough (descending thresholds) for each frequency. The values of the levels were expressed in dB (re.  $10^{-6}\text{ms}^{-2}$ ). The vibrometer software monitored the measurement, rejecting the acceleration values that differed from the mean value by more than  $\pm 2$  dB. The measurements were continued until 3 ascending thresholds and 3 descending thresholds were obtained, each with acceleration values within  $\pm 2$  dB.

#### Procedure

Prior to the experiment, a pre-test was performed to familiarize the subjects with the vibration stimuli and the measurement procedure. Initially, vibrotactile perception thresholds were determined for the index finger of the right hand for three consecutive frequencies of 4, 25 and 125 Hz.

Proper VPT measurements were taken for the index, middle and ring fingers of both hands using frequencies of: 4, 25, 31.5, 63, 125 and 250 Hz. Duration of the session did not exceed 40 min.

The finger skin temperature of both hands was measured on the distal phalanx with all 6 digits before and after VPT measurements, using a non-contacted infrared thermometer. Smoking was not allowed for at least 1h prior to VPT measurements. Room temperature was between 21°C and 25°C and noise level was lower than 50 dB-A.

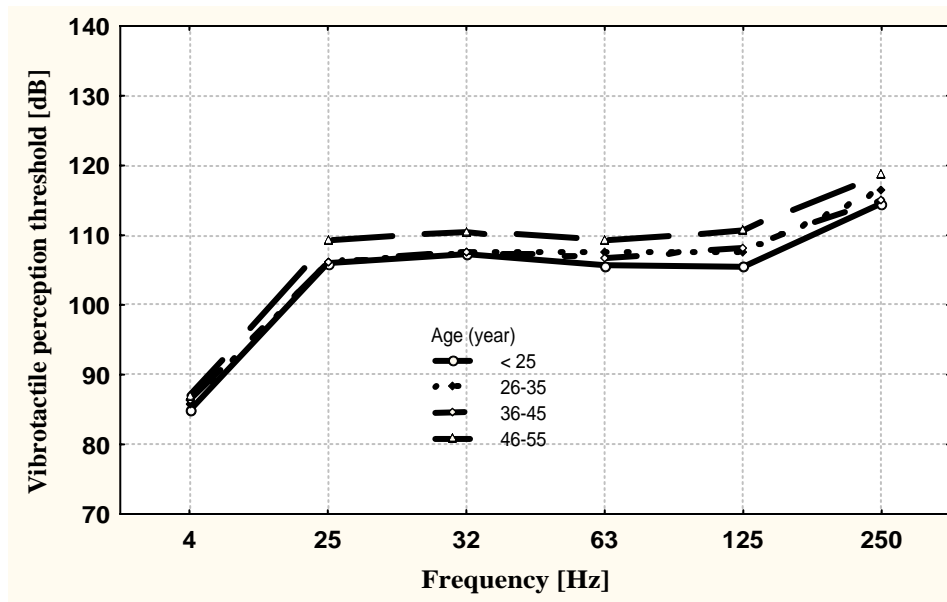
#### *Statistical analysis*

The statistical analysis of vibrotactile perception thresholds was performed using the Statistical Package for Statistica 6, StatSoft Poland.

Linear regression assessment of linear model of  $VPT = a + b \times \text{age}$ , determining relationship between vibrotactile perception threshold and age, calculated separately for six frequencies (4, 25, 31.5, 63, 125 and 250 Hz), was carried out using the significant test for linear regression coefficient. Predicted vibrotactile values for 30-year old women were calculated on the basis of linear regression data.

### **Results**

The results showed that values of perception thresholds increased from about 85 dB to 115 dB (re  $10^{-6}\text{ms}^{-2}$ ) as a function of frequency (Fig. 1). The frequency-dependent changes were not linear however, but displayed a constant sensitivity in range of 25-125 Hz.



**Figure 1** Effect of frequency and age on vibrotactile perception threshold values obtained in women

On the basis of linear regression assessment of the linear model of  $VPT = a + b \times \text{age}$ , linear regression coefficients 'b' were in the range from 0.09-0.20 in relation to the applied frequencies.

Correlation coefficients were found to be within the range from 0.147 to 0.272 (Table 2).

**Table 2** Linear regression assessment of linear model of  $VPT = a + b \times \text{age}$ , determining relationship between vibrotactile perception threshold and age. The significant test for linear regression coefficient was used.

Frequency [Hz]	Intercept of the regression a [ dB (re.10 <sup>-6</sup> ms <sup>-2</sup> ) ]	Regression coefficient b	p –value for the regression coefficient b	Correlation coefficient r
4	82.75	0.09	< 0.0001	0.182
25	102.67	0.12	< 0.0001	0.192
31.5	104.25	0.11	< 0.0001	0.180
63	102.80	0.12	< 0.0001	0.192
125	100.90	0.20	< 0.0001	0.272
250	111.62	0.13	< 0.0001	0.147

The obtained results of the intercepts of regression 'a' and regression coefficients 'b' enabled determination of predicted VPT values for 30-year old women (Table 3).



Table 3 Predicted value of vibrotactile perception thresholds for healthy women at age of 30 years  
(n = 840 fingers used in the estimate for each frequency)

Frequency [Hz]	Predicted value of vibrotactile perception thresholds dB [re 10 <sup>-6</sup> ms <sup>-2</sup> ]	95 % range of predicted value dB [re 10 <sup>-6</sup> ms <sup>-2</sup> ]	
4	85.4	75.9	95.4
25	106.2	93.8	118.7
31.5	107.6	95.1	120.1
63	106.6	93.2	119.9
125	106.7	92.5	121.2
250	115.4	98.1	132.8

### Discussion

Experimental studies involving subjects from different age groups indicate the relationship between age and VPT values. The VPT/age dependence is most often described using a linear regression model, separately for each frequency of vibrating stimulus. Linear regression coefficients indicate the VPT increase in dB during one year. So far only Wild et al. have determined linear regression coefficients for women aged 20-60 at frequencies of 31.5 and 125 Hz (Wild et al, 2001), which equaled 0.18 and 0.12 for the 3rd and 5th fingers at 31.5 Hz and 0.32 and 0.37 at 125 Hz respectively. In this study the linear regression coefficients, determined for women not older than 55 were 0.11 at 31.5 Hz and 0.20 at 125 Hz. Undoubtedly the VPT increases with age as a result of aging of the human organism and more frequent occurrence of diseases such as for example an arterial hypertension. Since health deterioration affects general population not exposed to harmful occupational factors, it cannot be taken into account in subjects with naturally occurring changes in the peripheral nervous system of upper extremities (Skre,1972). Impaired vibrotactile perception should be associated with reduced density of mechanoreceptors of the skin and alteration of their function. The results obtained in this study confirm observations expressed by other authors and show that linear regression coefficients depend on vibrating frequency and that impairment of vibrotactile perception with age is not the same in relation to different of kind of mechanoreceptor populations (Stevens et al, 1992). Linear regression coefficients were found to increase with frequency. The coefficient equaled 0.09 at 4 Hz (lowest value) and 0.12 at 25 Hz. As regards the frequency band of 31.5, the value in question was 0.08 in men according to Lundström et al (Lundström et al, 1992, Stevens et al, 1998) and 0.18 according to Wild et al (Wild et al, 2001). The result obtained in this study was 0.11. At 125 Hz the coefficients were significantly higher in all the three studies and equaled 0.22, 0.35 and 0.20 respectively. At 250 Hz the following values were obtained: 0.33 - Stevens et al, 0.31 - Lundström et al and 0.13 in this study (Lundström et al, 1992, Stevens et al, 1998).

The predicted reference VPT for women in this study was 85.4 dB at 4 Hz. However, the studies conducted so far as well as the ISO 13091-2 standard lack reference data for this frequency (ISO 13091-2, 2003). Neither can the predicted value of 106.2 dB at 25 Hz for women be compared with any data obtained by other authors. Although the ISO 13091-2 standard indicates the median value at 20 Hz determined only for women to be 94.8 dB, it cannot be considered representative as it had been calculated for a total of 60 fingers only and using too small a population sample. The ISO 13091-2 standard for women at 31.5 Hz was accepted following the results obtained by Wild et al in a group of 98 subjects aged 20-60 (196 fingers) (Wild et al, 2001). The median threshold value for 30-year old women, calculated from the linear regression model equals 101.8 dB and is almost 6 dB lower than the reference value obtained in this study. This difference may arise from the fact that Wild et al used a probe with surrounding and that in their examinations the contact force on the vibrating probe was 20 times greater than in this study. Ahrend obtained a VPT value in 21 women aged 25-35 that was only 1 dB higher than the respective figure determined in this study. In this case, however, similar measurement methods were adopted while the difference lay in the magnitude of contact force exerted on the vibrating

probe, which was 0.5 N in Ahrend's study (Ahrend, 1994). The ISO 13091-2 standard VPT of 110 dB at 125 Hz, 3 dB higher than the respective value determined in this study, was also accepted on the basis of the results obtained by Wild et al [215]. According to Ahrend, this VPT value was some 3 dB lower than the predicted threshold value calculated in this study (Ahrend, 1994). The predicted VPT of 115.4 dB in women at 250 Hz obtained in this study is not contained in the ISO 13091-2 standard.

Collation of own reference VPT values and the data obtained by other authors indicates differences between VPT values, especially at frequencies below 125 Hz. Bearing this in mind, correction procedures should be developed in order to enable different research centers to obtain similar reference results of pallesthesiometric examinations.

### Conclusions

The current data can be useful to determine normative values of VPTs for the assessment of peripheral neuropathy in women.

Regarding the fact that several measurement methods of VPTs are drafted in ISO 13091-1 standard it would be necessary to consider possibility of preparing the normative values adequate to proper methods.

### References

- Aatola, S. Färkkilä, M. Pyykkö, I. Korhonen, O. Starck, J. 1990. Measuring method for vibration perception threshold of fingers and its application to vibration exposed workers. *International Journal of Occupational Medicine and Environmental Health*, vol 62, pp 239-242.
- Ahrend, K.D. 1994. Validierung der Pallästhesiometrie als Screening-Methode zur Diagnostik der beruflichen Schwingungsbeanspruchung. Teilprojekt: Ermittlung von Normalwerten. 01 HK 071/1. Institut für Arbeits- und Sozialmedizin, Mainz, Germany, pp 1-136.
- Bovenzi, M. 1998. Exposure-response relationship in the hand-arm vibration syndrome: an overview of current epidemiology research. *Int Arch Occup Environ Health*, , 71, pp 509-519.
- Brammer, A..J. Piercy, J.E. Nohara, S. Nakamura, H. Auger, P.L. Haines, A.T. Lawrence, M. Brubaker R. Van Netten, C. 1990. Vibrotactile threshold in operators of hand-held power tools. In: Okada A., Taylor W., Dupuis H (eds): *Hand-arm vibration*. Kyoei Press Co. Ltd, Kanazawa, Japan, pp 221-223.
- Flodmark, B.T. Lundborg, G. 1997. Vibrotactile sense and hand symptoms in blue collar workers in a manufacturing industry. *Occupational and Environmental Medicine*, 54, pp 880-887.
- Gemne, G. Kihlberg, S. 1990. Vibration-perception changes in the carpal bones after work with a grinder and a chipping hammer. In: Okada A., Taylor W., Dupuis H (eds): *Hand-arm vibration*. Kyoei Press Co. Ltd, Kanazawa, Japan, pp 97-99.
- Harazin, B. Kuprowski, J. and Stolorz, G. 2003. Repeatability of vibrotactile perception thresholds obtained with two different measuring systems. *International Journal of Occupational Medicine and Environmental Health*, vol 16, pp 311-319.
- International Organization for Standardization, 2001. *Mechanical vibration - Vibrotactile perception thresholds for the assessment of nerve dysfunction – Part 1: Method of measurement at the fingertips*. ISO 13091-1:2001, pp 1-21.
- International Organization for Standardization, 2003. *Mechanical vibration - Vibrotactile perception thresholds for the assessment of nerve dysfunction – Part 2: Analysis and interpretation of measurements at the fingertips*. ISO 13091-2:2003, pp 1-24.
- Lundström, R. Strömberg, T. Lundborg, G. 1992. Vibrotactile perception threshold measurements for diagnosis of sensory neuropathy. *Int. Arch. Occup. Environ. Health*, 64, pp 201-207.
- Lundström, R. Nilsson, T. Burström, L. Hagberg, M. 1999. Exposure-response relationship between hand-arm vibration and vibrotactile perception sensitivity. *American Journal of Industrial Medicine*, 35, pp 456-464.

- Mirbro, S.M. Akbar-Khanzadeh, F. Onozuka, M. Jamali, M. Watanabe, K. Inaba, R. Iwata, H. 1999. A four-year follow-up study on subjective symptoms and functional capacities in workers using hand-held grinders. *Industrial Health*, 37, pp 415-425.
- Nakamoto, M. Iwamoto, M. Laska, M.S. Toibana, N. Harada, N. 1998. A study of fingertip vibration perception threshold in hand-arm vibration syndrome patients and healthy controls. Proc. 6<sup>th</sup> Japan Group Meeting on Human Response to Vibration, Japan, Kanazawa, Yokohama, 22-24 July, pp 46-54.
- Skre, H. 1972. Neurological signs in a normal population. *Acta Neurol.Scand.*, 48, pp 75-606.
- Stevens J.C. 1992. Aging and spatial acuity of touch. *Journal of Gerontology: Psychological Sciences*, 47, 1, pp 35-40.
- Stevens, J.C. Cruz, A. Marks, L.E. Lakatos, S. 1998. A multimodal assessment of sensory thresholds in aging. *J.Gerontology Psychol. Sciences*, 53B, 4, pp 263-272.
- Virokannas, H. 1992. Vibration perception thresholds in workers exposed to vibration. *International Archive of Occupational and Environmental Health*, vol 64, pp 377-382
- Wild, P. Massin, N. Lasfargues, G. Baudin, V. Unlu, D. Donati, P. 2001. Vibrotactile perception thresholds in four non-exposed populations of working age. *Ergonomics*, vol 44, pp 649-657.



# WORK-RELATED DISORDERS OF THE UPPER LIMB IN FEMALE WORKERS USING ORBITAL SANDERS

M. Bovenzi<sup>1</sup>, P. Nataletti<sup>2</sup>, B. Alessandrini<sup>3</sup>, Tullio Poian<sup>3</sup>

<sup>1</sup> Clinical Unit of Occupational Medicine, Department of Public Health Sciences, University of Trieste, Trieste 34129, Italy

<sup>2</sup> Physical Agents Laboratory, Department of Industrial Hygiene, ISPESL, Rome 00100, Italy

<sup>3</sup> Occupational Health and Safety Unit, NHS, Udine 33100, Italy

## Abstract

The prevalence of vascular, neurological and musculoskeletal disorders of the upper limb was investigated in a group of female workers performing either mechanical or hand sanding in the furniture industry (n=100) and in a control group of female office workers (n=100). Vibration exposure from orbital sanders was assessed according to ISO recommendations and ergonomic stress was estimated by the Strain Index methodology. There was no significant difference in the prevalence of Raynaud's phenomenon between the furniture workers (4%) and the controls (8%). The prevalence of carpal tunnel syndrome (CTS), peripheral sensorineural disturbances (after exclusion of CTS cases), and upper-limb musculoskeletal complaints was significantly greater in the furniture workers than in the controls. CTS was clinically diagnosed in 19% of the furniture workers and 8% of the controls. A log-binomial regression analysis showed that the occurrence of soft-tissue disorders of the upper limb increased significantly with the increase of both daily vibration exposure and the Strain Index score. These findings suggest that vibration exposure and ergonomic risk factors associated with professional use of vibratory tools seem to contribute in a multiplicative way to the occurrence of soft-tissue disorders in the upper limb of female furniture workers.

## Introduction

There is a shortage of epidemiological studies of upper-limb disorders in female workers using hand-held vibrating tools. It has been reported that the occurrence of vibration-induced upper-limb disorders is greater and the latent period for such disorders is shorter in female workers than in male workers (Bylund et al, 2002). These conclusions, however, are based on the findings of a limited number of epidemiological studies with cross-sectional or case-control design (Dimberg and Odén, 1991; Delgrosso and Boillat, 1991; Urban and Lukás, 1998; Zetterberg and Öfverholm, 1999).

Female workers are often involved in occupations and job tasks characterised by a combined exposure to hand-transmitted vibration and physical stresses such as forceful and repetitive movements and awkward posture. To study the influence of vibration exposure on health conditions of women at work and to contribute to the understanding of the possible adverse effects of exposure to a combination of vibration and ergonomic risk factors, we investigated the prevalence of vascular, neurological and musculoskeletal disorders in the upper limbs of female workers performing either mechanical or hand sanding in the furniture industry.

## Materials and Methods

All female workers (n=100) involved in either mechanical or hand sanding in 17 small-sized furniture plants in the Province of Udine (Italy) were investigated. Of these workers, 14 (group A) operated only orbital sanders, 76 (group B) used both orbital sanders and hand sanding paper, and 10 (group C) performed hand sanding solely. Job tasks were characterised by stereotyped operations consisting of mechanical and/or manual polishing of different furniture articles, mainly chairs. A preliminary workplace survey of operative conditions by means of an upper-extremity checklist, showed that group A and group B were exposed to both hand-transmitted vibration and physical stress factors (e.g. repetition, force, palm grip posture), while group C was exposed to physical stressors alone.

One hundred female office workers employed at local units of the NHS served as a control group. None of the studied subjects was exposed to hand-transmitted vibration during leisure activities.

At least 1 year of work seniority on the study jobs was required for each subject to be included in the survey sample.

### *Medical investigation*

All subjects underwent a medical interview and a complete physical examination. The personal, work, and medical history of each worker was taken by direct interview performed by the same occupational health physician. Occupational history showed that no worker had been exposed to industrial neurotoxic agents in the past. Vascular, neurological and musculoskeletal disorders in the upper limbs were investigated by means of a structured questionnaire validated by the European Research Network on Detection and Prevention of Injuries due to Occupational Vibration Exposures (Vibration Injury Network, VINET). No subject was affected with abnormalities of the fingers and hands such as post-traumatic injuries. A traditional clinical examination of the neurovascular and musculoskeletal systems of the upper limb was carried out by a physician according to the VINET protocol (2001).

The anamnestic diagnosis of Raynaud's phenomenon of occupational origin was based on the following criteria (Olsen et al, 1995): (i) positive history of cold provoked episodes of well demarcated blanching in one or more fingers; (ii) first appearance of finger blanching after the start of occupational exposure to hand-transmitted vibration and no other probable causes of Raynaud's phenomenon; (iii) experience of finger blanching attacks during the last two years.

The diagnosis of primary Raynaud's phenomenon was made according to the classic criteria proposed by Allen and Brown (1932).

The clinical diagnosis of suspected carpal tunnel syndrome (CTS) was based on consensus criteria for the classification of CTS in epidemiological studies (Rempel et al, 1998): (a) classic/probable symptoms for CTS such as numbness, tingling, burning, or pain in at least two of digits 1, 2, or 3; palm pain, wrist pain, or radiation proximal to the wrist were allowed; (b) nocturnal symptoms; (c) physical examination abnormality compatible with CTS (Tinel's test, Phalen's test). The onset of CTS symptoms had to be occurred while working on the study job.

When available, electrodiagnostic findings were used to support a definite diagnosis of CTS.

### *Measurement and assessment of vibration exposure*

Vibration was measured on all models of orbital sanders (n=9) used by the furniture workers. Vibration measurements were made according to International Standards ISO 8662:8 (1997) and ISO 5349-1 (2001). Three miniature accelerometers (PCB 309A) were attached to a palmar adaptor built according to ISO 10891 (1996). The accelerometer connecting cables were taped to minimise errors from triboelectric effects. The accelerometer signals were conditioned and recorded on a DAT recorder (Racal Heim DATaRec A80). The acceleration recordings were analysed in the laboratory by a real time frequency analyser (Ono Sokki CF5220). From the one third octave band frequency spectra (6.3-1250 Hz), the root-mean-square (r.m.s.) of the frequency-weighted acceleration ( $a_{hw}$ ) was obtained after applying the weighting factors recommended by ISO 5349-1 (2001). In the orbital sanders, the root-sum-of-squares of the frequency-weighted r.m.s. acceleration values for the x-, y- and z-axes  $a_{hv}=(a_{hw_x}^2+a_{hw_y}^2+a_{hw_z}^2)^{1/2}$  averaged from 3.7 (SD 0.5)  $ms^{-2}$  r.m.s. to 7.3 (SD 1.0)  $ms^{-2}$  r.m.s. For the most used sander (Mini Jolly YK 90),  $a_{hv}$  averaged 6.8 (SD 1.7)  $ms^{-2}$  r.m.s.

Daily vibration exposure was assessed in terms of 8-hour energy-equivalent frequency-weighted acceleration according to the European Union Directive on physical agents (2002):  $A(8)=a_{hv}(T/T_0)^{1/2}$ , where T is the daily duration of exposure to vibration acceleration  $a_{hv}$  and  $T_0$  is the reference duration of 8 h.

### *Assessment of ergonomic stress*

To evaluate the possible impact of ergonomic risk factors on distal upper-extremity musculoskeletal disorders, we used the Strain Index developed by Moore and Garg (1995). According to these authors, the Strain Index is a semiquantitative job analysis methodology based on physiological, biomechanical and epidemiological considerations. The Strain index methodology consists of measurement or estimation of six task variables: (1) intensity of exertion (i.e. force); (2) duration of exertion per cycle; (3) efforts per minute (i.e. repetitiveness); (4) hand/wrist posture; (5) speed of exertion; (6) duration of task per day. A five-level ordinal rating is assigned to each variable on the basis of direct observation of exposure conditions at workplace. A multiplier value is then given to each task variable and the Strain Index score is obtained as the product of these six multipliers. Three variables (intensity of exertion, hand/wrist posture, and speed of exertion) are qualitative and are estimated using verbal descriptors. The other three variables (duration of exertion per cycle, efforts per minute, and duration of task per day) are quantitative and are measured by the job analyst. On relating incidence rates of distal upper-extremity morbidity to the Strain Index score for 25 job categories, the authors estimated a score of 5 as a possible cut-off to distinguish between safe and hazardous jobs (Moore and Garg, 1995).

In the present study, job analysis was performed at the workplace by an occupational health physician (BA) and an industrial hygienist (TP). The Strain index score was estimated by direct observation of several job tasks performed with different orbital sanders and/or manually with sandpaper.

### Statistical Methods

Data analysis was performed with the statistical software Stata 8.2 (Stata Corporation, 2003). Continuous variables were summarised using the mean as a measure of central tendency and the standard deviation (SD) as a measure of dispersion. The Mann-Whitney test and the Kruskal-Wallis one-way analysis of variance were used to compare two or more independent groups, respectively. The  $\chi^2$  statistic or the Fisher's exact test was applied to data tabulated in 2 x 2 contingency tables. Log-binomial regression analysis was used to assess the relation between health complaints (dependent variable) and several individual and exposure variables. Prevalence ratios (PR) and 95% confidence intervals (95% CI), adjusted for several covariates, were estimated from the log-binomial regression coefficients and their standard errors.

### Results

Preliminary data analysis showed that the controls were, on average, older than the furniture workers (42 vs 34 years,  $p < 0.01$ ). Smoking and drinking habits were more prevalent in the furniture workers and the controls, respectively ( $p < 0.05$ ). As a result, these variables were always included in multivariate regression analysis. Anthropometric data (height, weight, and body mass index) were not different between the two groups. The proportions of subjects with one or more pregnancies, use of oral contraceptives and history of reproductive problems were similar in the two groups.

Table 1 reports the characteristics of the furniture workers according to their exposure status. Age and duration of employment were not significantly different among the three groups. As expected, daily vibration exposure, expressed in terms of A(8), was significantly greater in the female workers in group A who operated only orbital sanders (mean value:  $4.7 \text{ ms}^{-2}$  r.m.s.) than in those in group B who used both vibratory tools and hand sanding paper (mean value:  $3.9 \text{ ms}^{-2}$  r.m.s.), ( $p < 0.05$ ). The Strain Index score was slightly greater in the female workers in group C who performed hand sanding solely than in the other two groups, but the difference was marginally not significant ( $p = 0.10$ ). Job tasks performed by the controls (office workers) were always associated with Strain Index scores  $< 3$ , a cut-off value which identifies safe jobs with low risk for distal upper-extremity musculoskeletal disorders (Moore and Garg, 1995). Physical workload in the controls was associated with computer-related job tasks, mainly those involving the use of keyboards and mouse devices, as well as with the amount of working time spent performing these tasks.

**Table 1** Characteristics of the furniture workers according to their exposure status (see methods). Data are given as means (standard deviations)

	Group A (n=14)	Group (n=76)	Group C (n=10)
Age (years)	30.9 (7.3)	34.5 (8.5)	33.9 (12.4)
Work seniority (years)	8.5 (6.2)	8.2 (6.6)	5.0 (7.2)
A(8) ( $\text{ms}^{-2}$ r.m.s.)	4.7 (1.1)	3.9 (1.0)**	-
Strain Index (score)	9.8 (4.4)	11.4 (2.7)	12.8 (1.4)*

Kruskal Wallis test: \* $p = 0.10$ ; Mann-Whitney test: \*\* $p = 0.032$

Table 2 reports the crude prevalence of vascular, neurological and musculoskeletal disorders in the study population. There was no significant difference in the prevalence of Raynaud's phenomenon between the furniture workers (4%) and the controls (8%). Raynaud's phenomenon was reported solely by the furniture workers with A(8)  $4 \text{ ms}^{-2}$  r.m.s. The prevalence of CTS, peripheral sensorineural disturbances (after exclusion of the subjects with CTS), and upper-limb musculoskeletal disorders was significantly greater in the furniture workers than in the controls. CTS was clinically diagnosed in 19% of the furniture workers and in 8% of the controls ( $p < 0.01$ ). In nine furniture workers and in one control, the clinical diagnosis of CTS was confirmed by positive electrodiagnostic study findings ( $p < 0.02$ ).





**Table 5** Log-binomial regression analysis for the association between upper-limb disorders and exposures to hand-transmitted vibration ( $A(8)$ ) and physical stress (Strain Index) in the furniture workers using orbital sanders. The increase in age-, smoking-, and drinking-adjusted prevalence ratios (PR) for each one unit of increase in  $A(8)$  ( $\text{ms}^{-2}$  r.m.s.) and in the Strain Index (score) is given.

	A(8) ( $\text{ms}^{-2}$ r.m.s.)		Strain Index (score)	
	PR	95% CI	PR	95% CI
Vascular disorders (Raynaud's phenomenon)	1.60	0.60-4.24	1.27	0.74-2.17
Sensorineural disorders (finger tingling and/or numbess)	1.26	1.16-1.37	1.07	1.04-1.11
Musculoskeletal disorders (pain, limited motions): neck shoulder elbow wrist	1.06	0.78-1.46	1.04	0.93-1.17
	1.15	1.05-1.27	1.06	1.02-1.09
	1.36	1.09-1.70	1.09	1.01-1.19
	1.24	1.08-1.43	1.10	1.04-1.16
Clinical diagnosis of carpal tunnel syndrome	1.30	1.11-1.53	1.09	1.02-1.15

### Discussion

In this cross-sectional study, an excess risk for neurological and musculoskeletal disorders of the upper limb was found in a group of female workers exposed to hand-transmitted vibration and ergonomic stressors in the furniture industry, while no significant association was found between vascular disorders (Raynaud's phenomenon) and vibration exposure.

It is difficult to compare our findings with those of other investigations because in the literature there are few studies of health and exposure conditions in female workers who use vibratory tools (Delgrosso and Boillat, 1991; Dimberg and Odén, 1991; Mirbod et al, 1995; Bylund et al, 2002). This may be due to the fact that in industry vibration exposure is less common in women than in men. It has been reported that in 1996-97 twelve per cent of female trade unionists in Sweden were exposed to hand-transmitted vibration at workplace and about 2% of all Swedish women had used vibratory tools for more than 25% of their working time (Bylund et al, 2002). In Great Britain, a national survey estimated that among people of working age, about 4.2 million men (20.5%) and 667,000 women (2.9%) were occupationally exposed to hand-transmitted vibration in a 1 week period (Palmer et al, 2000a). It was also estimated that 1.2 million men and only 44,000 women were exposed to a vibration dose,  $A(8)$ , greater than  $2.8 \text{ ms}^{-2}$  r.m.s., i.e. the daily action level currently suggested in U.K.. In the same survey, the estimated proportion of cases of Raynaud's phenomenon attributable to hand-transmitted vibration ranged between 31.5 and 37.6% in men and varied from 3.1 to 5.3% in women, according to case definition (Palmer et al, 2000b). In the year 1997, 459 cases of vibration injuries were compensated in the Czech Republic (19.3% of all compensated occupational diseases), (Urban and Lukás, 1998). Vibration-induced white finger was reported in 16% of cases, while CTS was the most prevalent disorder. Among the cases who received compensation, the proportion of females was only 4%.

Community surveys have shown that the prevalence of Raynaud's phenomenon in the general population is higher in women (10-25%) than in men (5-10%), with large geographic variations mainly due to climate conditions (Leppert et al, 1987; Silman et al, 1990; Maricq et al, 1997). In addition to gender and climate, Raynaud's phenomenon in the general population was found to be negatively associated with body mass index in both men and women, and positively associated with age, smoking and use of vibrating tools in men, and with marital status and alcohol consumption in women (Maricq et al, 1997; Fraenkel et al, 1999). Thus, it seems that different factors influence the expression of Raynaud's phenomenon in men and women (Fraenkel et al, 1999). These findings, as well as the scarcity of epidemiological studies of vibration-exposed female workers, make difficult to attribute Raynaud's phenomenon to vibration exposure in women who operate vibratory tools. This difficulty is reflected in the risk assessment for hand-transmitted vibration provided by ISO 5349-1 (2001), which is derived solely from epidemiological studies of vibration-exposed male worker populations.

In this study, Raynaud's phenomenon was reported by a small number of vibration-exposed female workers (4%). The occurrence of Raynaud's phenomenon showed no significant trend with vibration exposure. This may be due either to the size of the study sample or to some characteristics of the worker group (young women, on average, with low cumulative vibration exposure). Nevertheless, it should be noted that white finger was found only in subjects with daily dose of vibration ( $A(8)$ )  $4 \text{ ms}^{-2}$  r.m.s., a value greater than the daily exposure action level ( $2.5 \text{ ms}^{-2}$  r.m.s.) established by the recent European Directive on mechanical vibration (2002/44/EC).

In this study of female furniture workers, suspected or definite diagnosis of CTS, peripheral sensorineural disorders (after excluding CTS cases), and upper-limb musculoskeletal complaints were associated with both hand-transmitted vibration and the Strain Index, an overall measure of exposure to several ergonomic stressors.

It is well known that repetitive tasks, high force requirements of the hand, and extreme joint postures are risk factors for an increased occurrence of CTS and soft-tissue disorders of the hand and wrist (Viikari-Juntura and Silverstein, 1999). In a series of epidemiological surveys of active workers from several industrial plants in U.S., it has been reported that high-force + high-repetitive jobs were associated with odds ratios of 15.5 and 29.1 for CTS and overall hand/wrist disorders, respectively, when compared to low-force + low-repetitive job tasks (Silverstein et al, 1986; Silverstein et al, 1987). In the same surveys, it was observed that the combination of high force and high repetitiveness increased the risk magnitude more than either factor alone. The NIOSH review on musculoskeletal disorders and workplace factors concluded that there is evidence for a positive association between repetitive work and CTS, and between forceful work and CTS, while such an evidence was considered insufficient for posture alone (Bernard, 1997). It was also concluded for a strong evidence of a positive association between CTS and combined exposure to the aforementioned risk factors.

The possible contribution of hand-transmitted vibration to the etiopathogenesis of soft-tissue disorders of the upper limb is still a matter of discussion. Cross-sectional studies have shown that professional users of vibratory tools are at higher risk for non-specific distal neuropathies and nerve entrapment syndromes in the upper limbs than heavy manual workers or reference individuals sampled from the general population (Seppäläinen, 1972; Färkkilä et al, 1988; Koskimies et al, 1990; Bovenzi et al, 1991; Nilsson et al, 1994; Bovenzi, 1994). In a previous electrophysiological study, we found that sensory nerve conduction in several segments of the median and radial nerves was significantly reduced in a group of vibration-exposed operators compared to a group of heavy manual workers unexposed to hand-transmitted vibration and a group of healthy males engaged in sedentary work activities (Bovenzi et al, 2000). The neurophysiological patterns more frequently observed in the vibration-exposed workers were compatible with either CTS or a multifocal neuropathy (i.e. impairment of multiple sites of several nerve segments) with predominant involvement of sensory rather than motor fibres.

In some case-control studies, CTS was significantly associated with the use of vibratory tools, repetitive wrist movements and heavy manual work (Cannon et al, 1981; Ahlborgh and Voog, 1982; Wieslander et al, 1989). It has been reported that exposure to hand-transmitted vibration combined with heavy manual work can increase the risk of CTS from five to ten times (Ahlborgh and Voog, 1982; Färkkilä et al, 1988).

In the aforementioned epidemiological studies of workers operating vibratory tools, the occurrence of CTS was found to be related to quantitative measures of daily vibration exposure, duration of exposure, and lifetime cumulative vibration dose. Accordingly, the NIOSH review concluded that there is both evidence for a positive association between jobs with exposure to hand-transmitted vibration and CTS, and strong evidence for a relationship between exposure to a combination of risk factors (forceful repetitive work, non-neutral wrist posture and vibration) and CTS (Bernard, 1977). This conclusion seems consistent with the findings of this study in which we observed a multiplicative effect of exposures to hand-transmitted vibration and ergonomic risk factors on the occurrence of CTS and peripheral sensorineural disturbances in the fingers and hands of female workers operating orbital sanders.

Even though the findings of clinical and epidemiological investigations support the notion of a combined effect of vibration and intensive manual work on the soft tissues of the upper limb, nevertheless it is hard to differentiate the role of vibration from that of ergonomic stress factors in workers who operate hand-held vibratory tools. In this regard, biodynamic studies have revealed the reciprocal influence that vibration and ergonomic stress exert on each other when holding a vibrating handle: vibration of increasing magnitude can cause increasing grip exertion through the activation of the so-called tonic vibration reflex, while, at the same time, forceful gripping results in both increased vibration transmission and higher absorption of vibration energy in the hand and arm (Armstrong et al, 1987).

Experimental and clinical investigations have shown that short-term exposure to hand-transmitted vibration can reduce tactile sensibility with concomitant onset of sensorineural disturbances in the fingers and hands such as paraesthesias and numbness (Verberk et al, 1985; Bovenzi et al, 1997; Malchaire et al, 1998). Tactile impairment may lead to an increase in the amount of grip force exerted on the handles of vibratory tools. The increase in aesthesiometric and vibrotactile perception thresholds following vibration exposure is probably the result of vibration-induced dysfunction in different skin mechanoreceptors and their afferent nerve fibres which are located in the epidermal, dermal, and subcutaneous tissues of the glabrous skin of the fingers and hands (Lundström and Johansson, 1986).

Some pathogenic mechanisms for the nerve injury caused by segmental vibration have been suggested by the findings of histological studies of both experimental animals and human finger skin biopsies. It has been reported that acute vibration exposure induced epineural edema in the sciatic nerve of rats, resulting in an increased intraneural pressure which can interfere with nerve fibre nutrition (Lundborg et al, 1987). Moreover, prolonged exposure to intense vibration was found to provoke a variety of lesions in the peripheral nerves of rabbits and rats such as disruption of the myelin sheaths, constriction of the axons, and disappearance of microtubules and microfilaments in the axons (Ho et al, 1989; Chang et al, 1994). These findings are consistent with the results of finger skin biopsy studies which found severe loss of myelin sheath, perineural fibrosis and a decreased number of myelinated nerve fibres in the fingers and the wrists

of patients exposed to hand-transmitted vibration (Takeuchi et al, 1986; Strömberg et al, 1997). The perineural fibrosis was interpreted as the result of previous vibration-induced edema.

In some studies of female workers exposed to physical load factors including vibration, such as wood product assemblers (Bylund et al, 2002), sewing machine operators (Mirbod et al, 1995), car assembly workers (Zetterberg and Öfverholm, 1999), and dental personnel (Milerad and Ekenvall, 1990; Åkesson et al, 1995), symptoms and signs of peripheral neuropathy, as well as upper-extremity musculoskeletal symptoms, were more frequent than vascular disorders. Similar observations arose from one British survey, in which the occurrence of sensorineural symptoms in women exposed to hand-transmitted vibration was found to be greater than that of finger blanching (Palmer et al, 2000c). These findings are consistent with those of this study in which neurological and musculoskeletal disorders in the upper limbs of female furniture workers were more prevalent than vascular complaints.

Previous studies of female workers using vibratory tools did not provide sufficient information on exposure data and the possible relation with upper-limb disorders was based on a job task approach. In this study, we measured both vibration exposure and ergonomic stress showing that these physical load factors are quantitatively associated with the occurrence of soft-tissue disorders of the upper limb.

The Strain Index methodology used in this study does not consider stress derived from localised mechanical compression. Direct observation of operating conditions revealed that the furniture workers exerted firm palmar grip strength and pressure when they held and used orbital sanders. This could be an additional risk factor for upper-limb disorders. Contact stress was not evaluated in this investigation and we recognise this limitation, although information on this potential risk factor is scarce and available only from clinical case series and cadaver studies (Viikari-Juntura and Silverstein, 1999).

In conclusion, even though the cross-sectional design of this epidemiological study does not allow etiologic considerations, our findings and those of other investigations suggest a significant association between professional use of vibratory tools and soft-tissue disorders in the upper limb of female workers. Quantitative estimation of vibration exposure (A(8)) and ergonomic stress (Strain Index) showed that these physical risk factors seem to contribute in a multiplicative way to the occurrence of chronic nerve and musculoskeletal disorders in female workers operating hand-held vibrating tools in the furniture industry.

### **Acknowledgement**

This research was supported by ISPESL (Italy) - Contract No. CM-1/01.

### **References**

- Åkesson, I., Lundborg, G., Horstmann, V. and Skerfving, S. 1995. Neuropathy in female personnel exposed to high frequency vibration. *Occupational and Environmental Medicine*, vol 52, pp 116-123.
- Ahlborgh, G. and Voog, L. 1982. Vibration exposure and distal compression of the median nerve ("carpal tunnel syndrome"). *Läkartidningen*, vol 79, pp 4905-4908.
- Allen, E.V. and Brown, G.E. 1932. Raynaud's disease: a critical review of minimal requisites for diagnosis. *American Journal of Medical Science*, vol 183, pp 187-200.
- Armstrong, T. J., Fine, L.J., Radwin, R.G. and Silverstein, B. 1987. Ergonomics and the effects of vibration in hand-intensive work. *Scandinavian Journal of Work, Environment & Health*, vol 13, pp 286-289.
- Bernard, P.B. (ed.) 1997. *Musculoskeletal disorders and workplace factors*. Cincinnati (OH), U.S. DHHS (NIOSH) Publication No. 97-141.
- Bovenzi, M. 1994. Hand-arm vibration syndrome and dose-response relation for vibration induced white finger among quarry drillers and stonecarvers. *Occupational and Environmental Medicine*, vol 51, pp 603-611.
- Bovenzi, M., Giannini, F. and Rossi, S. 2000. Vibration induced multifocal neuropathy in forestry workers: electrophysiological findings in relation to vibration exposure and finger circulation. *International Archives of Occupational and Environmental Health*, vol 73, pp 519-527.
- Bovenzi, M., Apostoli, P., Alessandro, G. and Vanoni, O. 1997. Changes over a workshift in aesthesiometric and vibrotactile perception thresholds of workers exposed to intermittent hand transmitted vibration from impact wrenches. *Occupational and Environmental Medicine*, vol 54, pp 577-587.
- Bovenzi, M., Zadini, A., Franzinelli, A. and Borgogni, F. 1991. Occupational musculoskeletal disorders in the neck and upper limbs of forestry workers exposed to hand-arm vibration. *Ergonomics*, vol 34, pp 547-562.

- Bylund, S. L., Burgstrom, L. and Knutsson, A. 2002. A descriptive study of women injured by hand-arm vibration. *Annals of Occupational Hygiene*, vol 46, pp 299-307.
- Cannon, L.J., Bernacki, E.J. and Walther, S.D. 1981. Personal and occupational factors associated with carpal tunnel syndrome. *Journal of Occupational Medicine*, vol 23, pp 255-258.
- Chang, K.Y., Ho, S.T. and Yu, H.S. 1994. Vibration induced neurophysiological and electron microscopical changes in rat peripheral nerves. *Occupational and Environmental Medicine*, vol 51, pp130-135.
- Commission Recommendation of 19 September 2003 concerning the European schedule of occupational diseases (2003/670/EC). *Official Journal of the European Union*, L 238/28, 25.9.2003.
- Directive 2002/44/EC of the European Parliament and the Council of 25 June 2002 on the minimum health and safety requirements regarding the exposure of workers to the risks arising from physical agents (vibration) (sixteenth individual Directive within the meaning of Article 16(1) of Directive 89/391/EEC). *Official Journal of the European Communities*, L 117/13, 6.7.2002.
- Delgrosso, I. and Boillat, M.-A. 1991. Carpal tunnel syndrome: role of occupation. *International Archives of Occupational and Environmental Health*, vol 63, pp 267-270.
- Dimberg, L. and Odén, A. 1991. White finger symptoms: a cross-sectional study. *Aviation, Space, and Environmental Medicine*, vol 62, pp 879-883.
- Färkkilä, M., Pyykkö, I., Jäntti, V., Aatola, S., Starck, J. and Korhonen, O. 1988. Forestry workers exposed to vibration: a neurological study. *British Journal Industrial Medicine*, vol 45, pp 188-192.
- Fraenkel, L., Zhang, Y., Chaisson, C.E., Maricq, H.R., Evans, S.R., Brand, F., Wilson, P.W.F. and Felson, D.T. 1999. Different factors influencing the expression of Raynaud's phenomenon in men and women. *Arthritis & Rheumatism*, vol 42, pp 306-310.
- Fransson-Hall, C., Byström, S. and Kilbom, Å. 1995. Self-reported physical exposure and musculoskeletal symptoms of the fore-arm-hand among automobile assembly-line workers. *Journal of Occupational and Environmental Medicine*, vol 37, pp 1136-1144.
- Hagberg, M., Morgenstern, H. and Kelsh, M. 1992. Impact of occupations and job tasks on the prevalence of carpal tunnel syndrome. *Scandinavian Journal of Work, Environment & Health*, vol 18, pp 337-345.
- Ho, S.T. and YU, H.S. 1989. Ultrastructural changes of the peripheral nerve induced by vibration: an experimental study. *British Journal of Industrial Medicine*, vol 46, pp 157-164.
- International Organization for Standardization 1996. Mechanical vibration and shock – Hand-arm vibration – Method for the measurement and evaluation of the vibration transmissibility of gloves at the palm of the hand. Geneva: ISO 10819.
- International Organization for Standardization 1997. Hand-held portable power tools - Measurement of vibrations at the handle - Part 8: Polisher and rotary, orbital and random orbital sanders. Geneva: ISO 8662-8.
- International Organization for Standardization 2001. Mechanical vibration - Measurement and the evaluation of human exposure to hand-transmitted vibration. Part 1: General requirements. Geneva: ISO 5349-1.
- Koskimies, K., Färkkilä, M., Pyykkö, I., Jäntti, V., Aatola, S., Starck, J. and Inaba, R. 1990. Carpal tunnel syndrome in vibration disease. *British Journal Industrial Medicine*, vol 47, pp 411-416.
- Leppert, J., Åberg, H., Ringqvist, I. and Sörensson, S. 1987. Raynaud's phenomenon in a female population: prevalence and association with other conditions. *Angiology*, vol 38, pp. 871-877.
- Lundborg, G., Dahlin, L.B., Danielsen, N., Hansson, H.A., Necking, L.E. and Pyykkö, I. 1987. Intra-neural edema following exposure to vibration. *Scandinavian Journal of Work, Environment & Health*, vol 13, pp 326-329.
- Lundström, R. and Johansson, R.S. 1986. Acute impairment of the sensitivity of skin mechanoreceptive units caused by vibration exposure of the hand. *Ergonomics*, vol 29, pp 687-698.
- Malchaire, J., Rodriguez Diaz, L.S., Piette, A., Goncalves Amaral, F. and de Schaetzen, D. 1998. Neurological and functional effects of short-term exposure to hand-arm vibration. *International Archives of Occupational and Environmental Health*, vol 71, pp 270-276.
- Maricq, H.R., Carpentier, P.H., Weinrich, M.C., Keil, J.E., Palesh, Y., Biro, C., Vionnet-Fuasset, M., Jiguet, M. and Valter, I. 1997. Geographic variation in the prevalence of Raynaud's phenomenon: a 5 region comparison. *Journal of Rheumatology*, vol 24, pp. 879-889.

- Milerad, E. and Ekenvall, L. 1990. Symptoms of the neck and upper extremities in dentists. *Scandinavian Journal of Work, Environment & Health*, vol 16, pp 129-134.
- Mirbod, S.M., Inaba, R. and Iwata, H. 1995. Operating vibrating tools and prevalence of subjective complaints in vibration syndrome. *Central European Journal of Public Health*, vol 3 (suppl), pp 97-102.
- Moore, J.S. and Garg, A. 1995. The Strain Index: a proposed method to analyze jobs for risk of distal upper extremity disorders. *American Industrial Hygiene Association Journal*, vol 56, pp 443-458.
- Nilsson, T., Hagberg, M., Burström, L. and Kihlberg, S. 1994. Impaired nerve conduction in the carpal tunnel of platers and truck assemblers exposed to hand-arm vibration. *Scandinavian Journal of Work, Environment & Health*, vol 20, pp 189-199.
- Olsen, N., Hagberg, M., Ekenvall L., Futatsuka, M., Harrison, J., Nasu, Y., Welsh, C., Yamada, S. and Yoshida, M. 1995. Clinical and laboratory diagnostics of vascular symptoms induced by hand-arm vibration. Report from discussion in a working group. In: Gemne, G., Brammer, A.J., Hagberg, M., Lundström, R. and Nilsson, T. (eds.). *Proceedings of the Stockholm Workshop 94. Hand-arm vibration syndrome: diagnostics and quantitative relationships to exposure. Arbete och Hälsa*, vol 5, pp 181-186.
- Palmer, K. T., Griffin, M.J., Bendall, H., Pannett, B. and Coggon, D. 2000a. Prevalence and pattern of occupational exposure to hand transmitted vibration in Great Britain: findings from a national survey. *Occupational and Environmental Medicine*, vol 57, pp 218-228.
- Palmer, K. T., Griffin, M.J., Syddall, H., Pannett, B., Cooper, C. and Coggon, D. 2000b. Prevalence of Raynaud's phenomenon in Great Britain and its relation to hand transmitted vibration: a national postal survey. *Occupational and Environmental Medicine*, vol 57, pp 218-228.
- Palmer, K. T., Griffin, M.J., Bendall, H., Pannett, B., Cooper, C. and Coggon, D. 2000c. The prevalence of sensorineural symptoms attributable to hand transmitted vibration in Great Britain: a national postal survey. *American Journal Industrial Medicine*, vol 38, pp 99-107.
- Rempel, D., Evanoff, B., Amadio, P.C., de Krom, M., Franklin, G., Franzblau, A., Gray, R., Gerr, F., Hagberg, M., Hales, T., Katz, J.N. and Pransky, G. 1998. Consensus criteria for classification of carpal tunnel syndrome in epidemiologic studies. *American Journal of Public Health*, vol 88, pp 1447-1451.
- Research network on detection and prevention of injuries due to occupational vibration exposures (Vibration Injury Network, VINET) 2001. Final Report to the European Commission. Brussels: EC BIOMED 2 concerted action - project no. BMH4-CT98-3251 (also at [http://www.humanvibration.com/EU/EU\\_index.htm](http://www.humanvibration.com/EU/EU_index.htm)).
- Seppäläinen, A.M. 1972. Peripheral neuropathy in forest workers. A field study. *Work Environment & Health*, vol 9, pp 106-111.
- Silman, A., Holligan, S., Brennan, P. and Maddison, P. 1990. Prevalence of symptoms of Raynaud's phenomenon in general practice. *British Medical Journal*, vol 301, pp 590-592.
- Silverstein, B., Armstrong, T.J. and Fine, L.J. 1986. Hand wrist cumulative trauma disorders in industry. *British Journal of Industrial Medicine*, vol 43, pp 779-784.
- Silverstein, B., Fine, L.J. and Armstrong, T.J. 1987. Occupational factors and carpal tunnel syndrome. *American Journal of Industrial Medicine*, vol 11, pp 343-358.
- Strömberg, T., Dahlin, L.B., Brun, A. and Lundborg, G. 1997. Structural nerve changes at wrist level in workers exposed to vibration. *Occupational and Environmental Medicine*, vol 54, pp 307-311.
- Takeuchi, T., Takeya, M. and Imanishi, H. 1986. Pathological changes observed in the finger biopsy of patients with vibration-induced white finger. *Scandinavian Journal of Work, Environment & Health*, vol 12, pp 280-283.
- Urban, P. and Lukás, E. 1998. Occupational disease due to hand-arm vibration in the Czech Republic in the year 1997. *Proceedings of the 8<sup>th</sup> International Conference on Hand-Arm Vibration*, National Institute of Working Life, Umeå, Sweden, pp 485-487.
- Verberk, M.M., Sallé, H.J.A. and Kempers, O. 1985. Vibratory and tactile sense of the fingers after working with sanders. *International Archives of Occupational and Environmental Health*, vol 56, pp 217-223.
- Viikari-Juntura, E. and Silverstein, B. 1999. Role of physical load factors in carpal tunnel syndrome. *Scandinavian Journal of Work, Environment & Health*, vol 25, pp 163-185.

Wieslander, G., Norbäck, D., Göthe, C.-J. and Juhlin, L. 1989. Carpal tunnel syndrome (CTS) and exposure to vibration, repetitive wrist movements and heavy manual work: a case-referent study. *British Journal of Industrial Medicine*, vol 46, pp 43-47.

Zetterberg, C. and Öfverholm, T. 1999. Carpal tunnel syndrome and other wrist/hand symptoms and signs in male and female car assembly workers. *International Journal of Industrial Ergonomics*, vol 23, pp 193-204.

# **WOMEN INJURED BY HAND-ARM VIBRATION - WHO CARES?**

S. H. Bylund

National Institute for Working Life

## **Introduction**

To what extent will women be included in research presented at 10th International Conference on Hand-Arm Vibration? What research is going on in order to make the vibrating machines lighter, to produce smaller handles, which suit the hands of women?

Previous research on hand-arm vibration has focused on men. There are indications that vibrations-exposed women have higher prevalence of symptoms and that the symptoms appear within shorter periods of exposure. However, there are far too few studies comparing the sexes in order to make any definite conclusions.

Women constitute half of the working population in Sweden and represent 15-20% of the Swedish metal workers. Half of the Swedish dentists are women. Obviously, women exposed to vibrations do exist.

## **Consequences of Vibration Injuries**

Most studies on vibration concern medical aspects, technical issues, prevention, and standards. Literature to date only to a minor extent address in what way vibration injuries influence the afflicted person's daily life. There are some studies that have shown decreased ability to perform activities of daily living (Cederlund et al, 1999), difficulties in using upper limb in everyday tasks (Palmer et al, 2002), impaired manipulation (Toibana et al, 2002), and quality of life (Haines et al, 2000).

A questionnaire study has been made to describe the effects of vibration injuries among Swedish women (Bylund et al, 2002). The questions concerned work tasks, self-rated health symptoms, latency time to symptoms, current work situation prognosis and tools used.

The occupational group with the highest prevalence of reported vibrations injuries was dental technicians. The prevalence of numbness at the time of reporting the injury was 91%, and the prevalence of white fingers was 54%. The first symptoms started after seven years of exposure. Neurological symptoms developed after a shorter period of exposure compared to vascular symptoms.

Two thirds of the women, principally unskilled workers, had stopped using vibrating machines in their work. Every fifth woman was retired and the same number of women had retrained due to the injury.

The results also show that the women had problems performing activities at home and during leisure time. One third of the women stated that the injury had affected their relationship with other family members.

The survey showed that 60% of the women did not know that hand-arm vibration might cause health effects. Knowledge differed between occupational groups. Only two per cent of the women stated that the employer had informed about the harmful effects of exposure despite there being laws in Sweden requiring employers to do so.

In order to gain a deeper understanding of the complexities of the problems shown in the questionnaire study an in-depth interview study was conducted (Bylund et al, 2004).

Eight women from the questionnaire study were interviewed. The findings show that the injuries had affected several arenas in the women's lives. Reduced hand function had caused restricted abilities to perform activities at work, at home and during leisure time, which in turn had caused social disruption, loss of self-esteem and feelings of burdening others.

The consequences of the vibration injury were related to the severity of the injury but also on personal characteristics, coping abilities and availability of supportive others. The consequences were also affected by factors such as distribution of work tasks, design of workstations, women's main responsibility for home maintenance and family considerations. Deficient knowledge on women's work-related health was also of importance for the risk of being injured as well as for the outcome of the injury.

The two studies show that the vibration injuries to a high extent have affected the women's lives.

## References

- Bylund, SH. and Ahlgren C. 2004. Experiences and consequences in women with hand-arm vibration injuries (Manuscript).
- Bylund, SH., Burström, L. and Knutsson, A. 2002. A descriptive study of women injured by hand-arm vibration. *Annals of Occupational Medicine*, vol 46, pp 299-307.
- Cederlund, R., Isacson, Å., and Lundborg, G. 1999. Hand function in workers with hand-arm vibration syndrome. *Journal of Hand Therapy*, vol 12, pp 16-24.
- Haines, T., Julian, J., Verrall, B., and Chong, J. 2000. Quality of life and work in nickel miners and smelter workers: symptomatic and aesthesiometric correlates. 8th International Conference on Hand-Arm Vibration 9-12 June 1998, Umeå, Sweden, pp 199-203.
- Palmer, K., Griffin, M., Syddall, H., Cooper, C. and Coggon, D. 2002. The clinical grading of Raynaud's phenomenon and vibration-induced white finger: relationship between finger blanching and difficulties in using the upper limb. *International Archives of Occupational and Environmental Health*, vol 75, pp 29-36.
- Toibana, N., Ishikawa, N. and Sakakibara, H. 2002. Measurement of manipulative dexterity in patients with hand-arm vibration syndrome. *International Archives of Occupational and Environmental Health*, vol 75, pp 106-110. PO Box 7654, SE 907 13 Umeå, Sweden



**Medical VII – Blood Pressure/Blood Flow**  
M/ Griffin - Session Coordinator



# THE EFFECT OF VIBRATION EXPOSURE ON THE FUNCTION OF ARTERIOLE AND ARTERY OF THE FINGER

N. Olsen

Department of Clinical Physiology and Nuclear Medicine, Rigshospitalet, University of Copenhagen, Denmark

## Abstract

The effect of vibration exposure on the function of arteriole and artery of the finger was investigated in 10 men with vibration-induced white finger (VWF), 9 men with same exposure and no Raynaud's phenomenon (RP) (HAV), and 10 male controls (MC). The results were compared with the findings in 16 men with chemotherapy-induced RP (CRP) and 16 men with same therapy and no RP (CVB). Finger systolic blood pressure was measured with cuff and strain gauge technique at 30°C and 10°C during body cooling. The arteriolar autoregulation of skin capillary blood flow in the finger was tested by raising the finger 20 cm above heart level. The washout of a  $^{133}\text{Xe}$  depot of the finger skin was measured by a scintillation detector before, during and after the postural manoeuvre. The test was repeated three minutes after an ipsilateral hand vibration ( $L_{h,w} = 130$  dB during 3 minutes).

Impairment of the autoregulation was a late-effect 4-9 years after the chemotherapy in both CRP and CVB ( $p < 0.05$ ). A normal autoregulation was measured in VWF and HAV ( $p > 0.10$ ). An impairment of the normal autoregulation was a transitory effect of the short term vibration in VWF, HAV, and MC ( $p < 0.01$ ). An exaggerated arterial reaction to cold was found in VWF and CRP ( $p < 0.05$ ). The attack of RP may be mediated through an exaggerated sympathetic nervous stimulus in CRP and possibly also in VWF.

## Introduction

Vibration-induced white finger is Raynaud's phenomenon (RP) caused by exposure to hand-arm vibration. Chemotherapy-induced RP is a late-effect of treatment for germ-cell cancer with cisplatin, vinblastine and bleomycin. The autoregulation F% of the capillary blood flow rate in the skin of the finger was investigated in men with RP and in their exposed and non-exposed controls. F% was measured before and after a short term exposure to hand-arm vibration. The findings were related to the cold reaction of the digital arteries (FSP%) and to the subjective symptoms of RP.

## Subjects and Methods

The following groups of subjects were investigated: Ten men with vibration-induced white finger (VWF); 9 men without RP after same vibration exposure as VWF (HAV); 16 men with chemotherapy-induced RP (CRP); 16 men without RP after same chemotherapy as CRP (CVB); 10 male controls (MC). The total range of age was 21-49 years. The exposure period was in median 16 years (12-19) in VWF and 16 years (9-19) in HAV without significant difference between the two groups of men ( $p > 0.10$ ). The latency period from start of the occupational vibration exposure to the first attack of RP was 8 years (2-10) in VWF with duration of finger symptom on 10 years (5-21) at the time of the present investigation. The treatment with cisplatin, vinblastine and bleomycin for metastatic testicular cancer did not differ between the two groups of patients. They received the same doses and courses and obtained a complete response and no relapse. The present investigation was performed 6 years (4-9) after the chemotherapy.

All subjects abstained from tobacco, alcohol and work with vibrating hand tools for at least three hours before the study. The anamnestic diagnose of RP was obtained in a medical interview. VWF was defined as RP with first appearance after start of occupational exposure to hand-arm vibration and without other probable causes (Taylor and Pelmeur, 1975; Olsen et al, 1995). CRP was defined as RP with first appearance after the given chemotherapy and without other probable causes (Vogelzang et al, 1981). The severity of RP was judged by the Stockholm Workshop Scale (Gemne et al, 1987). It was 2 (1-3) for the investigated hand in VWF and CRP.

The study was designed as follows: A medical interview was performed before the applied tests; a cold provocation test was performed on day 1; a postural test was performed before and after a short term exposure to hand-arm vibration on day 2. Systolic and diastolic blood pressure was measured auscultatorily by use of a 12 cm broad cuff on the upper arm of the investigated arm. The most severely affected fingers were tested in VWF and CRP. Corresponding fingers (second to fourth) were tested in the groups without finger symptoms. The finger systolic blood pressure FSP was measured by cuff and strain gauge technique at 30°C and 10°C in a cold provocation test using combined body and finger cooling (Nielsen and Lassen, 1977; Olsen et al, 1982). FSP% was FSP at 10°C in percentage of FSP at 30°C and was used as a measure of the arterial cold reaction in the investigated finger. A zero pressure verified an attack of RP (Lewis,

1929). The diagnostic value of FSP% has been found to be superior to the diagnostic values of other cooling parameters (Olsen, 2002). The total arterial contraction is executed by the arterial smooth muscle cells and was assumed to be composed of a cold reaction activated by non-neurogenic stimuli and a cold reaction mediated through the sympathetic nervous stimulus.

The autoregulation of capillary blood flow rate in the skin of the finger is assumed to be executed by the non-neurogenic terminal arterioles (Kastrup et al, 1985). It was tested by raising the finger 20 cm. The reference body posture was lying supine with the finger at the midaxillary line (Kristensen, 1980). The autoregulatory function F% was measured by the local xenon-133 washout technique at a constant room temperature of  $24.0^{\circ}\text{C} \pm 0.5^{\circ}\text{C}$  after at least 45 minutes' rest and when feeling comfortably warm without sweating (Sejrsen, 1969). Atraumatic  $^{133}\text{Xe}$  labelling was performed on the dorsum of the distal interphalangeal joint where there are no arteriovenous anastomoses (Sejrsen, 1968; Grant and Bland, 1931). The disappearance of radioactivity from the labelled area was externally monitored by a scintillation detector with a wide collimation. A two minutes' test period was proceeded and followed by a two minutes' reference period. Washout rate constants of the test period ( $k_2$ ) and reference periods ( $k_1$  and  $k_3$ ) were estimated. The relative blood flow rate was defined as:  $F\% = 100 k_2 / 0.5(k_1 + k_3) \%$ . It is also named autoregulation, arteriolar autoregulation, and autoregulatory function in the present study.

Subsequently, VWF, HAV and MC were exposed to an ipsilateral hand-arm vibration of three minutes' duration by using an impact drill kept with minimal pressure on a stone embedded in a concrete block. The acceleration level and its reproducibility were calculated from repeated measurements of three operators according to the guidelines of the International Organisation for Standardisation (ISO 5349, 1986). Ten measurements were performed for each operator. The median acceleration level and its total range were  $L_{h,w} = 130.0$  dB (129.8-130.4) with no significant difference between the three operators ( $p > 0.95$ ). It corresponded to a median acceleration  $a_{h,w}$  of  $3.16 \text{ m/s}^2$ . This vibration level should induce VWF after four hours daily exposure during ten years in about 10% of the exposed population (ISO 5349, 1986). F% was measured in VWF, HAV and MC three minutes after ended vibration exposure and in MC measured again sixty minutes after the vibration exposure. CRP and CVB were not exposed to the hand-arm vibration. The normal F% is 100%. The theoretical value of F% for a completely abolished autoregulation was about 80% as calculated from the measured systolic and diastolic blood pressure on upper arm and the estimated hydrostatic pressure of 20 cm whole blood at  $37^{\circ}\text{C}$ . F% was also measured in 10 men (4 MC, 2 HAV, and 4 VWF) three minutes after a three minutes' firm hand grip around the handle of the non-running drill. The calculated washout rate constant of the first reference period ( $k_1$ ) did not differ between the tested groups and was in median  $0.37 \text{ min}^{-1}$  ( $n=27$ ) corresponding to about 25 ml/min per 100 g skin. A difference in F% between groups of subjects was therefore assumed to show a difference in autoregulation and not a difference in reference blood flow rate. More information on materials and methods has been published elsewhere (Olsen et al, 1989; Hansen et al, 1990).

Statistical evaluation was performed by non-parametric statistics with a significance level of 0.05 (two-tailed). Values are given as medians with total ranges in bracket.

## Results

All subjects had a normal systolic blood pressure gradient from upper arm to the fingers ( $p > 0.10$ ). The results of FSP% and F% are given in Table 1. FSP% was significantly lower in VWF and CRP than in HAV, CVB and MC ( $p < 0.05$ ). F% of MC, HAV and VWF did not differ significantly from each other or from 100% before the short term exposure to vibration ( $p > 0.10$ ) and were significantly reduced three minutes after the exposure to vibration ( $p < 0.01$ ). Sixty minutes after vibration exposure, F% of MC did not differ significantly from 100% or from its value before vibration ( $p > 0.10$ ). F% was significantly reduced in CRP and CVB compared with 100% and with F% in MC before vibration ( $p < 0.05$ ). F% did not differ significantly between CRP and CVB ( $p > 0.10$ ). The median value of F% was 75% in CRP and 82% in CVB which were of same value as the theoretical F% for a total abolition of the autoregulatory function. F% after the firm grip on the non-running drill was of same size as F% before the grip in ten men ( $p > 0.10$ ).

## Discussion

All subjects had a normal systolic and diastolic blood pressure on the upper arm and a normal systolic blood pressure gradient from upper arm to the investigated fingers. The findings indicate that no organic obliterations of hemodynamic importance were located in the arteries leading to and through the fingers (Hirai, 1978). The subjective finger symptoms in VWF and CRP therefore were vasospastic types of RP and not obliterative types of RP. An exaggerated arterial reaction to cold was detected in nearly all men in VWF and CRP and several had a zero pressure that verified an attack of RP (Lewis, 1929). A normal cold response was detected in most men in HAV and CVB.

**Table 1** Results of the cold provocation test (FSP%) and the postural test (F%). FSP% is the finger systolic blood pressure at 10°C in percentage of its value at 30°C. F% is the washout rate constant of a <sup>133</sup>Xe finger depot when the finger is raised 20 cm above heart level in percentage of the median rate constant when the finger was at heart level. F% was estimated before and after a three minutes' exposure to hand-arm vibration ( $L_{h,w} = 130$  dB) of the tested hand. Values are given as medians (ranges).

Group	No	FSP%	F%		
			before vibration	3 min after vibration	60 min after vibration
VWF	10	30 (0-75)* <sup>§</sup>	99 (96-101)	82 (73-100)* <sup>°</sup>	
HAV	9	78 (20-96)	96 (92-109)	80 (67- 90)* <sup>°</sup>	
MC	10	85 (72-88)	99 (97-111)	80 (71- 94)* <sup>°</sup>	100 (96-106)
CVB	16	78 (30-104)	82 (52-106)*		
CRP	16	0 (0-70)* <sup>^</sup>	75 (44-114)*		

\* Significant difference from corresponding value of MC before hand vibration ( $p < 0.05$ ).

<sup>°</sup> Significant difference from its corresponding value before hand vibration ( $p < 0.01$ ).

<sup>§</sup> Significant difference from corresponding value of HAV ( $p < 0.05$ ).

<sup>^</sup> Significant difference from corresponding value of CVB ( $p < 0.05$ ).

A normal autoregulatory function (F%) is 100%. The impairment and abolition of autoregulation after the short term exposure to vibration is assumed to be exclusively caused by the exposure to hand-arm vibration and not by ischemia since the firm hold on the non-running drill did not change the normal autoregulation of ten men. The autoregulation was normal in VWF and HAV regardless of RP and occupational use of vibrating hand tools during the preceding 16 years (9-19). It was equally impaired in VWF, HAV and MC three minutes after the short term exposure to hand-arm vibration. The abolished autoregulation of MC was completely restored within sixty minutes. These findings indicate a rapid and complete reversibility of the vibration-induced disorder. An abolished autoregulation obtained without exposure to vibration was detected in both CRP and CVB. It indicates that the chemotherapy induces a prolonged toxic side-effect on the autoregulatory function. So, an equal impairment of the autoregulation could be induced in all five subject groups regardless of subjective finger symptoms of Raynaud's phenomena. The equally impaired autoregulations were of same size as the calculated total abolition on about 80%.

It has been suggested that the autoregulatory function is executed by the smooth muscle cells of the non-neurogenic terminal arterioles (Henriksen, 1977). This postulate seems verified by the findings of many young insulin-dependent patients with bioptically verified terminal arteriolar hyalinosis in skin regions with disturbed or impaired autoregulation but normal functions of the greater arterioles who are richly innervated by adrenergic sympathetic nerve fibres (Kastrup et al, 1985; Kastrup et al, 1987). The results of the present study may therefore indicate that short term low level vibration induces an immediate abolition of the function of the smooth muscle cells in the terminal arterioles. However, the autoregulation was completely regained within sixty minutes in MC. This indicates that the arteriolar damage after short term vibration exposure is not caused by permanent organic changes of the smooth muscle cells and that the terminal arterioles are without organic changes of hemodynamic importance. The normal autoregulation found in VWF and HAV further indicates that prolonged occupational exposure to vibration does not lead to prolonged impairment of the vasomotor function of the terminal arterioles. In opposite to the findings caused by the short term and the long term vibration exposure, the autoregulatory function was completely abolished even 4-9 years after the chemotherapy. This indicates a prolonged toxic effect that may reflect organic changes in the terminal arterioles as has been detected in young insulin-dependent patients (Kastrup et al, 1985; Kastrup et al, 1987).

The findings of an impaired function of non-neurogenic terminal arterioles in CRP and CVB make it probable that the non-neurogenic part of the total arterial cold reaction may have a decreased or normal vasomotor function whereas an increased function seems less probable. The exaggerated arterial cold reaction found in CRP therefore seems to be mediated mainly by an exaggerated sympathetic nervous stimulus that acts on the smooth muscle cells of the finger arteries. Prolonged neurotoxic effects after treatment with same type of chemotherapy as used in the present study have been described to include peripheral sensory neuropathy in the majority of patients; impotence mainly caused by parasympathetic damages; high-frequency hearing loss; and slowing of the central conduction in the brain (Roth et al, 1988, two articles). The attack of RP in CRP may therefore be a vascular symptom of a neurotoxic late-effect of the treatment. Prolonged neurogenic damages have also been described in workers exposed to hand-arm vibration and include peripheral sensory neuropathy; impotence; hearing loss; and slowing of neurogenic conduction velocity (Färkkilä et al, 1990). The findings open for the possibility that RP in VWF mainly may be mediated through an exaggerated sympathetic stimulus as was indicated for RP in CRP. An exaggerated sympathetic stimulus may reflect an intrinsic hyperactivity of the sympathetic nervous system or a reduced function of nerves that normally counteracts and moderates the intrinsic function of the sympathetic nervous system.

In conclusion, the results of the present study show that an impairment of the autoregulatory function is: 1) a toxic late-effect of the chemotherapy regardless of RP; 2) a transitory effect of the short term exposure to vibration regardless of RP and occupational exposure to vibration; 3) not a long term effect of the prolonged occupational exposure to vibration. The smooth muscle cells of the terminal arterioles therefore are highly vulnerable to chemotherapy and short term hand-arm vibration but have a normal function after prolonged occupational exposure to vibration. VWF and CRP are vasospastic types of secondary RP. The attack of RP is a closure of the main arteries of the finger. The arterial closure seems mainly mediated through an exaggerated sympathetic nervous stimulus in CRP and may be also in VWF. However, many other pathophysiological stimuli have been suggested and may be of importance for the release of an attack of vibration-induced white finger (Stoyneva et al, 2003).

## References

- Färkkilä, M., Pyykkö, I. and Heinonen, E. 1990. Vibration stress and the automatic nervous system. *The Kurume Medical Journal*, vol 37 supplement, pp S53-S60.
- Gemne, G., Pyykkö, I., Taylor, W. and Pelmeur, P.L. 1987. The Stockholm Workshop scale for the classification of cold-induced Raynaud's phenomenon in the hand-arm vibration syndrome (revision of the Taylor-Pelmeur scale). *Scandinavian Journal of Work, Environment and Health*, vol 13, pp 275-278.
- Grant, R.T. and Bland, E.F. 1931. Observations on arteriovenous anastomoses in human skin and in the bird's foot with special reference to the reaction to cold. *Heart*, vol 15, pp 385-411.
- Hansen, S.W., Olsen, N., Rossing, N. and Rørth, M. 1990. Vascular toxicity and the mechanism underlying Raynaud's phenomenon in patients treated with cisplatin, vinblastine and bleomycin. *Annals of Oncology*, vol 1, pp 289-292.
- Hirai, M.H. 1978. Arterial insufficiency of the hand evaluated by digital blood pressure and arteriographic findings. *Circulation*, vol 58, pp 902-908.
- Henriksen, O. 1977. Local sympathetic reflex mechanism in regulation of blood flow in human subcutaneous adipose tissue. Thesis. *Acta Physiologica Scandinavica*, suppl 450, pp 1-48.
- International Organisation for Standardisation. 1986. Mechanical vibration – guidelines for the measurement and the assessment of human exposure to hand-transmitted vibration. Switzerland. International Standard ISO 5349.
- Kastrup, J., Nørgaard, T., Parving, H.-H., Henriksen, O. and Lassen, N.A. 1985. Impaired autoregulation of blood flow in subcutaneous tissue of long-term type 1 (insulin-dependent) diabetic patients with microangiopathy: an index of arteriolar dysfunction. *Diabetologia*, vol 28, pp 711-717.
- Kastrup, J., Nørgaard, T., Parving, H.-H. and Lassen, N.A. 1987. Arteriolar hyalinoses does not interfere with the local veno-arteriolar reflex regulation of subcutaneous blood flow in insulin-dependent diabetic patients. *Scandinavian Journal of Clinical and Laboratory Investigation*, vol 47, pp 483-489.
- Kristensen, J.K. 1980. Local regulation of blood flow in cutaneous and subcutaneous tissue in patients with generalized scleroderma. Thesis. *Acta Dermato-Venereologica*, suppl 90, pp1-39.
- Lewis, T. 1929. Experiments related to peripheral mechanism involved in spasmodic arrest of the circulation in the fingers. A variety of Raynaud's disease. *Heart*, vol 15, pp 7-101.
- Nielsen, S.L. and Lassen, N.A. 1977. Measurement of digital blood pressure after local cooling. *Journal of Applied Physiology*, vol 43, pp 907-910.
- Olsen, N., Nielsen, S.L. and Voss, P. 1982. Cold response of digital arteries in chain saw operators. *British Journal of Industrial Medicine*, vol 39, pp 82-88.
- Olsen, N., Petring, O., and Rossing, N. 1989. Transitory postural vasomotor dysfunction in the finger after short term hand vibration. *British Journal of Industrial Medicine*, vol 46, pp 575-581.
- Olsen, N., Hagberg, M., Ekenvall, L., Futatsuka, M., Harrison, J., Nasu, Y., Welsh, C., Yamada, S. and Yoshida, M. 1995. Clinical and laboratory diagnostics of vascular symptoms induced by hand-arm vibration. Report from a working group. In: Gemne, G., Brammer, A.J., Hagberg, M., Lundström, R. and Nilsson, T. eds. *Proceed Stockholm Workshop 94. Hand-arm vibration syndrome: Diagnostics and quantitative relationships to exposure. May 25-28, 1994. Arbete och Hälsa*, 1995:5, pp 181-186.
- Olsen, N. 2002. Diagnostic aspects of vibration-induced white finger. *International Archives of Occupational and Environmental Health*, vol 75, pp 6-13.

- Roth, B.J., Greist, A., Kubilis, P.S., Williams, S.D. and Einhorn, L.H. 1988. Cisplatin-based combination chemotherapy for disseminated germ cell tumors: Long-term follow-up. *Journal of Clinical Oncology*, vol 6, pp 1239-1247.
- Roth, B.J., Einhorn, L.H. and Greist, A. 1988. Long-term complications of cisplatin-based chemotherapy for testis cancer. *Seminars in Oncology*, vol 15, pp 345-350.
- Sejrsen, P. 1968. Atraumatic local labeling of skin by inert gas: epicutaneous application of xenon-133. *Journal of Applied Physiology*, vol 24, pp 570-572.
- Sejrsen, P. 1969. Blood flow in cutaneous tissue in man studied by washout of radioactive xenon. *Circulation Research*, vol 25, pp 215-229.
- Stoyneva, Z., Lyapina, M., Tzvetkov, D. and Vodenicharov, E. 2003. Current pathophysiological views on vibration-induced Raynaud's phenomenon. *Cardiovascular Research*, vol 57, pp 615-624.
- Taylor, W. and Pelmear, P.L. 1975. *Vibration White Finger in Industry*, pp xvii-xxii. Academic Press, London.
- Voegelzang, N.J., Bosl, G.J., Johnson, K. and Kennedy, B.J. 1981. Raynaud's phenomenon: A common toxicity after combination chemotherapy for testicular cancer. *Annals of Internal Medicine*, vol 95, pp 288-292.





# INFLUENCE OF ROOM TEMPERATURE ON FINGER SYSTOLIC BLOOD PRESSURE RESPONSE TO FINGER COOLING IN HEALTHY SUBJECTS

M. S. Laskar<sup>1</sup>, K. Ohmura<sup>2</sup>, M. Inoue<sup>1</sup>, K. Yokoyama<sup>1</sup>, J. Inagaki<sup>1</sup>,  
Y. Takahashi<sup>1</sup>, M. H. Mahbub<sup>1</sup>, H. Ohnari<sup>1</sup>, N. Harada<sup>1\*</sup>

<sup>1</sup>Department of Hygiene, Yamaguchi University School of Medicine, 1-1-1, Minamikogushi, Ube 755-8505, Japan.

<sup>2</sup>Ogori Daiichi General Hospital, Japan

## Abstract

Percentage finger systolic blood pressure (%FSBP) in response to finger cooling is used to assess vascular components of the hand-arm vibration syndrome and the measurement method is under discussion for standardization. It has been suggested that measurement circumstances including room temperature may influence %FSBP. We investigated the influence of room temperature on %FSBP response to finger cooling in healthy subjects. Six healthy male subjects who were medical students volunteered for the study. Multi-Channel Plethysmograph was used for simultaneous multi-finger FSBP measurements. The examination room was kept at  $21 \pm 1$  °C and  $25 \pm 1$  °C, and the subjects were randomly assigned. %FSBPs for the index, middle, ring and little fingers at 15 °C and 10 °C cuff-water temperatures were calculated. Four-way analysis of variance was performed to determine the independent influence of the subject factor, room temperature factor, finger factor, and cuff-water temperature factor on %FSBP. The room temperature as an independent factor was significant ( $p < 0.01$ ). The results also indicated that the temperature of  $21 \pm 1$  °C may be better than that of  $25 \pm 1$  °C for room temperature during cold provocation test measuring FSBP. Room temperature might influence %FSBP response to finger cooling, and therefore, is expected to be controlled at  $21 \pm 1$  °C when assessing peripheral vascular components using %FSBP.

## Introduction

Development is being achieved in the work for standardizing vascular assessment methods for diagnosing hand-arm vibration syndrome (HAVS). For assessment of vascular components of the upper extremities in patients with HAVS, percentage finger systolic blood pressure (%FSBP) in response to finger cooling and measurement of finger skin temperature (FST) response to cold provocation are used. The measurement of FSBP in response to finger cooling has been reported to be a valuable test (Nielsen et al, 1977; Olsen et al, 1979; Olsen et al, 1982). A cold provocation test measuring FSBP on a middle phalanx after local cooling during 5-min ischemia was introduced in 1977, which was later, modified and applied to subjects with HAVS (Nielsen et al, 1977; Nielsen, 1978). Some researchers have reported that the cold provocation test including single finger cooling and additional body surface cooling may enhance sensitivity and specificity for diagnosing HAVS (Ekenvall et al, 1982; Olsen et al, 1979; Olsen et al, 1982). The measurement method is under discussion and currently being standardized as Draft International Standard within the International Organization for Standardization (ISO) (ISO/DIS 14835- Part 2, 2004). As vascular disorder may vary between fingers, it is desirable to assess all fingers when performing FSBP measurement for assessing vascular components of the HAVS. By using HVLab Multi-Channel Plethysmograph developed by Human Factors Research Unit, Institute of Sound and Vibration Research, University of Southampton, United Kingdom simultaneous multi-finger FSBP measurements are possible avoiding time-consuming performance (Lewis, 1996).

It has been reported that room temperature may affect FST measured during cold provocation test in healthy subjects (Harada et al, 1998; Ishitake et al, 2000). Cold provocation test measuring FST has been carried out in Japan using room temperatures from 17 °C to 26 °C (Harada et al, 1998; Ishitake et al, 2000; Kurumatani et al, 1981; Kurumatani et al, 1984). However, the range of room temperature recommended by Japanese Ministry of Labour for investigating peripheral circulatory function is 20-22 °C (Japanese Ministry of Labour, 1975). The room temperature of  $21 \pm 1$  °C for the study involving cold provocation test measuring FST was also proposed by others (Gautherie, 1995). It is assumed that room temperature may affect the test results using %FSBP in response to finger cooling. Therefore, in the present study, we investigated the influence of room temperature on %FSBP response to finger cooling in healthy subjects.

## Methods

Six healthy male subjects who were medical students (age:  $23.3 \pm 1.4$  years, BMI:  $20.9 \pm 1.9$  kg/m<sup>2</sup>) volunteered for the present study. The mean (SD) right-hand length, right-hand breadth at thumb, right-hand breadth at metacarpal, right-hand thickness with calipers were 18.8 (1.0) cm, 9.7 (0.9) cm, 8.0 (0.2) cm and 2.2 (0.4) cm, respectively (according to van Cott et al, 1972). The mean (SD) volume of the right-hand of the subjects with the "Archimedes' method", by submerging the hand in a water container, and measuring the displacement was 0.33 (0.04) dm<sup>3</sup>. The subject posture was

sitting with the wrist of the test hand held straight with the forearm and hand during the test as there may be a contradictory effect of supine posture on sympathetic nervous system activity response to cold provocation (Laskar et al, 2003). The measurements of FSBP were done according to ISO/DIS and that described elsewhere (ISO/DIS 14835- Part 2, 2004; Lindsell et al, 2002).

Before measurements, smoking, alcohol intake and time after food intake were controlled. To avoid potential effects of circadian rhythm, all sessions were taken place between 9:00 and 18:00. The subjects wore light indoor clothing during the tests. All of them rested for at least 30 min in the environment of the test room without physiological or psychological stress for thermal adaptation. The HVLab Multi-Channel Plethysmograph was used for data measurements.

The examination room was kept at  $21 \pm 1$  °C and  $25 \pm 1$  °C on the first and second days, respectively, and the subjects were randomly assigned. The FSBP measurements were done at 30 °C, 15 °C and 10 °C cuff-water temperatures on the right hand, simultaneously in four test fingers (cooled) and the thumb as reference (not cooled) of the right hand. Reference pressures were obtained with an air-inflated pressure cuff situated around the proximal phalanx of the thumb. Water-perfused pressure cuffs were used to measure on the test fingers; cuffs were placed around the middle phalanges of the index, middle and ring fingers and on the proximal phalanx of the little finger. Mercury-in-silastic strain gauges were placed on the distal phalanges of the reference and test digits. The fingertips of the right hand were squeezed, to remove blood from the digits so that stronger signals are elicited on return of blood flow during pressure reduction, whilst a supra-systolic pressure applied to all cuffs (250 mmHg). Water, controlled at 30 °C, perfused the double-inlet cuffs for 5 min before all cuffs were deflated at a rate of 2 mmHg/s, and basal FSBPs were measured. The measurements were repeated first at a water temperature of 15 °C, then at a water temperature of 10 °C. The FSBP of a digit was defined as the pressure at which the transducer detected the return of blood flow in that digit. Percentage FSBPs (%FSBPs) for index, middle, ring and little fingers at 15 °C and 10 °C cuff-water temperatures under both room temperature conditions were calculated (Nielsen, 1978).

For both room temperature conditions, a basal arm blood pressure on the left arm was measured in the sitting posture for all subjects at the end of 30-min rest period and recorded using a digital device (Critikon Dinamap™, United Kingdom). Table 1 shows the mean and standard deviation of basal arm blood pressures of the subjects at the two room temperatures. The basal arm systolic blood pressure at room temperature of  $21 \pm 1$  °C was significantly larger than that at  $25 \pm 1$  °C ( $p < 0.01$ , paired *t*-test).

Four-way analysis of variance (ANOVA) was performed to determine the independent influence of the subject factor, room temperature factor, test finger factor, and cuff-water temperature factor on %FSBPs. Simple correlation was examined using Pearson correlation analysis.

**Table 1** Mean and SD of basal arm blood pressures of the subjects at the two room temperatures

	Room temperature				<i>p</i> value
	$21 \pm 1$ °C		$25 \pm 1$ °C		
	Mean	SD	Mean	SD	
ASBP (mmHg)	116.8	4.8	110.0	2.5	<0.01
ADBP (mmHg)	63.3	8.6	61.7	8.3	>0.05

Number of subjects= 6. ASBP, arm systolic blood pressure; ADBP, arm diastolic blood pressure. Differences by paired *t*-test.

### Results

Table 2 shows the means and standard deviations of percentage finger systolic blood pressures at the two room temperatures. The %FSBPs at room temperature of  $21 \pm 1$  °C were slightly larger than those at room temperature of  $25 \pm 1$  °C.

**Table 2** Mean and SD of percentage finger systolic blood pressures at the two room temperatures

Cuff-water temperature	Fingers	Room temperature			
		21 ± 1 °C		25 ± 1 °C	
		Mean	SD	Mean	SD
15 °C	Index	99.1	26.1	82.8	19.2
	Middle	97.7	20.6	96.1	15.9
	Ring	105.7	36.5	91.3	9.4
	Little	102.4	17.9	98.7	16.7
10 °C	Index	101.1	14.9	86.4	16.5
	Middle	101.1	25.3	99.3	10.3
	Ring	106.9	38.3	92.0	8.2
	Little	110.9	26.7	102.7	11.8

Number of subjects= 6.

Table 3 shows the Pearson correlations between %FSBPs and basal systolic blood pressures of the subjects. The correlations for the ring finger under room temperature of 21 ± 1 °C at 10 °C cuff-water temperature and under room temperature of 25 ± 1 °C at both 15 °C and 10 °C cuff-water temperatures were negative and statistically significant (p<0.05).

**Table 3** Correlations between %FSBPs and basal arm systolic blood pressures (ASBPs) of the subjects

	Fingers	Correlation coefficients at room temperature			
		21 ± 1 °C		25 ± 1 °C	
		Cuff-water temperature		Cuff-water temperature	
		15 °C	10 °C	15 °C	10 °C
ASBPs (mmHg)	Index	-0.513	-0.204	-0.058	-0.432
	Middle	0.384	0.034	-0.351	-0.590
	Ring	-0.508	-0.784*	-0.738*	-0.862*
	Little	-0.678	-0.067	-0.462	-0.672

Number of subjects= 6. \*: p<0.05 (Pearson correlation test).

Table 4 shows the Pearson correlations between %FSBPs and subject characteristics. The correlation between right-hand length of the subjects and %FSBPs from the middle finger under room temperature of 21 ± 1 °C at 10 °C cuff-water temperature was negative and statistically significant (p<0.05). The correlation between right-hand length of the subjects and %FSBPs from the ring finger under room temperature of 21 ± 1 °C at 15 °C cuff-water temperature was positive and statistically significant (p<0.05). The correlation between right-hand volume of the subjects and %FSBPs from the middle finger under room temperature of 21 ± 1 °C at 10 °C cuff-water temperature was negative and statistically significant (p<0.05).

**Table 4** Correlations between %FSBPs and subject characteristics

Characteristics	Fingers	Correlation coefficients at room temperature			
		21 ± 1 °C		25 ± 1 °C	
		Cuff-water temperature		Cuff-water temperature	
		15 °C	10 °C	15 °C	10 °C
Age (years)	Index	-0.717	-0.108	0.635	0.699
	Middle	0.167	0.110	0.420	0.633
	Ring	0.554	0.516	0.343	0.496
	Little	-0.042	0.107	0.622	0.723
BMI (kg/m <sup>2</sup> )	Index	-0.490	-0.064	0.570	0.665
	Middle	-0.145	-0.210	0.269	0.404
	Ring	0.681	0.556	0.131	0.409
	Little	-0.187	-0.096	0.486	0.538
Right-hand length (cm)	Index	0.608	-0.305	-0.361	0.045
	Middle	-0.594	-0.836*	-0.482	-0.402
	Ring	0.775*	0.608	-0.344	0.365
	Little	0.051	-0.720	-0.276	-0.188
Right-hand breadth at thumb (cm)	Index	0.227	0.498	0.525	0.438
	Middle	-0.630	-0.345	0.458	0.054
	Ring	-0.135	-0.076	0.204	-0.130
	Little	-0.675	-0.267	0.345	0.081
Right-hand breadth at metacarpal (cm)	Index	0.670	0.018	-0.112	0.315
	Middle	-0.373	-0.258	0.142	0.096
	Ring	0.276	0.512	0.412	0.564
	Little	0.248	-0.410	0.196	0.209
Right-hand thickness (cm)	Index	0.447	-0.593	-0.693	-0.398
	Middle	0.344	-0.042	-0.342	-0.170
	Ring	-0.015	0.072	0.119	0.377
	Little	0.366	-0.476	-0.350	-0.130
Right-hand volume (dm <sup>3</sup> )	Index	0.395	-0.080	0.089	0.395
	Middle	-0.660	-0.760*	-0.066	-0.117
	Ring	0.676	0.571	-0.065	0.381
	Little	-0.253	-0.670	0.093	0.085

Number of subjects= 6. \*:  $p < 0.05$  (Pearson correlation test).

Table 5 presents the results by four-way ANOVA indicating factors influencing %FSBP. The room temperature as an independent factor was statistically significant ( $p < 0.01$ ). The subject factor was also significant as an independent factor ( $p < 0.01$ ). The interaction between subject factor and finger factor was also significant ( $p < 0.01$ ).

**Table 5** Factors influencing %FSBP (results by four-way ANOVA)

	<i>df</i>	F value	<i>p</i> value
<b>Independent factors</b>			
Room temperature factor (A)	1	7.88	<0.01
Subject factor (B)	5	6.16	<0.01
Test finger factor (C)	3	1.91	>0.05
Cuff-water temperature (D)	1	0.97	>0.05
<b>Interactions</b>			
A*B	5	1.86	>0.05
A*C	3	1.00	>0.05
A*D	1	0.02	>0.05
B*C	15	2.63	<0.01
B*D	5	0.63	>0.05
C*D	3	0.11	>0.05

Table 6 shows finger-wise correlations of %FSBPs at 15 °C cuff-water temperature with those at 10 °C cuff-water temperature. All the correlations were positive. The correlation under room temperature of  $21 \pm 1$  °C for the ring finger ( $p < 0.05$ ) and the correlations under room temperature of  $25 \pm 1$  °C for the index, middle and little fingers ( $p < 0.05$ ,  $p < 0.01$ ) were statistically significant.

**Table 6** Finger-wise correlations of %FSBPs at 15 °C cuff-water temperature with those at 10 °C cuff-water temperature

Fingers	Correlation coefficients at room temperature			
	$21 \pm 1$ °C	<i>p</i> value	$25 \pm 1$ °C	<i>p</i> value
Index	0.091	>0.05	0.833	<0.05
Middle	0.661	>0.05	0.857	<0.05
Ring	0.880	<0.05	0.606	>0.05
Little	0.362	>0.05	0.921	<0.01

Number of subjects= 6.

### Discussion

Blood is delivered to all tissues of the body by the maintenance of an adequate arterial blood pressure, which is directly dependent on cardiac output (volume of blood pumped by the heart per minute) and peripheral resistance (which is increased by constriction and decreased by dilation of the arterioles) (Braunwald, 1974; Ganong, 1995). The method measuring FSBP for assessing vascular components in the hands of HAVS suspected persons for diagnosing purpose is under discussion for standardization within the ISO. By using the HVLab Multi-Channel Plethysmograph simultaneous multi-finger measurements of FSBP in response to cold provocation are possible to have large number of data avoiding time-consuming performance (Lewis, 1996). Finger arteries are affected by constriction and dilatation in relation to psychological and physical (heat, cold, blood loss, orthostasis) stress (Imholz et al, 1998). Investigations have been done

using cold provocation test measuring FSBP under room temperature ranging from 17 °C to 28 °C (Bovenzi, 1998; Bovenzi, 2002; Lindsell et al, 2002; Nielsen, 1978; Pelmeur et al, 1985; Virokannas et al, 1991). It has been reported that %FSBP corrected for the change in systolic blood pressure in a reference finger rather than the arm showed the best performance for the disclosure of abnormal cold response in the digital arterial vessels of vibration-exposed workers who reported episodes of finger whiteness (Bovenzi, 2002). It has been shown from the data of working age healthy men originated from different studies that room temperature significantly correlated to %FSBP (Lindsell et al, 2002).

In the present study, we used simultaneous multi-finger measurement method with cooling of four fingers of the right hand considering right thumb as reference (not cooled), and without additional body surface cooling. The %FSBPs were within normative range (Lindsell et al, 2002). The results of the present study showed evidence that room temperature as an independent factor influenced %FSBP. The finger-wise correlations of %FSBPs at 15 °C cuff-water temperature with those at 10 °C cuff-water temperature suggested that the %FSBP results at 15 °C cuff-water temperature and 10 °C cuff-water temperature under room temperature of  $25 \pm 1$  °C were very similar whereas the results under room temperature of  $21 \pm 1$  °C were less similar. In the ISO/DIS 14835-2, 2004, the room temperature is proposed to be maintained at  $21 \pm 1$  °C over the whole length of the subject body for the duration of the cold provocation test. A necessity of body cooling with a cooling blanket during cold provocation test at an ambient temperature of 22 °C was reported to separate patients with Raynaud's phenomenon from normal persons (Nielsen, 1978). It has been mentioned in some studies that subject may experience considerable suffering during cold provocation test under the room temperature lower than 20 °C with or without body cooling, although additional body cooling may promote vasospastic reaction (Kurozawa et al, 1991; Kurozawa et al, 1992; Nasu et al, 1998). It was suggested in a study using finger cooling without additional body surface cooling that the difference in %FSBP between patients and control became larger at room temperature of 22 °C (Nasu et al, 1998). Our results from healthy subjects indicated that the temperature of  $21 \pm 1$  °C may be better than that of  $25 \pm 1$  °C for room temperature during cold provocation test measuring FSBP. Therefore, a room temperature of  $21 \pm 1$  °C seems to be suitable for cold provocation test.

From the results of the present study, it can be concluded that room temperature might have an influence on %FSBP in young healthy subjects. The temperature of  $21 \pm 1$  °C may be more suitable for room temperature during cold provocation test measuring FSBP. Room temperature is expected to be controlled at  $21 \pm 1$  °C when assessing peripheral vascular components of the upper extremities for diagnosing HAVS using %FSBP in response to cold provocation.

### Acknowledgements

This study was supported by a Japan Society for the Promotion of Science (JSPS) Grant-in-Aid for Scientific Research. The first author was awarded a Postdoctoral Research Fellowship from the JSPS to conduct research in Japan.

### References

- Bovenzi, M. 1998. Vibration-induced white finger and cold response of digital arterial vessels in occupational groups with various patterns of exposure to hand-transmitted vibration. *Scandinavian Journal of Work and Environmental Health*, vol 24(2), pp 138-144.
- Bovenzi, M. 2002. Finger systolic blood pressure indices for the diagnosis of vibration-induced white finger. *International Archives of Occupational and Environmental Health*, vol 75, pp 20-28.
- Braunwald, E. 1974. Regulation of the circulation. *New England Journal of Medicine*, vol 290, pp 1124-1129.
- Ekenvall, L. and Lindblad, L.E. 1982. Digital blood pressure after local cooling as a diagnostic tool in traumatic vasospastic disease. *British Journal of Industrial Medicine*, vol 39, pp 388-391.
- Ganong, W.F. 1995. Review of Medical Physiology. 17<sup>th</sup> ed. Prentice-Hall International Inc, London.
- Gautherie, M. 1995. Clinical studies of the vibration syndrome using a cold stress test measuring finger temperature. *Central European Journal of Public Health*, vol 3(Supplement), pp 1-5.
- Harada, N., Iwamoto, M., Laskar, M.S., et al. 1998. Effects of room temperature, seasonal condition and food intake on finger skin temperature during cold exposure test for diagnosing hand-arm vibration syndrome. *Industrial Health*, vol 36, pp 166-170.
- Imholz, B.P., et al. 1998. Fifteen years experience with finger arterial pressure monitoring: assessment of the technology. *Cardiovascular Research*, vol 38(3), pp 605-616.
- Ishitake, T., Miyazaki, Y., Kano, M., et al. 2000. Test room temperature effects on the recovery of skin temperature, vibrotactile threshold and thermal pain perception in cold provocation test. In: Lundstrom R, Lindmark A, eds.

- Proceedings of the 8<sup>th</sup> International Conference on Hand-Arm Vibration. National Institute for Working Life, Stockholm, Sweden, pp 419-424.
- ISO/DIS 14835-2. 2004. Mechanical vibration and shock– Cold provocation tests for the assessment of peripheral vascular function– Part 2: Measurement and evaluation of finger systolic blood pressure.
- Japanese Ministry of Labour. 1975. The procedure of a special medical examination related to workers handling vibrating tools. Japanese Labour Standards Bureau Notification, No. 609 (in Japanese).
- Kurozawa, Y., Nasu, Y., Nose, T. 1991. Diagnostic value of finger systolic blood pressure in the assessment of vasospastic reactions in the finger skin of vibration-exposed subjects after finger and body cooling. *Scandinavian Journal of Work and Environmental Health*, vol 17, pp 184-189.
- Kurozawa, Y., Nasu, Y., Oshiro, H. 1992. Finger systolic blood pressure measurements after finger cooling using the laser-dopler method for assessing vibration-induced white finger. *Journal of Occupational Medicine*, vol 34(7), pp 683-386.
- Kurumatani, N. 1984. Evaluation of cold water immersion test as a means of mass examination for workers using vibrating tools - with special reference to fingertip skin temperature obtained by 10 °C for 10 min method. *Journal of Nara Medical Association*, vol 35, pp 403-418 (in Japanese, with English abstract).
- Kurumatani, N., et al. 1981. Effects of immersion of hand in cold water (10 °C for 10 min) on the finger skin temperature of chain saw operators under different room temperature. *Japanese Journal of Industrial Health*, vol 23, pp 310-311 (in Japanese).
- Laskar, M.S., Yokoyama, K., Inoue, M., Suizu, K., Nakamoto, M. and Harada, N. 2003. A preliminary study on effect of posture on percentage finger systolic blood pressure assessing peripheral vascular function for diagnosing hand-arm vibration syndrome. *Proceedings, INTERNOISE 2003*, South Korea.
- Lewis, C.H. 1996. The development of a multi-channel plethysmograph. In: *Proceedings of United Kingdom Informal Group Meeting on the Human Response to Vibration*. Motor Industry Research Agency.
- Lindsell, C.J. and Griffin, M.J. 2002. Normative data for vascular and neurological tests of the hand-arm vibration syndrome. *International Archives of Occupational and Environmental Health*, vol 75, pp 43-54.
- Nasu, Y., Kurozawa, Y., Ishigaki, H., Shinohara, T. 1998. Interrelationship between room temperature and local cooling temperature on FSBP%. *Japanese Journal of Traumatology and Occupational Medicine*, vol 46(7), pp 435-441 (in Japanese, with English abstract).
- Nielsen, S.L. 1978. Raynaud phenomena and finger systolic pressure during cooling. *Scandinavian Journal of Clinical and Laboratory Investigation*, vol 38, pp 765-770.
- Nielsen, S.L. and Lassen, N.A. 1977. Measurement of digital blood pressure after local cooling. *Journal of Applied Physiology*, vol 43, pp 907-910.
- Olsen, N. and Nielsen, S.L. 1979. Diagnosis of Raynaud's phenomenon in quarrymen's traumatic vasospastic disease. *Scandinavian Journal of Work and Environmental Health*, vol 5, pp 249-256.
- Olsen, N., Nielsen, S.L. and Voss, P. 1982. Cold response of digital arteries in chain saw operators. *British Journal of Industrial Medicine*, vol 39, pp 82-88.
- Pelmeur, P.L., Taraschuck, I., Leong, D. and Wong, L. 1985. Cold water immersion test in hand-arm vibration exposed. *Journal of Low Frequency Noise and Vibration*, vol 4, pp 89-97.
- Virokannas, H. and Rintamäki, H. 1991. Finger blood pressure and rewarming rate for screening and diagnosis of Raynaud's phenomenon in workers exposed to vibration. *British Journal of Industrial Medicine*, vol 48, pp 480-484.
- van Cott, H. and Kinkade, R. 1972. *Human engineering guide to equipment design*, Washington.





# EFFECTS OF IMPULSIVE VIBRATION ON HUMAN RED BLOOD CELLS

Hideo Ando<sup>1,2</sup>, Kalevi Nieminen<sup>1</sup>, Esko Toppila<sup>1</sup>, Jukka Starck<sup>1</sup>, Tatsuya Ishitake<sup>2</sup>

<sup>1</sup> Department of Physics, Finnish Institute of Occupational Health, Helsinki, Finland

<sup>2</sup> Department of Environmental Medicine, Kurume University School of Medicine, Kurume, Japan

## Abstract

This study evaluated the damage of red blood cells (RBC) during exposure to impulsive vibration. Five peak accelerations were investigated: 50, 100, 200, 250 and 300 k m/s<sup>2</sup>. All impulsive vibrations had a repetition rate of 1/s. Each vibration was given for 10, 20 and 30 minutes to each blood sample which was put in a container whose inside was coated by heparin. After the vibration exposure the damage of RBC was analyzed. Each vibration was found to cause damage to RBC in all duration, which was confirmed by the microscopic study. Of five impulsive vibrations with three exposure duration, the largest damage was obtained in the vibration exposure with peak acceleration of 300 k m/s<sup>2</sup> for 30 minutes, followed by the exposure with 300 k m/s<sup>2</sup> for 20 minutes. The higher the peak acceleration and the longer the exposure duration, the more the damage of RBC. It was suggested that the damage of RBC in vitro depended on both peak acceleration and exposure duration of impulsive vibration.

## Introduction

Impulsive vibration can be found in some vibratory tools such as impact wrenches and chipping hammers. Those workers involved in percussive vibratory tools are thus exposed to impulsive vibration directly on their hands and palms (Pelmear PL et al, 1997). An association of hand-arm vibration syndrome with exposure to impulsive vibration is now recognized in workers who occupationally use hand held power tools (Pelmear PL et al, 1995). Thus the importance of impulsiveness is emphasized regarding the effects of vibratory tools on their users. On the other hand fragmentation of red blood cells (RBC) can be observed when they are exposed to excessive mechanical stress in the circulation. It is known clinically for hemolysis to occur when a part of body is exposed to intense impulse repeatedly in activities such as marathon and karate (Buckle RM, 1965; Streeton JA, 1967). It is suggested that hemolysis takes place by the pressure applied from outside blood vessels when hands and feet are hit directly on solid objects (Davidson RJL, 1964). Observing those clinical findings, it is possible that workers who are exposed for a long time to impulsive vibration repeatedly have the same pathology as those athletes mentioned above. In order to collect basic data on the effect of impulsive vibration, we evaluated in vitro the damage of RBC during exposure to impulsive vibration.

## Methods

### *Equipment of experiment*

Fig. 1 shows a block diagram of vibration generator and analyzing system. A vibration signal was sent to a linear motor through a controller (LinMot E-2000-AT, LinMot, Zurich). The motor hit a rotor weighing 1.5 kg with a stroke length of 400 mm against an adaptor where impulsive vibration was measured by an acceleration transducer (B&K 8309, Brüel & Kjær, Denmark). The vibration signal was then amplified by a charge amplifier (B&K 2635, Brüel & Kjær, Denmark) and recorded by a sampling unit (Agilent HP E1564, Agilent Technologies, USA).

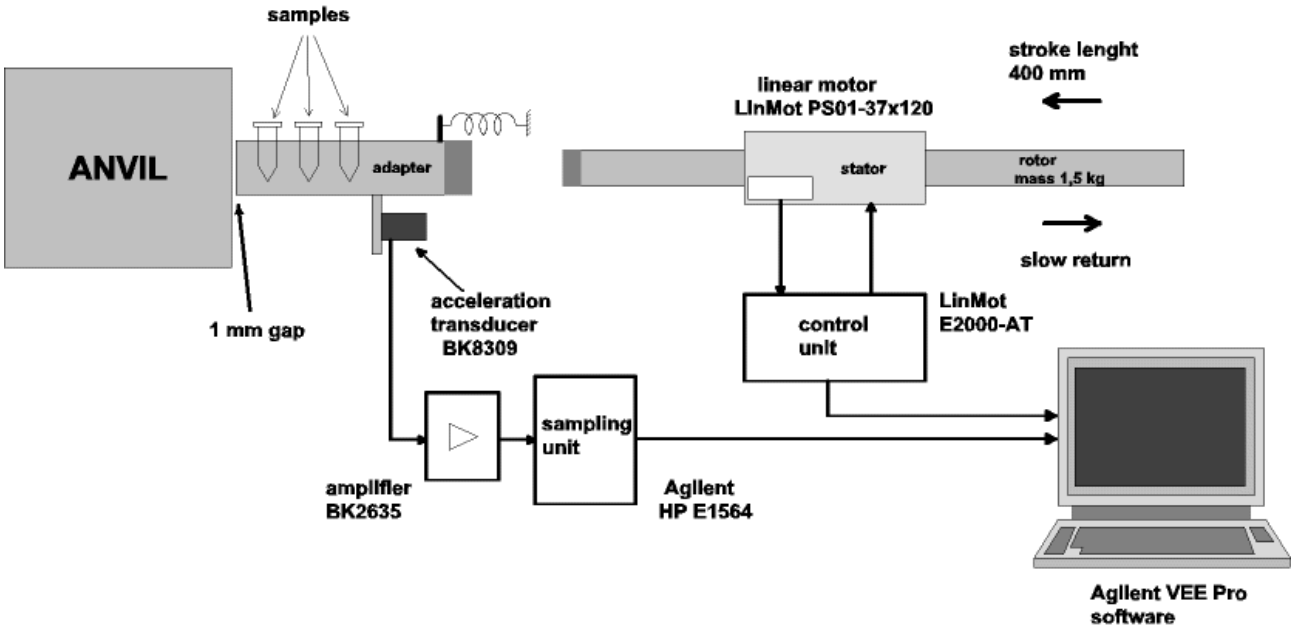
### *Experimental procedure*

A 10 ml of blood sample was collected from an antecubital vein of a healthy man aged 36 years old through a 20-G needle into a syringe containing EDTA; 0.6 ml was transferred into a polystyrene tube coated with heparin. This blood sample was put into the tube in a way that there was no space inside. RBC count for control was conducted before being applied to vibration. The tube was immediately put into a special machine generating impulsive vibration mentioned above.

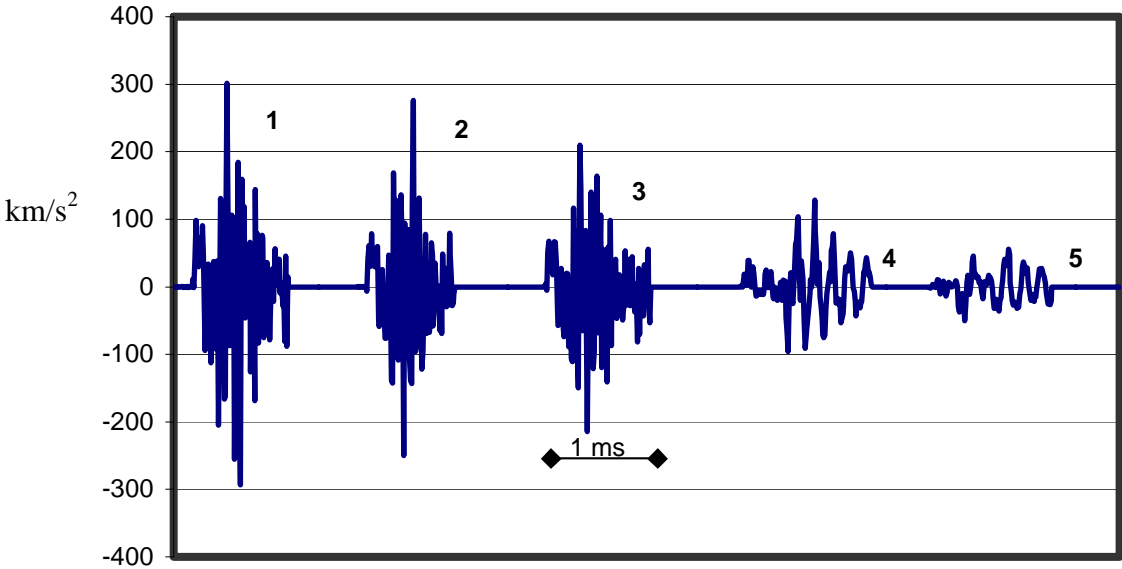
Five peak accelerations of impulsive vibrations used in the study included 50, 100, 200, 250 and 300 k m/s<sup>2</sup> (Fig. 2). All vibrations had a repetition rate of 1/s. Each vibration was applied to the blood samples for 10, 20 and 30 minutes. After the vibration exposure, RBC count was conducted again for each combination of peak acceleration and duration. The percentage of damaged RBC was analyzed. Microscopic examination for morphological study was performed for each impulsive vibration to confirm the destruction of RBC.

A series of experiments was conducted 7 times for each impulsive vibration altogether.

# IMPACT HAMMER SIMULATOR



**Figure 1** Block diagram showing vibration generator and analyzing system.



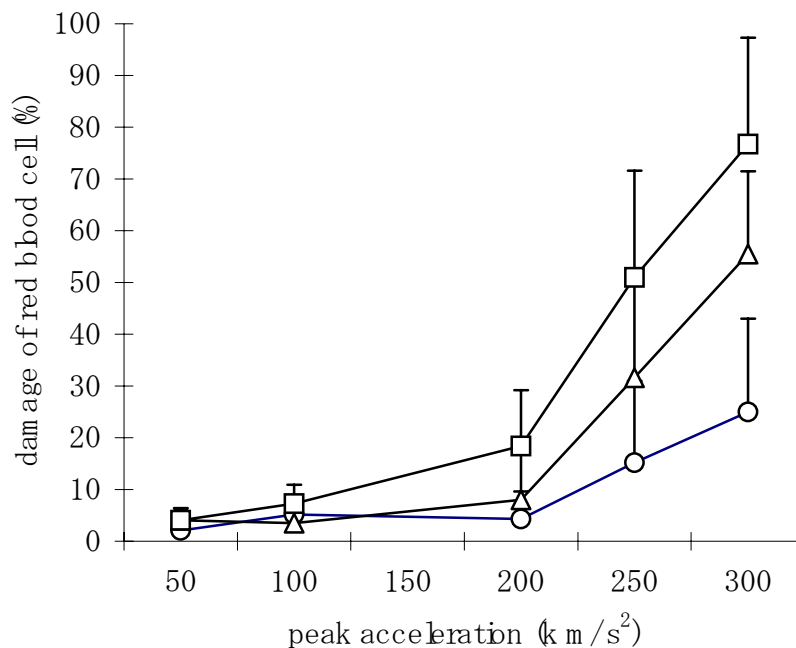
**Figure 2** Impulsive vibrations used in the study.

### Statistical analysis

A repeated measures analysis of variance (ANOVA) was used to evaluate the difference in the percentage of damage across the five peak accelerations and three durations of impulsive vibration. When it indicated a significant difference, a multiple comparison test (Bonferroni test) was used to compare the different conditions. A P-value of 0.05 was set as the limit of statistical significance.

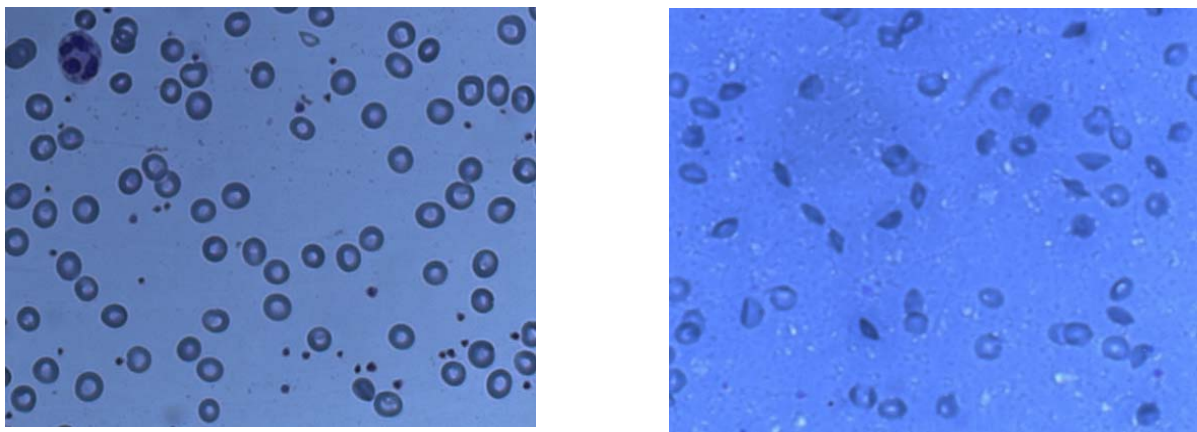
### Results

All impulsive vibrations used in the study caused damages to RBC. The higher the peak acceleration and the longer the exposure duration, the more the damage of RBC (Fig. 3). Of five impulsive vibrations with three exposure durations, the largest damage was obtained in the vibration exposure with peak acceleration of 300  $\text{k m/s}^2$  for 30 min with mean value of 76.7 %, followed by the exposure with 300  $\text{k m/s}^2$  for 20 min with 55.5 %. A repeated measures ANOVA indicated a significant difference in the damage of RBC among the five peak accelerations ( $F=25.8$ ,  $P<0.0001$ ). A multiple comparison test showed that the damage produced by the impulsive vibrations with peak accelerations of 250 and 300  $\text{k m/s}^2$  were significantly larger than those by 50, 100 and 200  $\text{k m/s}^2$  ( $P<0.0007$ ). The repeated measures ANOVA also indicated a significant difference in the damage of RBC among the three vibration durations ( $F=88.8$ ,  $P<0.0001$ ). The Bonferroni test showed that the damage induced during 30 min of vibration was the largest, followed by that during 20 min ( $P<0.0001$ ). Moreover, an interaction was found in the damage of RBC between those factors of peak acceleration and duration ( $F=19.8$ ,  $P<0.0001$ ).



**Figure 3** Percentage of damaged RBC during exposure to impulsive vibration. Data are presented as mean + SD. Circle, triangle and square mean exposure duration of 10, 20 and 30 min, respectively.

Fig. 4 shows typical photos of peripheral blood smears. No fragmentation of RBC was detected before exposure to impulsive vibration (Fig. 4, left). Some damaged RBCs, in contrast, were observed after exposure to all of the impulsive vibrations investigated (Fig. 4, right).



**Figure 4** Typical photos of peripheral blood smear before (left) and after (right) exposure to vibration with peak acceleration of  $300 \text{ k m/s}^2$  for 30 min.

### Discussion

Vibration induced white finger and noise induced hearing loss are among the pathology encountered in a long term exposure to impulsive vibration. A high prevalence of vibration induced white finger has been shown in those workers exposed to impulsive vibrations such as pedestal grindings and riveting hammers (Starck J et al, 1983; Engström K et al, 1986). It has been suggested that arterial shear stress is provoked by the impulsive vibration and contribute to the circulatory disorders (Nerem RM, 1973). In addition, percussive vibratory tools produce impulsive noise as well. Impulsive noise has been reported to be more likely to cause noise induced hearing loss compared to steady state noise (Starck J et al, 1988). The effect of impulsive vibration seems considerable and thus it is important to place emphasis on impulsiveness of hand transmitted vibratory tools when we consider the effect of vibration (Starck J et al, 1990). And it is desirable that other pathology should be checked for those workers who occupationally use percussive vibratory tools.

Clinically, on the other hand, red cell fragmentation syndrome is known to occur when a part of body is exposed repeatedly to mechanical intense impulses (Foerster J, 1999). The pathology has been reported in those athletes involved in karate and marathon. During those activities, hands and feet are hit repeatedly against the ground or hard objects. As a result, intravascular hemolysis is thought to occur (Telford RD et al, 2003). In some working places, likewise, workers often hit repeatedly their hands and palms against hard objects via hand transmitted vibratory tools. In such a condition is it possible that workers, even with their gloves on, could develop in their hands the same pathology observed as in marathon or karate. In the study presented here, we investigated impulsive vibration to collect basic data on the destruction of RBC during exposure to impulsive vibration.

Impulsive vibration was indicated in vitro to cause damage to RBC. Peripheral blood smear clearly showed fragmentation of RBC under exposure to impulsive vibrations. The damage seems to depend on peak acceleration and exposure duration of impulsive vibration in combination. The greater and the longer the exposure to impulsive vibration, the more the damage to RBC. This finding suggests a synergistic effect on RBC of peak acceleration and exposure duration of impulsive vibration. It can be also possible from Fig. 3 that the damage during exposure to impulsive vibration was provoked in a logical way at the peak accelerations of and higher than  $200 \text{ k m/s}^2$ . This finding suggests the presence of a critical point in peak acceleration from which RBC starts to break in a logical way by the exposure to impulsive vibration.

A limitation must be raised in that the response of RBC in vivo may be different from that in vitro. Elastic function will work in the hand to modify the transmission and thus the effect of vibration. In addition, a significantly higher quantity of transmission and absorption of mechanical energy into the hand was indicated during exposure to impulsive vibration compared with non-impulsive vibration (Burström L et al, 1999). Although the result obtained in the study would not exactly reflect the real working condition, attention should be drawn to those findings on the effect of impulsive vibration. It is still suggested from the study that hematological study should be performed on those workers involved in a long term exposure to impulsive vibration.

In conclusion, it could be said that this study shows that impulsive vibration in vitro causes damage to RBC which seems to depend on both peak acceleration and exposure duration of impulsive vibration. A critical peak acceleration was also suggested for impulsive vibration to cause a destruction of RBC.

## References

- Buckle RM. 1965. Exertional (march) haemoglobinuria. Reduction of haemolytic episodes by use of sorbo-rubber insoles in shoes. *Lancet*, vol 1, pp 1136-1138.
- Burström L and Sörensson A. 1999. The influence of shock-type vibrations on the absorption of mechanical energy in the hand and arm. *International Journal of Industrial Ergonomics*, vol 23, pp 585-594.
- Davidson RJL. 1964. Exertional haemoglobinuria: a report on three cases with studies on the haemolytic mechanism. *Journal of Clinical Pathology*, vol 17, pp 536-540.
- Engström K and Dandanell R. 1986. Exposure conditions and Raynaud's phenomenon among riveters in the aircraft industry. *Scandinavian Journal of Work, Environment & Health*, vol 12, pp 293-295.
- Foerster J. 1999. Red cell fragmentation syndromes. In: Lee GR, Foerster J, Lukens J, Paraskevas F, Greer JP, Rodgers GM, editors. *Wintrobe's clinical hematology*. 10th ed. Baltimore: Williams & Wilkins; pp 1305-1328.
- Nerem RM. 1973. Vibration-induced arterial shear stress. The relationship to Raynaud's phenomenon. *Archives of Environmental Health*, vol 26, pp 105-110.
- Pelmear PL, Kusiak R, Leong D. 1995. Hand-arm vibration syndrome associated with impact vibration. *Journal of Low Frequency Noise and Vibration*, vol 14, pp 73-79.
- Pelmear PL and Wills M. 1997. Impact vibration and hand-arm vibration syndrome. *Journal of Occupational and Environmental Medicine*, vol 39, pp 1092-1096.
- Starck J, Färkkilä M, Aatola S, Pyykkö I, Korhonen O. 1983. Vibration syndrome and vibration in pedestal grinding. *British Journal of Industrial Medicine*, vol 40, pp 426-433.
- Starck J, Pekkarinen J, Pyykkö I. 1988. Impulse noise and hand-arm vibration in relation to sensory neural hearing loss. *Scandinavian Journal of Work, Environment & Health*, vol 14, pp 265-271.
- Starck J, Pekkarinen J, Pyykkö I. 1990. Physical characteristics of vibration in relation to vibration-induced white finger. *American Industrial Hygiene Association Journal*, vol 51, pp 179-184.
- Streeton JA. 1970. Traumatic haemoglobinuria caused by karate exercises. *Lancet*, vol 2, pp 191-192.
- Telford RD, Sly GJ, Hahn AG, Cunningham RB, Bryant C, Smith JA. 2003. Footstrike is the major cause of hemolysis during running. *Journal of Applied Physiology*, vol 94, pp 38-42.



# EFFECT OF VIBRATION MAGNITUDE AND PUSH FORCE ON FINGER BLOOD FLOW

A. J. L. Welsh and M. J. Griffin

Human Factors Research Unit, Institute of Sound and Vibration Research, University of Southampton, Highfield,  
Southampton SO17 1BJ, England

## Abstract

Vibration of the fingers or hands causes vasoconstriction during vibration exposure and for a period following exposure. Some previous studies have explored how the vasoconstriction depends on the magnitude and frequency of vibration, but the systematic independent investigation of different magnitudes at each frequency is slow. This study explores a quick method of determining the effects of vibration magnitude and contact force on the vasoconstriction during exposure to vibration. Finger blood flow was measured every thirty seconds in ten healthy male subjects while the right middle finger was exposed to force and vibration. Blood flow was measured in the exposed right middle finger, the unexposed right little finger and the unexposed left middle finger. Subjects were exposed to two conditions each lasting 62 minutes. A vibration condition consisted of five periods: (i) no push force, (ii) 2 N push force, (iii) 2 N push force while the magnitude of 125 Hz vibration increased linearly in magnitude from 0 to 88 ms<sup>-2</sup> r.m.s. (iv) 2 N push force, (v) no push force. A control condition was similar but without vibration during the third period. The application of the push force reduced finger blood flow in the exposed finger. In the exposed finger, increases in vibration magnitude progressively reduced finger blood flow. The method may have application to the exploration of the effects of both vibration magnitude and force on finger blood flow.

## Introduction

Chronic exposures to hand-transmitted vibration can result in the signs and symptoms of vibration-induced white finger (VWF), typified by reduced digital blood flow during and following exposure to cold. International Standard 5349 (2001) assumes that the 8-hour energy-equivalent frequency-weighted root-mean-square (r.m.s.) acceleration,  $A(8)$ , can be used to predict the prevalence of vibration-induced white finger. However, both the frequency weighting and the duration weighting in the standard are suspect (Griffin *et al.*, 2003).

Acute exposures to various types of vibration also reduce finger blood flow (e.g. Bovenzi *et al.*, 2001). Although the chronic and acute effects of hand-transmitted vibration may not be identical, an understanding of the acute effects is of interest when seeking an understanding of the chronic vascular responses to vibration, including the effects of vibration frequency, vibration magnitude and exposure duration.

Studies with various magnitudes and durations of vibration have found that vasoconstriction in the finger during vibration is dependent on vibration magnitude but not highly dependent on the duration of exposure (e.g. Bovenzi *et al.*, 1998, 2001). In contrast, the vascular response following vibration exposure is highly dependent on the duration of prior exposure to vibration (Bovenzi *et al.*, 1998). A single simple method of assessing the severity of hand-transmitted vibration cannot predict these opposing effects. The present study is primarily concerned with the investigation of vasoconstriction during exposure.

The acute vascular responses during vibration appear to be mediated, in part, by the central nervous system, with a reduction in blood flow in both the digit exposed to vibration and in unexposed digits on the other hand. However, Bovenzi *et al.* (1999) found that vibration magnitudes of 22, 44 and 62 ms<sup>-2</sup> r.m.s. produced a stronger vasoconstriction in the exposed digit than in the unexposed contralateral digit, suggesting that local mechanisms also influence vasoconstriction in the exposed hand. The responses in both the exposed and unexposed hands suggest the activation of both the central and local mechanisms are dependent on vibration magnitude.

The dynamic coupling between the hand and the source of vibration may also influence the vascular effects of hand-transmitted vibration. International Standard 5349 (2001) states: "... forces between the hand and gripping zone should be measured and reported" and "...the effects of human exposure to hand-transmitted vibration in working conditions may also be influenced by...the coupling forces, such as the grip and feed forces". However, there are currently no known studies of the interactions between coupling forces and the acute vascular effects of hand-transmitted vibration.

Two aims of this study were to increase understanding of: (i) the relationship between vibration magnitude and finger blood flow, and (ii) the contribution of contact force to the vasoconstriction occurring during vibration exposure. It was hypothesised that force alone would not alter finger blood flow, but that blood flow would show a gradual

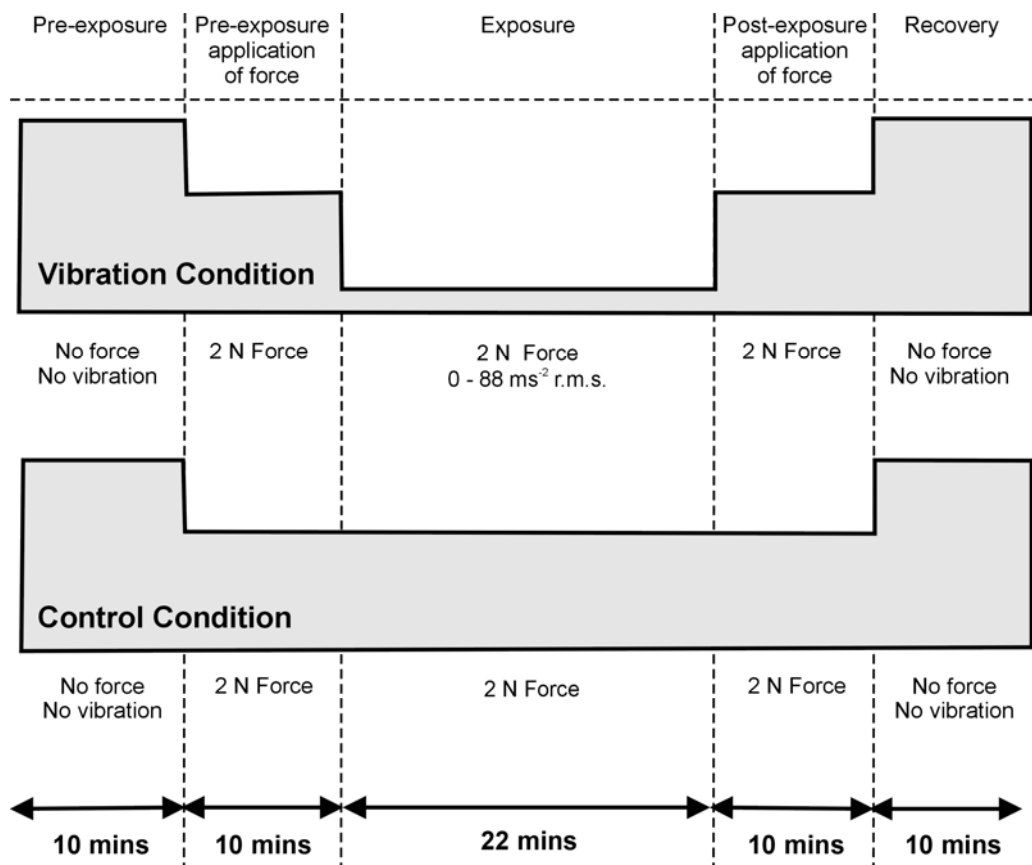
decrease with increasing vibration magnitude. Additionally, the study was conducted to investigate a new method for the more rapid investigation of the effects of vibration magnitude on finger blood flow.

### Method

Ten healthy male volunteers with a mean (standard deviation) age 28.8 yrs (5.7) participated in the study. All subjects were office workers with no history of regular exposure to vibration and no medical disorders known to influence finger blood flow. The subjects were asked to avoid smoking and caffeine for 2 hours prior to testing and avoid alcohol for 12 hours prior to testing.

Finger blood flow (FBF) was measured in the middle right finger while it was exposed to force and varying vibration. Finger blood flow was also measured in the unexposed right little finger and the unexposed left middle finger. The measurements of finger blood flow were obtained throughout the experiment every 30 seconds. Finger blood flow was measured using an *HVLab* multi-channel plethysmograph according to the technique proposed by Greenfield *et al.* (1963).

Subjects were exposed on separate days to two conditions, each lasting 62 minutes. A vibration condition consisted of five periods: (i) no push force for 10 minutes, (ii) 2 N push force for 10 minutes, (iii) 2 N push force during linearly increasing magnitude of 125 Hz vertical vibration (0 to 88 ms<sup>-2</sup> r.m.s. over 22 minutes), (iv) 2 N push force for 10 minutes, (v) no push force for 10 minutes. A control condition was similar but without vibration during the third period. Figure 1 shows the sequence of push force and vibration exposure at the right middle finger during the five experimental periods of the vibration condition and the control condition.

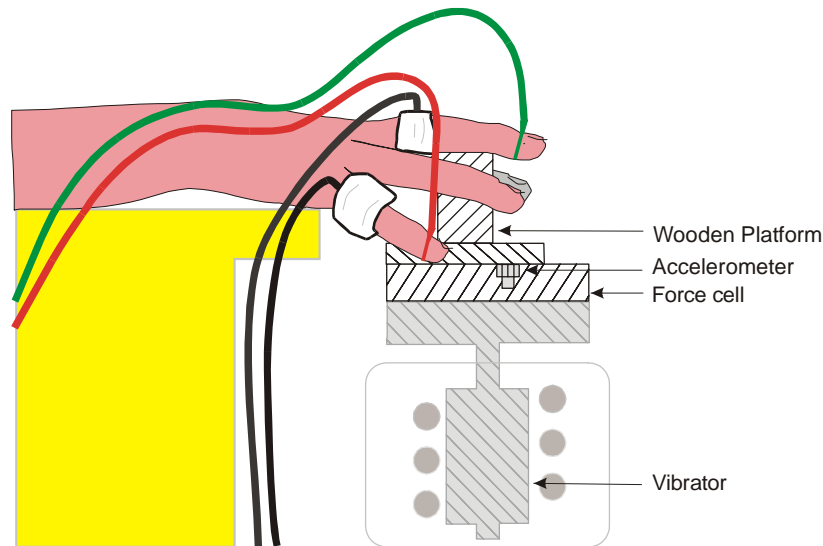


**Figure 1** The sequence of push force and vibration exposure of the right middle finger during the five experimental periods of the vibration condition and control condition: pre-exposure, pre-exposure application of 2 N force, vibration exposure from 0 to 88 ms<sup>-2</sup> r.m.s. at 125 Hz with a push force of 2 N (no vibration in the control condition), post-exposure application of force of 2 N, and recovery.

During acclimatisation and during the first of the five periods, the subject's right hand was supported on a cardboard box positioned at heart height adjacent to a wooden platform (40 x 12 mm) secured to a vibrator. After the 10-minute



pre-exposure measurements in period (i), the subject's hand was moved so that the middle phalanx of the right middle finger was positioned across the 12 mm of the wooden platform (Figure 2). The right wrist and arm were supported independently of the vibrator at heart height. The subject applied a downward push force of 2 N on the wooden platform. The other fingers of the right hand were suspended in air. The left arm was supported with the hand at heart height. Following the fourth period, the subject's hand was returned to the cardboard box to the same position as during the pre-exposure period.



**Figure 2** Experimental arrangement for generating and measuring the vibration and force at the right middle finger and measuring finger blood flow in the exposed right middle finger and the unexposed right little finger.

## Results

The median blood flow over the 10 subjects was calculated for each measurement (i.e. every 30 seconds) during the vibration condition and during the control condition (Figure 3).

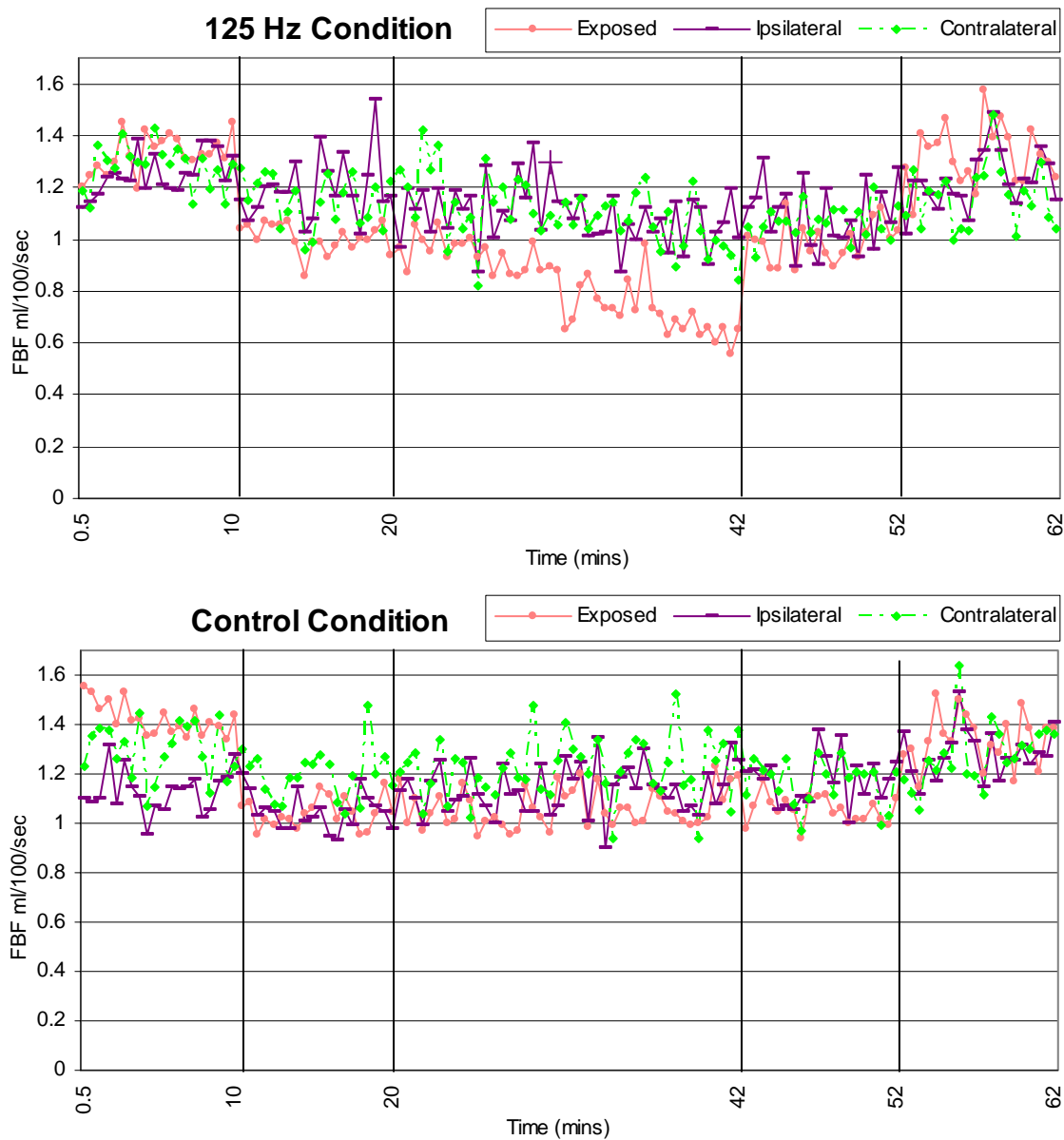
The median (IQR) blood flow at specific times during the vibration condition and at the corresponding time during the control condition may be compared (Table 1). The values for the four 10-minute periods (i.e. the pre-exposure period, the pre-exposure application of force, the post-exposure application of force and the recovery period) are the medians over the 10 subjects of their median finger blood flow during the 10-minute periods. During vibration exposure, finger blood flow measures were extracted by calculating the time at which a specific vibration magnitude would have been reached and then calculating the median finger blood flow of over the 10 subjects obtained for a single measurement at that instant; these values are therefore more variable than the averages obtained over the 20 measures during the 10-minute periods. The vibration magnitudes in Table 1 were chosen because they have been used in previous studies and allow comparison with previous results.

The percentage changes in finger blood flow relative to pre-exposure finger blood flow are shown in Table 2.

### *Finger blood flow during pre-exposure period*

Over the 20 measurements during the 10-minute 'pre-exposure period', there were no significant changes in FBF in the 'exposed finger', the 'unexposed ipsilateral finger' or the 'unexposed contralateral finger' during either the vibration condition or the control condition ( $p > 0.1$ ; Friedman).

Within each of the three fingers, there were no significant differences between the median pre-exposure finger blood flow during the vibration condition and the median finger blood flow during the control condition ( $p > 0.1$ ; Wilcoxon).



**Figure 3** Median finger blood flow in 10 subjects during the five experimental periods in the vibration and control conditions: (i) pre-exposure, (ii) pre-exposure application of 2 N force, (iii) vibration exposure 0 to 88 ms<sup>-2</sup> r.m.s. at 125 Hz with a push force of 2 N (no vibration in the control condition), (iv) post-exposure application of 2 N force, and (v) recovery.

#### *Finger blood flow during the pre-exposure application of force*

Over the 20 measurements during the 10-minute ‘pre-exposure application of force’, there were no significant changes in FBF in the ‘exposed finger’, the ‘unexposed ipsilateral finger’ or the ‘unexposed contralateral finger’ during either the vibration condition or the control condition ( $p > 0.1$ ; Friedman).

In both the vibration condition and the control condition, the 2 N push force reduced the median FBF in the ‘exposed finger’ compared to the median FBF during the pre-exposure period ( $p < 0.01$ ; Wilcoxon).

In neither the vibration condition nor the control condition, did the 2 N force on the ‘exposed finger’ change the median FBF in the ‘unexposed ipsilateral finger’ compared to the median FBF in the ‘unexposed ipsilateral finger’ during the pre-exposure period ( $p > 0.05$ ).

**Table 1** Median (IQR) finger blood flow (ml/100ml/sec) in 10 subjects during pre-exposure, pre-exposure application of force, vibration exposure 0 to 88 ms<sup>-2</sup> r.m.s. at 125 Hz with 2 N push force (no vibration in the control condition), post-exposure application of 2 N force, and recovery.

	Control Condition FBF (ml/100ml/sec)			125 Hz vibration FBF (ml/100ml/sec)		
	Exposed	Unexposed Ipsilateral	Unexposed Contralateral	Exposed	Unexposed Ipsilateral	Unexposed Contralateral
(i) Pre-exposure	1.408 (0.295)	1.083 (0.281)	1.295 (0.252)	1.414 (0.376)	1.259 (0.358)	1.329 (0.310)
(ii) Pre-exposure force	1.059 (0.256)	1.022 (0.154)	1.257 (0.456)	1.006 (0.089)	1.251 (0.387)	1.190 (0.409)
(iii) Vibration and push force:						
6 ms <sup>-2</sup> r.m.s.	1.098 (0.529)	1.101 (0.446)	1.287 (0.689)	1.057 (0.355)	1.114 (0.408)	1.087 (0.439)
12 ms <sup>-2</sup> r.m.s.	1.110 (0.295)	1.252 (0.523)	1.339 (0.932)	1.060 (0.335)	1.197 (0.521)	1.365 (0.515)
22 ms <sup>-2</sup> r.m.s.	0.949 (0.373)	1.112 (0.536)	1.188 (0.623)	0.931 (0.478)	0.872 (0.436)	0.822 (0.341)
44 ms <sup>-2</sup> r.m.s.	1.104 (0.298)	1.267 (0.413)	1.405 (0.521)	0.652 (0.349)	1.137 (0.381)	1.144 (0.396)
88 ms <sup>-2</sup> r.m.s.	1.193 (0.561)	1.254 (0.988)	1.375 (0.716)	0.650 (0.300)	1.005 (1.202)	0.845 (0.713)
(iv) Post-exposure force	1.045 (0.473)	1.216 (0.344)	1.219 (0.475)	0.972 (0.240)	1.210 (0.512)	1.060 (0.436)
(v) Recovery	1.386 (0.300)	1.313 (0.355)	1.171 (0.530)	1.373 (0.444)	1.274 (0.304)	1.165 (0.332)

In the vibration condition, the 2 N force on the ‘exposed finger’ reduced FBF in the ‘unexposed contralateral finger’ compared to FBF during the pre-exposure period ( $p=0.047$ ). In the control condition, the 2 N force on the ‘exposed finger’ did not change FBF in the ‘unexposed contralateral finger’ compared to FBF during the pre-exposure period ( $p>0.05$ ).

*Finger blood flow during exposure period: control condition (with no vibration)*

In the control condition, within each of the three fingers, there were no significant changes in FBF over the 44 measurements obtained during the 22-minute no-vibration ‘exposure period’ ( $p>0.1$ ; Friedman).

In the ‘exposed finger’ there was a significant reduction in median FBF during the ‘exposure period’ compared to the median FBF during the ‘pre-exposure period’ when there was no force ( $p<0.05$ ; Wilcoxon). In the ‘unexposed ipsilateral finger’ and in the ‘unexposed contralateral finger’ there was no significant difference between the median FBF during the ‘exposure period’ and the median FBF during the ‘pre-exposure period’ when there was no force ( $p>0.05$ ; Wilcoxon).

Within each of the three fingers, the continued 22-minute exposure to a push force of 2 N, did not produce any overall change in median finger blood flow compared to the median finger blood flow during the ‘pre-exposure application of force’ ( $p>0.05$ ; Wilcoxon).

**Table 2** Percentage change in median finger blood flow relative to the pre-exposure period for 10 subjects during pre-exposure application of force, vibration exposure 0 to 88 ms<sup>-2</sup> r.m.s. at 125 Hz with 2 N push force (no vibration in the control condition), post-exposure application of 2 N force, and recovery.

	Control condition (% of pre-exposure FBF)			125 Hz vibration (% of pre-exposure FBF)		
	Exposed	Unexposed Ipsilateral	Unexposed Contralateral	Exposed	Unexposed Ipsilateral	Unexposed Contralateral
(i) Pre-exposure	100	100	100	100	100	100
(ii) Pre-exposure force	75	94	97	71	99	90
(iii) Vibration and push force:						
6 ms <sup>-2</sup> r.m.s.	78	102	99	75	88	82
12 ms <sup>-2</sup> r.m.s.	79	116	103	75	95	103
22 ms <sup>-2</sup> r.m.s.	67	103	92	66	69	62
44 ms <sup>-2</sup> r.m.s.	78	117	108	46	90	86
88 ms <sup>-2</sup> r.m.s.	85	116	106	46	80	64
(iv) Post-exposure force	74	112	94	69	96	80
(v) Recovery	98	121	90	97	101	88

*Finger blood flow during exposure: vibration condition*

During vibration exposure, in the ‘exposed finger’ and in the ‘unexposed ipsilateral finger’, there were significant changes in FBF within the 44 measurements obtained during the 22-minute exposure ( $p < 0.05$ ; Friedman). In the ‘unexposed contralateral finger’ there was no significant change in FBF during vibration exposure ( $p > 0.05$ ; Friedman).

The instantaneous FBF was tested at each 2.0 ms<sup>-2</sup> r.m.s. increment in vibration magnitude (i.e. at 2, 4, ... 86, 88 ms<sup>-2</sup> r.m.s.) during exposure. Compared to the ‘pre-exposure period’ with no vibration or force, exposure to vibration and force produced a significant reduction in median FBF in the exposed finger at all vibration magnitudes ( $p < 0.05$ ; Wilcoxon). Compared to the ‘pre-exposure period’, the ‘unexposed ipsilateral finger’ showed significant reductions in median FBF at 10 of the 44 magnitudes tested (i.e. at 14, 22, 26, 30, 50, 58, 68, 74, 80 and 82 ms<sup>-2</sup> r.m.s.;  $p < 0.05$ ; Wilcoxon). Compared to the ‘pre-exposure period’, the ‘unexposed contralateral finger’ showed significant reductions in median FBF at 29 of the 44 magnitudes tested (i.e. at all except 2, 8, 10, 12, 16, 24, 32, 34, 42, 48, 56, 62, 64, 74, 76, ms<sup>-2</sup> r.m.s.;  $p < 0.05$ ; Wilcoxon).

In the ‘exposed finger’, the gradually increasing vibration magnitude produced a significant reduction in overall median FBF over the 22-minute exposure compared to the median FBF during the ‘pre-exposure application of force’ (i.e. 0.811 compared with 1.006;  $p < 0.05$ ; Wilcoxon). There were also significant differences between the median FBF during the ‘pre-exposure application of force’ and the instantaneous FBF measured at vibration magnitudes between 40 ms<sup>-2</sup> r.m.s and 88 ms<sup>-2</sup> r.m.s. ( $p < 0.05$ ; Wilcoxon), except at 60 and 64 ms<sup>-2</sup> r.m.s.

In the ‘unexposed ipsilateral finger’, there was a significant reduction in instantaneous FBF compared to the median FBF during the ‘pre-exposure application of force’ at only five of the 44 magnitudes (i.e. at 2, 14, 22, 58 and 80 ms<sup>-2</sup> r.m.s.;  $p < 0.05$ ; Wilcoxon). In the ‘unexposed contralateral finger’, there was a significant reduction in instantaneous FBF compared to the median FBF during the ‘pre-exposure application of force’ at only four of the 44 magnitudes (i.e. at 8, 22, 52 and 88 ms<sup>-2</sup> r.m.s.;  $p < 0.05$ ; Wilcoxon).

Finger blood flow during the vibration condition at each 2.0 ms<sup>-2</sup> r.m.s. increment in vibration magnitude (i.e. 2, 4, 6, ... 84, 86, 88 ms<sup>-2</sup> r.m.s.) was compared with finger blood flow at the corresponding times during the control condition

In the 'exposed finger', there were no significant differences in FBF between the vibration condition and the control condition for any vibration magnitude up to 40 ms<sup>-2</sup> r.m.s. ( $p>0.05$ ; Wilcoxon), except at 2, 18, 34 and 36 ms<sup>-2</sup> r.m.s. At vibration magnitudes between 42 ms<sup>-2</sup> r.m.s. and 88 ms<sup>-2</sup> r.m.s., there were significant reductions in FBF during the vibration condition compared to the control condition ( $p<0.05$ ; Wilcoxon), except at 54 and 64 ms<sup>-2</sup> r.m.s.

In the 'unexposed ipsilateral finger' there were no significant differences between the FBF during the vibration condition and FBF at the corresponding times in the control condition. In the 'unexposed contralateral finger' there were significant reductions in FBF in the vibration condition compared to the control condition at 22, 36, 44, 52, 72 and 88 ms<sup>-2</sup> r.m.s.

#### *Finger blood flow 'post-exposure application of force'*

Over the 20 measurements during the 10-minute 'post-exposure application of force', there were no significant changes in FBF in the 'exposed finger', the 'unexposed ipsilateral finger' or the 'unexposed contralateral finger', during either the vibration condition or the control condition ( $p>0.1$ ; Friedman).

In both the vibration condition and the control condition, the 'exposed finger', the 'unexposed ipsilateral finger' and the 'unexposed contralateral finger', showed no significant difference in median FBF between the 'post-exposure application of force' and the 'pre-exposure application of force' ( $p>0.05$ ; Wilcoxon).

In the control condition, the median FBF in the 'exposed finger', in the 'unexposed ipsilateral finger' and in the 'unexposed contralateral finger' during the 'post-exposure application of force' did not differ from the median blood flow during the preceding 22 minutes of application of force during the 'exposure period' ( $p>0.1$ ; Wilcoxon).

In the vibration condition, the median FBF in the 'exposed finger' during the post-vibration period was significantly greater than the median finger blood flow during exposure to vibration at vibration magnitudes of 44 ms<sup>-2</sup> r.m.s. or more (except at 48, 60 and 64 ms<sup>-2</sup> r.m.s) ( $p<0.05$ ; Wilcoxon). There were no differences in FBF in either the 'unexposed ipsilateral finger' or the 'unexposed contralateral finger' between the 'exposure period' and the 'post-exposure application of force period' ( $p>0.05$ ; Wilcoxon).

During the 'post-exposure application of force', the FBF did not differ between the vibration condition and the control condition in the 'exposed finger', the 'unexposed ipsilateral finger' or the 'unexposed contralateral finger' ( $p>0.1$ ; Wilcoxon).

#### *Finger blood flow during recovery (i.e. following the removal of push force)*

Over the 20 measurements during the 10-minute 'recovery period', there were no significant changes in FBF in the 'exposed finger', the 'unexposed ipsilateral finger' or the 'unexposed contralateral finger', during either the vibration condition or the control condition ( $p>0.1$ ; Friedman).

In the vibration condition, for the 'exposed finger' and the 'unexposed ipsilateral finger', there were no significant differences between the median FBF during the 'recovery period' and the median FBF during the 'pre-exposure period' ( $p>0.1$ ; Wilcoxon). However, the median FBF in the 'unexposed contralateral finger' was significantly less during the 'recovery period' than during the 'pre-exposure period' ( $p<0.01$ ; Wilcoxon).

In the control condition, for the 'exposed finger' and the 'unexposed contralateral finger', there was no significant difference between the median finger blood flow during the 'recovery period' and the median FBF during the 'pre-exposure period' ( $p>0.1$ ; Wilcoxon). However, the median FBF in the 'unexposed ipsilateral finger' was significantly greater during the 'recovery period' than during 'pre-exposure application of force' ( $p<0.05$ , Wilcoxon).

The removal of the 2 N push force produced a significant increase in blood flow in the 'exposed finger' compared to the median FBF during the 'post-exposure application of force' ( $p<0.01$ ; Wilcoxon). There was no change in FBF in the 'unexposed ipsilateral finger' following the removal of the 2 N push force compared to the 'post-exposure application of force' ( $p>0.05$ ; Wilcoxon).

In the 'exposed finger', the 'unexposed ipsilateral finger' and the 'unexposed contralateral finger', there was no difference between the median FBF during recovery in the vibration condition and the median finger blood flow during recovery in the control condition ( $p>0.05$ ; Wilcoxon).

## **Discussion**

With 125 Hz vibration at magnitudes greater than about 42 ms<sup>-2</sup> r.m.s. (corresponding to frequency-weighted accelerations greater than about 5 ms<sup>-2</sup> r.m.s.), there was a significant reduction in finger blood flow in the 'exposed

finger'. In this study, there were few significant changes in blood flow in the unexposed ipsilateral and contralateral fingers. Compared to 'pre-exposure' blood flow, the contralateral finger showed a reduction in finger blood flow at more vibration magnitudes than the ipsilateral finger. Bovenzi *et al.* (1999) found a reduction in blood flow in the 'unexposed contralateral finger' during 15-minutes exposure to vibration with a frequency of 125 Hz at vibration magnitudes of 22, 44 and 62 ms<sup>-2</sup> r.m.s. with a 10 N push force.

The push force reduced finger blood flow in the exposed finger compared to the pre-exposure finger blood flow. In the control condition, the reduction in blood flow in the exposed finger remained constant throughout the 42-minute application of the 2 N push force. The finding of an effect of force in the exposed finger differs from the findings of Bovenzi *et al.* (1998), possibly due to the different contact area and different distribution of force applied with a single finger in this study and multiple fingers in the previous study.

In the control condition, this study did not find a significant effect of force on blood flow in the 'unexposed ipsilateral finger' or the 'unexposed contralateral finger'. There were significant reductions in blood flow in the 'unexposed contralateral finger' associated with simultaneous exposure to vibration and force during the vibration condition. The results suggest that changes in finger blood flow caused by the application of force were mainly restricted to the exposed finger.

In the vibration condition, the finger blood flow in the 'exposed finger' returned to 'pre-exposure' levels after the removal of the push force. Bovenzi *et al.* (1998) found vasodilation following simultaneous cessation of vibration and force in exposed fingers compared to finger blood flow prior to the application of vibration and force. In this study, ending vibration exposure did not produce vasodilation in the 'exposed finger' compared to 'pre-exposure' levels. Similarly, the ending of the 2 N push did not result in vasodilation in the 'exposed finger'.

The methods used in this study could not be applied to the study of the effects of vibration or force if the instantaneous effects of vibration or force are highly dependent on prior exposure to either vibration or force. In respect of force, the study suggests that the force used here had an instantaneous effect that did not change over 42 minutes and ceased immediately on removal of the force. This suggests that the method might be reasonable for the investigation of the effects of force, including the effects of variable levels of force. Previous studies have found that the vasoconstriction during vibration exposure was not highly dependent on the duration of vibration exposure (e.g. Bovenzi *et al.* 1998). However, the vascular after-effects of vibration are dependent on the duration of prior exposure to vibration (Bovenzi *et al.*, 1995). Possibly, there are two or more mechanisms involved in vasoconstriction caused by hand-transmitted vibration. The current exposures were kept reasonably brief to minimise any cumulative effects while allowing, it was hoped, the monitoring of short-term changes caused by variations in vibration magnitude. The gradual increase in vasoconstriction apparent in the exposed finger as the vibration magnitude increased was probably mainly caused by the increases in vibration magnitude rather than the increased duration of exposure. However, it is not certain that an identical decrease would have been found if the vibration had reduced to zero over a similar subsequent period. Further use of this procedure may therefore require caution to consider the separate vascular changes caused by the instantaneous effects of vibration and the cumulative effects of vibration.

## Conclusions

A new method for assessing the effects of vibration magnitude on vasoconstriction in the finger found that increases in the magnitude of 125 Hz vibration produced expected decreases in finger blood flow in the exposed finger compared to finger blood flow before exposure and compared to blood flow measured in a control condition with no vibration.

A 2 N push force reduced finger blood flow in the exposed finger compared to blood flow prior to the application of the push force. The reduction in blood flow caused by the force was sufficient to be of interest to the understanding of vascular changes associated with gripping vibratory tools.

It is tentatively concluded that the method may be applicable to the further study of the effects of both force and vibration on finger blood flow.

## Acknowledgements

This research was partially supported by the European Commission under the Framework 5 Competitive and Sustainable Growth 2001 (GROW-2001) programme: VIB-TOOL "Grip-Force Mapping for Characterisation of Hand-Held Vibrating Tools"(Contract no. G6RD-CT-2002-00843).

## References

- Bovenzi M., Lindsell C.J., Griffin M.J. 1998. Duration of acute exposure to vibration and finger circulation. *Scand. J. Work Environ Health*, 24, (2): 130-137
- Bovenzi M, Lindsell CJ, Griffin MJ. 1999. Magnitude of acute exposure to vibration and finger circulation. *Scand. J. Work Environ Health*,25,(3):278-284
- Bovenzi M., Lindsell C.J., Griffin M.J. 2001. Response of finger circulation to energy equivalent combinations of magnitude and duration of vibration. *Occupational and Environmental Medicine*, 58:185-193.
- Bovenzi,M., Griffin,M.J., Ruffell,C.M. 1995. Acute effects of vibration on digital circulatory function in healthy men. *Occupational and Environmental Medicine*, 52, 834-841.
- Greenfield A.D.M., Whitney R.J., Mowbray J.F. 1963. Methods for the investigation of peripheral blood flow. *British Medical Bulletin* 19:101-9.
- Griffin M.J. Bovenzi M., Nelson C.M. 2003. Dose-response patterns for vibration-induced white finger. *Occupational and Environmental Medicine*, 60: 16-26.
- International Organization for Standardization. 2001. Mechanical vibration - measurement and evaluation of human exposure to hand-transmitted vibration - Part 1: General requirements. ISO 5349-1:2001(E).





**Prevention I – Focus Session**  
D. Wasserman - Session Coordinator



# DEVELOPMENT OF PREVENTION STRATEGY FOR VIBRATION DISORDER IN JAPAN

S. Yamada

Nagoya University School of Medicine, Tsurumai, Showa, Nagoya, Japan

## Introduction

The change from hand to power tools began in the 20<sup>th</sup> century. Power tools brought low human energy and higher productivity. But they also carried the new risk of 'Vibration'. Field surveys and research on vibration disorder started together with the Enforcement of the Factory Law in 1925. But Vibration disease was not included in the List of Occupational Diseases (which contained 6 specified and 1 unspecified diseases) under the Factory Law. In 1934, vibration disease by pneumatic hammer was noted in the book "Occupational Diseases" by B. Koinuma. He was a factory inspector, who later became a Professor.

Field surveys on vibration disease started in the later 1930s, and the following papers were published. Next, the power tool's name, kind of factory or industry, case number, author and published year in each paper are introduced.

1. Pneumatic hammer, Railway factory, 2 clinical cases, by Murakoshi H., 1938.
2. Jack hammer, Coal mine, 44 clinical cases, Ishinishi S., 1939.
3. Jack hammer, Coal mine, 24 / 165 operators (14.5%), Iwasaki I., 1943.
4. Rivet gun, 6 cases / 11 workers (55%), Aill craft factory, Kimura M. 1943.
5. Rivet gun, Rail way factory and shipyard, 75 / 254 (29.6%), Matsuhuji G., 1943.
6. Chipping hammer, Metal Factory, 39 / 181 (21.5%), Matsufuji G., 1943.

They proved vibration disease by power tools and recommended that it be on the List of Occupational Disease under the Factory Law.

In 1947, after World War II, a new Labor Standards Law took effect. The Old List of occupational diseases was revised on the basis of the above reports. New List includes specified 35 diseases and read No. 10: Vibration disease. New direction described vibration disease as including:

1. Neural disorder; vasomotor neural dysfunction and sensory neural dysfunction. A decrease in blood circulation appears in the hand and coldness and numbness in the fingers.
2. Other disorders appear in joints and muscle system.

The occupations involved mining, construction, ship building, machine and tool manufacturing, and other industries. The tools used are rock drill, rivet gun, grinder, hand-hammer and other. (Addition: chainsaw in 1965)

In 1978, the list of occupational diseases was modified under a new concept, which introduced 8 categories as follows:

1. Accident,
2. Physical environment factors,
3. Excessive load on physical ability,
4. Chemical environmental factors,
5. Dust,
6. Pathogenic organisms,
7. Carcinogenic factors, and
8. Other.

Category 3, 'Excessive load on physical ability', included the following diseases:

1. Vibration disease,
2. Back pain,
3. Cervical brachial syndrome, and
4. Others.

Vibration disease is mainly caused by vibration and human ergonomic factors. Following is a new definition of vibration disease. Disease is A and/or B, which requires treatment:

- A. Disorder in peripheral circulation, sensory neural, and musculoskeletal function from finger to forearm;
- B. Raynaud's phenomenon;
- C. Subjective symptoms from finger to arm; numbness, pain, coldness, stiffness, etc.

The list of occupational diseases included regulations for prevention and therapy and for compensation effected under the New Labor Standard Law. These promoted activity of members in the field of occupational hygiene and medicine. Thus, technological and medical cooperation grew.

In the 1950s, many power tools were introduced into the mining, forestry, quarrying, manufacturing, and construction fields. About 5 years later, worker's complaints gradually increased, and new surveys were developed in the 1950s and 1960s. High complaint rates and severe cases were reported. Especially, the 'White finger' problem in National and Private Forestry drew public attention.

#### **National Forest Model to solve vibration problems in national forestry**

The first vibration disease problem was caused in the National Forestry sector. The introduction of chain saws into national forests was recommended by a government committee in 1952. According to the European Forestry Expert Committee (early 1950s) the specialists and worker's unions doubted vibration hazards associated with chain saws with heavy weight and high vibration levels. In 1953, it all began with the introduction into the forests of Hokkaido (north Japan) when struck by a strong typhoon.

Tree felling in national forests developed on steep slopes under cold conditions in the high mountains across Japan. In central Japan, working places for tree felling were in a big mountain area at 1000-1300 meters above sea level. The work and environmental conditions were severe (chain saw operation hours: 5-6, acceleration levels: 150-200 m/s<sup>2</sup> r.m.s., weight: 15-12 Kg, wage: piece work rate, employment: seasonal). The number of operators was about 13,000 (about 6,000 chainsaw and about 7,000 bush cutter operators). Among them, chainsaw operation-induced complaints gradually increased

In 1957, the National Forest Agency conducted a National land survey, which examined complaints of chain saw and bush cutter operator. The result of the survey indicated 'complaints of fatigue'. In 1962, the National Forest Agency designed a second National land survey. The results were never made public. Worker's Union survey in central Japan forests doubted the vibration hazards for chainsaw operators.

Then, in October of 1964, an academic medical survey was conducted in the central Japan national forest. In March of 1965, detailed results of the medical survey were reported. Vibration-induced disorders and serious cases were proved beyond question. In conclusion, the report recommended certification of vibration disease and preventive measures to the National Forest Agency.

Forest workers were afraid of vibration white finger, and they named the vibration disorder the 'White Waxy Disease.' In March of 1965, TV broadcasted a documentary on 'White Fingers in Forestry.' Then, in April of 1965, the National Diet discussed vibration problems. Worker's unions in forestry, mining and construction industries asked for early measures in connection with the vibration problem.

In May to December of 1965, the Ministry of Labor, National Personnel Authority and Forest Agency decided to certify vibration disease of chainsaw operators and to solve these vibration problems in a wide sector of industries. In June to September of 1965, many universities, institutes and labor accident hospitals joined hands to investigate vibration diseases in various industries. On the basis of those investigations, the Japan Association of Industrial Hygiene organized the Vibration Disorder Research Committee. Soon, members of the Japan Association of Accidental Medicine and the Association of Industrial Hygiene and Technology merged. 1965 was a stormy year for vibration problems in Japan.

In 1965 to 1969, the following examinations of preventive measures and treatment were investigated by the National Forest Agency:

1. Exam of 'Operation time regulation',
2. Exam of 'Improvement of chainsaw',
3. Exam of '3G regulation in vibration acceleration',
4. Exam of 'Treatment system',
5. Exam of 'Diagnostics'.

Materials for the examinations were gradually accumulated.

A serious state developed among forest workers. Design improvements in chain saws progressed slowly. The effects of vibration developed very slowly among old operators, because the effect of past cumulative exposure to a high level of vibration took their toll. Vibration problems reached a crisis situation at the end of 1969 when the numbers of certified workers increased rapidly. Enforcement of operation hour control was strongly requested by the Academic Committee, Worker's Union and National Diet Committee.

The white finger problem in Britain was reported in 1970 at the 'Symposium on the Human Response to vibration'. G.D. Keighley (Forestry Commission) spoke on "Vibration Effects on Chain Saw Operators--Remedial Measures" adopted by the Forestry Commission. He stated that daily chainsaw usage by 3,000 regular operators in Britain had increased to 6 hours per day since 1966 and that most men with 5 years usage have white finger. He continued that usage on this scale would result in most operators changing their forest work or leaving forestry within 10 years of such usage. The same crisis appeared to exist in Japan.

In 1970, a labor-management agreement for prevention & treatment of vibration diseases was concluded between the National Forest Agency and Worker's Union. The agreement said that all enforcement is based on the spirit of humanitarianism. It included:

1. Operation time regulation,
2. Improvement of chainsaw and bush cutter,
3. Job changing for certified workers,
4. Early certification and early therapy, and
5. Measures against cold.

Time regulation and safety work in chainsaw operation was described as follows;

1. Time regulation: 10 minutes/continuous cutting, 2 hours/day, 5 days/week, 150 days/ year. For a bush cutter, 30 minutes of continuous cutting.
2. Age control: usage: until age 55; new usage: before age 50.
3. Alternative hand work and chainsaw (bush cutter) operation.
4. Remote control saw operation without time regulation.

Improved chainsaw and bush cutters were introduced after repeated testing in terms of physiological, sawing and productive effects. Improvement items were as follows:

1. Acceleration: 3G regulation under 2 hours/day operation in 1967 National Forestry and in 1977 National Directive with reference of ISO. 5349 (1979) guide line.
2. Improvement of handle structure: anti vibration handle (Lesson from 3 point support handle in Stihl chain saws, and handle heating).
3. Improvement of engine balance: In 1973, rotary engine saw (60 cc and 35cc) ( 5 m/s<sup>2</sup> r.m.s.) was introduced after 3 years' improvement, in 1980 twin cylinder engine saw (30 cc X 2) (6 m/s<sup>2</sup> r.m.s.) after 3 years' tests and in 1980 to 1985 the normal reciprocal engine saw (25-15 m/s<sup>2</sup> r.m.s.) after 2 – 3 years.
4. Improvement of small size engine: 1980s bantam chain saw (45 cc to 30 cc).
5. Isolation from vibration: 1970s to 1980s remote control chain saw for felling and cross cutting, and chainsaw with small carrier for cross cutting.

6. Bush cutter improvement: In 1980s, electric power bush cutter (low level vibration and noise).

In 1987, a U.S. researcher at Forest Center tested vibration in comparison with the Japanese twin cylinder chainsaw and the Swedish single cylinder chain saw. He wrote: "In strand test and during bucking test, the twin cylinder chainsaw had a lower vibration levels." Another researcher wrote that producing the same risk of vascular disorder would take 26 years with twin cylinder chain saw, as compared with 9 years with a single cylinder chain saw.

The anti-vibration structure of chain saw handles from Germany and the rotary engine and twin cylinder models of chain saws stimulated improvements in the Japanese single cylinder chain saw models. As a result, the acceleration levels of chain saws and bush cutters slowly decreased from 1965 to 1975, reaching 3 g's. After this, the vibration levels decreased more gradually. The effects on the physiological functions of the hands were proved by a change in the vibratory sensation during chain saw and bush cutter operation.

In 1973, the health care and treatment system recommended:

1. For healthy workers a special health examination twice a year for the early detection of vibration exposure effects; and
2. For certified workers with vibration-related diseases:
  - a. Early therapy with rehabilitation in local clinic,
  - b. Hot spring cure (for a month), 1 or 2 times/year,
  - c. Network system among local area clinics, rehabilitation hospital and hot spring hospital, and
  - d. Combination of work control and treatment.

Recommended measures against cold (keeping warm) were:

1. Keeping warm is an important measure for prevention and recovery of vibration disease.
2. In the work place, keep the chain saw handles warm and provide a warm rest cottage.
3. When commuting to work, keep the bus warm.

In 1977, the National Forest Agency organized a committee of 6 experts on the basis of the Labor-Management agreement in Japan. The committee consisted two labor hygiene experts and four clinical experts (circulatory medicine, hot spring medicine, orthopedic medicine, blood vessel surgical medicine). This Committee had an important role in completing the National Forest Model for 25 years.

This model for prevention succeeded in dramatically decreasing the number of newly certified worker's. The total number of chainsaw and bush cutter operators was about 20,000 (over 50 years from chain saw introduction). Certified workers in the past numbered 3,679.

In 2003, the wood production system within the national forests was closed down. Valuable measures and lessons from the National Forest Model were followed by the National Comprehensive System for Prevention, Therapy and Compensation for Vibration Disease by the Ministry of Health and Labor.

### **National Comprehensive System for Vibration Problems (Ministry of Health and Labor)**

The National Comprehensive System started in 1965. The Ministry of Labor (latter the Ministry of Health and Labor) issued Directives for prevention, treatment, compensation and social rehabilitation. These resulted in the National Comprehensive Measurement System for Vibration Disease. This system progressed together with the National Forest Model.

In 1967, Directive No. 38 required the vibration levels of chain saws to be decreased to 3 g's (29.4 m/s<sup>2</sup>).

In 1970, Directive No. 134 required comprehensive prevention measures for chainsaw operation. The directive contained the following fundamental items based on the 1970 National Forest Model:

1. Improvement of chainsaw (already issued),
2. Operation time regulation-2 hours,
3. Health examination,
4. Keeping warm (clothes, gloves, rest cottages), and
5. Chainsaw adjustment (on Chain and saw).

On the basis of Directive No. 134, further detailed Directives were issued in the following order:

- a. 1970: Notice indicating list of tools and tool operations, vibration measurements, and tentative exposure guideline.
- b. 1975: Directive No. 608 ordered comprehensive prevention measures for vibration tools other than chainsaws:
  - 1) Tools: Names, Vibration, weight, and noise;
  - 2) Operation time control, Operation method, Chisel, Compressed air, tool adjustment;
  - 3) Standard of operation;
  - 4) Rest room, Drying clothes, Protective glove; and
  - 5) Health examination, Safety education.
- c. 1975: Directive No. 609 took effect. It required health examinations for chainsaw operators:
  - 1) First step – questionnaire and examination: vascular function (skin temperature, nail press test), sensation (vibratory and pain sensation), muscular function (grip force, pinch force, tapping).
  - 2) Second step - cooling test: after 5°C (present 10°C) immersion for 10 minutes, skin temperature, nail press test, and vibratory and pain sensations.
  - 3) Other: warm and cold sensation, audiogram, ECG, etc.
- d. 1977: Notice No. 85: Chain saw standard took effect, regulating the following items:
  - 1) Acceleration level must be below 3g's (29.4m/s<sup>2</sup>).
  - 2) Hand guard and kick back guard are requested.
  - 3) Attached indication label must have: (1) maker's name, (2) production date, (3) exhaust gas volume, (4) weight, and (5) acceleration and noise levels.
- e. 1988: Directive No. 11 took effect, which required the measurement of vibration in power tools.
  - 1) Method of measurement: Based on JIS (Japanese Industrial Standard).
  - 2) Tools requiring vibration measurements are: Lock drill, Chipping hammer, Riveting hammer, Coking hammer, Baby hammer, Scaling hammer, Concrete breaker, Electric hammer, Coal pick hammer, Electric hammer, Sand rammer, Needle hammer, Kelen, Engine cutter, Tight tamper, Tamper, Concrete vibrator, Disk sander, Swing grinder, Impact wrench, Vibration drill.
  - 3) Standard of Operation and Measurement: (Detailed description omitted here)
- f. 2001: In July, the Vibration Exposure Guideline was approved by the Japan Association of Industrial Hygiene under medical technological cooperation. It corresponds well with ISO 53409-1, except for exposure years. It concerns differences in the incidence ratio of white finger between Japanese and European peoples.
- g. 2003: Correction of JIS began to correspond with ISO 8662. In 1988, the Ministry of Labor, Direction No.11, specified the measurement method for vibration in hand-held vibrating tools. However, the measurement method did not correspond to the procedures specified in 1988 ISO 8662-1 (Hand-held portable power tools measurement of vibration at the hands).
- h. 2003: Correction of JIS began and Direction 1988 - No. 11 will follow to correct for agreement with international standard.
- i. 2003: Evaluation of Personal Protective Equipment: anti-vibration gloves
- j. 1975: Directive 608 recommended protective gloves
- k. 1987: JIS T 8114: Evaluation of anti-vibration gloves
- l. 1996: ISO 10819 Measurement and evaluation of gloves
- m. 2003: Institute of Industrial Medicine began evaluation of anti vibration gloves on the basis of JIS 8114. JIS 8114 must correspond with ISO 10819.

Medical and technological cooperation developed nationwide from the northern to southern parts Japan. Many universities, research centers, prevention organizations, ambulant clinics and hospitals designated by labor accident

insurance, along with medical and technological experts, cooperated to solve and treat vibration problems. Their activities resulted in many National Directives dealing with vibration problems and promoted practical efforts. Thus, the prevention, treatment and social rehabilitation from vibration disorders gradually progressed.

Examined workers among vibration exposed workers in all industries were around 70,000 in 1985. The number of workers certified to suffer from vibration disease increased from 36 (1956-1960) to 10,370 (1976-1980) and then to 2,331 (1991-1995). The number of workers under treatment increased to 13,501 (1987), then gradually decreased to 11,578 (2000). The decrease in the number of certified workers after reaching the peak reflects the results of prevention effects.

The number of certified workers with vibration disorders in the construction industry increased from 23 (1956-1960) to 1,990 (1981-1985), decreased to 1089 (1986-1990), but again increased to 2297 (1996-2000). We do not currently know why there is a delay in the development of a good prevention system for the construction industry. This is a serious problem in Japan. The number of certified workers (2,221 in 1994 to 1997) by type of tool suggests that the number of certified workers with power tools in the construction industry very high.

Possible problems in the construction industry are presented here. The Japanese construction industry developed with national projects for construction of super high-speed railways and truck roads across the country and plans for developing large cities on the Pacific Ocean side. Many small subcontractors joined hands with big enterprises in these projects. They employed many workers from extensive rural areas in low poor conditions. Their work conditions included short-term employment, piece work rate wage, and rush work days and nights. Large enterprises utilized automatic machines, while small enterprise workers mainly used hand power tools. Their work consisted of repeated long hours of power tool usage and manual work for a short term. Their working place changed after every one to two years. They often experienced cold mountain side work. As a result, their vibration symptom became worse. They almost never had health examinations for vibration diseases. Even if they were examined, they hid any poor results, fearing they may be laid off because of their inability to work. Therefore it has been difficult to initiate a prevention system to cover workers in the construction industry.

In 1993, Directive No. 203 took effect. It was a strong step to promote national comprehensive measures for vibration disease. It sought success first in the construction industry, then in the forestry and manufacturing industries. This Directive sought cooperation among experts and organizations in the medical technological field, government administration and social organizations in order to attain these goals.

### **Conclusion**

Around 70 years have passed since Koinuma (1932) first mentioned vibration diseases in Japan. Some 57 years have passed since the first description of vibration disease in a national regulation (1947). 1965 was a stormy year for vibration problems in Japan, and 40 years have since passed. During these years, we have seen great cooperation among academic, administrative, and social experts in developing the first National Forest Model and finally a National Comprehensive System for vibration diseases.

The total number of certified vibration disease workers has now reached 30,144 in 40 years. By the end of 2000, the number of workers under treatment was 11,578. Half of them are in rehabilitation activity training. Others also are under treatment. Most are old and have other diseases.

Many workers lost their valuable life activity. We must remember this unfortunate history of so many workers. At the same time, we must remember the valuable lessons learned in overcoming the vibration disease problem.

We now have heavy trials to overcome in addressing vibration problems in the construction and other industries.



# PLANS FOR EFFECTIVE IMPLEMENTATION OF THE EUROPEAN VIBRATION DIRECTIVE

C. Nelson and P. Brereton

Health and Safety Executive, Magdalen House, Bootle, UK, L20 3QZ.

## Abstract

The adoption of the European Directive 2002/44/EC (the Physical Agents (Vibration) Directive) requires Member States to introduce implementing legislation by July 2005. The directive clarifies existing general duties of employers regarding risks from vibration and introduces exposure action and limit values. Where the exposure action value ( $2.5 \text{ ms}^{-2} A(8)$ ) is exceeded, a programmed of risk control measures and health surveillance is required. Exposure in excess of the exposure limit value ( $5 \text{ ms}^{-2} A(8)$ ) is prohibited.

In Great Britain, it is likely that nearly one million people are exposed to hand-arm vibration at or above the exposure limit value. This paper discusses plans for interventions on hand-arm vibration by the Health and Safety Executive between the introduction of regulations implementing the directive, through to the end of the transition period for the exposure limit value. Plans include the publication of revised guidance for employers on risk assessment/control and health surveillance and targeted campaigns aimed at industry sectors where high exposures remain prevalent. In industries where good practice and reasonably practicable control strategies have been established, these campaigns will feature appropriate combinations of information, guidance, education and support for duty holders, combined with inspection and enforcement as required. Where technical difficulties remain, the emphasis will be to encourage the development of new ways of working in order to avoid vibration exposures and to achieve compliance by the end of the transitional period in 2010.

## Introduction

Ill-health resulting from exposure to hand-arm vibration (HAV) is a common but largely preventable problem in Great Britain. Hand-arm vibration syndrome (HAVS) is the most frequently reported occupational disease for which statutory reporting is required, and the most common disease for which compensation is paid to workers (through both a national industrial injuries scheme and employers' insurance claims). Research undertaken for the Health and Safety Executive (HSE) during the 1990s (Palmer *et al.*, 1999) indicated that of approximately 5 million people exposed to vibration in Great Britain, about 300,000 had advanced vascular symptoms attributable to vibration exposure and a similar number had attributable sensorineural complaints.

Progress in the control of exposure to HAV has been made in recent years and there have been initiatives within some industry sectors to find new methods of working to eliminate or reduce exposure. The last decade has also brought an increased availability of power tools and other hand-held or hand-guided machinery with reduced vibration emissions. The HSE has encouraged the development and adoption of good practice as a means of complying with the general legal duties of employers, although no vibration-specific duties for employers (such as a statutory exposure limit) currently exist in the UK.

The adoption by the European Union (EU) of a directive on vibration in the workplace requires legislation in EU Member States, and provides an opportunity for European harmonization of good practice in the control of risks from HAV. This paper discusses plans by the Health and Safety Executive in Great Britain to build on recent progress and to further reduce risks from HAV through implementation of the 'Vibration Directive'.

## The Vibration Directive

The European 'Vibration Directive' (or, more formally, Directive 2002/44/EC, on the minimum health and safety requirements regarding the exposure of workers to the risks arising from physical agents (vibration)), sets minimum requirements for the prevention of ill health arising from occupational exposure to vibration. It is the first of a series of directives dealing with 'physical agents' (others in development apply to noise, electromagnetic fields and waves and optical radiation) and it was formally adopted by the European Parliament and the Council of the European Union in 2002. Member States of the European Union (EU) are required to implement the Directive in national law by 6 July 2005 (European Parliament and the Council of the European Union, 2002).

In the EU, risks to the health and safety of people at work must be assessed and controlled or managed under existing legislation, including Directive 89/391/EEC, the 'Framework Directive' (Council of the European Communities, 1989). These general duties of employers' include:

Assessment of risk;

- Planning and implementing the necessary control measures;
- Providing and maintaining suitable work equipment;
- Providing workers with information and training on risks and their control; and
- Monitoring and reviewing the effectiveness of the risk control programme.

The Vibration Directive is a so-called ‘daughter’ of the Framework Directive and is compatible with it, clarifying existing legal requirements as they apply to vibration risks. It introduces for the first time an *exposure action value* (EAV) and an *exposure limit value* (ELV). For hand-arm vibration the EAV and ELV are set at  $2.5 \text{ ms}^{-2} A(8)$  and  $5 \text{ ms}^{-2} A(8)$  respectively, where  $A(8)$  is the daily vibration exposure, as defined in ISO 5349-1:2001 (International Organization for Standardization, 2001). (The Vibration Directive also applies to whole-body vibration for which different EAV and ELV values are specified.)

Regardless of the level of exposure, the Vibration Directive places a duty on employers to eliminate at source risks from vibration, or to reduce them to a minimum, and to provide exposed workers with suitable information and training on the risks and how they can be controlled. Where the risk assessment indicates that the EAV is exceeded, a program of technical and organization measures is required to:

- Eliminate or reduce exposure by replacing the work process by a vibration-free or lower vibration alternative;
- Provide suitable tools and equipment with ergonomic design and reduced vibration emissions;
- Maintain work equipment and systems to prevent increases in vibration risks;
- Design workstations to reduce risks;
- Train workers to use equipment correctly to minimize their vibration exposure;
- Limit the duration and magnitude of the vibration exposures;
- Establish appropriate work schedules and rest periods;
- Provide clothing to protect workers from cold and damp; and
- Implement an appropriate health surveillance programme.

Exposure above the ELV is prohibited. If the ELV is found to be exceeded, the employer must take immediate action to reduce the exposure and prevent further exposures at this level.

The Vibration Directive permits Member States to allow a transitional period of up to five years (nine years for agriculture and forestry) before enforcing the duty to keep exposure below the ELV. The transition period can only be applied to work involving equipment supplied before July 2007 and for which there is no means, in the short term, of reducing the exposure sufficiently. The transitional period does not affect the duties arising from exposure above the EAV; it does, however, allow employers some time to implement the necessary changes to their processes and for improved work equipment to be developed in the longer term.

### **Impact of the Directive in Great Britain**

The HSE first published guidance on the control of risks from hand-arm vibration ten years ago (Health and Safety Executive, 1994). British industry therefore already has access to information on good practice in controlling vibration risk and on national expectations for compliance with the existing legal duties. The 1994 guidance includes a recommended ‘action level’ of  $2.8 \text{ ms}^{-2} A(8)$  above which employers are expected to take actions similar to those required by the Vibration Directive at exposures above the EAV.

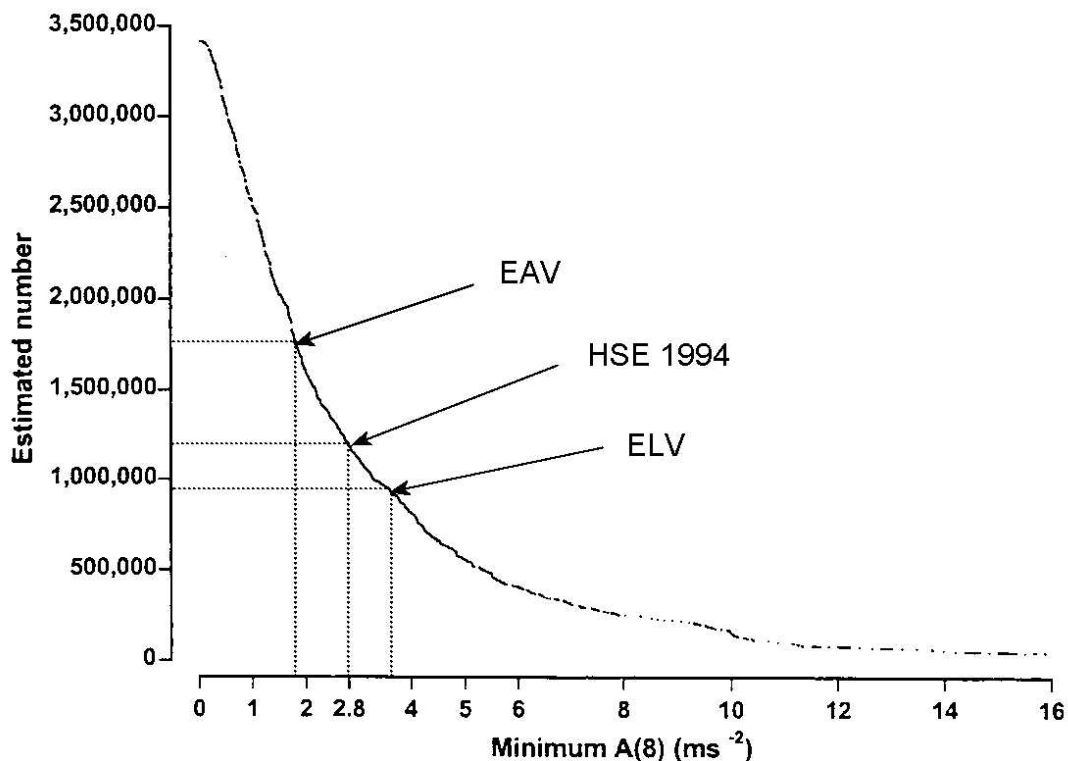
The 1994 HSE action level is based on vibration in the ‘dominant’ axis in accordance with the former British Standard 6842 (British Standards Institution, 1987). To convert from dominant axis to the vibration total value (3-axis ‘vector sum’) used in the Vibration Directive, ISO 5349-1:2001 recommends multiplying by a factor of 1.4. The 1994 HSE action level of  $2.8 \text{ ms}^{-2} A(8)$  then becomes approximately  $4 \text{ ms}^{-2} A(8)$  and lies mid-way between the new EAV and ELV ( $2.5$  and  $5 \text{ ms}^{-2} A(8)$  respectively).

Research conducted for the HSE (Palmer *et al.*, 1999) suggested that at least 1.2 million workers in Great Britain were exceeding the HSE action level. As shown in Figure 1, there were likely to be about 40% more workers exceeding the new EAV. Employers will need to extend their programmes of risk control measures and health surveillance to

include these workers, although for many of those who are already following the HSE's existing guidance, working to minimize exposures and complying with existing legal duties, this will involve little additional work.

In the UK, occupational health surveillance is the responsibility of the employer. A shortage of suitably qualified and experienced providers of occupational health services is anticipated in the early years following the introduction of the Vibration Directive, and a HAVS training scheme for occupational health professionals is being planned. HSE's draft guidance for employers on health surveillance aims to minimize the resources needed to establish adequate health surveillance programs, suggesting a tiered structure. Workers at risk would be screened using a simple questionnaire, at minimum cost; those with symptoms would be referred to occupational health professionals for further investigation (Barker & McCaig, 2003). It is also possible that the new statutory duty to provide health surveillance at exposures above the EAV will act as an incentive for employers to eliminate or minimize exposures where practicable, to reduce the requirements for health surveillance.

The major impact of the directive is likely to be the requirement to bring all daily exposures below the ELV. Of the 1.7 million exposed above the EAV, almost a million may also be exceeding the ELV. Compliance with the ELV before the end of the transitional period (July 2010) will require significant action in several sectors of British industry. Employers in many other European countries are likely to face a similar challenge.



**Figure 1** Estimated numbers of male workers in the UK exposed to hand-arm vibration at levels above the 1994 HSE action level and the EAV and ELV which will apply from 2005. (The  $A(8)$  exposures are expressed as 'dominant axis' values in accordance the 1986 edition of ISO 5349.) Adapted from Palmer *et al*, 1999.

### Implementing the Vibration Directive in Great Britain

The requirements of the Vibration Directive will be implemented in British law with the introduction of the *Control of Vibration at Work Regulations 2005*. Like the directive, these regulations will apply to both hand-arm and whole-body vibration. However, the risks to health from exposures to hand-arm and whole-body vibration, and the methods for their assessment and control, are very different and guidance for employers on each topic will appear in separate publications.

In November 2003 the Health and Safety Commission (HSC) published a Consultation Document on its proposals for implementing the Vibration Directive with regard to hand-arm vibration (Health and Safety Commission, 2003). This document contained draft regulations and accompanying guidance. A period of formal public consultation ended in

March 2004; the comments received will be taken into account by HSE, which is now developing final versions of the Regulations and guidance which will be published (subject to HSC and Government approval) before the Regulations come into force in July 2005.

### Revised HSE Guidance on HAV

HSE has published a comprehensive portfolio of guidance on HAV, building on the original 1994 publication; this includes various leaflets, a book of risk control case studies, a video for vibration-exposed workers, a multi-media CD-ROM containing guidance and reference material and several industry sector-specific publications and information sheets. Much of this material is included in the new guidance document which will replace the 1994 publication; it is broadly compatible with its predecessor, but has been restructured and amended to suit the new Regulations. It contains simple, practical chapters for employers, with additional technical appendices aimed at safety practitioners, occupational health professionals, etc. The main chapters cover:

- duties of employers;
- assessment of risk from HAV and planning for control;
- control of exposure and risk (with illustrative case studies);
- health surveillance for HAVS; and
- duties of manufacturers and suppliers of vibrating machinery.

#### *Guidance on Risk Assessment*

Experience has shown that many employers see the requirement for risk/exposure assessment as a bureaucratic burden, rather than as a useful component of the planning process for control of risk. Some also view assessment as complex, difficult and expensive, involving consultants and workplace vibration measurements, and this belief can be an obstacle to progress in control of the risks. The new guidance therefore explains that a high level of precision is not generally required in exposure assessment; it provides employers with advice on obtaining suitable information to help them decide whether the EAV and/or ELV is likely to be exceeded, and what action they need to take to reduce or eliminate risk. It encourages employers to consider the risk assessment qualitatively (i.e. what needs to be done to achieve acceptable control of risk) as well as the quantitative task of exposure evaluation, for which advice is given on the selection and interpretation of vibration information, including that provided by machinery manufacturers.

#### *The Exposure Points System*

A new system for describing exposure, in terms of 'points' which allows simple arithmetic adding of exposures, has been included in the draft guidance to help address the perception that hand-arm vibration is a highly 'technical' subject which requires specialist knowledge. This permits a move away from the representation of exposure by  $A(8)$  values, which are expressed in arcane units ( $\text{ms}^{-2}$ ) and require mathematical manipulation, replacing it with points which can be added together.

The number of exposure points,  $n$ , is given by:

$$n = \left[ \frac{a_{\text{hv}}}{2.5} \right]^2 \times \frac{t}{8} \times 100$$

where  $a_{\text{hv}}$  is a representative average vibration magnitude in  $\text{ms}^{-2}$  and  $t$  is the exposure duration ('trigger time') in hours. Daily exposures of 100 and 400 points correspond to the EAV and ELV respectively.

Many employers are likely to manage vibration risks through the control of exposure by limiting the time spent using vibrating equipment; some have found it useful to label tools with maximum daily use times. However, this approach has sometimes been difficult to implement effectively where workers use two or more vibrating tools in one working day. With the points system, tools or processes can be labeled or documented with a specified number of 'points per hour' (or other convenient period of time). This system allows operators and their supervisors to monitor, record and manage vibration exposures using a simple numerical method (without using vibration magnitudes or  $A(8)$  values).

## Interventions to Achieve Compliance

### *Control of risk through supply of 'safe' machinery*

The Vibration Directive places duties only on employers. However, manufacturers and suppliers of machinery in Europe are required by another piece of European legislation - the 'Machinery Directive' 98/37/EC (Council of the European Union, 1998) - to design and construct their products for minimum risk from significant hazards (including vibration where appropriate), to warn of residual risk and to declare the vibration emission of the machine. The Vibration Directive suggests that information from equipment manufacturers can be used in the assessment of exposure and risk, and this has raised the profile of the manufacturers' duty (under the Machinery Directive) to provide suitable information on vibration risk. Control of vibration risks in the workplace through the supply chain is seen as an efficient means of achieving widespread reduction in exposures, and the tool manufacturers have a significant role to play (by continued improvement to tool designs and by the provision of information on residual risks to inform the safety management of the tools).

Manufacturers' declared vibration emission values are measured using harmonized test codes (generally European Standards). These emission values can be valuable when selecting work equipment, identifying tools with particularly low or high vibration emissions. However, most current test codes consider vibration only in a single axis, sometimes at an inappropriate hand position, and many specify unrealistic operating conditions for the tool. A new European and International Standard has been developed (European Committee for Standardization, 2004) which establishes revised requirements for the test codes. Test codes which comply with these requirements, should produce more realistic emission values than before, and many existing codes will be revised in accordance with the new Standard in the next few years. Meanwhile, the declared emission will often be unsuitable for direct use by employers in estimating daily exposures, and supplementary information is required to warn of the risk and to assess it as required by the Vibration Directive.

Most power tool manufacturers have reduced the vibration emissions of their products in recent years and in some industries this has the potential for a significant reduction in exposures. However, the present (first) generation of 'vibration-reduced' tools (for example, pavement breakers with suspension handles) often require carefully controlled behavior from the operator (e.g. a specified feed force) to achieve the anticipated emission reductions; suitable operator training and supervision may be required if the potential for reduced vibration exposure is to be realized. It is to be hoped that the vibration characteristics of future designs will be less operator-dependent but, meanwhile, manufacturers must inform their customers of any requirements for training and correct operation.

HSE has been working with manufacturers and suppliers of powered hand tools, both in the UK and at the European level, to improve the provision of appropriate information to users on risk from residual vibration. This includes working within standards committees to improve vibration test codes and to ensure that all the vibration requirements of the Machinery Directive are adequately addressed in European machinery safety standards.

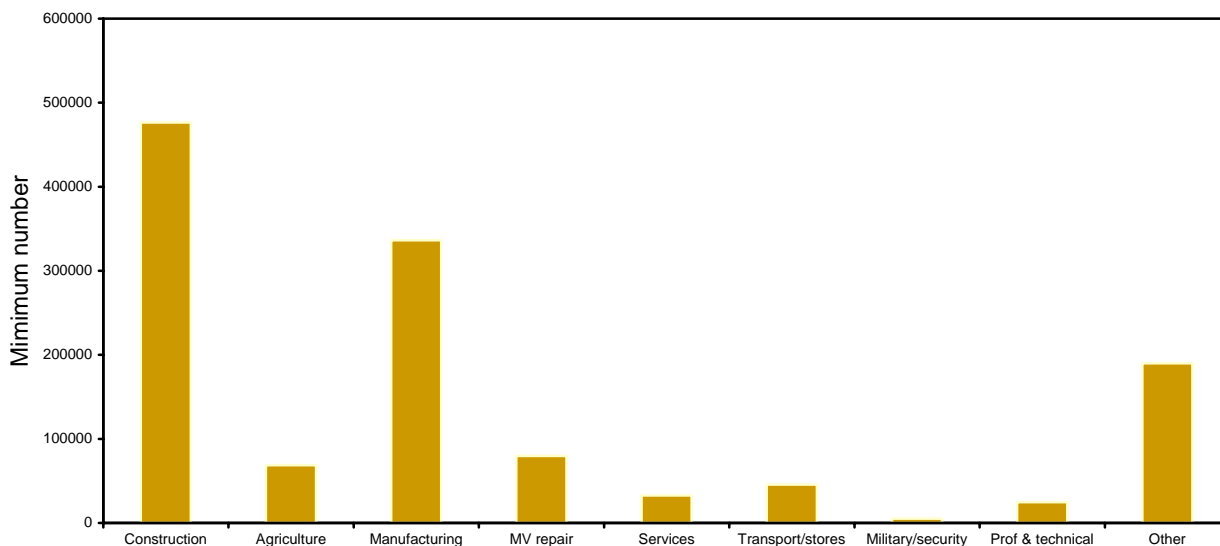
HSE information campaigns in recent years have encouraged tool users in the UK to ask their suppliers for information on vibration risks. With the adoption of the Vibration Directive, manufacturers are anticipating similar requests from their customers elsewhere in Europe to help them assess and manage vibration. The information may take the form of an indication of the (realistic) vibration magnitude, or the likely range of magnitudes, but may need to include instructions for correct use, training requirements, maintenance recommendations, and advice on maximum 'safe' use times. HSE continues to encourage suppliers to make the appropriate information freely available to potential tool users.

### *Priorities for Action*

EU Member States adopting the transitional arrangements for the Vibration Directive need not require employers to comply with the ELV, for activities involving equipment in use before 2007, where it is not currently possible to do so. They must, of course, do all that is reasonable to reduce the exposure and risk, because the EAV is also exceeded. HSE proposes to make use of the transitional period in Great Britain to concentrate its finite resources on the industries with the greatest numbers of people exposed at the highest levels (i.e. where the ELV is frequently exceeded), and where it can make the greatest impact in terms of reduced vibration exposures and risk of HAVS.

Figure 2 shows a breakdown, by industry, derived from data published by Palmer *et al.* (1999), of the minimum numbers of workers in Great Britain exposed above the current HSE action level. The numbers of workers exceeding the ELV will be smaller, but are expected to be similarly distributed across the industry categories. As in most western societies, manufacturing industry in the UK is declining, but manufacturing overall comprises the second largest group. The construction sector dominates with about 40% of the population exposed at or above the action level (the figure for

construction includes all construction-related trades such as masons, bricklayers, carpenters, fitters, electricians and plumbers).



**Figure 2** Numbers in Great Britain estimated exposed above the current HSE action level, by industry group.

The information in Figure 2 provides a broad overview of the distribution of HAV exposures in Great Britain, but a more detailed picture is required for an understanding of where the high exposures actually occur. Further exploitation of this data source, together with information on numbers employed, tools used in the industries, typical vibration emissions and existing HSE knowledge, will be undertaken to identify priority sectors for HSE’s attention during the next six years and beyond.

Table 1 shows a selection of industry sectors and work activities that are known to have high exposures, and where the solutions are at various stages of maturity (these examples are based on HSE’s experience, and the list is not exhaustive).

*HSE’s Role – Initiatives in the Workplace*

In some cases, good working practice and reasonably practicable control strategies are established and the challenge for HSE is to achieve compliance through an appropriate combination of available methods, some ‘traditional’ and some new:

- published guidance (generic and sector-specific where appropriate, including increasing use of web-based material);
- education and information campaigns for employers, directly and through trade associations and consultants;
- education and information campaigns for employees, directly and through training organizations and trade unions;
- an HSE programmed to develop partnerships for delivering occupational health support, particularly for small employers;
- workplace inspection and, as required, enforcement action.

In cases, where no reasonably practicable solutions are established, then to ensure compliance with the Vibration Directive’s ELV requirement, the challenge is to work with the industry, preferably through trade associations at national, European or international level, to encourage the development of new technologies and alternative ways of working, to achieve compliance as soon as is practicable, and in any case by 2010.

**Table 1** A selection of industries and processes with potential for high HAV exposures in HSE experience

<b>Industries</b>	<b>High exposure activities</b>	<b>Established Solutions</b>	<b>Challenges</b>
Construction Utilities	Use of: pavement breakers demolition hammers disc cutters scabblers (concrete surface preparation) vibrating compaction plates hammer drills, clay spades/jigger picks (tunneling)	Plan/design to avoid vibration mechanized tunneling mechanized boring to avoid manual full-length trenching new methods for pile cap removal machine-mounted picks vibration-reduced tools operator training job rotation/time limiting	Designers to consider vibration risks at planning stage  Manage tool selection, health surveillance and training in a largely casual workforce  Identify any specialist construction trades requiring development of control strategies
Foundries	Fettling using various grinders and chipping hammers Furnace refractory lining ramming and removal	Improving casting techniques reducing flash and need for fettling mechanized knock-off/cut-off hydraulic push-out of furnace lining suitable tool and abrasive selection	Technical advances have reduced the amount of fettling in foundries, but remaining skilled fettlers are often still exposed at high levels.
Shipbuilding Ship repair Heavy engineering/ fabrication	Use of: grinders scaling tools (surface preparation) chipping hammers (decreasing) other hand tools	modern fairing aids to avoid chipping/grinding modern cutting and welding techniques to reduce grinding and gouging grit/shot/water blasting for surface preparation vibration-reduced tools	Need to achieve wide-spread adoption of state-of-the-art procedures
Grounds maintenance (gardens, parks, schools, etc.)	Use of: chainsaws (arboriculture) lawnmowers hedge trimmers brush saws and strimmers	Selection of appropriate tools Maintenance of tools Job rotation/time limiting machine mounted tools suitable for some applications	High exposures arise from intensive work in the growing season.
Stone masons	Use of: chipping hammer and chisel grinders polishing tools	Machining of simple stone components selection of appropriate tools maintenance of tools time limiting	A small industry with high exposures.  Use of best pneumatic hammers/chisels, with sliding sleeves, reduces exposures but they remain high.  Some potential for use of CNC machining centers for complex stonework - requires development
Cast stone	Use of: pneumatic sand rammers electric demolition hammers as sand rammers	presses instead of rammers in some applications use electric tools (lower weighted vibration than pneumatic rammers) mount tools in frames/balancing rigs	A small industry with high exposures.  Need to understand nature of risk for rammers with high weighted acceleration due to low strike frequency and long stroke.
Forestry	Use of: chainsaws and brush cutters	mechanization of much work formerly carried out with chainsaws reduced vibration chainsaws long-established	Reduced numbers of people exposed, but some still have significant exposures which require managing.

## Conclusion

The European Vibration Directive builds on existing health and safety law, specifying duties of employers to ensure the health and safety of their employees with respect to risks from vibration and setting exposure action and limit values. In countries such as the UK, where guidance is already available and the expectation of the enforcing authorities has been well known for some years, the principal impact on industry in the early years will be the requirement to bring all exposures below the ELV of  $5 \text{ ms}^{-2} \text{ A}(8)$ .

The HSE intends to direct its resources on HAV where they can be most effective in preventing new vibration injury or worsening of existing injury. The introduction of the implementing regulations in 2005 through to the end of the transitional period for the exposure limit value (2010) will be accompanied by a campaign to achieve compliance with the ELV. In the longer term, the aim is to have a workforce aware of the vibration risk, and means of its control, and prevent new incidence of HAVS, allowing workers to reach their retirement without health impairment.

Much progress is being made on the reduction of vibration by tool manufacturers. However, the use of 'vibration reduced' tools alone will not always result in adequate control of risks from HAV. Accelerated changes to some industrial processes will be needed to eliminate or reduce manual operations involving vibrating hand tools. Some industries will need to use the transitional period to develop and establish good practice (where necessary, researching new processes, methods or equipment). This can involve significant capital expenditure and may require long-term planning and investment. Provision of sector-specific information and education will be required to establish industry acceptance: this will require partnership between employers, their employees, health and safety specialists, the enforcing authorities across Europe and ultimately the wider industrial world.

## References

- Barker, P and R McCaig (2003) Development of new guidelines on health surveillance for hand-arm vibration exposed workers. Presented at the 38<sup>th</sup> United Kingdom Conference on Human Response to Vibration held at Institute of Naval Medicine, Alverstoke, Gosport, PR12 2DL, England, 17-19 September 2003.
- British Standards Institution (1987) BS 6842. British Standard Guide to Measurement and evaluation of human exposure to vibration transmitted to the hand.
- Council of the European Communities (1989) Council Directive 89/391/EEC on the introduction of measures to encourage improvements in the safety and health of workers at work.
- Council of the European Union (1998) Council Directive 98/37/EC on the approximation of the laws of the Member States relating to machinery.
- European Committee for Standardization (2004) EN ISO 20643. Mechanical vibration – Hand-held and hand-guided machinery – Principles for evaluation of vibration emission. (Publication expected 2004.)
- European Parliament and the Council of the European Union (2002) *Official Journal of the European Communities* Directive 2002/44/EC on the minimum health and safety requirements regarding the exposure of workers to the risks arising from physical agents (vibration). OJ L177, 6.7.2002, p13.
- Health and Safety Commission (2003) Proposals for new Control of Vibration at Work Regulations implementing the Physical Agents (Vibration) Directive (2002/44/EC) Hand-arm Vibration. Consultative Document CD190. HSE Books.
- Health and Safety Executive (1994) Hand-arm vibration. HS(G)88. HSE Books ISBN 0-7176-0743-7.
- International Organization for Standardization (2001). ISO 5349-1. Mechanical vibration and shock – Measurement and evaluation of human exposure to hand-transmitted vibration – Part 1: General requirements.
- Palmer KT, Coggon D, Bendall HE, Pannett B, Griffin MJ and Haward BM (1999) Hand-transmitted vibration: Occupational exposures and their health effects in Great Britain. Contract Research Report 232/1999. HSE Books, ISBN 0-7176-2476-5.



# EFFECTIVE INTERVENTION WITH ERGONOMICS, ANTIVIBRATION GLOVES, AND MEDICAL SURVEILLANCE TO MINIMIZE HAND-ARM VIBRATION IN THE WORKPLACE

T. Jetzer<sup>1</sup>, P. Haydon<sup>2</sup>, D. Reynolds<sup>3</sup>

<sup>1</sup> Occupational Medicine Consultants, Minneapolis, Minnesota, USA

<sup>2</sup> Company Health, London, England

<sup>3</sup> The Center for Mechanical & Environmental Systems Technology, University of Nevada, Las Vegas, Las Vegas, Nevada, USA

## Introduction

This report is a follow up study on a five year perspective ergonomic intervention on workers in the roofing industry in the United Kingdom. These individuals were exposed to workplace hand/arm vibration in the course of their employment as roof tilers. The initial study has been reported upon in the past and involved all the workers<sup>1</sup>. Subsequent to this ergonomic assessment and safety evaluation of the working conditions, intervention with ISO 10819 gloves and new tools was undertaken to decrease the exposure of the workers to hand/arm vibration. This subsequently decreased the severity of workers with Hand-Arm Vibration Syndrome (HAVS) or associated conditions and prevented progression of HAVS as well as Carpal Tunnel Syndrome. The scope of this study involved 73 of the 225 initial workers were found to have potential HAVS and other upper extremity pathology on initial review study. Assessment focused on the neurological and vascular components of hand/arm vibration syndrome as well as other upper extremity pathology such as Carpal Tunnel Syndrome.

The study components included an extensive medical questionnaire for hand/arm vibration syndrome and other upper extremity pathology. This was done by clinical onsite hand examination by trained nurses or technicians. In addition, clinical onsite testing for neurological function was determined with questionnaire assessment. Questionnaire assessment for vascular symptoms was used. Yearly testing was a minimum with increased frequency for those who had the pathology. The specifics of the clinical examination performed included a medical questionnaire, clinical hand examination, vibrometry sensory testing, Semmes monofilament testing, grip strength and hand dexterity Purdue Pegboard. Nerve conductions were done on those with significant pathology suggesting entrapment syndrome. The clinical examination includes the Phalen's, Tinel's and Finkelstein's test and in addition Allen's test inspection on range of motion was performed. The Brüel-Kjær vibrometry system was used for vibration sensibility testing<sup>2</sup>.

A questionnaire was given to assess hand symptoms. The vibrotactile was used as a correlation with the Semmes-Weinstein testing and grip pinch gave a good measure of hand function. Dexterity was measured by the Purdue Pegboard Test as well as to determine the level of dexterity function. This dexterity testing also helps to categorize individuals according to the Stockholm Workshop Scale. All testing and screening was done at the facilities of employment by trained nurses with the remote physician review of the results. Those with significant pathology were referred on to specialists for more extensive testing and clinical evaluation. The repetitive and repeat surveillance was dependant upon the pathology. It was determined that the individuals most likely to have problems were those known as tilers and fitters who were installing and cutting heavy roof tiles.

The tool initially used had a vibration average rating of 2.5 m/s<sup>2</sup>. This was replaced over the course of a year with a different tool make with half of the vibration level. The time exposure and work tasks did not change for the group as a whole. The testing of the levels of ISO weighting of the vibration tools was done by an independent consultant in the United Kingdom. The average time of daily hand exposure was 2 - 3 hours. There were workers with some variable hand vibration exposures from other prior jobs but not anything that was significant and competitive with the cutting tool that was used for tiles. Other workplace factors such as age, health history and personal habits were also assessed by a surveillance question and were not significantly changed throughout the course of the study as the workgroup was quite stable. The ergonomic program involved introduction to various types of ISO 10819 certified gloves<sup>3</sup>. The glove type used was blind to the examiners and could be chosen by the workers. The job modifications were determined by the company by changing the tool or else changing job essential functions. Workers that were no longer involved the hand/arm vibration work they were dropped from the study. Those with significant vibration exposure that were in the initial studies had been removed from working with the tools.

## Results

Seventy-three workers with jobs of tilers and fitters were assessed. By the third year 21 or 28.7% were able to document some type of ergonomic tool or job modification, 51 or 69.86% were documented to have no change in job ergonomics and 1 or 1.37% stated that the ergonomics of the job was worse. ISO glove usage in the first year was noted to be 31 or 42.47% with documented use of 10819 anti-vibration gloves. Thirty eight or 52.05% chose not to use the 10819 gloves or use other non-anti-vibration gloves, and 4 or 5.48% glove usage was undetermined.

Workers who had noted a decrease in vibration exposure associated workplace tool modification and with the use of anti-vibration gloves showed the overall best improvement and had the least amount of pathology related to HAVS. Those workers who neither had workplace modifications nor used anti-vibration gloves in general showed some overall progression of HAVS induced pathology compared to other groups of workers. Those workers who had workplace vibration exposure reduction or used anti-vibration gloves showed an intermediate of progression the level of HAVS pathology.

In respect to the carpal tunnel syndrome six or 22% of the workers had symptoms consistent with carpal tunnel syndrome, five of them were confirmed by nerve conduction studies, three had successful surgery, and one was determined to have diffuse neuropathy unrelated to work.

Results of the fourth year of the study included 159 new subjects were tested including 67 of the original 73 tilers and 92 subjects who would join the workforce. There were no changes in protocols and the tool vibration levels were now averaging 1.25 m/s squared and there as increase of use on the average of ISO 10819 gloves to 61.2%. There was a variety of ISO 10819 glove manufacturers that were used with the worker having the choice based on comfort.

A four-year follow up study showed that those who had no use of ISO 10819 gloves revealed that 26.92% got worse and 73.8% got better on symptomatology. On testing 34.62% got worse and 65.38% had no change. None of these workers without use of ISO anti-vibration gloves had either improvement in testing or questionnaire results. For workers that used ISO 10819 gloves, 95.12% had symptoms that improved or were unchanged and 4.8% had symptoms that were worse. 19.51% of these workers had their symptoms totally resolved.

Workers who had symptoms worse than the Stockholm Scale of equal or unequal to it did not seem to be responsive to intervention and were advised to be eliminated from use of vibratory tools. Workers who had ISO 10819 gloves in addition to tool change were more likely improved whereas workers without tools and gloves were shown to be more likely to have progression. For the 92 workers tested for the first time in 8 facilities 52.5% had neurological symptoms, 4.3% had some vascular symptoms, and 3.3% had carpal tunnel symptoms, and only 5.4% were wearing ISO 10819 gloves initially. It was generally a younger group and had variable prior exposure from other jobs to hand/arm vibrations. It was noted that the original 73 fitter workers were more likely to use the gloves and the new workers who were younger and were less likely to use the gloves. There was still an incidence of carpal tunnel syndrome in the new tested workers and by year four new tools and ISO gloves were then made mandatory.

## Discussion:

It appears that there was a significant benefit of using ISO 10819 gloves and vibration tool in an effective ergonomic intervention to reduce HAVS. Some reversal of HAVS can be obtained with ergonomic intervention if the symptom level of pathology is below 2SN for neurological classification or vascular of  $v=2$ . It is felt that the effectiveness of anti-vibration gloves, which are effective in reducing the transmission of high frequency, vibration tends to imply that high frequency greater than 500 hertz may be more significant in the progression of HAVS pathology than other frequencies., The study suggests that addressing the present ISO rating curves may need to be reviewed as ISO 10819 gloves that are more effective in higher frequencies have positive clinical effects in attenuating HAVS in this group of workers. The study further shows that the use of personal protective devices in the form of anti-vibration gloves that meet the requirement of ISO 10819 can be effective along with job and tool modification in stopping the progression of HAVS in a similar fashion to hearing protection can work to protect workers from hearing loss.

The study suggests that bringing vibration below 1.0 may approach threshold for HAVS as there seemed to be no progression when one got to about 1.2 m/s<sup>2</sup> squared of exposure in the new tools as the addition of gloves would bring that below that. This has been supported by an unpublished study in the meat industry with similar low levels of vibration over long periods of time that are not associated with HAVS. Furthermore, this study would support that the European Directive<sup>4</sup> levels for ergonomic intervention seem to be appropriate.

Overall this onsite testing technique seems to be an effective way of identifying upper extremity pathology from vibration exposure in a cost effective fashion. It allows for documentation of the effectiveness of ergonomic intervention and referral for treatment and confirmation of diagnosis. It appears to be an effective tool for the European Directive surveillance requirements and works in a similar fashion to onsite hearing conservation programs<sup>3</sup>.

While identifying individuals with problems, a final diagnosis still needs to be made by further clinical evaluation. It is recommended that the long-term prospective of this study group be continued as well as studies on other groups to reconfirm these conclusions. It is also recommended that due to the incidents of carpal tunnel and other entrapment syndromes that onsite nerve conduction also be considered. This study will be continued and reported and follow up publication of the results will be forthcoming.

### References

Jetzer, T., Reynolds D. A Work Place Method of Medical Surveillance for Hand Arm Vibration, 9<sup>th</sup> International Conference on Hand Arm Vibration, Nancy France, 2001.

Jetzer T., Haydon, P., Reynolds D. Effective Intervention with Ergonomics, Anti-Vibration Gloves and Medical Surveillance to Minimize Hand-Arm Vibration Hazards in the Workplace, JOEM, Volume 45, Number 12, December 2003. pp 1312-1317.

Commission of the European Communities. Amended proposal for a Council Directive on the minimum health and safety requirements regarding the exposure of workers to the risks arising from physical agents. COM 230 Off J Eur Comm 1994: 19 August: 3-29.



# THE REVISION OF THE GLOVE VIBRATION ISOLATION STANDARD: ISO 10819

P. Voss

AkustikNet A/S, Frederikssundsvej 179 B, DK-2700 Bronshøj, Denmark

Background of ISO 10819: At birth (1996) this standard is really not an ISO standard. The standard was developed by the European standardization organization CEN as a necessity for a European Directive on Personal Protective Equipment (PPE), which states that a claimed protective performance also must be documented using a suitable test method. The European standard therefore acts as an integrated part on European regulation. On the market were a number of gloves, which were claimed and sold to be anti vibration but in reality offered no protection against vibration hazards. The standard offered for the first time a measurement method as well as minimum performance levels for claiming anti vibration properties.

The European EN 10819 was hereafter adopted in the ISO system using parallel voting procedures.

Experiences using the existing ISO 10819: The standard had the immediate effect that the vast majority of gloves sold as anti vibration gloves disappeared from the European market. Though the minimum performance level laid down in the standard does not correspond to a high degree of protection of the hand-arm system none of the existing gloves met the standard. But the standard had the effect that manufactures experimented with improvements and a number of gloves appeared which may or may not meet the minimum performance limit. A number of laboratories worked in parallel with the measurement method and a number of issues of critics began to appear. As a consequence a Round Robin test of a selection of gloves were performed in a number of laboratories, both in- and outside Europe. The Round Robin test concluded that the reproducibility of the test method is insufficient. It also concluded that the method was well suited to identify non-performing gloves but that the 'acceptance criteria' divided the group of the best gloves in a way so that the gloves, which met the criteria only just, met them and that the gloves, which did not meet the criteria only just, did not meet them. The difference between such test results was less than the reproducibility between laboratories.

On this background CEN suggested that the glove standard should be revised.

*Standardization work for the revision:* This work item was allocated to CEN TC 231 WG 3, which for this specific work was supplemented with WG members from the US, from Canada and from Japan. Formally, and because of the historical reason for the existence of the standard, it is a CEN job with ISO participation in the workgroup. The group held its first meeting in November 2001. After a meeting in October this year the first draft will be ready to the TC 231.

*Content of the revised ISO 10819:* This paper will present some of the technical contents and considerations for the revision. These include the suggestion for a change in the excitation spectra, the use of HA-weighting, introduction of measurements in 1/3-octave bands, better description of posture and grip, and finally it discusses the use of test results and a possible way to establish the minimum performance criteria.



**Prevention 2**  
C. Nelsen - Session Coordinator





# PREDICTING THE EFFECTS OF PUSH FORCE ON THE TRANSMISSION OF VIBRATION THROUGH GLOVE MATERIALS TO THE PALM OF THE HAND

M. J. O'Boyle and M. J. Griffin

Human Factors Research Unit, Institute of Sound and Vibration Research, University of Southampton, Southampton, SO17 1BJ England

## Abstract

The effects of push force on the apparent mass of the hand, the transmissibility of glove materials to the hand, and the dynamic stiffness of glove materials and have been measured in the laboratory. The material transmissibility was then compared with predictions of the transmissibility derived from the measured apparent mass of the hand and the measured dynamic stiffness of the material. The study was performed with three materials taken from current gloves: material 1 was a layer of gel inside two layers of foam, material 2 was a gel, material 3 was densely packed foam. The apparent masses, transmissibilities and dynamic stiffnesses were determined as a function of vibration frequency over the range 5 to 500 Hz with preload forces of 10, 20 and 40 N. The apparent masses and transmissibilities were obtained with 12 male subjects. A simple impedance model of the material-hand dynamic system was then used to predict the transmissibility of each material for each force and each subject. The simple model was found to provide reasonable predictions of the effect of force on material transmissibility over the frequency range 5 to 500 Hz.

## Introduction

A method for predicting the transmissibility of a material used in a glove from its response when loaded by a 2.5 kg mass was proposed by O'Connor (1991). The material-mass system was excited by random vibration over the frequency range 10 to 1000 Hz and then analyzed as a single degree-of-freedom mass-spring-damper system. The transmissibility was used to obtain an equivalent spring constant,  $k$ , and damper coefficient,  $c$ , for the material. The spring and damper coefficients for the material were then combined with the mechanical impedance of the hand obtained with a 25 N grip force, to predict the transmissibility of the material when used as a glove. O'Connor suggested that while this method may have limitations (e.g. it assumes that the attenuating material exhibits a linear response), it would indicate whether a material provides useful attenuation when used in a glove.

International Standard 13753 (1999) uses a method similar to that defined by O'Connor to predict the vibration transmissibility of glove materials. The standard states: "*This (laboratory test) will enable rank ordering of materials for gloves, but will not necessarily predict the transmissibility of the gloves fabricated from these materials*". In ISO 13753 (1999), the transmissibility is measured at one-third octave center frequencies between 50 Hz and 500 Hz. If the predictions show transmissibilities greater than 0.6 at these frequencies, the material is not expected to provide greater attenuation in the practical situation (i.e. in a glove) in the same frequency range.

Koton *et al.* (1998) applied the procedure in ISO 13753 (1999) on about 80 materials, found that 10 materials met the ISO 13753 (1999) criterion and ranked them in order from 1 to 10, with material 1 providing the most attenuation and material 10 providing the least attenuation. Gloves were manufactured from the 10 materials and the gloves were tested in accord with ISO 10819 (1996). They found that the predictions of the ISO 13753 (1999) test were not strongly correlated with measures of glove transmissibility using ISO 10819 (1996). Some materials were ranked highly when tested in accord with ISO 13753 (1999) but ranked poorly when tested in accord with ISO 10819 (1996). None of the gloves could be classified as an 'anti-vibration glove' according to ISO 10819 (1996).

Fairley and Griffin (1986) showed how mechanical impedance methods could be used to predict the transmissibility of seats. The method combines the apparent mass of the seated human body with the measured dynamic stiffness of a seat cushion to predict the transmissibility of vibration through the seat cushion to the subject.

In this study, the methods used by Fairley and Griffin have been adapted to predict the vibration transmitted to the palm of the hand through materials used in anti-vibration gloves. The apparent mass of the hand and the dynamic stiffness of material are dependent on the applied force, so the study was undertaken with three different levels of force. It was hypothesized that increased force would increase both the apparent mass of the hand and the dynamic stiffness of the glove material and cause corresponding changes in both the measured and predicted material transmissibility.

## Theory

The assumed dynamic model of the hand and glove material interface is shown in Figure 1. The equation used to model the glove transmissibility is shown in equation 6 and uses the apparent mass of the hand and the dynamic stiffness of the glove material to obtain a prediction of the glove material transmissibility.

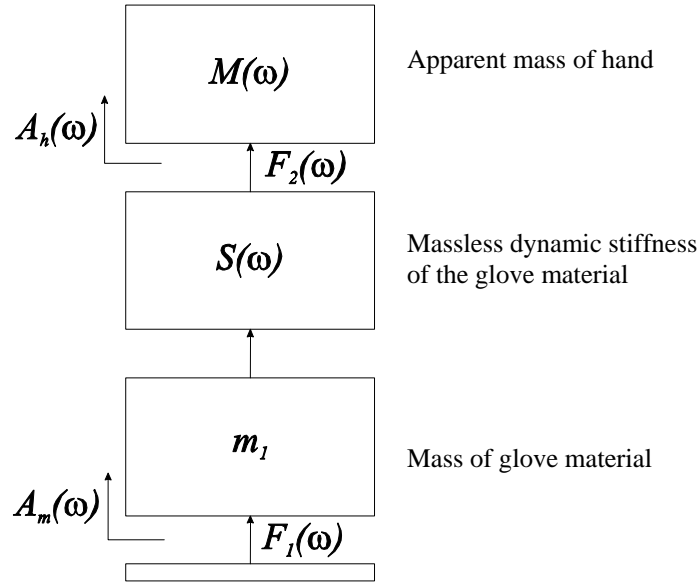
The variables shown in Figure 1 are as follows:

$F_1(a)$  : force at the interface between the glove material and the vibration source

$F_2(a)$  : force at the interface between the glove material and the hand

$A_m(a)$  : acceleration at the interface between the glove material and the vibration source

$A_h(a)$  : acceleration at the interface between the glove material and the hand



**Figure 1** The material-hand dynamic system

Apparent mass is defined as  $F(a)$  divided by  $A(a)$  and the dynamic stiffness is the apparent mass multiplied by  $-\omega^2$ , where  $\omega$  is the angular frequency ( $\text{rad}\cdot\text{s}^{-1}$ ).

The complex frequency response of the system shown in Figure 1 is defined as:

$$\text{Glove material transmissibility} = T(\omega) = \frac{A_h(\omega)}{A_m(\omega)} \quad (1)$$

and the apparent mass of the hand with the glove material present is defined by:

$$\text{Apparent mass of hand} = M(\omega) = \frac{F_1(\omega) - m_1 A_m(\omega)}{A_h(\omega)} \quad (2)$$

Multiplying equation (2) by  $-\omega^2$  enables the equation to be written in terms of the material dynamic stiffness:

$$\text{Dynamic stiffness of material} = S(\omega) = \frac{F_1(a) - m_1 A_m(a)}{\omega^{-2}(A_h(\omega) - A_m(\omega))} \quad (3)$$

Since equation (2) and equation (3) have the force transmitted by the glove material,  $F_2$ , as their numerators, we may write equation (2) as:

$$\text{Apparent mass of hand} = M(\omega) = \frac{F_2(a)}{A_h(\omega)} \quad (4)$$

and equation (3) as:

$$\text{Dynamic stiffness of material} = S(\omega) = \frac{F_2(a)}{\omega^{-2}(A_h(\omega) - A_m(\omega))} \quad (5)$$

The prediction of the glove material transmissibility may be obtained by rearranging equations (4) and (5) to make  $A_h(a)$  and  $A_m(a)$  the subject respectively and substituting into the transmissibility equation (1). This gives the result:

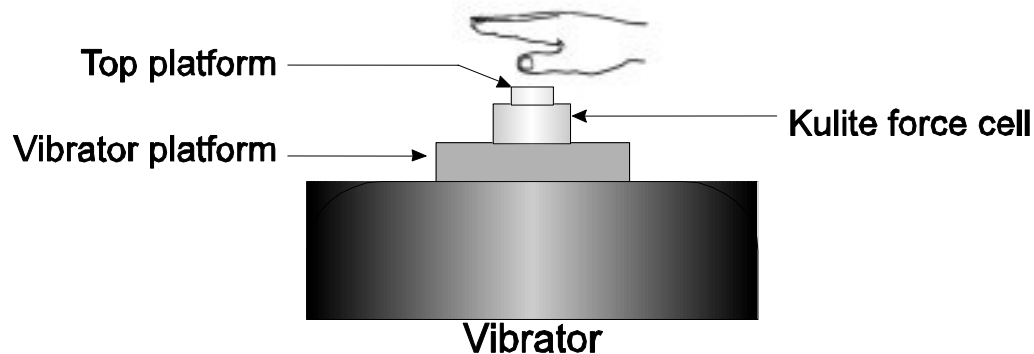
$$\text{Glove material transmissibility} = T(\omega) = \frac{\omega^{-2}S(\omega)}{\omega^{-2}S(\omega) - M(\omega)} \quad (6)$$

Measurement of the dynamic stiffness of the glove material,  $S(\omega)$ , and measurement of the apparent mass of the hand,  $A(\omega)$ , should therefore allow the prediction of the glove material transmissibility,  $T(\omega)$ .

## Method

### *Measurement of apparent mass at the hand*

Hand apparent mass was measured using the apparatus in Figure 2.



**Figure 2** Schematic diagram of apparatus for measurement of the apparent mass of the hand

A circular platform 25 mm in diameter was secured to a force cell (Kulite TC 2000 500) used to control the downward 'push' force and measure the dynamic force. A custom-made 'palm adapter' with a diameter of 25 mm, thickness 9 mm and mass 5 g was used to measure the acceleration applied to the palm.

An electrodynamic vibrator (Derritron VP30) powered by a 600 W G&W amplifier provided broad-band random vertical vibration with a spectrum, 'R', having a flat constant-bandwidth acceleration spectrum over the frequency range 5 to 1400 Hz. Spectrum R was presented at a frequency-weighted acceleration of  $3.0 \text{ ms}^{-2}$  r.m.s. (according to ISO 5349, 2001) for 10 seconds. The vibration was monitored using B&K 4374 accelerometers in the center of the platform above the force transducer and in the center of the palm adapter. The signals from the accelerometers and force cell were acquired at 5298 samples per second via 1740 Hz anti-aliasing filters using a computer-based data acquisition and analysis system (HVLab version 3.81).

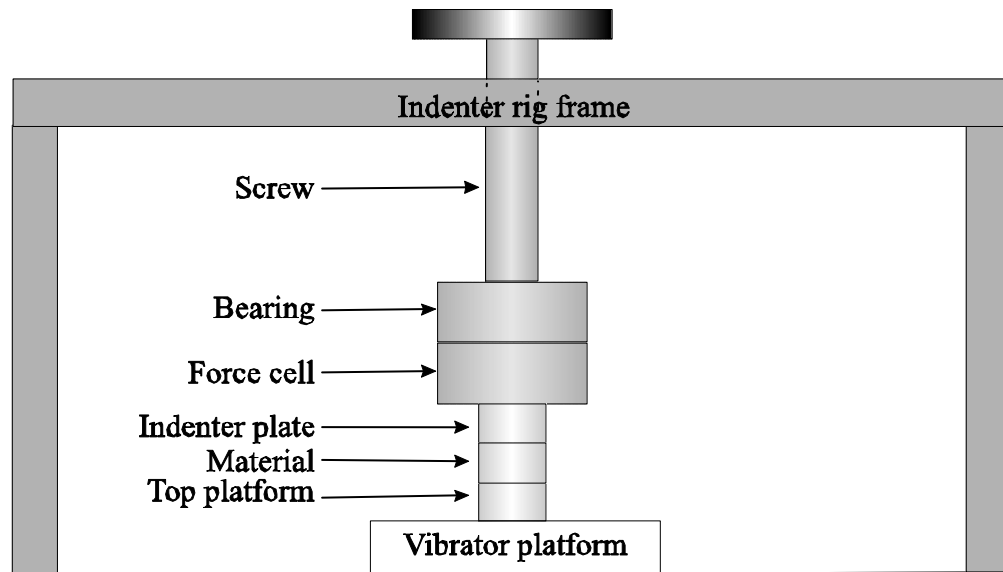
With feed forces of 10, 20 and 40 N, acceleration was measured on the platform and at the palm adapter. The subjects adopted a flat palm-down hand posture with the palm adapter in the center of the palm and in-line with the platform secured to the force cell. The temperature was  $25 \pm 5 \text{ }^\circ\text{C}$  with humidity less than 70%.

The dynamic force measured at the plate secured to the force cell and the acceleration measured in the palm adapter were used to obtain the apparent mass of the hand after suitable mass cancellation. Mass cancellation was achieved by obtaining the (apparent) mass of the force cell, top plate and palm adapter securely attached to each other, from a 'free run'. The mass was then multiplied by the acceleration time history for each test carried out with a subject and the resulting calculated force subtracted from the dynamic force measured for that test.

Twelve male subjects aged between 20 and 45 years participated in the experiment, which was approved by the Human Experimentation, Safety and Ethics Committee of the Institute of Sound and Vibration Research.

#### *Measurement of material dynamic stiffness*

The dynamic stiffness of the three materials was obtained using the 'indenter rig' in Figure 3.



**Figure 3** Schematic diagram of indenter rig for measurement of material dynamic stiffness of glove materials.

Material 1 consisted of a gel material sandwiched between two foam layers; the uncompressed thickness was 11 mm. Material 2 was a gel material 5 mm thick. Material 3 was a compacted foam similar in appearance to expanded polystyrene and was 7 mm thick. The three materials were cut from the palms of gloves so as to be the same diameter as the platform and the palm adapter (i.e. 25 mm).

An electrodynamic vibrator (Derritron VP4) powered by a 300 W G&W amplifier provided broad-band random vibration with a spectrum, 'R', having a flat constant-bandwidth acceleration spectrum over the frequency range 5 to 1400 Hz. Spectrum R was presented at a frequency-weighted acceleration of  $3.0 \text{ ms}^{-2}$  r.m.s. for 10 seconds. The vibration was monitored using a B&K 4374 accelerometer at the centre of the 25 mm diameter platform secured to the vibrator. The force transducer (Kulite TC 2000 500) was attached to the bearing on the indenter and a small indenter plate of the same diameter as the three material samples (25 mm) was attached to the force cell. The signals from the accelerometer and force cell were acquired at 5298 samples per second via 1740 Hz anti-aliasing filters using a computer-based data acquisition and analysis system (*HVLab* version 3.81).

The force was applied to the materials by screwing down the indenter plate until the desired pre-load was obtained. Two lock nuts (not shown in Figure 3), one above the indenter rig frame, the other between the frame and the bearing ensured the assembly was securely held in place at the desired pre-load. Each material was pre-loaded with a force of 10, 20 and 40 N for 1 minute to allow the materials to settle before the signal was applied to the vibrator and the force and acceleration signals were acquired.

The measurements of material dynamic stiffness and apparent mass at the palm were processed to produce predictions of the material transmissibilities when loaded by the hand (see below). The comparisons were made at frequencies between 5 and 500 Hz.

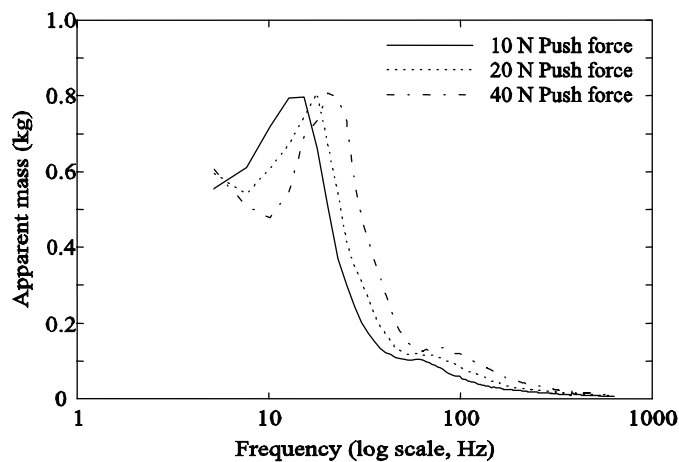
### Measurement of material transmissibility

A similar experimental arrangement to that outlined above was used to obtain the transmissibilities of the three glove materials when loaded by the palm of the hand. For each glove material, with feed forces of 10, 20 and 40 N, acceleration was measured on the platform and at the palm adapter with the material present. The transmissibility was obtained by dividing the cross spectral density of the acceleration at the palm and the acceleration on the platform by the power spectral density of the acceleration on the platform. The subjects were the same as those who participated in the measurements of apparent mass at the palm.

## Results and Discussion

### Apparent mass of the hand

Figure 4 illustrates the median apparent masses of the 12 subjects measured at the palm of the hand with the 25 mm diameter plate and push forces of 10, 20 and 40 Newtons over the frequency range 5 to 500 Hz. There were similar responses in the individual subjects. With increased force, the resonance frequency increased and the magnitude of the apparent mass at the principal resonance increased slightly. The changes might be due to increased stiffness in the hand with the greater push forces.



**Figure 4** Effect of push force on the median apparent mass at the palm of the hand for 12 subjects obtained with a circular contactor of diameter 25 mm.

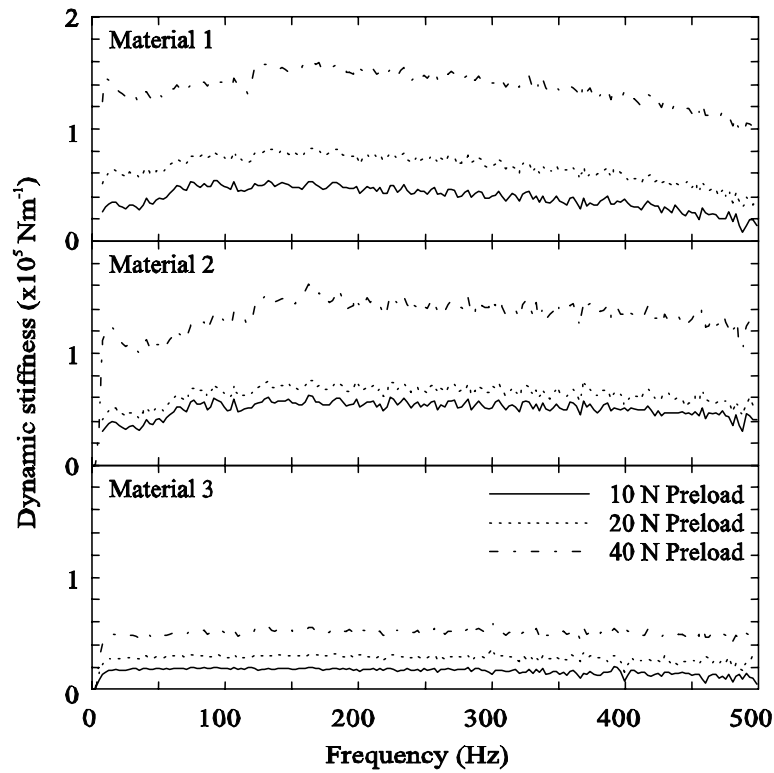
### Dynamic stiffness of the material

All three materials showed a consistent increase in dynamic stiffness as the force increased over the range 10 to 40 Newtons (Figure 5).

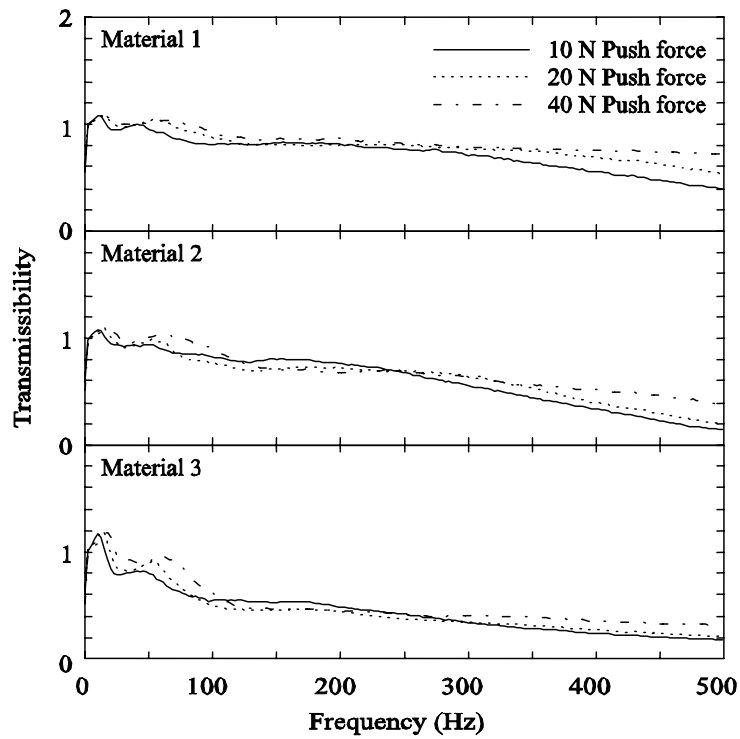
### Measured material transmissibility

The median transmissibilities of the materials to the palm of the hand obtained with the twelve subjects with push forces of 10, 20 and 40 Newtons are shown in Figure 6.

For material 1, there was an overall increase in transmissibility at most frequencies between 50 and 500 Hz as the push force was increased, although the effect of force was inconsistent at frequencies around 200 Hz (Figure 6). For material 2, there was a similar trend to that of material 1, with inconsistent effects of force between 100 and 250 Hz. Again, for material 3, although the transmissibility increased with increasing force at low and high frequencies, the effects of force were variable at intermediate frequencies.



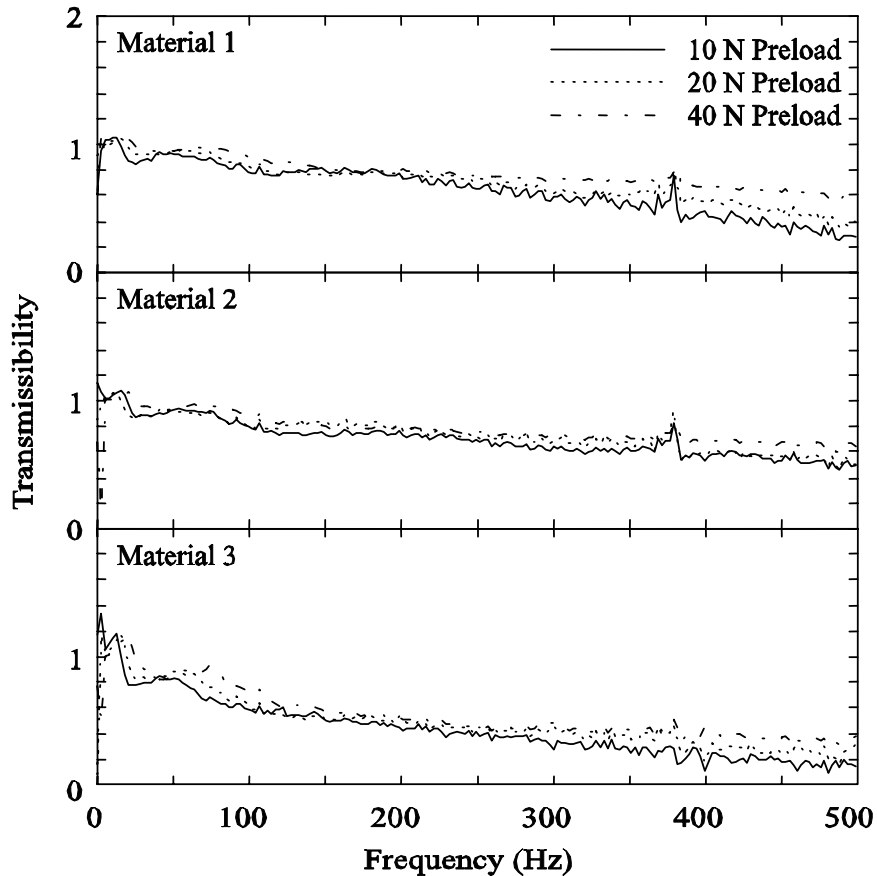
**Figure 5** Effect of push force on the dynamic stiffness of the three materials obtained with a circular contactor of diameter 25 mm



**Figure 6** Effect of push force on median measured transmissibilities to the palm of the hand for three types of material with 12 subjects with 10, 20 and 40 N force.

### Predicted material transmissibility

Figure 7 shows the median material transmissibilities predicted for the twelve subjects with 10, 20 and 40 N forces and may be compared directly with the measurements in Figure 6. Like the measured transmissibilities, the predicted transmissibilities tend to increase with increased push force at lower and higher frequencies but show less effect of force at intermediate frequencies.



**Figure 7** Effect of push force on predicted median transmissibilities to the palm for three types of material with 10, 20 and 40 N force (predictions from the measured apparent masses of 12 subjects)

### Comparison of predicted and measured transmissibilities

A statistical analysis (Wilcoxon matched-pairs signed ranks test) compared the measured transmissibilities with predicted transmissibilities at one-third-octave intervals from 16 Hz to 500 Hz, for each of the three forces: 10, 20 and 40 N (Figures 8 - 10). The criterion for statistical significance was selected at  $p < 0.01$ .

#### Glove material 1

For Material 1, the predicted transmissibility with 10 N force was similar to the measured transmissibility over the frequency range 50 to 500 Hz ( $p > 0.01$ ), although at frequencies less than 40 Hz there was a difference ( $p < 0.01$ ). With the 20 N force, the predicted transmissibilities did not agree with the measured results ( $p < 0.01$ ), except at 80, 250 and 500 Hz ( $p > 0.01$ ). With the 40 N force there was no significant difference between measured and predicted transmissibility at 20 Hz, 63 to 200 Hz and 315 to 500 Hz ( $p > 0.01$ ).

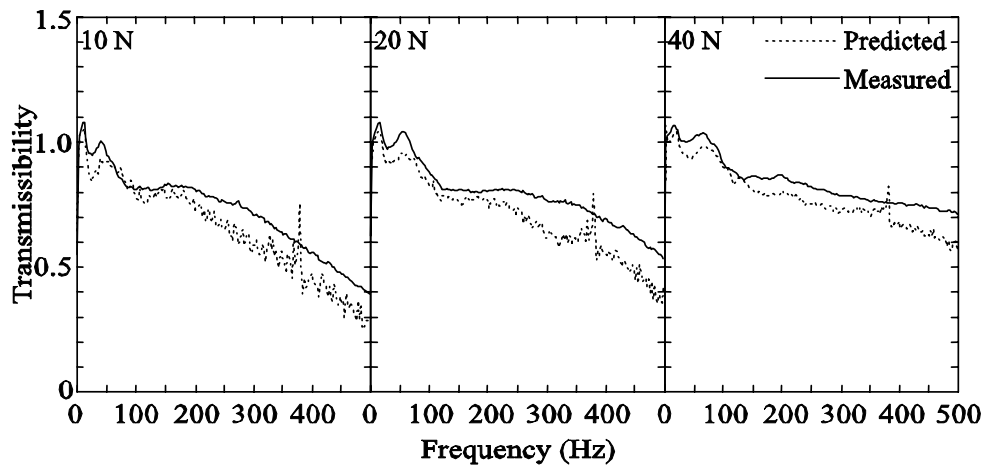


Figure 8 Comparison of measured and predicted transmissibilities for Material 1 at push forces of 10, 20 and 40 N

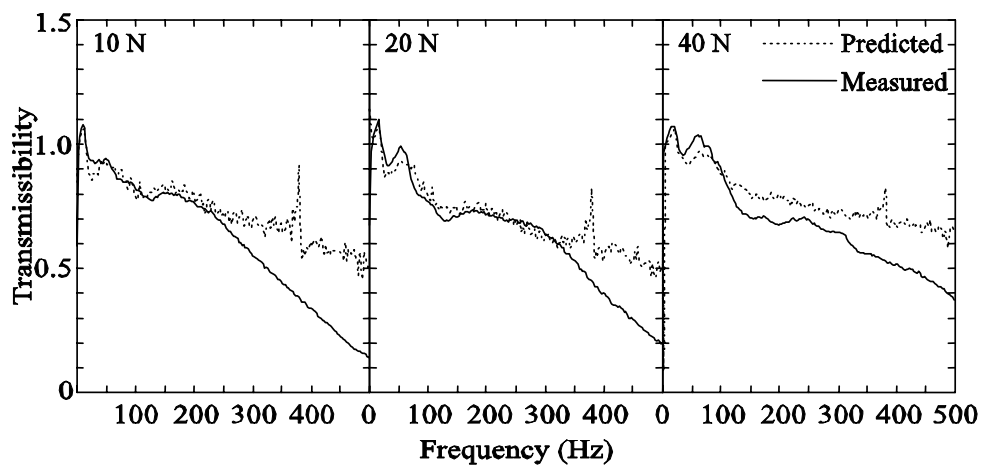


Figure 9 Comparison of median measured and median predicted transmissibilities for Material 2 at push forces of 10, 20 and 40 N

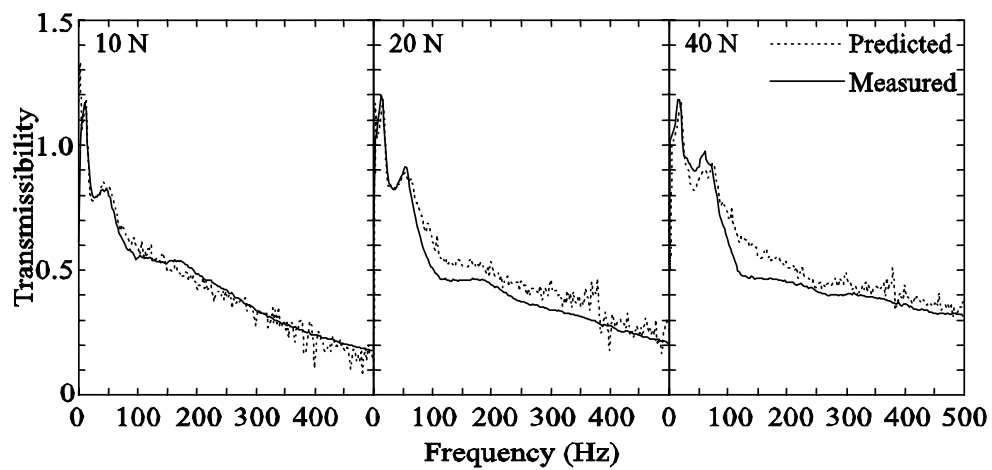


Figure 10 Comparison of measured and predicted transmissibilities for Material 3 at push forces of 10, 20 and 40 N



### *Glove material 2*

For material 2, the predicted transmissibility with the 10 N force agreed with the measured transmissibility in the range 16 to 250 Hz ( $p>0.01$ ) except at 25 Hz, but there was a significant difference for the preferred one-third octave center frequencies in the range 315 to 500 Hz ( $p<0.01$ ). With the 20 N push force, the predicted transmissibilities differed from the measured transmissibilities at 25, 400 and 500 Hz ( $p<0.01$ ) but agreed with measured transmissibilities at all other preferred one-third center frequencies. With the 40 N force, there was agreement between measured and predicted transmissibilities from 16 to 125 Hz ( $p>0.01$ ).

### *Glove material 3*

For material 3, the predicted transmissibility with the 10 N force was similar to the measured transmissibility at all preferred one-third octave frequencies ( $p>0.01$ ), except at frequencies of 80, 200, 400 and 500 Hz ( $p<0.01$ ). With the 20 N force, the predicted transmissibilities differed significantly from the measured transmissibilities ( $p<0.01$ ), except for the range 16 to 63 Hz ( $p>0.01$ ). With the 40 N push force, the measured and predicted transmissibilities were similar for one-third octave frequencies from 20 to 125 Hz and at 315 Hz ( $p>0.01$ ).

## **Discussion**

With increasing force, the measured and predicted transmissibilities showed similar trends with each of the three materials. The predicted transmissibilities show an increase as the force increased and this trend is observed in the measured transmissibilities.

Comparison of predicted and measured transmissibilities at preferred one-third octave center frequencies yielded a somewhat variable picture. Encouraging agreement was found for material 1 with 10 N force in the frequency range 50 to 500 Hz, and there was also good agreement with 40 N force. For material 2, overall agreement was good for frequencies up to around 250 Hz with the 10 and 20 N push forces but up to only 125 Hz with the 40 N push force. For material 3, agreement between measured and predicted transmissibilities was good up to about 400 Hz with the 10 N push force, up to 63 Hz with the 20 N push force and up to 125 Hz with the 40 N force.

The differences between measured and predicted transmissibility may be due to many factors that can affect the complex interaction between materials and the hand. The area of contact was artificially constrained to be similar when measuring apparent mass of the hand, the dynamic stiffness of the material and the transmissibility of the material (i.e. a 25 mm diameter). However, while the surface of the contactor used to measure the dynamic stiffness of the material was flat, the palm of the hand is not flat. In consequence the material will have been compressed differently in the palm than when its dynamic stiffness was measured. Similarly, the flat contact of the palm with the circular contactor may have provided an apparent mass that differed from the apparent mass 'seen' when the hand was in contact with the material. Greater differences are likely when trying to predict the transmissibility of a glove where the contact with the hand and fingers is much more complex.

The non-linearity of the dynamic properties of the hand and the material may also have affected the accuracy of the predictions. Although the same vibration magnitude was used to measure apparent mass, dynamic stiffness and transmissibility, the vibration entering the hand would have been different when the material was used, so altering the apparent mass of the hand.

Some of the differences observed at high frequencies may have arisen from the assumption that the mass of the material may be neglected.

Further study is required to investigate possible effects of force, uneven pressure distribution, non-linearities on the apparent mass of the hand-arm system and the measured and predicted transmissibilities of the materials used in gloves.

## **Conclusion**

A simple impedance model has been used to predict the vibration transmissibility of three anti-vibration materials. The predicted transmissibilities were compared to measured transmissibilities for three materials with three push forces (10, 20, and 40 N). Encouraging agreement was obtained between the measured and the predicted transmissibilities for all three materials over much of the frequency range up to 500 Hz. With changes in push force, similar changes were found in both the measured and predicted transmissibilities.

Further work is required to explore reasons for differences between the measured and predicted transmissibilities.

### **Acknowledgements**

This research was partially supported by the European Commission under the Framework 5 Competitive and Sustainable Growth 2001 (GROW-2001) programme: VIB-TOOL "Grip-Force Mapping for Characterisation of Hand-Held Vibrating Tools"(Contract no. G6RD-CT-2002-00843).

### **References**

- European Committee for Standardization. 1999. Mechanical vibration and shock - Hand-arm vibration – Method for the measuring the vibration transmissibility of resilient materials when loaded by the hand-arm system. European Standard, EN ISO 13753: 1999.
- Fairley, T.E. and Griffin, M.J. 1886. A test method for the prediction of seat transmissibility. Society of Automotive Engineers International Congress and Exposition, Detroit, 24th –28th February 1986.
- International Organization for Standardization. 1996. Mechanical vibration and shock – Hand-arm vibration – Method for the measurement and evaluation of the vibration transmissibility of gloves at the palm of the hand. ISO 10819 (1996).
- International Organization for Standardization. 1998. Mechanical vibration and shock – Free, mechanical impedance of the human hand-arm system at the driving point. ISO 10068 (1998).
- O’Boyle M. J. 2003. The effect of push force on vibration transmissibility to the hand of anti-vibration materials. In proceedings of 38<sup>th</sup> UK Conference on the Human Response to Vibration, held at the Institute of Naval Medicine, Gosport on the 17th - 19th September 2003.
- O’Conner D. E. 1991. A Method For Measuring the Vibration Transmissibility of Resilient Materials. In proceedings of Anglo-French UK informal Group meeting on the Human Response to Vibration, held at the Health and Safety Executive, Buxton on the 25th - 27th September 1991.
- Koton J., Kowalski P., Szopa J. 1998. An attempt to construct anti-vibration gloves on the basis of information on the vibration transmissibility of materials. 8th International Conference on Hand-Arm Vibration, 9-12 June 1998, Umeå, Sweden.

# ANTIVIBRATION GLOVES EFFECTIVENESS: IN FIELD AND LABORATORY TESTS AND PROPOSAL FOR A NEW STANDARD

P. Nataletti<sup>1</sup>, P. Lenzuni<sup>2</sup>, A. Lunghi<sup>3</sup>, A. Pieron<sup>3</sup>, E. Marchetti<sup>3</sup>

<sup>1</sup> Department of Occupational Hygiene – Italian National Institute for Occupational Prevention and Safety (ISPESL), Via di Fontana Candida 1, 00040 Monte Porzio Catone (Roma)

<sup>2</sup> Department of Florence – Italian National Institute for Occupational Prevention and Safety (ISPESL)

<sup>3</sup> Department of Occupational Hygiene – Italian National Institute for Occupational Prevention and Safety (ISPESL)

## Introduction

In the last few years, anti-vibration gloves have been used in Italy as personal protective equipment (PPE) with the aim of minimizing the health risks from hand-transmitted vibration. These gloves are certified and marketed by manufacturers according to the European Standard EN ISO 10819: 1996, which specifies the vibration reduction criteria for an anti-vibration glove: TRM < 1.0 and TRH < 0.6, where TRM and TRH are, respectively, the overall average transmissibility at medium (31.5,200 Hz) and high (200,1 kHz) frequencies. The standard only recommends to determine the transmissibility as a function of frequency.

Information provided for an anti-vibration glove do not help in determining the actual degree of protection at the palm of the hand when a specific tool is operated. This paper reports the findings of extensive measurements, both in laboratory and on field, carried out on 16 anti-vibration gloves commercially available in Italy (Table 1). The aims of the study were to assess the effective vibration isolation of the gloves when used with different tools; to develop a specific anti-vibration glove for rock drills and rotary hammers and to propose a standard for gloves selection.

## Materials and Methods

Field measurements were carried out on 12 different chain saws (following UNI ISO 7505: 1998), 4 different portable brush saws (following UNI ISO 7916: 1994), 10 different rock drills and rotary hammers and 7 different palmar sanders (following UNI EN ISO 8662-8: 1999), operated during normal operations. Tri-axial acceleration measurements were performed simultaneously at the palm of the hand inside and outside the glove by means of six piezoelectric miniature accelerometers fixed into two palm adaptor, according to the Standards ISO 5349: 2001 and EN ISO 10819: 1998. The 'field glove transmissibility' has been calculated as follows:

$$\bar{T}_F = \frac{\bar{a}_1}{\bar{a}_2} \quad (1)$$

where  $\bar{a}_1$  and  $\bar{a}_2$  are, respectively, the weighted acceleration at the palm inside and outside the glove, averaged over the operators and the series of operations.

Laboratory measurements were performed on the same anti-vibration gloves by means of an electro-dynamic shaker with one degree of freedom in order to verify both the certification parameters of the glove, TRM and TRH, and the field transmissibility TL using the FDR (Field Data Replicator) facility of the shaker, which allows to replicate third-octave band spectra measured in field with the tools object of this study.

## Results and Discussion

Some results are listed in tables 2, 3, 4 and 5. In table 6 are reported results of the tests done in laboratory with the shaker on glove 2013 and 2016.

From these samples of results it is possible to see the general outcome of the glove study: not all gloves can attenuate vibration to an hygienistic degree of interests. Moreover not all gloves are in condition of attenuation on every tool: in some cases they amplify vibrations. Gloves that are very effective on brush saws are not so effective on chainsaw and amplify on rock drills.

Transmissibility varies depending on the tool used. The reason is that the source has a dominating frequency range. If that range falls in the attenuation frequency range of the glove the transmissibility is less than one, otherwise the glove amplifies.

There has been a development of some gloves dedicated to rock drills. The test of such gloves was extensively conducted on the laboratory shaker in order to assess the real effectiveness. Results of this tests are listed in table 6. From these results it comes out the possibility that the glove n° 2016 is really effective for rock drills.

## Standardization Proposal for Gloves Selection

The choice of the correct glove is a task that deserves some kind of standardization in order to be effective. The idea that this paper brings on is to select gloves with a method that recalls that one introduced for ear protection based on European Standard EN ISO 4869-2 and EN 458.

In order to implement both method there is also the need to modify the EN ISO 10819.

**Table 1** Gloves Tested

n	Glove
1	Husqvarna
2	Ansell Criss-Cross
3	Giommy 2142
4	Glovemasters
5	Kusch
6	unknown
7	Ansell – Edmont
8	Atlas Copco
9	Impacto U2
10	North – Zorber
11	Ergodine Proplex
12	Ergo Air
13	2G 2002
14	2G 2022
15	2G 2013
16	2G 2016

**Table 2** Transmissibility on Brush Saws

Glove	Brush Saws				
	Alpina Vip52	Husqvarna 240RBD	Jonsered GR50	Kaaz VRX540	Stihl FS550
	T <sub>F</sub>	T <sub>F</sub>	T <sub>F</sub>	T <sub>F</sub>	T <sub>F</sub>
7	0,1	0,5	0,6	0,2	0,7
8	0,2	0,5	0,6	0,2	0,7
9	0,2	0,6	0,7	0,4	0,6
10	0,1	0,8	0,6	0,2	0,7

**Table 3** Transmissibility on Chain Saws

Glove	Chain saw			
	H. 262XP	H. 362XP	H. 365	J. 2055T
	T <sub>F</sub>	T <sub>F</sub>	T <sub>F</sub>	T <sub>F</sub>
7	0,5	0,4	0,5	0,5
8	0,5	0,5	0,5	0,5
9	0,6	0,4	0,6	0,3
10	0,5	0,7	0,7	0,5

**Table 4** Transmissibilities on Rock Drills

Glove	Rock drill			
	A.C.BBD12	A.C.RH571	A.C.TEX32	B.B190
	T <sub>F</sub>	T <sub>F</sub>	T <sub>F</sub>	T <sub>F</sub>
7	1,3	1,6	1,5	1,7
8	1,2	1,2	1,9	1,6
9	1,1	1,1	1,3	1,3
10	1,1	1,1	1,3	1,3

**Table 5** Average Transmissibility (average on 7 tools) on Orbital Sanders

Glove	T <sub>F</sub>
11	0,8
12	1,0
9	0,9
7	0,6
10	0,7
13	0,7
14	0,8

# CAN THE MEASURED TTS BE USED AS AN INDICATOR OF THE EFFECTIVENESS OF ANTI-VIBRATION GLOVES?

S. Maeda

Department of Human Engineering, National Institute of Industrial Health, Japan

## Abstract

In this paper, it evaluated whether the effect of vibration transfer for a worker that the vibration-reduction effectiveness of the anti-vibration gloves measured by the method according to the JIS T 8114 standard (1987) is what value would be reduce using the amount of temporary threshold shift of the fingertip vibrotactile perception threshold used as an index of the diagnostic item of Hand-Arm Vibration Syndrome.

## Introduction

The vibration syndrome prevention methods were shown by the No. 608 of the Ministry of Labour notification. As the vibration reduction methods of vibration transmitted to hand-arm system from the hand-held vibration tools, 1) improvement method of vibration tools, 2) shortening of vibration tool's usage time, and 3) use of an anti-vibration gloves as personal protection equipment, have been recommended as an implementation of work managements. Many researchers have reported the improvement methods of the vibration tools. The shortening of the tool's usage time is also studying as an optimum work rest scheduling. And the Anti-Vibration Gloves, recently, have been available in the market in Japan, but almost all of them are not noticed on attenuation characteristics to vibration. For the purpose of the screening test, the measuring method for effectiveness on the anti-vibration gloves was studied. These considerations were included to the JIS T 8114 standard in 1987.

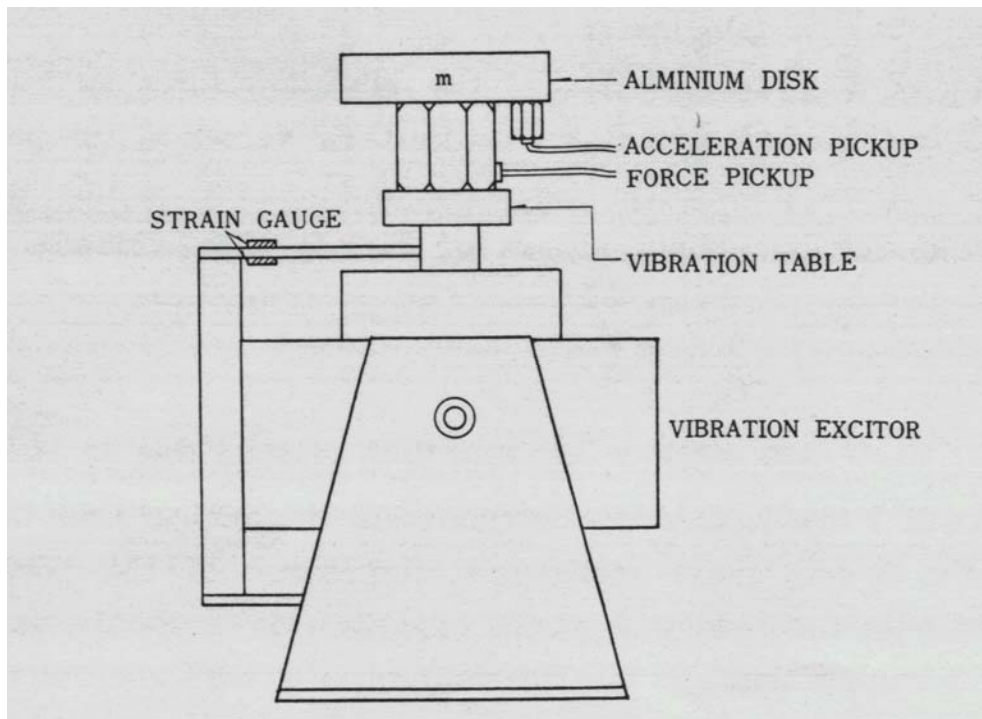
In the workplaces, such as mining, forestry, the engineering-works construction industry, and a manufacturing industry, JIS T8114 is specified as a standard which evaluates the vibration-reduction effectiveness of the anti-vibration gloves for reducing vibration transmitted from a tool, a machine, etc. to a worker's hand. Now, the measurement system, which can evaluate the vibration-reduction effectiveness of the anti-vibration gloves by the form based on this JIS standard. The vibration attenuation value is recommended by the JIS standard, such a recommendation attenuation value. Moreover, the recommendation value of this standard is not given from the physiological influence of people.

Then, while proposing the method of measuring the vibration-reduction effectiveness of the anti-vibration gloves in the method according to the JIS T 8114 standard in this report. It evaluated whether the effect of vibration transfer for a worker that the vibration-reduction effectiveness of the anti-vibration gloves measured by the method is what value would be reduce using the amount of temporary threshold shift of the fingertip vibrotactile perception threshold used as an index of the diagnostic item of Hand-Arm Vibration Syndrome.

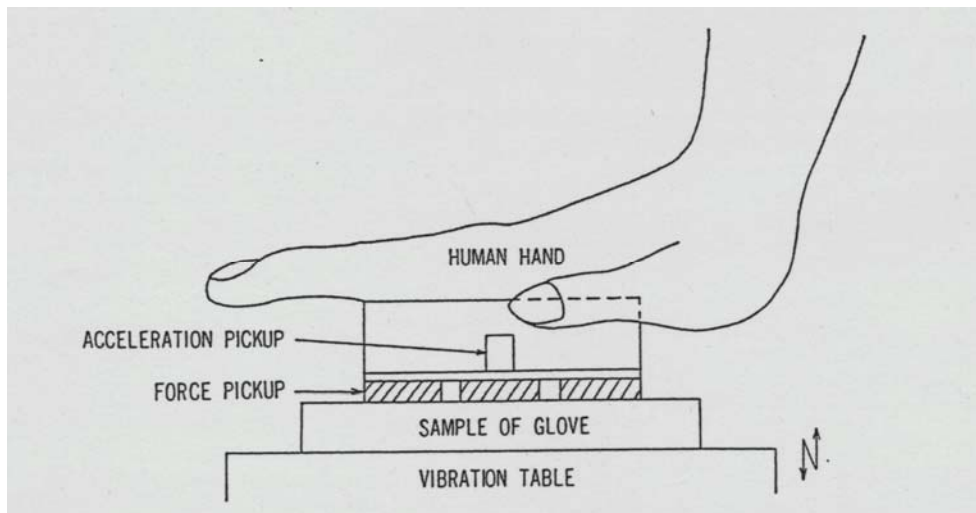
## Japanese Industrial Standard T 8114

It has been known that workers who use the pneumatic tools for long time are subject to circulatory disturbances of the hands. Not a few medical papers have dealt with this problem. Although elastic materials inserted between the worker's hands and the vibration tools have been used for absorption of the vibration, the efficacy of the devices has not been analysed theoretically. For this purpose, the attenuation effect was determined from the ratio of the driving point impedance of the human hand to that of the porous sample, which was pressed by the hand at the opposite side of the driving point. This ratio corresponds with that of the vibration displacements at the both ends of the elastic cylindrical samples. Miwa (1964a, 1964b) was used to measure mechanical impedance under compressive vibration the apparatus was designed as shown in Figure 1. The aluminum disk, which had a diameter of 5.0 cm and a thickness of 1.0 cm, was fixed to the upper side of the force pickup and the vibration table of the exciter was fixed to another side and the acceleration pickup was fixed on this disk. The protecting effect of the porous elastic materials inserted between the hand and the vibration source was examined by using the driving point mechanical impedance.

Figure 2 shows the vibration force measuring apparatus consisting of three force pickups pressed by the human hand to measure the force through the glove on the vibration table.

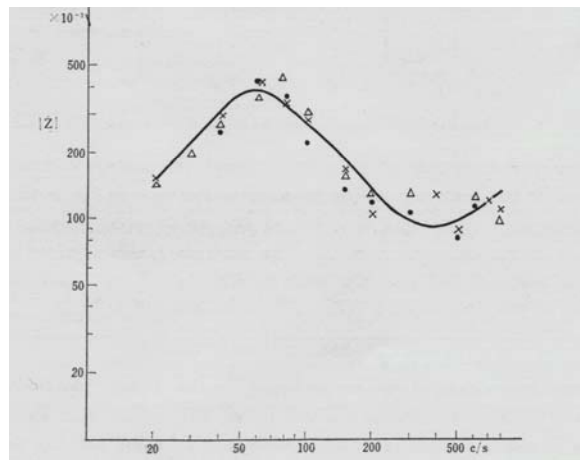


**Figure 1** Apparatus for measuring driving point impedance under compressive vibration

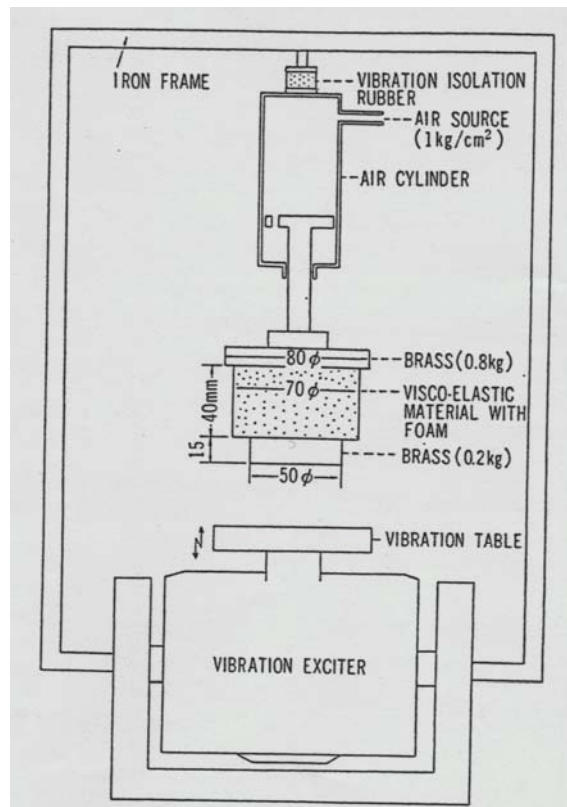


**Figure 2** Vibration force measuring apparatus consisting of three force pickups pressed by the human hand to measure the force through the glove on the vibration table

The attenuation characteristics that the sample was pressed by the human hand showed to be reasonable, but the dispersion of attenuation by different subjects was not so small. The statistical calculation on several subjects was necessary to estimate the average attenuation. As this process was inconvenient for the screening test, the mechanical model hand induced from the mechanical impedance as shown in Figure 3 was made as indicated in Figure 4. A synthetic form rubber for simulating the human hand (spring constant of  $1.3 \times 10^5$  N/M) was selected from many materials (thickness of 40 mm, static spring constant of  $13 \times 10^3$  N/M), because this material had suitable mechanical resistance.



**Figure 3** Driving point mechanical impedance of hands obtained with three subjects



**Figure 4** Model hand and air cylinder set on an iron frame, which was fixed on the vibration exciter stand

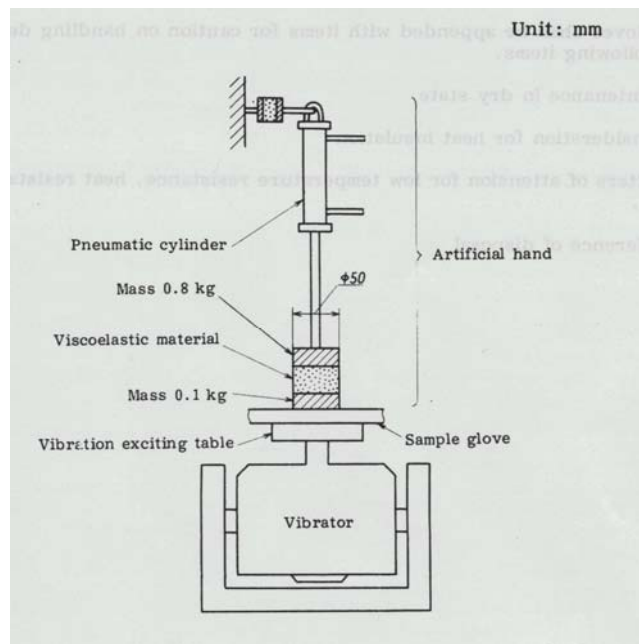
The model hand was pressed by a mini-air-cylinder (Koganei Co.) by about 7.5 kg (air pressure of  $1\text{kg/cm}^2$ ), which was considered as the usual working pressure for the gloves.

As mentioned above, the model hand was introduced to the JIS T 8114 standard. The Japanese Industrial Standard specifies the vibration isolation gloves to attenuate the vibration transmitted to hands of workman from tool, machine, etc. At the workshop of mining, forestry, civil engineering and construction industry, manufacturing industry, etc., hereafter, referred to as “glove”.

### Specification of the equipment to measure the vibration reduction of anti-vibration gloves

The test shall be the vibration isolation performance test using artificial hand. The construction of test device is shown in Figure 5. The test of the JIS T 8114 shall be the vibration isolation performance test using artificial hand and shall be as follows:

1. Sample: Use as sample the centre of palm portion of complete product.
2. Test Device: The construction of test devices is shown in Figure 5 and shall be as follows:
  - (a) Vibration Exciting Device: Use as the vibration-exciting device the electro-dynamic vibration-exciting device and the vibration-exciting table on which the sample is placed is to be circular shape with diameter 50 mm or over.
  - (b) Artificial Hand: Use artificial hand meeting the driving point mechanical impedance of man's hand when the vibration exciting table of vibration exciting device has been pressurized by force 25 N {2.5 kgf}.

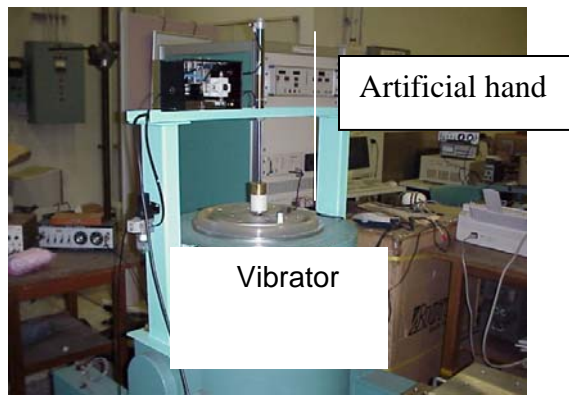


**Figure 5** Test device according to the JIS T 8114 standard

Japanese Standard Association has published the JIS T 8114 standard of the equipment for measuring the vibration reduction of the anti-vibration gloves in 1987. Science 1987, there is no equipment to measure the effectiveness of the anti-vibration gloves according to the JIS T 8114 standard in Japan. On 2001 year, the equipment was constructed in the National Institute of Industrial Health. Figure 6 shows the equipment for measuring the vibration reduction of the anti-vibration gloves according to the JIS T 8114 standard.

The Vibration Exciting Device of Test Device as shown in Figure 6 is consisting the electromagnetic vibration exciting device and the vibration exciting table on which the sample is placed is to be circular shape with diameter 50 mm or over. Artificial Hand is measuring the driving point mechanical impedance of man's hand when the vibration exciting table of vibration exciting device has been pressurized by force 25 N {2.5 kgf}.





**Figure 6** Measurement equipment of vibration reduction effectiveness of anti-vibration gloves according to the JIS T 8144 standard

#### Measured Anti-Vibration Gloves

The vibration reduction effectiveness of Anti-vibration gloves as shown in Figure 7 was measured by using the equipment as shown Figure 6. The vibration reduction effectiveness of these gloves is almost same values.



**Figure 7** Used Anti-vibration gloves in this experiment

#### Temporary threshold shifts of vibrotactile perception thresholds

The threshold of 125 Hz vibrotactile perception thresholds was measured at the fingertip of the index finger of the right hand. Vibrotactile perception thresholds were determined with vibration sensation meter (RION type AU-02A). Vibrotactile perception thresholds were determined by the method of adjustment. In this method, the measurement was performed three times. Thresholds were calculated from the mean values of three measurements obtained within a period less than one minute after the end of vibration exposure. The TTS was defined as the difference (in decibels) of the vibrotactile perception thresholds before and after vibration exposure. Consecutive sessions were separated by at least 6 hours. The noise level during the vibration exposure was 55dB(A). During the measurement of the vibrotactile perception thresholds before and after the vibration exposure, the noise level was 35 dB (A). The vibration exposure time was 5 minutes and the frequency-weighted r.m.s. acceleration was 10 m/s<sup>2</sup>.

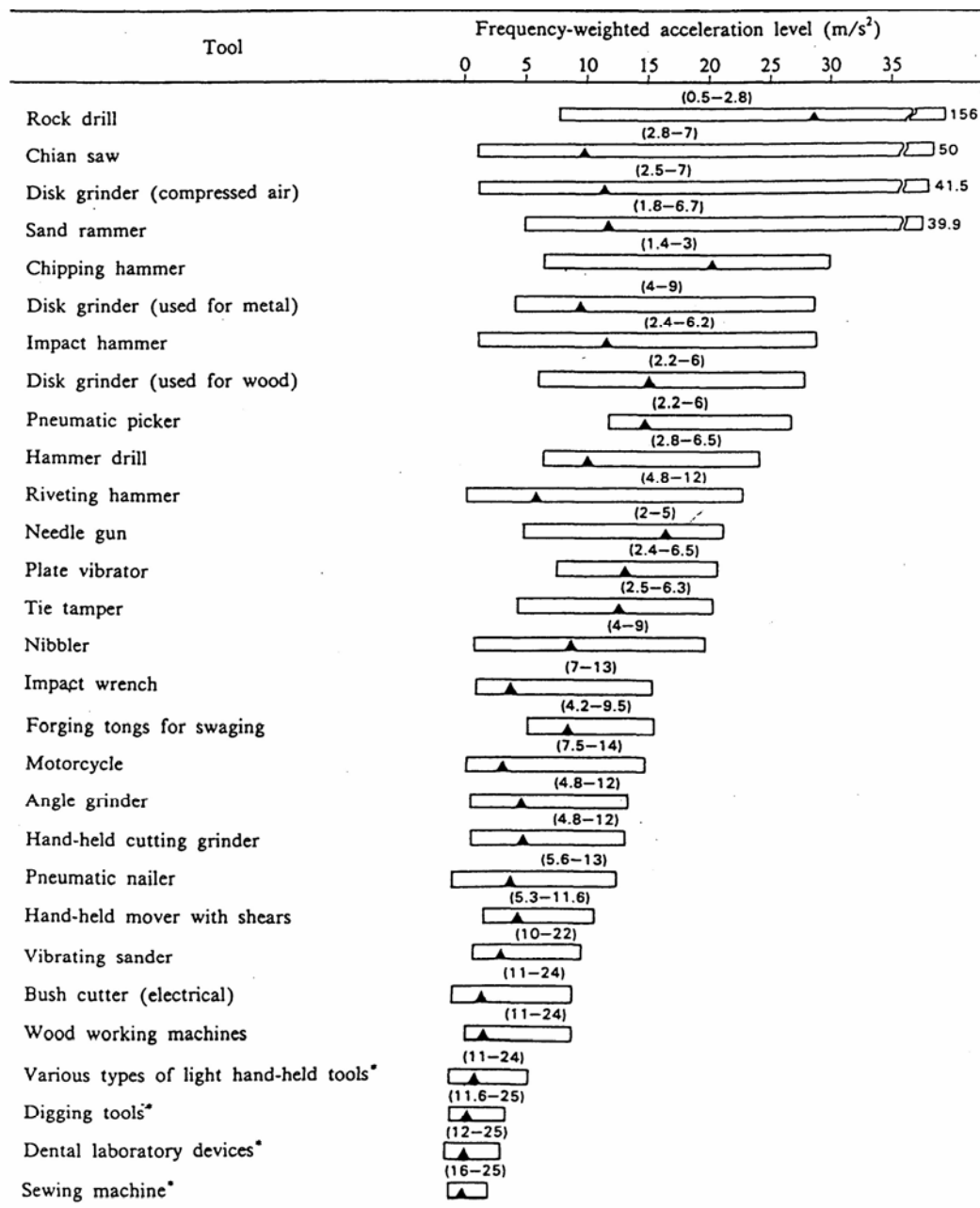
**Table 1** Results of TTS measurement of Anti-vibration Gloves and Bare hand

	Bare hand	Japanese AVG	US AVG (Air type)
TTS (dB)	19.0	15.2	10.2

## Results

The TTS value of the bare hand was greater than Anti-vibration gloves (Table 1). The difference of TTS values is depending on the materials of the fingertip areas. Although the US Anti-Vibration Gloves' material is the same one of the palm area ones, the Japanese Anti-Vibration Gloves' material is different with the palm area ones. In the JIS T 8114 standard, although the evaluation of the effectiveness of vibration reduction of anti-vibration gloves is only the palm area materials, in the future, the evaluation of the fingertip area materials is needed.

There are many tools with different vibration spectrum and with lower and higher vibration levels (Miwa et al, 1974; Maeda et al, 1981; Mirbod et al, 1992) as shown in Figure 8.



(\*) shows that the results of present study were included.

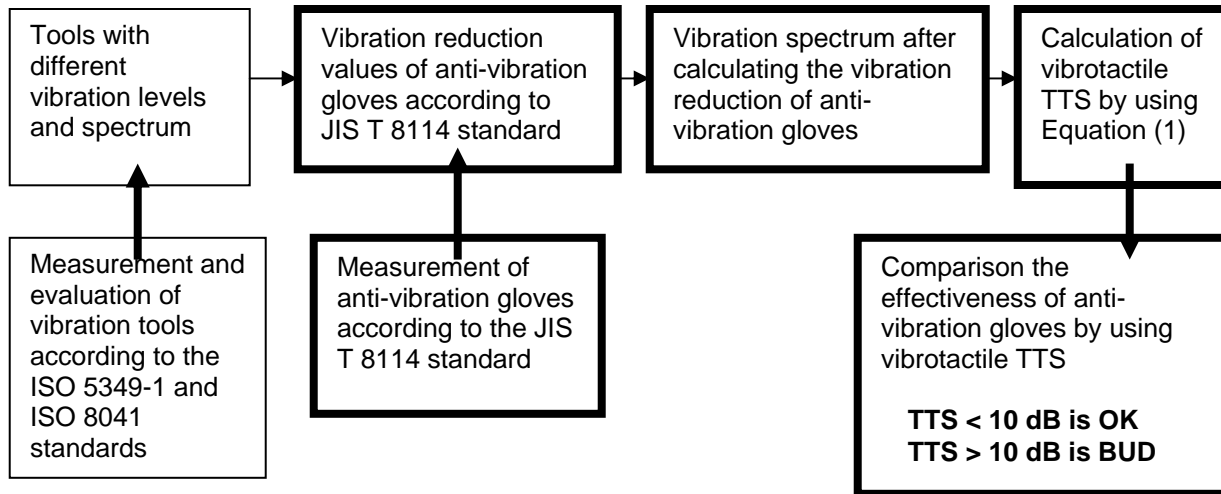
**Figure 8** Example of different frequency-weighted r.m.s. acceleration of different tools.

Although the anti-vibration effectiveness can be got by these standards, the physiological effectiveness of the anti-vibration gloves can't obtain or describe from the criteria before and after using the anti-vibration gloves. Because, the

users must be get the small vibrotactile TTS by using the anti-vibration gloves than by un-using ones. The vibrotactile TTS is a beneficial indicator to evaluate the vibration effect on human hand (Maeda et al, 1989). Also, they showed the following calculation equation for predicting the vibrotactile TTS from the usage of the vibration tools with different spectrum.

$$TTS = -11.76 - 8.59 \log_{10} T + 0.16S + 0.20S \log_{10} T \quad (1)$$

where T is the exposure time (minutes), S is the spectrum levels of the octave band levels of the 125 Hz centre frequency (dB). In the future, as shown in Figure 9, the new evaluation idea should be shown to us to select the ant-vibration gloves before buy.



**Figure 9** A new consideration of the evaluation of the effectiveness of the anti-vibration gloves to the vibration tools with different levels and different vibration spectrum

The effectiveness of the anti-vibration gloves are depending on the vibration tools with different levels and spectrum. It would be helpful to know the effectiveness of the anti-vibration gloves as shown in Figure 7.

### Conclusions

Although the measured vibration reduction values according to the JIS T 8114 standard were the almost same, the TTS results were different. Further investigation of vibration reduction effectiveness is required on the relation the anti-vibration reduction values and the physiological values for prevention of HAVS.

### References

- Japan Industrial Standard, 1987. Vibration Isolation Gloves. JIS T 8114.
- Maeda S, Iwata A, 1981. The fundamental study on the effects of noise and vibration upon human body and working efficiency – The vibration frequency patterns of air tools. Research Report of Environmental Institute of Kinki University, 9, 123-156. (in Japanese).
- Maeda S, Kume Y, 1989. Temporary threshold shift of finger-tip vibratory sensation induced by exposure to spectrum vibration. Journal of the Japanese Industrial Manufacturing Association, 40, 336-342. (In Japanese).
- Mirbod SM, Inaba R, and Iwata H, 1992. A study on the vibration-dose limit for Japanese workers exposed to hand-arm vibration. Industrial Health, 30, 1-22.

Miwa T, 1964a. Studies on hand protectors for portable vibrating tools: I. Measurements of the attenuation effect of porous elastic materials. *Industrial Health*, 2, 95-105.

Miwa T, 1964b. Studies on hand protectors for portable vibrating tools: II. Simulations of porous elastic materials and their applications to hand protectors. *Industrial Health*, 2, 106-123.

Miwa T, Yonekawa Y, 1974. Measurement of vibrations generated from portable vibrating tools. *Industrial Health*, 12, 1-21.

# ISSUES TO BE CONSIDERED WITH THE REVISION OF ISO 10819

E. Wolf and D.D. Reynolds

Center for Mechanical & Environmental Systems Technology (CMEST), University of Nevada, Las Vegas  
4505 Maryland Parkway, Box 454027, Las Vegas, Nevada 89154, USA

## Abstract

Effects of altering the palm adapter geometry on the results of ISO 10819 antivibration glove tests have been investigated at the University of Nevada, Las Vegas, Center for Mechanical and Environmental System Technology laboratory (CMEST). 30 rigid acrylic adapters were designed, fabricated, and evaluated. For an adapter to be acceptable for ISO 10819 glove vibration transmissibility tests, the adaptor linear vibration transmissibility in each 1/3 octave frequency band from 16-1,600 Hz, averaged over all test subjects, had to be between 0.95 and 1.05.

The palm adapters that met the acceptability criteria had similar adaptor vibration transmissibility results. The length of the adapters covered 70-80% of the width of the palm. The upper curvature of the adaptors was greater than or equal to the radius specified in ISO 10819:1996. Adaptors with a flat-topped profile also met the acceptability criteria.

Six adaptors were selected to conduct glove vibration transmissibility tests on three commercially available antivibration gloves according to the procedures outlined in ISO 10819:1996. Four adaptors met the adaptor acceptability criteria. Two adaptors did not meet the criteria. Glove vibration transmissibility tests were also conducted using a constant velocity vibration input that had a value of 0.01 m/s in each 1/3-octave frequency band from 16-1,600 Hz. This spectrum was referred to as the F spectrum.

Glove vibration transmissibility results obtained using the M (16-400 Hz) and H (100-1,600 Hz) spectra specified in ISO 10819:1996 were compared to similar results using the constant velocity F spectrum. The results obtained from the F spectrum when divided into the M and H frequency ranges were nearly the same as those obtained from the ISO 10819 M and H spectra.

Test subject training was required to ensure reliable glove vibration transmissibility results. The measured transmissibility values obtained with the M, H, and F spectra were all higher at the beginning of the test program. The transmissibility values decreased and approached lower limiting values as the test subjects became more experienced.

## Introduction

ISO 10819 is in the process of being revised through the efforts of a joint ISO/CEN working group. Several issues are being addressed in this revision process. They include the adaptor design, the input vibration signal used to obtain the glove vibration transmissibility, the method in which the glove vibration transmissibility is obtained, and the effects of tests subjects on the measured glove vibration transmissibility. These issues were investigated and are reported in this paper.

Alternative palm adapter geometries, compared to the one defined in ISO 10819:1996, were investigated with the goal of addressing proper adapter alignment and fit in the palm of the hand during an ISO 10819 test. The initial design concept was that a smaller, better fitting palm adapter would alleviate discomfort, facilitate proper gripping, be somewhat self-aligning in the palm, and would not affect the proper fit of the glove over the hand. Several different geometries were designed using Solid Works and produced using a Haas CNC milling machine at the University of Nevada, Las Vegas, Center for Mechanical and Environmental Technology. Adaptors were designed with regards to critical dimensions and overall fit in the hand and then evaluated during glove vibration transmissibility tests.

A proposed change to the input vibration spectra in the forthcoming revision of ISO 10819 was investigated. The current version of ISO 10819 uses two different spectra, named medium (M) and high (H) for their frequency content, as input signals. The proposed new method will be to use a constant 1/3 octave band velocity input of 0.01 m/s over the 1/3 octave band frequency range of 16-1,600 Hz. The use of a single input spectrum, rather than two separate spectra, will significantly reduce the testing and analysis time necessary to evaluate the vibration transmissibility of antivibration gloves. The proper use of a single constant-velocity input spectrum hopefully will eliminate some of the disagreements that currently exist with the use of the M and H spectra specified in ISO 10819.

The final part of this paper presents a finding that became apparent as testing progressed. The effect of the subject familiarizing himself with proper testing technique is quantified and an explanation for this effect along with supporting data is reported.

## Test Setup

Figure 1 shows the test equipment setup. The electro-dynamic shaker is a Tira Model TV 5550 LS. Vibration control was achieved with a Vibration View vibration controller. Monitoring, recording, and measuring the acceleration signals were performed with a Bruel and Kjaer Portable Pulse System and PCB 352C22 tear drop accelerometers. The grip force was monitored using handle-mounted strain gauge grip bar. The push force was monitored with a floor plate riding on bearings that was connected to a strain gauge proving-ring.



**Figure 1** CMEST Test Setup

## Test Procedures

Three different test procedures were used in this project. The first was developed to quantify the performance of different adapter geometries with regards to linear transmissibility between the handle and palm adapter accelerometers. These tests were performed with the subject's bare hand applied to adapter/handle.

The second test procedure used was the ISO 10819 test protocol. Selected adapters were tested to determine differences in measurement of the mean transmissibility values of antivibration gloves.

The last test procedure was used to investigate a proposed change to the input vibration spectra of ISO 10819. The protocol is nearly identical to that of the standard, with the exception of a modified input spectrum and corresponding calculations.

### *ISO 10819 Test Procedures*

ISO 10819 defines the test procedures for measuring the effectiveness of antivibration gloves. The requirements specify proper test subject posture and preparation, the levels of push and grip force, the palm adapter geometry, minimum instrumentation requirements, and the methods for numerical analysis.

ISO 10819 requires the use of three test subjects. They must be standing upright, dominant hand on the shaker handle with the palm adapter in between the handle and hand or inside the glove when one is tested. The angle of the elbow must be  $90 \pm 10$  degrees. The wrist angle should be between 0-40 degrees. Proper test posture is illustrated in Figure 2.

During the 30 second test duration, the test subject is required to maintain  $50 \pm 8$  N of feed force on the handle and  $30 \pm 5$  N of grip force. Between each test, the subjects must break their grip on the handle.

The input acceleration spectra used for feedback control were the medium (M) and high (H) spectra specified in ISO 10819.

The calculations of mean corrected transmissibility values were obtained in the following manner. Two bare hand tests were conducted, and the results were linearly averaged for each adapter and spectra. The three test subjects then perform two tests each wearing an antivibration glove for each adapter and spectra. The r.m.s. acceleration values for handle and palm adaptor accelerometer were measured for each test. The ISO-weighted acceleration values,  $a_w$ , for the M (16-400 Hz) and H (100-1,600 Hz) spectra were obtained by:



**Figure 2** Proper Test Posture

$$a_w = \sqrt{\sum (a_i * w_i)^2} \quad (1)$$

$a_i$  are the third octave band acceleration levels ( $m/s^2$ ) and  $w_i$  are the ISO weighting values specified in ISO 5349. The ISO-weighted vibration transmissibility values for the bare hand tests ( $TR_{iso(b)}$ ) and glove tests ( $TR_{iso(g)}$ ) for each spectrum are:

$$TR_{iso(b)} = a_{w(b-adaptor)} / a_{w(b-handle)} \quad \text{and} \quad TR_{iso(g)} = a_{w(g-adaptor)} / a_{w(g-handle)} \quad (2)$$

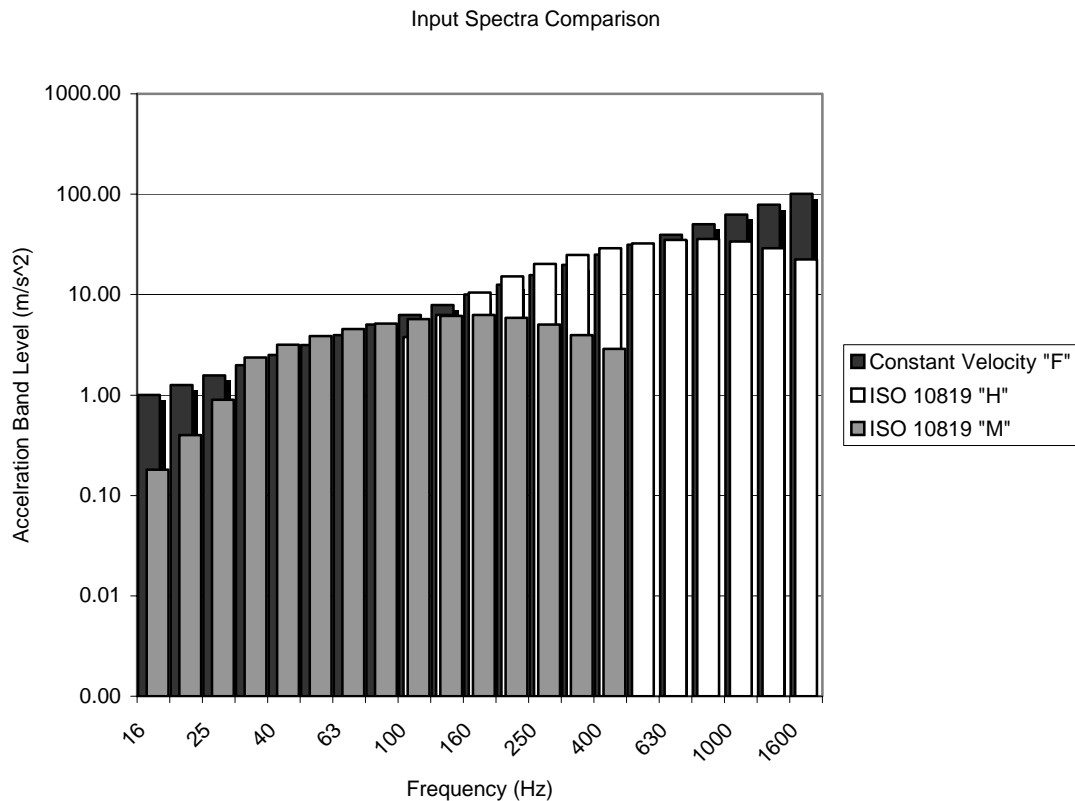
$a_{w(b-adaptor)}$  is the ISO-weighted bare-hand adaptor acceleration,  $a_{w(b-handle)}$  is the ISO-weighted bare hand handle acceleration,  $a_{w(g-adaptor)}$  is the ISO-weighted glove-hand adaptor acceleration,  $a_{w(g-handle)}$  is the ISO-weighted glove-hand handle acceleration. The ISO glove vibration transmissibility corrected for the bare hand vibration transmissibility is:

$$TR_{iso} = TR_{iso(g)} / TR_{iso(b)} \quad (3)$$

The average ISO-weighted vibration transmissibility is the linear average of the six individual (two tests for each of three subjects) ISO-weighted vibration transmissibility values. For a glove to be an antivibration glove, the ISO-weighted transmissibility must be less than 1.0 for the M spectrum and less than 0.6 for the H spectrum.

### Constant Velocity Spectrum Test Procedures

A constant velocity input spectrum for glove vibration transmissibility tests is being proposed for the revision of ISO 10819. The input spectrum that is being proposed is a constant velocity 1/3 octave band value of 0.01 m/s in the 16–1,600 Hz 1/3 octave frequency bands. This spectrum is referred to as spectrum F in this paper. Figure 3 graphs the F spectrum in relation to the ISO 10819 M and H spectra.



**Figure 3** F, H, and M Input Spectra

The calculation of the vibration transmissibility of an antivibration glove is as follows:

*Step 1:* Measure the handle and palm adaptor 1/3 octave band acceleration values for 12 tests: two bare hand and two gloved hand tests for each of three test subjects.

*Step 2:* Divide the data into two groups. One set contains the 1/3 octave band acceleration values from 16 – 400 Hz (FM spectrum) and the other contains the 1/3 octave acceleration values from 100 – 1600 Hz (FH spectrum). The following steps were repeated for the FM and FH spectra separately.

*Step 3:* Calculate the ISO weighted glove vibration transmissibility values as described for equations (1) through (3).

#### *Adapter Evaluation Procedure*

Thirty different palm adapters were constructed and tested to explore the effects of adapter geometry on bare hand linear vibration transmissibility between the adaptor and the vibrating handle used for ISO 10819 tests. The input spectrum used for these tests was the F spectrum. Four test subjects performed two tests each. All other requirements and methods for performing the tests were the same as for performing the ISO 10819 bare hand tests. The criterion for adapter acceptability was for the linear transmissibility between the handle and adaptor acceleration signals in each third octave frequency band between 16-1,600 Hz, averaged over the 8 tests (4 subjects, tests each), to be between 0.95 and 1.05.

#### *Linear Vibration Transmissibility Tests*

The 0.01 m/s constant velocity F spectrum input was used to measure the 1/3 octave frequency band glove vibration transmissibility in the 1/3 octave band frequency range of 16-1,600 Hz. The bare hand palm adaptor vibration transmissibility was measured. The gloved-hand vibration transmissibility was then measured. The measured glove vibration transmissibility was corrected for the bare hand adaptor vibration transmissibility as specified in ISO 10819. Two bare hand adaptor transmissibility tests were conducted for each of three test subjects. Two gloved hand vibration transmissibility tests were conducted for each of three test subject.

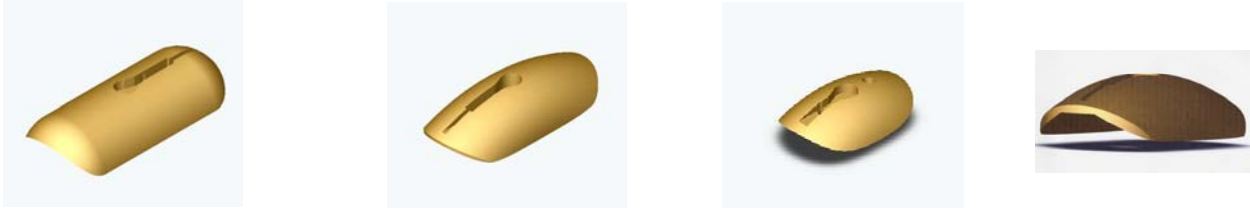
### **Palm Adapter design**

Palm adapters were designed to increase test subject hand comfort when using the adapter for an ISO 10819 test. To accomplish this, palm adaptors were designed to more closely fit the contour of the test subject hand. Several combinations of dimensions were tried, including those that met the ISO 10819:1996 requirements. The critical dimensions that were adjusted to produce the different adapters were the overall adaptor length, the radius along the length of the upper adaptor profile, the bottom adaptor cross-sectional radius, and the adaptor thickness measured at the centerline of the adapter. The ranges of the dimensions that were investigated are given in Table 1. The special cases listed in Table 1 were also tried. These cases included completely flat upper profiles and flat bottom sections designed to maintain 2 lines of contact while keeping the accelerometer a short distance above the handle surface in combination with other standard dimensions. A few typical adapters that were made are shown in Figure 4.

**Table 1** Palm Adaptor Design Dimensions

<b>Adapter dimensions (mm)</b>			
	<b>Min</b>	<b>Max</b>	<b>Special</b>
<b>Length</b>	28	72	
<b>Bottom radius</b>	19	22	3-flats
<b>Upper radius</b>	50	93	flat
<b>Thickness</b>	4.8	9.5	





**Figure 4** Palm Adaptor Shapes

### Discussion of Results

The adaptors were evaluated in two phases. Phase 1 determined whether or not the palm adaptors met the acceptability criterion. Phase 2 investigated the effect of the adaptor shape on the glove vibration transmissibility values, calculated for the ISO 10819 M and H spectra

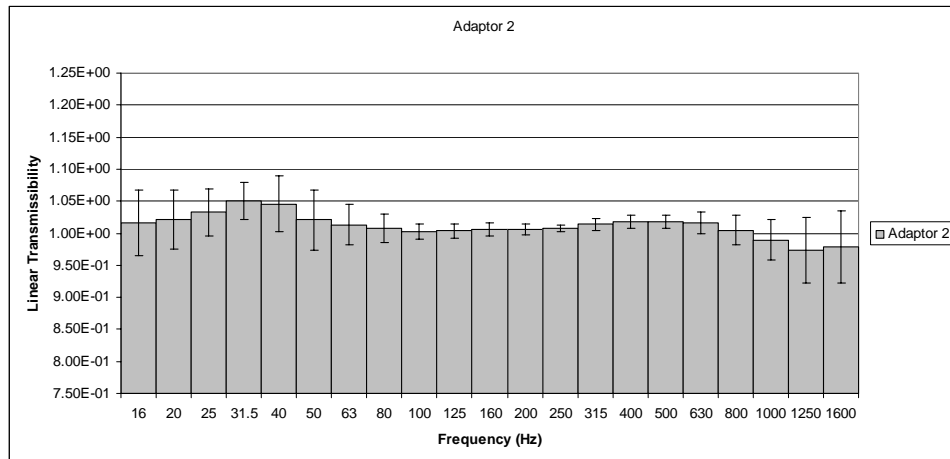
#### *Bare Hand Palm Adaptor Vibration Transmissibility*

The results of the bare hand linear vibration transmissibility tests were categorized into two groups. The graphs depict the 1/3 octave band linear transmissibility values averaged over 8 tests (4 subjects, 2 tests each). The error bars are  $\pm$  one standard deviation.

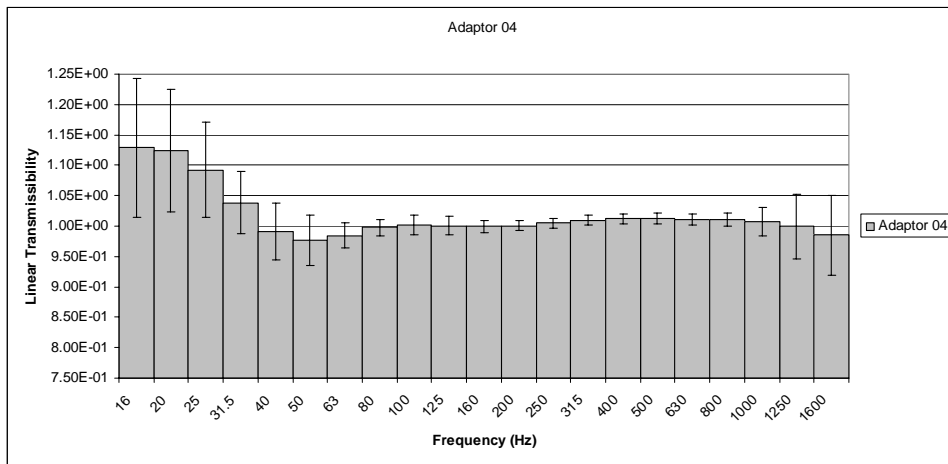
The first group of adaptors met the acceptability criteria, which were linear vibration transmissibility values between the adaptor and handle in each 1/3 octave band (averaged over 4 test subjects) of between 0.95 and 1.05. Seven of the thirty adaptors that were examined met the acceptability criteria. Figure 5 shows a representative vibration transmissibility plot of these adaptors.

Palm adaptors that met the acceptability criteria had some common characteristics. Their overall length covered 70-80% of the width of the palm. The radius of the upper adaptor curvature was greater than or equal to the upper adaptor curvature radius specified in ISO 10819:1996. The radius of curvature of the bottom side of the adaptor ranged from 19-22 mm.

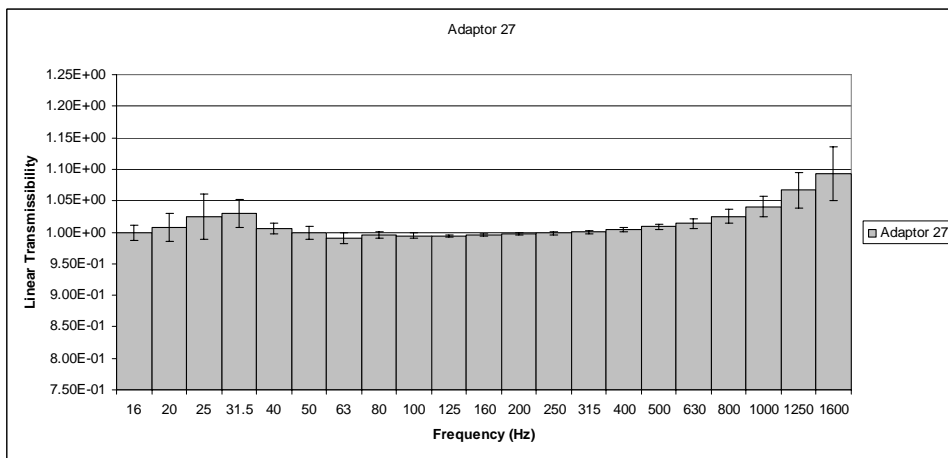
Figures 6 through 8 show typical vibration transmissibility plots of palm adaptors that did not meet the acceptability criteria.



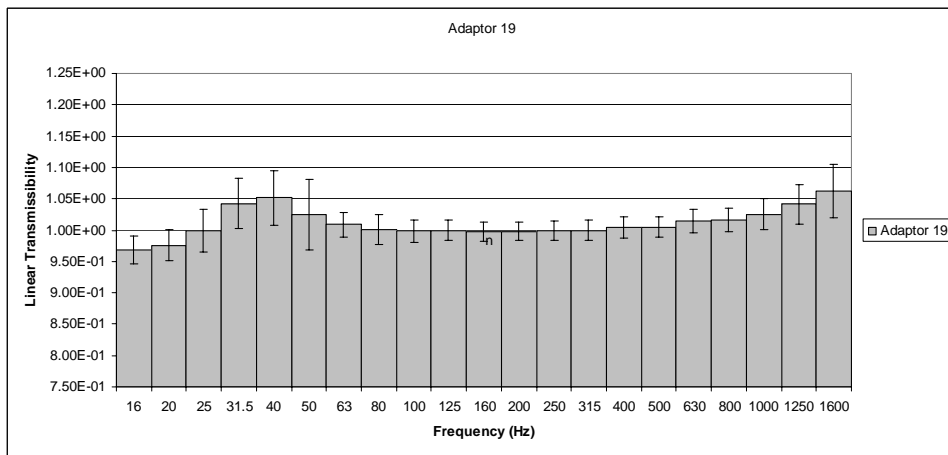
**Figure 5** Adaptors that Met Acceptability Criteria



**Figure 6** Adaptors with Low Frequency Deficiencies



**Figure 7** Adaptors with High Frequency Deficiencies



**Figure 8** Adaptors with Mid and High Frequency Deficiencies

*ISO 10819 Glove Vibration Transmissibility Tests*

The second series of tests were glove vibration transmissibility tests. Tests were conducted per the procedures specified in ISO 10819. Tests were then conducted using a 0.01 m/s constant velocity vibration input. Appropriate ISO 10819 test procedures were used with the constant velocity vibration input. Three commercially available antivibration gloves were

used in this project. Glove 1 used a gel foam elastomeric element, glove 2 used a Nu<sub>2</sub>O<sub>2</sub> polymer elastomeric element, and glove 3 used an air-bladder elastomeric element. Four palm adaptors that met the acceptability criteria were used for these tests. They were designated adaptors A02, A03, A29, and A30.

Table 2 shows a comparison of the glove vibration transmissibility values calculated for each adapter/glove combination. The M and H spectra results were obtained using the test procedures specified in ISO 10819. The FM and FH spectra results were obtained using the 0.01 m/s constant velocity input and appropriate ISO 10819 test procedures. The results show that for all gloves and input spectra, the related greatly between glove vibration transmissibility values do not significantly vary among the adaptors that were tested. The largest variation is found in the H spectra for glove 3, which ranges from 0.59 to 0.51. A range of 0.08 in this type of measurement is somewhat significant, but it is isolated to one adapter in one particular spectrum.

**Table 2** Glove Vibration Transmissibility (Adaptors Met Acceptability Criterion)

<b>H spectrum</b>				<b>FH spectrum</b>			
	Glove 1	Glove 2	Glove 3		Glove 1	Glove 2	Glove 3
<b>A02</b>	0.80	0.73	0.59	<b>A02</b>	0.75	0.64	0.53
<b>A03</b>	0.81	0.67	0.51	<b>A03</b>	0.72	0.63	0.49
<b>A29</b>	0.83	0.67	0.51	<b>A29</b>	0.73	0.60	0.49
<b>A30</b>	0.80	0.70	0.53	<b>A30</b>	0.75	0.64	0.50
<b>M spectrum</b>				<b>FM spectrum</b>			
	Glove 1	Glove 2	Glove 3		Glove 1	Glove 2	Glove 3
<b>A02</b>	0.86	0.80	0.64	<b>A02</b>	0.87	0.82	0.73
<b>A03</b>	0.87	0.79	0.63	<b>A03</b>	0.85	0.80	0.70
<b>A29</b>	0.86	0.80	0.66	<b>A29</b>	0.87	0.79	0.71
<b>A30</b>	0.87	0.79	0.64	<b>A30</b>	0.88	0.81	0.71

No single adapter consistently yielded the highest or lowest glove vibration transmissibility values for all spectra. The small variations of the glove vibration transmissibility values were well distributed among the adapters. The data suggest that, for adaptors that meet the adaptor acceptability criterion, there will be very small variations in the glove vibration transmissibility values obtained with different adaptors.

Two adapters that did not meet the acceptability criterion were also tested. They are designated adaptors A19 and A20. Adapter 19 failed in the 40 Hz 1/3 octave frequency band and in the 1600 Hz third octave band. Adapter 20 failed in the 1,250 and 1600 Hz 1/3 octave frequency bands. The glove vibration transmissibility values are reported in Table 3.

The calculated glove vibration transmissibility values for adaptors A19 and A20 lie within the respective ranges of the other four adaptors for all input spectra. The data confirm that even though an adaptor may slightly amplify the bare hand acceleration signal, the effect is negligible when the glove transmissibility values are properly corrected for the bare hand adaptor vibration transmissibility. The higher frequency 1/3 octave frequency band transmissibility values are increasingly weighted out by the ISO 5349 weighting values. thus their effect is greatly diminished. More testing is required to fully define the limit of bare hand adaptor transmissibility amplification that will not significantly affect glove vibration transmissibility values.

A comparison can be made between the H and FH spectra data and the M and FM spectra data. Table 4 shows this comparison. When comparing the H and FH data, the glove vibration transmissibility values obtained using the FH input spectra tend to yield slightly lower glove vibration transmissibility values. The range of these differences varies between the gloves that were tested. When comparing the FM and M spectra, the ranges of values between the two spectra are

much smaller on average than was the case with FH and H spectra. Given the expected variability between glove vibration transmissibility tests, the results are essentially the same for the FM and M spectra.

**Table 3** Glove Vibration Transmissibility (Adaptors Failed Acceptability Criterion)

<b>H spectra</b>				<b>FH spectra</b>			
	Glove 1	Glove 2	Glove 3		Glove 1	Glove 2	Glove 3
<b>A19</b>	0.83	0.70	0.55	<b>A19</b>	0.75	0.66	0.51
<b>A20</b>	0.81	0.67	0.54	<b>A20</b>	0.75	0.61	0.52
<b>M spectra</b>				<b>FM spectra</b>			
	Glove 1	Glove 2	Glove 3		Glove 1	Glove 2	Glove 3
<b>A19</b>	0.86	0.79	0.62	<b>A19</b>	0.88	0.83	0.71
<b>A20</b>	0.84	0.76	0.66	<b>A20</b>	0.86	0.78	0.72

**Table 4** Glove Vibration Transmissibility Values (Six-Adapter Average)

<b>H spectra</b>				<b>FH spectra</b>			
	Glove 1	Glove 2	Glove 3		Glove 1	Glove 2	Glove 3
<b>AVG</b>	0.81	0.69	0.54	<b>AVG</b>	0.74	0.63	0.51
<b>M spectra</b>				<b>FM spectra</b>			
	Glove 1	Glove 2	Glove 3		Glove 1	Glove 2	Glove 3
<b>AVG</b>	0.86	0.79	0.64	<b>AVG</b>	0.87	0.80	0.71

*Linear Glove Vibration Transmissibility Tests*

Figures 9 through 11 show the linear glove vibration transmissibility results for gloves 1 through 3, respectively. The figures show the results that were obtained for the six palm adaptors that were examined. Four of the adaptors met the adaptor acceptability criterion. Two failed the criterion. The transmissibility values for each adaptor are the averages of six individual tests (two tests from each of three test subjects). The average values of linear vibration transmissibility in the low frequency 1/3 octave frequency bands (16-40 Hz) showed a slight amplification for some gloves/adaptor combination.

"F" spectra glove test - Glove 1

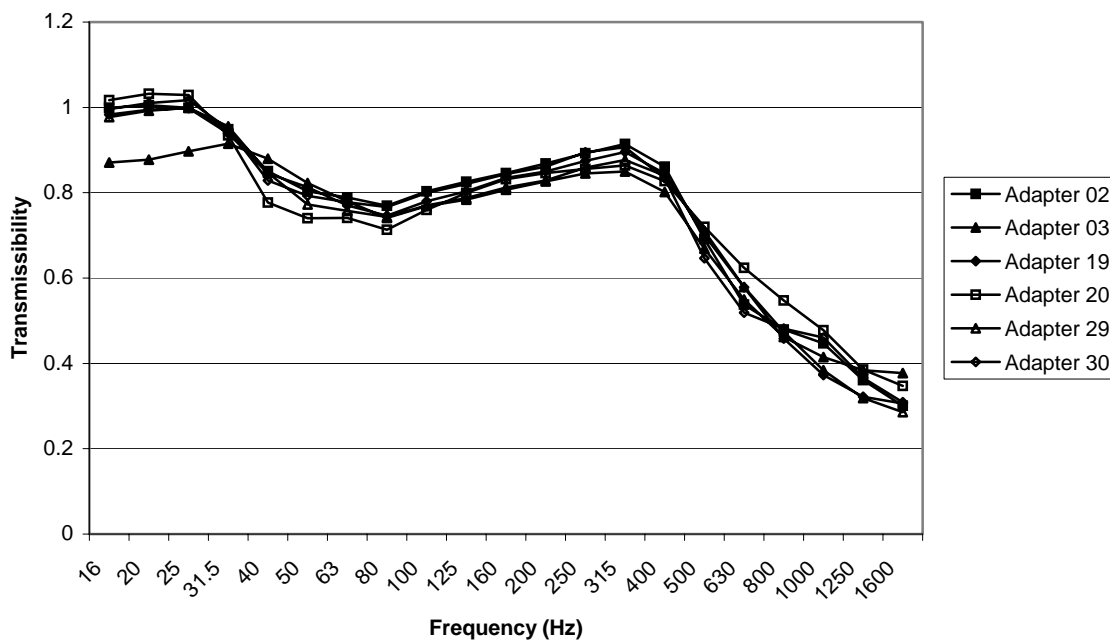


Figure 9 Linear Vibration Transmissibility, Glove 1

"F" spectra glove test - Glove 2

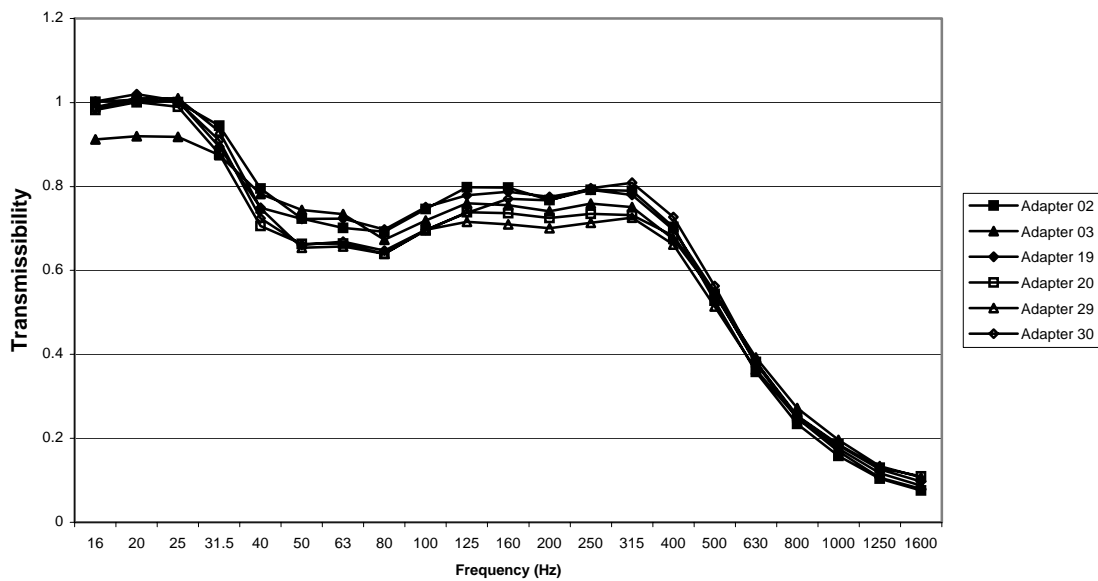


Figure 10 Linear Vibration Transmissibility, Glove 2

### "F" spectra glove test - Glove 3

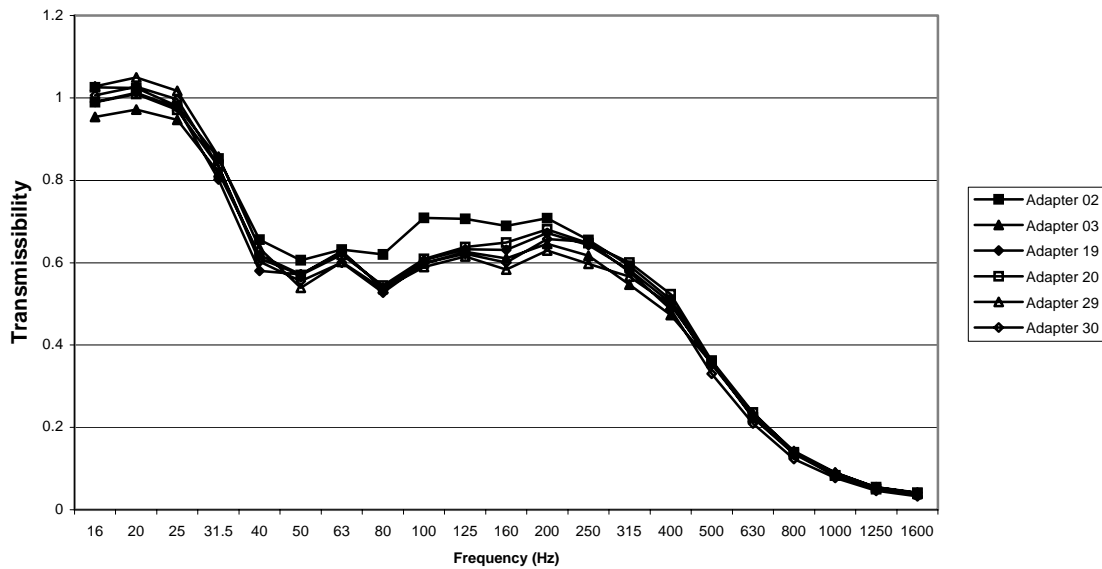


Figure 11 Linear Vibration Transmissibility, Glove 3

#### Test subject training

In the course of performing the vibration transmissibility tests reported in this paper, a general numerical trend was found to exist for each subject from test to test. All measurement equipment, calibrations, adapters, and gloves were the same for each series of tests. To ensure measurement consistency in the vibration transmissibility tests, all tests were repeated several times over a period of days and weeks. With each round of repetitions, the glove vibration transmissibility values for all individual test subjects continually decreased until limiting values were approached. These limiting values were close to corresponding values that were measured for each glove by other laboratories. This effect was not immediately present, but appeared when test data from previous days were compared to newer test data. Regardless of how many times a test was repeated over the course of a single day, the test values did not show appreciable variation. However, differences appeared on a day-to-day or week-to-week basis. This is attributed to a process of “familiarization” of the test subjects to the correct feel of the adapter inside the glove. There was little variation in the bare hand tests, because it is easier to align the adapter the same way every time when it can be seen. Table 5 is a compilation of glove vibration transmissibility values for each glove and spectra over two test runs. The effect is less pronounced in the H spectra data because those tests were run at the end of round 1. Only adapters 02 and 29 are presented.

By examining these results, it becomes clear that each subject became more experienced in proper glove testing methods as testing progressed or a period of several weeks. As a consequence, their ability to correctly perform the tests increased. This effect was present for all test subjects. These results suggest that it would be improper to use a test subject for antivibration glove testing without proper training and exposure to the appropriate test procedures.

It is necessary to “calibrate” the test subjects to obtain correct glove vibration transmissibility results. The easiest method to gauge proper subject performance is to test a glove with reasonably well-known glove vibration transmissibility values. Considering the high degree of variability introduced by the test subject’s physical nature, obtaining a clear picture of a correct vibration transmissibility value for a specific test subject and glove may not be easy. It is necessary to look at average values, and then determine a proper confidence interval. Further study on this matter is needed to define a complete procedure for properly training a test subject.

**Table 5** Test Subject Training Comparison

Round 1				Round 2			
<b>F Spectra</b>				<b>F Spectra</b>			
	<b>glove 1</b>	<b>glove2</b>	<b>glove3</b>		<b>glove 1</b>	<b>glove2</b>	<b>glove3</b>
<b>A02</b>	0.77	0.73	0.72	<b>A02</b>	0.81	0.74	0.65
<b>A29</b>	0.77	0.70	0.71	<b>A29</b>	0.80	0.71	0.64
<b>FM Spectra</b>				<b>FM Spectra</b>			
	<b>glove 1</b>	<b>glove2</b>	<b>glove3</b>		<b>glove 1</b>	<b>glove2</b>	<b>glove3</b>
<b>A02</b>	0.85	0.83	0.81	<b>A02</b>	0.87	0.82	0.73
<b>A29</b>	0.87	0.81	0.81	<b>A29</b>	0.87	0.79	0.71
<b>FH Spectra</b>				<b>FH Spectra</b>			
	<b>glove 1</b>	<b>glove2</b>	<b>glove3</b>		<b>glove 1</b>	<b>glove2</b>	<b>glove3</b>
<b>A02</b>	0.70	0.65	0.64	<b>A02</b>	0.75	0.64	0.53
<b>A29</b>	0.69	0.60	0.61	<b>A29</b>	0.73	0.60	0.49
<b>H Spectra</b>				<b>H Spectra</b>			
	<b>glove 1</b>	<b>glove2</b>	<b>glove3</b>		<b>glove 1</b>	<b>glove2</b>	<b>glove3</b>
<b>A02</b>	0.88	0.80	0.72	<b>A02</b>	0.80	0.73	0.59
<b>A29</b>	0.84	0.77	0.71	<b>A29</b>	0.83	0.67	0.51
<b>M Spectra</b>				<b>M Spectra</b>			
	<b>glove 1</b>	<b>glove2</b>	<b>glove3</b>		<b>glove 1</b>	<b>glove2</b>	<b>glove3</b>
<b>A02</b>	0.83	0.71	0.65	<b>A02</b>	0.86	0.80	0.64
<b>A29</b>	0.79	0.68	0.63	<b>A29</b>	0.86	0.80	0.66

**Conclusions**

1. Adapter geometry can significantly affect the outcomes of bare hand palm adaptor linear vibration transmissibility. The performance of an adapter is heavily influenced by the curvature of the upper profile and the fit of the adapter to the handle. A curved bottom surface that matches the diameter of the handle is recommended. An adapter's length must span at least 70-80% of the width of the palm.
2. The geometry of the palm adapter does not affect the glove vibration transmissibility value for an antivibration glove if the average linear transmissibility value for the adaptor falls within the range of 0.95 to 1.05 in each 1/3 octave frequency band from 16-1,600 Hz. Several adapter geometries that were tested met this requirement, including the ISO 10819 defined adapter.

3. Some adaptors that do not meet the linear vibration transmissibility criterion will give accurate glove vibration transmissibility values when the glove vibration transmissibility test results are adjusted for the adaptor vibration transmissibility.
4. It is possible to replace the M and H spectra currently defined as inputs in ISO 10819 with a single F spectra that consists of a 0.01 m/s constant velocity 1/3 octave frequency band value from 16-1600 Hz. The glove vibration transmissibility values obtained using the F spectra were nearly identical to the those obtained using the ISO 10819 M and H spectra when the F spectra was mathematically divided into the M and H spectra frequency ranges.
5. Test subjects must be trained in order to achieve acceptable repeatable glove vibration transmissibility test results. It is important for the test subject to perform many tests to become accustomed to the feel of the palm adapter in a glove.